



# LUND UNIVERSITY

## Measurements of knee rotation in vivo - Development and evaluation of an external device

Almquist, Per Otto

2012

[Link to publication](#)

### *Citation for published version (APA):*

Almquist, P. O. (2012). *Measurements of knee rotation in vivo - Development and evaluation of an external device*. [Doctoral Thesis (compilation), Human Movement: health and rehabilitation]. Department of Health Sciences, Lund University.

### *Total number of authors:*

1

### **General rights**

Unless other specific re-use rights are stated the following general rights apply:

Copyright and moral rights for the publications made accessible in the public portal are retained by the authors and/or other copyright owners and it is a condition of accessing publications that users recognise and abide by the legal requirements associated with these rights.

- Users may download and print one copy of any publication from the public portal for the purpose of private study or research.
- You may not further distribute the material or use it for any profit-making activity or commercial gain
- You may freely distribute the URL identifying the publication in the public portal

Read more about Creative commons licenses: <https://creativecommons.org/licenses/>

### **Take down policy**

If you believe that this document breaches copyright please contact us providing details, and we will remove access to the work immediately and investigate your claim.

LUND UNIVERSITY

PO Box 117  
221 00 Lund  
+46 46-222 00 00

From the Department of Health Sciences, Division of Physiotherapy, Faculty  
of Medicine, Lund University, Lund, Sweden

# Measurements of knee rotation in vivo – Development and evaluation of an external device

Per Otto Almquist



LUND UNIVERSITY  
Faculty of Medicine

Akademisk avhandling som med vederbörligt tillstånd av Medicinska fakulteten vid  
Lunds universitet, för avläggande av doktorexamen i medicinsk vetenskap, kom-  
mer att offentligen försvaras i Hörsal 01, Health Sciences Centre, Baravägen 3, Lund  
fredagen 26 oktober 2012 klockan 09.00

**Fakultetsopponent**

Docent Joanna Kvist  
Inst för medicin och hälsa  
Avd för sjukgymnastik  
Linköpings Universitet  
581 83 Linköping

**Handledare**

Professor Charlotte Ekdahl  
Inst för hälsa, vård och samhälle  
Avd för sjukgymnastik  
Lunds Universitet  
  
Docent Thomas Fridén  
Medicinska fakulteten  
Lunds Universitet

Organization LUND UNIVERSITY The Department of Health Sciences	Document name DOCTORAL DISSERTATION	
	Date of issue 2012-10-26	
Divison of Physiotherapy		
Author(s) Per Otto Almquist	Sponsoring organization	
Title and subtitle Measurements of knee rotation in vivo – Development and evaluation of an external device		
Abstract <p>The overall aim of this work was to evaluate a newly developed measurement device, the Rottometer, for measuring knee rotation in different flexion angles with different applied torques, in order to establish the normal range of healthy knee rotation reference values and to study possible differences due to age and gender, as well as possible differences between patients with habitual dislocating patella (HDP) and healthy controls. The validity of the Rottometer was evaluated by simultaneous registrations with roentgen stereometric analysis (paper I). The two methods showed high correlations concerning the total knee rotation at 90° and 60° of knee flexion angles with 3, 6 and 9 Nm applied torques. The Rottometer was also concluded to be a reliable measurement device concerning the one-week-apart and within day intra-tester as well as the inter-tester reliability at 90°, 60° and 30° with 6 and 9 Nm as well as the examiners apprehension of end-feel (paper II). In total, 120 knee healthy subjects (60 females and 60 males) equally distributed in four different age groups (15-30, 31-45, 46-60 and ≥ 61 years) were examined at 90°, 60° and 30° of knee flexion angles with 6 and 9 Nm applied torques as well as the examiner's apprehension of end-feel (paper III). No differences were found concerning the different flexion angles, between the left and right knee or between the different age groups within the genders. However, the females showed a 10-20 % larger range of knee rotation than the males at all different flexion angles and applied torques. The knee rotation was also examined in 20 patients (15 females and 5 males) with HDP (paper IV). No differences were found between the affected and unaffected knees within the subjects. In accordance with the healthy reference population, the females showed a 10 - 20 % significantly larger range of rotation than the male subjects in the HDP group, and no differences were found between the patients affected with HDP and age matched healthy controls.</p>		
Key words Knee, rotation, measurement, evaluation, gender, age, dislocating patella		
Classification system and/or index terms (if any)		
Supplementary bibliographical information	Language English	
ISSN and key title 1652-8229	ISBN 976-91-87189-17-3	
Recipient's notes	Number of pages 90	Price
	Security classification	

Distribution by (name and address)

I, the undersigned, being the copyright owner of the abstract of the above-mentioned dissertation, hereby grant to all reference sources permission to publish and disseminate the abstract of the above-mentioned dissertation.

Signature 

Date 2012-09-20

# Measurements of knee rotation in vivo

## Development and evaluation of an external device



**LUND UNIVERSITY**  
Faculty of Medicine

**Per Otto Almquist**

Department of Health Sciences  
Division of Physiotherapy  
Lund University  
Lund, Sweden

© Per Otto Almquist 2012

Lund University, Faculty of Medical Doctoral Dissertation Series 2012:54

ISSN 1652-8229

ISBN 978-91-87189-17-3

Printed in Sweden by Media-Tryck, Lund University  
Lund 2012

**CLIMATE  
COMPENSATED  
PAPER**



To Rose Zätterström



# Table of Contents

<b>List of papers</b>	<b>9</b>
<b>Abbreviations and definitions</b>	<b>10</b>
<b>Abstract</b>	<b>11</b>
<b>Summary in Swedish</b>	<b>13</b>
<b>Introduction</b>	<b>15</b>
Functional anatomy of knee rotation	15
Axial and terminal rotation	16
Closed kinetic chain rotational movements in the lower extremities	17
Earlier studies with non-invasive measurement devices of knee rotation in vivo	18
<b>Aims</b>	<b>21</b>
<b>Methods and subjects</b>	<b>23</b>
Development of the Rottometer	23
The Rottometer (Figure 1-4)	23
Testing procedure	26
Roentgen Stereometric Analysis	27
Validity	27
Validity of the Rottometer (paper I)	28
Reliability	28
Reliability of the Rottometer (paper II)	28
One-week-apart intra-tester reliability	29
Within-day intra-tester reliability	29
Intertester reliability	29
Healthy knee rotation reference values (paper III)	30
Knee rotation in patients with habitual dislocating patella (paper IV)	30
Ethics	30
Examiners	31
Statistics	31
<b>Results</b>	<b>33</b>
Validity (paper I)	33



Reliability (paper II)	34
Healthy reference group (paper III)	34
Patients with habitual dislocating patella (paper IV)	35
<b>Discussion</b>	<b>37</b>
Validity and reliability of the Rottometer	37
Healthy knee rotation reference values	38
Patients with habitual dislocating patella	39
The Rottometer vs earlier non-invasive measurement devices	39
Sources of possible errors	41
The Rottometer and it's clinical relevance	43
<b>Conclusion</b>	<b>45</b>
<b>Acknowledgements</b>	<b>47</b>
<b>References</b>	<b>49</b>

# List of papers

This thesis is based on studies reported in following papers, referred to in the text by their respective Roman numerals.

1. Almquist P O, Arnbjörnsson A, Zätterström R, Ryd L, Ekdahl C, Fridén T. Evaluation of an external device measuring knee joint rotation – An in vivo study with simultaneous Roentgen Stereometric Analysis, *J Orthop Res* 2002;20: 427-432
2. Almquist P O, Ekdahl C, Isberg P E, Fridén T, Reliability of an external device measuring knee rotation in vivo, *BMC Musculoskeletal Disorders* 2011;12:291 <http://www.biomedcentral.com/1471-2474/12/291>
3. Almquist P O, Ekdahl C, Isberg P E, Fridén T, Knee rotation in healthy individuals related to age and gender, *J Orthop Res*, accepted 11 June 2012 Published online in Wiley Online Library ([wileyonlinelibrary.com](http://wileyonlinelibrary.com)). DOI 10.1002/jor.22184
4. Almquist P O, Ekdahl C, Isberg P E, Ryd L, Fridén T, Knee rotation in patients with habitual dislocating patella – An in vivo study with an external device, submitted

# Abbreviations and definitions

ACL	Anterior cruciate ligament
CI	Confidence interval
HDP	Habitual dislocating patella
ICC	Intraclass correlation coefficient
Closed kinetic chain	Weight bearing exercise with a distally situated axis of motion where the distal segment usually is fixed to a supporting surface, creating a system where movement at one joint produces movements at all other joints in a predictable manner (e.g. a squat)
LCL	Lateral collateral ligament
MCL	Medial collateral ligament
PCL	Posterior cruciate ligament
Q-angle	<i>“The Q (quadriceps) angle of the knee is the angle formed between a line connecting the anterior superior iliac spine to the midpoint of the patella and a line connecting the tibial tubercle and the midpoint of patella” (69)</i>
Reliability	The consistency of a measurement when all conditions are thought to be hold constant
RSA	Roentgen stereometric analysis
$r^2$	Pearson’s coefficient of determination
SEM	Standard error of the mean
Validity	The evidence that a test measures what it is supposed to measure

# Abstract

The overall aim of this work was to evaluate a newly developed measurement device, the Rottometer, for measuring knee rotation in different flexion angles with different applied torques, in order to establish the normal range of healthy knee rotation reference values and to study possible differences due to age and gender, as well as possible differences between patients with habitual dislocating patella (HDP) and healthy controls. The validity of the Rottometer was evaluated by simultaneous registrations with roentgen stereometric analysis (RSA) (paper I). The two methods showed high correlations concerning the total knee rotation at 90° and 60° of knee flexion angles with 3, 6 and 9 Nm applied torques. The Rottometer was also concluded to be a reliable measurement device concerning the one-week-apart and within day intra-tester as well as the inter-tester reliability at 90°, 60° and 30° with 6 and 9 Nm as well as the examiner's apprehension of end-feel (paper II). In total, 120 knee healthy subjects (60 females and 60 males) equally distributed in four different age groups (15-30, 31-45, 46-60 and  $\geq 61$  years) were examined at 90°, 60° and 30° of knee flexion angles with 6 and 9 Nm applied torques as well as the examiner's apprehension of end-feel (paper III). No differences were found concerning the different flexion angles, between the left and right knee or between the different age groups within the genders. However, the females showed a 10-20 % larger range of knee rotation than the males at all different flexion angles and applied torques. The knee rotation was also examined in 20 patients (15 females and 5 males) with HDP (paper IV). No differences were found between the affected and unaffected knees within the subjects. In accordance with the healthy reference population, the female subjects showed a 10-20 % significantly larger range of rotation than the male subjects in the HDP group, and no differences were found between the patients affected with HDP and age matched healthy controls.



# Summary in Swedish

Knäleden är den största och sannolikt mest komplexa leden i kroppen. Den är belägen mellan tibia och femur, som är skelettets längsta hävarmar, vilket innebär att den utsätts för stora krafter vid belastning. Vid till exempel en snabb promenad är kraften som verkar över knäleden cirka fyra gånger kroppsvikten, och risken för skador är därför stor. Rörelser och kraftöverföringar i knäleden sker samtidigt i tre plan (frontal-, sagital- och transversalplanet), och för sin funktion är knäleden beroende av full rörlighet i alla tre plan. Fungerande samspel mellan flexions- /extensions rörelser i kombination med samtidig translation och rotation är en förutsättning för normal funktion i knäleden.

För att uppnå full funktion efter skador och operationer i knäleden är det viktigt att samtliga komponenter i knäledens mekanik fungerar tillfredställande. Vid främre korsbandskador har det visat sig att denna skada ofta påverkar knäledens sagitala translation och rotation, vilket inte alltid går att återställa vid en operation. Den förändrade mekaniken efter denna skada bidrar troligtvis till den artros utveckling i knäleden som ofta uppstår i ett senare skede i livet hos dessa individer. Förändrad rotation i knäleden har även registrerats hos individer som drabbats av primär gonartros, och hos personer med upprepade patella luxationer. Trots detta undersöks och utvärderas sällan knäledens rörlighet beträffande rotation vid kliniska undersökningar. Hur stor den normala knäledens rotationsrörlighet är, om det förekommer någon sidoskillnad mellan höger och vänster knä, eller skillnader beroende på kön eller ålder har så vitt vi vet inte säkerställts. Syftet med föreliggande arbete var därför att utveckla och utvärdera ett yttre kliniskt mätinstrument som möjliggör mätning av knäledens rotationsrörlighet i olika vinklar med olika vridmoment, för att utvärdera hur stor den normala knäledens rotationsrörlighet är, om det finns några skillnader beroende på kön eller ålder, samt om det finns någon skillnad i rotation mellan personer som drabbats av upprepade patella luxationer och en grupp ålders- och könsmatchade knäfriska personer.

Det konstruerade mätinstrumentet, Rottometern, utvärderades avseende validitet genom simultana undersökningar med RSA (Roentgen Stereometric Analysis). Fem tidigare korsbandsopererade män med tantalum markörer implanterade i proximala tibia och distala femur deltog i undersökningen. Studiens resultat visade höga korrelationer mellan de två mätmetoderna avseende knäledsrotation vid 90° och 60° knäflexion med 3, 6 och 9 Nm vridmoment. Rottometerns intra-tester reliabilitet avseende mätningar utförda av samma undersökare vid två tillfällen under samma dag samt med en veckas mellanrum utvärderades på 10 knäfriska personer. Inter-tester reliabiliteten utvärderades genom att två olika undersökare gjorde mätningar på 10 knäfriska personer. Studien

visade att Rottometern hade god reliabilitet avseende mätningar av knäledens totala rotationsrörlighet vid 90°, 60° och 30° flexion, med 6 och 9 Nm vridmoment samt vid undersökarens känsla för "end-feel". Totalt 120 frivilliga försökspersoner (60 kvinnor och 60 män), indelade i fyra olika åldersgrupper (15-30, 31-45, 46-60 och  $\geq 61$  år) undersöktes med Rottometern i 90°, 60° och 30° flexion med 6 och 9 Nm vridmoment samt undersökarens känsla för "end-feel". Kvinnorna uppvisade 10-20 % signifikant större rotation än män, i övrigt erhöles inga skillnader mellan olika åldrar, vinklar eller sidoskillnad mellan höger och vänster knä. Knäledens rotation undersöktes även på 20 personer (15 kvinnor och 5 män) med upprepade patella luxationer. Inga skillnader kunde påvisas mellan det skadade och friska knäet inom individerna, och inte heller mellan de skadade och knäfriska åldersmatchade försökspersoner. Slutsatsen av detta arbete är att Rottometern är ett tillförlitligt mätinstrument för mätning av knäledens rotationsrörlighet, att kvinnor har 10-20 % större rotationsrörlighet än män, att ålder inom det studerade området inte signifikant påverkade knäledens rotationsomfång samt att vi inte kunde finna någon skillnad mellan personer med friska knän och knän med patellaluxationer.

# Introduction

The knee function is determined by the manner in which injuries, impairment, recognition and remedy is determined. Understanding the normal functional anatomy and appreciate the deviation from normal, is the basis for understanding the pathology of the knee. Rotational alignment of the knee is most likely an important factor to maintain for adequate knee function. Several studies have reported that rotational malalignment is associated with different injuries and dysfunctional problems in the knee. Excessive rotational force to the knee is known to tear ligamentous structures resulting in rotatory instability (24). It has been reported that instability experienced after ACL (anterior cruciate ligament) injuries is a combination of abnormal tibiofemoral translation and rotational kinematics (26, 41, 81), and may not be restored after surgery (81). It is possible that this abnormal rotational kinematics may be one of the reasons for degenerative changes seen after ACL injuries (17). Reduced knee rotation and tibial torsion have been found in patients with osteoarthritis (52). Rotation has also been described in association with lateral patellar dislocation (21, 82). An abnormal relative femurotibial axial rotation has been described in patients with recurrent patellar dislocation using a radiographic technique (85) and several anatomical factors, including increased external tibial rotation, have been associated with patellar instability (6, 27, 93). To preserve rotational movements may be important in knee arthroplasty for the functional outcome. However, there is a lack of external measurement devices in vivo to assess knee rotation movements, and knee rotation is hardly ever estimated clinically.

## Functional anatomy of knee rotation

Knee joint flexion and extension is a combination of rotation around a transversal axis and a translatory gliding motion, combined with simultaneous rotation around a vertical axis (51). The configuration and the incongruous aspect of the femurotibial articulation surfaces partially cause the rotation observed during flexion and extension. The vertical axis of knee rotation pass through the medial condyle as a result of the different shape of the two tibial condyles, and the configuration of the intercondylar spines (51, 79). This is reflected in a greater movement of the lateral femoral condyle on the convex lateral tibial condyle, and that the medial femoral condyle moves relatively little on the concave medial tibial condyle during rotation of the knee (51, 59, 71). During



the movements of axial rotation, the menisci follow the displacements of the condyles. These movements of the menisci is passive, being drawn by the lateral femoral condyle, the fixations of the menisci horns and capsular fibers attached to the menisci (51).

The medial and lateral collateral ligaments (MCL and LCL) are taught in full extension, and slackened during flexion (51, 71). The MCL resists valgus- and the LCL varus stresses across the knee joint, but they are also aligned to check rotation of the tibia combined with either anterior or posterior tibial displacement (68, 69). The anterior and posterior cruciate ligaments (ACL and PCL) restrict anterior-posterior glide, and might also limit rotation of the tibia in relation to the femur. The ACL unwinds during the first part of external rotation, but becomes more taught during further outward rotation as it winds around the medial aspect of the lateral femoral condyle (53). During internal rotation, the ACL appears to twist around the PCL, thus limiting internal rotation (22). It has also been reported that anterior translation forces on the tibia produces a stress on the ACL which will create internal rotation of the tibia (97). The cruciate ligaments are mechanical stabilizers of the knee, but they also play a large role in neuromuscular stability by being involved in sensory feedback to joint motion (44).

In textbooks, the maximum range of femorotibial rotation has been reported to be found at 90° of knee flexion, and diminish as the knee approach both full extension and full flexion (20, 51, 59, 70, 71, 77). The anatomical explanation is that at 90° of knee flexion, the ligaments are lax, the tibial tubercles are no longer in the intercondylar notch and the menisci are more free to move.

## Axial and terminal rotation

When the knee is in full extension, the femur is internally rotated and the tibial tubercles are lodged in the intercondylar notch, the menisci are tightly interposed between the tibial and femoral condyles and the ligaments are taught (51). This final stage of knee extension together with internal rotation of femur is not voluntary, and is known as the locking mechanism or screw home mechanism of the knee (20, 51, 59, 71, 77). The locking, or terminal rotation, can be differentiated from the axial rotation. Axial rotation is due to joint incongruence and ligamentous laxity, and is to a great extent produced by the muscles that cross the joint. It can be performed voluntarily and is important in placing and positioning the foot as a fundament for weight bearing activities (20). The major functional importance of the motion is in closed chain movements (74) where the femur rotates on the fixed tibia, as in turning from kneeling, sitting or squatting positions and in sudden changes in direction while running (59, 71). In contrast, the screw home mechanism is produced by asymmetry of surfaces and by ligamentous tension, and is obligatory. It provides a mechanical stability and permits humans to stand erect without muscle contraction (77). Both axial and terminal rotations are prerequisites for normal knee function.

The functional anatomy and biomechanics of the patellar joint are extremely complex. During axial rotation, the patella moves relative to the tibia (39). Since the inferior aspect of the patella is tied to the tibial tuberosity, the inferior patella continues to point to the tibial tuberosity while moving with the femur. During internal rotation of the femur on the tibia, the upper part of patella will follow the femur medially, while the lower part will remain lateral with the tibia (51). The opposite movements occur during external rotation of the femur. When the knee joint goes into flexion from full extension or vice-versa, the movements of the patella depends on a complex three dimensional sequence of movements between the patella, the tibia and the femur (20, 51, 59, 71). The basis for these movements is interactions between articulating surfaces, ligaments, muscles, menisci and alignment of bony structures. With flexion from full extension the patella moves distally relative to the femur and is engaged in the femoral groove. This movement is guided by the congruence of the joint surfaces and complex rotations of the femur on the tibia, as well as by forces in ligaments and muscles (14, 25, 58, 76, 96). Also the depth and shape of the femoral groove, alignment of the extensor mechanism and the Q-angle (71) are involved in these movements(18, 76) where the Q-angle is connected to the femorotibial rotation (85). During lower extremity movement and activity, the patella is thus stabilized by limb alignment, articular geometry, static ligament stabilizers and dynamic muscle forces. (23, 36)

## Closed kinetic chain rotational movements in the lower extremities

The biomechanical profile of the lower extremities is a complex system, and the knee joint should not be considered as an isolated component. The trunk, the pelvis, the hip and the ankle joints should be considered in their relationship to resultant knee joint mechanics (1, 35, 77, 94). During human gait, the pelvis rotates in the horizontal plane as one limb advances in front of the other. Center of gravity shifts from side to side, and a rotational mechanism transmitted through the different segments of the limb must exist to tolerate torsional and angular movements simultaneous (1, 71). When the foot is fixed to the ground, rotation and coronal plane angular change are occurring simultaneously. As this occurs, the leg must undergo passive rotation. The pelvic rotation must be compensated for by opposite rotation in distal joints, that is, in the knee, the ankle and the subtalar joints (29, 40). Since the femur and the tibia are the human skeleton's longest levers (77), considerable loads affects the knee (70, 77). This makes the joint very vulnerable to rotational forces in closed kinematic chain movements of the lower extremities. An example of an inappropriate rotational force to the knee is when an athlete wears spiked shoes that enhances the grip of the foot to the surface, and a forced movement with planted foot and internal tibial rotation occurs. If pronation occurs beyond the contact phase, the tibia remains internally rotated, impeding the occurrence of subtalar joint supination and tibial external rotation (2). The excessive

internal rotation transmits abnormal forces upward in the kinetic chain (10), and the ACL may be affected with a greater stress, enhancing the risk of an ACL injury.

## Earlier studies with non-invasive measurement devices of knee rotation in vivo

Many of the earlier studies of knee rotation have been made in vitro (37, 62, 64, 69, 73, 87, 95). However, in vitro studies can probably not be compared with in vivo studies, due to differences in relative stiffness and lower soft tissue compliance of the cadaveric specimens (62). However, some in vivo studies using an external measurement device evaluating knee rotation have been reported (16, 60, 66, 67, 75, 88, 89, 98, 101).

Zarins et al. (101) measured knee rotation in a side-lying position. The knee was positioned and measured at 90°, 60°, 30°, 15° and 5° of flexion. The torque was applied manually by the examiner's estimation of end-feel but no grading of torques was reported. The test-retest reliability was calculated by two repeated measurements on each of thirteen subjects. High correlations for the total internal-external knee rotation ( $r = 0.93-0.96$ ) were described at 90°, 60° and 30° of knee flexion.

Shoemaker and Markolf (88) measured knee rotation in vivo combined with measurements of maximum isometrically generated tibial torque. Recordings were made in a seated position and the knee rotation was measured at 20° and 90° of flexion and a torque of 10 Nm was chosen. At 90°, seven tests were repeated on one subject, indicating good reproducibility (range 76°-83°).

Tsai et al. (98) evaluated an external device regarding inter- and test-retest reliability in 11 male subjects. The subjects were measured lying supine on an examination table, and were measured at 90° and 30° of knee flexion angle with 2, 4 and 6 Nm torques applied, and the total internal-external rotation was registered. The ICCs (Intraclass Correlation Coefficient) were all greater than 0.75 and the SEMs (Standard error of the mean) were all less than 2° in this study.

Maudi et al. (66) used a knee rotatory kinaesthetic device to determine proprioceptive acuity for internal and external active rotation, and to measure active and passive rotation range of motion in vivo. To determine intra- and inter observer reliability for active and passive rotation, 20 male subjects were recruited. Measurements were made at 90° of flexion angle with a 6 Nm torque applied. Both intra- and inter observer reliability were reported as good to excellent (ICC<sub>1,2</sub> 0.69-0.95).

Park et al. (75) measured knee rotation with a motorized device with a 7 Nm torque applied at 60° of knee flexion angle. Three LED markers positioned at the anteromedial tibial surface were used to measure the rotation. Unfortunately, the device was not described.

Lorbach et al. (60) used the Rotameter, a custom made boot attached to a handle bar, to apply rotational torques to the tibia. The test subjects were installed in the prone position, and were examined at 30° of knee flexion angle with 5, 10 and 15 Nm applied

torques. The Rotameter was evaluated concerning intra- and inter rater reliability, and ICC's ranged from 0.67-0.97, depending on the applied torque. The validity was evaluated using a knee navigation system on cadaver specimen, and showed high correlations between the two techniques ( $r > 0.85$ ). However, the Rotameter overestimated the total rotation with  $5^\circ$  at 5 Nm,  $15^\circ$  at 10 Nm and  $25^\circ$  at 15 Nm systematically.

Mouton et al. (67) used a second version of the Rotameter and evaluated reference values measured in 60 healthy participants (35 males and 25 females). The results of that study showed higher rotation in females than in males, and lower rotation in subjects with greater body mass. However, the authors stated that their results were preliminary and required confirmation.

Branch et al. (16) developed a custom robotic knee system that was adjustable to the subjects lower limb alignment. The ankle, the patella and the femur were fixed with stabilizers. The foot was positioned in dorsiflexion and pronation to obtain ankle stabilization. The device showed high reliability (ICC = 0.97) concerning total knee rotation at  $25^\circ$  with a 5.65 Nm torque applied, based on 10 subjects tested on 4 consecutive days by four different examiners.

In a recent study, Shultz et al. (89) evaluated 64 women and 43 men using the Vermont Knee Laxity device to analyze the influence of the menstrual cycle on rotational knee laxity, genu recurvatum and general joint laxity compared to men. Only the dominant leg was tested, and the results showed a 20% larger rotation in females at  $20^\circ$  of knee flexion angle with a 5 Nm applied torque than in males. The device was earlier reported to have high intra-tester reliability (90).

In these in vivo studies, there is a large variation in range of total knee rotation between the different studies ( $m \pm SD = 18.5^\circ \pm 4.7 - 120.8^\circ \pm 4.89$ ). It might be argued that different flexion angles and different applied torques have been used, and the set-ups during the examinations were different between different devices. It may also be argued that the number of subjects included in these earlier studies, except for the study of Schultz et al. (89), have been rather small. Non-invasive measurement devices, evaluated concerning their validity and reliability, are needed to objectively assess rotational knee laxity in clinical studies and daily work. To our knowledge, healthy reference values concerning knee rotation range of motion, and possible differences due to age or gender, have not been established in different knee flexion angles with different applied rotational torques in a larger knee healthy population. Nor have the characteristics of anatomical risk factors, with regard to stability of the patellofemoral joint, been completely established. The total range of knee rotation in patients affected with habitual dislocating patella (HDP) has previously, to the best of our knowledge, not been reported in different flexion angles.



# Aims

- \* To analyze and evaluate the validity and reliability of the Rottometer.
- \* To establish reference values concerning range of knee rotation in a knee healthy population
- \* To study possible differences in knee rotation due to age, gender and between the left and right knees in a knee healthy population.
- \* To study possible differences in range of knee rotation within patients with HDP between the affected and unaffected knee.
- \* To study possible differences in range of knee rotation between patients with HDP and age and gender matched healthy controls.



# Methods and subjects

## Development of the Rottometer

A prototype of an external measurement device, the Rottometer, making it possible to measure knee rotation in different flexion angles with different torques applied, was developed after studies of functional anatomy, biomechanics and clinical observations. Several minor pilot studies involving both healthy subjects and patients with different kinds of knee injuries were repeatedly performed during the development and construction of the device. Technical imperfections were corrected and the fixations of the device to the subjects were gradually improved. Discomfort and painful measurements due to the fixation clamps were minimized. Based on the literature and the results of several clinical tests before the main study, torques of 3, 6 and 9 Nm and the examiner's apprehension of end-feel were selected to be applied. Torques higher than 9 Nm were excluded, since several subjects did not tolerate these higher levels of torques due to discomfort or pain. Torques less than 3 Nm were not considered to be relevant to measure since the range of rotation was small and seemed to vary in relation to the mass of the lower limb.

## The Rottometer (Figure 1-4)

A modified chair, specifically designed and constructed for this purpose, served as the base of the instrument. The heavy chair provided a stable test situation, and because of the adjustability, it could accommodate subjects of various sizes. Knee positions, ranging from full extension to 90° of knee flexion, were achieved by minor changes in the setup. The thigh was strapped firmly to the chair with a dual-locking clamp. When the knee was positioned properly, the dual-locking clamp was tightened into place, along with gravity in order to keep the femur and hip from moving in the frontal and sagittal planes. At the bottom of the chair, a protractor was attached between two iron bars. A foot-plate, with ball bearings permitting rotation, was attached to the protractor. The subject's foot was secured to the foot-plate with six soft nosed screws, with the calcaneus held in the lateral-medial direction by two screws, and the medial and lateral malleolus in the anterior-posterior direction by four screws. A metal frame attached to the foot



plate served as a platform for the malleolus fixation screws. A U-shaped metal stay was used as platform for the calcaneus screws. The purpose of this construction was to prevent movements of soft tissue and of the subtalar and ankle joints as much as possible. Two vertical plastic poles with Velcro straps were riveted to the foot plate, one on each side of the tibia. A specifically designed textile orthosis, which could be attached to the Velcro straps, was tied around the lower leg. Four Velcro straps were tightened around the lower leg, including the plastic poles and textile orthosis, in order to minimize soft tissue movements. A measuring stick followed the foot-plate, pointing to the degree of tibial rotation on the protractor. An adjustable spanner (Fig 5) was used to apply the different torques (Nm). It permitted measurements with various forces (Nm), and was calibrated and tested to provide torques reproducible within  $\pm 3\%$  (Rausol, Germany).

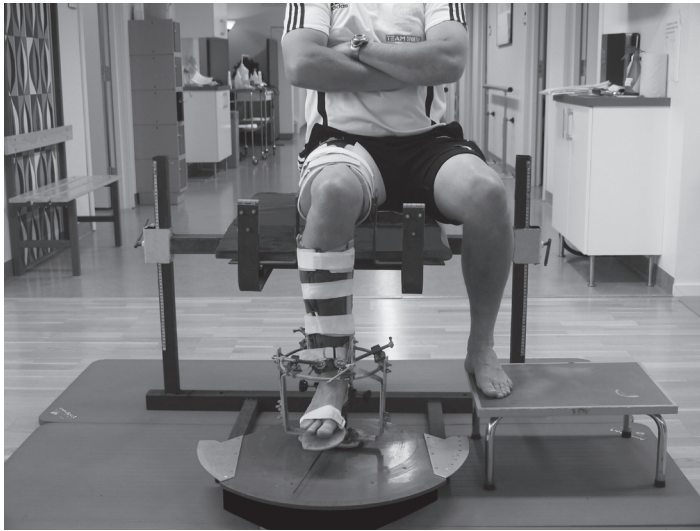

**Figure 1.** The Rottometer with a test person fixed to the device ready to be measured at 90° of knee flexion angle.



**Figure 2.** The Rottometer with a test person fixed to the device ready to be measured at 60° of knee flexion angle.

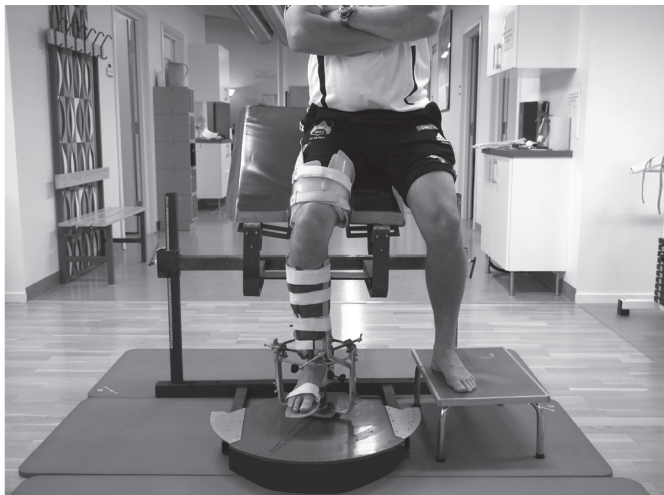

**Figure 3.** The Rottometer with a test person fixed to the device ready to be measured at 30° of knee flexion angle.

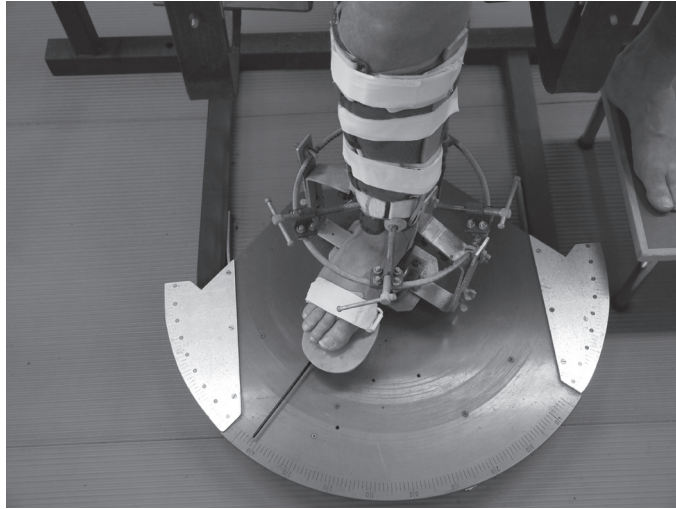

Figure 4. The tibia and lower part of the Rottometer during external rotation.

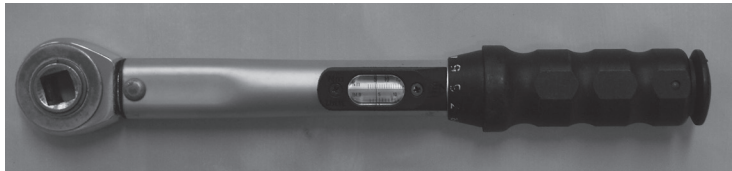

Figure 5. The adjustable spanner, used to apply different torques (Nm) during the measurements of knee rotation.

## Testing procedure

Measurements were made at 90° (Fig 1), 60° (Fig 2) and 30° (Fig 3) of knee flexion On both legs of each subject. Ninety degrees was chosen since the largest range of rotation has been reported at this knee flexion angle (13, 54, 62). Sixty and 30° of flexion were chosen to study the rotation at more physiological flexion angles for weight-bearing activities. At each flexion angle, passive total internal-external rotation of the tibia in relation to the femur was measured. The neutral position of “zero degree” rotation was defined as each individual subject’s resting position of the knee at each flexion angle. Total internal-external rotation was then measured from that zero position. The subjects were instructed to relax their muscles in order to allow the examiner to passively rotate the leg. The mean of three repeated measurements of internal and external rotation with 3, 6 and 9 Nm torques as well as the examiner’s apprehension of end-feel (50), was recorded at each torque at each flexion angle (90°, 60° and 30°) in both knees. The

examiner was instructed to stop the measuring procedure if the subject complained about pain or discomfort at any applied torque at any angle.

## Roentgen Stereometric Analysis

RSA (Roentgen Stereometric Analysis) (91) has been used for more than a decade to evaluate the laxity, migration of implants and kinematics in the knee (17, 33, 45-49, 54, 55, 86). It is a method with higher precision, both from a technical point of view and in dynamic set-up, when compared to conventional radiography. As a tool for measuring skeletal and implant motions, RSA is an accurate and precise method down to 0.1 mm and 0.1-0.3° (86, 100).

In this study, patients with ACL injuries and tantalum markers (33, 91) implanted in the proximal tibia and distal femur were evaluated. Simultaneous calibration radiographs were obtained in the frontal and lateral projections with the knee inside a Plexiglas calibration cage. The results were expressed in a cardinal axis coordinate system where the X-axis is transverse, the Y-axis is vertical and the Z-axis is sagittal and rotated so that the axes were parallel to the tibia. Care was taken to ensure that the tibia was parallel to the cage planes in both projections. After the calibration, the cage was excluded, leaving two reference planes to be exposed together with the patient's markers. The marker images on all radiographs were digitized, using a precision digitizing table (Hasselblad Engineering, precision 10 µm). Rotation of the tibia relative to the femur was performed by using the KINEMA routine, based on rigid body kinematics (33).

## Validity

The validity of an instrument refers to what is being measured. To ensure that the tool is measuring what it is intended to measure, empirical evidence must be produced. Different types of validity can be assessed (28, 95). Content validity is the extent to which a measure provides a complete representation of the concept of interest. Construct validity is the degree to which an experimentally-determined definition matches the theoretical definition. Criterion validity is the extent to which one measure is systemically related to accurate or previously validated measures or outcomes of the same concept. The correlation coefficient is often used to determine criterion validity. In this thesis the criterion validity of the measurement device was determined.

## Validity of the Rottometer (paper I)

The validity of knee rotation measurements with the Rottometer was evaluated by simultaneous registrations using RSA (91) in five male patients. Tantalum markers had been implanted during a previous ACL reconstruction and were used primarily for purposes other than the present one. The patients were examined at 90° and 60° of knee flexion angles, with 3, 6 and 9 Nm torques applied. Internal and external rotation were measured three times while radiographs were taken simultaneously.

## Reliability

Reliability refers to the consistency of a measurement, when all conditions are thought to be held constant (83). For measurements to be considered reliable, they must be comparable when performed on several occasions with the same subjects by the same tester (intra-tester reliability), or when performed with the same subject by different testers (inter-tester reliability). Reliability consists of various components: instrument reliability, intra- and inter-tester reliability (relative reliability), and intra-subject reliability (absolute reliability). Demonstrating the reliability of an instrument is the first step in providing evidence of the value of the instrument and demonstrating that measurements of individuals on different occasions, or by different testers, or by similar or parallel tests produce similar results (95). Different types of reliability data require different statistical tests, but there is a lack of consensus in the literature as to which tests are more appropriate (8, 78). It can and should be assessed in different ways. A measurement is said to be reliable if the error component is small, thus allowing consistent estimation of the true quantity of interest (28).

## Reliability of the Rottometer (paper II)

The one-week-apart and within day intra-tester as well as the intertester reliability of the Rottometer was evaluated at 90°, 60° and 30° of knee flexion angle, with 3, 6 and 9 Nm torques applied as well as the examiner's apprehension of end-feel. All the subjects participating in the studies had never undergone any knee, hip or foot surgery and had no documentation or history of prior major knee injuries (ligaments, cartilage, fractures, meniscus) or patellofemoral pain. Each knee was considered as one unit and thus, twenty observations were used in the calculations.

The results of the first measurement occasion, at each flexion angle with each applied torque, of each healthy subject participating in the reliability study, was also used as measurement results in the study of the healthy reference population (Table 1)

**Table 1.** The knee healthy population in study III was constituted of 120 subjects (60 females and 60 males) divided into four different age groups (15-30, 31-45, 46-60 and >61 years). Twenty of these subjects also participated in Study II (10 in the one-week-apart and within day reliability test, and 10 in the evaluation of the intertester reliability). The 15-30 years group also participated as healthy controls in study IV.

Age	Total knee healthy subjects, Study III Female/male	One-week-apart reliability, Study II Female/Male	Within day reliability, Study II Female/Male	Intertester reliability, Study II Female/Male	Healthy controls, Study IV Female/Male
15-30 years	15/15	2/0	2/0	2/2	15/15
31-45 years	15/15	2/3	2/3	4/2	0/0
46-60 years	15/15	1/1	1/1	0/0	0/0
≥ 61 years	15/15	1/0	1/0	0/0	0/0
<b>Total</b>	60/60	6/4	6/4	6/4	15/15

## One-week-apart intra-tester reliability

To evaluate the one-week-apart intra-tester reliability of the knee rotation, one examiner (physiotherapist) measured 10 healthy subjects, six females (age range: 28–69 years) and four males (age range: 37-60 years). The subjects were measured twice with a week's interval and these measurements were made at the same time of the day on both test occasions.

## Within-day intra-tester reliability

To evaluate the within-day intratester reliability, one examiner (physiotherapist) measured knee joint rotation in the same 10 healthy subjects as in the one-week-apart evaluation. The subjects were measured twice, once in the morning and once in the afternoon, on the same day.

## Intertester reliability

Ten healthy subjects, six females (range: 31-46 years) and four males (range: 24-35 years) participated in the study in order to evaluate the intertester reliability. They were measured twice on the same test occasion in random order by two independent examiners (physiotherapists). The first examiner fixed the subject to the Rottometer and carried out the measurements. After ten minutes' break, the second examiner repeated the whole procedure on the same test person.

## Healthy knee rotation reference values (paper III)

In total 120 healthy persons (60 females and 60 males) were invited and recruited from schools, universities, departments of health care, offices and members of different organizations and societies. These persons volunteered for the study and constituted the reference population. The test-persons were equally divided into four different age groups, 15-30, 31-45, 46-60 and  $\geq 60$  years. These persons had never undergone any knee-, hip- or foot surgery or been affected by any prior major knee injuries (ligaments, fractures, cartilages, meniscus) or patellofemoral pain. The total internal-external knee rotation was examined at 90°, 60° and 30° of knee flexion angle with 6 and 9 Nm torques applied and end-feel. Possible differences in range of total knee rotation due to age, gender and between the left and right knees were evaluated within the healthy reference population.

## Knee rotation in patients with habitual dislocating patella (paper IV)

The total range of knee rotation was measured in 20 patients (Table 2) with HDP (15 females – age range: 15-28 years, and 5 males – age range: 16-21 years). These persons were recruited and invited from the Department of Orthopaedics, Lund University hospital, Lund. All patients volunteered for the study. Seven of these subjects suffered from bilateral dislocations (6 females and 1 male), which means that totally 27 knees were included in the study (21 female knees and 6 male knees). Sixteen of these 27 knees had  $\geq 10$  dislocations (13 female knees and 3 males), and 11 had  $< 10$  dislocations (8 female knees and 3 male knees). Possible differences between the affected knees and unaffected knees within the subjects, as well as possible differences between the genders were evaluated. The results of the knees with HDP were compared with knee rotation in knees of age matched healthy controls. The total internal-external knee rotation was examined at 90°, 60° and 30° of knee flexion angles, with 6 and 9 Nm torques applied as well as the examiner's apprehension of end-feel.

## Ethics

All subjects participating subjects in study I-IV were volunteers, and were informed that they could stop their participation at any time, for any reason. Oral or written informed consent was obtained by all subjects. The studies were directed by the Helsinki Declaration, and approved by the Regional Ethical Review Board of Lund University, Lund.

**Table 2.** The patients with habitual dislocating patella (HDP) in study IV constituted of 15 females and 5 males. The subject's knees are accounted for unilateral, bilateral and no HDP, and for more or less than 10 occasions of HDP.

Patients with HDP	Female	Male	Total
Subjects	15	5	20
Unilateral	9	4	13
Bilateral	6	1	7
Dislocated knees	21	6	27
No dislocation	9	4	13
≥ 10 dislocations	13	3	16
< 10 dislocations	8	3	11

The 15 females and 15 males representing the 15-30 year group in paper III, were also used as healthy controls in paper IV (Table 1).

## Examiners

The two examiners in the present studies were physiotherapists and trained in using the measurement device before the study commenced.

## Statistics

In paper I, Pearson's coefficient of determination ( $r^2$ ) was calculated to study the relation between the two methods. In paper II, statistical evaluation of the one-week-apart intratester-, within-day intratester and intertester reliability tests were made with Intraclass Correlation Coefficient<sub>2,1</sub> (ICC<sub>2,1</sub>) (7, 12), 95% Confidence Interval (CI) of the ICC (90) and 95% CI between test trails and examiners. In paper III, the statistical evaluations of the healthy reference population were made with multi-way Analysis of variance (65), one way ANOVA, Students independent samples t-test and paired t-test (right vs left knee). In paper IV, the statistical analyses were made with Student's independent samples t-test and paired t-test (right vs left knees within subjects). P-values <0.05 were considered significant.





# Results

## Validity (paper I)

The correlations concerning total internal-external knee rotation between the Rottometer and RSA were high ( $r^2=0.87-0.94$ , depending on flexion angle and torque applied). Lower correlations were found concerning isolated internal- ( $r^2=0.48-0.87$ ) and external rotation ( $r^2=0.47-0.77$ ). The most accurate registrations were found in  $90^\circ$  ( $r^2=0.94$ ) and with 9 Nm torque applied ( $r^2=0.94$ ). The total rotation measured at  $90^\circ$  with the Rottometer the  $m\pm SD$  increased from  $29\pm 7^\circ$  at 3 Nm to  $66\pm 7^\circ$  at 9 Nm, and the corresponding figures at  $60^\circ$  were  $26\pm 7^\circ$  and  $65\pm 7^\circ$ . With RSA, there was an increase at  $90^\circ$  from  $19\pm 7^\circ$  at 3 Nm to  $32\pm 9^\circ$  at 9 Nm, and the corresponding figures at  $60^\circ$  were  $12\pm 7^\circ$  and  $28\pm 8^\circ$ , respectively (Fig 6).

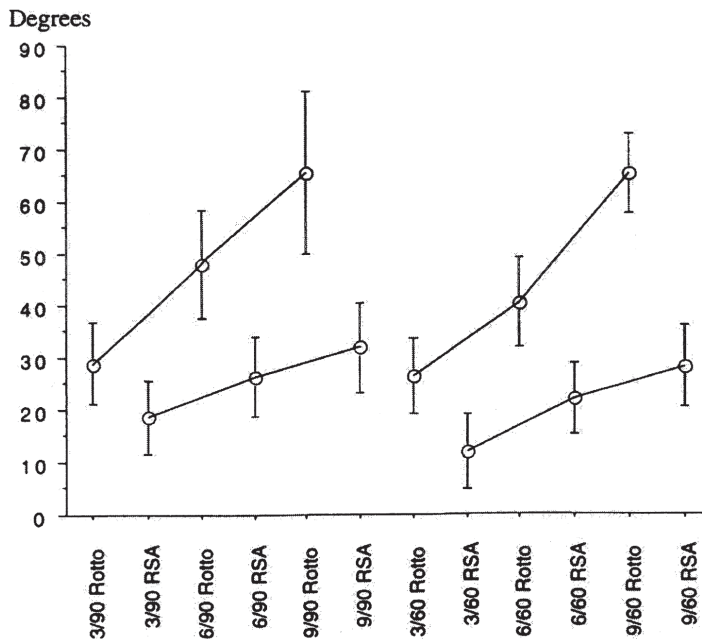

Figure 6. Total rotation as measured with RSA and the Rottometer at 60 and 90 of flexion angles with 3, 6 and 9 Nm applied torques.

## Reliability (paper II)

The reliability of the Rottometer was judged to be good (ICC 0.4-0.75) to excellent (ICC above 0.75) according to the recommendations of Fleiss (31), concerning one-week-apart and within day intra-tester as well as inter-tester reliability, for measuring knee rotation with 6 and 9 Nm torques applied and the examiner's apprehension of end-feel at three different flexion angles (90°, 60° and 30°). A torque of 3 Nm showed lower reliability in knee rotation measurements using the Rottometer as an assessment tool.

## Healthy reference group (paper III)

No significant differences (Table 3) in range of total internal-external rotation were found between the right and left knees, or between any of the three different flexion angles (90°, 60° and 30°), at any of the age- (15-30, 31-45, 46-60 and ≥60 years) or gender matched groups at any applied torque (6 Nm, 9 Nm and end-feel). For the whole group (60 females and 60 males), not considering age differences, the females showed a significant 10-20% larger ( $p < 0.01-0.001$ ) range of total knee rotation compared to the male subjects at all three flexion angles (90°, 60° and 30°) at all three torques applied (6 Nm, 9 Nm and end-feel) (Table 3).

**Table 3.** Total internal-external, knee joint rotation measured in a reference population of 120 knee healthy persons (60 females and 60 males) with 6 and 9 Nm torques as well as the examiner's apprehension of end-feel measured at 90°, 60° and 30° of knee flexion angles (mean ± SD) on the right and left knees. Results are given in degrees, and the significant differences between the females and the males at each torque applied are marked with \* ( $p < 0,05$ ), \*\* ( $p < 0,01$ ) or \*\*\* ( $p < 0,001$ ).

Total rotation	Female right knee	Male right knee	Diff	Female left knee	Male left knee	Diff
90° flex 6 Nm	59±11°	52±8°	7° **	59±11°	50±8°	9° ***
90° flex 9 Nm	77±11°	68±8°	9° **	77±13°	68±7°	9° ***
90° flex End-feel	75±11°	68±8°	7° ***	73±12°	64±7°	8° ***
60° flex 6 Nm	60±13°	51±9°	9° ***	60±13°	50±8°	10° ***
60° flex 9 Nm	78±14°	66±8°	12° ***	78±14°	67±8°	11° ***
60° flex End-feel	75±13°	65±9°	10° ***	74±14°	65±8°	9° ***
30° flex 6 Nm	57±14°	43±10°	14° **	56±14°	44±9°	12° **
30° flex 9 Nm	78±16°	62±11°	16° **	77±16°	63±10°	14° ***
30° flex End-feel	77±16°	62±10°	15° ***	75±15°	62±10°	12° ***

No significant differences were found between any of the four different age groups (15-30, 31-45, 46-60 and  $\geq 61$  years) within the genders (Table 4). However, the females showed generally a 6-19% non-significant decrease in range of total rotation in the three older female groups compared to the 15-30 year group, and the 46-60 year male group showed a non significant 3-19% decrease in total knee rotation compared to the other male age groups at all the three torques applied (6 Nm, 9 Nm and end feel) at all three flexion angles (90°, 60° and 30°).

**Table 4.** Total knee joint rotation measured in 120 knee healthy persons (60 females and 60 males) divided into genders and four different age groups (15-30, 31-45, 46-60 and >61 years) with 6 and 9 Nm torques applied as well as the examiner's apprehension of end-feel measured at 90°, 60° and 30° of knee flexion angles. Results are given in degrees (mean  $\pm$  SD). Since no differences between the left and right knees within the female and male population were found (table 3), the figures in the table are accounted for only one knee (the right one), in order to make a more comprehensible general view of the result.

Gender and age	6 Nm			9 Nm			End-feel		
	90°	60°	30°	90°	60°	30°	90°	60°	30°
F 15-30	65 $\pm$ 10°	64 $\pm$ 14°	62 $\pm$ 6°	82 $\pm$ 12°	84 $\pm$ 14°	85 $\pm$ 8°	78 $\pm$ 11°	79 $\pm$ 14°	81 $\pm$ 18°
M 15-30	52 $\pm$ 10°	52 $\pm$ 10°	46 $\pm$ 12°	69 $\pm$ 12°	69 $\pm$ 10°	64 $\pm$ 14°	66 $\pm$ 10°	66 $\pm$ 10°	65 $\pm$ 13°
F 31-45	58 $\pm$ 10°	61 $\pm$ 10°	58 $\pm$ 11°	77 $\pm$ 11°	77 $\pm$ 11°	79 $\pm$ 12°	71 $\pm$ 10°	74 $\pm$ 11°	77 $\pm$ 13°
M 31-45	52 $\pm$ 5°	51 $\pm$ 6°	45 $\pm$ 8°	70 $\pm$ 6°	70 $\pm$ 6°	64 $\pm$ 9°	65 $\pm$ 6°	65 $\pm$ 8°	64 $\pm$ 8°
F 46-60	56 $\pm$ 12°	60 $\pm$ 15°	57 $\pm$ 15°	74 $\pm$ 13°	74 $\pm$ 13°	75 $\pm$ 18°	70 $\pm$ 13°	74 $\pm$ 16°	74 $\pm$ 15°
M 46-60	46 $\pm$ 6°	48 $\pm$ 8°	40 $\pm$ 5°	65 $\pm$ 4°	65 $\pm$ 4°	60 $\pm$ 6°	63 $\pm$ 3°	65 $\pm$ 6°	59 $\pm$ 8°
F >60	57 $\pm$ 12°	54 $\pm$ 12°	50 $\pm$ 12°	76 $\pm$ 11°	76 $\pm$ 11°	70 $\pm$ 11°	71 $\pm$ 11°	70 $\pm$ 12°	70 $\pm$ 11°
M >60	54 $\pm$ 6°	51 $\pm$ 19°	45 $\pm$ 11°	69 $\pm$ 7°	69 $\pm$ 7°	63 $\pm$ 12°	66 $\pm$ 7°	64 $\pm$ 10°	63 $\pm$ 10°

In both the male and female subjects, internal rotation ranged from 40-44 % and external from 56-60 % of the total rotation at all three flexion angles (90°, 60° and 30°) with all the three torques applied (6 Nm, 9 Nm and end-feel).

## Patients with habitual dislocating patella (paper IV)

No significant differences (Table 5) in range of total knee rotation were found between the knees with HDP and the unaffected knees within the group of patients suffering from HDP, or between the patients affected knees in the HDP group and knees in the age matched control group when tested within the genders at any flexion angle (90°, 60° or 30°) at any applied torque (6 and 9 Nm as well as the examiner's apprehension of end-feel). However, the females with HDP showed a 10-20 % significantly larger range of knee rotation compared to the males at all three flexion angles (90°, 60° and 30°) at all three applied torques (6 and 9 Nm as well as end-feel), except at 30° of knee flexion angle at 6 and 9 Nm torques applied where no significant differences between the genders occurred.

**Table 5.** The total knee rotation  $m \pm SD$  in females (F) + males (M), females and males suffering from habitual dislocating patella and age matched healthy controls (15-30 years). Measurements are presented for in three different flexion angles (90°, 60° and 30°) with three different torques applied (6 Nm, 9 Nm and end-feel). Results are given in degrees and p-values <0.05 were considered significant.

Flex Torque	HDP F+M n = 26	Healthy F+M n =30	HDP F n=20	Healthy F n=15	HDP M n=6	Healthy M n=15
90° 6 Nm	58±14°	60±11°	62±10°	66±9°	45±19°	54±10°
90° 9 NM	79±15°	76±12°	83±11°	82±10°	65±18°	71±11°
90° End-feel	72±15°	73±12°	76±10°	79±11°	59±22°	66±10°
60° 6 Nm	63±14°	60±13°	67±11°	66±12°	50±15°	54±9°
60° 9 Nm	81±16°	75±13°	86±13°	82±12°	70±20°	69±10°
60° End-feel	75±16°	73±11°	79±12°	78±11°	62±21°	68±9°
30° 6 Nm	58±17°	56±17°	62±15°	64±6°	47±18°	48±13°
30° 9 NM	79±19°	74±17°	82±17°	83±16°	69±23°	65±14°
30° End-feel	76±17°	73±16°	80±15°	81±13°	63±20°	65±14°

In these patients, internal rotation ranged from 33-34 % and external from 66-67 % of the total rotation at all three flexion angles (90°, 60° and 30°) with all the three torques applied (6 Nm, 9 Nm and end-feel) at all three different flexion angles (90°, 60° and 30°).

# Discussion

## Validity and reliability of the Rottometer

Measurements of axial knee rotation with the Rottometer were evaluated by simultaneous measurements of skeletal movements (3), measured with RSA (89). The correlations between the two methods were high ( $r^2 = 0.87-0.94$ , depending on the applied torque and flexion angle) concerning measurements of total internal- external rotation. The result showed lower correlations concerning isolated internal ( $r^2 = 0.48-0.87$ ) and external ( $r^2 = 0.47-0.77$ ) rotation. Measurements of internal and external rotation might be influenced by the starting point that is defined as “neutral rotation ( $0^\circ$ )”. Since the “neutral rotation” of the knee can differ between subjects, and also between different flexion angles, this might have had an impact on these measurements. The lower correlation concerning isolated measurements of internal and external rotation might probably be a result of these circumstances. In our opinion, the total rotational range is the most accurate way to measure tibiofemoral rotation as the measurement is independent of the less defined rotational neutral position of the knee at the beginning of the measurement. Therefore, only the total range of knee rotation was evaluated and accounted for further in this thesis.

The within-day and test-retest reliability as well as inter-tester reliability of the device concerning total knee rotation were evaluated. As a result of the ICC calculations according to the recommendations of Fleiss (31), the Rottometer was judged to be a good (ICC 0.4-0.75) to excellent (ICC above 0.75) device with regards to the reliability for measuring knee rotation at three different flexion angles ( $90^\circ$ ,  $60^\circ$  and  $30^\circ$ ) with 6 and 9 Nm torques applied as well as the examiner’s apprehension of end-feel. A torque of 3 Nm showed lower reliability, and a possible explanation of poorer agreements could be that measurements made with 3 Nm produced a rather small range of rotation, and thus small differences between recordings resulted in relatively large disagreement. It is also possible that 3 Nm torque is too small to reach the end-points of the mechanical restraints and thus motions with a poorly defined end-point are measured.

## Healthy knee rotation reference values

The recordings in the healthy reference population showed a significant ( $p < 0.01$ ) 10-20% larger range of total knee rotation in females than in males. This result indicates that future studies evaluating axial knee rotation ought to provide a gender specific analysis. No significant differences within the genders were found between the different age groups. However, the largest range of rotation of all different gender and age groups were found in the youngest female group (15-30 years). Since younger females are more prone to sustain certain knee injuries and disorders compared to younger males (28), maybe the larger range of rotation affects the knee negatively in younger females.

The smallest range of rotation was registered in the male 46-60 year group, and surprisingly, a small but non-significant increase was noted after 60 years. It should be pointed out that there were difficulties in finding 15 males and 15 females with no prior or present knee injury, pain or surgery to represent the  $\geq 61$  year group. It is possible that the subjects representing the reference population being 61 years and older in this study are “too knee healthy” to represent the normal knee condition in older people in Sweden. Maybe a decrease of rotation can cause mechanical changes and disturbances and thereby to some degree have a causative role in dysfunctional problems in the older knee joint. If that is the case, it's possible that the older subjects in this study are born with a larger range of knee rotation, and are less vulnerable to a decrease, or have found a way to maintain their range of rotation in order not to disturb the fine tuned three-dimensional mechanics of the knee. No significant differences between the left and right knees were found in any of the different subgroups. Since no side-to-side differences were detected, comparisons between range of rotation in subjects with healthy knees and in knees affected with different injuries and disorders should be of great interest to systematically evaluate in future studies.

During the measurements in this study, we expected the knee rotation to decrease with decreasing flexion angle, since this has been reported earlier (51, 59, 70, 77). However, no significant differences occurred between the different flexion angles in this study. An explanation of this phenomenon might be that when the knee flexion angle was changed, the angle of the hip changed too. It has earlier been reported that the position of the hip influences the range of knee rotation, with greater values observed near hip extension compared to hip flexion at  $90^\circ$  (88). The changes of hip angles may have affected the range of rotation in the Rottometer measurements. It is also possible that there was a larger risk of movements in adjacent joints, such as the hip, at lower flexion angles ( $60^\circ$  and  $30^\circ$ ), which was detected as knee rotation by the Rottometer. Measurements employing  $30^\circ$  of knee flexion angle have not been compared and validated with measurements made with RSA (91) due to technical difficulties. However, in the present study,  $30^\circ$  of knee flexion was considered to be of great clinical interest and was therefore included, but the lack of validation should be taken into account.

## Patients with habitual dislocating patella

No significant differences in total knee rotation were found either between the affected or unaffected knees within the patients suffering from HDP, or compared to age matched healthy controls. The females in the HDP group showed a significant 10-20% larger range of total rotation than the males, which is in accordance with results of the healthy reference population. This result indicates that the range of total knee rotation has no impact in the injury mechanism of HDP except for maybe the gender difference.

However, four of the female subjects in the HDP group complained about discomfort and light knee pain during the examination. Three of these subjects proceeded the examination, but one female subject did not allow measurements with 9 Nm and end-feel due to these circumstances. It might be possible that these measurements with light pain present influenced the result negatively, and maybe concealed an even larger female rotation. The typical HDP patient is a young female (84) and the risk of a HDP is about 33% higher for girls compared to boys (32). The larger range of rotation in younger females might be a risk factor in HDP to occur. An increased outward rotation of the tibia will increase the q-angle and thereby create an increased laterally directed force in the patello-femoral joint during activation of the quadriceps (51, 71, 85). It should also be pointed out that the male patients in the HDP group only was constituted of 5 males (4 unilateral and 1 bilateral affected knees), and the knee rotation needs to be evaluated further in a larger male sample before any conclusions can be drawn.

An interesting observation was that the distribution of internal and external of the total rotation was different in the HDP patients and the healthy controls. The patients with HDP had a 6-11 % larger distribution of external rotation than the healthy controls, which in turn may have an impact on the HDP to occur. However, this result needs to be confirmed in a larger sample of patients, with a measurement device that is valid and reliable also for isolated measurements of internal and external rotation of the knee.

## The Rottometer vs earlier non-invasive measurement devices

It may be argued that comparing measurements of knee rotation between different studies are of less value since there is a rather large variation in range of rotation (Table 6). Different measurement devices, different flexion angles and different applied torques have been used. Also different positions have been used including seated (4, 75, 88), supine (16, 67, 89), prone (60), and lying sideways (101). There is also a probability that there is a rather large individual difference in range of rotation between different subjects. The subjects positioning, hip and knee flexion angles, leg fixation, applied torques, as well as movements in adjacent joints are thus critical factors that deserve particular consideration when measuring knee rotation. Neither the Rottometer nor other



**Table 6.** Results of different previously published studies of in vivo measurements of knee rotation with non-invasive external devices. The studies are accounted for authors, number of measured subjects, gender of the subjects, measured knee flexion angles, applied torques and total internal-external knee rotation. Results are given in degrees.

Author	n (subjects)	Gender	Knee flexion angle	Applied torque	Total rotation (°)
Almquist et al.	60	Female	90°	6 Nm	59±11
“				9 Nm	77±11
“				End-feel	72±11
“			60°	6 Nm	60±13
“				9 Nm	78±14
“				End-feel	75±13
“			30°	6 Nm	57±14
“				9 Nm	78±16
“				End-feel	77±16
“	60	Male	90°	6 Nm	52±8
“				9 Nm	68±8
“				End-feel	65±7
“			60°	6 Nm	51±9
“				9 Nm	66±8
“				End-feel	65±9
“			30°	6 Nm	43±10
“				9 Nm	62±11
“				End-feel	62±10
Branch et al.	14	Mixed	25°	5.65 Nm	38.1±8.4
Lorbach et al.	30	Mixed	30°	5 Nm	61.1±2.8
“				10 Nm	95.0±3.5
“				15 Nm	115.6±4.5
Mouton et al.	25	Female	30°	5 Nm	58.8±8.8
“				10 Nm	92.5±11.8
“	35	Male	30°	5 Nm	41.8±8.9
“				10 Nm	71.2±11.5
Shoemaker et al.	20	Mixed	20°	10 Nm	40.6±9.7
Schultz et al.	64	Female	20°	5 Nm	26.0±6.9
“	43	Male			21.2±6.9
Tsai et al.	11	Male	90°	6 Nm	18.5±4.7
“			30°		25.8±5.9
Zarins et al.	17	Mixed	90°	Not reported	74
“			60°		73
“			30°		72

external devices in previous studies seem to show the exact tibio-femoral rotational values. The validity of the non-invasive instruments presented earlier has not always been fully established. To the best of our knowledge, no other clinical external device to measure total range of knee rotation in vivo, except the Rottometer, has compared results of the measurement device with the actual femuro-tibial skeletal rotational movements in vivo in the same subjects simultaneously. In our study (3) with simultaneous RSA registrations (91) approximately 50 % of the registered rotation with the Rottometer did not originate from movements in the knee. However, the correlations between the Rottometer and RSA were high, and the differences were constant at repeated measurements with a linear increase at increasing torque. Therefore, the measurement error was systematic and thus can be predicted and compensated for. The results of our studies show that measurements of clinical non-invasive knee rotation with low applied torques, such as 3 Nm, are not meaningful to examine. It produces a rather small range of rotation, which doesn't reach the end-points of mechanical restraints. Measurements with applied torques higher than 9 Nm are not recommended, since it causes an increased risk of painful measurements and soft tissue movements. Higher torques also produces higher difference in range of the rotation compared to the real skeletal tibio-femoral rotation, compared with measurements with RSA (3). However, in measurements of certain patient categories there might be a risk of discomfort and light pain present also at 9 Nm applied torque. Therefore, measurements with lower torques, such as 6 Nm, are probably needed in order to be able to provide measurements of knee rotation for all different kinds of knee disorders.

There is a great interest in studying knee rotation in different flexion angles. Both, in order to establish the total available anatomical range of rotation (in 90°), but also to study more physiological flexion angles for weight-bearing activities (such as 60° and 30°). However, one should be aware of an increased risk of movements in adjacent joints (5) and influences of the hip in knee rotation at measurements at lower hip flexion angles (88), since this might affect the measurements.

Thus, it seems that the most valid and reliable measurements of knee rotation with an external non-invasive device, such as the Rottometer, probably should be performed with 9 Nm applied torque at 90° of knee flexion angle (3, 5). However, measurements with acceptable accuracy can also be provided with 6 Nm and the examiner's apprehension of end-feel at 60° and 30° (3, 5). As long as there is no golden standard measurement procedure, further studies with valid and reliable devices are needed.

## Sources of possible errors

There are a number of sources of variability inherent in rotation measurements of the knee in vivo. In measurements with the Rottometer the torque is applied to the foot in the tibial longitudinal axis, but not directly to the tibia. During repeated previous tests and minor pilot studies, it was concluded that this was the best solution given. A

disadvantage of this approach is that the torque might partly be absorbed by the fixation device and other anatomical structures of the leg rather than the knee joint. The amount of torque effectively applied to the knee is difficult to estimate, but ought to be evaluated further in the future. Knee rotation can also be measured directly at the tibia using skin sensors. However, such equipment is rare in daily clinical practice, and it has been reported that knee rotations other than flexion/extension may be affected with substantial errors when using external markers (80). Careful consideration was given to the design of the fixation clamps in the Rottometer, with the purpose of minimizing shifting due to soft tissue motion and at the same time avoiding pain. Pain or discomfort present during the examination makes it hard for the subject to relax, which may induce muscle tension. This in turn makes it impossible to measure the whole range of rotation. On the other hand, when different subjects endure different kinds of tightness of fixation this may cause a source of variability, as did the magnitude of each individual's soft tissue volume and elasticity. However, unless the ends of the goniometer are surgically fixed to the bone, the potential for soft tissue movements nonetheless exists.

Positioning-related faults are differences in orientation of the goniometer between trials if the various clamps of the instrument are not positioned on the bones identically each time the goniometer is attached, which may lead to variations in starting position.

There may be a variation in the limits of passive motion from differences in elasticity and plasticity in the soft tissue depending on whether the measurements are made in the morning or afternoon, or whether the subjects have been taking part in any physical activity shortly before the examination. It might also be possible that blood flow, temperature and stretching can influence the soft tissue characteristics. However, such possible changes in rotation during the day were not large enough to be registered with the device.

No documentation of the female subjects status concerning pregnancy has been done. If any of the female subjects in this study were pregnant, it could have affected the measurement result and may have been a source of error (63).

Different readings on the protractor between different examiners may also occur. It could be argued that the torque applied with the adjustable spanner might differ between examiners, if they had no experience in using the equipment. In the present study the two examiners were however trained in using both the protractor and the spanner before the study, and did not consider using the equipment to be a problem. It is also possible that the flexion angle could cause variability between trials if the examiner was not careful to adjust to the exact angle each time. The subjects in study III (4) represented a healthy knee reference population consisting of 120 persons (60 females and 60 males) divided into different age groups (15-30, 31-45, 46-60 and  $\geq 61$  years). The age groups were made in order to study possible changes in knee rotation due to age, and to be able to age match different categories of knee injuries and disorders in future studies. It may be argued that a group of 120 persons divided into several age and gender subgroups may be too small to represent a reference population. However, for the purpose it was assumed that the number of persons who volunteered for the study ought to be sufficient to represent a sample of the healthy knee population.

It should also be mentioned that the HDP population in study IV was constituted of only 27 knees (21 female and 6 male), and knee rotation needs to be evaluated further in a larger HDP sample before any more reliable conclusions can be made.

## The Rottometer and its clinical relevance

The Rottometer has been proven to be a valid (3) and reliable (5) measurement device in several different flexion angles with different torques applied. We believe that the Rottometer has the potential to be used in research and daily clinical work. It is a simple non-invasive device, and easy to use in clinical practice. However, it seems important to note that the Rottometer has advantages as well as limitations.

The Rottometer can only perform static measurements. Dynamic and subjective manual tests to detect and evaluate the pivot shift phenomenon as a sign of (43) rotational laxity after an ACL injury are sometimes used. Rotational instability of ACL deficiency has also been reproduced by using an electromagnetic measurement system (38). Static tests of rotation and the pivot shift test were evaluated after anatomic double bounding ACL reconstruction by using an optical navigation system, and no significant correlation between the two tests were found (11). However, the pivot shift test is not standardized and reproducible enough to allow a precise quantification, and are dependent of the examiner's experience and skills (61, 73). Furthermore, an ACL insufficiency has been shown to significantly increase isolated tibiofemoral rotation (57), and a significantly reduced static knee rotation in ACL injured patients has been reported in postoperative measurements (11, 60). The ongoing debate on different ACL reconstruction techniques to restore normal knee kinematics (19, 30, 34, 42) may also provide evidence for the need of well evaluated methods for measurements of knee rotation. Static measurements of knee rotation might add important information and offers the potential for an improved objective quality control in knee ligament injuries, their treatment and rehabilitation (60)

Similarities exist in patients at risk for patellar instability, patellofemoral pain and ACL injuries including a higher incidence in young females (32, 93). Our finding of 10-20% larger range of knee rotation in younger females compared to males (4) indicates that the amount of knee rotation may be an anatomical risk factor in these conditions. Evaluation and measurements of knee rotation and side-to-side differences, with valid and reliable measurement devices, may have an important part as a complement to existing examination tools and techniques in the diagnostic evaluations, during rehabilitation, and before and after surgery in certain knee injuries and disorders.



# Conclusion

The Rottometer has been shown to produce valid and reproducible results in a non-invasive setting. It therefore offers a potential to measure and evaluate total range of knee rotation in clinical studies and daily work. In the study of healthy reference values concerning total internal-external knee rotation, no differences between the left and right knee or between the different knee flexion angles (90°, 60°, 30°) were found. The female subjects showed a significant 10-20% larger knee rotation than the male subjects. However, no differences in range of rotation due to age were found within any of the genders. Patients affected with habitual dislocated patella showed no differences in knee rotation, nor between the affected and non-affected knee within the subjects or compared to age matched healthy controls.



# Acknowledgements

I wish to express my sincere gratitude to all those who helped me throughout this work. In particular, I would like to thank:

Charlotte Ekdahl, my main advisor, and Thomas Fridén, my deputy advisor, for excellent guidance in science, constructive criticism and for sharing your broad knowledge, experience and sharp analytic thinking with me. Thank You for your never failing encouragement and personal support. I hope that your long lasting patience has given results.

Per-Erik Isberg, my co-author, for invaluable statistical advice and fruitful discussions about soccer and skiing.

Leif Ryd, my co-author, for invaluable help and advice in study I and IV

Johan Lindquist and Jan Rademakers for the construction of the Rottometer, friendship and fertile discussions.

Mårten Lerner, for excellent technical support, skilful revision of the English text, friendship and for being a real cool dude.

The PhD students at the Department of Health Sciences, Division of Physiotherapy, Lund University, for fruitful discussions and honest, constructive criticism.

My friends and colleagues at Amadeus clinics and Nyhem health care central for friendship, support and for sharing experience and joy during every day of clinical works.

My employers, Geir Tangen, Pia Jildenheim, Gunilla Geijer-Lannerbro and Daniel Fritzson, for giving me the opportunity to take time off during the final stages of this work.

My mother, Signe Almquist, for your help and support in all ways one can possible think of.

My two sons, Zacharias and Noah, for enriching my life, being the main source of inspiration and being so lovely.

Above all, my mentor and co-author Rose Zätterström, for teaching me how to “think as a physical therapist”, for supporting my interest in research, for enjoyable discussions about research and other things in life, and for shearing her considerable knowledge, qualifications and skills in the field of physical therapy. Rest in piece.



This work was supported by grants from the County Council of Hallands FoU foundation, Bertil Hemborg Foundation, Emy Thulin Foundation and the Faculty of Medicine, Lund University.

# References

1. Adouni M, Shirazi-Adl A. Knee joint biomechanics in closed-kinetic-chain exercises. *Computer Methods in Biomechanics and Biomedical Engineering* 2009;12(6):661-670
2. Alentorn-Geli E, Myer GD, Silvers HJ, Samitier G, Romero D, Lázaro-Haro C, Cugat R. Prevention of non-contact anterior cruciate ligament injuries in soccer players. Part 1: Mechanism of injury and underlying risk factors. *Knee Surg Sports Traumatol Arthrosc* 2009;17:705-729)
3. Almquist P O, Arnbjörnsson A, Zätterström R, Ryd L, Ekdahl C, Fridén T. Evaluation of an external device measuring knee joint rotation – An in vivo study with simultaneous Roentgen Stereometric Analysis. *J Orthop Res* 2002;20: 427-432
4. Almquist P O, Ekdahl C, Isberg P E, Fridén T, Knee rotation in healthy individuals related to age and gender. *J Orthop Res*, accepted 11 June 2012
5. Almquist P O, Ekdahl C, Isberg P E, Fridén T, Reliability of an external device measuring knee rotation in vivo, *BMC Musculoskeletal disorders* 2011;12:291
6. Amis AA, Oguz C, Bull AM, Senavongse W, Dejour D. The effect of trochleoplasty on patellar stability and kinematics: a biomechanical study in vitro. *J Bone Joint Surg Br.* 2008;90:864-869
7. Armitage P. Intraclass correlation. In *statistical methods in medical research* (edited by P Armitage and G Berry). Oxford, Blackwell Scientific 1994, 273-276
8. Atkinson G, Neville AM. Statistical methods for assessing measurement error (reliability) in variables relevant to sports medicine. *Sports Med* 1998; 26:217-238
9. Balcarek P, Jung K, Ammon J, Walde TA, Frosch S, Schuttrumpf JP, Frosch K-H, Anatomy of lateral patellar instability. Trochlear dysplasia and tubercle-trochlear groove distance is more pronounced in women who dislocate the patella. *Am J Sports Med*, 2010;11:2320-2327
10. Becket ME, Massie DL, Bowers KD, Stoll DA. Incidence of hyperpronation in the ACL injured knee: a clinical perspective. *J Athl Train* 1992;27:58-62
11. Biggnozzi S, Zaffagnini S, Lopomo, N, Fu FH, Irrgang JJ, Marcacci M. Clinical relevance of static and dynamic tests after anatomical double-bundle ACL reconstruction. *Knee Surg Sports Traumatol Arthrosc* 2010;18:37-42
12. Bland JM, Altman DG: Measuring agreement in method comparison studies. *Stat Methods Med Res* 1999; 8:135-60
13. Blankevoort L, Huskies R. A mechanism for rotation restrains in the knee joint. *J Orthop Res* 1996;14(4): 676-679
14. Blauth M, Tillman B. Stressing on the human femoro-patellar joint. *Anat Embryol* 1983;168:117-123
15. Bragdon CR, Malchau H, Yuan X, Perinchieff R, Kärrholm J, Borlin N, Estok DM, Harris WH. Experimental assessment of precision and accuracy of radiostereometric

- analysis for the determination of polyethylene wear in a total hip replacement model. *J Orthop Res* 2002;20:688-695
16. Branch TP, Browne JE, Campbell JD, Seibold R, Freedberg HI, Arendt EA. Rotational laxity greater in patients with contralateral anterior cruciate ligament injury than healthy volunteers. *Knee Surg Sports Traumatol Arthrosc* 2010;18(10):1379-1384
  17. Brandsson S, Karlsson J, Eriksson BI, Kärrholm J. Kinematics after tear in the anterior cruciate ligament. Dynamic bilateral radiostereometric studies in 11 patients. *Acta Orthop Scand* 2001;72:372-378
  18. Brattström H. Shape of the intercondylar groove normally and in recurrent dislocation of patella. *Acta Radiol.* 1964;Suppl 68, p 5
  19. Bull AM, Earnshaw PH, Smith A, Katchburian MV, Hassan AN, Amis AA. Intraoperative measurement of knee kinematics in reconstruction of the anterior cruciate ligament. *J Bone Joint Surg Br* 2002;84(7):1075-1081
  20. Caillet RC: *Functional Anatomy*. In *Knee Pain and Disability*, F.A. Davis Co. Philadelphia. 1973. 49-69
  21. Carragher AM, Todd A, Blake G. Acute traumatic lateral patellar dislocation. *Ann Emerg Med* 1989;18: 149-150
  22. Caubad HE. Biomechanics of the anterior cruciate ligament. *Clin Orthop* 1983;172:26-30
  23. Cofield RH, Bryan RS. Acute dislocation of the patella: Results of conservative treatment. *J Trauma* 1977;17:526-531
  24. Colombet P, Robinson J, Christel P, Franceschi JP, Dijan P. Using navigation to measure rotation kinematics during ACL reconstruction. *Clin Orthop Relat Res.* 2007;454: 59-65
  25. Cox JS. Patellofemoral problems in runners. *Clin Sports Med* 1985;4:699-715
  26. Czerniecki JM, Lippert F, Olerud JE. A biomechanical evaluation of tibiofemoral rotation in anterior cruciate ligament deficient knees during running and walking. *Am J Sports Med* 1988;16:327-31
  27. Dejour H, Walch G, Nove-Josserand L, Guier C. Factors of patellar instability: an anatomic radiographic study. *Knee Surg Sports Traumatol Arthrosc.* 1994;2:19-26
  28. Domholt E: *Rehabilitation Research Principles and Applications*. St Lois, Missouri, Elsevier Saunders, 2005
  29. Evans P. Clinical biomechanics of the subtalar joint. *Physiotherapy* 1991;76: 47-51
  30. Favre J, Luthi F, Jolles BM, Siegrist O, Najafi B, Aminian K. A new ambulatory system for comparative evaluation of the three-dimensional knee kinematics, applied to anterior ligament injuries. *Knee Surg Sports Traumatol Arthrosc* 2006;14(7):592-604
  31. Fleiss J. Reliability of measurements. In: *The design and analysis of clinical experiments*. New York, John Wiley & Sons 1986, pp 2-31
  32. Fithian DC, Paxton EW, Stone ML. Epidemiology and natural history of acute patellar dislocation. *Am J Sports Med.* 2004;32:1114-1121
  33. Fridén T, Ryd L, Lindstrand A. Laxity and graft fixation after reconstruction of the anterior cruciate ligament: a roentgen stereophotogrammetric analysis of 11 patients. *Acta Orthop Scand* 1992;232 Suppl: 1-51
  34. Georgulis AD, Ristanis S, Chouliaras V, Moraiti C, Stergiou N. Tibial rotation is not restored after ACL reconstruction with hamstring graft. *Clin Orthop Relat Res* 2007;454:89-94

35. Gowitzke BA, Millner S. Scientific bases of human movements. Williams and Wilkins, Baltimore 1988; pp 1-3
36. Greiwe RM, Saifi C, Ahmad CS, Gardner TR. Anatomy and Biomechanics of patellar instability, Oper Tech Sports Med 2010;18:62-67
37. Hollis JM, Takai, S, Adams DJ, Horibe S, Woo S. The effects of knee motion and external loading on the length of the anterior cruciate ligament: A kinematic study. J Biomech Eng, 1991;113:208-214
38. Hoshino, Y, Kuroda R, Nagamune K, Araki D, Kubao S, Yamaguchi M, Kurosaka M. Optimal measurements of clinical rotational tests for evaluating anterior cruciate ligament insufficiency. Knee Surg Sports Traumatol Arthrosc. 2011; doi:10.1007/s00167-001-1643-5
39. Hungerford DS, Barry M, Biomechanics of the patellofemoral joint. Clin Orthop 1979;144:9-15
40. Inman V T. Analysis of ankle and subtalar motion during human locomotion. In: Inman's joints of the ankle. Second edition. Baltimore, Williams & Wilkins. 1976; pp 75-84
41. Ishibashi Y, Tsuda E, Tazawa K, Sato H, Toh S. Intraoperative evaluation of the anatomical double-bundle anterior cruciate ligament reconstruction with the Ortho Pilot navigation system. Orthopedics. 2005;28(10 Suppl): 1277-1282
42. Isberg J, Faxen E, Laxdal G, Eriksson BI, Karrholm J, Karlsson J. Will early reconstruction prevent abnormal kinematics after ACL injury? Two-year follow-up using dynamic radiostereometry in 14 patients operated with hamstring autografts. Knee Surg Sports Traumatol Arthrosc 2011;19(10):1634-1642
43. Jakob RP, Staubli HU, Deland JT. Grading the pivot shift. Objective tests with implications for treatment. J Bone Joint Surg Br 1987;69(2):294-299
44. Johansson H, Sjölander P, Sojka P. A sensory role for the cruciate ligaments. Clin Orthop 1991;268:161-78
45. Jonsson H, Elmqvist LG, Kärrholm J, Fugl-Meyer A. Graft lengthening after surgery of anterior cruciate ligaments. Roentgen stereophotogrammetry of 32 cases. Acta Orthop Scand 1992;63:587-592
46. Jonsson H, Kärrholm J. Three-dimensional knee joint movements during a step-up. Evaluation after anterior cruciate ligament rupture. J Orthop Res 1994;12:769-779
47. Jonsson H, Kärrholm J, Elmqvist LG. Laxity after cruciate ligament injury in 94 knees. KT-1000 arthrometer versus roentgen stereophotogrammetry. Acta Orthop Scand 1993;64:567-570
48. Jorn LP, Fridén T, Ryd L, Lindstrand A. Simultaneous measurements of sagittal knee laxity with an external device and stereometric analysis. J Bone Surg Br 1998;80:169-172
49. Järvinen M, Natri A, Lehto M, Kannus P. Reconstruction of chronic anterior cruciate ligament insufficiency in athletes using a bone-patellar tendon bone autograft. A two year follow up study. Int Orthop 1995;19:1-6
50. Kaltenborn F M, Evjenth O: Examination of joint movements. In Manual mobilisation of joints in the extremities. Manual examination and mobilisation of the joints in basic education, Olaf Norlis Bokhandel, 1985, pp 34-37
51. Kapandji I A: The Knee. In The Physiology of the Joints, Vol 2, Second edition, Livingstone, UK, 1970, pp 72-134
52. Khan MS, Seon KJ, Rotational profile of lower limb and axis for tibial component alignment in varus osteoathitic knees, The Journal of Arthroplasty vol 00 No 0 2011

53. King S, Butterwick DJ, Cuerrier JP. The anterior cruciate ligament: A review of recent concepts. *J Orthop Sports Phys Therap* 1986;8:110
54. Kärrholm J, Brandsson S, Freeman MAR. Changes of axial tibial rotation at the weight-bearing knee studied by RSA. *J Bone Joint Surg Br* 2000 ;82:1201-1203
55. Kärrholm J, Selvik G, Elmqvist LG, Hansson LI, Jonsson H Three dimensional instability of anterior cruciate deficient knee. *J Bone Joint Surg Br* 1998;70:777-783
56. Lambson, Barnhill, Higgins, Football cleat design and it's effect on anterior cruciate ligament injuries, *Am J Sports Med* 1996; 155-159
57. Lane JG, Irby SE, Kaufman K, Rangger C, Daniel DM. The anterior cruciate anterior ligament in controlling axial rotation. An evaluation of it's effect. *Am J Sports Med* 1994;22:289-293
58. Larson RL. Patellar compression syndrome: Surgical treatment by lateral retinacular release. *Clin Orthop* 1970;134:158-167
59. Lehmkuhl L D, Smith L K: Knee region. In Brunnstrom's Clinical Kinesiology, Edition 4, F.A. Davis Company, Philadelphia 1983, pp 287-307
60. Lorbach O, Brockmeyer M, Kieb M, Zerbe T, Pape D, Seil R. Objective measurement devices to static rotational knee laxity: focus on the Rotameter, *Knee Surg Sports Traumatol Arthrosc DOI* 2012;10.1007/s00167-011-1876-3
61. Lubowitz JH, Bernadini BJ, Reid JB 3rd. Current concept review: comprehensive physical examination for instability of the knee. *Am J Sports Med* 2008;36(3):577-594
62. Magit DP, McGarry M, Tibone JE, Lee TQ. Comparison of Cutaneous and Transosseous Electromagnetic Position Sensors in the Assessment of Tibial Rotation in a Cadaveric Model. *Am J Sports Med* 2008;36(7): 1389-96
63. Marnach ML, Ramin KD, Ramsey PS, Song SW, Stensland JJ, An KN. 2003. Characterization of the relationship between joint laxity and maternal hormones in pregnancy. *Obstet Gynecol* 101(2): 331-335
64. Matsumoto H, Seedhom B. Rotation of the tibia in the normal and ligament-deficient knee. A study using biplanar photography, *Proc Inst Mech Eng (H)* 1993;207:175-84
65. Montgomery DC. Factorial experiments. In: Design and analysis of experiments. 7 th edition, John Wiley & sons 2009: 162-201
66. Muiadi QI, Nicholson LL, Refshauge KM: Do elite athletes exhibit enhanced proprioceptive acuity, range and strength of knee rotation compared with non-athletes? *Scand J Med Sci Sports* 2009;19: 103-112
67. Mouton C, Theisen D, Pape D, Nuhrenborger C, Seil R. Static rotational knee laxity in anterior cruciate ligament injuries, *Knee Surg Sports Traumatol Arthrosc*, 2012; Apr;20(4): 652-62. Epub 2012 Jan 14
68. Nielsen S. Kinesiology of the knee joint: An experimental investigation of ligamentous and capsular restraints preventing knee instability. *Dan Med Bull* 1987;34:297-309
69. Nielsen S, Rasmussen O, Ovesen J, Andersen K. Rotatory instability of cadaver knees after transaction of collateral ligaments and capsule, *Arch Orthop Trauma Surg* 1984;235-41
70. Nordin M, Frankel V H: Basic Biomechanics of the Musculoskeletal System, Lea Febiger, Philadelphia, London, 1989
71. Norkin C C, Levangie P K. The knee complex. In: Joint structure and function: A comprehensive analysis, second ed. Philadelphia: F A Davis Company 1992 p 337-372

72. Noyes FR, Groot ES, Cummings JF, Wroble RR. An analysis of the pivot shift phenomenon. The knee motions and subluxations induced by different examiners. *Am J Sports Med* 1991;19:148-155
73. Noyes FR, Cummings JF, Groot Es, Walz-Hasselfeld KA, Wroble RR, The diagnosis of knee motion limits, subluxations, and ligament injury, *Am J Sports Med*, 1991;19:163-171
74. Palmitier RA, An K-N, Scott SG, Chao E. Kinetic chain exercise in knee rehabilitation. *Sports Medicine* 1991;11(6):402-413
75. Park HS, Wilson NA, Zhang LQ. Gender differences in passive knee biomechanical properties in tibial rotation, *J Orthop Res* 2008;26(7):937-944
76. Paulos L, Rushe K, Johnsson C, Noyes FR. Patellar malalignment. A treatment rationale. *Phys Ther* 1980;60: 1624
77. Petrén T, *Anatomy 1 (Anatomi 1 – in Swedish)*, Stockholm: Nordiska bokhandelns förlag: 1984. p 235-41
78. Rankin G, Stokes M. Reliability of assessment tools in rehabilitation: an illustration of appropriate statistical analyses. *Clin Rehab* 1998;12: 187-199
79. Reilly DT. Dynamic loading of normal joints. *Rheum Dis Clin North Am* 1988;14(3):497-502
80. Reinschmidt C, van den Bogert AJ, Lundberg A, Nigg BM, Murphy M, Stacoff A, Stano A. Tibiofemoral and tibioaneal motion during walking: external vs. skeletal markers. *Gait and Posture* 1997;6:98-109
81. Ristanis S, Giakas G, Papageorgiou C D, Moraiti T, Stergiou N, Georgoulis A D. The effects of anterior cruciate ligament reconstruction on tibial rotation during pivoting after descending stairs. *Knee Surg Sports Traumatol Arthrosc* 2003;11:360-365
82. Roger DJ, Williamson SC, Uhl RL. Difficult reductions in traumatic patellar dislocation. *Orthop Rev* 1992;21:1333-1337
83. Rothstein JM, *Measurement and clinical practice: Theory and application*. In Rothstein JM (ed) *Measurement in physical therapy*. New York, Churchill Livingstone, 1985
84. Rünow A. The dislocating patella. Etiology and prognosis in relation to generalized joint laxity and anatomy of the patella. *Acta Orthop Scand Suppl.* 1983; 201:1-53
85. Sanfridsson J, Arnbjörnsson A, Fridén T, Ryd L, Svahn G, Jonsson K. Femorotibial rotation and the q-angle related to the dislocating patella, *Acta Radiologica* 2001;42: 218-224
86. Saari T, Carlsson L, Karlsson J, Kärrholm J. Knee kinematics in medial arthrosis. Dynamic radiostereometry during active extension with weight-bearing. *J Biomech* 2005;38:285-292
87. Shaw JA, Eng M, Murray DG. The longitudinal axis of the knee and the role of the cruciate ligaments in controlling transverse rotation, *J Bone Joint Surg A* 1974;56:1603-1609
88. Schoemaker SC, Markolf KL. In vivo rotatory knee stability. *J Bone Joint Surg Am A* 1982;64(2): 208-16
89. Schultz SJ, Schmitz RJ, Beynonn BD. Variations in varus/valgus and in internal/external rotational knee laxity and stiffness across the menstrual cycle. *J Orthop Res* 2011;29(3):318-325
90. Schultz JS, Scmitz RJ, Benyon BD, Perrin DH. Measurement of Varus-Valgus and Internal-External Rotational Laxities In Vivo – Part I: assessment of measurement reliability and bilateral asymmetry, *J Orthop Res* 2007;25(8) 981-988

91. Selvik G. Roentgen Stereophotogrammetry. A method for the study of the kinematics of the skeletal system. Thesis, University of Lund, Lund, Sweden. Acta Orthop Scand Suppl 1974, Reprint: 1989;232:1-51
92. Shrout PE, Fleiss JL. Intraclass correlations: Uses in assessing rater reliability. Psychol Bull 1979;86(2):420-428
93. Stefancin JJ, Parker RD. First time traumatic patellar dislocation: a systematic review. Clin Orthop Relat Res. 2007;455:93-101
94. Steindler A. Kinesiology of the human body under normal and pathological conditions. Charles C. Thomas, Springfield IL 1973; 63
95. Streiner DL, Norman GR. Health measurement scales a practical guide to their development and use. New York, Oxford University Press, 2003
96. Terry GC, Hughston JC, Norwood LA. Anatomy of the iliopatellar band and iliotibial tract. Am J Sports Med 1986;14:39-45
97. Torzilli PA, Greenberg RL, Insall J. An in vivo biomechanical evaluation of anterior-posterior motion of the knee. J Bone Joint Surg 1981;63A:960-968
98. Tsai AG, Musahl V, Steckel H, Bell KM, Zanto T, Irrgang JJ, Fu F: Rotational knee laxity: Reliability of a simple measurement device in vivo, BMC Musculoskeletal Disorders 2008;9:35
99. Wang CJ, Walker PS Rotatory laxity of the human knee joint. J Bone Joint Surg Am 56(1):161-170
100. Yuan XH, Ryd L. Accuracy analysis for RSA, a computer simulation study on 3D marker reconstruction. J Biomech 2000;33:493-498
101. Zarins B, Rowe C, Harris BA: Watkins MP: Rotational motion of the knee. Am J Sports Med 1983;11:152-156









ELSEVIER

Journal of Orthopaedic Research 20 (2002) 427–432

Journal of  
Orthopaedic  
Research

www.elsevier.com/locate/orthres

## Evaluation of an external device measuring knee joint rotation: an in vivo study with simultaneous Roentgen stereometric analysis

Per O. Almquist<sup>a,\*</sup>, Arnbjörn Arnbjörnsson<sup>b</sup>, Rose Zätterström<sup>c</sup>, Leif Ryd<sup>b</sup>,  
Charlotte Ekdahl<sup>a</sup>, Thomas Fridén<sup>b</sup>

<sup>a</sup> Department of Physical Therapy, Lund University, P.O. Box 5134, Lund, Sweden

<sup>b</sup> Department of Orthopaedics, Lund University, Lund, Sweden

<sup>c</sup> Department of Physical Medicine, Lund University Hospital, Lund, Sweden

Received 26 March 2001; accepted 17 September 2001

### Abstract

An external device ("roto-meter") specially designed to measure knee joint rotation was developed and evaluated with respect to its validity. Simultaneous measurements were made with the roto-meter and Roentgen stereometric analysis (RSA) in five patients with implanted tantalum markers in the tibia and femur. Measurements of internal and external rotation were made at 90° and 60° of knee flexion using 3, 6 and 9 N m torques. The coefficients of determination ( $r^2$ ) between the results obtained with the roto-meter and RSA were around 0.9 for the total rotation. The roto-meter consistently overestimated the rotation by about 100% and this systematic error was most constant at 90° flexion for the different torques. The magnitude of this error from soft tissue deformation as well as the rotatory movements in the hip, foot and ankle joints must be considered when using external devices to measure knee rotation in clinical studies. The most accurate registrations were found in 90° flexion with 9 N m force ( $r^2 = 0.94$ ). © 2002 Orthopaedic Research Society. Published by Elsevier Science Ltd. All rights reserved.

**Keywords:** Knee joint rotation measurement instrument; Accuracy

### Introduction

The fine tuned three-dimensional mechanics of the knee are extremely complicated, because of the anatomical incongruence of the articular surfaces, the effect of intrinsic ligamentous structures, the presence of menisci, and the insertions of and forces in surrounding tendons [6]. During the stance phase of walking, the foot is fixed to the ground. This causes internal rotation of the tibia with ankle dorsiflexion and external tibial rotation with plantar flexion of the ankle [5]. Knee rotation is therefore important for most weightbearing movements, and also for the screw-home mechanism [6], which provides the mechanical stability to withstand forces in full extension [13]. Excessive forces in the knee may tear ligamentous structures, resulting in defects in the envelope of passive motion, including rotatory motions [2,4]. The normal range of rotation of the knee in

various healthy populations in vivo is not known, and rotation is hardly ever estimated in clinical work with ligament injuries or after surgical procedures, most probably due to the technical difficulties in obtaining reliable measurements. A device measuring knee joint rotation could be of great value as a complement to existing clinical tools and examination equipment. An abnormal femurotibial axial rotation has been described in patients with recurrent patellar dislocation using a radiographic technique [14]. Measurements with a clinical device might add further information in a larger population of these patients both pre- and postoperatively. Measuring knee rotation with an external device may also provide information about disturbances after different types of knee ligament lesions as well as the effect of different surgical procedures.

Clinically useful information concerning rotatory laxity of the knee has mainly been obtained from cadaver studies [7,9,11,15,17]. A few in vivo measurements of tibial axial rotation have been reported [3,16,18]. The instruments used are more or less experimental [3,16], or their validity has not been determined [18]. To our

\* Corresponding author. Tel.: +46-35-120924; fax: +46-35-134501.  
E-mail address: otto.carina@swipnet.se (P.O. Almquist).

knowledge, there are no studies that have compared measurements of knee joint rotation *in vivo*, using a goniometer and measurements of movements of the skeleton.

The aim of this study was to assess the validity of measurements of knee joint rotation *in vivo* by simultaneous registrations, using Roentgen stereometric analysis (RSA) [14].

## Methods

### *Development of the rottometer*

A measuring device, the rottometer, was developed after studies of biomechanics, functional anatomy, and clinical observations. Pilot studies involving both healthy subjects and patients were repeatedly done during its development and construction. Technical imperfections were corrected, the fixation of the subject to the instrument was gradually improved, and painful measurements due to the fixation clamps were avoided. Based on the results of repeated tests before the main study, we selected torques of 3, 6 and 9 N m. It was considered that torques over 9 N m would not be tolerated by the subjects because of pain. Torques less than 3 N m were not relevant or meaningful to measure, due to the inertia of the limb, meaning that the range of rotation was small and seemed to vary in relation to the mass of the lower limb.

### *The rottometer*

A modified chair, specially constructed for this purpose, served as the base of the instrument (Fig. 1). The heavy chair provided a stable test situation, and since it was adjustable, it could accommodate subjects of various sizes. Knee positions, ranging from full extension to 90° of knee flexion, were achieved by minor changes in the setup. The thigh was strapped firmly to the chair with a dual-locking clamp.

When the knee was positioned properly, the dual-locking clamp was tightened into place, to keep the femur and hip from moving in the frontal and sagittal planes. At the bottom of the chair, a protractor was attached between two iron poles. A foot-plate, with ball bearings permitting rotation, was attached to the protractor. The subject's foot was secured to the foot-plate with six soft nosed screws, with the calcaneus held in the lateral–medial direction by two screws, and the medial and lateral malleolus in the anteroposterior direction by four screws. A metal frame attached to the foot-plate served as a platform for the malleolus fixation screws. A U-shaped metal stay was used as platform for the calcaneus screws. The purpose of this construction was to prevent movements of soft tissue and of the subtalar and ankle joints. Two vertical plastic poles with velcro straps were riveted to the foot-plate, one on each side of the tibia. A textile orthosis, which could be attached to the velcro straps, was tied around the lower leg. Four velcro straps were tightened around the lower leg, including the plastic poles and the textile orthosis, to minimize soft tissue movements. A measuring stick followed the foot-plate, pointing to the degree of tibial rotation on the protractor. An adjustable spanner was used to apply the different torques (N m). It permitted measurements with various forces (N m), and was calibrated and tested to provide torques reproducible within  $\pm 3\%$  (Rausol, Germany).

### *Testing procedure*

Measurements were made at 90° and 60° of knee flexion, by a single examiner (POA). The angle of 90° of knee flexion was chosen for the study, since this has been reported [6,8,13] to be the angle where the knee has the largest rotational range of motion. To study whether a change in the angle of flexion would affect the validity of the instrument, 60° of flexion was also used. Smaller flexion angles were avoided in order not to lose control over femoral rotation. In each position, we measured passive internal and external rotations of the foot-plate in relation to the femur. The spontaneous resting position of the knee at each flexion angle was defined as neutral rotation (0°). The test persons were instructed to relax their muscles to allow the examiner to move the leg passively. Then internal and external rotation were measured three times during the application of 3, 6 and 9 N m torques while radiographs were taken.

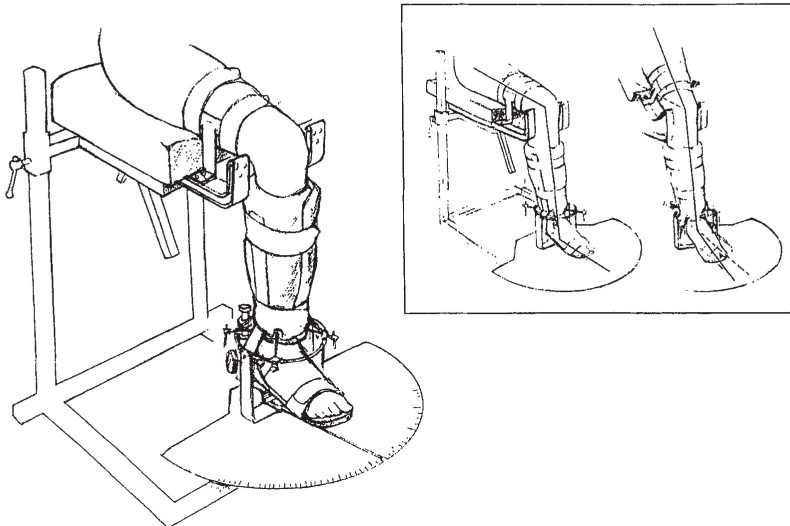

Fig. 1. The rottometer with a test subject fixed to the device ready to be measured. In the frame: changes in flexion angles from 90° to 30°.

## Subjects

All patients in the study were volunteers. Five male subjects who had tantalum [14] markers in the proximal tibia and distal femur were evaluated. The tantalum markers had been implanted during a previous anterior cruciate ligament reconstruction and were used primarily for purposes other than the present one. The study was approved by the Ethics Committee of Lund University.

## RSA

RSA is a method with higher precision, both from the technical point of view and in a dynamic setup, than conventional radiography. Calibration radiographs were obtained in frontal and lateral projections, using a plexiglas calibration cage and two reference planes. After calibration, the cage was excluded, leaving the two reference planes, one in front of each film, to be exposed, together with patient's markers. The knee was subsequently placed at 90° and 60° of flexion and was fixed firmly to the rottometer. Care was taken to ensure that the tibia was parallel to the cage planes in both projections. The marker images on all radiographs were digitized, using a precision digitizing table (Hasselblad Engineering, precision 10 µm). Rotation of the tibia relative to the femur was done by using the KINEMA routine, based on rigid body kinematics [14].

## Statistical analysis

Pearson's coefficient of determination ( $r^2$ ) was calculated to study the relation between the two methods.

## Results

### Total internal–external rotation

The total internal–external rotation (Fig. 2), with the external device at 90° of knee flexion, increased from 29 ± 8° at 3 N m to 66 ± 15° at 9 N m torque. At 60°, the corresponding figures were 26 ± 7° and 65 ± 7°. With RSA, there was also an increase at 90°, from 19 ± 7° at 3 N m to 32 ± 9° at 9 N m torque. At 60°,

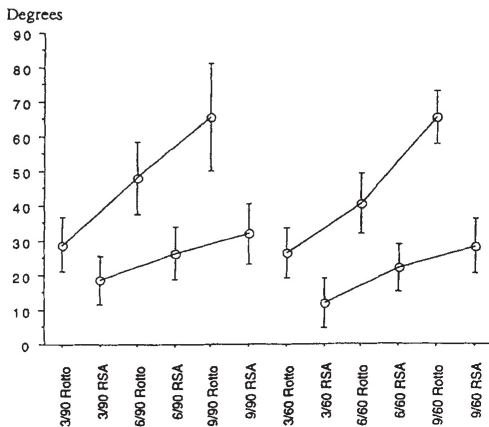

Fig. 2. Total rotation, as measured with RSA and the rottometer at flexion angle of 60° and 90° flexion angle with 3, 6 and 9 N m torque applied.

the corresponding figures were 12 ± 7° and 28 ± 8°, respectively. With increasing torque the differences between the two methods increased – i.e., from 12° at 3 N m, 20° at 6 N m, and 35° at 9 N m when recordings at both flexion angles were analyzed as one group. The coefficient of determination ( $r^2$ ) at 3 N m was 0.87 ( $p < 0.0001$ ), at 6 N m 0.93 ( $p < 0.0001$ ) and at 9 N m 0.94 ( $p < 0.0001$ ). The difference at 90° was 22° and at 60°, 23° when the recordings at the three forces were analyzed as a single group. The coefficient of determination at 90° was 0.94 ( $p < 0.0001$ ) and at 60° 0.92 ( $p < 0.0001$ ).

## Internal rotation

Internal rotation (Fig. 3(a), Table 1(a)) with the external device at 90° of knee flexion increased from 11 ± 4° at 3 N m to 30 ± 9° at 9 N m. At 60°, the corresponding figures were 11 ± 5° and 31 ± 3°, respectively. With RSA, the increase at 90° was from 6 ± 3° at 3 N m to 13 ± 5° at 9 N m and the corresponding figures at 60° were 6 ± 5° and 13 ± 4°, respectively. The differences between the two methods increased with increasing torque, 5° at 3 N m, 8° at 6 N m and 18° at 9 N m, when recordings at both flexion angles were analyzed as a single group. The coefficient of determination ( $r^2$ ) at 3 N m was 0.87 ( $p < 0.0001$ ), at 6 N m 0.48 ( $p < 0.03$ ), and at 9 N m 0.55 ( $p < 0.014$ ). The difference at 90° was 11° and at 60°, 10°, when recordings at the three forces were analyzed as one group and the coefficient of determination at 90° was 0.87 ( $p < 0.0001$ ) and at 60°, 0.58 ( $p < 0.0009$ ).

## External rotation

External rotation (Fig. 3(b), Table 1(b)) with the external device at 90° of knee flexion increased from 18 ± 6° at 3 N m to 36 ± 7° at 9 N m. At 60°, the corresponding figures were 16 ± 6° and 34 ± 5°, respectively. With RSA, the increase at 90° was from 13 ± 7° at 3 N m to 19 ± 8° at 9 N m and the corresponding figures at 60° were 6 ± 4° and 15 ± 6°, respectively. We found that the differences between the two methods increased with increasing torque, 7° at 3 N m, 12° at 6 N m and 18° at 9 N m, when recordings at both flexion angles were analyzed as a single group. The coefficient of determination ( $r^2$ ) at 3 N m was 0.47 ( $p < 0.028$ ), at 6 N m 0.77 ( $p < 0.0008$ ) and at 9 N m 0.51 ( $p < 0.02$ ). The difference at 90° was 11° and at 60°, 14°, when recordings at the three forces were analyzed as a single group and the coefficient of determination at 90° was 0.53 ( $p < 0.0008$ ) and at 60°, 0.66 ( $p < 0.0002$ ). The greater difference with increasing load between RSA and the rottometer (Figs. 2 and 3) was analyzed further by calculating the quotient between the two methods

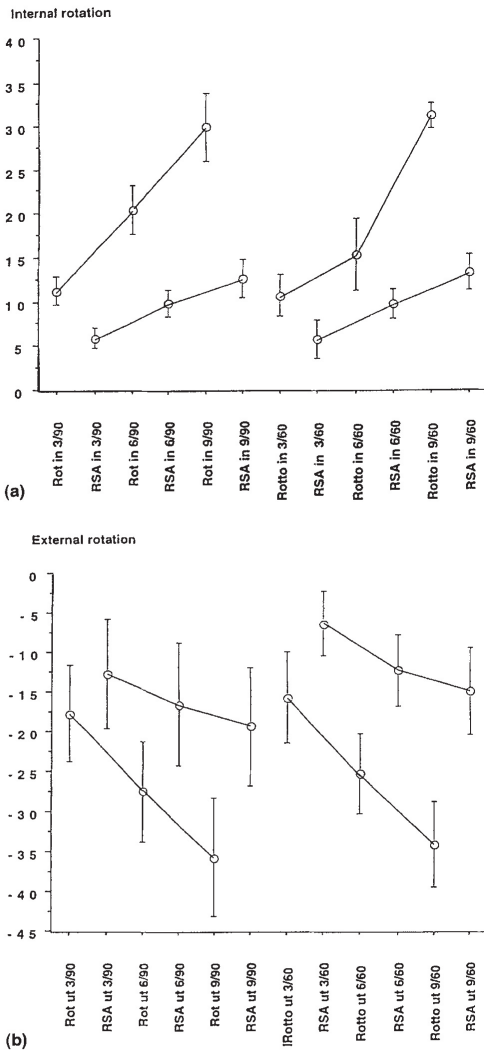

Fig. 3. Internal (a) and external (b) rotation, as measured with RSA and the rottometer at flexion angle of 60° and 90° with 3, 6 and 9 N m torque applied.

(Table 1). Such quotients tended to center around 0.5 (range 0.44–0.60), with the lowest relative variation at the 90° flexion angle. The difference in total rotation between RSA and the rottometer at the three torques showed good linearity ( $r^2 = 0.87$ ;  $p < 0.0001$ ) (Fig. 4), related to the rottometer recordings at a flexion angle of 90°.

**Discussion**

An externally applied measuring device cannot be as exact as recordings with devices secured directly to the skeleton for measurements of knee rotation, but to study patients clinically, a non-invasive, easily accessible method is necessary. Measurements of bone movements can be made on radiographs, the most precise method today probably being RSA [14]. The validation of the newly developed device could have been done in cadaver studies, but this would not have been adequate for in vivo measurements, since pain due to fixation to the instrument, and lack of control over self-generated muscle tonus would not be taken into account. Other disadvantages with in vitro studies, despite the possibility of perfect fixation, are postmortem stiffness with its differences in soft tissue compliance, and also the complete lack of muscular activity. Since the rottometer was constructed as a measurement instrument for clinical studies we felt that in vivo validation was necessary.

Zarins et al. [20] have measured knee rotation with the subject lying on one side. The knee was positioned and measured at angles of 90°, 60°, 30°, 15° and 5° of flexion. The torque applied was not reported. The measurements at both 90° and 60° showed a larger range of rotation than those with the rottometer (73° at 60° of knee flexion and 74° at 90° of flexion). Measurements made at this position have many advantages as well as disadvantages. For example, the femur and hip joint can easily be fixed well in this position and it is not hard for the patient to relax. However, when the patient lies on one side it is difficult to find the “zero position” of rotation. Good stabilization is hard to obtain in thighs of subjects who are obese, in patients with tibial torsion, genu valgum, genu varum and other malalignment syndromes. The test–retest reliability of the instrument was evaluated but no results of intertester reliability or validity were reported.

Schoemaker and Markolf [15] examined the passive range of motion for knee rotation, combined with the measurement of maximum isometrically generated tibial, torque by asking the subject to twist against a locked torque-cell. These active and passive components of axial knee rotation were measured with a clinical kneetesting apparatus. Measurements were carried out in the same sitting position as in the present study, and knee rotation was measured at 20° and 90° of flexion with the hip joint flexed and extended using a 10 N m torque. One of the results of that study was that a change in hip joint flexion influences the knee rotation, which indicates a possible source of error, if the femur and hip joint are not properly fixed. That instrument allowed the foot to move freely and registrations were made of both knee rotation and motion of the talocrural joint, making it possible to separate knee rotation from movements in the foot. Such measurements distribute

Table 1

(a) Internal rotation, as measured with RSA and the rottometer at flexion angle of 60° and 90° flexion with 3, 6 and 9 N m torque (mean, S.D., S.E., max. and min.); (b) External rotation, as measured with RSA and the rottometer at flexion angle of 60° and 90° flexion with 3, 6 and 9 N m torque (mean, S.D., S.E., max. and min.)

	Descriptive statistics					
	Mean	S.D.	S.E.	Count	Minimum	Maximum
<b>(a)</b>						
Rot in 3/90	11 400	3715	1661	5	6000	16000
RSA in 3/90	6020	2510	1123	5	3000	8900
Rot in 6/90	20600	6189	2768	5	13 000	28 000
RSA in 6/90	9960	3410	1525	5	6200	14 000
Rot in 9/90	30 000	8689	3886	5	19 000	39 000
RSA in 9/90	12 720	4649	2079	5	7300	18 000
Rotto in 3/60	10 800	5215	2332	5	4000	17 000
RSA in 3/60	5840	4722	2112	5	2000	12 500
Rotto in 6/60	15 400	9072	4057	5	4000	27 000
RSA in 6/60	9780	3707	1658	5	6400	14 500
Rotto in 9/60	31 200	3271	1463	5	27 000	36 000
RSA in 9/60	13 340	4333	1938	5	9000	19 000
<b>(b)</b>						
Rot ut 3/90	-17 600	6066	2713	5	-25 000	-10 000
RSA ut 3/90	-12 620	6910	3090	5	-20 200	-4200
Rot ut 6/90	-27 400	6269	2804	5	-36 000	-19 000
RSA ut 6/90	-16 440	7748	3465	5	-26 900	-7500
Rot ut 9/90	-35 600	7369	3295	5	-45 000	-29 000
RSA ut 9/90	-19 240	7471	3341	5	-29 000	-9200
IRotto ut 3/60	-15 600	5771	2581	5	-20 000	-6000
RSA ut 3/60	-6300	4076	1823	5	-13 200	-2600
Rotto ut 6/60	-25 200	4970	2223	5	-32 000	-18 000
RSA ut 6/60	-12 200	4483	2005	5	-15 700	-5300
Rotto ut 9/60	-34 000	5385	2408	5	-42 000	-27 000
RSA ut 9/60	-14 860	5478	2450	5	-20 100	-6700

the torque over more than one joint, and cannot be compared to our measurements. However, the total foot and tibial rotation showed a larger range of motion than in the present study (73 ± 16° at 20° of knee flexion and 88 ± 16° at 90° of flexion) and the isolated tibial movements showed a smaller range of rotation than

with the rottometer but were higher than the RSA findings in the present study (33 ± 8° at 20° of knee flexion and 47 ± 9° at 90° of flexion). To test the validity, Schoemaker and Markolf compared their results with cadaver studies, and close agreements were reported. However, the differences in soft tissue compliance between living and dead tissues were not discussed. The best validation test for a new measurement instrument is probably to compare the recordings with the results using a device of high accuracy. It is probably also important to measure the same subjects, since there may be significant individual variations. With clinical measurements, an error can arise from soft tissue movements, but in no other study measuring knee rotation in vivo have the goniometer results been compared with an X-ray examination in order to quantify this error. However, Jorn et al. [5] evaluated the Stryker Laxity tester, since external devices often plays a central part in the evaluation of cruciate ligament injured knees and makes it possible to measure knee laxity in the sagittal plane, with simultaneous RSA recordings. The measurements with that instrument did not concern an actual femurotibial displacement of the joint, since more than 50% of the knee laxity as measured with the external device was due to a systematic error from soft

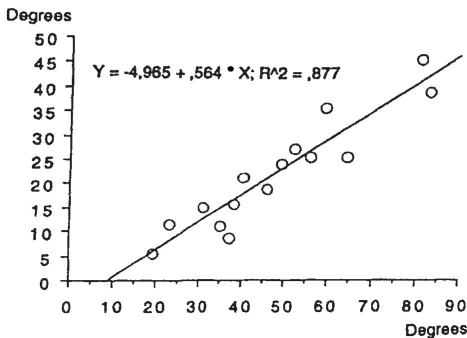

Fig. 4. Individual differences in total rotation at 3, 6 and 9 N m torque between RSA and the rottometer (y-axis), related to the rottometer recordings at flexion 90° (x-axis).

tissue deformation. Findings of a low correlation (at 90 N,  $r = 0.30$  and at 180 N,  $r = 0.20$ ) between RSA and the Stryker Laxity tester were presented. In the present study, simultaneous recordings with RSA [14] made it possible to calculate the magnitude of soft tissue movements which are important for the correct interpretation of measurements of axial rotation with an external device in vivo.

#### Rottometer vs. RSA

The measurements of total rotation with the rottometer differed from those with RSA. They varied between  $12 \pm 7^\circ$  and  $35 \pm 15^\circ$ , according to the flexion angle and the torque applied. The correlation ( $r^2$ ) between the rottometer and RSA was high, but approximately 50% of the registered total rotation with the external device did not originate from movements in the knee. However, this error was constant at repeated measurements and showed a linear increase with the increasing torque. It was therefore concluded that since the error was systematic, it could be predicted and compensated for. The most consistent measurements were found when total rotation was recorded at a flexion angle of  $90^\circ$ .

#### Rottometer

A number of possible errors are inherent in clinical goniometer measurements of knee rotation in vivo. The main errors in rottometer measurements are probably due to movements of soft tissue and adjacent joints, such as the hip, talocrural or subtalar joints. Careful consideration must be given to the design of the fixation clamps to minimize these errors. The construction of the rottometer was the result of several pilot studies to minimize discomfort and pain, without losing the fixation. However, unless the ends of the goniometer are surgically fixed to the bone, movements may nonetheless occur.

#### Conclusion

Measurements of axial knee rotation with this external device, the rottometer showed a significant correlation with skeletal (bony) movements, as measured with RSA. A systematic error was found where the external device overestimated the knee rotation by around 100%, irrespective of the torque applied. The most accurate

registrations were found in  $90^\circ$  ( $r^2 = 0.94$ ) and with 9 N m force ( $r^2 = 0.94$ ).

#### Acknowledgements

We acknowledge Jan Rademakers and Johan Lindqvist, JOJ Medical Technics, for the construction of the apparatus used, as well as all the test persons who voluntarily took part in the study. This work was funded by Hallands läns landsting FoU-foundation.

#### References

- [2] Calliet R.C. Functional anatomy. In: Knee pain and disability. Philadelphia: F.A. Davis Company; 1973. p. 49–69.
- [3] Czerniecki JM, Lippert F, Olerud JE. A biomechanical evaluation of tibiofemoral rotation in anterior cruciate ligament deficient knees during running and walking. *Am J Sports Med* 1988; 16:327–31.
- [4] Evans P. Clinical biomechanics of the subtalar joint. *Physiotherapy* 1990;76:47–51.
- [5] Jörn LP, Fridén T, Ryd L, Lindstrand A. Simultaneous measurements of sagittal knee laxity with an external device and radiostereometric analysis. *J Bone Joint Surg B* 1998;80:169–72.
- [6] Kapandji IA. The knee. 2nd ed. The physiology of the joints, vol. 2. UK: Livingstone; 1970. p. 72–134.
- [7] Lane JG, Irby SE, Kaufman K, Rangger C, Daniel DM. The anterior cruciate ligament in controlling axial rotation. An evaluation of its effect. *Am J Sports Med* 1994;22:289–93.
- [8] Lehmkuhl LD, Smith LK. Knee region. In: Brunnstrom's clinical kinesiology. 4th ed. Philadelphia: F.A. Davis Company; 1983. p. 287–307.
- [9] Matsumoto H, Seedhom B. Rotation of the tibia in the normal and ligament-deficient knee. A study using biplanar photography. *Proc Inst Mech Eng (H)* 1993;207:175–84.
- [10] Nielsen S, Rasmussen O, Ovesen J, Andersen K. Rotatory instability of cadaver knees after transection of collateral ligaments and capsule. *Arch Orthop Trauma Surg* 1984;103:165–9.
- [11] Petrén T. In: Anatomy 1 (Anatomi 1 – in Swedish). Stockholm: Nordiska bokhandels Förlag; 1984. p. 235–41.
- [12] Sanfridsson J et al. Femurotibial rotation and the q-angle related to the dislocating patella. *Acta Radiol* 2001;42:218–24.
- [13] Schoemaker SC, Markolf KL. In vivo rotatory knee stability. *J Bone Joint Surg Am A* 1982;64(2):208–16.
- [14] Selvik G. Roentgen stereophotogrammetry. A method for the study of the kinematics of the skeletal system. *Acta Orthop Scand* 1989.
- [15] Shaw JA, Eng M, Murray DG. The longitudinal axis of the knee and the role of the cruciate ligaments in controlling transverse rotation. *J Bone Joint Surg A* 1974;56:1603–9.
- [16] Stiehl BS. Inman's joints of the ankle. 2nd ed. Baltimore: Williams and Wilkins; 1991.
- [17] Zarins B, Rowe C, Harris BA, Watkins MP. Rotational motion of the knee. *Am J Sports Med* 1983;11:152–6.







RESEARCH ARTICLE

Open Access

# Measurements of knee rotation-reliability of an external device in vivo

Per O Almqvist<sup>1\*</sup>, Charlotte Ekdahl<sup>1</sup>, Per-Erik Isberg<sup>2</sup> and Thomas Fridén<sup>3</sup>

## Abstract

**Background:** Knee rotation plays an important part in knee kinematics during weight-bearing activities. An external device for measuring knee rotation (the Rottometer) has previously been evaluated for validity by simultaneous measurements of skeletal movements with Roentgen Stereometric Analysis (RSA). The aim of this study was to investigate the reliability of the device.

**Method:** The within-day and test-retest reliability as well as intertester reliability of the device in vivo was calculated. Torques of 3, 6 and 9 Nm and the examiner's apprehension of end-feel were used at 90°, 60° and 30° of knee flexion. Intraclass Correlation Coefficient  $_{2,1}$  (ICC  $_{2,1}$ ), 95% confidence interval (CI) of ICC and 95% CI between test trials and examiners were used as statistical tests.

**Result:** ICC $_{2,1}$  ranged from 0.50 to 0.94 at all three flexion angles at 6 and 9 Nm as well as end-feel, and from 0.22 to 0.75 at 3 Nm applied torque.

**Conclusion:** The Rottometer was a reliable measurement instrument concerning knee rotation at the three different flexion angles (90°, 60° and 30°) with 6 and 9 Nm applied torques as well as the examiner's apprehension of end-feel. Three Nm was not a reliable torque. The most reliable measurements were made at 9 Nm applied torque.

## Background

Knee rotation play an important part in weight-bearing activities in the lower extremities, such as changing direction while walking, running and jumping [1-3]. It is possible that abnormal rotational kinematics may contribute to degenerative changes after ACL injuries [4], and abnormal femurotibial axial rotation has been described in patients with recurrent patellar dislocation using a radiographic technique [5]. However, the normal range of rotation of the knee in various healthy populations in vivo is not known, age and gender differences are not established, and knee rotation is hardly ever estimated in clinical practice. A non-invasive manual device to measure knee rotation evaluated regarding its validity and reliability could be of value as a complement to existing clinical tools and examination equipment. The device would aid in diagnosing rotational instability and provide an objective clinical assessment of normal knee kinematics and possible

pathological findings after different knee injuries and disorders [6]. A few in vivo studies concerning knee rotation measuring devices, their validity and reliability, as well as knee rotation reference values have been reported [7-12]. Zarins et al. [11] measured knee rotation in a side-lying position. The knee was positioned and measured at 90°, 60°, 30°, 15° and 5° of flexion. The torque was applied manually by the examiner's estimation of end-feel but no grading of torques was reported. The test-retest reliability was calculated by two repeated measurements on each of thirteen subjects. High correlations for the total internal-external rotation ( $r = 0.93-0.96$ ) were described at 90°, 60° and 30° of flexion. Shoemaker and Markolf [12] measured knee rotation in vivo combined with measurements of maximum isometrically generated tibial torque. Recordings were made in a sitting position and knee rotation was measured at 20° and 90° of flexion and a torque of 10 Nm was chosen. At 90°, seven tests were repeated on one subject, indicating good reproducibility (range 76°-83°). In a recent in vivo study [10] an external device was evaluated regarding inter- and test-retest reliability in 11 male subjects. The subjects were measured lying supine on an

\* Correspondence: per.almqvist@amadeushk.se

<sup>1</sup>Department of Health Sciences, Division of Physiotherapy, Lund University, Box 157, SE-221 00 Lund, Sweden

Full list of author information is available at the end of the article

examination table, and were measured at 90° and 30° of knee flexion angle with 2, 4 and 6 Nm applied torques, and the total internal-external rotation was registered. The ICCs (Intraclass Correlation Coefficient) were all greater than 0.75 and the SEMs were all less than 2° in this study. Maudi et al. [8] used a knee rotatory kinaesthetic device to determine proprioceptive acuity for internal and external active rotation, and to measure active and passive rotation range of motion in vivo. To determine intra- and inter-observer reliability for active and passive rotation, 20 male subjects were recruited. Both intra- and inter-observer reliability were reported as good to excellent (ICC<sub>1,2</sub> 0.69-0.95). Measurements were made at 90° of flexion angle with 6 Nm applied torque. However, different flexion angles and different applied torques have been used and none of these measurement devices has been evaluated for validity by simultaneous measurements of actual skeletal movements in the same subjects. There is no consensus as to the most appropriate torque to use in knee rotation in vivo studies. In a previous study [13] a clinical device to measure the knee rotation in vivo (the Rottometer) was presented and evaluated for validity by simultaneous registrations with Roentgen Stereometric Analysis (RSA) [14]. The correlation between the two instruments was high ( $r^2 = 0.87-0.94$ ) concerning total internal-external rotation. However, when evaluating knee rotation assessment tools, reliability must also be considered before they are used in research and clinical practice. The aim of this investigation was to evaluate the one-week-apart-, within-day- and inter-tester reliability of the Rottometer concerning total internal-external knee rotation, and to establish the most reliable torques and flexion angles.

## Methods

### The Rottometer (Figure 1) and testing procedure

The Rottometer and details of the examination procedure and the fixation of the test persons to the device have been presented previously [13]. Measurements were made at 90°, 60° and 30° of knee flexion in each subject's both legs. Ninety degrees was chosen since the largest range of rotation has been reported at this knee flexion angle [1,2,15]. Sixty and 30° of flexion were chosen to study the rotation at more physiological flexion angles for weight-bearing activities. At each flexion angle, passive total internal-external rotation of the tibia in relation to the femur was measured. The neutral position of "zero degree" rotation was defined as each individual subject's resting position of the knee at each flexion angle. Total internal-external rotation was then measured from that zero position. The subjects were instructed to relax their muscles to allow the examiner to passively rotate the leg. An adjustable spanner was used to apply the different torques (Nm). It permitted

measurements with various forces (Nm), and was calibrated and tested to provide torques reproducible within  $\pm 3\%$  (Rausol, Germany). The mean of three repeated measurements of internal and external rotation with 3, 6 and 9 Nm torque as well as the examiner's apprehension of end-feel [16] were recorded at each torque at each flexion angle (90°, 60° and 30°) in both knees. These forces were based on the results and experiences of several pilot studies before the main study. The examiner was instructed to stop the measuring procedure if the subject complained about major pain or discomfort at any applied torque at any angle.

### Reliability

#### On-week-apart intratester reliability

To evaluate the test-retest reliability of the knee joint rotation, one examiner (physiotherapist) measured 10 healthy subjects. The subjects were measured twice with a week's interval and these measurements were made at the same time of the day.

#### Within-day intratester reliability

To evaluate the within-day reliability, one examiner (physiotherapist) measured knee joint rotation in 10 healthy subjects. The subjects were measured twice, once in the morning and once in the afternoon, on the same day.

#### Intertester reliability

Ten healthy subjects participated in the study in order to evaluate the intertester reliability. They were measured twice on the same test occasion in random order by two independent examiners (physiotherapists). The first examiner fixed the subject to the Rottometer and carried out the measurements. After ten minutes' break after the first examination, the second examiner repeated the whole procedure on the same test person.

The examiners in the present study were physiotherapists and trained in using the measurement device before the study began.

### Subjects

In the within-day and one-week-apart evaluation 10 subjects, six females (age range: 28-69 years) and four males (age range: 37-60 years) were measured. The measurements of intertester reliability were also performed on ten subjects, six females (range: 31-46 years) and four males (range: 24-35 years). These subjects had never undergone any knee, hip or foot surgery and had no documentation or history of prior major knee injuries (ligaments, fractures, meniscus). Each knee was considered as one unit and thus, twenty observations were used in the calculations. This study has been directed by the Helsinki Declaration and was approved by the Ethics Committee of Lund University

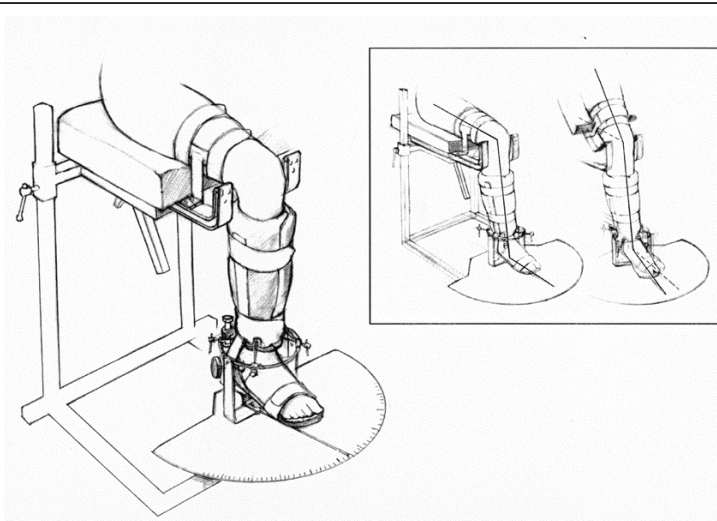

**Figure 1** The Rottometer with a test person fixed to the device ready to be measured. In the frame: changes in flexion angles from 90° to 30° of knee flexion angle.

### Statistics

All statistical analyses of the data were performed using SPSS 14.0 statistics software. Statistical evaluation of the one-week-apart intratester-, within-day intratester and intertester reliability tests were made with Intraclass Correlation Coefficient<sub>2,1</sub> (ICC<sub>2,1</sub>) [17], 95% Confidence Interval (CI) of the ICC [18] and 95% CI between test trails and examiners.

### Results

#### One-week-apart intratester reliability (Table 1)

The highest ICC<sub>2,1</sub> (0.84) was registered at 30° of knee flexion angle with 9 Nm applied torque, and the lowest (0.22 and 0.24) at 60° and 30° with 3 Nm. The 95% CI between the two different tests was -4.9-5.6 at all four applied torques (3, 6 and 9 Nm and end-feel) at all three flexion angles.

#### Within-day intratester reliability (Table 2)

The highest ICC<sub>2,1</sub> was calculated as 0.94 at 9 Nm applied torque at 30° flexion angle, and the lowest (0.59) also at 30° but at 3 Nm. The 95% CI between the two different tests was -3.4-9.9 at 6 and 9 Nm as well as end-feel, and -6.0- -2.7 at 3 Nm at all three flexion angles.

#### Intertester reliability (Table 3)

The highest ICC<sub>2,1</sub> was 0.87 at 90°, and 0.61-0.70 at 30° at 6 Nm applied torque, and the lowest 0.49 also at 90° but with at 3 Nm applied torque. The 95% CI between

examiners was -7.1-3.8, except at 30° with 3 Nm (CI-7.9- -2.1).

### Discussion

As a result of the ICC calculations according to the recommendations of Fleiss [19], the Rottometer was judged to be a good (ICC 0.4-0.75) to excellent (ICC above 0.75) device concerning reliability for measuring knee rotation with 6 and 9 Nm applied torques and the examiner's apprehension of end-feel at three different flexion angles (90°, 60° and 30°). A torque of 3 Nm showed lower reliability in knee rotation measurements using the Rottometer as an assessment tool.

It seems as if the most valid [13] and reliable measurements of the knee rotation made by the Rottometer were registered at measurements of the total rotation at 9 Nm applied torque.

As measured with the Rottometer in present study, the range of total knee rotations at 9 Nm applied torque were 70°-79°. In earlier clinical in vivo studies measuring knee rotation, the total range of rotation have varied between 18° and 90° [7-12]. It may be argued that comparing measurement of knee rotation between different studies are of limited value, since different measurement devices, different flexion angles and different applied torques have been used. Also the set-ups during the examinations vary between different devices. However, as long as there is no accepted golden standard, further investigations of knee rotation both in healthy reference populations and in

**Table 1 The results of the one-week-apart reliability evaluation of the external measurement device presented in means and Standard Deviations given in degrees (M 1 = measurement occasion one and M 2 = measurement occasion 2), and calculated with Intraclass Correlation Coefficient<sub>2,1</sub> (ICC<sub>2,1</sub>), 95% Confidence Interval (CI) of ICC and 95% CI between M 1 and M 2**

Angle/applied torque	M 1 m ± SD	M 2 m ± SD	ICC <sub>2,1</sub>	95% CI of ICC	95% CI of M 1 and M 2
90°/3 Nm	30 ± 6	29 ± 6	0.49	0.04-0.77	-2.0-3.1
90°/6 Nm	56 ± 9	56 ± 5	0.67	0.31-0.86	-1.6-3.0
90°/9 Nm	76 ± 9	76 ± 7	0.80	0.56-0.92	-1.2-1.6
90°/End-feel	72 ± 8	71 ± 7	0.65	0.32-0.84	-1.3-2.2
60°/3 Nm	33 ± 8	33 ± 4	0.24	-0.15-0.59	-3.8-3.7
60°/6 Nm	58 ± 8	61 ± 9	0.50	0.11-0.76	-2.6-3.8
60°/9 Nm	77 ± 10	75 ± 8	0.82	0.60-0.92	-0.2-3.9
60°/End-feel	74 ± 8	73 ± 8	0.76	0.48-0.90	-0.4-3.2
30°/3 Nm	28 ± 8	29 ± 7	0.22	-0.48-0.40	-4.9-2.9
30°/6 Nm	55 ± 10	53 ± 8	0.50	0.11-0.77	-0.4-3.5
30°/9 Nm	79 ± 12	77 ± 11	0.84	0.65-0.93	-0.6-4.6
30°/End-feel	78 ± 11	76 ± 9	0.82	0.64-0.93	-0.4-5.6

Calculations were made at three different flexion angles (90°, 60° and 30°) with four different applied torques (3, 6 and 9 Nm as well as the examiner's apprehension of end-feel) of the total internal-external knee joint rotation

patients with different knee disorders and injuries, with valid as well as reliable measurement devices are needed.

#### Sources of error

There are a number of sources of variability inherent in rotation measurements of the knee in vivo. A possible explanation of poor agreements at 3 Nm could be that measurements made with this torque produced a rather small range of rotation, and thus small differences between recordings resulted in relatively large disagreement. It is also possible that 3 Nm torque is too small to reach the end-points of the mechanical restraints and

thus motions with a poorly defined end-point are measured. One aspect that could have affected the measurements at 60° and especially at 30° was that when the knee angle was changed and adjusted the hip angle was changed too, and thereby probably allowed movements in the hip [12], which could have been registered as knee rotation by the Rottometer. Careful consideration was given to the design of the fixation clamps [13] with the purpose of minimizing shifting due to soft tissue motion and at the same time avoiding pain, which makes it hard for the subject to relax during the examination. As in the within-day analyses, the design of the inter-tester measurements

**Table 2 The results of the within-day reliability evaluation of the external measurement device presented in means and Standard Deviations given in degrees (M 1 = measurement occasion one and M 2 = measurement occasion 2), and calculated with Intraclass Correlation Coefficient<sub>2,1</sub> (ICC<sub>2,1</sub>), 95% Confidence Interval (CI) of ICC and 95% CI between M 1 and M 2**

Angle/applied torque	M 1 m ± SD	M 2 m ± SD	ICC <sub>2,1</sub>	95% CI of ICC	95% CI of M 1 and M 2
90°/3 Nm	30 ± 6	33 ± 6	0.64	0.13-0.86	-5.1- -1.5
90°/6 Nm	56 ± 8	57 ± 7	0.73	0.43-0.87	-2.7-1.5
90°/9 Nm	76 ± 10	74 ± 10	0.79	0.54-0.91	-2.7-1.5
90°/End-feel	72 ± 8	73 ± 8	0.66	0.33-0.85	-3.4-0.9
60°/3 Nm	33 ± 8	37 ± 6	0.67	0.33-0.85	-0.6- -2.7
60°/6 Nm	58 ± 8	61 ± 9	0.76	0.50-0.90	0.4-4.4
60°/9 Nm	77 ± 10	78 ± 11	0.86	0.62-0.95	-2.6-1.3
60°/End-feel	74 ± 8	74 ± 9	0.90	0.75-0.96	-1.9-2.0
30°/3 Nm	24 ± 8	31 ± 9	0.59	0.21-0.81	-4.7- -0.2
30°/6 Nm	55 ± 10	56 ± 10	0.87	0.72-0.95	-2.7-1.2
30°/9 Nm	79 ± 12	77 ± 12	0.94	0.87-0.98	-0.4-9.9
30°/End-feel	78 ± 11	75 ± 11	0.83	0.61-0.93	-0.3-5.2

Calculations were made at three different flexion angles (90°, 60° and 30°) with four different applied torques (3, 6 and 9 Nm as well as the examiner's apprehension of end-feel) of the total internal-external knee joint rotation

**Table 3 The results of the inter-tester reliability evaluation of the external measurement device presented in means and Standard Deviations given in degrees (M 1 = measurement occasion one and M 2 = measurement occasion 2), and calculated with Intra-class Correlation Coefficient<sub>2,1</sub> (ICC<sub>2,1</sub>), 95% Confidence Interval (CI) of ICC and 95% CI between M 1 and M 2**

Angle/applied torque	M 1 m ± SD	M 2 m ± SD	ICC <sub>2,1</sub>	95% CI of ICC	95% CI of M 1 and M 2
90°/3 Nm	30 ± 6	33 ± 7	0.49	0.09-0.76	-6.4-0.2
90°/6 Nm	53 ± 7	54 ± 8	0.87	0.71-0.95	-2.8-0.3
90°/9 Nm	70 ± 10	72 ± 10	0.85	0.68-0.94	-4.6-0.6
90°/End-feel	67 ± 8	66 ± 9	0.74	0.44-0.89	-1.7-3.8
60°/3 Nm	37 ± 7	38 ± 6	0.75	0.47-0.89	-3.5-0.9
60°/6 Nm	56 ± 8	58 ± 9	0.83	0.62-0.93	-3.6-0.4
60°/9 Nm	72 ± 10	74 ± 10	0.84	0.63-0.93	-3.7-0.1
60°/End-feel	71 ± 10	71 ± 9	0.77	0.51-0.90	-3.7-3.1
30°/3 Nm	28 ± 7	33 ± 8	0.52	0.10-0.78	-7.9 -2.1
30°/6 Nm	52 ± 10	55 ± 10	0.61	0.25-0.82	-6.8-0.2
30°/9 Nm	72 ± 11	74 ± 12	0.69	0.34-0.87	-7.1-2.4
30°/End-feel	73 ± 12	74 ± 10	0.70	0.36-0.87	-6.0-2.5

Calculations were made at three different flexion angles (90°, 60° and 30°) with four different applied torques (3, 6 and 9 Nm as well as the examiner's apprehension of end-feel) of the total internal-external knee joint rotation

might have constituted a risk of a change in soft tissue characteristics or pain occurring, since two repeated measurements were made on the same subject on the same day. However, pain was not reported by any of the subjects at any time during the examinations. Unless the ends of the goniometer are surgically fixed to the bone, the potential for soft tissue movements nonetheless exists. On the other hand, pain or discomfort during the examination may induce muscle tension, which makes it impossible to measure the whole range of rotation. When different subjects endure different kinds of tightness of fixation this may cause a source of variability, as did the magnitude of each individual's soft tissue volume and elasticity. Positioning-related faults are differences in orientation of the goniometer between trials if the various clamps of the instrument are not positioned on the bones identically each time the goniometer is attached, which may lead to variations in starting position. This variation would cause problems in defining a starting "zero" resting position. During repeated non published pilot studies before the present investigation, we discovered a large individual variation of neutral knee rotation position between subjects, and the neutral position could also change due to different knee flexion angles within the subjects. The resting "zero" knee rotation position in Rottometer measurements was therefore defined as each individual subject's resting position of the knee at each flexion angle.

There may be a variation in the limits of passive motion from differences in elasticity and plasticity in the soft tissue depending on whether the measurements are made in the morning or afternoon, or whether the subjects have been taking part in any physical activity shortly

before the examination. Maybe it is also possible that blood flow, temperature and stretching can influence the soft tissue characteristics, but such possible changes in rotation during the day were however not large enough to be registered with the device. However, during the intertester reliability test there was only a 10-min break between the two examinations, and that short break may have been a risk factor of soft tissue stretch effect.

The examinations were not blinded, and there is a risk that the examiners could have been influenced by earlier recordings or by measuring both knees on the same subjects. The risk of this kind of error is rather small due to the large number of recordings. The order of the different flexion angles (90°, 60° and 30°) and applied torques (3, 6, 9 Nm and end-feel) were not performed in random order due to technical and practical reasons, and that may have been a source of error. Different readings on the protractor between different examiners may also occur. It could be argued that the applied torque with the adjustable spanner might differ between examiners, if they were not experienced in using the equipment. In the present study the two examiners were however trained in using both the protractor and the spanner before the study, and did not consider using the equipment to be a problem. It is also possible that the flexion angle could cause variability between trials if the examiner is not careful to adjust to the exact angle each time.

However, despite all these possible errors, we believe that the Rottometer has the potential to be used in research and clinical practice, due to both its validity [13] and reliability. It may also be valuable to establish normal knee joint rotation reference values in a larger population

of healthy individuals as well as to study possible age or gender differences.

## Conclusion

The Rottometer was judged to be a reliable measurement instrument concerning knee rotation at three different flexion angles (90°, 60° and 30°) at 6 and 9 Nm applied torques and as evaluated by the examiner's apprehension of end-feel. The most reliable measurements of the knee rotation made by the Rottometer were registered in measurements of the total rotation at 9 Nm applied torque. Measurements with 3 Nm were considered less reliable.

## Acknowledgements

We thank Jan Rademakers and Johan Lindqvist for the construction of the apparatus used, and all the persons who voluntarily took part in the study. This work was funded by the County Council of Halland FoU-foundation.

## Author details

<sup>1</sup>Department of Health Sciences, Division of Physiotherapy, Lund University, Box 157, SE-221 00 Lund, Sweden. <sup>2</sup>Department of Statistics, Lund University, Lund, Sweden. <sup>3</sup>Faculty of Medicine, Lund University, Lund, Sweden.

## Authors' contributions

P A conceived the manuscript, carried out the examination of the subjects, participated in the statistical analysis and participated in the design of the study, C E participated in the design and supervised the study, P-E I participated and supervised the statistical analysis, T F participated in the design and supervised the study. All authors read and approved the final manuscript.

## Competing interests

The authors declare that they have no competing interests.

Received: 1 August 2011 Accepted: 30 December 2011

Published: 30 December 2011

## References

1. Cailliet RC: **Functional Anatomy, Knee Pain and Disability** F.A. Davis Co. Philadelphia; 1973, 49-69.
2. Kapandji IA: **The Knee**. In *The Physiology of the Joints. Volume 2*. Second edition. Livingstone, UK; 1970:72-134.
3. Lehmkuhl LD, Smith LK: **Knee region**. *Brunstrom's Clinical Kinesiology*. 4 edition. F.A. Davis Company, Philadelphia; 1983, 287-307.
4. Brandsson S, Karlsson J, Eriksson BI, Kärholm J: **Kinematics after tear in the anterior cruciate ligament: Dynamic bilateral radiostereometric studies in 11 patients**. *Acta Orthop Scand* 2001, **72**:372-378.
5. Sanfridsson J, Arnbjörnsson A, Fridén T, Ryd L, Svahn G, Jonsson K: **Femurotibial rotation and the q-angle related to the dislocated patella**. *Acta Radiol* 2001, **42**:218-24.
6. Blankevoort L, Huskies R: **A mechanism for rotation restrains in the knee joint**. *J Orthop Res* 1996, **14**(4):676-679.
7. Mills OS, Hull L: **Apparatus to obtain rotational flexibility of the human knee under moment loads in vivo**. *J Biomech* 1991, **24**(6):351-369.
8. Muiaidi QI, Nicholson LL, Refshauge KM: **Do elite athletes exhibit enhanced proprioceptive acuity, range and strength of knee rotation compared with non-athletes?** *Scand J Med Sci Sports* 2009, **19**:103-112.
9. Shultz JS, Shimokochi Y, Nguyen A-D, Scmitz RJ, Benyon BD, Perrin DH: **Measurement of Varus-Valgus and Internal-External Rotational Laxities In Vivo-Part II: Relationship with Anterior-Posterior and General Joint Laxity in Males and Females**. *J Orthop Res* 2007, **25**:989-996.
10. Tsai AG, Musahl V, Steckel H, Bell KM, Zanto T, Irrgang JJ, Fu F: **Rotational knee laxity: Reliability of a simple measurement device in vivo**. *BMC Musculoskeletal Disorders* 2008, **9**:35.
11. Zanins B, Rowe C, Harris BA, Watkins MP: **Rotational motion of the knee**. *Am J Sports Med* 1983, **11**:152-156.

12. Schoemaker SC, Markolf KL: **In vivo rotatory knee stability**. *J Bone Joint Surg Am A* 1982, **64**(2):208-16.
13. Almquist PO, Arnbjörnsson A, Zätterström R, Ryd L, Ekdahl C, Fridén T: **Evaluation of an external device measuring Knee Joint Rotation-An in vivo study with simultaneous Roentgen Stereometric Analysis**. *J Orthop Res* 2002, **20**:427-432.
14. Selvik G: **Roentgen stereophotogrammetry: A method for the study of the kinematics of the skeletal system**. *Acta Orthop Scand* 1989, **60**(Suppl 232).
15. Nordin M, Frankel VH: **Basic Biomechanics of the Musculoskeletal System**. Lea Febiger, Philadelphia, London; 1989.
16. Kaltenborn FM, Eyjenth O: **Examination of joint movements. Manual examination and mobilisation of the joints in basic education** Olaf Norlis Bokhandel; 1985, 34-37.
17. Shrout PE, Fleiss JL: **Intraclass correlations: Uses in assessing rater reliability**. *Psychol Bull* 1979, **86**(2):420-428.
18. Bland JM, Altman DG: **Measuring agreement in method comparison studies**. *Stat Methods Med Res* 1999, **8**:135-60.
19. Fleiss JL: **Reliability of measurements. The design and analysis of clinical experiments** New York, John Wiley and Sons; 1986, 1-31.

## Pre-publication history

The pre-publication history for this paper can be accessed here:  
http://www.biomedcentral.com/1471-2474/12/291/prepub

doi:10.1186/1471-2474-12-291

**Cite this article as:** Almquist et al: Measurements of knee rotation-reliability of an external device in vivo. *BMC Musculoskeletal Disorders* 2011 **12**:291.

**Submit your next manuscript to BioMed Central and take full advantage of:**

- Convenient online submission
- Thorough peer review
- No space constraints or color figure charges
- Immediate publication on acceptance
- Inclusion in PubMed, CAS, Scopus and Google Scholar
- Research which is freely available for redistribution

Submit your manuscript at  
www.biomedcentral.com/submit









# Knee Rotation in Healthy Individuals Related to Age and Gender

Per O. Almquist,<sup>1</sup> Charlotte Ekdahl,<sup>1</sup> Per-Erik Isberg,<sup>2</sup> Thomas Fridén<sup>3</sup>

<sup>1</sup>Division of Physiotherapy, Department of Health Sciences, Lund University, Box 157, SE-221 00 Lund, Sweden, <sup>2</sup>Department of Statistics, Lund University, Lund, Sweden, <sup>3</sup>Faculty of Medicine, Lund University, Lund, Sweden

Received 12 March 2012; accepted 11 June 2012

Published online in Wiley Online Library (wileyonlinelibrary.com). DOI 10.1002/jor.22184

**ABSTRACT:** An external device (“the Rottometer”) was especially designed to measure passive knee rotation in vivo. The device had earlier been evaluated with respect to its validity and reliability. In the present study, we evaluated knee rotation in knee-healthy individuals and studied possible age and gender related differences. Measurements of total internal–external rotation were made at 90°, 60°, and 30° of flexion using 6 and 9 N m torques, as well as the examiner’s apprehension of end-feel as displacing forces. The study group constituted of 120 healthy subjects (60 females and 60 males) with no prior or present knee disorders. The sample was divided into four age groups (15–30, 31–45, 46–60, and >60 years). The results showed no differences in knee rotation between the right and left knees or between the different flexion angles. The females showed 10–20% ( $p < 0.01$ ) larger knee rotation than the males at all the three flexion angles and at all the three applied torques in all age-matched groups. In all age groups in both genders, the internal rotation accounted for 40–44% and the external for 56–60% of the total internal–external knee rotation. © 2012 Orthopaedic Research Society. Published by Wiley Periodicals, Inc. *J Orthop Res*

**Keywords:** knee; rotation; age; gender

Knee rotation plays an important role in the kinetic chain in the lower extremities<sup>1,2</sup> and therefore in normal knee function. Excessive rotational force to the knee tears ligamentous structures resulting in rotatory instability.<sup>3</sup> Instability experienced after anterior cruciate ligament (ACL) injuries results from a combination of abnormal tibiofemoral translation and rotation.<sup>4–6</sup> This abnormal rotational kinematics may contribute to the degenerative changes frequently seen after ACL injuries.<sup>7</sup> Abnormal femorotibial axial rotation has also been described in patients with recurrent patellar dislocation using a radiographic technique.<sup>8</sup>

Many studies of knee rotation are made in vitro<sup>5,9–13</sup>; however, in vitro studies can probably not be compared with in vivo studies, due to differences reflected in stiffness and soft tissue compliance of cadaveric specimens.<sup>10</sup> Some in vivo studies using a clinical external measurement device evaluating knee rotation were reported.<sup>14–19</sup> But the number of subjects included in these studies was rather small, and different flexion angles and different applied torques were used. To our knowledge, in no earlier study has knee rotation been evaluated in a large knee-healthy population to establish in vivo reference values and possible age- and gender-related differences.

Schultz et al.<sup>16</sup> found a 25% larger ( $27.5 \pm 7.5^\circ$ ) rotation in females at 20° of knee flexion with 5 N m applied torque than in males ( $20.2 \pm 4.1^\circ$ ). This study included 10 males and 10 females, and the authors indicated a need for further evaluation concerning gender differences in a larger population at several different flexion angles.

The aims of the present study were thus to establish reference values with regard to knee rotation in a

large population and to study age and gender variations.

## METHODS

### The Rottometer and Testing Procedure

The external measuring device, the Rottometer, was earlier evaluated concerning its validity<sup>20</sup> and within-the-same-day and 1 week apart intratester and intertester reliability.<sup>21</sup> The Rottometer and details of the examination procedure were presented previously (Fig. 1).<sup>20</sup>

Measurements were made at 90°, 60°, and 30° of knee flexion (Figs. 1–4) in both knees in each subject. 90° was chosen since the largest range of rotation was reported at this knee flexion angle.<sup>22,23</sup> Sixty degree and 30° were chosen to study the rotation at more physiological flexion angles for weight bearing activities. At each angle, passive total internal–external rotation of the knee was measured. The neutral position of “zero” degrees rotation was defined as each subject’s resting position of the knee at each flexion angle. Total internal–external rotation was then measured from that zero position. The subjects were instructed to relax their muscles to allow the examiner to passively rotate the leg. An adjustable spanner (Fig. 5) was used to apply the different torques. It permitted measurements with various loads, and was calibrated and tested to provide torques reproducible within  $\pm 3\%$  (Rausol, Germany). Three repeated measurements of internal and external rotation with 6 and 9 N m torque, as well as the examiner’s apprehension of end-feel, were recorded in both knees. These forces were based on several pilot studies undertaken prior to the main study. The examiner was instructed to stop the measuring procedure if the subject complained of major pain or discomfort.

### Healthy Reference Population

One hundred twenty healthy persons (60 females and 60 males) were recruited from schools, universities, departments of health care, offices, and different organizations and societies. The subjects volunteered and constituted the reference population. The subjects were equally divided into four age groups: 15–30, 31–45, 46–60, and >60 years. The subjects had never undergone any knee, hip, or foot surgery or

Correspondence to: Per O. Almquist (T: +46-35-124858; F: +46-35-146031; E-mail: per.almquist@amadeushk.se)

© 2012 Orthopaedic Research Society. Published by Wiley Periodicals, Inc.

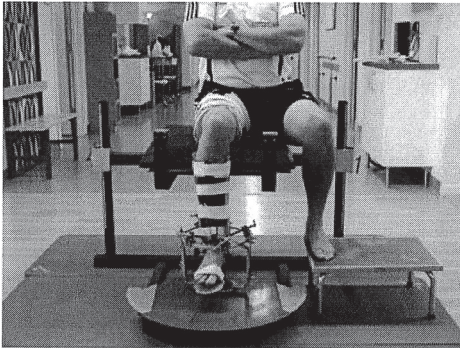

**Figure 1.** The Rottometer with a test person fixed to the device ready to be measured at 90° of knee flexion angle.

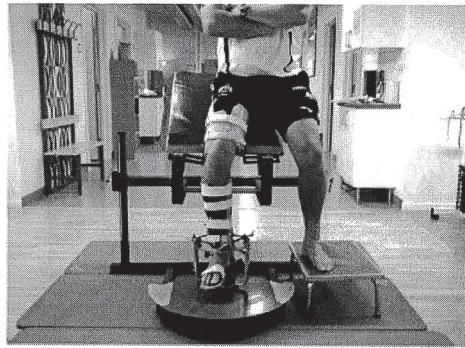

**Figure 3.** The Rottometer with a test person fixed to the device ready to be measured at 30° of knee flexion angle.

been affected by any prior major knee injuries (ligaments, fractures, cartilage, meniscus, or patellofemoral pain). The study was directed by the Helsinki Declaration and was approved by the Ethics Committee of Lund University (20141/187).

**Statistics**

Statistical analyses of the data were performed using SPSS statistics 20 software. Evaluations of the healthy reference population were made with multi-way ANOVA, one-way ANOVA, Students *t*-tests, and paired *t*-tests (right vs. left knee).

**RESULTS**

**Right Versus Left Knees**

No significant differences in the range of total internal-external rotation were found between the right and left knees at any of the age- or gender-matched groups at any flexion angle (90°, 60°, and 30°)

at any applied torque (6 and 9 N m, and end-feel; Table 1).

Since no differences between left and right knees were found, all further calculations were accounted for in only one knee (the right one) to make a more comprehensible general view of the results.

**Knee Rotation at Different Knee Flexion Angles**

No significant differences in total rotation between the three flexion angles (90°, 60°, and 30°) were found at any of the three torques (6 and 9 N m, and end-feel) in any of the age or gender groups.

**Female Versus Male Knee Rotation**

For the whole group, regardless of age, female subjects showed a significantly larger ( $p < 0.01-0.001$ ) range of total knee rotation than males at all three flexion angles (90°, 60°, and 30°) at all three applied torques (6 and 9 N m, and end-feel). The female population

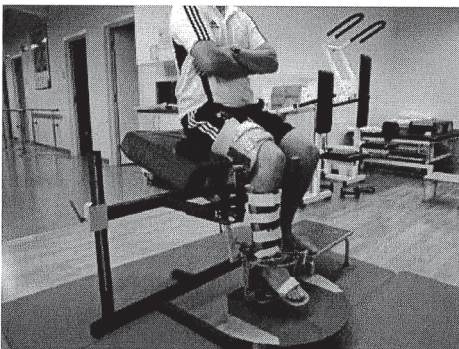

**Figure 2.** The Rottometer with a test person fixed to the device ready to be measured at 60° of knee flexion angle.

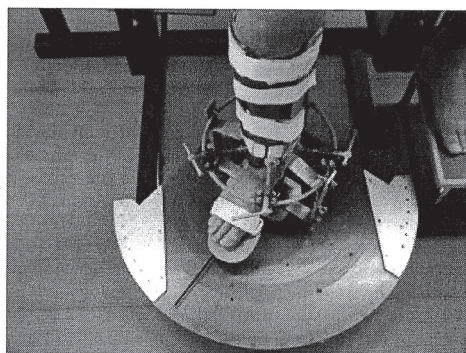

**Figure 4.** The tibia and lower part of the Rottometer during external rotation.

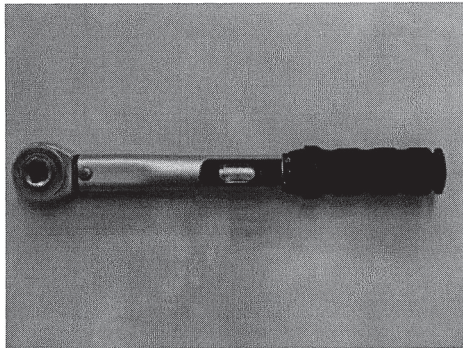

**Figure 5.** The adjustable spanner, used to apply different torques during the measurements of knee rotation.

had 10–20% larger range of total knee rotation than the male population (Table 1).

**Differences in Knee Rotation Due to Age in Females**

No significant differences were found between any of the four female age groups. However, the females showed generally a 6–19% non-significant decrease in range of total rotation in the three older groups compared to the 15–30 year group at all the three applied torques (6 and 9 N m, and end feel) at all three angles (90°, 60°, and 30°; Table 2).

**Differences in Knee Rotation Due to Age in Males**

The four male age groups showed no significant differences. However, the 46–60 year group showed a non-significant 3–19% decrease in total knee rotation compared to the other age groups at all three angles (90°, 60°, and 30°) with all three applied torques (6 and 9 N m, and end-feel; Table 2).

**Distribution of Internal and External Rotation in Relation to Total Knee Rotation**

In both males and females, internal rotation ranged from 40% to 44% and external from 56% to 60% of the total rotation at all three angles (90°, 60°, and 30°) with all three applied torques (6 and 9 N m, and end-feel).

**The Rottometer Measurements Versus Roentgen Stereometric Analysis**

The Rottometer has been validated by simultaneous measurements with roentgen stereometric analysis (RSA).<sup>21</sup> The correlation between the Rottometer and RSA was high ( $r^2$  0.87–0.94), but a measurement error was registered that did not originate from movements between the femur and tibia. However, this bias, probably due to soft tissue movements, was highly constant at repeated measurements and showed a linear increase with increasing torque. Therefore, we concluded that since the error was systematic, it could be predicted and compensated for. In this study, the female knee joint rotation (mean ± SD) was measured to be 77 ± 11° and the males to be 68 ± 8° at 9 N m applied torque at 90° of flexion. The range of rotation between the tibia and femur could then be predicted to be 33–44° in females and to 30–38° in males at 9 N m applied torque. The corresponding figures at 6 N m could be predicted as 24–35° for females and 20–30° for males, and with the examiner’s apprehension of end-feel as 30–42° in females and 29–36° in males.

**DISCUSSION**

The data in the reference population showed no significant differences between left and right knees or between any flexion angle (90°, 60°, and 30°) at any applied torque. We expected the knee rotation to decrease with decreasing flexion angle, especially at lower angles such as 30°, since this was reported earlier.<sup>22,23</sup> However, no significant differences occurred between different flexion angles in our study.

**Table 1.** Total Internal–External Knee Joint Rotation Measured in the Reference Population of 120 Knee Healthy Persons (60 Females and 60 Males) with 6 and 9 N m Torques and with the Examiner’s Apprehension of End-Feel Measured at 90°, 60°, and 30° of Knee Flexion (Mean ± SD) on the Right and Left Knees

Total Rotation	Female Right Knee	Male Right Knee	Diff	Female Left Knee	Male Left Knee	Diff
90°, 6 N m	59 ± 11°	52 ± 8°	7°***	59 ± 11°	50 ± 8°	9°***
90°, 9 N m	77 ± 11°	68 ± 8°	9°***	77 ± 13°	68 ± 7°	9°***
90° end-feel	72 ± 11°	65 ± 7°	7°***	73 ± 12°	64 ± 7°	8°***
60°, 6 N m	60 ± 13°	51 ± 9°	9°***	60 ± 13°	50 ± 8°	10°***
60°, 9 N m	78 ± 14°	66 ± 8°	12°***	78 ± 14°	67 ± 8°	11°***
60° end-feel	75 ± 13°	65 ± 9°	10°***	74 ± 14°	65 ± 8°	9°***
30°, 6 N m	57 ± 14°	43 ± 10°	14°***	56 ± 14°	44 ± 9°	13°***
30°, 9 N m	78 ± 16°	62 ± 11°	16°***	77 ± 16°	63 ± 10°	14°***
30° end-feel	77 ± 16°	62 ± 10°	15°***	75 ± 15°	62 ± 10°	12°***

Results are in degrees, and differences between the females and the males knees at each torque are marked with \*\* $p < 0.01$ , or \*\*\* $p < 0.001$ .

**Table 2.** Total Knee Joint Rotation Measured in 120 Knee Healthy Persons (60 Females and 60 Males) Divided Into Gender and Four Different Age Groups (15–30, 31–45, 46–60, and >61 Years) with 6 and 9 N m Applied Torques and the Examiner's Apprehension of End-Feel Measured at 90°, 60°, and 30° of Knee Flexion

Gender and age	6 N m, 90°	6 N m, 60°	6 N m, 30°	9 N m, 90°	9 N m, 60°	9 N m, 30°	End-Feel 90°	End-Feel 60°	End-Feel 30°
Female 15–30	65 ± 10°	64 ± 14°	62 ± 16°	82 ± 12°	84 ± 14°	85 ± 18°	78 ± 11°	79 ± 14°	81 ± 18°
Male 15–30	52 ± 10°	52 ± 10°	46 ± 12°	69 ± 10°	69 ± 10°	64 ± 14°	66 ± 10°	66 ± 10°	65 ± 13°
Female 31–45	58 ± 10°	61 ± 10°	58 ± 11°	77 ± 11°	77 ± 11°	79 ± 12°	71 ± 10°	74 ± 11°	77 ± 13°
Male 31–45	52 ± 5°	51 ± 6°	45 ± 8°	70 ± 6°	70 ± 6°	64 ± 9°	65 ± 6°	65 ± 8°	64 ± 8°
Female 46–60	56 ± 12°	60 ± 15°	57 ± 15°	74 ± 13°	74 ± 13°	75 ± 18°	70 ± 13°	74 ± 16°	74 ± 15°
Male 46–60	46 ± 6°	48 ± 8°	40 ± 5°	65 ± 4°	65 ± 4°	60 ± 6°	63 ± 3°	65 ± 6°	59 ± 8°
Female ≥61	57 ± 12°	54 ± 12°	50 ± 12°	76 ± 11°	76 ± 11°	70 ± 11°	71 ± 11°	70 ± 12°	70 ± 11°
Male ≥61	54 ± 6°	51 ± 19°	45 ± 11°	69 ± 7°	69 ± 7°	63 ± 12°	66 ± 7°	64 ± 10°	63 ± 10°

Results are given in degrees (mean ± SD). Since no differences between left and right knees within the female and male population were found (Table 1), the figures in the table are for only one the right knee to make a more comprehensible general view of the results.

Measurements employing 30° of flexion have not been compared and validated with measurements made with RSA<sup>24</sup> due to technical difficulties. However, in our study, 30° of flexion was considered of clinical interest and was therefore included. Nonetheless, the lack of validation should be taken into account.

The female population showed a significant ( $p < 0.01$ ) 10–20% larger range of total knee rotation than the male population. There were no significant differences between the age groups. However, a non-significant decrease due to age was found within both genders. The youngest female group (15–30 years) showed the largest range of rotation of all different gender and age groups, and in the male population the smallest rotation was registered at 46–60 years of age, and a small non-significant increase was noted beyond 60 years. This may be of clinical relevance, and should be evaluated further in the future.

In both genders, about 40% of the total rotation was estimated as internal and 60% as external, in accordance with the distribution of internal–external rotation reported in textbooks.<sup>22,23</sup>

In earlier clinical in vivo studies total knee rotation differed between 18° and 90°.<sup>14–19</sup> Tsai et al.<sup>17</sup> measured knee rotation with 6 N m applied torque, and reported total rotation of  $18.5 \pm 4.7^\circ$  at 90° and  $25 \pm 5.9^\circ$  at 30° of flexion. Maudi et al.<sup>15</sup> measured total knee rotation at 90° with 6 N m applied torque of 76° to 90°. Shoemaker and Markolf<sup>19</sup> used 10 N m applied torque, and reported the knee rotation to be  $47 \pm 9^\circ$  and a total knee and ankle rotation of  $88 \pm 16^\circ$ . Zarins et al.<sup>18</sup> reported a total range of rotation of 72–74° when using the examiner's apprehension of end-feel as provocation force.

It may be argued that comparing measurements of knee rotation among different studies is of less value since different measurement devices, flexion angles, and applied torques were used. Also, different positions were used, including seated,<sup>19,20</sup> supin,<sup>16</sup> and lying sideways.<sup>18</sup> A rather large individual difference likely exists in range of rotation among subjects. Subjects positioning, hip and knee flexion angles, leg fixation, applied torques, and movements in adjacent joints are thus critical factors that deserve particular consideration when measuring knee rotation. With no gold standard, further studies with valid and reliable devices are needed. To our knowledge, no other clinical external device to measure total range of knee rotation in vivo than the Rottometer has compared results of the measurement devices with the actual femorotibial skeletal rotational movements.<sup>20</sup>

The subjects in our study represented a healthy knee reference population divided into different age groups. The groups were chosen to study possible changes in knee rotation due to age, and to be able to age-match different categories of knee injuries and disorders in future studies. It may be argued that a group of 120 persons divided into several age and gender subgroups may be too small to represent a reference

population. However, we assumed that the number of persons who volunteered for the study ought to be sufficient to represent a sample of the healthy knee population. There were difficulties in finding 15 females and 15 males to represent the group of 60 years and older with no prior knee injury, surgery or knee pain. A surprising majority of the proposed subjects could not participate due to prior or present knee problems. Thus, the subjects representing the elderly in this study might be "too knee-healthy" to represent a normal population >60 years.

In clinical external measurements, a number of possible device-related errors could arise.<sup>20,21</sup> Careful consideration was given to the design of the fixation clamps with the purpose of minimizing shifting due to soft tissue motion and at the same time avoiding pain. Pain or discomfort present during the examination makes it hard for the subject to relax, which may induce muscle tension, making it impossible to measure the whole range of rotation.

Conversely, different subjects enduring different kinds of tightness of fixation may be a source of variability, as could be the magnitude of each individual's soft tissue volume and elasticity. However, unless the ends of the goniometer are surgically fixed to the bone, the potential for soft tissue movements exists.

Positioning-related faults are differences in orientation of the goniometer between trials if the various clamps of the instrument are not positioned on the bones identically each time the goniometer is attached, which may lead to variations in starting position. There may be a variation in the limits of passive motion from differences in elasticity and plasticity in the soft tissue depending on whether the measurements are made in the morning or afternoon, or whether the subjects have been taking part in any physical activity shortly before the examination. Blood flow, temperature, and stretching could influence soft tissue characteristics, but such possible changes in rotation during the day were not large enough to be registered with the device.

No documentation of the female subjects' status concerning pregnancy was done. If any of the female subjects were pregnant, it could have affected the measurement result and may have been a source of error.<sup>25</sup>

Finally, an external device for measurements of knee rotation would aid as a complement to existing examination tools in clinical assessment of knee kinematics. It would be of interest in the future to measure knee rotation both in injured and uninjured knees after different injuries and disorders in relation to the results of the normal population in the present study.

In conclusion, we found no significant differences in total knee rotation according to age or between the right and the left knees at 90°, 60°, and 30° of knee flexion with 6 and 9 N m applied torques, as well as the examiner's apprehension of end-feel. The females showed 10–20% larger range of rotation ( $p < 0.01$ ) than

the males. The internal rotation accounted for 40–44% and the external for 56–60% of the total knee rotation.

## ACKNOWLEDGMENTS

This work was funded by the County Council of Halland FoU-foundation. We thank Marten Lerner and Fristil Reklam for excellent technical support.

## REFERENCES

- Caillet RC. 1973. Functional anatomy. In: Knee pain and disability. Philadelphia: F.A. Davis Company. p 49–69.
- Blankevoort L, Huskies R. 1996. A mechanism for rotation restrains in the knee joint. *J Orthop Res* 14:676–679.
- Colombet P, Robinson J, Christel P, Franceschi JP, Dijan P. 2007. Using navigation to measure rotation kinematics during ACL reconstruction. *Clin Orthop Relat Res* 454:59–65.
- Ishibashi Y, Tsuda E, Tazawa K, Sato H, Toh S. 2005. Intraoperative evaluation of the anatomical double-bundle anterior cruciate ligament reconstruction with the OrthoPilot navigation system. *Orthopedics* 28:1277–1282.
- Czerniecki JM, Lippert F, Olerud JE. 1988. A biomechanical evaluation of tibiofemoral rotation in anterior cruciate ligament deficient knees during running and walking. *Am J Sports Med* 16:327–331.
- Ristanis S, Giakas G, Papageorgiou CD, Moraiti T, Stergiou N, Georgoulis AD. 2003. The effects of anterior cruciate ligament reconstruction on tibial rotation during pivoting after descending stairs. *Knee Surg Sports Traumatol Arthrosc* 11:360–365.
- Brandsson S, Karlsson J, Eriksson BI, Kärrholm J. 2001. Kinematics after tear in the anterior cruciate ligament: dynamic bilateral radiostereometric studies in 11 patients. *Acta Orthop Scand* 72:372–378.
- Sanfridsson J, Arnbjörnsson A, Fridén T. 2001. Femurotibial rotation and the q-angle related to the dislocating patella. *Acta Radiol* 42:218–224.
- Lane JG, Irby SE, Kaufman K, Rangger C, Daniel DM. 1994. The anterior cruciate ligament in controlling axial rotation. An evaluation of its effect. *Am J Sports Med* 22:289–293.
- Magit DP, McGarry M, Tibone JE, Lee TQ. 2008. Comparison of cutaneous and transosseous electromagnetic position sensors in the assessment of tibial rotation in a cadaveric model. *Am J Sports Med* 36:1389–1396.
- Matsumoto H, Seedhom B. 1993. Rotation of the tibia in the normal and ligament-deficient knee. A study using biplanar photography. *Proc Inst Mech Eng (H)* 207:175–184.
- Nielsen S, Rasmussen O, Ovesen J, Andersen K. 1984. Rotatory instability of cadaver knees after transaction of collateral ligaments and capsule. *Arch Orthop Trauma Surg* 103:235–241.
- Shaw JA, Eng M, Murray DG. 1974. The longitudinal axis of the knee and the role of the cruciate ligaments in controlling transverse rotation. *J Bone Joint Surg A* 56:1603–1609.
- Mills OS, Hull L. 1991. Apparatus to obtain rotational flexibility of the human knee under moment loads in vivo. *J Biomech* 24:351–369.
- Muiadi QI, Nicholson LL, Refshauge KM. 2009. Do elite athletes exhibit enhanced proprioceptive acuity, range and strength of knee rotation compared with non athletes? *Scand J Med Sci Sports* 19:103–112.
- Shultz JS, Shimokochi Y, Nguyen A-D, Smits RJ, Benyon BD, Perrin DH. 2007. Measurement of varus-valgus and internal-external rotational laxities in vivo—Part II: Relationship with anterior-posterior and general joint laxity in males and females. *J Orthop Res* 25:989–996.

17. Tsai AG, Musahl V, Steckel H, Bell KM, Zanto T, Irrgang JJ, Fu F. 2008. Rotational knee laxity: reliability of a simple measurement device in vivo. *BMC Musculoskelet Disord* 9:35.
18. Zarins B, Rowe C, Harris BA, Watkins MP. 1983. Rotational motion of the knee. *Am J Sports Med* 11:152–156.
19. Schoemaker SC, Markolf KL. 1982. In vivo rotatory knee stability. *J Bone Joint Surg Am A* 64:208–216.
20. Almquist PO, Arnbjörnsson A, Zätterström R, Ryd L, Ekdahl C, Fridén T. 2002. Evaluation of an external device measuring knee joint rotation—an in vivo study with simultaneous Roentgen stereometric analysis. *J Orthop Res* 20: 427–432.
21. Almquist PO, Ekdahl C, Isberg PE, Fridén T. 2011. Measurements of knee rotation—reliability of an external device in vivo. *BMC Musculoskelet Disord* 12:291. <http://www.biomedcentral.com/1471-2474/291>
22. Lehmkuhl LD, Smith LK. 1983. Knee region. In: Brunnstrom's clinical kinesiology. 4th ed. Philadelphia: F.A. Davis Company. p 287–307.
23. Norkin CC, Levangie PK. 1992. The knee complex. In: Joint structure and function: A comprehensive analysis. 2nd ed. Philadelphia: F.A. Davis Company. p 337–372.
24. Selvik G. 1989. Roentgen stereophotogrammetry A method for the study of kinematics of the skeletal system. *Acta Orthop Scand* 60:1–51.
25. Marnach ML, Ramin KD, Ramsey PS, Song SW, Stensland JJ, An KN. 2003. Characterization of the relationship between joint laxity and maternal hormones in pregnancy. *Obstet Gynecol* 101:331–335.