



LUND UNIVERSITY

Energy Efficiency in Residential Buildings in Mozambique - Measurements and Simulations

Auziane, Gabriel

2015

[Link to publication](#)

Citation for published version (APA):

Auziane, G. (2015). *Energy Efficiency in Residential Buildings in Mozambique - Measurements and Simulations*. [Doctoral Thesis (compilation), Department of Construction Sciences]. Division of Building Science, Lund University.

Total number of authors:

1

General rights

Unless other specific re-use rights are stated the following general rights apply:

Copyright and moral rights for the publications made accessible in the public portal are retained by the authors and/or other copyright owners and it is a condition of accessing publications that users recognise and abide by the legal requirements associated with these rights.

- Users may download and print one copy of any publication from the public portal for the purpose of private study or research.
- You may not further distribute the material or use it for any profit-making activity or commercial gain
- You may freely distribute the URL identifying the publication in the public portal

Read more about Creative commons licenses: <https://creativecommons.org/licenses/>

Take down policy

If you believe that this document breaches copyright please contact us providing details, and we will remove access to the work immediately and investigate your claim.

LUND UNIVERSITY

PO Box 117
221 00 Lund
+46 46-222 00 00



LUND
UNIVERSITY



ENERGY EFFICIENCY IN RESIDENTIAL BUILDINGS IN MOZAMBIQUE

Measurements and Simulations

GABRIEL AUZIANE

Building
Science

Doctoral Thesis

DEPARTMENT OF CONSTRUCTION SCIENCES

DIVISION OF BUILDING SCIENCE

ISRN LUTVDG/TABK--15/1027--SE (1-176) | ISSN 1103-4467

ISBN 978-91-7623-159-3 (print) | ISBN 978-91-7623-160-9 (pdf)

DOCTORAL THESIS

**ENERGY EFFICIENCY IN RESIDENTIAL
BUILDINGS IN MOZAMBIQUE**

Measurements and Simulations

GABRIEL AUZIANE

Copyright © Gabriel Auziane 2015.

Printed by Media-Tryck LU, Lund, Sweden, April 2015 (*Pf*).

For information, address:

Division of Building Science, LTH, Lund University, Box 118, SE-221 00 Lund, Sweden.

Homepage: <http://www.bkl.lth.se>

Acknowledgements

I am deeply thankful to my main supervisors, Professor Bertil Fredlund and Associate Professor Susanne Heyden, my co-supervisors Dr. Kurt Källblad, Dr. Daniel Baloi, and the former Head of the Department of Construction Sciences, Professor Göran Sandberg and Professor Anne Landin for offering me the possibility of working in this project and also for support, encouragement, inspiration and patience over the years, without their help and advice this thesis work would never have been successful.

Furthermore, I would like to thank the Head of the Division of Structural Mechanics, Professor Erik Serrano and Professors Jesper Arfvidsson and Petter Wallentén, for their supervision of the work and great help in the overall process of this research.

I thank Asdi/SAREC for this research receiving financial support through Lund University and Eduardo Mondlane University under the coordination of Prof. Dr. José da Cruz. I thank the Department of Construction Sciences, for accepting me as a PhD student in this area of knowledge which constitutes a vital additional matter to my background in electrical engineering industry and building systems.

Most of my work was made possible thanks to the great collaboration of the late Mr. Thord Lundgren, research engineer, for his help in the field of measurement equipment, setting-up in the test house and treatment of data for this work and also for the social life.

I would also like to thank the staff from the Department of Construction Sciences, Divisions of Structural Mechanics and Construction Management. Thanks to Christina Glans, for her help in all administrative activities, Bo Zadig for helping me with printing and amusing social life and Artur Grabowsky for helping me with computer software.

I thank all my friends, in particular Raymond Chamboco, and my colleagues at Faculty of Engineering of Eduardo Mondlane University, Marcelino J. Rodrigues and Prof. Dr. Jorge O. P. Nhambiu.

Finally, I wish to express my greatest thanks to my family and siblings for their help and abetment in my study career.

Dedication

I dedicate this work to my beloved mother Virgínia Chume and my late father, Auziane Auze, who showed me all the paths to school and to life.

Gabriel Auziane
Lund, April, 2015.

Abstract

Mozambique, situated in south-east Africa, has sub-tropical and tropical climate and plenty of natural resources for energy production. The country is however poor, and only about 25% of the population has access to electricity from the grid. A very large part of the energy used in the country is used in the residential sector, and there is a general lack of knowledge, regulations and tools concerning energy efficiency in buildings.

The aim of this work is to contribute to a framework of knowledge and tools that can improve the energy efficiency in buildings, which in turn can lead to better use of natural resources, better indoor comfort in residential buildings and better economy for the dwellers. The framework consists of several parts, such as measurement equipment, an energy balance simulation tool and analysis of the potential of efficient appliances and PV-systems, as described in the following. It is believed that this knowledge and tools can be a resource for professionals in Mozambique, which will improve their possibilities to work for better energy efficiency in the residential sector.

A reference building, “3 de Fevereiro Residential”, in Maputo City was used in the project. This building is typical for the housing stock in Maputo City and can serve as a case study for studying energy improvement in buildings in Mozambique.

The use of electricity in the reference building was examined, and it was found that the equipment that use the largest part of the electrical energy was the cooling system, 26%, water heating, 23% and lighting, 15%. Old, inefficient appliances and traditional light bulbs were used in the house. The effect of changing to new, more efficient, appliances and using LED lamps was analysed and the evaluation showed that this could result in 24% decrease in electrical energy use.

Measurement equipment for monitoring outdoor and indoor climate was installed in the building. Outdoor climate variables measured included global and diffuse irradiance, temperature, wind speed and direction. Indoor temperature and relative humidity was measured. Measurements were performed for a continuous period of one year, and the equipment included a facility for collecting the data via internet.

Different theoretical and experimental techniques for analysing and evaluating energy used in buildings were examined in order to find a suitable tool for the climatic conditions and building types prevailing in Mozambique. DEROB-LTH was considered to be the most suitable tool among the evaluated ones. DEROB-LTH is a dynamic simulation tool with three-dimensional modelling of the building geometry for analysis of the effect of solar radiation as a key feature.

DEROB-LTH was validated by comparing results of indoor temperature from simulations with measured indoor temperatures for the reference building. Measured outdoor climate data was used as input data. The comparison of simulation results with ones from the measurement equipment presented good agreement, which

indicates that the selected tool can be used in Mozambican climatic conditions in particular, and in subtropical and tropical countries in general.

An interesting way of decreasing electricity bought from the grid is the use of PV-systems. PV-systems could also be used where there is no grid, and as back-up for critical functions where the grid is unreliable like in Mozambique. To explore this possibility, a pilot PV-system was installed in the reference building. The system proved to work well, and its performance was monitored by measurement equipment. An evaluation of the life-cycle cost, however, showed that the electricity price when using the system would be about eight times higher than buying from the grid.

Keywords: Energy, Building, Measurements, Simulations, DEROB-LTH, Mozambique, Subtropical and Tropical climates, Energy efficiency, PV system, Electrical energy savings.

Popular science abstract

Energy savings and climate change mitigation have been discussed in the world since the oil crisis in the 1970s and the building sector has been seen as one of the largest contributors to global warming effects in the world. Energy efficiency in buildings is a critical issue to be addressed in order to reduce electricity energy used in buildings and is one of the main tasks that is developed within the program Advancing Sustainable Construction in Mozambique. The work done in this thesis contributes to better knowledge in the field of building energy performance through energy analysis, auditing, modelling, and simulations of energy use in buildings with a focus on the residential sector in Mozambique.

Research in the energy efficiency in buildings sector is an important issue, because it can generate knowledge and awareness among builders, architects and engineers about the benefits of using tools which predict the energy use in buildings during the design stage or when retrofitting.

It was found that there is a lack of suitable tools in Mozambique, for assessing building energy use during the design stage and at renewal. It was also found that the energy in residential buildings is used inefficiently. In order to find tools to cope with these problems, seven modelling and simulation tools were studied and among them one was selected as suitable to be used in Mozambique, considering factors as climate, building stock and education level.

Additionally, measurement equipment for measuring indoor temperature, humidity, and electricity data and outdoor climate such as direct and diffuse solar radiation, temperature and humidity, wind direction and wind speed was installed in the case study “3 de Fevereiro Residential” building. The measured indoor and outdoor climatic factors were necessary for gauging the predictions of the simulation tool.

From a literature review and the inspection done in the case study building, it was found that the existing appliances in residential buildings are old and energy inefficient. An analysis showed that using new and efficient technologies for air conditioning, appliances and for lighting could result in a reduction of electrical energy use by 24%.

It was concluded that the improvements mentioned above can be enhanced with the use of renewable energy such as solar panels. To test this, a photovoltaic system generating electricity from the sunlight was designed and installed in the “3 de Fevereiro building”. The system supplied the building with electricity for cooling and lighting. This research system proved to work well and included the possibility to collect data via internet.

The use of renewable energy is vital in improvement of electrical energy used in urban and rural zones. The constraint for its use is related to the price which is unaffordable for the majority of the Mozambican population living in rural zones. Thus, loans and

incentives from the government for households who need to use efficient appliances and solar panels is highly recommended.

Abbreviations and acronyms

AC	Air Conditioner
AC	Alternating Current
COP	Coefficient of Performance
DEROB	Dynamic Energy Response of Buildings
DD	Degree Day
DC	Direct Current
DHW	Domestic Hot Water
DOD	Depth of Discharge
EDM	Electricidade de Moçambique
ETS	Emission Trading Scheme
EU	European Union
GHG	Greenhouse Gas
HCB	Cahora Bassa Hydroelectric
HVAC	Heating Ventilation air Conditioning
IEA	International Energy Agency
LED	Light Emitting Diode
LNG	Liquefied Natural Gas
LPG	Liquefied Petroleum Gas
LTH	Lunds Tekniska Högskola
MAMS	Maputo Airport Meteorological Station
MTN	Mocambican metical
MWD	Meteorological Weather Data

NN	Neural Networks
OPEC	Organization of Petroleum Exporting Countries
PARP	Acção para Redução da Pobreza
PPP	Purchasing Power Parity
PV	Photovoltaic
PSTAR	Primary and Secondary Term Analysis and Renormalization
PPD	Predicted Percentage Dissatisfied
PMV	Predicted Mean Vote
SEK	Swedish krona
STEM	Short-Term Energy Monitoring
TRY	Test Reference Year
RH	Relative humidity
SHT	Humidity and temperature sensor
USA	United States of America
USD	US Dollar
WMR	Weather measurement - Oregon Scientific
ZAR	South African Rand

Contents

Acknowledgements	i
Dedication	iii
Abstract	v
Popular science abstract	vii
Abbreviations and acronyms	ix
Contents	xi
1 Introduction	1
1.1 Overview and research context	1
1.2 Problem statement and research questions	3
1.3 Aim, scope and limitations	4
1.4 Outline of the thesis	4
2 Background	9
2.1 Energy situation and strategies	9
2.1.1 Climate and natural resources in Mozambique	9
2.1.2 Electrical power production, distribution and demand in Mozambique	11
2.1.3 Energy use in Mozambique and the world	14
2.1.4 Energy efficiency in buildings	19
2.1.5 Energy efficiency strategies	20
2.2 Solar energy	21
2.2.1 Solar collectors	21
2.2.2 Photovoltaic systems	21
2.3 Modelling and simulation of energy in buildings	22
2.3.1 Surroundings	23
2.3.2 Envelope and ventilation	24
2.3.3 Interior volumes	24
2.3.4 Types of models and simulation tools	25
2.4 Methods used for energy studies	26
2.4.1 The Save HELP Method	26
2.4.2 STEM & PSTAR	27
2.4.3 Neural Networks (NN)	27

2.4.4	The University Projects	28
2.4.5	The Energy Barometer	28
2.4.6	The BKL Method	28
2.4.7	DEROB-LTH Program	29
3	Methods and results	31
3.1	Building modelling and simulation tool	31
3.1.1	Brief introduction to DEROB-LTH Program	31
3.1.2	Climatic conditions of Maputo city	32
3.1.3	Characterization of the “3 de Fevereiro Residential”	33
3.1.4	Selecting volumes for simulation	34
3.1.5	Simulation results	35
3.2	Design of weather station and field measurement of climatic data	38
3.2.1	Design and installation	38
3.2.2	Measurement results	43
3.2.3	Comparison with MAMS measurements	54
3.3	Improvement of electrical energy use in residential	55
3.3.1	Electrical energy use in Mozambican buildings	55
3.3.2	Comparison with South Africa and Sweden	56
3.4	Photovoltaic system design and installation	59
3.4.1	Relevance of photovoltaic systems in Mozambique	59
3.4.2	PV system design	60
3.4.3	PV system tested at Lund University	61
3.4.4	Lund measurement results	62
3.4.5	Economic evaluation of the PV system for air conditioner	71
4	Discussion	73
4.1	Socio-economic perspective	73
4.2	Methodology used	74
4.3	Research questions	77
5	Conclusions and recommendations for further research	81
5.1	Conclusions	81
5.2	Recommendations for further research	82
	References	83

1 Introduction

1.1 Overview and research context

Energy resources management is one of the principal challenges that both developed and developing countries confront nowadays. The economic development that occurred the last decades in the world has resulted in a large utilization of energy produced from fossil resources. The finite nature of this natural resource, and the environmental impact of its production and consumption, has made many countries develop plans regarding energy use in buildings.

Mozambique is located in southeast Africa between 10°-27°S and 30°-41°E and has subtropical and tropical climates. The country has a lot of conventional buildings with traditional home devices supplied by the electrical grid, though only 23% of the population has access to electricity. Biomass (fuel-wood and charcoal) is the basic energy source for most of the population in Mozambique. Many district capitals depend on expensive and often unreliable power generation with diesel generators, leading to increased greenhouse gas (GHG) emissions.

In the European Union, it is estimated that about 40% of the total energy is used in buildings and in this sector the use of energy is continuously increasing [1, 2]. In terms of primary energy use, buildings represent around 40% in most International Energy Agency (IEA) countries [3]. In Mozambique, on the other hand, it is estimated that from the total average of the energy produced, as much as 72% is used in residential buildings [4].

Currently, energy demand is increasing in Mozambique. There is a need for an electricity supply that covers a larger part of the population and from an environmental point of view there is also a need for renewable energy. Therefore, measures are now being taken to cope with the problem through planning new power generation, transportation infrastructures and efficient energy use in buildings [5].

Figure 1.1 presents a schematic of the current situation and challenges to be considered in dealing with energy in Mozambique. Tools for meeting the challenges include legislation and economic incentives as well as technical tools.

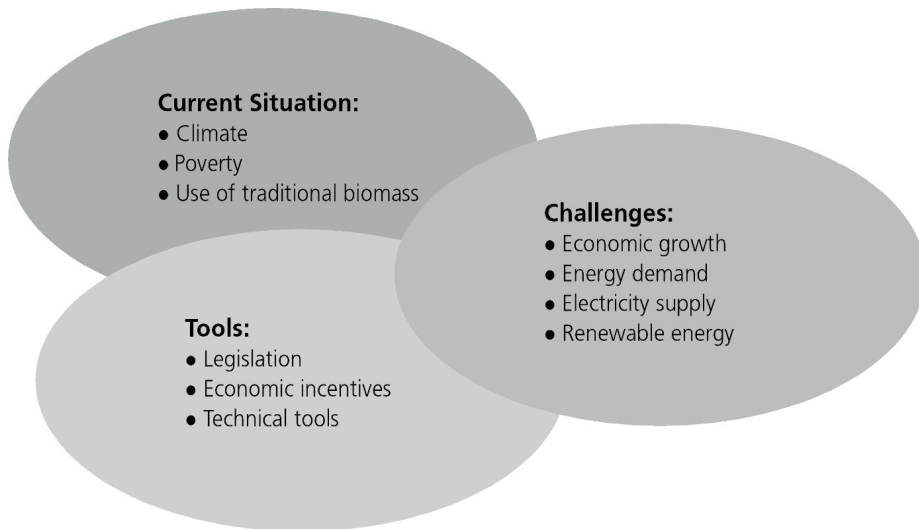

Figure 1.1: Schematic of current situation, general energy challenges and tools in Mozambique.

Table 1.1 illustrates examples of tools that can be used for addressing the issue of energy use in buildings. The research context of this work is the situation and challenges regarding energy use in the world and in Mozambique, and the palette of tools that can be used to meet the challenges. The main focus of this work is related to technical tools on the building level. This includes creating a climatic database, selecting a model and simulation tool to be used in evaluation of energy use in buildings inherent to Mozambican climatic conditions as well as presenting means and techniques to decrease the dependency on energy from the grid and on energy from non-renewable resources to be used in residential buildings, e.g. by using PV systems.

Table 1.1: Legislation, economic incentives and technical tools, examples on different levels.

		Global	National/regional	Building
Legislation and economic incentives	Policies	Environmental-, climatic-, energy system policies	Governmental/ regional policies	Local/community policies
	Economic incentives	Emissions trading	Taxation	Subsidies
	Building regulations, standards and codes	International standards	Standards and codes, spatial planning	Local building regulations
Technical tools	Measurements	Climate/weather measurements	Climate/weather measurements	Outdoor/indoor climatic data
	Modelling	Climate modelling	Weather modelling	Building modelling
	System design	-	Power generation and distribution	HVAC system
	Technical devices	-	Hydro power plant	HVAC device

1.2 Problem statement and research questions

The building sector is one of the largest contributors to global GHG emissions. This work attempts to contribute to better knowledge in the field of building energy performance through energy analysis, auditing, modelling, and simulations of energy use in buildings. This is important as it generates knowledge, data and information for architects, engineers, building designers, constructors and maintenance operators that help them contribute to decrease the energy use in buildings.

This work deals with the following research questions:

- What are the most important aspects to take into account considering energy efficiency in residential buildings in Mozambique?
- How can the influence of building design, equipment, lighting and occupants on the building energy use be analysed?
- How should building energy systems be managed?

1.3 Aim, scope and limitations

In general terms, the aim of the research presented in this thesis is to provide means for improving the energy efficiency in residential buildings in Mozambique. To do this, there is a need to select and validate a model and simulation tool suitable for Mozambican climatic condition to be used by professionals in the field of energy efficiency in buildings and to present the best means for improving energy use in buildings. This leads to the following specific aims:

- Review of the current practices concerning energy use in buildings in Mozambique and worldwide.
- Identify, analyse and evaluate suitable models, and simulation tools for assessment of energy use in buildings in tropical and subtropical climate.
- Suggest technical and other means of improving the energy performance of residential buildings.
- Develop a framework of models and tools that can be used by researchers, designers and constructors in the field of energy efficiency in buildings.

The scope of the work is to develop a framework for measuring and modelling indoor and outdoor climatic factors, and studying the use of photovoltaic (PV) systems to reduce the energy used (or rather to reduce the amount of electrical energy bought from the grid) in buildings and their implementation in Mozambique. The work includes design and implementation of a system for measuring, collecting and storing the data to be used in building energy modelling and simulation tools, to evaluate and present the means to improve energy use in buildings and, finally, to design a PV system.

This research is limited to studying modelling and simulation tools of energy use in buildings suitable for the climatic conditions of Mozambique (Maputo City region). The PV system presented in this thesis does not support the entire demand of the particular apartment in the study, due to lack of financial resources for installing a system with sufficient capacity.

1.4 Outline of the thesis

This thesis is structured in two parts: Part I is a statement of the overall work and is divided into five chapters, including this one, and Part II contains the appended papers as presented below.

Part I: Summary of the thesis.

Chapter 2 gives a background in terms of the context and situation concerning energy in Mozambique, an overview of energy efficiency strategies and a literature review on some existing models.

Chapter 3 is devoted to the methods and main results of the work. The first part of Chapter 3 relates to simulations done using the DEROB-LTH program and based on Test Reference Year (TRY) data from Meteonorm. The second part relates to the design of measurement equipment. A weather station and equipment for measuring the outdoor and indoor climatic factors, respectively, were designed and installed within this work. The third part treats possible improvement of electrical energy use in residential buildings. The fourth part, finally, relates to PV system design and installation, presenting the design of a photovoltaic system for low energy systems in tropical and subtropical countries and the use of active systems in buildings.

Chapter 4 presents a discussion of the overall matter described in this thesis.

Chapter 5 presents the overall conclusions, recommendations and further research needs.

Part II: Appended papers.

Part II contains five papers which constitute the basis of this thesis and whose summaries are presented below.

Figure 1.2 describes schematically the relationship amongst the appended papers and how they contribute to better energy efficiency in buildings.

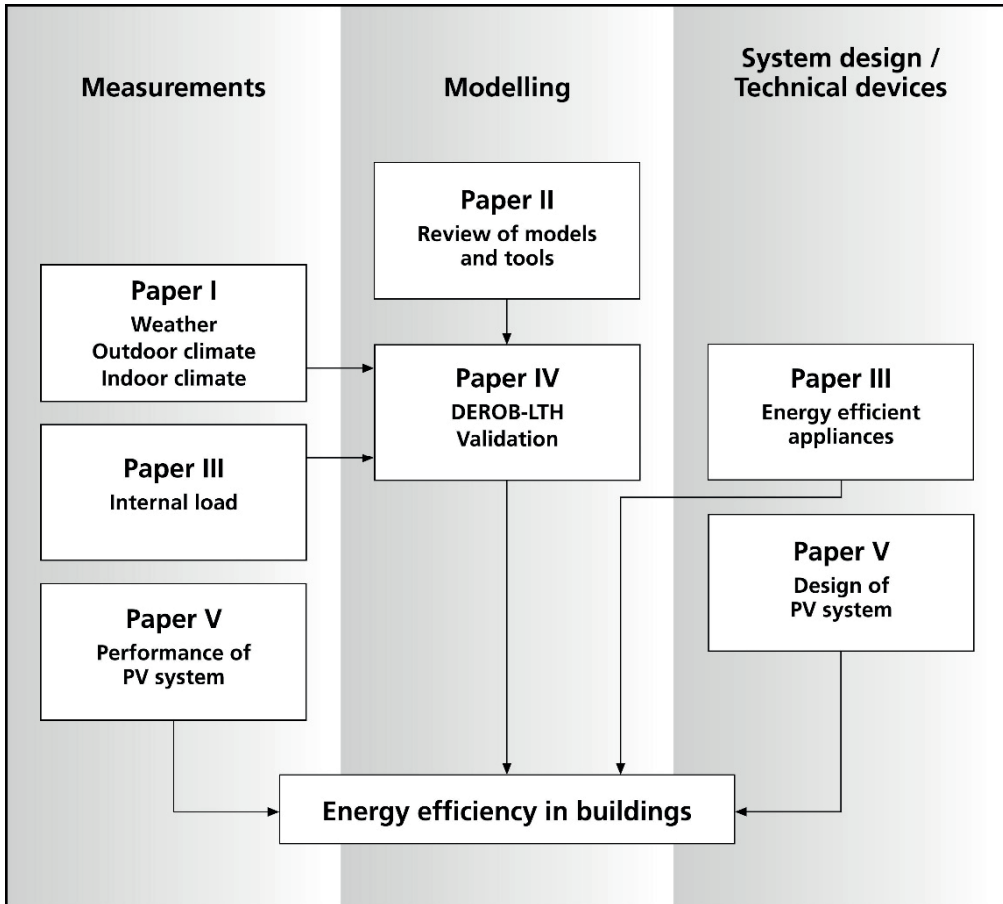

Figure 1.2: Relationship amongst the appended papers.

Paper I

Auziane, G., Landin, A. and Baloi, D., Design of weather station and measurement equipment for assessment of buildings energy use in Mozambique. Published in Proceedings of Second International Conference on Advances in Engineering and Technology, AET2011 (078).

This paper presents the design of the measurement equipment of a weather station, sensors for measuring indoor and outdoor temperatures and humidity. The measurement equipment allows collecting and storing parameters and factors useful for assessing energy use in buildings as well as for testing, validation and calibration of tools for modelling and simulation of energy use in buildings.

My contribution in this paper was to conceive the sketch of the main layout of the measurement equipment, to coordinate the installation in the test house and to organize the database. The co-authors of the paper supervised and reviewed the work.

Paper II

Auziane, G. and Fredlund, B., Energy assessment methodologies and energy use in buildings – A review of selected theoretical and experimental techniques. Accepted for publication in Scientific Journal of Eduardo Mondlane University (RC-UEM), (2013).

The paper presents a literature review on methods and methodologies of experimental techniques and energy characterization in buildings. The basic theory for energy characterization and energy efficiency in buildings was studied. The most appropriate tool for evaluating energy use in buildings for Mozambican climatic conditions was selected. Among the seven modelling and simulation tools studied, the DEROB-LTH program was selected to be used by engineers, architects and professionals to analyse and evaluate the energy use in buildings, such as energy for heating and cooling, peak loads for heating and cooling, thermal and visual comfort, and thermal comfort indices such as: Predicted Mean Vote (PMV) and Predicted Percentage Dissatisfied (PPD) in buildings.

My contribution in this paper was to perform the literature study and critical analyses of the various modelling and simulation tools, and to select the suitable one for climatic conditions of Mozambique. The co-author helped by planning and reviewing the work.

Paper III

Auziane, G., Fredlund, B., Improvement of residential energy use Case Study: “3 de Fevereiro Residential”. To be submitted.

The work presented in this paper is inherent to the breakdown of the appliance loads in the “3 de Fevereiro Residential” building which can be used as benchmark for typical buildings in Maputo and other Mozambican cities and districts throughout the country. Using these results the dwellers can gain awareness about energy saving and the use of energy-labelled devices. This will lead to energy savings since households have a lack of energy efficiency techniques for saving energy in buildings. In Mozambique information related to the electrical energy used in residential buildings by appliances is in general not available and this paper presents useful data to fill this gap.

My contribution was to provide electrical energy use breakdown data of the “3 de Fevereiro Residential” building, by measurements and calculations, to analyse the potential for reducing electrical energy used in buildings using energy efficient equipment as well as to show the advantages of using light emitting diode (LED) lamps. The co-authors helped in planning the activities related to the work and assisted in writing the paper by reviewing and giving relevant suggestions to the work.

Paper IV

Auziane, G., Källblad K., Wallentén, P., Validation of building energy modelling and simulation tool for Mozambican climate a case study: “3 Fevereiro Residential”. To be submitted.

In this paper, the main goal is to test the performance of the DEROB-LTH building simulation tool, using the data from the measurement equipment installed in the “3 de Fevereiro Residential” building. The special climatic file using data from the measurement equipment was defined and used to test and validate the modelling and simulation tool.

My contribution was to prepare input data, perform the simulations and compare the results with measured data. The co-authors helped in planning the activities and assisted in writing the paper by reviewing and giving relevant suggestions to the paper.

Paper V

Auziane, G., Källblad, K., Fredlund, B., Design and implementation of an experimental photovoltaic system for use in buildings in Mozambique. To be submitted.

Paper V completes the field of energy efficiency in buildings and provides a framework for studying the behaviour of PV systems in the area of engineering. The low PV power system presented in this work can be used for academic purposes and the results from this work can be used by designers of the PV systems. The main idea in this paper was to provide the structure where physical experiments can take place for reducing energy used in buildings in urban areas as well as for rural areas such as schools, medical clinics, administrative posts, etc. located off grid.

My contribution was to design and build the pilot low power photovoltaic system, including measurement equipment for monitoring its performance. Furthermore my contribution was to create a database and analyse the measurement results. The co-authors helped in planning the work and assisted in writing the paper by reviewing and giving relevant suggestions inherent to the work.

2 Background

2.1 Energy situation and strategies

2.1.1 Climate and natural resources in Mozambique

Mozambique is located in southeast Africa, see Figure 2.1, and has sub-tropical and tropical climates with minimum average monthly temperatures of 19.5°C and maximum of 25.9°C. The year is divided into a wet season, or summer period, from October to March and a dry season, or winter period, from April to September. The average monthly temperature and rainfall is presented in Figure 2.2. On average, Mozambique has about 4.4 to 6 hours of sunshine throughout the year [8].



Figure 2.1: Localization of Mozambique and Maputo on the African continent map, [6], adapted by Bo Zadig.

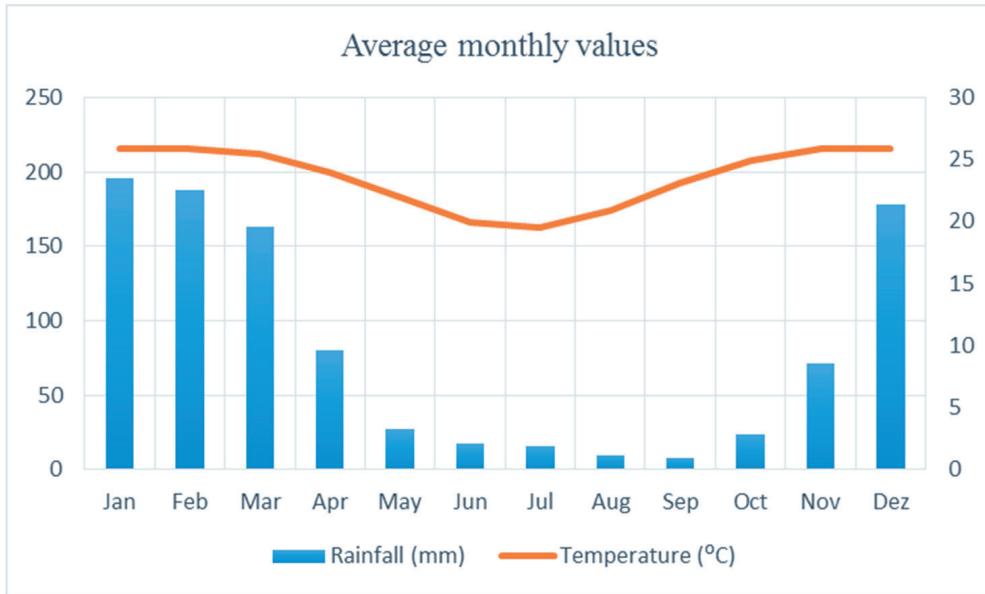

Figure 2.2: Average monthly temperature and rainfall of Mozambique, adapted from [7].

Mozambique has plenty of natural resources for producing energy. In 2009, a total primary energy supply of 9 766 ktoe was registered, the main sources of the energy in use today being biomass (78.3%), hydropower (14.3%), oil (6.5%), natural gas (0.8%) and coal/peat (0.1%) [9].

In previous years, the country has invited many international companies for prospecting the existence of petroleum and gas in Rovuma River, offshore and onshore along the Mozambican coast. The government of Mozambique has granted licenses for prospecting gas in the Rovuma basin to two companies, Anardarko and Eni, which have discovered the existence of over 4.25 trillion cubic meters (Tm³), equivalent to 150 trillion cubic feet (Tcf), of natural gas. The Rovuma basin discoveries could set Mozambique as one of the biggest exporter of liquefied natural gas (LNG) in the world in the coming years.

Beyond that, Mozambique has large sedimentary basins of gas. Three accumulations of gas have been discovered onshore at Pande and Temane in the Inhambane Province and at Buzi in the Sofala Province. The total gas reserves might be as high as 87.50 billion tons. Pande gas is now being exported to South Africa through a pipeline linking the locality of Temane to Secunda in the Gauteng Province in South Africa, a distance of 865 km, where 340 km lies in South Africa [10]. Pande gas is used for domestic and industrial activities in both countries.

Mozambique has large reserves of coal located in the Zambeze coal basin, which underlies the Tete Province and are believed to hold some 23 billion tons of coal [11]. The Tete is provided by coal reserves of approximately 6.7 billion tons [12], of which

3 billion tons represent the estimated exploitable rate [13]. The largest coal reserve presently discovered in the Tete Province is the Moatize metallurgical and thermal coal deposit which is believed to have about 2.4 billion tons of coal and is located within the Moatize sub-basin. Now, the province is regarded geologically as the largest undiscovered coal province in the world and by 2025, the province could be producing about 25% of the world's coking coal [14].

The country is also endowed with great potential of renewable energy, namely hydropower, solar power, wind power and biomass, as presented in Table 2.1.

Table 2.1: Summary of the renewable resource potential [12, 13].

Resource	Estimated potential of renewable energy
Hydropower	12 GW (1 GW in small installations up to 10 MW)
Solar power	1.49 Million GWh
Wind power	Along coast of Niassa Province (wind speed 4.5 to 7 m/s, average 6 m/s)
Biomass	100's of MW (Big bagasse potential)

2.1.2 Electrical power production, distribution and demand in Mozambique

Most of the electricity in Mozambique is produced at the Cahora Bassa Dam, built and completed before independence in 1975. The total electricity capacity installed in Mozambique is about 2 308 MW where the hydropower is the dominant source, with 99.7% of the total electricity produced [9].

Mozambique started to build a link from Tete to South Africa in 1977 and the link was completed after three years. So, in 1979 export of electricity was initiated, as 1 920 MW of the 2 075 MW generated by the company Cahora Bassa Hydroelectric (HCB) was exported [15]. In 2009, 73.40% of the electrical power was exported to South Africa [9].

Considering that Mozambique is a large country with about 2 515 km of coastline and 784 090 km² of total area [16], it is extremely costly for a poor country like Mozambique to extend the electric grid throughout the country. In 1977 the country was without industrial infrastructure and without economic activity generating demand of the electrical energy produced at HCB. Thus, during the development of the HCB draft, it was concluded that with no industry to justify the deployment of a line in HVDC \pm 533 kV, 1 920 MW, 1 800 A, from Tete to Maputo, the economic alternative was to export the energy directly from HCB to Eskom (a South African company), which in turn should sell the power back to southern Mozambique, leading to increased energy rates for Mozambique.

Mozambique is one of the poorest countries of the world, which means that a great part of the population does not have access to good medical clinics, schools, drinking

water, electricity, etc. To give an idea, the ratio of poverty in the country is indicated in Figure 2.3. Poverty is here defined as a purchasing power parity (PPP) basis of about \$2 (1996/2003 PPP) a day [17, 18]. In order to cope with this problem, in 2011, the Government of Mozambique launched a plan called, Poverty Reduction Action Plan (Plano de Acção para Redução da Pobreza, or PARP). The main goal of this plan is to reduce the incidence of poverty from nearly 55% to 42% by 2014 [19].

One part of this problem is that only few inhabitants have access to, or can afford, electricity. The PARP therefore includes electrification of the country. In this context, the main energy resource for the population is biomass, which satisfied more than 71.7% of total domestic energy requirements in 1999 [20].

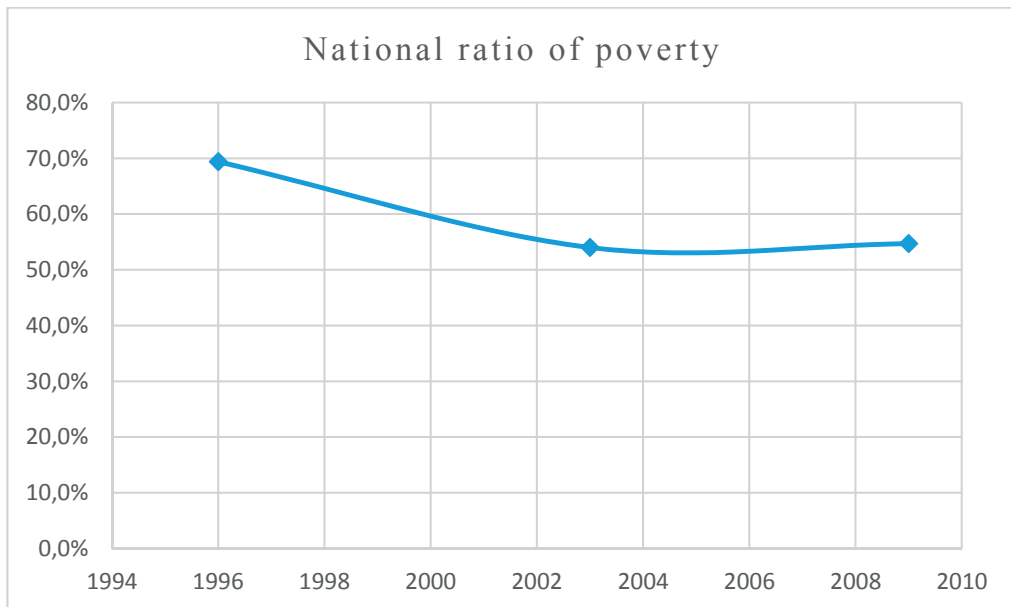

Figure 2.3: Population living below the national poverty line, [21].

Electricidade de Moçambique (EDM), an energy company of Mozambique which deals with the generation, transmission, distribution and sale of electricity throughout the country, has great difficulties in reconciling its objectives of economic viability with subsidized power provision to dispersed low-income communities. Electricity from the main grid reached 1 010 780 customers in 2011, about 21% of the population, see Figure 2.4, mostly in urban areas. The vast majority of these connections are for domestic customers. The electrification of the whole country was just 23% in 2012, 26% in urban areas and only 5% in rural areas [9]. In rural areas, the main source for lighting is kerosene (paraffin oil).

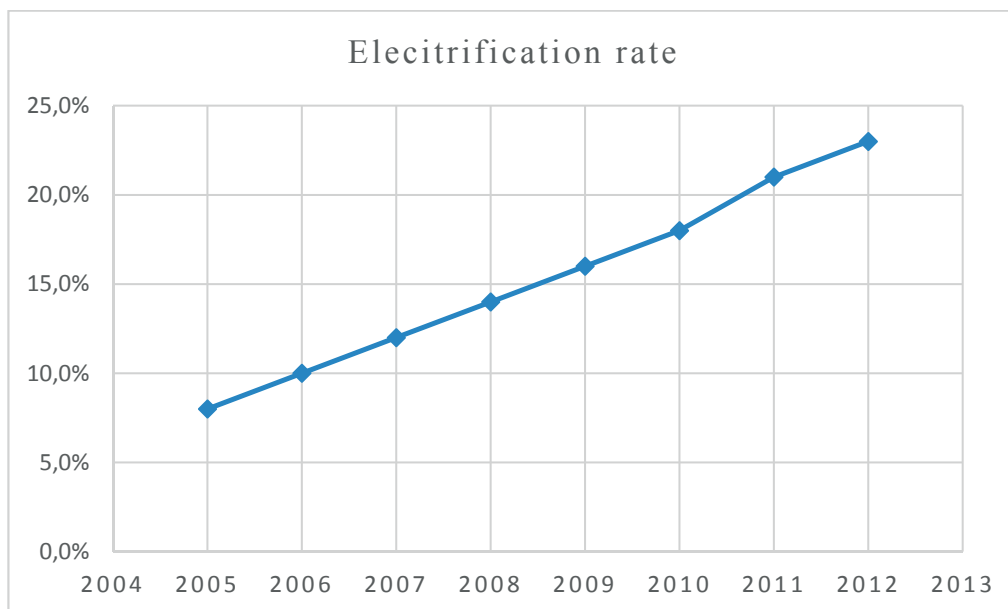

Figure 2.4: Electrification rate for Mozambique during 2005-2012, adapted from [22].

The supply of electricity is not reliable and there are blackouts. The power supply from the public network is available only 60 to 70 percent of the working time [9]. Thus many economic sectors and individuals fall back on fuel generators in order to supplement the power in blackout moments, incurring additional investment costs and increasing GHG emissions. The unreliable electricity supply is reported to be one of the reasons for the failure of some industries, clothing in particular. All businesses, except Mozal Aluminium Smelter (Mozal) which has its own particular electrical line and price as the biggest electricity consumer, are constrained by high costs of the electrical energy (high means here in relation to the economic conditions of the majority of Mozambican businesses and of the population).

The country's energy demand is growing as business is growing considerably; the annual average rate of increase of the energy demand is around 7–8 %. Table 2.2 presents the energy demand by households for a reference scenario and it considers the principal sources of energy used by households in Mozambique.

Table 2.2: Reference scenario of the households' energy demand, [23].

Ktoe	2000	2005	2010	2015	2020	2025	2030	Average annual growth (2010-2030)
Wood	3 992	4 263	4 534	4 855	5 036	5 093	4 962	0.5%
Charcoal	395	602	808	1 159	1 609	2 191	2 915	6.6%
Kerosene	49	32	20	25	31	38.6	49	4.6%
Electricity	34	41	77	153	229	302	372	8.2%
LPG	8	14	16	32	62	104	168	12.4%
Total	4 478	4 953	5 455	6 224	6 966	7 727	8 466	2.2%

2.1.3 Energy use in Mozambique and the world

The estimated total primary energy use in the World, the European Union (EU-28), South Africa, Sweden and Mozambique is presented in Figure 2.5.

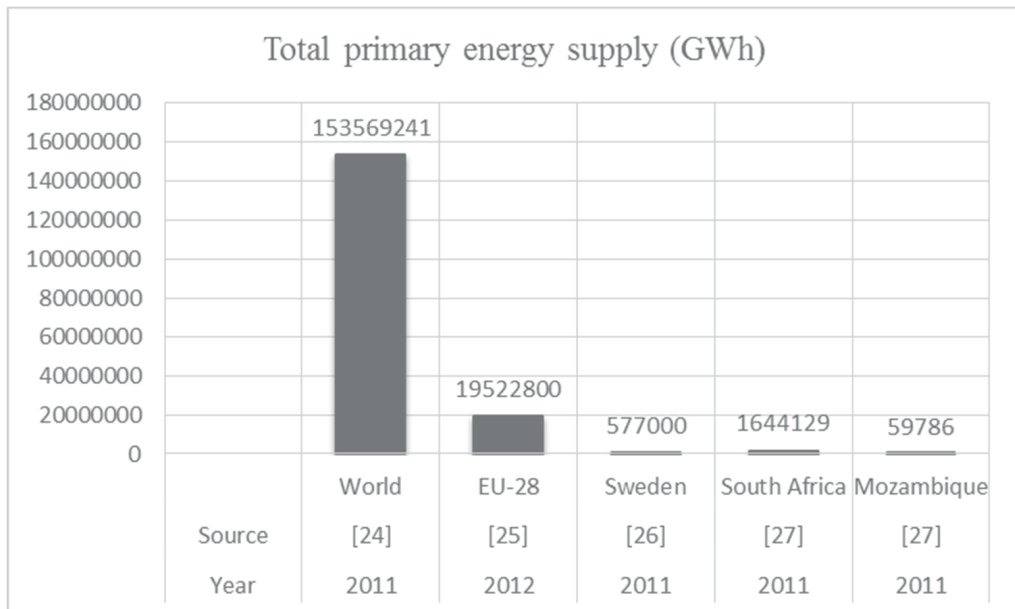

Figure 2.5: Estimated total primary energy use in the World, EU-28, Sweden, South Africa and Mozambique.

An overview of the energy supply per capita in Sweden, South Africa and Mozambique is given in Figure 2.6 as it, in general, is an important statistical

indicator of the saving per person in countries and in many cases is used in reports of economic data as well as in descriptions of a country's population. The *per capita* energy use in Sweden is approximately twice the use in South Africa and more than ten times the use in Mozambique.

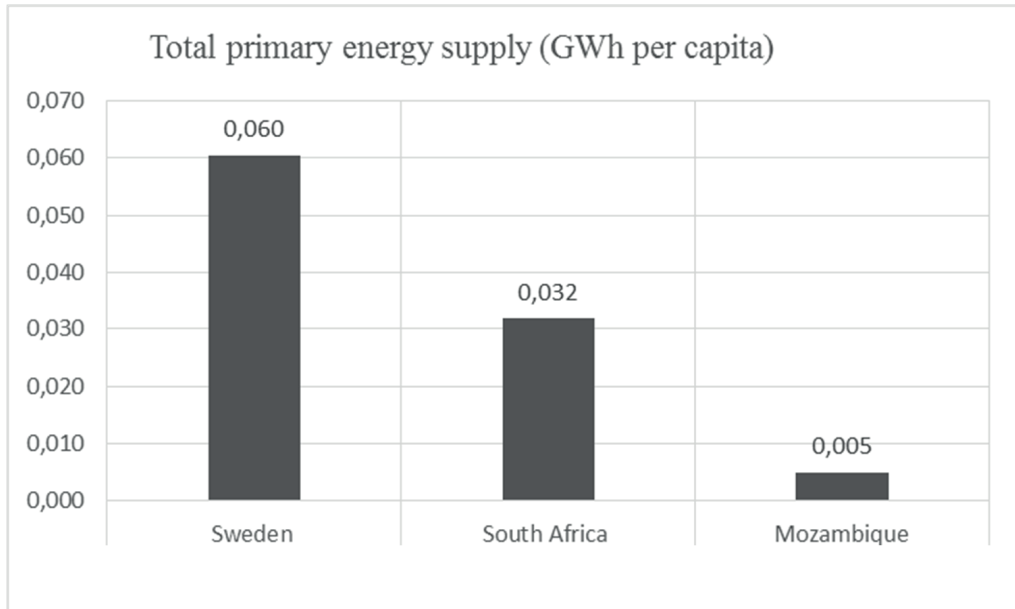

Figure 2.6: Total primary energy supply in Sweden, South Africa and Mozambique [24-28].

The focus in this work is the residential building sector. For completeness, data of other sectors such as industry, transportation, commercial, and other services, are also given, see Table 2.3. Here, the percentage of the energy use by sector in the World, European Union (EU-28), South Africa, Sweden and Mozambique is presented.

Table 2.3: The percentage of the energy use by sector.

Countries Sector	World	European Union	Sweden	South Africa	Mozambique
Residential	18%	26.2%	22.5%	18%	72%
Industry	51%	25.6%	39.3%	36%	23%
Transportation	20%	31.8%	24.1%	26%	4%
Other	12%	16.3%	14.1%	20%	1%
Year	2011	2012	2011	2010	1999
Reference	[24]	[25]	[26]	[28]	[29]

Reference [27], indicated in Figure 2.5, does not present the share of the total energy use by sector, so in Table 2.3 the percentage of the energy use by sector from [28], referring to the year 2010 instead of 2011 was used. The difference from one year to another does not generate problems in this case, because normally the total energy use does not change significantly. In Mozambique all references for total energy use are for the year 1999, which indicates a lack of research in this matter.

As mentioned in the introduction, the building sector is responsible for 40% of the total energy use in the European Union [1] and the same tendency shows in other state unions and countries in the world.

Figure 2.7 illustrates the energy used in the South African, Swedish and Mozambican residential sectors, respectively. Data are from Table 2.3 but shown in this format for a better illustration.

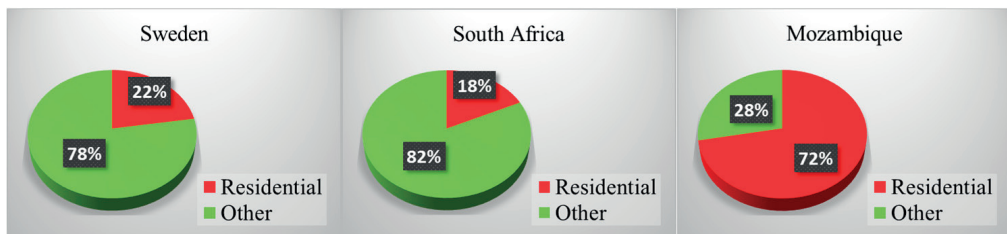

Figure 2.7: Percentage of energy used in residential sector.

From Table 2.3 and Figure 2.7 it is clear that in Mozambique, the largest energy use occurs in the residential sector, and the percentage of energy used in other sectors is rather low. This can be explained by lack of economic infrastructures with large energy usage before 1999. In recent years, the country is recording economic growth that generates energy demand from the current energy capabilities of the country. Hence the need for promoting studies and projects aiming at energy production, aiming at implementation of tools for evaluating the energy use and aiming at reducing the energy use in various economic sectors of the country.

Electrical energy use by sectors in the World, European Union, Sweden, South Africa and Mozambique is presented in Table 2.4. In this Table, IOS stands for value integrated in other sectors. This is caused by differences in what categories are used by different organizations evaluating energy use. This is not considered to create constraints in this study, since the main objective here is only to give an overview of the use of electricity in these sectors.

Table 2.4: Electrical energy use by sector.

Sector	World (GWh)	European Union (GWh)	Sweden (GWh)	South Africa (GWh)	Mozambique (GWh)
Residential	15 239 696	803 342	36 437	39 671	1 233
Commercial	8 499 061	IOS*	IOS*	28 833	258
Industry	58 614 214	1 032 011	53 800	116 631	1 175
Transportation	29 600 178	53 347	2 640	3 480	NI**
Agriculture	IOS*	47 950	1 198	IOS*	IOS*
Services	IOS*	805 110	30 564	IOS*	IOS*
Other	IOS*	67 477	2 640	27 125	0.15
Total	111 953 149	2 809 238	127 279	215 739	2 667
Year	2011	2011	2011	2006/2009	2012
Reference	[24]	[30]	[30]	[31]	[32]

*Value included in other sectors, **Value non-existent for this sector in Mozambique.

From Table 2.4 it can be seen clearly that Mozambique, despite being one of the major producers of electricity in the southern zone of Africa, is the country with less electricity power use in all sectors, which reveals that the country is poor.

Figure 2.8 shows a comparison of electrical energy use in the residential sector and other sectors. As mentioned in section 2.1.2, the majority of the customers of Electricidade de Moçambique Company are domestic, i.e. residential buildings which account for 46 percent of the electricity used. Thus, the conclusion is that, in Mozambique, a large part of the electrical energy is used in the residential sector.

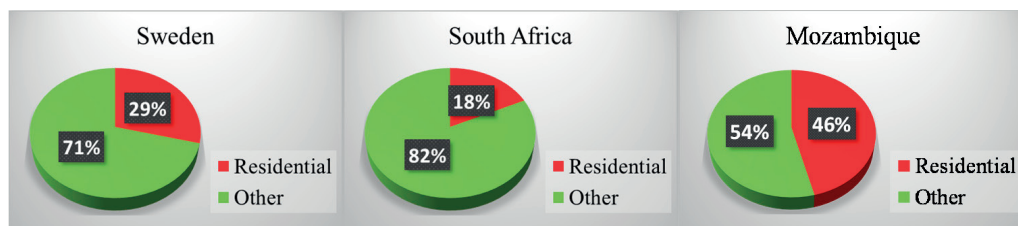

Figure 2.8: Percentage of electrical energy used in residential sector.

As indicated in Table 2.4, in Mozambique, electricity is not used for means of transport. Nevertheless, in some electricity statistic studies, electrical energy use in the transportation sector is indicated, but this is basically related to electricity use in offices and other activities of this sector but not in transport facilities such as trains or electric buses.

The higher share of electricity used in the residential sector in Mozambique, Figure 2.8, emphasizes the importance of studying energy efficiency in the residential sector.

In recent years, South Africa has implemented projects which supply electrical power to the residential sector from renewable energy, e.g. solar collectors. This contributes significantly to the reduction of electrical power use in the residential sector. To give a general idea, in 2006 the residential sector used about 52 889 GWh [31] from renewable and waste systems. Despite this, the South African residential sector is still using a significant amount of electricity from other sources.

The electricity use is correlated to the state of development, the climate conditions and the poverty rate of a country and the best indicator for this is the electricity use per capita [33] which is presented in Figure 2.9. Among the three countries, Mozambique has the smallest absolute electrical energy use (Table 2.4) and electricity use per capita as indicated in Figure 2.9, despite being endowed with several distributed energy resources throughout the country. This indicates that Mozambique is a very poor country. This is corroborated by [19], who mentions that “Mozambique is one of the world's poorest countries”.

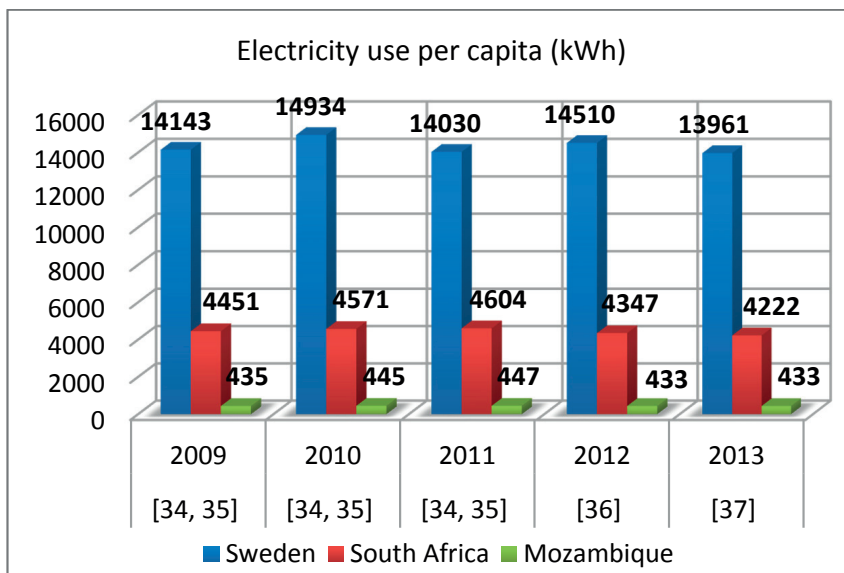

Figure 2.9: Electricity use per capita in Sweden, South Africa and Mozambique.

According to [37] the definition of poverty is related to indirect measurement factors which beyond e.g. education, sanitation and communication, include the energy as one of the indicators.

During this study it was noted that there is a lack of data inherent to how the residential electricity is used in Mozambique, which indicates the absence of research in this area. An effort to obtain this kind of data was made in this work and presented in Paper III. This paper presents details of the electrical energy use in the “3 de Fevereiro Residential” building.

2.1.4 Energy efficiency in buildings

In Mozambique as well as in other developing countries, a large number of residential buildings are being constructed every year, and many of these buildings work very poorly in terms of energy efficiency.

Many of the modern buildings and settlements throughout the country reflect an uncritical reception of modern European building style without taking into consideration the climatic and social conditions of the home country. In the last years, the construction sector started to construct some buildings using glass materials as in Europe and USA, with less observance of the site climatic conditions. This results in the need for installing air conditioning systems in order to maintain good comfort in the buildings, which increases the energy use in those buildings [38].

In Mozambique, a large quantity of energy is used in a highly inefficient manner in buildings, since the dwellings in general are equipped with energy inefficient appliances, such as e.g. cooling, lighting, refrigeration and cooking. This has a huge impact in tropical and subtropical countries, where the excessive heat from the appliances generates an increased need for cooling. In countries with cold climate, the heat from inefficient appliances can contribute to the heating of the building.

In general, the designers of residential buildings in Mozambique do not focus on energy efficiency. In fact, the Mozambican government has not developed building energy codes in any form for the construction sector, despite the recognized fact that about 40% of the primary energy produced in the world is spent in buildings. Instead older Portuguese codes are used. That is, there is a lack of builders' incentives from the government. This is unlike what happens in many other countries. For instance in Sweden, the Swedish Energy Agency promotes and provides subsidies to the municipal energy sector and climate advisory service for supporting the regional energy work in offices. In manufacturing companies, the Agency also encourages the production of goods which use less energy and disseminate the implementation of the EU Emission Trading Scheme (ETS) in Sweden [39].

In Mozambique, there is also insufficient awareness and training of building managers, builders and engineers. In addition, tools for simulating the energy use in buildings are not generally used by architects and engineers during the design stage and during construction of the buildings.

Mozambique has not adopted any instruments to measure energy use or evaluate and calculate the quantity of energy used in buildings. This is due to lack of sufficient funding to assist the penetration of home rating systems on the market and also due to the lack of specialized professionals to perform energy audits and ratings in residential buildings.

There is also a lack of awareness and knowledge of energy efficiency benefits from the end users. Another problem from the house owners' point of view is the relatively high cost of home energy systems.

2.1.5 Energy efficiency strategies

Mozambique is endowed with diverse energy resources, and it is necessary to adopt specific strategies in order to have both a reliable production and distribution of energy to be able to empower the country with efficient energy resource and avoiding the blackouts which frequently occur throughout the country. These blackouts affect the development of economic activities and, consequently, the development of the country. Strategies for reliable energy production and distribution can be developed in the following areas of energy: hydroelectric, biomass, natural gas, wind and solar resources, since in all of them there is a large potential as presented in Table 2.1.

In order to reduce buildings' energy demand many policies have been developed in the world, such as for example the "European Energy Efficiency Directive" [40] and the "Net Zero Energy Buildings" [41], which can be applied as mandatory from the directive's perspective.

In Mozambique, the energy strategies focus on how to implement the existing policies related to improvement of energy in sectors such as buildings, commerce, industry and transportation, and how to have participation of the private sectors in these policies for their implementation. Energy policies are established for producing energy based on renewable energy, namely biofuel, solar, wind and hydropower systems. The government has developed plans, programs, and projects to be implemented in these systems. So, the promotion of investments and other actions are of vital importance in order to attain these objectives.

Following the Energy Sector Strategy (2000) which focuses specifically on how to implement the energy policies mentioned above, the Energy Reform and Access Project (2003-2011), with the aim to accelerate the use of electricity for economic growth and social services in a commercially viable manner, was established. The main objective was to improve the quality of life in disadvantaged areas, as well as to increase the access to modern energy technologies. The project encourages the development of renewable energy such as solar photovoltaic and collector systems, micro-hydropower projects, and methodologies which can contribute to reducing GHG emissions in industry, in commerce and in the building sector.

In addition, the Electricity Master Plan for Development of the National Grid (2005-2019) has been designed [42]. The focus in this project is on grid supply expansion in the short-to-medium term in order to extend the electrification of the country to cover most of the population not connected to the grid. Paper V of this work, aims to investigate photovoltaic systems for implementation in residential buildings and to address concerns related to lack of electrical energy in rural areas.

2.2 Solar energy

2.2.1 Solar collectors

As shown in appended paper III, water heating systems are important consumers of electrical energy in residential buildings, for instance in South Africa 24% of the energy supplied in residential building is related to water heating [43]. In Mozambique, many apartments are provided with water heaters based on resistance which are not recommended to be supplied by small PV systems and the alternative for saving energy in water heating systems is the use of solar collectors.

In this project these systems were not considered since the focus of the work is on active systems related to generation of electrical energy. In general, solar collectors can also be applied to reduce electrical energy use in buildings and they can be used in rural areas as water heaters in e.g. medical clinics, and schools.

Investigations have been done within this area, involving researchers from the Department of Physics of Eduardo Mondlane University, and in small scale, collectors can be seen throughout the country.

2.2.2 Photovoltaic systems

The physical principles used in PV systems were discovered in 1839 by a French physicist and until now they have been applied in many economic and individual areas to supply electrical loads in zones off and on the national electrical grid.

Nowadays, PV systems have been applied for supplying many different electrical devices in many technical and social areas such as education, health, transportation, telecommunication and residences. PV systems have the advantage of producing electricity from the sun and have an environmental benefit since the primary power source is an abundant renewable resource, especially in Mozambique where solar energy is almost available every day and throughout the country.

The main limitation for many people in using PV systems is related to the high price for its implementation. In recent years, the cell technology has improved significantly and, consequently, the price is decreasing annually. With this improvement in photovoltaic technologies, the decline of PV modules price will continue and in the near future, the PV systems may be accessible even for rural people in developing countries such as Mozambique.

Many developed countries have installed a lot of solar power systems into their electrical grid systems to supplement or provide an alternative to other sources such as wind, geothermal, tidal, thermal and hydro systems. Solar power plants use one of two technologies, namely, arrays of PV modules mounted on buildings or ground mounted solar parks, and solar thermal energy plants, using concentrated solar energy to make steam which is converted by a turbine to electricity.

Figure 2.10 presents the countries with the highest capacity of photovoltaic systems in the world. As seen in Figure 2.10, Germany, Italy, China, USA and Japan have a larger amount of PV systems than other countries in the world. It is also evident that only developed countries are among those with a large amount of PV systems. The constraint in application of this renewable source of energy in developing countries is the economic factor since, as mentioned above, the PV price is high. Mozambique has excellent access to solar energy. The most important insolation data which can be considered in PV system evaluation throughout the country can be seen in [45].

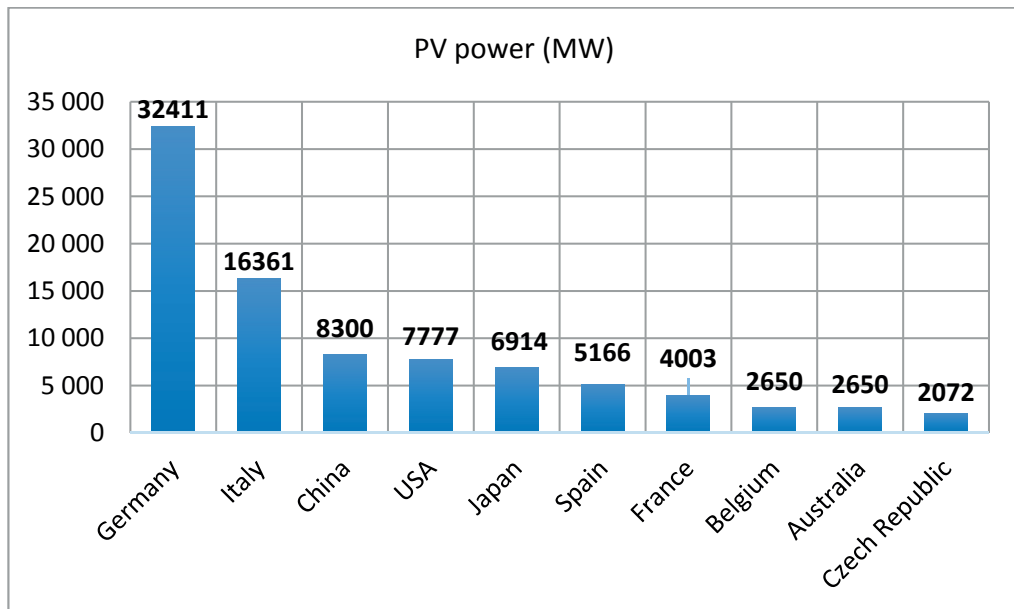

Figure 2.10: Countries with the highest installed capacity of PV systems [44].

2.3 Modelling and simulation of energy in buildings

Figure 2.11 shows a sketch of some components in the energy balance used in the conception of software for assessing energy performance in buildings. Not shown is e.g. the heat transfer by thermal radiation between inner surfaces and at outer surfaces.

The theoretical basis for energy balance in buildings is the first law of thermodynamics, which states that energy cannot be created or destroyed, only be modified into other forms of energy. So, the energy balance can be described as a system of mathematical formulas related to conservation of energy in buildings.

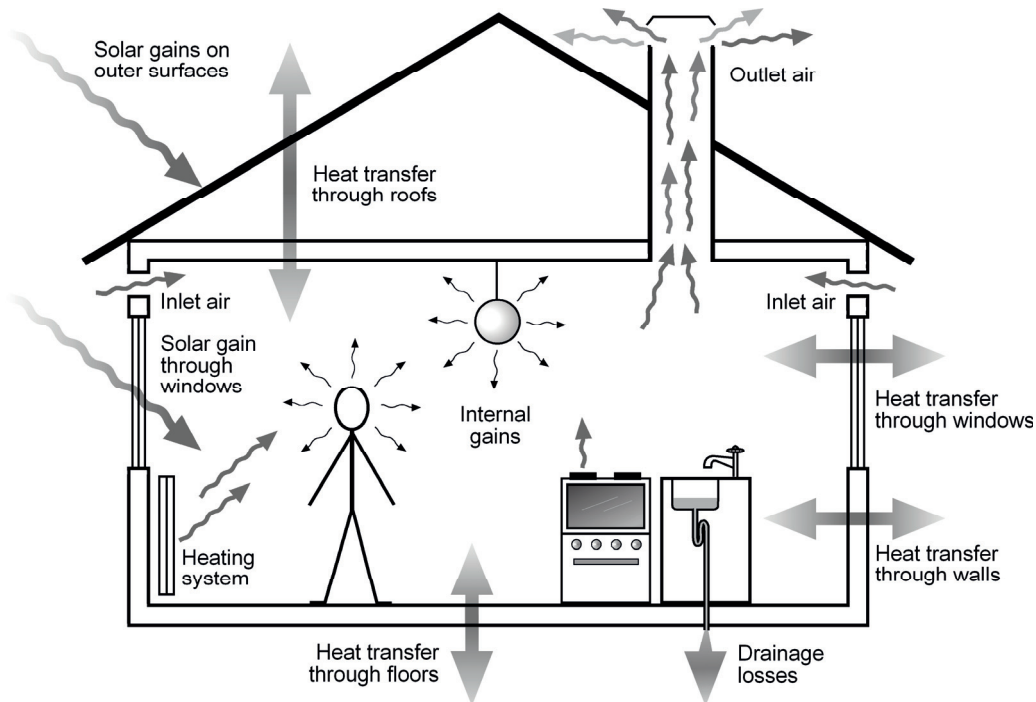

Figure 2.11: Illustration of components in the energy balance in a building, adapted from [46].

The heat transfer phenomena are the modes of heat transfer such as conduction, convection and radiation that occur in building components, namely roofs, floors, windows, walls, etc. The driving force of heat transfer is the temperature differences and pressure differences occurring in building elements. According to [47], the modes of heat transfer presented above can be described as follow: Conduction is defined as the transfer of heat energy through a material such as solids, liquids and gases without changes in molecules of the basic portions of the material. Convection is transfer of heat energy occurring in fluids namely liquids and gases and implies movement of the particles of the material. Radiation is transfer of heat energy by electromagnetic waves as visible light from the sun and infra-red radiation that occurs when the thermal energy of surface atoms of a material generates radiation in the infrared range of wavelengths.

2.3.1 Surroundings

A building is exposed to the local climate where the building is situated. The main climate data influencing the energy balance of a building are:

- Outdoor air temperature and humidity.

- Solar and sky radiation. The amount of solar gains depends essentially on the geographical latitude and orientation of the building on the site, the season of the year and the local cloud conditions.
- Infra-red radiation from the sky and the surroundings mainly depending on clouds and humidity.
- Wind speed and direction.

2.3.2 Envelope and ventilation

In terms of energy use in buildings, the building envelope and the ventilation are the most important parts of a building. It operates as the interface element for energy transmissions and is an effective predictor of energy use in buildings [48] and has great influence on thermal energy flow.

The following factors have to be observed when the heat transfer in a wall or a window is modelled:

- Conduction and heat storage in solids.
- Convection and infrared radiation at surfaces.
- Convection, conduction and infrared radiation in gaps.
- Absorbed solar and sky radiation at surfaces and in window panes.

Building envelopes can be characterized as air tight or air leaking enclosures. Air tight building envelopes are often well insulated, allowing the control of the quality of indoor air, energy use, temperature and humidity.

In building envelopes characterized by air leakage, the enclosure allows natural air transfer through it to occur, which can be used to improve indoor air quality instead of mechanical ventilation. In this case the use of mechanical ventilation apparatus is not necessary for indoor air exchange, but it is not easy to regulate the air flows.

In the air tight enclosures, because of the use of mechanical ventilation systems it is easy to control the indoor environment for occupants. Furthermore, the use of mechanical ventilation allows control of the humidity, heating or cooling of the inlet air.

To summarize, well designed air tight enclosures result in less heating and cooling costs and also reduce the risk of mould or mildew caused by moisture infiltration in the walls of the envelope and can thus extend the life span of building components.

2.3.3 Interior volumes

The interior part of the building should be held in comfortable climatic conditions for the occupants. In terms of building performance, the factors which influence the indoor comfort in buildings can be classified as temperature, humidity, thermal comfort, acoustic comfort and lighting.

The energy flows within a volume include:

- Internal gains produced by heat from lighting, cooking, electrical appliances, hot water, people and pets.
- Solar gain, which is the solar and sky radiation transmitted through the windows and then absorbed by inner surfaces.
- Infrared radiation between inner surfaces.
- Heat from convective heating system.
- Inlet and outlet air flows.
- Drainage losses.

2.3.4 Types of models and simulation tools

In the world, there exists a huge quantity of simple and complex software for building energy simulation such as static and dynamic building energy simulations. Among the existing models, the most simple is the so called Degree Day (DD) Method, in which all the losses are lumped together and the energy used for heating is described by a single equation. The output from this type of model is less accurate and in order to overcome this problem, more complex models, where sometimes hundreds of differential and non-linear equations are coupled together to form a simulation model, can be used.

Static models are simplified models for evaluating energy in the stationary regime, often with a limited number of building factors. This kind of tools are used for energy labelling in order to compare the energy use in standard conditions of use [49].

In general, detailed building energy simulation programs are always complex, they require a large number of input and parameters and produce large quantities of output. To design a complex model which involves all the details of the building components and parameters is arduous and practically impossible, since a lot of parameters are unknown and consequently difficult to define. For example, it is difficult to foresee furniture and appliances during the design stage of the model. In the world, there exists a huge quantity of simple and complex software for building energy simulation such as static and dynamic building energy simulations.

According to [49] dynamic models are divided, according to their complexity, in semi-dynamic and dynamic models. Semi-dynamic models are models that use dynamic simulations to take into account thermal inertia and require simplified input such as climatic data and building description.

Finally, dynamic models are the most complex models, designed for detailed contribution of thermal inertia of walls, variability of outdoor temperature, solar radiation, natural ventilation and end-user requirements.

2.4 Methods used for energy studies

To study energy use in buildings, two approaches can be adopted as tools namely: theoretical models as described in subchapter 2.3 and experimental methods which cover field measurements. Some methods also combine measurements with statistical methods to develop models which then can be used.

In this study, some instruments such as degree-days, statistic and dynamic models and simulation tools were selected and presented below, in order to obtain one which can be suitable for use in the climatic conditions of Mozambique. The selection is based on [50] and covers different types of experimental and simulation methods.

Table 2.5: Methods, models and simulation tools for energy evaluation in buildings.

Methods/Tools	Model	Institution	Country
The Save HELP	Pseudo-steady state	Belgian Research Institute	Belgium
STEM & PSTAR	Macro-static and macro-dynamic	Golden, Colorado	USA
Neural Networks	Neural networks and quasi-physical	Umeå University	Sweden
University Projects	Dynamic	Stockholm University	Sweden
Energy Barometer	Statistical and energy balance	Stockholm University	Sweden
BKL METHOD	Improved degree day method	Lund University	Sweden
DEROB-LTH	Dynamic	Lund University	Sweden

2.4.1 The Save HELP Method

The method was developed within the framework of the EU-financed Save HELP project [51] with the objective to characterize energy performance in non-occupied buildings. Factors such as solar radiation, outdoor temperature, air exchange, indoor temperature and energy for heating and appliances are considered in the field of measurements.

The heated space is handled as a single-zone and internal doors are considered open during the simulation. The simulations are carried out considering a defined climatic conditions and internal gains data set to determine energy use in buildings, once obtained the single-zone model.

This tool is based on a pseudo-steady state model and gives good results in non-occupied buildings. This because of relatively small uncertainties in the internal gains, the ventilation rates and the average temperature occurring in non-occupied dwellings.

2.4.2 STEM & PSTAR

The STEM & PSTAR (Short-Term Energy Monitoring, Primary and Secondary Term Analysis and Renormalization) is a method used to monitor the energy use in buildings. This method basically consists of three consecutive days of monitoring energy used in buildings. STEM & PSTAR is classified as macro-static and macro-dynamic methods.

According to the procedure developed by [52], the STEM protocol was programmed in the computer and three days and nights were considered for analysis. The steady state conditions were obtained in the first night, the second night was for cooling down and the last night for calibration of the heating system. The test during the last two days started at midnight after a steady state period. The effect of the solar gains is determined using daytime data.

Reference [50] developed and presented a detailed background of the method as well as an explanation of the macro-static and macro-dynamic procedures. The macro-static procedure can be considered as based on time integration of the energy balance of the building with input data such as building performance and outdoor temperature, while macro-dynamic methods directly employ the dynamic energy balance equation of the building.

2.4.3 Neural Networks (NN)

Neural Networks is a model using interconnected nodes and it is constituted basically of three parts namely: input layer, hidden layer and output layer. The neural network operation is based on the following four parameters which must be introduced as input to the model: outdoor and indoor air temperature, solar radiation and energy use at time $t-1$. The result obtained from the model is the energy use at time t , which is the heating power. Neural Networks gives accurate results and can also be developed for control purposes within the building systems.

In reviewing previous research, [52] found that the results from case studies indicate that in NN techniques, with the use of “only measured data of supplied space heating demand and climatic data in terms of indoor and outdoor temperatures, the supplied space heating demand can be predicted within 5-10% on an annual basis”.

This method combines the operation principles of neural networks and a quasi-physical description, which requires only the access of the average daily outdoor and indoor temperatures and the space heating demand for a limited period of time.

2.4.4 The University Projects

Within this project two projects were developed, namely Project 1 and Project 2 [49]. These methods were introduced in Sweden as energy-saving measurement programs in existing buildings with the objective to promote efficient methods in heating systems of the buildings.

The University projects are retrofitting methods adopted within these programs for estimation of the characteristics of the existing buildings and to evaluate energy savings based on data collection of the energy bills and inspections in the building elements and installations.

The computation methods are based on degree-days. Among the seasonal variations of factors which influence the heat balance of buildings such as temperature, solar radiation, wind, snow, long wave radiation and moisture, the outdoor temperature was considered the most important factor. Temperature data from weather stations in Swedish territory was used.

2.4.5 The Energy Barometer

The Energy Barometer method was developed with the aim to measure energy use in single-family houses during winter and summer. It was projected to provide foundation for analysis and assessment of energy use for heating, hot water and indoor environment. The Energy Barometer is divided into two parts.

- The first part is related to population level, supplying estimates of actual and predicted energy use; the estimates were based on a representative statistical sample from a selected population.
- The second part is related to providing individual house owners with means for monitoring their energy cost. So that, buildings connected to the system can analyse their own energy cost and also have information on what is happening in relation to other people conjoint in the same system.

Considering the degree-days and climatic factors, the calculation in this model is based on energy balance for buildings. This system presents advantages because apart from offering facilities in the houses, it also allows the collection of data using the net communication systems and allows operations and maintenance to be done remotely, thus saving on transport expenses [51].

2.4.6 The BKL Method

The BKL method is a simplified model developed at the Department of Building Science, Lund Institute of Technology, Sweden, in order to predict energy use in buildings [53]. This method has a more detailed treatment of solar gains than the degree-day method.

The main objective in developing this model was to provide engineers, architects and other building professionals with a hand calculation tool for evaluation of energy use in houses. The calculations were designed in order to assess energy demands in low energy houses.

The computation using this method is performed considering that heating loads are thermostatically controlled, i.e. the indoor temperature is maintained within certain intervals of time. So, heat from people, pets, appliances, hot water and solar radiation are considered controlled. In this context, the heating system operates in order to maintain the desired indoor environment.

The model is a good tool for evaluation of energy use in buildings. However, it is not useful in tropical countries because it was especially designed for countries with cold climate and problems can arise if it is applied in warmer climates [53].

2.4.7 DEROB-LTH Program

DEROB-LTH is an acronym for Dynamic Energy Response of Buildings and is a detailed energy simulation program tool. It includes an accurate model to calculate the influence of solar radiation and shading devices on the building energy balance. The buildings are modelled in 3-D, a necessary condition for accurate calculations of the solar radiation distribution and temperatures in rooms [54]. Heat transfer in solids is treated as one dimensional flow.

For simulation, two general types of input data are necessary: the first part is the building description data and the environment data. The description of data comprises the geometry of the spaces defining the thermal and active building elements such as wall, roof, floor and openings, doors and windows, and the thermal inactive building elements, namely exterior shading screens, orientation of the building, schedules for forced ventilation, infiltration, heating, cooling and free heating. The second part is related to weather data given as hourly values.

3 Methods and results

This chapter is subdivided into four parts, corresponding to four main research efforts of this work: modelling and simulation tool to be used in Mozambique (section 3.1), weather station design and installation (section 3.2), improvement of electrical energy use in residential buildings (section 3.3) and photovoltaic system design and installation (section 3.4).

3.1 Building modelling and simulation tool

The motivation of this study is to select and validate a modelling and simulation tool for use in Mozambique. With the use of such a tool it is possible to create improvement of comfort in residential buildings, meaning improvement of living conditions for people in buildings maintaining an efficient energy use.

3.1.1 Brief introduction to DEROB-LTH Program

After the study and analysis done in the literature review presented in the introduction and paper II, it was concluded that the best tool for modelling and simulation of energy use in buildings for Mozambican climatic conditions, among the studied ones, is the DEROB-LTH program. This program was selected on the basis that it has advantages in terms of calculations and analyses of peak loads, energy demand, temperatures, thermal and visual comfort of the buildings as compared to other software considered in this work. The objective of the simulations presented in this thesis is to verify the functionality of the DEROB-LTH Program in residential buildings of Maputo City.

DEROB-LTH is an acronym for Dynamic Energy Response of Buildings and is a detailed energy simulation program tool, originally developed at Austin School of Architecture, University of Texas in USA, and later developed at the Department of Construction and Architecture, at Lund University.

A lot of research programmes have been conducted using the DEROB-LTH program and it has proved to be a good tool for analysis of the indoor thermal environment of buildings. In [55], a study about the “Indoor Thermal Environment of Residential Buildings in Subtropical Climates in China”, it is demonstrated that the simulation results are in good agreement with field measurements and the deviation of average indoor air temperature is less than 1°C, maximum temperature 2°C and the deviation of surface temperature is 1°C.

DEROB-LTH has some limitations, but those were not considered to be serious considering the use in this work. In [54], which is a study of desert buildings that includes a parametric study on passive acclimatization, some limitations of this

program are shown. It was e.g. shown that the program could not handle the issue of excavation into the ground.

3.1.2 Climatic conditions of Maputo city

Maputo City, the capital of Mozambique, is situated at 25° 57' S, 32° 35' E, with a typical subtropical climate. Meteorological statistics for Maputo City are available and are presented in Figure 3.1 which shows the maximum and minimum monthly temperature in Maputo City.

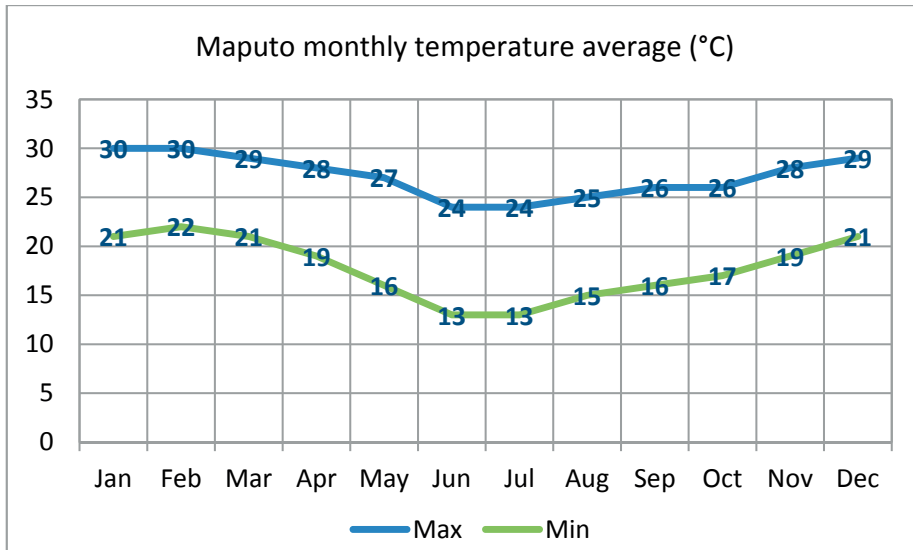

Figure 3.1: Climatic conditions in Maputo City, [56].

Figure 3.2 shows the average monthly rainfall and the average number of rain days per month in Maputo City.

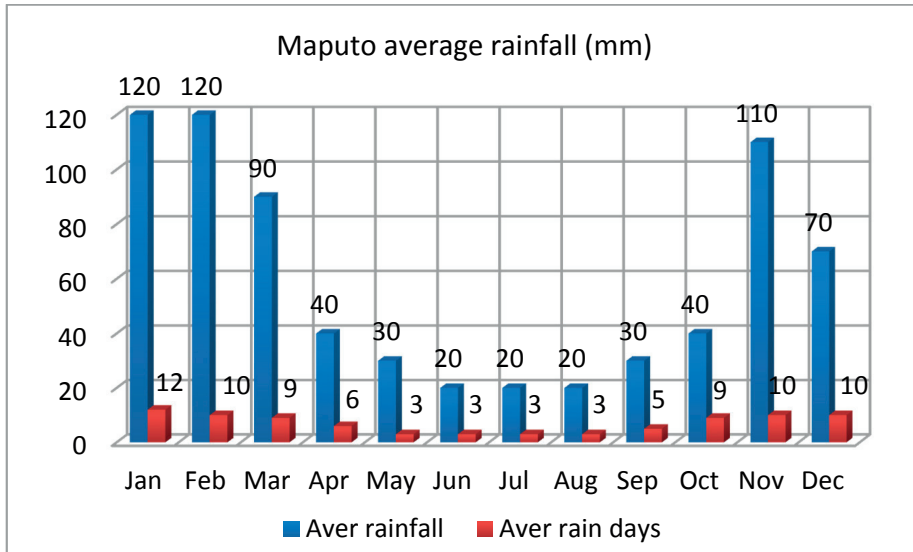

Figure 3.2: Climatic conditions in Maputo City, [54].

3.1.3 Characterization of the “3 de Fevereiro Residential”

In order to have a building for this study several buildings in Maputo City were considered. The “3 de Fevereiro Residential” building was selected since it would be possible to gather relevant parameters and also since the building is similar to most residential buildings of the Mozambican housing stock. In addition the building belongs to the Faculty of Engineering of the Eduardo Mondlane University with secure conditions for installing the measurement equipment of the project. Consequently, all activities related to this work were done in this residential.

The building was built in the 1990s. The materials used were: plastered hollowed concrete block walls, concrete columns and windows with wood frame and single glass, concrete cement ceiling, and gypsum ceiling roof. It has about 378 m² with 2 floors with 3 apartments on each floor. More details about the construction components, elements, plans and areas of the compartments of the building can be found in [57], appendix B.

The long axis of the building is oriented E-W and the main facade is south oriented as presented in Figure 3.3 (a-b). This kind of orientation can be seen in many district blocks of the Maputo City districts, but other orientations can also be found. In general, the building blocks are oriented according to the arrangement of the streets, of which some are E-W and other N-S oriented.

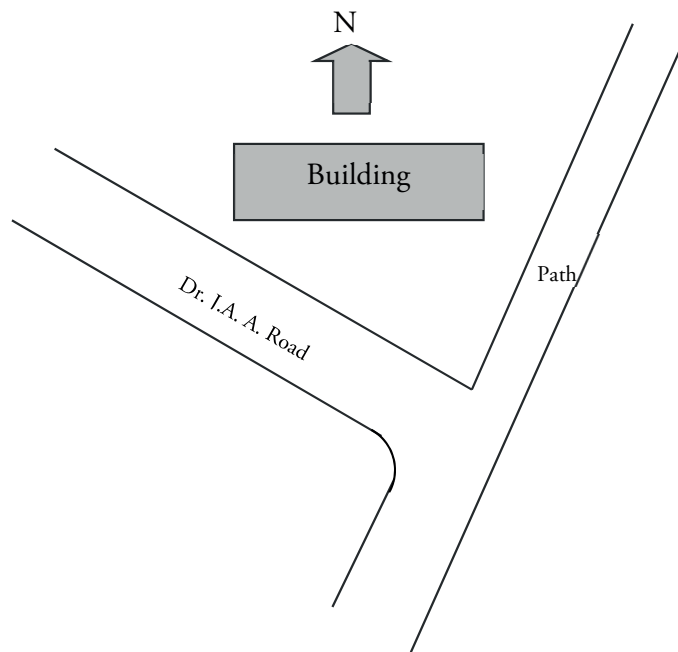

Figure 3.3: (a) Photo of the building (photo by the author) and (b) Location plan.

3.1.4 Selecting volumes for simulation

To simulate the building, it was decided to reduce the number of volumes, once the DEROB-LTH Program does not allow to simulate buildings with more than 8 volumes. So, the apartments of the right side (see Figure 3.3 (a)) were selected for this simulation.

The wall which separates the left side of the apartments from the rest of the house was assumed to have infinite resistance (adiabatic). The Tables 3.1(a-b) show the volumes in each selected flat.

Table 3.1(a): Selected volumes for simulation on ground floor.

Ground floor				
Compartments				Volume
Bedroom	Storage	-	-	V1
Living room	Corridor	-	-	V2
Kitchen	Bathroom	-	-	V3
Stairs	-	-	-	V4

Table 3.1(b): Selected volumes for simulation on first floor.

First floor				
Compartments				Volume
Living room	Bedroom	Corridor	Storage	V5
Bathroom	-	-	-	V6
Kitchen	-	-	-	V7

3.1.5 Simulation results

Below the results from simulations done using meteorological data from the computer program Meteonorm [58] to create the climate data file for DEROB-LTH are presented. According to [59] Meteonorm weather files are suitable as input data for different simulation tools. The created DEROB-LTH climate data file contain information on outdoor air temperature, relative humidity, beam irradiance, horizontal irradiance, infrared sky radiation, wind direction and wind speed.

The simulated Meteonorm data were compared with the data from the measurement equipment installed in the 3 de Fevereiro Residential. As a first example, Figure 3.4 shows the annual variation of outdoor temperature. In general, there is fair agreement between the measured and simulated data, except in December where the difference of the maximum simulated and measured values is 6.1°C, but in the same month the average and minimum values are almost contiguous.

It was seen that the average values from Meteonorm were slightly higher, with a maximum difference of 2.2°C. This is a great similarity considering that the Meteonorm data are Test Reference Year data based on a period from 1961 to 1990 for temperature and wind and from 1986 to 2005 for solar radiation, whereas the measured ones are for the single year from 2012-05-01 to 2013-04-30.

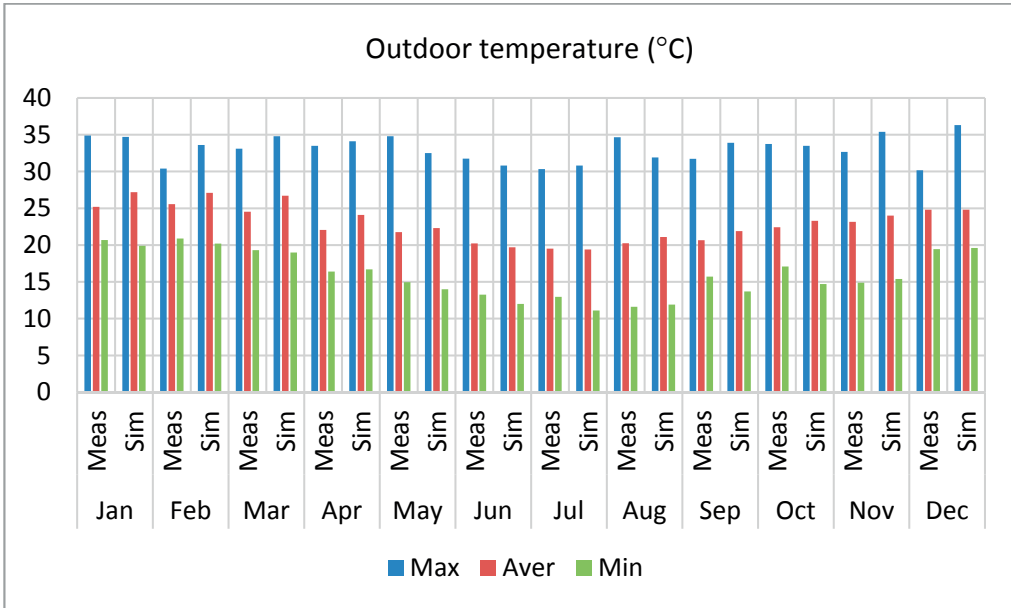

Figure 3.4: Annual variation of outdoor temperature.

Figure 3.5 (a-b) presents the indoor temperatures per volume for January and July, the hottest and coldest months. The data are based on simulations and measurement results from May, 2012 up to April, 2013, respectively.

As the data from the measurement equipment is based on measurements from one specific year, while the simulations are based on outdoor climate for a test reference year the results cannot be expected to be identical.

One important thing that can be seen in the graphs is that the volumes located on the north side have higher temperatures than that ones on the opposite side. This information is important for designing equipment to improve comfort in the building.

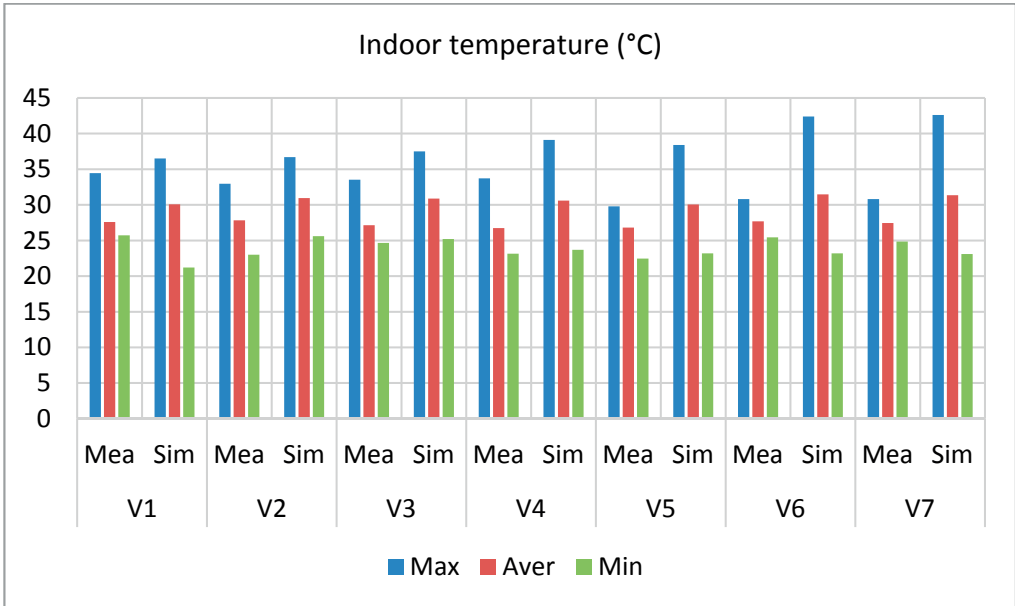

Figure 3.5(a): Indoor temperature per volume in January.

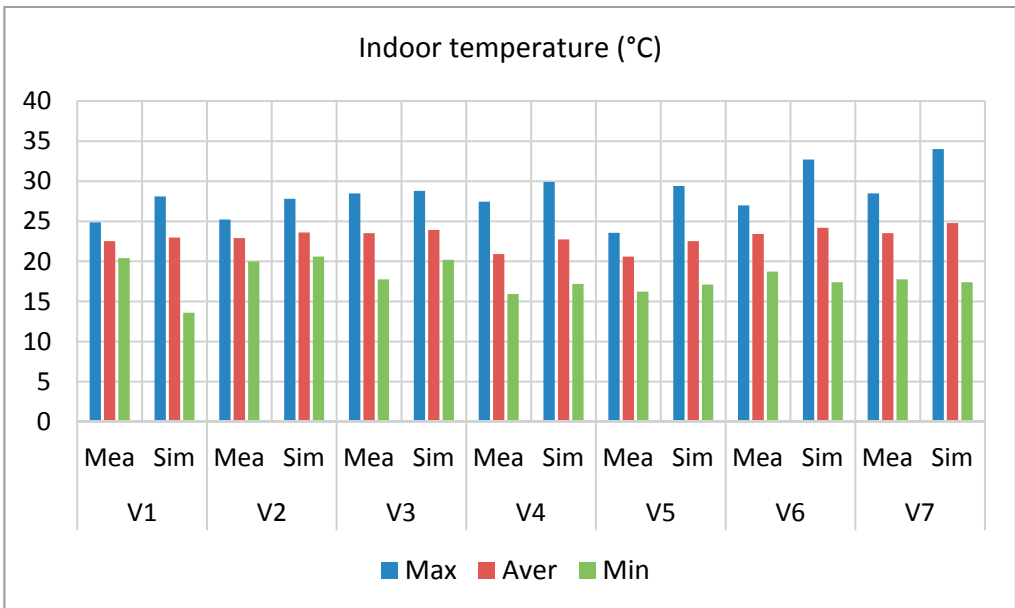

Figure 3.5(b): Indoor temperature per volume in July.

Figure 3.6, finally, presents the insolation outside the windows and the part of that which is absorbed at the inner surfaces of that volume during January, one of the hottest months in Maputo. Here we observe that bigger volumes and glazing areas present higher insolation (see Table 3.1 (a-b) and plans in Figure 3.7 (a-b)).

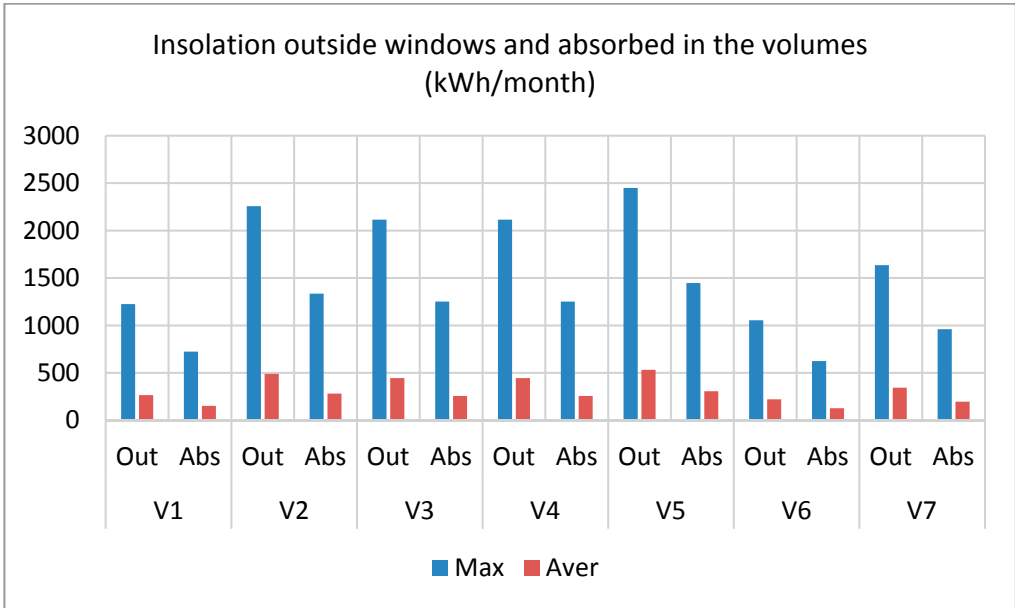

Figure 3.6: Insolation outside windows and absorbed in the volumes.

3.2 Design of weather station and field measurement of climatic data

Measurement equipment was installed in the “3 de Fevereiro Residential” building. The need for input data to DEROB-LTH as well as measurement data to compare the simulation results with, and the need to estimate the potential and performance of a PV system, was the main motivation for this work.

3.2.1 Design and installation

The measurement equipment was installed in May, 2009. The East and West sides of the building were seen as the best for measuring the thermal loads because these are directly radiated by the sun during the morning and the afternoon periods of the days. The owner of the building (Faculty of Engineering) allowed installing the equipment on the East side. Since that side present good conditions in terms of thermal loads, it was decided to install the measurement equipment on that side.

The layout of the sensors installed on the ground and first floors is presented in Figures 1 and 2 in Paper I.

Figure 3.7 (a-b) present the localization of the indoor temperature and humidity sensors assembled in the building. The amount of electricity used in the residential was also measured. The sensors assembled outdoor (on the first floor) are for measuring outdoor climatic data, such as the global and diffuse irradiance, temperature, humidity, wind and rainfall.

The installation was carried out according to the Portuguese Regulation [60], applied in Mozambique with some items excluded, and [61]. According to these references, the installation of indoor temperature and humidity sensors must be at a height of 1.5 m in occupied spaces, and at least 0.50 m from the adjacent wall and installation near lamps, above radiators and on external walls is not recommended. The outdoor temperature and humidity sensors must not be exposed to solar radiation or be placed on a facade affected by significant rising heat or warmed by solar radiation and not under the eaves. Installation above windows and ventilation shafts must be avoided and they must be placed at least at 0.60 m distance from the factors which can create interference.

The irradiance sensors installation must be on structures where it is easy to perform testing and inspection, and all types of shade must be avoided. The wind sensors must be installed on facades exposed to the main wind direction.

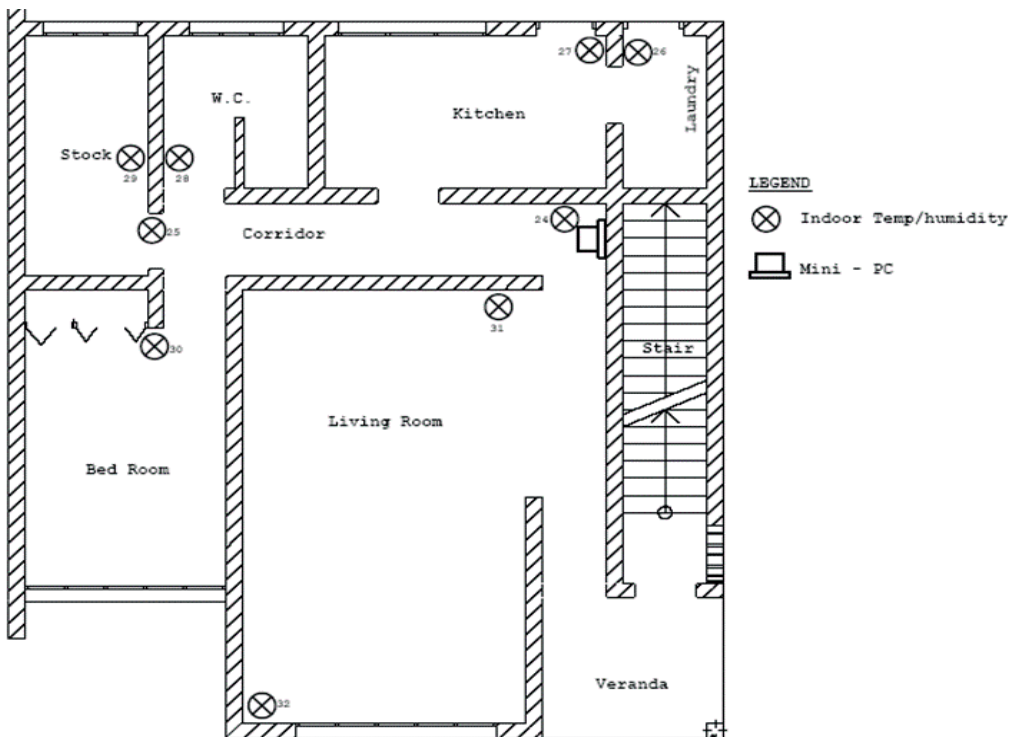

Figure 3.7 (a): Temperature and humidity sensors on the ground floor.

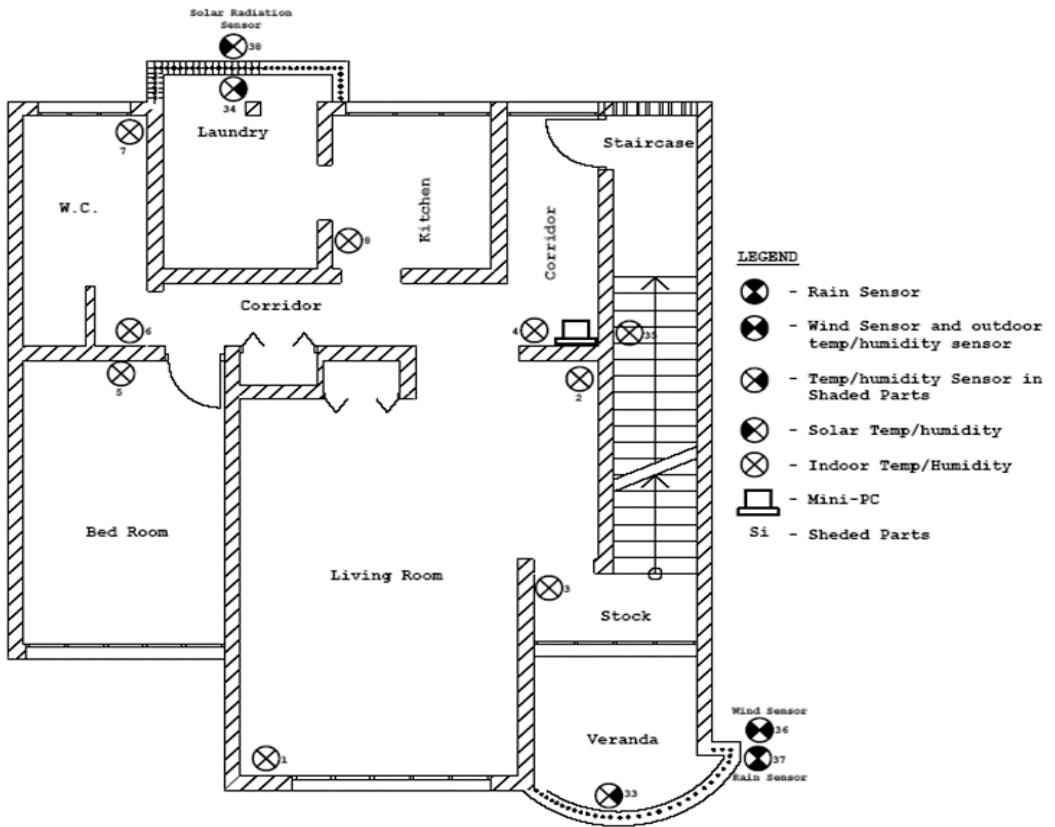

Figure 3.7 (b): Temperature and humidity sensors on the first floor.

Table 3.2 presents the components of the measurement equipment installed in the apartments and the measured factors.

The indoor temperature, humidity and electrical current are processed and stored in a Mini-PC Data Logger System, eBOX-4851 (see Figure 2 in Paper I). The data can be collected from the Mini-PC using a USB flash drive for storing data to the database or displayed on the touch screen display for local analyses.

The system is connected to the internet and it is also possible to access the data from any remote location, see Figure 3.8, which shows the measurement equipment system to web server data transfer.

Table 3.2: Measured factors and measurement equipment.

Measured factors	No. of sensors		Sensor	Range	Accuracy
	Ground floor	First floor			
Global and diffuse horizontal irradiance	-	1	BF3	0 – 1250 W/m ²	Global: ±5 W/m ² ±12% Diffuse: ±20 W/m ² ±15%
Wind speed	-	1	WMR200	2 m/s ~ 10 m/s 10 m/s-56 m/s	(+/- 3 m/s), (+/- 10%)
Wind direction	-	1	WMR200	0-360°	16 positions, approx. every 14 seconds
Outdoor temperature	-	1	WMR200	-30°C to 60°C (-4°C to 140°C)	+/- 1% (+/- 2%)
Outdoor Humidity	-	1	WMR200	25% to 90%	+/- 7%
Rainfall	-	1	WMR200	0 to 999 mm	+/- 7%
Temperature in shaded volumes	-	1	SHT75	-30°C to 60°C (-4°C to 140°C)	+/- 1% (+/- 2%)
Humidity in shaded volumes	-	1	SHT75	25% to 90%	+/- 7%
Inside temperature	9	11	SHT75	-30°C to 60°C (-4°C to 140°C)	+/- 1% (+/- 2%)
Inside humidity		11	SHT75	25% to 90%	+/- 7%
Electrical current	1	1	Onset CTV-B	0 to 50 A	+/- 4.5%

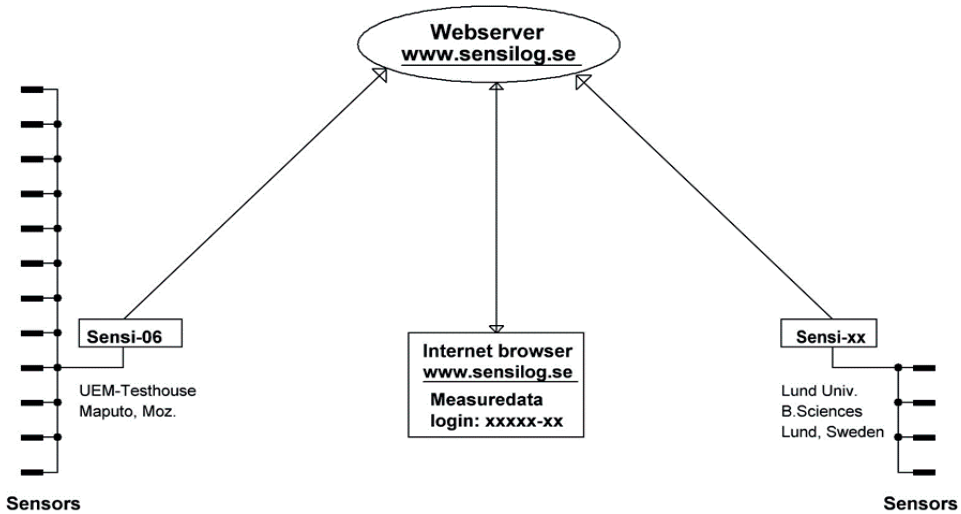

Figure 3.8: Data transfer system, by Thord Lundgren.

Figure 3.9 (a) shows a weather station equipped with sensors for measuring the outdoor temperature, outdoor humidity, wind speed, wind direction and rainfall. The system is wireless and sends data to the wireless console and stores it in a Mini-PC Data Logger System. The data can be collected as mentioned above.

Figure 3.9 (b) shows the irradiance sensor, installed on the north side of the building, which measures the global and diffuse irradiance.

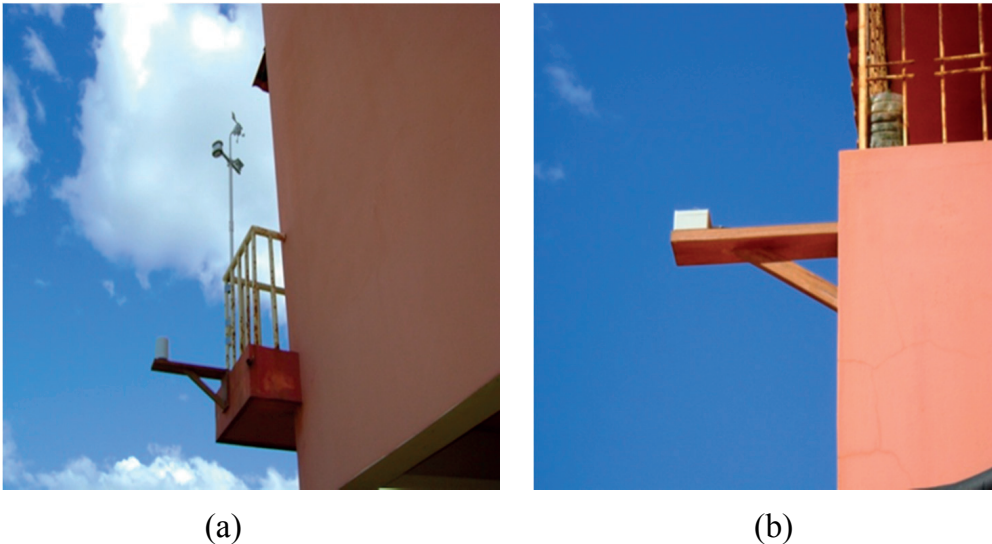

Figure 3.9: (a) Wind, temperature, humidity and rainfall sensors on the south side of the building. (b) Irradiance sensor on the north side of the building.

SHT75 are the types of sensors installed in “3 de Fevereiro Building” for measuring the indoor and outdoor temperature and humidity. Figure 3.10 (a) shows the sensors installed indoor and Figure 3.10 (b) shows the temperature and humidity sensor installed in the shaded parts represented by numbers 33 and 34 in Figure 3.7 (b). 4x2.5x5.1 mm, modular wire fixed on the walls are the type of cables used for connecting the sensors in the Pic-logger ADC16, see Figure 3.10 (a) and 3.10 (b).

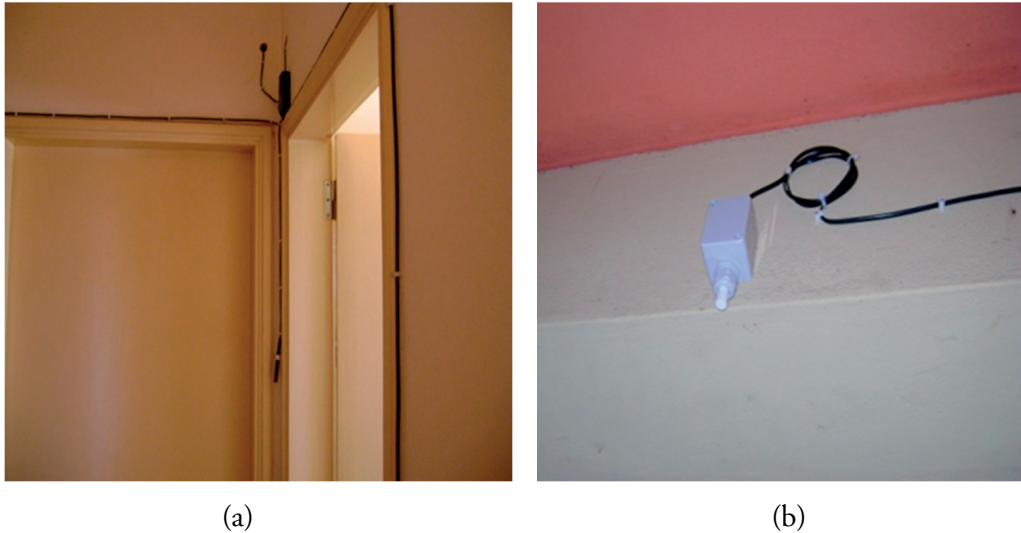

Figure 3.10: (a) SHT75 temperature and RH sensor inside the flat. (b) SHT75 temperature and RH sensor in shaded parts of the building.

3.2.2 Measurement results

Measurements were performed from June to September 2009, that is for the greater part of the winter of that year, and for one full year, 2012-05-01 up to 2013-04-30.

Solar and sky radiation

One of the basic climatic variables used to make a DEROB-LTH simulation, as well as simulation or modelling with other tools, such as presented in Table 2.5, is solar radiation. This shows the importance of measuring solar radiation data. These data are also needed for designing and analysing the performance of a PV system.

Figure 3.11 (a) presents the measured global and diffuse irradiance in July, 2009, and to illustrate the difference with summer, data of February, 2013, is presented in Figure 3.11 (b). The coldest months in Mozambique are June and July and the hottest ones are January and February as indicated in Figure 2.2 as well as Figure 3.4 [7, 55]. According to the measurements in this work, the coldest and hottest days occurred in July and February, respectively. Thus, these months were selected to be presented here. The data for February is important in evaluation of cooling systems, which means it is also critical in studying the PV system behaviour in supplying

appliances in buildings and in particular in the “3 de Fevereiro Residential” building. In July there is less solar irradiance to produce electricity from, but on the other hand there is no need for cooling so the amount of electricity needed is much smaller.

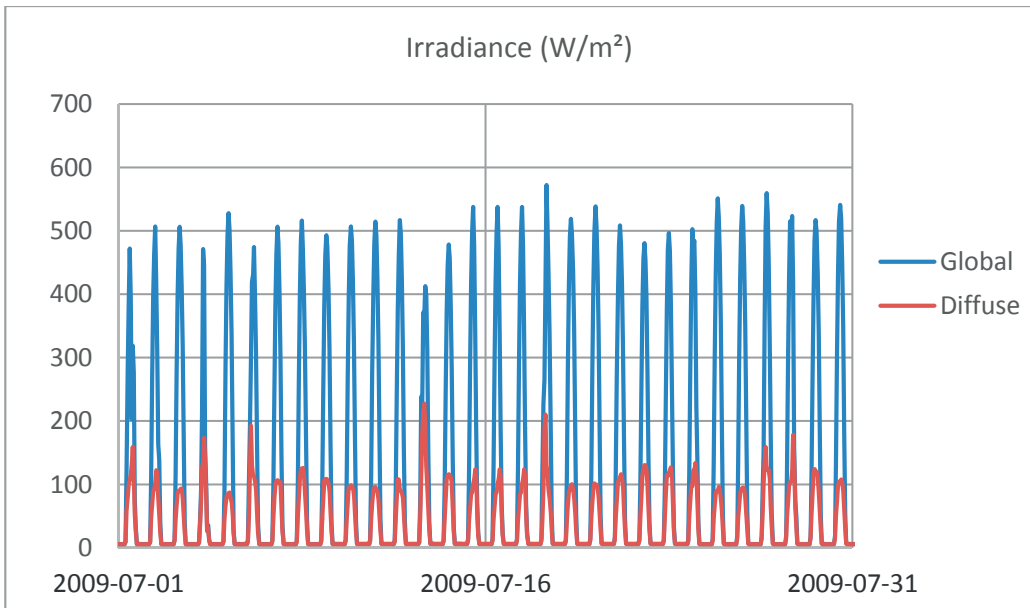

Figure 3.11 (a): Global and diffuse horizontal irradiance in July, 2009.

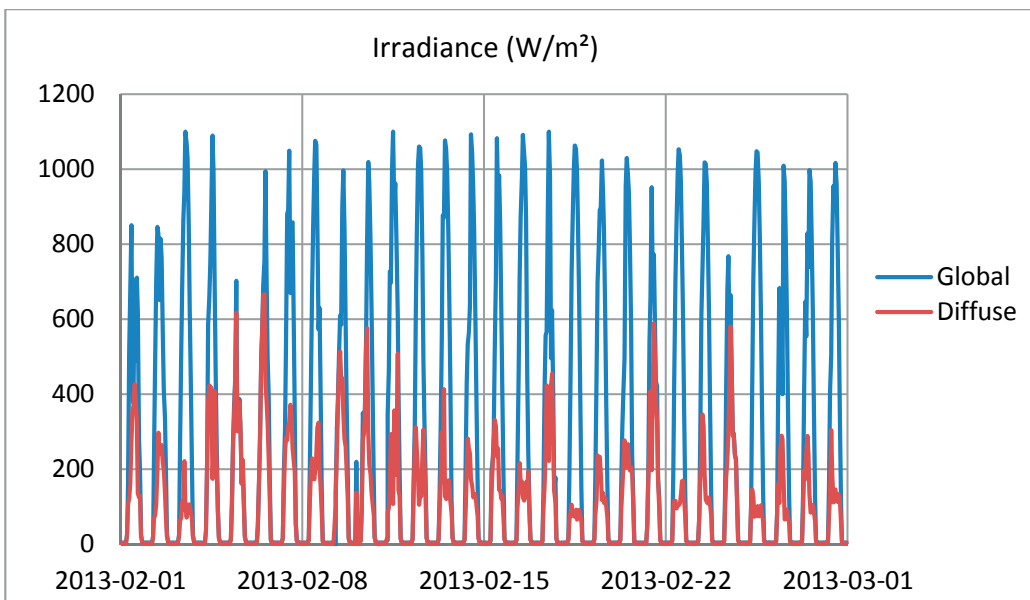

Figure 3.11 (b): Global and horizontal irradiance in February, 2013.

On 2009-07-25 the minimum temperature of the winter (11.2°C) occurred. Figure 3.12 shows the detailed variation of the global and diffuse solar radiation on 2009-07-25. The maximum value of the global horizontal irradiance during this day was 551 W/m^2 and occurred at noon and the maximum diffuse horizontal irradiance was 91 W/m^2 at 1:00 PM.

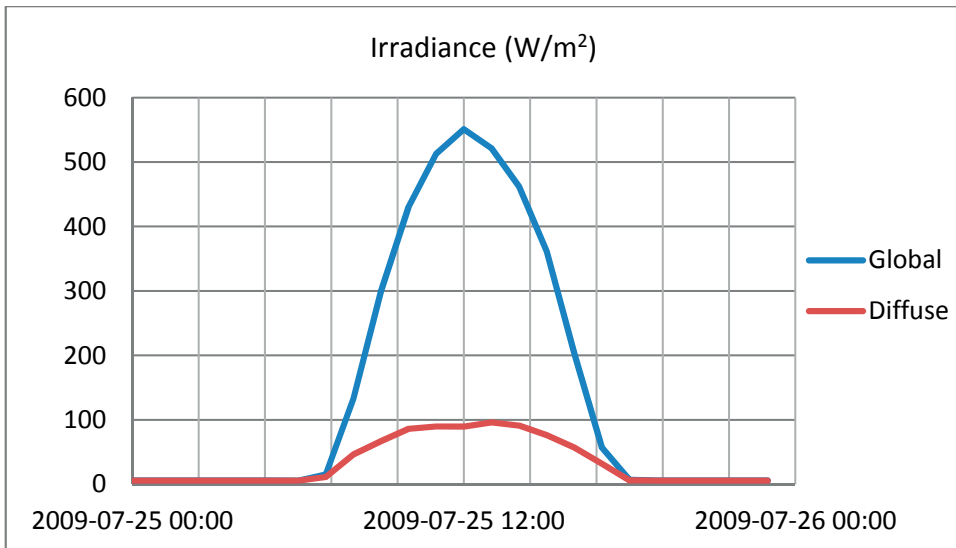

Figure 3.12: Global and diffuse horizontal irradiance on 2009-07-25.

It can be seen from the results that Maputo City has enough solar energy to cover the need for hot water and cooling systems in buildings [51]. More details related to measured results from June to September are presented in Paper I and [57].

Outdoor temperature

The outdoor temperature sensor is placed on the south side of the building, see Figure 3.7 (b) and Figure 3.9 (a). In 2010, it was decided to install another, more accurate, temperature and humidity sensor above the top roof of the building (see Figure 3.13) for comparison with data from the previous one which was assembled close to the wall of the building and data from other meteorological stations.



Figure 3.13: Oregon WMR200 (left side) replaced by Ultimeter 800 (right side).

Figure 3.14 (a-b) presents the measured outdoor temperature in July, 2009 (winter) and February, 2013 (summer).

July is the month with lowest outdoor temperature and 2009-07-25 was the coldest day with a minimum of 11.2°C at 6:00 AM as shown in Figure 3.14 (a). The temperature values of the whole measured period, from June to September, can be seen in Figure 6 of Paper I.

Figure 3.14 (b) presents the outdoor temperature values of February, 2013, the summer period. The maximum temperature in this month was 30.1 °C and occurred in 2013-02-08 at 2:00 PM.

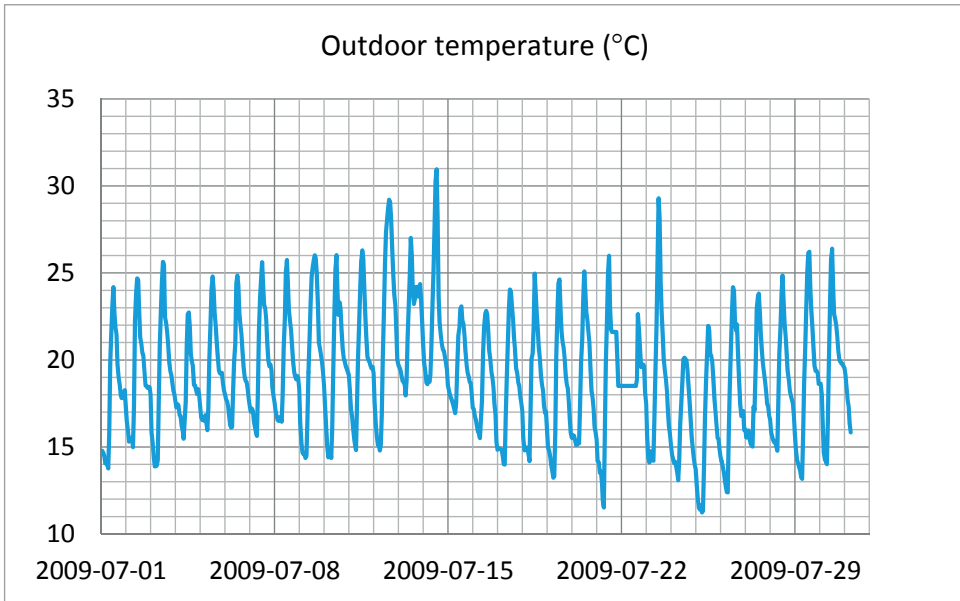

Figure 3.14 (a): Outdoor temperature in July, 2009.

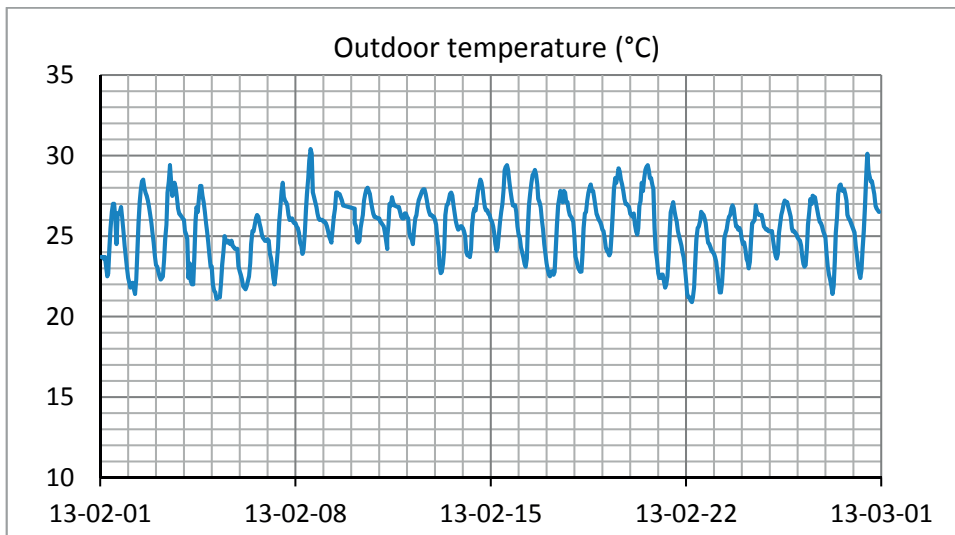

Figure 3.14 (b): Outdoor temperature in February, 2013.

Although heating systems do not have much application in Mozambique, in case of necessity, data from the coldest day can be used for evaluating heating systems and PV systems. Figure 3.15 shows a detail of the outdoor temperature of 2009-07-25, the coldest day of winter as mentioned above and detached from Figure 3.14 (a).

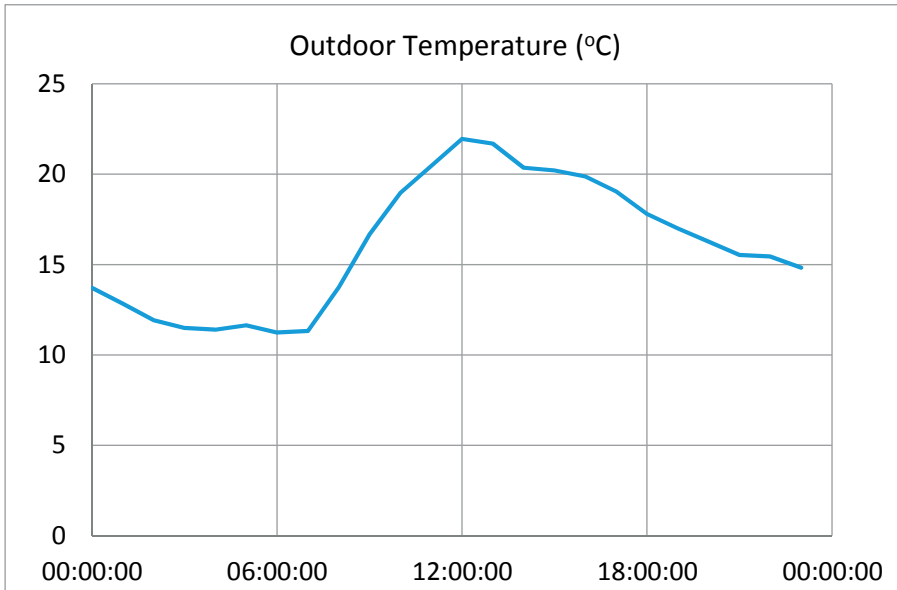

Figure 3.15: Outdoor temperature on the coldest day in July, 2009-07-25.

Figure 3.16 shows the monthly outdoor temperature from reference [54], the outdoor temperature used as input in DEROB-LTH (Sim) from Meteonorm, and the one from the measurement equipment (Mes.) measured using the Ultimeter 800 sensor, for illustration and comparison among them. The data used in the simulation tool corresponds to a time step of one hour, the maximum, average and minimum values were computed from the monthly values of the hourly recorded data.

The differences between the maximum, average and minimum outdoor temperature values are presented in Figure 3.16. From this figure is observed some similarity of the average and minimum temperature values from reference [54], the simulation tool and the measured values but it can be seen that for maximum values great differences occur. These differences make sense since the data considered do not correspond to the same year.

It was found that the maximum difference in terms of average outdoor temperature between Meteonorm/simulated and reference [54] was 1.7°C, and between Meteonorm/simulated and measured was 2.0°C, and between the reference [54] and measured was 1.95°C.

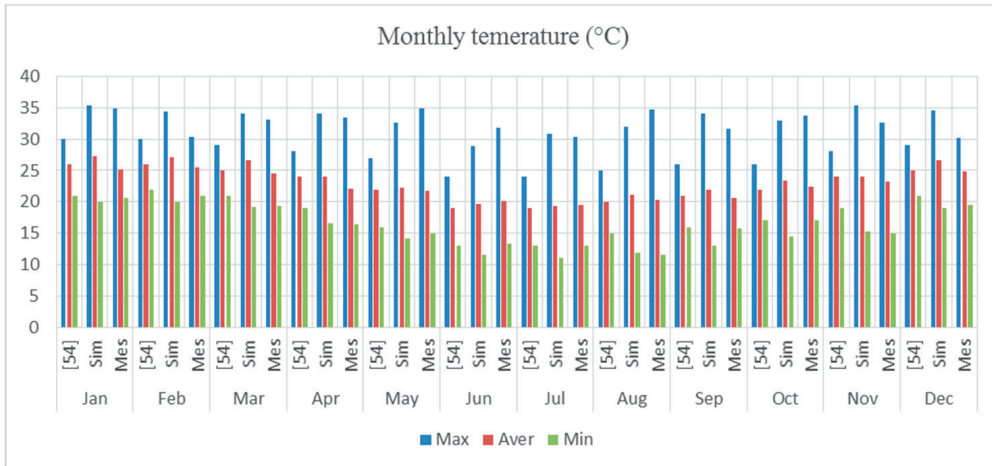

Figure 3.16: Monthly outdoor temperature in Maputo City.

Wind speed and direction

DEROB-LTH can be used without the inclusion of wind data as input, but, according to [62] climatic data files for DEROB-LTH without wind speed and wind direction data is not recommended because the tool then produces uncertain output. In order to get the best possible result, the measurement equipment includes a sensor for measuring wind speed and direction around the building.

A WM200/WM200A anemometer was used to measure the wind speed and its direction around the building. This sensor was installed outside of the building as indicated in Figure 3.9 (a) and Figure 3.13. In Figure 3.13, the location of the “Ultimeter 800”, the temperature and humidity sensor, is also indicated in the right side of the figure.

Wind is often described by two characteristics, namely wind speed and wind direction. There are sixteen principal wind direction bearings which are commonly used to report wind direction. Thus, wind direction is measured from the direction where the wind comes from. For example: southerly wind blows to the north and a northerly wind blows towards the south.

Figure 3.17 (a) shows the measurement results of the wind in June. From the results it is seen that there is wind around the building which can be used in studies related to ventilation, cooling and wind frequency in the building. For more information about wind speed from July to September, see [57], appendix D. analysing the results of the wind-speed measurement, it is concluded that the wind rates increase from June to subsequent months. The dominant wind direction presented in Figure 11 of Paper I is blowing from Southwest to Northeast in certain periods and in other from East-Northeast to West-Southwest. This was one of the reasons for installing the “Ultimeter 800” sensor above the top roof of the building (see Figure 3.13), in order

to compare with results from the M200/WM200A anemometer installed close to the wall as presented in Figure 3.9 (a). According to [63], in the building location the prevailing wind directions should be east and south.

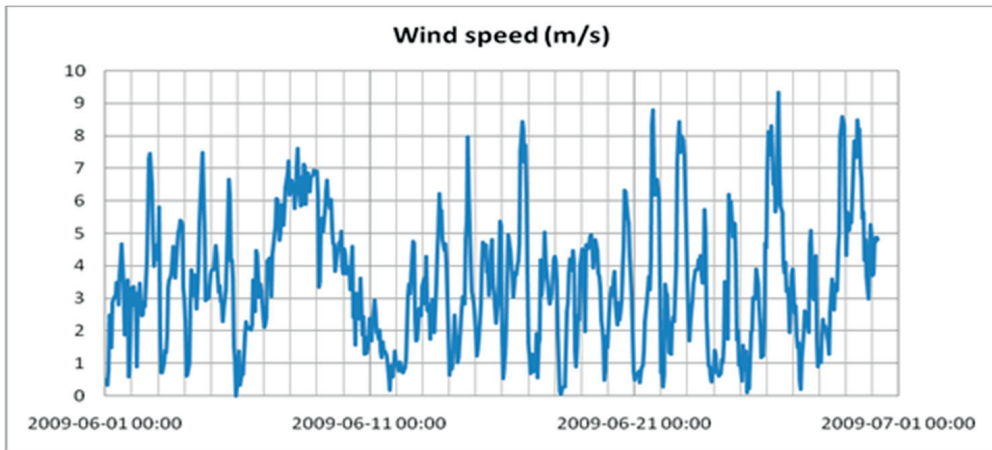

Figure 3.17: Wind speed in June, 2009.

Rainfall and outdoor relative humidity

In the measurement equipment installed in the “3 de Fevereiro Residential” building were included sensors for measuring rainfall and outdoor humidity. Even if these meteorological parameters are not being used as input in DEROB-LTH, they are important to be analysed in studies related to harmful environmental phenomena in buildings. In Paper I and appendix D of reference [57] details related to rainfall and outdoor relative humidity, measured around the building during the winter of 2009 are presented.

Figure 3.18 presents the outdoor humidity from 2012-05-01 up to 2013-04-30, where the maximum humidity value occurred in 2012-08-22 at 08:00, with 96%, the minimum in 2012-08-11 at 17:00 with 10% and the average was 75%.

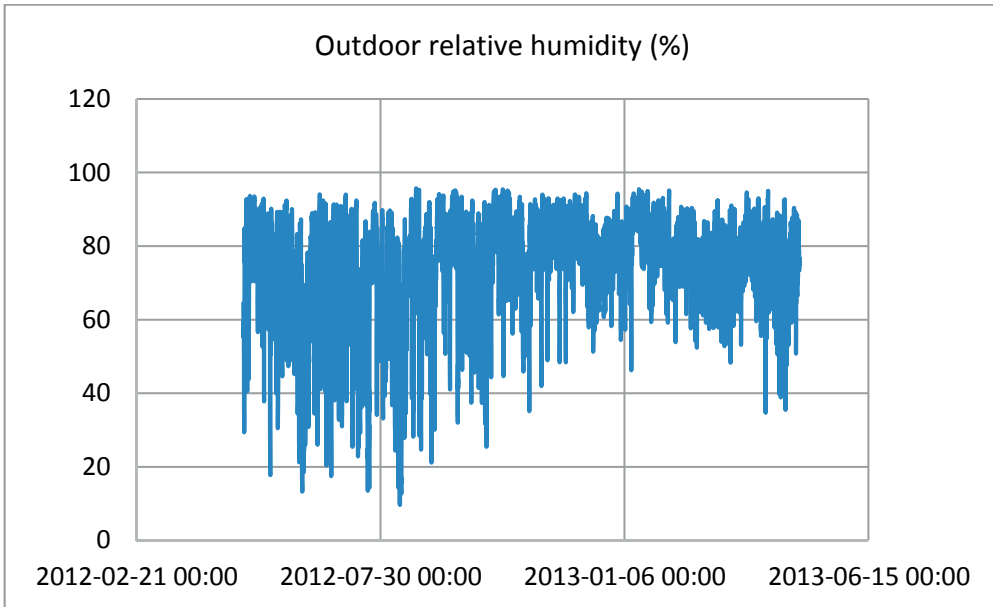

Figure 3.18: Annual outdoor relative humidity.

Figure 3.19 presents the outdoor relative humidity (RH) measured around the building for the coldest month of 2009.

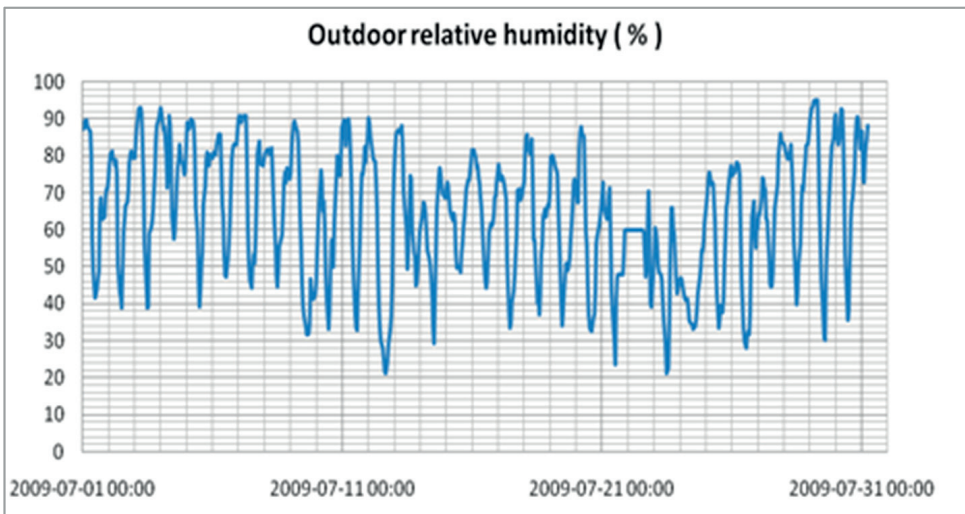

Figure 3.19: Outdoor relative humidity in July, 2009.

The maximum, average and minimum outdoor relative humidity of the period analysed were calculated and presented in Paper I, in Figure 13. The relative humidity of the coldest day was also measured and is presented in Figure 20.

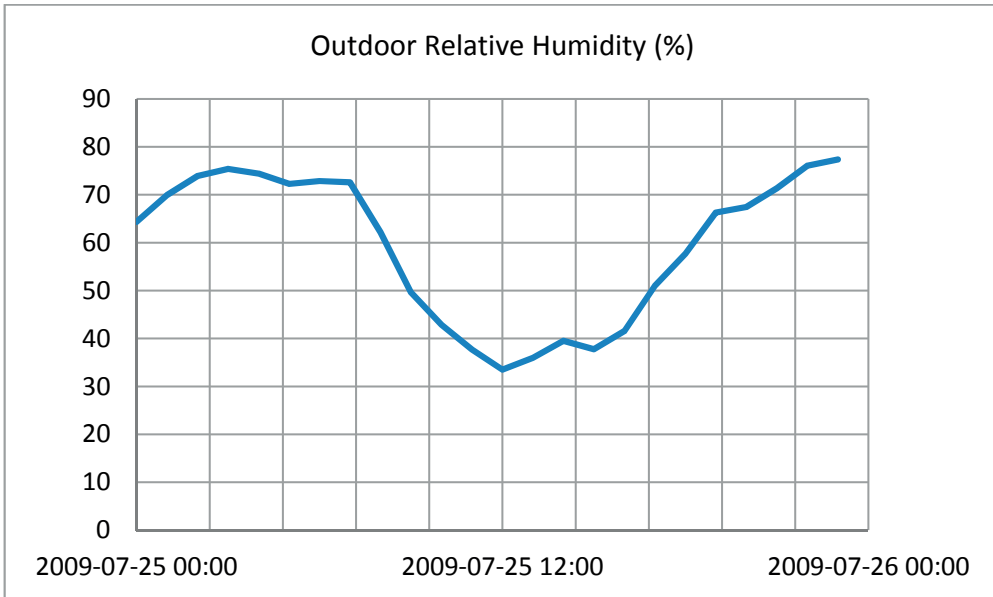

Figure 3.20: Outdoor relative humidity in July, 2009.

Temperature inside the building

The indoor temperatures on the ground and first floors are presented in Paper I, Figure 9 and Figure 10. It was seen that the staircase is the volume with the lowest temperature in the building except in the days indicated in Table 3.3. The reason of high temperature in the staircase in those days is lack of good natural ventilation. This means that those days were days without wind.

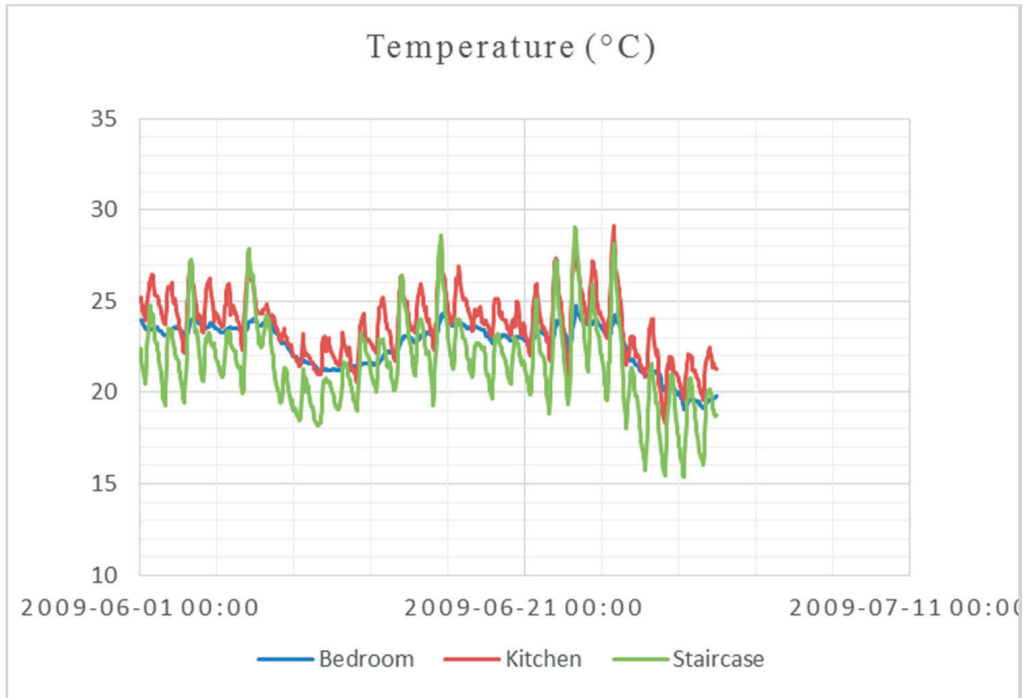

Figure 3.21: Indoor temperature on the first floor, in June, 2009.

Table 3.3: The days with high temperature in the staircase.

Days with high temperature in the staircase		
Date	Hour	Temp.(°C)
2009-06-03	15:00	27.1
2009-06-06	15:00	27.6
2009-06-14	15:00	26.4
2009-06-16	15:00	28.5
2009-06-22	16:00	27.2
2009-06-23	16:00	28.9
2009-06-25	16:00	28.1

The east wall of the staircase is directly irradiated by the solar radiation in the mornings and this heats the air in this volume. So, with very little natural ventilation the air temperature of this volume becomes high in afternoons and consequently heats the staircase's west wall which also increases the air temperature in the living room of the first floor, see Figure 3.7 (a) and Figure 3.7 (b).

The kitchens of the apartments are located on the north side, the hottest position in terms of solar gains. So, the temperatures in these rooms are higher than the rooms situated in the south side of the building see Figure 9 and Figure 10 in Paper I.

On the ground floor, Figure 9 of Paper I, the graphs present a good agreement between the temperature of the living room and the bedroom. This is due to the fact that the two volumes have the same orientation (south side), the same characteristics, the same solar radiation and the same casual gains.

From June to September the maximum indoor temperature on the ground floor was 25.3°C in September and the minimum in the first floor was 19.2°C in July.

During the heating season the minimum temperature is 11.2°C as indicated in Paper I, Table 3 and Figure 5. Thus, during winter, a heating system is necessary to maintain the building with temperature between 18°C - 22 °C, winter comfort condition [64].

Table 3.4 shows the maximum, average and minimum indoor temperatures in the apartments.

Table 3.4: Indoor temperatures in the apartments.

	Indoor temperatures (°C)							
	Ground Floor				First Floor			
	June	July	August	September	June	July	August	September
Max	24.8	23.8	24.0	25.3	23.2	20.4	22.3	24.4
Aver.	24.5	23.4	23.7	24.9	22.3	20.4	21.4	22.9
Min	24.2	23.0	23.3	24.4	20.4	19.2	20.4	20.4

Comparing the temperatures between the two floors it can be concluded that the ground floor presents higher temperatures than the first floor. That fact can be interpreted as temperature increase by internal gains, which in this case depends essentially on occupant behaviour such as the closing and opening the windows and doors, the crowding of the apartment, the use of electric devices, etc.

3.2.3 Comparison with MAMS measurements

For verification, the measurement results were compared with data from Maputo Airport Meteorological Station (MAMS), see Table 6 in paper I and Figure E.1 appendix E of reference [57]. The difference of the outdoor temperature measured and those from MAMS is between -0.7°C to +2.3°C and for relative humidity -2% to 4.5%. Considering these data, it can be concluded that there is no major difference in results between measured data and those from MAMS. For verification of the simulation tool, it is however important to have corresponding data of indoor and outdoor parameters for the very same building. The difference registered is because of the place where the measurement took place and the kind of the measurement equipment, the MAMS measurement equipment is placed in the open space and far away from the building.

3.3 Improvement of electrical energy use in residential

The oil price has increased dramatically since 1973 fuel crisis, “when the member nations of OPEC (the Organization of Petroleum Exporting Countries) were able for the first time to coordinate their policies” [65]. The dwellers in Mozambique have been complaining about the electrical energy bills that they are paying to Electricidade de Moçambique (EDM) because the Mozambican government has periodically, increased the energy price due to the high cost of oil importation. Thus, it is interesting to examine the potential for saving electricity in residential buildings, both from an environmental perspective and from the perspective of the economy of the dwellers.

3.3.1 Electrical energy use in Mozambican buildings

This study deals with assessing and improving energy use in buildings in Maputo City, based on data from “3 de Fevereiro Residential”. The analysis done concerning the main components and elements of this residential led to the conclusion that this building can represent most of the housing stock in Maputo City and can serve as a benchmark for studying resident’s lifestyle pattern in buildings, and energy use data in buildings.

The main task of the work is to evaluate the electrical energy use, energy costs and measures for reducing the energy use in the building. The results from this work can also be used in energy simulation tools for buildings, which require input data of internal loads in the calculation steps.

In Paper III, the evaluation of the energy use in the “3 de Fevereiro Residential” as well as the comparison of the results with data from Sweden and South Africa are presented. Below an overview of that material is presented.

Figure 3.22 shows the percentage of the current electrical energy use in the studied apartment which in general is similar to the other 5 apartments in the building when occupied by the same number of people. The figure shows that the highest use of energy occurs in the cooling system (26%), followed by the water heater (23%) and lighting (15%). The small rate for cooking (2%) is because the basic energy resource used for cooking in the urban area of Maputo City and other cities in the country is liquefied petroleum gas (LPG) and natural gas (CNG).

In the peripheral zones of the Maputo City and countryside, many people use charcoal and dry-wood for cooking instead of electricity and gas as mentioned above. So, the 2% presented in Figure 3.22, represents e.g. the use of a kettle and, in rare cases, the stove. Computer electricity energy use (6%) is higher in this apartment, because of the existence of the mini-computer for the measurement equipment system which is constantly in operation.

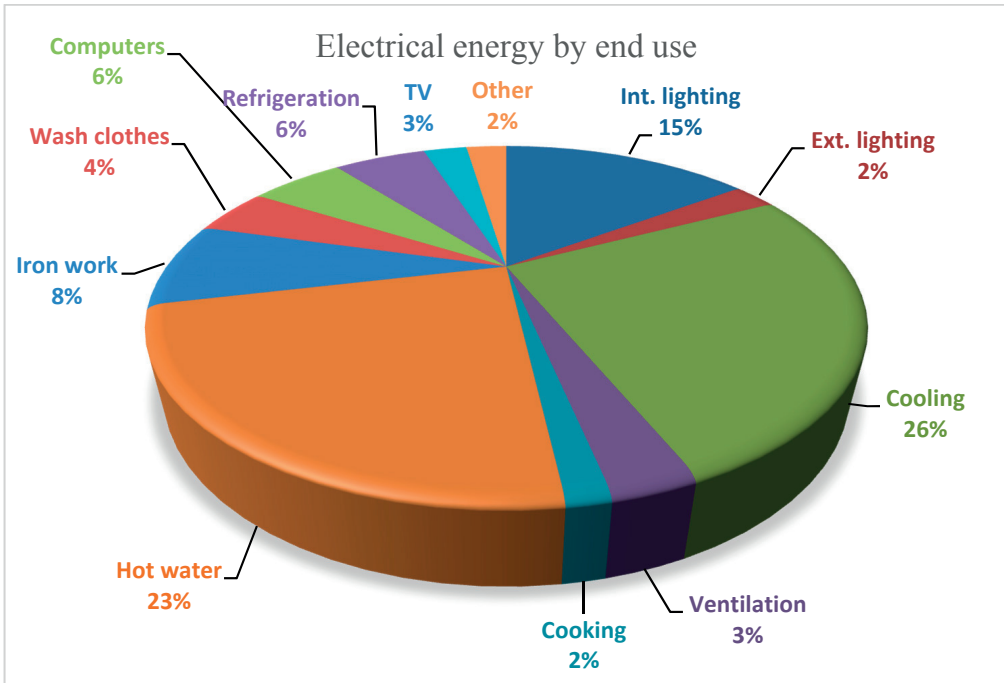

Figure 3.22: Electrical energy by end use in the apartment.

3.3.2 Comparison with South Africa and Sweden

For comparison purposes the electrical energy use in South Africa is illustrated in Figure 3.23, adapted from reference [43]. As can be seen in Figure 3.23, in South African residential buildings, the highest use of energy occurs in hot water systems (24%), followed by lighting (17%). In South Africa, energy is also used for space heating, this is not included in the figure.

Since South Africa, in general, is a cooler country than Mozambique this leads to an increased use of electrical energy in hot water systems whereas in Mozambique a larger part of the electrical energy is used for cooling systems.

The electrical energy use rate by sector in both countries is almost the same, but it should be pointed out that in South Africa, the use of electrical energy is much larger in absolute numbers than in Mozambique, see Figure 2.5 and Figure 2.7.

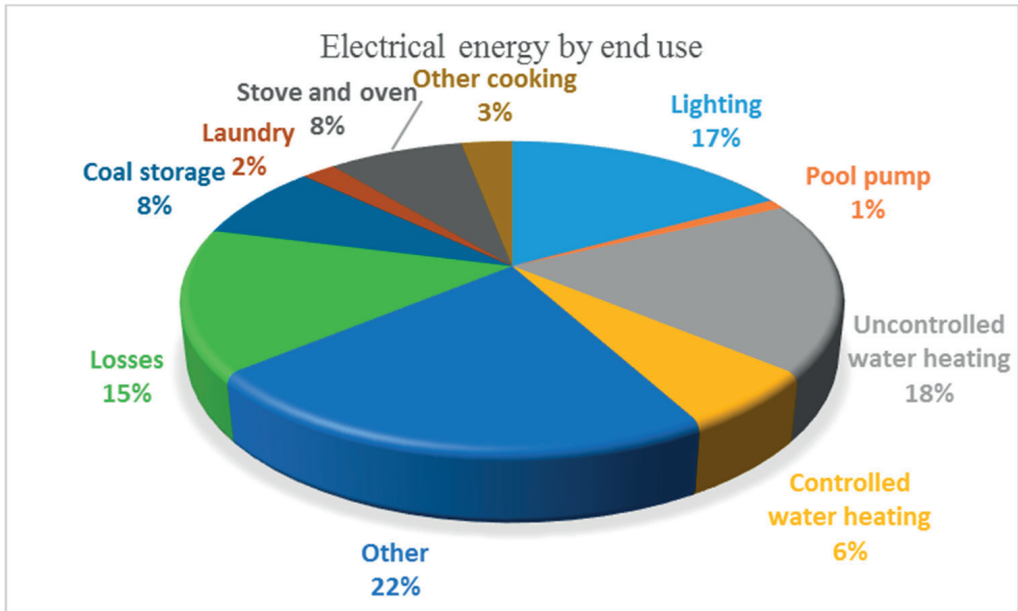

Figure 3.23: Electrical energy by end use in buildings in South Africa.

Also in Sweden the tendency is that a large and increasing amount of electrical energy is used in the building sector. Figure 3.24 shows an example of the domestic electrical energy use in Sweden. For a household consisting of a couple without children the average annual use for the studied households is 17 173 kWh [66]. In Sweden the highest domestic electricity energy use relates to lighting (excluding the space heating), followed by water heating devices and cold appliances. In Sweden a large amount of energy is also used for space heating which is not included in Figure 3.24.

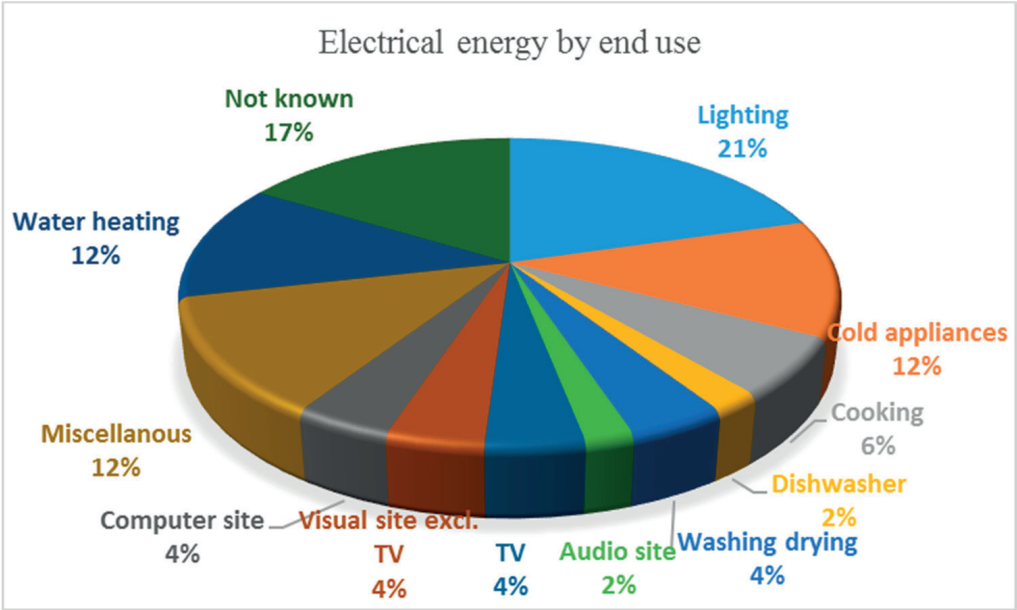

Figure 3.24: Electrical energy by end use in houses in Sweden, [66].

Figure 3.25 shows a comparison of the electricity energy use for certain end uses in the buildings.

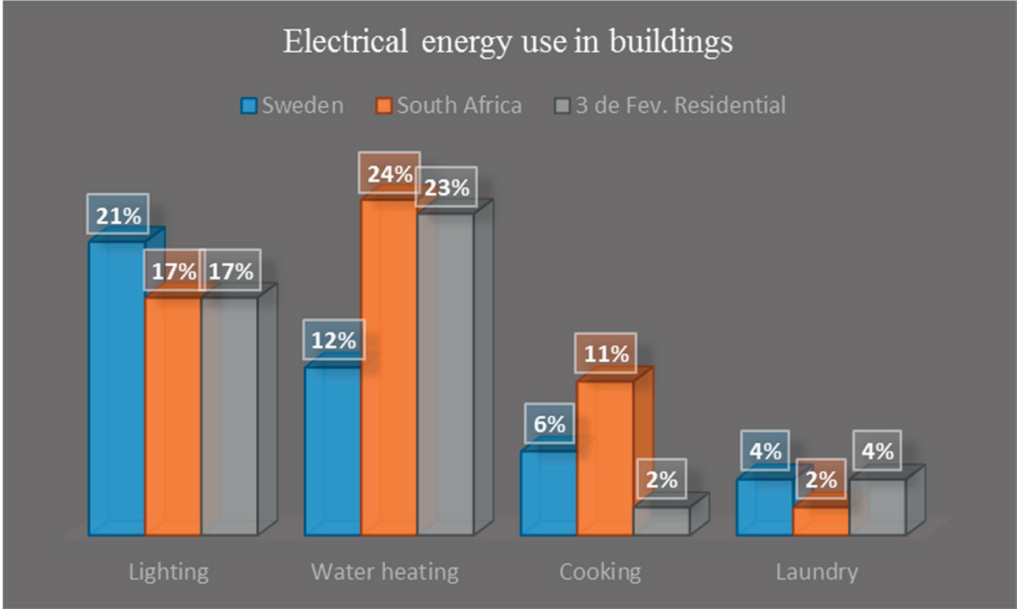

Figure 3.25: Electrical energy by end use in buildings.

The electrical energy use for lighting in Sweden is higher than South Africa and Mozambique due to the long-time use of lighting mainly in winter time due to climatological conditions in the country. The reduced use of electricity in water heating systems in Sweden can be explained by the existence of other sources of energy used to supply those systems such as district water heating systems which are based on biomass, natural gas and waste. The same consideration applies for cooking systems. In Mozambique, very few people use electricity for cooking since this is considered expensive. Gas and charcoal is used instead.

More details about the analysis of improvement of electrical energy use in the “3 de Fevereiro Residential” is presented in appended Paper III. In this paper it was concluded that the possible electrical energy reduction when introducing energy efficient lighting and white goods was 24% per year. The saving was estimated to 162 USD/year. This value can vary slightly, depending on the behaviour of the home occupants in using the household devices.

3.4 Photovoltaic system design and installation

3.4.1 Relevance of photovoltaic systems in Mozambique

The use of renewable green energy sources to generate electricity can reduce the electrical energy demand in buildings from traditional power plants and can thus reduce CO₂ emissions to the atmosphere which in turn can reduce the greenhouse effect and also the cost of the energy use in buildings.

In addition to the environmental reasons, the need for decreasing bought electrical energy in buildings and to minimize the shortage of electrical energy to infrastructures in remote areas, such as schools, health clinics, farmhouses, administrative posts and dwellings makes it interesting to evaluate the function of a photovoltaic (PV) system in the present work.

PV systems would be a natural choice for renewable energy production in Mozambique, since the country has solar radiation in the order of 4.4 to 6 hours of sunshine daily [8] throughout the year as indicated in chapter 2. Furthermore, the use of PV systems in Mozambique can minimize the shortage of electricity in remote areas which the national grid does not cover, and in urban areas, these systems can furnish electrical energy in buildings during blackouts which frequently occur in electrical installations throughout the country.

The main motivation for introducing PV systems in this work is to reduce the amount of bought energy used in buildings. The conclusions from Paper III indicated that the highest use of electrical energy occurs in cooling, water heating and lighting systems, so the focus of this part of the thesis is to reduce the electrical energy used in

air conditioning and lighting systems. Finally, PV systems have a large field of application throughout the country which is not the case for other types of systems.

3.4.2 PV system design

In order to implement this project, it was decided to install a PV system in the “3 de Fevereiro Residential” building, in order to integrate other measurement equipment already installed there with the purpose of monitoring the energy used in the building.

In Paper V an evaluation of three alternative systems for supplying the load installed in the residential is presented. The results of the economic assessment is presented in Table 3.5.

Table 3.5: Estimated cost of the three alternatives.

	Alternatives		
	A	B	C
Life cycle cost (LCC), (USD)	37 062	17 491	4 519

Alternative A corresponds to a system for supplying the entire load installed on the first floor of the residential (for more details, see appended Paper V, Table 3). As alternative A was seen economically unaffordable within this project budget, another alternative (B) was considered. Alternative B was designed towards the priority load of the flat from the appliances for lighting, refrigeration, ventilation, DVD player and clock radio. Unable to cover the budget of this alternative as well, it was decided to implement a system only for research purposes which is indicated as alternative C in Table 3.5.

Thus, first of all the main layout of the system and the corresponding measurement equipment was tested in the climatic conditions of Lund in Sweden. The main objective of the test was to verify the functionality of the components of the system. The test took place during summertime in Lund in 2012. The system presented fair results and the initial sketch was considered as the main layout to be implemented in the residential in Maputo City. Later on, the components of the system tested in Lund were transferred and assembled in Maputo City where the test is ongoing.

In order to control the functionality of the system and collect data from the location of the installation, the equipment was connected to the internet. Currently, the system is supplying external lighting and can feed an air conditioner installed in the building for test purposes in future research activities.

3.4.3 PV system tested at Lund University

Given that the system is also intended to be implemented in rural zones, the system is a stand-alone PV system which basically consists of the components indicated in appended Paper V, Figure 1.

The concept of the system was based on the need to have a possibility to power air conditioning equipment and some luminaries for test purposes. The system includes an electronic unit system (ART-Data Acquisition Device, USB 5 935.0) for storing data in the mini-computer via a SensiLog device.

Figure 3 in Paper V presents the details of the connections from current clamp meter, battery bank, DC load and DC charge controller thermistors, irradiance and temperature sensors to the SensiLogger and from this to the ART-Data Acquisition device. Figure 3.26 shows the PV system supplying the air conditioner and two luminaries. Figure 3.26 (a) presents the PV components and measurement equipment whereas Figure 3.26 (b) shows the PV array on the roof of the V building at Lund University. Considering that the test in Lund was performed during summertime of the year 2012, the tilt angle of the PV array was fixed at 26.38° and oriented to the south. For the tilt angle determination, the latitude of 55.42° N of the Lund LTH site was considered. From the layout of the PV equipment, a list of materials needed in order to implement the project at Lund University for testing the PV components was compiled before sending them to Maputo City, see Table 3.6. The costs are based on a procurement for the Swedish and abroad (China) market.



(a)



(b)

Figure 3.26: PV system installed at Lund University. (a) – PV System testing equipment (b) – PV array. Photos by T. Lundgren.

Table 3.6: Components and its costs based on procurement.

List of material of the PV system	Quantity	Cost (USD)
PV mod., Mono-cryst., $W_p = 100$ W, $I_{sc} = 6.14$ A, $I_{mp} = 5.71$ A, $V_{oc} = 22$ V, $V_{mp} = 17.5$ V	2	458
Charge controller, PWM, 10 A, 580 W	1	20
Battery cost, (C/10 – C/20) rate, 75 Ah, Lead-acid, 24 V	1	302
Battery bank accessories	1	10
Inverter, 3 000 W, 24 VDC/230 VAC	1	360
PV installation accessories	1	69
Luminaries, LED, 3 W, 10-30 V	6	160
Split air conditioner, 5 250 BTU/h, 220 V, 1 phase	1	430
Air conditioner wiring	1	50
Digital timer, 24 VAC/DC	1	35
Irradiance meter, Apogge, SP-212, Pyranometer	1	420
Energy meter, 230 VAC, 5(32) A, 1 phase	1	42
Automatic fuse, 10 A	1	5.5
Current clamp meter Onset CTV-B, 0-50 A, AC output	1	135
Thermistor, 10 K, NTC + casing	1	7.5
Shunt resistor 10 A, output 100 mV	1	30
Shunt resistor 100 A, output 100 mV	1	30
Data acquisition, Model: USB5935	1	185
PV array frame	1	200
PV array frame wiring	1	285
Total	-	3 234

3.4.4 Lund measurement results

The main purpose of the measurement done in Lund was to test the functionality of the PV components once the system was designed and assembled at Department of Construction Sciences. Thus, it was necessary to inspect the operation of all the PV components before sending them to Maputo. The measurements from 2012-09-07 to 2012-09-10 are presented in Figures 3.27 to 3.35.

Irradiance

For measuring the irradiance on site, the measurement of the irradiance for tilt and horizontal angles was considered. The tilt irradiance is measured with an irradiance sensor assembled on the PV array so that it can follow the angle of the PV array. The irradiance on horizontal surface is measured by another sensor. These sensors measure the global irradiance.

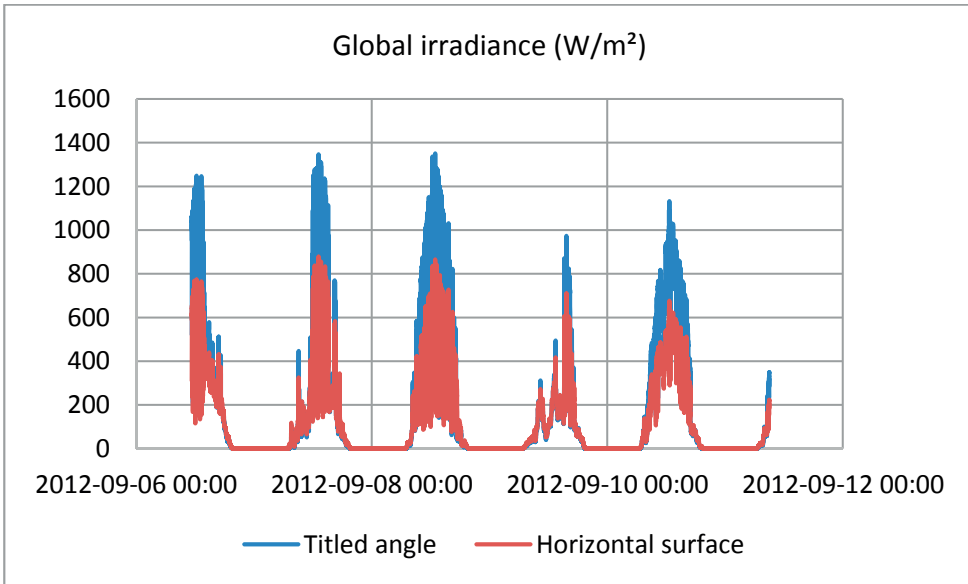

Figure 3.27: Global irradiance.

During the measurement period, the maximum global irradiance was 1 350 W/m² for the tilted surface occurring on 2012-08-07 with an average of 390 W/m². The maximum and average global irradiance on the horizontal surface was 865 W/m² and 257 W/m² respectively. Additional values can be obtained in Figure 3.27 and Figure 3.28.

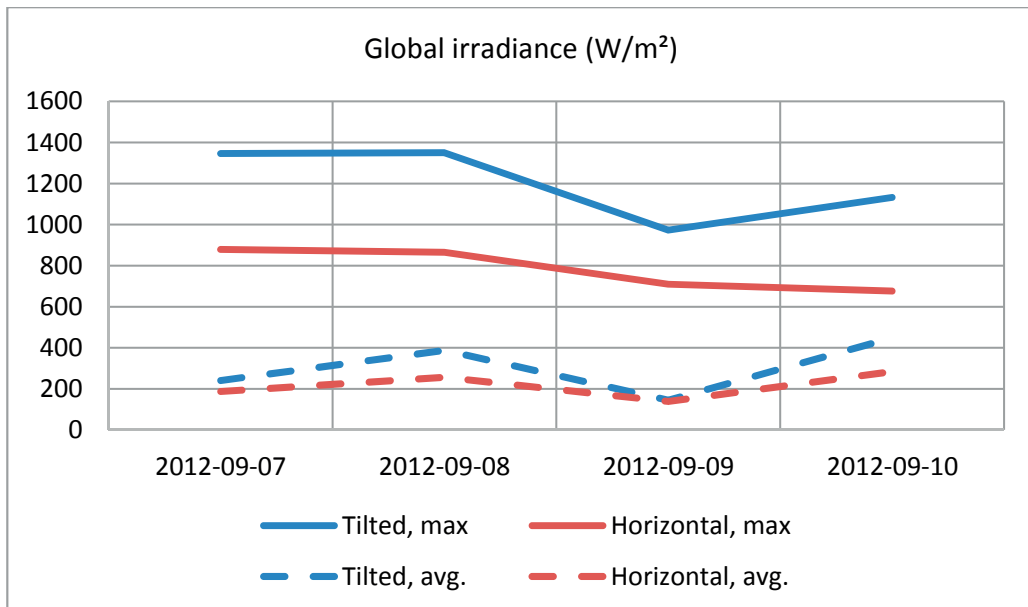

Figure 3.28: Global irradiance.

Solar cell and air temperatures

Figure 3.29 shows the temperature measured on the rear of the solar cell and the air temperature. The maximum, average and minimum values for air temperature extracted from this figure are presented in Table 3.7.

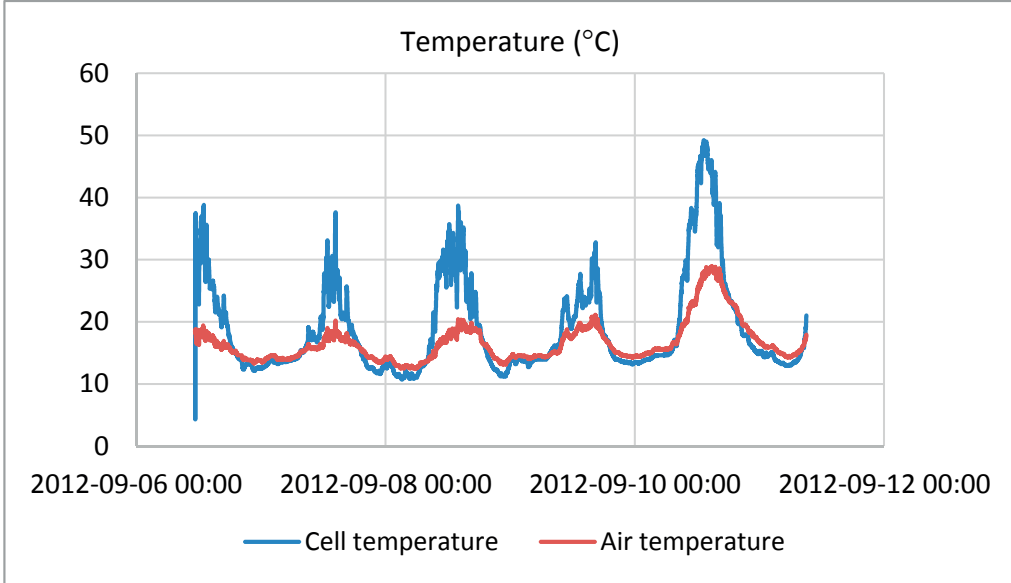

Figure 3.29: Cell and air temperatures.

Table 3.7: The maximum, average and minimum temperatures (°C) extracted from Figure 3.29.

Day	Sensors	Maximum	Average	Minimum
7	Cell	38	17	12
	Air	20	15	13
8	Cell	39	18	11
	Air	20	15	13
9	Cell	23	17	13
	Air	21	16	14
10	Cell	42	24	13
	Air	29	20	14

Battery bank

In this system two batteries with a capacity of 75 Ah, 12V were used. The results from the battery charging are presented in Figure 3.30. The charging process was from 2012-09-06 until the end of the next day. From 2012-09-08 it was fully charged and a low current demand was needed for recharging it until 2012-09-09.

From 2012-09-10 the system has drawn a small current charge because it was not fully charged since it was supplying energy to the lighting connected to the system.

Figure 3.31 shows the details from Figure 3.30 of the battery current during 2012-09-07, the day with complete charging process. At 7:22 the charging process started, and the maximum of 5.8 A was reached at 12:05. Then the current remained constant until at 12:48 where it started to decrease until the current became zero at 19:37. The behaviour of the charging current presented in this figure is in agreement with that one from figure 3.27 related to solar irradiance of horizontal and titled surfaces.

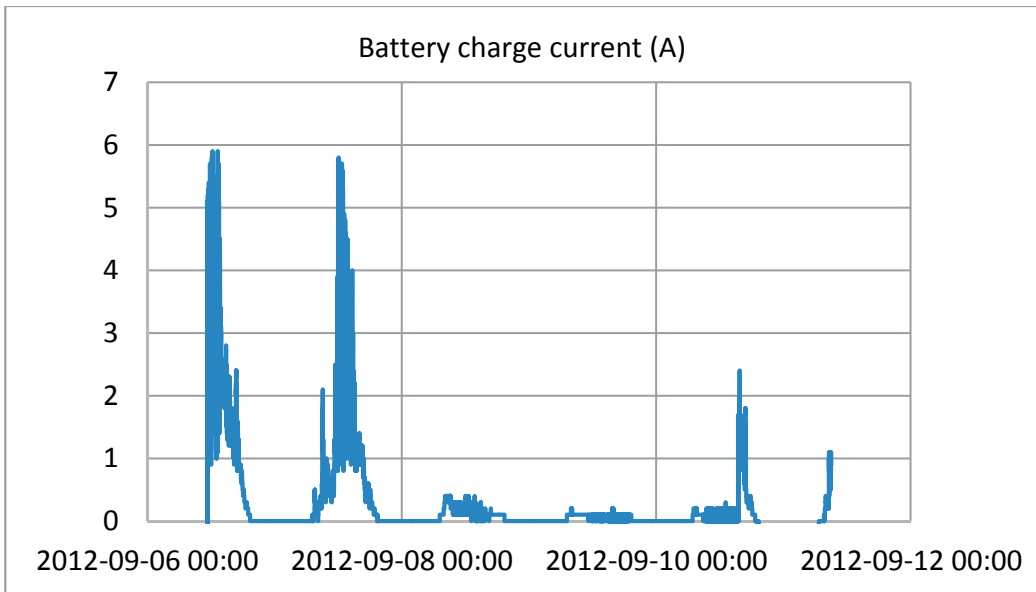

Figure 3.30: Battery charge current.

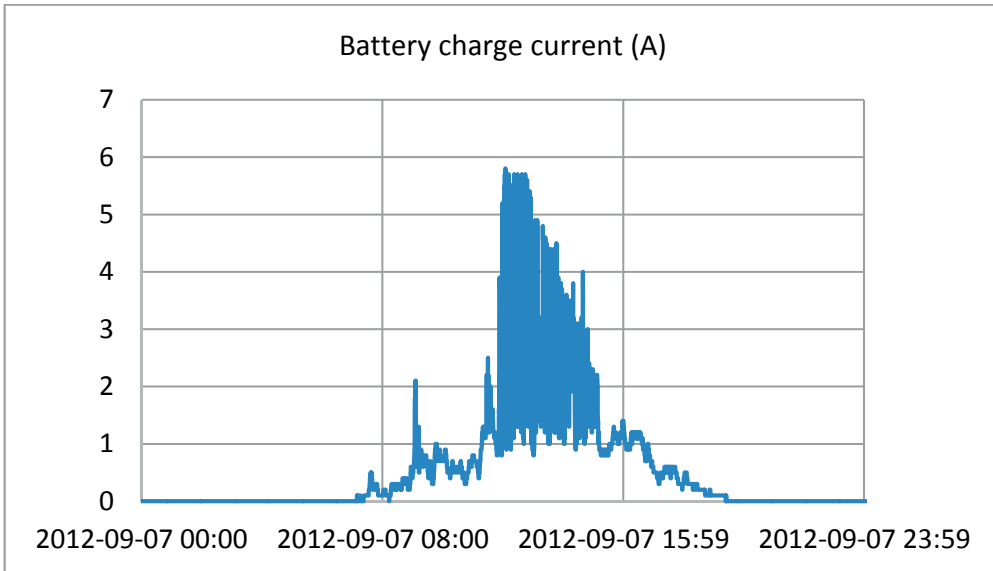

Figure 3.31: Battery charge current, partial zoom of Figure 3.30.

Figure 3.32 presents the behaviour of the battery voltage during the charging and discharging process from 2012-09-07 up to 2012-09-11, and Figure 3.33 shows the details of the battery voltage during 2012-09-07. When the charging process started at 7:05 the battery bank voltage was 25.8 V, this value increased until 12:05 to 28.9 V, this value with small floating and with a maximum peak of 30.2 V remained almost constant until 15:07. From this time the air conditioner was connected to the system until 15:28 when the voltage was 27.5 V and insufficient to maintain the load connected. From this point, the voltage increased and the maximum value was reached again, and it started to decrease again at 16:35 until 19:53 and by then the battery voltage was 26.8 V. From Figure 3.33 it was possible to get the necessary information for controlling the level of depth of discharge (DOD) in order to avoid discharging the battery completely which is harmful for batteries operation.

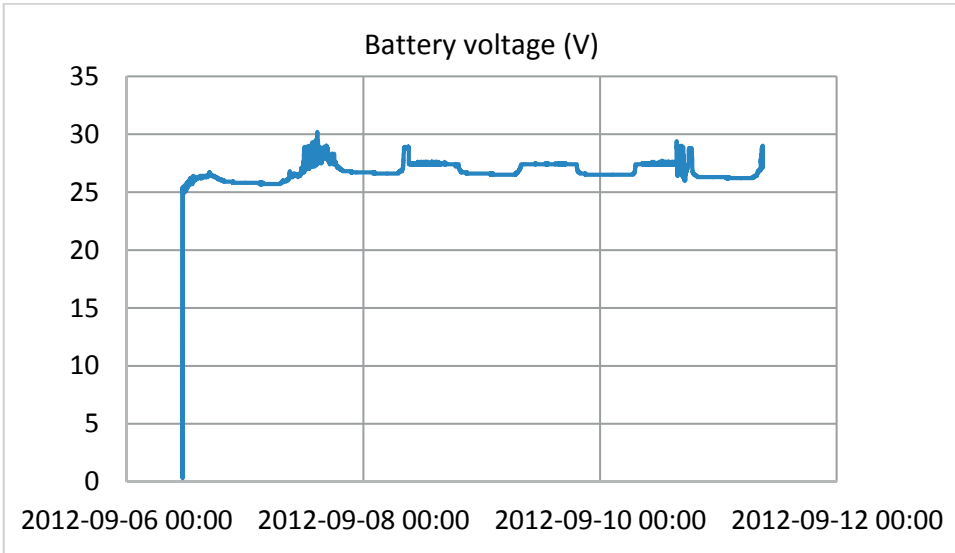

Figure 3.32: Battery voltage.

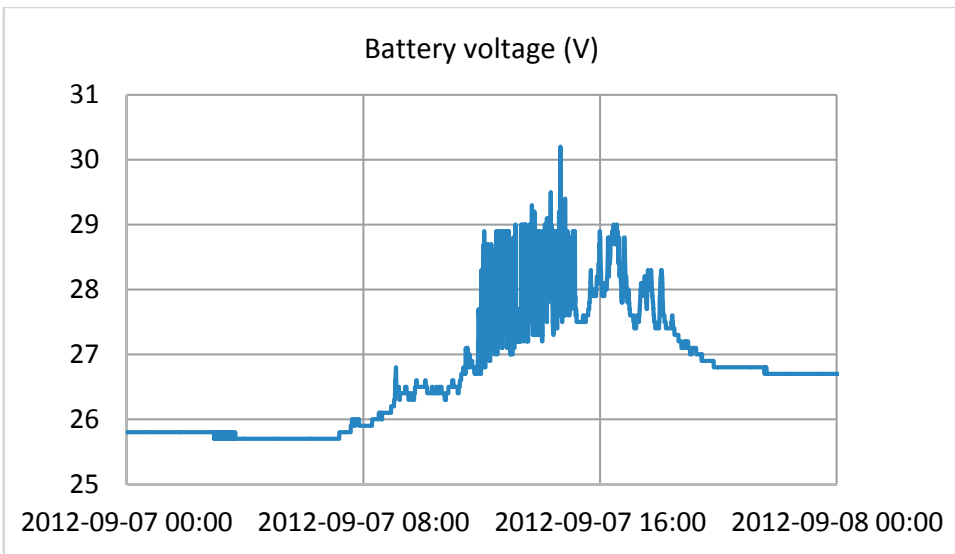

Figure 3.33: Battery voltage, 2012-09-07.

Air conditioner supply

Considering that many occupants of the buildings most probably will install air conditioners in bedrooms and living rooms, the estimation of the thermal load for this work is based on these types of rooms from the building “3 de Fevereiro Residential”, chosen for test purpose. The details of the evaluation were done considering the parameters indicated in Table 3.8. This table presents the computation of the capacity of the air conditioner for cooling the bedroom on the

ground floor of the residential indicated above which resulted in 1.5 kW. For comparison purpose, the calculation method from [67] was used, which indicated that an air conditioner with 1.5 kW of cooling is adequate for small sized rooms up to 14 m². Thus, the air conditioner capacity estimated was considered suitable for this purpose and, since cooling air conditioners range from 1.5 to 7.0 kW, it was decided to use an air conditioner with a rated capacity of 1.5 kW.

Table 3.8: Evaluation of the air conditioner.

Parameters for air conditioning estimation	
Local summer characteristics:	
Latitude	25° 58'S
Operation hours	12h
Dry bulb temperature	38°C
Gains:	(W)
Conduction gains	306
Solar gains	899
Internal gains:	
People	235
Lighting	80
Ventilation and infiltration	22
Total:	1 542

In order to calculate the electricity input of the air conditioner, it is necessary to consider the Coefficient of Performance (COP), and according to [68], for AC with P<8.8 kW, the COP is estimated to 3.1. So, the air conditioner power input presented above is 497 W, according to equation (3.1).

$$\text{COP} = (\text{power output}) / (\text{power input}) \quad (3.1)$$

As mentioned in subchapter 3.4.1, one of the purposes of this part of the work is to investigate and test an air conditioner powered by a photovoltaic system in a residential building. The figures below present the measured results from the experiment done in powering the air conditioner by the PV system presented in Figure 3.26, above.

Figure 3.34 shows the direct current (DC), the current from the battery to the inverter. The main role of the inverter is to convert 24 V DC to 230 V AC, 50 Hz, in order to supply the alternating current loads. In this work, the AC load supplied is an air conditioner.

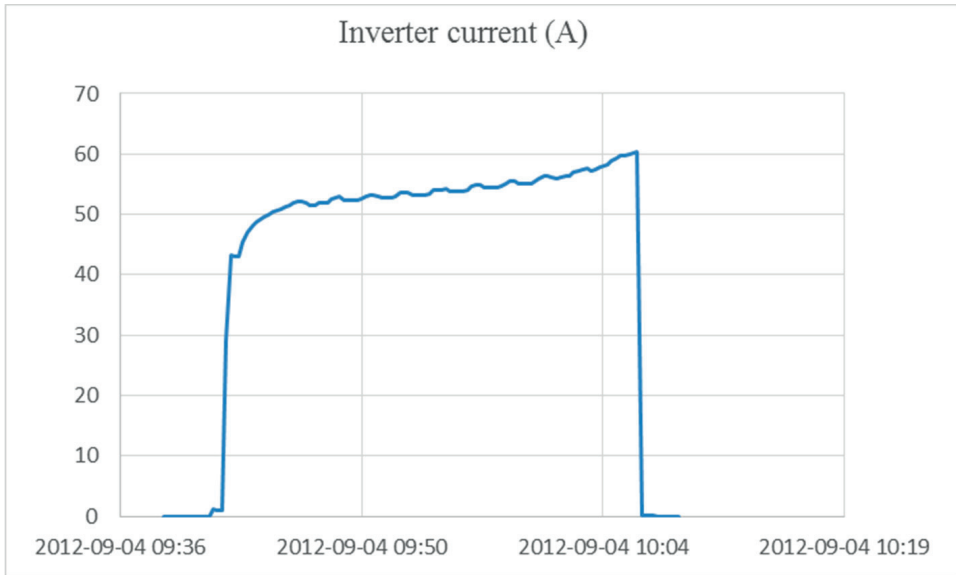

Figure 3.34: Inverter current with the air conditioner connected to the system.

With lack of financial funds for implementing the project as initially conceived, an air conditioner with 3.7 kW, 220 V, 50 Hz was used. Even though the capacity of the air conditioner was higher than for the PV system, it was able to supply it for test purposes and the result is presented in Figure 3.35.

To account for surge effects, which occur in electrical rotational machines such as electrical motors, it was decided to use one 3 kW inverter instead of one with 0.6 kW referent to the air conditioner power, 2 LED lamps with 15 W each and 15% of the total load in order to take into account future necessities.

Despite the large load used in this test, it was possible to supply it during about 30 minutes. The measured current during this period is plotted in Figure 3.35. This current corresponds to the sum of the current pulled by the compressor, the main pump that pressurizes the refrigerant gas as part of the process of turning it back into a liquid, by fans, which blow the air to condenser and evaporator and the current drawn by additional accessories such as sensors, timers and valves. This justifies the current oscillation presented in the Figure 3.35.

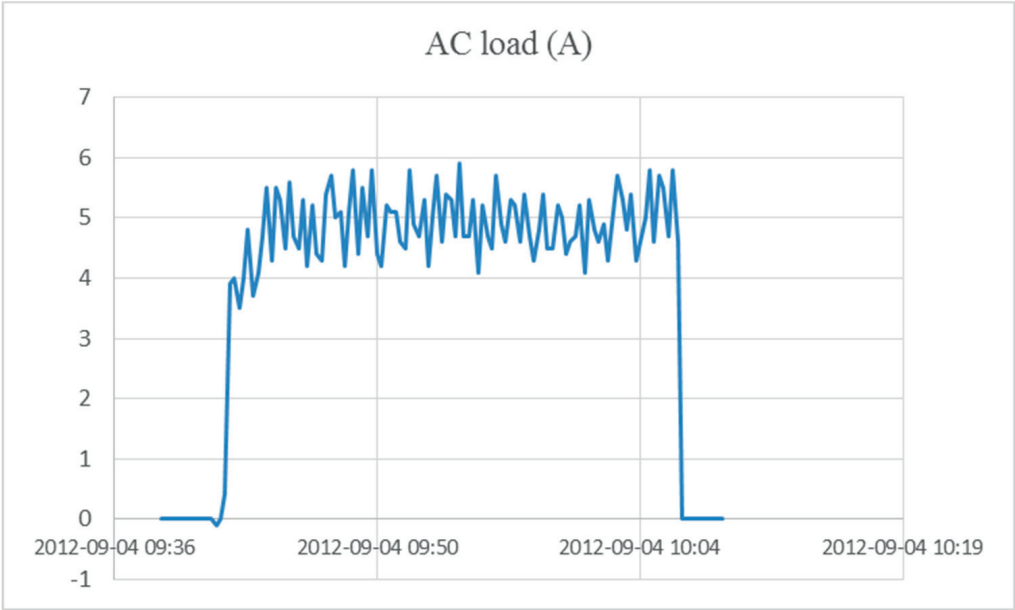

Figure 3.35: Air conditioner current.

During the test period, the average air conditioner current was about 5A and the thermostat temperature sensor was set to an indoor temperature of 25°C. Figure 3.36 presents the air conditioner energy use during the operation period.

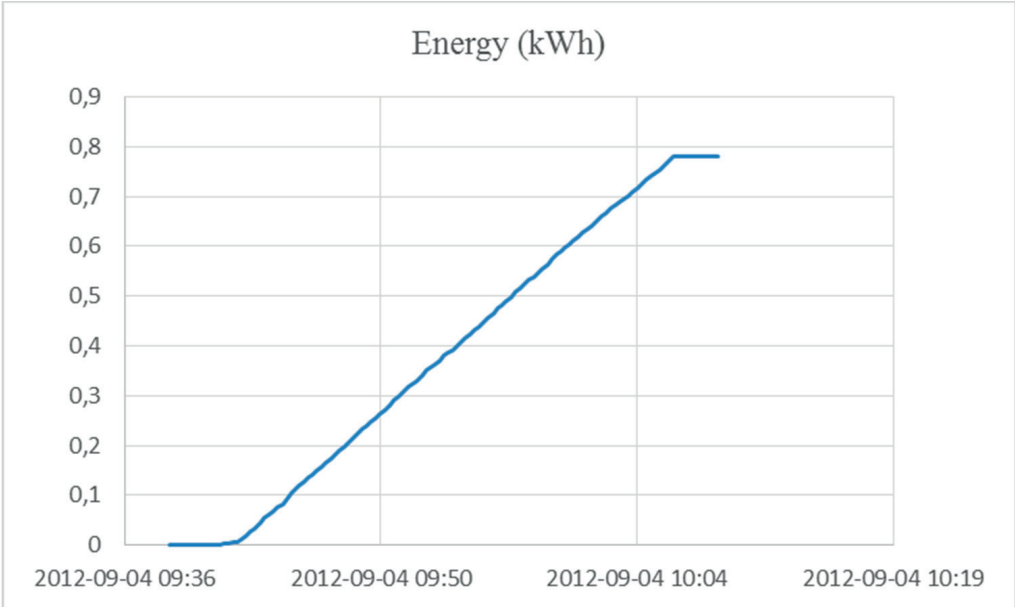

Figure 3.36: Air conditioner energy use.

The results presented above indicate that PV systems can be applied to improve energy use in building stocks with traditional air conditioners. As indicated in Paper III, cooling systems are responsible for 26% of the total electrical energy used in the building evaluated in Maputo City.

3.4.5 Economic evaluation of the PV system for air conditioner

This subchapter presents the economic evaluation of a PV system used to power a typical air conditioner installed in most of the residential building stock in Maputo. The evaluation of the facility includes the sum of all the costs needed for decision making: the PV modules, storage batteries, charger controller, inverter, and the installation cost (manpower).

According to [69], the average module prices, average selling price (ASPs), has been decreasing by 42 percent in the last years. In 2011 the global ASP was 1.37 USD /W_p and in 2012 the average module price was about 0.79 USD /W_p, (W_p is the peak power of the solar cell). In 2013, ASPs have continued to decrease by 18 percent to 0.65 USD/W_p with inventory averages of 0.58 USD/W_p. An overview of the decreasing tendency of the ASPs from 1992 up to 2012 is presented by [69].

In general, the average prices of the main components of PV array installations are decreasing due to industry improvements. So, in this work, a value of 2.29 USD /W_p was assumed in order to consider the shipping expenses. This price was confirmed through the invoice request in Swedish and abroad (China) markets. The PV component costs are presented in Table 3.9 and Table 3.10 shows the economic parameters and its costs.

Table 3.9: The PV cost data base

Item	PV	Charge controller	Battery	Inverter	Installation	USD OM/year of PV modules
Cost (USD)	2.29/W _p	1.96/I _{cc}	2.01/Ah	0.12/W _i	20% of PV system cost	2% of PV system cost

Note: I_{cc} [A], B_c [Ah].

Table 3.10: Economic parameters.

Economic parameters	Quantity	Cost (USD)
PV module., Mono-crystalline., $W_p = 200 \text{ W}$, $I_{sc} = 4.68 \text{ A}$, $I_{mp} = 4.43 \text{ A}$, $V_{oc} = 57.6 \text{ V}$, $V_{mp} = 45.63 \text{ V}$	11	5 038
Charge controller, MPPT, 50A, 2400W, 48 VDC	1	98
Battery, Lead-acid, 270Ah (12V), 48 VDC	4	2 171
Inverter, 2.1 kW, 48VDC/230VAC	1	252
Additional components	1	1 770
Installation cost	1	1 866
Global Total	-	11 195

The results presented in chapter 3.4, shows that the PV components were suitable and operate according to the layout of the photovoltaic system presented in Figure 3 of Paper V. Since the functionality of the system components was verified and confirmed, the equipment was transferred and installed in Maputo City in order to integrate the other measurement equipment installed in 2009 and updated in 2010 for energy efficiency research in buildings.

The system presented above can be applied for reducing the electrical energy used from the grid for cooling systems using traditional air conditioners during the summer. During the winter, the system can be used to supply other kind of appliances. Additionally, during the design stage of the residential, these systems can be integrated for solar assisted air conditioning. The solar assisted air conditioning system operate with considerably less electricity use than conventional air conditioning systems [70]. Hybrid solar air conditioners is another field where PV systems are used with the objective of reducing electrical power use.

From the measurements of charge current and battery power the estimated peak power was calculated to be 168 W. The average efficiency of the PV system and the battery was found to be 9.5%, based on the time integration of charging current (0.5 A or more) times battery voltage and the measured irradiance and the gross area of the PV system ($0.55 \times 1.2 \times 2 = 1.32 \text{ m}^2$). The minimum efficiency as claimed by the labelling of the PV system is 7 – 17%.

4 Discussion

The discussion is presented under five main topics, relating to the socio-economic perspective, to the methodology used in this work and to the three research questions presented in the introduction chapter, subchapter 1.2.

4.1 Socio-economic perspective

The situation in Mozambique is paradoxical in the sense that the country has substantial natural resources for producing energy, but still, the energy use per capita is very low and the people have only to a limited extent access to electricity. Even though electrification rate is used as an indication of the rate of poverty, the problems of poverty are of course not solved automatically by giving everyone access to electricity. Electricity will, however, give better conditions in e.g. medical clinics, the education sector and in homes. On a national level, the natural resources should have a potential to contribute to export incomes that could be used for investments in education and health infrastructures, which will in turn improve the possibilities for businesses that could give further economic development. Development in the energy sector is thus a key challenge for Mozambique.

Nowadays, Mozambique is showing a considerable and significant socioeconomic development. Despite this progress, the country continues to struggle with huge inequality between urban and rural areas. The city households are provided with access to basic social services, but people in the countryside are not.

In general, the rate of poverty in Mozambican population is high and rated at about 55%. In this context, there is a large difference in terms of gender and age. Women, children and the elderly are more vulnerable to lack of good social conditions in Mozambique.

The availability of electricity covers only 23% of the population and the rural population is the most affected. For survival, the rural population depend basically on wood, charcoal and kerosene as energy resources.

The majority of the population in cities survive thanks to informal economic activities and the access to formal employment is very restricted and this has a great impact especially for women and young people.

The main factors for reducing the rate of poverty in Mozambique is to increase the agriculture and fishing production and productivity as well as other sectors such as industrial and formal commerce.

The government faces a number of challenges to reduce poverty in Mozambique, such as the boosting of farms, fishing, and promotion of employment, economic

growth and social development. In addition, and from an energy perspective, one of the great challenges to cope with in order to promote development and enhance energy resource management in order to meet the constant increase of use fuel from fossil resources is to introduce legislation and economic incentives promoting energy saving and efficiency in buildings.

4.2 Methodology used

An important tool for examining the influence of different parameters on the energy performance of a building is a modelling and simulation program. In this work, DEROB-LTH was selected for predicting the energy used in buildings.

Initially, seven modelling and simulations tools were selected, see Table 2.5. From the analysis it was seen that the Save HELP, the STEM & PSTAR and the Neural Network are based on pseudo-steady state, macro-static & macro-dynamic and neural networks & quasi-physical models, respectively. These tools were not seen as adequate to be used in Mozambique once their use require detailed knowledge about the building energy balance, thus limiting their wide-spread use. The fourth one, the BKL Method uses the improved degree day method, and is a model designed for cold climate and not recommended for hot climates such as that of Mozambique.

Thus, the Energy Barometer, the University projects, and the DEROB-LTH were seen as reasonable candidates for use in Mozambican conditions. The Energy Barometer model is similar to the measurement equipment installed in the reference building in terms of main operating principles and data collection. The remaining two models were compared in terms of advantages and disadvantages as related to the output from them, and DEROB-LTH was seen as the more advantageous one: DEROB-LTH allows more climatic factors and parameters to be simulated than does the University Projects. A full description of these model is presented in paper II.

From the literature review presented in paper II, it was found that DEROB-LTH demonstrated good results and performance in studies done in cold climates [53, 71, 72, 73] and its use in subtropical and tropical climates [54, 55] also presented good outcomes. For the other tools, less is reported in literature related to their use in hot climates.

DEROB-LTH is a tool using dynamic calculations to determine peak loads and energy use for heating and cooling, thermal comfort and visual comfort of buildings. This tool, despite its many advantages in modelling and simulation of energy use in buildings, cannot be used in issues related to excavation into the ground and does not treat the effects of moisture. This is not a great issue, since excavations into the ground are not common in Mozambique and for the kind of studies to be conducted in Mozambique within the scope of this project.

In addition to the advantages related to input and output parameters, DEROB-LTH is seen by users as a relatively simple tool to use. This is a great advantage for its application in Mozambique where there are not many academic professionals that can manage with complex theory relating to building energy balance as is required in other, more complex tools.

The main input parameters required by DEROB-LTH are the geometry and thermal properties of the building to be simulated, set points for heating and cooling, internal gains from occupants and appliances and outdoor climatic data. As outdoor climatic data is needed, it was initially decided to use data from Meteonorm computer software as input when analysing the indoor climate of the “3 de Fevereiro building”.

Meteonorm is a reference catalogue of meteorological data for solar applications and system designs at any location in the world. According to reference [59] data from Meteonorm are suitable as input for different simulations tools. In order to verify this, the gauging of the simulated results were done using the data from measurement equipment installed in the “3 de Fevereiro Residential” building.

The comparison between the outdoor temperature from Meteonorm, from the measurement equipment and from reference [57], presented good agreement, see Figure 3.4 and Figure 3.16. This shows that data from Meteonorm is actually reliable and could be used as input for DEROB-LTH to evaluate energy use in buildings in Mozambique.

Thus, the indoor temperature was measured and compared with that one obtained from DEROB-LTH using outdoor data from Meteonorm. As indicated in Figure 3.5 (a-b) the comparison showed that the simulated indoor temperature is slightly higher than that from the measurements. The differences in terms of average indoor temperature from simulation and measurements were considered reasonable once the Meteonorm data represent a Test Reference Year based on the period from 1961 up to 1990 for temperature and wind and from 1986 up to 2005 for solar radiation, whereas the measured data is for one specific year.

From the literature review it was seen that in spite of the existence of several experimental methods developed in the world for evaluation of building energy use, most of the references are focused on calculation methods instead of presenting results from measurements. In this study, in addition to modelling and simulation, the design of a weather station was included, consisting of sensors for measuring global and diffuse irradiance, indoor and outdoor temperature and humidity. This measurement equipment constitutes an important asset since it provides the microclimate to be used in testing and validation of new modelling and simulation tools in the future. Paper I present the full description of the measurement equipment installed in the case study.

One problem faced was to transfer data from the measurement equipment, since the researcher was based in Sweden. As a solution, a technician was trained for collecting data and sending them via email to Sweden. The technician was also trained for repairing some breakdowns to the system. This method of collecting data was ineffective because the technician sometimes was not able to send data in due course. In order to overcome this problem, a system was established which allows to collect data via internet and also to detect inoperability of the system. It is believed that the same approach can be used in future projects within Mozambique as a means to simplify the evaluation process.

For improving the energy use in buildings, it was decided to examine, in addition to the use of efficient appliances, technologies based on renewable energy for supplying electricity to the building for air conditioning, tap water heating and lighting systems. Furthermore, it was concluded that many social infrastructures in rural areas work without any connection to the power grid. Thus, a stand-alone PV system to be used in urban and rural areas was studied.

Initially, a PV system for supplying the entire electrical power needed was planned for. Due to lack of financial funds for its implementation, it was later decided to have a system for priority loads only. Thus, a low power PV system for research purpose was implemented.

As the research took place at Lund University, initial build and operability tests were done at Lund University. After the test phase, the PV system equipment was transferred and installed in Maputo City where it is now working and provides data which are collected via internet for analysis.

Currently the system is working as a pilot system for research purposes, but effort has been done in order to get funds for its enlargement in the future. Currently, the system is supplying external lighting, and for test purpose it can feed the air conditioner installed for research activities within the scope of this project.

This research introduced the use of a PV system, and examined the possibility to use it in urban and rural areas for reducing the energy used in buildings and for providing rural areas with means of generating electricity in order to solve the current problems inherent to lack of electrical energy. The introduction of these systems will enhance the possibility of improvements in the area of energy efficiency in buildings as well as the replacement of the use of conventional energy sources which are not sustainable, because of the environmental problems associated with the use of fuel from fossil resources.

4.3 Research questions

Research question 1: What are the most important aspects to take into account considering energy efficiency in residential buildings in Mozambique?

The subtropical and tropical climate is one of the most important characteristics of Mozambique in this context. Subtropical and tropical climates are characterized by high air temperature and solar radiation during the day which result in high indoor temperature and a discomforting indoor environment for occupants, especially during summer and at low altitudes. The air temperature varies greatly as a function of latitude. The high level of solar radiation obviously gives substantial thermal loads in buildings. Thus, a high electricity demand to supply air conditioning in order to maintain indoor comfort within the acceptable indexes for occupants is to be expected.

The simulation results of the Maputo, Tete and Nampula Provinces using DEROB-LTH files, verified the expected increase of temperature and solar irradiance from subtropical to tropical zones, this is corroborated by [8].

With regards to ventilation in subtropical and tropical climates, ventilation can be used for cooling purposes if the building design is properly performed for cross ventilation. The effect of louvres as well as the stack effect must be considered in the building design in order to improve the indoor comfort. In milder and colder climates these systems must of course also be carefully designed once ventilation involves infiltration and exfiltration which will result in increase of the energy demand for heating.

Thermal loads in buildings increase due to internal gains from e.g. appliances, occupants and lighting which increase the electrical energy demand for cooling whereas in mild and cold climates the presence of internal gains contribute to the required heating resulting in significant reduction on energy demands for heating systems. Thus, in cold climates the internal thermal loads can positively contribute to the heating systems reducing the heating demands whereas in hot climates, internal thermal loads increase cooling energy demands in buildings.

Another very important aspect is the socio-economic situation in the country, which is discussed in a separate section above. The dwellers lack of financial resources constitutes a restraint on what measures can be taken to improve the energy efficiency in buildings. To show the impact of the climate and socio-economic situation, some comparisons were made with countries like South Africa and Sweden, representing different climate and/or socio-economic situations.

Research question 2: How can the influence of building design, equipment, lighting and occupants on the building energy use be analysed?

Previous studies done in the area of building design, concerning equipment, lighting and occupants, indicated that these parameters have a great influence on energy used in buildings as they can be considered as thermal loads which can affect positively or negatively the energy performance of the buildings.

In general, and regarding to building design, the local climate is determinant in making decisions related to what must be done in order to provide the building with comfortable indoor climate. For instance, buildings located in cold climates, can be designed to use solar energy for heating through glazing elements and measures should be taken to avoid air leakage as this increases substantially the heating energy demand. In hot climates, the building envelope must include shading elements in order to avoid excess indoor temperatures whereas the wind can be used to improve the indoor climate through cross ventilation approaches. This can of course also be applied during summertime for buildings located in cold countries. The influence of all these parameters, and others, can be analysed by means of parameter studies using a simulation tool like DEROB-LTH.

Since a lack of knowledge was identified concerning internal loads in Mozambique a study with the reference building was done considering the electrical energy by end-use. From this it was found that the highest use of energy occurs in cooling, followed by heating of tap water and lighting systems. Studies like this are an efficient means of identifying the potential of upgrading of appliances and other equipment.

Research question 3: How should building energy systems be managed?

From the findings of this work it is believed that the main challenge to address is the establishment of legislation to regulate the management of energy demand in buildings through the adoption of international codes and the introduction of national norms which should be followed by designers, architects and engineers. This would allow prediction of the use of energy during the design stage and retrofiting of buildings, and it would mean that the energy could be used efficiently, leading to economic benefits for the occupants. Other approaches could be making building energy modelling and simulation tools easily available and promoting the use of solar panels by introducing economic incentives to households who want to use these technologies.

The main purpose of building energy management is to manage the building energy systems, namely HVAC, lighting, and other miscellaneous building loads

(appliances), in order to reduce the building energy use, reducing costs for the occupants while increasing occupant comfort. It is believed that building energy management systems should be provided in terms of a centralized platform since this enables control of the complete building and thus minimizing the risk of sub-optimization.

From the literature review, it was concluded that in Mozambique about 72% of the estimated total energy used is used in residential buildings [4], and still the country does not have any instruments for management of building energy use. A unique means, provided by Electricidade de Moçambique (EDM), is to let households manage their electricity energy use by replacement of traditional energy meters by a pre-paid system called “credelec”. In addition, according to [5] measures are now being taken to cope with energy efficiency in buildings, focusing mainly on training courses for the disclosure and dissemination of the energy strategy for the following subject areas:

- Strategies for sustainable use of energy in appropriate environmental conditions in buildings.
- The rational and efficient use of energy resources, improving and increasing energy efficiency in buildings.
- The involvement of the scientific and technological communities as well as the private sector and the population in general in order to establish sustainable energy solutions in the country.

According to EDM 46% of the total electrical energy use is used in the residential sector, representing the largest single share of electrical energy usage in the country. According to [74], statistics inherent to electrical energy use in HVAC, lighting and other appliances are important for energy management in order to achieve savings and energy efficient use in buildings. In addition this reference considers that the combination of appliances, energy monitoring and control, with intelligent lighting can result in significant energy savings.

The limitation for using building envelope strategies for improving energy use in buildings is the higher cost for these. Thus, many inhabitants prefer using mechanical technologies to improve the indoor climate instead of passive design strategies which results in an increase of energy used in buildings. According to findings from Paper III, the use of efficient equipment could be a good measure to reduce the use of energy. But again, because many Mozambican cannot afford efficient equipment as these are relatively expensive, they continue purchasing older and less efficient equipment which is cheaper to buy.

In Paper V three alternatives for supplying power for the reference object were analysed, among them it was found that the unit electrical cost of the PV system was higher than current prices for consumers connected to the grid of EDM. This was

also the case for the South African context studied. So, in both countries the PV electricity price is not affordable for low income households, and this conclusion would probably also extend to other developing countries. However, as PV systems present great advantages considering that they can be easily implemented in urban areas to improve energy used in buildings as well as in rural areas where the national grid does not cover, and since in addition PV-systems have environmental advantages an implementation of their increased use in Mozambique is believed to be of vital importance.

5 Conclusions and recommendations for further research

This chapter presents the conclusions of the research developed in this thesis and recommendations for future work to be done in scope of the thesis statements, i.e. recommendations for future research efforts and recommendations for actions that can and should be taken already today by legislators and authorities.

5.1 Conclusions

The first specific aim of this research (cf. section 1.3) is related to reviewing the current practices concerning energy use in buildings in Mozambique and worldwide.

Conclusion 1: The relative amount of energy used in the residential sector is high in Mozambique, in comparison with other countries. It was found that 46% of total electrical energy produced in Mozambique is used in the residential sector whereas in South Africa and Sweden, the corresponding shares are 18% and 29%, respectively.

A second conclusion identifies the cause of inefficient use of energy in buildings in Mozambique.

Conclusion 2: It was concluded that in Mozambique, due to the lack of regulations, models for energy rating and the use of inefficient appliances, the energy is used inefficiently in residential buildings.

The second aim was to identify, analyse and evaluate suitable models and modelling and simulation tools for assessing energy use in buildings in subtropical and tropical countries.

Conclusion 3: It is concluded that among the seven modelling tools evaluated herein the most suitable for Mozambican climatic conditions is the DEROB-LTH Program, this being a simple-to-use tool that does only require a reasonable knowledge about the building energy balance.

The third aim was to suggest technical and other means of improving the energy performance of residential buildings.

Conclusion 4: It was concluded that in order to improve the energy performance of residential buildings it is necessary to: (a) establish codes for regulating the use of energy in buildings, including for example

windows with efficient glazing and building envelope elements with high R-value, (b) disseminate and promote the use of modelling and simulation tools during the design stage of buildings and retrofitting.

Conclusion 5: It was concluded that the use of efficient HVAC, water heating, lighting systems and appliances, as well as PV systems should be promoted. It was for example shown that with the use of efficient appliances and lamps the energy use in buildings can be decreased by 24%, and that a PV system can be used for supplying electricity in rural and urban areas.

The fourth and last aim was to develop a framework of models and tools that can be used by researchers, designers and constructors in the field of energy efficiency in buildings.

Conclusion 6: It is concluded that the approach used in this work in terms of development of measurement equipment, validation of a simulation tool and establishment of a photovoltaic system for research purposes provides a framework for further work, both for researchers and for practicing engineers, in the construction sector.

5.2 Recommendations for further research

In the course of this research, it was found that the price of solar panel systems is unaffordable for the majority of the Mozambican population, especially in rural areas. However it is also evident that the development of solar energy technology is strong and that the prices for solar energy products are decreasing annually. This indicates that in a near future the solar energy could be affordable for many people in Mozambique. Thus, in order to contribute with solutions to face the lack of electrical energy in both urban and rural areas, the following areas were identified for further research:

1. Design of photovoltaic systems that are economically viable for reducing energy used in air conditioning systems for building stocks in urban and rural areas.
2. Investigation of energy efficient systems towards zero-energy use in buildings.
3. Further investigations should be carried out regarding efficient strategies for training of professionals within the areas of solar energy and energy efficiency in buildings.

References

- [1] Laustsen, J. Energy efficiency requirements in building codes, energy efficiency, policies for new buildings, IEA information paper, OECD/IEA, March 2008.
- [2] Pietiläinen, J., Total building energy monitoring–Basis for performance verification, VTT, Technical Research Centre of Finland, Finland, 2012.
- [3] OECD/IEA and United Nations Development Programme (UNDP), Modernising Building Energy Codes, IEA, Paris, France, 2013.
- [4] Anon. Country energy information Mozambique, Developing Renewables, Report from Developing Renewables– RECIPES (6th Framework Programme), 2006.
- [5] Boletim da República, publicação Oficial da república de Moçambique, I série- Número 4/, 2005.
- [6] Dalet, D., d-maps, <http://d-maps.com/index.php?lang=en>, Accessed September 30, 2014.
- [7] Climate Change Knowledge Portal, For Development Practitioners and Policy Makers. The World Bank group. <http://sdwebx.worldbank.org/climateportal/>, Accessed October 01, 2014.
- [8] Hammar, L., Wind and Solar Energy Resources in Tanzania and Mozambique, Report No. 2011:5, ISSN No. 1404-8167, Department of Energy and Environment, Division of Environmental Systems Analysis, Chalmers University of Technology, Gothenburg, Sweden, 2011.
- [9] Mozambique 2012 Energy sources, Reegle, <http://www.reegle.info/policy-and-regulatory-overviews/mz>, Accessed October 01, 2014.
- [10] Nuvunga, A., Exportações de gás de pande temane para a África do sul: Primeiros grandes projectos do sector extractivo frustram as expectativas dos moçambicanos, CIP, 2013.

- [11] Tracy Hancock, Mozambique coal output expected to jump to 100 Mt/Y in next decade, Mining weekly, Creamer Media, <http://www.miningweekly.com/article/mozambique-coal-reserves-expected-to-jump-to-100-million-tons-a-year-in-next-decade-2012-06-08>, Accessed October 01, 2014.
- [12] Revuboè Coal Mine, Tete, Moçambique, mining-technology.com, Sonic enclosures lda, 2012. <http://www.mining-technology.com/projects/revubo-coal-mine-tete/>, Accessed October 01, 2014.
- [13] Mozambi Coal Limited, 2012 Mozambique Coal Conference Maputo, Mozambi Coal, <http://www.mozambicoal.com/docs/asx/2012/MOZpres20120703.pdf>, Mozambique, Accessed October 02, 2014.
- [14] Talking Tete – Mozambique’s new mining epicenter, The International Resource Journal, George media network, 2014. http://www.internationalresourcejournal.com/mining/mining_july_11/mozambique_s_new_mining_epicentre.html, Accessed October 02, 2014.
- [15] Cahora Bassa, The Cahora Bassa HVDC transmission system is an important source of imported power for the South African grid, ABB, <http://new.abb.com/systems/hvdc/references/cahora-bassa>, Accessed October 02, 2014.
- [16] Junior, P. C., Spaliviero M., et al, Climate Change Assessment for Maputo, Mozambique, united Human Settlements Programme (UN-HABITAT), 2004.
- [17] Fox, L., Bardasi E., et al, Poverty in Mozambique, Unraveling Changes and Determinants. Africa Region Working Paper Series No. 87, 2005.
- [18] Anon. Poverty and well-being in Mozambique: The second national assessment, National Directorate of Planning and Budget, Ministry of Planning and Finance Economic Research Bureau, Ministry of Planning and Finance International Food Policy Research Institute Purdue University, 2004. http://www.sarpn.org/documents/d0000777/P880-Mozambique_032004.pdf, Accessed August 15, 2014.
- [19] Barros, A. N. and Mucavele, C., Investing in rural people in Mozambique, Rural poverty in Mozambique, International Fund for Agricultural Development, IFAD, 2014.

- [20] Artur, M. F. S. R., Energy Sources of Mozambican Households and the Demand-Supply Curves for Domestic Electricity in the Northern Electrical Grid in Mozambique, 2009.
- [21] Mozambique, sub-Sahara Africa, The World Bank, IBRD-IDA, <http://data.worldbank.org/country/mozambique>, Accessed October 15, 2014.
- [22] Fernando, A. S., Plano de Desenvolvimento na Área da Energia em Moçambique, 2013.
- [23] Gilberto M., Mulder, P., et al., Energy outlook for Mozambique 2012-2030 LEAP-based scenarios for energy demand and power generation, 2012.
- [24] Frequently asked questions, How much energy is consumed in the world by each sector? Eia, U.S. Energy Information Administration. <http://www.eia.gov/tools/faqs/faq.cfm?id=447&t=1>, Accessed October 14, 2014.
- [25] Consumption of energy, From statistic explained, European Commission, Eurostat, 2014. http://epp.eurostat.ec.europa.eu/statistics_explained/index.php/Consumption_of_energy, Accessed October 25, 2014.
- [26] Energy policies of IEA Countries Sweden, 2013 Review, International Energy Agency, IEA, OECD/IEA, 2013. http://www.iea.org/textbase/nppdf/free/2013/sweden2013_excerpt.pdf, Accessed October 25, 2014.
- [27] International Energy Statistics, U.S., Energy information Administration, Eia, 2012. <http://www.eia.gov/cfapps/ipdbproject/IEDIndex3.cfm?tid=44&pid=44&aid=2>, Accessed October 25, 2014.
- [28] South Africa Situation, Energypedia. https://energypedia.info/wiki/South_Africa_Energy_Situation, Accessed October 26, 2014.
- [29] Mozambique Energy Industry Business Opportunities, Iag/kr. http://www.tipmoz.com/library/resources/documents/usinvestorconference/bye_xpertinenergy.pdf, Accessed October 2, 2014.

- [30] Energy balance sheets 2010-2011, eurostat, statistical books, edition, European Commission, 2013.
<http://ec.europa.eu/eurostat/documents/3217494/5776405/KS-EN-13-001-EN.PDF/dda45f01-c4c1-4b5c-9cac-70fe10122956?version=1.0>, Accessed October 26, 2014.
- [31] Milford, R., GreenHouse Gas Emission Baselines and Reduction Potentials from Buildings in South Africa, Sustainable Buildings & Climate Initiative, UNEP SBCI, 2009.
- [32] Arthur, F., Nhassengo, A. J., et al., Statistical Summary, Electricidade de Moçambique, 2012.
- [33] Leung, C. S., and Eisen, P., How electricity consumption affects social and economic development by comparing low, medium and high human development countries, 2005.
- [34] Electric power consumption (kWh per capita), 2009-2011, The World bank, IBRD-IDA, 2011.
<http://data.worldbank.org/indicator/EG.USE.ELEC.KH.PC>, Accessed October 27, 2014.
- [35] Electricity consumption per capita (kWh) 2012 country ranks, by rank, Countries of the World, 2012.
http://www.photius.com/rankings/economy/electricity_consumption_per_capita_2012_0.html, Accessed October 27, 2014.
- [36] Electricity consumption per capita, country ranks (kWh) 2013 country Ranks, by rank, Countries of the World, 2013.
http://www.photius.com/rankings/energy/electricity_consumption_per_capita_2013_0.html, Accessed October 16, 2014.
- [37] Lehohla, P. J., Mid-year population estimates, Statistical release P0302, Statistics South Africa, 2013.
<http://www.statssa.gov.za/publications/p0302/p03022013.pdf>, Accessed October 16, 2014.
- [38] Persson, U., et al, Ten Years of Sustainable Construction – Perspectives from a North Construction Manager and a South Architect Point of View, Conference paper, Technology and Engineering, World Sustainable Building Conference, SEB08, Melbourne, Austria, 2008.

- [39] Statistics Sweden, Population statistics, SCB,
<http://www.scb.se/Grupp/OmSCB/Dokument/SCB-folder-engelsk.pdf>,
Accessed October 27, 2014.
- [40] Energy Efficiency Directive, European Commission.
http://ec.europa.eu/energy/efficiency/eed/eed_en.htm, Accessed November 03,
2014.
- [41] Pless, S. and Torcellini, P., Net-zero Energy Buildings: A Classification System
Based on Renewable Energy Supply Options, National Renewable Energy
Laboratory, NREL, Technical Report NREL/TP-550-44586, 2010.
- [42] OECD Investment Policy Reviews Mozambique, 2013,
http://www.keepeek.com/Digital-Asset-Management/oecd/finance-and-investment/oecd-investment-policy-reviews-mozambique-2013_9789264203310-en#page1, Accessed April 19, 2015, Accessed April 19,
2015.
- [43] Greenhouse gas emission baselines and reduction potentials from buildings in
South Africa, Sustainable Buildings & Climate Initiative, UNEP SBCI. 2014,
<http://www.unep.org/sbci/pdfs/SBCI-SAreport.pdf>, Accessed December, 30,
2014.
- [44] Maehlum, M. A., Where is Solar Power Used the Most? Energy Informative,
the Homeowner's guide to solar panels, 2014.
- [45] B. C. Cuamba, et al, A solar energy resources assessment in Mozambique,
Journal of Energy in Southern Africa, Vol 17 No 4, November 2006.
- [46] Källblad K., The model of typical energy balance in buildings, Adapted from
the author.
- [47] Adhikari, R.S., Lucchi, E, et al, Static and Dynamic Evaluation Methods for
Energy Efficiency in Historical Buildings, PLEA2013, – 29th Conference ,
Sustainable Architecture for a Renewable Future, Munich, Germany 10-12
September, 2013.
- [48] Basarir, B., Diri C., et al., Energy efficient retrofit methods at the building
envelopes of the school buildings Department of Architecture, Mimar Sinan
Fine Arts University, Istanbul, Findikli, 34427, Turkey.

- [49] Building Energy Software Tools Directory, Energy Efficiency & Renewable Energy, U.S. Department of Energy.
http://apps1.eere.energy.gov/buildings/tools_directory/subjects.cfm/pagename=subjects/pagename_menu=whole_building_analysis/pagename_submenu=energy_simula, Accessed November 03, 2014.
- [50] Santamouris, M. Energy Performance of Residential of Residential Buildings, A practical guide for energy rating and efficiency, ISBN: 1-902916-49-2, 2005.
- [51] Martin, S., Wouters P., et al., evaluation of a simplified method for the energy certification of non-occupied buildings, Final Report, Save HELP project, Belgian Building Research Institute, Brussels, 1996.
- [52] Subbarao, K., Burch, J., et al., Measurement of Effective Thermal Capacitance in Buildings.
- [53] Källblad, Kurt, Adamson, Bo, A Simplified Method to predict energy consumption in Buildings, Swedish Council for Building Research, Lund University, Sweden, 1984.
- [54] Hans, R, “Housing Development & Management” Climate adaptation and energy efficiency of Buildings Experiment in Ghardaia, Algeria, 1993.
- [55] Wang, Z., Controlling Indoor Climate, Passive cooling of residential buildings in hot-humid climates in China, Lund Institute of Technology, department of Building science, report TABK—96/1008.
- [56] Maputo: Annual weather averages, Holiday weather. Com, Daily Worldwide forecasts for your holiday, <http://www.holiday-weather.com/maputo/averages/>, Accessed November 03, 2014,
- [57] Auziane, G., Energy Assessment Methodologies and Climatic Measurements – A Field Monitoring project in Maputo City, Report TABK—10/1026, Lund Institute of technology, Lund University, 2010.
- [58] Remund, J., Kunz S., et al., Meteororm Version 6.0, SoftwareComputer program from METEOTEST, Fabrikstrasse 14, CH-3012 Bern, Switzerland, 2007.
- [59] Chea L.C., et al. Irradiation Analysis for Maputo, Journal of Civil Engineering and Architecture, volume (6-12), pp. 1654-1662, 2012.

- [60] Regulamento Das Características de Comportamento Térmico dos Edifícios, RCCTE-7, Decreto-Lei nº. 40/90 e Decreto-lei nº. 118/98, Portugal, 1998).
- [61] Bader, R., Landolt, et al., Sensor Installation Handbook, preface 3th edition. <https://www.google.se/#q=Sensor+Installation+Handbook%2C+preface+3th+edition>, Accessed December, 30, 2014.
- [62] Kvist, H., Hellstrom B., DEROB-LTH v2.0, Department of Architecture and Built Environment. Lund Institute of Technology, Lund University, 2013. http://lthbyggark2.arkitektur.lth.se/ebdsw/Derob/Information/InstallationsEN2_0S20071105.pdf, Accessed December, 30, 2014.
- [63] Average weather for Maputo, Mozambique, <https://weatherspark.com/averages/29131/Maputo-Maputo-City-Mozambique>, Accessed April 10, 2015.
- [64] Creder, H. Instalações de ar condicionado, Rio de Janeiro, RJ – CEP 20040-040, 1997.
- [65] Boyle, G., Renewable Energy, Power for a Sustainable Future, Printed in the United Kingdom by the Bath Press, Glasgow, 2000.
- [66] End Use Metering in the Residential Sector, Sydney 090203. https://www.energimyndigheten.se/Global/Engelska/Facts%20and%20figures/Household%20electricity%20metering%20090203_E%20Ofverholm.pdf, Accessed December, 31, 2014.
- [67] InspectApedia, Free Encyclopedia of Building & Environmental Inspection, Testing, diagnosis, and repair. http://inspectapedia.com/aircond/Air_Conditioner_BTU_Size_Chart.php, Accessed December, 31, 2014.
- [68] COPs, EERs, and SEERs How Efficient is Your Air Conditioning System? Power knot. http://www.powerknot.com/pdf/Power_Knot_about_COP_EER_SEER.pdf, Accessed December, 31, 2014.
- [69] Solar PV Profit's Last Stand, Renewable Energy.World.com, <http://www.renewableenergyworld.com/rea/news/article/2013/03/solar-pv-profits-last-stand>, Accessed December, 31, 2014.

- [70] Fredlund, B., Blocks of flats with glazed verands, Taberg Analysis of energy and international climate, Swedish Council for Building Research, D3:, 1989.
- [71] Wall, W., climate and Energy Use in Glazed Spaces, Lund University, Department of building Science, Lund, Sweden, ISSN, ISRN LUTADL/TABK—1009—SE, 1996.
- [73] Bülow-Hübe, H., Energy-Efficient Window Systems, Effects on Energy Use and Daylight in Buildings, Division of Energy and Building Design, Department of Construction and Architecture, Lund University, Report TABK—01/1022, 2001.
- [74] Iwayemi, A., Wan, W., et al, Energy Management for Intelligent Buildings, Accessed April 20, 2015.

Paper I

CHAPTER 2: ARCHITECTURE, URBAN PLANNING AND BUILT ENVIRONMENT

Design of Weather Station and Measurement Equipment for Assessment of Buildings Energy Use in Mozambique

Gabriel Auziane¹, Anne Landin², Daniel Balo³

¹PhD Student, Faculty of Engineering, Eduardo Mondlane University, P.O.Box 257, Maputo, Mozambique

Corresponding author email: gabriel.auziane@construction.lth.se

²Professor, Division of Construction Management, Lund University, P.O.Box 22263-Lund, Sweden

³Dr, Department of Civil Engineering, Eduardo Mondlane University, P.O.Box 257, Maputo Mozambique

ABSTRACT

The use of modeling and simulation tools for assessment of buildings energy in Mozambique is under investigation. Thus, measurement equipment was installed in the “3 de Fevereiro Residential” building in Maputo City, Mozambique. The measurement equipment comprises of Data Logger System, Weather Station, temperature and humidity sensors. This aims at measuring climatic factors around the building and indoor parameters which influence the internal environment of the buildings. This paper describes the plan design and the layout of the measurement equipment. It also presents and discusses the results of the climate parameters and the building factors for the winter season such as global and diffuse solar radiation, outdoor temperature and humidity, indoor temperature and humidity, wind speed, wind direction and rainfall. The measured results relate to a period of four months from June to September, 2009. With this field measured results it was possible to analyze a greater part of the winter climate factors. Maputo City has a subtropical climate with two seasons, a wet season from October to March (summer) and a dry season from April to September (winter). The measured results show that the equipment provides fair data which can be used for evaluating energy of the building and for testing and validating the simulation tools of building energy.

Keywords: Design experiment, Energy efficiency, Outdoor and indoor thermal environment, Field measurements, Subtropical climate.

1.0 INTRODUCTION

Maputo City, the capital of Mozambique, is situated at 25°57'S and 32°35'E with a subtropical climate which means that it is submitted to vast solar energy with potential to increase the thermal loads inside the buildings especially in summer. On the other hand, the solar energy can be used to reduce the electrical energy used in buildings if active systems using solar energy are implemented in the buildings.

The main aim for installing the measurement equipment in the “3 de Fevereiro Residential” building is to collect data and create a database from field measurements for testing and validation of modeling and simulation tools of energy use in buildings for Mozambican climatic conditions. DEROB-LTH Program, an acronym for Dynamic Energy Response of Buildings, was selected by the author in the work related to Energy assessment Methodologies and Energy use in

Buildings. This Program was tested in other tropical and subtropical countries. Espriella (1993), verified the conditions of comfort in offices in Bocota, Colombia, Fernandes (2004), analyzed the indoor temperatures in Porto Alegre, Brazil with good results and Zhiwu (1992) showed that simulations with DEROB-LTH program indicate that the results agree well with full-scale tests of the Nanning dwellings, China. The results of the field measurement from June to September, 2009 are presented in this paper.

1.1 CHARACTERIZATION OF THE BUILDING AND THE MEASUREMENT SYSTEM

The measurement equipment was installed in the “3 de Fevereiro Residential” building as presented in Figure 1 and Figure 2.

The building was built in the 1990s. The materials used were plastered hollow concrete block walls, concrete columns, wood framed windows with single glass, wood frame external and internal doors, concrete cement ceiling, and gypsum ceiling roof and has a floor area of 378 m² spread over the floors, 3 apartments on each floor. The long axis of the building is E-W and the main facade is south oriented. This orientation is typical in Maputo Municipality.

1.1.1 Measurement Equipment

Figure 1 and Figure 2 show the measurement equipment installed on the first floor. The ground floor has the same layout of the measurement equipment as in Figure 2, but without the solar meter sensor. The equipment allows measuring the outdoor climatic data such as the global and diffuse solar radiation, wind, rainfall, temperature and humidity and indoor parameters such as temperature and humidity.

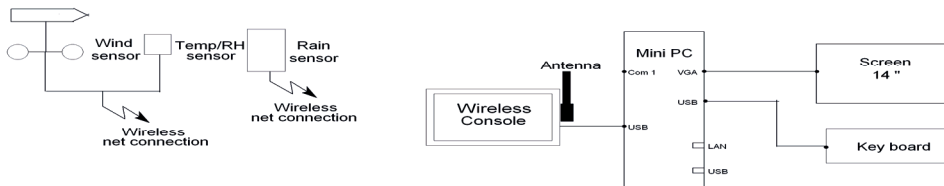

Figure 1: Weather Station system installed on the first floor.

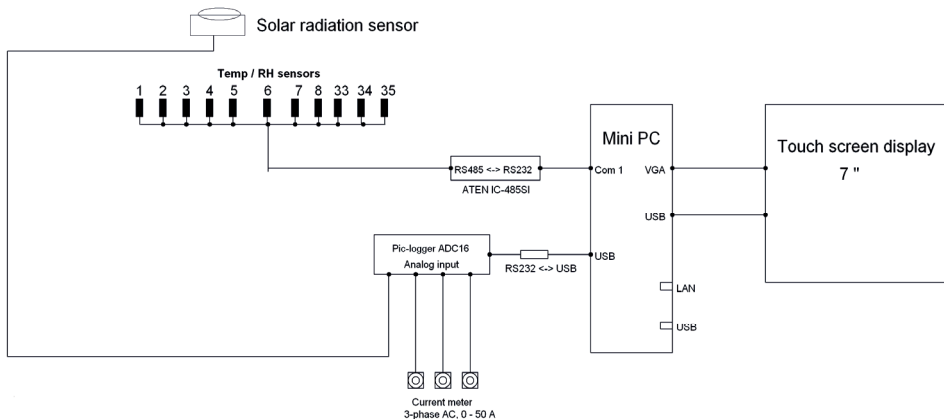

Figure 2: Measurement equipment installed on the first floor.

The East and West sides of the building are the best for analyzing the thermal loads because these are directly radiated by the sun during the morning and afternoon periods of the days respectively. But, the owner of the building (Faculty of Engineering) allowed installing the equipment in the East side. The equipment was installed at the beginning of May, 2009.

Table 1: Measured factors and measurement equipment.

Item	Measured factors	Quant. Ground floor	First floor	Sensor	Range	Accuracy
01	Global and diffuse solar radiation on horizontal surface	-	1	BF3	0 – 1250 W/m ²	Global: $\pm 5\text{W/m}^2 \pm 12\%$ Diffuse: $\pm 20\text{W/m}^2 \pm 15\%$
02	Wind speed	-	1	WMR 200	2m/s ~ 10m/s 10m/s~56 m/s	(+/- 3m/s), (+/- 10%)
03	Wind direction	-	1	WMR 200	0-360°	16 positions, approx. every 14 seconds
04	Outdoor temperature	-	1	WMR 200	-30°C to 60°C - 4°C to 140°C	+/- 1% (+/- 2%)
	Outdoor Humidity	-	1	WMR 200	25% to 90%	+/- 7%
05	Rainfall	-	1	WMR 200	0 to 999mm	+/- 7%
06	Temperature in shaded volumes	-	1	SHT75	-30°C to 60°C - 4°C to 140°C	+/- 1% (+/- 2%)
	Humidity in shaded volumes	-	1	SHT75	25% to 90%	+/- 7%
07	Inside temperature	9	11	SHT75	-30°C to 60°C - 4°C to 140°C	+/- 1% (+/- 2%)
08	Inside humidity	9	11	SHT75	25% to 90%	+/- 7%
09	Electrical current	1	1	Onset CTV-B	0 to 50 A	+/- 4.5%

2.0 MEASUREMENT RESULTS AND DISCUSSION

The field measurement results present data (outdoor climatic elements and indoor parameters) which are important for analysis of indoor thermal loads, heating and cooling and ventilation systems for providing indoor comfort. July, 2009 measurements are used as the reference month as it is the coldest one.

2.1 Solar Radiation

Figure 3 shows the variation of the global and diffuse solar radiation in July, 2009 and Figure 4 shows the monthly maximum and mean global and diffuse solar radiation from June to September, 2009.

Mozambique has two main seasons, namely hot, normally wet season from October to March and a cooler, mostly dry season from April to September. So, from April to September it is winter with June and July presenting low rates of the solar radiation and July the lowest month as indicated in Figure 4.

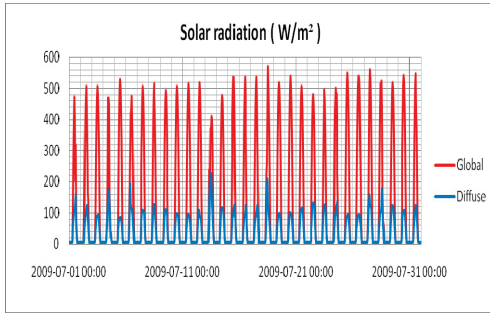

Figure 3: Global and diffuse sol. rad., July, and 2009.

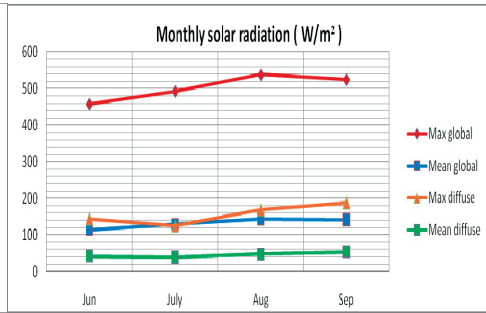

Figure 4: Monthly maximum and mean global diffuse sol. rad., June to September, 2009.

The maximum and mean solar radiation energy from June to September are presented in Table 2. The rates show that Maputo City has enough solar energy to cover the needs for hot water and heating or cooling in buildings.

Table 2: Solar radiation energy.

	Solar radiation energy (KWh/m ² /Period)		Daily solar radiation energy (KWh/m ² /day)	
	Global	Diffuse	Global	Diffuse
Max.	1,475	457	12	4
Mean	386	132	3	1

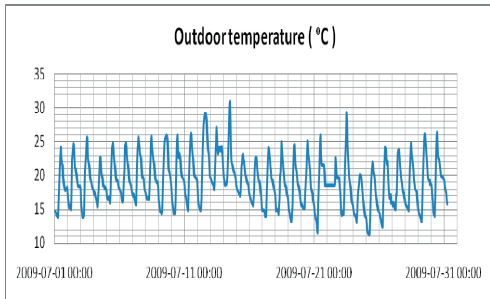

Figure 5: Outdoor temperatures of July, 2009.

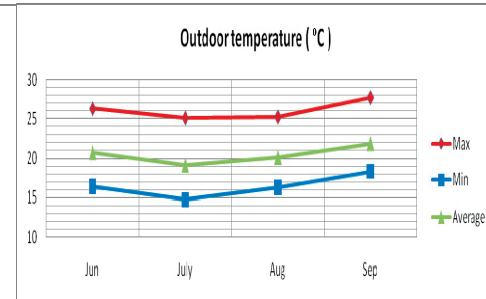

Figure 6: Max., Mean and min. outdoor temp.

2.2 Outdoor Temperature and Solar Radiation of the Coldest Day

Figure 5 presents the measured outdoor temperature in July, the coldest month in winter, 2009, with low outdoor temperature and 25th July 2009 was the day with a minimum of 11.2°C at 6:00 a.m., the lowest temperature from June to September, 2009, see Table 3.

Table 3: Maximum and minimum temperatures (monthly peak outdoor temperature).

Month	Day	Time (h)	Out. Temp. (°C)	Month	Day	Time (h)	Out. Temp. (°C)
June	23-06-09	13:00	Max. 30.3	Aug.	09-08-09	14:00	Max. 30.4
	27-06-09	07:00	Min. 11.3		09-08-09	06:00	Min. 12.9
July	14-06-09	12:00	Max. 30.3	Sep.	08-09-09	14:00	Max. 35.8
	25-07-09	06:00	Min. 11.2		13-09-09	04:00	Min. 16.1

Figure 7 shows the graph of the outdoor temperature on 25th July 2009, the coldest day in winter and Figure 8 shows the global and diffuse solar radiation on the same day. The maximum value of the global solar radiation was 527.8 W/m² and occurred at 12:00 and the diffuse was 87.2 W/m² at 13:00.

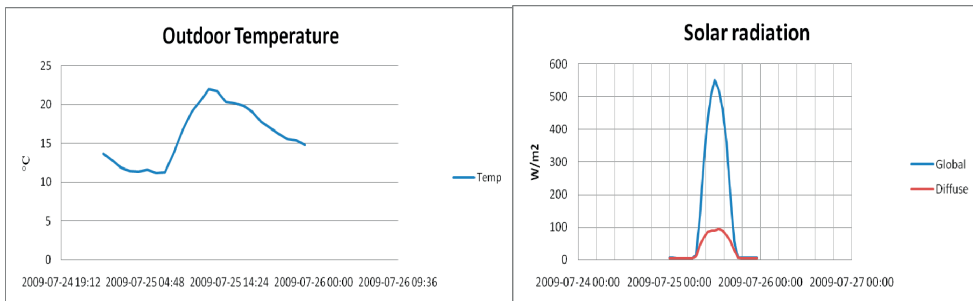

Figure 7: Outdoor temperature of the coldest day in winter, 2009.

Figure 8: Global and diffuse solar radiation in coldest day in winter, 2009.

2.3 Temperature Inside of the Building

Figure 9 shows the indoor temperature of the ground floor and Figure 10 shows the indoor temperature of the first floor. The kitchens of the apartments are located in the north side, the hottest position in terms of solar gains. The temperatures in these rooms are higher than the rooms placed in the south side of the building. In both flats, the temperatures of the living room and bed room are very similar due to the fact that the two volumes have the same location (south side), the same characteristics, the same solar radiation and the same casual gains.

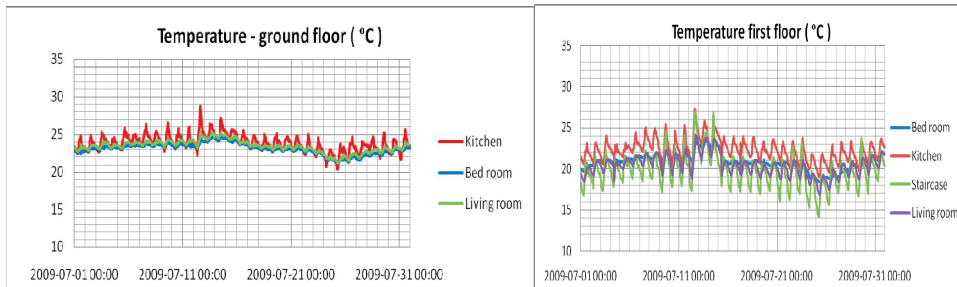

Figure 9: Indoor temperatures on the ground floor, July, 2009.

Figure 10: Indoor temperatures on the first floor July, 2009.

Table 4: Maximum, mean and minimum indoor temperatures in the apartments.

	Indoor temperatures (°C) Ground Floor				Indoor temperatures (°C) First Floor			
	June	July	Aug	Sep	June	July	Aug	Sep
Max	24.8	23.8	24.0	25.3	23.2	20.4	22.3	24.4
Mean	24.5	23.4	23.7	24.9	22.3	20.4	21.4	22.9
Min	24.2	23.0	23.3	24.4	20.4	19.2	20.4	20.4

From June to September the maximum indoor temperature on the ground floor was 25.3°C in September and the minimum on the first floor was 19.2°C in July.

2.4 Meteorological Instrument

WM200/WM200A anemometer was used to measure the wind speed and its direction around the building. This instrument was installed outside of the building in the south side. Analyzing Figure 11 related to the wind, it can be concluded that the wind is southerly.

Table 5: Maximum, mean and min. wind speed, for the months from June to September.

Wind speed (m/s)				
	June	July	Aug	Sep
Max	6.4	7.1	7.5	9.7
Mean	3.5	3.9	4.2	5.8
Min	1.0	1.2	1.6	1.5

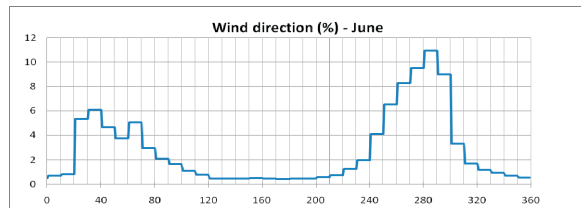

Figure 11: Wind direction in June, 2009.

2.5 Rainfall

The objective of measuring the rainfall is to provide a database of the rainfall on the site of the building. This information is useful for preventing the harmful phenomena caused by moisture in the structure of the buildings. If the quantity of rain is known; it is possible to take certain precautions for eliminating the harmful effects of the moisture caused by the rain. The rates of the rainfall from June to September are presented in Table 6.

2.6 Outdoor Relative Humidity

Figure 12 illustrates the outdoor relative humidity during July and Figure 13 represents maximum, mean and minimum outdoor humidity from June to September, 2009.

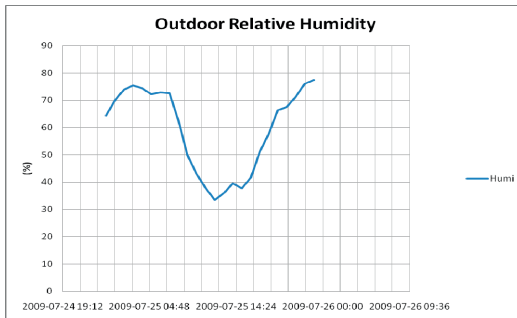

Figure 12: Relative humidity of the coldest day in winter.

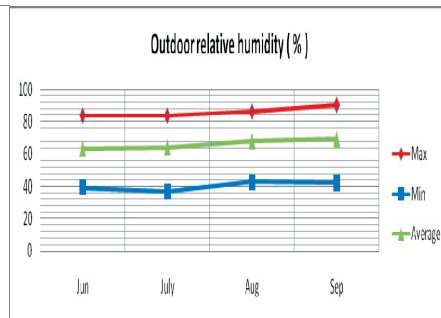

Figure 13: Maximum, mean and minimum outdoor relative humidity.

2.7 Comparison of the Site Measurements and Maputo Airport Meteorological Station Data.

Table 6 presents the data from field measurement and the outdoor data from Maputo Airport Meteorological Station for comparison.

Table 6: Data of the outdoor temperature, rainfall and relative humidity.

		Outdoor temperature (°C)			Rainfall(mm)	Relative Humidity (%)		
		Max.	Mean	Min.	-	Max.	Mean	Min.
June	Meas.	26.3	20.7	16.4	9.5	83.9	63.4	39.2
	MAMS	25.0	18.5	14.2	26	-	66	-
July	Meas.	25.1	19.1	14.7	2	83.8	64.0	36.8
	MAMS	25.0	18.2	13.9	12	-	66	-
August	Meas.	25.3	20.1	16.3	-	86.2	68.1	42.8
	MAMS	25.7	19.1	15.0	12	-	65	-
September	Meas.	27.7	21.9	18.3	-	90.3	69.5	42.4
	MAMS	28.4	20.6	16.0	35	-	65	-

Meas. = Measured and MAMS = Maputo Airport Meteorological Station.

3.0 CONCLUSIONS

The measurement equipment installed in the apartments can be considered effective and reliable as it can provide data on building parameters and the climatic weather elements which can be used for assessment of energy use in buildings as well as for testing, validation and calibration, modeling and simulation tools of building energy use.

Analyzing data from the measurement equipment it can be concluded that, it provides fair results since the comparison of these data with the one from other weather stations, such as Maputo Airport Meteorological Station presents similar trends.

Further work will consist of measuring several variables for testing the functionality of the DEROB-LTH.

1.4 ACKNOWLEDGEMENTS

The authors would like to acknowledge the financial support from Sida/SAREC, Supervisors from Division of Construction Science, Lund University and Eduardo Mondlane University.

1.5 REFERENCES

Ana Eliza Perreira Fernandes, (2004) A School in the South of Brazil In Search of Sustainability, Porto Alegre, Brazil, 2004.

Carla de la Espriella, (1993), Improving Comfort by Using Passive Design, Bocotá, Colombia.

Godfrey Boyle (2000), Renewable Energy, Power for a Sustainable Future, First published in the United Kingdom.

Orgen Scientific, User Manual, (2007), Professional Weather Center Model: WMR200/WMR 200A.

SENSIRION, The Sensor Company, (2009), Hum and Temp Sensor, Datasheet SHT71, SHT75.

Wang Zhiwu, (1992), Indoor Thermal Env. of Resid. Build. in Subtrop. Clim in China, ISRN LUTADL/TABK-92/3007-SE, 1992.

Paper II

Energy assessment methodologies and energy use in buildings – a review of selected theoretical and experimental techniques

Gabriel Auziane¹, Bertil Fredlund²

¹Faculty of Engineering, Lund University, Sweden/Fac. de Engenharia, UEM, Moçambique, gabriel.auziane@construction.lth.se

²Faculty of Engineering, Lund University, Sweden bertil.fredlund@construction.lth.se

Abstract: A great deal of energy in buildings is used in a highly inefficient manner in Mozambique. The available instruments for measuring and evaluating the quantity of energy used in buildings have not been utilized. This fact leads to failure in achieving best comfort levels and economy for occupants of buildings. In fact, the energy evaluation in houses provides information about energy used in buildings so that professionals and buyers can have exact information on how much they have to pay and how they can reduce the expenditure associated with energy use. This paper reviews theoretical, experimental and measurement techniques of energy used in buildings in order to find acceptable tools for energy assessment in buildings. In the world, there is a wide variety of models and tools for energy assessment in buildings. In this study, the most suitable tools for Mozambican climatic conditions were selected and analysed such as: the University Project, Energy Barometer, and DEROB-LTH Program. The University Project is a retrofitting method which allows energy assessment in existing buildings and, estimation of energy saving based on bill data collected in buildings. Energy Barometer predicts the energy use in buildings for house owners with means of monitoring their expenditure. Finally, DEROB-LTH is a tool to estimate the indoor thermal climate, energy for heating and cooling and comfort indices in buildings. It has been concluded that among the selected tools, DEROB-LTH is the most suitable tool for building energy assessment for the types of single- and multi-family houses under investigation in Mozambique.

Keywords: Energy efficiency in buildings, simulation tools, energy assessment, selected methods

Metodologia de avaliação de energia e uso de energia em edifícios – uma revisão de técnicas experimentais e teóricas seleccionadas

Resumo: Uma grande porção de energia em edifícios é utilizada de forma muito ineficiente em Moçambique. Os instrumentos disponíveis para medir e avaliar a quantidade de energia utilizada nos edifícios não têm sido empregados, facto que leva ao fracasso na obtenção de melhores níveis de conforto para as famílias. Na verdade, a avaliação de energia em edifícios fornece informações sobre a energia utilizada para que os profissionais e os compradores possam dispor de dados precisos sobre quanto devem pagar e como reduzir as despesas associadas ao uso de energia. Este artigo faz a revisão teórica, técnica e experimental de avaliação de energia utilizada nos edifícios a fim de encontrar ferramentas aceitáveis para a avaliação do uso de energia em edifícios. No Mundo, existem diversos modelos e ferramentas para a avaliação de energia em edifícios. Neste estudo, foram seleccionadas e analisadas as ferramentas mais adequadas para as condições climáticas de Moçambique, tais como o Projecto Universidade, Barómetro de Energia e o programa DEROB-LTH. Projecto Universidade é um método que permite a adaptação e avaliação energética em edifícios existentes e a estimativa de economia de energia com base em dados de facturas colectadas nos edifícios. Barómetro de Energia fornece previsões de uso de energia mais actualizadas para o monitoramento das despesas de energia pelos proprietários de habitações. Finalmente, DEROB-LTH é uma ferramenta para estimar a energia térmica, o aquecimento e arrefecimento, bem como os índices de conforto nos edifícios. Concluiu-se que para as ferramentas seleccionadas, DEROB-LTH é a mais adequada para a avaliação de energia nos edifícios em investigação em Moçambique.

Palavras-chave: Eficiência energética em edifícios, ferramentas de simulação, avaliação de energia, métodos seleccionados.

INTRODUCTION

The energy resources management is one of the principal challenges that both developed and underdeveloped countries confront nowadays. Moreover, energy efficiency is a critical issue for high quality use in buildings. Energy does not only represent a high percentage of the running cost of buildings, but it also has a major effect on the visual and thermal comfort to the occupants of the houses, (SANTAMOURIS, 2005).

Diverse factors have caused an increase in energy use throughout the world. Globalisation has spread the lifestyle of the developed countries worldwide, changing the expectations about the quality of life in many societies to a point where sustainability is no longer possible on large scale, (GUERRA O.; ITARD L. and VISSCHER H., 2009).

The characteristics of an energy-efficient building in cold climate countries are presented mainly as: well-insulated walls, a ventilated roof with a thick layer of insulation over the ceiling, quality windows with low-e glass, and a high-efficiency heating and cooling system, (CONSERVATION TECHNOLOGY, 2008).

In most countries of the world, the energy performance of building envelopes has been significantly neglected while there has been substantial success in improving the energy efficiency of new appliances, such as lighting, heating and cooling equipment. Many buildings are still being constructed under bad conditions, for example, have no insulation or exterior shade control, have single-glazed clear glass windows and solar-absorbing roofs in hot climates such as Mozambique. Heating and cooling account for over a third of global energy use in the building sector and optimising building envelope design should be a key part of long-term energy reduction strategy.

In the northern part of the European Union, 41% of the total final energy use comes from buildings, with 30% being used in residential buildings (ITARD, L., TOWARDS, F., 2008).

The building sector is the largest consumer of energy in the United States (US), using approximately 41% of total US energy use (INTERNATIONAL ENERGY AGENCY, 2007).

Energy efficiency is usually assessed in the building envelope, lighting and air conditioning for commercial buildings, and public services. Residential buildings are valued at building envelope, water heating systems and the equipment located in the common areas of single- and multi-family buildings, such as lighting, elevators, centrifugal pumps etc.

According to SPECHT L. P.; BORGES P. A. P.; et al, 2004, 57% of the energy used in buildings was for space heating, 25% for water heating, 11% for lighting and electrical appliances, and 7% for cooking.

In Mozambique, it is estimated that from the total average of the energy produced, 0.39% is used in commercial buildings, 4% in industry and 72% in residential buildings, (MOZAMBIQUE ENERGY INDUSTRY BUSINESS OPPORTUNITIES, 1999).

The survey carried out by the author in 2009, reviewed all years within the work inherent to Monitoring Energy Use in Buildings in Maputo City, aimed at studying the energy use in buildings and to characterize the thermal parameters which influence the indoor environment,

showed that the highest use of energy occurs in the cooling system (25%), followed by the water heater (22%) and lighting (15%).

Due to the importance of good quality of the indoor environment and the problems caused by high energy use, many countries have enacted a series of policies and regulations aimed at increasing the energy efficiency of dwellings and ensuring a good indoor environment, (GUERRA O.; ITARD L, and VISSCHER H., 2010).

Generally, among appliances, the energy used for lighting, cooking and cooling represents a great part of the energy used in buildings and the issue of energy efficiency in buildings is completely ignored in Mozambique.

The impact of the building's thermal characteristics on space heating demand has been well studied, quantified and validated from viewpoint of individual buildings and building simulation, (CLARKE J. A., 2001).

Studies in development of energy technology make it possible to significantly reduce energy used in buildings, create housings that are more comfortable and decrease carbon emissions to the environment, (MCMULLAN, 2002).

Specialized and accredited professionals provide information on energy use in buildings by performing energy rating through standard measurements and carrying out specific experimental protocols. Moreover, it is possible for potential buyers and energy users to have exact information of the energy bills. Thus, the owners of the buildings may have to identify specific costs of effective improvement of energy efficiency, (SANTAMOURIS, 2001).

Energy demand has increased in Mozambique; therefore, measures are now being taken to cope with the demands through introducing new power generation, implementing new electrical transport infrastructures and studies in efficient energy use in buildings, (INE, 2005).

However, these activities are not going to guarantee enough energy production unless efficient strategies are put in place and properly implemented. Thus, the Mozambican government has defined energy efficiency in its strategy for science and technology as one of the major key areas to be addressed. The strategy includes; energy efficiency and energy conservation research in buildings and production of construction materials with reduced energy requirements.

Recent development in energy efficiency studies and its technology in the world enabled; firstly, the significant reduction of energy use in buildings; secondly, the creation of more comfortable housing and finally, the reduction of carbon emissions to the environment, (BOYLE, 2000).

In order to assess energy use in buildings, University Projects (UP), Energy Barometer (EB) and DEROB-LTH, which stands for dynamic energy response of buildings-Lunds Tekniska Högskola, methods were selected. These methods were seen as appropriate in solving the problems of high indoor temperatures during summer. This season represents a period of great demand of energy for cooling the houses in tropical countries. The analysis of the methods presented in this paper shows that they can be successfully applied in Mozambique for energy rating of buildings.

After analysing the three methods, it was seen that the University Project methods are suitable for analysis of energy saving either before or after retrofitting buildings. Energy Barometer is useful for getting information of the energy used in buildings and can give the buyers data of the energy bills. DEROB-LTH program is a simulation tool of the energy use in buildings considering the influence of solar insolation, shading devices on energy balance and investigation of thermal mass of the buildings on cooling demands.

Huge quantity of energy in buildings is used in a highly inefficient manner in Mozambique. The obstacles for the use of home energy rating systems in Mozambique are presented below:

- Lack of knowledge and training of building managers, builders and engineers;
- Lack of specialized professionals to perform energy audits and ratings in buildings;
- Lack of owners' awareness of energy efficiency benefits;
- Relative high cost of home energy rating systems;
- Lack of energy use data from housings;
- Lack of builders' incentives and motivation from the government;
- Lack of proven energy efficient products and system solutions adapted to the climate in Mozambique.

In Mozambique, professionals such as: architects, engineers and constructors do not implement instruments for assessing energy during designing, construction, and exploration stage. Thus, this study, searches to attain tools and methodologies for evaluating energy used in buildings in these stages for providing best indoor climatic conditions for dwellers.

METHODS

Some available methods

Energy assessment in buildings has attained a high level in many European and American countries and low level in sub-tropical and tropical countries. The recent view of energy efficiency in buildings is expected to enforce energy studies in order to prepare local methodologies in sub-tropical and tropical countries, in the Southern European countries and particularly in both subtropical and tropical countries such as Mozambique.

The Swedish government has introduced a financial support through instalments and subsidies for energy-saving measures within the building stock. The aim was to stimulate the use of energy efficient equipment and reduce energy use for indoor heating. The specific goal was to reduce the gross energy use for heating in residential buildings, (WESTERGREN, 2000).

The energy assessment in both the USA and UK has been used since the 80s. The Home Energy Rating System program (HERS) started in five pilot states, namely: Alaska, Arkansas, California, Vermont and Virginia. Today many states in the USA have adopted the (HERS) version or its equivalent for building energy assessment. However, only 2% of new houses receive energy rating in the USA recently, and most are essential programs with tax payer subsidies, (SANTAMOURIS, 2005).

In the UK, the Building Research Establishment (BRE) performed hundreds of energy audits in residential buildings through which it was then possible to develop the Domestic Energy Model (BREDEM), in the 1980s and 1990s. (SANTAMOURIS, 2005).

In Denmark, studies about energy efficiency have been developed in commercial buildings since 1992 and were extended to residential buildings in 1993, (SANTAMOURIS, 2005).

The National Irish Centre for Energy Rating (NICER) created the Energy Rating Bench Mark (ERBM) in 1992 to deal with energy use in existing buildings, (SANTAMORIS, 2001).

In Sweden, in the 70s, the simplified BKL METHOD to predict energy use in buildings was developed by Kurt Källblad and Bo Adamson, (KÄLLBLAD; ADAMSON, 1978).

The University projects 1 and 2 were developed in Stockholm, Sweden in 1980. These methods were introduced together with the Swedish government decision on financial support for energy-saving measurement programs in existing buildings. The objective was to stimulate the use of efficient methods for reducing energy to the buildings heating systems, (SANTAMOURIS, 2005).

The Energy Barometer method was developed in Stockholm, Sweden, in the 1970s. This method consists of monitoring the development of building energy use through measuring energy and climatic conditions in the houses. The data collected in the measurement was divided into two parts: the first, aimed at providing wider public information on the latest use of energy and to predict energy use of the dwellings, and the second, aimed mainly at providing individual house owners with means of monitoring their energy bills, (WESTERGREN, 2000).

The DEROB program from University of Texas, USA, developed by Arumi-Noa (1979) has been used in many countries and presented in many versions, one of which is DEROB-LTH, adopted by Department of Building Science at Lund University, (MANUAL, 1984).

In Spain, Energy assessment system has been developed to classify new residential buildings, (SANTAMOURIS, 2005).

Finally, in Netherlands, energy rating in buildings was developed in the 90s, with target to social housing, (SANTAMOURIS, 2005).

In general, the University Projects, Energy Barometer and DEROB-LTH are tools for assessing energy used in buildings. The University Project is used for measuring energy-saving in the existing building stock, simulates efficient energy use in order to reduce energy for heating and to assess the characteristics of the building stock, the Energy Barometer is applied for measuring run time oil, pulses for oil burn, outdoor and indoor temperature, district heating and electricity energy used in buildings. The DEROB-LTH is the tool which presents the building geometries, draws the diagrams for space temperatures, heating and cooling demands, solar parameters and diagrams for comfort indices such as Predicted Mean Votes (PMV) and Predicted Percentage of Dissatisfied (PPD) for each volumes, peak loads, energy demands, and thermal loads.

Examined methods of energy assessment in buildings

As presented in the previous chapter, there are a lot of methods for assessing energy use in buildings; this paper only focuses on three of them which are suitable for Mozambican

climatic conditions. The criteria considered to focus on the three methods were the opportunities of receiving training and financial support for its implementation in Mozambique.

The University Projects

The University projects are retrofitting methods adopted in order to assess the characteristics of the existing buildings and to estimate energy savings on the basis of collecting data of the energy bills and inspections of the buildings and its installations.

The principal steps followed in the University Project 1 and 2 were: collection of the energy used from bills before and after retrofitting, normalization of the energy used according to the variations of temperature over the years. The calculation methods are based on degree-hours and seasonal variations of the outdoor temperature among the climatic factors, such as: temperature, solar radiation, wind, snow, long wave radiation and moisture, which influence the heat balance of the buildings. The outdoor temperature data from existing weather stations in Swedish territory was considered the most important factor.

The University Project 2 (UP2) was applied as a continuation of University Project 1 (UP1) with the objective to introduce some improvements related to the accuracy of the results where the UP1 was considered weak.

The most important results obtained within these methods show that the energy conservation measures presented statistical established savings in many cases. The measured thrifths agree with the theoretically predicted savings, (SANTAMOURIS, 2005).

The summary of the factors used for energy assessment and comments on advantages and disadvantages of the methods is presented in Table 1, below.

Table 1: Summary of the University Project Methods

Name	The University Projects	
Factors used for calculation	Outdoor temperature	From weather station
	Indoor temperature	Assumed 21°C
	Internal gains	Assumed values
	Electricity Power	Assumed values
Advantages	<ul style="list-style-type: none"> In most cases, the measured savings agreed with the theoretically predicted economies. 	
Disadvantages	<ul style="list-style-type: none"> It is not possible to evaluate the values of energy used by appliances. So, it is necessary to assume some values for these equipments. 	

The Energy Barometer

Likewise, the University Project 1 and 2, the Energy Barometer method was developed in Stockholm, Sweden, with the aim to measure energy use in different types of single-family houses during the winter and summer. EB was designed to make a foundation for analysis and energy assessment for heating and cooling indoor environment.

The information from Energy Barometer method was divided into two parts. The first part was aimed at a public level by supplying latest estimates and predicting energy use. These estimates were based on a representative statistical sample from a selected population. The second part was aimed at providing individual house owners with means of monitoring their energy cost. So, the dwellers connected with this system can manage their own energy cost and they can observe what happens in relation to other people associated to the same system.

Westergren; Högberg and Norlén, 1998, described the static and dynamic energy balances and presented the background and calculation methods considering the different periods of the year, when the buildings are heated and other periods when the buildings are not heated.

NORLÉN, 1985, concluded that the Energy Barometer system gives a solution to various problems of obtaining timely and reliable estimates of energy use in buildings.

(SANTAMOURIS, 2005), described the details and specifications of the measurement equipment used in this method such as presented in Table 2.

Table 2: Summary of Energy Barometer.

Name	Energy Barometer	
Factors Measured	Run time-oil	Sensor/electromagnetic sound
	output of pulses for oil burn	Flow meter
	Outdoor temperature	Temperature sensor
	Indoor temperature	Temperature Sensor
	District heating	Integration meter
Advantages	Electricity energy	Kilowatt meter
	<ul style="list-style-type: none"> • The use of the Energy Barometer project seems to be the most appropriate for the currently developed method. The use of the internet and the modem to collect the data is the most promising technology available for developing an accurate method with reasonable exploitation costs. 	
	<ul style="list-style-type: none"> • Provides latest estimates and predicts energy use in buildings. 	
	<ul style="list-style-type: none"> • Provides individual house owners with means of monitoring their energy cost budgets. 	
<ul style="list-style-type: none"> • Provides possibility to measure electrical energy used by 		

	household appliances and heating systems, including heating from tap water.
Disadvantages	<ul style="list-style-type: none"> • The accuracy of the results depends on the quality of the sensors used in the installation for measuring various types of energy used in buildings. • The sensitiveness of the sensors can influence the results.

The sub-project of the Energy Barometer, the 'Virtual Housing Laboratory' (VHL) was the first application of this method, this was a system for simulating total energy use in the examined houses and it was based on a sample with very detailed data from the buildings and latest climatic data from the nearest weather station.

This system presents a lot of advantages, once in the houses, facilities can be used without the need of cables, and it allows the collection of the data using the communication nets. This system also allows operations and maintenance to be done remotely, thus, saving on transport costs.

The details and specifications of the measurement equipment used in this subproject are presented in Table 3.

Table 3: Summary of Energy Barometer (VHL)

Name	The Energy Barometer	
Inputs	Building description and environmental data	Walls, roofs, floors, openings Orientation, shading screen Ventilation, infiltration Direct solar radiation on horizontal surface
	Weather data	Diffuse solar radiation on horizontal surface Sky temperature Air temperature
Results	Total energy use	

DEROB-LTH Program

DEROB-LTH is an acronym for Dynamic Energy Response of Buildings and detailed energy simulation program tool, originally developed at Austin School of Architecture, University of Texas, in the USA and later developed at the Department of Construction and Architecture, in Lund University. The improvement made in the Department of Construction and Architecture in Lund turned DEROB-LTH v1.0 into DEROB-LTH v2.0 and some updates are made annually.

The users consider this program as simple because it does not require detailed knowledge in mathematics and thermal physics. However, it requires some thermal model understanding and the dependency between building design and performance parameters.

It is an accurate model to calculate the influence of solar insolation and shading devices on energy balance in the buildings. “The buildings are modelled in 3-D, a necessary condition for accurate calculations of the distribution of solar insolation and temperatures in the rooms and its surfaces”, (KÄLLBLAD, 1993).

For simulation, two general types of input data are required; first, the building description data and second, the environmental data. The building description data includes the geometry of the space, which defines thermal active and inactive building elements and the environment data which includes the natural environment, consisting of sunlight and heat, the weather, wind, plants, animals, and social environment of the humanity community.

A lot of research programs have been done using DEROB-LTH program and appeared to be the best tool for analysis of the indoor thermal environment.

Table 4: Summary of the DEROB-LTH Program.

Name	DEROB-LTH PROGRAM	
Inputs	Building description environmental data weather data	Walls, roofs, floors, openings orientation, shading screen Ventilation, infiltration, heating, cooling and free heating direct solar radiation on horizontal surface diffuse solar radiation on horizontal surface sky and ambient air temperature
Results	Drawings of the building geometry Diagrams for space temperatures Space heating and cooling demand and solar parameters Diagrams for comfort indices PMV and PPD for each space.	
Advantages	<ul style="list-style-type: none"> This tool evaluate energy use of the rooms with specific geometries, buildings with 8 volumes and several zones and can be used to calculate peak loads, energy demand, temperatures and thermal comfort in the buildings. 	
Disadvantages	<ul style="list-style-type: none"> Humidity is not simulated 	

RESULTS

In this section, it is presented the results from the literature, related to the three methods described above for assessing energy-saving in buildings.

University Projects

The experimental and predicted evaluation of energy conservation measures on statistically selected objects within the Swedish building stock in approximately 300 single- and multi-family houses in seven municipalities and predicted values based on simulations using University project tool are presented in Table 1.4 (correspondence between measured and theoretical predicted savings), (see M. SANTAMOURIS, 2005).

Energy Barometer

The results from Energy Barometer tool are presented in Table 2 by WESTERGREN K_E.; HÖGBERG and NORLÉN U., 1996, the work was based on motoring the development of building energy use via continuous energy and climatic measurements in a random sample of houses and reporting changes of building energy use in a short time span. The technical solution was tested by (LINDFORS A. and LILJESTRALE M., 1998).

DEROB-LTH Program

The results of the simulation for the base case show that the annual heating energy demand and the heating load are in agreement with data measured in single-family housing in Canada and Quebec, (SAUCIER JEAN-PHILIPPE; DUBOIS MARIE-CLAUDE, 2009).

(Zhiwu, 1983), in her study about the “Indoor Thermal Environment of Residential Buildings in Subtropical Climates in China”, showed that the simulations results are in good agreement with field measurements and the deviation of mean indoor air temperature is less than 1°C, maximum temperatures 2°C and the deviation of surface temperature is 1°C.

The simulation results from DEROB-LTH deliver the space-heating demand and the hourly load of the heating system, (WALL M., 2006).

The simulation of the described reference houses with the program DEROB-LTH, gave the resulting space-heating demand in the Stockholm climate great agreement with measurement, (KVIST H., 2005).

DISCUSSION

Comparison of the selected methods

Table 5, shows the summary of the selected methods and the comparisons made to find out the best method for retrofitting, assessing, simulating and evaluating the number of climatic factors which can be measured.

Table 5: Summary of the methods selected.

Methods		The University Projects	The Energy Barometer	DEROB-LTH Program
Retrofitting		G	F	F
Assessment		F	G	G
Simulation		–	F	G
Items	Factors	Results		
01	Global solar radiation in horizontal surface	FM	FM	FM
02	Diffuse solar radiation	NM	NM	FM
03	Solar radiation in vertical surface	NM	NM	FS
04	Outdoor temperature	FM	FM	FM
05	Wind speed	FM	NM	FM
06	Relative humidity	NM	NM	NS
	Surface heat flux	NM	NM	FS
07	Air change	NM	M	FS
08	Indoor temperature	FM	FM	FS
09	Internal gains	NM	FM	FS
10	Electrical energy	FM	FM	FS
11	Air pressure	FM	FM	FS
12	Long wave radiation	FM	NM	FS
13	Moisture	FM	FS	NS

Note: F= Fair, G = Good, FM = Factors measured, NM = Factors not measured, FS = Factors simulated, NS = Factors not simulated, M = Factors measured.

The energy assessment in houses has attained a high level in many European and American countries and low level in non-cooling countries. The recent view in energy efficiency in buildings is expected to enforce the studies on national methodologies of energy efficiency in the Southern European countries and in non-cooling countries, particularly in both subtropical and tropical countries such as Mozambique.

There are various theoretical, methodological and technical instruments dealing with estimations and prediction of energy used in buildings. Some are based on calculation methods and others are using software tools. In this paper, instruments which could be used to assess energy used in buildings were selected. The selection was focused on the methods and software tools which could be usable to assess energy efficiency in residential buildings of both subtropical and tropical countries such as University Project, Energy Barometer and DEROB-LTH Program.

According to ELMROTH A.; HJALMARSSON C., et al., 1989, within the University projects, the most important results were: (a) in most cases, energy conservation measures gave statistical established savings, however, savings were reduced, (b) for most cases, the measured savings agreed with the theoretically predicted savings, (c) energy savings of heat pump installations in single-family houses were 40-60% of pre-retrofit energy. The results showed the savings in relation to energy used of the measured and predicted values.

Based on Energy Barometer, the energy used and indoor temperature were observed in four occupied houses. The period of observation was in cold weather with an indoor-outdoor temperature difference of about 20°C and a moderate solar radiation. From the observation it was seen that the static and dynamic models gave similar estimates of total energy use for heating and small standard deviations occurred with dynamic model. The results were experimental and there were monitored only four houses for a limited period of time and this model can give representative variations in climate with long period of observations, (K-E WESTERGRÉN, H. HÖGBERG and U. NORLÉN, 1996).

DEROB-LTH program is a dynamic building energy simulation software for calculation of heating/cooling demands, peak loads, indoor temperature, etc. It comprises very detailed windows and solar radiation models and is therefore very well suited for building with large glazing areas. DEROB-LTH has been used with success for simulation of passive houses, (STEPHAN A.; MYTTENAERE K., 2011).

These methods were developed and tested in cooling countries but the theoretical analyses carried out in this study; indicate that they can be well implemented in subtropical and tropical countries and it is a good contribution to the scientific field of energy efficiency in Mozambique.

CONCLUSION

From the methods of experimental techniques and energy characterization of buildings presented in this study, it was concluded that, following the features of the buildings in Maputo City, the selected experimental methods bring the basis for energy assessment in buildings. The best method to analyse the energy, thermal and visual environment in buildings is through simulation. Thus, analysing the results presented in Table 5, it was concluded that, DEROB-LTH Program is the most appropriate tool in analysing the energy use, heating and cooling, peak loads for heating and cooling, thermal and visual comfort. So, in our future studies, we will focus on evaluation and improvement of indoor climate in Maputo City through the use of DEROB-LTH Program.

ACKNOWLEDGEMENT

The research presented in this study, has received financial support from ASDI/SAREC, Swedish International Development Cooperation Agency and Swedish Agency for Research Cooperation with Developing Countries, Department of Construction Science of Lund University and Eduardo Mondlane University.

REFERENCES

SANTAMOURIS, M. *Energy Performance of Residential Buildings: a practical guide for energy rating and efficiency*, James & James/Earthscan, London, NW1 OJH, UK, 2005.

GUERRA O.; ITARD L. and VISSCHER H., The effect of occupancy and building characteristics on energy use for space and water heating in Dutch residential stock, 2010.

CONSERVATION TECHNOLOGY, 2008. Available in:
http://www.conservationtechnology.com/building_design.html

ITARD, L., TOWARDS, F., Comparing European residential building stocks: performance, renovation and policy opportunities, 2008.

INTERNATIONAL ENERGY AGENCY, 2007. Available in:
http://www.iea.org/publications/freepublications/publication/NAM_Building_Stock.pdf

SPECHT L. P.; BORGES P. A. P.; et al, Heat transfer analysis in walls composed by different materials, 2010.

MOZAMBIQUE ENERGY I. BUSINESS OPPORTUNITIES, 1999. Available in:
<http://www.tipmoz.com/library/resources/documents/usinvestorconference/byexpertinenergy.pdf>

GUERRA O.; ITARD L, and VISSCHER H., Occupant's behaviour: determinants and effects on residential heating consumption, 2010.

CLARKE J. A., *Energy Simulation in Building design*, 2nd Edition, 2001.

MCMULLAN, R. *Environmental Science in Buildings*, Fifth Edition, Macmillan Press Lda, ISBN 0-333-9477-1, London, W1T 4LP, 2002.

SANTAMOURIS, M. *Final Report of the EUROCLASS project, SAVE program, Euro Commission Directorate General for Transport and Energy, Brussels, Proceedings of Conference on Optimization of Heating Consumption, Prague, Swedish Institute for Building Research, Gävle*", 2001.

INE. *Instituto Nacional de Energia-Regulamento Nacional de Energia*, Maputo, 2005.

BOYLE, G. *Renewable Energy, Power for a Sustainable Future*, First published in the United Kingdom, 2000.

WESTERGREN, E. *Estimation of energy need for heating in single-family house, R&D-report No. 3, R&D committee*, Royal Institute of Technology, Stockholm, 2000.

KÄLLBLAD, K. and ADAMSON, B. *A Simplified Method to predict energy consumption in buildings*, Swedish Council for Building Research, Lund University, Sweden, 1984.

MANUAL of derob-lth, version 2.0, ebd - lth, se, 1984.

WESTERGREN, E. HÖGBERG H. and NORLÉN U. *Monitoring energy consumption in single family house, and Buildings*, 1998.

NORLÉN, U. *Monitoring energy consumption in the Swedish building Stock Proceedings Institute for Building Research, Gävle*, 1985.

KÄLLBLAD, K. *DEROB-LTH, User Manual*, ISSN 1103-4467, Department of Building Science, Lund Institute of Technology, Lund University, Sweden, 1993.

WESTERGREN K_E.; HÖGBERG and NORLÉN U., *The Energy Barometer – A new system for monitoring energy use in the housing stock*, 1996. Available in: <http://www.irbnet.de/daten/iconda/CIB8727.pdf>

LINDFORS A. and LILJESTRALE M., Lindfors A, Westergren K-E and Lilliestrale M C J (1998) 'An Internet-based system suitable for European-wide monitoring of building energy end use', *Proc. EPIC '98*, Lyon, pp606-11. 1998.

SAUCIER JEAN-PHILIPPE; DUBOIS MARIE-CLAUDE, *Retrofit of Bungalow Houses in Quebec to Improve Energy Efficiency and thermal Comfort*, PLEA2009.

ZHIWU, W. *Indoor Thermal Environment of Residential Buildings, in Subtropical Climates in China*, ISSN0281-6318, ISRN LUTADL/TABK-92/3007-SE

WALL M., *Enhanced energy conservation in houses through high performance design*, (2006).

KVIST H., *DEROB-LTH for Windows, User Manual*, Report No. TABK—95/7019, Lund Institute of Technology, Department of Building Science, Lund University, Lund, Sweden, 2005.

ELMROTH A.; HJALMARSSON C., et al., *1 Energy performance of Residential Buildings* 989

K-E WESTERGREN; H. HÖGBERG and U. NORLÉN, *Energy Performance of residential Buildings: A practical guide for energy rating and efficiency*, 1996.

STEPHAN A.; MYTTENAERE K., *Implementing adapted Passive House standards in public buildings, retrofitting of a university building in Brussels*, Belgium, 2011.

Paper III

Improvement of residential electrical energy use in Mozambique

Case study: “3 DE FEVEREIRO RESIDENTIAL”

Gabriel Auziane¹ and Bertil Fredlund

¹Lund University, Faculty of Engineering LTH, Sweden and Eduardo Mondlane University UEM, Mozambique, gabriel.auziane@construction.lth.se

ABSTRACT

The use of electrical energy in residential buildings in Mozambique is high, and the cost for electricity is considered to be high by householders in Mozambique. This paper focuses on assessing and improving energy use in the “3 de Fevereiro Residential” building in Maputo City. The studied building was built in the 1990s and consists of 6 apartments. This type of residential building represents most of the housing stock in Maputo City and can serve as a benchmark for studying resident’s lifestyle pattern and energy use data. The main aim of this paper is to evaluate the electrical energy use, energy costs and models for reducing the energy use in the building. The results from this work are also useful for building energy simulation tools because these types of simulation tools require internal loads as input data in the calculation. By analysing electricity used and its costs, it was concluded that if the households would use energy saving light bulbs and energy efficient white goods devices it would be possible to reduce the costs for electricity by 24%.

Keywords

Energy efficiency, energy use, domestic appliances, electrical energy savings

1 Introduction

Ever since the days of the 1973 fuel crisis, the cost for energy has been increasing. As in other parts of the world, the dwellers in Mozambique have experienced electricity bills showing increasing amounts.

This study deals with the need to improve energy use in dwellings and to promote the use of efficient appliances in residential buildings. The survey was carried out in 2009, within the program “Advancing Sustainable Construction in Mozambique” (ASCoM) in Maputo City, which aimed at studying the energy use in buildings and characterizing the thermal parameters which influence the indoor environment. As known, the tendency of energy use in buildings in the world, and particularly in Mozambique, is increasing and it will increase further in the coming years. In Mozambique, the rate of electricity demand is estimated to increase at an average annual rate around 7-8% per year [1].

For implementing this study, “3 de Fevereiro Residential” building, located at 25° 57' S and 32° 35' E [2], was selected as Case Study for evaluation of internal and external electricity end uses (loads). This building is typical of the building stock in the urban zone of Maputo City and other cities in Mozambique.

In general, the improvements of energy use in residential buildings, according to [3], “...typically include some combination of air sealing, insulation, lighting efficiency measures, window replacement or enhancement, duct sealing, furnace or heat pump replacement, water heater replacement, air conditioner replacement, solar thermal water heating, etc. ... Onsite renewable energy generation (e.g., solar photovoltaic and hot water systems, small scale wind mills) is also within the realm of ‘home energy improvements’”.

According to [4], in the world about 60% of the electrical energy is used in residential and commercial buildings. So, the main focus of this paper is, assessment of the impact of the internal loads in order to improve the electrical energy use and reduce the exploitation costs in residential buildings.

2 Description of the reference building

As mentioned in the introduction, “3 de Fevereiro Residential” building, Figure 2.1, was selected for this study. It was found that there were no drawings available of the building. The first step of the survey was thus to perform measurements from which drawings could be produced, which were then used in the design of the measurement equipment.

Measurement equipment was installed in two apartments. In this paper, the details of that measurement equipment is not considered since the main objective of the work is to study the electricity consumption in the building whereas the measurement equipment was for measuring microclimate factors, indoor and outdoor temperature and humidity in the building, as can be seen in [2]. The equipment however also included measurement of the use of electrical energy which is of interest for this study.



Figure 2.1: 3 de Fevereiro residential.

The characterization of the building and the areas of the compartments are presented in Table 2.1. Analysis done on site indicated that the best side for studying thermal and internal loads in this residential is the side located at its east end which is out of shading, whereas near of the west side there are trees which shade the wall. The first floor of the selected side is always occupied by 2 persons, unlike the other apartment on the east side which is rented for short time by researchers from abroad staying there for short periods. Consequently, the measurement equipment was installed in apartments C and F, on the ground and first floors of the east side of the building.

Table 2.1: Characterization of the “3 de Fevereiro Residential”.

Apartments	Floor	Position	Number of residents	Living area [m²]
A	Ground	West	*	91
B	Ground	Middle	2 adults + 1child	91
C	Ground	East	*	84
D	First	West	*	90
E	First	Middle	*	90
F	First	East	2 adults	83

*Apartments with no permanent tenants.

3 Energy use in the building

In order to get information about the appliances in the apartments, an energy audit was conducted to collect technical data generally indicated on the nameplate of the equipment, such as power, voltage, current, frequency and power factor in case of alternating current, and efficiency and speed (RPM) for electric engines.

The main data needed for determining the energy used by an appliance is the electric power, which can be obtained from the nameplate. If the power is missing on the equipment, it can be evaluated according to equation 3.1 for direct current.

$$P = U \cdot I \quad (3.1)$$

For alternating current equation 3.2 is used.

$$P = U \cdot I \cdot \cos \theta \quad (3.2)$$

where

$$P = \text{Power [W]}$$

$$U = \text{Voltage [V]}$$

$$I = \text{Current [A]}$$

$$\cos \theta = \text{Power factor}$$

The residential is equipped with single phase electrical loads whose power can be estimated using the formulae above. In the case of system with three phases, equation (3.2) is modified into:

$$P = \sqrt{3} \cdot U \cdot I \cdot \cos \theta \quad (3.3)$$

The electrical energy used per year by one type of appliance is evaluated by multiplying the power rating of the appliance with the number of such appliances, their daily duty cycle (DDC, hours of use per day) and the number of days per year. Table 3.1 gives an example of the electrical energy used by a spotlight.

Table 3.1: Example of evaluation of the total energy use per year.

Type of load	Number of units, n	Power, P [Watt/unit]	Daily duty cycle, DDC [Hours/day]	Number of days per year [Days/year]	Factor	Total energy per year, E [kWh/year]
Lighting	1	36	5	365	1000	65.7

Table 3.2 shows data for the appliances installed in flat F. During the work, the lack of nameplate was observed for some appliances. In these cases a voltmeter and clamp meter were used to measure the voltage and current and with the use of equations 3.1–3.2 the respective electrical power was calculated. These items are marked with an asterisk in Table 3.2. The daily duty cycle (DDC) values were based on references [5, 6, 7], correlated with the results from interviews with the people living in the building and others in the district around.

Table 3.2: Equipment in flat F.

Living room				Bedroom			
	<i>n</i>	<i>P</i> [W]	<i>DDC</i> [h/day]		<i>n</i>	<i>P</i> [W]	<i>DDC</i> [h/day]
Fluorescent lamp	1	36	5	Incandescent lamp	5	40	5
Incandescent lamp	4	40	5	AC (9000 BTU/h)	1	1250	8
Pedestal fan	1	120	4	Clock radio	1	5	24
DVD player	1	75	1.71	Laundry	<i>n</i>	<i>P</i> [W]	<i>DDC</i>
Meas. Equip. System	1	26	24	Fluorescent lamp	1	18	5
Mini-computer	1	90	3	Iron*	1	1250	1
TV 18"	1	70	5	Washing machine	1	1000	0.71
Cable TV decoder	1	10	8	Boiler h. water 60 L	1	1500	6
Kitchen				Bathroom			
	<i>n</i>	<i>P</i> [W]	<i>DDC</i> [h/day]		<i>n</i>	<i>P</i> [W]	<i>DDC</i> [h/day]
Fluorescent lamp	1	36	5	Fluorescent lamp	2	18	5
Mixer*	1	120	0.5	Electric shaver	1	10	0.08
Electric barbecue*	1	3800	0.006	Flat iron straight.*	1	65	0.006
Juicer	1	65	0.17	Hair dryer	1	600	0.25
Stove (2 plates)*	1	3500	0.03	Exterior lighting	<i>n</i>	<i>P</i> [W]	<i>DDC</i> [h/day]
Stove (small resist.)	1	800	0.06	Fluorescent lamp	2	18	11
Refrigerator (1 door(90/3))	1	90	10	-	-	-	-

Table 3.3 shows the calculated energy consumption of the appliances in apartment F. External lighting was estimated separately since it does not affect the heat balance of the apartment in study. The separation thus gives the possibility of using internal loads as input in modelling and simulation tools. The equivalent energy for liquefied petroleum gas (LPG) was estimated based on one cylinder of 11 kg, which is the amount used in the apartment per month.

Table 3.3: Annual electrical and gas energy use in flat F.

Electricity [kWh/year]				Gas [kWh/year]	Total [kWh/year]
Lighting		Other appliances	Total electricity		
Internal	External				
887	145	4 828	5860	579	6 439

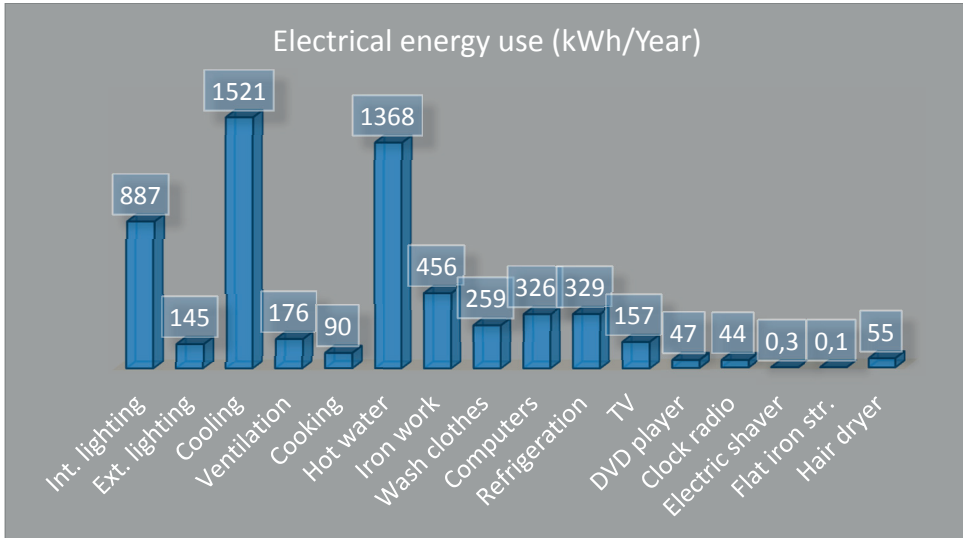

Figure 3.1. Breakdown of electrical energy use per year by end use in apartment F.

Figure 3.1 shows the breakdown of electrical energy use per year by end-use in apartment F. As can be seen in Figure 3.1, the air conditioning system, the hot water system and internal lighting are the main electricity consumers. One of the loads that could be expected to be bigger is electrical energy used for the stove for cooking. The dwellers, however, consider it expensive using electricity for cooking, so they prefer using gas (LPG) or natural gas (CNG) instead of electricity. The LPG equivalent energy use is also presented in Table 3.3. Thus, the electrical energy for cooking presented here represents the energy used for the kettle and occasional use of the stove.

Regarding the use of energy for cooking, in the peripheral zones of Maputo City and countryside, a lot of people use charcoal and dry wood for cooking instead of electricity and gas. This is corroborated by [1] who refers that the principal energy source for the majority of Mozambicans is biomass, particularly wood fuel (dry wood and charcoal), coming from an estimated 30.6 million hectares of forests which represents 80 percent of the energy used by households in Mozambique.

Figure 3.2 shows the data from Figure 3.1 as the percentage of the total electrical energy use in the apartment studied. It is obvious once again that the highest use of energy occurs in the cooling system (26%), followed by the water heater (23%) and interior lighting (15%). The computer's electricity consumption (6%) is higher in this apartment, because of the mini-computer used for the measurement equipment system which is working around the clock.

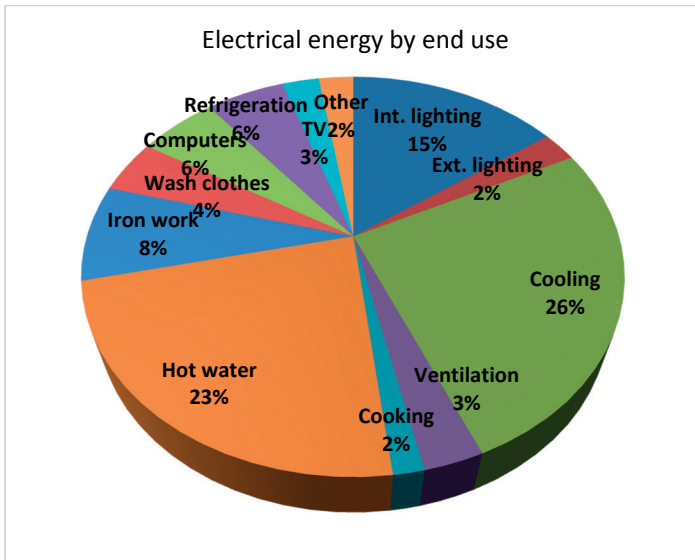

Figure 3.2: Percentage of electrical energy use per year by end use in apartment F.

The electricity use in apartments C and F was also measured. Figure 3.3 presents the measured electricity use during a month for flat C. As can be seen in Figure 3.3, from 2009-06-01 up to 2009-06-25 the apartment was unoccupied and the electricity consumption recorded was related to entrance and facade lighting and the power for supplying the measurement equipment's mini-computer.

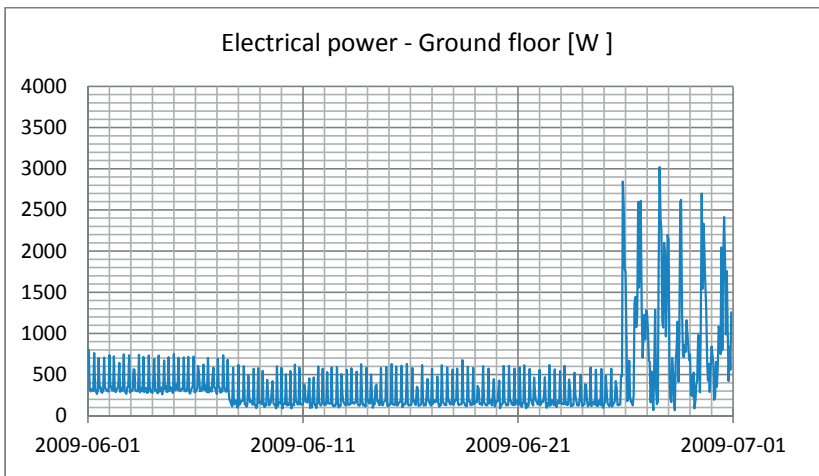

Figure 3.3: Electrical power measured in flat C during June 2009.

Figure 3.4 shows the measured electricity consumption in flat F, on the first floor, during a month when it was occupied by one person. During the occupied period of the ground floor, the electricity consumption was higher than that of the first floor because the ground floor tenant was using a portable air conditioner, whereas on the first floor a pedestal fan was used.

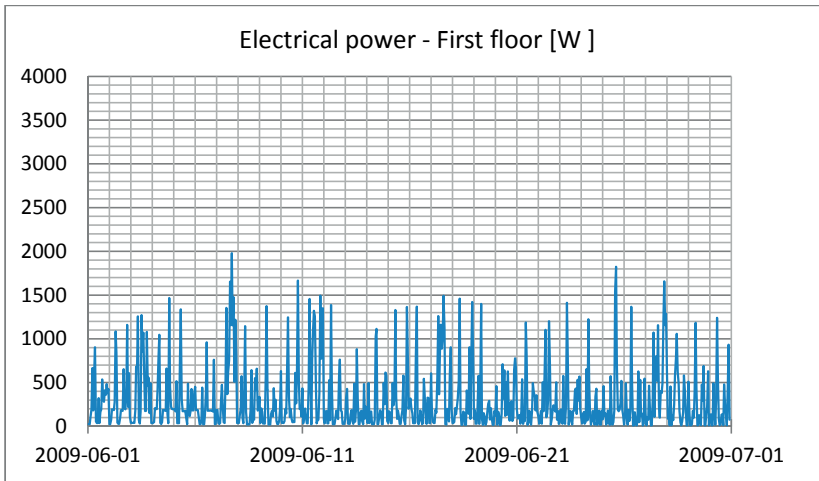

Figure 3.4: Electrical power measured in flat F during June 2009.

Figure 3.5 shows the measured electricity consumption in flat F during the next month, when it was occupied by two persons.

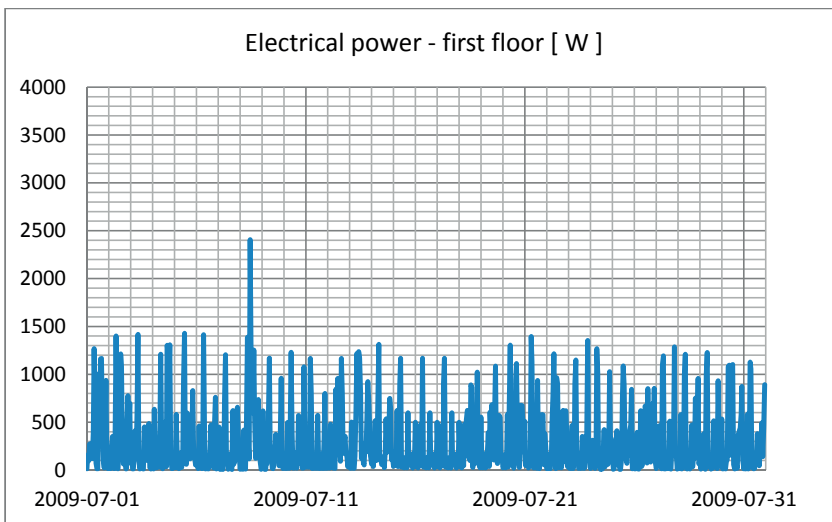

Figure 3.5: Electrical power measured in flat F during July 2009.

The average electricity consumption computed from the measured data presented in Figure 3.4 was 307 W which gives about 221 kWh/month. The average electricity power computed from the measured data presented in Figure 3.5 was 618 W which gives about 445 kWh/month. This shows clearly the influence of the number of people living in the flat.

The electrical energy use calculated considering the installed load in the apartment as presented above, was 488 kWh/month. The difference between the calculated and measured consumption is about 43 kWh/month. The calculated value is higher, which could be expected since this is an average value while the measured value applies to a winter month. It is expected that the electrical energy use will increase in summer due to higher energy demand for air conditioning systems.

4 Comparison with energy use in other countries

Table 4.1 presents an overview of the electrical energy used in households in Sweden, South Africa and the data from the case study building, in Maputo, Mozambique. The acronym NI in Table 4.1 stands for “not included”.

In Sweden, space heating and water heating are often not measured for the apartments, but for the complete residential block, and in some cases the houses are connected to district heating and water systems. As the heating systems is not considered in Table 4.1, the highest electricity consumption in Sweden is for the refrigerator and the freezer followed by lighting systems, these being standard appliances.

In South Africa, the highest consumption of electricity occurs in water heating and cooking systems for the type of household considered in this work (Urban Higher-Income Electrified).

Mozambique presents the lowest electrical energy use for cooking because many dwellers use LPG as the main source for cooking since electricity is expensive for many dwellers. The row “MEE” in Table 4.1, includes miscellaneous household electrical loads which are small consumers of electricity in buildings. In Mozambique, it was verified that the main consumer of electricity is to be found in the air conditioning systems followed by water heating and lighting systems, respectively.

Table 4.1: Electrical energy use for appliances in the households in Sweden, South Africa and Mozambique.

Household end use	Electrical energy use [kWh/year]		
	Sweden	South Africa	Mozambique
Lighting	1 180	520	887
Cooking	1 030	1 043	90
Space cooling	NI	NI	1 521
Water heating	NI	1 563	1 368
Dish washer	750	NI	NI
Refrigerator and freezer	1450	NI	329
MEE	NI	967	1520
Year	2005/2008	2001	2009
Reference	[8]	[9]	Current study

Note: NI = not included and MEE = miscellaneous electrical equipment.

According to [10], in Sweden the average energy used for appliances in houses is between 4 and 5 MWh/year, which is almost the same as household electrical energy use in urban zones in South Africa. Mozambique presents the highest annual energy use since here it is the total load installed in the house.

The total energy use per year presented in Table 4.1 is related to appliances, and for South Africa and Mozambique also water heating. For instance in Sweden according to [10], for a standard detached house built in 1990, the total energy use is about 15 000 kWh/year, distributed as follow: heating 5 000 kWh/year, appliances 4 500 kWh/year, hot water 3 500 kWh/year and pumps and fans 2 250 kWh/year.

Reference [11] in his study (related to impact of ceiling insulation on household energy use) assumed that the electricity consumption per household is 9 300 kWh/year in South Africa. This value includes all the electrical equipment installed in a typical South African house.

5 Evaluation of energy cost

The main source for supplying energy to the case study building is the electrical grid from the Electridade de Moçambique (EDM). EDM is Mozambique’s publicly owned electricity company, responsible for production, transport, distribution and selling of electrical energy throughout the country.

The evaluation of electrical energy presented in chapter 3 was done considering exactly the kind and number of appliances installed in the flat (standard appliances). All equipment in the apartments of the building is of the same brand and characteristics.

The evaluation of the cost of the electrical energy used in the flat is done considering the energy E calculated above, i.e. E multiplied by the electricity price (energy rate) which can be obtained from the electricity company or can be seen in electrical energy bills.

In order to estimate the energy costs in the building, the calculation method applied by EDM [12] for billing the electricity consumption in domestic buildings was analysed. This reference presents different category tariffs for social, domestic, agricultural and general (Low Voltage) applications, as presented in Table 5.1.

The EDM has been replacing the traditional energy meters by prepaid energy meter systems throughout the country. So, the evaluation of the cost of the electrical energy used in this work was based on the tariff for the domestic, prepaid system (3.18 MT/kWh) as indicated in Table 5.1.

Table 5.1: EDM electricity tariffs by monthly consumption levels.

Registered energy use (kWh)	Tariff				
	Social	Domestic	Agricultural	General	Fixed
	(MT/kWh)				MT/month
From 0 to 100	1.07	-	-	-	-
From 0 to 300	-	2.50	2.68	2.97	85.35
From 301 to 500	-	3.53	3.81	4.24	85.35
Above 500	-	3.71	4.17	4.64	85.35
Prepaid	1.07	3.18	3.71	4.25	-

Note: MT is the Mozambican currency (USD/30.80MT - the exchange rate of 2014-11-10), [13].

The total monthly amount of invoice is computed considering the difference between the readings of the current month with the reading of the previous month on the energy meter, multiplied by the domestic prepaid tariff presented in Table 5.1, resulting in the Partial Price (PP) on which is added the following duty:

IVA – Value Added Tax, a tax similar to “VAT” in Europe, estimated as 17% of 62% of the PP;

So, the monthly electrical energy cost C is calculated according to equation 5.1.

$$C = PP + IVA \quad (5.1)$$

where: PP = Partial Price, [MT]

IVA = Value Added Tax, [MT]

Figure 5.1 presents the costs per year for all the appliances and lighting installed in the apartment. In the description of the calculation process presented above, the currency used was MT, but the calculations and final results are presented in US Dollars as can be seen in Figure 5.1. The conversion rate used is presented in the note of Table 5.1.

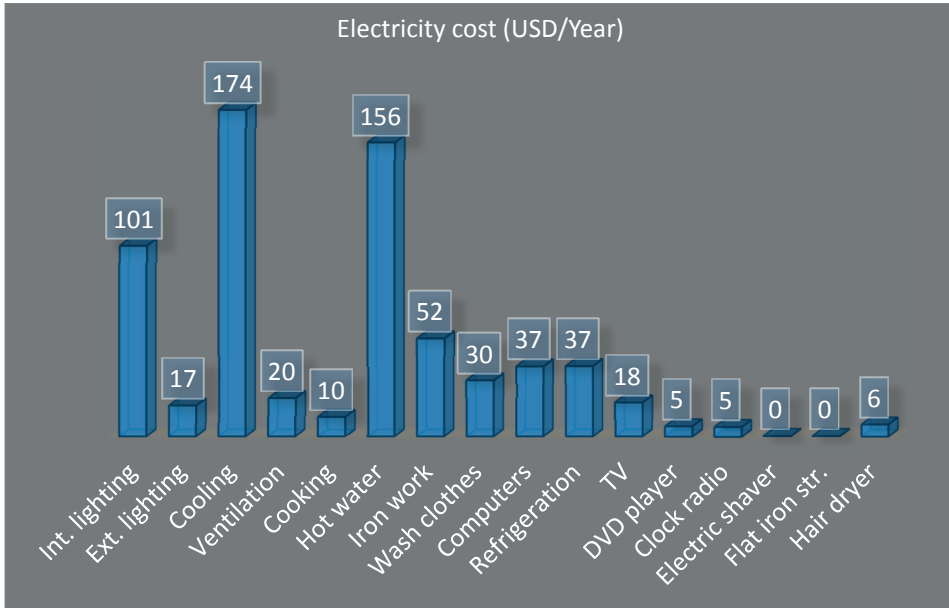

Figure 5.1. The annual cost for electricity use by end use.

In Sweden, since 2011 the price of electrical energy is divided according to four geographical areas. The reason for dividing the country into zones is to make clear where in the country there is a need to increase the electricity production and to expand the grid [14]. Due to this division of Sweden into electricity price areas, and also due to the fact that electricity in Sweden is produced and distributed on an open market, there exists no unique price for the whole country, and the price also varies considerably over time. An estimate of the price for Sweden is 0.188 USD/kWh (1.40 SEK/kWh) with VAT included, based on an exchange rate of USD/7.46 SEK [15, 16].

In South Africa the cost of electricity varies from one area to another, and for households the cost of electricity is subsidized. The survey done by [17] in some South African areas found that the average prepaid electricity cost is R80 to R150 per household in Kwadengzi–Shongweni and Witbank areas, which gives in average about 0.36 USD/kWh. According to [18] the tariffs for home power standard tariffs vary as a function of the type of electrical feeding system (dual-phase or three-phase), power and current per phase and is thus divided into four grades of home power tariffs for residential customers which corresponds to home power 2 for energy charge of 0.085 USD/kWh (0.94 ZAR/kWh) with VAT included, based on an exchange rate of USD/10.95 ZAR [18, 19].

Table 5.2 presents the estimated cost of electricity per year, based on the electricity price per kWh, per household in Sweden, South Africa and the evaluated electricity cost from the case study in Maputo City.

Table 5.2: Estimated electricity use and costs per household in Sweden, South Africa and Mozambique.

	Sweden	South Africa	Mozambique
Electricity energy use (kWh/year/HH)	15 000	9 300	5 860
Electricity energy cost (USD/year/HH)	2 814	795	669

The higher electrical energy cost for Sweden, presented in Table 5.2, is realistic, since in Sweden the use of heating and lighting systems is higher than the use of those systems in South Africa and Mozambique and the same can be said for South Africa in relation to Mozambique. The cost presented above can vary slightly with the behaviour of the occupants in using appliances.

6 Improvement of energy use in the building

For assessing the potential for energy use improvement, the energy data evaluated in chapter 3 was considered. During the design stage of this building no account was taken to equipment with energy saving label or efficient appliances that save energy. Nowadays, the industry is producing energy efficient equipment such as compact fluorescent light bulbs (CFL) and LED lamps which can be used in dwellings for lighting instead of traditional incandescent bulbs, and also efficient appliances for the household.

The largest user of energy in the typical Maputo City home is the cooling and water heater systems which account, as presented in this work, for about 50% of the electrical energy use per year, followed by lighting 15% (see Figure 3.2). So, in this work, these devices, as well as the washing machine and the refrigerator were considered for energy improvement in the building.

In order to calculate possible energy reduction in the building, it was necessary to compare efficiency of the existing appliances with new and more efficient ones. As mentioned in chapter 3, the existing appliances were assembled in the 1990s. They are less efficient than new ones, and there is need for retrofitting. According to [20], a new air conditioner uses 30 to 50% less energy to produce the same cooling effect as air conditioners made in the 1970s, and considering an air conditioner which is only 10 years old, it is possible to save 20% to 40% of the energy used replacing it with a new and more efficient one.

A similar development has occurred for refrigerators, for instance studies done by [21], based on NOM-015_ENER-2002, indicate that refrigerators marketed nowadays are 30% more efficient than the old ones of the 1990s.

The 23% of electricity expenditure used for hot water presented in Figure 3.2 is related to the existing water heater apparatus. The water heaters have been improved greatly in recent years. There are basically 5 alternatives for reducing the electrical energy use in water heater systems depending on the type of resources available in the dwelling, namely electrical, gas, propane, natural gas and solar energy systems. First of all, it was

necessary to check which systems are used for hot water production in the residential. The inspection done in the building showed that hot water was produced with an electrical apparatus.

An interesting feasible system among the five water heater systems mentioned above is solar energy. According to [22], the payback time considering the initial investment and installation costs of solar water heating systems is only two years. For hot water production the alternative with solar energy was analysed and it was seen as the best solution for improving the energy use in this building amongst the five systems. For this alternative, no electricity is used for water heating.

Although not as economically favourable as solar water heating system, using systems based on electricity, gas, or propane as a heat source for tank-less water heaters, in some cases can cut water heating bills by 10 to 20 percent [23]. The savings are reached eliminating standby losses, which occur by warming unused water in the water reservoirs. This alternative was also evaluated for water heating.

According to this work, lighting stands for 15% of the annual electricity energy use in apartment F. So, the energy saving by changing less efficient lamps to a more energy efficient type was analysed, and Table 6.1 shows the technical characteristics and the rate of energy savings of the more efficient lamps. From Table 6.1 the advantage of using LED bulbs rather than traditional incandescent bulbs and compact fluorescent lamps can be seen. In this work, LED bulbs with 8 and 13 W for indoor use and 16 W for outdoor use was assumed.

Table 6.1. Characteristics of different types of lamps.

Light output [lm]	Electrical power (W)		
	Traditional	Energy efficient	
	Incandescent	Compact (CFL)	LED
400 – 500	40	8 – 12	4 – 5
750 – 900	60	13 – 18	6 – 8
1 100 – 1 300	75 – 100	18 – 22	9 – 13
1 600 – 1 800	100	23 – 30	16 - 20
2 600 – 2 800	150	30 – 55	25 - 28
Energy relative to traditional	100%	20% – 25% less than incandescent	50% – 80% less than incandescent
Lifespan (hours)	1 000	8 000 - 8 500	25 000 - 40 000 (2015)
Application	Indoor/outdoor covered	Indoor/outdoor covered	General and special purposes

Source: Traditional incandescent, compact and LED lamps [24, 25]

Based on equation 5.1 presented above, the present cost and the saving using efficient equipment was evaluated. The savings were assumed to be 30% for white goods, 20% for hot water and 50% for lighting based on LED lamps. Figure 6.1 illustrates the improved electrical energy use in apartment F. The blue colour correspond to the cost of energy per year (total USD 669/year) using the existing standard equipment, whereas the red one is related to improved electrical energy cost per year (total USD 507/year) when using the efficient white goods and LED lamps. Figure 6.1 shows the alternative with a tankless water heater. For the alternative with a solar water heater the total cost is USD 382. Only the electricity cost is evaluated, no investment costs are included.

Mozambique lack laws which regulate the use of electrical appliances with energy classes, which exist in other countries, especially in Europe and America. So, on the Mozambican market, household appliances such as air conditioners, refrigerators, water heaters and washing machines without labelling letters are sold.

The LED lamps proposed for energy improvement in this work are not well known in Mozambique as it is a relatively new technology. In general, on the Mozambican market, incandescent bulbs, fluorescent tubes and CFLs are sold since these are more available and less expensive than LED lamps.

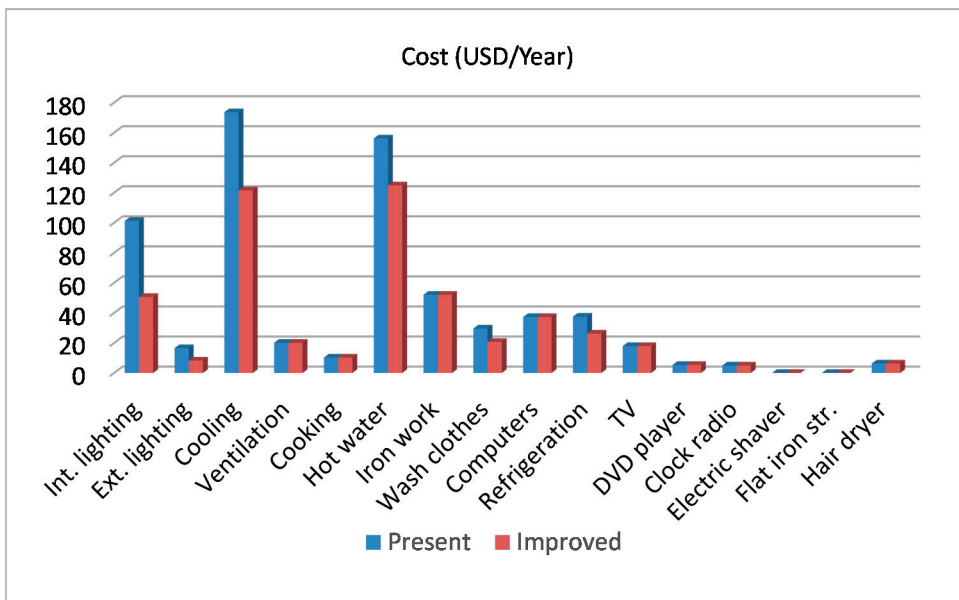

Figure 6.1. Comparison of cost of electrical energy for existing and improved appliances.

7 Discussion and conclusions

The survey showed that the improvement in electricity cost was 24% with the use of efficient equipment and a tank-less water heater, and 43% if a solar collector for water heating is installed. The values of the improvement can however vary, depending on the behaviour of the home occupants using the household devices.

The case study building is a typical dwelling which means that the results can serve as an estimate of the electricity saving potential for a majority of the buildings in Mozambique, which present similarity with that analysed in this work. The work thus provides important information about the potential of electrical retrofitting in the building stock.

The results can also be used in modelling and simulation tools of energy use in buildings where appliances loads are needed as input.

The Mozambican dwellers do not have the information on building energy saving methodologies, and data related to electrical energy use breakdown in residential buildings do not exist in the country. For dwellers, by using these results it is possible to raise awareness towards energy savings and the use of energy labelled devices, leading to energy savings especially to residents with lack of knowledge in this matter.

Finally, it is believed that the work presented could contribute to increase and spread the knowledge among professionals and dwellers about LED lamps and their advantages once they can be used in many applications, and are the most technically favourable considering their lifespan, light out and efficiency. However, these advantages are not enough to justify their application for the majority of Mozambican dwellers, because the price plays the main role for their use in developing countries like Mozambique.

8 Acknowledgements

The authors would like to acknowledge the financial support from ASDI/SAREC, supervisors from Department of Construction Sciences and Building Physics at Lund University and Eduardo Mondlane University.

References

- [1] Chambal, H., Energy Security in Mozambique, International Institute for Sustainable Development, Series on Trade and Energy Security – Policy Report 3, 2010.
- [2] Auziane, G. Energy Assessment Methodologies and Climatic Measurements – A Field Monitoring project in Maputo City, Report TABK—10/1026, Lund Institute of Technology, Lund University, 2010.
- [3] Zimring, M., Borgeson, M. G. et al., Delivering Energy Efficiency to Middle Income Single Family Households. Report LBNL-5244E, Environmental Energy Technologies Division, Lawrence Berkeley National Laboratory, USA, 2011.
- [4] Ürge-Vorsatz, D., Eyre, Nick, et al., Energy End-Use: Buildings, Review Editor Eberhard Jochem (Fraunhofer Institute for Systems and Innovation Research, Germany). http://www.iiasa.ac.at/web/home/research/Flagship-Projects/Global-Energy-Assessment/GEA_Chapter10_buildings_hires.pdf, Accessed April 07, 2015.
- [5] Diji, C. J., and Ganiyu, H., Energy Auditing of a Typical Residential Building in Ibadan Metropolis, IOSR Journal of Electrical and Electronics Engineering (IOST_JEEE), 2013.
- [6] Roth, K., Mckenney, K., et al., U.S. Residential Miscellaneous Electric Loads Electricity Consumption, ACEEE Summer Study on Energy Efficiency in Buildings, ACEEE, Pacific Grove, CA, USA, 2008.
- [7] Floriano, J., Custo do Consumo de Energia Elétrica dos Eletrodomésticos, O ECONOMISTA, 2014. <http://www.oeconomista.com.br/custo-do-consumo-de-energia-eletrica-dos-eletrdomesticos/>, Accessed November 12, 2014.
- [8] Smedes, J., Energy Efficient Household Appliances in Sweden, Department of Construction and Architecture, Division of Energy and Building Design, Lund University, Lund, Sweden. http://smeds.eu/johan/Energy_efficient_household_appliances.pdf, Accessed November 07, 2014.
- [9] Winkler, H., Energy policies for sustainable development in South Africa’s residential and electricity sectors, Energy Research Center, University of Cape Town, 2006.
- [10] Hiller, C., Sustainable energy use in houses Will the energy use increase with time? Study of literature and computer estimations, Report TVBH-3041 Department of Building Physics, Lund University, Lund, 2003.
- [11] Mathews, E. H., Taylor, P. B., et al. Impact of ceiling insulation on household energy consumption, Centre for Experimental and Numerical Thermo-flow (CENT), University of Pretoria. http://active.cput.ac.za/energy/past_papers/DUE/1997/PDF/8%20Mathews%20EH%20-%20Impact%20of%20Ceiling.pdf, Accessed April 07, 2015.
- [12] Electricidade de Mozambique, EDM, Tarifas de Energia Elétrica, Maio de 2013. <http://www.edm.co.mz/>, Accessed November 08, 2014.

- [13] Bank of Mozambique. http://www.bancomoc.mz/Default_en.aspx, Accessed November 10, 2014.
- [14] Energy in Sweden 2013, Reports published by the Swedish Energy Agency, Swedish Energy Agency ET 2013:29, 2014.
- [15] Kullander, S., Bengtsson L., et al., Sveriges elpriser – en analys av den nordiska elmarknaden, Energi Utskottet, SE-114 05Stockholm, Sweden.
http://www.kva.se/globalassets/kalendarium/2013/130226_rapport_elpriser.pdf, Accessed April 14, 2015.
- [16] Forex Bank, Sweden, <http://www.forex.se/en/>, Accessed November 10, 2014.
- [17] Tewari, D. D., An assessment of South African prepaid electricity experiment, lessons learned, and their policy implications for developing countries, Energy policy 31 (2003) 911-927, 2014.
- [18] Tariffs & charges Booklet, 2013/14.
<http://www.eskom.co.za/CustomerCare/TariffsAndCharges/Documents/ESKOM%20TC%20BOOKLET%202013-14.pdf>, Accessed April 19, 2015.
- [19] XE Live Exchanges Rates, <http://www.xe.com/>, Accessed November 10, 2014.
- [20] Energy-Efficient Air Conditioning, DOE/GO-10099-379 FS 206, 1999.
<http://www.nrel.gov/docs/fy99osti/17467.pdf>, Accessed March 23, 2015.
- [21] Arroyo Cabañas, F.G., Aguillón- martnez, J.E., et al., Electric energy saving potential by substitution of domestic refrigerators in Mexico, energy policy, 2009.
- [22] Solar Water heating Pays for Itself Five Times Over, ScienceDaily,
<http://www.sciencedaily.com/releases/2009/03/090309105021.htm>, Accessed March 14, 2015.
- [23] Residential Water Heaters, Consumer Energy center, California Energy Commission, 2002-2015.
<http://www.consumerenergycenter.org/residential/appliances/waterheaters.html>, Accessed May 08, 2015.
- [24] LED Light Bulbs: Comparison Charts, Solutions for Sustainable Living,
http://eartheasy.com/live_led_bulbs_comparison.html, Accessed May 08, 2015.
- [25] Life-Cycle Assessment of Energy and Environmental Impacts of LED lighting products, building technologies program, U.S. Department of ENERGY, 2012.
http://apps1.eere.energy.gov/buildings/publications/pdfs/ssl/2012_LED_Lifecycle_Report.pdf, Accessed April 08, 2015.

Paper IV

Validation of building energy modelling tool for Mozambican climate

A case study: “3 Fevereiro Residential”

Gabriel Auziane¹ Kurt Källblad² Petter Wallenten³

¹Faculty of Engineering, Lund University, Sweden and Eduardo Mondlane University UEM, Mozambique, gabriel.auziane@construction.lth.se

²Faculty of Engineering, Lund University, Sweden, k.kallblad@tele2.se

³Faculty of Engineering, Lund University, Sweden, petter.wallenten@byggtek.lth.se

ABSTRACT

Mozambican professionals lack suitable modelling and simulation tools for predicting energy use and indoor climate in new buildings and improvement in retrofitted buildings as well as the means for rating the impact of new efficient strategies and technologies during the building design stage. DEROB-LTH (DEROB is an acronym of dynamic energy response of buildings) is an energy simulation tool used to evaluate energy performance of buildings. The main goal of this paper is to evaluate the performance of DEROB-LTH, for the climatic conditions and type of buildings prevailing in Mozambique. Measurement equipment was installed in the residential building “3 de Fevereiro Residential” in Maputo City, with the objective of monitoring indoor and outdoor climate and energy use in the building. Measurement data for every hour for a complete year was obtained. DEROB-LTH was tested by using outdoor climate data as input and comparing the simulation results of indoor temperature with measured data. The comparison of the DEROB-LTH simulation results with ones from the measurement equipment presented good agreement, indicating that the tool can be used in Mozambican climatic conditions in particular, and in subtropical and tropical countries in general.

Keywords: Energy, field measurement, simulation, DEROB-LTH, validation, subtropical and tropical climates, Mozambique

1 Introduction

Considering the concern over the effects of climate changes in the world, green building design and the increase in energy price over the years, efficient use of energy is primordial for future energy sustainability. The use of modelling and simulation tools for buildings is a relatively simple method for predicting energy use in the building sector. These tools allow to calculate the energy required by apparatus for creating good indoor comfort during the design of new buildings, or retrofits of the building stock and they can also be used to compare different designs to determine the most energy efficient one [1].

In Mozambique, many building projects are still designed without any energy related considerations beyond those enforced by energy codes. One reason of this is lack of knowledge. Building designers have few means for accessing the impact of new strategies and efficient technology. They lack a reliable building energy simulation tool to be used during the design stage.

The main objective of this work was to demonstrate the suitability of the DEROB-LTH simulation tool for the climate conditions in Maputo City, Mozambique. DEROB-LTH is an acronym for Dynamic Energy Response of Buildings, and it is a detailed energy simulation program tool, originally developed at Austin School of Architecture, University of Texas, in the USA. The program has been further developed at the Department of Building Science and Department of Construction and Architecture at Lund University. The improvements done in Lund are mainly development of a friendly user interface, improved treatment of irradiance and heat transfer through windows and calculation of air leakage considering wind speed and direction.

The program operates with multi thermal zones and allows modelling of single rooms or entire buildings. The main strength of DEROB-LTH is the 3-dimensional calculation of how building shape and shading devices impacts the irradiance and thus the energy consumption of buildings [2]. Heat transfer in building surfaces are treated as one dimensional flows while the building shape is modelled in three dimensions. Besides the above mentioned, DEROB-LTH contains a simplified routine for modelling and simulation HVAC. Moisture transfer phenomena is not considered by the software.

Any simulation tool used needs to be tested and validated for the intended use. The literature review done by [3] found that this tool in addition to being used in energy studies in buildings in cold countries like Sweden [4, 5] also presented good results in countries with climate partly different from Maputo City [6, 7]. In reference [6], the author demonstrated that the simulation results using DEROB-LTH program were in good agreement with field measurements in China. This was corroborated by [7] in his research in Ghardaia, Algeria.

In order to demonstrate the suitability of DEROB-LTH, it becomes necessary to test the performance with climatic data from Maputo City. An evaluation of a building energy tool can be done by analytical, empirical sensitivity, range and comparative methods [1, 8]. In this paper results of the empirical method are presented, which compare simulated results with experimental data. This was performed by comparing

the output from simulations with results from measurement equipment. Therefore, the DEROB-LTH input climate file was based on measurements of the local outdoor climate data.

2 The Measurement Equipment

Within the program “Advancing Sustainable Construction in Mozambique (ASCoM)”, in 2009 the measurement equipment for measuring climate factors was installed. Sensors for measuring indoor temperature and humidity were installed in the apartments on the east side of the ground and first floors of the “3 de Fevereiro Residential” building, Figure 2.1. On the outside of the building, sensors for measuring temperature and humidity, global and diffuse irradiance, wind speed and wind direction were assembled.



Figure 2.1. “3 de Fevereiro Residential” (by the author).

In 2009, the first measurement equipment consisting of the sensors mentioned above and one mini-computer with a Sensirion Temp/RH Logger System for data storing was assembled on each floor in the building. Later on, this measurement equipment was updated and instead of one system on each floor, only one mini-computer with a SensiLogger system was assembled on the first floor. The temperature and humidity sensors on the ground floor were connected to the new system on the first floor.

Figure 2.2 shows the layout of the measurement equipment installed in the residential for data collection and storing.

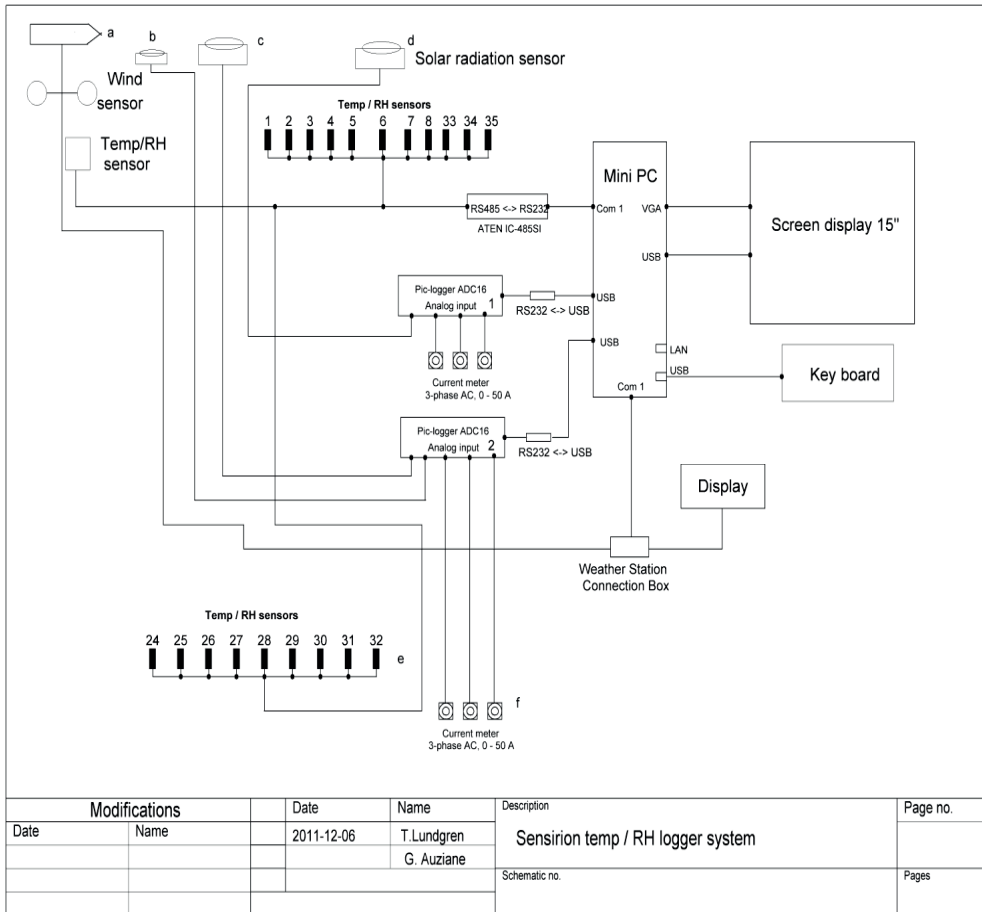

Figure 2.2 Layout of the measurement equipment.

The measurement equipment presented some data problems and an analysis showed that some components, which did not present good performance, must be replaced. Thus, the Mini-Weather Station (Oregon WMR200) previously installed on the first floor, which was not working properly, was replaced by another brand, “Weather Station Ultimeter 800”. The full details about this system are presented in [3].

Tables 2.1 and 2.2 present the technical specifications of the devices that compose the Data Logger System installed in the building as indicated in Figure 2.2 above.

Table 2.1 Data logger system.

Data Logger System		
Mini PC	eBox-4 Series	
Operating system	Win XP SP3 (Eng)	
Pico Logger	ADC16-2	
Mini PC drivers	LAN	
	VGA for XP	Resolution 1024 × 768
	VIA-Hyperion Pro-V510A	

Table 2.2 Sensors installed in the apartments.

Sensors				
No.	Designation	Technical characteristics		
01	Temp. and Rel. Humidity	Sensirion SHT75		
02	AC current transformer	Onset CTV-B	0 – 50 A AC	Output 0 - 2.5
03	Sunshine Sensor	Delta-T Devices Ltd, type BF3		
04	Pyranometer	SP-212	0 – 1100 W/m ²	Output 0 - 2.2
05	Wind speed & direction	Ultimeter 800		
06	Radiation shield house	Davis 7714, for outdoor temperature/humidity		

3 Climate Data

The DEROB-LTH calculations are based on an energy balance model, using a time step of one hour and calculate different types of building energy performance parameters in response to hourly values of climatic data. The program can be scheduled for input such as indoor temperatures, maximum power for heating and cooling, internal loads, airflow rates and window openings.

The DEROB-LTH climate file does not have to contain wind data, but in this work, wind speed and wind direction were included, since [9] recommends including such data in order to avoid the uncertainty of output produced when not including it.

The first period which presents complete data from the measurements was selected. Thus, the period from May 2012 up to April 2013 was used.

3.1 Outdoor temperature

Figure 3.1 shows the outdoor temperature with maximum, average and minimum of 34.9°C, 22.5°C and 11.6°C, respectively, from May, 2012 up to April, 2013. The maximum outdoor temperature occurred on 2013-01-10 at 13:00 and the minimum on 2012-08-08 at 05:00.

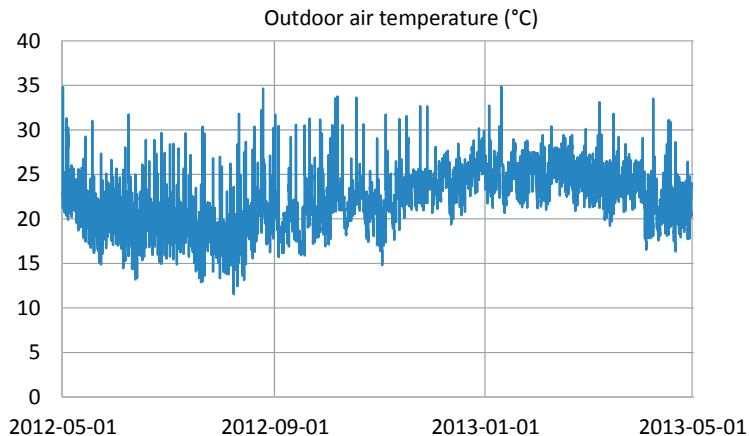

Figure 3.1. The outdoor temperature on site.

3.2 Irradiance

Figure 3.2 shows the global and diffuse irradiance on a horizontal surface during the measured period. The maximum and average global irradiance were 1010 W/m^2 and 218 W/m^2 and the diffuse were 700 W/m^2 and 92 W/m^2 , respectively.

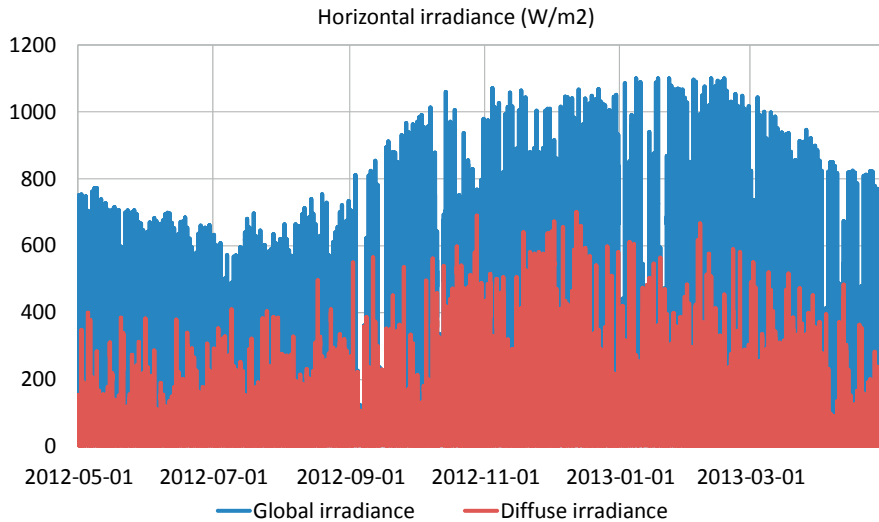

Figure 3.2. Measured global and diffuse irradiance on horizontal surface.

The maximum value of the global irradiance on horizontal surface occurred in three days of this measured year, namely on the 3rd, 11th and 17th of February 2013. Thus, for illustration of the variation of the irradiance on a horizontal surface in these hottest days the graph of the 3rd of February 2013, is presented in Figure 3.3.

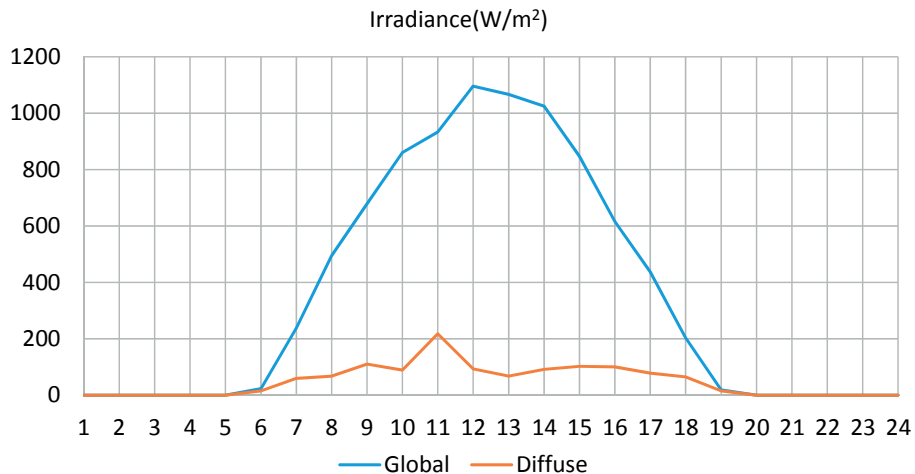

Figure 3.3. Global and diffuse irradiance on the hottest day.

3.3 Wind speed and direction

Figure 3.4 presents the measured monthly wind speed around the “3 de Fevereiro Residential” building. Mozambique has basically, two seasons, the wet season (summer) from November to March, and the dry season (winter) from April to October. So, according to data presented in Figure 3.4, the wintertime in Maputo City is characterised by higher wind speed. This is corroborated by [10] based on measured average wind speed from National Institute of Meteorology (INAM) in the period of 1971 up to 2000.

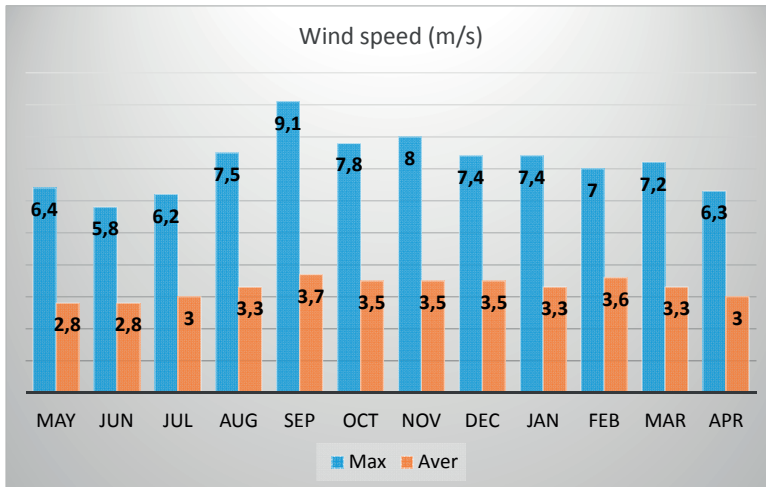

Figure 3.4. Wind speed during one year.

Figure 3.5 presents the measured wind directions in Maputo City. The diagram shows the number of hours with wind in different direction sectors.

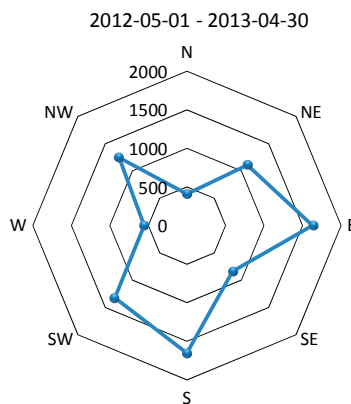

Figure 3.5. Measured wind direction.

4 Characterization of the Building

The “3 de Fevereiro Residential” building has two floors with rectangular shape and the long axis oriented E-W, see also Figure 2.1. In Table 4.1 the building characteristics are indicated and in Table 4.2 the areas of the building’s compartments are given.

Table 4.1 Characterization of the “3 de Fevereiro Residential”.

Apartments	Floor	Number of residents	Living area (m ²)
A	Ground	*	91
B	Ground	2 adults + 1 child	91
C	Ground	*	84
D	First	*	90
E	First	*	90
F	First	2 adults	83

*Apartments without permanent tenants.

Table 4.2 The compartment areas of the apartments.

Room type	Apartment C (m ²)	Apartment F (m ²)
Living room	29.2	32.3
Bedroom	14.6	14.4
Kitchen	11.8	7.6
Bathroom	6.1	7.1
Laundry	3.1	7.7
Storage	7.0	2.8
Corridor	12.4	10.8
Total living area	84.2	82.7

4.1 Materials

DEROB-LTH has a library for opaque and transparent building materials, which were modified in order to be in harmony with the building materials of the residential building as presented in Figure 4.1 and Table 4.3.

The two apartments C and F at the east gable was monitored and used in the calculations. The inner walls between these apartments and the rest of the building were treated as adiabatic, i.e. the same temperature was assumed on both sides, and thus no heat transfer could occur.

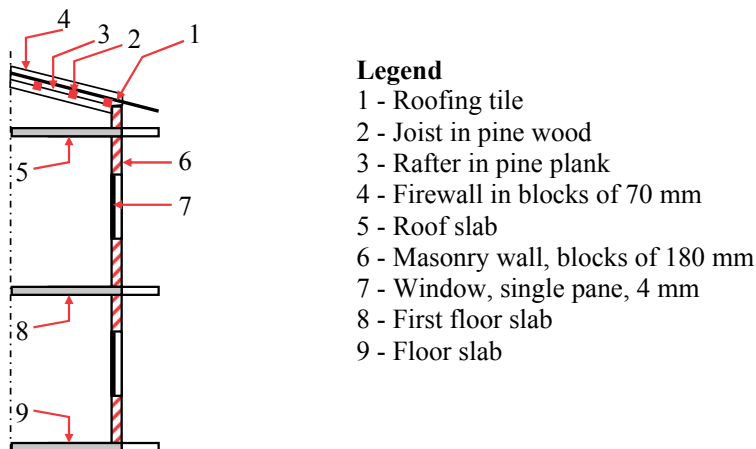

Figure 4.1. Building elements section.

Figure 4.2 (a-b) shows the plans of the building used as case study. As mentioned above, the measurement equipment was installed on the right side of the building and the same side, the shaded parts in Figure 4.2 (a-b) were used in the simulations.

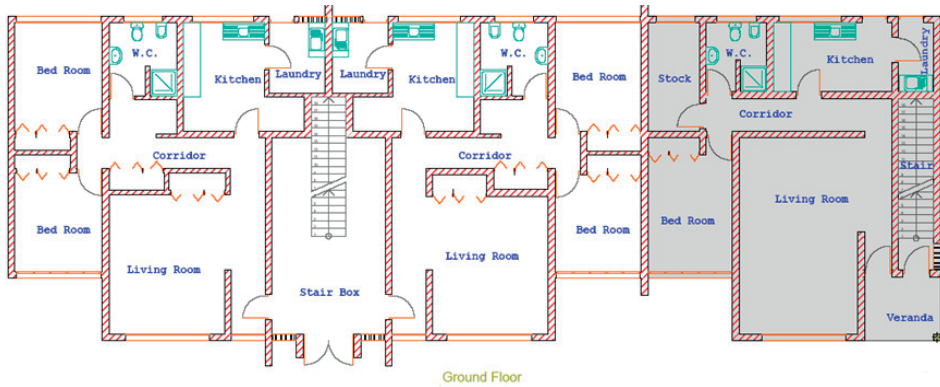

Figure 4.2 (a). Plan of the ground floor.

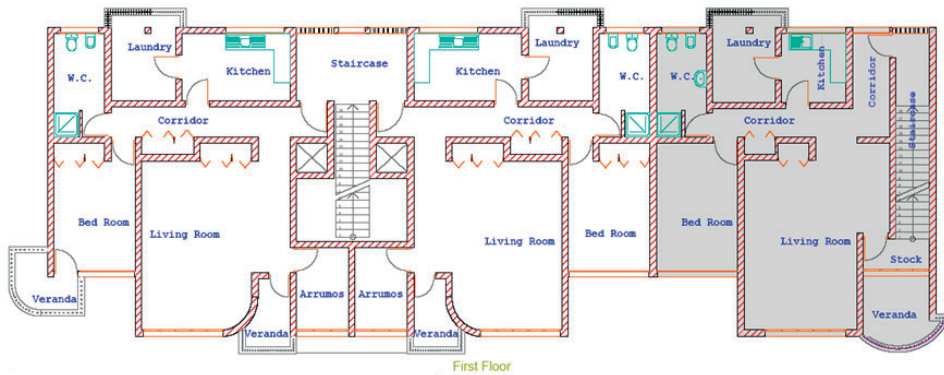

Figure 4.2 (b). Plan of the first floor.

Table 4.3 Building envelope.

Elements	Components	Dimensions (mm)	U-value (W/m ² , °K)
Exterior walls	Cement mortar	15	2.21
	Concrete blocks	150	
	Cement mortar	15	
Exterior door	Chanfuta wood	20	3.83
Roof	Roofing tile	2	4.08
Windows	Wood frame with single pane	4	2.9
Ground floor	Parquet in mecrusse wood	420x70x20	1.17
	Cement mortar	30	
	Floor slab	150	
	Riprap with median stone	¾"	
	Compacted red sand	70	

4.2 Ventilation

The leakage through the outer surfaces was set to 1/s per m² at 50 Pa. With measured wind speed and direction, the infiltration flows calculated in DEROB-LTH was 8.0 l/s on the ground floor and 9.6 l/s on the first floor. These flows correspond to 0.12 and 0.15 ac/h, respectively.

4.3 Internal loads

The internal load of the occupied living rooms and bedrooms of each of apartment is assumed to consist of lighting (4 units of 40 W), pedestal fan (1 unit of 65 W), TV (1 unit of 70 W) and radio clock device (1 unit of 5 W). In addition the apartment is occupied by 2 people (one person sitting or moving slowly at 25°C, 116 W).

The use of pedestal fans in the living rooms of the building is intended to improve the comfort of the occupants during summer.

5 Simulation Results

Climatic data from the measurement equipment installed in Maputo City were used in the simulations. For these simulations, the form of the building was modelled with a number of 3-D surface geometries in correspondence to the two flats on the right side of “3 de Fevereiro Residential”. The number of the zones was maximized to 8 as recommended by [2]. Figure 5.1 shows the simulated model of the building.



Figure 5.1. The geometrical model built in DEROB-LTH.

5.1 Operative temperature

Figures 5.2 and 5.4 show the graphs of the measured (Mea) and the simulated (Cal) operative temperatures in the living rooms on the ground floor and first floor respectively, right side of the building. The green line represents the difference between measured and simulated data (Mea – Cal).

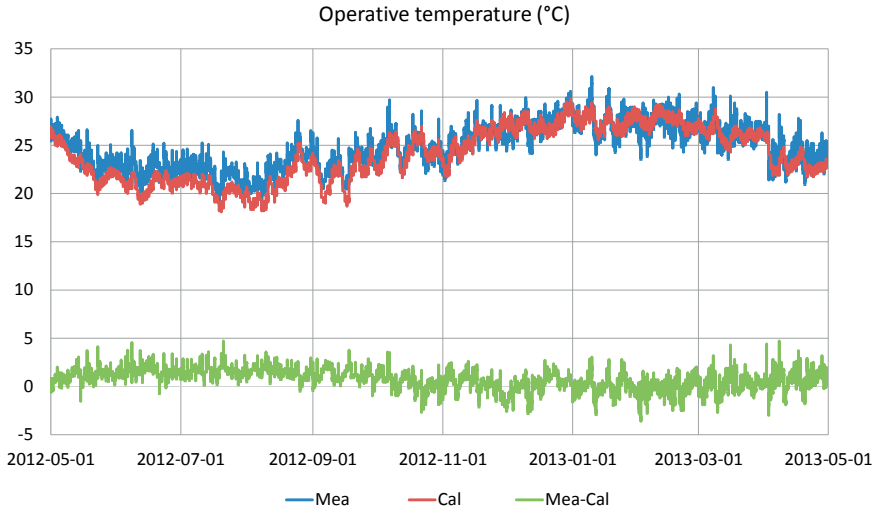

Figure 5.2. Measured and simulated operative temperature on the ground floor.

The day with the highest temperature is of interest in evaluation of air conditioning systems in buildings. During the period in consideration in this work, 2013-01-10 was the hottest day with maximum outdoor temperature of 34.9°C which occurred at 13:00. Thus, in Figure 5.3 and Figure 5.5 the measured and simulated operative temperatures of that hottest day is shown. The maximum difference between the measured (Mea) and the simulated (Cal) values of the operative temperature on the hottest day on ground and first floors was 3.0°C and 1.9°C respectively.

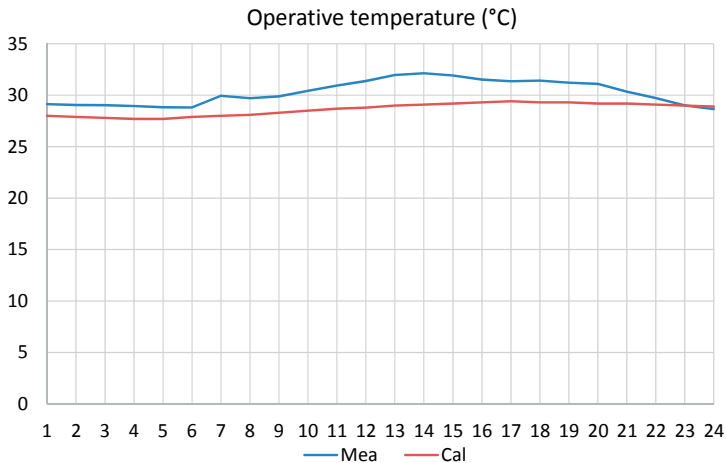

Figure 5.3. Measured and simulated operative temperature of the hottest day on the ground floor.

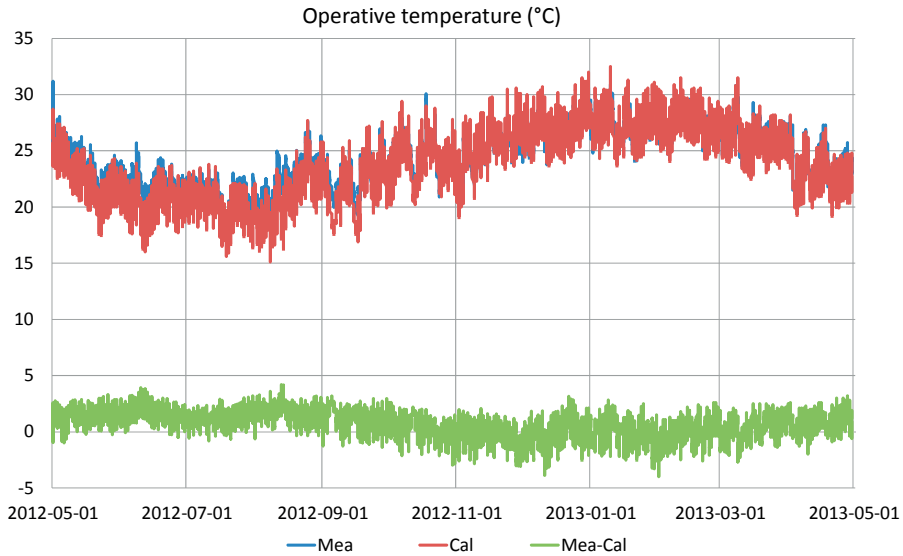

Figure 5.4. Measured and simulated operative temperature on the first floor.

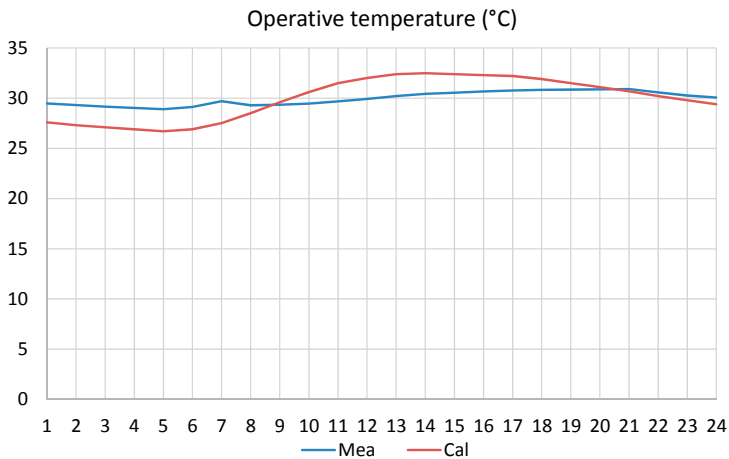

Figure 5.5. Measured and simulated operative temperature of the hottest day on the first floor.

Figure 5.6 presents the maximum, average and minimum values of the operative temperature extracted from Figure 5.2 and Figure 5.4. From this figure, it was seen that the difference between measured and simulated maximum operative temperature was 2.3°C on the ground floor. On the first floor, the maximum difference occurred in minimum values with 2.5°C. These differences can be related to certain internal default parameters of the tool assumed during the simulation process and uncertainties in the assumed input data.

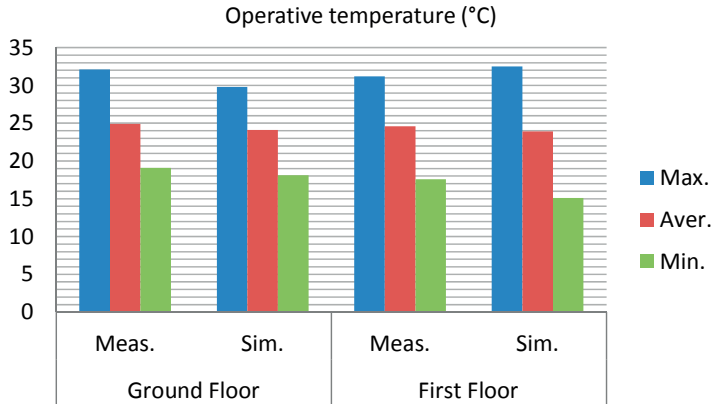

Figure 5.6. Measured and simulated operative temperature.

5.2 Indoor air temperature

Figures 5.7 and 5.9 show the graphs of the measured (Mea) and the simulated (Cal) indoor air temperatures in the living room on the ground floor and first floor respectively, right side of the building. The green line represents the difference between measured and simulated data (Mea-Cal).

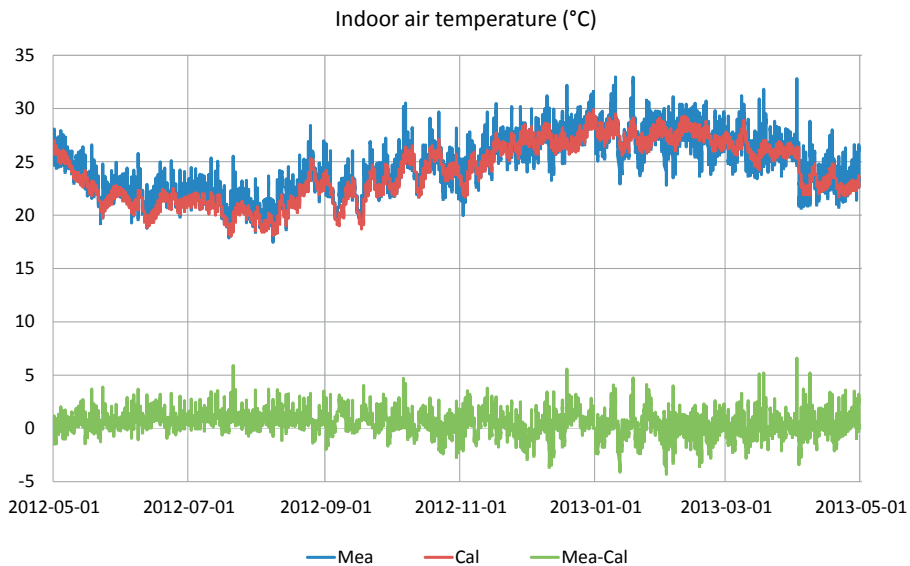

Figure 5.7 Measured and simulated indoor air temperature on the ground floor.

Figure 5.8 and Figure 5.10 show the measured and simulated indoor air temperatures of the hottest day. The maximum difference between the measured (Mea) and the simulated (Cal) values of the indoor air temperature on the hottest day on ground and first floors was 4.0°C and 1.7°C respectively.

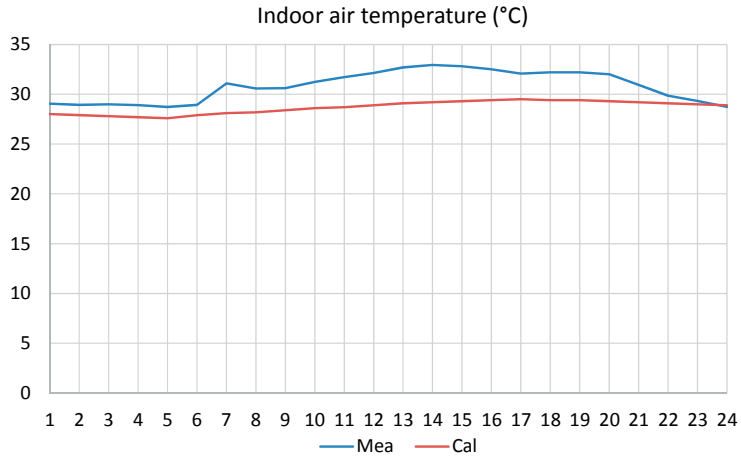

Figure 5.8. Measured and simulated indoor air temperature of the hottest day on the ground floor.

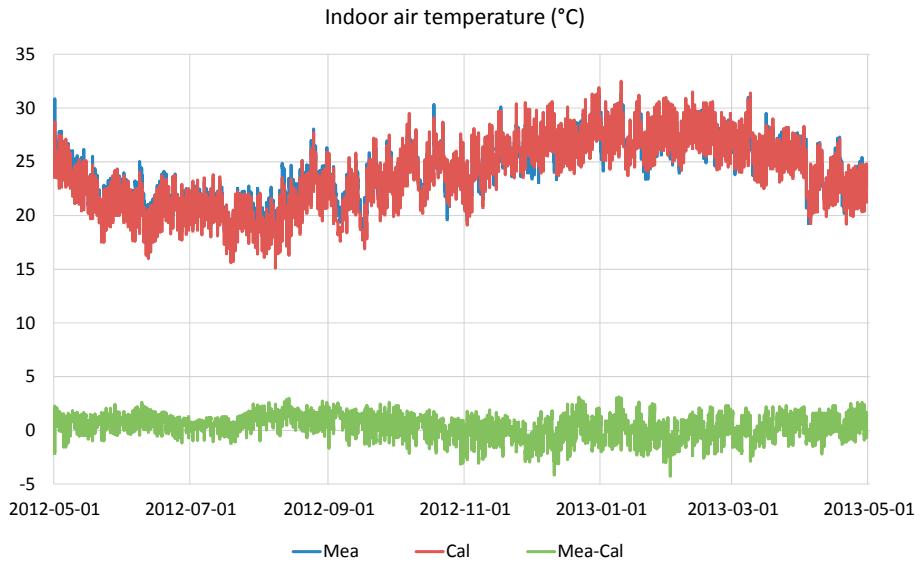

Figure 5.9 Measured and simulated air temperature of the living room on the first floor.

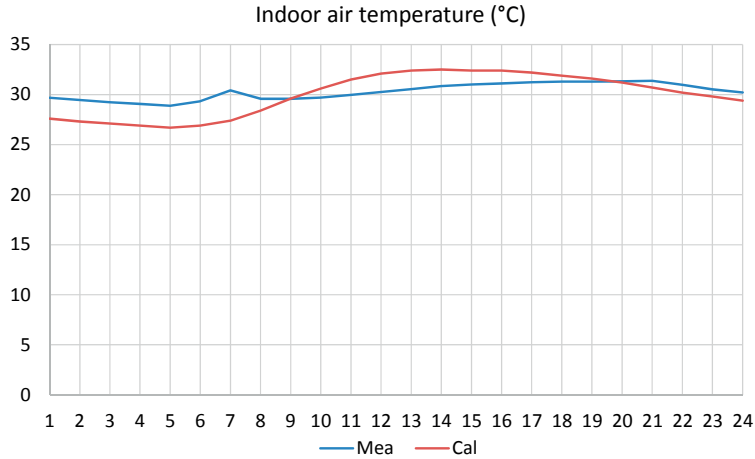

Figure 5.10. Measured and simulated indoor air temperature of the hottest day on the first floor.

Figure 5.11 presents the maximum, average and minimum values of the indoor air temperature extracted from Figure 5.7 and Figure 5.9. From this figure, it can be seen that the maximum difference between measured and simulated indoor temperature was 1.6°C, and this occurred in maximum values on the ground floor. On the first floor, the maximum difference occurred in minimum values with 1.7°C.

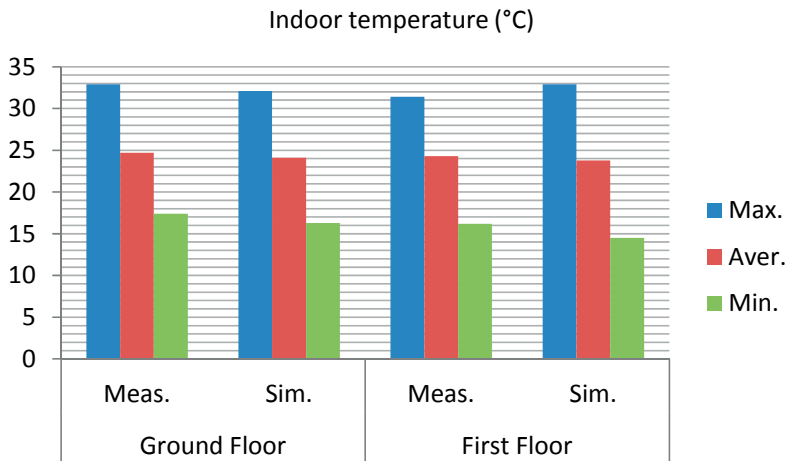

Figure 5.11. Measured and simulated data of the indoor temperature.

6 Example of Heating and Cooling Simulations

This chapter illustrates the use of the DEROB-LTH program when the influence of internal loads on the heating and cooling load is considered. Studies like these may be part of a parametric study for a building to be accomplished in future work, since this work is more related to prove that DEROB-LTH can be used for the climatic conditions of Maputo City and other parts of the country (with similar conditions).

When simulating heating and cooling demand the set point for indoor temperature needs to be specified. According to [11], the nominal interior temperature conditions for verification of the thermal systems are fixed to 25°C for summer and 20°C for winter. This was corroborated by [12] who in her simulations fixed the heating set point to 20°C, but the highest indoor temperature varied between 20 and 26°C in the different simulation cases, and [13] based on recommendation from the Canada Mortgage and Housing Corporation, fixed the set points to 19-21°C in his simulation work. So, in this paper, the set points for temperature was fixed to 22-26°C. This is corroborated by [14] who based on [15], recommend to fix the set point for indoor temperatures to 25°C and [16] who indicates that the cooling set point temperature should be not lower than 26°C.

Figure 6.1 shows the simulated loads in the bedroom of the ground floor for the case of unoccupied building. In this simulation, default values were assumed for maximum peak loads for heating (Mp-Heating), maximum peak loads for cooling (Mp-Cooling), internal loads, inflows, outflows, windows and doors. The maximum cooling load in this case occurred on 2013-02-09 at 1:00 PM with 644 W. The maximum load needed for heating is about 18 W, which can be considered negligible.

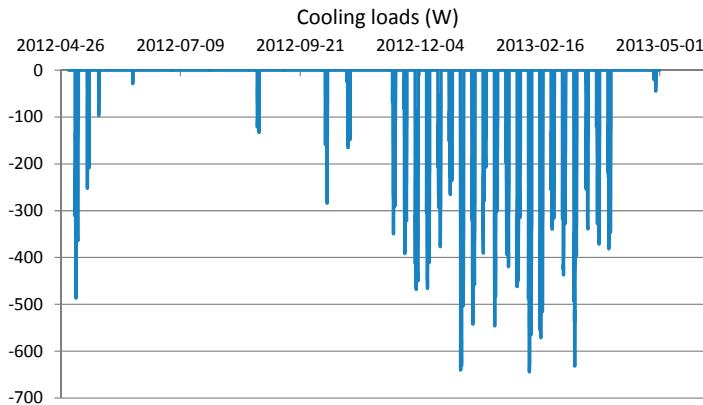

Figure 6.1. Cooling loads without occupants in the bedroom.

Figure 6.2 shows the simulated loads in the bedroom, assuming that the internal loads is constituted by 2 people, lighting and a radio clock device. In this simulation, default values were assumed for Mp-Heating, Mp-Cooling, inflows, outflows, windows and doors. The maximum load for cooling occurred on 2013-02-09 at 2:00 P.M. with 966 W.

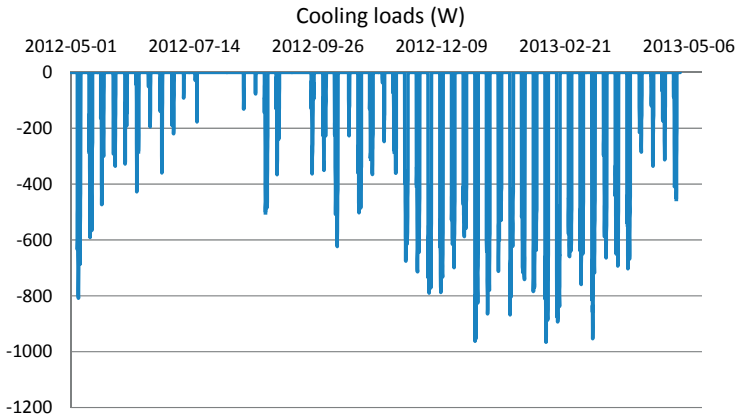

Figure 6.2. Cooling loads with occupants in the bedroom.

Figure 6.3 and 6.4 present the graphs of the same storey, but the living room. The first Figure shows the unoccupied case and the second the occupied apartment with 2 people, lighting and TV device. The need for heating appears in the unoccupied case with maximum on 2012-08-04 at 06:00 AM with 424 W and the need for cooling has the maximum value on 2012-08-29 at 17:00 AM with 1095 W. For the occupied case the need for cooling has the maximum value on 2012-02-29 at 17:00 AM with 1511 W. The need for heating occurs in a very short band during the winter, which can be despised. In fact, heating systems for improving comfort is not common for climatic conditions of Maputo and all provinces of Mozambique, except Niassa Province.

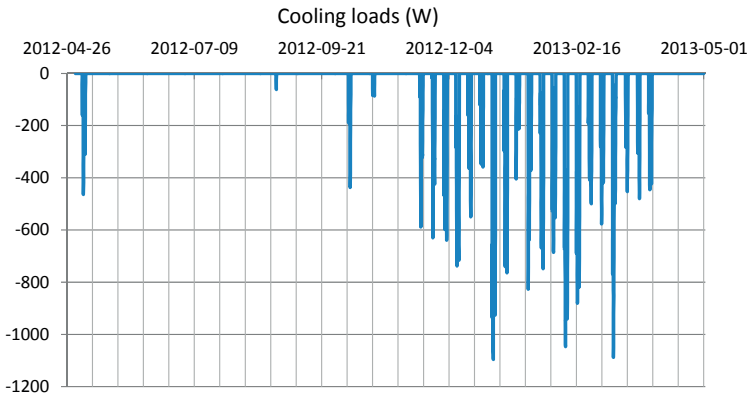

Figure 6.3. Simulated cooling loads without internal loads in the living room.

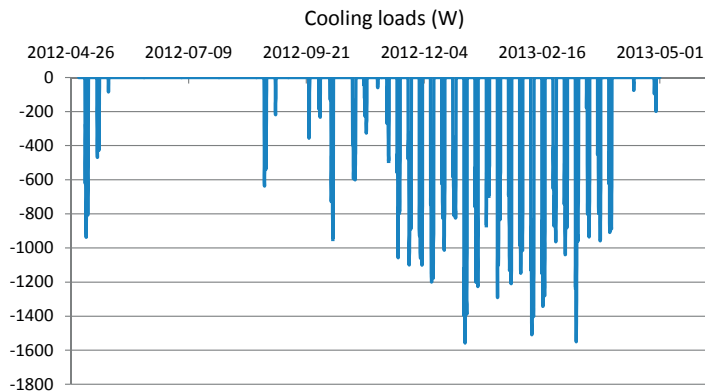

Figure 6.4. Cooling loads with internal loads in the living room.

7 Conclusions

In a larger perspective, the main objective of this work was to contribute to a framework for improving the use of energy in residential buildings in Mozambique. Such a framework should be a tool for professionals and researchers for their modelling and simulation of the performance of buildings. A key component in this kind of framework is a simulation tool for analysing the energy balance of a building. Other components are e.g. measurements of input data and internal loads. The specific objective of this work is to validate that DEROB-LTH is a suitable tool for this purpose.

For validation of a simulation tool like DEROB-LTH, corresponding sets of measured input and output data is needed. This data was obtained by performing measurements of outdoor and indoor climate data in the reference building, for the period of one year. The measurement results used in this study could also be used in the future for validation of other tools for short, medium and long term studies of energy performance in buildings in Mozambique.

The simulation results for indoor operative temperature and air temperature presented excellent agreement with those from the measurement equipment. Since there are a lot of variables that influence the energy balance of a building it is often difficult to get good agreement between simulations and measurements. One reason for the good agreement in this case may be that the outdoor temperature has a very strong influence on the indoor temperature. The results indicate that DEROB-LTH performs well for the climate and type of buildings prevailing in Mozambique, and it is recommended for use by engineers and researchers.

Simulations were performed for analysing the heating and cooling loads as a function of the internal loads for the reference building. The heating loads were, as expected, negligible. The cooling loads for the case of two people and some appliances was about 45% higher than for the case of an unoccupied building.

When a simulation tool has been validated, it can be used for studying the influence of parameters such as e.g. set points for indoor temperature, airtightness, solar gains and diverse type of windows applied in buildings or like in this case, the influence of internal loads. This is recommended as future work to be carried out in this residential

including other buildings existing in the same terrain. Parameter studies like these provide knowledge that can be used for improving building design and systems in an efficient way, in order to improve the energy performance of buildings.

8 Acknowledgements

The authors would like to acknowledge the financial support from Sida/SAREC and Supervisors from Department of Construction Sciences, Lund University and Eduardo Mondlane University. We would also like to thank all employees at the departments who contributed to the project.

References

- [1] Ryan, E. M. and Sanquist, T. F., Validation of building energy modeling tools under idealized and realistic conditions, *Energy and Buildings* 47,375-382, ELSEVIER, 2012.
- [2] Energy and Building Design, Faculty of Engineering, LTH, 2014. <http://www.ebd.lth.se/english/research/software/derob-lth/>, Accessed April 10, 2015.
- [3] Auziane, G., Energy Assessment Methodologies and Climatic Measurements – A Field Monitoring project in Maputo City, Report TABK-10/1026, Lund Institute of Technology, Lund University, 2010.
- [4] Dubois, M-C., Solar-Protective Glazing for Cold Climates, A Parametric Study of Energy Use in Offices, Report TABK-98/3053, Department of Building Science, Lund Institute of Technology, Lund University, 1998.
- [5] Wall, M. and Bülow-Hübe, H., Solar Protection in Buildings, Report TABK-01/3060, Division of Energy and Building Design, Department of Construction and Architecture, Lund Institute of Technology, Lund University, 2001.
- [6] Wang, Z., Controlling Indoor Climate, Passive cooling of residential buildings in hot-humid climates in China, Report TABK-96/1008, Department of Building science, Lund Institute of Technology, Lund University, 1996.
- [7] Rosenlund, H., “Housing Development & Management” Climate adaptation and energy efficiency of Buildings Experiment in Ghardaia, Algeria, Architecture and Development Studies, Lund Institute of Technology, Lund University, 1993.
- [8] Nyemark, J., Girault, P., et al, The “ETNA BESTEST” Empirical Validation Data Set. Ninth International IBPSA Conference, Montréal, Canada, August 15-18, 2005.

- [9] DEROB-LTH v2.0, Department of Architecture and Built Environment. Lund Institute of Technology, Lund University, Updatred-2013.
http://lthbyggark2.arkitektur.lth.se/ebdsw/Derob/Information/InstallationsEN2_0S20071105.pdf, Accessed April 10, 2015.
- [10] Cuamba, B. C., Uthui, R., et al., (unpubl.) Identification of areas with likely good wind regimes for energy application in Mozambique. Eduardo Mondlane University, Maputo, Mozambique.
- [11] Regulamento das Características de Comportamento Térmico dos Edifícios, DECRETO-LEI Nº 118/98, de Maio, Regulamento dos Sistemas Energéticos de Climatização em Edifícios, ISBN 972-0-06801-9, Portugal.
- [12] Wall, M., Energy-efficient terrace houses in Sweden Simulations and measurements, *Energy and Buildings* 38(6) pp. 627-634, ELSEVIER, 2005.
- [13] Saucier, J.F. and Dubois, M. C., Retrofit of Bungalow Houses in Quebec to Improve Energy Efficiency and Thermal Comfort. PLEA-26th Conference on Passive and Low Energy Architecture, Quebec City, Canada, 22-24 June 2009.
- [14] Anwar M., Rasul M. G., et al., Air Conditioning Energy Saving by Rooftop Greenery System in Subtropical Climate in Australia, *World Academy of Science, Engineering and Technology International Journal of Environmental, Ecological, Geological and Geophysical Engineering* Vol:7, No:7, 2013.
- [15] Energy standard for Buildings Except Low-Rise residential Buildings, ANSI/ASHRAE Standard 90.1 -2007, ISSN 1041-2336, 2007.
- [16] International Energy Conservation Code, International Code Council, 2012 (ICC),
http://publicecodes.cyberregs.com/icod/iecc/2012/icod_iecc_2012_re4_sec003.htm. Accessed April 10, 2015.

Paper V

Design and implementation of an experimental photovoltaic system for use in buildings in Mozambique

Gabriel Auziane*[‡], Kurt Källblad**^{*}, Bertil Fredlund***^{*}

*Department of Construction Sciences, Lund University, Box 118, S-221 00 Lund, Sweden and Faculty of Engineering, Eduardo Mondlane University, Maputo, Mozambique

**Department of Construction Sciences, Lund University, Box 118, S-221 00 Lund, Sweden

*** Department of Construction Sciences, Lund University, Box 118, S-221 00 Lund, Sweden
(Gabriel.Auziane@construction.lth.se, k.kallblad@tele2.se)

[‡]Corresponding Author; Gabriel Auziane, Department of Construction Sciences, Lund University, Box 118, S-221 00 Lund, Sweden, Tel: +46 462220000,

gabriel.auziane@construction.lth.se

Abstract In Mozambique, in many rural areas there is no electrical grid. In cities there is a grid, but the service is unreliable. With increased demand, electricity is expected to be insufficient, and worldwide, there is also a need for renewable energy sources for environmental reasons. PV systems have a great potential to contribute to solving these problems in Mozambique and other similar countries with plenty of solar resource. A PV system providing electricity for a residential building was designed and a pilot system was installed in Maputo. The system includes measuring equipment for monitoring the system via internet. Cost analyses were made for different alternatives. The pilot system works well and provides electricity for cooling and lighting. The capacity of the system agrees with the predictions made during design state. The electricity cost is about eight times higher than that from the grid. Despite the high cost, systems like this can today provide electricity for critical functions, like e.g. medical clinics in rural areas. They can also be used as back-up in critical systems in cities. As prices decrease, PV systems will have a great potential to provide electricity based on renewable sources in cities. The process could be faster by introducing subsidies and/or regulations. The system developed provides a framework for further research by testing and monitoring the function of different components, climatic conditions, loads etc. via internet.

Keywords Photovoltaic system, PV system, experimental design, energy efficiency, buildings, Mozambique.

1. Introduction

1.1. Energy situation in Mozambique

Mozambique is located in southeast Africa and has sub-tropical and tropical climate with a minimum average temperature of 19.5°C and maximum of 25.9°C [1]. It has a lot of conventional buildings with traditional home devices supplied by the electrical grid from Electricidade de Moçambique Company (EDM).

In Mozambique, it is estimated that from the total average of the energy used, 72% is used in residential buildings, 23% in industry, and 4% in transportation, whereas for electricity, 46% is used in residential buildings, 44% in industry and 10% in commercial and other sectors, [2].

In Europe, buildings consume about 40% of the total final energy requirements [3], buildings represent

32% of total final energy use in the world and in terms of primary energy use buildings represent around 40% in most IEA countries [4]. In the context of all the end-use sectors, the building sector is the largest sector in the world, with great energy use. The amount of energy used per building varies widely depending on the standard of living of the country, climate, and the age and type of the building.

In Mozambique, a lot of buildings in rural areas such as medical clinics, schools and residential buildings work without electrical energy, leading to for example bad working conditions in clinics and lack of providing lighting for evening classes in schools.

1.2. Available resources

Mozambique has a lot of natural resources for producing electrical energy, such as hydropower, biomass (wood, charcoal and animal waste) and gas. There are also findings of petroleum and gas in Rovuma River and offshore and onshore along the Mozambican coast.

Most of the electricity of Mozambique is produced at Cahora Bassa Dam, built and completed before independence in 1975. The total electricity capacity installed in Mozambique is about 2 308 MW, where hydropower is the dominant source, with 99.7% of the total electricity produced. The main sources of the primary energy in use are biomass (85%), hydropower (11%) and oil (5%). Mozambique is a net exporter of electricity; as 73.4% of the 2 075 MW generated by the Cahora Bassa Hydroelectric in Tete Province is exported to South Africa [5].

Mozambique is exposed to a predominant solar energy which increases the indoor thermal heat, especially in summer. According to [6], the average global horizontal insolation in Mozambique is 5.7 kWh/m²day, with a minimum average of 5.2 kWh/m²day and a maximum of 6.0 kWh/m²day. Maputo city presents an average of 5.3 kWh/m²day the minimum being in June and July; 3.8 kWh/m²day and the maximum rated at 6.9 kWh/m²day in January. This indicates that photovoltaic (PV) systems can certainly be used for creating electricity throughout the country.

1.3. Energy strategies

Following appeals from green buildings and building sustainable construction organizations, many architects and engineers nowadays take into consideration passive systems for indoor comfort during the building design stage. In hot climates with significant degree days of cooling requirements like in Mozambique, it is however not possible to get suitable indoor thermal comfort by solely the use of passive systems. An alternative for reaching acceptable indoor

comfort is the use of active systems such as HVAC. The drawback of this is increased use of energy in buildings.

The Mozambican government has a project called "Energy Reform and Access Project". This project aims to accelerate in a commercially viable manner, the use of electricity for economic growth and social services and thus improve the quality of life in unserved areas, as well as strengthen Mozambican ability to increase access to modern energy. The project supports the Government's National Energy Strategy that looks to reform the country's energy sector and increase private participation. The project also promotes the development and use of renewable energy, in particular solar PV systems, micro-hydro and other renewable sources which can contribute to the reduction of greenhouse gases.

1.4. Photovoltaic systems

Reduction of the energy use in buildings is an important issue due to the depletion of fossil fuel energy sources in the world. Renewable energy, such as PV systems, can provide electricity on sites with no grid and can provide back-up for important functions where there is a grid. It can also reduce the external energy use in buildings and, as prices are decreasing, in the future thereby probably lower end-user energy costs.

Since the photovoltaic effect was first discovered in 1839 by A. E. Becquerel there has been an enormous development. Nowadays, PV systems are available, that supplies electricity to a lot of devices in many technical and social areas such as education, health, transportation, telecommunication, residence, etc. PV systems have an advantage in producing electricity from the sun and have environmental benefits because the power source is an abundant renewable resource which is available almost every day. Even though PV systems are not as effective during cloudy weather, they still produce electricity with a small amount of power in those periods. PV systems are for example used for water pumps, floodlights in highways, in businesses, and as in the purpose of this work, in buildings [7].

The PV system presented in this paper was designed with the objective to integrate PV systems in rural buildings like clinics and schools, as well as in urban buildings for reducing energy use from the grid to zero for cooling, lighting and electrical domestic appliances. Combined with efficient appliances, significant energy reduction can be attained in buildings since efficient appliances by themselves; according to [8] can decrease the electrical consumption in dwellings by 10 to 60%.

2. Design of the stand-alone PV system

Photovoltaic systems include a lot of components that must be designed according to the specific type of system studied, site location and the load to be supplied. In general, the main PV system components are PV modules, charge controller, battery bank, inverter and devices (loads).

As a reference object, a flat in the “3 de Fevereiro Residential” was chosen for implementing a system for testing purposes. The flat meets all the requirements for implementing a PV system and the PV system can be integrated with another equipment already installed in the flat. This other equipment can monitor energy related parameters and consists of indoor and outdoor temperature and humidity sensors, irradiance sensors, wind speed and wind direction sensors and a data logger system for collecting and storing data.

2.1. Load estimation

Table 1 presents the loads installed in the flat in the “3 de Fevereiro Residential”.

Table 1. Load data of the flat.

Type of load	Number of units	Power (Watt/unit)	Daily duty cycle (Hours/day)
Indoor lighting, CFL	3	15	5
	2	25	5
	9	11	5
Outdoor lighting	6	15	10
Cooling	1	496	8
Ventilation	1	65	8
Washing clothes	1	1000	0.5
Refrigeration	1	90	10
Meas. equipment	1	26	24
Laptop	1	90	3
TV	1	70	5
DVD player	1	75	1.7
Clock radio	1	5	24

The total installed load is 2.2 kW. From Table 1, the total energy use per day of the whole load was found to be $E_L=9.3$ kWh, according to Eq. (1),

$$E_L = \sum_{i=0}^n n_i P_i H_i \quad (1)$$

where

E_L = Total energy use per day [kWh]

n_i = Number of units for the i^{th} load

P_i = $V_i I_i \cos \phi_i$ for AC loads and $V_i I_i$ for DC loads [kW]

H_i = Daily duty cycle of the i^{th} load in hours [h]

2.2. Tilt angle for a PV array

When designing a PV system the tilt angle is an important parameter. In this section we will only discuss the tilt angle for non-concentrator systems with fixed tilt angle. Tracking system will not be discussed.

If a system is to be used during the whole year and the site is placed between the two polar circles the “latitude tilt” is normally used; i.e. the tilt angle is set equal to the latitude and facing South in the Northern hemisphere and North in the Southern. This gives the maximum irradiance during the year if the beam radiation is dominating. North or south of the polar circles one must take into account the time of the year when the sun is below the horizon.

If a PV system is to be used only in a part of the year it can be of interest to see the variations of the irradiance over the year for different tilt angles.

The hourly climate data used for the calculations in this section is created by the computer program Meteororm [9]. The data created by the program is based on measured irradiance for Maputo City from 1981 to 2000. The used data contains information about beam irradiance and diffuse horizontal irradiance. Chea et al. [10] concluded that “METEONORM weather files are viable for using as input data for different simulation tools.”

The insolation caused by the beam irradiance depends on the incident angle which in turn depends on the sun’s declination, the equation of time, the site’s latitude, longitude and its time meridian. The insolation caused by diffuse horizontal irradiance and radiation reflected from the surroundings are determined by use of view factors. The albedo was set to 0.25. All calculations have been carried out using formulas given in [11].

Figure 1 and 2 present the results for the tilt angles 15°, 30° and 45° in kWh/m² and percent of insolation on a horizontal surface respectively. The yearly average insolation for the three tilt angles are 108, 110 and 107% respectively. Reference [10, table 1] gives for a surface tilted 26° and a ground reflectance of 0.2 the global insolation on a horizontal surface 1 916 kWh/m² and on the tilted 2 060 kWh/m². The quotient is 108%, i.e. in good agreement with the above result.

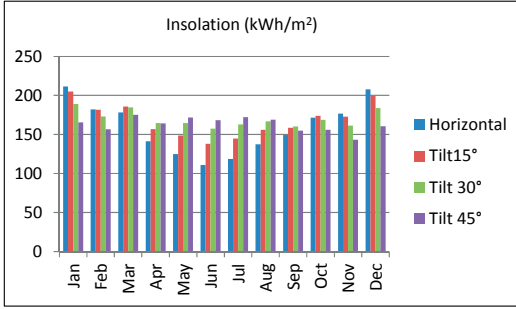

Figure 1. Monthly insolation in kWh/m².

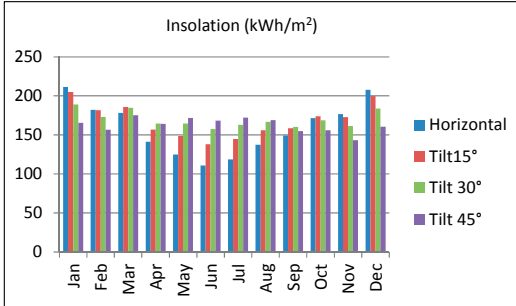

Figure 2. Monthly insolation in % of insolation on a horizontal surface.

2.3. PV array sizing

In the stand-alone battery-based system, the PV array must be rated to produce an amount of energy equal to average daily energy use, that is, 9.3 kWh per day, as calculated from Table 1.

The estimation of the PV array size took into account that the battery bank to be used must be recharged fully and dipped into the reserve supplied for desired two days of independent operation. In addition, data gathered from the site survey and some assumptions regarding the operation of the system such as PV array efficiency, total solar resource factor (TSRF) and the value of the peak sun hours were considered. In this project, auxiliary resources such as generators or other types of renewable energy were not included.

The peak sun hours for designing the system was based on the lowest amount of solar resource, which is typically the value found in the middle of winter. According to [6], the minimum value 3.8 kWh/m²day occurs in June and July.

Assuming 85% for the inverter efficiency, 85% for battery efficiency, 75% for PV array efficiency, 90% for TSRF from a site survey, and 3.8 h for peak sun

hours, the value of the power of the PV array was estimated to 5.0 kW according to Eq. (2).

$$E_{PV} = \frac{E_L}{\eta_i \eta_b \eta_{PV} \cdot TSRF \cdot G_{PS}} \quad (2)$$

where

- E_{PV} = PV array power [kW]
- E_L = Total energy load per day [kWh]
- η_i = Inverter efficiency
- η_b = Battery efficiency
- η_{PV} = PV array efficiency
- $TSRF$ = Total solar resource factor
- G_{PS} = Peak sun hours of the site [h]

The array size calculated here is the size needed to produce energy according to the amount of solar resource available. The actual performance of the system once installed on site will vary over the different seasons. So, assuming that the array will be constituted by modules rated at 200 W, it was estimated that a PV array with 25 modules is needed for supplying the load existent in the residential.

2.4. Battery bank sizing

The battery bank will be the main source for supplying the residential load in this stand-alone system since the PV array will work only for replenishing the battery bank when it is discharged. Thus, in order to calculate the battery bank capacity it is necessary to consider the inverter efficiency (85%), the number of days that the battery bank must last with charge (2 days), the temperature compensation factor (90%, based on a reference temperature of 15.6°C), the depth of discharge (DOD = 80%) needed and the battery voltage operation. The battery bank capacity computation is evaluated according to Eq. (3).

$$C_{Ah} = \frac{E_L}{\eta_i \cdot TC \cdot DOD \cdot U} ND_{ba} \quad (3)$$

where

- C_{Ah} = Battery bank capacity [Ah]
- E_L = Estimated average daily energy use [kWh]
- η_i = inverter efficiency
- TC = Temperature compensation factor
- DOD = Battery depth of discharge
- U = Battery bank voltage [V]
- ND_{ba} = Number of days for battery autonomy

Considering the charge controller output of 48 V, the battery bank was estimated to 630 Ah. The battery will consist of four 12 V batteries in a series. [12].

2.5. Charge controller sizing

The main function of the charge controller is to regulate the charge going into the battery bank from the solar panel array and prevent overcharging and reverse current flow at night or clouded days. The charge controller should be one with at least 120 A, 48 VDC [13].

2.6. Evaluation of the inverter

In the evaluation of an inverter for any battery-based application, the voltage for the loads, the maximum power draw, charging capabilities (from an AC source), and the ability for the inverter to supply power when certain loads surge (draw a large amount of power for a very short duration) must be considered. The inverter should be one with 4 kW, 230 VAC, 50 Hz [7].

3. Economic viability of the PV system

PV systems, in general, are characterized by high initial investment. Thus, for its implementation it is necessary to evaluate the economic viability for decision making over its affordability. It is in this context that the life cycle cost (LCC) analysis of a PV system is presented.

The LCC of a PV system consists of the initial capital investment (CI_0), (PV modules, charge controller, battery bank, inverter, additional components and cost of installation), the present value of the battery replacement costs (BR_{PV}) and the present value of the operation and maintenance costs (OM_{PV}).

In this work, the LCC was computed according to Eq. (4), [14].

$$LCC = CI_0 + BR_{PV} + OM_{PV} \quad (4)$$

where

LCC = Life cycle cost

CI_0 = initial capital investment

BR_{PV} = present value of the battery replacement costs

OM_{PV} = present value of the operation and maintenance costs

For computation purposes, the costs of the system was divided in PV array cost (C_{PV}), charge controller cost (C_{CC}), initial battery bank cost (C_B), inverter cost (C_I), cost for additional components and installation cost (C_{Inst}). So, the CI_0 is determined summing the costs from equations (5) up to (8), presented below.

$$C_{PV} = \frac{P_{PV}}{W_p} W_p N_{PV} \quad (5)$$

where

C_{PV} = PV array cost

P_{PV}/W_p = price of PV module per rated power

W_p = rated power of PV module

N_{PV} = number of PV modules

$$C_{CC} = \frac{P_{CC}}{I_{CC}} I_{CC} \quad (6)$$

where

C_{CC} = charge controller cost

P_{CC}/I_{CC} = price of the charge controller per current unit of the charge controller

I_{CC} = estimated charge controller current.

$$C_B = \frac{P_B}{B_C} B_C \quad (7)$$

where

C_B = battery bank cost

P_B/B_C = price of the battery per ampere hour

B_C = capacity of the battery

$$C_I = \frac{P_I}{W_I} W_I \quad (8)$$

where

C_I = inverter cost

P_I/W_I = price of the inverter per inverter power

W_I = power of the inverter

The cost for additional components, C_{AC} was in this work calculated by summing the costs for all the items, and the installation cost was assumed to be 20% of the PV system cost [15].

The lifetime (N_L) of all the items is assumed to be 25 years. The exception of this lifetime goes to the battery bank which is considered to have 5 years lifetime. Thus, an extra 4 groups of batteries (each with 4 batteries) must be purchased every 5th year to complete the lifetime of the system.

The present value of the battery replacement costs, BR_{PV} is calculated according to Eq. (9), [15].

$$BR_{PV} = C_{B5PV} + C_{B10PV} + C_{B15PV} + C_{B20PV} \quad (9)$$

where

$$\begin{aligned} BR_{PV} &= \text{present value of the battery} \\ &\quad \text{replacement costs} \\ C_{BNPV} &= \text{present value of the extra group of} \\ &\quad \text{batteries purchased after year } N \\ C_{BNPV} &= C_B \left(\frac{1+i}{1+d} \right)^N \end{aligned} \quad (10)$$

where

$$\begin{aligned} C_{BNPV} &= \text{present value of the extra group of} \\ &\quad \text{batteries purchased after year } N \\ C_B &= \text{battery bank cost} \\ i &= \text{inflation rate} \\ d &= \text{discount or interest rate} \end{aligned}$$

According to [16], the city of Nampula, in northern Mozambique, recorded the highest average annual inflation in 2012, with 3.14 percent, followed by the cities of Beira (3.07 percent) and Maputo (2.09 percent). Thus, in this work an inflation rate of 3% and a discount or interest rate of 10% was assumed.

The operation and maintenance cost per year was assumed to be 2% of the PV system cost, [15]. The present value of the operation and maintenance cost C_{OMPV} was determined according to Eq. (11).

$$C_{OMPV} = (OM) \cdot \left(\frac{1+i}{1+d} \right) \cdot \left[\frac{1 - \left(\frac{1+i}{1+d} \right)^{N_L}}{1 - \left(\frac{1+i}{1+d} \right)} \right] \quad (11)$$

where

$$\begin{aligned} C_{OMPV} &= \text{present value of operation and} \\ &\quad \text{maintenance cost} \\ OM &= \text{operation and maintenance cost per} \\ &\quad \text{year} \\ N_L &= \text{lifetime of the system [years]} \end{aligned}$$

Considering the matter presented above, Eq. (4) for LCC computation, can be rewritten as presented in Eq. (12)

$$\begin{aligned} LCC &= C_{PV} + C_{CC} + C_B + C_I + C_{AC} + \dots \\ &+ C_{B5PV} + C_{B10PV} + C_{B15PV} + C_{B20PV} + C_{OMPV} \end{aligned} \quad (12)$$

The LCC can also be presented in terms of annual basis, and in this case, the annualized LCC ($ALCC$) of the PV system can be estimated using the Eq. (13).

$$ALCC = LCC \cdot \frac{\left[1 - \left(\frac{1+i}{1+d} \right) \right]}{\left[1 - \left(\frac{1+i}{1+d} \right)^{N_L} \right]} \quad (13)$$

Therefore, the unit PV electrical cost can be calculated with the use of Eq. (14).

$$U_{PVC} = \frac{ALCC}{365 E_L} \quad (14)$$

where

$$\begin{aligned} U_{PVC} &= \text{Unit PV electrical cost} \\ ALCC &= \text{annualized life cycle cost} \\ E_L &= \text{total energy per day} \\ 365 &= \text{total number of days per year.} \end{aligned}$$

3.1. Results and discussion

The cost data used for all items that constitute the PV system in this work, Table 2, were obtained from quotations relating to these specific installations, and they include shipping costs etc. They are thus relevant for the case of installing one single system. If the volumes become larger there is a potential for much lower prices.

Given that PV systems are characterized by high initial cost, and having the need to verify which alternative is affordable within an available budget, the following three alternatives were established and considered:

- (A) PV system for supplying the load installed in the flat (see Table 1).
- (B) PV system for supplying the priority load (lighting, refrigeration, ventilation, DVD-player and clock radio) of the flat.
- (C) Small PV system which is suitable for research purpose in a pilot study.

Table 3 presents the characteristics of the (A), (B) and (C) PV system alternatives, and Table 4 the respective economic parameters based on the unitary prices presented in Table 2.

The LCC from Eq. (12) of the PV system alternatives are presented in Table 5. With annualized LCC ($ALCC$) and considering the values of the total energy per day (E_L), evaluated according to Eq. (1), and

using Eq (14), the unit PV electricity cost for each alternative was estimated as presented in Table 5.

The PV electricity cost of these systems is higher than the one charged to the electricity consumers by Electricidade de Moçambique (EDM) [5], since the domestic tariff from this company varies between 0.035 USD/kWh and 0.121 USD/kWh for 0 to >500 kWh, respectively for traditional energy meters. In recent years the EDM Company has been replacing the traditional energy meters by prepayment systems. Therefore, in this paper we considered a prepayment tariff for price comparisons once the work is related to social and domestic activities.

Considering the energy tariff presented in Table 6, it was concluded that the energy cost from the PV system presented in this work is higher than the social and domestic tariffs applied by EDM. For alternative (A) it is 8.3 times higher, for (B) 9.0 times higher and for (C) it is 10.2 times higher.

4. PV System installation

The alternative (C) was implemented as a pilot experimental PV system for research purposes. The system was tested during summertime in Lund, Sweden, in 2012 to verify its operability. After the test of the PV system components and its operability, all the

PV system components were transferred and installed in Maputo city. The system was integrated with the other measurement equipment installed in “3 de Fevereiro Residential”, namely: solar irradiance sensors, indoor and outdoor temperature and humidity sensors, wind speed, wind direction and electric energy meters. This residential building represents the typical characteristics and parameters of the dwellings in the cities and districts in Mozambique.

4.1. Layout of the PV system

The layout of the PV system assembled in Maputo city is basically similar to the one tested in Lund, but with some changes inherent to local installation conditions. The layout is presented in Fig. 3.

The conception of the PV system presented in Fig. 3 was based on the possibility to power an air conditioning and some luminaries. An electronic unit system (ART-Data Acquisition Device, USB 5935) was included for collecting and storing data in the mini-computer via a SensiLog device. Additionally, the system is designed with an access to data stored in the system via internet.

Table 2. PV cost data base.

Item	PV	Charge controller, stand-alone (A) (B)	Charge controller, integrated (C)	Battery	Inverter	Installation	OM/year of PV modules
Cost (USD)	$2.29/W_p$	$1.96/I_{cc}$	$1.23/I_{cc}$	$2.01/B_c$	$0.12/W_I$	20% of PV system cost	2% of PV system cost

Table 3. Characteristics of the PV systems.

	(A)	(B)	(C)
PV module, Mono-crystalline	$W_p = 200$ W $I_{sc} = 4.68$ A $I_{mp} = 4.43$ A $V_{oc} = 57.6$ V $V_{mp} = 45.63$ V	$W_p = 200$ W $I_{sc} = 4.68$ A $I_{mp} = 4.43$ A $V_{oc} = 57.6$ V $V_{mp} = 45.63$ V	$W_p = 100$ W $I_{sc} = 4.68$ A $I_{mp} = 4.43$ A $V_{oc} = 57.6$ V $V_{mp} = 45.63$ V
Charge controller	MPPT 120 A 5760 W 48 VDC	MPPT 50 A 2400 W 48 VDC	PWM 10 A 580 W 48 VDC
Batteries, lead-acid	630 Ah (12V) 48 VDC	270 Ah (12V) 48 VDC	75 Ah (12V) 24 VDC
Inverter	4 kW 48 VDC/230VAC	2.1 kW 48 VDC/230VAC	3 kW 24 VDC/230VAC

Table 4. Cost of the different alternatives.

Item	Alternatives					
	(A)		(B)		(C)	
	Qty	Cost (USD)	Qty	Cost (USD)	Qty	Cost (USD)
PV module, Mono-crystalline	25	11 450	11	5 038	2	458
Charge controller	1	235	1	98	1	12
Batteries	4	5 065	4	2 171	2	302
Inverter	1	480	1	252	1	360
Electric component devices (ECD)	1	1 931	1	1 770	1	1 609
Installation cost	1	3 832	1	1 866	1	550
Present values of the 1 st extra group of batteries	1	3 646	1	1 563	1	217
Present values of the 2 nd extra group of batteries	1	2 625	1	1 125	1	156
Present values of the 3 rd extra group of batteries	1	1 889	1	810	1	113
Present values of the 4 th extra group of batteries	1	1 360	1	583	1	81
Present value of operation and maintenance cost	1	4 549	1	2 215	1	653

Table 5. Life cycle cost and estimated unit PV electrical cost.

	Alternatives		
	(A)	(B)	(C)
Life cycle cost (LCC), (USD)	37 062	17 491	4 519
Unit electrical cost (U_{PVC}), (USD/kWh)	0.86	0.94	1.06

Table 6: Social and domestic energy tariff applied by the EDM.

Energy use registered (kWh/Month)	Social tariff* (MTN/kWh)**	Social tariff* (USD/kWh)	Domestic tariff* (MTN/kWh)**	Domestic tariff* (USD/kWh)		
From 0 up to 100	1.07	0.035	2.50	0.08		
From 101 up to 300			3.53	0.12		
From 301 up to 500					3.71	0.12
More than 500						
Prepayment						

* Social and domestic tariffs are used for different types of family dwellings.

**MTN is the Mozambican currency (USD/30.7 MTN – the exchange rate of 2014-09-24).

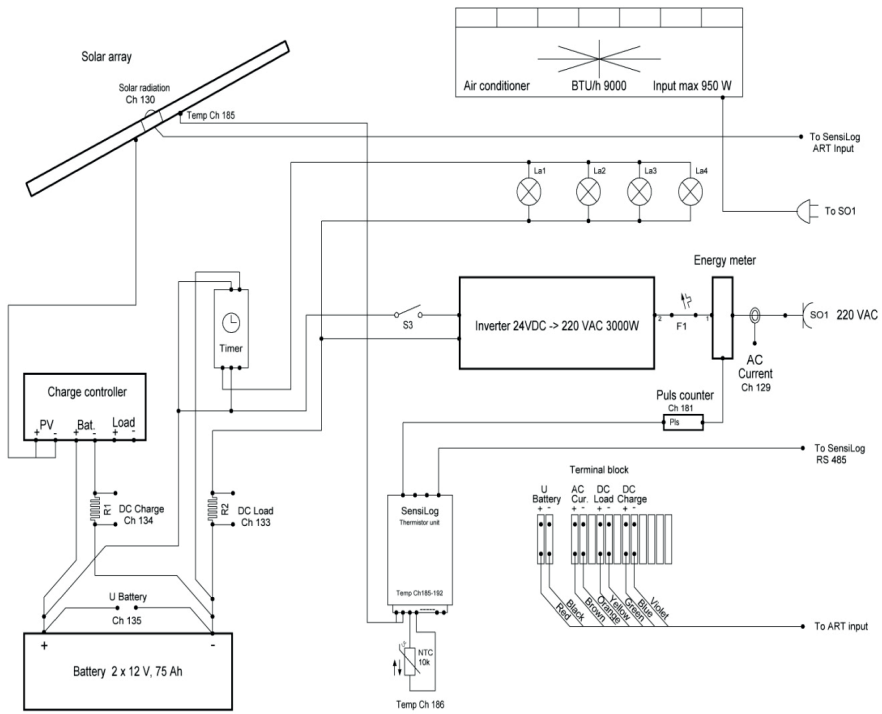

Figure 3. Layout of the PV system (by G. Auziane and T. Lundgren)

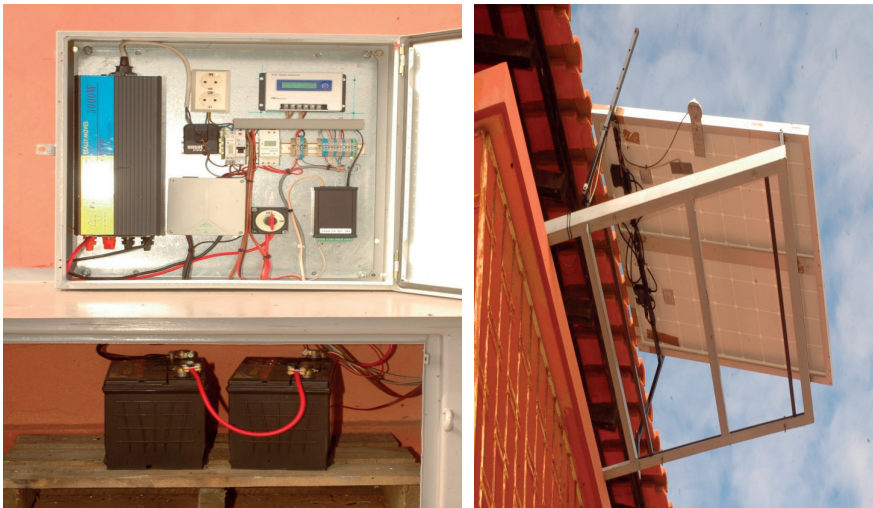

Figure 4. PV system installed in the “3 de Fevereiro Residential”, a: Electronic components and b: PV array frame.

4.2. System assembled in Maputo City

Figure 4 shows the PV system installed in the "3 de Fevereiro Residential" in Maputo city. Fig. 4a illustrates the electronic components presented in Fig. 1 and Fig. 4b shows the PV array frame with connections to the main PV panel box. The tilt angle was fixed at 30° and oriented to the north.

4.3. Measurement results for February 2013

In this section the measurement results of a summer month, February 2013, are presented. The global and diffuse solar irradiance on a horizontal surface are measured using the sensors (Ch121 and Ch122) of the measurement equipment installed in 2010 [17]. A sensor (Ch130) for measuring tilted global solar irradiance was installed on the PV array, see Figs. 3 and 4b.

Figure 5 shows the variation in global and diffuse solar irradiance on a horizontal surface. The maximum and average global irradiance during this period was 1 120 W/m² and 302 W/m² and, the maximum and average diffuse irradiance on a horizontal surface was 667 W/m² and 106 W/m², respectively.

The maximum values of the global irradiance (1 120 W/m²) occurred on 2013-02-03, 12:00, noon, and the maximum diffuse (667 W/m²) occurred in 2013-02-06 at 11:00 AM.

Figure 6 shows a detail of the irradiance on 2013-02-03, the day with maximum global horizontal irradiance.

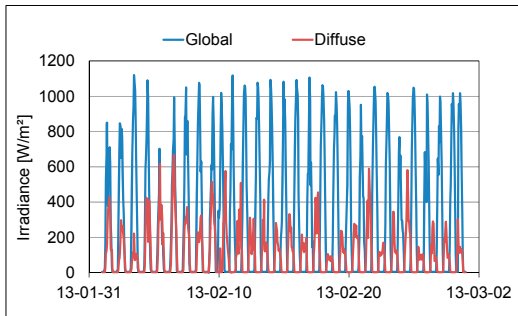

Figure 5. Global and diffuse solar irradiance on a horizontal surface.

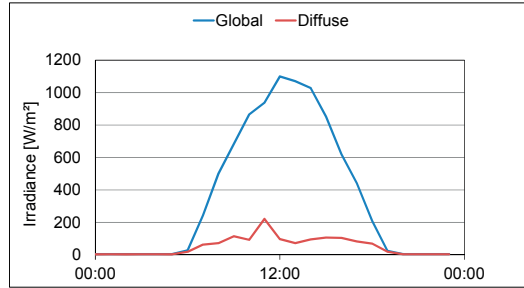

Figure 6. Global and diffuse solar irradiance on horizontal surface on 13-02-03.

Figure 7 presents the values of the solar irradiance on the tilted angle. The maximum value 1 141 W/m² occurred on 2013-02-14 the average value was 293 W/m².

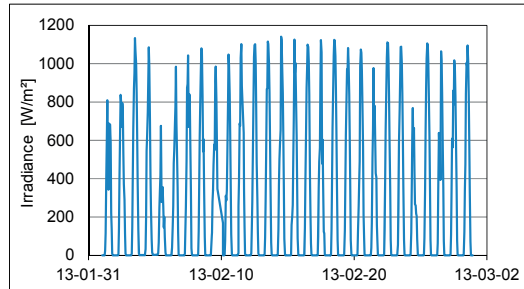

Figure 7. Global solar irradiance of the PV array tilt angle.

Figure 8 shows a comparison of the global solar irradiance on a horizontal surface and tilted angle at noon during the day with maximum value on the horizontal surface, 2013-02-03. The maximum irradiance on the horizontal surface was 1 120 W/m², compared to 1 133 W/m² on the tilted surface. The relation between these values is expected to be the opposite, but this may be explained by the accuracy of the meters. The used pyranometers have a calibration uncertainty of ± 5% and a directional response of ± 5%. As the main purpose of this work is to show that the equipment works, and not to present meteorological data, these deviations were not further examined.

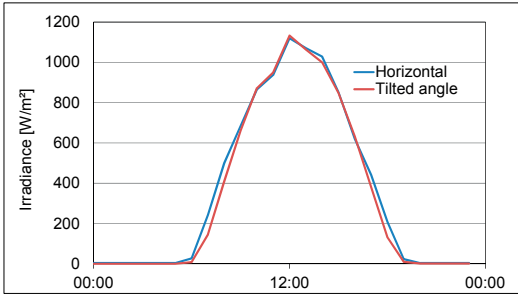

Figure 8. Global solar irradiance on horizontal and tilted angle on 2013-02-03.

Figure 9 presents the air temperature on site and PV cell temperature (Ch81 and Ch185 as indicated in Figure 3). The maximum, average and minimum air temperature in February of 2013 was 30.4°C, 25.5°C and 20.9°C respectively, whereas on the rear of the cell was recorded at the same time 52.6°C, 31°C and 20°C respectively.

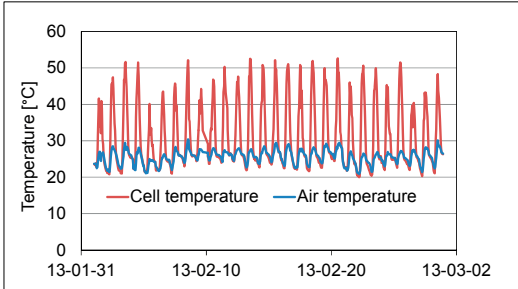

Figure 9. Air temperature and PV cell temperature during February 2013.

Figure 10 presents the behaviour of the current from the charge controller to the battery bank. This graph has the same shape as the one of the global irradiance on tilted angle presented in Figure 7. From Figure 10, it is seen that the minimum charge current occurred on 2013-02-05. The maximum charge current (3.1 A) of that day occurred at 11:00AM.

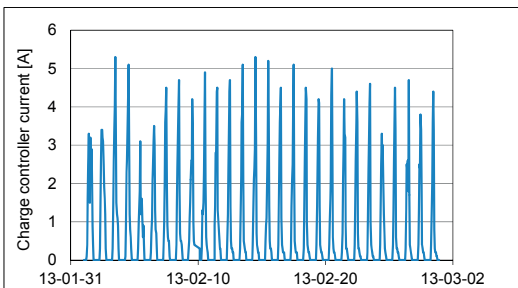

Figure 10. Current from charge controller to battery bank during February 2013.

Figure 11 and 12 show the similarity of the global irradiance on the tilt angle with that of the charge controller current on 2013-02-05.

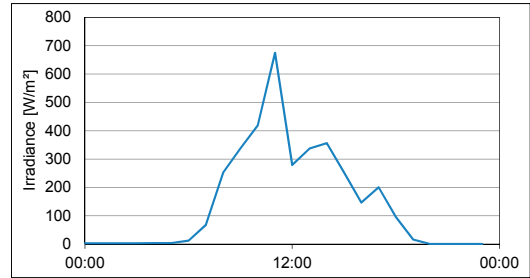

Figure 11. Global irradiance on tilted angle on 2013-02-05.

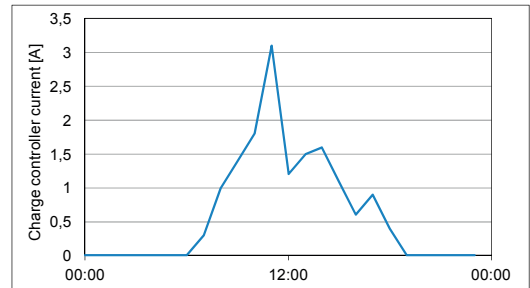

Figure 12. Current from charge controller to battery bank on 2013-02-05.

From Fig. 11 it becomes clear that the fluctuation of the charger current occurring in Fig. 12, was caused by clouds that appeared in two moments, the first moment was from 11:00 up to 12:00 AM and the second one from 14:00 up to 16:00 PM. From 17:00 the irradiance decreased continuously until it became completely zero at 20:00 PM.

Figure 13 presents the battery bank voltage during the whole month. A detail of the battery charging and discharging is illustrated in Fig. 14 for 2013-02-05, the day with lowest global solar irradiance.

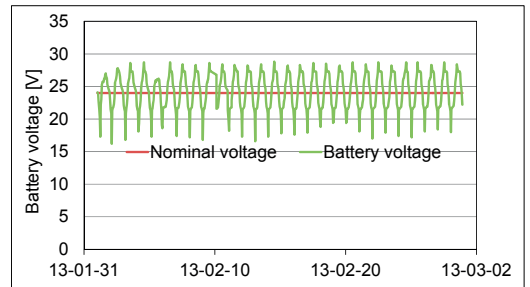

Figure 13. Voltage of the battery bank during February 2013.

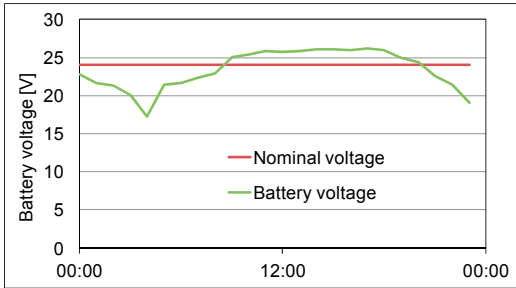

Figure 14. Voltage of the battery bank on 2013-02-05.

Figure 15 presents an aggregation of the graphs of the DC load current (Ch133), battery bank charging current (Ch134) and the battery bank voltage (Ch135). The DC load is constituted by LED luminaries which are controlled by an electric timer which switch on-off the outdoor lighting every day. Figure 15 shows the setup periods of the electric timer and in which period the battery was charged during this test day.

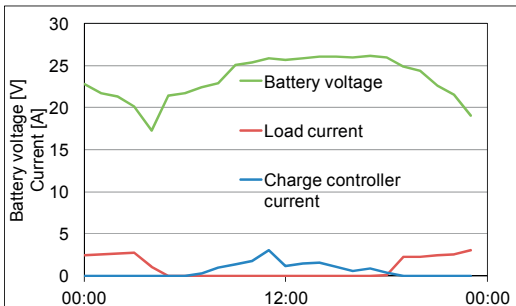

Figure 15. Battery voltage, load current and charge controller current on 2013-02-05.

5. Conclusions

The PV system presented in this paper showed good performance in supplying DC and AC loads. This indicates that the design method used is appropriate for the climatic conditions and typical loads in Mozambique.

The measuring equipment worked well and the test data could be retrieved anywhere in the world via internet. This setup gives the possibility to monitor installations in rural areas for research or control of the operation from offices in urban areas. The extra cost for this system was not included in the LCC analysis.

From the alternatives (A) and (B) in Section 3.1 it is concluded that the initial investment of the PV systems is high and unaffordable for most people today. In addition, the electricity price is higher than that applied by the holder of the national grid. As prices of

PV systems decrease, these systems will be more interesting to use.

To accelerate this development towards more renewable energy, the government could introduce incentives and loans so that people can be motivated to use PV systems.

For urban areas, rules for selling excessive energy produced by PV systems to the national grid could be introduced for household who possess PV systems.

In rural areas, where there is no grid, PV-systems are interesting already today for supplying electricity to critical functions such as medical clinics, and also for priority loads in residential buildings. PV-systems could also be used as back-up for critical functions in urban areas.

Acknowledgements

The authors would like to acknowledge the financial support from Sida/SAREC and Supervisors from Department of Construction Sciences, Lund University and Eduardo Mondlane University. We would also like to thank all employees at the departments who contributed to the project.

References

- [1] Climate Change Knowledge Portal, The World Bank Group, Accessed October 1 2014, http://sdwebx.worldbank.org/climateportal/index.cfm?page=country_historical_climate&ThisRegion=Africa&ThisCCCode=MOZ
- [2] Arthur, F., Nhassengo, A. J., et al., Statistical Summary, Electricidade de Moçambique, 2012.
- [3] EUROPE'S BUILDINGS UNDER THE MICROSCOPE, Accessed October 1 2014, http://www.europeanclimate.org/documents/LR_%20CbC_study.pdf
- [4] International Energy Agency Accessed October 1 2014, <http://www.iea.org/aboutus/faqs/energyefficiency/>
- [5] Electricidade de Moçambique (EDM), Accessed September 26 2014, <http://www.edm.co.mz/>
- [6] B. C. Cuamba et al., "A solar energy resources assessment in Mozambique", Journal of Energy in Southern Africa, Vol 17, No 4, November 2006.
- [7] R. Mayfield, Photovoltaic Design & Installation for Dummies, Wiley Publishing, 2010.
- [8] M. Ellis, Experience with Energy Efficiency Regulations for Electrical Equipment, OECD/IEA, August 2007.
- [9] Meteororm Version 6.0, Computer program from METEOTEST, Fabrikstrasse 14, CH-3012 Bern, Switzerland, 2007.
- [10] Chea L.C., Karlsson, B. and Cuamba B., "Irradiation Analysis for Maputo", Journal of Civil Engineering and Architecture, ISSN 1934-7359, Volume 6, No. 12 (Serial No. 61), pp. 1654-1662, USA, 2012.
- [11] Källblad, K., "Thermal Models of Buildings. Theories, Models and Computer Programs". Department of

- Building Science, Faculty of Engineering, University of Lund, Sweden. (ISSN 1103-4467, ISRN LUADL/TABK--1015--SE), 1998.
- [12] Bundu Power-Renewable Energy, Accessed October 1 2014 http://www.hybridpower.co.za/battery_620.php.
- [13] Guangzhou Helizhanchuang Electric Technology Co., Accessed October 1 2014 http://rittalups.en.alibaba.com/product/1069409378-212463933/48V_40A_to_120A_LCD_display_cheapest_price_solar_charge_controller.html
- [14] A. Amal, Hassan, Faten H. Fahmy, Abd El-Shafy A. Nafeh and Mohamed A. El-sayed, Stand-alone photovoltaic system for an emergency health clinic. The online Journal on Electronics and Electrical Engineering (OJEEE), Vol. (2) – No. (4), Reference number: W10-0025, 2010.
- [15] Abd El-Shafy A. Nafeh, Design and economic analysis of a Stand-Alone PV system to electrify a remote area household in Egypt: The open renewable energy Journal, Vol 2, pp. 33-37, 2009.
- [16] Portal of the Government of Mozambique, Accessed October 1, 2014 http://www.portaldogoverno.gov.mz/noticias/news_folder_econom_neg/dezembro-2012/economia-mocambicana-devera-crescer-8-4-por-cento-em-2013/
- [17] G. Auziane, “Energy Assessment Methodologies and Climatic Measurements – A Field Monitoring project in Maputo City”, Report TABK—10/1026, Lund Institute of Technology, Lund University, 2010.

