



LUND UNIVERSITY

Social Ecography

International trade, network analysis, and an Emmanuelian conceptualization of ecological unequal exchange

Nordlund, Carl

2010

[Link to publication](#)

Citation for published version (APA):

Nordlund, C. (2010). *Social Ecography: International trade, network analysis, and an Emmanuelian conceptualization of ecological unequal exchange*. [Doctoral Thesis (monograph), Human Ecology]. Department of Social and Economic Geography, Lund University.

Total number of authors:

1

General rights

Unless other specific re-use rights are stated the following general rights apply:

Copyright and moral rights for the publications made accessible in the public portal are retained by the authors and/or other copyright owners and it is a condition of accessing publications that users recognise and abide by the legal requirements associated with these rights.

- Users may download and print one copy of any publication from the public portal for the purpose of private study or research.
- You may not further distribute the material or use it for any profit-making activity or commercial gain
- You may freely distribute the URL identifying the publication in the public portal

Read more about Creative commons licenses: <https://creativecommons.org/licenses/>

Take down policy

If you believe that this document breaches copyright please contact us providing details, and we will remove access to the work immediately and investigate your claim.

LUND UNIVERSITY

PO Box 117
221 00 Lund
+46 46-222 00 00

LUND STUDIES IN HUMAN ECOLOGY 11

Social Ecography

International trade, network analysis, and an
Emmanuelian conceptualization of ecological
unequal exchange

Carl Nordlund



LUND
UNIVERSITY

Human Ecology Division
Lund University
Sölvegatan 12
S-223 62 Lund
Sweden

© Carl Nordlund 2010
Illustration on rear cover by Kristina Anshelm

ISSN 1403-5022
ISBN 978-91-628-8138-2

Printed at Lund university, Media-Tryck, Sweden

To Alice and Ebba

Contents

Acknowledgements	7
1. Introduction: Themes, hypothesis and thesis structure	9
On international trade, its theories, and contrasting views on its distributional role.....	11
On structures	16
The hypothesis in this thesis	17
The world-system perspective on the fragmentation of scientific disciplines.....	18
Social ecology?	20
Thesis structure	21
2. Economic exchange theory and international trade: Past and present	25
The anthropological perspective: modes of distribution.....	26
Classical trade theory	30
The Ricardian theory of comparative costs	33
Division of the gains from trade	36
John Stuart Mill: reciprocal demand as determining division of gains from trade.....	37
Friedrich List: a non-English classical discourse.....	39
The legacy of the classical school.....	41
Neo-classical trade theory.....	42
Three characteristic traits of the neo-classical school.....	42
Neo-classical trade theory I: post-classicism and Alfred Marshall	45
Neo-classical trade theory II: the Heckscher-Ohlin model.....	47
Neo-classical trade theory III: New Trade Theory	51
Sticky wages, demand elasticities, and diminishing terms of trade: Prebisch and Singer.....	53
Conclusions.....	59
3. Economic exchange structures.....	61
Economic geography	66
Transport networks as related to economic growth and development.....	69
'New Economic Geography' (a.k.a. geographical economics)	76
Paul Krugman	79
Puga and Venables.....	83
Conclusion	85
4. Social Network Analysis I: Basic concepts and centrality analysis.....	87
Approaching structures and networks.....	87
Basic concepts, network data and visualization methods	90
Visualizing networks	95
Centrality analysis.....	98
Theoretical conceptualizations.....	103
Balanced Distribution Deviation (BDD) index.....	105
5. Social Network Analysis II: Role-analysis and structural world-system studies.....	113
Role analysis	113
Structural equivalence.....	114
Regular equivalence.....	116
Blockmodeling: regular blockmodels	119
Previously conducted network-analytical studies of the contemporary world-system....	126
The Kick-start of international blockmodeling.....	126
Breiger (1981).....	131
Nemeth and Smith (1985).....	132
Smith and White (1992).....	134

Smith and White on unequal exchange: asymmetrical commodity flows.....	139
Mahutga (2006).....	141
Mahutga: Summary and critique.....	146
Summary of previously done studies.....	148
Conclusion.....	150
6. Commodity flow analysis and notions of unequal exchange.....	151
On the analysis of global commodity flows.....	151
Global Commodity Chains: research agenda, theoretical stances, and general findings.....	154
Conventional and ecological unequal exchange.....	161
The pre-Emmanuel Latin American traditions.....	162
Emmanuel.....	164
World-systemic conceptualizations of unequal exchange.....	166
Ecological unequal exchange.....	169
Bunker.....	171
Hornborg.....	172
Andrew Jorgenson.....	175
Towards an Emmanuelian conceptualization of ecological unequal exchange.....	178
7. Fuel commodity trade.....	183
Data.....	185
Degree centrality: National flows of value and energy content.....	190
Centrality analysis.....	196
Regular role-equivalence: the exchange value aspect.....	200
Regular role-equivalence: the energy aspect.....	205
Energy unequal exchange vis-à-vis structural positionality.....	209
Conclusion.....	212
8. Agricultural commodity trade.....	215
From ghost acreages to Ecological Footprints.....	216
National Ecological Footprint methodology as of 2004.....	217
Method and algorithm: Ecological Footprints.....	225
Calculating “embedded areas” of wheat exports from El Salvador.....	227
Selecting the agricultural commodities to include.....	229
Degree centrality: National flows of exchange value and appropriated areas.....	238
Centrality analysis.....	245
Regular role-equivalence: the monetary aspect.....	247
Regular role-equivalence: the cropland hectares aspect.....	251
Hectare unequal exchange vis-à-vis structural positionality.....	256
Conclusion.....	259
9. Concluding discussion.....	263
General ecographic findings.....	265
On monetary and biophysical trade balances.....	266
On measuring centrality.....	268
On role-structural mapping.....	269
On structural positionality and ecological unequal exchange.....	272
Ecological unequal exchange of fuel commodities.....	272
Ecological unequal exchange of primary agricultural commodities.....	273
Summary discussion on the results regarding the thesis hypothesis.....	274
Concluding words.....	276
Appendix A: Dataset generation and coverage.....	279
References.....	283

Acknowledgements

A central idea in Paul Krugman's models on spatial economics is concerned with the interplay between centripetal and centrifugal economic forces. Instead of finding all human economic activity drawn into a singular point, or spread equally across all possible spaces, these two counteracting forces, it is argued, create the regularities and structures that we recognize from the real world.

In the non-modeled world, I note that the social context of a PhD student resembles what Krugman describes. The centripetal forces are represented by colleagues, teachers, fellow students, and other scholars whose knowledge, suggestions and work have pulled me towards completing this thesis. My family and friends represent the centrifugal forces – although constantly spurring me to finish this thesis, they have also made sure that I have experienced the sun, the world, the inside of a pub, and, as far as it is possible for a PhD student, a rich social life. However, any attempt to partition the actors in my own social network into these two distinct set of roles would be undermined by the substantial overlap between colleagues and friends.

First, I would like to thank and show my appreciation to all my colleagues at the Human Ecology Division, Lund University. Pernille Gooch, my thesis supervisor, has been a great support and has offered me a lot of advice, having read through my material several times. Her enduring support, our discussions on how to structure the thesis, her insightful comments and suggestions on which darlings to keep and to kill, etc., were all fundamental for me to complete this thesis. Alf Hornborg has equally been a great inspiration and foundational for the development of this thesis. In addition to having introduced me to world-system analysis, ecological economics and thoughts on ecological unequal exchange, there would be no thesis without Alf's belief in my ability to write one. Thomas Malm has also been a great support during my doctorate studies. Having assisted me in matters big and small, guiding me through all the practicalities of writing a thesis, Thomas has also been very encouraging in my work.

Thanks to Douglas White, my external methodological supervisor who read through my network-methodological chapters, also teaching me more about regular equivalence and centrality analysis. I am very grateful for your crucial assistance and guidance, letting me tap into your vast knowledge in network analysis!

There are several past and present colleagues at the Human Ecology Division that I wish to extend my thanks to. Sabina Andrén, John Brolin, Carina Borgström Hansson, Love Eriksen, Jutta Falkengren, Kenneth Hermele, Per Johansson, and Ebba Lisberg Jensen, Michael Moon, Pernilla Ouis – thank you all for your inspiration, feedback and interesting discussions at the department. Thanks to Lynn Åkesson, Magnus Wikdahl, Kerstin Helgesson and others at the department of European Ethnology, and thanks to all the people at the department of Social and Economic Geography. Pernilla – thanks for letting me stay in your cottage outside Lund, where I wrote a crucial part of this thesis. Michael – thanks for the graphical layout files. A special thank to John Brolin for our ongoing academic discussions, for babysitting Wilma, for coffee breaks, parties, and hanging out.

Thanks to Jason Moore for checking through my thesis at the end and supplying me with valuable insights, dinners, friendship and hanging out. Thanks to Diana Gildea for her

unyielding support and encouraging comments – and congratulations to the three of you (hi Malcolm!). Thanks to Andrew Jorgenson for his equally unyielding support and constant belief that I actually would pull this thesis together some day – the best ones are indeed those that are finished.

During the years, I have had correspondence and dialogue with several scholars around the world, supplying me with details, arguments, knowledge, and hard-to-find articles. Steve Borgatti and Martin Everett – thanks for your patience in answering all my network-methodological questions over the years, questions which I now realize were quite *noobish*. Thanks to Jennifer Bair, Trevor Barnes, George Barnett, Gary Gereffi, Andreas Grotewold, Matthew Mahutga, William Rees, Eric Sheppard, Mathis Wackernagel, Aleš Žiberna, among others, for reading my mails, answering my questions, and sending me material I had a hard time to find. I am absolutely certain that there are several more to thank that simply have slipped my mind at the moment.

That said, it must of course be underlined that I am solely responsible for whatever errors and imperfections which are to be found in this thesis.

Although there are loads of friends and acquaintances I would like to send my gratitude to, I have to restrict myself here, but you all have my warmest thanks. Ana-Gabriela, Emil, Emma, Jenny, Per-Arne, etc *in absurdum* – thanks for your friendship, for the Roskilde festivals, for the crocheting sessions, the Simpan coffee breaks, the travels, and the Bräde game tournaments.

Finally, but definitely not least, I would like to extend my thanks and gratitude to my family. To my fiancée Johanna: thank you for being by my side and constantly supporting and encouraging me, thesis-wise and otherwise. Mother Ingrid, father Roland, sister Kina (plus Johan, Viggo and Love) – thanks for all your support, warmth and fun thesis-free (and Guitar Hero-filled) breaks in Uppsala. A special thanks to Alice and Ebba, my grandmothers, whom, in loving memory, this thesis is dedicated to.

CHAPTER 1

Introduction: Themes, hypothesis and thesis structure¹

During the 8 years it has taken to complete this thesis, a total of four personal computers have passed through my household metabolism. Significant amounts of notebooks, books, articles, printer papers, electric power and the like have been spent – the per-copy footprint is probably quite substantial for this thesis. My feet in general are probably quite substantial as well. Although not driving it regularly, mostly lending it to my dear friends, I do own a Ford Escort, made up of parts from 15 countries across three continents, assembled at a, for me, unknown location. My 72-square-meter Scandinavian apartment, in which I live alone, is constantly heated, my fridge is well-stocked with plenty of exotic foodstuffs, and I spend more money each month on Wilma's dog food than it costs to sponsor a child in Peru – as Wilma has a sensitive stomach, I think her quality of life is significantly improved, and thus also mine, by the relatively expensive McHill dog food brand. I have recently bought a Pocket PC mobile phone (it has Windows – I just *had* to have one), I took a flight down to Singapore and Malaysia in July 2008 for a two-week thesis break, I consume peanuts from Latin America, TV shows from North America, music from Australia, fossil fuel from the Middle East – and my fiancée recently told me how impressed she was with how little I consume. Clearly, I type these words from a bastion of affluence.

According to World Bank figures, me, my fiancée and the average Swede are part of the 15 percent who obtain 56 percent of total global income.² At the other side of the table, 40 percent of the world's population has to share a meager 11 percent of total global income. Expressed as a value between 0 and 100, where zero is total equality and 100 is the theoretically maximum inequality, the Gini coefficient of the income distribution among the countries of the world lands at 55. Although this might seem hefty enough, this does not include income differentials *within* countries: a very affluent few in a country could very well drive up national per-capita values significantly. Integrating such national distribution data into the global account, looking at the income distribution between *people* rather than nations, World Bank economist Milanovic finds that the richest 5 percents obtains a third of global income, which is the same slice size of the pie obtained by 80 percent of the world (2005). Milanovic predicts that this gulf separating the fortunate from the not-so-fortunate will increase in the future.

Transcending the monetary limitations of mainstream economics, Hedenus and Azar (2005) look at the distribution of global income and how this translates into differences in resource appropriation. Comparing income and material consumption between the richest and poorest quintiles during the 1960-90 period, the authors note that the relative shares of income to each quintile has remained fairly constant over the years, where the richest 20 percent receive 14 times the income obtained by the poorest 20 percent. Even though the rich segment consume 89 times more paper, 35 times more electricity, 13 times more energy, and releases 22 times more carbon dioxide into the atmosphere, the authors do find that there was a slight

¹ This introduction touches upon several different academic disciplines: economic history, economic theory, various strands of development thinking, ecological economics, world-system analysis, global commodity chain analysis, and social network analysis. However, being an introduction to a thesis rather than a stand-alone thesis per se, I have found it necessary to only skim the various surfaces in this chapter. For those lines of thinking that only make their appearance in this chapter, references are to be found in footnotes.

² Source: World Bank 2001: World Development Indicators. Gross national income figures adjusted to purchasing power parity (PPP).

decrease in some of these relative figures during the period in question. In absolute terms, however, the gaps in resource appropriation (and income) have increased.

Other sources provide us with similar magnitudes. In 1993, energy consumption in North America was 30 times higher than that of India – and 60 times higher than that of sub-Saharan Africa (Know and Agnew 1998:30). While the affluent parts of the world spend resources on treating obesity-related illnesses, a staggering 900 million people were under-nourished at the end of the millennia. While we consume 140 percent of the minimum daily requirement of calories, the minimumness of what minimum is is de facto redefined as Ethiopia, Somalia, and Mozambique has a corresponding figure of 75 percent. Borrowing a physical analogy of Martinez-Alier (2002:204), quite suitable in the non-monetary context of this paragraph, there seems to be some sort of tricky Maxwellian demon at work, making sure that the gap between the haves and the have-nots either remains intact or widens even further.

But what about endowments? Couldn't it just be that the skewed distribution of incomes and resource appropriation simply reflects an uneven distribution of natural resources across the globe? It is very true that the endowments of natural resources – soil types, climate, mineral deposits and the like – are quite good in Europe, most certainly being contributing factors to the European expansion and the birth of a singular world-economy in the 15th century and onwards. It is equally true that USA has significant amounts of mineral deposits, including 44 percent of known hydrocarbon reserves in the world (Knox and Agnew 1998:27), which surely has contributed greatly to its growth as an economic and political superpower. Furthermore, the relatively high per-capita incomes experienced by a handful of countries in the world today cannot be attributed to anything else than these being blessed with exceptionally large endowments of specific natural resources, in particular fossil fuels but also other non-renewable hard-to-substitute minerals.

However, as shown in an agro-ecological zones study³ by FAO and IIASA, it is equally true that approximately 70 percent of the world's potential cropland is to be found within the developing world. Even though this land is shared among the significantly larger population in the developing world, the potential to mitigate under-nourishment is certainly there: even with low, non-industrial levels of agricultural inputs, a United Nations report from 1984 found that the developing world, in theory, could self-sufficiently support a population that is 60 percent larger than it was in 1984.

Actually, the evidence for a would-be relationship between resource endowments, economic growth and high levels of consumption seems to point in the opposite direction. Several studies have shown an inverse relationship between economic development and resource extraction since the 1960's (e.g. Gylfason and Zoega 2003). Whether due to a lack of sectoral linkages, the Dutch disease⁴, or other problems facing extractive economies (see Bunker 1985), the possession of natural resources does not automatically imply the consumption of these, or other, resources – quite on the contrary. Even though the global addiction to fossil fuel deepened between 1965 and 1988, per-capita GNP figures in OPEC countries actually decreased by an average of 1.3 percent per year during this period (Gylfason and Zoega

³ <http://www.fao.org/ag/agl/agll/gaez/index.htm>

⁴ The Dutch disease refers to the phenomena when increased revenues from raw material exports lead to increased exchange rates, as well as a reallocation of production factors in favor of the primary extractive sector, resulting in hampered secondary sector growth and/or de facto de-industrialization. Named after the sectoral effects on the Dutch economy after the discovery of a large natural gas field in 1959, the term was coined in an *The Economist* article of 1977 (November 26:82-83).

2003:11). Furthermore, Japan, Singapore, Hong Kong, and Switzerland are all countries with very high levels of consumption and resource appropriation, while having very few natural resources, both in absolute and relative terms. Looking closer at one specific category of consumption – forestry commodities – Rice has noticed that regions with high levels of forestry commodity consumption actually are attributed with an increase in forest cover, whereas regions with low consumption levels paradoxically experience a decline in forest cover (Rice 2007:55). Although the African continent is rich in natural resources, much of which is untapped, the existing extraction of these resources is almost exclusively geared toward the international market and its exogenous demand. In Africa, resource endowments and the extraction of such very seldom – if at all – correspond to economic growth and development. And regarding the experience of the Western world, the natural resource endowments of Europe and North America as of today play a very insignificant part in generating the incomes that make our high standards of living possible.

The good soils, the temperate climate and the mineral deposits of Europe might very well have contributed to its global expansion and the growth of the modern world-system. Once established, there have been few successful attempts to duplicate this process and its outcome. I see no end to all the peanuts, mobile phones, fossil fuels, expensive dog food, coffee, paper, overseas trips and everything else I consume – I am convinced that the Maxwellian demon will keep it up, making sure that the 15 percent I belong to can keep on spending more than half of the world's total income. But what is the actual nature of this demon? What is he doing? What are the means through which this enormous gap not only remains, but actually widens?

World history contains many episodes where resources have been appropriated and transferred by the use of brute force. Whether it was the influx of New World silver and gold to Europe in the 15th century, war reparations and the annexation of disputed regions following the First World War, or the Iraqi Oil Law favoring US and UK oil companies, such brute force appropriations still only accounts for a fraction of global resource transfers between nations of the world. Albeit they may have been very intensive and brutally unfair, furthermore not denying their importance in establishing certain structures or initiating certain processes affecting future events, global resource transfers based on non-commercial mechanisms have never been anything but temporal in the long-run.⁵ In addition to this, it has even been argued that the European colonization project as a whole was uneconomical for the colonizers in the long run: questioning, among other things, that Third World raw materials played any significant part in the industrialization of Europe (Bairoch 1995:59), Bairoch instead finds an overall negative correlation between colonialism and economic growth (ibid.:78). While this of course can be disputed on various accounts, transfers of resources and commodities through the use of military and political power – plunder – is not what maintains the consumption gaps of the world of today. Instead, it is trade that facilitates, and has historically been the main facilitator of, resource and commodity transfers among the nations of the world. Maxwell's demon wears a business suit, not an army uniform.

On international trade, its theories, and contrasting views on its distributional role

Ever since its genesis in the late 18th century, mainstream theories of international trade have always shared a common belief in its role as an equalizer. Formulated as a response to the more hostile undertones of the mercantile mind, the theoretical work done by scholars such as Hume, Smith and Ricardo also reflects a transition of the intellectual climate at the time: just

⁵ Come to think of it, international aid might very well be an exception here.

as the liberalization of the social, political and religious spheres of society would lead, it was argued, to the greater good for all, so would unregulated trade among the nations of the world eventually lead to the equalization of profits and factor costs, consequently eliminating any welfare gaps that might have existed prior to free trade. Borrowing both concepts and mathematical methods from Newtonian physics, a science that itself is a suitable representation of this period, models of economic exchange striving towards equilibrium made it very clear that there were huge advantages to be gained by all through market-based trade between nations.

More than two centuries later, contemporary theory and models of international trade have all the significant characteristics of its classical (and post-classical) ancestors. Its mathematical complexity having evolved significantly over the years, neo-classical models are still based on the same basic Ricardian construct where two countries choose to engage in trade with each other, resulting in a utilitarian win-win-situation, increased absolute well-being and the eventual equalization of incomes and costs in both countries. Although the emerging neo-classical New Trade Theory of today has modified some crucial aspects of the standard model, the fundamental belief in the overall benefits of free trade remains very much intact – as reflected by the 97 percent of academic economists in USA that view free trade favorably (Prasch 1996). According to mainstream theory, free market-based international exchange is anything but a Maxwellian demon of the insinister type – it is rather the antidote.

Despite centuries of theoretical agreement within mainstream economics on the positive outcomes of international trade, the idea of trade-led growth and development made its first serious entry on the developmentalist agenda in the 1980s. Inspired by the miraculous growth of the East Asian export economies, a neo-liberal resurgence took place: replacing the post-war focus on capital formation, dualism and industrialization, several scholars within the field of development studies started to emphasize export trade as a way to achieve growth and development. This late introduction of a long known “truth” underlines a fact that is often obscured by contemporary scholars in political economy, namely that there have been very few occurrences of free market-led international trade in the world (Bairoch 1993). Thus, to criticize neo-classical trade theory on the basis of the current state of the world is not a very honest enterprise. When Third World countries chant for trade rather than aid, when renegotiation of the NAFTA treaty turns into a political hot potato in presidential election campaigns, and when the World Trade Organization struggles so hard to achieve something that at least can resemble free trade as stipulated by classical and contemporary models of international trade, it should be obvious that we can only pass any empirical judgment on these mathematical constructs through the very few spatiotemporal occurrences of actually existing free trade. This, of course, does not imply that these models are without flaws. On the contrary, they are very much flawed if they are meant to describe the current world of international trade and if they are intended to be suitable models for predicting future events and outcomes, rather than just being leftover tools to advance a specific political agenda in the late 18th century. Clearly, real world observations and the current distribution of incomes and resources can only to a very minor degree be attributed to the assumptions and the theoretical outcomes of these models. The gap in income and resource usage exists despite international trade, so the demon is obviously not functioning in the manner as described by classical and neo-classical trade theory.

Prior to the neo-classical resurgence and its belief in trade as a viable path towards development, an alternative line of thought appeared where trade was seen as, more or less, detrimental to the development process. Albeit the prospects of development-through-trade

was sometimes questioned on theoretical grounds within the modernization school (e.g. Nurkse 1952:576), the work done by Prebisch and Singer was rooted in empirical observations of the deteriorating terms-of-trade of the less developed, primary commodity-exporting countries, primarily in Latin America. As a contrast to the modernization school and the neo-classical resurgence of the 1980s, where development was seen as a process occurring over time, this alternative school instead tended to view development as space-functional: underdevelopment in certain parts of the world was, fully or partly, related to development in other parts of the world. The explanations put forward by Prebisch and Singer were nevertheless framed strict in a strict neo-classical syntax: arguing that income elasticities of demand differed between primary non-processed goods and industrial manufactures, the outcome of an exchange between the two could, over time, be a widening of the income gap between the not-so-developed countries – the periphery – and the developed parts of the world – the center. The suggested solutions were, according to Prebisch and Singer, to be found in the internal properties of the to-be-developed countries: under the leadership of Prebisch, the United Nation's Economic Commission for Latin America (ECLA) suggested state-intervening policies such as import-substitution, planned national allocation of capital and a general overhaul, or the creation, of internal production structures - industrial fostering – to overcome the deteriorating terms-of-trade facing peripheral countries.

Combined with neo-Marxist thought, the Latin American structuralism evolved into dependency thinking, a school where trade was not only seen as detrimental to the development prospects of the periphery but instead its underlying cause. In this rather radical and politicized school, the proposed solution was delinking: only through a clean break with the exploitative nature of international trade between the center and the periphery could the latter develop and pursue the explicitly stated socialist goal. Reinforcing and developing the Prebisch-Singer theorem further, dependency and neo-Marxist scholars advanced the notion of unequal exchange, particularly through the work by Arghiri Emmanuel (1972). Steeped in a Marxian framework and the Ricardian labor theory of value, Emmanuel found the underlying cause to be the wage-differential between centers and peripheries, where trade between these two zonal categories would lead to a net-transfer of labor value, even in situations of perfect competition.

Just as any other theory of the social world, the dependency school was a manifestation of a specific time and space: with left-wing revolutions sweeping across Latin America, combined with the inability of ECLA to address non-economic issues, it is perhaps not surprising that the dependency school had its roots and its principal followers in Latin America, as such being the only development perspective formulated out of the experiences of a non-western, non-developed periphery. Partly due to its inability to describe the economic success stories in East Asia, as well as the rather dismal results from the sporadic implementations of its policy suggestions, the dependency school lost its momentum in the 1980s. However, many of its concepts and foundational ideas lived on in what became known as the world-system perspective.

The origins of the world-system perspective⁶ can be found in a combination of neo-Marxism and dependency thinking with the French Annales school of history. Complementing the core-periphery model with a third zonal category – the semi-periphery – the world-system perspective put greater emphasis on dynamic processes and non-linearity than what was to be found within the often static and deterministic models of dependency. Combined with the trans-disciplinary approach of Fernand Braudel, the world-system perspective argues that social, economic and political processes in the world can only be understood by systematic, broadband analyses of the unit as a whole – the world – and the structure and dynamics that integrate the sub-systemic parts and layers into a coherent whole, a scientific endeavor that only can be conducted through an analytical lens that is not constrained by the artificial boundaries separating sociology, economics and history from each other. For instance, the industrialization of England cannot be understood simply by looking at the spatial and temporal context of the phenomena itself – the industrialization of England – instead, one has to analyze the whole historical system that led to this particular outcome at this particular time and place, i.e. an analysis of the capitalist world-economy.

Even though Wallerstein's perspective has had a tremendous impact in the social sciences, with a plethora of scholars writing just as many books and articles based on world-systemic concepts, the perspective is, according to Wallerstein himself, primarily a critique towards the compartmentalization and fragmentation of scientific inquiry into various isolated disciplines (Wallerstein 1987:309). We will return below to this critique of his and how it relates to the thesis at hand.

Through prominent scholars such as Bunker, Hornborg, Jorgenson, Martinez-Alier, Rice (among others), the world-system perspective has recently been combined with the emerging line of thinking known as ecological economics⁷. With several conceptual overlaps, a new school of political ecology seems to have entered the scene. To begin with, both schools share a common interest in the totality of systems. Instead of analyzing individual sub-entities or conceptual levels in isolation, both schools are more concerned with the system at large, the interactions and structures that connect these sub-entities into a coherent whole, and the role of such structures on the developmental trajectory of the individual sub-entities.

⁶ Any attempt to describe the world-system perspective in a couple of paragraphs is bound to fail. Refraining from making such an attempt, I prefer to provide references, either directly to the writings of Wallerstein – his original three volumes (1974;1980;1989), his writings on the world-system approach (1982;2004), or his collection of essays (1979;1999;2000) – or how other writers describe the perspective (So 1990; Shannon 1996). Other relevant reading include the writings by Chase-Dunn (1989), Chase-Dunn and Hall (1997), Frank and Gills (1996), and perhaps also Hugill (1993), among several others.

⁷ Due to space limitations in this introduction, as well as the fact that this is a thesis in human ecology, I take the liberty to assume a rudimentary prior knowledge of the basics of ecological economics – but a very concentrated (and indeed rudimentary) description follows. While mainstream economics of today typically begins with the household, the firm and the assumption of rational behavior among economic actors, ecological economics instead starts off with the biophysical system in which the economic (and social) systems are seen as embedded in, thus often describing economic processes and transactions in physical (non-monetary) terms. This perspective of looking-in-from-the-outside leads to quite different assumptions and points of interest as compared to mainstream economics: instead of being concerned with the maximization of profits and utility for the individual actors, ecological economics is more focused on the size of the inner economic system with respect to its outer ecological system, and the distribution of physical resources and risks instead of the accumulation and exchange of symbolic monetary wealth. Ecological economics is not the same as environmental economics, the latter being a looking-out-from-the-inside-style branch within mainstream economics where the physical environment is typically viewed through a monetary lens. A comparison between ecological economics and environmental economics is given by Borgström-Hansson (2003:65-176). Two classical references on ecological economics are Martinez-Alier (1987), and Costanza et al (1997), as well as the journal *Ecological Economics* (Elsevier).

Secondly, by looking at total systems, both schools recognize the inherent limits of systems, resulting in more focus on the distribution and the exchange equality of various resources among its component parts rather than ideas based on growth and development *ad infinitum* within each sub-entity and/or locale. Thirdly, most importantly, due to the ecological-economic departure from strictly monetary or labor-related value schemes, instead preferring to view economic systems and processes in the same biophysical terms used to describe the outer system, i.e. the biophysical system surrounding the economic system, world-system analysis gains access to the third Ricardian factor of production. Complementing labor and capital in the original classical literature, natural resources (land) was somehow abstracted away from in classical and neo-classical theory formulations, trade-related or otherwise⁸. Thus, ecological economics can provide world-system analysis with an additional scientific dimension to further breach inter-disciplinary boundaries, this time across the Cartesian divide.

The concept of unequal exchange, in popular usage within the dependency and world-system traditions, has recently gained significant interest in its ecological interpretation. Instead of viewing unequal exchange in the traditional political-economic sense, the concept of ecological unequal exchange as introduced by Hornborg and subsequent scholars is here typically depicted as an inequality regarding the net-transfers of biophysical resources stemming from international trade.⁹ While many studies on ecological unequal exchange primarily are empirical or descriptive, general theories and/or explanatory models have also been suggested (Bunker 1984, 1985; Hornborg 1998, 2001, 2003; Jorgenson 2006, 2009a; Jorgenson et al 2009b; among others). Just as the notion of unequal exchange implies that trade could result in non-compensated net transfers of economic value or potential, whether through unequal profit sharing due to different income elasticities for different goods or as transfers of labor value due to center-periphery wage-differentials, so does the notion of ecological unequal exchange imply would-be occurrences of non-balanced exchange, here however conceptualized as monetarily non-compensated net-transfers of resources, expressed in biophysical terms. That is, even though a voluntary economic exchange on a free market between pairs of actors is equal, which it by definition always is with respect to exchange values, such an exchange could very well represent an unequal exchange in terms of useful biomass, useful minerals, arable land, spent or contained energy, waste/toxins, sharing of environmental risks, or in any other biophysical, non-monetary accounting unit.

Based solely on the huge global differences in resource consumption, the differences in the economic-geographical range of consumption patterns around the world, and the figures found in physical trade flow matrices, combined with the fact that international trade is the mechanism through which global resource flows occur, it is difficult to deny the existence of some kind of ecological unequal exchange, whatever the scientific-disciplinary inclination of the observer and whatever its underlying mechanisms. A few percentages of the global population consume most of the available natural resources, drawn into our life-spheres from

⁸ Simply discarded in production function (such as the Cobb-Douglas function) in neo-classical theory, only calculating production as depending on labor and capital (Perloff 2004:151ff; see also Daly 1996:47ff), this externalization of natural resources is perhaps, sadly, one of the tightest connections between economic theory and praxis.

⁹ The ecological varieties of unequal exchange often bear scant resemblance to the original formulation of unequal exchange as formulated by Emmanuel (see Brodin 2006). This is nothing unique to the ecological-economic variety (or rather reformulation) of unequal exchange; as will be discussed in the second half of chapter 6, many scholars seem to have a relatively poor understanding of the actual claims and the theoretical assumptions used by Emmanuel (1972). Instead, the ecological varieties often reinterpret the actual causes and effects of unequal exchange.

global, rather than local, sources. The Maxwellian demon is thus more than an analogy borrowed from the natural sciences – instead, through the biophysical lens on trade provided by ecological economics, he is doing exactly as originally stipulated in the physics textbooks.

On structures

One of the main characteristics of the world-system perspective is its explicit focus on global structures. Depicting the current historical system as a world-economy in which multiple political sub-structures, i.e. national states, are tied together in a shared, system-wide division of labor, this structure is typically modeled into three different zones: the core, the semi-periphery, and the periphery. Located in the center of the world-economy, the core countries constitute the developed part of the world, as such seen as monopolizing and controlling the network of economic exchange. Opposite the core, the periphery consists of countries on the outskirts of this network: lacking the monopolizing power held by the core, peripheral countries are typically seen as being bound to the economic and political will of its relatively few trading partners, located in the core. The semi-periphery represents the dynamic aspect of the system: containing countries that are in-between core and periphery status, the semi-periphery acts as a political-ideological stabilizer to the system at large as it demonstrates the flexibility and the possibility of upward-mobility in the hierarchical world-economic structure.

Initiating the Global Commodity Chain (GCC) school, Wallerstein and Hopkins have shown how the system-wide division of labor can be analyzed by looking at production chains in the world-economy. Focusing on the production (and consumption) of individual commodities and its segmentation across several locations within the world-economy, the GCC school examines how the uneven sharing of costs and profits among the various links of such production chains in effect leads to occurrences of unequal exchange. Most of these studies underscore the structural differences between core and non-core countries, where core elements of such chains often enjoy monopolies and where peripheral chain elements are kept in dependence to core segments, typically under fierce competition from other peripheral segments. These differences reflect the structural assumptions in the world-system perspective in which core countries are tightly knit together and where peripheral countries have few lateral linkages within their own zonal category, instead having their relatively few trading linkages concentrated to a few core countries.

However, even though the GCC school affirms the structural assumptions found in the world-system perspective, and even though system structure is an explicitly stated research agenda within this line of thinking, there have been few empirical studies that focus specifically on these structures. Instead of defining the zonal categories and classifying countries as belonging to either of these based on the *patterns* of interactions, economic or otherwise, between the sub-entities in the structure, the classification of countries into the three perceived strata are instead often based on the *internal* properties of countries. That is, instead of looking for validation of the theoretically derived trimodal division through empirical analysis of the structural properties that is supposed to reflect this trimodality, and instead of classifying the various national states as belonging to either of these strata based on their structural properties, the trimodality is a priori assumed to be a valid theoretical construct where countries are classified based on parameters such as factor costs, labor structure, profit distribution, institutions and similar internal parameters.

Contrary to their explicit importance in the world-system perspective, exchange structures are all but ignored in the mainstream neo-classical theory of international trade. The complete

disregard for would-be occurrences of core-periphery structures, a historical disregard Paul Krugman deems as scandalous (Krugman 1998b:13), is the trivial consequence of the fundamental trade model presented by Ricardo, kept ever since, where two countries choose to engage in trade with each other. As this model is expanded with additional trading partners, a hidden assumption regarding structures emerges – assuming potential trade ties between each pair of trading partners in a perfectly competitive market, controlled not only by the invisible hand but also a Walrasian auctioneer, structures of exchange do of course become quite irrelevant in such all-with-all setups. When the positionality within an exchange network is a common denominator for all participating trade partners, it cannot, of course, play any role on issues such as profit sharing, monopolistic situations, and occurrences of unequal exchange due to skewed bargaining positions, thus turning the focus to the internal properties of participating actors when addressing issues concerned with trade and would-be development.

The hypothesis in this thesis

In this thesis, I advance the hypothesis that structures of exchange are important when trying to understand and/or model occurrences of ecological unequal exchange. The hypothesis builds on the structural theory of ecological unequal exchange (as proposed by Jorgenson 2006, 2009a; Jorgenson et al. 2009b) which implies that the actual positions – the structural properties – within an exchange network, manifested in actually-existing ties of bilateral trade, are important if we are to understand the resource-distributional outcomes of such exchanges.

The hypothesis is constructed out of a theoretical discussion on contemporary neo-classical exchange theory as well as models and empirical analyses of structures of economic exchange stemming from economic geography, both traditional as well as its neo-classical neophyte. As this discussion hopefully will reveal, there are compelling arguments to suspect that actor B in Figure 1.1(b) has an advantageous position relative to other trading partners, thus underlining the importance to look at structures of exchange rather than assuming the existence of an all-with-all structure as depicted in Figure 1.1(a).

The empirical core of this thesis consists of analyses of the global trade network of two types of primary commodities – fuel commodities and primary edible agricultural crops – for the period 1995-99, using bilateral trade data for up to 100 countries gathered from the Comtrade database. Using various quantitative tools from social network analysis, this thesis attempts to map the structural features of the exchange networks for each of these two commodity groups. These tools allow us not only to classify countries according to the different roles they play in global exchange, but also to actually estimate how many such distinct roles that can be found in each network as well as mapping the structural relations between the different roles. Furthermore, through a novel algorithm for measuring centrality, which will be introduced in the first network-methodological chapter in this thesis, we obtain a measure of trade network centrality which could provide information about the positional properties for each country in each network. Additionally, while analyses of trade value flows are important, the empirical chapter will also analyze trade from a non-monetary perspective: using different physical units of accounting in the two empirical chapters allows us to contrast the economic and the ecological, arriving at a first-cut conceptualization of ecological unequal exchange for these specific primary commodity groups.

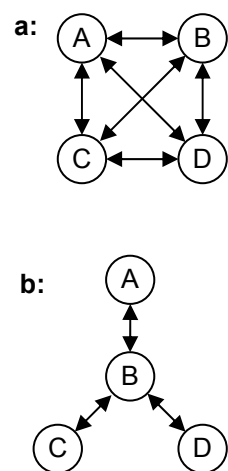

Figure 1.1: Total graph versus core-periphery structure

Based on the results from these empirical analyses, the core question that underlines this thesis is addressed: whether, and to what extent, there is a relationship between structural positionality and ecological unequal exchange. By comparing the price-quantity ratio of imports and exports with the structural results on zonal classification and centrality, the concept of ecological unequal exchange can be viewed in terms of differences in resources-per-dollar rather than mere net transfers of physical resources. As economic exchange occurs due to bargaining processes concerned with exchange values, the complementary non-monetary dimension makes it possible to address whether the ability to appropriate and consume resources is related to the positional properties of the various political entities that constitute the sub-entities of the grander world-system and its economy. As the commodities in question constitute relatively unprocessed natural resources and thus can be seen as representing the third Ricardian production factor, the conceptualization of ecological unequal exchange of this thesis is, I argue, more in line with the original formulation of unequal exchange (Emmanuel 1972) while simultaneously integrating this with the exchange-structural aspects often found in the dependency and world-system literature on the matter. This argument will, of course, be elaborated further later on in this thesis (chapter 6).

Perhaps not surprisingly, I believe that the theoretical significance of this hypothesis is important. If the hypothesis holds, it would underline the inadequateness of the contemporary mainstream theory of international trade and its underlying assumptions regarding the irrelevance of exchange structures. However, and perhaps most importantly, this thesis is primarily a methodological endeavor, aimed at demonstrating how quantitative network-analytical approaches can be applied to relational trade data in order to address fundamental world-systemic questions regarding its structure, its zonal categories and questions on ecological unequal exchange. Whether the hypothesis holds or not, I hope that this thesis is able to demonstrate how network analysis can be used to map the structure of the world-economy and, more importantly, the corresponding world-ecology of the contemporary historical system that evidently is so brutally unfair in terms of resource consumption.

The world-system perspective on the fragmentation of scientific disciplines

According to Immanuel Wallerstein himself, the world-system perspective is more than a specific perspective on the world; rather, it is a critique towards the actual existence of plural scientific perspectives per se:

World-systems analysis is not a theory about the social world, or about part of it. It is a protest against the ways in which social scientific inquiry was structured for all of us at its inception in the middle of the nineteenth century. (Wallerstein 1987:309)

The existing, and ongoing, partitioning of human knowledge into a set of distinct disciplines – anthropology, economics, political sciences, sociology, history, and so forth – has, according to Wallerstein, hindered us from asking questions about the social world that, quite obviously, overlap these artificial boundaries. While inter-disciplinary work can be seen as a partial remedy to this fragmentation, Wallerstein argues that such approaches instead tend to strengthen the claims that each discipline represents a specific level of analysis, as such motivating the continued existence of separate sets of logics, methods and assumptions within each discipline.

The world-system perspective thus refuses to view the social, the economic and the political as distinct areas of human existence that can be addressed separately. If we are to understand

social processes, especially in a larger spatiotemporal setting (i.e. historical systems), the contemporary partitioning of our knowledge has to be dealt with. Furthermore, the historical dimension of social systems also means that there has to be some sort of balance between the specific and the general – the tiller has to be held firmly between idiographic and nomothetic ways to describe the world.

Ever since its genesis, human ecology at Lund University has marketed itself as a trans-disciplinary subject. It explicitly attempts to transcend the academic boundaries in order to obtain more comprehensive perspectives of the world, an approach that rejects the “crackpot rigor” (Ehrlich 1994) of individual disciplines and the limitations imposed by any specific lingua, set of models or theories that could inhibit its ability to address relevant research questions. This is however not only bound to the social sciences: human ecology also tries to bridge the Cartesian canyon in its attempt to create syntheses between the cultural and the natural sciences, encouraging research agendas that combine economics, sociology, anthropology, history, political sciences with biology, physics and earth sciences, a combination of which is deemed as necessary for conducting research on the relationship between man and nature.

While adhering to the human ecology ambitions, indeed agreeing with the inherent problematique of the fragmented state of accumulated knowledge across several, often autistic, even antagonistic, disciplines, and while agreeing with Wallerstein on the advantages of a more transdisciplinary approach for understanding the entity, i.e. the singular world, its subjects, objects and post-modern derivatives thereof, I nevertheless believe that we will fail in a normative sense if we refuse to accept this fundamental reality: the fragmented state of our sciences. There is, I believe, no way we can address the most pressing issue within human ecology – humankind’s relations to her biophysical environment – in any meaningful way if we at the same time ignore the *various* beliefs and assumptions that influence the processes that both shape and are shaped by the human-nature relationship, i.e. the fragmentation of knowledge into various disciplines. Even though this fragmentation often undermines attempts to describe the human experience beyond specific spatiotemporal contexts, this very fragmentation per se is a significant part of this very same reality that simply cannot be ignored. The specific partition currently existing not only reflects but is intrinsically tied to the modus operandi of the historical system existing at this particular time and space. Thus, we can indeed criticize the contemporary fragmented state of our accumulated knowledge and we can indeed sketch on a more holistic and inclusive social science that even bridges the Cartesian split, but then we might as well begin by sketching on a different historical system that is equally holistic, inclusive and conceptually non-Cartesian, i.e. a system that, regrettably, is vastly different from the contemporary one.

This thesis attempts to be a multi-disciplinary endeavor, spanning over several distinct sciences as they currently are partitioned within academia: economics, economic geography, history of (economic) ideas, ecological economics, anthropology – including a fair bit of statistical mathematics (as reflected in quantitative social network analysis). The breaks between these various disciplines are intentionally sharp, reflecting the prevailing state of academia: just as neo-classical economics and substantivist economic anthropology very seldom are seen together, the latter only acts as an introduction to the former in this thesis. Similarly, albeit economic geography and spatial neo-classical economics (a.k.a. New Economic Geography) both arguably address similar phenomenon and share similar research agendas, their lack of institutional overlap is reflected in this thesis.

This thesis assumes that there is an underlying problem definition: that the research agenda is motivated by the observation that resource appropriation and consumption are unevenly distributed among the different countries of the world, a distributional skewness that is related to international trade and, particularly, its structure. This thesis thus not only assumes the importance of this particular research question, but it further assumes that it is actually possible to address and process this research question, even though it is ridiculously large in scope – at least as measured in disciplinary overlap. This thesis is multi-disciplinary, reflecting the fact that our knowledge is separated into multiple, linguistically and conceptually often non-overlapping disciplines, each of these concerned, at least partially, with the underlying research question, a fragmentation that is an integral part of the subject matter. In order to address the issue at hand, I argue that we thus must combine knowledge, insights, models and ideas from each of the disciplines concerned with the research question, without dismissing certain scientific perspectives as irrelevant or simply “wrong”. Instead, I argue that we have to have to be intellectual anthropologists, shifting and situating the research perspective from within these various, contradicting disciplines. The actual integration of these various disciplines is not, and should not be, a prerequisite here, nor an outcome to explicitly strive towards: as such, this thesis indeed “lacks the political clout to affect the existing institutional structures” (Wallerstein 2000:132) of our university milieu. The research question is what is central – the various perspectives, assumptions and insights of the various concerned disciplines (mainstream economics, economic geography, and ecological economics) are merely tools to address the question. If this thesis should succeed in reducing the barriers between these various disciplines, demonstrating overlapping and contradictory parts between them, and perhaps even facilitating inter-disciplinary dialogue and would-be cross-breeding of ideas and insights, that would be, I think, a very positive outcome by itself.

Social ecography?

As an inheritance from the title my MA thesis (Nordlund 1999), which my dissertation partly builds upon, I originally used the term “ecography” to imply a disciplinary combination of ecological economics, economic geography and structural analysis, in what I then thought was a neology. However, which I was unaware of at the time, *Ecography* is first and foremost the name of an internationally acclaimed academic journal. Under the heading of *Holarctic Ecology*, established in 1978, the journal was renamed in 1992 as most of its content had expanded from the previous primary focus on the holarctic regions.

In the first issue under its new banner, the editor-in-chief at the time stated the profile of the renamed journal:

ECOGRAPHY will be given a profile with emphasis on the natural history of organisms, biodiversity, landscape ecology, biogeography and conservation aspects of ecology. The journal will also consider paleoecological studies, for instance, past changes in communities and studies which explain present day distributions. [...] In short the journal will, regardless of trophic level, concentrate on all types of descriptive and/or analytical studies in ecology and particularly on studies relating to variation, diversity and patterns in ecology. (Malmer 1992:1)

Although the trophic level in this thesis is as high as it possibly can be, the journal description above is, I argue, quite compatible with what this thesis – and the combination of ecological economics, world-system analysis, economic geography and network analysis – is all about. As the empirical/descriptive analyses in this thesis are concerned with distributions and structural patterns of global biophysical flows resulting from human economic activity, I

have chosen to add the “social” prefix to distinguish it from the purely ecological (non-social) meaning of the term.

Thesis structure

Starting off with a short economic-anthropological introduction to the subject matter, chapter 2 is concerned with economic exchange theory: its genesis in the classical school, its subsequent development into neo-classical trade theory, and the emerging neo-classical school of New Trade Theory. The aim is not only to understand the specifics of these theories – assumptions, limitations, perspectives, and models – but also, partly, to situate the evolution of these theories into their historical contexts and methodological innovations that spurred their development. The chapter demonstrates how mainstream trade theory, ever since the initial work by David Hume, contains a fundamental belief in win-win-situations where free trade eventually will reduce any would-be welfare gaps over time. This chapter will also include the critical views of Friedrich List who not only placed the English classical school in its specific spatiotemporal context but also preceded many of the recently done “findings” in neo-classical New Trade Theory. Although this latter theoretical development, which indeed contributed to Paul Krugman’s recent Nobel prize, has meant a quantum leap in economic theorizing, for instance by introducing “novel” concepts such as path-dependence and core-periphery structures, mainstream trade theory is nevertheless still based on the Ricardian scenario where two countries choose to engage in trade with each other. Thus, what is assumed to be true for the two-actor-model is automatically assumed to hold true when the model is expanded to multiple actors: assuming perfect competition among participating actors, neo-classical approaches still pay very little, if any, respect to structures of exchange, and is still strictly a model-building enterprise with little, if any, empirical data to support its claims. Contrasting the latter, this chapter is rounded off with the theoretical work by Prebisch and Singer where the assumptions of the benefits of free trade were questioned from inside the discipline, i.e. using neo-classical theories and concepts.

As a contrast to neo-classical approaches to international trade, chapter 3 explicitly focuses on exchange structures. At the beginning of the 20th century, economic geography and economics crystallized into two distinct disciplines: as the latter became more focused on deductive model-building, economic geography took quite an opposite stance with its descriptive focus and its overall wariness towards theory building. Still, over its rather bumpy intellectual history, economic geography had a period of intense model-building and mathematical approaches where exchange structures, particularly infrastructures, were high on its research agenda. In this chapter, we will look at a number of empirical studies where structural properties were examined and put in relation to economic development and growth. This chapter also includes the recent neo-classical redefinition of economic geography – New Economic Geography – a line of thinking made possible by novel modeling techniques, rather than a newly found belief in the importance of exchange structures. Although the re-emergence of neo-classical interest in the economic landscape is strictly deductive and model-oriented, its novel mathematical techniques oblige mainstream economics to address questions regarding exchange structures, something which perhaps could lead to revised neo-classical theories and models of international exchange where structures play a more significant role when determining the outcome of trade.

As hopefully will be demonstrated in these two chapters, it would be a futile enterprise to use contemporary neo-classical theories of international trade to answer questions based on the *de facto* existing welfare gaps in the world, not just due to its deductive, or rather abductive, nature but particularly due to its total disregard for structures of exchange and the role such

evidently have on the outcomes of economic exchange. Through this, I make the case that it is vastly more promising, at this point, to instead examine actually existing global exchange structures from an empirical point of view – similar to what was done in the economic-geographical studies presented in chapter 3. However, instead of resorting to the rather crude methods of these particular studies, the tools from the emerging science of social network analysis are more promising for doing such analyses.

In chapter 4 and 5, the quantitative approach of social network analysis is presented, a set of statistical-mathematical tools that is explicitly designed to look at relations between entities, i.e. the structures that bind these entities into larger networks. Chapter 4 introduces the basic network concepts as well as a novel heuristic for measuring centrality within networks, a heuristic explicitly designed for networks containing valued ties whose magnitudes can vary greatly, which is the case for trade flow networks. In chapter 5, the concept of role-analysis is introduced, a series of tools highly suitable for identifying and categorizing actors according to the structural roles they play in networks. Role-analysis has been combined with world-system analysis on several occasions; chapter 5 contains an overview of previous studies where the perceived strata of the world-system – core, periphery, semi-periphery, and so forth – are identified based on relational (inter-national) rather than attributional (national-internal) data, economic and otherwise.

Chapter 6 begins with a presentation of the Global Commodity Chain school. Initiated by Wallerstein and Hopkins, developed further by other scholars, this school uses empirical data to look at specific threads in production networks, threads representing the economic life-cycles of individual commodities and how they traverse several geographical locales, where the gains from such chains are shared unequally among its component links. Derived from world-system analysis, this school offers some interesting insights for the thesis at hand. First, although not representing complete analyses of exchange networks, instead rather looking at a series of individual bilateral trade segments that constitute a commodity chain, these studies hint at an overall structure as to how the various links relate to each other. Secondly, the GCC school underlines the importance of looking at commodity exchange between the political sub-entities that make up the grander world-economy: in his own work on commodity chains, Wallerstein has stressed its importance for understanding occurrences of unequal exchange. Although GCC studies are important per se and indeed could identify occurrences of unequal exchange, it differs quite fundamentally from the network-analytical approach proposed in this thesis, differences which will be highlighted in this chapter.

The second part of chapter 6 looks at the concept of unequal exchange. Beginning with its origins in the post-war debate on deteriorating terms of trade for raw materials, and the subsequent usage of the concept among neo-Marxists, dependency and world-system schools, the recent idea of ecological unequal exchange will be discussed and exemplified with a handful of its proponents. Whereas ecological unequal exchange so far typically has been perceived as non-compensated net transfers of biophysical resources, such a conceptualization share very few similarities with how unequal exchange originally was defined by Arghiri Emmanuel. Setting the scene for the empirical chapters that follows, chapter 6 is rounded off by presenting an alternative conceptualization of ecological unequal exchange that is, it is argued, more in line with the original Emmanuelian definition. Based on the insights from the Global Commodity School as well as the structural theory of ecological unequal exchange as proposed by Jorgenson, this second type of ecological unequal exchange focuses on global differences in factor costs (of natural resources) and

whether these are somehow related to parameters of structural positionality obtained from the network analysis of global trade flows.

Chapter 7 and 8 contain the empirical network-analyses in this thesis. These two chapters analyze the trade flow networks of two commodity types: fuel commodities (chapter 7), and edible agricultural commodities (chapter 8). Both these chapters look at the monetary value of trade as well as their respective non-monetary dimensions: energy content for the analyzed fuel commodities, and a modified version of ecological footprints for the agricultural commodities in chapter 8. While the conversion between fuel commodity quantities and energy content is relatively rudimentary, the conversion from primary agricultural goods to hectares can be quite complex. Containing an examination of the most established standard ecological footprint method, followed by a presentation of a semi-recursive algorithm for calculating appropriated hectares embodied in individual trade flows, chapter 8 is by necessity somewhat larger than the chapter concerned with fuel commodities. Otherwise, both these chapters follow a similar structure and disposition.

Concluding this thesis, chapter 9 summarizes the theoretical arguments, discusses the findings from the empirical analyses, and outlines possible future research. At the very end, the literature references are given and an appendix describing how the trade dataset used in the empirical chapters was compiled.

CHAPTER 2

Economic exchange theory and international trade: Past and present

Ska vi byta,
Ska vi byta grejer,
Ska vi byta grejer med varann?
Hans Alfredsson

The purpose of this chapter is to analyze theories and models of international trade, their alleged implications for development versus underdevelopment, and how these over the years have developed into the contemporary mainstream theory of today. Beginning with the 19th century classical school, this chapter broadly outlines the history of trade theory, including the various dissidents which have contrasted the mainstream view at various times. The chapter will attempt to demonstrate some of the reciprocal relationships between theories of international trade vis-à-vis historical events of economic as well as non-economic sorts. Models of international trade have indeed influenced socio-economic trajectories – may it be the abolishing of the English Corn Laws in 1849, the various attempts at implementing national import-substituting strategies in the 1970's, or the WTO negotiations of today – while, of course, simultaneously striving to explain such changes. Economics is however not a passive and considerate science; due to its normative influence on political decisions, even the fundamental cornerstones used for building models of explanation, as well as subsequent interpretations of such models, are indeed influenced, implicitly or explicitly, by pre-analytical standpoints of an often non-economic nature. To paraphrase John Stuart Mill (see below), economic theory is more than an explanatory endeavor in its most abstract form, it is also a normative carrier of morality, ideas, ideologies, behavioral codes and conducts, this making it truly unique among its siblings in the social sciences.

Based on the fact that contemporary models of international trade, mainstream or otherwise, build on models dating back from the 19th century, developed during the greatest transitional era known in the economic history of mankind, subsequently patched and modified ever since, and occasionally under the influence of political ideas and ideologies with their respective agendas, one can ask whether it is feasible to draw any conclusions based on such models which are of relevance for the global economy of today. Given the network of world trade today, the implicit aim of this chapter is to underline that it might indeed be more viable and relevant to study this global network of trade using inductive empiricism, an argument implicitly made by demonstrating the somewhat shaky historical development of contemporary (mainstream) perspectives on international trade and the underlying theoretical foundations that these perspectives rest upon.

Most significantly, this chapter underlines the fact that international trade theory, ever since its genesis, is a deductive endeavor that is based on models in which two – only two – countries choose to engage in trade in a free market. As these models are expanded to include more actors, the hidden classical and neo-classical assumption on structures emerges: their irrelevance.

Although international trade today is depicted as a market, this chapter begins from an anthropological viewpoint, contrasting market exchange with other possible types of exchange. After that, the chapter focuses on tracing the trade-theoretical development that has

taken place since its birth in the midst of the industrial revolution, specifically focusing on how trade has been seen either as an engine or, quoting Friedrich List, a “Trojan” for the economic development of the actors participating in international trade. The chapter also delves into New Trade Theory, a branch within neo-classical economics that has truly infused quite revolutionary concepts into its discipline: these concepts, their theoretical and would-be disciplinary consequences, are discussed below. This chapter will also introduce the reader to Prebisch and Singer whose works have been foundational to the concept of unequal exchange, addressed further in chapter 6.

The anthropological perspective: modes of distribution

With the economic *anima mundi* of contemporary social systems typically being equated with market exchange, substantivist economic anthropology on economic functions in human societies takes a more pluralistic view on the matter. Instead, market exchange is seen as *one* mode of exchange among other, alternative modes, each with their own specific characteristics, institutional settings, moral codes, and individual behavior. Initiated by the foundational work of the economic historian Karl Polanyi (1957 [1944]; 1968), economic anthropology often base socio-economic analyses on three main types of distribution: reciprocity, redistribution, and market-based exchange.¹⁰ Contrary to the substantivist line in anthropology, the formalist approach (e.g. Keesing 1981:205) treats patterns of economic behavior across time and space as best being explainable using market models, i.e. mainstream economic thinking, an approach which according to substantivist thinking blurs the relevance of the social context such patterns are manifested in (see also Polanyi 1968:xv, Polanyi 1957:33, 44, 78; Condliffe 1950:678; Lawson 2004:23):

But [treating economic theory as having universal validity] makes conventional economic theory into a Holy Ghost: everywhere present but often unseen. It is gross ethnocentrism to assume that the monk, the feudal lord, the Inca priest-king, the commissar, and the Trobriander are directed in their material lives to bide by the same market rules that drive the London stockbroker and the Iowa wheat farmer. (Polanyi 1968:xxviii)

Polanyi and Dalton have proceeded to argue that the basic models of economics, and notions like scarcity, economizing, allocation, and maximizing, properly apply to systems of market exchange. To talk in such terms about tribal economics is to superimpose notions based on the market onto social institutions that differ in *kind*, not merely in degree and the nature of scarce goods. (Keesing 1981:207)

By contrasting the great transformation of English institutions in the 19th century with ethnographic data collected and analyzed by Malinowski in the Trobriands, Polanyi argues that market exchange is the only mode of distribution/exchange which is disembedded from social relationships (Polanyi 1968:xiv). While reciprocity is exchange based on friendship, kinship, status and hierarchy, and redistribution is based on political and religious affiliation, i.e. representing economic dimensions of otherwise non-economic social relationships, the market mode of exchange differs in a way that is directly parallel to the concepts of *gemeinschaft* and *gesellschaft* (Polanyi 1957:82ff):

The market pattern, on the other hand, being related to a peculiar motive of its own, the motive of truck or barter, is capable of creating a specific institution, namely, the market. [...] Instead of economy being embedded in social relations, social relations are embedded in the economic system. (Polanyi 1957:57)

¹⁰ Polanyi originally included a fourth possible mode – the household – a mode of autarchy which “is only an accessory trait of an existing closed group” (Polanyi 1957:57). Explaining the lack of other dominant types rather than constituting a mode of exchange in itself, it is typically excluded in various writings.

While reciprocal and redistributive modes of exchange represent economic interactions that confirm the *gemeinschaft* of social groups, market exchange is quite the opposite:

[E]xchange at fluctuating prices [i.e. in markets where prices are set by the interplay of supply and demand] aims at a gain that can be attained only by an attitude involving a distinctive antagonistic relationship between the partners. [...] Hence the universal banning of transactions of a gainful nature in regard to food and foodstuffs in primitive and archaic society. (Polanyi 1968:155)

The inherent paradox of institutionalized antagonism can probably only be countered by ideological means. Sharing the common belief that “[t]his pursuit of individual advantage is admirably connected with the universal good of the whole” (Ricardo 1996:93) can perhaps act as a counter-weight to the disintegrative consequences of antagonism. Marshall Sahlins’ work can also shed light on the nature of antagonism in exchange: extending Polanyi’s definition of the reciprocal mode of exchange, Sahlins argued that reciprocity comes in many different variants depending on “social distance” between the transactional partners. Generalized reciprocity occurring at close social distances is in many ways a pure gift, being “putatively altruistic” (Sahlins 1972:193), while balanced reciprocity is exchange between equals of equal “values”. Negative reciprocity, “the attempt to get something for nothing, as expressed in barter and theft” (Gudeman 2001:85), is thus a putatively antagonistic relationship. In Sahlins’ original article, social distance was correlated to spatial distance between participants, a feasible assumption in pre-modern societies under study, but whether such a correlation exists in modern societies can be questioned.

There is usually one dominant mode of exchange in a society, but most societies contain aspects of all modes. Market exchange forms the basis for the distribution of societal resources in our contemporary societies of today, but it is not difficult to find complementary aspects of both reciprocity and redistribution, exchange patterns which here have purely social (non-subsistence) significances. In Malinowski’s study of the Trobriands, all three modes of exchange can be found, each with their specific functions and rules of conduct (Polanyi 1957:47; Keesing 1981:206). Among the Trobriands, the non-economic functions of certain modes of exchange have far more significance than the mere possibilities of economic gain, a phenomenon that indeed is puzzling from a formalist economic-anthropological perspective:

Trobrianders would exchange fine pearls only for traditional ceremonial trade goods, not money; they would refuse to dive for pearls when the gardens were in full swing; and they would fish rather than dive for pearls, even when the payment for pearls was 10 to 20 times as great in exchange value as the fish they would barter. [...] A wide gulf separated the Trobriand logic of value and the capitalist logic of value. (Keesing 1981:210ff)

[T]he higher the wages the smaller the inducement to exertion on the part of the native, who unlike the white man was not compelled by his cultural standards to make as much money as he possible could. (Polanyi 1957:164)

In his treaty on the evolution of market patterns in England, Polanyi argues that economic functions were embedded in social institutions up until the industrial revolution, when the market form of exchange became the dominant mode of exchange, thus truly creating an “economic system” as distinct from society at large (Polanyi 1957:71; 1968:84). This process of economic disembedding was, however, not a spontaneous process growing out from any natural propensity in human nature to truck and barter:

The orthodox teaching started from the individual’s propensity to barter deduced from it the necessity of local markets, as well as of division of labor; and inferred, finally, the necessity of

trade, eventually of foreign trade, including even long-distance trade. In the light of our present knowledge we should almost reverse the sequence of the argument: the true starting point is long-distance trade, a result of the geographical location of goods, and of the “division of labor” given by location. Long-distance trade often engenders markets, an institution which involves acts of barter, and, if money is used, of buying and selling, thus, eventually, but by no means necessarily, offering to some individuals an occasion to indulge in their alleged propensity for bargaining and haggling. (Polanyi 1957:58, 140ff)

On his extensive treatment on trade, Polanyi falls back on Aristotle’s discussions on natural vis-à-vis unnatural trade. Natural trade is here seen as administrated market exchange where prices, i.e. exchange rates, are set based on status and factual demand (Polanyi 1968:106-111). Unnatural trade, on the other hand, is based on commercial logics and strives for gain (Polanyi 1957:54). Tangential to Sahlins’ reasoning on social distances, long-distance trade was by definition not an integral part of local communities, thus lacking the redistributive character of local, communal markets. In Polanyi’s account, the mechanisms of commercial trade became a tool for undermining the sovereignty of individual cities: supported by religious reforms¹¹, mercantilism became a policy for state-crafting which united national territories under the umbrellas of national market:

An increasingly strict separation of local trade from export trade was the reaction of urban life to the threat of mobile capital to disintegrate the institutions of the town. The typical medieval town did not try to avoid the danger by bridging the gap between the controllable local market and the vagaries of an uncontrollable long-distance trade, but, on the contrary, met the peril squarely by enforcing with the utmost rigor that policy of exclusion and protection which was the *rationale* of its existence. [...] Deliberate action of the state in the fifteenth and sixteenth centuries foisted the mercantile system on the fiercely protectionist towns and principalities. Mercantilism destroyed the outworn particularism of local intermunicipal trading by breaking down the barriers separating these two types of noncompetitive commerce and thus clearing the way for a national market which increasingly ignored the distinction between town and countryside as well as that between the various towns and provinces. (Polanyi 1957:64ff)

The watershed between long-distance trade and local, communal markets marked a separation between spheres of exchange. Ethnographic data points to many occurrences of such where not only the exchange of goods and services, but also different kinds of labor, were categorized in specific exchange circuits (see also Keesing 1981:210ff):

Rice and maize – though counted – were not traded one for the other among agriculturalists in Panama. In addition, the labor used to produce them was measured by task and by time, but these counters were not used in trade; men exchanged labor in rice and labor in maize but not one for the other. [...] In contrast, the measuring rod of cash received for the sugar cane was used to purchase any item, including labor to raise the domestic crop. (Gudeman 2001:14)

Generally, exchange spheres designate cases in which goods are exchanged one for another within a circuit but do not circulate outside it. Exchanges within a sphere usually take the form of barter, but a single currency may serve as the measuring rod for the exchange rates. Exchanges between circuits also occur, but these are less frequent and are morally weighted, for the spheres are socially ranked. To trade “upward” represents a gain in prestige, exchanging “downward” loses status. (Gudeman 2001:142, note 17)

Modern market exchange in the Western society is monospheric: bicycle pumps are not only valued according to the same measurement rod as rusty nails, but the singular exchange

¹¹ “It is the change of moral standards which converted a natural frailty into an ornament of the spirit, and canonized as the economic virtues habits which in earlier ages had been denounced as vices. The force which produced it was the creed associated with the name of Calvin. Capitalism was the social counterpart of Calvinist theology.” (Weber et al 1930:2)

sphere as we know it also contains such diverse things as insurances, foodstuffs, means of production, natural resources, land ownership, human labor, household work, sex, status symbols, professional titles, money currencies et cetera. Occasionally, separate spheres of exchange, such as the provisioning of food stamps in welfare programs or the rationing of fuel in times of shortages, do appear, and instances of polyspherical exchange can also be found in our everyday lives, for instance in the exchange of Christmas cards, party invitations or support and assistance within close social distances. However, such bounded exchanges are mere exceptions to the general monospherical world of market exchange:

The alchemy of money, with its power of commensuration, lies in its ability to dissolve distinctions between value schemes or measuring rods, and to create the fiction that a flattened, comparable world exists. We make and live both realms continuously. (Gudeman 2001:15)

From an anthropological point of view, the global economy is best described as a market system where exchange is governed by prices dictated through the interplay between supply and demand, the former guided by production for profits and the latter established by a combination of tastes and, often forgotten, purchasing power. As such, the world-economy is disembedded from any other social institutions except from the institution through which it is manifested – the global market. Global market exchange is monospheric: the trade balances of nations contain virtually all possible types of goods and services and the balancing act of exchange is based on the singular measuring rod of market-established prices. Similar to Polanyi's description of the pre-integration of national markets in Europe, where there was a sharp distinction between external trade and local markets, it is feasible to assume that the external trade of the global market is integrated to national markets in different fashions, i.e. where international trade (inter-city trade) influences, breaks down, and transforms national economic systems (intra-city trade).

Mainstream economics of today, i.e. the neoclassical school, has as its stated objective to model national and the international market systems – that is, market modes of exchange of a monospherical kind, socially disembedded, where exchange rates are determined and constantly adjusted based on supply and demand as measured by the singular measuring rod of prices. Whether mainstream economics is adequate or not to model this particular type of market exchange, it is nevertheless important to remember that such models have been developed with the contemporary national and international systems of market exchange in mind.

In the spring of 2000, the movement for post-autistic economics grew out of a student protest in Sorbonne, France. Having gained wider support since then, this movement is at odds with how economics is taught around university departments around the world, where the term “autistic” refers to the discipline's tendency to separate itself from the real world it is supposed to describe, instead stubbornly holding on to assumptions which the movement simply views as incorrect. Overall, this critique often boils down to the issue of embeddedness in the Polanyian sense: ever since its genesis, the science of economics is fundamentally separated from all things social, viewing optimization, rational behavior and utility maximization as given, undisputable facts.

While this critique has led to a heated scholarly exchange and the prospect of an interesting revision of the economic discipline itself, much of which has bearing on international trade theory, the ambition of this chapter is to view exchange theory on its own accounts. For an

interesting overview of the post-autistic critique towards mainstream economics, I thus only refer the reader to Fullbrook (2004; 2007) as well as the *Real-world economics journal*¹².

Classical trade theory

The classical school of economic thinking constitutes both part and parcel of the significant period of transition occurring in England at the beginning of the first industrial revolution. As the era of mercantilism drew to its end, the second half of the 18th century implied a transformation of the political, social and economic landscapes, changes co-evolving with the emerging science of economics and adjacent strands of social theory. 1776 was not only the year when Adam Smith published *An Inquiry into the Nature and Causes of the Wealth of Nations*, it was also the year when Jeremy Bentham published his *The Fragment on Government*, arguing that man is driven solely by self-interest and that the role of government should be to accommodate this drive, and of Cartwright's *Take your Choice*, a highly influential book arguing for democratic reforms in the spirit of liberal democracy. 1776 was also the year of the US Declaration of Independence, representing a new doctrine of commercial liberalism, a "great historical fact, of which Adam Smith's doctrine is the theoretical equivalent" (Halévy et al 1928:106).

One way to interpret the emergence of the classical school of this time is entropic: as economic functions became disembedded from their previous institutional settings, the models of a post-mercantilistic economic system, as presented by the classical economists, filled an explanatory and institutional vacuum. As Polanyi (and others) have perceived, prior to the industrial revolution in England and the "great transformation" it represented, there was hardly any analytically distinct economic system to speak of. Instead, economic functions of production and distribution were embedded in different parts of the social weave as a whole: trade was regulated, private property was not universal, production was often controlled by different trade guilds, and proletarianized labor was an exception. With the disembedding of economic functions from such institutions, a new institution – the market – was created. The classical school in economics co-evolved with the creation of this new market institution: to some degree being a blueprint for the construction of it, to another degree reflecting the workings of it, and, most importantly at the time, demonstrating and defending the all-embracing social benefits to be gained by dismantling the old mercantilist structures in favor of the market institution.¹³

Condliffe dates the classical school between 1817 and the 1870s, beginning with the publication of Ricardo's *Principles of Political Economy and Taxation* and ending with the death of John Stuart Mill occurring at the same time as when Marx' *Das Kapital* was introduced in England (Condliffe 1950:163). The labeling of certain identified trends in the history of ideas into concepts such as "mercantilism", "classical school" and "neo-classicals" is only, as Condliffe is well aware of, a crude *ad hoc* simplification, often reflecting the labeler more than a distinct historical interval. Thus, before delving into Ricardo and the classical period, we will first look at two important influences to the classical school: Adam Smith and David Hume.

Often seen as the founder of the science of economics, Adam Smith's book of 1776 was not so much a detailed theoretical construct, instead being more concerned with practical issues

¹² Available online at <http://www.paecon.net/>

¹³ "Economics as we know it grew out of a great social need, the need to harmonize the Medieval logic of the 'schoolmen' with the changed conditions of the marked-dominated Age of Trade." (McNee 1959:190)

and dilemmas of the time (Condliffe 1950:120; see also Bagehot 1880). Holding a professor chair in logic at Glasgow University at the age of 27, subsequently transferred to the chair of moral philosophy, Adam Smith was more of a social philosopher than he was an economist in the same methodological vein as the classical economists that were to come. The importance of Adam Smith for the development of economic theory is nevertheless difficult to ignore: “by applying to economic questions the theory of natural liberty already worked out by political philosophers and theologians [of the time] ... [h]is fame is secure” (Condliffe 1950:122). These applications of his resulted in many ground-breaking concepts which have survived and developed well up to this day: the classic supply-demand-model, price theory, the concept of market equilibrium, the idea of man as a rational individual seeking to maximize his own well-being, and how this self-centric propensity of mankind to “truck, barter, and trade”, when left undisturbed, would lead to economic benefits for all. With such radical ideas, *The Wealth of Nations* was indeed a thorough attack on what Smith termed the “mercantile system”¹⁴ and its practice of government interference in economic affairs; instead, Adam Smith advocated a moral philosophy of individual liberty which would be far more superior to mercantilist policies for producing wealth. Still, in comparison with the subsequent work by Ricardo, Adam Smith had relatively little to say regarding international exchange.

Publishing his work almost a century before John Stuart Mill brought classical trade theory to its most refined state, “in so far as the classical theory of the mechanism of international trade had one definite originator, it was David Hume” (Viner 1937:292). Hume was born in 1711 and died on that special year of 1776. In his *Political Discourses* of 1752, Hume demonstrated how the mechanism of international trade and balancing of payments are best left without government interference. Assuming an unregulated international money standard, the flow of money (bullion) would, according to Hume, always end up where it was needed. A net outflow of bullion due to excessive imports over exports would, according to Hume, lead to lower prices which in turn would increase exports while lowering imports, thus restoring the balance in international trade. Similarly, if a country exported more than it imported, bullion would flow into the country, leading to rising prices and wages which would lower exports, making imports more attractive, restoring the delicate balance of payment between trading nations. Hume’s concept of an automatic self-regulating mechanism in trade, inter- as well as intranational (Viner 1937:293), was not only a critique of prevailing mercantilistic practices, but it was also an important precursor to Adam Smith’s ideas centered upon similar self-regulating, “invisible-hand”-style mechanism to obtain equilibrium between, and achieve the greatest good among, economic actors of such a system (Condliffe 1950:118ff). The *price specie-flow theory*, as this mechanism is usually referred to, played a substantial part in the models and arguments constructed by the classical economists, indeed being a foundation for the whole implementation of an international bullion-based money standard which developed in the 19th century.

David Ricardo, only four years old at the publishing of *The Wealth of Nations*, grew up during this period of transition. Initially following his father’s footsteps, the latter being a wealthy Dutch banker who had immigrated to London prior to his son’s birth, David Ricardo amassed a large fortune at the London Stock Exchange, giving him the opportunity to indulge in his scientific interests in mathematics, economics and the natural sciences. Inspired by

¹⁴ Adam Smith was the first to use the term “mercantile system” in his attack on prevailing practices in England, most probable inspired by the French physiocrats where the term was first used in 1763 (Condliffe 1950:67, note 10). A historical analysis of the actual practices of the period does point to different lines of thought within the “mercantilist school”; see Viner (1937:3ff) for an overview of these differences.

both Adam Smith and David Hume, Ricardo's *Principles of Political Economy and Taxation*, published in 1817¹⁵, broke with his predecessors in two important aspects. First, Ricardo's reasoning was abstract and mathematical, with hypothetical examples and deductive methods. Strongly inspired by the methodological advances done in the natural sciences, of which Ricardo were much interest in (Ricardo 1996 [1817]:8), his methodological approach came to define the classical school of the time and, indeed, contemporary mainstream economics of our own time (Condliffe 1950:159, 163, 171). Secondly, in contrast to Adam Smith and Malthus¹⁶, Ricardo put greater emphasis on the *distribution* of the produce between the factors of production than on production *per se*:

The produce of the earth – all that is derived from its surface by the united application of labor, machinery, and capital, is divided among three classes of the community, namely, the proprietor of the land, the owner of the stock or capital necessary for its cultivation, and the laborers by whose industry it is cultivated. But in different stages of society, the proportions of the whole produce of the earth which will be allotted to each of these classes, under the names of rent, profit, and wages, will be essentially different... (Ricardo 1996:13)

This focus on the distribution of the products of industry, combined with Ricardo's elaboration of the labor theory of value, lead to Marx finding Ricardo's work to be of such great scientific value as to call him a classical scholar (Marx 1867; Condliffe 1950:159; Keynes 1936:3n), a label which has come to represent not only Ricardo himself but, most probably unintentional on behalf of Karl Marx, the whole line of scholars following Ricardo.

The essays making up *Principles of Political Economy and Taxation* spans over many different lines of economic inquiry, of which his work on value, rent, and foreign trade is what he is most renowned for. Although Ricardo never used the term 'comparative cost', a term first used by Robert Torrens in 1827, later to be elaborated by John Stuart Mill in 1844 (see Viner 1937:443, note 12), Ricardo is attributed with the discovery of the idea of mutual gains from trade based on comparative instead of absolute costs. Whether Ricardo actually was the first to discover the concept of comparative costs has been questioned, especially with regards to Robert Torrens, a retired colonel and Fellow of the Royal Society, who has been claimed to be the first to formulate the idea in *An Essay on the External Corn trade* of 1815. (Torrens 1815; see also Condliffe 1950:166ff, 180; Viner 1937:442). These claims are partly supported by Viner (*ibid.*:442ff), while Condliffe seems to be more skeptical towards this claim in general and Torrens as a scholar in particular, pondering over Torrens being "a difficult colleague... always ready to claim priority for his theories" (Condliffe 1950:200; see also Viner 1937:444). John Stuart Mill does, however, pay homage¹⁷ to Torrens for formulating the theory of comparative costs as early as 1808 in *The Economist Refuted*. Going back further in history, the first known instance where the idea of comparative costs

¹⁵ The third edition of *Principles of Political Economy and Taxation* was published in 1821, at a time when the impact of the first edition already had established political economy as the new scientific basis for conducting economic analysis, which goes to demonstrate the impact Ricardo's book indeed had on contemporary thought (Condliffe 1950:162ff).

¹⁶ In 1820, Ricardo wrote the following in a letter to Malthus: "Political economy you think is an enquiry into the nature and cause of wealth; I think it should rather be called an enquiry into the laws which determine the division of the produce of industry amongst the classes who concur in its formation." (quoted from Condliffe 1950:159).

¹⁷ In the fifth (1862) edition of Mill's *Principles of political economy*, this acknowledgement was added as a note to chapter 17: "...Torrens, by the republication of one of his early writings, *The Economist Refuted*, has established at least a joint claim with Mr. Ricardo to the origination of the doctrine, and an exclusive one to its earliest publication." (Mill 1862)

can be found is in the document *Considerations on the East-India Trade*¹⁸ from 1701, whose author is unknown. There are many other precursors to the concept of comparative costs in various historical documents (Viner 1937:104-106), none however seemingly having any direct influence on the classical school. As Viner points out, the reasoning done in the *Considerations* document of 1701 as well as other pre-Ricardian treaties dealing with the gains from trade all ponder upon the general rule “that it pays to import commodities from abroad whenever they can be obtained in exchange for exports at a smaller real cost than their production at home would entail” (Viner 1937:440), perhaps a well-known pre-Ricardian rule but which Ricardo nevertheless was the first to formulate into a complete doctrine.

The Ricardian theory of comparative costs

Drawing a sharp demarcation line between inter- and intra-national trade (Ricardo 1996:93), based on the assumption of differences in factor mobility within and between nations, Ricardo’s classical example on English cloth and Portuguese wine is well known. Ricardo does however serve the reader with an analogous and perhaps more pedagogical example where he uses two individuals instead of nations:

Two men can both make shoes and hats, and one is superior to the other in both employments; but in making hats he can only exceed his competitor by one-fifth or 20 percent, and in making shoes he can excel him by one-third or 33 percent; – will it not be for the interest of both that the superior man should employ himself exclusively in making shoes, and the inferior man in making hats? (Ricardo 1996:95, note 1).

Thus it is not, as Adam Smith and the mercantilists before him argued, the real cost differences that determine what should be produced in different nations, but comparative costs within each nation (or craftsman). Reflected in the inferior man’s assumed inability to obtain some of the tools and skills the superior man has, Ricardo’s doctrine on international trade rests on the assumption of immobility of factors of production between countries, while an opposite assumption is made regarding factor mobility within nations:

If the profits of capital employed in Yorkshire should exceed those of capital employed in London, capital would speedily move from London to Yorkshire, and an equality of profits would be effected; but if in consequence of the diminished rate of production in the lands of England from the increase of capital and population wages should rise and profits fall, it would not follow that capital and population would *necessarily* move from England to Holland, or Spain, or Russia, where profits might be higher. (Ricardo 1996:93ff, my italics)

Experience, however, shows that the fancied or real insecurity of capital, when not under the immediate control of its owner, together with the natural disinclination which every man has to quit the country of his birth and connections, and intrust himself, with all his habits fixed, to a strange government and new laws, check the emigration of capital. These feelings, which I should be sorry to see weakened, induce most men of property to be satisfied with a low rate of profits in their own country, rather than seek a more advantageous employment for their wealth in foreign nations. (ibid.:95)

Writing his book in English rather than Dutch, Ricardo’s own family history contradicts the above: his father apparently did fairly well in this new country with its “strange government and new laws”. The mechanisms that keep capital within national borders are, as we can see above, described in socio-psychological rather than economic terms: capital flight does not *necessarily* follow in the hunt for better profit margins, as men of property prefer to stay in a

¹⁸ This document can be found in McCulloch and Ramsay (1954), *Early English tracts on commerce*.

social environment they are accustomed to. Not necessarily, that is, meaning that it still very well might occur.

Ricardo's trade example concerns the production of wine and cloth in England and Portugal – see Table 2.1. Similar to the craftsmen example above, Ricardo state his theory in the amount of labor needed, building on his labor value theory explained in the first chapter of *Principles*.

	Cloth	Wine	Comparative cost ratio
England	100	120	5:6
Portugal	90	80	9:8

Table 2.1: Amounts of labor needed to produce one unit of cloth and wine in England and Portugal

In this example, the production of one unit of cloth in England requires 100 units of labor. If this labor force instead were to produce wine in England, it would result in $\frac{5}{6}$ (~0.83) units of wine, which according to Ricardo's labor theory of value implies that one unit of cloth has the same value as $\frac{5}{6}$ units of wine. Expressed in terms of wine, one unit of wine produced in England has the same cost as $1\frac{1}{5}$ units of cloth. To produce one unit of cloth in Portugal requires only 90 units of labor. If Portugal employ this labor to produce wine, it would result in $1\frac{1}{8}$ (1.125) units of wine, which makes one unit of cloth in Portugal having the same value as $1\frac{1}{8}$ units of wine.

As Portugal and England thus both have comparative advantages in different goods, mutually beneficent trade between the two would take place, with each country specializing in what they are comparatively best at producing:

Under a system of perfectly free commerce, each country naturally devotes its capital and labor to such employments as are most beneficial to each. This pursuit of individual advantage is admirably connected with the universal good of the whole. (Ricardo 1996:93).

As England would prefer more than $\frac{5}{6}$ units of wine for each unit of cloth they produce, and as Portugal would prefer paying less than $1\frac{1}{8}$ units of wine for each unit of cloth, the exchange rate for one unit of cloth would be between $\frac{5}{6}$ and $1\frac{1}{8}$ units of wine. Expressed in wine, Portugal would prefer more than $\frac{8}{9}$ units of cloth for each unit of wine they produce, and similarly England would prefer a situation where they pay less than $1\frac{1}{5}$ units of cloth for each unit of wine. In Ricardo's example, trade between the two countries would be done where one unit of English cloth was exchanged for one unit of Portuguese wine¹⁹; however, the actual midpoint between the two different cost ratios, i.e. where the gain from trade would be divided equally between the two trading countries, is actually where one unit of cloth equals $\frac{47}{48}$ (~0.98) units of wine (Viner 1937:446, note 9). We will return to the issue regarding the division of the gains from trade later in this chapter; suffice it to note that "Ricardo does not indicate whether he regards this precise ratio as required by the conditions of the problem as he had stated them, or how the actual ratio would in practice be determined" (ibid.:446).

Although Ricardo's analysis is static in many ways, only focusing on long-term equilibriums while assuming a wide range of static conditions (Condliffe 1950:175), Ricardo does, however, discuss the possibilities for unilateral technical advances, exemplified with a general productivity increase in England, and how trade is affected by such. In Ricardo's

¹⁹ "England would give the produce of the labor of 100 men for the produce of the labor of 80." (Ricardo 1996:94)

example, this could lead to England and Portugal producing their own cloth and wine. According to Ricardo, trade would however continue for a while until the price specie-flow mechanism has found a new balance, setting new relative price levels according to the Humean price specie-flow mechanism:

Cloth would continue for some time to be exported from [England], because its price would continue to be higher in Portugal than [in England]; but money instead of wine would be given in exchange for it, till the accumulation of money [in England], and its diminution abroad, should so operate on the relative value of cloth in the two countries that it would cease to be profitable for the two countries to exchange employments. (Ricardo 1996:96)

Ricardo does not explicitly say so, but it can be assumed that the hypothetical invention improving wine production in England actually affects the comparative cost ratios in such a way that the comparative advantage of English production shifts. This would imply that the labor cost in England for producing one unit of wine is actually less than for producing one unit of cloth, “so that it should become [England’s] interest rather to grow it than import it;... she would cease to manufacture cloth for exportation, and would grow wine for herself.” (Ricardo 1996:96). Nevertheless, according to Ricardo, trade would still carry on for a while, exchanging British cloth for Portuguese money, until the price specie-flow mechanism has balanced the prices accordingly: “[B]ills would be bought, and money would be exported, till the diminution of money in Portugal, and its accumulation in England, had produced such as [sic] state of prices as would make it no longer profitable to continue these transactions.” (Ricardo 1996:97). Thus, trade do of course also occur in the Adam Smithian way, i.e. based on real costs (as measured in money), but in the long run, which was of interest to the classical economists, the Humean mechanism would balance these cost differentials.

The Ricardian theory of international trade carries with it a number of assumptions, most of them being implicit. First, the factors of production have total mobility within nations: the labor and capital displaced due to imports would find alternative employment in industries of which the country had better comparative advantages in. Secondly, as we have seen above, Ricardo argued that the factors of production stayed within national boundaries: capital and labor did not move to other places, thanks to the “natural inclination” of people not wishing to move to another country with its “strange government and new laws” (Ricardo 1996:95). Thirdly, the price specie-flow mechanism was seen as fully operational and worked according to the specified logic: an international and unregulated money standard was assumed, balancing prices across the world.

The first assumption was widely disputed outside England, especially in the newly independent USA where the “floods of imports” from England seemed to threaten the development of US domestic industries. Mathew Carey, a significant influence among protectionists in USA, criticized the Ricardian theory as early as 1819: “Carey’s view was that, theory or no theory, the unemployment was real. Hence, he argued, the assumptions were so unrealistic as to make the theory useless and misleading.” (Condliffe 1950:174). Ricardo does, however, admit that the reallocation of capital and labor within nations can be temporarily displaced without finding employment; in a discussion on capital allocation due to different profit ratios, Ricardo temporarily steps away from the abstract modeling to reflect on empirical observations of the time:

The present time [1817] appears to be one of the exceptions to the justness of this remark [regarding intra-national capital reallocation]. The termination of the [Napoleonic] war has so deranged the division which before existed of employments in Europe, that every capitalist has not yet found his place in the division which has now become necessary. (Ricardo 1996:63)

Ricardo was the first to blame post-war disturbances for such empirical deviations from trade models. Similar post-war-based explanations were later used to defend the correctness of neo-classical models when faced with empirical anomalies after both the First and Second World War; see below.

The second assumption regarding the immobility of factors of production between nations is crucial for the workings of the Ricardian model. Without these barriers to movement in capital and labor, the factors of production could reallocate to the nations where the lowest real cost of production would be. However, this assumption was weakened by John Stuart Mill in his refinement of international trade theory, diminishing the restraining role played by “strange governments” and “new laws” (which obviously had no effect on Ricardo’s own father when moving to England, from Holland):

[C]apital is becoming more and more cosmopolitan; there is so much greater similarity of manners and institutions than formerly, and so much less alienation of feeling, among the more civilized countries, that both population and capital now move from one of those countries to another on much less temptation than heretofore. (Mill 1849b:113)

Mill thus preferred to define international trade as trade between two regions where there was factor immobility between them (Condliffe 1950:174ff), thus actually excluding a significant part of world trade at the time – and perhaps the whole world of today.

The third assumption regarding the functioning of the price specie-flow mechanism proved to be fairly volatile as well. “Ricardo wrote when the monetary circulation of England was inconvertible into gold.” (Condliffe 1950:187); apparently, much of the trade that occurred was credit-based rather than bullion-based, making balancing of payment a more subtle and non-trivial process than as depicted in the price specie-flow theorem.

Except for the above three assumptions, Ricardo’s doctrine also contains a number of implicit assumptions that began to be addressed more extensively in the post-classical era. Transaction costs between countries were ignored, return to scale was assumed to be constant, factor endowments, tastes, and demand were given and static, and labor time was seen as the only way to measure wealth. Labor costs were also implicitly seen as corresponding to the money costs by which trade operated (Viner 1937:183, note 5).

Division of the gains from trade

In Ricardo’s example, trade would occur if the exchange rate between English cloth and Portuguese wine were within the interval determined by comparative costs in each of the participating nations: as long as one unit of English cloth was valued at between $\frac{5}{6} - 1 \frac{1}{8}$ units of Portuguese wine, both countries would benefit from the trade. However, if the exchange ratio was at either of the endpoints of this interval, only one of the trading partners would benefit from the exchange. For instance, if one unit of English cloth was exchanged for $\frac{5}{6}$ units of Portuguese wine, corresponding to the hypothetical price ratio for an isolated England, this would mean that the whole gain of the trade would end up in Portugal, a gain corresponding to 28 units of Portuguese labor.²⁰ Similarly, if one unit of English cloth was

²⁰ Exchanging one unit of English cloth for $\frac{5}{6}$ units of Portuguese wine means that Portugal would get 1.2 units of English cloth for each unit of wine traded with England. If Portugal were to produce 1.2 units of cloth instead, it would cost Portugal 108 units of labor. Through trade, Portugal would spend 80 units of labor (producing one unit of wine for export) to gain cloth which would cost Portugal 108 units of labor to produce, thus gaining an equivalent of 28 units of labor through this trade.

valued at $1\frac{1}{8}$, the whole gain of trade (corresponding to 35 units of English labor) would end up in England. Although such trade at either extreme of the bargaining interval would not occur according to Ricardo, the question concerning exactly where in the interval the exchange rate would be established at, and the underlying factors determining the exchange rate, came up on the agenda fairly shortly after Ricardo presented his doctrine. Ricardo himself took no interest in this question, simply arguing that each of the participants in trade would get what it was entitled to, based on competitive efficiency (Condliffe 1950:195). Condliffe interprets this original lack of interest in the division of the gains from trade as one ingredient in the anti-mercantilism inherent in classical doctrine (ibid.:197): it is conceivable that a focus on the division of gains would make the classicals' argument on the win-win situation more vulnerable from contemporary mercantilist counter-arguments.

John Stuart Mill: reciprocal demand as determining division of gains from trade

In his refinement of the Ricardian trade doctrine, John Stuart Mill was the first to formulate a systematic reply to the question on how gains from trade were divided. Being the son of James Mill, who also made important contributions to the emerging science of economics²¹, (John Stuart) Mill received a scholarly upbringing inspired by the thoughts of the time, especially those of Jeremy Bentham and, of course, his father. Although Mill's work in the fields of political economy is our main focus here, his collected writings spanned over several related fields. Publishing his *System of Logic: Ratiocinative and Inductive* in 1843, Mill's two writings on political economy in 1844 and 1848 were followed by a diverse blend of writings such as *On Liberty: Thoughts on Parliamentary Reform* (1859), *Utilitarianism* (1863), *The Subjection of Women* (1869), and *Three Essays on Religion: Nature, the Utility of Religion, and Theism* published post-mortem in 1874.

John Stuart Mill published his *Essay on Some Unsettled Questions of Political Economy* in 1844, followed four years later by his renowned *Principles of Political Economy*. Similar to the post-war modernization school view, John Stuart Mill depicted trade, in addition to its undisputed economic benefits, as a carrier, injector and progressor of moral values:

...the economical advantages of commerce are surpassed in importance by those of its effects which are intellectual and moral. It is hardly possible to overrate the value, in the present low state of human improvement, of placing human beings in contact with persons dissimilar to themselves, and with modes of thought and action unlike those with which they are familiar. [...] [C]ommerce first taught nations to see with good will the wealth and prosperity of one another. Before, the patriot, unless sufficiently advanced in culture to feel the world his country, wished all countries weak, poor and ill-governed, but his own; he now sees in their wealth and progress a direct source of wealth and progress to his own country. [...] [T]he great extent and rapid increase of international trade, in being the principal guarantee of the peace of the world, is the great permanent security for the uninterrupted progress of the ideas, the institutions, and the character of the human race. (Mill 1849b:121)

Although adhering to the strict formal reasoning initiated by Ricardo, in many ways Mill resembles the practical "social philosophical" school as can be found in Adam Smith's work. Having a thorough education in many different fields of science, Mill viewed political economy as an abstract science, ridiculing the notion that students of political economy actually suppose that mankind are constituted to act like they are described in the science of deductive political economy (Condliffe 1950:238). Stating that "the mere political economist,

²¹ James Mill published his *Elements of Political Economy* in 1821 in which Ricardo's theories were refined further. Co-founding the *Westminster Review* with Jeremy Bentham in 1842, James Mill put great emphasis on spreading the gospel of Ricardo in his work as a journalist and propagator (Condliffe 1950:165ff).

he who has studied no science but Political Economy, if he attempts to apply his science to practice, will fail.” (Mill 1844:151), Mill’s somewhat humble approach to the deductive science of economics was perhaps dwarfed by the brilliant deductions per se of which he is renowned for.

Mill’s contribution to political economy and the theory of international trade are mainly twofold. In his elaboration on the price specie-flow mechanism, Mill’s treatment of money as an intermediate commodity (by equating money and precious metals) made it possible to model international trade as simple barter trade. His second major contribution, which is of special interest here, was on the division of the gains from trade and how it was determined by the reciprocal demand of each other country’s products. The idea was formulated by Mill as early as 1829-30, and was later published in his 1844 collection of essays. The idea of reciprocal demand can be found in Longfield’s *Three Lectures on Commerce and Absenteeism* of 1835, expressed more explicitly by Pennington in 1840 (see Viner 1937:447), and, similar to the pre-Ricardian conceptualization of comparative costs, in Torrens’ *The Budget* (1841-44), the latter being the first to use the term “reciprocal demand” (Viner 1937:536n3). Mill does acknowledge that he is not responsible for “the original conception, but only the elaboration” of the idea of reciprocal demand (Mill 1844: preface), but it is nevertheless from Mill that subsequent economic discussions on reciprocal demand usually stem from.

The concept of reciprocal demand is explained by Viner in the following manner (exchanging commodities A and B in Viner’s explanation with the wine-cloth Ricardian example):

The greater demand for [wine] in terms of [cloth] in the country with a comparative advantage in the production of [cloth, i.e. England], the closer, other things being equal, would the rate of exchange of [cloth] for [wine] approach to their relative costs of production in [England]. The greater the demand for [cloth] in terms of [wine] in the country with a comparative advantage in the production of [wine, i.e. Portugal], the closer, other things being equal, would the rate of exchange of [cloth] for [wine] approach to their relative costs of production in [Portugal]. (Viner 1937:447)

This reasoning was further advanced by Nicholson in 1897 and by Graham in 1923, both stressing the importance of not only reciprocal demand but also the magnitude of the trading countries (Viner 1937:448). With country size being deemed as related to size of demand, the contents of their reasoning on reciprocal demand as determinant of barter exchange rate holds a great promise for smaller countries engaging in free trade: assuming different comparative costs between trading countries, the larger demand of the larger country for the products of the smaller countries would lead to, ceteris paribus, that the smaller countries would obtain the larger share of the gain. The greater the differences between the sizes of the countries engaging in trade, the greater the differences in reciprocal demand and the greater the share of trade gains ending up in the smaller country. Marshall extended the concept of reciprocal demand further – we will look closer at his deductive reasoning in the subchapter on neo-classical trade theory below.

Although Graham pointed out that this phenomena was only applicable when there were two countries trading two commodities, the more realistic case with more countries and commodities entering the arithmetical constructions, meant that the gains of trade are shared somewhat more equally. John Stuart Mill, however, stated that “[t]rade among any number of countries, and in any number of commodities, must take place on the same essential principles as trade between two countries and in two commodities” (Mill 1849b:130), Mill

also recognizes the possibility of partial specialization due to discrepancies in supply and demand in international trade. In his hypothetical example on English cloth and German linen, where Germany's demand for cloth exceeds England's productive potential, Germany would counter this by producing a share of the consumed cloth by herself (Mill 1849b:125, also see Viner 1937:450).²²

A debate on how the division of the gains of trade was affected with more than two commodities was initiated by Longfield and Torrens in 1835, followed by Stirling (1853) and von Mangoldt (1871) (Viner 1937:455-458). Though, as more commodities, as well as more trading partners, entered the arithmetics, things became much more complicated. Edgeworth stated that "it is not in general possible to determine *a priori*, from a mere observation of the [real] costs of production in the respective countries before the opening of trade, which commodities will be imported and which produced at home." (Edgeworth 1925:55). Condliffe arrives at a similar conclusion, stating that "[t]hese measurements have some practical value as indicating the way in which, for example, raw material exporting countries may find themselves with export prices moving favorably or unfavorably as compared with the prices of the manufactured goods they import", but that "[s]uch measurements can be made only after the statistics have been compiled...[thus being] useless as a guide to current policy..." (Condliffe 1950:201). Stating it more aptly, now having entered the neo-classical era in economic thinking, Haberler stated that "these considerations [on the division of the gains of trade]...[ignoring] such important factors as changes in distribution and gains or losses due to the fact that a cumulative process of expansion or contraction might be started or interrupted, retarded or accelerated...have such an unreal air that there is little point in pursuing them further" (Haberler et al 1936:166). This general neglect on the question on the division of the gains from trade is not only to be found in post-classical analyses; in 1874, Cairnes seems to foresee the problems, arithmetical or otherwise, in determining the exact nature of the gains:

We know the nature of the gain: it consists in extending the range of our satisfaction, and in cheapening the cost at which such as in its absence would not be beyond our reach are obtained; and we know that the amount which it brings to us under each of these categories cannot but be very great; but beyond this indefinite and vague result our data do not enable us to pass. (Cairnes 1874:421)

Friedrich List: a non-English classical discourse

Either seen as a political dissident, or simply disregarded altogether in discussions on the development of international trade theory, Friedrich List does indeed deserve to be treated with the same type of analytical respect as other economists of the time.²³ Reflecting significant frustration over English manufacturing supremacy at the time²⁴, the theoretical arguments of List demonstrate not only a thorough understanding of the theoretical specifics

²² The idea of partial, instead of total, specialization can actually be found in the third edition of Ricardo's *Principles* regarding corn imports (Ricardo 1996:15), but the concept was not extensively elaborated there.

²³ Alfred Marshall praised the brilliant genius of Friedrich List (Marshall 1895:69), arguing that the historical economics as presented by List greatly extended the boundaries of economic theory.

²⁴ Describing the hypothetical consequences of free-trade under "the existing conditions of the world" of 1841, the future of Germany is indeed painted in gloomy colors: "[T]he European Continental nations would be lost as unimportant, unproductive races. [...] Germany would scarcely have more to supply this English world with than children's toys, wooden clocks, and philological writings, and sometimes also an auxiliary corps, who might sacrifice themselves to pine away in the deserts of Asia or Africa, for the sake of extending the manufacturing and commercial supremacy, the literature and language of England. It would not require many centuries before people in this English world would think and speak of the Germans and French in the same tone as we speak at present of the Asiatic nations." (List 1999:19).

of the English classical school but also the specific socio-economic and cultural context from which it stemmed. In List's treatment of value theory, international trade and factors of production, demonstrating a thorough grasp of the classical arguments and models, List can be seen as a verbally spiced-up German version of Ricardo. At times inventing a parallel terminology to the concepts introduced by the English line of political economy, List institutional perspective on economics can, for instance, be noticed in his questioning on the definition of capital as specified by Smith et al:

That which we understand by the term 'instrumental powers' is called 'capital' by the [classical] school. [...] The school now understands by the term 'capital' not merely the material, but also all mental and social means of and aids to production. It clearly ought, therefore, to specify wherever it speaks of capital, whether the material capital, the material instruments of production, or the mental capital, the moral and physical powers which are inherent in individuals, or which individuals derive from social, municipal, and political conditions, are meant. (List 1999:129)

His second volume – *The theory* – is more a dissection and modification of the classical school than a presentation of an alternative doctrine. Published in German in 1841, with the English translation by Sampson Lloyd released in 1885, the major critique of “classical” (i.e. English) doctrine is its disregard for the political dimension of economic systems; instead, List argues, the two have a reciprocal influence on each other (List 1999:30) and the phenomenal growth of manufacturing industries in England was not in spite of, but *due* to, active state involvement.²⁵ The proclamation of unregulated free-trade among scholars and policy makers in England was, according to List, a strategic policy in the interest of the English, just as the Corn Laws and the Navigation Acts previously had been:

Any nation which by means of protective duties and restrictions on navigation has raised her manufacturing power and her navigation to such a degree of development that no other nation can sustain free competition with her, can do nothing wiser than to throw away these ladders of her greatness, to preach to other nations the benefits of free trade, and to declare in penitent tones that she has hitherto wandered in the paths of error, and has now for the first time succeeded in discovering the truth. (List 1909: chapter 33, p. 16)

Given this history, argued Friedrich List, the leading German economist of the mid-19th century, Britain preaching free trade to less advanced countries like Germany and the USA was like someone trying to “kick away the ladder” with which he had climbed to the top. (Chang 2002)

Still being a firm believer in the mutually beneficial advantages of trade as advocated by the classical school (List 1999:13), List argues that the classical school “confounds effects with causes” (ibid.:14): the popular school assumes the existence of a great commercial republic of states of equal prominence, instead of accepting the fact that the world is made up of politically independent states striving for their own individual well-being. Therefore, List argues, the free-trade advocates and policies of England are postulating nothing else than economic warfare. Imported manufactures were seen as “Trojans” (List 1999:37), best dealt with using protective devices until the countries were on equal footing, in principle addressing the same questions on relative magnitude and reciprocal demand as J S Mill, Nicholson and Graham (see above):

The system of protection, inasmuch as it forms the only means of placing those nations which are far behind in civilisation on equal terms with the one predominating nation (which, however, never received at the hands of Nature a perpetual right to a monopoly of manufacture, but which merely gained an advance over others in point of time [sic]), the system of protection regarded

²⁵ There are some interesting parallels between List and Polanyi's writing, parallels concerned with embeddedness and the would-be separation between economic exchange and the social sphere at large.

from this point of view appears to be the most efficient means of furthering the final union of nations, and hence also of promoting true freedom of trade. (List 1999:14ff)

A second critique of List regarding the popular school of relevance for trade theory is the non-distinction between agricultural produce and manufacturing goods:

With regard to the interchange of raw products, the [English classical] school is perfectly correct in supposing that the most extensive liberty of commerce is, under all circumstances, most advantageous to the individual as well as to the entire State. [...] But the manufacturing productive power, on the contrary, is governed by other laws, which have, unfortunately, entirely escaped the observation of the school. (List 1999:119)

Not too different from Hirschman's argument regarding on-the-job cultural training (Hirschman 1992:19), i.e. how a production process per se is a carrier of modernization, also being very similar to the functional dualism as advocated by Boeke et al, Friedrich List argues that national specialization on either agriculture or manufacturing has different effects on non-economic institutions and "modes-of-thought":

In a condition of merely agricultural industry, caprice and slavery, superstition and ignorance, want of means of culture, of trade and of transport, poverty and political weakness exist. In the merely agricultural State only the least portion of the mental and bodily powers existing in the nation is awakened and developed, and only the least part of the powers and resources placed by nature at its disposal can be made use of, while little or no capital can be accumulated. [...] Manufactories and manufactures are the mothers and children of municipal liberty, of intelligence, of the arts and sciences, of internal and external commerce, of navigation and improvements in transport, of civilisation and political power. (List 1999:31)

To be engaged in foreign trade, specializing in the production and exchange of agricultural products for foreign manufactures is thus, according to List, subjugation not only to a specific division of labor, but also a division of institutional functions representing different cultural standards.

The legacy of the classical school

Ricardian doctrine, and the classical school which it initiated, was indeed a formidable weapon in the fight against prevailing policies and practices. Government regulations on trade and import duties as manifested in the Corn Laws were worthy opponents for the Ricardian argument: "[f]or the basis of an argument against the Corn Laws it would have been difficult to invent anything more effective than the Ricardian theory of distribution." (Cannan 1903:391). The Anti-Corn Law League, a free-trade movement founded in Manchester in 1838 under the leadership of Richard Cobden, gained a lot of impetus after a nation-wide crisis in manufacturing growth in the 1840's, followed by the potato famine in 1845-46; allowing for free imports of corn and other foodstuffs would, according to this movement, lead to lower and more stable food prices, with more labor being available for manufacturing jobs in accordance with Ricardian doctrine. The Anti-Corn Law movement had, however, broader objectives than the mere abolishment of the Corn Laws; this free-trade movement "was both an attempt to organize an idealistic system of international relations and a painstaking reform of the public finances and of the regulations by which trade was controlled." (Condliffe 1950:210). Conducting a program to educate the broad masses in the advantages of free-trade à la Ricardo²⁶, the movement was indeed successful as the Corn

²⁶ Although the free-trade movement apparently managed to change public opinion regarding tariff protection and the benevolence of free-trade, one interesting opposition to the free-trade movement is the Chartist labor movement. This movement opposed free-trade as, they argued, lower prices on foodstuffs would inevitably lead

Laws and the Navigation Acts were abolished in 1849. The 1,150 items on the English custom tariffs in 1840 were reduced to a meager 15 items at the end of the 19th century, a reduction which in practice meant that England became the centre of international commerce and trade:

Though she lost the commanding leadership in manufactures with which she had started the century, her export trade continued to expand. The shipping, commercial, insurance, and financial commissions which were gained from acting as the clearinghouse of world trade and investment were very considerable. (Condliffe 1950:216)

Outside the British Isles, the classical school of political economy did not enjoy a similar welcoming among the broad masses and government policies. Instead, as is reflected in List's writings above, this line of thought was interpreted somewhat differently:

On the continent of Europe what came to be known as English political economy – in the effective German phrase, national economy – could be represented as a rationalization of policies which Britain alone among the nations could afford and profit from. (Condliffe 1950:239)

In academia, the situation was somewhat opposite. In his survey of contemporary political economy at the time (1837), Blanqui stated that English political economy had “created a nomenclature, which has finally been adopted by all the economists of Europe, and which will serve as a starting point for their future labors.” (Blanqui 1968 [1880]:530). The concepts formed by the classical (and pre-classical) economists in this exceptional economic power, at this exceptional time in history, came to influence economic theory in general; not only defining the basic Smithian concepts forming the core of mainstream economic curricula, but also forming the triangular division of the factors of production into land, labor and capital (see above), and formulating the core doctrine of international trade which, as we shall see below, subsequent theoretical constructs built upon.

Neo-classical trade theory

Three characteristic traits of the neo-classical school

No matter when the neoclassical period started, the term itself is somewhat problematic. Neo-classicism, similar to other terms carrying the same affix, implies a rebirth of dormant ideas with something else in-between. When Condliffe thus labels “the development and restatement of economic thought after the death of John Stuart Mill in 1872” (Condliffe 1950:401) as neo-classical doctrine, the term turns into a representation of models and concepts building directly on the classical school. Although socialist doctrine can be seen as an alternative to the late classical school, appearing and slowly gaining significance in the post-Mill era, the development and restatement of economic thought from 1872 and onwards is perhaps better classified as *post-classical* rather than neo-classical.

However, when looking at the historical development of neo-classicism, we do indeed find a heterogeneous collection of theorems and model constructs over time. This is especially evident when it comes to trade theory: beginning with a slightly modified Ricardian model, neo-classical trade theory has since transformed itself, absorbing new aspects of relevance while reformulating and expanding previous arguments and assumptions. At each step in this historical trajectory, slightly different policy recommendations has been put forward in order

to lower wages (see Condliffe 1950:213-214); the Chartist's standpoint thus reflected a belief in the Malthusian perspective, or at least a belief in that the socio-economic mechanisms setting wages did indeed work as Malthus had explained them.

to attain the one “truth” which has remained unchanged within neo-classical (and classical) trade theory: the undisputed benefits to partners participating in international trade. With the advent of New Trade Theory á la Krugman in the early 1980’s, the universality of this common truth has implicitly been questioned, but without any major repercussions – at least up to this date – on national and supra-national policy recommendations.

Although Condliffe includes the marginalist school in his chapter on neo-classical doctrine, a cornerstone of contemporary mainstream economics (Perloff 2004:84), it took decades of debate before marginalist thinking became fully accepted by neo-classicists. The controversies surrounding this incorporation of marginalist thinking into economics, most notably the concept of marginal utility, is well worth mentioning as it per se demonstrates the three characteristic traits which differentiates neo-classical economics from the classical school: a reformulated theory of value, methodological refinements through the use of advanced mathematics, and, based on a combination of these two traits, the introduction of pre-analytical, method-rooted conditions on what actually *can* constitute a relevant economic questions to address.

Originating in the writings of von Gossen in 1854 on the satiation of wants, marginal utility was independently presented by Jevons and Menger in 1871, followed by Walras and Marshall a couple of years later. The concept of marginal utility - that the utility of each successive addition of an individual’s stock of commodities will diminish - inevitably led to the use of differential calculus as the relationship between utility and quantity turned non-linear. With such mathematical tools, a theory and model of general equilibrium was made possible: individual commodities as well as factors of production could be modeled as separate but interdependent markets, constantly heading towards equilibrium where marginal costs on the supply side would equal marginal utility on the demand side. This led to a reformulated theory of value: discarding the Ricardian labor-cost theory of value, represented by the amount of labor required for production, neo-classical doctrine treated value as determined only by the degree to which people’s desire for a good exceeded the supply. With supply and demand of different goods and services being interdependent with each other, prices became the common denominator and measure of value as economic actors decide how to spend their purchasing power among these goods and services according to their assumed propensity to maximize their utility.²⁷

To model an economy with separate markets for each good and factor of production, each market having its own specific non-linear relationship between prices and quantities, a quantum leap in mathematical methods was required. These methodological developments *per se* turned into a cornerstone of the neo-classical paradigm:

²⁷ The Marxian rejection of the neo-classical concept of value has been intense. The classical Marxian counter-argument is simple: if capital is seen as productive, i.e. creating value, there are no moral obligations *not* to share the profits of production with the machines (or their owners) contributing in the value-adding processes. Another possible interpretation of the Marxian reactions to the neo-classical concepts of value is of a more mathematical kind: as the labor-cost theory of value implied a linear relationship between labor quantity and value, the value theory based on marginal cost as applied on production factors meant that the relationship between labor quantity and value turned non-linear, making the moral implications of solidarity and equality a scale-dependent issue. As Marxism explicitly address the social embeddedness of labor, viewing labor as actual human beings in need of subsistence, the neo-classical focus on marginal production of labor meant a further step towards the commodification of human beings into units of production, thus reinforcing the disembedding of the economic system from all things social.

The neo-classical economists displayed a remarkable degree of concentration upon methods of analysis rather than upon observation and classification of economic phenomena. [...] A distinguished member of the Cambridge school which Marshall founded has been cited as defining the subject matter of economics as neither more nor less than its own technique. Detailed analysis was sometimes developed as a demonstration of mathematical symmetries rather than a deduction from observed and tested premises. (Condliffe 1950:404ff)

This focus on methods rather than observed phenomena reflects how several of the neo-classical institutional assumptions – such as private property, freedom of contract, non-monopolistic situations and free competition – became incorporated in the models rather than being ideal assumptions whose relevance could be open for discussion:

The increasingly elaborate use made of algebraic symbols expanded by mathematical manipulation, and of geometrical diagrams, demonstrated the fact that the reasoning was implicit in the assumptions that lay behind the precise definition of the symbols. (Condliffe 1950:404)

Although Condliffe states that these mathematical models “assumed the continuance of political and economic institutions” (ibid.:403; see also ibid.:678), a more accurate statement would be that the models assumed *ideal* institutions rather than the continuance of institutions actually existing at the time. Such ideal settings were crucial for the workings of such models more than they were reflections of actually existing institutions, all this representing a grand Korzybskian switch between map and reality within the science of economics.

The mathematicalization and quantification of economics-as-science had profound implications for economic reasoning: instead of discussing economic arguments and hypotheses based on their correspondence with observed phenomena, the pros and cons of economic arguments were based on how well they could be mathematically integrated with the specifics of the growing body of economic models. Although the concept of marginal utility contributed to this shift of focus, pre-analytical conditions on form, rather than substance, actually turned marginal utility into a target for neo-classicists at the turn of the 19th century.

Veblen (1909) argued that marginal utility was incompatible with neoclassical economics: having only limited relevance on issues on distribution in static scenarios, the theory of marginal utility “is not drawn in casual terms but in terms of teleology.” (Veblen 1909:621). Building partly on Veblen, Downey’s (1910) critique on marginal utility more explicitly reflected the analytical pre-conditions imposed on would-be neo-classical concepts: as the concept does not explain prices, marginal utility “only restate the price problem in language which is unintelligible to the layman, and which is meaningless even when understood.” (Downey 1910:253).²⁸ The debate over marginal utility as a valid neo-classical concept was thus more focused on the actual *formulation* of the concept rather than on the validity of the phenomena itself; Bernadelli (1938) says the following on the facets of this controversy:

The way in which this concept [of marginal utility] has been used in mathematical economics so far, it is contended, is incompatible with the fact that utility being an intensive, psychological magnitude cannot [sic] be subjected to any form of measurement. The theory of value, it is

²⁸ Interestingly, both Veblen and Downey view marginal utility as imposing a hedonistic view on human economic behaviour: “Deliberation, reasoned choice, plays but a minor part in the affairs of men. [...] Habit, not calculation, governs the greater part of all our acts. Even such calculating and choosing as we do is done only upon the basis and within the limits of habit” (Downey 1910:255; see also Veblen 1909:623). Veblen and Downey thus challenge the relevance of utility through an attack on the rationality postulate in neo-classical economics.

claimed, has to be reconstructed so that no doubt is left as to the fundamental immeasurability of total and marginal utility, and if it should turn out that either of these two concepts, or both, cannot be fitted into the reshaped framework [of mathematical economics], it is concluded that they must be eliminated as “meaningless” and “unscientific”. (Bernadelli 1938:192)

With the formulation of utility as a cardinal rather than an ordinal measure, marginal utility became compatible with the reshaped mathematical framework which characterized neo-classical doctrine, eventually turning marginalist thinking into one of the cornerstones of mainstream economics of today. The grand issue at hand was thus not whether the concept was viable or not – i.e. whether it reflected observed phenomena in human economies - but rather whether the concept could be expressed in the “algebraic symbols”, which were necessary for a concept in order to qualify as relevant in the science of economics. Bernadelli’s mathematical reformulation of marginal utility, although disputed in later writings, is concluded by a comment whether it is necessary to rewrite the textbooks: echoing the more nuanced view on map versus terrain, abstraction versus reality, as could be found in John Stuart Mill:

I feel inclined to consider [rewriting the economic textbooks] as too puristic. Generally it is not advisable in a science to break away from a firmly established tradition. [...] One could retain the traditional method as a *façon de parler*, if only economists become aware what they are doing and let themselves not any longer get entangled in the pitfalls of the measurability dispute. (Bernadelli 1938:210)

Placing such importance on the cartography of economics, rather than the actual creation of realistic maps, is indeed indicative of the neo-classical methodological shift, away from deductiveness in favor of abductiveness. In the chapter on economic exchange structures, we will look at how the spatial dimension has been treated in neo-classical economics: although the spatial dimension in economic exchange systems has always been recognized as important, it was not until it could be modeled in an acceptable manner that the spatial dimension entered into the equations of neo-classical economics. Form and methods thus precede substance and arguments, this forming a central characteristic of economics-as-science up to this day:

So what is it that makes some ideas acceptable, while others are not? The answer – which is obvious to anyone immersed in economic research yet mysterious to outsiders – is that to be taken seriously an idea has to be *something you can model*. A properly modeled idea is, in modern economics, the moral equivalent of a properly surveyed region for eighteenth-century mapmakers. (Krugman 1995:5; original italics)

The problem is that there is no alternative to models. We all think in simplified models, all the time. The sophisticated thing to do is not to pretend to stop, but to be self-conscious – to be aware that your models are maps rather than reality. (ibid.:79)

Neo-classical trade theory I: post-classicism and Alfred Marshall

The early neo-classical models of international trade built firmly on the same framework as used by the classicals, thus effectively separating international trade theory from the main body of economic theory (Condliffe 1950:410). This sharp division is still present in contemporary economics courses where international trade is treated in macroeconomics, separated from microeconomic theory. The assumptions on factor immobility became what distinguished international trade from its intra-national counterpart: viewing international trade as trade between non-competing groups specified by Cairnes as early as 1873, the division seemed to make sense. However, as was concluded by Graham (1948), it was nevertheless discussed and treated as competitive trade between individuals (Condliffe

1950:413, note 7). Although the factor immobility assumption was questioned by Bagehot as early as 1870, deeming such a conceptual ring-fence of capital transfers to be unfeasible, the classical assumptions on factor mobility within and between nations remained firmly within the neo-classical model constructs. Under this assumption, “the theory of comparative costs continued to be the justification for a separate theory of international trade” (Condliffe 1950:411).

Instead of presenting comparative advantage using quantities of labor, the neo-classical approach stated costs as measured in prices. Doing so implied another hidden assumption: the structure of industrial production and factor costs were approximately the same in the countries participating in the trade (Condliffe 1950:423). While the classical theory focused on describing trade patterns between countries with different comparative advantages in different goods, the neo-classical theory of trade set out to explain why such differences existed (Dicken 1994:74).

With regards to the third Ricardian assumption, neo-classical scholars added very little to the Humean price specie-flow theory of the classicists (Condliffe 1950:415). The post-First-World-war restoration and the subsequent collapse of the international gold standard did not automatically lead to a revamped theory or model of balancing of international trade payments; instead, as we shall see, traditional assumptions took precedence over anomalies.

Often referred to as a pioneer in neo-classical trade theory, Alfred Marshall published *Industry and Trade* in 1919, followed by *Credit and Commerce* four years later, writings which eventually culminated in his *Pure Theory of International Trade* in 1930. In this fairly short paper, Marshall outlines a number of possible trading scenarios which built on John Stuart Mill’s example on English cloth and German linen and the idea of reciprocal demand as defining the exchange rate between trading partners. Marshall’s pure theory is deduced from the same simple setting: trade is conducted between two countries, trading two goods, with the Ricardian assumptions on factor mobility and balancing of payments. Instead of using quantities of labor alone as an indicator of value, Marshall combines labor and capital into a common singular unit measuring the cost of productions (Marshall 1930:2). Assuming perfect competition, the costs of production is seen as equal to the price, thus making the former equal to the values of commodities.

Two exceptional trading scenarios are identified by Marshall:

[A] diminution of the total exports of a country may cause these to be in such urgent demand abroad that she obtains in return for her diminished exports an increased instead of a diminished supply of foreign wares. (Marshall 1930:5)

[A]n increase in the amount of wares which a country produces for exportation effects a very great diminution in the expenses at which she can produce them; so that the consequent fall in their value diminishes the total amount of the imports that she receives in exchange for them. (ibid.)

The first hypothetical scenario reflects the importance of the demand elasticity of a good: if the demand of a good is very high, a lowering of the volumes exported could lead to an

increase in revenues (as expressed in volumes of imported goods) for the exporter. Similarly, an increase in the volume exported could result in a net loss of revenues (ibid.:6).²⁹

The second scenario above, a hypothetical scenario “which is of minor importance” (ibid.:5), concerns the effects of economies of scale.³⁰ This is, according to Marshall, only relevant from a model point of view as it has little bearing on the real world outside the models:

The [second scenario] does not yet appear to have much direct bearing on questions relating either to the trade that is actually carried on between existing countries, or to the terms on which any compact industrial group is able to sell its wares or its services. But it claims attention on the ground that it is not logically excluded by the hypothesis on which the pure theory of foreign trade has been constructed since the time of Ricardo. (ibid.:12)

Marshall’s first scenario has a direct analogy in the trading skepticism put forward by Raul Prebisch and Hans Singer in the mid 20th century (see next subchapter), and the idea of increasing returns to scale to be found in the second scenario was highlighted by the “new trade theory” presented in the 1980’s. Nevertheless, neither of these scenarios and their respective implications were considered and implemented in the mainstream model of international trade. Instead, the Heckscher-Ohlin-model growing out of Ohlin’s writings a couple of years after Marshall’s pure theory represented a reversal and consolidation of classical assumptions on constant returns to scale and perfect competition among the “non-competing” nations of the world.

Marshall’s extension of Ricardian supply-side trade theory, with a mathematically formalized demand-side, marked a step towards integrating general equilibrium theory with trade theory (Condliffe 1950:416). Influences from locational studies, especially that of Alfred Weber, gradually turned international trade into a special case of regional trade. In Weber’s account on the mechanisms determining the spatial location of industries, both the supply and demand sides are included in the same theoretical framework, somewhat analogous to how general equilibrium theory encompasses both the supply and demand side of market interaction.

Neo-classical trade theory II: the Heckscher-Ohlin model

In 1933, Bertil Ohlin published his *Interregional and International Trade*, building on previous work done by his teacher, Eli Heckscher. In Ohlin’s book, general equilibrium theory was applied to international trade in a model which became the standard theory of mainstream economics: the Heckscher-Ohlin model³¹. The model is also referred to as the 2x2x2-model, as it concerned trade in two commodities between two countries, using two factor inputs; however, it was argued that the model also holds true when extending the setup with more countries, commodities and factors of production. Model assumptions as follows:

²⁹ Marshall’s pure theory assumes an instant balancing-of-payment, with trading partners “not under any obligations to make foreign payments excepting those arising from trade” (Marshall 1930:1). This Humean barter type of trade is crucial for making the first scenario realistic.

³⁰ Basing his examples and a fair amount of his discussion on John Stuart Mill’s treatment on international trade, Marshall does not refer to Mill regarding increasing returns to scale; in Mill (1849b), we find the following passage which reflects, at least partly, a recognition of scale economies as a result of international trade: “A country which produces for a larger market than its own, can introduce a more extended division of labour, can make greater use of machinery, and is more likely to make inventions and improvements in the processes of production. Whatever causes a greater quantity of anything to be produced in the same place, tends to the general increase of the productive powers of the world.” (Mill 1849b:121)

³¹ As Paul Samuelson developed and consolidated this model further, it is also referred to as the Heckscher-Ohlin-Samuelson model (see for instance Maneschi 2000).

- A given and static distribution (endowments) of the factors of production in the trade-participating countries, where each country has a specific set of production factors. The model presented encompassed two factors – capital and labor – but it is argued that it could be extended to any number of factor types.
- Different production functions for different goods, i.e. that each good is produced using a specific combination of labor and capital, and where the production function is the same in all countries.
- Although modeled using the same methodological framework – general equilibrium theory – the distinction between interregional and international trade concerns factor mobility: similar to the classical school, free international movements of goods are assumed, while the movements of factors of production are confined within national borders.
- All markets are assumed to be perfectly competitive: monopolies and oligopolies are assumed to be non-existent. Each trading partner can choose to trade with each and every other partner.³²
- There are no transactional costs, nor barriers of trade in the form of tariffs and similar protectionist devices.
- Constant returns to scale are assumed: whether production is done for the home market alone, or a foreign market in addition to the home market, the same unit price is assumed. This assumption implies the absence of scale-based barriers of entry for new trading partners.
- Consumer preferences and tastes are assumed to be identical across the world.

While Marshall's pure theory adopted the third Ricardian assumption regarding balancing-of-payments in international trade, the Heckscher-Ohlin-model (H-O-model) abandoned the idea of a Humean price specie-flow mechanism. Recognizing that the balancing act was a far more complex process than how Hume and Ricardo had viewed it, the tools of general equilibrium theory instead made it possible to model the payment process with multiple, interdependent variables and currencies, a "large keyboard on which the balancing processes could play [where] many of the keys were subtly connected" (Condcliffe 1950:431).

From a developmental point of view, a number of conclusions were drawn from the H-O model. Firstly, similar to Ricardo, international trade is a win-win-situation. With each country focusing on producing goods in which they have a comparative advantage, derived from their specific factor endowments, all countries participating in trade benefit from exchanging these goods with countries having different comparative advantages. Secondly, as developing countries most often are characterized by large pools of labor combined with relatively scarce amounts of capital, these countries should focus on producing labor-intensive goods, just as capital-abundant countries should focus on producing capital-intensive goods. Such a focus was seen as extra beneficial for the developing countries of the world: instead of profits mostly going to the few capital owners, which would increase income differentials within developing countries, labor-intensive production would instead lead to a distribution of incomes among the broad masses (Oman and Wignaraja 1991:69).

³² The model presented in Ohlin (1933) follows the Ricardo-Mill-Marshall setup with only two countries trading with each other. However, following the implicit assumptions of the deductiveness of such a setup, the Heckscher-Ohlin model is argued to be fully workable when adding more nations. This means that the implicit assumption of an exchange structure where each country can choose to trade with each and every other country must hold true, i.e. that the exchange structure must resemble a "total graph". We will return to this implicit assumption in the next chapter as it forms a central theme in this thesis.

Thirdly, although the endowments of different factors of production were static in the H-O model, free trade would result in their prices being equalized among trading partners.³³

Assuming constant returns to scale in the H-O model implied that the third chapter, entitled *Another Condition of International Trade*, in Ohlin's book of 1933 was quite ignored in the model bearing his name. The "alternative condition", which Ohlin refers to in this specific chapter, is concerned with economies of scale, seen by Ohlin as a plausible condition for trade in addition to comparative advantages based on factor endowments:

Assume that a number of regions are isolated from each other, and that their factor endowments and their demand are so balanced that the relative prices of factors and commodities are everywhere the same. [...] [I]nsofar as the market for some articles within each region is not large enough to permit the most efficient scale of production, division of labor and trade will be profitable. Each region will specialize on some of these articles and exchange them for the rest. (Ohlin 1967[1933]:38)

Due to economies of scale and the trade that might occur between countries with identical factor endowments, economic development and trade turns into a path-dependent process. Ohlin's own recognition of historical bifurcation points, expressed using the neo-classical concept of scale economies, clearly reflects the objections List had with regards to English industrial supremacy (see above):

...the location of an industry in one region and not in another might simply be due to chance, the industry having gained strength in that particular region and having reached an efficient scale. Since it cannot profitably be carried on in every region because the total demand is too small, it tends to remain where it was first located. (List 1999:39)

The mathematical sophistication of general equilibrium theory, with the supply and demand of each good and each factor of production being modeled separately, was however not sophisticated enough to describe international trade based on increasing returns to scale. Recognized by Ohlin himself as being of importance, contrasting Marshall's opinion of it as being "of minor importance", no aspects of economies of scale were included in the H-O model, which became the standard model for decades to come. This is fully in line with one of the characteristic traits of neo-classical doctrine: if it could not be modeled in a mathematically sound way, it was simply left out of the models which formed policy and recommendations on international trade for decades to come. The map, although recognized as being only partial and exclusive, turned into terrain.

Combining a conceptual simplification with a mathematical sophistication, the H-O model of international trade came to replace the Ricardian model in academia as well as in national and supra-national policy. Continuing the prosperous win-win prediction derived from the Ricardian model, basing the arguments on the same assumptions of perfect competition, constant returns to scale and international factor immobility, the H-O model of international trade became more than a *façon de parler*, instead forming the theoretical backbone – a *façon de l'action* – in the strive for a world of international free trade as advocated ever since the GATT agreement of 1948.

³³ This constitute Samuelson's contribution to the Heckscher-Ohlin trade model as presented in the Stolper-Samuelson theorem: an increase in the relative price of one good will increase the real return of the factor used most intensively in the production of that good. Thus, an increase in the price of a labor-intensive good would lead to an increase in real wages relative to the real return of capital.

Accepted as the standard model for international trade within the neo-classical school, the H-O model was nevertheless challenged on two accounts, challenges “from the inside” based on empirical observations. First, it was observed that the vast majority of world trade was confined within the developed world, i.e. countries with similar factor endowments. According to the H-O model, trade would instead be conducted between countries of different and complementary comparative advantages in factor supply, where the capital-intensive goods of the developed world would be exchanged for labor-intensive goods of the developing world (Maneschi 2000:2). The phenomena of trade between countries with similar factor endowments, although possible to address using Ohlin’s third chapter, remained unexplained by the H-O model.

The second assault on the H-O model came in 1954 when Wassily Leontief analyzed the imports and exports of US trade in 1947. Through his input-output-analysis, a method which gave him the Nobel Prize for economics in 1973, Leontief found that US imports were 30 percent more capital-intensive than exports, findings running counter with H-O model predictions. Although Leontief was criticized for choosing an atypical year as normal trading patterns had not returned to equilibrium since the disturbances from Second World War, Leontief repeated his analysis using 1951 data, finding that the capital-intensity of imports still exceeded that of exports. A similar study by Baldwin (1971) for US trade in 1962 confirmed the Leontief paradox, finding that imports were 27 percent more capital-intense than that of exports. A different type of the Leontief paradox was found by Tatemoto and Ichimura in 1959: Japan, deemed as a labor-abundant country at the time, exported capital-intensive goods in exchange for labor-intensive goods, this also being inconsistent with the H-O model. However, when analyzing Japan’s trade with countries that were either more or less developed than Japan, the pattern conformed to the H-O predictions: in Japanese trade with less developed countries, constituting 75 percent of total exports at the time, exports were more capital-intensive than imports, while Japan’s exports to USA were more labor-intensive than imports from USA. Several other studies were conducted for different countries and years, results sometimes being consistent with the H-O model, sometimes not.

Although the anomaly found by Leontief and subsequent analyses indeed stressed the need to revise the H-O model, the responses from trade theorists concerning this anomaly were virtually non-existent. In an interesting study on how the Leontief paradox was treated by the science of economics, de Marchi (1976) found that the most common response was that of ignorance: under the theoretical guidance of Paul Samuelson, this group of prominent economic researchers “for fifteen years...chose to all but ignore the Leontief paradox” (de Marchi 1976:115). As Leontief demonstrated his paradox in a mathematical and formal way, coherent with mainstream methods, this might indicate a fourth characteristic trait of neo-classical doctrine, namely that of selective, arbitrary ignorance.

The debate on the validity and theoretical implications of the Leontief paradox underlines another important aspect of neo-classical doctrine at large, namely that of social disembodiment. When looking at the labor-intensity of traded goods, wage labor is treated only as a factor of production: although the distributive aspect of wage labor in itself was discussed for developing countries, there were very little considerations regarding labor-intensiveness as a way to distribute income within developed countries. This reflects the disembodiment and commodification of labor per se as the debate ignored the possibility that there may be non-economic incentives of full national employment, incentives which in effect translates into production being relatively labor-intensive.

Instead of facing the consequences of the theoretical anomaly of the Leontief paradox with respect to the validity of the H-O model, mainstream economic trade theory developed the model further. In 1971, Corden extended the H-O model by allowing for growth of production factors and productivity, still keeping firmly within the conceptual ring-fence of the international factor-immobility assumption. Identifying five possible effects of liberalization and opening up to international trade, Corden found that these effects were all of a positive nature for trading partners (Oman and Wignaraja 1991:73). Balassa (1977; 1979) extended the model further by allowing for changes in the composition of production factors in each country so that their comparative advantages change over time. Not too dissimilar to Friedrich List, Balassa argued that countries move through different stages of comparative advantage as their factor endowments shift over time due to higher wages and increases in the capital stock. However, contrary to List, Balassa sees no inherent problem with this stages approach for the development of developing countries. Instead, his findings “warn against distorting the system of incentives in favor of products in which the country has a comparative disadvantage... in particular when the system of incentives is biased in favor of import substitution in capital-intensive products and against exports in labor-intensive products” (Balassa 1979:264). These stages of comparative advantages which countries pass through does not, according to Balassa, imply that developing countries are confined to constantly being one step behind the developed countries: “A case in point is Japan, whose comparative advantage has shifted towards highly capital-intensive exports and is now competing with the United States and European countries in these products” (Balassa 1979:265).

Neo-classical trade theory III: New Trade Theory

In the late 1970’s, a number of scholars embarked on novel approaches to international trade, approaches sharing a common set of modified assumptions from the traditional model. The “New trade theory” (NTT), as this line of study was labeled, nevertheless consists of a fairly heterogeneous mix of models which initially were designed to merely complement the standard Heckscher-Ohlin model, aimed at the shortcomings of the latter in explaining the Leontief paradox and intra-core trade. The canonical nature of the H-O model is thus not (yet) to be found in NTT: the set of models designed under the NTT parole have yet to converge into a common framework with agreed-upon concepts, interpretations and policy recommendations. Nevertheless, NTT does indeed seem to represent a paradigm shift in the Kuhnian sense, “marking a clear milestone on the road to a more realistic theory of trade” (Maneschi 2000:7).

The relaxing of two assumptions in the H-O, and previous, models is what constitute the paradigmatic change of NTT. First, perfect competition is not taken for granted as NTT allows for the existence of international mono- and oligopolies. Second, NTT allows for the existence of increasing returns to scale. Although the latter of these have implications on the former, imperfect international competition that is, exploratory models have been developed where such imperfections are related to exchange structures per se; we will return to this issue in the next chapter on exchange structures.

The birth of NTT stems from the late 1970’s, when formal methods to deal with monopolistic competition and economies of scale were developed. The most influential of these methods was presented by Dixit and Stiglitz in 1977: although not explicitly addressing international trade, the mathematical methods spread fairly instantaneously into the domain of international trade theory. Krugman’s paper of 1979 – *Increasing Returns, Monopolistic Competition, and International Trade* – marked the beginning of the NTT era, a treaty that

was followed by Lancaster, and Dixit and Norman the year after. In 1981, Helpman published a paper which combined increasing returns to scale with the conventional neo-classical trade model, as such presenting NTT as a complement, rather than a replacement, to the conventional wisdom. In 1985, Helpman and Krugman published the first NTT-style textbook on international trade.

The inclusion of economies of scale in international trade theory underlines the importance of economic history in understanding trade patterns and economic development. Not only explaining the vast volumes of trade occurring between countries with similar factor endowments, but also able to explain the Leontief paradox, increasing returns to scale also explains why less developed countries often find it difficult to enter the global market on competitive terms. The inclusion of economies of scale in trade models had however been on the agenda before NTT: Graham (1923) had been critical of the neglect of increasing returns in contemporary trade models of the time. NTT finally included the third chapter from Ohlin's book of 1933, extending the implications of this alternative condition for trade into a more modern setting. Going further back to the classicals, NTT versus the H-O model represents a fundamental distinction between Ricardo and Smith:

Smith's productivity theory of trade contains a profound insight on the nature of the cumulative productivity gains associated with the division of labor, which lead to changes in a country's comparative advantage. The latter is shaped by the experience acquired through past production, or learning by doing. Instead of being exogenously given, comparative advantage is determined by an evolutionary or feedback process, and thus contrasts not only with Ricardian trade theory where it is based on given technologies in the two trading countries, but with the Heckscher-Ohlin theory based on given factor endowments and internationally identical production functions. *Smith's perception that the division of labor is limited by the extent of the market, which includes the world market as well as the domestic one, inspired the construction of models that are linear descendants of his productivity theory, where history and initial conditions determine an economy's evolutionary pattern.* (Maneschi 2000:8; my italics)

Krugman's explanation on the reason for the neglect of Smith over Ricardo for such a long time is very indicative of the third of the characteristic traits of neo-classical economics:

The long dominance of Ricardo over Smith – of comparative advantage over increasing returns – was largely due to the belief that the alternative was necessarily a mess. In effect, the theory of international trade followed the perceived line of least mathematical resistance. Once it was clear that papers on noncomparative-advantage trade could be just as tight and clean as papers in the traditional mold, the field was ripe for rapid transformation. (Krugman 1990a:4)

Although the paradigmatic change of NTT with respect to the theoretical modifications might seem small, it is the more obvious when addressing the implications of these modifications. Increasing returns and global monopolies meant that free-trade and open-economy development were questioned, either directly or indirectly:

Recent research contains support for almost all the vocal and popular views on trade policy that only a few years ago struggled against the economists' conventional wisdom of free trade. Now the mercantilist arguments for restricting imports and promoting exports are being justified... The fears that other governments could capture permanent advantage in industry after industry by giving each a small initial impetus down the learning curve now emerge as results of impeccable formal models. (Dixit 1986:283)

The new set of policy recommendations following these impeccable formal models, recommendations labeled everything from strategic trade policy to neo-mercantilism, thus put infant-industry protectionism and export-promotion back on the agenda, i.e. interventionist trade policies (Deraniyagala and Fine 2001:812), not too unlike how Friedrich List presented

his case for such policies. Since 1984, Krugman has been arguing that government intervention of different kinds indeed can have a benevolent impact on growth and development, this being in stark contrast with the general view among economists (Prasch 1996). The motivation for such interventions is however different from the traditional infant-industry argument: instead of protecting the domestic market from foreign “Trojans” (to borrow List’s terminology), such protective devices should instead be geared at building up export-oriented industries in order to send their own “Trojans” abroad (see Krugman 1984). Thus, when it here boils down to the question regarding the developmental pros and cons of free-trade in general, Krugman has no clear answer, instead reflecting on the tight reciprocal bonds between economic theory, policy implications, and the normativity of the science at large:

Is the case for a free-trade policy really as over-whelming as the professional consensus might suggest? The answer, I will argue, is no: there is a case for free trade, but it is a more subtle and above all a more *political* case than we are used to making. (Krugman 1993:362; original emphasis)

It is, to be honest, somewhat disappointing that a fundamental rethinking of theory can have such modest implications for policy; but this does not mean that nothing has been accomplished. Even if the ultimate aim of economic theory is better policy, one does not best serve that aim by trying to make every journal article into a policy proposal. (ibid. : 366)

As was indirectly proved with the discovery of the Leontief paradox (de Marchi 1976), many years may pass before an observed phenomena has any effect on theoretical constructs, even when this phenomena is explained using the accepted syntax of the time. This, in combination with the ‘second age’ of NTT being somewhat in a non-coagulated, heterogeneous flux (Deraniyagala and Fine 2001:812), will most probably mean that the H-O model and its emphasis on comparative advantages will remain the official trade-theoretical doctrine for years to come.

In the next chapter, we will look closer at two of Krugman’s models that, among other things, include economies of scale. Although these models, as we shall see, follow many of the neo-classical trade-theoretical assumptions, they are complemented by some very interesting exchange-structural components expressed in spatial terms. These NTT-style models by Krugman implicitly run counter with the all-with-all assumption inherent in all trade-theoretic models derived, since Ricardo, from two-country deductions. Before doing so, we will look at a parallel line of trade-theoretic thinking where, similar to NTT, the undisputed win-win-implications of trade is not taken for granted: by questioning the universal benefits of trade at all times and situations, the Prebisch-Singer is also a critique towards the universality of such theories.

Sticky wages, demand elasticities, and diminishing terms of trade: Prebisch and Singer

This chapter has so far been concerned with models of international trade and how these models reflect issues on national development. As can be seen, these models are all based on a fundamental concept – the classical idea of comparative advantages – a concept which has been modified and complemented over the years. Although New Trade Theory implies, or should imply, a paradigmatic shift in our understanding of international trade, new would-be policy guidelines are nevertheless derived and “discovered”, as always, by looking and experimenting with theoretical constructs rather than through empirical observations. Economies of scale and imperfect competition were introduced in trade-theoretical constructs

because they could be modeled, thanks to the theoretical work done by Dixit and Stiglitz (1977), i.e. not because these phenomena suddenly were observed in the early 1980's.

We will end this chapter by looking at the work of Raul Prebisch and Hans Singer. Although they both used mainstream economic concepts in their reasoning, they base their studies on empirical observations rather than theoretical conclusions from models. The so-called Prebisch-Singer-hypothesis (or theorem), named after the similar arguments of Prebisch and Singer, tries to explain an empirically perceived fact – diminishing terms of trade for primary-product exporting economies – which incidentally seems to undermine the validity of classical and neo-classical models of international trade.

The Argentinean economist Raul Prebisch, strongly influenced by Keynes during his studies (and later teachings) at the University of Buenos Aires, worked at Argentina's Central Bank before being appointed director of the UN Economic Commission of Latin-America (ECLA). In 1950, ECLA/Prebisch published *The Economic Development of Latin-America and its principal problems*, a report which boldly began by questioning the validity of contemporary mainstream trade theory for solving specific problems in non-Western “peripheral” countries, especially those of his own continent:

One of the most conspicuous deficiencies of general economic theory, from the point of view of the periphery, is its false sense of universality. (Prebisch 1950:7, note 1).

[T]he studies published on the economy of Latin-American countries often reflect the points of view or the experience of the great centres of world economy. Those studies cannot be expected to solve problems of direct concern to Latin America. (ibid.:2)

While a large part of the Prebisch 1950 report, and structural thinking in general, is concerned with monetary policy, a doctrine parting ways with the IMF policy recommendations at the time (see Oman and Wignaraja 1991:147-149), Prebisch is perhaps most renowned for his work on international trade. Echoing, but of course not referring to, Friedrich List, Prebisch do admit that ideas on comparative advantages and an international division of labor seems valid for trade between “countries that are equal” (ibid.:7), ideas which may not be valid for trade between manufactured and primary products (ibid.). Based on a 1949 UN report³⁴ that demonstrated diminishing terms of trade for primary product exporting under-developed countries, termed the periphery, vis-à-vis manufacturing exporting countries, termed the center(s), Prebisch note that the spread effects – the sharing of gains and equalization of factor prices – predicted by trade theory has not come into effect. While traditional trade theory predicts that productivity increases anywhere among trading partners would be beneficial to all, the empirical data points to the opposite effect. The main reason for this, according to Prebisch, is due to profits from productivity increases, wherever they occur, always end up in the center. Although productivity increases in manufactures theoretically would reduce the relative price of these goods vis-à-vis primary products, this is, according to Prebisch, offset by an even higher increase in incomes in the center. In contrast, productivity increases in peripheral primary production, although not as common, does instead lead to lower prices for primary products.

³⁴ The UN Report which Prebisch refers to is *Post War Price Relations in Trade Between Under-developed and Industrialized Countries*; released in February 1949, this was a preliminary version of the December 1949 report *Relative Prices of Exports and Imports of Under-developed Countries*, the latter which Singer referred to in his writings. The February UN report was limited in scope but is similar in substance with the December report.

Different labor institutions in the center and periphery, in combination with the up- and downswings of the business cycle, are what explain these differences. Strong trade unions and organized labor in the center results in higher wages in periods of economic upswing, while the same forces prevent wages to drop during downswings. Another reason for incomes to increase instead of falling prices in the center, especially USA, is attributed to the substantially higher degree of factor mobility within countries of the center compared to the periphery (ibid.:16). Higher incomes in the center lead to higher prices of manufactured goods, while a disorganized labor force in the periphery results in the prices of primary goods to fluctuate more. According to Prebisch, this may very well explain the 36.5 percentual deterioration of the price ratio between primary and manufactured goods between 1870-1930 as found in the UN reports:

In other words, while the centres kept the whole benefit of the technical development of their industries, the peripheral countries transferred to them a share of the fruits of their own technical progress. (ibid.:10)

Similar to Prebisch, Hans Singer also builds his arguments on the UN Report, arguing that productivity increases in manufactures lead to higher incomes in rich countries, while productivity increases in primary goods in poor countries lead to lower prices. If these phenomena appear in a closed economy where production and consumption takes place in the same crowd, this is fairly unproblematic and would nevertheless be equalized over time. However, as producers and consumers represent different crowds in international trade, profits thus always end up in developed countries, either as higher incomes or lower prices, this representing “the germ of economic imperialism and exploitation” (Singer 1950:479ff).

Price Elasticity of Demand

The price elasticity of demand (ϵ) is the percentual change in quantity demanded responding to a percentual change in price, defined mathematically as follows (Perloff 2004:48):

$$\epsilon = \frac{\% \text{ change in quantity demanded}}{\% \text{ change in price}} = \frac{\Delta q / q}{\Delta p / p}$$

The Law of Demand, stating that demand always increases as price falls (*ceteris paribus*), implies that ϵ is a negative number. In the left diagram, ϵ equals -0.5; being between 0 and -1, this depicts an inelastic price-demand relationship. In the right diagram, ϵ equals -2; being less than -1, this depicts an elastic price elasticity of demand. In the inelastic example, total revenue ($p \cdot q$) decreases as prices fall ($p_2 \cdot q_2 < p_1 \cdot q_1$). In the elastic example, total revenue increase ($p_2 \cdot q_2 > p_1 \cdot q_1$).

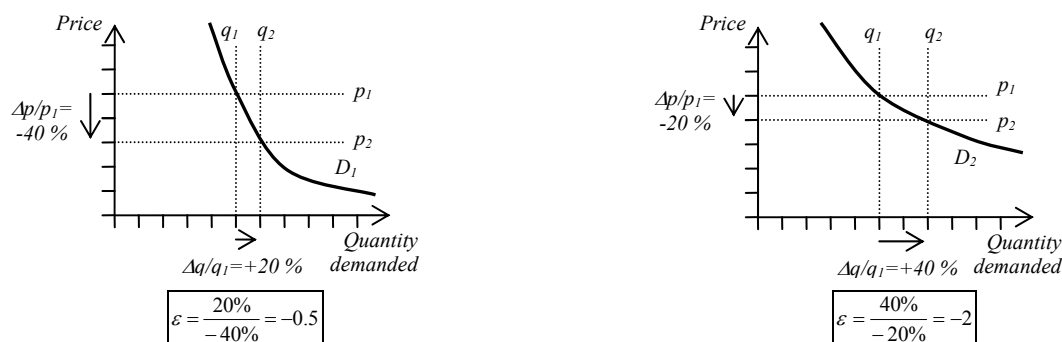

Two aspects are important with regards to the elasticity concept. First, the price elasticity differs at different points of the demand curve. Secondly, the elasticity measure does not reflect the slope at different points: if we were to shift the curves vertically, thus changing the $\Delta q/q$ value, this would affect the elasticity measure.

Building on the fairly accepted idea regarding different elasticities of demand (see above) for different types of goods, Singer outlines the consequences of these in two arguments on price

and income elasticities respectively. Just as Nurkse et al had noted, Singer argue that the price elasticity for primary goods is inelastic: although falling prices of primary goods increase the quantity demanded, the total revenue decreases (Singer 1950:479).

Income Elasticity of Demand

The income elasticity of demand (ξ) is the percentual change in quantity demanded responding to a percentual change in income (Perloff :53):

$$\xi = \frac{\% \text{ change in quantity demanded}}{\% \text{ change in income}} = \frac{\Delta q / q}{\Delta y / y}$$

Contrary to the price elasticity of demand, ξ can be either positive or negative. Increasing incomes usually implies that demanded quantities increase ($\xi > 0$), either elastic ($\xi > 1$) or inelastic ($0 < \xi < 1$). However, an increase in income can also imply a decrease in quantity demanded for certain goods (Perloff :113ff), i.e. $\xi < 0$. For instance, at low income levels, cassava is the preferred foodstuffs for many, this demand increasing as incomes increase. For higher incomes, demand for the ‘superior good’ potato replaces the ‘inferior good’ cassava, thus implying a negative income elasticity of demand for cassava at this point.

The relationship between income and quantity demanded is given by so-called Engel curves; the three example Engel curves below depict (from left to right) inelastic, elastic, and negative income elasticities of demand. In these figures, all other things (including the price of the good) are assumed to be constant.

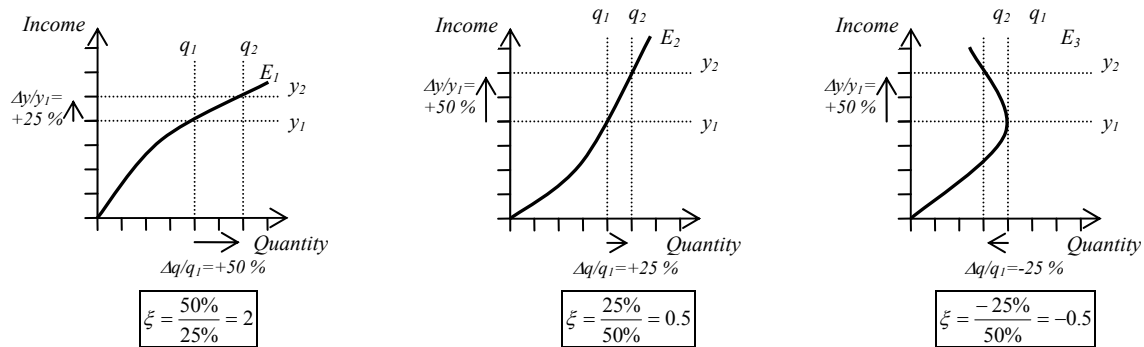

The income elasticity of demand, reflecting the relationship between changes in income and demand, is also, according to Singer, different between primary goods, such as food, and manufactures:

[T]he rise in real incomes generates a more than proportionate increase in the demand for manufactures [i.e. $\xi_{manufactures} > 1$]... In the case of food, demand is not very sensitive to rises in real income [i.e. $\xi_{food} < 1$], and in the case of raw materials, technical progress in manufacturing actually largely consists of a reduction in the amount of raw materials used per unit of output [i.e. $\xi_{raw_materials} < 0$], which may compensate or even overcompensate the increase in the volume of manufacturing output. (Singer 1950:479)

As productivity increases univocally leads to higher real incomes in the rich world, the different income elasticities of demand for primary and secondary goods thus seems to form a vicious circle in Singer’s article, quite similar to how Prebisch depicts the (non-)working of international trade.

While Prebisch emphasizes on production functions and labor costs, i.e. wages, on the supply side, and Singer place more focus on different elasticities of demand for primary and manufactured goods, i.e. the demand side, their arguments are indeed highly compatible with each other. Both present pragmatic solutions to the dilemma: poor (peripheral) countries must keep profits at home, increase productivity (industrialize), and raise wages. A state-induced

policy of ‘industrial programming’ was recommended in order to curb imports of foreign manufactures, a policy which initially would imply protective measures vis-à-vis foreign manufactures. Neither of the two do view international trade per se as incompatible with development: Prebisch states that “[t]he more active Latin America’s foreign trade, the greater the possibility of increasing productivity” and that “[t]he solution does not lie in growth at the expense of foreign trade...” (Prebisch 1950:2), while Singer argues that the comparative advantages of underdeveloped countries could work in favor for national development, as long as these advantages became dynamic (Singer 1950:484), which industrialization with the aid of foreign assistance could lead to.

Although the UN Report notes that “the general trend from the 1870’s to the last pre-war year, 1938...was unmistakably downwards” (ibid.:23), the variations between different commodities were great, thus making theoretical constructs based on a bimodal world – center and periphery – somewhat blunt. Just as Prebisch distrusted the applicability of conventional trade theory, derived from the economic history of the developed world, to solve the problems facing Latin-America, a classification of the countries of the world into the two discrete categories of center and periphery, each category characterized by a set of properties as specified by the theoretical construct in question, is equally non-contextual. However, the theoretical importance of the Prebisch-Singer theorem is difficult to underestimate. Parting ways with the distributive trickle-down-effects as stipulated by Heckscher-Ohlin and other models, Prebisch and Singer formalized the amendment that some indeed are more equal than others:

Development and underdevelopment are thus seen as related processes occurring within a single, dynamic economic system. Development is generated in some areas – the centres are defined as those countries whose economies were first penetrated by capitalist production techniques – and underdevelopment is generated in others. Modern underdevelopment is therefore seen as the result of a process of structural change in the peripheral economies that occurs in conjunction with – is conditioned by, but is not caused unilaterally by – their relations with the centre. (Oman and Wignaraja 1991:142)

Opposite to the dependency line of thinking that found inspiration in Prebisch’s foundational work, Prebisch himself saw foreign trade as the effect of flawed internal properties of the periphery, problems which could be solved with sound macro-economic policies. The dependency school, on the other hand, saw cause and effect differently, viewing foreign trade as causing the growing income gap between rich and poor nations, a phenomenon which no ordinary non-revolutionary macro-economic policy could remedy (see chapter 6).

The validity of the claims of Prebisch and Singer has been debated ever since their ideas were put forward, debates criticizing the theorem from a number of viewpoints. In the UN report, the equating of rich and poor countries with manufacturing and primary commodity exports was admitted as being a simplifying construct (UN 1949:4), stating that the empirical study is unable to show the complete picture of the terms of trade facing underdeveloped countries. This simplified bimodal world-view is however present in the analyses by Prebisch and Singer, dividing the world into two sets of countries: center and periphery in Prebisch’s terminology, and rich and poor countries in Singer’s. Meier and Baldwin (1957) underline that many primary products – for instance wheat, beef, sugar, and even non-edibles such as cotton – are exported by the rich countries. As of today, the typological division between a primary-product exporting periphery and a manufactures exporting center has dissolved even more: a large and growing share of the export-earnings of poorer countries stems from manufactured goods, while USA is the largest exporter of wheat. Foodstuffs do however take

on a special significance, both in the UN report of 1949 and also in the analyses done by Prebisch and Singer.

Another critique towards the works by Prebisch and Singer concerned the empirical data: Ellsworth (1956) argued that reduced transportation costs could explain the phenomena which Prebisch found in the data. Extending the analysis back to the beginning of the 19th century would, according to Morgan (1959), reverse the argument, instead indicating an improvement in the terms of trade for primary-product exporting countries. Similarly looking further back than 1870, Viner (1953) argued that primary product exports indeed could lead to national development and spread effects, using Australia, New Zealand and Denmark as prime examples – Nurkse did however doubt that such a strategy could be viable for the countries in the mid-20th century. Here again, the distinction between exports of foodstuffs and non-edible primary products becomes relevant as these three examples by Viner all were major exporters of foodstuffs.

The debate regarding relative prices of primary and manufactured goods has continued ever since (see Oman and Wignaraja 1991:187ff, note 18), subsequent analyses coming to various conclusions regarding the terms of trade. However, in light of the contemporary global restructuring of production processes (see chapter 6), the fundamental issue on primary versus manufactured exports has lost some of its former relevance. Nevertheless, the theorem was highly influential, both with respect to applied policies in under-developed countries as well as to academic discussions on the relationship between trade and economic development.

While Prebisch explicitly distrusted the universal validity of contemporary trade theory, both he and Singer put confidence in industrialization as an engine of growth and the possible benefits of participating in international trade, as long as the necessary pre-conditions were met. The periphery could therefore experience a similar economic history as the center, without any consequences for the already developed countries, this constituting a sharp distinction between the structuralist³⁵ ‘cepalistas’ vis-à-vis the dependency line of thought and subsequent world-system analysis.

The arguments by Prebisch and Singer were crafted from mainstream economic theory at the time. As such, their analyses pay no attention to the possibilities of scale economies: while argued to be somewhat disturbed, comparative advantages are what form the basic mechanisms of international trade in their respective treaties. Similar to other classical and neo-classical theories of international trade, the discussions of Prebisch and Singer are based on a two-partner setup (represented as the two generalized categories of rich (center) and poor (periphery) countries), exchanging two types of commodities (manufactures and primary products, with foodstuffs being a subcategory of the latter). Prebisch and Singer are thus, both in their models, reasoning, and prospects, not only a part of neo-classical economics but also of the modernization school. The discussion that followed on industrial programming and import-substituting industrialization was instantly complemented by a debate on “industrial fostering” which indirectly reflected ideas of global mono- and oligopolies. The idea of protective measure for fostering domestic industrialization was however widely disputed by other mainstream economists, up until Paul Krugman made an

³⁵ Although the ECLA and Prebisch line of structuralist thinking addresses the perceived malfunctioning of the distributive aspect of international trade, the term “structuralist” in this sense refers not to the structure of world trade but rather the internal production structures of peripheral countries.

almost identical argument, an argument based on a revised model construct rather than de facto existing global oligopolies.

Conclusions

The different strands of international trade theory are all derived from two-country setups: ever since Ricardo's England-Portugal example, the underlying trade mechanisms, the division of the gains from trade, and the developmental outcomes of trade, are all derived from deduced examples concerning two countries engaging in trade with each other. What is true for two countries, it is argued, is also true for several countries participating in trade. However, when extending trade theory to encompass more than two countries, a hidden assumption concerning exchange structure becomes evident: as it is assumed that Portugal and England indeed have the possibility to trade with each other, similarly it is assumed that any country added to the model has the possibility to engage in trade with every other country on equal terms. Assuming such a total potential connectivity between countries, the issue of exchange structures becomes theoretically irrelevant. As the occurrences of trade between Uganda, Iceland, Japan, and Korea is seen as due to comparative advantages, factor endowments, economies of scale, and other nation-centric properties, international trade theory – and mainstream economic theory in general – has put very little, if any, interest in exchange structures.

In the next chapter, the theoretical importance of such exchange structures will be addressed, combining theoretical constructs with insights from economic geography when arguing that empirical structural analysis is a more fruitful alternative when understanding international trade and distribution of resources.

CHAPTER 3

Economic exchange structures

[A]ttention to positionality calls attention to how connections between places play a role in the emergence of geographic inequalities within the global economy; inequalities that show remarkable persistence and path dependence, notwithstanding the new possibilities that globalization supposedly creates for all. Second, attention to positionality has profound theoretical consequences for understanding globalization... (Sheppard 2002:319)

Ever since David Ricardo's England-Portugal example, theories of international trade have been derived from deductive models where two partners engage in trade. As we have seen in the previous chapter, the classical school was not the only one crafting their arguments from models of two interacting partners: it is instead a common element of all trade-theoretical constructs. What holds true in a two-partner model is also, it is argued, true when extending the model to many countries.

However, as we extend these traditional two-country models with more trading partners (as in Figure 3.1), a hidden, implicit assumption on *structure* emerges: an all-with-all world is assumed in which each and every partner is free to engage in trade with any other partner, at either zero or universally constant transaction costs. Although mathematically more complex to describe, the extension of standard models to encompass more than two trading partners has no effect on theoretical outcomes, as long as the all-with-all structural assumption remains. That is, based on comparative advantages due to different factor endowments, an international division of labor will emerge where the gains of trade will be spread evenly among participating trading partners. Having incorporated Dixit-Stiglitz-style scale economies into the standard Heckscher-Ohlin model, partly leading to a return to pre-classical (and Listian) arguments on industrial protection and fostering, the all-with-all assumption is nevertheless very present in New Trade Theory as well: monopolistic situations are due to economies of scale, not due to possible trade partner combinations. Similarly, the models which Prebisch and Singer based their argumentations on rested on a bimodal world: although the periphery and the center are best seen as *types* of countries rather than individual countries, the hidden assumption is, of course, that countries of either type can choose to engage (or not to engage) in trade with each other. With such non-constrained transactional freedom being a common assumptional denominator, the issue on exchange structures can thus be theoretically ignored.

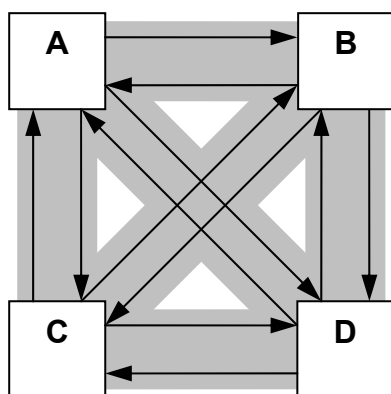

Figure 3.1: Possible bilateral trade links for four countries, assuming an all-with-all exchange structure.

Let us hypothesize that the four trading partners above instead were placed in a hub-and-spoke setup as given in Figure 3.2 below. Here we have one central actor that is free to engage in economic exchange with any other actor, while the other three actors only can engage in trade with this common central actor. Through this, the central actor not only has direct access to three sources for its imports and three destinations for its exports; the central actor can also, in this hypothetical exchange structure, act as a broker in trade between any of the non-central actors. Assuming the same factor endowments as in the previous examples, both with regards to labor and capital composition as well as natural resources, it is not difficult to conceive that the sharing of the gains from trade in this Y-shaped scenario would be different from the all-with-all setup. As perceived by Condliffe, “[a] large buyer may often squeeze a dependant supplier, but as long as the supplier has alternative outlets there are limits to the extent of the squeeze” (Condliffe :816) – in the hub-and-spoke scenario of Figure 3.2, country A, B and D lack any alternative outlets other than the hub C.

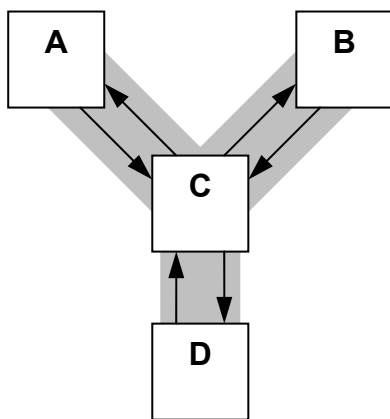

Figure 3.2: Possible bilateral trade links for four countries in a hub-and-spoke structure.

Exchange structures and their implications for development is one of the issues that Galtung addresses in his *Structural Theory of Imperialism* (1971). The ‘feudal structure’ that connects centers and peripheries (Figure 3.3) in a similar fashion as the Y-structure above (Figure 3.2) has, Galtung argues, different implications for the developmental prospects for the two types of countries. In their structural disadvantage vis-à-vis the centers, peripheral actors are confined to trade with a singular center, often resulting in peripheral countries focusing on the export of a single primary commodity (Galtung 1971:90), while also having no possibility to engage in trade with other peripheries. Despite these consequences for trade, this type of center-periphery structure is, according to Galtung, mainly a political divide-and-conquer device aimed at “protecting the center from the peripheries” (ibid.), as such being a mean to obtain a specific end rather than an end resulting from other causes.

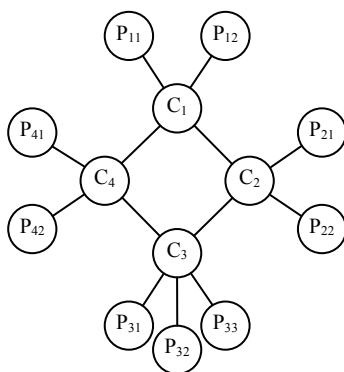

Figure 3.3: Galtung’s ‘Feudal center-periphery structure’ (redrawing from Galtung 1971:89).

The notion of a global core-periphery structure is a fundamental ingredient in dependency theory and the world-system perspective, and has also recently been introduced, at least partly, into mainstream economic thinking (as we shall see below). Knox and Agnew (1998:20ff) finds an early core-periphery definition cast in structural terms in the writings of Meier and Baldwin of 1957, a definition that indeed reflects how Galtung (among several others) view the concept:

[A core country] plays a dominant, active role in world trade. Usually such a country is a rich, market-type economy of the primarily industrial and agricultural-industrial variety. Foreign trade revolves around it: it is a large exporter and importer, and the international movement of capital normally occurs from it to other countries. (Meier and Baldwin 1957:147)

[A peripheral country] plays a secondary or passive role in world trade. In terms of their domestic characteristics, peripheral countries may be market-type economies or subsistence-type economies. The common feature of a peripheral country is its external dependence on the centre as the source of a large proportion of imports, as the destination for a large proportion of exports, and as a lender of capital. (ibid.)

Whether the introduction of structural concepts such as core-periphery in the neoclassical version of “new economic geography” will have any substantial influence on the modeling tradition of the neoclassical school at large, contemporary mainstream theory and models concerned with international trade, as well as their historical predecessors, are not at all concerned with exchange structures and possible occurrences of asymmetries in such. Although New Trade Theory most certainly could be applied to explain the emergence of certain exchange patterns and structures, the effects of already existing trade structures are assumed to be irrelevant for issues on development and the sharing of gains. Instead, a nation’s integration with, and the national outcomes of, world trade is seen as dependent on internal properties alone: whether the gains from trade are dependent on certain factor endowments, stiff competition from foreign economies of scale, or flawed production structures, labor organizations, and macroeconomic policies, these are all issues concerned with the individual trading partners, i.e. nation-centric properties that, at best, are reflected in, but not caused by, external factors and the nature of their embedment into a larger system of interconnected nations.

If we are to address economic exchange structures in any meaningful way, I argue that such analytical endeavors are best conducted from the discipline of economic geography. With a methodological pendulum that has been oscillating between several different analytical approaches, as will be demonstrated below, this relatively young and pluralistic discipline nevertheless has a deeply rooted tradition of focusing on *structures* – the relations between spatially dispersed social entities, however defined – that make up the economic geography of the world and its various sub-global levels. Furthermore, the specific experiences and insights of the economic-geographic discipline contribute greatly to any study that addresses international dynamics, economic development and the global distribution of resources.

The discipline of economic geography inspires the current thesis in three major ways: its structural approach, its focus on empirical real-world observations (rather than theoretical constructs), and, through this, its non-essentialist nature that allows for studies that are not bound to specific value schemes or other fundamental axioms that prescribes how to measure phenomenon in the economic geography of the world.

In this chapter, we will look at a handful of studies where formal structural-analytical methods have been developed and deployed in economic geography, studies where system-

wide properties and different structural positions in spatial (infrastructural) networks have been related to economic and demographic indicators of growth and development. This chapter will also look at the even younger line of neoclassical thought dubbed “new economic geography” among its proponents (and “geographical economics” among its opponents) where the inclusion, and the perceived importance, of exchange structures has been framed as a new “discovery”. After a brief presentation of the foundations of this neophyte economic geography, and how it has been perceived by its archaeophyte counterparts, we turn to the foundational papers of Paul Krugman as well as a study conducted by Puga and Venables whose conclusions in many ways reflect the arguments put forward by Galtung et al and the core-periphery definition by Meier and Baldwin (see above).³⁶

The argument here is not that the studies of Taffee, Kansky, Garrison, Krugman, Puga and Venables have any direct bearing on international trade and issues concerned with global development and ecological unequal exchange, even though such connections may indeed exist (see Taffee et al, Kansky, and the Bunkeresque interpretation of Kansky below). Instead, the point I would like to make is simply that structures matter: the properties of exchange structures, and the positionality (in a general Sheppard sense) of social entities within such structures, have to be included in analyses and would-be explanations and models concerned with the relationship between economic exchange and development, at least if we want to step outside the traditional two-actor models that dominate the contemporary intellectual market. However, instead of resorting to the geometrical techniques in transport geography anno 1960’s, and instead of biding our time in anticipation for methodological breakthroughs in neoclassical economics (which nevertheless would be more model-centric than real-world-related), the two chapters that follow the current one will introduce a set of tools that are far more suitable for the structural-analytical tasks at hand. Similar to the academic discipline of statistics – though explicitly concerned with relations between, rather than internal properties of, social entities – the formal methods of social network analysis can be applied to a wide variety of datasets, including (as we shall see in chapter 5) different relational aspects of the contemporary world-system. As will become evident in this and the following two chapters, there is a significant overlap between the analytical techniques employed in structural economic geography and social network analysis, albeit where the latter tradition is far more generic and applicable to more than infrastructural networks – such as networks of international trade.

Contrary to mainstream economics, the discipline (or art³⁷) of economic geography is not rooted in a set of non-disputable theorems and axioms through which explanatory models and empirical studies have to be based upon or filtered through. Instead, economic geography is by tradition a very theory-wary science, either refraining from theory constructs at all, or with a relatively open-minded and pluralistic view on theory in general. Through the lens of economic geography, it makes more sense to view the world in an inductive, empirical fashion rather than trying to accumulate knowledge and insight through deductive models – this was an important lesson learned all too well during the heydays of the quantitative

³⁶ While there are several other studies which could have been included in this chapter – Pitt’s study of the river networks in Russia, Fujita and Mori’s geographical-economic study on the role of ports, among others – the studies chosen for this chapter are, I argue, enough for the point I would like to make: that exchange structures do indeed matter.

³⁷ Sheppard and Barnes (2000:chapter 1) compares the work of an economic geographer with that of a painter, viewing economic geography primarily as a form of art: “In both cases, there is a need for appropriate techniques, sensitive interpretation, enthusiasm, dedication, adequate preparation, and prior training” (ibid.:2)

revolution in economic geography. That is, if we are interested in the structure of international trade and how the properties of these structures relate to economic development and resource distribution, we should indeed look at the empirical manifestations of such structures as the first step in acquiring knowledge that, possibly, eventually could lead to models and theories to explain observed phenomenon. This scientific approach underpins and motivates the empirical chapters that form the core of this thesis.

Lastly, but anything than least, by conducting empirical analyses from an economic-geographic perspective rather than a neoclassical framework, there are no inherent obstacles to analyze, in a dual sense, what *matters*. While the global economy and the distribution of resources indeed is rooted in trade, and while the bulk (if not virtually all) of macroeconomic studies of international trade are conducted through a monetary lens, the exchange-values of specific trade flows or national trade balances cannot be anything more than a crude proxy of actual resource usage, the material want-satisfaction, and the ecological economics occurring behind this monetary veil.³⁸ With crude oil prices having passed 120 US dollars per barrel at the time of writing this paragraph (subsequently having declined back again to 50 USD per barrel at the time of editing), the energy content of a barrel of oil is very much the same whether valued at 120 or 50 USD. National trade balance data reveals that Sweden is a net-receiver of revenues from trade in forestry commodities, but obfuscates the fact that Sweden is a net *importer* of such goods as measured in actual tonnage. France does indeed appropriate more cropland than what can be found within its borders, but nevertheless earn a net-revenue from trade in agricultural goods. Such profound distinctions between monetary and non-monetary measures and corresponding perspectives are pondered upon by Herman Daly when discussing a statement by William Nordhaus, distinguished professor of economics at Yale University:

William Nordhaus...said that global warming would have only a small effect on the U.S. economy because basically only agriculture is sensitive to climate, and agriculture is only 3% of total value added, of gross national product. Evidently it is the value added to seeds, soil, sunlight, and rainfall by labor and capital that keeps us alive, not the seeds, soil, and sunlight themselves. Older economists might have asked about what happens to marginal utility, price, and the percentage of GNP going to food, when food becomes very scarce – say, due to a drought? Could not the 3% of GNP accounted for by agriculture easily rise to 90% during a famine, in view of the price inelasticity of the demand for food? But these considerations give “mere stuff” a more than passive role in value, and diminish the dogmatic monopoly of value added by human agents of labor and capital. (Daly 1996:63ff).

The non-essentialism of economic geography, where the art is not bound to a specific ontology or a certain way to view and document the world, puts economic geography in a unique position to choose its own contextual points of view. As Barnes puts it, with reference to Rorty, “as soon as we accept essences, we have a closed system, a system impervious to the dynamics, diversity, and difference of the changing contexts in which social practices are embedded” (Barnes 1996:56) – by inheriting a decontextual vocabulary from either neo-classical or Marxist economics, the conversation is killed (*ibid.*). In the empirical chapter that follows, monetary as well as non-monetary, physically resource-oriented units are used, and contrasted against each other, to address the context in this thesis: the interplay between flows of economic exchange value and ecological resources.

³⁸ “Economists...acknowledge problems of inequality deriving from conditions of imperfect information. The economists’ solution is thus to try to create conditions for more perfect information flow. I would add that one very crucial kind of information that seems universally to be ‘imperfect’ is the physical properties of the traded products...” (Hornborg 2003:4, note 3)

Economic geography

In comparison with its academic siblings, the discipline of economic geography is fairly young, perhaps still going through its turbulent adolescence years in search of a proper identity. Its foundations are to be found in the works of George Chisholm and Russell Smith, in England and USA respectively, two scholars whose similar research interests came to set the initial agenda when geography and economics were combined into a specific discipline. Mainly concerned with the gathering of empirical data, in combination with a general wariness for theory construction³⁹, Chisholm viewed trade mainly as a geographical phenomenon, occurring in a Ricardian fashion as “different parts of the world yield different products, or furnish products under unequally favorable conditions” (Chisholm 1889:1). Similar to Chisholm, the work by Russell Smith focused heavily on empirical observations of economic-geographical facts, followed by regional classifications based on such observations. In his *Industrial and Commercial Geography* of 1913, Smith first describes the production of different goods and resources at particular geographical locations, followed by a discussion on trade between regions made possible thanks to development in transportation and communication technologies. In a period when economics turned more and more to abstractions and model construction, consequently abandoning geography from its syllabus, the work of Chisholm and Smith resulted in economic geography establishing itself as a discipline in its own right.

In a review of Smith’s book of 1913, Ray Whitbeck raised criticism towards its econocentric focus, instead stating that “the unit [of analysis] should be the country and not the commodity.” (Whitbeck 1915-1916:197), a perspective that was restated 1924 in his book *Economic Geography* (co-written with Vernor Finch). Similar to Chisholm and Smith, the idiographic collection of geographic facts was foundational in Whitbeck’s work, followed by a process where the particularities of different areas were used to classify regions in any of the four conceivable types: agricultural, mineral, manufacturing, and commercial. Jones’ book carrying the same title, published in 1935, followed an identical scholastic line: “By comparing the facts of the different regions by using the same typological grid, geographical differences are immediately seen, and areal differentiation shines by its own light.” (Sheppard and Barnes 2000:19). Hartshorne’s book in 1939 further stressed the descriptiveness of economic geography and a disregard for theory building, arguing that the geographical region, defined economically, was interesting in and of itself (Sheppard and Barnes 2000:20). Similar to Whitbeck and Jones, Hartshorne classified regions according to their internal properties rather than their embeddedness in a wider network of world trade⁴⁰, the latter which was at least partly of interest to Chisholm and Smith.

Regionalism became the defining feature of economic geography for two decades until the “quantitative revolution” in the 1960’s challenged its supremacy. The seeds for this revolution were planted as early as 1940 with McCarty’s *The Geographical basis of American economic life*, a book that albeit being written through a regionalist narrative nevertheless was founded on economic theory, where market forces were depicted as the

³⁹ “As a discipline [economic geography] grew less out of concerns by economists to generalize and theorize, than the concerns of geographers to describe and explain the individual economics of different places, and their connections one to another.” (Sheppard and Barnes 2000:2ff)

⁴⁰ This type of classification is typical in studies on the modern world system: although core, semi-periphery, and periphery are conceptualized in relational terms, the classification of different national economies into these zonal categories are done based on the *internal* properties – labor structures, profit distribution, institutions etc – instead of their relational patterns with each other. (Wallerstein 1974:400ff; Wallerstein 1972:95ff; Chase-Dunn 1989:77; see also Bergesen 1990:68)

universal laws that shape geographic regions. In later writings (1956), during his time at Iowa University, McCarty introduced statistical analysis to economic geography in a book which became pivotal in the development of a more quantitative, statistical approach to economic geography. Also at Iowa, which turned into a “center of calculation” in economic geography (Sheppard and Barnes 2000:22), Fred Schaefer had earlier written an article (published post-mortem 1953) where he called for a more “scientific” economic geography, reflecting a belief in the existence of “geographical laws” whose task it was for the nomothetically bended economic-geographer to discover.⁴¹

The introduction of statistics and other quantitative tools did allow for more advanced and formal methods for cross-examinations of economic regions, but the “quantitative revolution” more importantly marked a shift away from descriptive regionalism in favor of more overarching, system-wide analyses. The heydays of quantitative tool-making in economic geography resulted in several formal methods for the analysis of systems of interconnected spatial units. The internal properties of such spatial units – urban centers in particular – were still of interest but, more importantly, the quantitative revolution led to formal analytical tools for examining the *structures* – infrastructures in particular – that connected the individual spatial units, and especially how the positioning of individual units in such structures was related to the development of the individual units.⁴² Among the scholars concerned with what we may label *structural economic geography*, we find Kansky, Garrison, Ullman, Bunge, and Isard in USA, and Haggett and Chorley in the UK, the latter two subsequently nicknamed “the terrible twins” for their role in introducing a scientific approach to economic geography (Sheppard and Barnes 2000:22ff).

After some 20 years, a counter-revolution took place in economic geography:

During the 1970s and 1980s, economic geography moved away from spatial science. The new economic landscape that was theoretically constructed bore little resemblance to the old one; as Dorothy said to Toto, this wasn't Kansas anymore. Gone were the assumptions of isotropic plains, uniform population densities, and distance minimizers. Instead, the new landscape was much more troubled, restless, and unsettled. (Barnes 1996:48)

Discarding much of the “spatialness” and the quest for formal rigor, a new form of regionalism developed in economic geography: although termed localization studies this time, economic geography once again turned to individual localities in search of the locally bounded explanations for changes in the economic landscape, albeit with a somewhat stronger belief in theory-building that could be found in regionalism of the early 20th century. The return to place-based analyses coincided with, and was reinforced by, a revival of the Marxian concept of annihilation of space by time (see especially Harvey 1989:205)⁴³, an idea pushing economic-geographic analysis further away from relational and structural concepts. This shift from the structural to the particular had consequences for the research agenda in general and the type of questions that could be raised, and answered, in economic geography:

⁴¹ Prior to McCarty and Schaefer are earlier calls for a more theoretical geography; see Bunge (1966:203-213) for an overview of such calls, an overview written by one of the strongest supporters for a more theoretical science of geography.

⁴² Within the regionalist school, transport structure growth was on the research agenda but it was overall a descriptive endeavor. Sharing many similarities with the typology of Taaffe et al (see below), Fisher's study (1941) on the growth of the Irish railway system from 1837 onwards is entirely descriptive in its approach.

⁴³ While the Marxian arguments presented by David Harvey in the 1980s can be seen as an assault on the neo-classicism which underpinned much of the implicit rationality assumptions in spatial science, the critique is part of a much broader quantitative counter-revolution.

Economic geography shifted from a paradigm dominated by ideas of uneven development, industrial restructuring, and dependency theory, in which the economic prospects of a place were argued to be driven by external forces, to one dominated by industrial districts, whose economic prospects were argued to be driven by local, place-bound characteristics. Over time, the list of these characteristics has broadened [...] to embrace the local political, social, and cultural milieu within which economic activities are embedded and through which they may be catalyzed. (Sheppard 2002:311)

This focus shift in economic geography sparked several post-modernist debates on its role and identity as a discipline (e.g. Barnes 1996). While several of the formal structural-analytical tools developed during the quantitative era have remained fairly intact within the transport geography sub-branch, Sheppard's (2002) inspiring call for reintroducing concepts such as positionality and networks could indicate the beginning of a third methodological U-turn for the discipline of economic geography. Sheppard do acknowledge the importance of place-based factors – territorial studies – but it has to be complemented with a greater priority on issues on positionality within structures:

Our understanding of the spatiality of globalization will be impoverished, however, if positionality is neglected. First, attention to positionality calls attention to how connections between places play a role in the emergence of geographic inequalities within the global economy; inequalities that show remarkable persistence and path dependence, notwithstanding the new possibilities that globalization supposedly creates for all. Second, attention to positionality has profound theoretical consequences for understanding globalization; theories can mislead when they fail to take account of positionality. Third, positionality stresses that the conditions of possibility in a place do not depend primarily on local initiative or on embedded relationships played across scales, but just as much on direct interactions with distant places. Fourth, it highlights the unequal power relations that stem from such asymmetries. Fifth, positionality demands attention to questions of scale. (Sheppard 2002:319).

In retrospect, the counter-revolution which put an end to the terrible twins and their cousins was perhaps a necessity: while the abandonment of geography by mainstream economics marked the beginning of economic geography as a discipline, both did seem to follow a similar trajectory, more and more defining themselves by their methods, high levels of abstraction, and reductionism, rather than specific fields of inquiry. Haggett himself did stress that model constructs had to be tested against the real world, but it was nevertheless a search for laws and facts that could be expressed in a *quantitative* way. Contrary to neo-classical model builders, the “quantitativists” did often demonstrate a sound understanding of the role of models in relation to the real world of observed phenomena⁴⁴ - perhaps it is not too far-fetched that this methodological self-awareness actually set the scene for the counter-revolution of the 1980's.

While most of the spatio-structural approach was swept out from the economic geography-departments in the counter-revolution in which structural/relational analysis was discarded in favor of locational/internal attributes, the studies of the 1960's do contain some very interesting insights on the relationship between infrastructural setups and economic-

⁴⁴ See, for instance, Kansky's philosophical discussion on the role of symbols and mathematics (Kansky 1963:2) in the introduction to an otherwise highly abstract and mathematical thesis, Haggett and Chorley's introductory chapter in *Socio-Economic Models in Geography* (Chorley and Haggett 1968 [1967]:19-27), or Bunge's introductory chapter in *Theoretical Geography* (Bunge 1966:1-13). These reflections on theory and models in economic geography are not only the first-line-defense towards anticipated counter-arguments on the viability of quantitative methods, but they do also reflect a profound understanding, bordering to humbleness, of the role of theory and models in relation and dependence upon actually observed phenomena. The lack of a similar understanding in neo-classical economics seems all too evident (Condliffe 1950:404ff; see also chapter 2).

geographic development, insights which have direct bearing on the hypothesis of this thesis. In what follows, we will look closer at some of these studies.

Transport networks as related to economic growth and development

In 1963, Taaffe, Morrill, and Gould presented a typology on the evolution of transport networks in underdeveloped countries.⁴⁵ Based on empirical observations in Ghana and Nigeria, Taaffe and his colleagues argued that the development of transport networks in underdeveloped countries demonstrated broad regularities that could be modeled as a sequence of four distinct stages. Underlining that these stages are best seen as parts of an ideal model aimed at reflecting real-world non-discrete *processes*, the authors nevertheless make an analogy with Rostow’s stages of economic growth and development (Taaffe et al 1963:505, note 2).

In the first phase of their model, there are a large number of small seaside ports and trading posts scattered along the coastline⁴⁶ (see Figure 3.4). Each of these has their own hinterlands, i.e. an (inland) area which it serves, but there are only sporadic, sea-based connections between these small ports. The second stage consists of the growth of inland routes – “penetration lines” – stretching from a few of these small ports, either to access natural resources inland, or as means for obtaining political control. In the case of Ghana and Nigeria, the construction of penetration lines were mainly for military and administrative reasons (ibid.:506); in other regions, penetration lines were primarily built to access natural resources, for instance the Kaese copper line in Uganda, the Garoua manganese line in the Cameroons, and the Fort Gourard iron-ore line in Mauritania (Haggett 1965:79ff). Penetration lines such as these most often implied path-dependent economic-geographic events: “the ports at the termini of the earliest penetration lines are usually the ones that thrive at the expense of their neighbors” (Taaffe et al 1963:509), ports that will “pirate” on the hinterlands for adjacent smaller ports (Taaffe et al 1996:40).

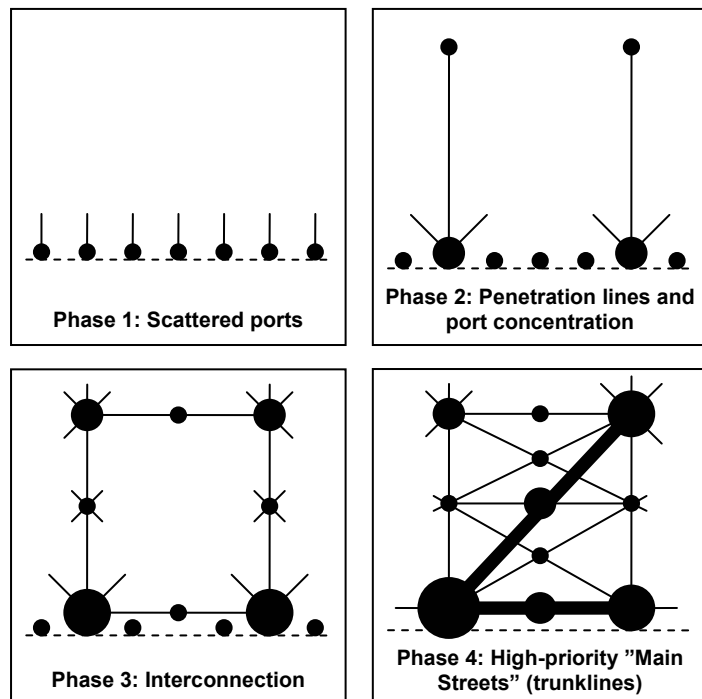

Figure 3.4: Four-phase development sequence of transportation networks (Source: Taaffe et al 1963:504; Haggett 1965:80)

The third phase is characterized by “lateral inter-connectivity”, a phase in which the previously established penetration lines connect with each other. New settlements appear

⁴⁵ Although only the Taaffe et al model is presented here, there are other models that describe the same phenomena, such as the “mercantile” models presented by Vance (1970) and the more detailed multi-modal typology presented by Rimmer (1967). Each of these models, strikingly similar, were derived from empirical observations from different parts of the world: west Africa, north America, and Australasia, respectively.

⁴⁶ Needless to say, the model by Taaffe et al (and the models by Vance and Rimmer; see previous footnote) is concerned explicitly with coastal regions.

along the penetration lines, and rail- and roadways interconnections gradually appear between settlements in a criss-cross fashion.

The final phase is the growth of high-priority trunklines, being indicative of transportation networks for developed countries. In the emerging urban hierarchy, these “Main Streets” (Taaffe et al 1963:504) tie the largest urban centers to each other. Contrary to the penetration lines, these major routes fill an internal rather than an external purpose: “In underdeveloped countries high-priority linkages would seem to be less likely to develop along an export trunk line than along a route connecting two centers concerned in internal exchange.” (Taaffe et al 1963:514). These trunklines might though connect urban centers that gained an initial advantage due to previously established penetration lines.⁴⁷

Without specifying any time-frames for each step, Taaffe et al (1963) note that Nigeria and Ghana seemed to be in the third phase, i.e. the growth of lateral inter-connections, presumably heading towards the final phase. That these two countries eventually will arrive at the fourth stage is “based, somewhat weakly, on a logical extrapolation of the concentration processes noted in the earlier stages of transport development in Ghana and Nigeria, and is supported in part by highly generalized evidence from areas with well-developed transportation systems” (ibid.:514). In later writings, Taaffe stressed that the third phase takes place over a relatively long period of time (Taaffe et al 1996:40) and that the fourth phase characterize a mature transport structure, “usually in an industrialized [i.e., by definition, a non-developed] country.” (ibid.), reaffirming the belief that Ghana, Nigeria, and other underdeveloped countries eventually would turn into developed, industrialized countries.

While only being a generalized typology, the sequence from initial penetration lines up to the stage of lateral inter-connections seems to hold true for many regions of the world. Haggett note that the railway network for coastal São Paulo and Rio de Janeiro followed a similar process, and the typology has also been successfully applied in studies of transport networks in Ecuador, Liberia, the Cameroons, Ethiopia, Poland, Yugoslavia, and New Zealand (Hoyle 1973; Taaffe et al 1996:38; Hoyle and Knowles 1998:22ff), as well as “ex-colonial areas” such as western United States (Haggett 1965:81).

The model presented by Taaffe, Morrill and Gould, building on empirical observations and the extrapolation of such, points to an association between network structure and economic development. Whether the model holds true for non-coastal or non-underdeveloped, non-colonial regions can be questioned: the penetration lines in the model are not only a response to external influences, notably colonial demand for political or resource control, but the actual infrastructural technology, i.e. railways and motor-vehicle roads, represent non-local technologies that are infused into a region.⁴⁸ However, there is indeed (as we shall see below)

⁴⁷ In Vance’s model, which is based on historical data of European colonization of North America, the initial penetration lines play a more significant role in determining the structure of the mature network: in North America of today, “the historical evolution is still apparent in both its transport network and its urban system” (Hoyle and Knowles 1998:18), i.e. the structure of the contemporary urban system in USA is shaped by its colonial history.

⁴⁸ Although ignored by Taaffe et al in their study, it would be interesting to examine the networks of communication and exchange that existed prior to western colonialization, may these structures be caravan trails, animal trails, or sea-based trading routes, and whether the introduced non-domestic transportation technologies (i.e. railways and vehicle roads) complement or contradict existing structures. In a 1969 study, Burghardt looked at route development in the Niagara peninsula at four different periods, beginning with the structure of the Indian Trails in 1770, the white man’s early penetration routes around 1790, up to the year 1851.

an association between different transport network structures and economic development, for underdeveloped as well as developed countries: the take-off phase has not yet occurred in either Ghana or Nigeria, both with respect to their transport networks as well as their GDP per capita. In Nigeria, the main railway routes of today are Lagos-Kano, Port Harcourt-Maiduguri, and Zaria-Gusau-Kaura Namoda, these being the same narrow-gauge penetration lines as what was the case in Taaffe's study. Contemporary railway maps for Nigeria and Ghana, in comparison with France, are given in Figure 3.5 below, demonstrating a stark difference in occurrences of lateral inter-connections.

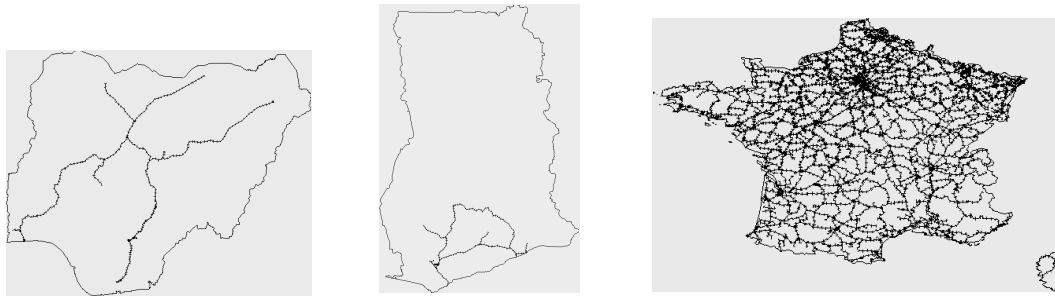

Figure 3.5: Contemporary railway structures of Nigeria, Ghana, and France (at respective scales) (Source: Digital Chart of the World; <http://www.maproom.psu.edu/dcw/>)

While the model above was typological and conceptual, there was extensive work done on the development of more formal methods to analyze structures of transportation networks, methods based on the mathematical sub-branch of graph-theory (Garrison 1960; Garrison and Marble 1961; Nystuen and Dacey 1961; Kansky 1963, among others). Defining links (a.k.a. edges) as infrastructural connections between vertices (a.k.a. nodes), the latter usually⁴⁹ represented by urban centers, the creation of abstract topological versions of economic-geographic structures allowed for formal, comparative studies of transportation networks. Using fairly simple graph-theoretical indices, usually involving the counting of nodes and edges of networks, a number of studies were conducted, mainly on physical infrastructure such as road- and railway structures but also on “imaginary networks”, to borrow Kansky's term (1963:2), such as intercity telephone calls in the state of Washington (Nystuen and Dacey 1961).

Of the 14 different graph-theoretic indices on “network shape” that Kansky presented in his PhD thesis (1963), two of these will be examined here. As a measure of connectivity, the Beta index is calculated by dividing the number of edges with the number of nodes in a network. The higher the Beta-index, the more circuits (closed loops) are to be found in the network, while a Beta-index below unity indicates either a tree-like structure or a disconnected network (i.e. a network which consists of two or more graphs that have no connections between them). The Pi-index, slightly more complicated to calculate than the Beta-index, is best described as an indicator on whether a network is elongated or circular. Calculated as the total mileage of a transportation network divided by its diameter, the latter being the maximum length (in miles) of the shortest path between any two nodes in the network, this measure differs from the Beta-index as it is based on actual spatial distances in

Burghardt noted that the penetration lines into the Niagara peninsula did follow already established Iroquois trails.

⁴⁹ At times also defined as the actual location where links intersect, with or without urban centres at these locations; see Garrison and Marble (1962:233).

the network, being “a measure of length per unit of diameter” (Kansky 1963:22).⁵⁰ The Pi-measure is not affected by the overall size of transport networks or relative distances between nodes (urban centers in this context), thus being applicable at all geographical scales to indicate the shape of a network.

Kansky’s own hypothesis on the shapes of transportation networks as related to economic development is as follows:

A superficial comparison of transportation networks of different countries would suggest that less developed countries are served by transportation systems which look more like disconnected graphs or trees. In contrast, highly developed countries benefit from highly connected transportation networks. (Kansky 1963:12)

Kansky’s hypothesis indeed turned out to be correct. Calculating Beta- and Pi-indices for the railway networks of 18 countries, these indices were subsequently compared with national statistics reflecting levels of economic well-being. Comparing the Beta-index with energy consumption revealed a statistically significant relation between the two (see Figure 3.6): a high Beta-index, i.e. a high degree of interconnectedness, implied a high level of national energy consumption, and vice versa. Comparing the Pi-indices with GNP per capita for these countries revealed another statistically significant relation: while a “circular” railway structure was related to high per-capita GNP, a more elongated, tree-like structure was characteristic of low-income countries. Based on these findings, Kansky embarks on a comprehensive statistical examination of the shape of transport networks as compared to indices of economic development, including time-series analyses for French Indochina, Algeria and Italy, finding that “the correlation between the degree of economic development of countries and the degree of structural development of countries’ railroad networks is a persistent association in both space and time” (Kansky 1963:103), thus pointing to the relationship between structure and development.

Affirming the findings by Kansky, Haggett touches upon a would-be casual mechanism between network structure and economic development:

In both graphs there is a high a consistent trend which is significant statistically and strongly suggests that the geometry of some route networks may be very closely related to the general development of regional resources. Should this be so, [...] we suggest that while [political factors] may have a dramatic effect on individual routes the major pattern suggests the importance of more purely economic factors. (Haggett 1965:71)

⁵⁰ In Medvedkov (1968), the Pi-index is defined somewhat differently. Defining e as the number of edges in a graph, the Pi-index is “given by the term, e/d , where d (the diameter of the graph) is the number of links in the *shortest path* between the *most distant* vertices. Distances are expressed here by the number of links (edges) that separate the vertices in question” (Medvedkov 1967:79; original emphasis). The difference lies in that Kansky is working with valued links, expressed as spatial distances, contrary to Medvedkov who deals with dichotomous networks, i.e. networks where links either exist or not.

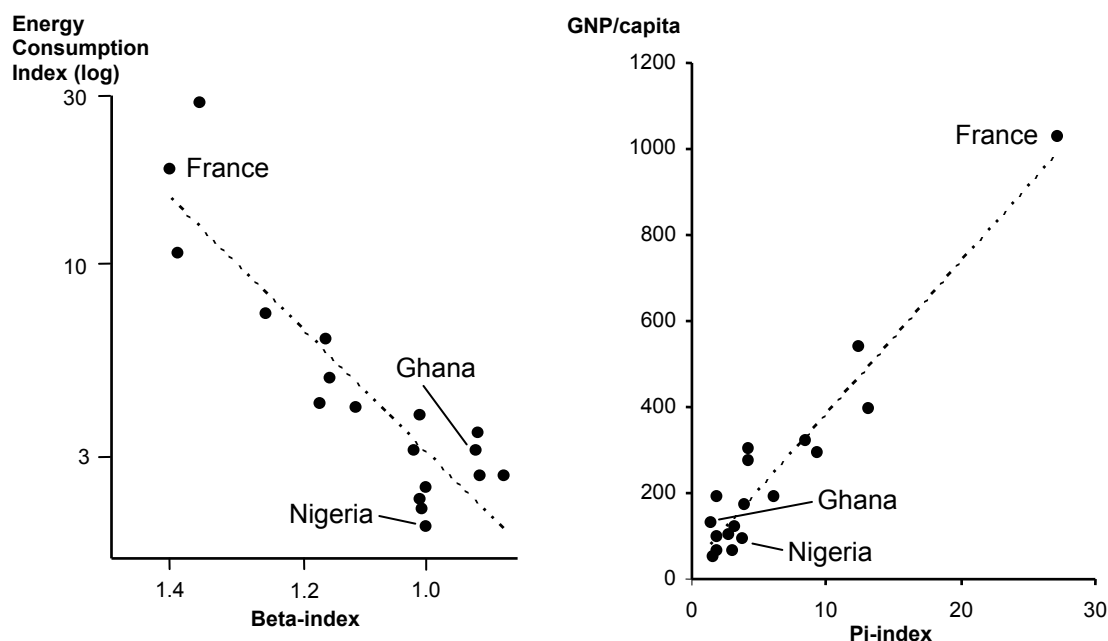

Figure 3.6: Relations between network structure – connectivity and shape – and indicators of economic development. (Redrawing from Kansky 1963:42 and Haggett 1965:70)

From a different disciplinary perspective, referring neither to Taaffe, Kansky nor Haggett, Bunker's writings on productive (developed/industrial) versus extractive (non-developing/resource-based) economies does not only reflect Kansky's findings, but Bunker also addresses the underlying economic logic that generates particular infrastructural setups depending on whether the economy is based on production or extraction:

Extractive economies tend to develop fewer lateral linkages than productive economies. [...] [E]xtractive economies do not respond to the locational advantages that tend to foster the mutual proximity of productive enterprises. Extractive economies necessarily locate at the sources of raw materials, and these sources may be far removed from existing demographic and economic centers. (Bunker 1985:26).

[The limit of] the extent that extractive economies can share with other enterprises the locational advantages of population centers and infrastructure creates cycles in which costly infrastructure and human settlements are periodically abandoned or suffer a severe reduction in economic utility. [...] The locational advantages of shared labor pools and infrastructure which production systems usually enjoy are much more likely to allow adaptation to changing technologies and markets. *The most of the infrastructure developed for extractive export economies is specific to the requirements of resource removal and transport exacerbates their loss of utility as the extracted resource is exhausted or substituted.* (ibid.:27, my emphasis)

Contrary to the inherent belief in the model by Taaffe et al, Bunker's arguments imply that a certain structure of transport networks in certain countries is characteristic for a certain *type* of economy, rather than being an intermediate stage in a Rostow-style universal sequence of development. The lack of infrastructural interconnections in the railway systems of Nigeria, Ghana and other predominantly primary-product-exporting countries is thus self-explanatory: with fuel commodities representing 99 percent of the value of Nigerian exports⁵¹, constituting

⁵¹ In 1999, SITC-category 3 – Fuels, lubricants, etc. – constituted 21.1 bn USD of Nigeria's reported exports, while other commodity types were valued at a meager 0.2 bn USD (Source: Comtrade 2001). Ghana's exports for the same year, valued only at 6 percent of Nigeria's exports, is dominated by SITC categories 1 (Food and Live animals) and 3 (Crude materials, inedible), these two categories representing 63 percent of Ghana's total exports

a similarly large share of Nigeria’s total national income, the initial penetration lines *are* the “high-priority Main Streets”. The transport networks of Nigeria, Ghana and other “extractive economies” are thus as mature as they can be for the type of economy they represent, which of course explains the lack of interconnectedness and high-priority trunklines aimed at internal (productive), rather than external (extractive), exchange. Furthermore, there is no discrepancy between Galtung’s structural typology (Figure 3.3), Kansky’s Pi-measures, and the railway maps of Ghana, Nigeria, and France (Figure 3.5). If we were to replace the C-actors in the typology with France, and each of the four subgroups of P-actors with underdeveloped countries such as Ghana and Nigeria, we would arrive at the same type of structure, i.e. where interconnectedness is the characteristic feature of the center and where the absence of such is what characterizes peripheries.

An observed association between two phenomena – in this case, economic development and the shape of transport network – does not indicate any casual relationship between the two. However, echoing Taaffe et al’s view that “the expansion of a transportation network [is] a critical factor [for] the economic growth of underdeveloped countries” (Taaffe et al 1963:503), politically induced changes in the structure of transport networks in order to foster economic development and to spur development in certain locales are quite commonplace. For instance, in a study by Vinod et al (2003) of roads and railways in 21 sub-regions in northern Kerala, very low Beta-indices were noted, this being indicative of tree-like railway networks all across the region. The concluding policy recommendation is that “[i]mportance should be given for the effective interconnection of roads” as this would “contribute to the overall development of [the region and its sub-regions]” (ibid.:38). Whether “forced” interconnectedness has any effect on the prospects of economic development of an underdeveloped region, or whether it is more of an infrastructural “demonstration effect” (in the veins of Duesenberry) to imitate internal exchange, remains an open question.

While Kansky looked at the properties of whole networks, a number of indices reflecting structural properties for individual nodes were also developed and applied in the 1960’s. Garrison’s study on the Interstate Highway Network in USA uses both types of indices, the latter represented by three indices to measure the accessibility of nodes in networks (Garrison 1960). While the whole network covered 41,000 miles (as of 1957), represented by 325 edges connecting 218 vertices with each other, Garrison focused on the southeastern part, a subset consisting of 45 places tied together by a total of 64 routes.

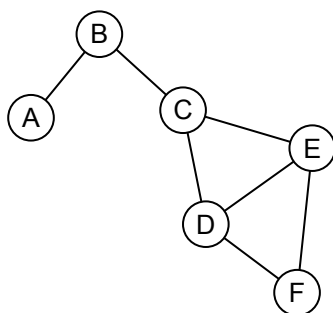

Figure 3.7: Example highway network

The node-centric indices presented by Garrison are all based on the notion of distance, i.e. the length of the shortest path between two nodes. For the example in Figure 3.7, the distance between nodes B and E is equal to 2, while the distance between A and F is equal to 4. The first index presented by Garrison is the *associated number*, this being the maximum distance from a node to any other node. In Figure 3.7, the associated number is 4 for A and F, 3 for B,

and equal to 2 for C. The second node-centric index is the *accessibility index*, this simply being the sum of all distances for a node. In Figure 3.7, the accessibility index for C is 7, while it is 8 for D, 11 for F, and 13 for A.^{52,53} The third index is a variant of the accessibility index: however, paths in the *Shimbel-Katz accessibility index* are weighted according to their lengths so that shorter paths results in higher index scores.⁵⁴

Calculating these node-centric indices, Garrison found Atlanta to be the most accessible place, followed by other locations found along the central “spine” of the analyzed network (i.e. the southeastern subpart of the Interstate Highway Network). Miami, located at the far southeast corner of the network, has the lowest Shimbel-Katz rating, thus being the least accessible among the locations in the network.

In essence, the place-specific indices introduced by Garrison introduce extra attributes to the locations of the network. Alongside the attributes of individual places, such as demographics, socio-economic factors, institutions etc, node-specific indices represent “structural attributes”. As such, these attributes are calculated on the basis of the structural properties of each node, thus being wholly independent of the internal properties of nodes. For example, two urban centers having identical internal properties may indeed be structurally different: the fact that they might differ in how they are embedded in larger networks is, according to structural economic geography, a highly relevant parameter for explaining different developmental trajectories for otherwise identical units. “Structural attributes” thus pinpoints the differences between otherwise identical social units, differences which according to standard comparative social-scientific practices, for instance regionalism, would go unnoticed.

Although Garrison discusses the possibilities for comparative analyses, his call for comparing different networks using the suggested indices is somewhat flawed: different networks might be of vastly different sizes (with respect to absolute numbers of nodes and edges), thus affecting relative values on distances. For instance, Atlanta’s Shimbel-Katz-index of 1.88 is a reflection of the actual network studied: if an analysis of the west-coast Interstate Highway System would yield a Shimbel-Katz-index of 1.50 for Los Angeles, this does not imply that LA is “less” accessible in the western region than Atlanta is for the southeastern region.⁵⁵ Furthermore, contrary to Kansky’s Pi-index, the topological abstractions used by Garrison ignores spatial distances. Instead, the connectivity matrix is dichotomous: a route between two places either exists or not, which means that the “distance” between Miami and Jacksonville (equal to 2 traversed edges), is equal to the New Orleans-Baton Rouge distance. Thus, Garrison’s analysis is best seen as first-cut research, presenting fairly crude (but nevertheless still applied in contemporary transport geography) methods to measure the properties of structural embeddedness. A more thorough integration of the methods used in

⁵² For example, calculating the accessibility index for D is done by adding the distance (i.e. shortest paths) from all other nodes to D: with A-D=3, B-D=2, C-D=1, E-D=1, and F-D=1, the accessibility index for D is thus $3+2+1+1+1=8$.

⁵³ The accessibility index is equivalent to the closeness centrality index as used in Social Network Analysis: see Freeman (1979)

⁵⁴ The Shimbel-Katz accessibility index is equivalent to the influence centrality index in Social Network Analysis: see for instance Hubbell (1965).

⁵⁵ When Garrison chooses to focus on the southeastern part of the Interstate Highway System, rather than the whole network, he commits another methodological fallacy which could have severe repercussions on analytical results. Due to the nature of structural analysis, the selection of an arbitrary subset of a network has to be theoretically motivated, which it would be if the subset chosen by Garrison can be seen as a separate system in its own right, with very few connections to the rest of the network. This is obviously not the case here.

structural economic geography and the tools provided by contemporary network-analysis is, as far as I know, still waiting to be done.

'New Economic Geography' (a.k.a. geographical economics)

Similar to how the introduction of imperfect competition and economies of scale lead to a recasting of international trade theory, a similar introduction, again initiated by Krugman, of the Dixit-Stiglitz-models to spatial issues has paved the way for 'New Economic Geography' (NEG). According to Krugman, economies of scale are absolutely fundamental for understanding why economic activities are spatially agglomerated: "in the absence of such scale economies, producers would have no incentive to concentrate their activity at all" (Krugman 1998a:163; also see Krugman 1991:5; Krugman 1995:35). Up until the necessary tools for modeling imperfect competition and scale economies were invented, spatial issues were simply ignored in mainstream economic theory (Krugman 1995:36), with the effect that "trade among countries is usually given a sort of spaceless representation in which transport costs are zero for all goods that can be traded" (Krugman 1991:2). Furthermore, according to Krugman, as the 'old' economic geography lacked the necessary tools for dealing with market structures, instead being "obsessed with geometry" (Krugman 1991:5), "the study of economic geography was condemned to lie outside the mainstream of the profession [of economics]" (ibid.:4). This is where 'New Economic Geography' (NEG) comes to the intellectual rescue, offering "a reconsideration of economic geography" (Krugman 1990b:3).

NEG implies a complete recasting of the discipline of economic geography, transforming the foundations of the subject to be based on neoclassical axioms and perspectives, pre-requisites for neoclassical economic analysis. NEG implies the construction of general equilibrium models, representing virtual economic landscapes containing forces for agglomeration as well as dispersion. Agglomerating (centripetal) forces are most often represented by increasing returns to scale: as unit cost decreases with increased production output, there are incentives for production to focus at certain place, resulting in an influx of labor at a manufacturing region, labor whose added demand further spurs production increases at this place in a circular fashion. Dispersing (centrifugal) forces are represented by immobile factors – supply-side (resources, labor input) as well as demand-side (the demand of such immobile labor/populations) – spread across the virtual landscapes of NEG-style models: with non-zero transportation costs, there are Weber-style incentives to spread out production among several locales. This interplay between scale economies and transport costs thus results in models which, at certain parameter settings, yields multiple equilibriums where production is spread among several production locales, thus, it is argued, reflecting observed phenomena of real-world economic geographies. The advantage with NEG models is, according to Krugman, that they actually explains the *creation* of spatial economies, this being in contrast with the models by Lösch and Christaller who, it is argued, only has the ability to *describe*, partly, observed economic-geographic phenomena (Krugman 1995:40).

Through its redefinition of the discipline, discarding the inductive analyses of geographical units in favor of the development of, and subsequent experimentation with, mathematical models, the reaction from mainstream economic-geographic scholars has been highly critical. When the 'geography' part in 'economic geography' is reduced to quantitative parameters in general equilibrium models – Henderson et al actually defines 'geography' as nothing more than "the spatial relationship between economic units" (2001:81, note 1) – the protests from 'economic geography proper' are, not surprisingly, quite intense. Stressing its neoclassical foundations, Meardon (2000) prefers to label NEG as "geographical economics" (ibid.:326), further noticing that NEG can be seen as a mere extension of the work by Alfred Weber, i.e.

where the location of production is solely determined by the economic rationale of relative locations of factor inputs and markets (ibid.:327ff). In a review of *The Spatial Economy* (Fujita et al 1999), Sheppard notes that the applied axioms used by NEG run counter with how economic geography defines itself, further arguing that NEG has “a tendency to reinvent wheels which geographers threw overboard long ago, as they became a drag on intellectual progress” (Sheppard 2001:132). Sunley (2001), reviewing the same book, argues that the enthusiasm for NEG-models stems “not so much from their ability to increase our understanding of the real space economy, but more from their role as a statement of faith in such techniques to eventually produce some profound insights” (Sunley 2001:138). Writing as the honorary editor for the influential geographical journal of *Transactions of the Institute of British Geographers*, Ron Martin’s critique of NEG is indeed reflecting the general sentiment of ‘Old Economic Geography’:

There can be no denying the parsimonious elegance, expositional lucidity and deft topicality that characterize the contributions of these neophyte ‘economic geographers’. But the formal-model-driven nature of their work, their pursuit of ever more general deterministic mathematical solutions, sacrifices empirical realism for abstract universalism. [...] Obviously, this research programme is considerably removed from what economic geographers proper are currently doing. (Martin 1999:387ff)

On two accounts, I find the critique raised against NEG from ‘economic geographers proper’ as relevant. First, proponents of NEG often seem to lack a thorough insight into what is, and has been, done in economic geography (Sheppard 2001:132). NEG scholars often seem to equate economic geography with the spatial typologies of von Thünen, Christaller, Lösch and Weber, conceptualizations appearing long before economic geography turned into its own discipline but nevertheless treated as the “folk theorem of spatial economics” (Meardon 2000:351). Secondly, it is also somewhat disrespectful to label a new line of study within one discipline as a new version of another discipline, thus making the term “geographical economics” more appropriate than ‘new economic geography’. However, whether a fuzz is raised or not by the discipline whose name is borrowed seems more to reflect the self-identity and confidence of the discipline rather than something else: editorial pieces in mainstream economic journals do not discuss how ‘economics proper’ should relate to ecological economics and post-autistic economics, for instance, two areas of research which label themselves as ‘next-generation economics’. Discussing the axiomatic and methodological differences between mainstream economic geography and ‘new economic geography’ reflects, I believe, a lack of understanding for what neoclassical economics is all about: economic geography proper and NEG seem different not due to one side being ‘correct’ while the other is not, but simply because they *are* fundamentally different disciplines as defined by their respective methods, agendas and axioms. Neoclassical economics and its NEG sub-branch are concerned with the development of models which are built on a characteristic set of micro-foundational assumptions on rational choice and market mechanisms, models which are aimed at replicating and mimicking conceived real-world events. For NEG, such models are judged by their ability to reflect a certain degree of certain aspects of real-world economic geographies, such as scattered production and hierarchical urban systems. Economic geography, on the contrary, begins with real-world events, describing and analyzing observed phenomena from a plethora of methodological and axiomatic standpoints. Mathematics are indeed used in economic geography, thus making it somewhat similar to NEG in a rationalist-logic sense (Barnes 2003:4), but contrary to the simulational-mathematical models in NEG, economic geography apply mathematics in a

statistical sense, using real-world observations in such statistical analyses.⁵⁶ Much of the skepticism towards NEG perhaps tell us more about the still prevailing identity crisis of economic geography and its lack of self-confidence rather than the threat posed to the discipline as a whole by a set of neoclassical model constructs: why defend the home-turf of economic geography when NEG apparently is so far away from it?

Although Krugman stresses the need for empirical data to validate NEG-style models (Krugman 1998b:15ff), and although Henderson et al (2001) notice that the cost of transporting a standard container from Baltimore to Central African Republic is more than four times higher than its shipment to Cote d'Ivoire, empirical data is not a prerequisite for conducting new economic geography. According to Krugman, it is imperative to collect such empirical data (thus either assuming that such data is non-existent or that the empirical data collected in economic geography proper is unsuitable and maladapted):

In the end, of course, while the achievements of new economic geography to date certainly justify the work involved, a theory must survive or be discarded based on its empirical relevance. So empirical and quantitative work is clearly the next geographical frontier. (Krugman 1998b:16)

Looking at the history of trade theory, such survival tests are not necessarily necessary. The empirically observed and overall undisputed Leontief paradox had no impact on prevailing trade theory (see chapter 2): it was methodological development, not empirical data, which finally lead to models which could explain the empirical data, with several decades of ignorance making up the time-period between empirical data and model-based explanation. Thus, even if empirical data fails at supporting the models of NEG, this does not necessarily has to result in an abandonment of NEG-style models: instead, neoclassical models are notoriously good at 'standing their grounds' when faced with overwhelming empirical evidence running counter to these models. Although this often is interpreted as some sort of characteristic stubbornness and ignorance, even conspiracy, it is more a defining feature of mainstream economics:

Many of those who reject the idea of economic models are ill-informed or even (perhaps unconsciously) intellectually dishonest. Still, there are highly intelligent and objective thinkers who are repelled by simplistic models for a much better reason: they are very aware that the act of building a model involves loss as well as gain. [...] Model-building, especially in its early stages, involves the evolution of ignorance as well as knowledge; and someone with powerful intuition, with a deep sense of the complexities of reality, may well feel that from his point of view more is lost than is gained. (Krugman 1995:79)

Albeit the abstractness of NEG and the massive counter-attack from economic geography proper, the models and analytical findings of the 'new economic geography' branch of mainstream economics offer a set of very interesting findings which are of relevance for economic exchange structures. As these models include spatial distances between economic actors, the outcomes differ vastly from what would be the case in a "black hole" economy, i.e. where the cost of spatial distances and other structural conditions for exchange, are

⁵⁶ It can of course be questioned whether some of the models in economic geography actually have been useful to describe real-world events. Both the German tradition in location analysis (von Thünen, Christaller, and Lösch) and similar approaches during the quantitative era (see especially Haggett 1965; Haggett and Chorley 1969) were indeed somewhat abductive (in the sense that they were developed independently from empirical material), but they were nevertheless constantly tested against empirical observations and real-world events, models aimed more at being descriptive rather than explanatory. Furthermore, mathematical endeavors in economic geography, such as what can be found in structural economic geography (see above), are certainly more methodologically pluralistic than what is the case in neoclassical economics and NEG.

ignored. To begin with, similar to New Trade Theory (see chapter 2), the NEG-style models points to the role of developmental path-dependence: “insofar as the location of economic activity in space is concerned, the idea that an economy’s form is largely shaped by historical contingency is not a metaphysical hypothesis; it is simply the obvious truth.” (Krugman 1991:100). Secondly, NEG has lead to the introduction of new concepts and ways of understanding economic outcomes – suddenly, the concept of core-periphery has become not only accepted but indeed fundamental:

Since its original statement in Krugman (1991), this core-periphery model [containing a manufactured ‘core’ and an agricultural ‘periphery’] has become to the new economic geography more or less what, say, the two-by-two-by-two model is in international trade...as the simplest model that illustrates all the main principles of the genre... [...] It is such a striking feature of modern economic history that one must view it as nearly scandalous that economists have ignored it until now. But it remains true that much, perhaps most, of the usefulness of the core-periphery model is that it opens the door to the study of a much wider range of issues. (Krugman 1998b:13)

Thirdly, and connected to these above, is the recognition of spatial structures and issues on nearness and farness from points of economic agglomeration (Henderson et al 2001): spatial distances do indeed matter in the models of NEG.

Still, importantly, NEG is model-centric and the “findings” of NEG-style analytical work are conceptual rather than observational/empirical. This, however, could in the long run have significant implications on the future research agendas within mainstream economics. To reiterate Wallerstein: “Conceptions precede and govern measurements” (1974:415): the entry of core-peripheral structures into the neoclassical standard discourse, as Krugman says (see above), “opens the door to the study of a much wider range of issues”.

In what follows, we will look closer at two NEG-style models that point to the relation between exchange structure and economic development: Krugman’s initial model (1990b; 1991; 1995), and Puga and Venables’ study of preferential trading agreements between nations (1997).

Paul Krugman

Krugman’s geographical model that initiated the ‘new economic geography’ was first presented in his 1990b article *Increasing Returns and Economic Geography*, a model further refined in later writings (Krugman 1991, 1995). The initial model was concerned with two locations in which two commodities were produced – agricultural and manufactured goods – employing two types of laborers for respective good. The labor force represents both the production factor as well as the demand for the goods: Krugman’s model, similar to other NEG-style models, are concerned with the question on *where* manufacturing production occurs in a set of fixed regions as explained through equilibrium of market forces.

Agricultural production employs an immobile labor force which is uniformly distributed across all regions in the model and producing at constant returns to scale. Manufacturing production is produced at increasing returns to scale, modeled as a fixed, initial cost for establishing manufacturing production at each location, thus making it more optimal to concentrate manufacturing and its labor force in either of the two locations. As more manufacturing labor is located in one of the two locations, demand at this location is increased further, thus spurring further agglomeration of manufacturing in a self-reinforcing circular way. However, the demand of the immobile agricultural labor force is also accounted

for in the model, a demand that has to be catered for by transport⁵⁷ of manufacturing goods from the location where these are produced. The outcome of the model, i.e. the locations where manufacturing goods are produced, are thus dependent on two parameters⁵⁸ of the model: initial costs for establishing manufacturing production (centripetal/agglomerating forces) vis-à-vis transport costs (centrifugal/distributive forces). High initial costs for manufacturing production and low transport costs result in manufacturing production to be located in one of the two locations, while the opposite – low initial costs and high transport costs – result in manufacturing production being spread out across both locations.

The 2-location scenario is extended further in Krugman’s 1991 book, first to include four regions subsequently extended to six. In the 6-location example (Figure 3.8), regions are placed in a circle structure, with transactions only allowed around this circle.⁵⁹ The same model components are applied: two commodities are produced – immobile agricultural production and mobile manufacturing production – using constant and increasing economies of scale, respectively. The iterative model yields different outcomes depending on the initial distribution of manufacturing production and the parameters of initial costs (economies of scale) and transport costs: not only the case of where manufacturing production is located either in all or in a specific location, but under certain parametric conditions, two “cores” may appear (Krugman 1991:86).

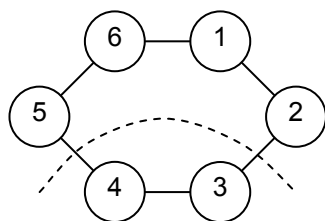

Figure 3.8: Krugman’s 6-location setup (from Krugman (1991:86; figure 3.2))

An interesting aspect of Krugman’s model is his inclusion of national barriers of trade between the two sets of locations (dashed line in Figure 3.8), dividing the 6 locations into two distinct “nations” with restrictions on movement of manufacturing production between the two “nations”. With these restrictions, the model yields one core in each of the “nations”: the core in region 1 caters for the demand of three peripheral regions (2, 5 and 6), while the core in region 4 is smaller as it only serves a singular peripheral region (3). The consequences of subsequent trade liberalization are then pondered upon by Krugman:

Then the two countries do a 1992, and merge into a single economic unit. What happens? The answer depends on whether the ultimate equilibrium has one core or two. If the integrated economy ends up with only one core, then region 1, with its head start, will presumably attract all the manufacturing away from region 4. But if the integrated economy ends up with two cores, manufacturing in region 4 will actually expand at the expense of region 1, as it gains access to its full natural hinterland. (Krugman 1991:87)

⁵⁷ In Krugman’s models, as well as in many other NEG-style models, transport costs are modeled in the iceberg fashion suggested by Paul Samuelson, meaning that the quantity of goods transported are diminished in relation to the distance it is transported. (See Krugman 1991:103; 1995:96)

⁵⁸ There is also a third parameter regarding taste, i.e. the relationship between preferred amounts of manufactured and agricultural goods respectively. The Cobb-Douglas function used to describe this relationship is also used to calculate welfare (see below).

⁵⁹ The circular setup represents regions in a closed one-dimensional space, i.e. where the endpoints are connected to each other (Krugman 1991:84ff)

Needless to say, this reasoning on the effects of trade liberalization and the mechanisms that result in manufacturing activities relocating to the region closest to the largest demand is, of course, quite contrary to empirical findings. When disregarding the possibility of different labor costs at different locations prior to trade liberalization, Krugman's models cannot (yet) capture the effect of industrial flight from high-wage to low-wage countries as the more realistic effect of trade liberalization between nations. The model instead assumes that labor costs⁶⁰ are constant across all regions and that the workforce employed in manufacturing actually leaves one country for another, further being in contradiction to real-world observed phenomena.

Testing different values on the transport cost parameter in the model, Krugman looks at the post-equilibrium welfare function (equated with the amount of goods that can be consumed according to the Cobb-Douglas function) for the immobile segments of the labor force, i.e. the landlocked part of the population engaged in production of agricultural goods (Figure 3.9). Although temporarily resorting to the 2-location setup, his welfare analysis does hold true for similar models containing any number of regions.

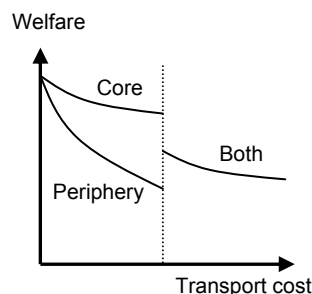

Figure 3.9: Welfare function of immobile workforce in relation to transport costs⁶¹

At high transport costs, welfare is the same in all regions as manufacturing production is uniformly distributed across all regions. As transport costs are lowered, “we will reach a critical point at which the regions become differentiated into a manufacturing core and an agricultural periphery” (Krugman 1991:88), where there is a huge welfare gap between the immobile population in the core and the periphery respectively. As transport costs are reduced further towards zero, welfare will however increase everywhere, resulting in a state where the welfare in cores and peripheries are not only equal, but at a higher total level than the pre-integration state:

This immediately suggests that for the region[s] that becomes the periphery, there is a U-shaped relationship between economic integration and welfare: close integration is good, but a limited move toward integration may hurt... (Krugman 1991:89)

Thus, a lowering of welfare in peripheral (non-manufacturing) areas due to economic integration, i.e. the reduction of barriers of trade, is theoretically explained as a transient phenomenon. Further integration, in effect meaning diminishing transport costs, will eventually result in a higher state of equal welfare everywhere for all production segments and at all locations. The implicit policy message is to ‘hang in there’ – things will eventually improve for all in a win-win-situation, even though the welfare effects initially point to the opposite direction.

⁶⁰ As a matter of fact, Krugman does not use labor cost at all in his model. In a Ricardian fashion, Krugman resorts to a labor theory of value where one unit of labor produces one unit of goods.

⁶¹ Redrawing of Figure 3.3 in Krugman (1991:89).

According to Krugman, policy action can play a crucial role for tipping the scales in favor of one region, an argument exemplified using the following hypothetical scenario where lower transport costs would be the result of the development of railroads:

Imagine that it is 1860, and you perceive correctly that the invention of railroads is about to lead to the division of your continent into a manufacturing nation that contains a core and an agricultural nation that does not. Then you might very plausibly advocate a temporary tariff to ensure that you get the core. Once you have established a decisive lead in manufacturing, you can remove the tariff – and lecture the other country, which has effectively become your economic colony, on the virtues of free trade. Has anything like this ever happened? Well, not exactly. (Krugman 1991:90)

Krugman is obviously unaware, or plainly ignorant, on how Friedrich List interpreted international trade more than a century earlier. Although arriving at very tangential conclusions regarding the role between protective measures and economic development, Krugman lacks any reference whatsoever to Friedrich List. While they use different transport modes in their arguments – railways versus seafaring – it is very worthwhile to recite the passage by List where he argues, contrary to Krugman, that “anything like this” indeed was under way in the second half of the 19th century:

Any nation which by means of protective duties and restrictions on navigation has raised her manufacturing power and her navigation to such a degree of development that no other nation can sustain free competition with her, can do nothing wiser than to throw away these ladders of her greatness, to preach to other nations the benefits of free trade, and to declare in penitent tones that she has hitherto wandered in the paths of error, and has now for the first time succeeded in discovering the truth. (List 2005 [1841]: 46ff)

In 1995, Krugman presented an extended model containing a total of 12 locations, similarly placed in a circle using the same model components as his previous models (Krugman 1995:105-108). In his numerical example, manufacturing production is initially randomly spread among the regions, where iterations of the model result in two distinct manufacturing “cities” emerge at location 6 and 11, that is, almost, but not exactly, opposite each other in the circle setup. Due to different initial shares of manufacturing production, the simulation model can thus yield results that, similar to real-world spatial structures, are sub-optimal, “with an almost perfectly smooth initial distribution producing a perfect central-place pattern” (Krugman 1995:63).

Although not expanding his model further in his 1995 writing, Krugman is confident that extensions of the model would yield results that reflect familiar, albeit somewhat outdated, concepts for the spatial analyst:

All this is for a one-dimensional economy, but I am...highly confident that the same model extended to two dimensions would produce a lattice of central places with hexagonal market areas: Lösch vindicated. I am less confident but hopeful that in a model with two or more manufacturing sectors characterized by different scale economies or transport costs the approach will yield Christaller-type hierarchies. I even have a fantasy that in a many-sector model there will emerge some deep justification for the rank-size rule, though that may be too much to hope for. (Krugman 1995:63ff)

New economic geography as defined by Krugman is thus concerned with the development of simulational models based on what is deemed to be relevant from a neoclassical point of view, i.e. models of general equilibrium between supply and demand. As the models yield results in which, similar to observed real-world phenomena, production is spread among a

handful of possible locations, these models thus, it is argued, describe the basic mechanisms that form such real-world phenomena. Similar to most theoretical endeavors in mainstream economics, the task is to construct models based on a set of fundamental axioms, models which in their virtualness are perceived as reflecting real-world phenomena: empirical data is thus wholly absent in the modeling process.

The “geography” aspect in the models by Krugman (and his fellow NEG-scholars) is a highly reduced version of how it is treated in economic geography proper. If the transport costs instead were conceptualized as non-spatial transaction costs in a broader sense, the models would yield exactly the same results while lacking any reference whatsoever to geography. Whether perceived spatially or not, the structural aspect in Krugman’s models are nevertheless novel: with transaction costs being different for each pair of economic locations, structure becomes relevant for the outcome of the simulations. Through this, similar to New Trade Theory (see chapter 2), path-dependence and initial conditions are given theoretical importance in the understanding of development and lack-of-development for different actors in an exchange system. The spatial structures are indeed trivial in Krugman’s models, where every location/actor is on structurally equal terms in the circular setup. Nevertheless, if the models were to employ an all-with-all structure, the outcome of Krugman’s numerical example would always result in a singular manufacturing core, a result which does not conform to real-world patterns of spatial agglomerations. Krugman conceives that an extension of the model into two spatial dimensions would yield central-place lattices: this might very well be the case in a closed 2-dimensional room (i.e. the surface of a sphere), but a more realistic open 2-dimensional room would imply that central locations have a structural advantage vis-à-vis locations on the edges of the virtual landscape.

Albeit highly abstract, virtual and molded according to questionable axioms, Krugman’s models explicitly put the role of structures on the research agenda. And this is perhaps the largest contribution to economic theorizing: the structures that connect economic actors, conceptualized as spatial distances connecting geographical regions or otherwise, contradict Walrasian assumptions regarding total transactional freedom between economic units making up an exchange system. In doing so, the concepts of core and periphery turn into foundational aspects of geographical economics, indeed paving the way for neoclassical analyses that are *allowed* to differ from the almost compulsory win-win-results from previous models. Thus, the inclusion of spatial distances into standard “pin-head economics” has profound consequences for concepts, conclusions, mainstream economic research agendas, and possibly also policy proposals.

Puga and Venables

Similar to Krugman (1991), Puga and Venables (1997) look at trade liberalization and its effect on the relocation of industrial activity. Instead of placing a given number of regions along a circle, the model presented by Puga and Venables can handle an arbitrary number of countries structured in a more variable way than is the case in Krugman’s model. Similar to Krugman, the model consists of one sector producing at constant returns to scale, whose output is transported without costs between countries. The second industrial sector produces not one but several types of goods at increasing returns to scale, each of these goods using other industrial goods as well as labor as input factors. This industrial sector thus differs from Krugman’s model, the latter in which only a single homogeneous good was produced. Each of the industrial sub-sectors in Puga and Venables’ model compete with each other for labor, each having its own production functions and differently demanded by the laborers.

Compared to Krugman's models above, the mathematics employed in the models by Puga and Venables are quite advanced (Puga and Venables 1997:349-353), for instance as reflected in how the structural setup of the locations (countries) are implemented. Instead of restricting trade between locations in a static fashion, for instance along a circle, Puga and Venables use matrices to describe the structures between locations.⁶² In this "trade barrier"/"trade policy" matrix (ibid.:352), the values represent transport costs between each pair of countries.

The first example presented by Puga and Venables consists of 3 countries (ibid.:353-355). Initially separated by high trade barriers, each of the countries are self-sufficient in their production of the various goods in the model. As trade barriers are reduced, intra-industry trade of intermediate goods between the countries appears, however still remaining at the previous system-wide equilibrium. When trade barriers are reduced further, agglomeration occurs in the country with the largest share of industrial production, indeed similar to the results obtained by Krugman's models.

If a free-trade area is established between some of the countries in the model, firms located within the area benefit while those outside the area suffer negative profits. The latter firms consequently relocate into the free-trade area, in effect resulting in deindustrialization of the non-member countries. Through cost-savings on internal trade, fewer intermediate goods suffering from barriers of trade, and an increase in the varieties of industrial goods, the welfare in countries within the free-trade area increases while it decreases in countries outside the area (ibid.:356ff).

In the second example, a hub-and-spoke setup is tested, this aimed at reflecting the situation between EU countries (modeled as one location) and some of its eastern neighbors:

[T]he Association Agreements between the EU and several Central and East European countries (CEECs) have bilaterally liberalized trade between the EU and each of these CEECs. They have not, however, addressed trade barriers between the CEECs, nor have they included all CEECs. The term 'hub-and-spoke' has been coined for these type of arrangements that give one region (the hub) better access to other regions (the spokes) than these have to each other. (Puga and Venables 1997:357).

After coding the trade policy matrix to reflect such a hub-and-spoke structure, where EU acts as a singular country (the hub) and the CEEC:s are represented as the internally non-connected spokes, the model yields results that reflect the intuitive understanding of such structures as conceived, for instance, by Galtung (see Galtung 1971):

Overall, a hub-and-spoke arrangement unambiguously increases the number of firms and welfare in the hub. In spoke nations the number of firms and welfare certainly increases by less than in the hub and may fall, the latter being more likely the lower are initial trade barriers. (Puga and Venables 1997:358ff)

As *absolute* welfare is increased for spoke countries engaging in preferential trading agreements with the hub, there are incentives to obtain such agreements. However, the

⁶² As we will see in the forthcoming chapter on Social Network Analysis, matrices are the standard format in contemporary network analysis for representing the relations between the entities of a systems. Suffice to say for now, a matrix is a square table whose size is given by the number of entities in the network, where each cell describes the structural value between each possible pair of entities.

structural advantage of the hub, along with the competitive nature between spoke countries, leads to *relative* welfare to actually decrease for spoke countries.

The two examples presented by Puga and Venables lead to slightly different policy proposals. For countries creating a free-trade area, the authors find a similar phenomenon as Krugman (1991:89) where there is a U-shaped relation between economic integration and welfare effects. As integration eventually will lead to increased welfare across all free-trade countries, “a firm and credible commitment to full integration may convince peripheral regions to put up with harder times during the intermediate stages of trade liberalization.” (ibid.:364). This argument is based on the outcome of the model in which reduced barriers to trade leads to industrial activity to relocate to the country with the largest share of initial manufacturing – which is quite opposite of what the NAFTA agreement has resulted in, where manufacturing instead is relocated to Mexico due to low wage costs. However, in line with their model, it seems viable that producers serving the US market indeed would move into the free-trade area, presumably Mexico, thus increasing relative welfare for the area at large vis-à-vis non-member countries.

The models by Puga and Venables underline the theoretical importance of looking at exchange structures and how different transaction costs between pairs of economic actors (countries) results in different developmental outcomes (as manifested in industrial activity). Although the models runs somewhat counter to observed phenomena – the formation of NAFTA has not lead to a net inflow of industrial activity from Mexico to USA, but rather on the contrary – the model and the reasoning is of great importance on a conceptual level: structures do indeed matter more than any would-be internal attributes of the countries making up the systems. Furthermore, albeit on a fairly technical and methodological level, the usage of matrices to model structural relations makes the line of study compatible with the available formal network-analytical tools offered by Social Network Analysis (which we will look at in the subsequent chapter).

Conclusion

Except for a common interest in structures of exchange, another common element in the studies presented in this chapter can be seen in their usage of mathematics. Mathematics is, however, not always the same as mathematics. In the structural economic-geographic studies above, mathematics is applied in a statistical sense to process empirical real-world observations in order to map and identify would-be statistical associations between two (or more) types of observed phenomena, for instance between structural properties (as reflected in Pi-indices) and national indicators of development. In New Economic Geography, similar to the neoclassical school at large, mathematics is used to build models which subsequently turn into the center of attention: in its attempt to mimic processes and events which are perceived as being accurate reflections of real-world phenomena, parameters are adjusted and new mathematical constructs having passed the disciplinary Litmus tests are integrated. Insofar as economic geography proper uses mathematics, New Economic Geography *is* mathematics.

This distinction between statistical versus simulational mathematics, I argue, is crucial. Economic geography indeed had its period of abductive thinking, where the search for an imaginary set of economic-geographical nomothetical “laws” were to be revealed through the use of mathematics, quite similar to the on-going model-centric frenzy within New Economic Geography. However, there is, I believe, a fundamental difference between central-place theory, gravity laws, rank-size rules and other similar mathematical constructs vis-à-vis the

usage of statistical mathematics aimed at examining would-be relations and dependencies between empirically observed phenomena. Ignoring this distinction, as seems to have been the case in the quantitative counter-revolution in economic geography, analyses of exchange structures will most probably remain at a rather vague, non-comparative and informal stage.

While the usage of mathematics might differ between the archaeophyte and neophyte economic-geographic studies presented in this chapter, they do share a common concern for structures of exchange between entities in economic systems and how such structures are related to economic development, of the system at large and its individual sub-entities. However, instead of resorting to the rather crude indices used by Kansky and Garrison, and instead of resorting to the neoclassical non-empirical spatial simulations – mimicking what it is thought to mimic and laden with disciplinary assumptions of questionable validity – the next two chapters introduce the mathematical-statistical approach known as social network analysis. Without any fundamental assumptions, value schemes, or conceptual and theoretical filters – other than the implicit belief that structures should not be ignored in system studies – applying social network techniques on empirical trade data is, I argue, the most plausible method not only to map the structure of the world-economy, but also to examine whether positionality, in the broader Sheppard sense, is related to the uneven distribution of resources that undeniably occurs within this system: the world-system.

CHAPTER 4

Social Network Analysis I: Basic concepts and centrality analysis

”Umuntu ngumuntu ngabantu”
- Traditional Xhosa aphorism

This chapter will present the generic toolbox known as social network analysis (SNA), presenting the basics of network analysis, its difference from more traditional social-scientific methods, its underlying concepts and terminology, and typical research questions that can be addressed using network methodology. A short introduction to network visualization follows as such have both pedagogical as well as analytical purposes. Once the foundation has been laid, a handful of centrality indices are presented, followed by a novel centrality index specifically designed to address issues on centrality in datasets such as global trade flows.

The chapter that follows (chapter 5) constitutes a sibling chapter to the current one, a chapter in which tools for role-analysis in network datasets will be introduced. Together, these two chapters form the methodological basis for the empirical chapters that constitute the core of this thesis.

Approaching structures and networks

In the last chapter, a number of economic-geographic studies were presented in which an all-with-all assumption were not taken for granted but, instead, in which structures were given a greater role for the understanding of social-economic phenomena. Although the structural methods in economic geography were phased out in the quantitative counter-revolution of the 1980's, Sheppard's recent call for positionality analysis could very well be a pre-cursor for a structural renaissance in economic geography. Such a would-be revival could furthermore be reinforced by the 'findings' in the so-called 'New Economic Geography' (NEG): although the reductionalism of NEG has its practical shortcomings, reflecting the neoclassical abductionism more than being concerned with real-world observations, NEG nevertheless brings issues on structures, at least implicitly, into the mainstream research agendas.

Deviations from assumed all-with-all trading structures offer new trade-theoretical avenues to pursue. A would-be introduction of structures into formal models of international trade would most certainly have repercussions on policy proposals, explanatory concepts and compatibility with observed phenomena, similar to how 'new trade theory' reshaped the view on international trade, theoretically more than practical, away from the proposals suggested by standard Heckscher-Ohlin models. Addressing the fundamental questions - on the relationship between trade, the sharing of gains from trade, and the socio-economic development of national economies participating in international trade - using trade-theoretical models which lack any structural-analytic components and that apparently has a hard time dealing with imperfect competition, would thus seem somewhat shaky. The world described in the Heckscher-Ohlin model is obviously not the world we all live in: the trading profiles of Iceland, Zimbabwe, Singapore and USA are indeed more due to structural positionality, shaped by path-dependent historical trajectories, geographical locations, and imperfect competition, rather than comparative advantages based on different factor endowments.

From a world-systemic, space-functional perspective, structures are argued to be of paramount importance for understanding development vis-à-vis lack-of-development across different parts of the world. This is in sharp contrast to the time-functionalism to be found in the modernization school, as well as in regionalism and localization studies, schools that prefer to view the prospects for development as based on internal properties. Albeit this explicit concern for structures, world-system analysis most often define the different strata of the world by their internal, non-structural properties: what actually constitute the cores and peripheries of the world-structure is not based on the defining features of such positions, i.e. the characteristic *structural features* of strata (see Meier and Baldwin 1957:147), but they are instead categorized according to how such structures are believed to be reflected in different internal parameters of the systemic parts (Wallerstein 1974:400ff; Wallerstein 1972:95ff).

How to talk in a formal way about structures in general – and exchange structures in particular? From the different strands of social science that are concerned, more or less, with structures, a handful of concepts relevant for the issue at hand can be found: trade policy matrices, interconnectedness, imperfect competition, hub-and-spoke setups, Pi- and Beta-indices, centrality indices, central place patterns – the list goes on. These vocabularies have been quite autistic: methods, concepts and analytical tools for addressing structural and relational aspects of social systems seems to have been confined within their respective disciplinary boundaries, many of whom have kept on inventing variations of the same analytical wheels.

In recent decades⁶³, a set of formal tools for analyzing structure has evolved into a fairly distinct and reasonably coherent scientific-methodological platform. Social Network Analysis (SNA) has entered the scene, offering a formal approach for explicitly addressing relations among different parts of systems, i.e. networks. Similar to statistics, SNA is a generic approach which offers a coherent and meta-disciplinary way to look at just any type of structures, social as well as non-social.

The best way to describe the SNA perspective is by comparing it to the standard cross-comparative methods in social science:

The network perspective differs in fundamental ways from standard social and behavioral science research and methods. Rather than focusing on attributes [i.e. internal properties] of autonomous individual units, the associations among these attributes, or the usefulness of one or more attributes for predicting the level of another attribute, the social network perspective views characteristics of the social units as arising out of structural or relational processes or focuses on properties of the relational systems themselves. (Wasserman and Faust 1994:7ff)

In the atomistic perspectives typically assumed by economics and psychology, individual actors are depicted as making choices and acting without regard to the behavior of other actors. [...] In the individualistic approach, social structure is seldom an explicit focus of inquiry, to the extent that it is even considered at all. Network analysis, by emphasizing relations that connect the social positions within a system, offers a powerful brush for painting a systematic picture of global social structures and their components. (Knoke and Kuklinski 1982:9ff)

Social structure is regularities in the patterns of relations among concrete entities; it is *not* a harmony among abstract norms and values or a classification of concrete entities by their attributes (White, Boorman and Breiger 1976:733ff; original emphasis)

⁶³ The development of Social Network Analysis is fairly complex and spans several different scholars and schools from equally several disciplines. See Freeman (2004) for an interesting and thorough description of its genealogy (see also Scott (2000:chapter 2) and Wasserman and Faust (1994:9-17))

With its origin in sociology and the behavioral sciences, SNA is traditionally concerned with human individuals interacting and relating to each other in various ways. The generic nature of the approach does however allow for very liberal definitions of what constitute actors in systems, may they be collections of individuals, geographical locations, organizations (including firms), national states, and so forth. Actors does not necessarily have to consist of social units: SNA has successfully been applied for studying trophic food webs between (non-social) species (Luczkovich et al 2003), electrical grids, airline traffic, internet connections, computer networks and so forth. Similarly, several of the indices applied in the structural economic geography school (see chapter 3) are present in the standard set of SNA tools: the Shimbel-Katz closeness centrality measure applied by Garrison (1960) is equally applicable to any other type of social (as well as non-social) network.

From a world-system perspective, SNA offers a novel and very promising way for the mapping and the understanding of the international economic system. As world-system analysis is based on structural conceptions, it is, of course, highly relevant to look at such structures and how the different parts of a system occupy specific types of *structural roles*:

In the example of trade among nations, information on the imports and exports among nations in the world reflects the global economic system. Here the world economic system is evidenced in the observable transactions (for example, trade, loans, foreign investment, or, perhaps, diplomatic exchange) among nations. The social network analyst could then attempt to describe regularities or patterns in the world economic system and to understand economic features of individual nations (such as rate of economic development) in terms of the nation's location in the world economic system. (Wasserman and Faust 1994:9ff)

While traditional statistics could categorize two countries as belonging to the same world-system stratum based on their internal properties, a similar categorization based on SNA methods could indeed place them in different strata, even though the two countries in question have virtually identical internal properties.

The development of the formal tools offered by SNA has coincided with an overall increase in the 'network' metaphor. Perhaps best exemplified by Castells' writing on 'the network society' (Castells 2000), reinforced by the growth of the Internet and its associated culture and social patterns, networks and networking has turned into popular buzzwords implying fundamentally novel types of social organization, social behavior, and social processes. Suddenly, everything is a network! The network metaphor as used in these traditions is partly connected to SNA, but the importance and methodological practicality of the latter is very much independent of the popularity of the former. SNA can indeed be applied to a wide range of "network stuff" – management and corporate structures, social interactions, Internet communication, technical infrastructures etc, but SNA is indeed much more than the rather sweeping and non-formal usage of the network term as can be found in Castells:

Networks constitute the new social morphology of our societies, and the diffusion of networking logics substantially modifies the operation and outcomes in processes of production, experience, power, and culture. While the networking form of social organization has existed in other times and spaces, the new information technology paradigm provides the material basis for its pervasive expansion throughout the entire social structure. (Castells 2000:500)

With "networking logic" and networking as a form and engine of social organization, Castells depict networks as some sort of new *modus operandi* of social interaction. In SNA, it is neither necessary nor strived towards to assume that social processes are driven by any specific logic at all: by explicitly addressing relations between, rather than internal properties

of, social units, SNA is an analytical perspective rather than a prophecy for the advent of a new type of social dynamic.

Basic concepts, network data and visualization methods⁶⁴

A network dataset consists of two parts: a set of *actors* and a set of *relations* connecting pairs of actors. In the social and behavioral sciences, actors usually represent human individuals but other social and non-social entities may just as well be defined as actors. As the actors in a dataset usually⁶⁵ are of the same type, their internal properties – *attributes* (or *composition variables*) in SNA terminology – may very well differ, such differences being the focal points in traditional cross-comparative analysis. Possible attributes for actors representing human individuals could be age, ethnic origin, income per month et cetera. For actors representing national states, possible attributes could be GDP per capita, population size, geographical area, literacy rate, and so forth.

The relations that connect pairs of actors constitute the *structural variables* of the network data. Contrary to the attributes of the actors, structural data only makes sense in relation to other actors⁶⁶. Similar to actors, relations may be anything concerned with social (and non-social) interactions, may they be friendship ties, infrastructural connections, or bilateral trade flows.

What actors and relations represent differ, of course, depending on what is to study: the research focus, available data, model constructs, and theoretical considerations. If we were to analyze the social structure between pupils in a school class, it would make sense to view the students as actors, each sharing a common set of attributes (for instance, age, sex, social background and so forth). The structural data could then consist of friendship relations, i.e. a set of relations that connect pairs of actors in mutual friendships. Together, the set of actors (pupils) and the set of relations (mutual friendship) constitute a network dataset upon which different SNA methods can be applied.

The most intuitive representation of network data is in graph-form, where a set of nodes (actors) are connected with each other by edges (relations). While visual representations have pedagogical as well as analytical advantages, network data is more commonly expressed in matrix-form, square-shaped tables titled *sociomatrices* in SNA terminology. An example of relations of mutual friendship between a set of imaginary pupils are given in Figure 4.1 below: the graph and the sociomatrix below are two representation of the same, identical network dataset. While the relational patterns of the dataset are easier to comprehend by looking at the graph, the matrix form allows for the application of the mathematical and statistical methods and heuristics which form the backbone of SNA.

⁶⁴ In this basic introduction to SNA, most references are omitted in the text. The general references, if not otherwise stated, are Wasserman and Faust (1994), Knoke and Kuklinski (1982), and Scott (2000).

⁶⁵ SNA also allows for the study of network data which have several types of actors – see Wasserman and Faust (1994:39ff) for more information on so-called multi-mode and affiliation networks.

⁶⁶ Structural data can also contain self-ties, i.e. where an actor has a tie to itself. Actor self-ties are not applicable for bilateral trade flows and are thus ignored in this introduction. However, we will return to where a *group* of actors may have a self-tie, this implying that actors within the group are connected to each other to a certain degree.

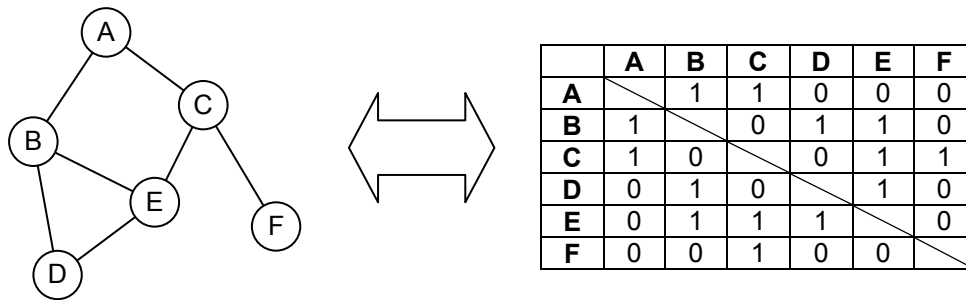

Figure 4.1: School children example data in graph and sociomatrix forms

Looking at the friendship relations in the network data above, we note that friendship is either present or absent between each pair of actors, represented by 0 or 1 in the corresponding sociomatrix. This type of binary structural data is referred to as *dichotomous* data in SNA terminology. Structural variables may, however, just as well be *valued*: instead of looking at whether a friendship tie exists between each pair of pupils, we could instead gather data on how often, or for how many hours per week, each pair of pupils meets after school. We would then have continuous, valued structural data: each edge in the graph would have a value attached to it, a value that would replace the corresponding non-zero value in the sociomatrix.

Several types of SNA methods require relational data to be dichotomous, i.e. binary, rather than valued. Prior to conducting such analyses, valued data first has to be dichotomized: using a cutoff value, valued data are converted into binary data depending on whether the valued data are above or below the stipulated cutoff value. Figure 4.2 below demonstrates dichotomization of a valued dataset that represents the number of hours per week each pair of children spends with each other off-school. Structural values below the chosen cutoff value – 7 in the example below – are thus discarded, while the remaining relations are set to 1 in the sociomatrix. As can be seen in Figure 4.2 below, dichotomization in this manner implies that the example network is split up into two sub-graphs.

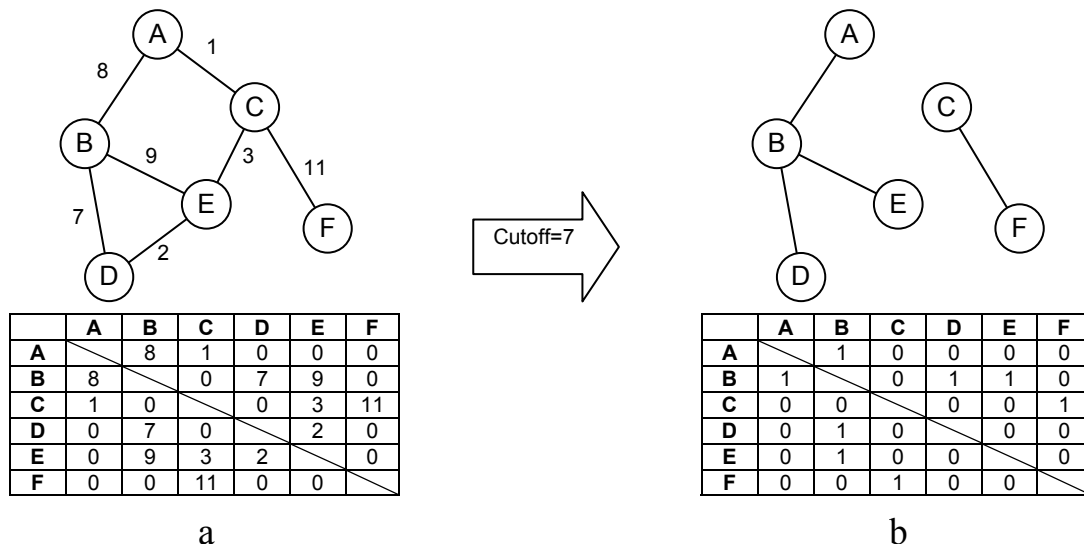

Figure 4.2: Dichotomization of valued school children example data

The theoretical viability of dichotomizing valued data does of course depend on what the data represents. In our school-class example above, dichotomization would perhaps be theoretically motivated by the assumption that every pupil has the same amount of off-school

spare-time to “distribute” across its fellow pupils. There are however instances where such assumptions are difficult to hold: if the pupils have different amounts of spare-time, the dichotomization would downplay structural data which nevertheless are significant from the point of view of certain actors.⁶⁷ Instead of applying system-wide cutoff values, in essence thus defining “significance” on a network-wide and absolute level, a centrality heuristic will be presented in this chapter where significance instead is defined on a per-actor basis.

In the school pupils example above, relations are *symmetric*: if A is a friend of B, B is also a friend of A, just as 8 hours spent by A with B also represents 8 hours spent by B with A. If we instead were to gather friendship data by asking each pupil, relations would not necessarily be mutual but instead *directional*: although A might view B as a close friend, the opposite relation might sadly not be true. Directionality of relations can also apply for valued network data: if we were to gather data on the number of phone calls each pupil makes to any other, we would end up with valued directional data. In graph form, arrowheads are typically added to the lines in order to indicate the directionality of relations, arrows complemented in directional, valued datasets with the values for each of these directional relations.

Similar to how valued data can be dichotomized, directional relations can be converted into symmetric (mutual) relations. The conversion of directional into symmetric (non-directional) data could be done either by using a criteria where at least one directional tie must exist, or that directional ties must exist in both directions, between each pair of actors. For valued data, discarding the directionality of valued data could be done using a number of procedures: either by calculating the sum, the minimum value, the maximum value, or the average of the two structural values between each pair of actors. However, similar to when choosing a suitable dichotomizing cutoff-value, the choice of method for converting directional data into symmetric data should always be theoretically motivated. Resorting to our example above, if we had directional valued data on the number of initiated phone calls, it would make theoretical sense to make this data symmetric by calculating the total number of phone calls between each pair of pupils. If the directional data instead indicated how much time each pupil thinks about each other pupil, it would perhaps make most sense to symmetrize this dataset by choosing the minimum structural value between each pair of pupils. Obviously, the symmetrization of directional data implies a new interpretation of what the data represents, for instance by calculating the total number of phone calls among pairs of pupils from a set containing the number of initiated phone calls.⁶⁸

To summarize, there are four standard types of relational data where directionality versus symmetry is combined with dichotomous versus valued data. Which type of data that is to be analyzed is determined by research design, theoretical considerations and, of course, data availability. In the structural economic geography of the 1960’s (and contemporary transport geography), relational data is typically symmetric: the spatial distance from location A and B is typically the same as the distance from B to A. As we saw in chapter 3, Garrison (1960) used dichotomous (binary data) in his study of the interstate highway system, a dataset

⁶⁷ Looking at the data, it can be noted that pupil C spends 24 hours a week with other pupils while A and D only spend 9 hours of off-school spare-time with other pupils; obviously, the assumption on equal amount of spare-time can thus be questioned here. Furthermore, depending on the chosen cutoff value, pupils that distribute their available time fairly evenly among fellow pupils could seem to be totally isolated in the dichotomized network.

⁶⁸ As the analytical methods chosen in this thesis are applied on directional valued “raw” data, dichotomization and symmetrization of data, and the theoretical motivations behind such procedures, is not something we have to be overly concerned with in this thesis. We will however return to some previous studies in which the theoretical underpinning of such pre-analytical data modifications can be questioned.

allowing for the application of certain methods for calculating centrality indices. In Kansky's study, valued data were used: total mileage as well as the length of individual railway segments constituted the input for identifying different network shapes. Contrary to the geographical contexts, it is more common to find directional relational data in the behavioral sciences.

Although it is possible to dichotomize valued data into binary form, and to symmetrize directional relations, certain SNA methods require the data to be of a specific type. For instance, while any type of relational data can be used in the role-analytical methods for identifying structural equivalence among actors, the common algorithm for estimating the more sophisticated concept of regular equivalence demands the relational data to be directional.

While the number of actors in a network dataset is constant, there may be several structural datasets for the same set of actors, each of these representing a specific type of relation. For our example set of school pupils, we could have several sets of relations for the same set of actors, each relational set representing mutual friendship, antagonistic relations, number of (directional) phone calls, family ties, and so forth. While it is possible to analyze each of these *tofts* (*type of ties*) separately, procedures exist where centrality, subgroups and role structures are determined based on all datasets simultaneously. In the classic role-relational study of inter-personal relations in a monastery (White, Boorman and Breiger 1976, building on data collected by Sampson 1969), role structures were estimated based on eight sets of structural data, such as antagonism, esteem, praise and so forth.⁶⁹ The resulting partition of the actors into specific role sets were thus established using all these eight datasets simultaneously in the role-set-partitioning algorithm.

However, when using several relational datasets simultaneously for determining centrality and role properties of networks and actors, all relational sets are typically weighted *equally*. For instance, in the monastery study mentioned above, the relational sets *esteem* and *antagonism* have equal importance in determining role structures among the monks: applied methods often discard the possibility that different types of relations are more important than others for determining role (or centrality and sub-group) properties of the actors. The study by Snyder and Kick (1979), which we will look closer at in the next chapter, is not the only one where many relational sets are used to determine overall role structures of the world-system, but they all share this dilemma: of the four relational datasets used in the 1979 study, trade is given equal importance as any other set. Furthermore, Snyder and Kick (and subsequent Kick studies) argues that better results would be obtained by including more relational datasets, though without addressing issues on weighting and differential importance among these datasets. Although it is a simple procedure to modify the calculation procedures to allow for different weighting of the datasets, this seems to be absent in most studies, world-systemic as well as other, where several relational sets are used simultaneously. Weighting would necessarily have to be theoretically motivated however: that a certain relational set, trade for instance, is twice as important as another would not only affect the end results but it would also require a theoretical discussion in order to underpin this particular weighting.

⁶⁹ Role-structural analysis and the blockmodeling technique (see next chapter) is often associated with the usage of multiple datasets, this most probably due to the fact that the two approaches were combined in the original blockmodeling article (White et al 1976). Blockmodeling does however work just as well for singular relational datasets.

The gathering and compiling of relational datasets can be done using a variety of techniques. When actors constitute human individuals, data on inter-personal relations is often obtained by interviewing each actor or by observing interactional patterns between the actors. In the school pupil example above, interviews would probably be the preferred method, especially if we were to study the directional relations of affection, antagonism, friendship and so forth as perceived by each pupil. Thus, while such data is obtained from individual actors rather than any observable relation, the data is nevertheless structural as it only makes sense in relation to other actors.

In the fairly novel economic-geographic sub-branch of world city research, studies have been conducted aimed at mapping the structure of global cities. Building on the research agenda initiated by Friedmann and Wolff (1982), world-city research is concerned with the characteristics, functions and development of cities around the world which play a significant role, often argued to surpass the role of national states, in the development and trajectory of the world economy. Several studies of world city structure utilize the scarcely available datasets of inter-city relations, for instance airline traffic (Smith and Timberlake 1995; 2001; 2002), telecommunication traffic (Barnett 2001), and, on a national level, Federal Express shipment data (Mitchelson and Wheeler 1994). The most renowned studies of world city networks are the ones conducted at the Globalization and World City study group and Network (GaWC), studies which have attempted to solve the problem of overall data scarcity, a scarcity that constitute the “dirty little secret” of world-city research (Short et al 1996), by constructing artificial relational datasets. Resorting to the gravity-model tradition in urban geography, Peter Taylor and his colleagues at GaWC often apply a procedure where the existence and strength of corporate interlock linkages between world cities are obtained by multiplying the sizes of corporate establishments in each pair of cities (Taylor 2001). Such pseudo-relational data is however not relational (Nordlund 2004), just as the multiplication of the total GDP of two countries hardly would equal the volume of the trade flow between the two countries. There are instances where internal attributes of actors can be used to estimate the presence and strength of relations between actors in a theoretically sound way. Carley (1991) uses a “constructural” approach to derive network properties by analyzing the characteristics and behaviors of individual actors, in essence conducting a similar transition of actor attributes into structural data as Taylor and colleagues does. Carley’s transformation has a solid theoretical foundation attached to the process that, along with the type of actor attributes – the possession of information – combined with the context of her study – information exchange among interacting social groups – do result in a model where structural change can be predicted successfully.

The relational datasets used in this thesis are however truly relational, consisting of international commodity trade flow statistics from the 1995-1999 period.⁷⁰ Tracking both the monetary value as well as alternative, resource-oriented measures of such flows, the bilateral trade data constitute valued, directional relations which, in contrast to attributes such as national GDP and the sizes of corporate establishments, only make sense in collections of actors. In the empirical chapters that follows (chapter 7-8), one *toft* at a time is analyzed, i.e. only one set of relational data between the nations-as-actors are analyzed at a time. While it is possible to fetch network properties using several sets of relational data simultaneously, such approaches face the weighting dilemma mentioned above. The matrices analyzed in the forthcoming chapters do indeed cover more than singular commodity categories, but instead of using one sociomatrix for each commodity sub-category, the analyzed matrices instead

⁷⁰ A description of the dataset and its pre-analytical processing is to be found in the Appendix.

contain the aggregate sum of a selection of commodity categories, chosen as to represent a specific main commodity type as much as possible.

Visualizing networks

The visualization of network data plays a similar role as that of diagrams and charts in comparative statistics, the former not only being an alternative representation of data but often also revealing structural properties that are virtually impossible to identify in matrix form. First introduced by Moreno, seen as one of the most important founders of social network analysis (Freeman 2004:7, 31-42), sociograms depict network data as graphs, where the nodes represent actors and the edges represent relations. In the sociograms of our example pupil data (see above), actors are placed arbitrarily, resulting in arbitrary lengths of the edges connecting pairs of actors. As long as the actors and relations, i.e. the network data, remains the same, any placement of actors in a sociogram is allowed. A sociogram may thus not only accentuate the structural properties of a network dataset, but it might just as well mislead the viewer by placing certain actors so that they appear to be more central than other actors (McGrath et al 1997).

For valued relations, where structural values represent the strengths of relations, it often makes sense to place actors with a high-valued relation closer to each other, while a relation with a low value would imply placing connected actors farther apart. The sociogram below (Figure 4.3), containing the example data on how much time our pupils spend with each other, is drawn so that pupils that spend more time with each other are placed closer⁷¹ to each other than pupils that spend less time together. Contrary to the sociogram where the edges had fairly equal length (Figure 4.2), the sociogram of the same network data as visualized below allows for a more intuitive interpretation of the valued data. As actor A and C only spend 1 hour per week together, they are placed further apart than actor C and F who spend 11 hours together. Not only revealing the occurrences of relations among actors, i.e. which pairs of pupils that spend time together, the sociogram below also reflects the value of such ties, in this case representing the number of hours spent together.

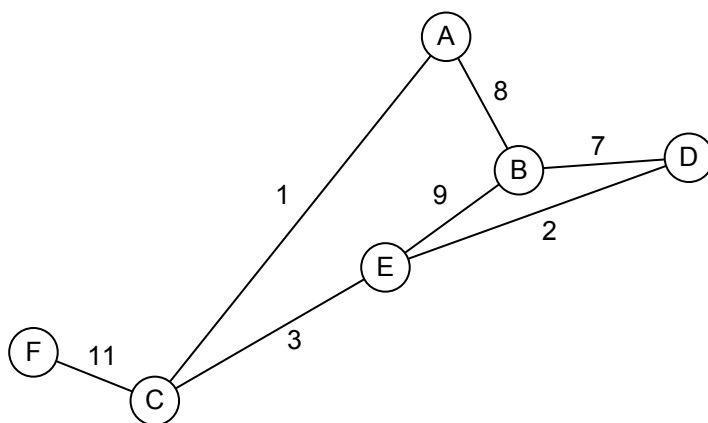

Figure 4.3: Distance-related visualization of valued data: the hours-spent-by-pupils example

Any standard inter-city map is in effect a two-dimensional sociogram of spatial distance data between urban centers. By its nature, such data is quite unique among network data as it

⁷¹ The length of each edge is proportional to the inverse of the relational value it represents ($L_{A,B}=c/v_{A,B}$, where $v_{A,B}$ is the structural value between actor A and B, $L_{A,B}$ is the length of the edge representing value $v_{A,B}$, and c is a global constant). Figure 4.3 was generated using a simple spring-embedder algorithm, resulting in a perfect fit where the Kruskal stress indices approaches zero (see below).

allows for an almost perfect graphical representation⁷², this being contrary to most non-spatial network data. The distance-related sociogram above (Figure 4.3) does however reflect one such exceptional dataset that allows for a perfect distance-related visual representation of structural data. However, if we were to add more relations of varying magnitudes to the school kids example in Figure 4.3, for instance if actor A and F were to spend 12 hours together each week, it would not be possible to visualize the network so that the relation between edge lengths and relational values would remain constant across the graph. Analogously, if we were to reduce the distance between Stockholm and Gothenburg by relocating the former closer to the latter, this would of course have repercussions on the spatial distances between Stockholm and all other geographical locations in Sweden.⁷³

Unlike our example above, visualization of valued (symmetric) data containing more than 3 actors is thus indeed a non-trivial exercise if we want edge lengths to represent the relational values between the actors. If we were to draw a sociogram of gross trade flows among the five Nordic countries, we would need more than the two dimensions offered by a page in a thesis if we want edge lengths to be related to the gross trade flows among each pair of Nordic countries: we would actually need to draw such a sociogram in a four-dimensional room, quite ungraspable for the human mind.

With the mathematical procedure known as multi-dimensional scaling (MDS), the number of necessary dimensions needed for visualizations of a dataset can be reduced to two (or three) dimensions. While MDS inevitably leads to distortions regarding edge lengths representing the structural data, the iterative procedure strives to position actors in a way that reduce the overall distortions as much as possible, arriving at best-fit placement of actors in the chosen number of dimensions. Once such optimal coordinates of actors have been established through MDS, the network-wide distortion can be calculated: the Kruskal stress indices⁷⁴ can tell us to what degree the resulting sociogram (in two or three dimensions) is representative of the structural data it attempts to visualize.

A somewhat more intuitive variant of MDS-based visualizations are so-called spring-embedders. By simulating a system of connected springs, where the length and elasticity of each spring is (inversely) proportional to the relational data, spring-embedding algorithms arrive at an equilibrium where the resulting placement of actors implies an overall “least tension” of the virtual springs. Spring-embedders typically do not arrive at the same low Kruskal stress indices as MDS does, stress indices being equally applicable to both heuristics, but spring-embedders are nevertheless useful as a pedagogical tool for understanding the problematique as well as the principal workings of MDS algorithms.⁷⁵

The more actors and the denser the network, the more probable that an MDS-based visualization will imply high stress indices, thus yielding a poor representation of the

⁷² Maps of smaller regions and cities most often assume the planetary surface to be flat. On a global scale, the solution is to map the spatial data on a sphere, i.e. a two-dimensional closed space, or to apply some sort of projection heuristic such as the Mercator projection.

⁷³ While the geometric distance from Stockholm to Gothenburg is the same as the distance in the opposite direction, this is typically not the case for directional networks, thus making it somewhat problematic to visualize the latter. Prior to such visualizations, possible solutions would be to symmetrize such network data, for instance based on the mean structural value between pairs of actors.

⁷⁴ See Kruskal and Wish (1978).

⁷⁵ Not to mention how easy spring-embedders are to implement in any object-oriented programming language, this being the sole reason why a home-brewed (albeit here undocumented) spring-embedder written in Java was used to determine the positioning of the actors in Figure 4.3.

structural data.⁷⁶ Using gross trade flows between a set of 100 countries for the period 1995-1999 as input⁷⁷ data to establish actor coordinates in two dimensions, we end up with a very high Kruskal stress index of 0.41 and a fairly uninterpretable visualization where the major trading countries, together with Sudan (!), are grouped together in the center – see Figure 4.4.

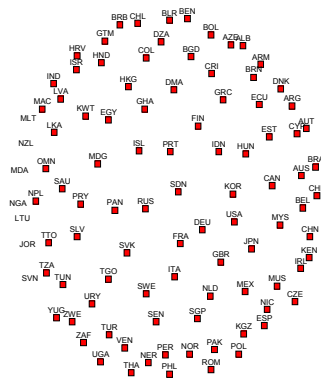

Figure 4.4: MDS-based visualization of gross trade flows between 100 countries, excluding the 8278 edges that represent bilateral gross trade

So far we have looked at visualizations of relations among individual actors, noting that the interpretability of such visualizations tend to decrease as the number of actors increase. For datasets containing large number of actors, visualizations are instead often done between *sets* of actors, i.e. where each node in the sociogram/graph represents a set of several actors. These types of visualizations, often referred to as “reduced graphs”, are often found in role-analysis, i.e. where actors are categorized according to the different structural roles they play in a network.⁷⁸ Reduced graphs are equally often used to depict relations among other types of actor subsets, whatever the criteria for forming such subsets. As noted above, if we were to visualize gross trade flows between each and every country of the world, the resulting MDS-derived sociogram is indeed quite distorted and non-representative of the data. However, if we were to create subsets of nations, for instance based on the world regions they belong to, we would only have a handful of nodes in our reduced graph. In Figure 4.5 below, 100 countries of the world are grouped according to world regions, where the coordinates of the nodes-as-regions are established through a MDS of the gross trade flows between each pair of regions.

Based on relational data between 7 nodes-as-actor-subsets, the MDS-derived reduced graph below has a Kruskal stress index of 0.21, far better than the 0.41 stress index we arrived at when dealing with the 100 nodes-as-actors. As was the case in our school children example (Figure 4.3), the nodal coordinates in Figure 4.5 are calculated so that there is an (inverse) relation between structural value and Euclidean distances between relating actors. If we were to visualize the network in three dimensions, the Kruskal stress index would fall further to 0.11, albeit without revealing any significant improvements from the two-dimensional mapping in Figure 4.5 below.

In reduced graphs, whatever the criteria for determining subset membership, the idea of self-ties suddenly make sense, in our example representing the total values of intra-continental trade. In Figure 4.5 below, gross trade among the 18 countries belonging to the EUD group surpasses any other inter- or intra-continental trade flows. Furthermore, it can be noted that EUD, ASI and NAM are the only continents whose internal trade are larger than the gross trade of any of these continents with other continents. Looking at LAT, EUE and AFR, we note the contrary: that these regions have more trade with some other region(s) than they have internally, which in the case of EUD and EUE reflects the substantial findings by Puga

⁷⁶ In combination with a heuristic called ‘hierarchical clustering’, MDS can quite often be fruitfully applied to the analysis of role-structures, even when the analyzed networks consist of a large number of actors, this being due to the fact that role-equivalence matrices are more “Euclidean” in nature. Role-analysis combined with MDS will be briefly presented in the next chapter.

⁷⁷ MDS visualization of processed trade data by square-rooting all bilateral flows also results in a similarly uninterpretable layout with a Kruskal stress index of 0.40.

⁷⁸ Role-analysis will be presented in the next chapter.

and Venables (1997), and which in general reflects the general core-periphery definition provided by Meier and Baldwin (1957) (see previous chapter). While these observations on continental trade flows are interesting per se, there is especially one important observation that can be done from Figure 4.5: MDS-based reduced graphs most often allow for intuitive and interpretative visualizations of very large datasets which in matrix form would be far more difficult to interpret for the human mind.⁷⁹

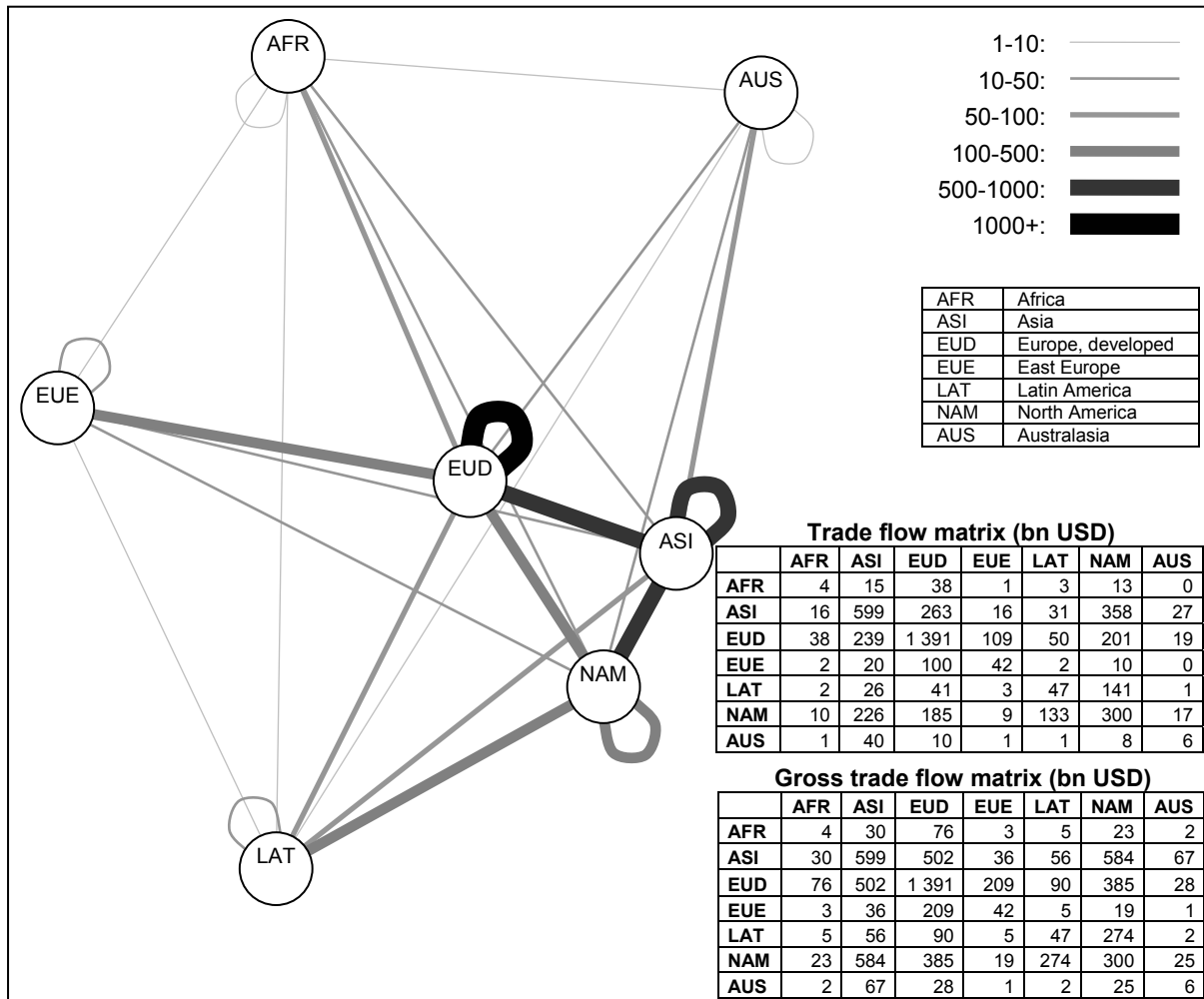

Figure 4.5: MDS-based visualization of gross trade value flows between 7 geographic regions of the world (Kruskal stress index: 0.21)

Of the three major set of tools in SNA, we now turn to centrality identification and role-analysis. Clique/subgroup detection, the third major toolbox in SNA, is left out from the empirical chapters that follow, thus not being presented further in this thesis.⁸⁰

Centrality analysis

The study of network centrality, in economic geography as well as within SNA, has its intellectual roots in mathematical graph theory and the exploratory work done by Bavelas and Leavitt in the 1950's. Although the concept of "centrality" often is intuitively treated as

⁷⁹ A possible extension of a reduced graph would be through recursion: where the subsets of actors represented by each node are visualized separately *within* their respective subset-node, a heuristic which I hope to present in a forthcoming paper.

⁸⁰ For more on clique/subgroup analysis, see Knoke and Kuklinski (1982:56-58), Wasserman and Faust (1994:249-290) or any other standard textbook on social network analysis.

something universal, the property to be “central” in networks does indeed come in a variety of flavors, such as “(potential for) autonomy, control, risk, exposure, influence, belongingness, brokerage, independence, power and so on” (Borgatti and Everett 2006:467). A number of such varieties will be examined as follows.

Degree centrality is the simplest form of centrality index for actors in networks. Formally defined by Freeman (1979), the degree of a node is equal to the number of edges that are connected to the node in question. In our school children example (Figure 4.1 above), pupil E and B both have a degree of 3, thus, according to the degree measure of centrality, being more central than pupils A and F which degrees 2 and 1 respectively. For valued data, the degree of an actor is either the sum of all relational values that connect to the actor, or the number of connecting relations that are above a specific cutoff value. In Figure 4.2(a), A has a degree of 9, compared to the degree of 24 for B. Dichotomizing this network (Figure 4.2(b)) results in actor B having a degree centrality of 3 while each other only having degree centralities of 1.⁸¹

For directional data, both an indegree and an outdegree can be established for each actor, representing the number of inbound and outbound relations respectively. Directional data also allow us to introduce the concepts of net degrees and gross degrees, representing the difference and the sum, respectively, of indegrees and outdegrees. In sociomatrix form, we can calculate actor degrees by looking at the row and column vectors⁸² for each actor. For directional data, the outdegree of an actor is equal to the sum of its row vector, while the indegree is equal to the sum of its column vector, in both cases usually excluding a would-be self-tie. For symmetric data, these two sums are equal. Dealing with trade flow matrices, the sum of a column vector represents the total imports of the column actor, while the sum of a row vector is equal to its total exports.

As degree centrality only takes account of the relations that are connected directly to an actor, there are several occasions when the intuitive notion of centrality is non-related to the number of direct relations. In Figure 4.6 below, actors 1 and 3 both have (non-normalized) degrees of 3, but the former does nevertheless seem to be more central than the latter.

There are a handful of centrality indices that take account of indirect as well as direct ties to the actors. Garrison’s “accessibility index” (see chapter 3) does exactly this when measuring how central different urban centres on the US Interstate Highway system is. To reiterate the procedure: first, the distances, i.e. the length of the shortest path between all pair of nodes are calculated. The accessibility index for each node is then calculated by adding all such distances involving the node. Being an indicator on how close an actor is to the other actors, this centrality index is referred to as *Closeness* in SNA, formalized by Freeman in his 1979 article. In Figure 4.6, actor 1 is indeed ranked as having the highest “closeness centrality” in the network, independent from the fact that its degree centrality is only half that of actor 2.

⁸¹ For comparison reasons, the degree centrality measures are often normalized by dividing the degree of each node with the total number of possible connected edges $N-1$, where N is the number of nodes in the network (Wasserman and Faust 1994:178ff). The normalized degrees for the school pupils and continental trade examples are obtained by dividing the indices with 5 and 6, respectively. For simplicity, I only present non-normalized measures in this presentation of centrality indices.

⁸² A row vector is a “horizontal slice” in a matrix while the column vector is a vertical one. For instance, the row vector (being identical to the column vector for symmetric data) for actor E in Figure 4.2(a) is [0,9,3,2,-,0], its (non-normalized) degree thus being 14. The column vector for LAT in the trade flow matrix in Figure 4.5 is [3,31,50,2,47,133,1], the (non-normalized) indegree being 219, thus excluding the Latin American intra-continental flows of 47 bn USD.

In Garrison's 1960 study, a version of the above – the Shimbel-Katz accessibility index – was also applied to the Interstate Highway system. Usually referred to as *Influence* in SNA terminology, this index weights the nodal-pair distances in the Closeness index according to path length: putting a premium on shorter path lengths, long path lengths result in a lower influence index for the actor. The actual penalty to be put on longer path lengths is decided by the analyst by choosing a suitable attenuation factor for the calculation process, this factor deciding the “fall-off importance” of longer paths in the network. Contrary to Closeness, the Influence index works fine with both directed and valued data as input – though including an arbitrariness when selecting and motivating a specific attenuation factor for the calculation procedure.

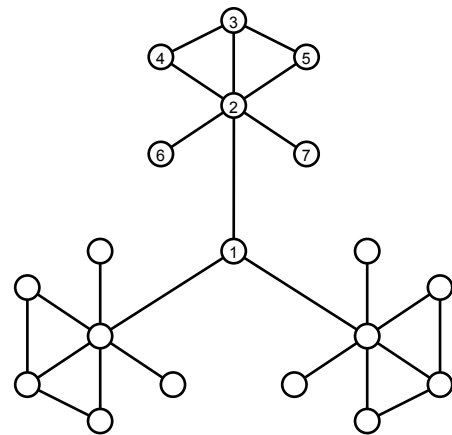

Figure 4.6: Example network for demonstrating centrality indices

The *Betweenness* centrality index is principally similar to the Closeness and Influence indices as it deals with the shortest paths connecting pairs of actors in a network. However, instead of focusing on the actors at the endpoints of such shortest paths, *Betweenness* is concerned with the actors in-between: actors that are placed on the shortest paths between other pairs of actors thus end up having a large betweenness centrality ranking. In Figure 4.6 above, actor 1 has a very high *Betweenness* ranking as every shortest-path between actors located in different subgroups must pass through actor 1. Although the betweenness centrality index was formalized to a SNA setting by Freeman in 1979, its origins are to be found in the works by Shimbel and Shaw in the 1950's (Wasserman and Faust 1994:189ff).⁸³

Degree, Closeness and Betweenness represent three different types of centrality indices (Hanneman and Riddle 2005; Borgatti and Everett 2006), each implementing a specific meaning of centrality in social networks. Although the lack of a common, unifying notion of centrality can be problematic for a network analyst, the more probable that the analyst can find a centrality index that suits the analyst's particular sociological meaning of the concept of being “central”:

A network analyst's choice among various indices...is not a simple decision, but can be revealed only after careful consideration of the conceptual, substantive, and empirical features at hand. [...] Because the grounds for index usage constantly change across situations, we can offer no universal rules for choice, but only counsel the network analyst to proceed only after thorough investigation of the implications of using alternative measures. (Knoke and Kuklinski 1982:55ff)

As each centrality index gives different results on a given dataset, the network researcher could very well be tempted to choose a centrality index that yields the most sought-after results, using this specific index as representing some general notion of “centrality”. While the choice of index should be based on theoretical and substantive aspects, a choice

⁸³ While betweenness is best suited for dichotomous data, flow betweenness was developed explicitly for valued directional data, particularly trade flow data. Often wrongly attributed to Freeman et al (1991), the original development and definition of flow betweenness is to be found in an earlier conference paper by Douglas White (1988), a paper which undoubtedly formed the basis for Freeman et al (1991). Although White's original intention with the heuristic was to measure centrality in trade flow matrices, flow betweenness in Freeman et al (1991) and Borgatti and Everett (2006) was reframed as a heuristic deemed as suitable for information flows rather than trade flows.

preferably done *prior* to the actual analysis, the analyst may however very well test different indices on the same dataset. My point here is not that only a singular centrality index may be applied on a dataset – on the contrary. My point is instead that each centrality index implies different conceptualizations of “centrality”, each requiring their own specific interpretations for the actors in a network.

Conceptions must not only precede measurements, conceptions must also decide the *choice* of method for measurements. What, then, are the empirical and conceptual features of international trade data?

The structural datasets analyzed in this thesis consist of bilateral trade flows between sets of up to 100 countries. The data is directional and valued, representing the exchange values and quantities of each flow.⁸⁴ The datasets are quite dense: for total trade among our 100 actors, there exists 8,278 trade linkages out of a total of 9900 possible, meaning that the (non-zero) density for the total trade flow network is 84 percent. Compared to the (non-zero) density of 47 percent for our school children example, the total trade network is indeed quite dense.⁸⁵

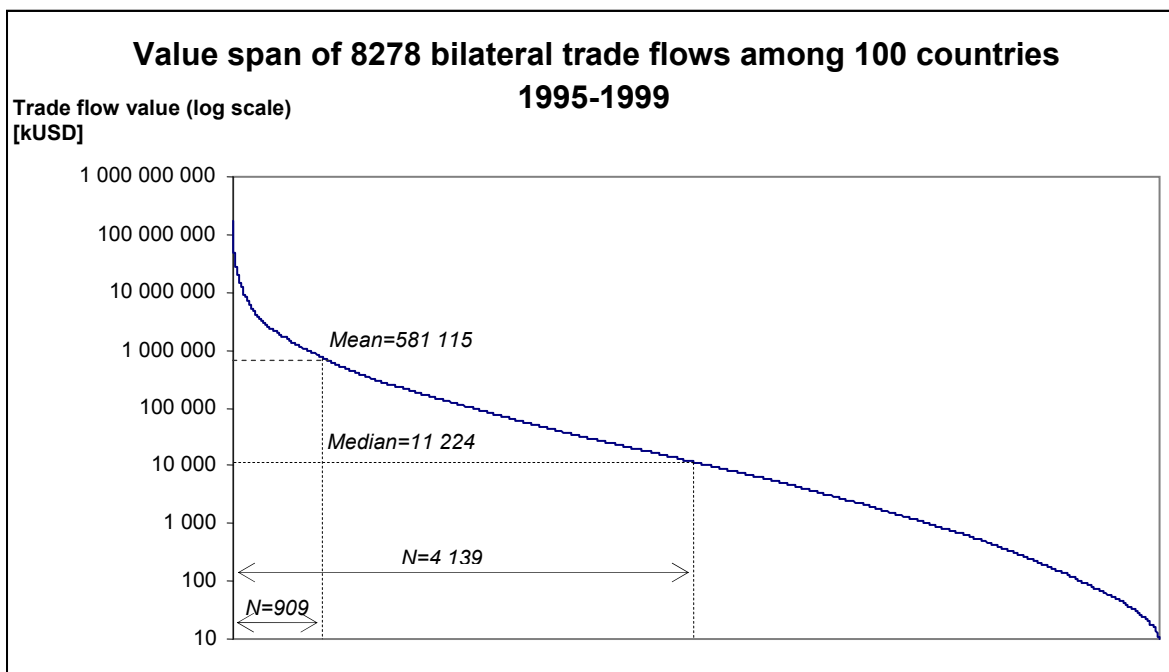

Figure 4.7: The 8 278 bilateral trade flows (all commodities) sorted by value (1000's of USD) along a logarithmic scale. (N=number of trade flows)

The trade network data is not only very dense but the relational values, i.e. the individual bilateral trade flows, span over very large magnitudes. For the dataset containing total commodity trade, the largest flow is valued at 171 bn USD (from Canada to USA), this flow being twice as large as the fourth largest flow (from Mexico to USA). The mean bilateral flow is valued at 581 million USD, more than 40 times the (non-zero) median flow value of

⁸⁴ The particular trade flow data given as examples in this chapter are with respect to total trade flows between countries, i.e. the “Total Commodities” commodity selection in the Comtrade database. A more detailed specification of the dataset used throughout this thesis can be found in the Appendix.

⁸⁵ The density Δ of a directional network containing e actors is $L / e \cdot (e-1)$, where L is the number of existing relations, and where $e \cdot (e-1)$ is the total possible number of directional relations that can exist. For a non-directional (symmetrical) network, the density is $2 \cdot L / e \cdot (e-1)$.

11 million USD. Even when plotting the sorted bilateral trade flows on a log-scale (Figure 4.7 above), the enormous span of magnitudes among bilateral trade flows can be noted.

With these substantive and empirical features in mind, let us now turn to the different centrality indices presented earlier, looking at the possibilities, meanings and implications of their usage. To begin with, we note that centrality indices often are designed for dichotomous data (Wasserman and Faust 1994:169; Knoke and Kuklinski 1982:52). Thus, in order to calculate the standard measures of degree, closeness, and betweenness for the 100 nations, we must first convert the valued data into binary form. Using a global cutoff value to dichotomize the data, similar to what we did for the school children's spare-time (Figure 4.2), does however have severe implications for analyses based on such dichotomized data. If we were to use the mean flow value as a cutoff, we would only end up with the 909 largest trade flows, in effect ignoring 89 percent of the bilateral trade flows of the world. A dichotomization using the mean value as cutoff would thus exclude all trade flows from and to small and/or undeveloped countries, giving the impression that these countries are all not only non-central but in fact isolated from world trade. If we instead were to use the median value as the cutoff in the dichotomization of the valued trade data above, half of the trade flows would remain for subsequent centrality analyses. The same problem would though remain: while total imports to USA from 93 countries exceed the median value of 11 million USD, only 3 of the trade flows from Dominica's 45 trading partners exceed this value.

To dichotomize trade flow data based on a common absolute value, wherever one chooses to cut the cake, does have profound consequences for centrality analyses derived from such dichotomized trade data. As dichotomization using a global (network-wide) cutoff value results in a disregarding of trade data for countries trading smaller volumes, whether by country size or level of integration in the global economy, centrality analyses on such dichotomized trade data would inevitably favor countries with larger trade volumes – whether by country size or level of integration. The fundamental problem with dichotomization using a global cutoff value is an assumption on egalitarianism. For the school children spending time with each other, dichotomization was done on the assumption that they each had an equal allotment of “resources” (off-school hours) to spend among friends. Under this assumption, we can further assume that there is a consensus among all pupils on the quantity of hours that is to be deemed as significant. Assuming a similar situation in the network of world trade would be more than misleading as the concept of a significant trade flows literally depends on point of view. For instance, while the bilateral trade flow from USA to Mexico constitutes 76 percent of Mexico total imports, this flow only represents 12 percent of US exports. Similarly, while total trade from Mexico to USA constitute 83 percent of Mexican exports, this very same flow only amounts to 10 percent of US imports. Although lending strong support to the notion of a central set of core countries among a larger set of non-central peripheral countries, centrality analyses done on dichotomized trade flow values would be inherently flawed and misleading due to the nullification of the relative significances of individual flows.

Similar to Closeness and Betweenness, the standard version of Degree centrality is concerned with binary data. The “dichotomizing dilemma” above is just as present for the standard Degree centrality index, for our trade flow dataset resulting in that high-volume traders are deemed to be more central than smaller countries with less absolute volumes crossing their borders. To calculate Degree centrality indices for our set of 100 countries, using an arbitrary cutoff value, would thus only emphasize what we already know tautologically: large

economies, such as USA, Japan and China, have many large-volume trade connections with other countries as they trade with large volumes.

Applying a cutoff value of 50 bn USD on the inter-continental gross trade flows (Figure 4.5), followed by a degree centrality calculation, we end up with the centrality indices for each continent as given in Figure 4.8. According to this centrality index, developed Europe (EUD) is the most central of the continents, followed by Asia, and with the American continents on a shared third place. The three remaining continents all have a centrality index of unity, i.e. only having a single connection to another continent. Although partly reflecting an intuitive understanding on geographical locations of cores and peripheries of the world, the dichotomization problem for valued data is present here as well. With Australasia (AUS) and North America (NAM) only containing two countries each, their combined trade flows with other continents are naturally of a lesser magnitude than the combined trade of the 18 countries contained in the EUD actor.

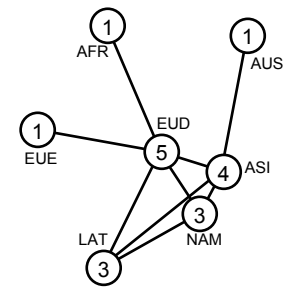

Figure 4.8: Degree indices for gross continental flows (cutoff: 50 bn USD)

Theoretical conceptualizations

While substantial and empirical aspects of the trade data put constraints on the usability of certain centrality indices, we now turn to the more fundamental issue regarding theoretical considerations, to see what the concept of centrality could mean with respect to world trade.

Ever since its genesis, economic exchange theory has built on an assumption that trade may be freely conducted between any pair of nations (see Chapter 2). This assumption is present in the Heckscher-Ohlin model of international trade: as trade occurs due to comparative cost advantages based on different factor endowments, trade should thus indeed be global, integrating all nations and populations of the world. However, as can be seen with regards to contemporary inter-continental trade (Figure 4.5), trade is not evenly spread across the world, neither geographically nor demographically. Instead, the majority of trade occurs within a tightly knit set of countries that share similar factor endowments and comparative cost advantages, where non-core countries have their major trade flows with core regions.

Whether being a cause or an effect of the mechanisms of the global market, there is a notion of centrality that indeed has bearings on economic exchange theory:

A large buyer may often squeeze a dependant supplier, but as long as the supplier has alternative outlets there are limits to the extent of the squeeze. [...] The real problem for the small country is to maintain the possibility of alternative markets. (Condliffe 1950:816)

Condliffe's remark, the Leontief paradox and the patterns of inter-continental trade all seem to be compatible with the structural-analytical perspectives presented in chapter 3. The Galtung typology (Figure 3.3) and general hub-and-spoke structures (Figure 3.2) underline the role of structures and a general intuitive notion of centrality. Applying the three types of centrality indices on these two typological (dichotomous) networks, as well as on the inter-continental trade example (Figure 4.5), all indicate that the core actor(s) in each of these are vastly more central than the spokes and peripheries. The latter have no "alternative outlets", lacking the "possibility of alternative markets" (Condliffe 1950:816) which the former indeed have.

With respect to the observed density of the network of world trade, where 84 percent of trade relations between all pairs of nations actually exist, the assumption on interconnectedness in Heckscher-Ohlin does at first glance seem to hold true. With only a fraction of links missing for the network of total commodity trade to resemble a “total graph” (i.e. where each possible pair of actors are connected), there thus seems to be freedom of transactional interaction among the countries of the contemporary world, a world of inter-connectedness where there are very few, if any, occurrences of structural advantage.⁸⁶

If the criterion for free trade is the mere existence of trading relations, the world economy indeed reflects a Walrasian all-with-all structure. However, such an argument must build on the fallacy of the “dichotomization dilemma”. Assuming that any flow, whether valued at 1 trillion or 10,000 USD, is indicative of transactional freedom does indeed ignore the vast span of values: the differences in the volumes of inter-continental trade (Figure 4.5) are only nullified if we choose to equate all existing trade flows, i.e. dichotomizing with a cutoff value larger than zero. Looking at the distribution of flow values (Figure 4.7), at the same time bearing in mind the highly integrated state of global production (chapter 6), it would rather be somewhat surprising if the density of the world trade network was lower than it actually is.

It is however difficult to theoretically explain the high (non-zero) density of total commodity world trade from a Heckscher-Ohlin framework. Even when ignoring transaction costs, as is done in the Heckscher-Ohlin model, it would be hard to conceive of a world where so many nations have so many unique combinations of factors of productions to explain the existence of so many trading relations. Even if we extend the model beyond the two standard factors of production – labor and capital – it would still be difficult even to simulate a world economy containing so many unique pair-wise comparative cost situations that would result in 84 percent of all possible trade relations to actually exist, not to mention how a would-be introduction of transaction costs into such a simulation would undermine many of these comparative cost advantages from turning into actual trading relations.

A better explanation is perhaps best found in the genesis of the theory-wary economic geography. Chisholm, among others, viewed world trade arising out of geographical differentiation and biophysical advantages (see Chapter 3). Combined with economies of scale⁸⁷ and product specialization in the primary as well as secondary sectors, as well as the possible effects of comparative cost advantages, this could perhaps better explain the factual mesh of bilateral trade flows across the globe than what the Heckscher-Ohlin model by itself can explain. The trading profiles of different countries would then not be due to comparative costs alone, but mainly due to geographical conditions, natural resource endowments, and path-dependent economies of scale, factors which explain the high non-zero density of the world trade network.

If we are to examine the theoretical validity of Galtung’s typology and the occurrences of global hubs-and-spokes, addressing “the extent of the squeeze” for non-central actors, we thus, once again, face the dilemma of dichotomization and its egalitarian assumption. If we reasonably can assume that all actors in a network have the same amount of “relational resources” to distribute among its partners, “significance” could be defined globally across

⁸⁶ In their article on structural autonomy in world trade of commodities, Sacks et al (2001) equate the significance of all non-zero trade relation between pairs of countries whatever the volumes of these trade flows may be.

⁸⁷ Referring here especially to the specialization effects of scale-economies as presented in chapter three in the book by Bertil Ohlin (1933) (see chapter 2)

the network, making it possible to estimate the number of significant trading partners each actor has. However, with not only the sizes of countries but also their levels of economic development and world-market integration differing so much, it would be ludicrous to assume that there is a general agreement on what constitute a significant flow in absolute terms. Instead of trying to find such a globally agreed-upon definition of what constitute a significant flow, I have instead chosen to develop a heuristic that defines significance on a per-actor basis.

In what follows, a centrality index will be presented, developed explicitly at the theoretical, substantial and empirical question at hand. Aimed at representing a centrality concept with its basis in the theoretical discussions on trade, alternate markets and exchange structures (Chapter 2 and 3), the heuristic presented below have also been developed to encounter the dichotomization dilemma facing the majority of standard centrality indices when dealing with valued datasets containing large value spans. The index will be exemplified using the inter-continental trade flows⁸⁸ previously presented (Figure 4.5): although the proposed heuristic will be applied to bilateral trade flow data in later chapters, it should indeed be applicable to any structural datasets for measuring centrality as conceptualized in this context.

Balanced Distribution Deviation (BDD) index

Whether a specific relational value between a pair of actors is significant or not depends literally on point of view: as previously noted, the trade flows from Mexico to USA constitute 83 percent of the total exports of the former, while only representing 10 percent of total imports for the latter. Visualizing the previously used inter-continental data as a 3-dimensional bar chart (Figure 4.9 below), we note a similar situation, for instance regarding the trade flow from developed Europe (EUD) to East Europe (EUE). Valued at 109 bn USD, this flow represents 78 percent of total imports to EUE, while only representing 17 percent of total exports from EUD. As a specific significant flow for one partner indeed might be insignificant for the other, we are well advised to define significance on a per-actor basis.

Having calculated the total import and export vectors for each actor, we can normalize these trading vectors, converting each individual flow into its percentual share of the total imports and exports, respectively, for each actor. In Figure 4.10 below, these marginal-normalized import and export vectors are shown, this time however sorted according to percentual share of total imports and exports. As can be seen in Figure 4.10, total imports to Eastern Europe (EUE) from developed Europe (EUD) corresponds to 78 percent of total imports to EUE, while this very same flow only accounts for 17 percent of total exports from EUD.

⁸⁸ There are two reasons for using the inter-continental, rather than inter-national, trade flows to exemplify the centrality indices proposed in this chapter. First, using a network with only a handful of actors is more pedagogically than using a network with 100 actors. Secondly, the inter-continental dataset constitute a complete system – using a small selection of nations to exemplify the heuristics would not constitute a complete system, thus generating misleading results, especially due to the high density of the inter-national trade flow network.

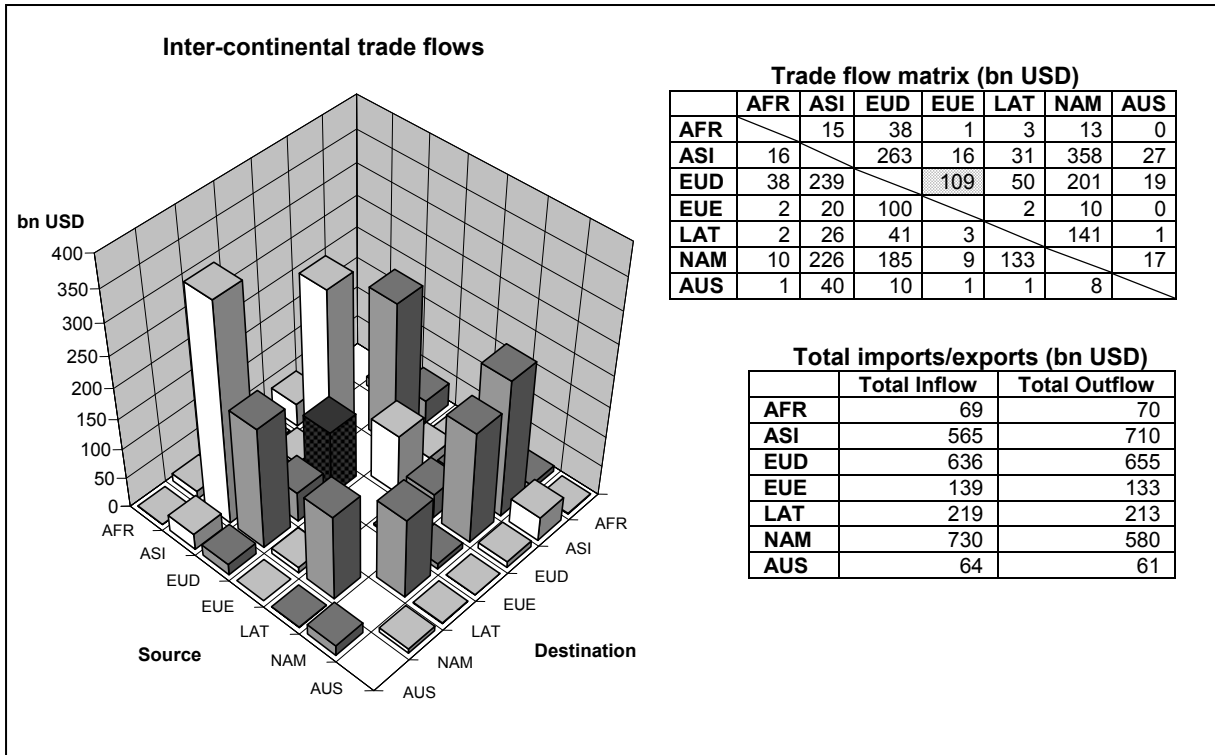

Figure 4.9: Three-dimensional matrix visualization of inter-continental trade flows and total continental imports/exports. The chequered bar is the trade flow from EUD to EUE.

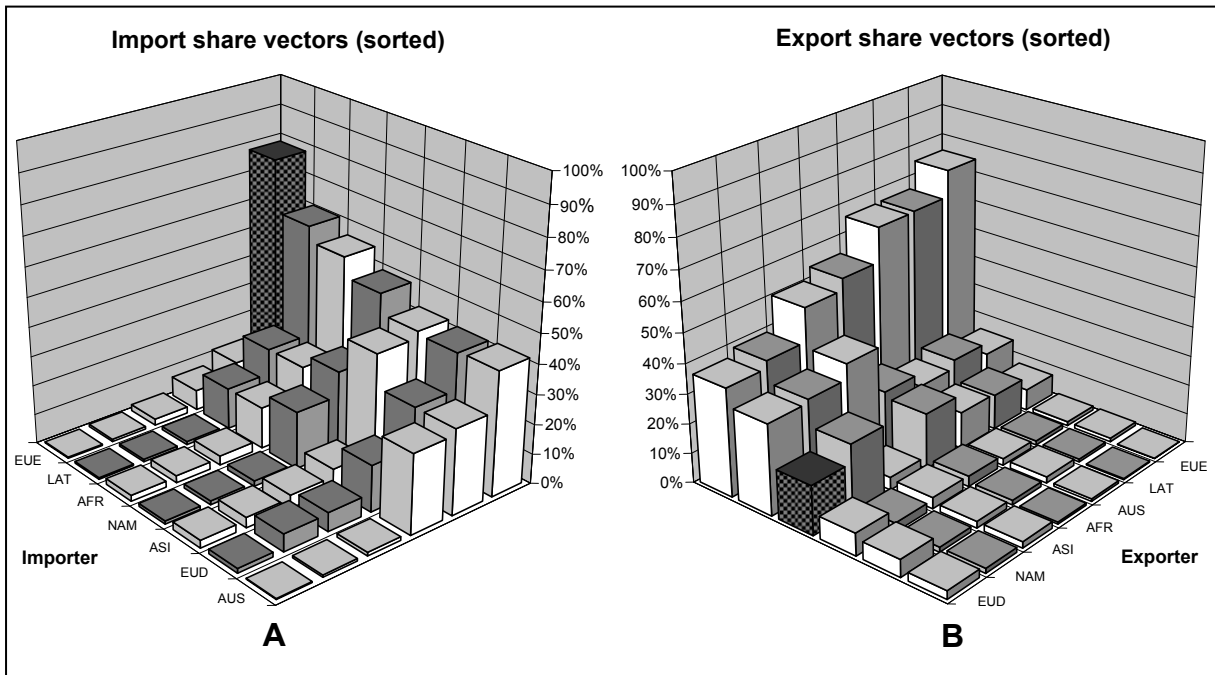

Figure 4.10: Inter-continental import vectors (A) and export vectors (B) as shares of total imports and exports. The chequered bars represent the trade flow from EUD to EUE.

These share vectors for imports and exports reveals an interesting phenomena regarding the distribution of trade among partners. The imports of EUE, LAT and AFR are relatively concentrated, with the majority of their respective total imports having singular origins. Their second largest inflows are less than half than that from their primary import sources, this being in contrast with the import vectors for the other four continents. The same phenomena can be noted in Figure 4.10(B): the export profiles for EUD, NAM and ASI seem to be

“flatter” than the export-concentration “spikes” for AUS, LAT and, especially, EUE. Judging by Figure 4.10, an intuitive difference between trade partner concentrations seems to be the case among our seven actors-as-continent. Independently from the differences in total trade volumes, row and column marginal normalization of trade flow matrices thus allows for the identification of “significant” trade flows from an actor-based perspective.

What, then, would an ideal distribution of imports and exports look like? If we assume that the total in- and outflows for each actor are of the same magnitude, an optimal distribution in Figure 4.10 would then translate into bars of equal height – in this case 16 percent. However, part of the reason why Mexican exports to USA represent a much larger share than Mexican exports to Honduras is, of course, that the former partner constitutes a much larger economic actor than the latter partner. Similarly, resorting to the inter-continental trade flow example, it can be noted that the value span of continental imports and exports is very large: imports to NAM are more than 10 times the exports from AFR. It would thus be theoretically impossible for NAM to have an evenly distributed import vector as it would imply imports of 117 bn USD, i.e. a sixth of total imports to NAM, from each continent, thus exceeding the total exports from AFR of 70 bn USD. Instead of assuming equal importance of actors in a network, the Balanced Distribution Discrepancy (BDD) index presented below takes these differences into account.

As above, we begin by calculating the percentual shares of trade flows with the potential partners of each actor. Demonstrating this heuristic with the export profile of the African continent, the first two lines in Table 4.1 below depict the absolute value and the percentual shares of African exports to all other actors. We then look at the total imports for each of these possible partners (Table 4.1, 3rd line). Using the sum of these total imports, i.e. excluding Africa’s own total import, we arrive at an average import share vector (4th line) whose percentages are slightly higher than if Africa were to be included in the total imports.⁸⁹

	ASI	EUD	EUE	LAT	NAM	AUS	Sum
AFR Exports	14 590 515	38 006 272	1 130 260	2 508 126	13 282 277	499 368	70 016 818
% of total	21%	54%	2%	4%	19%	1%	100%
Total imports	565 403 081	635 833 310	139 065 091	218 890 503	729 926 539	64 129 755	2 353 248 279
% of total	24%	27%	6%	9%	31%	3%	100%
Discrepancy	-3%	27%	-4%	-6%	-12%	-2%	

Table 4.1: Comparing the export vector of Africa with the total imports for Africa’s potential partners

If the exports from Africa to each other continent were to be proportional to the total imports of these potential partners, i.e. a balanced distribution of its exports, the normalized export vector of AFR (line 2) would be identical to the average import share vector of the potential partners to AFR (line 4). That is, instead of assuming that the export of AFR are evenly divided among potential partners in an absolute sense, a balanced distribution of exports is instead defined as reflecting the total imports of potential partners to AFR. The deviation between the balanced distribution (from the point of view of AFR) and the actual distribution of trade flows from AFR can be found on line 5 in Table 4.1. Interpreting line 5, we note that exports from AFR to EUD are 27 percent larger than what would be the case if African exports were proportional to total imports of its potential partners. We further note that the

⁸⁹ As self-ties are not relevant for the analyses that follows, I have chosen to discard such in this presentation. However, the proposed heuristic could just as well be applied to networks with self-ties, for instance the continental trade flow data that includes intra-continental trade (Figure 4.5): in such applications, the average share vector (line 4 in Table 4.1, and the “Balanced” lines in Table 4.2 and Table 4.3) would include all actors in the network, thus making the average share vector identical for all actors when calculating BDD indices.

share of African exports to North America is 12 percent below the share of the total, network-wide imports to NAM.

As the set of percentual deviations in line 5 have a mean value of zero, as well as a sum of zero, we can calculate a measure of overall deviation from the balanced distribution by measuring the standard deviation of these values, resulting in a BDD_{Export} index of 0.138 for AFR. Repeating the above procedure for imports as well as exports for each actor, calculating an average share vector for the partners of each actor, we end up with BDD indices given in the right-hand column of Table 4.2 (exports) and Table 4.3 (imports).

Once import and export BDD indices for each actor have been established, a scatterplot can be created using the import and export indices as coordinates. Such a scatterplot for our continental example can be found in Figure 4.11 below. With the exception of Australia, BDD indices for imports and exports are fairly similar for each actor. Australia, while having a fairly balanced import vector, has an export vector whose partner concentration is only superseded by Eastern Europe (EUE): the exports from Africa and Latin America are actually better distributed among world importers than what is the case for Australia.

		Export partner shares (percentages)							
		AFR	ASI	EUD	EUE	LAT	NAM	AUS	BDD_{Export}^*
AFR	<i>Actual</i>		21	54	2	4	19	1	
	<i>Balanced</i>		24	27	6	9	31	3	
	<i>Discrepancy</i>		-3	27	-4	-6	-12	-2	0.138
ASI	<i>Actual</i>	2		37	2	4	50	4	
	<i>Balanced</i>	4		34	7	12	39	3	
	<i>Discrepancy</i>	-2		3	-5	-7	11	0	0.066
EUD	<i>Actual</i>	6	36		17	8	31	3	
	<i>Balanced</i>	4	32		8	12	41	4	
	<i>Discrepancy</i>	2	5		9	-5	-10	-1	0.068
EUE	<i>Actual</i>	1	15	75		1	7	0	
	<i>Balanced</i>	3	25	28		10	32	3	
	<i>Discrepancy</i>	-2	-10	47		-8	-25	-3	0.245
LAT	<i>Actual</i>	1	12	19	1		66	0	
	<i>Balanced</i>	3	26	29	6		33	3	
	<i>Discrepancy</i>	-2	-14	-10	-5		33	-3	0.168
NAM	<i>Actual</i>	2	39	32	2	23		3	
	<i>Balanced</i>	4	33	38	8	13		4	
	<i>Discrepancy</i>	-2	6	-6	-7	10		-1	0.065
AUS	<i>Actual</i>	2	66	16	1	2	13		
	<i>Balanced</i>	3	24	27	6	9	31		
	<i>Discrepancy</i>	-1	42	-11	-5	-7	-18		0.214

Table 4.2: Calculation of BDD_{Export} indices for inter-continental trade example.⁹⁰

*: Standard deviation of discrepancy values

⁹⁰ Due to one-digit rounding errors, the discrepancy values in Table 4.2 and Table 4.3 may differ from the differences between actual and balanced values.

		Import partner shares (percentages)						BDD _{Import} *	
		AFR	ASI	EUD	EUE	LAT	NAM		AUS
AFR	Actual		23	56	2	3	14	2	0.140
	Balanced		30	28	6	9	25	3	
	Discrepancy		-7	28	-3	-6	-11	-1	
ASI	Actual	3		42	4	5	40	7	0.055
	Balanced	4		38	8	12	34	4	
	Discrepancy	-2		4	-4	-8	6	4	
EUD	Actual	6	41		16	6	29	2	0.049
	Balanced	4	40		8	12	33	3	
	Discrepancy	2	1		8	-6	-4	-2	
EUE	Actual	1	12	78		2	7	0	0.255
	Balanced	3	31	29		9	25	3	
	Discrepancy	-2	-19	50		-7	-19	-2	
LAT	Actual	1	14	23	1		61	1	0.179
	Balanced	3	32	30	6		26	3	
	Discrepancy	-2	-18	-7	-5		34	-2	
NAM	Actual	2	49	27	1	19		1	0.075
	Balanced	4	39	36	7	12		3	
	Discrepancy	-2	10	-8	-6	8		-2	
AUS	Actual	1	42	29	0	1	27		0.070
	Balanced	3	30	28	6	9	25		
	Discrepancy	-2	12	1	-5	-8	2		

Table 4.3: Calculation of BDD_{Import} indices for inter-continental trade example.

*: Standard deviation of discrepancy values

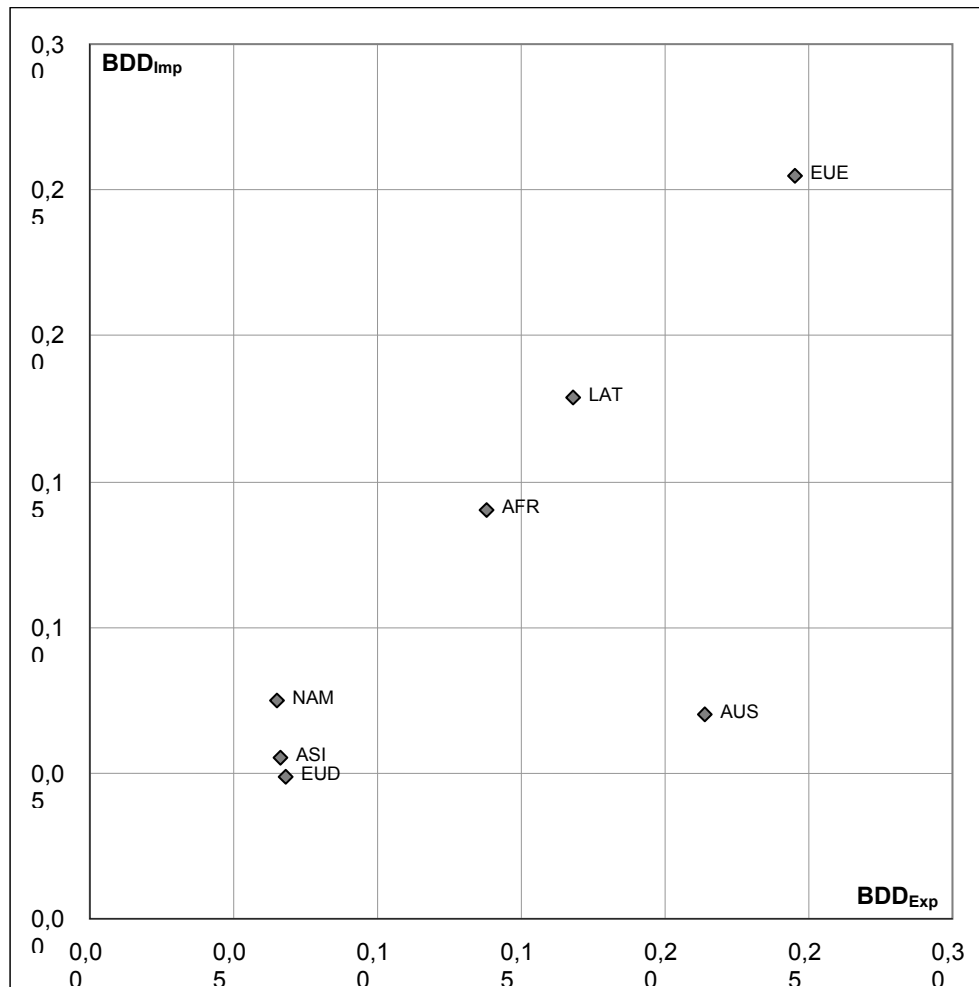

Figure 4.11: Scatterplot: BDD indices for inter-continental example.

From the scatterplot in Figure 4.11, a combination of import and export BDD indices can be conceptualized as the distance from the bottom-left origin. Calculating the distance from the origin to each country in Figure 4.11 yields a combined index (BDD_{Combo}) depicting overall distribution of exports as well as imports. Sorted by increasing BDD_{Combo} indices, the BDD-indices for seven continents are given in Table 4.4 below.

	BDD_{Export}	BDD_{Import}	BDD_{Combo}
EUD	0.068	0.049	0.084
ASI	0.066	0.055	0.086
NAM	0.065	0.075	0.099
AFR	0.138	0.140	0.197
AUS	0.214	0.070	0.225
LAT	0.168	0.179	0.245
EUE	0.245	0.255	0.354

Table 4.4: Balanced Distribution Discrepancy (BDD) indices for inter-continental exports and imports, sorted by increasing combined-BDD index.

The BDD index thus reflects the overall difference between the values of an actor's relations to its partners and the overall relational degrees of the partners in question. If the BDD index of an actor approaches zero, the relations of this actor reflect the overall, network-wide relations to the partners of the actor. Judging by Table 4.4 above, the import patterns of EUD is most similar to the export patterns of the other six continents in the dataset. For instance, with exports from ASI representing 40 percent of total world exports (excluding exports from EUD), EUD obtains 41 percent of its imports from ASI. Similarly, as NAM's exports constitute 33 percent of total world exports (excluding the contribution of EUD to world exports), 29 percent of imports to EUD has NAM as its source. By contrast, while 29 percent of total world trade originates from EUD (when excluding the contribution by EUE), a staggering 78 percent of imports to EUE originate from its developed counterpart, thus representing a huge discrepancy from the would-be balanced distribution of EUE imports. Thus, the Balanced Distribution Discrepancy index acknowledges the fact that different actors have different importance in a network, importance as reflected in different-sized contributions to total flows. A low BDD_{Import} index for NAM would thus not mean that its imports from AFR and ASI would be valued at 117 bn USD each, but instead valued at 28 and 281 bn USD respectively, reflecting the respective shares of AFR and ASI of the total, non-NAM exports in the network at large.

A somewhat more stylized and typological example of BDD indices can be found in Figure 4.12 below, these four figures depicting different scenarios and BDD indices for actor A in relation to 3 partner countries: B, C, and D. In Figure 4.12(a) and Figure 4.12(b), the total inflows to A (In_A) are equal to 2, while the total exports from B, C and D being equal to 5, 3, and 2, respectively, i.e. with a total export for all these partner countries (Out_{BCD}) at 10. In Figure 4.12, In_A is composed of inflows from B, C and D in proportion to the outflows of these potential partner countries, resulting in a BDD_{Import} -index for A equal to zero. For instance, with the outflows from B representing 50 percent of all outflows (excluding any would-be outflows from A), 50 percent of the inflows to A originates from B. In Figure 4.12(b), A obtains all its inflows from D, the total outflows of the latter only representing 20 percent of all outflows from the potential partners of A. This deviation from a balanced distribution of A's imports implies a (relatively) high BDD_{Import} index for A in Figure 4.12(b). Figure 4.12(c-d) demonstrate similar scenarios, this time instead looking at the outflows from A and how these are distributed among its potential partners in relation to their total inflows. Figure 4.12(c) depicts a BDD_{Export} index equal to zero, this being in contrast to Figure 4.12(d) where the BDD_{Export} index is relatively high.

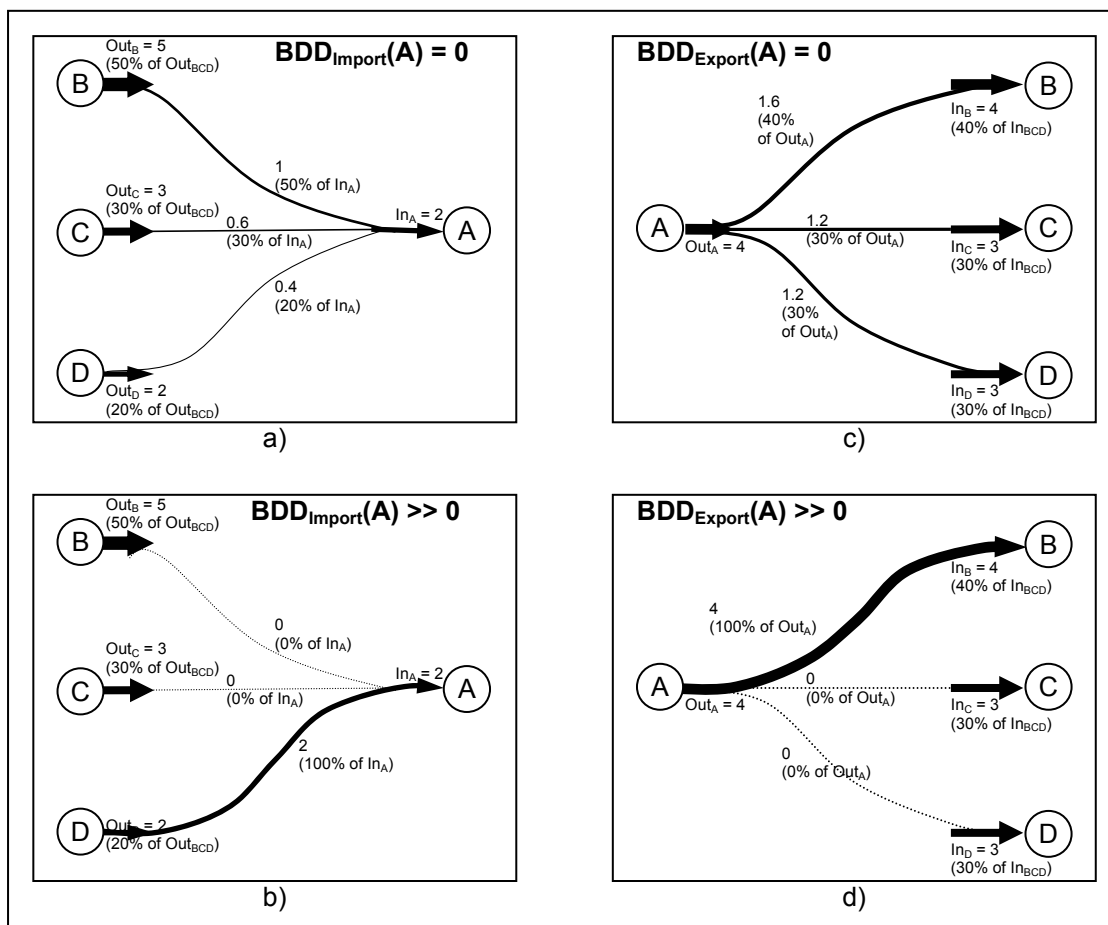

Figure 4.12: Exemplifying the usage of BDD indices for measuring centrality

Contrary to the standard set of centrality indices found in the SNA toolbox, the BDD index proposed above is without any egalitarian assumptions, forced upon the analysis through a system-wide dichotomization, instead focusing explicitly on differences in the prominence and overall importance of actors in a network. Developed in conjunction with the reasoning on economic exchange structures previously in this thesis (chapter 3), the BDD index is aimed at capturing the fundamental essence of “centrality” as conceptualized in a world-trade context: assuming the existence of a balanced Walras-style all-with-all exchange structure, the objective of the proposed index is to measure deviations from such ideal patterns. While the BDD index proposed above has to be tested, reviewed and, possible, altered before establishing its viability as a centrality index, the forthcoming empirical chapters will employ the BDD index – inbound and outbound – as a measure of centrality. However, as will become evident before that (in the final section of the next chapter), a fair bit of interpretational modesty is quite needed in current SNA-applications on contemporary international relations and world-system analysis. A more thorough interpretation of BDD-index results thus depends on the actual viability of using BDD-indices in general network analysis, and in this world-trade context in particular, a methodological test which I hope to conduct in forthcoming work.

CHAPTER 5

Social Network Analysis II: Role-analysis and structural world-system studies

Role analysis

Emerging from a series of articles in the 1970's, role-analysis is perhaps the best example of the analytical novelty of social network analysis. Similar to the rather vague notion of "centrality" in qualitative sociological writings, role-analysis in SNA provides formal definitions of the perhaps equally vague notion of "social roles". Occasionally seen as a possible foundation for a formal theory of social structure (White, Boorman and Breiger 1976:732; Snyder and Kick 1979:1103), it is a powerful set of tools which allow the researcher to obtain answers to certain questions that simply cannot be raised in the cross-comparative analytical tradition.

This chapter will present two strands of role analysis: structural equivalence as introduced by Lorrain and White (1971), followed by the more general concept of regular equivalence (White and Reitz 1983; 1985).⁹¹ Two datasets will be used to exemplify role-analysis: a slightly modified⁹² version of the Galtung typology (see chapter 3), and our previously studied dataset on inter-continental trade flows (chapter 4).

The chapter is rounded off by a critical examination of a handful of network-analytical studies of the contemporary world-system, studies in which the nations of the world are categorized in different world-system strata (or equivalent) based on role-analysis of different types of international relations. The three studies most often referred to – Snyder and Kick (1979), Nemeth and Smith (1985), and Smith and White (1992) – represent a chronological improvement in network method which has strengthened the analytical rigor in later studies which address the zonal stratification and systemic properties of the contemporary world-system (see especially Mahutga 2006). However, the actual relations *between* different *strata* of the world-system have either been ignored - or determined using fairly crude and outdated methods. Using a newly proposed heuristic for establishing such zonal relations (Nordlund 2007), it should be possible to analyze the actual structure of the world-economy without sacrificing the higher resolution that characterizes international trade statistics.

How, then, is the sociological concept of roles perceived through the lens of social network analysis? Two examples might serve as illustrations:

While two people may have direct connections to totally different individuals, the type of relations that they have with these others may, nevertheless, be similar. Two fathers, for example, will have different sets of children to whom they relate, but they might be expected to behave, in certain respects, in similar 'fatherly' ways towards them. [...] They occupy the same social position – that of 'father' – and so are interchangeable so far as the sociological analysis of fathers is concerned. (Scott 2000:123)

⁹¹ As the existing literature on role analysis is large, expanding further as the field constantly develops, the presentation in this subchapter is quite selective, aimed only at introducing the concept of role-analysis and the methods that will be applied in subsequent chapters of this thesis. More information on role-analysis in SNA can be found in Wasserman and Faust (1994:344-424), Scott (2000:123-145), Knoke and Kuklinski (1982:19ff, 59-86), among others.

⁹² In the original Galtung imperialist structure, relations between actors were symmetrical. However, as Regular Equivalence is typically only applicable to directional data, I have added directionality to the Galtung typology.

Actors occupying the same position [i.e. being role-equivalent] need not be in direct, or even indirect, contact with one another. For example, nurses in different hospitals occupy the position of “nurse” by virtue of similar kinds of relationships with doctors and patients, though individual nurses may not know each other, work with the same doctors, or see the same patients. (Wasserman and Faust 1994:348ff)

Role-analytical methods identify different roles in a network based on the actually existing patterns of relations among its actor. Rather than assuming that doctors, nurses and administrative staff have specific roles based on their occupational titles, role-analytical methods are concerned with finding the different types of roles that exist in a network, classifying the actors in accordance to these roles, and subsequently identifying relational patterns between these sets of role-equivalent actors. Thus, while an organizational chart of a hospital could be ideal, typological, or formal, the analysis of relational patterns could indeed reveal that a janitor may play a more crucial role in a hospital than what a golf-loving doctor might do.

Structural equivalence

Structural equivalence was the first formal concept for role-analysis. Introduced by Lorrain and White (1971), the definition of structurally equivalent actors is that they have identical relations to all other actors (including each other). In sociomatrix form, this implies that structurally equivalent actors all have identical vectors (both row and column vectors), thus being equivalent and analytically interchangeable with each other. A group of actors sharing the same structural role in a network is called a position in SNA terminology.

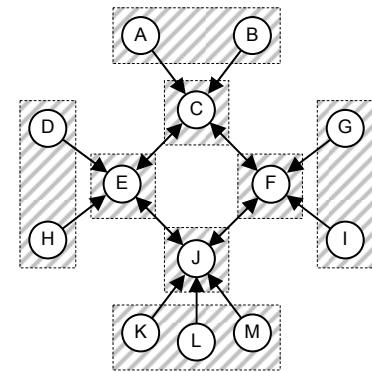

Figure 5.1: The modified Galtung typology with its 8 positions of structurally equivalent actors.

While intuition most probably would suggest the existence of two types of roles in the Galtung typology, the strict definition of structural equivalence actually results in 8 positions (Figure 5.1). The four “peripheral branches” contain actors that fulfill this strict definition, i.e. having identical inbound and outbound ties to other actors, these being the only positions containing more than one actor. Although all peripheral actors have singular connections to a core actor, their respective core actor is not the same, just as the core actors have relations with different peripheral actors, resulting in core actors not being structurally equivalent according to the strict definition.

As real-world data seldom have actors that conform to the strict definition of role equivalence, it is more fruitful to measure to what degree the chosen formal definition is fulfilled for pairs of actors. The most common of such measures is to calculate the correlation coefficient between the column and row vectors between each pair of two actors.⁹³ These pair-wise measures, forming an Equivalence matrix containing data on degrees of role similarities among actors, are then used to decide upon the number of role-types (positions) that can be found in the dataset, classifying actors into these different role-equivalent subsets. With equivalence matrices always being symmetrical, optimal scaling (similar to MDS-based

⁹³ Another measure of structural equivalence of two actors is to calculate the Euclidean distance between their respective column and row vectors. In general, the Euclidean distance measure is more suitable for identifying similarities in the strength of ties, while the Pearson product-moment correlation coefficients presented here puts more emphasis on similar patterns of ties. See Wasserman and Faust (1994:366-375) for more information on these two measures of structural equivalence, and Cormack (1971:324ff) for an overview of alternative measures of similarity.

visualizations) are often useful for these tasks. Calculating the (structural) equivalence matrix for our Galtung typology, its MDS-based visualization can be found in Figure 5.2 below.

So-called hierarchical clustering of the equivalence matrix, either stand-alone or topographically combined with MDS-based visualizations, can also be used to identify suitable equivalence classes of actor. Beginning with a threshold value equal to the largest value in the equivalence matrix, a hierarchical clustering is obtained by lowering this threshold, clustering together actors that are above or equal to the threshold level. The resulting dendrogram in Figure 5.3 show hierarchical clustering of the structural equivalence matrix for the Galtung example, revealing the same information on the structural equivalence of actors as found in the MDS-based visualization.

If we were to classify actors as belonging to the same position when the measure of structural equivalence are above 0.4, we would end up with 6 position: 4 positions for respective peripheral branch and 2 positions containing actors E and F, and C and J respectively.⁹⁴ While the actors in two of these positions are not perfectly structurally equivalent, they are nevertheless classified as being role-equivalent as they fulfill the strict definition to the chosen degree. Lowering this threshold further would result in fewer positions, eventually arriving at the threshold level when all actors are deemed as being structurally equivalent. While hierarchical clustering, MDS-based visualization and other techniques may assist the analyst in choosing a suitable number of positions, the choice is *syvende og sist* up to the analyst to decide upon.

An alternative method for identifying and classifying actors according to structural equivalence is the peculiar algorithm known as Concor. Introduced in the 1970's, the algorithm starts off with an equivalence matrix containing correlation coefficients (see above) reflecting the degrees of structural equivalence among pairs of actors. The Concor algorithm uses the phenomena where the repetitive calculation of correlation coefficients for the previous correlation coefficient matrix converges in a manner so that the network can be split into two distinct positions argued to contain role-equivalent actors. Based solely on a mathematical phenomena, rather than a theory of role classification, the Concor algorithm has been heavily criticized (Sim and Schwartz 1979; Doreian 1988; Faust 1988), for instance by one of its founders who argue that there is “[no] justification for advocating the iteration of [correlation coefficient] matrices as a method for analysis of data” (Schwartz 1977:266ff). Schwartz, and others, have also objected to how the Concor algorithm always generate a bipartite split, even for typological networks that contains three very distinct role types (positions). Once Concor has split a network into two positions, the analyst can choose to

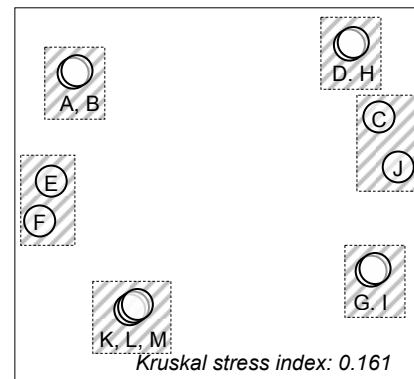

Figure 5.2: Visualization of (structural) equivalence for the modified Galtung typology.

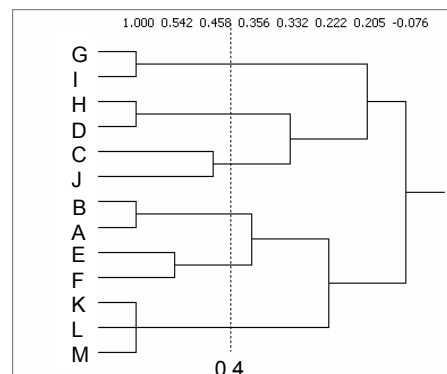

Figure 5.3: Dendrogram of (structural) Equivalence matrix for the modified Galtung typology.

⁹⁴ As E and F have identical ties to C and J, and vice versa, they are deemed more structurally equivalent than other combinations of core actors.

apply the Concor algorithm again on either, both, or neither of these two positions. The arbitrary choice on which positions to split further, its lack of theoretical foundation, and that it always splits a set of actors into two positions have rightly put the Concor algorithm out of popular use.⁹⁵ The algorithm was nevertheless extensively used in the genesis of role-analysis, for instance in the first SNA-style world-system studies which we will return to at the end of this chapter.

Regular equivalence

The definition of structural equivalence implies that actors have identical relations to all other actors. Thus, in our hospital example, nurses sharing the same role as defined by structural equivalence have identical relations to the *same* doctors and patients. This, however, runs counter to an intuitive perception of role-equivalence: nurses at different hospitals could indeed be seen as having the same role in relation to doctors and patients, whether or not the nurses relate to identical doctors and patients. Similarly, core and peripheral actors constitute two distinct roles in the Galtung typology, roles which the typology in question is supposed to demonstrate. Defining role-equivalence as structural equivalence does however fail to identify these two distinct role-sets; thus, it is reasonable to assume that applications of structural equivalence on real-world data will equally fail to identify similar structures.

First introduced by Sailer (1978), the concept of regular equivalence was developed in a series of papers in the 1980's by White and Reitz. Instead of defining role-equivalence among actors as having identical ties to the same actors, *regularly equivalent actors have similar ties to actors which in turn are deemed to be regularly equivalent*. With nurses, doctors and patients have similar relations to each other as groups, whether working at the same hospital or ward, they constitute regularly equivalent positions. Another example is provided by Wasserman and Faust:

[N]eighborhood bullies occupy the same social position, though in different neighborhoods, because they beat up some kid(s) and are scolded by some irate parent(s), but they do not necessarily beat up the same kid(s) nor are they scolded by the same parent(s). (Wasserman and Faust 1994:474)

Contrary to how role-equivalent positions are identified according to structural equivalence, actors in a network may form different number of positions containing actors that fulfill the definition of regular equivalence. The classification yielding the lowest number of positions that are consistent with the definition – the maximal regular equivalence – is typically what is sought. However, as the maximal regular equivalence in a symmetrical, fully connected network results in a singular role-equivalent position containing all (non-isolated) actors, regular equivalence is usually⁹⁶ only applicable for directional data, such as the example network of a neighborhood provided by Wasserman and Faust above.

As real-world data seldom conform to the strict definitions of role-equivalence, the definition has more theoretical than practical value. Rather, as with structural equivalence, it is often more relevant to measure the degree to which the definition for regular equivalence is

⁹⁵ However, as late as 2004, Lincoln and Gerlach published a major study of the corporate structures in Japan in which they extensively, and exclusively, apply the Concor algorithm, treating it as a state-of-the-art technique all through the 400 pages of their study, without any reference to the critique the Concor algorithm has raised. Similarly, the copper trade network analysis by Tong and Lifset (2007) also utilizes Concor to split their four trade value networks into what they deem to be structurally equivalent positions.

⁹⁶ Approaches for estimating regularly equivalent positions for non-directional networks do exist, for instance by looking at the direct connections for each actor (its neighborhood) (see Everett et al 1990)

fulfilled. The REGE algorithm, developed by White and Reitz (1983; 1985), is the most common method for measuring the degree of regular equivalence between actors. Through an iterative procedure, the algorithm measures how well the relations of each pair of actors match each other, weighted by the measures obtained in the previous iteration of the algorithm.⁹⁷ After a suitable number of iterations, the REGE algorithm ends up with a matrix containing measures of regular equivalence among actors, a (regular) equivalence matrix which, similarly to (structural) equivalence matrices, can be analyzed using MDS or hierarchical clustering in order to establish a suitable number of role-sets (positions).

The REGE algorithm has been applied to a wide range of different datasets, such as interpersonal relations, kinship structures (Denham and White 2005), organizational structures (Wolfe 2005), inter-firm relations (Nakamo and White 2004), trophic food webs (Luczkovich et al 2003), world trade (Mahutga 2006; Srholec 2006), among several other scenarios. Applicable to both valued and binary data alike, the algorithm has been shown to have a number of shortcomings. First, low REGE equivalence measures are not adequate ordinal measures of regular equivalence: two pairs of actors that are equally non-equivalent may have different, albeit low, REGE measures. A rank order of degree of regular equivalence is thus somewhat volatile. Secondly, the REGE algorithm has been shown to behave somewhat peculiar when dealing with valued data (Borgatti and Everett 1991; see also Borgatti and Everett 1993). Due to the workings of the matching function in REGE, where the algorithm searches for the least common value of flows for the role-sets of would-be equivalent actors, a few similar ties of large magnitudes could very well dwarf several similar ties of lower magnitudes. As our dataset evidently contains large value spans (see Figure 4.7, previous chapter), we must be aware of this shortcoming. Thirdly, the decision on the number of REGE iterations adds an arbitrariness over its applications. The “industry standard” is to choose three iterations – although we will adhere to this recommended setting, we will nevertheless compare the optimal partitioning results of using different number of iterations when looking at fuel commodity trade flows (Chapter 7).

Applying 3 iterations of the REGE algorithm on the Galtung typology, we arrive at the hierarchical clustering scheme as shown in Figure 5.4. As immediately noted, the REGE algorithm succeeds in identifying the two distinct role-sets that the typology, according to both Galtung (1971) and mere intuition, is supposed to reflect. The core actors form a common position of their own, just as the peripheral actors form a singular position.

Turning to the inter-continental trade flow example, applying 3 iterations of the REGE algorithm, we arrive at the dendrogram in Figure 5.5. Complementing this, an MDS-based visualization of the regular

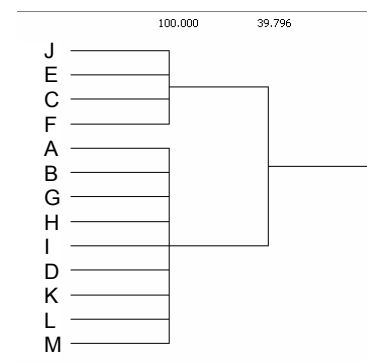

Figure 5.4: Dendrogram of (regular) Equivalence matrix for the modified Galtung typology.

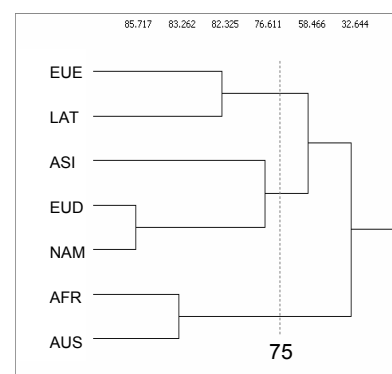

Figure 5.5: Dendrogram of (regular) equivalence matrix for the inter-continental trade example.

⁹⁷ Except for the White and Reitz (1985) paper, a detailed description of the REGE algorithm can be found in Wasserman and Faust (1994:479-481). Also see Borgatti and Everett (1991, 1993) and Žiberna (2008).

equivalence matrix of this real-world data can be found in Figure 5.6, where actors are categorized as belonging to the same rolesets (positions) when their regular equivalence values are above 75. North America (NAM), Asia (ASI) and Developed Europe (EUD) share a similar role, while the four remaining continents form two distinct positions. Judging by the hierarchical clustering scheme (Figure 5.5), we further note that EUD and NAM are the two most (regular) role-equivalent actors in this dataset, and that AFR and AUS are more role-equivalent than what ASI is to EUD and NAM. Thus, while an intuitive visual interpretation of inter-continental trade flows (Figure 4.5) might suggest two rolesets – that of three core and four peripheral continents – the REGE algorithm instead suggests that the actors in the latter set seems to have either one of two roles: LAT and EUE being more role-similar to the three core continents than what is the case with AFR and AUS.

The classification of Australasia as having the same role as Africa can however raise some eyebrows as Australia and New Zealand are fairly developed countries, contrary to most African nations. Two reasons might explain the REGE-derived role-equivalence of AUS and AFR. First, it might simply be the case that these two continents indeed play a similar role in inter-continental trade. Although reflecting a different analytical aspect of network data, it can be noted that both of these continents have very similar BDD_{Combo} centrality indices (Table 4.4). While AFR is heavily dependent on EUD with regards to imports, AUS is similarly heavily import-dependent on ASI. Such similarities could reflect that AUS and AFR play the same role in inter-continental trade. Secondly, it might be a side-effect of so-called value dwarfing inherent in the workings of the REGE algorithm. As AUS only consists of two nations, its imports and exports are naturally quite small: looking at total imports and exports of these two actors (Figure 4.5), we note that this indeed is the case, these being very similar to the trade degrees of AFR. Thus, the REGE algorithm may simply fail at identifying AUS as a core continent, if that now is the case. The reason for AUS and AFR being identified as regularly role-equivalent could of course also be a combination of these two possible explanations.

As suggested by the hierarchical clustering and MDS-based visualization of the two examples above, there seems to be two and three distinct types of roles, respectively, in the Galtung typology and the inter-continental trade example. However, determining the number of positions of a network, i.e. how many different sets of actors deemed as role-equivalent, is usually not as straight-forward as in the examples above. Classifying actors into several positions does imply that actors are more regular equivalent within each position, at the cost of reducing the possibility to identify the fundamental role-structure among actors. On the other hand, the classification of actors into a few number of role-equivalent positions could mean that actors whose role-regularity are fairly insignificant would nevertheless be categorized as having the same role in the network. For trade flow networks containing up to 100 countries, the analyst has to decide how many distinct regular role-sets the actors should be categorized as belonging to, a choice ranging from two and upwards.

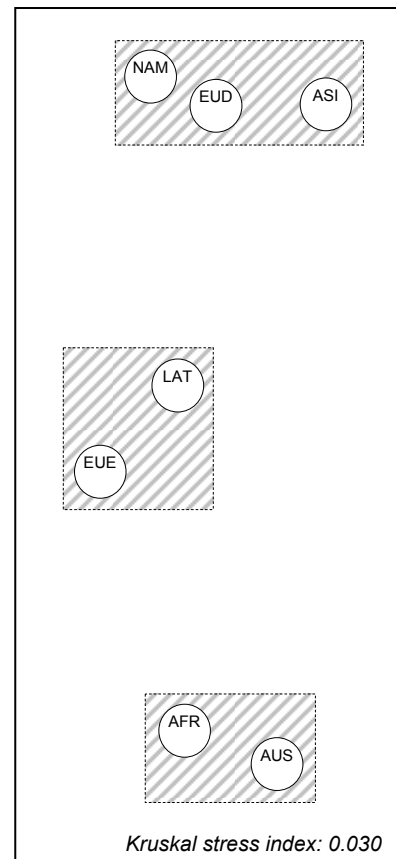

Figure 5.6: MDS-based visualization of (regular) Equivalence matrix for the inter-continental trade example.

In the study of regular equivalence in trophic food webs, Luczkovich et al (2003) used a method that can act as a guide to choose the number of regularly equivalent positions of a network. Using an Anova density model, measuring the goodness-of-fit when partitioning the network into various numbers of regularly equivalent positions, the analyst can determine the number of distinct positions the actors should be classified into.⁹⁸ In Figure 5.7 below, the regular equivalence matrix for the inter-continental trade example is analyzed with the Anova Density procedure, measuring the goodness-to-fit (the R^2 -value) when classifying the network into two to five distinct role-sets. With the R^2 -value reaching a peak when partitioning the actors into three distinct positions, this is in accordance with the number of partitions suggested by the MDS-based visualization (Figure 5.6 above). While increasing the number of positions would imply a higher degree of regular role-equivalence of the actors within each position, this would actually reduce the goodness-to-fit as indicated by the Anova Density test.

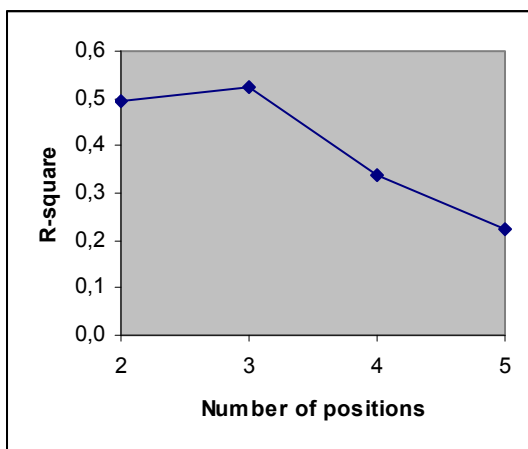

Figure 5.7: Anova density measure for testing goodness-to-fit for different number of regularly equivalent positions in the inter-continental trade example.

Similar to MDS-based visualizations and hierarchical clustering dendrograms, the Anova Density test proposed by Luczkovich et al (2003) can only offer guidance on how many distinct roles a network should be modeled as containing. We will use this measure in the empirical chapters that follows in order to determine how many distinct types of roles the nations in the world-economy best can be categorized into. As an analytical guide, when applicable, it should be complemented with, and at times superseded by, theoretical considerations. In the forthcoming empirical chapters, we will at times deviate from the number of positions as suggested by Anova Density measures in order to enhance the analytical resolution.

Blockmodeling: regular blockmodels

Once the actors in a network have been classified as belonging to the set of role-equivalent positions, the next step in the analysis is usually to examine the relations between and within these positions. This is typically done using ‘blockmodeling’, a technique aimed at revealing the more fundamental role-relational properties of a network (Lorrain and White 1971; White et al 1976). Blockmodels can be created for structural as well as regular equivalence

⁹⁸ Being a fairly advanced mathematical-statistical procedure, the workings of the Anova Density model is not presented in detail here. Specifications of how Anova (analysis of variance) tests are conducted can though be found in most standard textbooks in statistics. Applications of this procedure, using the constant homophily method, can be found in Luczkovich et al (2003; see also Nordlund (2006)).

analyses; however, as the forthcoming empirical role-analyses are concerned with regular equivalence, we will focus on regular blockmodels in this chapter.

In practice, a blockmodel of a network is created by sorting the original sociomatrix according to positional belonging.⁹⁹ The sorted sociogram can then be split into inter- and intra-positional “blocks”: sub-matrices containing the inter-actor relations between and within each position. In Table 5.1(a) below, a blockmodel is constructed for the inter-continental trade example where the actors belong to one of the three regular role-equivalent positions – labeled P_1 to P_3 – as suggested by the previous hierarchical clustering (Figure 5.5) and Anova Density test (Figure 5.7). The nine blocks representing inter- and intra-positional ties are indicated by thicker lines.

		P_1			P_2		P_3	
		NAM	EUD	ASI	LAT	EUE	AFR	AUS
P_1	NAM		185	226	133	9	10	17
	EUD	201		239	50	109	38	19
	ASI	358	263		31	16	16	27
P_2	LAT	141	41	26		3	2	1
	EUE	10	100	20	2		2	0
P_3	AFR	13	38	15	3	1		0
	AUS	8	10	40	1	1	1	

A: Regular Blockmodel (3 positions) of inter-continental trade flow (values in bn USD; shaded cells contain values above the median flow value of 17 bn USD)

	P_1	P_2	P_3
P_1	1472	348	127
P_2	338	5	5
P_3	124	6	1

B: Collapsed (reduced) blockmodel containing aggregate inter- and intra-positional trade flows (values in bn USD).

Table 5.1: A blockmodel of inter-continental trade flows and its collapsed block image.

Similar to reduced graphs (see above), a network in matrix format can also be reduced to depict relations among and within groups of actors rather than individual actors. Table 5.1(b) is a collapsed blockmodel of Table 5.1(a), containing aggregate trade flows within and between positions.

At this point, it has to be stressed that our blockmodel example on inter-continental trade is merely demonstrational. Furthermore, as is evident in Table 5.1(a) and Table 5.1(b) above, intra-continental trade flows are excluded in the inter-continental example used here. The reason for this exclusion of actor self-ties is due to the fact that we will apply the methods presented here on inter-national trade flow networks, i.e. where domestic trade (self-ties for actors-as-nations) are ignored. In the forthcoming chapters, we will divide networks containing more than 90 actors into a similar handful of role-equivalent positions, thus resulting in much larger blocks than is found in our inter-continental trade example.¹⁰⁰

As the next step in blockmodeling is concerned with the presence, or absence, of ties in each block, valued data is typically dichotomized prior to this step. Using the median inter-continental flow value of 17 bn USD as cutoff, we arrive at a binary blockmodel as indicated

⁹⁹ As the order of the actors in a sociomatrix is arbitrary, we may freely shift the order, as long as both the row and column vectors of an actor are shifted simultaneously.

¹⁰⁰ The reason for choosing the inter-continental example, where intra-continental trade is ignored, rather than a dataset containing bilateral flows is for clarity: it is easier to understand the basics in network methodology when using 7, rather than 90, actors.

by the shaded cells in Table 5.1(a) above. For blockmodels, these binary ties within each block are typically called “1-cells”.

Examining the contents of each block, we note that position P_1 constitute a cohesive subgroup as the block representing the intra-positional tie for P_1 is filled with 1-cells (that is, the relation between each pair of actors in position P_1 are above the previously stipulated cutoff value). As a contrast, there are no 1-cells in the intra-positional blocks for P_2 and P_3 . Regarding positional ties from and to position P_1 , about half of the cells in the corresponding blocks are 1-cells, while the inter-positional ties between P_2 and P_3 lack 1-cells altogether.

The interpretation of intra- and inter-positional ties differs whether on the blockmodel depicts structural or regular equivalence. A positional tie in a structural blockmodel should ideally correspond to a block completely filled with 1-cells, while the corresponding block for a positional non-tie should ideally only consist of 0-cells. However, as real-world data seldom conforms to ideal types, positional ties in structural blockmodels are usually identified using more relaxed criteria. Often attributed to the work on ‘structural holes’ (see Burt (1994)), the zero-block criteria equate all non-zero blocks as positional ties, i.e. assuming that “the primary indicator of a relation between [positions] is not the occurrence but the absence of ties between individuals in the [positions]” (White et al 1976:739). An opposite approach only deems blocks completely filled with 1-cells as constituting a positional tie. A third approach is to calculate the percentage of 1-cells in each block, where a positional tie is perceived to exist when this percentage is above a chosen value.

The definition of positional ties in regular blockmodels differs from how they are defined for structurally equivalent blockmodels. Instead, a *regular block* (i.e. a *regular positional tie*) is defined as having at least one 1-cell in each row and column of the corresponding block. Thus, in our regular blockmodel on inter-continental trade, we note that position P_1 has regular ties to P_2 and P_3 , alongside its (intra-positional) regular self-tie. Further, we note a regular tie from position P_2 to P_1 .

Regular blocks are a combination of two additional types of blocks: row-regular and column-regular blocks. A *row-regular block* has at least one 1-cell in each row, while a *column-regular block* has at least one 1-cell in each column. Examples of inter-positional interaction between actors for these three block types can be found in Figure 5.8. Not fulfilling the definition of a regular block, the positional tie from P_3 to P_1 does however represent a row-regular block.

In the inter-continental trade blockmodel above, the data was dichotomized using the median flow value, always resulting in the number of 1-cells being equal to the number 0-cells. If we instead were to dichotomize the blockmodel using the mean flow value – in our example amounting to 58 bn USD – fewer 1-cells would appear in the regular blockmodel, only yielding a singular regular self-tie for position P_1 , and a row-regular (and column-regular) positional tie from P_2 to P_1 (and vice versa). Position P_3 would however lack both row-regular and column-regular ties when dichotomizing the data using the mean flow value, thus giving

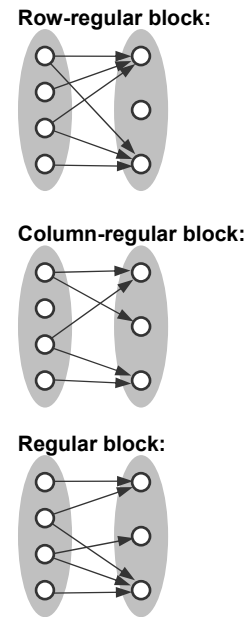

Figure 5.8: Examples of row-regular, column-regular, and regular blocks between two positions (from Doreian et al 2005:212)

the impression that position P_3 would be totally isolated and non-connected in the role-structure of continental trade.

Similar to the problematic relationship between standard centrality indices and valued network data, dichotomization of valued data is just as problematic in blockmodeling, even for the trivial continental trade example above. If we were to apply the above procedure when mapping the role-relational structure of inter-*national* trade, a dataset whose value span is much higher than in the inter-continental example (see Table 5.1), we would arrive at even more peculiar results, only being able to identify regular positional self-ties for actors with large trading volumes. Even though the total trade of USA is enormously larger than the total trade of Ghana, this does not imply that the role played by, for instance, Ghana (and its fellow role-equivalent siblings) – from the point of view of Ghana – is a role played in isolation. Similar to the dichotomization dilemma encountered in the discussion on centrality indices, regular blockmodels of valued networks can indeed cause some interpretational headaches as it implies using a system-wide definition of what a significant trade link actually is.

In a separate article (Nordlund 2007), a novel heuristic for identifying regular blocks in valued networks is presented, a heuristic where the criteria for positional ties are measured from the point of view of each actor. Through a dual marginal-normalization procedure, combined with a measure of definitional criteria-fulfillment for regular ties, intra- and inter-positional ties can be identified where the significance of each tie is deemed on a per-actor basis. The heuristic yields a percentual share of criteria-fulfillment for each regular block, percentages which either can be used as-is or dichotomized by treating all blocks above a certain criteria-fulfillment percentage as regular blocks. The heuristic thus allows for the identification of regular role-structures in valued networks without the distortive effects attributed to value dwarfing.¹⁰¹

While its details are to be found in a separate article (Nordlund 2007), the heuristic is fairly simple to describe. Beginning with a row-based marginal normalization of the blockmodel, similar to what is done when calculating BDD_{Export} indices (see previous chapter), the export profiles for each actor are given as percentual shares among the receiving actors. Using a suitable percentual cutoff-value, a significant tie in the blockmodel (i.e. a 1-cell) is defined as being above this chosen value. With the criteria for a row-regular block implying at least one 1-cell in each row of the corresponding sub-matrix, the criteria-fulfillment share for a row-regular block is equal to the number of 1-cell-containing rows divided by the total number of rows in the sub-matrix. The above process is then repeated for columns, i.e. using a column-based marginal normalization where the criteria-fulfillment share for a column-regular block is calculated. A regular block is subsequently calculated by combining the combined criteria for row-regularity and column-regularity.¹⁰²

¹⁰¹ In Nordlund (2007), two datasets were used to test the heuristic: the St. Marks carbon flow network used in the Luczkovich et al (2003) study and a new dataset on total quantities of cereals and cereal products between 1995-1999. Both these datasets contains large spans in their relational data, and both were successfully modeled in the heuristic. Except for its application in the chapters that follows, the heuristic has also been applied to communication data between members of a local web community in Malmö (forthcoming).

¹⁰² For a block with N rows and M columns, there are $N+M$ number of criteria for a regular block to exist, i.e. there must be at least one 1-cell in each of the N rows and in each of the M columns. The criteria-fulfillment percentage for a regular block is therefore the sum of rows and columns fulfilling the definitions for row-regularity and column-regularity respectively, divided by the sum of M and N . Two alternative measures for regular blocks were also presented in Nordlund (2007), measures where the criteria-fulfillment for row- and column-regular blocks are combined differently; in what follows, we will however use the standard criteria-fulfillment method as explained in this footnote.

Applying the heuristic on the regular blockmodel of inter-continental trade, dichotomizing the row- and column-normalized blockmodels so that all outbound and inbound flows exceeding 5 percent of total outbound and inbound flows respectively are converted to 1-cells in the blockmodels, we arrive at the criteria-fulfillment measures for each of the three block types as given in Table 5.2.

a) Criteria-fulfillment for row-regular blocks

	P ₁	P ₂	P ₃
P ₁	100%	67%	33%
P ₂	100%	0%	0%
P ₃	100%	0%	0%

b) Criteria-fulfillment for column-regular blocks

	P ₁	P ₂	P ₃
P ₁	100%	67%	67%
P ₂	67%	0%	0%
P ₃	67%	0%	0%

c) Criteria-fulfillment for regular blocks

	P ₁	P ₂	P ₃
P ₁	100%	80%	60%
P ₂	80%	0%	0%
P ₃	80%	0%	0%

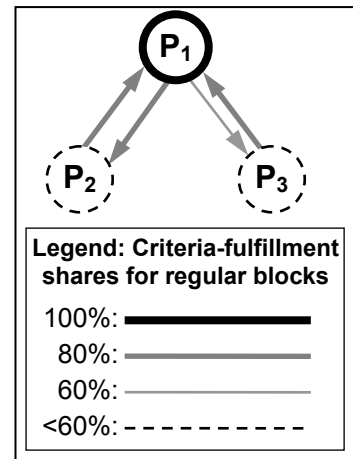

Figure 5.9: Image graph of inter-continental trade.

Table 5.2: Criteria-fulfillment percentages for row-, column-regular, and regular blocks in the inter-continental example.

Similar to what was done with regards to the gross trade flows between and within continents (Figure 4.5), the density matrices above can be visualized as reduced graphs or, as these role-structural visualizations are typically called in SNA, image graphs. In such image graphs, contrary to the continental gross trade visualization (Figure 4.5), it is important to note that the regular ties among positions do not indicate the strength or volume of flows, but instead the occurrences of regular ties among and within positions containing role-equivalent actors. This is also true for the self-ties in regular blockmodels (and their corresponding image graphs), where a regular self-tie implies at least one directional tie between all possible pairs of actors within the block. Furthermore, density matrices and corresponding image graphs are not necessarily symmetrical. For example, while the criteria for a regular tie from position P₃ to P₁ are fulfilled to 80 percent, the positional tie in the opposite direction only fulfils 60 percent of the definition of a regular tie.

The image graph depicting regular ties (Table 5.2(c)) between the three regularly role-equivalent positions are to be found in Figure 5.9.¹⁰³ This visualization of a regular role-structure utilizes a special graphical notation that also will be used in forthcoming chapters. The shading and width of *all* lines in the image graphs indicate the degree of criteria-fulfillment for a regular block, as explained in the legends of the image graphs. This graphical notation also applies to the positions themselves: as the criteria for a regular self-tie (as defined in the heuristic above) is fully satisfied for position P₁, this is indicated by the thickness and shading of the node representing the position in question. As such self-ties are missing for position P₂ and P₃, these nodes are drawn with thin, dashed lines.

¹⁰³ The coordinates of each node are arbitrarily chosen in Figure 5.9. In the image graphs that will follow in later chapters, coordinates are established using a spring-embedder algorithm where criteria-fulfillment percentages for regular ties will be used as input.

Let us now turn to the more ideal structure proposed by Galtung. As the Galtung typology contains binary data, there is no need for the heuristic applied above: instead, we can identify occurrences of regular blocks immediately by looking at its blockmodel (Table 5.3). Using the strict, standard definition of a regular block, two perfect regular blocks can be identified in the blockmodel: a regular self-tie for the position containing the core actors (P_C), and a regular tie from the core to the periphery (P_P).

		P_C				P_P								
		C	E	F	J	A	B	D	G	H	I	K	L	M
P_C	C	1	1	1	0	1	1	0	0	0	0	0	0	0
	E	1	1	0	1	0	0	1	0	1	0	0	0	0
	F	1	0	1	1	0	0	0	1	0	1	0	0	0
	J	0	1	1	1	0	0	0	0	0	0	1	1	1
P_P	A	0	0	0	0	1	1	0	0	0	0	0	0	0
	B	0	0	0	0	0	0	0	0	0	0	0	0	0
	D	0	0	0	0	0	0	0	0	0	0	0	0	0
	G	0	0	0	0	0	0	0	1	0	0	0	0	0
	H	0	0	0	0	0	0	0	0	1	0	0	0	0
	I	0	0	0	0	0	0	0	0	0	1	0	0	0
	K	0	0	0	0	0	0	0	0	0	0	1	0	0
	L	0	0	0	0	0	0	0	0	0	0	0	1	0
	M	0	0	0	0	0	0	0	0	0	0	0	0	1

Table 5.3: The Galtung typology in matrix format.

Figure 5.10 depict the image graph of the Galtung regular blockmodel. This image graph tells us the essence of the core-periphery structure as perceived by Galtung: a set of internally connected core actors, a set of internally disconnected peripheral actors, and a regular tie between the two sets, the tie indicating that each core actor is connected to at least one peripheral actor and where each peripheral actor is connected to at least one core actor. If we were to add more actors to the Galtung typology, placed either among the core or as peripheral on-hangers, the regular image graph would nevertheless be the same.¹⁰⁴ In essence, this is what blockmodeling is all about: boiling down a network into its foundational role-relational structure, identifying which actors that have which roles, and how these different roles relate to each other.

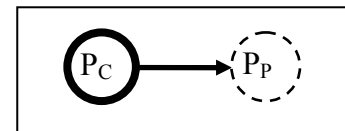

Figure 5.10: Regular image graph of Galtung typology.

With the Galtung typology reflecting the most popular conception of a core-periphery relation¹⁰⁵, the regular image graph in Figure 5.10 can thus be seen as a shorthand representation of this particular type of role-structure. Apart from this, there are other

¹⁰⁴ As previously stated, the directionality of relations was merely added to the Galtung typology in order to facilitate the usage of the REGE algorithm: thus, the direction of the positional tie in Figure 5.10 could just as well have pointed in the opposite direction.

¹⁰⁵ Borgatti and Everett (1999) has suggested an alternative method for identifying core and periphery among actors in a network where the relational data of a network is compared to a perceived ideal model of core-periphery. Implemented in the Ucinet software package, the method comes in two varieties: one that yields a classification of actors into discrete core and periphery positions, and one that yields a continuous measure of coreness (from 0 to 1). Submitting the Galtung typology to these two algorithms, the continuous version indicates the typological core actors (C, E, F, and J) as being only half core-like (0.5), and a coreness of 0 for the peripheral actors. However, in the categorical version, all actors except G, H and I are identified as core actors. These non-intuitive results are probable due to the idealized core-periphery structure of the algorithm: core actors representing a perfect 1-block, peripheral actors representing a perfect 0-block, and where each peripheral actor has ties to *several* core actors (Borgatti and Everett 1999:376ff), this being different from core-periphery structures as perceived by other (White et al 1976:744; Wasserman and Faust 1994:421,423).

conceivable role-structural types, each identifiable by their respective image graphs – see Figure 5.11.¹⁰⁶

By creating a regular blockmodel of the neighborhood bully example provided by Wasserman and Faust, we arrive at a (perfect) *hierarchical* role-structural type. In this role-structural type, the different “organizational levels” – here consisting of parents, bullies and kids respectively – are separated into distinct position, with the positional ties representing the “chain of command”. Although not specified in the bully example, the positions in the hierarchical type could very well have – or lack – self-ties: the parents might indeed confront each other at PTA meetings while the bullies stay well clear of other bullies in other neighborhoods. The hospital example would also translate into the hierarchical image graph type, with doctors instructing nurses and nurses treating patients. However, if the doctors also were to meet the patients, the role-relational structure would be similar to the *transitivity* role-structural type. With an intuitive notion of “delegation” in the hierarchical role-structural type, the transitivity version implies actors interacting with actors in all “lower-level” positions. Similar to the hierarchical type, the individual positions may have self-ties: doctors and nurses, and perhaps even patients, might indeed interact with their respective “role-peers” – or they may not.

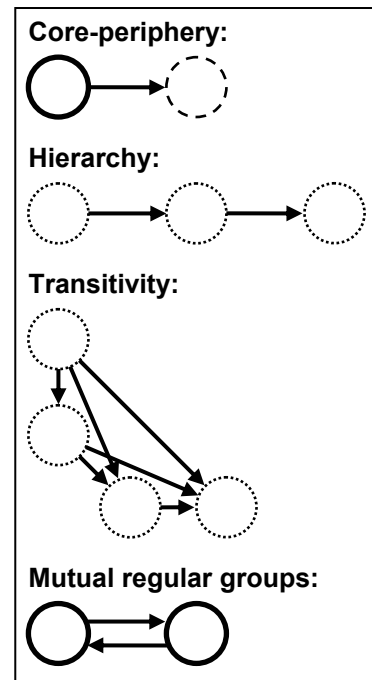

Figure 5.11: An assortment of ideal role-structural type.

The last role-structural type in Figure 5.11, the *mutual regular groups* type, consists of two (or more) positions with self-ties, where there are mutual regular ties among the positions. A suitable example would perhaps be a junior school dance – at least how I personally recall the occasions from the mid 1980’s. Here we have two fairly cohesive groups – boys and girls – with frequent interaction confined to their respective positions, role-equivalent as well as spatially in the school hall. During the course of the evening, pairs of actors from each position start to interact: each boy had his eyes on (at least) one girl, whereas each girl was flattered by the attention from (at least) one boy.¹⁰⁷

As evident in the regular block image of the inter-continental trade example (Figure 5.9), real-world data seldom conforms to any of the ideal types proposed above. Instead, we are more likely to encounter role-structures containing mixtures of different ideal types. Despite being equipped with an extra peripheral position, the inter-continental trade example does nevertheless resemble the core-periphery type as identified by a self-tying position relating to a position lacking such a regular self-tie. The ideal types presented above should thus be seen as guidelines for interpreting regular image graphs and blockmodel analyses. Furthermore, the directionality of the inter-positional ties may very well differ from how they are portrayed in Figure 5.11 above, either pointing in the opposite, or in both, directions between positions. In the empirical chapters in this thesis, these ideal types can be used to

¹⁰⁶ The ideal role-structural types presented by White et al (1976:744) and Wasserman and Faust (1994:421,423), mainly applicable to structural rather than regular equivalence, do form the basis of the ideal types presented in Figure 5.11. This collection do not claim to cover all possible role-relational structures.

¹⁰⁷ As I actually recall it, the mutuality of the regular ties among these two positions was not as ideal as made to appear here. Although I personally would have preferred the ideal role-structure of mutual regular groups at that time, the tie between the two positions was perhaps more row-regular than regular!

interpret the regular blockmodels of international trade and how the role-structures of world trade in fuel commodities and agricultural products, respectively, looks like.

Previously conducted network-analytical studies of the contemporary world-system

With its genesis about three decades ago, formal role-analysis has been conducted on different aspects of the modern world-system from the early beginning of the approach. Using slightly different relational datasets, obtaining different answers to slightly different questions, answers obtained using slightly different role-analytical methodologies, the amount of articles combining SNA with world-system issues does indicate the utility of – or at least a belief in the utility of – the method for addressing the issues at hand.

In what follows, we will look closer at a series of path-breaking role-analytical studies where the datasets fully or partly constitute trade flow data. Characteristic of these studies is that they are explicitly conducted from a world-system perspective, aimed at comparing different role-sets (positions) with the trimodality perceived as existing within the modern world-system.

The Kick-start of international blockmodeling

The article by Snyder and Kick in 1979 was the first blockmodel study on international relations. Adhering to the world-system perspective, the authors begin their study by addressing some of the dilemmas within this line of thought. First, world-system analysis lacks the necessary empirical tools to address the fundamental question on structure that is inherent in the world-system perspective. This had led to the second dilemma: the classification of national economies into core, semi-periphery, and periphery has so far only been done based on the internal properties, i.e. attributes, of the individual nations. Thirdly, this trimodality of the world-system remains a perception without any real empirical backing. As the existence of three separate strata has theoretical significance, the trimodal world is more than a simple “heuristic device” which thus has to be proven empirically. The solution to these dilemmas is multi-relational blockmodeling, offering formal methods for the identification of various roles in the world-system and the classification of nations into these different role-sets based on relational, rather than attributional, data.

The 1979 study covers 118 countries of the world of 1965, utilizing four different relational datasets: commodity trade flows, military interventions, diplomatic missions, and treaty membership. Obtained from various sources (ibid.:1106), these four relational datasets are all binary. The compiling of the trade dataset begins with Comtrade export data: if the reported export trade between two countries is above 100 kUSD for at least two years in the period 1963-67, the trade flow is coded as a tie (1) – else non-existing (0). As data for Comecon countries was missing, Snyder and Kick simply assumed that the trade between each of these countries was significant enough to be coded as a tie. For non-reporting countries however, they assume trade flows to be below the stipulated cutoff value, thus viewing trade from and between the non-reporting countries as non-existing.

Applying the Concor algorithm simultaneously on these four binary matrices, repeating the Concor splitting on the larger of the two previous splits, they arrive at a 10-positional partition with countries categorized as given in Table 5.4. The 10-positional split does nevertheless, according to the authors, reflect a trimodal world-system, classifying these ten

blocks into the three world-systemic strata as shown in Table 5.4.¹⁰⁸ As has been pointed out in subsequent studies by other authors (Nemeth and Smith 1985; Smith and White 1992), this classification of nations is somewhat peculiar and non-intuitive. While Australia is identified as a core nation, New Zealand is to be found in the periphery, joined by China, Iceland, Poland and Kuwait in the same position. Mexico is identified as peripheral, while Uganda and Peru can be found in the semi-periphery. Israel is classified as role-equivalent to nations in an otherwise socialist position, while Finland, India and Saudi-Arabia are semi-peripheral.

Position	Countries	Stratum
A	Chad, Congo (Brazzaville), Congo (Kinshasa), Uganda, Burundi, Rwanda, Somalia, Ethiopia, Malagasy Republic, Morocco, Algeria, Tunisia, Libya, Sudan, United Arab Republic, Yemen	P
B	Mali, Mauritania, Ghana, Upper Volta, Senegal, Dahomey, Niger, Ivory Coast, Guinea Rep., Liberia, Sierra Leone, Togo, Cameroun, Nigeria, Gabon, Central African Rep.	P
C	Canada, USA, United Kingdom, Netherlands, Belgium, Luxembourg, France, Switzerland, Spain, Portugal, West Germany, Austria, Italy, Yugoslavia, Greece, Sweden, Norway, Denmark, South Africa, Japan, Australia	C
C'	Venezuela, Peru, Argentina, Uruguay, South Korea	SP
D	Cuba, Ireland, East Germany, Hungary, Cyprus, Bulgaria, Rumania, USSR, Kenya, Iran, Turkey, Iraq, Lebanon, Jordan, Israel	SP
D'	Finland, Saudi Arabia, Taiwan, India, Pakistan, Burma, Ceylon, Malaysia, Philippines	SP
E	Panama, Colombia, Ecuador, Brazil, Bolivia, Paraguay, Chile, North Vietnam	P
E'	Haiti, Dominican Rep., Mexico, Guatemala, Honduras, El Salvador, Nicaragua, Costa Rica	P
F	Jamaica, Trinidad-Tobago, Poland, Czechoslovakia, Malta, China, Mongolian Rep., Nepal, Thailand, Cambodia, Laos, New Zealand, Iceland	P
F'	Albania, Syria, Kuwait, Afghanistan, North Korea, South Vietnam, Indonesia	P

Table 5.4: Block membership in Snyder and Kick (1979:1110) – 118 countries circa 1965

*: C=Core, SP=Semiperiphery, P=Periphery

There are several methodological flaws in the analysis of Snyder and Kick (1979), flaws which cause these somewhat peculiar results. First, establishing role-equivalence based on several relational datasets implies that each of these datasets have equal importance in the algorithm. That is, the (dichotomized) trade flow dataset has equal significance as the diplomatic mission dataset, each having a 25 percent influence on the resulting role-classification. Arguing, correctly, that non-economic relations are important in world-system analysis, protesting against the traditional econocentricism of world-system analysis, they nevertheless implicitly argue that non-economic relations are three times as important as economic ties when they use these four datasets as input to the Concor algorithm. Anticipating would-be critique regarding the actual choice of datasets, the authors welcome forthcoming studies that utilize more datasets:

We invite replications with additional or different networks as they become available. We also recognize that different results could be obtained (though that becomes less likely as more networks add successively less independent information). (Snyder and Kick 1979:1108)

However, including more datasets into the role-equivalence analysis would dilute the significance of each dataset even further. The world-system, its structure and its processes are

¹⁰⁸ The authors refrain from commenting why the trimodality appears first at ten blocks rather than the intuitive three. This is however not surprising: when applying the notion of structural equivalence on the Galtung typology, we did end up with far more role-equivalent positions than the anticipated two (see Figure 5.1).

indeed multi-faceted phenomena, but to give equal weight to every possible network in the role-classification of nations is highly non-theoretical.

The second flaw concerns their preparation of the trade flow dataset, a process which can be criticized on several accounts. First, by using an absolute cutoff value for determining significant trade flows does put a premium on nations that trade in large volumes. Secondly, their assumption on 100 percent density of trade ties among the socialist countries – assuming that there is significant bilateral trade between each possible pairs of Albania, Bulgaria, Cuba, East Germany, Czechoslovakia, Hungary, Mongolia, North Korea, North Vietnam, Poland, and USSR – creates an artificial cohesiveness that definitely affects the results. Thirdly, assuming a similar non-existence of export trade from, and between, all 24 non-reporting countries is just as volatile an assumption. Fourth, they prefer to use export data rather than import data, even though the latter is typically deemed to be of better quality than the former (e.g. Durand (1953) and Linnemann (1966)).

The third methodological flaw is, of course, the usage of the Concor algorithm. Used extensively for role-structural partitioning in the genesis of blockmodeling, deemed as state-of-the-art at that time, the Concor algorithm has proven to be of minor use in the partitioning of correlation matrices, even failing at identifying core and peripheral actors in the Galtung typology.

Once having established the ten role-equivalent positions, Snyder and Kick examine the density matrices of each of these datasets, noticing that the density matrix for the trade dataset seems to be the best representation of the trimodal structure of core, semi-periphery, and periphery. The study rounds off by examining the relationship between role-positional membership and GDP per capita, concluding, for instance, that the cost of being non-core is about 500 USD per capita.

Stressing that their study is mainly methodological, the authors nevertheless argue that their results lend strong empirical support for a trimodal world-system. Being a “first-cut study” (Evans 1979), the largest contribution of the 1979 study is perhaps the proclamation of a “natural wedding” (Snyder and Kick 1979:1123) between multiple-relational blockmodeling and world-system analysis. Snyder and Kick thus pioneered a new type of formal, structural-empirical genre of world-system analysis.

Without any significant improvements in network methodology, Kick has published more studies using virtually the same approach as in the 1979 article (Kick 1985; 1987; 1995; 2001).

In the 1987 study, Kick addresses the prospects for a socialist world order through an analysis of 8 datasets for 130 countries in the period 1970-75: four sets of bilateral treaties (on economic assistance, communication, sociocultural cooperation, and diplomacy), and sets concerned with export trade, armament treaties, political conflicts, and military conflicts.¹⁰⁹ Extending the number of datasets from the 1979 setup, each of these datasets affects the role-equivalent partitioning to 12.5 percent, with the treaties datasets representing half of the decisive factor behind perceived roles in the world-system. The export trade matrix is prepared as its counterpart in the 1979 article, assuming complete trade ties between the

¹⁰⁹ The eight datasets in Kick (1987) are taken from various sources (see Kick 1987:131-133). The treaties dataset are gathered from the United Nations Treaty Series, these datasets only containing data on treaties “that were signed, entered into force, or registered during 1970-1975” (ibid.:132).

socialist block and the lack thereof from and between the “few developing countries” (ibid.:153, note 3) lacking export data.

Applying the Concor algorithm simultaneously on the 8 datasets, Kick this time chooses to partition the dataset into 11 role-equivalent positions, a chosen partition as the positions “best capture substantively important but not unwieldy information” (ibid.:153, note 6), however without offering the reader any substantive insight into how the partitioning process was done.¹¹⁰ Compared to the 1979 study, fewer peculiarities can be found this time: however, the blocks seem instead to reflect geographical proximity. Sorted in a rough order from core to periphery, the bulk of OECD countries make up the singular core position, with the socialist states to be found in the second position.¹¹¹ While Australia and New Zealand were placed in diametrical strata in the 1979 study, both are to be found in the fourth position, together with China, Ireland and Israel, these all being one step less core-like than Austria, Finland, Lebanon, Norway, and Portugal.

Similar to the 1979 article, density matrices for each of the datasets are examined, however this time finding strong support for a quadmodal system consisting of a core, a socialist semicore, a semiperiphery and a periphery in these density matrices. Furthermore, based on these density matrices, Kick draws some fairly bold conclusions regarding the prospects for a would-be socialist world order:

[T]he results show strong transideological trade ties that integrate socialist states into the capitalist world economy and attenuate the chances for transformation of the system to a socialist world order. ...the division of the system into four (or three) separate tiers further reduced the incentives for *collective* action on the part of the states occupying the bottom two tiers of the hierarchy, making a socialist world order far less likely than would be the case for a bipolar arrangement. (Kick 1987:141; original emphasis)

Finally, the study looks at the statistical associations between membership in the different positions and national attributes: GDP per capita, density of radio receivers, secondary school enrollment, and life expectancy.

The 1987 article repeats the network-methodological procedure of the 1979 article in all respects, thus prone to the same critique as was raised for the earlier study. In the choice of relational datasets, the structure of bilateral treaties that were signed, registered, or entered into force during the period 1970-1975 constitute a 50-percentual significance in the classification of nations in world-system strata, while trade flows representing a meager 12.5-percentual significance in the Concor algorithm. In historical hindsight, the drawn conclusions, based solely on the interpretation of a set of density matrices of dubious relevance and quality, turned out to be quite wrong:

¹¹⁰ Although Kick et al (1995) refers to the Kick (1987) study when it comes to the blockmodeling procedure, the source for the actual blockmodel procedure seems to be an unpublished study of 1985, at least according to the Kick and Davis study of 2001. There is a reference to “Kick [1985]” in the Kick et al (1995) paper (p. 240), though it is not listed among the references. According to the source for Table 1 in Kick and Davis (2001:1567), the 1985 study also contains a blockmodel analysis for the 1960-1965 period. Without success, I have tried to obtain the Kick 1985 study with the following reference found in Kick and Davis (2001:1577): Kick, E. (1985), *The form and operation of the world system*. Boulder, CO: Education Resource Information Center.

¹¹¹ As previously noted, the actual sorting of actors – as well as positions in a blockmodel – is arbitrary. The used criteria when sorting these 11 positions are not stated in the article – it may have been arbitrarily done, based on intuitive notions on core-periphery membership, or it may be done using attributional measures (such as total positional gross trade).

Transnational linkage data show a world-system that is hierarchically arranged in four structural tiers – a core, semicore, semiperiphery, and periphery. This structural configuration will limit the spread of state-level, antisystemic forces in the system. The structure will nevertheless continue to encourage capitalist-socialist contention among states in the “top dog” tiers and among states in the bottom tiers. (Kick 1987:128)

In 1995, Kick et al once again analyzed the same 1970-1975 blockmodel, with the 1985 piece stated as the original source (Kick et al 1995:240), once again comparing role-positional membership with different attributional properties. Although referring to the 1987 article, there is no mentioning of the previously drawn conclusions on the exact same datasets – instead, the more modest argument in the 1995 study is that non-economic linkages must be taken into account in structural analysis of the modern world-system.

In 2001, the same methodology was once again applied on the same dataset, this time complemented with role-positional data for the 1960-65 period. Contrary to the previous studies, Kick and Davis now identify five different world-system strata for both of these periods: a core, a socialist semicore, a capitalist semicore, a semiperiphery, and a periphery. Block 5 for the 1970-75 is however forgotten, placed in neither of these strata. Although using identical data as in the 1987 and 1995 papers, the interpretation of the same density matrices are totally different. Instead of the data revealing a structure that will “continue to encourage capitalist-socialist contention” (see above), the comparison of the 1960-65 and the 1970-75 periods “show an expected, overall consistency in world-system structure for two historical streams: the end of the colonial period and the advent of the modern world system.” (Kick and Davis 2001:1574).¹¹²

The Snyder and Kick paper of 1979 was truly path-breaking, demonstrating how formal role-analysis could address several of the issues on structures that constitute a central concept in world-system analysis. While the notion of structural equivalence has proven to be not-so-compatible with intuitive perceptions of world-system structures, not to mention the highly questionable Concor algorithm applied in the various Kick papers, the 1979 paper has to be seen for what it was, that is, as a first-cut methodological endeavor. The substantive conclusions in the 1979 paper are fairly modest, instead underlining the utility of blockmodeling as a formal investigative tool, but “[without implying] that such investigations are a substitute for the historical analyses and case studies that are necessary to understand national variations within structural positions and the mechanisms through which system position influences domestic processes” (Snyder and Kick 1979:1124).

However, although blockmodeling methods have improved since 1979, later writing by Kick et al (1987; 1995; 2001) apply identical analytical procedures as in the 1979 paper and using the same dataset since 1985. What changed, however, was the interpretation: there was massive system change just a couple of years after 1987 with respect to the prediction of continued global interplay between capitalism-socialism. Herein lies an important lesson for network-analytical approaches to world-system analysis: interpretational modesty. Indeed opening up brand new analytical perspectives on structures, world-systemic or otherwise, network-analysis cannot be, and should not be, anything more than a complementary method which, in combination with other approaches, can help us to, perhaps, predict the past.

¹¹² The reader should here be reminded that “the modern world-system” is generally seen as having its roots for five-hundred, or even five-thousand, years ago, i.e. not a phenomena occurring somewhere between 1960-1975.

Breiger (1981)

Similar to Snyder and Kick (1979), Breiger (1981) proclaims world-system analysis to be naturally compatible with role-analysis and blockmodeling. The aim of his 1981 study is mainly methodological: whether “operational procedures [can] be developed to identify core, peripheral, and semiperipheral states on the sole basis of the structural positions they occupy in international exchange networks” (ibid.:354). Departing from a world-system perspective, Breiger stresses how trade theory since David Ricardo always has been generalizations of two-nations, two-commodity examples (see chapter 2 and 3), a conceptual fallacy and disregard for structures that can be dealt with using network analysis.

Similar to Snyder and Kick (1979), the role-equivalent positions were established by applying the Concor algorithm on four relational datasets for the year 1972. Focusing solely on the economic aspects of the world system, each of the four trade flow matrices represents a major commodity type: food and live animals (SITC 0), (inedible) raw materials (SITC 2), fuel commodities (SITC 3), and manufactured goods (SITC 6). The study only covers the 24 OECD countries of 1972: with full and detailed bilateral trade data coverage for these countries, there is no need for any assumptions on missing data, similar to the assumptions found in the Kick studies. The total trade among the 24 countries in Breiger (1981) accounted for 22 percent of total world trade in 1972. Incidentally, Breiger notes that virtually all of these countries were labeled as core in Snyder and Kick (1979).

Contrary to the Kick studies, the trade data is not dichotomized prior to the Concor algorithm. Breiger is however well aware of the issue on “value dwarfing”, criticizing Snyder and Kick (1979) for having “no explicit adjustment for the fact that some countries export (and import) vastly higher quantities of material than others.” (ibid.:364ff). Instead of dichotomizing, Breiger applies a method where row and column means are subtracted from each of the matrices, thus arriving at a set of transformed matrices where “[e]ntries greater than zero indicate positive (statistical) interaction for the trade of a given commodity between pairs of countries” (ibid.:365).

Position	Countries
1	Canada, Japan, USA
2	Belgium-Luxembourg, France, (West) Germany, Italy, Netherlands
3	Australia, UK
4	Austria, Denmark, Finland, Greece, Iceland, Ireland, Israel, New Zealand, Norway, Portugal, Spain, Sweden, Switzerland, Yugoslavia

Table 5.5: Block membership in Breiger (1981:366) – 24 OECD countries as of 1972.

Applying the Concor algorithm on three of these datasets, excluding the fuel commodity dataset for the time being, Breiger stops the partition at the second level, arriving at four positions containing the nations as given in Table 5.5. Once actors are classified into these role-equivalent positions, Breiger look at the statistical association between positional membership and national attributes. A blockmodel is then created for the fourth dataset containing fuel commodity trade flow data, using the partitioning arrived at for the other three datasets – the correlation (similarity) between these datasets are then analyzed, using the fuel commodity as a benchmark reference. Finally, Breiger looks at intra- and inter-positional flows of mean-adjusted trade data (see above), drawing a set of fairly simple image graphs. Dichotomized blockmodels for the Food and Live Animals, and the Manufactured goods datasets are also created and analyzed.

Breiger draws two conclusions from his study. Regarding the methodological aim of the study, the suggested operational procedure seems to work well. Secondly, on a substantive note, Breiger argues for the existence of a “strong center-periphery pattern” (ibid.:375) among the 24 studied OECD-countries themselves.

The study by Breiger is explicitly methodological, testing a mixture of techniques. In retrospect, the usage of the Concor algorithm can indeed be criticized, but its usage here is more consistent than in Snyder and Kick (1979) as Breiger applies the algorithm on each of the partitions from the first split, choosing the four positions at the second-level split.¹¹³ The substantive conclusion – the proclaimed evidence for a strong center-periphery pattern among the 24 OECD-countries – is however more open for criticism. As previously discussed with respect to Garrison’s analysis of a subset of the interstate highway system (see chapter 3), an analysis of a minor part of a larger network – in this case the network of world trade – most probably has repercussions on perceived results. With intra-OECD trade covering 22 percent of total world trade in 1972, and where 70 percent of world trade involved the OECD countries, this implies that 69 percent of OECD trade – i.e. trade from or to OECD countries with non-OECD countries – is disregarded in the study, thus undermining the possibilities for drawing any major substantive conclusions. Based on a fictitious scenario of a network consisting only of these 24 countries, the finding of a center-periphery-structure within the OECD countries is therefore not very interesting or relevant.

The contribution of Breiger (1981) is instead methodological. Addressing the issue on strength vis-à-vis patterns (see above), Breiger tries to solve this with a procedure to ‘net-out’ the effects of “value dwarfing”, seemingly arriving at better results with regards to role-equivalent classification than what Snyder and Kick (1979) obtained.¹¹⁴ Furthermore, Breiger also looks at positional trade flows, mapping the actual relations among and within role-equivalent actors in proto-versions of reduced image graphs.

Nemeth and Smith (1985)

In a special issue of the Fernand Braudel Center’s *Review* on quantitative methods in world-system analysis, the Nemeth and Smith paper of 1985 was the second major paper in this genre following Snyder and Kick (1979). Similar to their predecessor, Nemeth and Smith ground their paper in a discussion on the structural foundation in world-system analysis: dependency, the authors argue, must be treated as a “referential context” rather than being a variable property of countries (Nemeth and Smith 1985:521). Role-analysis and blockmodels are, according to the authors, suitable tools for looking at dependency structures and, through this, notions of unequal exchange. While the ideal situation would be to look at international profit flows, data which is not available, the authors choose to look at trade flows of different commodity types, something which very well reflects the structural conceptions that are to be found within world-system analysis:

World-systems theory suggests that position in the world-economy is related to the type of commodities nations trade. The economic strength of the core countries is reflected in the type, diversity, and quantity of their exports. Moreover, these countries trade with nations located in all the strata of the world-economy. Conversely, peripheral countries are tied to the world-economy

¹¹³ The normalization-style row and column subtraction procedure could indeed work in favor of the Concor algorithm, as the correlation coefficients intuitively should be more “balanced” in Breiger (1981) than the corresponding coefficients in Snyder and Kick (1979).

¹¹⁴ In the first part of his study, Breiger exemplifies the drawbacks with dichotomization of trade data by constructing blockmodels based on such data.

mainly through bilateral trade with core (and some semiperipheral) nations. (Nemeth and Smith 1985:524ff)

Beginning their empirical treatment with commodity flow matrices of 53 different 2-digit SITC commodity types for the year 1970, the authors use this data in its raw (non-dichotomized) form. Excluding all countries with populations less than one million, further excluding all Eastern block countries due to missing data (ibid.:526, note 4), their analysis covers 86 countries of the world in 1970. Instead of using all these 53 matrices as input in their analysis, these matrices were compared (using factor analysis, see ibid.:528ff) in search of pattern similarities, finding that these 2-digit SITC commodities can be grouped into 5 broad categories, each containing commodities whose trade patterns resemble each other.¹¹⁵ The authors note that these five different groups of commodity types, derived from their similarities with regards to flow patterns, also are commodity types that share similar degrees of processing and/or whether the commodities are raw materials or manufactures. For instance, trade in non-electrical machinery is more similar to trade in organic chemicals, pharmaceutical products and coloring materials, than what it is to trade in footwear. Footwear, on the other hand, is more similar to the trade patterns in travel goods, handbags, cork and wood manufactures than it is to non-electrical machinery – and so on. As such, the results from this factor analysis are interesting by themselves as they lend support to an international division of labor, further elaborated by the authors in Smith and Nemeth (1988).

The second step prior to the role-analysis is the collapse of the commodity flow matrices within each group, resulting in 5 group-wise matrices used as input for the Concor algorithm. Similar to Snyder and Kick (1979), but contrary to Breiger (1981), the splitting at each level only separates a handful of countries, while the bulk of countries are split further using Concor again until arriving at 8 positions (Table 5.6). Contrary to Snyder and Kick (1979), the core actors are the first to be identified by the Concor algorithm: Nemeth and Smith view this as more consistent than in Snyder and Kick (1979) in which a set of African countries were the first to be split by Concor, this “suggesting a basic difference between these countries and all others” (Nemeth and Smith 1985:534).

Having established the 8 would-be role-equivalent sets (see Table 5.6), Nemeth and Smith look at mean flow matrices for each of the 5 commodity groups, deriving two sets of corresponding block images using the mean flow and the top-quintile, respectively, as dichotomizing cutoff values. Based on these block images, the authors identify not three but four world-system strata: a core (A), a strong semiperiphery (B-D), a weak semiperiphery (F and G), and a periphery (E and H). The authors are somewhat surprised by the block image similarities for the different commodity groups, for instance that the core is a bigger exporter of raw materials and food products than the periphery: “Given the emphasis on unequal exchange based on differences in raw material/finished product flows, it is rather surprising that the image matrices for all five commodity types are so similar” (ibid.:543). This is however somewhat contradictory: if there would be an “inverse” flow structure for unprocessed versus processed goods when looking at the exchange values of these flows, there would be no unequal exchange in the monetary sense, instead merely demonstrating international specialization of goods exchanged at equal prices. When dealing with the absolute *values* of commodity flows, this tells us very little about the *volumes* of goods exchanged. Nevertheless, based on the exchange-value structures for the five commodity

¹¹⁵ This approach of identifying clusters of commodity networks that share similar pattern structures were later presented in Smith and Nemeth (1988), an article in which they identified flow clusters for three years: 1965, 1970 and 1980. These results were subsequently used by Smith and White (1992) – see below.

groups, the authors find support for the idea that the raw material/manufactures distinction between core and periphery may gradually become less significant.

Position	Countries	Stratum
A	Belgium, Canada, France, Italy, Japan, Netherlands, United Kingdom, USA, West Germany	C
B	Australia, Austria, Brazil, Denmark, Mexico, Nigeria, Spain, Switzerland, Sweden, Venezuela	SSP
C	Argentina, Hong Kong, India, Philippines, Singapore, South Korea	SSP
D	Finland, Greece, Iran, Ireland, Israel, Libya, Norway	SSP
E	Cameroun, Ivory Coast, Madagascar, Morocco, Senegal, Tunisia	P
F	Chile, Colombia ¹¹⁶ , Ghana, Pakistan, Thailand	WSP
G	Egypt, Kenya, Malaysia, New Zealand, Portugal, Zaire, Zambia	WSP
H	Afghanistan, Benin, Bolivia, Burma, Cambodia, Central African Rep., Chad, Congo, Costa Rica, El Salvador, Equador, Ethiopia, Guatemala, Honduras, Indonesia, Jordan, Laos, Lebanon, Liberia, Malawi, Mali, Mauritania, Nicaragua, Niger, Panama, Paraguay, Peru, Sri Lanka, Somalia, Sudan, Tanzania, Togo, Turkey, Uganda, Upper Volta, Uruguay	P

Table 5.6: Block membership in Nemeth and Smith (1985:527) – 86 countries as of 1970

*: C=Core, SSP=Strong Semiperiphery, WSP=Weak Semiperiphery, P=Periphery

Stressing that the role-structural analysis are interesting in and of itself, the authors also look at the statistical association between block membership and national attributes - GDP per capita, annual GDP growth rates 1970-1979, Gini coefficients, and child mortality – finding a strong relationship between block membership and all these different indicators of national development.

Recognizing the limitations of not having data on the Eastern block countries, plus the fact that the study only looks at one point in time, the authors refrain from drawing any major substantive conclusions regarding the world-system and occurrences of unequal exchange. The authors do however identify four strata in the world-system of 1970, strata populated in a manner that seems to be more consistent than what was done in Snyder and Kick (1979).

Similar to Snyder and Kick (1979) and Breiger (1981), the main contribution of Nemeth and Smith (1985) is of a methodological nature, stressing the utility of SNA-style approaches in world-system analysis as an approach that truly treats dependency as a referential context. Despite the possibilities with network-analysis, Nemeth and Smith end their study by underlining that structural analysis should be a complement to traditional cross-national analyses rather than a replacement:

[W]e find that the structural position that a country occupies can restrict or promote patterns generally associated with national development. This does not argue, however, for the primacy of “external” world-system factors over “internal” regional or historical effects as the ultimate explanation for social change. Indeed, we feel that posing the question of the importance of factors affecting development in such stark dichotomies actually obfuscates the complex interrelatedness of processes operative at the various levels of the modern world-system. (Nemeth and Smith 1985:556ff)

Smith and White (1992)

In 1992, David Smith joined forces with the originator of the REGE algorithm, Douglas White, writing the third major article in this genre of SNA-style role-analysis of the modern

¹¹⁶ In Figure 1 in Nemeth and Smith (1985:527), it says “Columbia” instead of “Colombia”, an assumed typing error.

world-system. Building on Nemeth and Smith (1985), two improvements are made in the 1992 article. First, Smith and White conduct a dynamic study, looking at the network of international trade at three different points in time: 1965, 1970, and 1980. Secondly, contrary to Snyder and Kick (1979) and Nemeth and Smith (1985), the notion of structural equivalence is abandoned in favor of regular equivalence, the latter argued to be “methodologically superior to previous work” (Smith and White 1992:857).

Similar to the previous work in the genre, Smith and White begin by situating their study, and the general approach of role-analysis in world-system contexts, in a broader economic-theoretical framework. Noting that there are three different and sharply contrasting models concerned with international trade and development – a neoclassical, a geopolitical, and a world-systemic perspective – the authors argue that the toolbox offered by social network analysis eventually “may provide a means of scientifically adjudicating between [these] competing images of international systems structure and dynamics” (ibid.:858). The ambitions for their 1992 article are stated as being more modest, using SNA methods to address a number of unanswered questions within the world-system perspective: the number of, and country classification within, world-system strata, strata mobility over time, and the nature of unequal exchange between strata. The article also addresses empirical evidence of a New International Division of Labor (NIDL) and whether there are signs of a forthcoming hegemonic shift towards a more multicentric core.

Only including countries which report data for each of the years, the 86 original countries in Nemeth and Smith (1985) are reduced to 63 in the study by Smith and White (1992). Utilizing the results from the factor analysis done by Smith and Nemeth (1988), where 2-digit SITC commodity categories¹¹⁷ were categorized into 5 groups of commodities with similar flow patterns, Smith and White choose the three most significant commodities in each of these 5 groups representing the average for years 1965, 1970 and 1980 (see Smith and Nemeth 1988:235), ending up with 15 commodity flow matrices – see Table 5.7 – for each of the three years studied. Although 38 2-SITC commodity categories thus are omitted from the analysis, the choice of commodities is nevertheless representative of these 5 major commodity clusters for all three years.

Using a variant of the REGE algorithm (REDI), regular-role structures for each of the three years were calculated, simultaneously using the 15 commodity flow matrices as input for respective point in time. Contrary to the discrete partitioning into role-equivalent sets obtained by the Concor algorithm, REGE/REDI results in equivalence matrices that contain continuous measures of role-equivalence between pair of actors. When Smith and White consequently plot the results from an optimal scaling of the equivalence matrices, the actual clustering of actors into role-equivalent sets is more open for interpretation than when using the Concor algorithm as the former yields continuous, rather than discrete, results. This lends support for the Chase-Dunnian view of world-system stratification, i.e. where “the vocabulary of zones [such as core, semi-periphery, and periphery] is just a shorthand [where] the core/periphery hierarchy [is understood] as a complex continuum” (Chase-Dunn 1989:214), but where this complexity is almost fully explained by a single dimension of the optimal scaling in Smith and White (1992). Applying two types of hierarchical clustering on the scaled equivalence matrices, they choose to divide the equivalence matrices into three

¹¹⁷ Nemeth and Smith (1985) and Smith and Nemeth (1988) used the second revision of the SITC nomenclature, a revision released in 1975 and subsequently replaced by a third revision in 1986. As the studies by Smith and White (1992) and Mahutga (2006; see below) build on the data in Nemeth and Smith (1985), these articles also employ the second revision of the SITC nomenclature (personal communication with Smith and Mahutga).

major positions (i.e. role-equivalent sets of actors) – core, semi-periphery, and periphery – complemented with a finer division where the latter two are split into upper and lower semi-peripheries and peripheries respectively. Strata membership for different countries for the year 1965 are given under the column headers in Table 5.8 below, with membership for 1980 are given by row headers.

High Technology Heavy Manufacture

Machinery, non-electrical
Artificial resins, plastics, cellulose, ethers
Manufactures of metal, n.e.s.

Low Wage/Light Manufactures

Articles of apparel, clothing accessories
Footwear
Travel goods, handbags, similar containers

Sophisticated Extractive¹¹⁸

Paper, paperboard, articles of paper pulp
Pulp and waste paper
Gas, natural and manufactured

Food Products and By-Products

Meat, meat preparations
Dairy products and bird's eggs
Crude animal and vegetable materials, n.e.s.

Simple Extractive

Oil seeds and oleaginous fruit
Animals oils and fats
Cereals and cereal preparations

Table 5.7: 2-digit SITC commodity classes (15 out of 53) covered in Smith and White (1992).

Similar to the previous studies in this genre, Smith and White proceed with looking at the statistical association between membership in the perceived role-equivalent sets and internal national attributes. However, contrary to the previous studies, this step in the analysis is not to verify the network-analytical methods using national attributes as some sort of benchmark. Instead, Smith and White use the role-analytical results in a far more confident manner, comparing their findings with GNP per capita measures to prove the superiority of role-analysis over national attributes for identifying world-system strata membership:

[T]he correlations of GNP per capita over the time periods 1965-1970, 1965-1980, and 1970-1980, with block membership (.75, .74, .80) and the first scaling dimension (.77, .76, .81), reinforce the view that we are measuring a distinct indicator of world-system position. Closer analysis of discrepancies between the GNP per capita figures... shows that GNP per capita is a much poorer measure of core-periphery status. Libya, for example, fits clearly into our periphery at all three time points. Like other oil-producing countries...it lacks a diversified industrial economy but has a GNP per capita nearly at parity with the top core states. (Smith and White 1992:874)

The dynamic aspect of their study is manifested in how the authors look at strata movements over the three time-points, stating (incorrectly¹¹⁹) that 15 countries move upwards among the five strata and where only two move downwards. Containing only four countries in 1965, the core had expanded to 11 countries in 1980, which could point towards a multi-centric core and hegemonic decline for, especially, USA. Strata movement also gives some support for a New International Division of Labor (NIDL), where the typical Newly Industrialized Countries (NIC:s) of Brazil, Singapore and South Korea all move upwards over the time

¹¹⁸ While Smith and White choose to name this group “Sophisticated Extractive”, Nemeth and Smith referred to this group as “intermediate manufactures” (Nemeth and Smith 1985:529) - a group that Mahutga (2006) later on choose to label “Extractive”. This, and the addition “Low Wage”, are the modifications on the naming of the groups.

¹¹⁹ Judging by their detailed table on block membership for the different years (Smith and White 1992:872ff, Table 1), there are actually 19 countries moving upwards in the hierarchy, not 15. The figure of 15 that Smith and White mention is most probable obtained by visual inspection of their table on block mobility between 1965 and 1980 (ibid.:879, Table 5), a table that however is flawed (see next footnote).

period. With more countries climbing upwards in the world-system hierarchy than falling downwards, “[c]learly this suggests that international mobility is not a zero-sum game.” (ibid.:880). Furthermore, they argue, “if all countries moved up to core and semiperiphery, the semiperiphery as a whole would necessarily become a renormalized periphery” as “[c]ore and periphery are relative terms, not absolute” (ibid.).

		C	SP1	1965 SP2	P1	P2
1980	C	USA, Canada, West Germany, United Kingdom	France, Japan, Italy, Netherlands, Switzerland, Belgium*, Sweden			
	SP1		Denmark, New Zealand, Argentina, Australia, Austria, Hong Kong, Spain, Finland, Venezuela, Ireland, Norway	Brazil, Yugoslavia, South Korea, Greece, Singapore		
	SP2		India	Philippines, Thailand, Peru, Chile, Malaysia, Colombia, Portugal, Israel, Turkey, Egypt, Hungary	Morocco, Tunisia, Libya, Ecuador	
	P1			Pakistan	Nicaragua, Guatemala, Sudan, Costa Rica, Panama, Honduras, Senegal, Madagascar, Sri Lanka, El Salvador	Cameroon, Jordan, Gabon
	P2					Congo, Togo, Niger, Burkina Faso, Central African Rep., Malawi

Table 5.8: Block membership for 1965 and 1980 of 63 countries in Smith and White (1992:872ff).¹²⁰

*: Includes Luxembourg

As was previously demonstrated in this chapter with respect to the Galtung typology on core-periphery structures, regular equivalence is indeed superior to structural equivalence when it comes to identifying the role-equivalent sets of actors which the Galtung typology is supposed to reflect. This methodological superiority shines through in the analysis by Smith and White: compared to previous studies where the notion of structural equivalence is used to determine role-equivalent sets, the role-equivalent partitioning done by Smith and White (1992) seems to be most in line with intuitive notions of the modern world-system for the three years covered in their study. Contrary to how the Concor algorithm results in a

¹²⁰ The table in Smith and White (1992:879, Table 5) that is supposed to depict block membership and change for the years 1965 and 1980 does not correspond to the results as presented in their previous data tables (ibid.:873, Table 1; also ibid.:877, Table 3): while discussing their finding of a 1965 core consisting only of four countries (ibid.:873), their table on block mobility between 1965 and 1980 depict a 1965 core consisting of 8 countries. Table 5 on page 879 in Smith and White thus indeed seems to be erroneous.

partitioning of a network into discrete sets of would-be role-equivalent actors, the algorithm used in Smith and White (1992) for determining regular equivalence yields a continuous measure of role-equivalence between each pair of actors. Combining the results from optimal scaling of the equivalence matrix with two types of hierarchical clustering schemes (ibid.:868, 870), Smith and White find support for a trimodal world-system, where a finer partition of these results in 5 distinct strata: a core, two semi-peripheries, and two peripheries.

Using the factor-analytical results from Smith and Nemeth (1988), where 53 different commodity types were categorized into 5 groups based on their flow-similarities, Smith and White (1992) only includes actual data on 15 of these commodities, these representing 3 commodity types in each of the 5 groups identified by Smith and Nemeth. Role-set membership and strata mobility are thus only based on these 15 commodities alone: while 15 flow matrices are quantitatively more than 5, the flow matrices analyzed by Nemeth and Smith (1985) did however contain (aggregated) data on *all* 2-digit SITC commodity types rather than a selection thereof. Used to determine strata membership of the 63 countries for each of the three time periods, the 15 commodity categories chosen for this analysis is what forms the empirical basis for the conclusion on strata movement: there is, according to the authors, an overall upward movement of countries between the five identified strata. If other, or all, 2-digit SITC commodity categories were to be used in the regular role-analysis, the subsequent conclusion regarding the overall mobility of countries between strata – not to mention the actual strata categorization of countries – could though be slightly different, possibly reflecting a net downward movement of strata membership, perhaps a zero-sum movement situation, and a possible shrinking of the core between 1965 and 1980. Still, as the selection of commodities was based on them being representative of their particular commodity groups, such differences could also be minor, if any.

The discussion by Smith and White on inter-strata movements and whether it is zero-sum or not is not related to world-system discussions on unequal exchange and whether international exchange and development reflects a zero-sum or a cornucopian situation (see, for instance, Hornborg 2001:23ff). Instead, zero-sum strata movement in the context of Smith and White (1992) is concerned with classification of countries into role-equivalent sets. As the expansion in 1980 of a relatively small core of 1965 does indicate hegemonic decline – particularly for USA – and the advent of a more multicentric core, this does not imply a general flattening of the perceived world-system hierarchy during this time-period nor a general hegemonic decline, except from the point of view of these 15 particular commodity types.

With core, semi-periphery and periphery indeed being relative concepts (Smith and White 1992:880), there are nevertheless also substantial and functional differences between the different zonal categories used in world-system analysis, differences which are reflected in internal, non-relational parameters of the countries classified into these different strata. The nature of national production structures (especially labor relations and wage levels) and product specialization are perhaps the best attributional indicators of zonal membership of countries: core countries are typically defined as having diverse economies with skilled labor employed in high value-added segments, while countries belonging to the peripheral stratum usually are depicted as having fairly specialized economies, producing low value-added to the products. Thus, the eradication of a whole world-system stratum can hardly be determined or pondered upon after a structural analysis for the period 1965-1980: a would-be “renormalization” of a semi-periphery into a periphery (ibid.:880) would in essence imply a lot more than a shift in role-classification results obtained by looking at a handful of

commodity categories. Except for the differences in internal production structures and institutions of the countries occupying each of the three world-system zones as depicted by Wallerstein et al, the semiperiphery is also depicted as fulfilling a unique role as a political stabilizer in the modern world-system (Wallerstein 1974:403; 1979:69), a role whose disappearance would have repercussions on the future stability of the system as a whole.

Smith and White on unequal exchange: asymmetrical commodity flows

The second part of their article addresses aspects of unequal exchange. Acknowledging its origin and genesis in the works of Mandel, Emmanuel and other neo-Marxists, i.e. as differences in wage levels between trading partners, Smith and White find that “the debate about the precise nature of unequal exchange is a complex and contentious one” (ibid.:881). Admitting that their own treatment of the issue does not deal with unequal exchange in “the Mandelian sense”, they put some effort in erecting a conceptual bridge between this traditional of unequal exchange to their analysis of asymmetrical commodity flows. Referring explicitly to Wallerstein, Amin and Frank, Smith and White state that “[a]symmetrical commodity flows are related to the notion of unequal exchange proposed by [these] world-system theorists” (ibid.), but they prefer to use the term “asymmetrical trade patterns to avoid any terminological confusion” (ibid.). By referring to Bunker’s work (1984) on extractive economies, the authors search for further validation that “these [trade] asymmetries...provide information that is relevant to various theories about how unbalanced flows of commodities maintain global inequality” (ibid.).

What the authors in essence do in the second part of their article is that they look at inter- and intra-positional net trade flows for each of the 15 chosen 2-digit SITC commodity categories at each of the three points in time. Examining how the flow direction of these 15 commodities change over the various years, they find strong empirical support for the emergence of a NIDL, furthermore noting that “[t]his seems to fit the standard arguments...about trade asymmetries between core and periphery in which highly processed capital-intensive commodity production is centered in the core and export agriculture becomes a specialty of the periphery” (ibid.:882).

While their sophisticated analysis of the changing directions of trade flows for the different commodities lends empirical support for the emergence of a NIDL, the connection between their findings and unequal exchange, conceptually bridged using a notion of “asymmetrical trade patterns”, has some noticeable shortcomings. First, it has to be remembered that only 15 (out of 52) 2-digit SITC commodity categories are used in the study, commodities selected on their flow patterns being the best representatives of the 5 pattern-similar groups as identified in Nemeth and Smith (1985). Although meat, meat preparations, dairy products, bird’s eggs, and non-edible animal and vegetable materials (not elsewhere specified) very well might be adequate representations of the “Food products and by-products” segment in the role-structural analysis, it can be questioned whether these commodities alone can capture the “export agriculture [deemed as being] a specialty of the periphery” (ibid.:882). Secondly, what trade asymmetry means in this context is exactly this: occurrences of inter-positional net flows of the *values* of each these 15 commodity types. High values could thus reflect high prices rather than high volumes, which in turn would mean that the study only cover commodity categories having a fairly high value-to-weight ratio, thus ignoring the “under-valued goods, produced at low wages in peripheral areas” (ibid.:881) which their account is supposed to address. Occurrences, and magnitudes, of trade asymmetries as perceived by the authors should intuitively vary depending on the choice of 15 commodity categories that are used to establish such asymmetries, argued to be in relation to unequal exchange.

Third, related to the issue of looking at exchange values of commodity flows, Bunker is a somewhat poor supporting reference in a study that explicitly looks at the net value flows of commodities as a proxy for unequal exchange in a non-Mandelian, non-Emmanuel sense. Rather, Bunker promoted an ecological approach to unequal exchange: the type of net trade flow asymmetries which maintains global inequality are, in Bunker's work, explicitly concerned with non-monetary measures of economic exchange, not exchange-value commodity trade balances. I do strongly agree on their statement that trade asymmetries "provide information that is relevant to various theories about how unbalanced flows of commodities maintain global inequality" (ibid.:881), but it is the non-monetary segments of such information that has the greatest bearing on the gulfs in material want-satisfaction between parts of the world, which is what is of concern in the work of Bunker.

The last objection I would like to raise towards the unequal/asymmetrical exchange/trade part of the article is also related to the usage of monetary values for addressing the issue at hand. While unequal exchange in the Emmanuel sense very well may exist, economic exchange as measured in exchange values is never unequal: when two partners choose to engage in economic exchange in an open market, the amount of commodities, credits or services changing hands are by definition valued at equal monetary values. "Asymmetric trade" as perceived by Smith and White do indeed exist, but as trade imbalances which are adjusted by Humean-style¹²¹ repercussions in contemporary currency and credit markets – at least according to standard theory. The perceived connection between such "trade asymmetries" and world-systemic unequal exchange is too diffuse and, simultaneously, too simplistic, raising further questions as the complex issue of unequal exchange is remolded: does the unequalness of trade balance sheets and resource transfers apply to the importer or the exporter of net trade value? What does the huge trade deficit of USA mean in terms of a would-be hegemonic decline? Do the equally huge trade surpluses of China indicate a rise towards imminent core status?

Although some of the substantive conclusions drawn by Smith and White can be questioned, primarily on grounds on the chosen selection of commodities and the somewhat problematic conceptual bridging between net trade value balances and notions of unequal exchange, their article of 1992 represents a significant leap forward in applied methods. Introducing the notion of regular (rather than structural) equivalence to a world-system context, their classification of countries into role-equivalent sets represents a definite improvement compared to the previous studies by Snyder and Kick (1979) and Nemeth and Smith (1985). Secondly, Smith and White demonstrate how structural change can be analyzed over time, comparing different snapshots of the world-system for a number of years to look at inter-strata mobility. Overarching both the substantive and methodological aspects of their paper is an attitude of methodological confidence: when encountering deviations between GNP per capita measures and role-set membership, the authors do not perceive this as a flaw with general SNA approaches at large, but instead underline that they indeed are mapping a distinct aspect of the world-system. Fulfilling the vision of Snyder and Kick (1979; see also Steiber 1979), Smith and White (1992) demonstrate how the structural-analytical approach of SNA-style role analysis is fully compatible with, and offering a brand new perspective on, world-system analysis and the global marked-based distribution of the essences that provides material want-satisfaction.

¹²¹ See chapter 2 on Hume and the price specie-flow mechanism.

Mahutga (2006)

Building on Smith and White (1992), Mahutga's study of 2006 looks at the network of world trade in five year periods, extending the former study with data for the years 1990 and 2000. Similar to its predecessor, Mahutga applies regular equivalence on commodities derived from the factor analysis of Smith and Nemeth (1988), identifying different world-system strata and mobility between these. Mahutga addresses three basic questions: whether trade patterns reflect a core-periphery structure, whether role-structural properties reflect inequalities with respect to levels of industrial sophistication, and whether globalization and NIDL has encouraged upward mobility of historically poor countries. The author notes that while there is a consensus on the occurrence of a NIDL, there is no consensus on its effect for development and a would-be reduction of global inequalities.

Framing his study in a theoretical discussion that, among others, refers to Marshall, Hirschmann and Galtung, Mahutga notes that the classical distinction of raw materials and manufactures for periphery and core is breaking down as industrial production spreads globally with a NIDL occurring in conjunction with free trade ideologies. However, integrating ideas from global commodity chain research (see next chapter), Mahutga notes that there are qualitative differences in levels of industrial processing in this new world order of production: Mahutga underlines the need to look at the gap in product sophistication between different types of industrial commodities, a gap that partly has replaced the traditionally perceived raw material-manufactures distinction in international trade.

According to Mahutga, different levels of processing and industrial sophistication are related to product diversity, both which are related to different structural positions in the world economy:

[A] country's position in structures of international trade is therefore highly correlated with its level of processing: high variation in the types of commodities a country produces means greater access to markets and trading partners. [...] [C]ore countries will tend to export and import large volumes of commodities to and from *many* countries located throughout the entire world economy. The role of non-core countries involves specializing in exports of raw materials and, increasingly, intermediate processed goods to higher zones in the hierarchy. Consequently, these countries will tend to have fewer trading partners, most of which will be located at higher zones in the hierarchy. (Mahutga 2006:1867)

The data used in the study covers the years 1965, 1970, 1980, 1990, and 2000, data which were acquired exclusively for the study. The commodity coverage consists of four of the 2-digit SITC groups used by Smith and White (1992) – see Table 5.7 above – though excluding the “Simple extractive” group containing “Oil seeds and oleaginous fruit”, “Animals oils and fats” and “Cereals and cereal preparations”. The group labeled as “Intermediate manufactures” by Nemeth and Smith (1985), labeled “Sophisticated Extractive” by Smith and White (1992), is renamed once again by Mahutga to “Extractive” (2006:1877). Only countries reporting trade data for all of the five years are included in the study, reducing its coverage to 53 countries. For each year, an aggregate commodity flow matrix was created containing the 12 2-digit SITC commodity categories for that particular year.

Contrary to Smith and White (1992), Mahutga applied a log-10-transformation on these five aggregated flow matrices prior to the REGE algorithm, thus significantly reducing the inherent value spans of the commodity trade data. The *raison d'être* for this transformation, however, was not an explicit attempt to counter the value-dwarfing syndrome of the REGE algorithm; instead it was due to the used REGE implementation created non-sensical results

without such a transformation (personal communication). The log-10-transformed trade flow matrices were subsequently used as input to the REGE algorithm, which after 3 iterations yielded coefficient matrices containing measures of regular-role equivalence between each pair of the 53 countries for each of the five years.

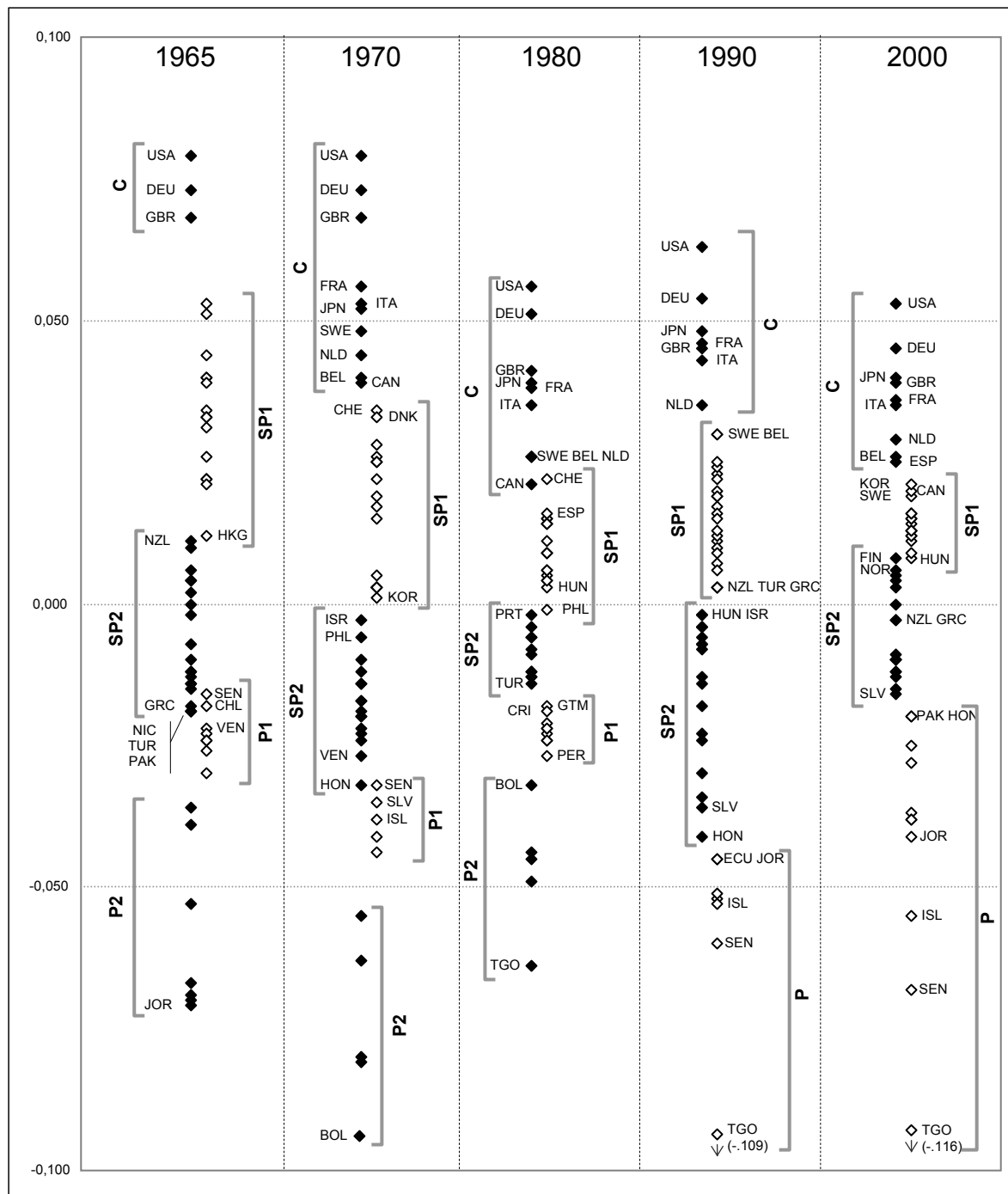

Figure 5.12: Scatterplot of network measures of world-system position and strata membership for the 5 years covered in Mahutga (2006).¹²²

Using factor analysis (singular value decomposition), Mahutga finds that 95-97 percent¹²³ of the REGE coefficient variations can be explained by a one-dimensional value. Confident

¹²² Data from Mahutga (2006:1872ff:Table 2a and 2b, and 1874ff:Table 3a and 3b)

from such a high correspondence, this first-dimensional correspondence value is subsequently labeled as a “network measure of world-system position” (ibid.: 1872ff). A scatterplot of these values, arranged vertically according to world-system-positional network measure, for the 53 countries for each year are given in Figure 5.12 above.

Similar to Smith and White (1992), following the sociological tradition of Chase-Dunn et al, Mahutga views core-periphery-stratification as a continuous variable, something that his non-discrete network measure of world-system position indeed lends support to. Also similar to Smith and White, the author does categorize countries into a chosen number of discrete strata for each year. Arriving at the same number of strata for the years covered by Smith and White (1992), i.e. five, Mahutga only finds support for four strata in 1990 and 2000, the latter two years containing singular peripheral blocks. The number of strata for each year – and the membership of countries into these strata – is done by visual inspection of hierarchical clustering dendrograms. While not including these dendrograms in the article, an explanation on how this eye-balling procedure is done can be found in an endnote of the article:

While choosing the appropriate number of blocks can sometimes seem arbitrary, Wasserman and Faust (1999) note that “the trick” is to choose the point along the series that gives a useful and interpretable partition of actors into equivalence classes [blocks].” (383). (Mahutga 2006:1885, note 15; original square-bracketing)

The strata membership of countries for each year is marked in Figure 5.12 above. With the “network measure of world-system position” arguably explaining 95-97 percent of regular equivalence (ibid.:1871), it is at times in conflict with the classification of countries into the different strata identified by Mahutga from the (non-documented) hierarchical clustering schemes. In 1965, the network measures of world-system position of Senegal and Chile being higher than the corresponding measures for Nicaragua, Turkey and Pakistan, the former two are nevertheless deemed as belonging to the 1st periphery while the latter three are members of the 2nd semi-periphery.¹²⁴ For 1980, Switzerland is placed in the 1st semi-periphery and Canada is placed in the core, even though the former has a higher value on its network measure than the latter. Although Finland and Hungary have the same network measure in 2000, as have Honduras and Senegal in 1970, these two pairs of countries are nevertheless placed in different strata.¹²⁵

Looking at the vertical scatterplot in Figure 5.12 above, the breaks between identified strata does not correspond to the breaks between the (vertical) positions of countries, i.e. their network measures of world-system position. That is, judging by Figure 5.12, there seems to be little empirical support for the chosen number of strata arrived upon – and there is no other empirical support or measure of goodness-of-fit for the chosen number of partitions and actual breakpoints that define these strata. Although the difference in the network position measure between New Zealand and Hong Kong is only 0.001 in 1965, the breakpoint

¹²³ The first dimension in the singular value decomposition analysis explains more than 97 percent for all years except 2000 in which the first dimension explains 95 percent of the variation.

¹²⁴ The rank orders for each country in 1965 and 2000 are given in Mahutga (2006:1879, Table 6). Senegal and Chile have rank orders 35 and 36, while Greece, Pakistan, Turkey, and Nicaragua have rank orders 37-40. These rank orders, subsequently used to measure mobility in the world-system, thus reflect the measures of world-system position as given in Figure 5.12, although apparently not used for determining membership in the different strata of the world-system.

¹²⁵ Theoretically, these discrepancies could be due to the residual percentages not explained by the first dimension in the Singular Value Decomposition; however, as the explained variance is very large (95-97 percent), it seems unlikely that this is the case.

between the 1st and 2nd semi-periphery is chosen to be exactly between these two countries. Rather than defining strata as based on the maximum relative differences in the proposed measure, the maximum differences between countries are instead typically to be found *within* the strata identified by Mahutga.

Using the strata identification above, Mahutga creates a collapsed blockmodel containing the (non-logarithmic) values of aggregate trade flows between and within the five strata identified in 1965. With 45 percent of total trade flows being intra-core trade, and only 4 percent being trade between non-core countries, Mahutga finds that “[t]he latent structure of the data conforms well to the conception of core/periphery from network theory” (Mahutga 2006:1876), an argument reinforced by collapsed blockmodels for the other years studied.

Creating similar collapsed (reduced) blockmodels for each commodity and year, Mahutga addresses the second question in his article concerned with the “gap” between different types of industrial production:

If there is a systematic pattern in which commodities produced at higher levels of processing originate at higher zones of the structure and commodities produced at lower levels of processing originate at lower zones of the structure, this would suggest that the international division of labor remains bifurcated between countries with advanced industry and countries with less advanced industry. Such a bifurcation would suggest that unequal terms of trade still benefit the advanced industrial group over the less advanced group. (Mahutga 2006:1877)

Following the same procedure as in Smith and White (1992), Mahutga uses an index¹²⁶ depicting whether, and to what degree, a commodity moves up or down the core-periphery-hierarchy. Over the period studied, Mahutga finds that commodities in the High Technology/Heavy Manufacture group (SITC 71, 58, 69) move down the hierarchy, from core to periphery, while the commodities in the Low Wage/Light Manufactures group (SITC 84, 85, 83) (as well as the commodities in the Extractive group) tends to move upwards – the trends of the indices for nine of the studied commodity categories are found in Figure 5.13 below. The contrast between the High Technology/Heavy Manufacture and the Low Wage/Light Manufacturing commodity groups “suggests”, according to Mahutga, “that industrial expansion in developing nations is highly uneven. While industrialization has occurred in non-core countries, not all countries have industrialized to the same degree in levels of processing.” (ibid.:1878). Although the ratio of High Technology commodities flowing down the hierarchy has decreased over the period does indicate that less of such commodities are produced in the core, Mahutga notes that it is the strong semi-periphery that has gained this production, finding that “countries that were already relatively advantaged *vis-à-vis* lower peripheral countries benefited from globalization in ways that the poorest countries have not.” (ibid.).

Except for these few strong semi-peripheral countries, Mahutga finds that the indices do point to a persistence in the “gap” between levels of processing between the identified world-system strata. However, as strata membership varies over time for some countries, inter-stratum trade in one period may very well be intra-strata trade in another. Also, by reducing

¹²⁶ “The index assesses whether or not the core/periphery structure conforms to a segmented division of labor by dividing the sum of the cells below the diagonal (flows directed up the hierarchy) by the sum of the cells above the diagonal (flows directed down the hierarchy) for each of the 60 block models estimated in the previous section. I log the ratio so that it is 0 at parity, positive when net commodity flows move up the hierarchy and negative when they move down.” (Mahutga 2006:1878). Although explained in detail by Mahutga, it is the same index as used in Smith and White (1992:882ff) to determine changing flow directions in relations to a NIDL.

the number of strata to four in the last two years does also affect the indices in a dampening way: as the number of strata change post-1980, this will affect the indices, and the conclusions, to a minor degree.

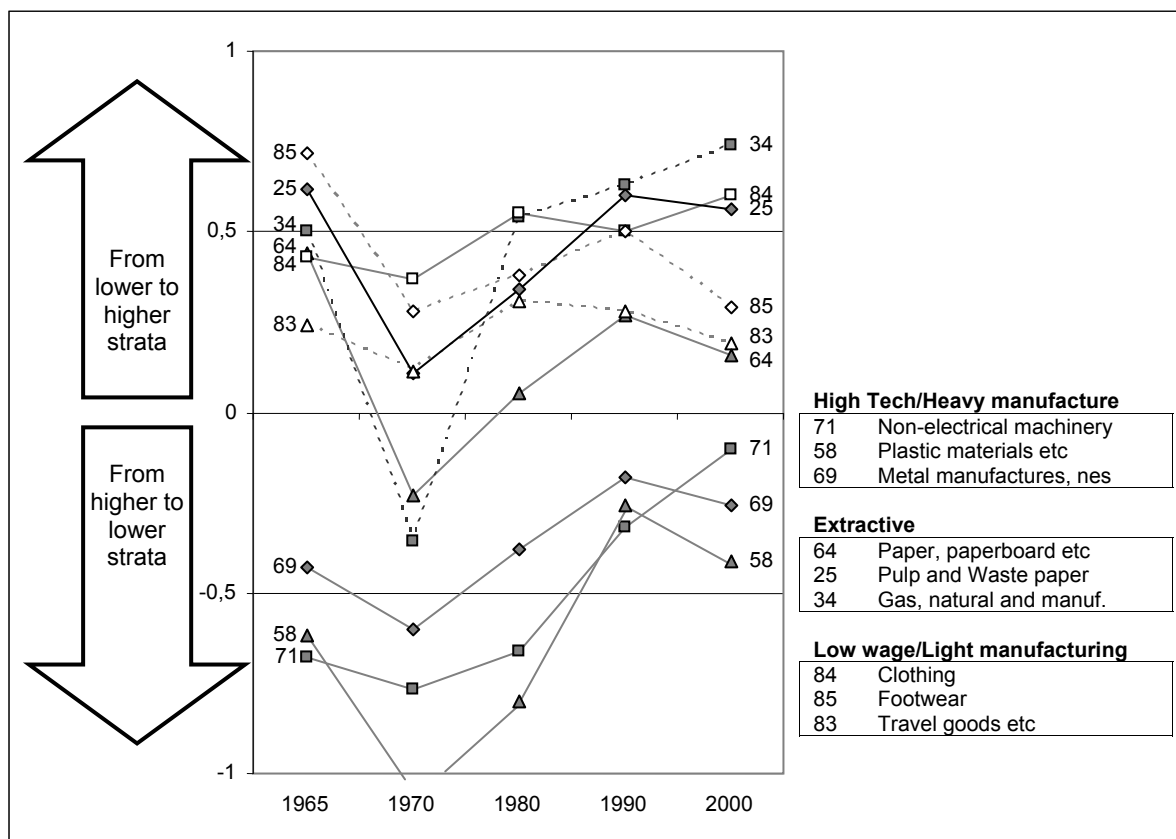

Figure 5.13: Index trends of overall direction of flows for 9 (out of 12) commodities analyzed by Mahutga (Source: visualized excerpt from Mahutga 2006:1877; Table 5)

Judging by the analytical results stemming from the Global Commodity Chain school (see next chapter), clothing (SITC 84) and footwear (SITC 85) are two highly relevant commodities when studying globalization and a NIDL. However, the index trends for these two commodities point in different ways in Figure 5.13 above: although both clothing and footwear flow upwards in the hierarchy, the ratio of the upward flow of the latter has decreased substantially between 1965 and 2000. This, however, does not necessarily indicate that less footwear are produced in the periphery for markets in the core: the index, and the analysis by Mahutga, is concerned with the *values*, i.e. not volumes, of flows. That the index for footwear does decrease for the time-period could thus very well indicate that a NIDL indeed has occurred for this commodity category as, which other empirical evidence points to, production is relocated to countries with even lower wage levels, a fact which could be reflected in how the *values* of these trade flows from periphery to core decrease over this period.

The discussions regarding the directions of trade flows differ somewhat between Smith and White (1992) and Mahutga (2006). The former study does find support for a NIDL for the period 1965-1980, exemplified by the trends in Low Wage/Light Manufacturing commodities whose upward flow ratios Smith and White found to be increasing:

Particularly for clothing and travel goods there is a clear trend toward increasing exports from lower blocks between 1965 and 1980 (which is precisely the period during which the NIDL changes were purported to take place). In these industries, cheap labor costs and relatively simple

technology allow noncore countries to compete on international markets. [...] We found that the share of the average value that our two semiperipheral blocks exchanged internationally rose significantly for all three commodities [including footwear]... These results provide clear evidence for the NIDL thesis. (Smith and White 1992:884)

The indices in Mahutga (2006) do not indicate such a “clear trend” – for 1970, the indices for these three commodities (as well as the others) all took a rather drastic downturn. While the overall upward flow of Clothing increased somewhat between 1965 and 1980 (though not as continuous as found by Smith and White (1992:883, Table 7), the ratio of Travel goods flowing up the hierarchy decreased somewhat - and decreased significantly for Footwear. These trends, in conjunction with the equally significant reduction of trade flows of High Technology/Heavy Manufacture commodities down the hierarchy, makes it somewhat surprising that Mahutga concludes that the overall “pattern of trade asymmetry in which goods with high levels of processing are exchanged between the core and higher zones of the hierarchy for goods with low levels of processing from lower zones has not changed” (Mahutga 2006:1878).¹²⁷

Addressing the third question on mobility, Mahutga rounds off his study by examining the change in rank order of countries as given by his network measure of world-system position. With the notable exceptions of South Korea, Singapore and Turkey, showing significant upward mobility (ibid.:1881), there seems to be little structural mobility over the period 1965 and 2000. Breaking down the 14.4-percentual change for each of the four intervals, Mahutga finds that most of this change occurs between 1970 and 1980. Therefore, while “the expansion of neo-liberal trade policy since the 1980s could account for much of the change between 1965 and 2000” (ibid.:1880), rank order mobility was very low between 1980-1990 (3.1 percent) and 1990-2000 (2.9 percent). Mahutga also notes that the structure is most stable at the top and at the bottom, with most of the movement occurring in the middle of the structure. Thus, “the high level of stability that is especially pronounced at the upper and lower ends of the continuum suggests further that the equalizing effect of globalization and the NIDL may be overstated.” (ibid.).

Mahutga: Summary and critique

Reflected in the title of the paper, the main substantial finding of Mahutga (2006) is the persistence of structural inequality: the NIDL and free trade ideologies have not led to any advancement of historically poor countries. Instead, “[t]he winners are the core countries that maintained their dominant positions throughout these global shifts [that began in the 1960s]” (ibid.:1882). Arriving at approximately similar strata classifications as Smith and White (1992), with the core expanding from 3 to 8-10 countries from 1965 onwards, Mahutga only finds support for four strata in 1990 and 2000 as the two peripheral strata merged into one for these years.

Regarding the analysis on the perceived gap between different manufactures, using the flow-direction ratio analysis of different commodities, Mahutga states the following in his conclusion:

¹²⁷ As the analyses by Smith and White (1992) and Mahutga (2006) both are concerned with the *values* of flows, i.e. not their *volumes*, this could imply, as mentioned above, that interpretations of their findings can lead to quite diametrical conclusions. A decreasing ratio of upward flows as measured in value could imply that more volumes are flowing up the hierarchy due to falling prices due to the relocation of production to low-wage countries.

[T]he analysis of commodity exchange suggests that unequal levels of processing continue to create structural inequality through the reproduction of a segmented international division of labor. [...] The most important change...was the rise of labor-intensive manufacturing in non-core zones of the core/periphery hierarchy. Thus, the old world of a manufactured goods/raw materials dichotomy co-exists with a low value added/high value added dichotomy. (Mahutga 2006:1882)

The indices on the direction of the commodity flows do reflect an increase of manufacturing in the non-core zones defined for each year, but the last sentence in the quote above is hardly supported by the empirical analysis done by Mahutga. Any evidence for a “manufactured goods/raw materials” dichotomy is not to be seen from the commodities chosen to represent the “Extractive” kind: apart for gas (SITC 34), which can be seen as a fairly processed commodity, no raw materials are covered by Mahutga.

Similar to Smith and White (1992), Mahutga use SNA methods in a far more confident manner compared to studies in this genre prior to Smith and White (1992). As such, there are no explicit methodological conclusions in his study. Instead, as stated in an endnote, “there has been an almost universal recognition in studies of global political economy that the best ways to conceive changes in the world economy use the concept of networks” (ibid.:1883), a statement reflected in his confident usage of network methods without any noticeable urge to pre-defend the usage of such or to validate his findings. While extending the time period studied, Mahutga use the same analytical procedure as Smith and White (1992) when looking at the flow-direction of different commodity categories. The novel approach in Mahutga (2006) is instead how the first dimension of the Singular Value Decomposition is treated as a continuous measure of world-system position, and how he subsequently examines changes in the rank order of these values over the studied period.

In relation to the intertwined discussion regarding the global division of labor, Mahutga can be criticized on the basis of the chosen commodities. The 12 commodities (out of a total of 52) are chosen as they best represent 4 out of 5 distinct groups of flow-pattern-similar commodities with respect to their exchange value during the 1965-1980 period (cf. Smith and Nemeth (1988)), even though his analysis also includes the years 1990 and 2000. Clothing and footwear – typical commodities studied in the Global Commodity Chain (GCC) literature (see next chapter) – are indeed relevant for the questions raised by Mahutga, but one can question the choice of the other 10 commodities. It would perhaps be more plausible to choose commodities based on the qualitative literature on global industrial restructuring and research on GCC and NIDL: it would be interesting to see commodities such as consumer electronics, semi-conductors, textiles, other low-wage manufacturing commodities, car manufacturing – not to mention a selection of raw materials such as fuel commodities, timber, minerals, food and fibers etc. Furthermore, as Smith and Nemeth (1988) classified clusters of pattern-similar commodity categories based on the *exchange values* of commodities, this might lead to the discarding of low-wage commodities and semi-finished goods which nevertheless, or just because of this, are highly important in NIDL research.

Although done for practical rather than methodological reasons, the log-10-transformation of the raw trade data prior to the REGE algorithm does nevertheless yield results that are strikingly similar to the role-set classifications by Smith and White (1992). A more thorough examination of pre-processing of REGE algorithm input data should therefore be an interesting methodological avenue to pursue: whether a log-10 (or similar) transformation of data is beneficial for the REGE algorithm in identifying regular role-equivalent actors as based on patterns, rather than mere strengths, of ties.

As previously discussed and demonstrated in Figure 5.12, the number of different strata identified for the different years seems to be chosen fairly arbitrary and at times also inconsistent with the proposed measure of world-system position. As the number of strata is of theoretical importance in world-system analysis, it is somewhat unviable to “choose the point along the series that gives a useful and interpretable partition” (Mahutga 2006:1885, note 15). However, the analysis on country mobility in the world-system is not affected by the strata definitions for each year as this final analysis looks at the the rank orders of different country as defined by the proposed network measure of world-system position. As such, the evidence from the mobility study seems to be the most reliable substantial finding in Mahutga’s study. It would have been interesting to study commodity flow directions between countries as based on these rank orders rather than inter-strata movement as the former would address the issue more *ceteris paribus*.

Summary of previously done studies

Without claiming coverage of all role-analytical studies of the contemporary world-system¹²⁸, the selection of studies above demonstrate a gradual improvement in methods in a research field currently evolving. From structural to regular equivalence, from static to time-dynamic data, and from dichotomization to more sophisticated data processing – the ventures into a new scientific terrain, coinciding with an overall popularity rise in SNA methods, opens up new research agendas, allowing for raising new questions as well as answering traditional questions from a new perspective. Except for the initial dilemmas posed by Snyder and Kick (1979) regarding the lack of empirical evidence for a core-periphery world-system and classification of countries into different strata, subsequent studies address issues concerned with mobility and structural persistence, the effects of a perceived new international division of labor, questions raised by the Global Commodity Chain school (see next chapter), issues concerned with the notion of unequal exchange, and comparisons between network-analytical results and more traditional cross-comparative studies of the actors in such systems.

There are indeed substantial differences in the findings of the various studies above. Using different datasets, the resulting role-equivalence sets do differ between authors – and, in the case of the Kick series of studies, the interpretations of the results seems to differ over time. Each of these studies, including the intra-OECD trade study by Breiger (1981), arrives at a structure consisting of a smaller core with various numbers of peripheral strata, related to each other in a typical core-periphery pattern.

The actual number of strata identified in the studies above varies somewhat – and in the case of the Kick series of papers, different number of strata are identified from the same datasets. Due to the nature of the Concor algorithm, the studies that utilize this algorithm arrive at several positions which subsequently are classified as belonging to a fairly arbitrary chosen number of strata. For instance, arriving at 10 positions in Snyder and Kick (1979), these positions are grouped into the three classical world-system strata of core, semiperiphery and

¹²⁸ Due to space limitations, I have been forced to leave out other studies which might have been of relevance here. One of those is Srholec (2006) which, contrary to the above studies, does not depart from a world-system perspective, instead departing from a general globalization perspective, partly including the Global Commodity Chain school as represented by Gereffi (see next chapter). Srholec use the REGE algorithm when looking at the trade structure of capital and intermediate goods, comparing these results with gravity-based models of international trade. Also, the blockmodel study of the international copper flow network by Tong and Lifset (2007) has been excluded here; applying the Concor algorithm on four trade flow matrices containing exchange values of these goods, the actual appearance of a network-analytical article in the *Ecological Economics* journal is perhaps its most important contribution.

periphery, without any thorough – formal – way of knowing whether these 10 positions best are categorized into three role-equivalent sets. In the studies that look at regular rather than structural equivalence – Smith and White (1992) and Mahutga (2006) – the identification of strata and categorizations of countries into these are more open for different interpretations as the REDI/REGE algorithms yield continuous measures of role-equivalence. However, while (non-documented) hierarchical clustering is used to classify countries into different strata, the actual number of strata can be chosen, as Mahutga states, “that gives a useful and interpretable partition of actors into equivalence classes” (Mahutga 2006:1885, note 15). As the number of strata are stated as being theoretically important and an explicit aim of several of the studies, these studies would benefit greatly from some sort of goodness-to-fit measure (such as the Anova Density measure presented earlier in this chapter) for the chosen number of partitions.

Commodity trade flow for various years and at different detail levels constitute the data for the studies above, though only representing a minor share in the Kick series of papers. Prior to analysis, the datasets are processed differently in the studies. In the Kick studies, trade data are dichotomized using a global cutoff value, further assuming total or complete lack of trade ties among actors for which there are no available data. Criticizing the dichotomization of data done in Snyder and Kick (1979), Breiger (1981) prepare the raw trade flow matrices by subtracting column and row means in an effort to reduce the spikes inherent in trade flow data. Mahutga (2006) also prepares the raw trade data using a log-10-transformation, albeit without stating any purpose for doing so related to the value-dwarfing syndrome inherent in the REGE algorithm (Borgatti and Everett 1991). Nemeth and Smith (1985) and Smith and White (1992) instead prefer to use the raw trade data as it is argued that the (absolute) strength of ties are just as important as the (relative) pattern for mapping the world-system structure. While discrepancies exist between Smith and White (1992) and Mahutga (2006), these are surprisingly small considering the data transformation done by the latter¹²⁹. Whether trade flow data should be transformed in a similar way or not is however related to theoretical issues: are core and periphery defined by the magnitudes or the patterns of trade flows? Which country is more core-like: a (relatively) low-volume trading country exhibiting a core-like position with regards to its pattern, i.e. where trade is conducted with several other core-like actors, or a (relatively) high-volume trading country with peripheral-like patterns, i.e. where the majority of this trade is conducted with a few core actors? A thorough examination of how the REGE algorithm reacts to various types of pre-processed datasets with large value-spans is long overdue and is beyond the scope of this thesis.

The time-series analysis in Smith and White (1992) and Mahutga (2006) are very interesting as they make it possible to address questions on mobility within world-system structures. As previously stated, their analysis of flow directions for different commodities are not done fully *ceteris paribus*, something which could distort their substantial findings on this particular issue. Still, the development of this index – together with the time-series analysis, the factor analysis in Nemeth and Smith (1985) (from Smith and Nemeth (1988)), and the testing of various methodological approaches in Breiger (1981) – indicates the novelty of the genre itself.

¹²⁹ In my own (non-documented) comparisons between raw and square-root-processed trade flow data as input to the REGE algorithm, more profound differences in role-membership between the two were found than the differences between Smith and White (1992) and Mahutga (2006).

Conclusion

Whether core-periphery is seen as a continuous variable or not, role analysis allows for the identification of countries into sets that share similar structural roles in the world. The notion of regular equivalence is especially relevant for finding countries which, although they may lack any direct or indirect linkages to each other, nevertheless share the same functional properties in the world of economic exchange. As previously shown in this chapter, regular role analysis is better at detecting core-periphery structures that follow the intuitive notion of such as presented by Galtung (1971).

Except for the Kick articles, each of the studies above look exclusively at commodity flows. Kick is however indeed correct when stating that the world-system and its zones also are defined by non-economic processes and linkages. It would thus be unviable if definite conclusions regarding number of world-system strata, and membership among these, are drawn based on economic exchange alone. SNA-style analysis of commodity flows can be of great assistance in the study of would-be core-periphery structures in the *economic exchange dimension* of world-systems, which albeit often being deemed as the most important dimension in the configuration of the contemporary world-system nevertheless does not capture the complete picture of such structures. In the empirical chapters that follow, I will look exclusively at trade in primary commodities – thus, the perceived structure and the used terminology will also refer explicitly to the economic exchange system alone, i.e. without any implicit argument that these structures mirror the world-system zones as presented in the more qualitative literature.

Finally, while the above studies focused on the value of commodity trade flows, I will partly depart from this tradition, instead trying to recast parts of the issues in an ecological-economic context. Looking only at the exchange value of commodity trade represents, I believe, a generalized Nordhaus fallacy (Daly 1996:63ff) which implies a fundamentally flawed belief that “it is the value added to seeds, soil, sunlight, and rainfall by labor and capital that keeps us alive, not the seeds, soil, and sunlight themselves”. Nor is it the value of fuel, textiles, manufactures and services that satisfy our material want-satisfaction, but it is the energy content of fuel, the actual coats we wear, the Playstation consoles themselves, and the time spend on Radiohead concerts that fuel our cars, keep us warm and satisfy our consumer preferences. While economic exchange indeed is governed by the interplay between supply, demand, and purchasing power as measured in exchange values, a ecological-economic perspective is nevertheless what “matters” and should therefore be included in studies of the contemporary world-system, whether SNA-style or not.

CHAPTER 6:

Commodity flow analysis and notions of unequal exchange

In the whole range of economic disciplines, the point of common interest is set by the process through which material want-satisfaction is provided. Locating this process and examining its operation can only be achieved by shifting the emphasis from a type of rational action to the configuration of goods and person movements, which actually make up the economy. (Polanyi 1968:119)

The village of Hällberg in northern Sweden is a small cluster of nowadays mostly abandoned houses, located about 20 minutes drive from Arvidsjaur. Currently with less than ten permanent residents, Hällberg was once bustling with ambitions: looking at old maps of the village, plots of land had been allocated for would-be industrial sites, just next to the still standing, two-storey school. Although these would-be industries never materialised, Hällberg did have a flour mill and a saw mill.

Although the exact construction date of the saw mill is unknown, it was operational in the mid 19th century, drawing its mechanical power directly from the Gallaken stream. Its capacity was very low – it could take up to one hour to cut through an average log, but once started, the mill could be left unattended. That hour was typically spent fishing in the stream.



After several destructive spring floods, the old saw mill was decommissioned in 1920, replaced with a more modern one. Equipped with an electrical water turbine, a circular saw blade, and organized in the form of a shareholding company – Hällberg-Bäcknäs Såg AB – the shareholders from Hällberg and neighboring Bäcknäs could refine their own timber from their own local lands.

The particularly aggressive spring flood of 1956 saw the end of the sawmill in Hällberg, and the remaining capital goods – primarily the turbine and various construction material – were sold on auction on the 4th of August 1959. Since then, instead of processing timber from Hällberg *in* Hällberg, improved infrastructure and economies of scale (elsewhere) made it economically more feasible to transport the unprocessed timber to larger sawmills outside Hällberg. Ever since, Hällberg is strictly an extractive economy. Heavy machines now make their way around the forests, harvesting the trees and injecting them into regional and global commodity chains. Living in southern Sweden, I very seldom get to touch or even see the timber in the same way as my great grandfather, once a shareholder in Hällberg-Bäcknäs Såg AB, did. I have absolutely no idea where the wood in my IKEA kitchen table here in Malmö is from. My qualified guess: from nowhere and everywhere, at the same time.

On the analysis of global commodity flows

Among various possible indicators of contemporary global economic integration, the rise in the amount of world trade in the recent decades is perhaps the best measure thereof (Dicken 1998:24). At a mere 391 billion USD in 1970, the value of total world exports has increased twentyfold in 30 years, with IMF forecasting a further acceleration of this growth. Comparing world trade with world GDP for the period 1980-2002 (Figure 6.1), we note a more than fivefold increase in GDP in this period, along with an almost sevenfold increase in total world exports. Although total world trade retracted in absolute terms in the early 1980's and although IMF predicts an absolute decrease in the current year (2009) back to 2006 levels,

world trade measured as a share of world GDP almost doubled, from 17 to 32 percent, in the 1986-2008 period. With exports of merchandise having grown faster than its production since 1950 and onwards (Dicken 1998:25), it is difficult to underestimate the growing importance of international trade for the provision of “material want-satisfaction”.

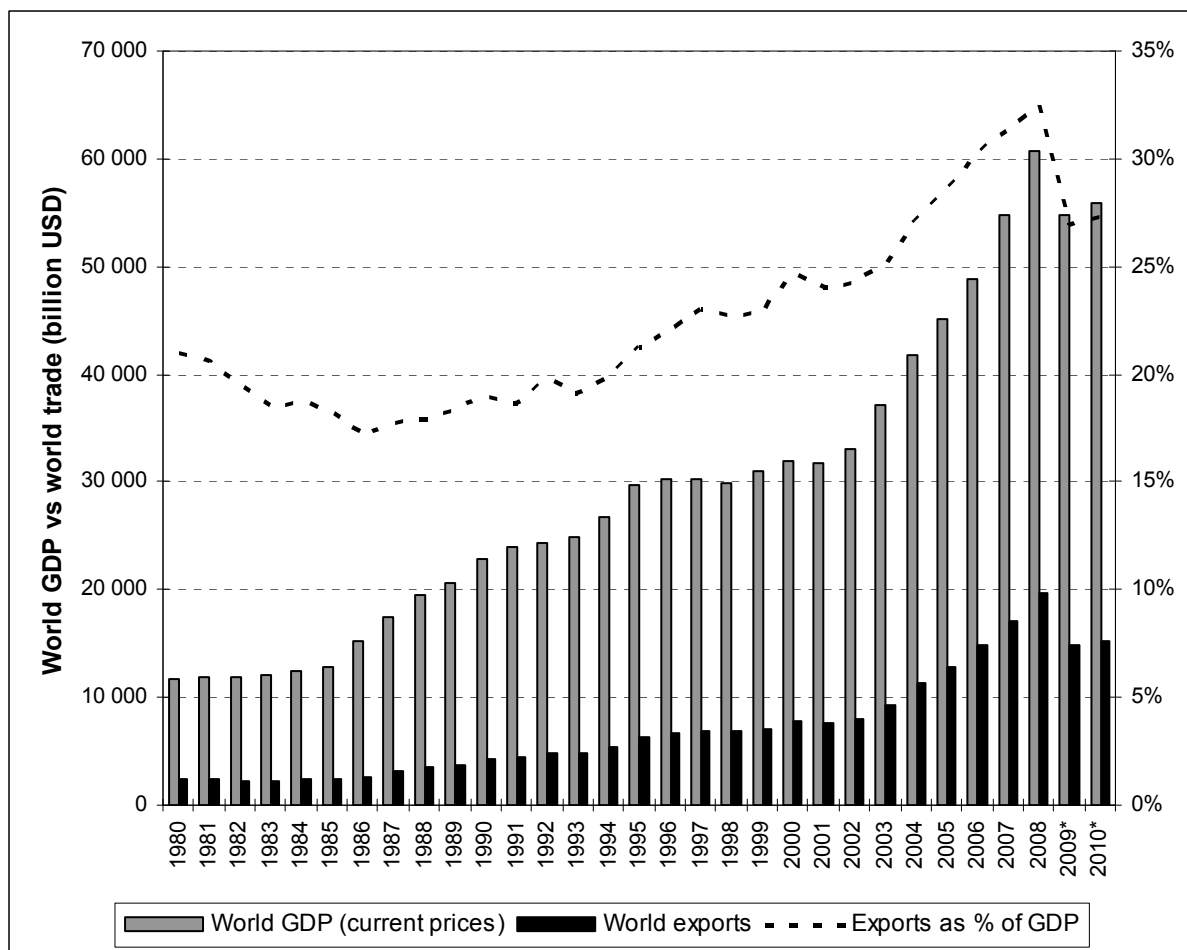

Figure 6.1: Total world exports compared with total world GDP (measured in current prices), 1980-2008. Data for 2009-10 are predictions from 2009. (Source: World Economic Outlook Database, IMF, June 2009)

The tremendous growth in international trade has not been accompanied by an equalization of global welfare as stipulated by classical and contemporary theory. On the contrary, the gaps between the haves and the have-nots has rather increased (Hedenus and Azar 2005; Milanovic 2005) as the global Polanyian integration deepens. Even though absolute welfare might have risen among certain, previously even poorer, societies and nations across the world, any would-be correlation between the growth of international trade and the distribution of economic development rather seems to be of an inverse kind in the *longue duree* of the modern world system.

Arguing that the different strands of economic exchange theory are too straggling to explain contemporary international trade and its consequences for the distribution of global resources (see chapter 2), these theories profoundly lacking a concern for economic exchange structures (see chapter 3), I have instead chosen to approach the subject matter in a more inductive fashion. Instead of adhering to certain explanatory models, each with their specific historical origins, assumptions and policy agendas, I believe that the best understanding of the global distribution of resources is to be gained through empirical observations and analyses of

actually occurring trade flows across the globe. An inductive endeavor such as this could also be helpful for assessing the viability of the deductively-derived economic exchange theories and, possible, be useful in the development of alternative, more realistic models of international trade.

Limiting the scope of analysis to commodity flows alone, further narrowed down to certain groups of primary commodities for a specific time period (1995-1999), do of course have implications for the types of conclusions that can be drawn. The focus is furthermore only on trade flows *between* national economies: I ignore resource distributions *within* nations¹³⁰, either spatially or between different social strata. The empirical parts of this thesis take no account of political settings and institutions, factor endowments, or historical patterns of societal systems, nor do I pay any attention to modes of production, division of labor, and organization of production, all being hallmark concepts¹³¹ of contemporary world-system analysis as represented by Wallerstein. If one instead choose to adhere to the sociological, Chase-Dunnian definition of world-system analysis, i.e. where the defining feature is the existence of a systemic intersocietal network (Chase-Dunn and Hall 1997:4) where the interactions (such as trade) are important for the reproduction and change of internal structures of the composite units making up the system (ibid.:28), the approach chosen for this thesis is indeed world-systemic. However, contrary to Wallerstein's critique of the sociological nomothetic approach, my analysis is not based on a set of universal concepts such as "core/periphery", "class conflict", "capital accumulation" etc (Wallerstein 2000:153), concepts with which to conduct comparative analysis with other spatio-temporal "TimeSpace" situations (ibid.:150). Of course, the results from the analyses done in this thesis could, and should indeed, be compared with global resource flows at other time periods, perhaps also for other historical social systems periods, and even perhaps with trade networks at different sub-global geographical scales. However, being based on a set of methodological tools which in themselves are inherently systemic, rather than concepts reflecting the specifics and the assumed *modi operandi* of social systems characteristic for certain TimeSpace situations, I hope that I hold the tiller somewhat firm in the rough seas between the nomothetic and idiographic shorelines of the world of world-system analysis (see Wallerstein 2000:149-159). Network-analysis is indeed a product of the modern age, seen by many as a paradigm in its own right, but to my knowledge, there is only one concept (or theory) embedded into the approach itself: the underlying belief that relational patterns between the parts that make up a social system play an important (if not decisive) role in the development of each social unit and the system as a whole. As world-system analysis in substance is concerned with exactly this - relational concepts (such as core and periphery), mechanisms (unequal exchange), and research agendas (how social systems and their internal components develop) - I find it unlikely that the "relations matter"-standpoint can be

¹³⁰ An earlier draft of this thesis contained an analysis of commodity flows within Sweden, using the commodity flow dataset VFU2001 compiled by the Swedish Institute for Transport and Communications Analysis (SIKA institute). The dataset did turn out to be too inconsistent and incomplete for conducting network analysis, but the main reason for discarding VFU2001 from this thesis was the lack of relevance for global resource distribution. Intra-national structural analyses of resource flows could yield interesting insights into the different roles of, and distribution between, different national regions, these patterns however reflecting not only economic exchange mechanisms but, perhaps more importantly, the policies and actions of national governance.

¹³¹ The concepts mentioned here are best used in world-system studies of the modern age. As Wallerstein has underlined (2000:153), concepts such as these often depend on, and are best defined through, a specific historical social system, i.e. the modern world-system in this case, as well as being inter-dependent concepts. Other historical social systems might very well need different concepts to describe such systems.

criticized as nomothetic, even if we were to expand a would-be comparative network-analysis to other historical social systems than the current one.¹³²

Whether this study can truly be labeled world-systemic or not is, of course, of minor, if any, concern per se. Basing the analyses on a methodological perspective rather than a set of concepts, or a number of hypotheses, I do hope that I can escape most of the ideological biases and normative aspirations which often pops up in arguments on the pros and cons of international trade in relation to economic development from different scholastic perspectives. Instead, I hope that the analyses done here, and similar analyses using the same methodological approach, can act as *complements* – plug-ins, to use a software-metaphor – not only to the different flavors of world-system analysis but also to other, more mainstream, social-scientific schools dealing with issues on trade and development.

This chapter will begin by looking closer at previous studies of so-called global commodity chains (GCC), a concept initiated by Hopkins and Wallerstein in 1986, subsequently refined and developed further. Although a different methodological approach is used in this thesis, an examination of the GCC approach – its theoretical motivation, the chosen methods, and the findings and observed phenomenon that characterize the approach – does not only underline the importance of looking at commodity flows for understanding international trade and development, but it also lends support to the specific methods (network-analysis) and data (inter-national commodity flows) used in this thesis.

Most importantly, the GCC school inspires the present thesis in its view on production as a global phenomenon. By recognizing the existence of global production chains, where the production of individual commodities are dispersed among several national entities, international commodity flows in raw and primary goods can, I argue, be interpreted as factor allocations within production structures that are global in scope. Thus, as will be argued in the section on unequal exchange in this chapter, the monetary-biophysical analyses in this thesis allows for a conceptualization of ecological unequal exchange that is quite related to the original formulation as described by Emmanuel (1972).

Global Commodity Chains: research agenda, theoretical stances, and general findings

Based on prima facie evidence, the conventional assumption of a relationship between manufacturing exports and economic development no longer seems to be as valid as it (perhaps) once was. As secondary-sector employment opportunities in most of the developed world has decreased in the recent decades, much of the world's commodity production, previously located within the developed countries, has been segmented into chains of

¹³² Wallerstein's discussion on the fragmented state of social sciences and his critique on the merits of interdisciplinary is somewhat related to this. In Wallerstein's view, "[w]orld-systems analysis is not a theory about the social world" (2000:129): it is more "a protest against the ways in which social scientific inquiry was structured [in its genesis]" (ibid.) into distinct, sharply separated disciplines which makes it hard to answer questions about the world which are the most necessary to ask. "Interdisciplinary work", Wallerstein continues, "is in no sense an intellectual critique, per se, of the existing compartmentalization of social science" (ibid.:132): instead such work reinforces the distinctions that make up the boundaries between the social sciences. So, then, is network-analysis interdisciplinary? My own answer is no: it is not even a discipline. Being a set of statistical tools with an inherent belief (or theory for that matter) that "relations matter", network-analysis is, similar to statistics in general, instead more trans-, or even meta-, disciplinary. However, as I am concerned with resource flows alone, viewing them from two slightly different disciplines – economics and ecological-economics – this thesis as a whole is interdisciplinary in the separatist sense above, as such reflecting "the existing compartmentalization of social science" (ibid.) at large.

production stretching over the whole world (Gereffi 2005:162). Fordism seems to have cracked the walls of individual industrial sites: the components in a Ford Escort anno 1994 are produced in 15 countries stretching over three continents (Gereffi et al 1994:1), and the value share of manufactured exports for most countries, including many of the LDC:s, has surpassed primary (non-manufactures) goods. In spite of reconfigured production processes, resulting in changes to where, and how, commodities are produced, the lion's share of the finished commodities are nevertheless consumed by a small set of affluent countries, this being no different from the past.

Instead of resorting to the often assumed correlance between industrial production and economic development, Wallerstein and Hopkins suggest that it is more fruitful to look at global commodity chains (GCC), defined as "a network of labor and production processes whose end result is a finished commodity" (Wallerstein and Hopkins 2000 [1985]:223). In practice, the GCC approach focuses on individual commodities and the tracing of their production processes, its separate segments (boxes) making up the production chain, and how these segments are locally constructed: the origins, the costs, and the provision of inputs (including labor), where the total value produced ends up, labor relations and regulations, and the local/regional market conditions for each of the segments making up a GCC. The originators of the concept not only reject the idea that industrial activity per se is a motor for growth; they have come to reject the whole idea of classifying economic activities into primary, secondary, and tertiary sectors.¹³³

The GCC concept is in many ways similar to the value-chain approach (Porter 1987; see Gereffi 2005:167), a similar production-chain tracking method which is aimed at identifying the structural setup – the (often) global layouts of production segments – which give companies a competitive edge while remaining flexible concerning possible reconfigurations – re-optimizations – of the value-chains for individual commodities. Although different varieties of the GCC concept has developed since its inception (see below), the approach as such is not primarily aimed at being a guide for management policies, but instead place more interest in the local, socio-economic effects of such commodity chains, how these effects differ between segments (boxes), and their consequences for capital accumulation at each segment as well as for the chain at large (Gereffi et al. 1994: 6ff; Hopkins et al 1994:49).

Bounding the analysis on individual commodities instead of national economies makes it possible to address certain questions that otherwise cannot be asked:

Use of [the GCC] concept has considerable advantages over other methods of tracking and depicting a trans-state division of labor. The predominant current procedure is to trace primarily the economic flows between states (that is, across frontiers) such as trade, migration, or capital investment. [...] Research organized along these lines effectively shows movements from one state jurisdiction to another, helping to delineate direct or indirect exchange between states. Such efforts do not, however, and for the most part cannot, show the totality of the flows or movements that reveal the real division, and thus the integration, of labor in complex production processes. (Wallerstein and Hopkins 2000 [1985]:223)

If one thinks of the entire chain as having a total amount of surplus value that has been appropriated, what is the division of this surplus value among the boxes of the chain? This is the kind of issue that lay behind the debate on unequal exchange. (Hopkins et al 1994:49)

¹³³ "What the commodity chain construct makes evident is that the Colin Clark trinity of primary, secondary, and tertiary sectors is descriptive and not terribly helpful. Each box in the chain transforms something and is therefore 'industrial'. [...] In any case, there is no long-term fixed priority for the 'secondary' sector as a motor of capitalist development." (Hopkins et al 1994:50).

The questions addressed by the GCC school are indeed highly relevant in the midst of contemporary global industrial restructuring, with governments in the developed world facing rising unemployment and possibly social unrest due to manufacturing industries leaving the national premises¹³⁴. The concept was nevertheless initiated by Wallerstein and Hopkins in order to address a specific question in a different era: whether a world-economy, identified by the existence of “vast uneven chains of integrated production structures dissected by multiple political structures” (Wallerstein 2000:139), existed in the period between the 16th to 18th century. Wallerstein and Hopkins consider two commodity chains which they deem to be of relevance for the period in question, namely shipbuilding and wheat flour. Backtracking these commodities, looking at the properties of each segment in the production process – geographic locations, labor forms, production technology, and levels of concentration (Hopkins and Wallerstein 2000 [1985]:226) – at eight different time points during this period, the authors conclude that there indeed existed a global division of labor at this time, manifested in the global commodity chains for these two commodities.

Gereffi et al. (1994) has proposed a distinction between producer-driven versus buyer-driven commodity chains, largely corresponding to the distinction between mass production and flexible specialization. In the former, transnational firms usually play the central role in the whole commodity chain: owning (at least partly) all production facilities of a chain, these firms often shape the character of demand (ibid.:99). Producer-driven commodity chains are characteristic for capital-intensive products such as cars, computers, electrical machinery and the like, where profits mostly derive from economies of scale. In buyer-driven commodity chains, often being garments, footwear, toys, simple household appliances etc., transnational firms act more like trading houses, coordinating the production of the actual goods using subcontracting among several independent producers in developing countries. Seldom owning any productive units of their own, these firms obtain most of their profits from marketing, branding, sales etc. For buyer-driven commodity chains, “the organization of consumption is a major determinant of where and how global manufacturing takes place.” (ibid.:99).

A number of characteristic features of GCC:s has been noted in the various studies conducted on the present as well as past historical systems. First, it can be noted that the direction of commodity chains is typically from the periphery to the core (Hopkins et al 1994:17). Often originating in the less-developed parts of the world, global commodity chains are typically, if not exclusively, aimed at consumption markets in the developed world.

Secondly, the actual configuration of global commodity chains seems to follow economic cycles and trends, specifically the different phases of the Kondratieff cycle. For shipbuilding, Hopkins and Wallerstein note how B-phases “are characterized by a commodity chain containing fewer boxes, which are nevertheless geographically more dispersed and locally ‘ruralized’” (Hopkins et al 1994:31). In contrast, A-phases seems to imply commodity chains with an increased number of segments (boxes), often spatially concentrated in urban areas

¹³⁴ By coincidence, I watched Michael Moore’s movie “The Big One” (1997) prior to writing this paragraph, an on-the-road documentary of Moore’s advertising tour across USA for his book “Downsize this” (1997). The theme of this movie, along with his previous “Roger & Me” (1989), is concerned with the consequences of manufacturing industries downsizing in the USA as global commodity chains are reconfigured. Indeed often taking a naïve and populist perspective on the issue, and would-be solutions, the popularity of these movies, not to mention the bestselling book “Downsize this”, underlines that the actual issue – the laying-off of jobs within the manufacturing sectors of the developing world – is a concrete dilemma facing not only the recently unemployed manufacturing workers but also the local and federal government which often, in Moore’s movies and books, are held responsible for the situation.

under the organization of vertically integrated business enterprises (ibid.:31ff). A similar pattern is noted with regards to wheat flour: “[t]here appears to be a tendency for the chains to lengthen geographically in B-phases” while commodity chains in A-phases either shrink or, more often, remain the same as in the previous B-phase (ibid. :44). The interplay between Kondratieff cycles and commodity chain layouts seems to hold true not only for the historical system studied by Wallerstein and Hopkins but can also be observed in the current transformations of production structures in the contemporary world-economy (Gereffi et al 1994:5).

The third aspect of global commodity chains is concerned with monopolization and how it varies among the different segments (boxes) making up commodity chains:

The GCCs approach explains the distribution of wealth within a chain as an outcome of the relative intensity of competition within different nodes. (Gereffi et al 1994:4)

A core-like box is likely to have its units located in a very few countries. A peripheral box will tend to have units in a large number of countries (unless there are ecological reasons that limit the location of the production activity). It follows that as boxes are historically shifted from being core-like (relatively monopolized and highly profitable) to being peripheral (competitive and yielding a low rate of profit), their units tend to become located in more and more countries. (Hopkins et al 1994:18)

As Heintz (2006) points out with regards to buyer-driven commodity chains, individual subcontracting manufactures in peripheral chain segments often find it difficult to upgrade their chain status, i.e. capturing a larger share of the total value created, as they are under intense competitive pressure from other subcontracting producers. With little control over the demand side of commodity chains, Heintz argue that productivity enhancements in peripheral chain segments only results in lower prices to consumers or more profits to the multinationals that control branding and marketing, indeed reflecting the argument put forward by Singer (see chapter 2)¹³⁵. Appelbaum et al (1994) also look at the garment industry, also noticing that the competitive environment, and thus the difference in value/profit appropriation, differs between core and peripheral segments of the commodity chains in question. High-value (core) nodes seems to be more geographically concentrated, while the geographical dispersal of low-value (peripheral) nodes is due to “capital search[ing] the globe for ever cheaper mixes of labor and materials” (ibid.:202). This phenomena – where competition is (kept) fierce among non-core boxes while core-like boxes often, at least temporarily, enjoy monopolies – is highly relevant for our previous discussion on the role of economic exchange structures (chapter 3) and how this is linked to the discussion of price elasticities of demand (chapter 2). With several small subcontractors, non-coordinated as a group, each one delivering their produce to a very small number of transnational firms, a raise in wages (and thus costs) in any of these subcontractors would naturally out-compete this specific producer in favor of other subcontractors, already existing or newly established. A crucial incentive thus exists among peripheral governments to keep wage levels low. When new producers (subcontractors) with lower cost ratios enter the market, existing producers have to decrease

¹³⁵ Heintz also recognizes an extraordinary scenario that could be the result of subcontracting firms reducing their per-unit costs: “Under certain extraordinary circumstances – the existence of an inelastic demand curve and high marginal rents due to branding – lower production costs can theoretically lead to higher retail prices. This occurs when the increase in per-unit rents associated with a higher level of branding more than offset the effect of lower production costs. This is only likely to happen when there is practically no competition in the final consumer markets.” (Heintz 2006:515). This scenario is similar to the second extraordinary scenario identified by Alfred Marshall (see chapter 2): lower production costs (such as wages) combined with a specific demand elasticity could, at least in theory, have an opposite outcome from what is intuitively expected.

costs per unit produced to match the new price, either through raised productivity or lower wages, simply to avoid being by-passed in the commodity chain:

[W]hen a new competitor with lower production costs enters the market, other producers have a clear incentive to improve productivity. The entry of lower-cost producers will place downward pressure on unit labour costs... However, the benefits of productivity improvements due to the entry of new competitors are realised in terms of *retaining* existing jobs and production, not in terms of higher average living standards per worker. (Heintz 2006:515, my emphasis).

The emergence of a new producer with lower production costs does not only force previous subcontractors to lower their costs: the new equilibrium in the supply-demand model of contractor-subcontractor relations implies that although more commodities are produced (at a lower per-unit price), the share of income to each subcontractor actually diminishes.

The existence and changes in monopolistic structures seems to be linked to Kondratieff-cycles: Wallerstein and Hopkins notice how monopoly situations among the segments (boxes) in the global wheat chain under study differ depending on where the boxes were situated:

[C]onsolidation (monopolization) appears to have taken place in response to B-phases (such as the periods after 1590 and 1650), as landlords [in areas such as Sicily and Poland] attempted to shore up their rates of profit and eliminate competition in the face of diminished markets. In core areas, the opposite appears true: increased monopolization appears to have happened in response to A-phases and increased demand and higher prices. (Hopkins et al 1994:44)

In her overview of the decade-long history of the GCC approach, Bair (2005) notes the extension of the concept from being rooted in the typical macro-sociological perspective characteristic of world-system analysis, into “a network-based, organizational approach to studying the dynamics of global industries.” (Bair 2005:158). Although the concept implies the analysis of spatially dispersed production processes, Bair identifies a split between the world-system approach to the study of global commodity chains and the ‘global value chain’ (GVC) approach, led by Gereffi and colleagues. The former approach is based on an historical outlook in which the study of GCC:s reflect global economic processes in the system as a whole, discarding the prospects for national development through policies for industrial upgrading in peripheral boxes as part of a ‘developmentalist illusion’. Rejecting the idea that commodity chains are recent phenomena (Wallerstein and Hopkins 2000 [1985]:222), GCC analysis as formulated by Wallerstein and Hopkins view contemporary chain structures as being the result of specific historical events and path-dependent trajectories. The global value chain approach, more influenced by business management and organization theory, seems more inclined to view globalization and the geographical dispersal of commodity chains as a contemporary phenomenon (Gereffi et al. 2005:78ff). In the GVC approach, commodity chains are interesting in themselves as they bring insight into the creation and distribution of value-added and the possible developmental policy options available for ‘industrial upgrading’ and the appropriation of a larger share of value-added (Bair 2005; Lee and Cason 1994:226). Just as Wallerstein has noted regarding the spatio-temporariness of certain concepts, the view of globalization and global value chains as a modern phenomena allows for a more formal treatment of commodity chains, reflected in the taxonomy suggested by Gereffi et al (2005) to describe, analyze, and compare different global commodity chains. Such a taxonomy contains certain concepts – firms, for instance – that indeed reflects, and is best suited under, a specific historical social system, in this case the contemporary world since the mid-20th century.

Whether the objective is to maximize the competitiveness of individual firms, to search for optimal government policies to facilitate the upgrading of subcontracting producers, or to map and understand the structures and mechanisms underlying unequal exchange in past and present historical systems, the focus on individual commodities per se – the hows and the wheres of segmented production processes – is an interesting methodological avenue well worth pursuing. Contrary to the conclusions that can be drawn from analyzing vast flow matrices of different commodities between national economies, the GCC approach allows for a more nuanced perspective on industrialization and the specific conditions, if any, that determine whether industrial production is related to socio-economic development. Furthermore, the GCC approach also makes it possible to ask question on labor input, wages, and profit sharing, questions that are at best blurred, at worst disguised, when looking at input-output-tables for individual nations.

In spite of the advantages of the GCC approach, this thesis nevertheless look at commodity flows using the “predominant current procedure” (Wallerstein and Hopkins 2000 [1985]:223), i.e. by tracking commodity flows between national states. Such a procedure cannot show differences in the quantity of labor inputs between different commodities from various national economies, whether we were interested in the value-added by labor, the embedded labor time in commodities, or the cost of the labor input. Although it might be possible to estimate conversion factors to transform traded quantities into ‘embedded labor’ (in one form or another), such estimations would not only vary between different commodity types for different countries at different times, but it would also discard the possibility of would-be regional differences within nations (Gereffi 1994:113, 120 note 29). Furthermore, it would be difficult to modify such conversion factors to reflect the outsourcing of assembling of certain commodities, which in effect converts the semi-finished commodities found in national import statistics into finished goods to be found in the export statistics. If such conversion factors nevertheless were to be estimated and applied, uncertainties and a vast array of theoretical assumptions would undermine the validity and robustness of any conclusions drawn from such analyses. Reflecting a single commodity at a time, the GCC approach is indeed, as pointed out by Wallerstein and others, vastly superior in mapping aspects of the world-economy, its global division of labor, and how the profits of commodity production are divided among the different strata of the world-system, past and present, within and between national states – as far as is concerned with the specific commodity chosen for analysis.

To my knowledge, there is no coherent analytical framework that explicitly focuses on the physical dimensions of global commodity chains.¹³⁶ Intuitively, it should indeed be possible to apply the GCC concept when tracking resource inputs - material and energy spent and/or embedded – among the different segments (boxes) making up global commodity chains. Such a physical-resource-oriented GCC analysis could probably benefit greatly from the taxonomy used in *emergy* analysis (Odum 1995; Abel 2007), i.e. where the different production steps (chain segments/boxes) of individual commodities are modeled as the resources spent/appropriated in the providing of a specific function, i.e. the production and consumption of a specific commodity. Although it would require the analysis of a large

¹³⁶ The study of Dahlström and Ekins (2006) combines value-chain analysis with material flow analysis in their study of iron and steel in the UK for 2001, arriving at a heuristic that allows for the simultaneous analysis of economic and biophysical flows. Applying their proposed methodology on international scale, possibly complemented by additional dimensions (such as wages and other factor costs) would be a very interesting endeavor.

number of commodity chains, if not all, it should be possible to examine the possible existence of ecological unequal exchange using the GCC approach.

Although this thesis looks at commodity flows from a different methodological angle, there are nevertheless a number of insights from the GCC approach that are relevant for the study at hand. First, the GCC approach underlines the analytical importance of commodity flows for understanding the distribution of resources in world-economies (Wallerstein and Hopkins 1994 [1985]:49). Although an emphasis on “the larger institutional and structural environments in which commodity chains are embedded” (Bair 2005:154) is necessary for a fuller understanding of uneven development, the actual transfers of commodities – the want-satisfaction they provide, the resources they manifest, and the distribution of profits/value their production entails – constitute the outcome of the underlying economic mechanisms behind such exchange, while also reflecting the actual exchange structures which these mechanisms are part and parcel of.

Secondly, the GCC studies done so far underline the fact that industrial production and manufacture exports are not necessarily synonymous with economic development and rising living-standards. A country exhibiting vast amounts of manufactured goods in their trade statistics – imports, exports, or both – does not necessarily mean that the country enjoys a high standard of living.¹³⁷ If there ever has been a correlance between industrial production for exports and economic development in the past, contemporary GCC studies indicate that no such direct correlation exists today.

Thirdly, the GCC approach stresses how the actual exchange structures, and monopolistic situations based on different structural setups, are fundamental for understanding power relations and bargaining positions between different actors taking part in global production. The vast majority of GCC studies points to the same phenomena: commodity chain segments (boxes) located in the periphery are often in fierce competition with a multitude of alternative, or would-be, peripheral segments, while the ‘chain-driving’ segments at the demand side of commodity chains have the possibility to reconfigure their supply chains in order to minimize production costs, putting intense pressure on peripheral boxes to keep their production costs down. We are thus well advised to study these structures: finding the different structural roles of different national economies, identifying the relations among and between these role sets, and examining whether certain countries are in a structural position vis-à-vis others that give them a *structural advantage* (see chapter 3) in trade.

Finally, and perhaps most relevant to the core of this thesis, the GCC school emphasis on production as a global process has inspired the current thesis with a novel conceptualization of ecological unequal exchange. Rather than being the results of a singular combination of production factors within a singular spatial entity, commodities are often produced through international production chains whose segments are to be found in a variety of national economies, each with specific combinations of production factors and, most importantly,

¹³⁷ In a separate (not documented) analysis of the sectoral composition of exports for the countries in the dataset, it was found that a high GDP per capita often, but indeed not necessarily, is related to an export profile dominated by manufactured goods. Iceland, for instance, having the 6th largest GDP per capita in the world, only earn about 20 percent of their export earnings from manufactured goods (SITC category 6-8): instead, 70 percent of the value of their export stems from commodities in the food and beverages category (SITC 0). Similarly, only 27 percent of the export value from Switzerland-Liechtenstein consists of manufactured goods (SITC 7), and a staggering 50 percent of Norwegian export revenues comes from “Fuels, lubricants etc.” (SITC 3).

different factor costs (such as wages). This insight, in combination with the relatively non-processed, primary nature of the commodities analyzed in this thesis, allows for an ecological conceptualization of unequal exchange that is quite close to its original Emmanuel formulation, an argument I will develop in what follows.

Conventional and ecological unequal exchange

When Portugal and England choose to trade cloth and wine with each other at a mutually agreed-upon ratio or price, they do so as it is mutually beneficial for both; while the exact ratio or price is defined through the interplay between supply, demand and purchasing power in the countries participating in trade, the actually-occurring trade is what defines the equality of the exchange. In addition to this zero-sum exchange of values, trade-participating countries are better off through trade as they thus utilize their specific comparative cost advantages; specializing in what each country is best at doing, exchanging their surplus production with goods that would cost more to produce domestically, international trade actually leads to win-win-situations among all participating actors. So the theory goes.

This conventional mainstream view on the outcome and equality of trade has however been disputed, partly from within but particularly from outside the mainstream domains. Coined and originally formulated by Arghiri Emmanuel in 1962, the various ideas on unequal exchange, prominent in neo-Marxism, the dependency school and world-system analysis, depict trade as a manifestation of, or an underlying cause that leads to, under various conditions, forms of exploitation for certain actors participating in trade. Running counter to the equalizing aspect of mainstream trade theory, i.e. where trade eventually leads to an equalization of economic development, growth, factor costs and welfare, the various notions of unequal exchange typically view trade as increasing the gaps in economic welfare between developed and not-so-developed parts of the world.

Recently, the concept of unequal exchange has been translated in ecological-economic terms. Instead of framing occurrences of unequal exchange in terms of labor values, extraction of super-profits, or wage-differentials, ecological unequal exchange typically depict certain trade relations, seemingly equal, as implying non-compensated net transfers of biophysical resources, or an unequal sharing of environmental burdens, between rich and poor economies, thus increasing the metabolical rift between rich and poor economies. Typically drawing inspiration from Odum, the notion of ecological unequal exchange has been developed by scholars such as Bunker, Hornborg, Andersson, Jorgenson, Martinez-Alier, among others.

In his writing on the history of the concept, Brolin (2006a) has suggested that a distinction should be made between “non-equivalent” and “unequal” exchange, where the latter category only should be used to label theories that, similar to Emmanuel’s original formulation, have something to say about factor market mechanisms, in particular wage-levels. Such a distinction would imply that much of what has been said about unequal exchange, and perhaps all that has been said regarding its ecological variety, actually is concerned with non-equivalent, rather than unequal, exchange. In historical hindsight, I agree that much of the heritage of the concept has been either distorted or ignored. Still, the concept of unequal exchange has undoubtedly obtained a life of its own, even though several of its usages, contemporary as well as historically, has little bearing on Emmanuel’s original idea.

The pre-Emmanuel Latin American traditions

Occasionally seen as the founder of the unequal exchange concept (Amin 1974:609ff; Brolin 2006a:98), Prebisch cannot be excluded from any discussion concerned with trade and development. Questioning the universal validity of economic theory, Prebisch used a relatively conventional syntax in his discussions of the root cause for the deteriorating terms of trade facing peripheral economies. Productivity increases had, according to Prebisch, different outcomes in centers and peripheries: while leading to lower prices of peripheral primary goods, the gains from increases in productivity in the center instead tended to result in higher wages rather than lower prices on manufactures, resulting in the deteriorating terms of trade observed at the time.¹³⁸ Thus, due to organized labor in the center wielding relatively more political power, the gains from productivity increases in the center and the periphery always tended to end up in the former.

The second originator of the oft-mentioned theorem, Hans Singer, built his arguments using an equally conventional syntax. Basing his ideas on the same empirical data as Prebisch, publishing his findings and arguments almost simultaneously as Raul Prebisch, there are indications that Singer not only preceded Prebisch but also inspired the latter's work to a great degree.¹³⁹ Similar to Prebisch, Singer argued that the gains from productivity increases in primary goods and manufactures led to lower prices and increased wages, respectively, this being "the germ of economic imperialism and exploitation" (Singer 1950:479ff). In addition, Singer also addressed the differences in price- and income-elasticities between primary goods and manufactures, arguing that the demand of primary products is more sensitive to price variations, as well as incomes, than what is the case for manufactured goods. In combination with the argument on the distribution of the gains from productivity increases, Singer argues that this thus leads to the observed deterioration of the terms of trade between industrial and primary-producing economies.

Building on the work by Prebisch and Singer, the dependency school can perhaps best be seen as a response to the failures attributed to the policy proposals of ECLA. Instead, its main inspiration seems to come from Paul Baran and his *The political economy of growth* (1957), representing a post-war line of neo-Marxism that tried to solve, or bypass, the Marxist contradiction of the capitalist non-contradiction.¹⁴⁰ Rather than adhering to the orthodox view that each and every country, rich and poor, had to walk the same, universal path towards socialism, neo-Marxists instead argued that western imperialism and colonialism diminished the possibilities of less-developed countries to pass through the stipulated steps of bourgeois revolutions towards the socialist goal. Inspired by the Chinese and Cuban post-war experiences, neo-Marxists typically deemed it possible to not only skip steps along the orthodox Marxist path of social development, but also that socialist revolution could be initiated through peasants and non-wage labor (So 1990:92; Oman and Wignaraja 1991:209). As one of the most influential neo-Marxists with regards to the emergence of the dependency school, Paul Baran found the roots of backwardness to be colonialism and how western capitalism had disturbed and replaced previously existing, often proto-capitalistic, economic

¹³⁸ See chapter 2 for a more theoretical description of the arguments put forward by Prebisch (and Singer).

¹³⁹ While Love (1980:58ff) claims that Prebisch crafted his arguments prior to Singer, the thorough examination of Prebisch's mail correspondence, conducted by Toye and Toye (2003), identifies three different channels through which Singer's work reached ECLA and Prebisch (ibid.:462).

¹⁴⁰ As it became evident that the orthodox idea of diminishing rates of profits did not seem to be occurring in the post-war, post-colonial era, the lack of an evident "crisis of capitalism" instead led to a crisis in Marxist theory, resulting in the spawning of a cadre of neo-Marxists that put greater emphasis on supra-national processes and events.

structures with structures that favored the imperialist powers. As argued in his influential study on the colonization of India and its aftermath, politics took precedence over economics: it was asymmetrical power relations, rather than mere economic factors, that determined the depressed fate of former colonies. Detaching the concept of product surpluses from the labor theory of value, Baran argued for the existence of surplus extraction from developing to developed economies; refined further in the posthumous publication of 1966 (co-written with Paul Sweezy), continuing a line of thinking from Hilferding, Lenin, Kalecki among others, the inherent monopolistic tendencies in capitalism was seen as fundamental for understanding the systemic extraction of surpluses from poor to rich countries.

Although the dependency school is a rather broad categorization, monopoly capitalism and the extraction of “superprofits” became central tenets in much of dependency thinking. Offering a broad critique towards the modernization school, as well as the similar time-functional perspective on social development as found among orthodox Marxists, the dependency school represented the first perspective originating from the periphery on development, and the lack thereof, in the non-western world. As an indigenous line of thinking primarily stemming from Latin America, Andre Gunder Frank is often seen as a front figure in the rather heterogeneous crowd of dependency theorists, this probably due to Frank writing most of his manuscripts in English (Oman and Wignaraja 1991:162), thus perhaps primarily aimed at a western audience. In spite of the proclaimed non-western origin of the school, Frank was born in Berlin, completing his PhD in economics in Chicago (having Milton Friedman as one of his teacher) in 1957, living in Latin America between 1962-1973. Contrary to Prebisch and Singer, Frank argued (similar to Baran) that the terms of trade argument was a sham (Brolin 2006b:218); instead, he envisioned a world consisting of a tree-like hierarchical structure where metropolis-satellite relations at all levels of a global hierarchy enabled the flow of profits upwards, from the poor third-world peasant up to the top segments of the capitalist system. According to Frank (and characteristic of most other dependency scholars), development and underdevelopment thus constituted two sides of the same coin; only through a socialist revolution, Frank argued, could the satellites of the system break free from the exploitative economic and political relations, both global and domestic, that hindered development.

Building on Frank, Theotonio dos Santos coined and defined dependency in his 1970 article as “a conditioning situation in which the economies of one group of countries are conditioned by the development and expansion of others” (dos Santos 1970:289ff). Similar to Frank, dos Santos explained the actual process of underdevelopment through monopoly capitalism and extraction of superprofits in the Baran vein, but identifies three types of dependence: colonial dependence (augmented through monopolization of trade and foreign ownership of colonial resources), financial-industrial dependence (through the expansion of foreign capital into underdeveloped economies, particularly sectors promoting export-orientation), and technical-industrial dependence (through the monopoly of technology and patents of multinational corporations needed by the underdeveloped world). Similar to Frank, dos Santos finds that “[t]he political measures proposed by the developmentalists of ECLA, UNCTAD, BID, etc., do not appear to permit destruction of these terrible chains imposed by dependent development”; rather, the choice is eventually one between fascism and socialism (ibid.:235ff).

With dos Santos addressing issues on capital-intensity and domestic wage-differentials between various sectors in dependent economies, as well as how the super-exploitation of the labor force limits its purchasing power, the French edition of Emmanuel’s treaty on unequal

exchange - *L'Echange Inégal* (1969) - is only used as a reference on how dependence leads (among other things) “to trade under unequal conditions” (dos Santos 1970:235), without any thorough discussion of the Emmanuelian theory of unequal exchange. Referring also to the observed deterioration of the terms of trade as found in the ECLA study, the gist of dos Santos’ argument focused on monopoly structures; dependence, with its symptoms of wage-differentials, foreign capital penetration, technological backwardness, lack of purchasing power etc, is due to monopoly structures – and the solution is, similar to Frank, of a radical political nature rather than the policy proposals of Prebisch et al. Still, Frank and dos Santos represent the more radical branch of dependency scholars, whereas Sunkel and Furtado took a more developmentalist approach in their recommendations of continued industrial planning and internal restructuring that could reverse the trends observed by ECLA. Cardoso and Faletto went somewhat further, arguing that dependency and development, in certain circumstances, actually could go hand-in-hand. In spite of such differences, common for all strands of dependency thinking was a disbelief in the neoclassical idea on the beneficial nature of free, unrestricted economic relations between rich and poor; while the rhetorical intensity, as well as suggested policies, differed among dependency scholars, they typically saw monopolistic, hierarchical relations, particularly of the international kind, as the causes for exploitation and extraction, detrimental to the development efforts of the underdeveloped world.

Emmanuel

Contrary to the dependency school, Emmanuel built his theory of unequal exchange on assumptions of free international trade and perfect competition, void of market irregularities. Labor was deemed as internationally immobile by Emmanuel, but capital was seen as sufficiently mobile to give rise to tendencies of world-wide equalization of profits. Thus, there were no Baran- and dependency-style monopoly capitalism or asymmetrical trade structures (see Oman and Wignaraja 1991:171), nor was it technological rent, capital-intensity differentials, or product-specific properties (such as demand elasticities), that caused unequal exchange. Rather, Emmanuel argued that the wage-differential between developed and underdeveloped countries was the root cause – the exogenous independent variable – that led to unequal exchange. Requoting from Brolin (2006a:179), Emmanuel’s core argument is as follows:

At any moment, the total of world revenue, that is the sum of world wages and profits, is a given magnitude. It follows that any variation of wages in a particular country, leading to an identical variation in the world total of wages, must entail an opposite variation in the total amount of world profits and, therefore, in the profits of the country [in] question. However, this variation of the profits is spread out among all the countries and it is only a part of it that affects the products of the country [in] question, while the equivalent but opposite variation of wages is passed on in its entirety to these products alone. Consequently, the *relative* prices of these products will vary in the same direction as that of the supposed variation of wages, whereas the general rate of profit will be in the opposite direction (Emmanuel 1975:39)

Although “[e]lementary logic and the natural order of things tell us that one can only spend as much as one earns” (Emmanuel 1972:172), i.e. where wages depend on prices, Emmanuel set out “to prove that under capitalist production relations one earns as much as one spends, [and] that prices depend upon wages” (ibid.). Not surprisingly, his unconventional perspective drew significant attention from neo-classicists and Marxists alike.

The observed deterioration of the terms of trade was what Emmanuel set out to explain (Brolin 2006a:179), but it was not the terms of trade, nor unequal exchange per se, that led to uneven development (ibid.:205). Although higher wages imply an increase in purchasing

power and worker's consumption, the relationship between unequal exchange and wage levels are to be found in the organic composition of capital, where high wages tend to translate into capital-intensive production and low wages typically implied labor-intensive production, resulting in the capital accumulation in the center that defines development according to Emmanuel (see also Brolin 2006a:215):

The dynamic of Emmanuel's argument assumed that continuous exogenously enforced wage increases over the preceding century or so had created crucial incentives to invest and thereby helped 'save' the capitalist system from its inherent blocking. In a closed system such an increase would rapidly have reduced the rate of profit to nothing, and it was made possible only by letting the rest of the world (the periphery) pay for these (centre) wage increases through the terms of trade, i.e. through unequal exchange (Brolin 2006a:182)

According to Emmanuel, such wage-differentials not only explain development and underdevelopment in the post-war context, but its importance is also reflected in the divergent historical experiences of various colonies:

The men who settled in the United States and Australia in those periods came from certain parts of Europe that were already advanced and had a standard of living higher than the others; when they emigrated they naturally demanded even higher incomes. This was not the case with the Spaniards and Portuguese who settled in Central and South America, or even with the French who settled in Quebec. The consequence has been that Quebec has remained backward in comparison with the rest of Canada, and Latin America has remained underdeveloped as compared with the United States, although, except for a few regions, the conditions and natural resources were much the same throughout the New World. (Emmanuel 1972:126ff)

Arguing that both labor and capital in the center benefited from unequal exchange, at the expense of peripheral labor, Emmanuel put little faith in international worker solidarity (e.g. Brolin 2006a:185; Oman and Wignaraja 1991:171), spawning heavy critique from both orthodox and neophyte Marxism. The main Marxist critique was however Emmanuel's separation between factor costs and the value of production (see Brolin 2006a:184; Oman and Wignaraja 1991:172). His tutor Bettelheim objected very much to Emmanuel's "misunderstanding" of the significance of the labor theory of value (Brolin 2006a:184); Emmanuel in fact disagreed with this fundamental Marxist idea that the value of labor power itself is determined by the amount of labor necessary to produce it (Oman and Wignaraja 1991:191, note 64). Emmanuel initially expressed his theory as the exchange of products with unequal amounts of socially necessary labor time and based on differing capital intensity, this being referred to by Bettelheim as unequal exchange in the broad sense. However, although many authors have referred to Emmanuel's *two* types of unequal exchange (e.g. Chase-Dunn 1989:231), the capital intensity variety was not unequal exchange according to Emmanuel, but only a demonstrational device to distinguish and compare with his own wage-differential version (Brolin 2006a:180).

Among the writings on Emmanuelian unequal exchange, de Janvry and Kramer (1979) offer a thorough examination of the theory from a Marxist perspective. Recognizing that wage-differentials indeed exist in the real world (ibid.:11), the authors are nevertheless at odds with the theoretical consequences of Emmanuel's assumptions on capital mobility, arguing that capital mobility eventually would lead to international wage equalization in the perfectly competitive, free-trade scenario of Emmanuel:

Just as workers have an incentive to seek out higher wage sectors, so capitalists have an incentive to seek out areas where wage costs are lower, all else being equal. Since capital is perfectly mobile on a world scale in Emmanuel's model, what is to keep it from moving to those countries

where wages are lower in order to take advantage of lower production costs and realize higher profits? This movement of capital would mean an acceleration of accumulation and an increase of employment in the bargaining power of labor as the reserve army shrinks and workers are increasingly concentrated in large-scale capital enterprises. There will be upward pressure on wages. (de Janvry and Kramer 1979:11)

That is, while the immobility of labor could imply wage-differentials, the mobility of capital would counter such a phenomenon, thus undermining the root cause of Emmanuelian unequal exchange.¹⁴¹ In light of *de facto* existing wage-differentials in the world, de Janvry and Kramer discuss would-be complementary factors that might save the theory, however finding such additional conditions as incompatible with the assumptions of perfectly free trade and capital mobility. The authors conclude that the theory of unequal exchange “cannot be used as a general basis for understanding underdevelopment” (ibid.:13); without ruling out the possibility of trade-based exploitation of the periphery in favor of the center, they are more inclined to trace such value transfers to occurrences of monopoly power and policies restricting trade, in essence representing the pre-Emmanuel dependency tradition.

World-systemic conceptualizations of unequal exchange

In the late 1970's, the dependency school lost its momentum, paving way for more pragmatic and less ideological development approaches (So 1990:169). Many of the dependency concepts, however, lived on in the world-system perspective, with former dependency scholars, notably Frank, instead preferring to be viewed as world-system scholars. Integrating dependency and neo-Marxist ideas with the Braudelian ‘total history’ approach to social science, the world-system perspective became both a counter-weight to the modernization school and orthodox Marxist thought as well as a more comprehensive scientific perspective on social change at large.

Unequal exchange is typically seen as integral to the world-system perspective, described by Wallerstein himself as the feature that actually defines cores and peripheries (Wallerstein 1995:31; Brolin 2006b:234), even though the specifics of the concept as seen by Wallerstein are rather difficult to pinpoint. Although referring to Emmanuel (as well as Baran, Frank, Amin and previous dependency scholars) in his various writings, his own treatment of unequal exchange is either quite non-specific or internally contradictory. Friedmann (1980) notes that Wallerstein adopted the unequal exchange concept from Emmanuel, but in a manner that violates several of the original assumptions regarding profit equalization and perfect markets; instead, Wallerstein seems more inclined to emphasize the role of states in the establishment and upholding of relations of unequal exchange, typically resorting to the monopoly capitalism of Paul Baran and state-induced core-periphery structures as relevant for understanding and describing unequal exchange. Noted previously in this chapter, Wallerstein also related unequal exchange to his views on commodity chain and how surplus value is unequally allotted along the various chain segments making up global commodity chains (Hopkins et al 1994:49).

However, there is a passage in *Historical capitalism* (1995), well worth quoting in full, in which Wallerstein makes an attempt to specify the manifestation of and mechanisms underlying unequal exchange as Wallerstein sees it:

¹⁴¹ A counter-argument regarding the lack of wage-equalization is presented by Chase-Dunn: “While both labor and capital have flowed from the core to the periphery and vice versa throughout the history of the capitalist world-system, it is alleged by Emmanuel that the frictions preventing wage equalization are greater than the frictions encountered by exports of investment capital.” (Chase-Dunn 1989:59). Still, in Emmanuel’s model, there is either no friction at all (capital mobility) or ‘full friction’ (labor immobility).

How did this unequal exchange work? Starting with any real differential in the market, occurring because of either the (temporary) scarcity of a complex production process, or artificial scarcities created *manu militari*, commodities moved between zones in such a way that the area with the less 'scarce' item 'sold' its items to the other area at a price that incarnated more real input (cost) than an equally-priced item moving in the opposite direction. What really happened is that there was a transfer of part of the total profit (or surplus) being produced from one zone to another. Such a relationship is that of coreness-peripherality. By extension, we can call the losing zone a 'periphery' and the gaining zone a 'core'.

We find immediately several mechanisms that historically have increased the disparity. Whenever a 'vertical integration' of any two links on a commodity chain occurred, it was possible to shift an even larger segment of the total surplus towards the core than had previously been possible. Also, the shift of surplus towards the core concentrated capital there and made available disproportionate funds for further mechanization, both allowing producers in core zones to gain additional competitive advantages in existing products and permitting them to create ever new rare products with which to renew the process.

The concentration of capital in core zones created both the fiscal base and the political motivation to create relatively strong state-machineries, among whose many capacities was that of ensuring that the state machineries of peripheral zones became or remained relatively weaker. They could thereby pressure these state-structures to accept, even promote, greater specialization in their jurisdiction in tasks lower down the hierarchy of commodity chains, utilizing lower-paid work-forces and creating (reinforcing) the relevant household structures to permit such work-forces to survive. Thus did historical capitalism actually create the so-called historical levels of wages which have become so dramatically divergent in different zones of the world-system. (Wallerstein 1995:31-32)

Evidently, at the end of the first paragraph above, cores and peripheries are here defined on the basis of unequal exchange, in effect making the categorization of zonal stratification fully dependent on a viable, functional definition of unequal exchange. However, when comparing the passage above with the previous perspectives on unequal exchange, Wallerstein seems to take a *smörgåsbord* approach in his specification of the concept.

Although his usage of quotes adds doubts to the notions of scarcity and perhaps also questioning the non-coerciveness of the process of selling goods on the world market, the discussion on relative scarcity not only resemblances the elasticity discussions of Singer (1949) but it also echoes the classical scarcity-demand discussions by John Stuart Mill (1844) and Torrens (1841) (as well as the post-classicists Nicholson (1893) and Graham (1923)), as long as such scarcity of goods translates into movements along a typical demand curve and that scarce goods, reasonable, are assumed to be manufactured goods produced in the center. In contrast to these previous scholars, Wallerstein adds a non-economic political dimension to the nature of scarce goods, deeming such scarcities as possibly induced through the wielding of state-mediated military power which, in Wallerstein's perspective, of course is part and parcel of the modern world-system and the working of its capitalist world-economy.

The logical step from non-reciprocal demand to higher factor costs (more real input) for less scarce goods is however not specified, but it seems reasonable that this step goes through the exchange ratios between goods of differing scarcity. As non-reciprocal demand implies 'non-balanced',¹⁴² ratios of exchange between exchanged goods in the model, this results in that more of the non-scarce good is needed to exchange for the scarce good, thus leading to more inputs (and costs) to produce such non-scarce goods.

¹⁴² Here, 'non-balanced' is meant in an Edgeworth sense, i.e. where the point of equilibrium in an Edgeworth box (the ratio of exchange) is displaced from the point where the exchange ratio would be located in the case of reciprocal demand for the two goods.

However, according to Wallerstein, what ‘really happens’ here is a net transfer of profits or surpluses from one zone to the other – presumably from the zone whose inputs had increased due to higher scarcity of the other zone’s goods. It is this Baran-Frank-style transfer of profits that *is* unequal exchange as it defines cores and peripheries.

Dodging the counter-argument that such net transfers would balance out over time, Wallerstein identifies mechanisms that upholds the “disparity”, although it is unclear whether he refers to disparities in demand, availability (scarcity), factor (input) costs, or the obvious disparity in welfare and development that exist between centers and peripheries. My bet is on the latter; the disparity in economic welfare is argued to be a result due to the working of both relative scarcity as well as differences in factor costs, even though the connection between these two aspects of consumption and production, respectively, is non-specified. Rather, in reference to his global commodity chain writings, it is the vertical integration of segments in commodity chains that allows for even greater surpluses to be shifted to the core.

The second mechanism is concerned with technological improvement and increases in capital intensity. Noteworthy, this is cast in terms of increased “competitive advantages” and new products rather than increased productivity (as long as increased competitive advantages can be interpreted as anything else than productivity increases), the latter which reasonably would alleviate, and thus undermine, the scarcity which causes unequal exchange in the first place. Furthermore, one has to assume that the core goods in question are exclusively aimed at the peripheral markets rather than intra-core trade as scarcity of goods in the core, wherever they may be produced, is not very evident. This particular argument on productivity advantages in the core out-competing peripheral production echoes the productivity/capital-intensity type of unequal exchange found in Amin and Lewis, and is similar to the pre-industrial technological-induced unequal exchange between Europe and China, in favor of the latter, as identified by several scholars (Chase-Dunn and Hall 1997:191ff; see also Frank 1994; Wolf 1982).

At the end in his explanation of unequal exchange, Wallerstein adds national politics. It is the state-mediated capital-bolstered power of core nations that has suppressed peripheral states, forcing and holding them down at the bottom low-wage segments of commodity chains. Rather than being the independent variable that results in unequal exchange according to Emmanuel, wage-differentials are instead the result of historical capitalism, argued to include an active ingredient of state-mediated power and coercion to uphold the inequality of exchange systems.

To summarize, unequal exchange according to Wallerstein is a rough mixture of most, if not all, previous varieties of the notion. With traces of Prebisch, Singer, Mill, Baran, Frank, Wallerstein-Hopkins, Amin, Lewis, and Emmanuel, and with several references to several other scholars, Wallerstein nevertheless concludes that it is geopolitical power structures that are the prime prerequisite and the underlying cause for unequal exchange. In his extended thesis version, Brolin (2006b) argues that Wallerstein’s treatment of unequal exchange “even seems opposed to [Emmanuelian] unequal exchange” (ibid.:234); Brolin instead suggests that “the works [of Wallerstein and others in this tradition] seem not concerned with terms of trade or unequal exchange at all, other than as a powerful rhetorical instrument” (ibid.). The lack of a non-contradicting description of unequal exchange by Wallerstein indeed seems to reinforce this claim of Brolin.

Representing the sociological variety of world-system analysis, whose subject definition¹⁴³ and somewhat more stringent formality allow for comparative world-system studies, Chase-Dunn (and Hall) do not view unequal exchange, or exploitation at large, as a given aspect of world-systems. Even though core-periphery structures might exist, these are not necessarily exploitative according to Chase-Dunn. Noting that the concept of unequal exchange typically implies “that unequal amounts of labor are being exchanged such that the exploited party is transferring labor power to the exploiting party” (Chase-Dunn and Hall 1997:142), it is problematic to analyze occurrences of such exchanges within, for instance, the very small world-system of the Wintu Indians and their neighbors in northern California (ibid):

[T]he Wintu did not exercise political power over Hokan peoples in a way that might bias the terms of trade. Neither did the Wintu have a monopoly over anything needed by the Hokan speakers that might have served as a basis for unequal exchange” (Chase-Dunn and Mann 1998:119)

Finding the problem of unequal exchange “an extremely sticky one” (Chase-Dunn and Hall 1997:142), Chase-Dunn demonstrates a sound knowledge of Emmanuel (Chase-Dunn 1989:59) and how the wage-based theory of unequal exchange differs from “exchange of unequals” due to market distortions (ibid.:355). However, instead of being an external variable outside the explanatory model, Chase-Dunn deems international wage-differentials to be a part of the ‘institutional nature’ of the capitalist world-economy (ibid.:72ff): “[wage-differentials] are themselves produced by competition and conflict among classes and states in the context of the capitalist mode of production.” (ibid.:73). Chase-Dunn is thus slightly at odds with Wallerstein regarding the attainment of socialism through the complete proletarianization and commodification of labor (Wallerstein 1974); the unholy alliance between labor and capital in core countries indicate how “[p]olitical and ethnic stratification have proven effective in maintaining wage differentials among formally ‘free’ proletarians” and where the core-periphery hierarchy “could become increasingly based on inequality between politically protected labor and ‘free’ labor.” (Chase-Dunn 1989:86ff).

Without treating unequal exchange as the defining feature of world-systems, occasionally viewing monopoly structures and market distortions as a cause for unequal exchange, Chase-Dunn’s handling of the concept seems to be more informed by the original Emmanuelian theory than what can be said about the straggling treatment of the concept by Wallerstein. As noted by Brolin (2006b:234), unequal exchange is a powerful concept per se, giving rise to connotations that not always are faithful to its original formulation by Emmanuel. When used in a world-system context, the concept often contradicts the assumptions on profit equalization, capital mobility and perfect non-monopolistic market structures, assumptions that are integral to how the concept was initially perceived by Emmanuel. Although Chase-Dunn seems to have a sound understanding of its original formulation and the various other interpretations of the unequal exchange concept, such insights are often missed in the ecological varieties of unequal exchange to which we now turn.

Ecological unequal exchange

In his study of the history of unequal exchange, Brolin finds a precursor to ecological unequal exchange in the mercantilist mind of Cantillon. Preceding contemporary thought on ecological unequal exchange by 250 years, Cantillon managed to combine labor value and

¹⁴³ “[W]e define world-systems as intersocietal networks in which the interactions (e.g., trade, warfare, intermarriage, information) are important for the reproduction of the internal structures of the composite units and importantly affect changes that occur in these local structures” (Chase-Dunn and Hall 1997:28).

income levels with biophysical dimensions of international exchange, placing greatest importance on this latter, proto-footprint aspect of the exchange:

When a State exchanges a small product of Land for a larger in Foreign Trade, it seems to have the advantage; and if current money is more abundant there than abroad it will always exchange a smaller product of land for a greater. When a State exchanges its Labour for the produce of foreign land it seems to have the advantage, since its inhabitants are fed at the Foreigner's expense. (Cantillon 1931 [1755]:225, quoted in Brodin 2006a:28)

This section will look closer at some of the contemporary scholars and how these have reinterpreted the concept of unequal exchange in ecological/environmental terms. Although there are several interpretations of this novel concept – for instance as externalization of carbon dioxide emissions (Roberts and Parks 2007; Muradian et al 2002), distribution of organic water pollution (Shandra et al 2009), transfers and appropriation (bio-piracy) of genetic resources (Fowler et al 2001), etc. – this section is restricted to its most popular conceptualization, i.e. as net-transfers of biophysical resources. Due to space limitations, I have chosen to focus on scholars that not only argue for the actual occurrence of ecological unequal exchange but in addition do some *theorizing* on the underlying mechanisms and causes for its existence. The scholars presented below all build, or at least claim to do so, on the post-war concepts of unequal exchange previously described. As they represent different theoretical approaches for explaining occurrences of ecological unequal exchange, I have chosen to focus primarily on Bunker, Hornborg, and Jorgenson in what follows.¹⁴⁴ This is not to diminish the role of Jan Otto Andersson, James Rice and, in particular, Martinez-Alier, the latter whose coining of ‘political ecology’ and co-founding of the *Ecological economics* journal, along with his work on environmental justice and ecological Marxism, is highly relevant in this context. The choice of scholars in this section is simply made to represent a handful of different theoretical perspectives, with their respective hypotheses, on the underlying causes of ecological unequal exchange.

Still, although not part of the political ecology tradition or forming any explicit theory on its occurrence, Howard T. Odum cannot be disregarded in any discussion on ecological unequal exchange. Through his various writings, Odum developed the concept of ‘emergy’ as an alternative measure of value through which he definitely¹⁴⁵ pointed towards occurrences of

¹⁴⁴ The exclusion of Rice (2007) and Pérez-Rincón (2006) deserves a couple of comments. In Rice (2007), a comprehensive discussion on ecological unequal exchange is combined with a statistical analysis, the latter which finds a significant relationship between income level groups (where countries are classified according to GDP per capita) and Ecological Footprint. However, although adhering to the structural theory of ecological unequal exchange as proposed by Jorgenson (2003; 2006; 2009a; Jorgenson et al. 2009b), it can be questioned whether the income classification done by Rice is a good indicator of world-system positionality and to what degree the comparison between GDP and EF consumption is tautological. Regarding Pérez-Rincón (2006), the author strives towards an “ecological Prebisch thesis” in his material flow analysis of the Colombian physical trade balance. However, in his incorrect description of income-elasticities, in addition to attaching statements concerned with agricultural subsidies (which Prebisch wrote about in 1963, i.e. not part of the original “Prebisch thesis”), technological penetration and capital-intensity, and fixed prices due to market prices to the “Prebisch thesis” anno 1949, there are some substantial problems with his ecological Prebisch thesis. Furthermore, while the material flow analysis could be interesting *per se*, depicting the weight of Colombian raw material exports outpacing the weight of its manufactured imports, the analysis does not take account of the material-, energy- and emission footprints of the manufactured goods that definitely should be substantially higher than the weight of the finished products.

¹⁴⁵ Although emergy is added in the production process, this does not automatically imply that the exchange of raw materials for manufactured goods is equal. On the contrary, Odum clearly states that “[m]arket prices are inverse to real-wealth contributions from the environment and cannot be used to evaluate environmental contributions or environmental impact” (Odum 1996:60).

unequal, non-compensated biophysical flows between exporters of raw materials and manufactured goods. Contrary to how some social scientists perceive their own understanding of natural sciences (particularly thermodynamics), Odum the system ecologist refrained from stepping too far into the social and economic domains in search of underlying causes. Odum simply noted that exchange was ‘unfair’ from his *emergy* point of view and that market prices were inaccurate as a measure of value.

Bunker

Presenting his thoughts in the mid-80’s, Bunker (1984; 1985) is often seen as the originator of ecological unequal exchange (Martinez-Alier 1987:238; Rice 2007:1371; Hornborg 2009:249). Referring to the works of Baran, Frank, dos Santos, Galtung, Cardoso, Emmanuel, Wallerstein, etc., Bunker attempts to retract the world-system perspective into its broader ecological framework, perceiving it as a “new historical materialism” (Bunker and Ciccantell 1999:107). Influenced by Georgescu-Roegen and Richard Adams (though without referring to Odum in his 1984 and 1985 writings), Bunker can rightly be seen as the first attempt to integrate world-system analysis and the concept of unequal exchange with ecological economics. Rather than continuing the excessive concern with labor values, effectively sterilizing the developmental debate, Bunker argues that “the unbalanced flows of energy and matter from extractive peripheries to the productive core provide better measures of unequal exchange in a world economic system than do flows of commodities measured in labor or prices” (Bunker 1984:1018), as “[t]he fundamental values in lumber, in minerals, oil, fish, and so forth, are predominantly in the good itself rather than in the labor incorporated in it” (ibid.:1054).

Instead of adhering to the idea of time-functional development found in modernization school, Bunker proposes that a distinction has to be made between productive and extractive economies as they represent two very different, albeit complementary, types of regional economic systems. Not only do the export flows of non-processed resources from extractive regions imply a loss of ‘natural value’ that cannot be expressed in terms of labor or capital (Bunker 1984:1019), but the internal dynamics and characteristics of extractive economies significantly hamper any future prospects for western-style, ‘productive’ development; with diseconomies of scale, very low ratios of labor and capital, dispersed and non-cumulative physical infrastructure (see chapter 3), different property and exchange legislations, weak labor organization, skewed domestic incomes, and environmental degradation, the establishment of extractive economies tends to be path-dependent. The exchanges occurring between extractive and productive regions of the world thus often tend to be of the unequal kind.

Rooted in these principal differences between the two types of regional economic systems, Bunker is at odds with how unequal exchange has traditionally been explained by previous scholars. Apparently knowing his Emmanuel, Bunker finds wage-based theories of unequal exchange to be problematic as the labor-component in exported raw materials is very low. In addition, Bunker argues, quite correctly, that a biophysical rather than a wage-based account of unequal exchange would also resolve dilemmas concerned with coerced labor, as exemplified in his study of rubber tapping workers in the Amazon (Bunker 1984:1030ff). However, Bunker does not rule out other manifestations of, and causes for, unequal exchange. Labor organization and its mobilization, the role of locally dominant classes in extractive regions, and the role of states (Bunker 1985:122) could also affect occurrences of unequal exchange, ecological-, labor-, or profit-wise, where international wage-differentials, skewed localization of market value realization, or trade structures also could lead to unequal

exchange (Bunker 1985:45; see also Brolin 2006a:307). Still, the main thrust of his argument is the distinction between extractive and productive economies, and how the internal dynamics of these two types lead to occurrences of biophysical unequal exchange and diminishing prospects for production-style development within extractive regions.

Hornborg

Commencing with an article in the anthropological journal *Man* (1992), Hornborg has written extensively on ecological unequal exchange, writings that have had a significant impact among other scholars within the field. In all these articles, Hornborg criticizes how technology, economy and ecology are treated as separate fields of inquiry; in his attempt to create an integrated perspective, Hornborg eagerly steps outside his anthropological domains, feeling quite at home at the other side of the Cartesian divide. Although various approaches and concepts have been tested in his almost two decades of writing about ecological unequal exchange, recurrent themes are discussions of inherent productivity potential in raw materials (and the concurrent lack of such in manufactured goods), technology/machine fetishism, social and physical power, the role of money, the failings and ideological role of neoclassical economics, and discussions about normative theories of value.

Similar to Georgescu-Roegen (1971), Hornborg approaches economics from a thermodynamic point of view. Using biological and physical concepts, Hornborg views industrial production as a dissipative process aimed at maintaining the technomass of the core. Following Gudeman (1986:154), industrial production of manufactured goods is primarily a production of entropy. Raw materials thus represent productive potential while manufactured goods represent already-spent resources.¹⁴⁶ Herein lies what Hornborg sees as ecological unequal exchange: the exchange of peripheral raw materials with high productivity potential for core-industrial manufactures is, in effect, a net transfer of resources. Keeping the thermodynamic and economic perspectives analytically separated, Hornborg notes that there is an inverse relationship between productive potential and price.

Presented as a suitable measure of productivity potential, Hornborg (1992; 1998; 2001) often use the physical concept of exergy (interchangeably with negative entropy; negentropy), representing not the total energy of raw materials or manufactured goods but instead the usable work that can be withdrawn from the resource/good. In later writings, Hornborg (2003b; 2006; 2009) have instead adopted the ecological footprint concept, typically combined with “time” (the latter corresponding, more or less, to labor time), where industrial technology (machines) and its production are better seen as tools and manifestations of time-space appropriation:

The high-tech sectors of global society presently celebrating their efficient use of time and space appear largely oblivious of the extent to which this “efficiency” has been made possible by exploiting vast investments of human time and natural space made, historically and presently, elsewhere in the world system. (Hornborg 2003b:7ff)

The rationale of machine technology is to (locally) save or liberate time and space, but (crucially) at the expense of time and space consumed elsewhere in the social system. (Hornborg 2006:80)

In essence, Hornborg challenges the perceived productivity of machines. Similar to the functioning of magic in pre-modern cultures, machine fetishism of today has made us to perceive industrial machines as autonomously productive, even though this cornucopian

¹⁴⁶ “The notion of a reasonable market price conceals the fact that what is being exchanged are intact resources for products representing resources already spent.” (Hornborg 2001:47)

illusion obscures the unequal exchange of resources that machines utterly depend upon. In the articles where exergy is used, machines represent the dissipation that reproduce the technomass of the core, exporting disorder and entropy (i.e. manufactured goods) to the periphery, whereas machines in later writings (2003b; 2006; 2009) are seen as appropriators of time and space from the periphery, favoring the core (see 2006:80). In both cases, industrial technology, and our perceptions of it, is intimately intertwined with occurrences of ecological unequal exchange.

Contrary to Odum, Bunker and Marxist value theory, Hornborg stays well clear of proposing a normative measure of value: rather, he analytically separates the economic and ecological processes as two sides of the same coin, where perceptions of value are best left to the humans doing the actual evaluations (Hornborg 2003b:6). Market prices are nevertheless addressed extensively in his writings: playing a key role for understanding ecological unequal exchange, market prices supposedly hide its underlying non-reciprocity: “Ultimately, what keeps our machines running are global terms of trade.” (Hornborg 2009:241)

As the illusionary reciprocity of international market exchange typically disguises the unequal exchange of productive potential, the focus should naturally turn to price formation. While the western world and its industrial machines benefits greatly from the unequal exchange as it maintains and accumulates its technomass, it has to be understood why the exchange actually takes place: why does the periphery exchange their raw materials for manufactured goods, especially when the latter actually represent entropy, i.e. waste, and the raw materials represent order, structure and productive potential? From a conventional economic perspective, the reason for the occurrence of such exchanges is to be found in utility. As the perceived utility of owning and using a manufactured good – a car, a CPU, a refrigerator – is greater than owning the raw materials – energy and materials – that is used to create the manufactured good in question, it is, according to mainstream economics, reasonable and probable that this difference in perceived utility is reflected in market prices. However, although Hornborg explicitly wants to stay away from how people choose to value things (Hornborg 2003b:6), for instance why humans value a car more than the non-processed materials and energy used to make a car, Hornborg nevertheless dismisses the fundamental concept that best describes such value judgments, simply on the basis that it is ‘culturally defined’:

We can completely disregard the subjective “utility” of the products, which is more or less arbitrary and ephemeral anyway – arbitrary because it is culturally defined (cf. Sahlins 1976), and ephemeral because it diminishes rapidly with use – and observe that if a finished product is priced higher than the resources required to produce it, this means that “production” (i.e., the dissipation of resources) will continuously be rewarded with even more resources to dissipate. (Hornborg 2001:45)

When excluding utility from the equation, solely looking at productive potential (including land and time) and the thermodynamic properties of raw materials and manufactured goods, it is of course highly questionable why one part in the exchange – the periphery – would choose to freely exchange more exergy, negentropy, or time and space, for less. The answer to this question is however not that easy to find in Hornborg’s work. One answer is that the market prices for the two commodity types is based on ideology and a cultural (mis)understanding: somehow, it is the neoclassical school that has made people believe that they need, and thus value, a car, a CPU and a refrigerator more than the material and energy that went into the production of these goods. However, an explanation based on perceived needs of consumers is nothing else than an explanation based on perceived utility. Another recurrent explanation

is that it is market prices (and mediums of exchange) *per se* that act as ideological agents making exchanges to appear as reciprocal (Hornborg 2009:240, 242ff), rather than being reflections of the interplay between supply, demand and purchasing power. Other explanations for the peripheral participation in ecological unequal exchange that have been presented by Hornborg (personal communication) are local elites within peripheries (who reap relative benefits from the exchange), forced proletarianization of the peripheral labor (who lack alternative sources of income than selling their labor and natural resources cheap), and goods fetishism (an exogenously created urge for western manufactures), the latter which brings us, once again, into the domains of perceptions of utility.

Through their coercive natures, forced proletarianization, direct or indirect, and local peripheral elites à la Frank seem to be the most viable explanations to why the periphery chooses to partake in ecological unequal exchange with the core. Nevertheless, it is of course quite problematic to discard valuations based on perceived utility from the discussions above, especially as Hornborg explicitly prefer value judgments to be made by the actors in the market (i.e. socially defined). As any consumer, and economist, knows, people do value an assembled car more than its non-combined materials and energy inputs, just as a computer processor is far more useful for calculating role-equivalence than the ounces of silicone, copper and semi-conductive materials *per se*, even at exchange rates where only a fraction of the energy and materials exchanged are used to produce a CPU.

Still, even if we remain in the strictly thermodynamic and physical aspect of exchange of raw materials for manufactured goods, the processor example underlines an aspect of the exchange that is missing in Hornborg's account: information. Intimately connected to Maxwell's demon (see Sundström 1992:64), information and negentropy are not only similar, but actually the very same thing in physics.¹⁴⁷ Using a neological linguistic derivative of Odum, the *imformation* in a computer processor, a car, or any conceivable manufactured good produced under a high-technology modern regime should be quite substantial.¹⁴⁸ Creating a processor out of its actual raw materials is not just a process of melting and mixing its metals substances and reducing the productive potential of its inputs through the burning of high-exergy fuels; rather, the processor is the result of several hundred years of scientific progress, information processing and arduous thought. The information and knowledge embedded in a manufactured good, seemingly cornucopian through its replicability, is, by definition, negentropy that thermodynamically benefits the buyer, in addition to the culturally and/or psychologically perceived utility of the good. Thus, if we remain strictly within physics and thermodynamics, and treating information as how it is treated in these disciplines, an inclusion of *imformation*, i.e. negentropy, when determining the exchange equality between raw materials and manufactured goods could very well tip the scales of the whole equation, resulting in thermodynamic unequal exchange in the very opposite direction to what is intuitively perceived.

Notwithstanding the formal critique above, Hornborg's work is intriguing and has had a tremendous impact on contemporary thought on ecological unequal exchange. Even though

¹⁴⁷ The physical unit of information, as derived from Boltzmann's original formula on entropy, is energy per degree Kelvin (see Ayres 1988:14).

¹⁴⁸ "The physical identification of information as negentropy suggests the possibility that stocks of information embodied in structure/organization can be regarded in some sense as reserves or storehouses of negative entropy." (Ayres 1988:7). While this primarily applies to the technomass of industrial societies, my argument here is that negentropy-as-information is substantially larger in manufactured goods than it is in extracted raw materials.

the bulk of today's manufacturing occurs far away from the final consumers, seemingly breaking down the typological dichotomy between an industrial core and a raw-material producing periphery, Hornborg offers a revival of the perspectives on production put forward by Gudeman and Georgescu-Roegen, i.e. where production is primarily seen as production of entropy. Finding the root causes for unequal exchange in various forms of culturally defined fetishisms while explicitly dismissing the similarly anthropogenic perceptions of utility, the only concrete similarity with Emmanuel is perhaps the usage of independent variables – cultural perceptions of productivity, market prices, or neoclassical theory – in order to explain occurrences of ecological unequal exchange.

However, there is a passage in one of his latest (2009) writings in which Hornborg hints at the relationship between ecological unequal exchange and structural positionality within networks of world trade:

[A] population's perceptions of technology, economy, and ecology are conditioned by its position within global systems of resource flows, and how mainstream modern perceptions of 'development' can be viewed as a cultural illusion confusing a privileged position in social space with an advanced position in historical time. (Hornborg 2009:239)

Not referred to directly in the passage above, the relationship between structural positionality and ecological unequal exchange is something that has been extensively addressed by the third scholar addressed in this chapter. In a series of articles, Andrew Jorgenson have proposed, and empirically tested, a structural theory of ecological unequal exchange, a line of thought to which we now turn.

Andrew Jorgenson

Steeped in the macrosociological world-system approach of Chase-Dunn, Andrew Jorgenson has written a series of articles concerned with ecological unequal exchange.¹⁴⁹ As a quantitative environmental sociologist, Jorgenson applies his knowledge of statistics to formally test world-system-related theories with issues on environmental degradation and resource consumption. A common thread in Jorgenson's writings is his hypothesis that links structural positionality within world-systems with environmental/ecological issues into a structural theory of ecological unequal exchange (see also Jorgenson 2006:687):

[T]he structural theory of ecologically unequal exchange asserts that more-developed countries externalize portions of their consumption-based environmental costs to lesser-developed countries, which in turn increases forms of environmental degradation in the latter while suppressing levels of resource consumption within their borders [...] It is argued that the populations of more-developed countries are positioned advantageously in the contemporary world-economy, and thus more likely to secure and maintain favorable terms of trade allowing for greater access to the natural resources and sink capacity of bioproductive areas within lesser-developed countries. (Jorgenson et al. 2009b:265)

Albeit the applied statistical methods differ somewhat between papers, Jorgenson compares measurements of structural positionality with various sets of national development indicators. In the 2003 article, the two main variables are world-system position and national ecological footprint (EF) data, where additional data on GDP per capita, literacy rates, domestic inequality, and urbanization are used as control variables. In later articles (2006; 2009b), Jorgenson focuses mainly on the relation between world-system positionality and

¹⁴⁹ Similar to Hornborg, Jorgenson has written extensively on the subject matter. Due to space limitations, this part is mainly based on four of his articles (Jorgenson 2003; 2006; 2009a; Jorgenson et al. 2009b).

deforestation, with additional datasets used as control variables. Furthermore, while the 2003 article covers the whole world-system, later articles (2006; 2009a; 2009b) only cover less-developed countries.

In all these articles, Jorgenson argues that there is a statistically significant relationship between world-system position vis-à-vis, respectively, resource consumption (2003; 2009a) and deforestation (2006;2009b). It can however be questioned whether the used metrics for measuring structural positionality are suitable for quantifying structural positionality. In the 2003 article, Jorgenson uses a composite index calculated by Kentor (2000) in which several national attributes are combined to arrive at a continuous measure supposed to reflect structural positionality along a one-dimensional core-periphery axis. With ten different national attributes¹⁵⁰ covering economic power, military dependence and global dependence (Kentor 2000:36-38), they are nevertheless internal properties that are supposed to reflect positions of nations within the world-system. Why these specific national attributes can be treated as independent measures of structural positionality rather than, for instance, similar national attributes such as Ecological footprint, GDP per capita, literacy rate, or level of urbanization is however not discussed. An observed relationship between the Kentor index of world-system position and the national attributes can thus be criticized as being tautological.

In later writings (2006; 2009a; 2009b), Jorgenson has developed an index of structural positionality that involves relational data. The weighted export index, aimed at quantifying “the relative extent to which a nation’s exports are sent to more-developed countries” (Jorgenson 2006:693), is specified as follows:

$$D_i = \sum_{j=1}^N p_{ij} a_j$$

Where D_i is the weighted export index for country i , p_{ij} is the proportion of exports from country i sent to country j , and a_j is the GDP per capita of receiving country j .

The p_{ij} variables, summing up to unity for each country i , is based on total export flows in two articles (2006; 2009a), whereas it only represents primary goods exports in the latest (2009b) article. Although indices are calculated for high- and low-income countries alike, Jorgenson only examines low-income countries in these three articles.

As a measure of structural positionality, the weighted export index is a step in the right direction as it, contrary to the Kentor indices, includes relational data. It can nevertheless be criticized on two accounts, corresponding to each of its inbound variables. First, although the normalized export vectors p_i (i.e. the p_{ij} variables) are calculated using relational data (bilateral trade flows), the normalization in effect nullifies the *magnitudes* of export flows, thus ignoring the relative overall significance of exports from each country. For instance, a country whose relatively small amounts of exports goes to a singular high-income country would get a higher index score than a country whose relatively large exports goes to another singular, slightly lower high-income country B. It would thus make sense to somehow include the importance of exports for a nation in the index. Secondly, the multiplication with per-capita GDP of the receiving country (i.e. a_{ij}), deemed to be more important than the

¹⁵⁰ The national indicators used by Kentor in calculating his composite indices are capital intensiveness, productive size, trade size, global capital control, military expenditures, military exports, global military control, export commodity concentration, foreign capital dependence, and military dependence. Although many of these are calculated by dividing aggregate exports with imports, such in- and out-degree magnitudes are still attributes of the individual countries rather than the structural data used to calculate such aggregate figures (see chapter 4).

actual magnitudes of the export flows in question, has a very significant impact on the resulting indices. Hypothetically, if all export vectors were perfectly balanced (i.e. where the shares of exports from each country is perfectly distributed across possible receivers), the rank order of the weighted export indices and GDP per capita would be identical.¹⁵¹

As only lesser-developed countries are accounted for in the papers that apply the weighted export index, there are no index results available for higher-income countries. Due to the large volumes of intra-core trade that evidently occurs, the weighted export indices for high-income countries should be quite large, no matter whether total exports or just primary exports are accounted for. There are, however, index scores for the 69 low-income countries covered in the 2006 study (for the period 1990-2000), together with data on deforestation and forest stock (Jorgenson 2006:712). A scatterplot of deforestation rates for the period 1990-2000 and the weighted export index can be found in Figure 6.2(A), whereas Figure 6.2(B) depict the relationship between deforestation and per-capita GDP (using complementary data¹⁵² from the World Bank). Although the statistical techniques used by Jorgenson are more advanced and sophisticated, the rudimentary linear regressions in Figure 6.2 does seem to indicate that per-capita GDP actually are better at explaining deforestation rates than what is the case for the weighted export index.

In light of de facto existing differences in resource consumption across the globe, Jorgenson's structural theory of ecological unequal exchange offers a hypothesis that, in addition to being quantitatively testable, is foundational from a theoretical point of view. Contrary to how Bunker and Hornborg explain the causes behind the phenomena, Jorgenson's focus on the structural properties of international trade flow networks is definitely more in line with the core issues found in dependency and world-system analysis; whereas new taxonomies of economic system types and a fundamental questioning of machine technology are novel, and certainly intriguing, explanations, the concern with structural positionality is more recognizable with the traditional concerns on monopoly capitalism, asymmetric trade structures and core-periphery hierarchies. The work by Jorgenson can thus be seen as a consolidation of the theoretical heritage found in the broader discussion of unequal exchange, even though the linkages to Emmanuel, Prebisch and Singer are quite weak in his discussion.¹⁵³

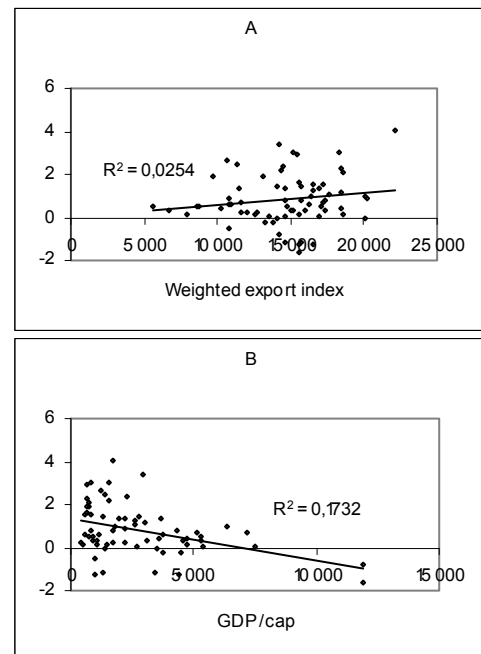

Figure 6.2: Linear regression analysis of deforestation (% change) vis-à-vis, respectively, the weighted export index (A) and per-capita GDP (B). (Sources: Jorgenson 2006; World Bank)

¹⁵¹ In the example provided by Jorgenson (2006:694ff), the rank order of the resulting indices (Jorgenson 2006:695) are identical to the partner attributes (per-capita GDP) (ibid.:694).

¹⁵² Per-capita GDP data for the year 1990 obtained from the World Bank (<http://data.un.org/>)

¹⁵³ Jorgenson argues that the theory of ecological unequal exchange “has much of its roots in the classical trade dependence, unequal exchange, and world-systems traditions in political-economic sociology (e.g. Emmanuel 1972;...)” (Jorgenson et al. 2009b:264), furthermore stating that “[u]nequal exchange theory proposes that forms of international economic inequality are partly structured and maintained through these trade dependent dynamics (Emmanuelle [sic] 1972).” (Jorgenson 2006:688).

Towards an Emmanuelian conceptualization of ecological unequal exchange

Raising several new questions while providing fresh perspectives on previously asked ones, the combining of world-system analysis and ecological economics has proven to be a fruitful endeavor. One of the most relevant overlap is the shared recognition of system totalities: admitting the finite boundaries within which human economies exist, both scientific strands are subsequently more focused on issues of distribution within this totality rather than adhering to ideas of infinite independent growth among its sub-entities.

In the section above, different varieties of the concept of ecological unequal exchange has been presented, a concept that probably is the most intriguing result of this disciplinary integration. However, rather than building on its original formulations as found in Emmanuel (as well as Prebisch and Singer), the notion of ecological unequal exchange should best be seen as a reinterpretation of the unequal exchange concept. Although the authors above dutifully refer to, and occasionally misinterpret, these original sources, the writings on ecological unequal exchange are not concerned with wage-levels, factors of production, elasticities of demand, or how the surpluses from productivity increases affect factor costs or commodity prices in different parts of the world. Instead, 'ecological unequal exchange' is implicitly defined simply as net transfers of biophysical resources between nations, i.e. the outcome of certain processes, rather than being something defined on the underlying mechanisms that leads to such transfers. While Bunker and Jorgenson look at such biophysical aspects alone, Hornborg (similar to Odum and Andersson – and Cantillon, too) combine such biophysical net flows with their monetary counterparts.

By the orthodox convention suggested by Brodin (2006a), ecological unequal exchange is not really concerned with unequal exchange proper, as the former typically lack any theoretical discussions on factor cost that defines the latter. Still, if concepts were not allowed to evolve and be reinterpreted outside their original contexts, we would surely have run out of a useful vocabulary by now. Ecological unequal exchange, as described by the authors above, is a very useful analytical concept with significant analytical potential. It describes a phenomenon that most certainly exists; it is hard to deny that the ecological footprints of high-income countries are not only larger than low-income ditto, but the former also has a far larger global range than the smaller ranges of low-income country footprints. Somehow, I consume products from all over the world, and equally somehow, the consumption patterns of the low-income masses are, in comparison, far more constrained, in scale as well as in scope.

As a phenomena whose existence is hard to deny, research should be focused on pushing the theoretical frontiers forward in search of the underlying dynamics that leads to ecological unequal exchange á la non-compensated net transfers of biophysical resources. Although a fundamental questioning of machine technology and a proposed distinction between productive vis-à-vis extractive economies are interesting per se, these two explanatory suggestions are quite far away from the fundamental theoretical stanzas found in the dependency school and world-system analysis.

By formulating, and empirically testing, a structural theory of ecological unequal exchange, Jorgenson is very much in tune with the core issues found within the world-system perspective. Despite having few substantial connections with the original formulations of unequal exchange, Jorgenson's explicit focus on international structures of exchange and how the positionality of countries within such networks are related to occurrences of (ecological) unequal exchange is an argument that is very much prevalent in the post-war discourse on

development. If a relationship between structural positionality and unequal exchange, ecological or otherwise, can be identified (which according to Jorgenson is something that can be statistically found), this would not only open up new theoretical avenues to pursue within world-system analysis but could also, I dare say, contribute to theory formulations within all brands of economics.

Similar to Jorgenson's writings, the hypothesis of this thesis is that structural positionality is related to occurrences of ecological unequal exchange. Building on the theoretical arguments of chapter 2 and 3, this thesis advances a similar structural theory of ecological unequal exchange, i.e. that a nation's ability to appropriate resources relatively advantageously is related to its incorporation in networks of international economic exchange. The disregard for exchange structures within the neoclassical school, their importance found within various strands of economic geography, and the overall lack of suitable formal comparative methods with which to address these issues – all this underpin the necessity of empirical analyses, similar to those conducted by Jorgenson.

As presented in chapters 4 and 5, a set of formal tools exist that are highly suitable for establishing and quantifying the various properties of structural positionality, world-systemic or otherwise. The various tools for measuring centrality and role-structures are, I argue, far better at formalizing the elusive notion of structural positionality than what can be done with the weighted export index proposed by Jorgenson. Based strictly on relational data, this thesis applies network-analytical tools to quantify a core theme within the dependency and world-system tradition, tools through which we can obtain formal comparative data relating to trade dependence, network centrality, zonal stratification and the various structural roles countries have within the contemporary world-system.

Contrasting Jorgenson further, this thesis depicts ecological unequal exchange on the basis of actually occurring trade flows between countries, rather than using differences in ecological footprint measurements per se as suitable indicators of ecological unequal exchange. In addition to the questions surrounding the official footprint methodology (see chapter 8), the official national footprint accounts not only include inbound and outbound resource flows to a country (in a manner that is methodologically problematic), but it also accounts for consumption of resources obtained from purely domestic endowments, as such reflecting ecological unequal consumption rather than ecological unequal *exchange*.

Albeit the net flows of natural resources are interesting per se, this thesis advances a novel conceptualization of unequal exchange that builds more directly on Emmanuel, Prebisch and Singer and their explicit focus on factors of production. At the same time, the proposed conceptualization simultaneously puts its main emphasis on trade flow structures and the identification, through the network-analytical tools, of asymmetries within global exchange networks and their implications for dependency and structural monopoly. This proposed conceptualization of ecological unequal exchange builds on three observations.

The first observation is that production, the combination of factors of production, is a global phenomenon. As shown by the global commodity chain school, the internationalization of production is not necessarily a modern phenomenon, but its scale, scope and significance has certainly increased over the years. Instead of having singular national origins, production cycles often traverse several industrial sites and locations before reaching final consumers, the latter often found within the high-income countries of the world. Each link in these global commodity chains has its own specific production function, organic composition of capital,

institutions, and factor costs. Perhaps with the exception of unskilled labor, the factors of production indeed seem to be internationally mobile, thus increasingly contradicting the classical analytical distinction between an industrialized core and a non-industrialized periphery. However, judging by the contemporary gaps in welfare and consumption across various parts of the world, the internationalization of production does not necessarily correlate to a reduction of such gaps.

The second observation is concerned with factors of production. Conventional economic theory, as well as Marxism and its sibling schools, focuses specifically on two types of production factors - labor and capital – a focus that is clearly reflected in the post-war development discourse. However, through the combination of ecological economics with world-system analysis, the third Ricardian factor of production enters the debate. With the reintroduction of land, i.e. natural resources, into the developmental discourse, the notion of ecological unequal exchange has materialized; as Bunker argues, it is more relevant to study unequalness in terms of biophysics than continuing a seemingly endless debate on labor values whose relevance, according to Bunker and Hornborg, is in a steady decline.

The third observation underpinning the conceptualization of ecological unequal exchange used in this thesis is, not surprisingly, concerned with exchange structures. Disregarded completely in mainstream exchange theory, furthermore absent in the works of Prebisch, Singer and Emmanuel, there are several empirical and theoretical arguments for putting a greater emphasis on the structures through which economic exchange occurs. While explicitly referred to in the dependency and world-system literature, there are few attempts that tie formal analyses of these structures with the core issues found within world-system analysis into a broader explanatory framework.

In the empirical chapters that follow, the trade flow networks for two groups of primary commodities will be analyzed. In these chapters, using network-analytical tools, the role-structures and role-positional membership of up to 100 countries will be calculated, as well as centrality scores using the BDD centrality index presented in chapter 4. In addition to looking at the strict monetary dimensions of these trade flows, the analyses will also cover the non-monetary aspect; using different biophysical units of accounting for each commodity group – chemical energy content of fuel commodities (chapter 7), and direct production hectares for primary agricultural goods (chapter 8) – the monetary and biophysical dimensions of these commodity flows can be compared.

The production (extraction) of primary goods does indeed imply allocation of labor and capital, but it is not primarily the value of these labor and capital inputs that constitute the large part of the market value of these primary goods: rather, it is the biophysical properties of the produced/extracted goods per se. As such, even though labor and capital (as well as other resources) are used in the growing of crops and the extraction of fossil fuels, I argue that the two types of primary goods studied in the forthcoming chapters can be seen as adequate representations of the third Ricardian factor of production.

Based on the above, the empirical chapters can thus be seen as studies of factor allocation within global production structures. Rather than looking at complete production chains for one or more individual commodities, the empirical chapters that follow look at international factor allocations of natural resources for the chain segments found within each of the covered countries.

As the analyses combine the monetary and biophysical dimensions of these primary goods, it is possible to contrast the net flows of these in search of Cantillonian ecological unequal exchange. This first type of ecological unequal exchange is thus similar to the ideas put forward by Bunker and Hornborg, i.e. where a non-compensated net flow of biophysical resources is concealed behind a seemingly equal exchange of values. While this is also done in the empirical chapters, revealing some interesting contradictory findings for a handful of countries, the empirical chapters are concluded by combining the monetary and biophysical accounting units, arriving at value-quantity ratios for imports and exports to each country. In essence, factor costs, as measured in exchange value per biophysical unit, are calculated for resources entering and leaving national borders.

While Emmanuel thus examined the national price-differentials for labor (i.e. wages), this thesis looks at price-differentials of another factor of production: land (and natural resources). Similar to Emmanuel, the hypothesis states that these price-differentials are related to structures, but contrary to Emmanuel's focus on differences in national labor organization and related institutions, the thesis hypothesis is that such price-differentials instead depend on global exchange structures. In each of the empirical chapters that follow, price-quantity ratios are therefore compared with the results from the network-analyses, in effect searching for would-be relationships between structural positionality and would-be differences in factor costs for the third Ricardian production factor. As such, this second type of ecological unequal exchange is, I argue, far more in line with Emmanuel's original formulation of unequal exchange than how the notion so far has been used within political ecology.

CHAPTER 7

Fuel commodity trade

Three months after two airliners crashed into the World Trade Center in New York, Michael Klare wrote the introduction to *Resource Wars* (2002), correctly predicting that “Washington will take other steps to bolster its position in the Gulf, including the initiation of a new drive to oust Saddam Hussein.” (ibid.:xi). In line with the theme of Klare’s book, the reason behind such a positional bolstering in the Gulf is the scramble for control over natural resources scattered across the globe, a scramble which constitute, as the book’s under-title says, “the new landscape of global conflict”.

Whether Klare turns out to be correct or not in the long-run is perhaps too early to say.¹⁵⁴ However, the “non-negotiability” of certain life-styles that implies the consumption of large volumes of natural resources, especially energy, is not merely a proviso by Bush Sr. when signing the Convention on Climate Change, but an active ingredient in state policy guidelines.

In the writings of the PNAC think-tank, one of the suggested policies for securing continued US prosperity is concerned with keeping markets open and non-monopolistic, with force if necessary, analogous to domestic anti-trust legislation within USA:

A concerted national trade and security policy to prevent monopolistic collusion by foreign energy producers, especially in crude oil--and thus to restore more U.S. energy independence. Since collusion is not tolerated in any domestic industry, why must we tolerate collusion abroad against a vital U.S. interest, especially by oil-producing countries whose political existence depends to a large extent on U.S. military power? (Lehrman 2003:29)

While the PNAC writings did not represent the official doctrine of the previous Bush Jr. government, a recent speech by Jacques Chirac on a visit to the strategic air- and maritime base in Landivisiau, Bretagne, hints at a similar shift in military doctrine, from the defense of national territories to a defense of ‘vital interests’, including natural resources outside the national jurisdiction:

Our world is constantly changing and searching for new political, economic, demographic and military equilibria. It is characterized by the swift emergence of new poles of power. It is confronted with the appearance of new sources of imbalance, in particular *the sharing of raw materials, the distribution of natural resources*, and changing demographic equilibria. [...] [S]afeguarding our *strategic supplies* or the defence of allied countries are, among others, interests that must be protected. [...] The credible threat of their [nuclear weapons] utilization permanently hangs over those leaders who harbour hostile intentions against us. It is essential for making them see reason and for making them aware of the inordinate cost their actions would entail for themselves and their States. Furthermore, it goes without saying that we always reserve the right to resort to a final warning to mark our determination to safeguard *our vital interests*. (Chirac 2006; my italics)¹⁵⁵

Among the different types of natural resources demanded by human societies, fossil fuels clearly stand out in importance. With the major part of our various transportation systems,

¹⁵⁴ Or perhaps it isn’t. The Iraqi Oil Law gives unprecedented access of Iraqi oil fields to a handful of US and UK companies through exclusive production sharing agreements for 20-30 years. For more information, see [http://en.wikipedia.org/wiki/Iraq_oil_law_\(2007\)](http://en.wikipedia.org/wiki/Iraq_oil_law_(2007)) and <http://www.handsoffiraqoil.org>.

¹⁵⁵ Speech available at <http://abolition2000europe.org/index.php?op=ViewArticle&articleId=134&blogId=1>

and through this our whole economy, being dependent on these resources, combined with its scattered spatial availability, has led to very peculiar patterns of trade flows in these commodities. With increasing demand from growing economies, notably China, in combination with growing political tension between regions of extraction vis-à-vis consumption, these trade patterns are most likely to change, unless the contemporary fuel-dependent nations of today, notably USA, interpret such changes as “collusional” and decide to act accordingly.

With global demand seemingly outpacing supply, leading to an all-time record increase in prices, it is sometimes difficult to conceptualize the vast amount of energy appropriated by human society. Suggested by Crane and Kinderman, the CMO unit represents a cubic mile (4.17 km³) of crude oil, which is approximately the current global annual consumption. Converting the consumption of other energy sources to CMO-equivalents, based on energy content, Crane and Kinderman estimate annual world energy consumption at 2.5 CMO as given in Table 7.1.

	Fuel	CMO equivalent	Total (% Share)
Fossil	Oil	1.0	
	Coal	0.6	
	Gas	0.5	2.1 (85%)
Solar	Hydropower	0.2	
	Biomass	<0.01	
	Solar cells, wind, thermal	0.001	0.2 (7.5%)
Nuclear	Fission	0.2	0.2 (7.5%)
Other	Geothermal	<0.01	
			2.5 (100 %)

Table 7.1: Global annual consumption of energy as measured in CMO (cubic miles of oil). (Source: http://www.bootstrap.org/colloquium/session_02/session_02_crane.html)

From the supply side of the equation, the Bunker-esque distinction between production and extraction shines by its own light. According to standard neo-classical theory, an increase in demand leads to increased production, resulting in a new equilibrium at a lower price level. In the case of fossil fuels (and most other non-renewable resources), increased demand does not translate into increased “production” – instead there are clear signs of diseconomies of scale, where the price is inversely related to volumes consumed. An increase in labor and capital, the two standard types of production factors, increase the rate of extraction, but it does not increase the actual geological substances that constitute fuel commodities. In short, the lack of the third Ricardian factor of production – land/resources – in standard neo-classical production functions gives the impression that additional capital and labor to the extraction process actually can substitute diminishing access to, and existence of, the substances that constitute the final product.

Whether the world has reached peak oil or not, i.e. the point where the rate of global oil extraction is at its maximum, remains to be seen, but the contemporary discussion on peak oil is, similar to the debate on climate change, a discussion concerned with *when* rather than *if*. Abiotic theories notwithstanding, there is an overall consensus that fossil fuels are a non-renewable resource that eventually will run dry. As shown in Table 7.1 above, a forthcoming transition from fossil fuels, crude oil in particular, will indeed be a redefining moment in the history of civilizations. The new landscape of global conflict, as manifested in the Iraq invasion, war-mongering towards Iran, fossil-fuel-motivated resentment towards UN intervention in the Darfur region, militarization and multi-national involvement around the Caspian sea, the Spratly islands, the North pole etc, seems to reflect a desperate attempt to

postpone, at whatever cost and with whatever consequences, this inevitable transition to post-fossil civilization. Meanwhile, the specter of anthropogenic climate change, fuelled by fossil fuels, looms in the foreseeable future, possibly posing an even greater threat to mankind at large.

This chapter will look at the exchange structure of the four most important fuel commodities traded across the world, analyzing not only the monetary aspect of such trade flows but also the actual energy transfers these flows represent, the latter representing the non-monetary aspect chosen for this chapter. The common denominator of the fuel commodity types chosen for this chapter is that their utility is obtained through incineration: although different fuel types have different usages and utilities – liquid fuels are far more convenient for vehicles than solid fuels such as coal – this chapter focuses strictly on the energy metabolism of the world. Once the monetary and physical data layers have been created and analyzed, this chapter will focus on ecological unequal exchange and how it relates to the structural results obtained in this chapter, focusing on the second type of ecological unequal exchange as presented in chapter 6.

Data

Fuel commodities constitute a division of its own (SITC 3) in the Comtrade database and at the 4-digit level, we find the commodities¹⁵⁶ listed in Table 7.2 below. Representing more than half of the total value of traded fuel commodities, crude oil is followed by motor gasoline, fuel oils, non-agglomerated coal, gas oils, and natural gas – these commodities representing almost 90 percent of the value of all traded fuel commodities for the 100 countries reporting data for the 1995-1999 period (the R-set of countries).¹⁵⁷

Two trade flow matrices were created¹⁵⁸ for each of the commodities in Table 7.2, matrices containing the exchange values and weights, respectively, of bilateral trade flows between pairs of R-set countries. The second column (B) in Table 7.2 below contains the sum of these trade flow values for each commodity, as such naturally being somewhat lower than the sum of total (world) imports for all countries. While the aggregate values in all these flow matrices represents 78.2 percent of reported total imports, there are noticeable variations in the coverage for each commodity. For instance, 89.6 percent of the total world imports of motor gasoline (SITC 3341) for the R-set is intra-R-set trade, only 72.1 and 52.0 percent of total R-set imports of Crude oil (SITC 3330) and Natural gas, gaseous (SITC 3432), respectively, can be found in the flow matrices for these commodities. There are two plausible explanations for the relatively low coverage for these (and other) commodities: either a fair amount of trade data were excluded in the creation of the flow matrices due to lack of reported quantities, or reported imports have origins outside the R-set of countries. A closer inspection of the trade statistics for the Natural gas categories (SITC 3431, 3432) reveals a number of causes of this relatively low coverage for these two commodities.

¹⁵⁶ Electrical energy (SITC 3510), representing 6 billion USD, is however excluded here as its quantities in the PC-TAS 1995-1999 dataset are stated in the incomprehensible unit of Megahertz.

¹⁵⁷ Import trade data for a total of 100 countries are found in the Comtrade-derived PC-TAS dataset used in this thesis, countries labeled the R-set in this thesis. Although most of their import partners are to be found within this R-set, there are also reported imports from countries other than those found in the R-set. These non-reporting countries are labeled as the NR-set in this thesis. A more thorough description of the used dataset, its global coverage, and a list of reporting and non-reporting countries are to be found in the Appendix.

¹⁵⁸ Using the procedure described in the Appendix, i.e. by calculating annual mean imports based on data availability for each country and year, only including bilateral flows where both the value and the quantity (in metric tons) are given and where both the source and destination are members of the R-set.

SITC	Commodity	A. Total world imports (R←WLD)		B. Total R-set bilateral trade (R←R)		Intra-R-set coverage (R←R)/(R←WLD) (B/A)
		Value [kUSD]	% of total	Value [kUSD]	% of total	
3330	Crude petroleum	212 072 353	57,2%	152 935 261	52,7%	72,1%
3341	Motor gasoline, light oil	28 629 021	7,7%	25 641 397	8,8%	89,6%
3344	Fuel oils, n.e.s.	20 323 799	5,5%	16 937 635	5,8%	83,3%
3212	Oth. coal, not agglomerated	19 845 815	5,4%	19 406 199	6,7%	97,8%
3343	Gas oils	18 806 613	5,1%	17 804 771	6,1%	94,7%
3432	Natural gas, gaseous	16 569 248	4,5%	8 611 203	3,0%	52,0%
3431	Natural gas, liquefied	13 289 000	3,6%	11 909 678	4,1%	89,6%
3345	Lubricants	8 239 384	2,2%	7 779 827	2,7%	94,4%
3342	Kerosene, medium oils	6 476 751	1,7%	5 674 702	2,0%	87,6%
3421	Propane, liquefied	5 413 541	1,5%	4 579 550	1,6%	84,6%
3340	REST OF 334 NOT DEFINED	4 484 951	1,2%	3 472 559	1,2%	77,4%
3354	Petrolm. bitumen, coke, etc	3 264 180	0,9%	3 167 132	1,1%	97,0%
3425	Butanes, liquefied	3 048 640	0,8%	2 441 090	0,8%	80,1%
3352	Mineral tars and product	2 426 572	0,7%	2 241 801	0,8%	92,4%
3250	Coke, semi-coke, ret. carbn	2 285 498	0,6%	2 236 963	0,8%	97,9%
3442	Gas. hydrocarbon, liq., nes	1 962 788	0,5%	1 790 463	0,6%	91,2%
3351	Petroleum jelly, wax etc	1 090 650	0,3%	1 015 573	0,4%	93,1%
3211	Anthracite, not agglomerated	904 098	0,2%	697 637	0,2%	77,2%
3223	Peat	553 535	0,1%	549 552	0,2%	99,3%
3441	Ethylene, etc., liquefied	408 808	0,1%	394 402	0,1%	96,5%
3353	Mineral tar pitch, p. coke	338 070	0,1%	283 316	0,1%	83,8%
3222	Lignite	242 530	0,1%	233 502	0,1%	96,3%
3449	Gas. hydrocarbon, gas. nes	114 272	0,0%	109 661	0,0%	96,0%
3221	Briquettes, coal	63 559	0,0%	62 421	0,0%	98,2%
3210	REST OF 321 NOT DEFINED	23 681	0,0%	23 681	0,0%	100,0%
3450	Coal gas, water gas, etc.	7 092	0,0%	6 841	0,0%	96,5%
3350	REST OF 335 NOT DEFINED	1 808	0,0%	1 807	0,0%	99,9%
Total imports (all 3nnn):		370 886 257	100,0%	290 008 624	100,0%	78,2%

Table 7.2: 4-digit SITC fuel commodities sorted by decreasing total world imports for the R-set.

In the case of SITC 3432 (Natural gas, gaseous), there are several problems with the available trade data. For Germany, being the largest importer at more than 7 bn USD, the origin of its singular source is stated as SPEC CATS, i.e. a non-specific actor. For USA, the second largest importer at 4.7 bn USD, there are no quantities reported for this singular flow of imports from Canada. Canadian imports from USA are however quantified, though in cubic meters instead of metric tons, and so are US imports from Mexico - while Mexican imports from USA lack quantities altogether. Of the total Russian imports at 95 million USD, approximately 88 of these have Kazakhstan and Turkmenistan specified as sources, these two countries belonging to the set of non-reporting countries (the NR-set). As this relatively large mixture of problems – missing data on quantities, non-specified sources, and various units of physical accounting – applies to the major importers of natural gas, the exclusion of these faulty data records does result in the inter-R-set coverage of total world imports being significantly reduced for this commodity.

For liquefied natural gas (SITC 3431), the problems are not as overwhelming as it is for its sibling category above, reflected in an inter-R coverage at 89.6 percent of total world imports for the R-set of countries. However, in contrast to all other country reports of this commodity, USA measures the quantities of imported LNG in cubic meters rather than metric tons, resulting in US imports being excluded in the matrix creation process. While it is possible to

convert cubic meters of LNG to metric tons¹⁵⁹, quantities are still missing for the reported imports of Israel, Canada and Mexico. The online version of the Comtrade database does have quantity data for the latter two countries, given in liters, but its quality can be questioned: the trend of Canadian LNG imports from USA during the period 1995-1999 varies greatly, going from 4 (!) cubic meters in 1997 to 28,090 cubic meters the following year. Quantities of Mexican imports are given in liters in 1995, missing altogether in 1996, and given in kilograms in 1997-99, and the trend of Mexican imports of LNG for the whole period goes from 1 kUSD to 2,620 kUSD. In short, SITC 3431 is equally problematic to include as its gaseous sibling SITC 3432 due to inconsistent data.

SITC 3344 – Fuel oils, not elsewhere specified – represents 5.5 percent of total world imports reported by the R-set of countries. While the data seems statistically “reasonable”, with intra-R-set flows covering 83.3 percent of total imports of SITC 3344, the “not elsewhere specified”-aspect is problematic to study in the context of this thesis. The energy content of various fuel oils vary, which makes it difficult to use the quantities given in this commodity flow matrix in an ecological-economic reasonable manner.

This chapter will use trade data on four of the fuel commodities above: crude oil (SITC 3330), Motor gasoline (SITC 3341), other coal (non-agglomerated) (SITC 3212), and gas oils (SITC 3343). Taken together, these four commodities represent 75.3 percent of total world imports reported by our set of 100 countries, thus hopefully being an adequate representation of world trade in fuel commodities at large. A second reason for choosing these specific categories is their relatively constant weight-to-energy ratio, this being in contrast to categories such as “Fuel oils, not elsewhere specified”. To include the two natural gas commodity types, especially LNG, is possible – I have however chosen not to as the total coverage only would increase by 3.6-8.1 percent, an increase which has to be weighted against an increased error margin due to what could be erroneous data.

With only 72 percent of total world imports of crude oil (SITC 3330) originating from countries in the R-set, it is well-advised to have a closer look at the raw trade data for this commodity. Most of the typical oil-exporting countries can be found among the R-set of countries, but there are also a handful of relevant countries in the NR-set. For instance, looking at the value of Japanese imports of crude oil, it can be noted that its largest supplier is United Arab Emirates, representing more than a quarter of Japanese world imports and being the origin of 6.4 percent of world total imports of crude oil. Iran is another important oil extractor: also representing 6.4 percent of world total imports, Iran differs from other oil exporters as none of this export is destined for USA. Exceptions withstanding¹⁶⁰, Iraq is not reported as being a source of crude oil imports until 1997 (when the Oil-for-food program came into effect); imports from Iraq during 1997-1999 nevertheless represents 2.9 percent of world total imports of crude oil of which more than a third being reported as US imports. Gabon and Angola are two other interesting countries in the NR-set: only representing 1.0 and 1.8 percent of world total imports, respectively, 79 and 67 percent respectively of these imports have USA marked as their destination. Finally, while reported imports from Kazakhstan only represent 0.6 percent of total world imports, it can be noted that virtually all of Russian imports of crude oil has Kazakhstan as its origin.

¹⁵⁹ 1 billion cubic meters of Natural Gas is equal to 0.73 million tons of Liquid Natural Gas.

¹⁶⁰ In 1995, Jordan and Croatia reported imports from Iraq, at 356 and 6 million USD respectively. In 1996, Turkey reported on imports from Iraq amounting to 32 million USD. This is to be compared with the 6 bn USD worth of imports from Iran reported over the 1995-1999 period as a whole.

Although we are looking exclusively at four specific fuel commodities, it could be tempting to assume that the NR-set countries above lack any imports whatsoever of the commodities which they apparently export to such a great degree. Such an assumption would make it easy to expand our dataset with these countries simply by using the reported import data from the R-set of countries. While absent as reporting countries in the used PC-TAS dataset, consulting the online version of Comtrade reveals that import data indeed exists for a number of these countries for various years in the 1995-99 period, i.e. these countries seemingly being reporting countries after all for the period in question. Based on this online data availability and significance with respect to total world imports, I have chosen to integrate three countries – United Arab Emirates, Iran, and Kazakhstan – into the dataset used in this chapter, in effect using import trade data as reported by these three countries that are found in the online Comtrade database. Regarding imports *from* these countries, data from the PC-TAS dataset is used.

Calculating mean annual flows in the same way as when creating the flow matrices above, the 8 trade flow matrices, containing values and weights of the four commodities, are expanded by three extra rows (containing import data already existing in the PC-TAS dataset) and three extra columns (containing import data obtained from the online Comtrade database for UAE, Iran and Kazakhstan).¹⁶¹

The inclusion of these three countries into our dataset has implications for its overall coverage of total world imports in the four fuel commodities chosen for this study. As Table 7.3 reveals, the inclusion of our troika increases the coverage of crude oil by 12.7 percentages, also pushing the coverage of motor gasoline above 90 percent. Out of total world imports at 279 bn USD for fuel commodities to our 103 countries, 87.2 percent of these trade flows now occurs within our expanded set of countries. Without the inclusion of UAE, Iran and Kazakhstan, the overall data coverage for these four commodities would be 10 percent less.

SITC	Commodity	A. Total world imports (R<-WLD)		B. Total R-set bilateral trade (R<-R)		Intra-R-set coverage (R<-R)/(R<-WLD) (B/A)
		Value [kUSD]	% of aggregate	Value [kUSD]	% of aggregate	
3330	Crude petroleum	212 154 015	75.9%	179 890 838	73.8%	84.8%
3341	Motor gasoline, light oil	28 629 021	10.2%	26 221 258	10.8%	91.6%
3212	Oth.coal,not agglomeratd	19 890 862	7.1%	19 631 596	8.1%	98.7%
3343	Gas oils	18 806 613	6.7%	17 921 468	7.4%	95.3%
Aggregate:		279 480 511	100.0%	243 665 160	100.0%	87.2%

Table 7.3: Imports of four fuel commodities for our expanded dataset as coverage of total world imports.

In spite of the high overall coverage for the selected commodity types, there are significant individual discrepancies regarding the coverage for each country. For instance, the data on Israeli imports of crude oil, a singular import flow valued at 1.3 bn USD, lack quantities altogether and has “Areas, not elsewhere specified” as its source, thus in effect reducing the coverage of Israeli crude oil imports to zero percent. In spite of such poor coverage, all 103 countries will be included in the net flow and centrality analyses that follows – the coverage for each country will however be supplemented in this analysis, including a breakdown of coverage for each of the four commodities. These coverage figures must thus be considered

¹⁶¹ In 1997 and 1998, Iran imported a very small amount of crude oil from United Arab Emirates, this being the only reported bilateral trade between the three countries added to the dataset. This flow, along with some of the complementary online Comtrade data is however discarded as their values are below 50 kUSD, i.e. the same cutoff applied in the PC-TAS database.

when interpreting the magnitudes of net flows. It is possible to do a linear adjustment of net flows for each country and commodity based on total (world) imports for the countries, but such an adjustment would assume a constant value-to-weight ratio for all imports of a commodity to a country, furthermore being impossible to do in the case of Israel whose import statistics lack quantities altogether. Contrary to the net flow analysis below, poor coverage can have a more profound impact on role-structural analyses¹⁶². The set of countries will therefore be reduced prior to the role-analysis, removing countries whose overall coverage is below a specific threshold.

The final step prior to analysis is the conversion of the 8 flow matrices containing values and weights for our four commodities into two aggregate flow matrices containing total bilateral flows of value (V_{Fuel}) and energy (E_{Fuel}) content of the selected fuel commodities, the latter which is calculated as follows:

$$E_{Fuel} = Q_{3212} \cdot c_{3212} + Q_{3330} \cdot c_{3330} + Q_{3341} \cdot c_{3341} + Q_{3343} \cdot c_{3343}$$

where E_{Fuel} is the matrix containing total energy flows, Q_{3NNN} is the matrices containing the weight of flows for SITC-commodities 3NNN, and c_{3NNN} is the energy content per unit of weight for SITC-commodity 3NNN.

The conversion factors representing the energy content of coal, crude oil, motor gasoline and gas oils can be found in Table 7.4. Regarding SITC 3212 – Other coal, not agglomerated – this commodity category is further divided into two 5-digit SITC categories: Bituminous coal (SITC 32121), and Other coal (SITC 32122), both containing non-agglomerated coal. With bituminous coal (at least) representing 80 percent of the SITC 3212 category, I treat this category as consisting only of bituminous coal. In the case of SITC 3341 – Motor gasoline, light oil – there are three SITC categories on its 5-digit level: Motor gasoline (including aviation gasoline), gasoline-type jet fuel, and a category containing light petroleum and fuel oils derived from other bituminous (non-crude) minerals. Each of these 5-digit SITC categories reflects their parent SITC 3341 category at 41, 4 and 55 percent respectively. I have chosen to use the conversion factor for standard motor gasoline for the SITC 3341 commodity group as the energy content per unit of mass is fairly constant for all these petroleum products – it is instead the density that differs between these different sub-categories for SITC 3341.

SITC	Commodity	Energy content [GJ/ton]	Total weight [tonnes]	Total energy flows [PJ] (10^{15} J)	Share of aggregate (%)
3212	Oth.coal,not agglomeratd	27	427 952 484	11 555	13.3%
3330	Crude petroleum	45	1 435 542 398	64 599	74.3%
3341	Motor gasolene,light oil	43.5	139 728 322	6 078	7.0%
3343	Gas oils	42.5	109 643 673	4 660	5.4%
Aggregate:			2 112 866 877	86 892	100.0%

Table 7.4: Energy conversion factors and total weight and energy flows for four fuel commodities. (Source: Oak Ridge National Laboratory, http://bioenergy.ornl.gov/papers/misc/energy_conv.html)

¹⁶² Poor coverage could also affect when calculating BDD-indices (see chapter 4). As the source of Israeli imports of crude oil is unspecified and thus omitted from our dataset, this affects the total exports of crude oil and, through this, having a slight effect on the deviations between the balanced total export vector and the import vectors for every country in the dataset. As these missing data is relatively small, these effects should be of minor importance for the resulting BDD-indices. In contrast, if Natural gas, gaseous (SITC 3432) was covered in this analysis, the exclusion of its two largest trade flows would result in more than slight effects on the deviations in question, resulting in less representative BDD-indices for all countries in this study.

Degree centrality: National flows of value and energy content

Calculating gross and net flows of fuel commodity values and energy contents for each country, we arrive at the monetary and energy trade balances as given in Table 7.5, sorted by decreasing net value flows. A scatterplot of the net flow data can also be found in Figure 7.1 below. Lacking fuel commodity data, Nepal is omitted from this chapter.

Country	Coverage	Exchange value [kUSD]			Energy [GJ]		
		Import	Export	Net	Import	Export	Net
USA	89 (100;88;96;96)	50 381 334	5 837 212	44 544 122	17 802 965 871	2 472 478 069	15 330 487 802
JPN	91 (100;89;93;97)	36 182 311	302 873	35 879 438	13 214 356 256	73 334 085	13 141 022 172
DEU	87 (100;81;99;100)	16 749 732	1 663 325	15 086 407	5 442 790 959	376 908 215	5 065 882 744
KOR	86 (100;89;49;58)	15 564 846	1 823 022	13 741 824	5 796 985 727	460 944 250	5 336 041 478
FRA	89 (100;87;89;95)	12 388 061	1 317 956	11 070 105	4 184 683 920	295 354 511	3 889 329 409
ESP	77 (100;72;93;95)	6 230 804	458 652	5 772 152	2 359 950 309	120 323 097	2 239 627 212
ITA	61 (100;56;73;90)	6 981 700	1 348 256	5 633 444	2 615 704 200	334 039 401	2 281 664 799
BRA	94 (100;93;98;92)	5 163 521	187 886	4 975 635	1 791 647 121	49 007 341	1 742 639 780
IND	98 (100;98;-;-)	4 945 815	212 924	4 732 891	1 896 824 880	58 258 764	1 838 566 116
BEL	99 (100;100;97;96)	6 337 243	1 747 235	4 590 008	2 184 813 957	403 787 425	1 781 026 532
THA	85 (96;83;100;99)	3 683 979	436 548	3 247 431	1 153 220 471	117 870 755	1 035 349 716
SGP	87 (90;86;96;94)	7 091 977	4 150 296	2 941 681	2 375 119 822	972 446 648	1 402 673 175
TUR	73 (98;68;95;85)	2 620 068	95 291	2 524 777	960 862 673	29 968 751	930 893 922
PHL	98 (100;98;100;98)	2 395 685	101 120	2 294 565	855 021 261	24 347 065	830 674 196
SWE	100 (100;100;100;100)	3 023 805	1 103 687	1 920 118	1 040 780 357	253 233 092	787 547 265
HKG	98 (100;-;100;98)	1 914 897	16 826	1 898 071	609 330 378	5 584 865	603 745 513
CHE	88 (100;63;100;100)	1 884 464	73 468	1 810 996	470 414 719	29 299 988	441 114 732
PRT	89 (100;89;73;100)	1 824 185	193 342	1 630 843	692 422 586	44 035 408	648 387 178
NLD	96 (100;95;99;99)	9 916 108	8 439 699	1 476 409	3 501 669 931	2 448 875 947	1 052 793 984
POL	99 (98;99;100;100)	2 370 272	914 928	1 455 344	833 443 523	578 323 843	255 119 680
AUT	83 (100;70;100;100)	1 551 354	108 634	1 442 720	461 294 986	27 676 942	433 618 044
PAK	98 (100;100;84;97)	1 337 905	54 269	1 283 636	412 077 097	16 254 853	395 822 244
GRC	87 (100;87;90;81)	1 420 257	185 923	1 234 334	576 850 030	48 637 575	528 212 455
FIN	100 (100;100;100;100)	1 769 148	600 985	1 168 163	651 274 625	125 012 000	526 262 625
CHL	89 (100;90;90;61)	1 196 311	36 023	1 160 288	409 470 499	11 617 040	397 853 459
ROM	97 (99;96;-;-)	1 008 805	207 264	801 541	389 981 772	48 976 179	341 005 594
BLR	100 (93;100;-;-)	756 048	17 677	738 371	455 853 024	5 343 875	450 509 150
IRL	95 (68;100;100;100)	769 998	32 585	737 413	210 208 296	8 897 649	201 310 647
SVK	98 (90;100;-;-)	814 005	144 253	669 752	340 435 683	32 180 690	308 254 994
CZE	97 (100;96;100;85)	1 056 822	425 357	631 465	411 110 338	187 911 520	223 198 818
HUN	99 (100;99;-;-)	727 076	180 196	546 880	293 515 020	40 364 168	253 150 853
NZL	96 (-;95;100;93)	691 346	260 411	430 935	205 810 894	95 910 391	109 900 503
DNK	100 (98;100;100;100)	1 545 379	1 134 721	410 658	528 612 886	354 881 717	173 731 169
PER	99 (100;100;88;98)	622 111	246 727	375 384	213 258 229	93 311 312	119 946 918
SVN	93 (99;83;100;88)	355 239	9 870	345 369	86 331 999	2 843 522	83 488 477
KEN	93 (100;98;89;79)	328 177	5 041	323 136	93 026 073	1 595 125	91 430 948
LTU	100 (95;100;99;100)	485 371	168 618	316 753	215 183 966	47 499 722	167 684 244
BGD	74 (100;53;99;87)	310 775	3 279	307 496	86 300 950	842 943	85 458 007
ISR	21 (100;0;-;-)	368 753	74 866	293 887	260 199 000	38 339 880	221 859 121
PAN	97 (100;100;82;91)	314 330	71 445	242 885	112 697 757	19 994 189	92 703 569
HRV	66 (100;64;94;98)	393 802	158 727	235 075	137 963 094	39 509 714	98 453 380
SEN	78 (-;94;9;65)	218 837	2 859	215 978	63 234 347	889 883	62 344 465
URY	90 (-;90;94;-)	205 010	8 717	196 293	54 373 068	2 172 775	52 200 294
PRY	99 (100;100;98;100)	196 497	1 024	195 473	36 414 907	355 827	36 059 080
YUG	67 (77;67;-;-)	183 443	1 025	182 418	56 873 889	338 049	56 535 840
CHN	74 (100;68;95;99)	3 525 904	3 359 062	166 842	1 101 681 189	1 399 950 306	-298 269 117
CYP	95 (100;93;100;100)	159 260	8 658	150 602	108 657 069	3 071 867	105 585 202
CRI	92 (-;100;87;-)	128 880	767	128 113	105 199 245	194 076	105 005 169
GHA	109 (-;109;-;-)	136 791	9 162	127 629	212 478 075	2 496 011	209 982 065
SLV	85 (-;96;58;-)	127 693	531	127 162	34 573 133	86 240	34 486 893

Country	Coverage*	Exchange value [kUSD]			Energy [GJ]		
		Import	Export	Net	Import	Export	Net
NIC	98 (-;100;75;96)	129 133	2 983	126 150	35 483 648	1 762 722	33 720 926
LKA	100 (-;100;-;-)	135 437	17 196	118 241	47 210 400	4 126 410	43 083 990
GTM	83 (98;100; 59 ;-)	167 643	74 527	93 116	44 719 014	36 332 993	8 386 022
MDG	87 (88;96; 66;72)	97 979	14 339	83 640	25 435 214	5 725 742	19 709 472
MDA	83 (7 ;100;88;87)	82 553	0	82 553	17 885 266	0	17 885 266
ISL	100 (99;-;100;100)	84 475	2 025	82 450	21 492 567	639 584	20 852 983
MUS	84 (76;-;81;85)	79 119	30	79 089	23 091 049	8 500	23 082 549
ZWE	33 (<i>100</i> ;-; 36;30)	62 934	376	62 558	104 002 916	183 060	103 819 856
KGZ	85 (100; 0 ;82;76)	56 395	371	56 024	107 318 713	478 092	106 840 621
EST	100 (100;99;100;100)	221 289	167 561	53 728	59 242 926	47 963 416	11 279 511
BOL	99 (-;-;86;99)	63 578	16 894	46 684	9 594 872	7 446 828	2 148 045
SDN	79 (-;100;86; 72)	88 407	42 129	46 278	20 421 032	11 616 300	8 804 732
ARM	86 (0;4 ;88; 0)	45 727	0	45 727	9 373 083	0	9 373 083
TZA	99 (0 ;100;-;-)	47 032	2 401	44 631	12 179 251	690 735	11 488 516
MAC	100 (98;-;100;100)	42 895	0	42 895	5 066 459	0	5 066 459
<i>HND</i>	<i>74</i> (-;98; 73 ;-)	37 976	509	37 467	6 989 040	164 008	6 825 033
ALB	100 (99;99;97;100)	17 901	2 146	15 755	3 686 580	567 812	3 118 768
BRB	96 (-;-;100;91)	13 072	5 880	7 192	3 100 831	652 812	2 448 019
DMA	99 (-;-;100;99)	5 731	809	4 922	779 853	461 772	318 081
NPL	- (-;-;-;-)	0	0	0	0	0	0
UGA	- (-;-;-;-)	0	153	-153	0	23 338	-23 338
<i>JOR</i>	<i>0</i> (52 ;0;-;-)	30	5 029	-4 999	2 700	1 261 203	-1 258 503
TGO	- (-;-;-;-)	0	7 958	-7 958	0	2 368 820	-2 368 820
BEN	- (-;-;-;-)	0	7 959	-7 959	0	2 719 823	-2 719 823
MLT	95 (95;-;-;-)	398	22 195	-21 797	262 278	5 816 232	-5 553 954
NER	- (-;-;-;-)	0	97 403	-97 403	0	31 693 875	-31 693 875
<i>AZE</i>	<i>44</i> (-; 35;73;44)	4 698	120 673	-115 975	1 013 169	32 989 205	-31 976 036
TTO	91 (99;91;100; 73)	310 502	442 908	-132 406	79 007 402	131 002 209	-51 994 808
TUN	29 (97; 0;78 ;-)	56 727	314 529	-257 802	13 728 323	103 301 338	-89 573 015
LVA	98 (98;97;-;-)	5 485	672 445	-666 960	3 598 245	201 319 511	-197 721 266
BRN	91 (91;-;-;-)	68	924 445	-924 377	31 968	292 653 999	-292 622 031
KAZ	95 (-;95;-;-)	72 632	1 146 687	-1 074 055	35 401 748	963 884 783	-928 483 035
ECU	82 (98;100;86;78)	31 648	1 308 233	-1 276 585	8 242 358	488 035 498	-479 793 140
<i>ZAF</i>	<i>31</i> (<i>100;29;52;76</i>)	798 442	2 135 527	-1 337 085	330 267 198	1 407 268 300	-1 077 001 103
MYS	98 (100;90;100;100)	1 222 969	2 758 592	-1 535 623	316 540 545	937 130 528	-620 589 984
ARG	83 (100;65;92;89)	355 860	2 466 546	-2 110 686	107 449 527	766 471 347	-659 021 820
<i>EGY</i>	<i>27</i> (98; 0;99;88)	164 779	2 314 550	-2 149 771	61 437 995	831 130 351	-769 692 356
COL	97 (-;100;98;90)	276 201	3 386 040	-3 109 839	65 046 860	1 418 344 333	-1 353 297 473
IDN	95 (85;93;100;99)	2 277 614	5 936 604	-3 658 990	648 409 916	2 427 393 070	-1 778 983 154
CAN	98 (100;98;98;99)	5 781 435	10 587 904	-4 806 469	2 279 270 637	3 851 704 848	-1 572 434 211
OMN	- (-;-;-;-)	0	4 820 825	-4 820 825	0	1 592 375 717	-1 592 375 717
DZA	100 (100;100;98;98)	54 666	5 423 610	-5 368 944	19 903 142	1 576 395 372	-1 556 492 231
GBR	96 (81;98;98;100)	6 118 442	11 720 933	-5 602 491	2 145 411 437	3 651 575 981	-1 506 164 544
<i>AUS</i>	<i>66</i> (<i>100;63;100;97</i>)	1 834 676	8 100 867	-6 266 191	628 174 415	3 960 529 156	-3 332 354 741
MEX	99 (100;-;99;99)	1 078 942	8 239 588	-7 160 646	328 358 464	3 218 758 115	-2 890 399 651
KWT	- (-;-;-;-)	0	9 187 458	-9 187 458	0	3 209 078 978	-3 209 078 978
<i>VEN</i>	<i>35</i> (<i>100;49;26</i> ;-)	31 979	12 311 956	-12 279 977	8 756 439	4 704 479 059	-4 695 722 620
NGA	99 (94;96;100;-)	18 070	12 313 362	-12 295 292	1 458 773	4 168 618 395	-4 167 159 623
IRN	100 (100;84;-;-)	45 088	12 604 822	-12 559 734	15 546 183	4 622 805 771	-4 607 259 588
ARE	- (-;-;-;-)	0	14 003 169	-14 003 169	0	4 617 161 076	-4 617 161 076
RUS	97 (99;100;89;100)	814 965	15 637 362	-14 822 397	751 569 727	6 034 911 360	-5 283 341 633
NOR	100 (100;100;99;100)	462 959	18 088 766	-17 625 807	140 492 326	5 949 394 076	-5 808 901 751
SAU	96 (89;-;90;99)	5 341	38 257 532	-38 252 191	577 615	13 527 988 158	-13 527 410 543

Table 7.5: Net flows of selected fuel commodities (SITC 3212, 3330, 3341, and 3343), between the set of 103 countries, as measured in exchange value and energy content, sorted by decreasing net exchange value flows.

*: The first coverage figure is aggregate intra-set flows of all four commodities as percentage of total reported world imports. Figures in brackets are similar coverages for each of the four commodities: SITC 3212, 3330, 3341 and 3343. Coverage percentages below 75 percent are marked in **bold** – countries with aggregate coverage below 75 percent as marked in *curly*. A dash (-) indicates no reported total imports.

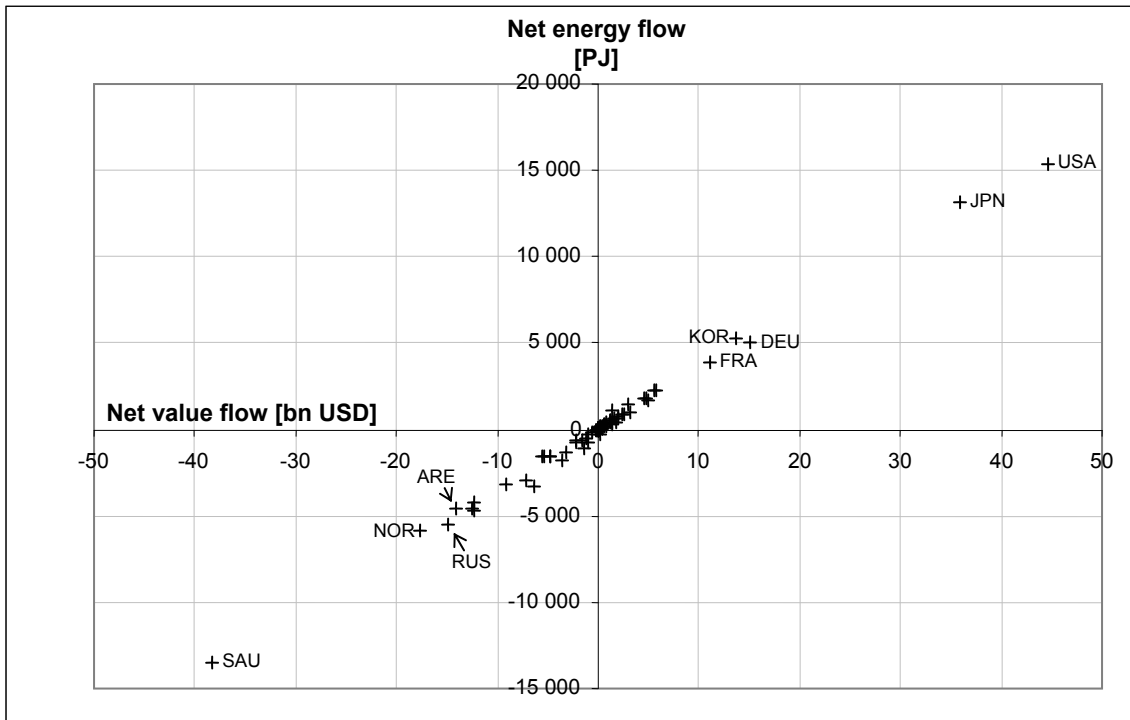

Figure 7.1: Scatterplot of net flows of fuel commodities – value and energy content

The results of the net flow analysis in Table 7.5 (and Figure 7.1) above can hardly come as a surprise, instead reflecting a fairly general perception of world energy flows. About a third of the countries are net exporters of fuel commodities, measured in value as well as energy content, this third facilitating the net imports for the other two thirds. With one exception, value and energy flow in the same direction for each country: a net exporter (importer) of fuel commodities as measured in value is also a net exporter (importer) of energy. The exception is China: being a net importer of fuel commodities as measured in value, China is a net exporter of energy content according to the results above, surely reflecting differences in energy-cost ratios for exported coal versus imported crude oil and refined products thereof.

The low coverage for a number of countries can at times undermine the results in Table 7.5 above. Italy is obviously a net importer of fuel commodities, but as only 56 percent of Italy’s imports of crude oil are included in the study, the actual magnitude of net flows can indeed be questioned. Similarly, the non-documented source(s) of Israeli imports of crude oil makes it unfeasible to conclude that the magnitudes of its net flows as given in Table 7.5 are accurate – the only conclusion that we can draw is that Israel is a net importer of fuel commodities, measured in value as well as energy content. Judging by the percentual coverage and the net flows in Table 7.5, South Africa (ZAF) is perhaps the only country where the direction, i.e. not only the actual magnitude, of its net flows of fuel commodities can be questioned.

The largest net importers of fuel commodities are the most “developed” countries of the world. USA is at the top of the list with a net energy inflow of 15.3 Exajoules, valued at 44.5 bn USD, a net inflow that is approximately a third larger than Japan, the second largest net importer. At the bottom of the list, the value of the Saudi net outflow is more than twice as large as the second largest net exporter of fuel commodities – Norway – whose dual role as energy provider and advanced industrial economy is quite out of the ordinary. While the net value outflow from Kuwait is almost 50 percent larger than the value of the net outflow from Australia, the energy content of the latter’s outflow is nevertheless slightly higher than the

former, indeed reflecting different energy-value ratios between the exports of Australian coal and Kuwaiti crude oil.

Net flow results for Kyrgyzstan are somewhat peculiar: with net value inflow approximately at parity with Estonia, the net energy inflow for Kyrgyzstan is almost 10 times as large as the corresponding inflow to Estonia. However, a closer inspection of Kyrgyzstan import data reveals what most probably is faulty data. While the weight-value ratio of imports from Russia and Uzbekistan are 26:1 and 55:1, respectively, this ratio for Kyrgyzstan imports from Kazakhstan is 248:1 in 1995 and 297:1 in 1996. The removal of these data records based on mere assumptions of faulty data would however be precarious – pre-analytical conceptions should preferable not precede the choice of individual data records.

The net outflows of fuel values and energy content from Kazakhstan motivates its inclusion: its unique role for Russia. Looking at Table 7.5, it can be noted that net outflows of energy content are more than three times as large as the net energy outflows of Brunei, these two countries being almost at parity with regards to their net value outflows. Closer inspection of the import and export vectors of Kazakhstan reveals its role as a source of Russian energy. The weight-value ratio for Russian imports of coal (SITC 3212) from Kazakhstan is 81:1, far higher than the corresponding ratio for Russian coal imports from other countries (as well as coal imports from Kazakhstan to other countries). Assuming this data to be correct, it thus seems like Russia has a tremendous discount on its coal imports from Kazakhstan.

Turning once again to the advanced industrial top dogs in Table 7.5, the ratios between imports and exports for six of the seven largest net importers of fuel commodities are approximately 10:1. For Japan, however, the value of its imports is more than 100 times as large as Japanese exports of fuel commodities. This could indicate that Japan, contrary to USA, Germany, Korea, France, and Spain, is strictly a final-consumer rather than having any brokerage function in the fuel commodity network.

Similar to Japan, Netherlands is not endowed with any (significant) natural fuel commodity resources of the kind studied here. Measured in gross value, the Netherlands is however the 6th largest importer and the largest exporter of fuel commodities among the net importing countries. Dutch in- and outflows of these commodities nevertheless balance each other out fairly well, placing Netherlands at position 19 with regards to net imports. This phenomenon, which to a lesser extent also can be noted for Singapore and Denmark, could indicate roles as intermediates, acting as gateways in different geographical regions (and sub-regions).

Combining the net flow values above with attributional data on population yields a slightly different picture: per capita net flows of value and energy contents for our four fuel commodities. A scatterplot of net value and energy content flows for each country can be found in Figure 7.2 below, along with an enlargement of this figure containing the bulk of countries to be found in Figure 7.3.

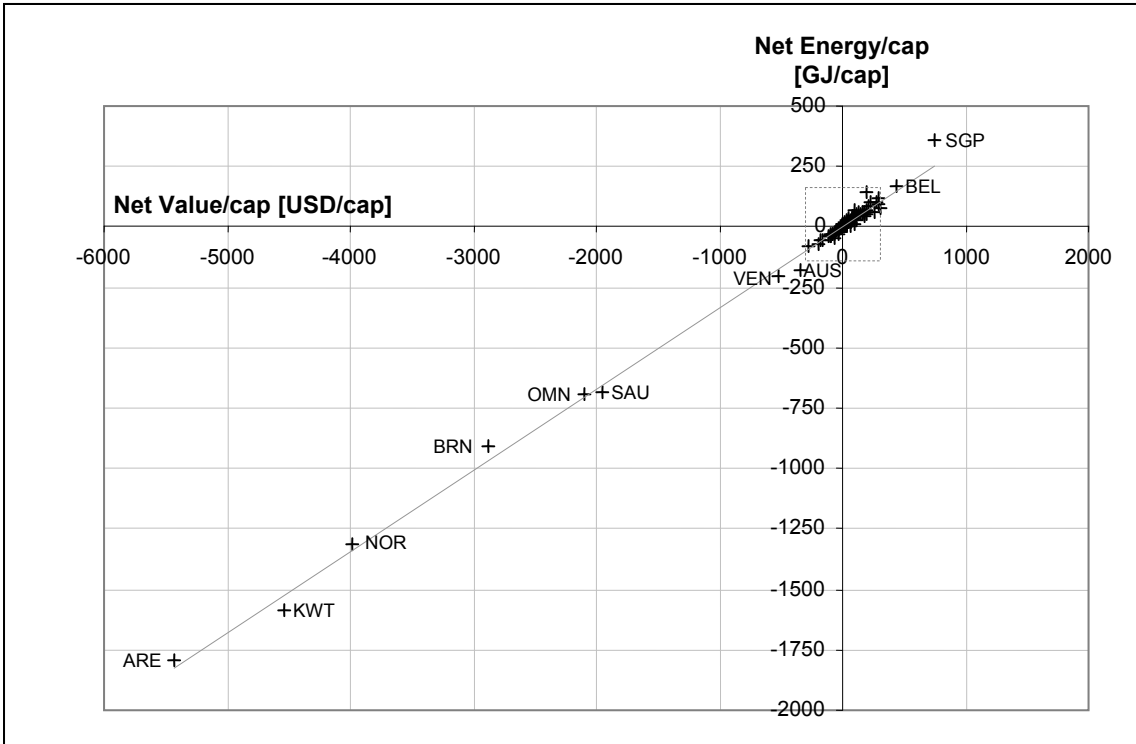

Figure 7.2: Net fuel commodity flows per capita – value and energy content

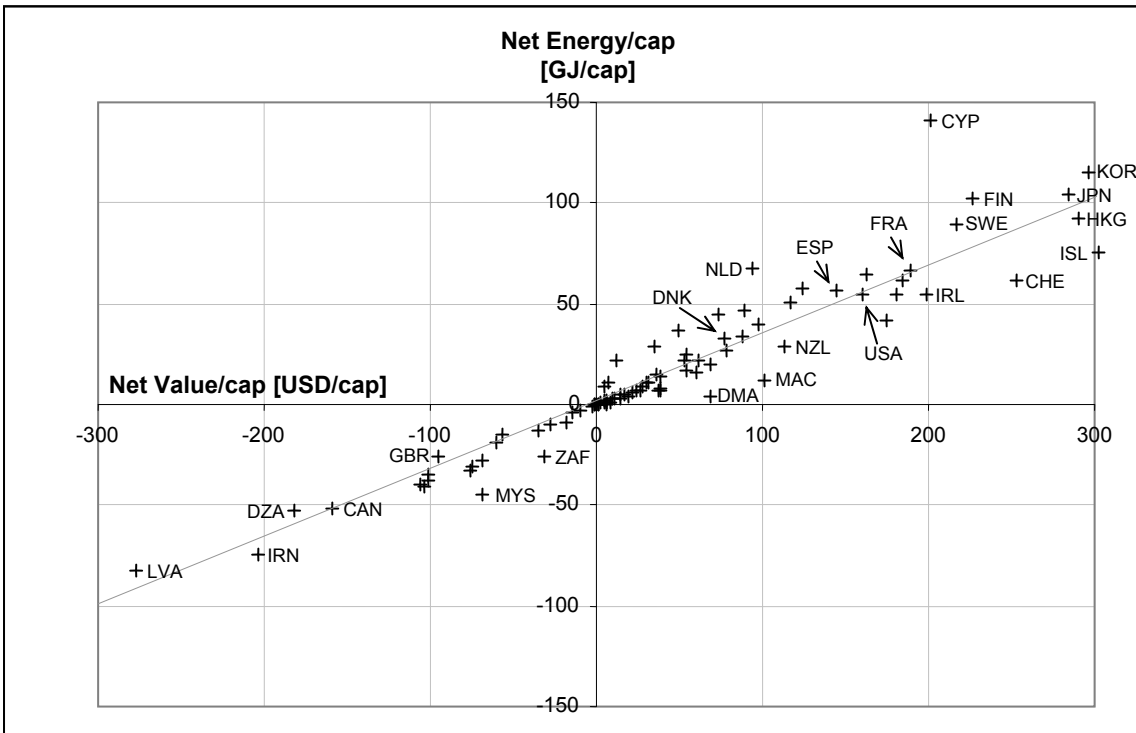

Figure 7.3: Net fuel commodity flows per capita: main cluster of countries

On a per capita basis, Singapore is the largest net importer of fuel commodities. With a per capita net inflow at 358 GJ, corresponding to 750 USD, the net energy inflow for the average Singaporean is more than twice as large as Belgium-Luxembourg, the latter being the runner-up with per capita net inflows of energy at 168 GJ. The value of these 168 Gigajoules of net flows is however only 42 percent less than the corresponding figure for Singapore: while the

cost-energy ratio of net fuel flows for both these countries are above the mean ratio (indicated by the dashed line), Singapore seems to get slightly more energy per capita per dollar than what is the case for Belgium.

At the opposite end, United Arab Emirates (ARE), followed by Kuwait, have the largest per capita net outflows of these fuel commodities. The third largest per capita net exporter of fuel commodities is Norway, with per capita net outflows more than twice as large as for Saudi citizens - slightly less than twice as large in energy terms.

Enlarging the dashed area in Figure 7.2, we find that the bulk of countries are within the ranges as given in Figure 7.3. Here it can be noted that the major per capita net importers all are countries which not only lack any significant natural endowments in these commodities, but they are also countries with high standards of living and, with the exception of Iceland, all being advanced industrial-based economies. Endowed with energy resources of various kinds, per capita inflows to USA is not exceptionally large in relation to other “developed countries” in Figure 7.3, the figures above of course not reflecting the absolute or per-capita energy *consumption* which USA indeed dominates.

The dashed lines in Figure 7.2 and Figure 7.3 is the linear trend for the ratio between value and energy content of per capita net flows for our set of 102 countries. This line, cutting the Y-axis slightly above the origin (at 2.1 GJ/capita), makes some novel interpretations possible. Net-importing countries above this line obtain more energy per spent dollar than what countries below the line do. For net exporters, countries above the trend line obtain higher net revenues for the net outflows than net exporters below this line. While Cyprus and Ireland both have per capita net inflows valued at approximately 200 USD, they are located on different sides of this trend line, with per capita net energy inflows to Cyprus being almost three times as large as what it is for Ireland. Netherlands, previously noted to be a large gross trader in fuel commodities, has a very favorable cost-energy ratio for its net inflows, similar to Singapore and, to a lesser extent, Denmark, these countries which also were identified as possible intermediates in the network of fuel commodity trade.

Looking at the countries with very low net inflows per capita (below 25 USD), it can be noted that virtually all of these are located below the overall trend line.¹⁶³ These countries are all commonly attributed as developing countries. For their relatively meager net inflows of fuel commodities, these countries obtain less energy per spent dollar than what is the case for most countries with per capita net inflows above 100 USD.

The interpretations above on net flows do have their limitations. Albeit representing a very large share of total trade in fuel commodities, the data used here only covers 4 commodity categories, excluding the natural gas categories which could turn some of the interpretations above head over heel. Furthermore, the data coverage of each country must be taken into account when attempting to draw any overall conclusions, and particularly when drawing conclusions on countries with low coverage percentages (see Table 7.5, second column). It furthermore has to be underlined that we are looking at energy content alone and not utility in any economic sense: as coal, crude oil and derivatives thereof have different usages and utility,

¹⁶³ Sorted by increasing per capita net inflows of fuel commodity value, these countries below the trend line are Tanzania, Sudan, Bangladesh, India, Albania, Madagascar, Bolivia, Honduras, Sri Lanka, Guatemala, Pakistan, Kenya, Armenia, Peru, Yugoslavia, Moldova republic, El Salvador and Senegal. While the triad of Zimbabwe, Ghana and Kyrgyzstan also has per capita net inflows below 25 USD, they are located above the trend line: in the case of Kyrgyzstan, significantly above.

their respective economic values do of course differ even when the energy content for bundles of different commodities is constant.

Centrality analysis

In the net flow analysis above, approximately a third of the countries were identified as net exporters of fuel commodities. With crude oil representing more than half of the exchange value and energy content in the flow matrices, the few countries at the bottom of Table 7.5 are, not surprisingly, economies based on oil-extraction, these few countries being the major providers of world energy.

As only a minority of countries are endowed with major reserves of fossil fuels, it would be conceivable that these countries play a central role in the energy metabolism of the world, acting as central hubs in their roles as net energy exporters to the majority of net-importing countries. At the same time, the net flow analysis above revealed that certain net-importing countries, especially Netherlands, have relatively large gross flows compared to their net flows, something which could indicate an intermediate role – a gateway – between providers and consumers of energy. In this section, the BDD-index will be used in an attempt to shed some light on the validity of these intuitive conceptions.

Using the V_{Fuel} flow matrix as input, BDD-indices were calculated for each of the 102 countries. As three of the countries – Macau, Moldova republic, and Armenia – lack data on outbound flows, their BDD_{Export} indices are undefined, just as the BDD_{Import} indices for seven countries – Kuwait, Oman, United Arab Emirates, Benin, Togo, Niger, and Uganda – are undefined as their import vectors are blank. In Figure 7.4 below, all 102 countries can be found in the scatterplot, where the combined BDD_{Combo} index for each country is the Euclidean distance from the origin to respective marker. Different symbols are used to depict whether countries are net-importers or net-exporters (see legend). Countries that have undefined BDD-indices are placed outside the actual diagram area.

Saudi Arabia, followed by Kuwait, has the lowest BDD_{Export} index values, i.e. with exports being more proportional to world total imports than any other country in the dataset. The plausible interpretation is that these two countries indeed act as distributive hubs in the network of world trade. Contrasting this, the BDD_{Import} index is quite high for Saudi Arabia, and undefined for Kuwait, meaning that their respective imports are not in proportion to total exports from other countries. However, imports of fuel commodities to Saudi Arabia are, not surprisingly, insignificant (and non-existing for Kuwait): it would instead be surprising if the total Saudi import at 5.3 million USD were to originate from all fuel-exporting countries in a proportional manner. Similarly, Iran has a low BDD_{Export} index while having a significantly high BDD_{Import} index: while importing minor volumes of coal (SITC 3212) from Canada, China, Spain and Australia, no Iranian imports of crude oil or refined products thereof are to be found in the dataset.

Netherlands has the lowest BDD_{Import} value of all countries in the V_{Fuel} dataset, indicating that Netherlands imports fuel commodities from several sources in proportion to the total exports of these sources. With its total exports being almost at parity with its total imports, Dutch (re)exports of fuel commodities have a much higher BDD index than what is the case for its imports. A closer inspection of the export vector for Netherlands reveals that the major receivers are within Europe: out of total Dutch outflows of fuel commodity value, 53 percent goes to Belgium-Luxembourg and 33 percent to Germany, while only 2 percent going to USA. The low BDD_{Import} index for the Netherlands in combination with its moderately high

BDD_{Export} index thus indicate that the Netherlands is an important gateway for European fuel commodities, something which indeed could be related to the very favorable energy-cost ratio that Netherlands enjoys on its net imports (see Figure 7.3). This particular case thus supports the hypothesis on ecological unequal exchange.

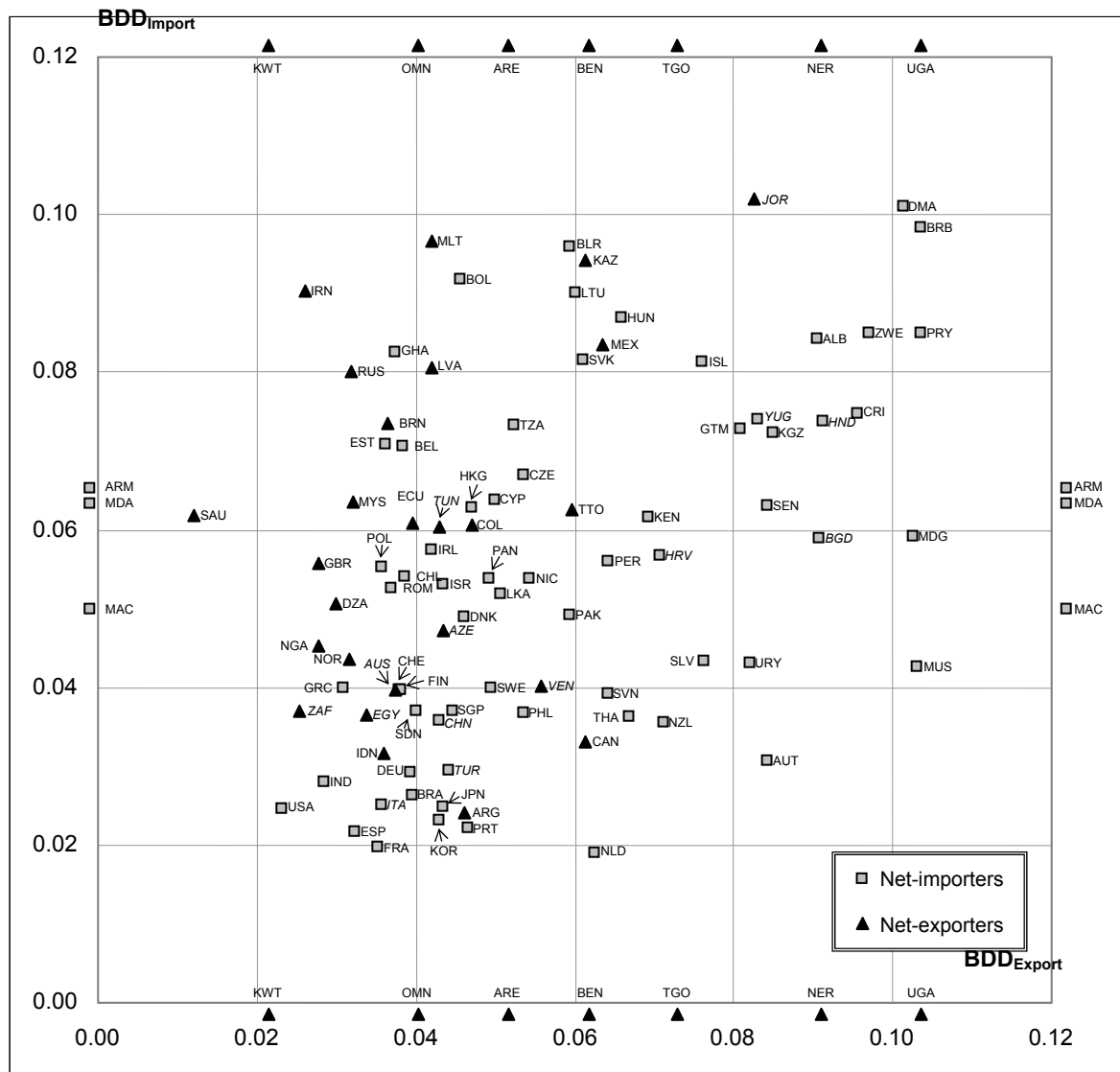

Figure 7.4: Scatterplot: BDD indices for fuel commodity value flow matrix (V_{Fuel}).

In contrast to the Netherlands, there are no indications in the previous net flow analysis (Table 7.5) that France would be an important fuel commodity gateway. However, according to the BDD_{Export} and BDD_{Import} indices in Figure 7.4, France is a very central actor in the network of fuel commodity trade, both with regards to its import and export vectors. Similar to the Netherlands, France obtains its imports from several sources in proportion to the exports of these sources, but the exports from France are more globally oriented than Dutch exports.¹⁶⁴ Thus, while a net flow analysis could hint at countries with certain network-

¹⁶⁴ The energy-cost ratio for French imports of fuel commodities is however not as favorable as for the Netherlands. While both countries have net energy imports of 67 GJ per capita, France pays almost twice as much per gigajoule (2.84 and 1.40 USD per gigajoule for net energy inflows to France and the Netherlands respectively).

central properties, the BDD indices are better at identifying and measuring to what degree a country can be considered to be a central hub in the trade network.

As US imports are very large in absolute terms, its low BDD_{Import} index is quite expected as such large quantities by necessity must have several different sources. The more surprising is the very low BDD_{Export} index for USA: its exports are proportionally spread among several destinations, indicating that USA, similar to Saudi Arabia and Kuwait, acts as a hub in world energy distribution, simultaneously being the largest importer by far. Contemplating on these results, it should be stressed that BDD-index are calculated using relative (rather than absolute) flows, furthermore excluding the contribution of the actor in question. The low BDD-indices of USA are thus not a result of a value-dwarfing phenomenon.

The correlation between absolute net value flows and BDD-index scores is striking for several countries: the top 9 net importers all have BDD_{Import} and BDD_{Export} indices below 0.03 and 0.05, respectively. This could point towards a flaw with the BDD index: to what extent is the index dependent on absolute net flows? Further comparisons between the net flow rank order in Table 7.5 and BDD indices in Figure 7.4 does point to independence between these two analytical procedures. Being the 10th largest net importer with absolute import and exports similar to Italy, the BDD_{Import} index of Belgium-Luxembourg is vastly higher than Italy's. Austria and Greece, holding positions 21 and 23 respectively, both have in-, out- and net flows almost at parity but nevertheless have very different BDD indices. Sudan is perhaps the best demonstration of the independence between net flows and BDD indices: being a very minor net-importer of fuel commodities at rank position 62, its BDD-indices are exceptionally low, in essence appearing to be more central in the network of fuel commodity trade than countries such as Singapore and Sweden, the latter being the 12th and 15th largest net-importers of fuel commodity value. As net-exporting countries such as Argentina and Indonesia also have low BDD-indices, this indeed strengthens that we are measuring a unique aspect independent of net import flows, turning the correlation between these two measures that could be noted for the top-9 net-importing countries into non-tautological findings that have to be explained by their own.

Except for the above, there are many interpretations that can be done from the BDD-indices in Figure 7.4. For instance, while net-importing Sweden and net-exporting Venezuela have equal BDD_{Import} -indices, fuel commodity exports from Sweden is more hub-like than what is the case for Venezuela, the latter whose exports are more concentrated. Net-exporting Kazakhstan, added to the original R-set in this chapter, has very high BDD-indices due to its special relation with Russia. With Russian fuel commodities representing 98 percent of imports to Kazakhstan and, in the opposite direction, Russia is the destination of 55 percent of fuel commodity exports from Kazakhstan, Kazakhstan can hardly be considered very central in the world trade network of fuel commodities, albeit being very important for Russia¹⁶⁵. A similar relation seems to be the case for USA and Mexico: while Mexican fuel commodities constitute a smaller share (13 percent) of US total imports than what is the case for Kazakhstan and Russia, respectively, 82 percent of Mexican exports end up in USA whereas US imports only (!) represent 21 percent of total world imports. A third observation can be made regarding Iceland and Barbados, two high-income countries that both have very high BDD-indices. The reason for this is most probably due to their low absolute in-, out-, and gross flows: similar to the reasoning above concerning the Saudi imports, it is unfeasible that such low absolute flows were to be distributed across several trading partners as the

¹⁶⁵ Of the total world imports to Russia valued at 814,965 kUSD, 77 percent (625,930 kUSD) originates from Kazakhstan, this explaining why the BDD_{Import} -index for Russia is very high.

volumes for each dyadic flow would be too low and, thus, uneconomical from a trading point of view. The centrality heuristic used here does seem to indicate this particular structural property for Iceland and Barbados, that is, only having fuel commodity trade relations with a few, relatively small gateway actors.¹⁶⁶

Table 7.6 summarizes average BDD indices for a number of different sets of countries. On average, net-exporters seem to be slightly more central than net-importers. Acting, on average, as hubs in the world energy trade, the average BDD_{Export} index is lower than the BDD_{Import} index for net-exporting countries, while the opposite is true for net-importing countries. The BDD_{Export} index for the 33 net-exporting countries is insignificantly lower than the corresponding value for OECD countries, the latter thus seemingly being just as hub-like as the average net-exporting country. The selection of 8 OPEC countries has even lower BDD_{Export} indices than the set of OECD countries, the former having a slightly lower BDD_{Combo} index than the latter. However, the top-5 net importers – USA, Japan, Germany, Korea, and France – have the lowest average BDD_{Combo} index of all 5 sets, although being slightly less hub-like than the OPEC countries when specifically looking at export profiles.

	Average BDD indices		
	BDD_{Import}	BDD_{Export}	BDD_{Combo}
Net-importers (N=69)	0.055	0.059	0.081
Net-exporters (N=33)	0.060	0.046	0.075
OECD countries (N=29)	0.044	0.047	0.064
OPEC countries (N=8)	0.053	0.033	0.062
Top-5 net-importers	0.024	0.037	0.044

Table 7.6: Average BDD indices for various sets of countries (fuel value flows).

^{*}: Consists of Indonesia, Algeria, Kuwait, Venezuela, Nigeria, Iran, United Arab Emirates, and Saudi Arabia. BDD_{Import} indices for this category exclude Kuwait and United Arab Emirates as their BDD_{Import} indices are undefined due to lack of imports.

Judging by the results in Table 7.6, the set of 8 OPEC countries are the most hub-like of the sets, having the lowest average BDD_{Export} index. Endowed with large amounts of crude oil, and other fuel commodities, the relatively high BDD_{Import} index for the OPEC set is of no real significance as fuel imports to these OPEC countries, similar to Iceland and Bermudas, are of very low magnitudes.

The very low average BDD_{Export} index for the top-5 net importers, significantly lower than the average BDD_{Export} index for net-exporters and almost at parity with the OPEC countries, is an unexpected finding. These 5 high-income countries seem to act as major hubs in the global distribution of energy, even though – or perhaps precisely because – they have exceptionally large net energy imports. Thus, while natural endowments of energy resources correlates to a more hub-like position than what is the case for net-importing countries in general, there is a small set of high-income net-importing countries that actually are more central than any other country with respect to imports and exports, as their average BDD_{Combo} index is lower than, by a significant margin, any other set or country.

In the next section, role-equivalences and the role-relational structure of the fuel commodity dataset will be analyzed. The BDD-index will be applied in this section as well, this time, however, looking at BDD centrality indices for each of the sets of role-equivalent actors as derived from the value component of the fuel flow data.

¹⁶⁶ 96 percent of total imports to Barbados originate from Trinidad-Tobago, Barbados being the third largest receiver of Trinidad-Tobagoan fuel exports (after USA and France). For Iceland, the primary source of its imports of fuel commodities is Norway.

Regular role-equivalence: the exchange value aspect

In the centrality analyses above, all 103 countries in the extended R-set were included, even though data coverage was problematic for a handful of countries. Due to the inner workings of the REGE algorithm that is used to identify role-similar actors, anomalies and missing data can have a more significant impact on the results when studying network role-structures. Before embarking on our role analysis, a handful of countries will be removed from our dataset, countries which play a fairly insignificant role in the fuel commodity network with regards to demographics and gross trade flows.

To begin with, based on the coverage percentages in Table 7.5, Nepal, Jordan and Israel are removed. Once removed, a preliminary REGE analysis (using 3 iterations) of the remaining 100 countries suggests that seven more countries should be removed – Albania, Malta, Uganda, Barbados, Dominica, Benin, Uganda, and Togo – as these countries alone form five separate positions where the first three of these form singleton positions. The underlying motivation for removing these countries is that they (according to the REGE algorithm) have such unique roles, which in turn will distort the inner working of the REGE algorithm, reducing its ability to identify role-equivalence for the other countries that are far more significant actors in the network¹⁶⁷. Furthermore, if we were to include these countries, we would either end up with a large amount of positions (role-types, that is), or where the resolution of the bulk of countries would be severely reduced.

In what follows, the role structure of this reduced R-set consisting of 93 countries will be mapped, beginning with its exchange value dimensions (V_{Fuel}), followed by a role-analysis of the physical energy flows (E_{Fuel}) between these countries. Prior to this, however, we will first look at how different number of iterations of the REGE algorithm results in differences when it comes to the recommended number of role-equivalent positions to partition the dataset into.

Although the “industry standard” seems to be to run 3 iterations of the REGE algorithm¹⁶⁸, the choice of number of iterations affects the resulting REGE coefficients, subsequently resulting in differences in the optimal number of partitions as suggested by Anova density tests. In Figure 7.5 below, results from Anova density tests are given when using different number of REGE iterations on the V_{Fuel} matrix. With four and five iterations, it seems suitable to choose partitions that result in five positions. At three iterations, at least 6 positions would be preferable, and at 100 iterations, 8 positions would seem suitable.

For analytical consistency, I have chosen to use three iterations for all role-analyses in this thesis, even though there are some minor variations in positional membership as the number of iterations are changed. For instance, when using any number of REGE iterations other than three, Great Britain and Malaysia are placed in the same position as the major fuel exporting countries. At three iterations, however, Great Britain is placed alongside the most advanced industrial countries, and Malaysia is placed in a position containing less significant fuel exporters. The REGE algorithm may indeed have its drawbacks, but positional movements such as these, based on the choice of number of algorithmic iterations, could perhaps assist in identifying actors that are not so easy to classify into distinct roles, as these two countries indeed are with respect to world fuel trade.

¹⁶⁷ According to Martin Everett (personal communication), single actors that differ substantially from the other actors with regards to their structural data patterns tend to distort the overall working of the REGE algorithm when identifying regularly equivalent positions.

¹⁶⁸ The default value for the REGE algorithm in the UCINET software package is 3 iterations, a choice that seems to be the most common in studies utilizing the REGE algorithm.

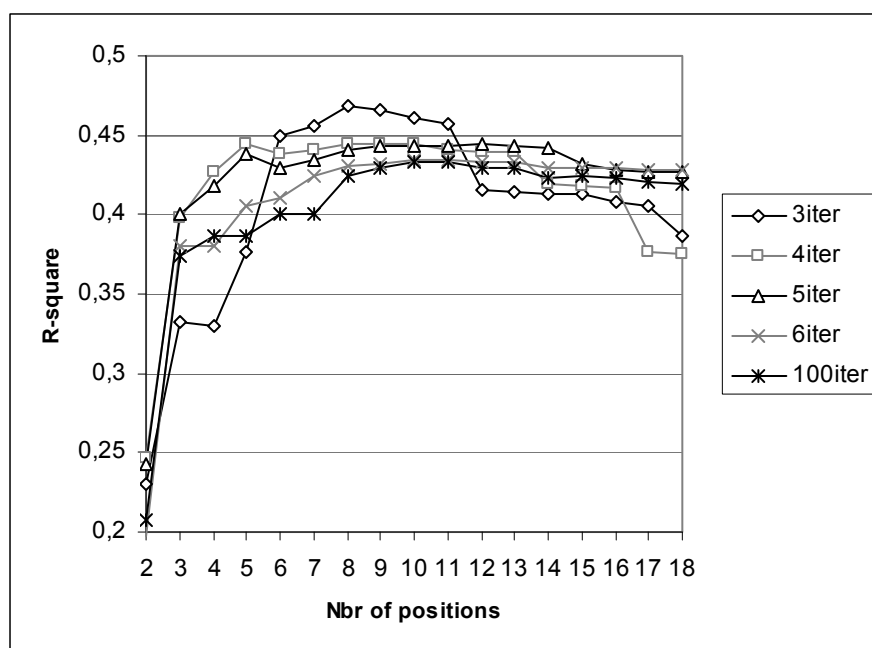

Figure 7.5: Anova-density test for REGE results of fuel commodity value flows (93 countries) using various numbers of iterations.

While the most significant peak (when using 3 iterations) occurs when going from five to six partitions, I have nevertheless chosen to partition the dataset into 8 positions, i.e. where the Anova density test reaches its maximum value. The country memberships of these positions are given in Table 7.7 below, together with aggregate data on GDP, population and positional net flows of fuel commodity exchange value.

		GDP [mill USD]	Population	Net value flow [mill USD]
A _v	ARE, AUS, CAN, CHN, COL, IDN, IRN, KWT, MEX, NGA, NOR, OMN, RUS, SAU, VEN	3 422 842	2 011 689 000	-160 572
B _v	AUT, BLR, BRA, CHE, CHL, CZE, DNK, ESP, FIN, GRC, HKG, HRV, HUN, IND, IRL, ITA, KEN, LTU, NZL, PAK, PHL, POL, PRT, ROM, SWE, SVK, THA, TUR	5 449 107	1 792 896 000	50 036
C _v	BEL, DEU, FRA, GBR, JPN, KOR, NLD, SGP, USA	18 801 845	681 015 000	123 777
D _v	BGD, BOL, CRI, CYP, EST, GHA, ISL, LKA, MDA, MDG, NIC, PRY, SDN, SEN, SVN, TZA, URY, YUG	205 649	293 582 530	2 491
E _v	ARG, BRN, DZA, ECU, EGY, KAZ, LVA, MYS, ZAF	692 217	220 658 000	-16 298
F _v	GTM, PAN, PER, TTO	93 102	40 003 000	590
G _v	ARM, HND, KGZ, MAC, MUS, SLV, ZWE	37 193	33 865 000	450
H _v	AZE, NER, TUN	26 336	27 292 000	-475

Table 7.7: Membership of 93 countries among the 8 role-regular positions of fuel commodity value (as determined by using 3 iterations of the REGE-algorithm on the raw trade data).

The role analysis thus identifies three different types of net-exporting countries, and five types of net-importers, each of these types having different roles in the global network of fuel trade. Position A_v and C_v contain the major exporters and importers, respectively, of fuel commodities. In position B_v, the position with the most members, we find most European developed countries and a handful of other, mainly mid- and east-Asian, countries, all being fuel commodity net-importers. Net-importing Latin American countries are however found in positions D_v and F_v, and a set of very small net-importers are found in G_v. Finally, two positions – E_v and H_v – contain minor net-exporting countries.

A number of actors are placed in positions whose aggregate net value flows do not correspond to the direction of their individual net flows: the role-classification obtained above is thus not automatically correlated to the results from our degree analysis. China, although being a net importer of fuel commodities as measured in value, being the 45th largest net-importer (Table 7.5), is however placed alongside the largest fuel exporters of the world, something which holds true for all the different REGE iterations tried above. Coincidentally, China is the only country whose energy- and value-flows are contra-directional, which is a non-tautological finding as the role analysis here is exclusively concerned with value flows. Great Britain seems to have an opposite role to China: although being a net exporter¹⁶⁹ of fuel commodities (as measured in value and energy content), the REGE algorithm has nevertheless placed Great Britain in the position containing the top-tier of developed, large net-importing countries. As previously noted, Great Britain only holds this position when using three REGE iterations, seemingly having a role that is difficult to classify: being the 8th largest gross exporter for the period 1995-99, it is at the same time also the 11th largest gross importer, both these aspects being in stark contrast with gross export and import flows for countries in either of position C_V and A_V. Finally, we have Trinidad-Tobago, a minor net-exporter of fuel commodities although sharing the same role-equivalent position as three geographically adjacent net-importing countries.

Interestingly, Singapore is placed in position C_V even though its gross imports are fairly modest. The net flows to Singapore are also larger than what it is for Netherlands, even though the latter trade in slightly larger amounts. However, the ratio between gross imports and gross exports is still very high for both Singapore and the Netherlands, seemingly indicating a brokering role in the network.

Aggregate value flows between and within positions are given in Table 7.8 below. With 73 percent of all exports originating from A_V, and a third of all imports going to C_V, these two positions form the backbone of the fuel trade structure as more than half of all fuel trade flows goes from A_V to C_V.

	A _V	B _V	C _V	D _V	E _V	F _V	G _V	H _V	Total
A _V	8 652 (4%)	38 958 (16%)	124 957 (51%)	1 561 (1%)	1 428 (1%)	1 006 (0%)	150 (0%)	3 (0%)	176 715 (73%)
B _V	780 (0%)	4 046 (2%)	3 314 (1%)	487 (0%)	149 (0%)	4 (0%)	9 (0%)	38 (0%)	8 828 (4%)
C _V	5 079 (2%)	8 075 (3%)	22 171 (9%)	317 (0%)	1 050 (0%)	129 (0%)	90 (0%)	14 (0%)	36 925 (15%)
D _V	25 (0%)	78 (0%)	175 (0%)	7 (0%)	11 (0%)	0 (0%)	15 (0%)	0 (0%)	311 (0%)
E _V	1 539 (1%)	7 448 (3%)	9 152 (4%)	407 (0%)	52 (0%)	246 (0%)	150 (0%)	3 (0%)	18 996 (8%)
F _V	45 (0%)	13 (0%)	671 (0%)	21 (0%)	7 (0%)	22 (0%)	39 (0%)	0 (0%)	817 (0%)
G _V	0 (0%)	0 (0%)	0 (0%)	0 (0%)	0 (0%)	1 (0%)	0 (0%)	0 (0%)	2 (0%)
H _V	23 (0%)	245 (0%)	262 (0%)	2 (0%)	0 (0%)	0 (0%)	0 (0%)	0 (0%)	533 (0%)
Total	16 143 (7%)	58 864 (24%)	160 702 (66%)	2 803 (1%)	2 698 (1%)	1 408 (1%)	452 (0%)	57 (0%)	

Table 7.8: Inter- and intra-positional flows of fuel commodity value [million USD] (with percentages of total flows).

¹⁶⁹ Great Britain was a net-exporter of crude oil between 1981 and 2006, since then, and prior to this period, being a net-importer.

Looking at intra-positional flows, we note that position C_v has the most significant internal trade of the positions in the analysis, indeed reflecting coreness as perceived by the Galtung model and in the global commodity chain school. A closer examination of intra-trade between countries in position C_v reveals that Great Britain and the Netherlands are the largest intra-positional exporters, at 38 and 35 percent respectively of its aggregate intra-positional flows, with Germany and Belgium as the largest intra-positional importers at 28 and 23 percent respectively of total intra-positional trade. The largest individual trade flow within position C_v is the trade flow from Netherlands to Belgium-Luxembourg, valued at 4.5 billion USD. USA, however, is not exceptionally prominent in intra-positional trade: although 34 percent of its total exports end up at other actors in position C_v , only 6 percent of its huge imports originate from countries in its own position. US sources of fossil fuels are thus more direct and bilateral than what is the case for the other countries in position C_v .

Significant intra-positional flows notwithstanding, a more coherent and formal way to identify cores and peripheries is through a structural mapping of the different role-equivalent sets of actors, i.e. by looking at the occurrences of regular ties between and within the different positions identified by the REGE algorithm. With reference to the discussion on how regular ties are identified (see Chapter 5), a heuristic for identifying regular ties in valued networks is used to map the role structure of fuel commodity trade. Using this heuristic, presented elsewhere (Nordlund 2007), we end up with the structural map as shown in Figure 7.6. (Positional coordinates are determined through multidimensional scaling of the symmetrized positional flow matrix).

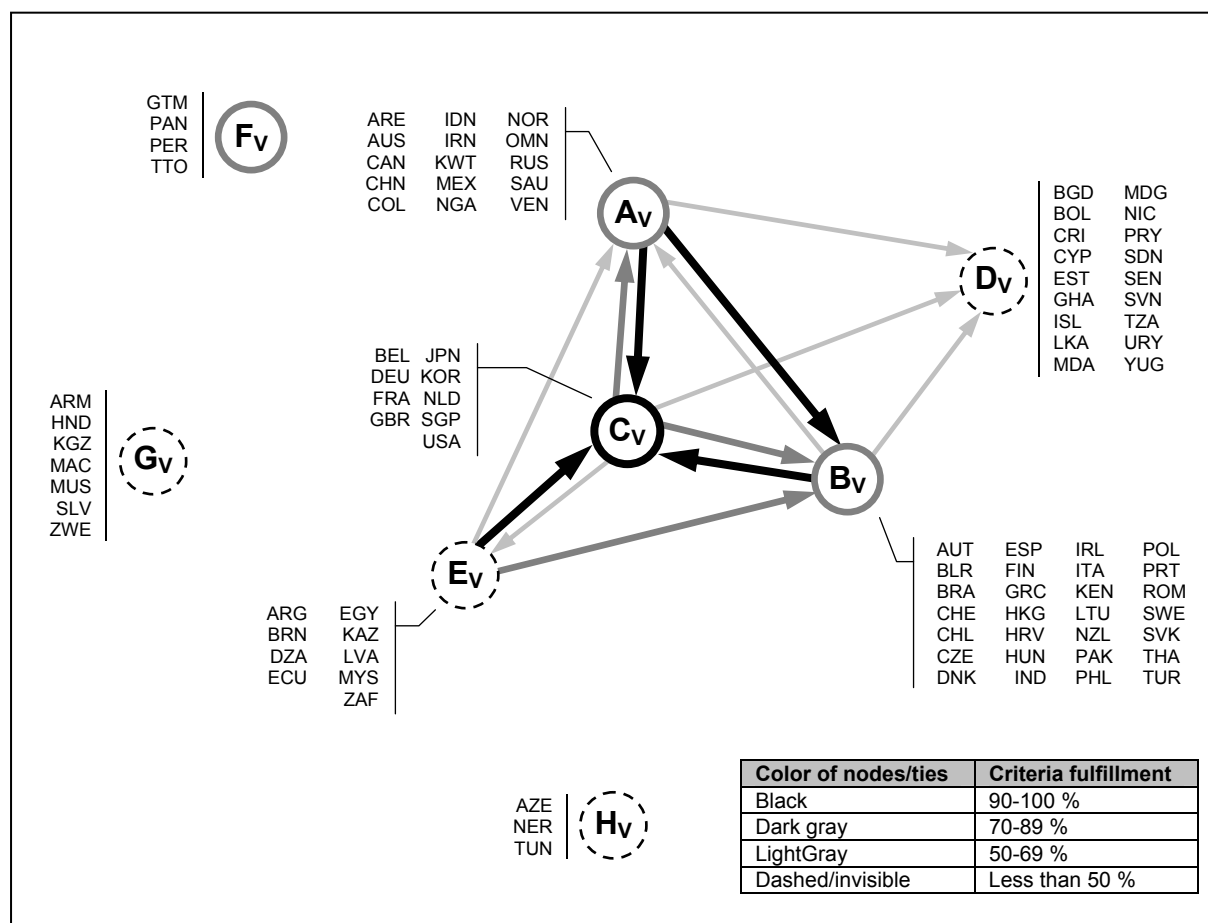

Figure 7.6: Structural map of fuel commodity flow values between the 8 regularly equivalent positions (applying criteria fulfillment formula 1 with a relative cutoff value of ~ 0.0107 ($1/93$)).

The role-structural mapping above reinforces the impression that position C_V indeed contains the core countries in the network of fuel commodity trade. Having the strongest regular self-tie (with a self-tie criteria-fulfillment at 100 percent) among the 8 positions, furthermore being the receiver of 3 out of the 4 strong regular ties in Figure 7.6, core status is indeed not correlated to resource endowments. Rather, the countries in C_V are the most substantial net importers.

This is perhaps contrary to conventional wisdom: the countries in position A_V , undoubtedly having the largest endowments of fuel resources and equally being the largest net exporters of fuel commodities, is less core-like than the top-importers (and consumers) of these commodities. Judging by the absolute positional flows in Table 7.8, position C_V seems to have taken the role as the major hub in fuel trade, obtaining the majority of its resources through the very large inter-positional flow from position A_V to B_V . As such, the network structure seems to revolve around the demand, rather than the supply, of fuel commodities.

Also worth noting is the structural role played by the (mostly) “medium-developed” countries in position B_V : while having a strong regular tie *from* position A_V , it also has a strong regular tie *to* position C_V , furthermore having a fairly strong regular self-tie. Whether B_V , or A_V , or perhaps both of these, can be labeled as semi-peripheries or not, whether strong or weak (e.g. Mahutga 2006; Smith and White 1992; Nemeth and Smith 1985), is not only slightly difficult based on the structural map in Figure 7.6, but it has to be stressed that labels such as these are meant to be applied to the world-system at large, rather than the analysis of individual commodity classes that, at best, only reflects a certain detailed aspect of the systemic properties at large.

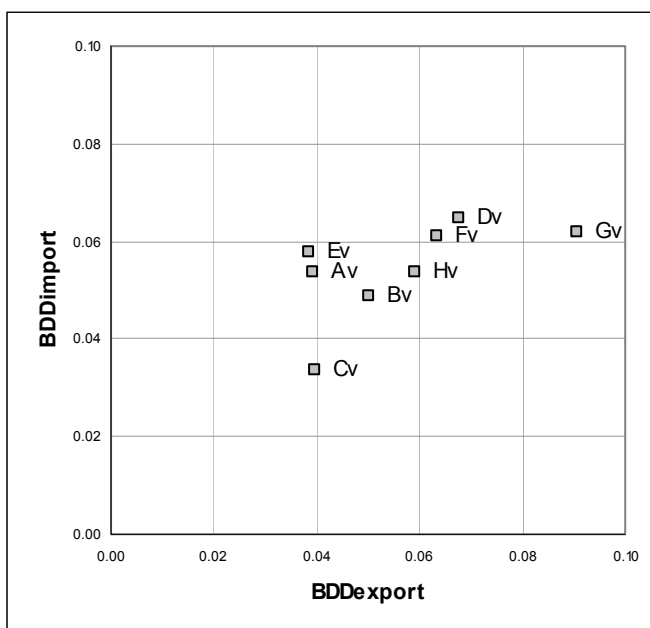

Figure 7.7: Positional average BDD indices for each of the 8 positions in the fuel commodity value flow analysis.

Calculating average BDD-indices for our 8 positions, i.e. based on positional aggregate flows, yields the results given in Figure 7.7. Independent from the regular ties shown in Figure 7.6, the centrality indices in Figure 7.7 reaffirms that position C_V seems to hold a very central role in the global fuel commodity network. Having the lowest BDD_{Import} index in Figure 7.7, position C_V obtains its imports from a wide variety of sources. Looking at the

positional export vectors, position C_V is also almost at parity with the BDD_{Export} indices of the net-exporting positions A_V and E_V . However, with the export vector of position C_V being proportionally equal, or equally balanced, as the export vectors of A_V and E_V , the former is thus not actually *more* central than the latter two when it comes to fuel commodity outflows. However, compared to the other positions having BDD_{Export} indices above 0.05, outflows from position C_V are remarkably balanced, i.e. central.

Having so far looked at the value component of fuel commodity trade, we now turn to analyzing the role types and the structural map concerned with flows of energy contents.

Regular role-equivalence: the energy aspect

Using the same 93 actors as in the above analysis, three iterations of the REGE algorithm is applied on the energy flow matrix E_{Fuel} in order to obtain REGE coefficients, i.e. measures of regular role-equivalence similarities. Through an Anova density test (Figure 7.8 below), the choice is made to partition the dataset into 5 positions. Although there is a slight increase in the R^2 -measure when going from 5 to 6 partitions, the increase is not large enough to motivate a higher resolution.¹⁷⁰

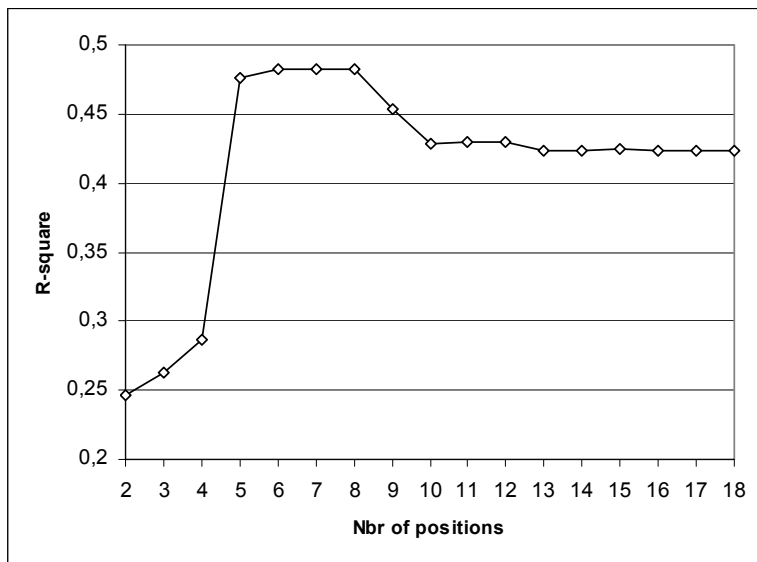

Figure 7.8: Anova-density test for REGE results of fuel commodity energy flows (93 countries) using 3 iterations.

The five role-equivalent positions in the energy flow matrix are specified in Table 7.9 below, together with aggregate data on GDP, population and positional net energy flows (as measured in Terajoules). Contrary to what was the case in the exchange value-based role-analysis above, the REGE algorithm and the subsequent Anova density test identifies two net-exporting, and three net-importing, positions.

The similarities in role membership between the value- and energy-analysis (compare with Table 7.7) is quite striking, indirectly reflecting the general overlap between the directionality of flows of value and energy respectively (see Figure 7.2). Once again, we have a position containing the largest net-exporters (A_E) and a position with the largest net-importers of energy (position C_E). In between, we have a position containing most net-importing countries

¹⁷⁰ The difference between the 5- and 6-positional partitions is that Honduras and Macau are placed in a position of their own.

(position B_E), and a position containing the remaining net-importing countries (position D_E). Position B_E basically consist of the countries found in the value-based position B_V and F_V , and position D_E contains the countries found in G_V , where the countries in the value-based position D_V is shared among positions B_E and D_E . We will return to a more detailed comparison between the two role-analyses below.

		GDP [mill USD]	Population	Net energy flow [Terajoule – 10^{12} J]
A_E	ARE, ARG, AUS, BRN, CAN, CHN, COL, DZA, ECU, EGY, GBR, IDN, IRN, KAZ, KWT, MEX, MYS, NGA, NLD, NOR, OMN, RUS, SAU, VEN, ZAF	5 925 679	2 304 231 000	-65 377 053
B_E	AUT, BGD, BLR, BRA, CHE, CHL, CRI, CYP, CZE, DNK, ESP, FIN, GHA, GRC, GTM, HKG, HRV, HUN, IND, IRL, ITA, KEN, KGZ, LTU, NZL, PAK, PAN, PER, PHL, POL, PRT, ROM, SEN, SWE, SVK, THA, TTO, TUR, YUG, ZWE	5 640 585	2 019 452 530	19 324 671
C_E	BEL, DEU, FRA, JPN, KOR, SGP, USA	16 985 137	606 721 000	45 986 398
D_E	ARM, BOL, EST, ISL, LKA, MDA, MDG, MUS, NIC, PRY, SDN, SLV, SVN, TZA, URY, HND, MAC	144 467	140 894 000	417 936
E_E	AZE, LVA, NER, TUN	32 424	29 702 000	-351 953

Table 7.9: Membership of 93 countries among the 5 role-regular positions of fuel commodity energy (as determined by using 3 iterations of the REGE-algorithm on the raw trade data).

Similar to the value-based role-analysis, the positional placement of two countries – Netherlands and Trinidad-Tobago¹⁷¹ - seems to be perceived anomalies in Table 7.9 concerning the directions of positional vis-à-vis individual net flows of energy. As in the previous analysis, China is here placed alongside the major energy net-exporters, however this time not being an anomaly as China indeed is a net-exporter of energy (see Table 7.5). Similarly, Great Britain is found in this very same position, this indeed corresponding to its role as a net-exporter of energy in the 1995-1999 period. While the direction of energy net flows for these two countries are the same as the aggregate net flow of their position, it is instead Netherlands that constitute an anomaly in Table 7.9: being the 12th largest net-importer of energy, the REGE algorithm nevertheless deems Netherlands as having the same role as the major energy exporters of the world. Being totally independent of the previous results for the Netherlands (as we deal with the energy content rather than the value of fuel commodities here), Netherlands once again seems to be quite unique in the network of fuel commodity trade.

Using the same heuristic as previously, a structural mapping of global energy flows within and between role-equivalent positions is given in Figure 7.9 below.

With fewer positions than what was the case in the exchange value analysis (Figure 7.6), the structure of global energy flows is nevertheless quite similar to its exchange-value sibling. Energy flows are indeed occurring within the C_E position, this intra-positional tie indicating that C_E is a cohesive subgroup. However, judging by the strong regular ties of A_E , position A_E actually seems to be the most core-like position. This is reinforced by the actual placement of position A_E in Figure 7.9: as the coordinates are established using multidimensional scaling of the (symmetrized) criteria-fulfillment matrix, the central placement of position A_E is in itself an indication of coreness.

¹⁷¹ As a minor net-exporter of energy, Trinidad-Tobago is nevertheless placed in a position that otherwise contains net-importing countries.

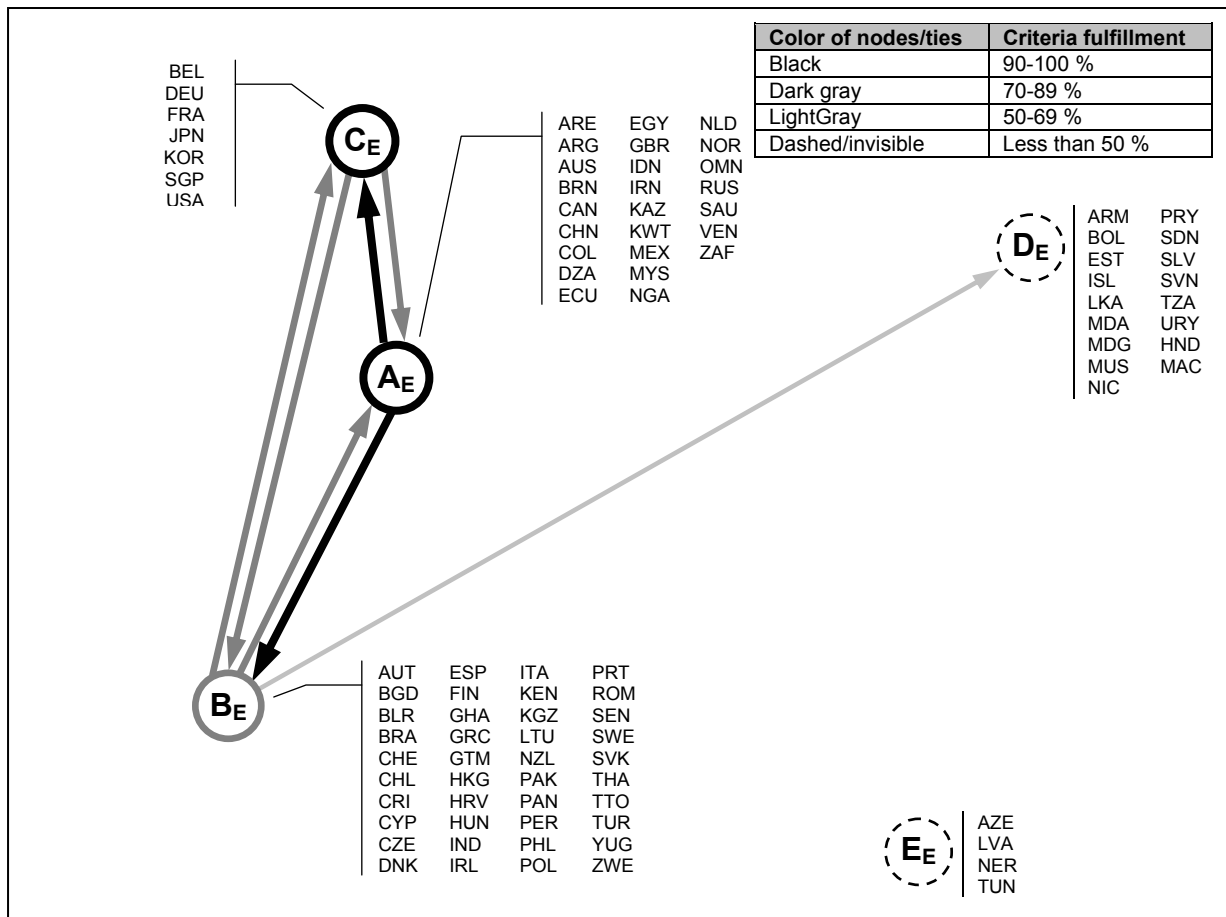

Figure 7.9: Structural map of fuel commodity energy flows between the 6 regularly equivalent positions (applying criteria fulfillment formula 1 with a relative cutoff value of ~ 0.0107 ($1/93$)).

	A _E	B _E	C _E	D _E	E _E	Total
A _E	10 044 (12%)	19 092 (22%)	48 370 (56%)	358 (0%)	6 (0%)	77 869 (90%)
B _E	498 (1%)	1 342 (2%)	1 035 (1%)	119 (0%)	10 (0%)	3 003 (3%)
C _E	1 821 (2%)	1 727 (2%)	1 437 (2%)	20 (0%)	2 (0%)	5 007 (6%)
D _E	25 (0%)	21 (0%)	33 (0%)	6 (0%)	0 (0%)	86 (0%)
E _E	104 (0%)	146 (0%)	119 (0%)	1 (0%)	0 (0%)	369 (0%)
Total	12 492 (14%)	22 328 (26%)	50 994 (59%)	504 (1%)	17 (0%)	

Table 7.10: Inter- and intra-positional flows of fuel commodity energy [Petajoule – 10^{15} J] (with percentages of total flows).

Table 7.10 contains intra- and inter-positional energy flows between the five positions above. With almost all energy net-exporters grouped in the same position (A_E), this accounts for 90 percent of all energy outflows in our network. Although position C_E contains less countries than its value-based sibling (position C_V; see Table 7.7), now representing only 11 percent of the total population of our reduced R-set, inflows to this position represents almost 60 percent of all energy inflows in the network. Furthermore, Table 7.10 reveals that position A_E has the largest absolute intra-positional flows – at approximately 10 Exajoules – while the intra-positional flows for position C_E only represents a meager 2 percent of total trade. This is indeed due to the fact that the Netherlands and Great Britain are part of the A_E position this time, rather than the position containing the largest net-importing top-dog countries. This also

affects the total energy inflows to position A_E ; at 12.5 Exajoules, this represents 14 percent of all inflows in the network.

An underlying thought in this thesis is that economic exchange (as measured in exchange value) and the actual resource transfers facilitated through such exchange constitute, to paraphrase Andre Gunder Frank, two sides of the same coin, sides which intuitively, but not necessarily, overlap. The second major theme in this thesis is that it is imperative to look at the structures of such exchanges to fully understand the outcomes of such exchanges with respect to the appropriation and consumption of resources. One way to look at discrepancies between the economic and the ecological aspects of international trade is through role-analysis.

Table 7.11 compares the role-equivalent positions of the exchange-value vis-à-vis the energy transfer structures as analyzed in this chapter.

	C_E	B_E	D_E	E_E	A_E	Net value flows [mill USD]
C_v	BEL, DEU, FRA, JPN, KOR, SGP, USA				GBR, NLD	123 777
B_v		AUT, BLR, BRA, CHE, CHL, CZE, DNK, ESP, FIN, GRC, HKG, HRV, HUN, IND, IRL, ITA, KEN, LTU, NZL, PAK, PHL, POL, PRT, ROM, SWE, SVK, THA, TUR				50 036
D_v		BGD, CRI, CYP, GHA, SEN, YUG	BOL, EST, ISL, LKA, MDA, MDG, NIC, PRY, SDN, SVN, TZA, URY			2 491
F_v		GTM, PAN, PER, TTO				590
G_v		KGZ, ZWE	ARM, MUS, HND, MAC, SLV			450
H_v				AZE, NER, TUN		-475
E_v				LVA	ARG, BRN, DZA, ECU, EGY, KAZ, MYS, ZAF	-16 298
A_v					ARE, AUS, CAN, CHN, COL, IDN, IRN, KWT, MEX, NGA, NOR, OMN, RUS, SAU, VEN	-160 572
Net energy flows (TJ)	45 986 398	19 324 671	417 936	-351 953	-65 377 053	

Table 7.11: Comparison between role positions based on value versus energy contents of fuel commodities.

In this comparison, we note the general overlap between the economic and the ecological: although the resolution of the exchange value analysis is higher (8 positions) than what is the case for the energy content transfer analysis (5 positions), this difference is mostly reflected in the merging and splitting of country subsets between the two analyses. Great Britain and

Netherlands, both previously addressed on numerous occasions, are though quite different: from an energy point of view, these countries are grouped alongside the major energy net-exporters, while an exchange-value perspective puts them among the major exchange-value net-importers of the world. For Great Britain, however, this is highly coincidental, as Great Britain only holds its C_V membership when using the chosen 3 iterations of the REGE algorithm. As the number of iterations to choose is debatable, and as Great Britain is categorized in position A_V for all tested iterations other than 3, we should not draw any conclusions about the dual role of Great Britain as perceived in Table 7.11.

The Netherlands, however, is indeed an intriguing actor in the analyses done in this chapter. Located within the core position in the exchange value analysis, Netherlands is to be found in the most core-like position in the network of energy transfers. With very distinct properties in the degree and centrality analyses done above (see Table 7.5, Figure 7.3 and Figure 7.4), seemingly acting as a gateway with the lowest import centrality index of all 93 countries, its dual role in the structures of economic exchange and energy flows is most likely a reflection of its structural uniqueness.

Energy unequal exchange vis-à-vis structural positionality

In this chapter, the network of world trade in fuel commodities has been analyzed, mapping its structure, its various role-positions and calculating BDD centrality indices on inbound and outbound flows. As often done within ecological economics, the monetary dimension of these flows are complemented with their biophysical aspects; while the working of the world market, and contemporary economic processes in general, are based on monetary flows, the material want-satisfaction provided by just any commodity is rather to be found in the physical properties of goods. In the case of fuel commodities, the property in question is the heat energy released through incineration/combustion. Contrasting net flows of monetary values with energy content reveals some differences, but there are no clear indications of ecological unequal exchange of the first type, i.e. as non-compensated net flows of resources, regarding trade in fuel commodities.

Although net flow analyses of monetary and biophysical fuel resources are interesting per se, this can only reveal a partial, albeit important, picture of ecological unequal exchange. Any attempt at a more comprehensive statement or measurement of ecological unequal exchange in this regard must of course include virtually all resource transfers, both in pristine conditions as well as those embedded in (used in the production of) traded manufactured goods that constitute the bulk of global trade values.

By viewing fuel commodities as manifestations of the third Ricardian factor of production, combining this with how the Global Commodity Chain school depicts production of commodities as a global process spanning a multitude of national economies, this chapter's analysis of world trade in fuel commodities can be cast as a study of factor allocations within global production structures. Combining the monetary and biophysical dimensions, relating these value-quantity-ratios with the structural findings, we can address the hypothesis underlying this thesis, a hypothesis based on Jorgenson's structural theory on ecological unequal exchange that at the same time is quite similar to Emmanuel's original formulation of the concept. Calculating national import costs and export revenues of each traded gigajoule, these factor costs can then be compared with role-positional membership and the novel BDD centrality indices calculated in this chapter.

Separated according to the value-based role-positions identified previously in this chapter, Figure 7.10 below depicts import costs and export revenues per gigajoule for each country. Judging by the positional value flows (see Table 7.8 above), as well as demographics, the most significant positions to look closer at are exports from A_V , and exports and imports to and from B_V and, especially, C_V .

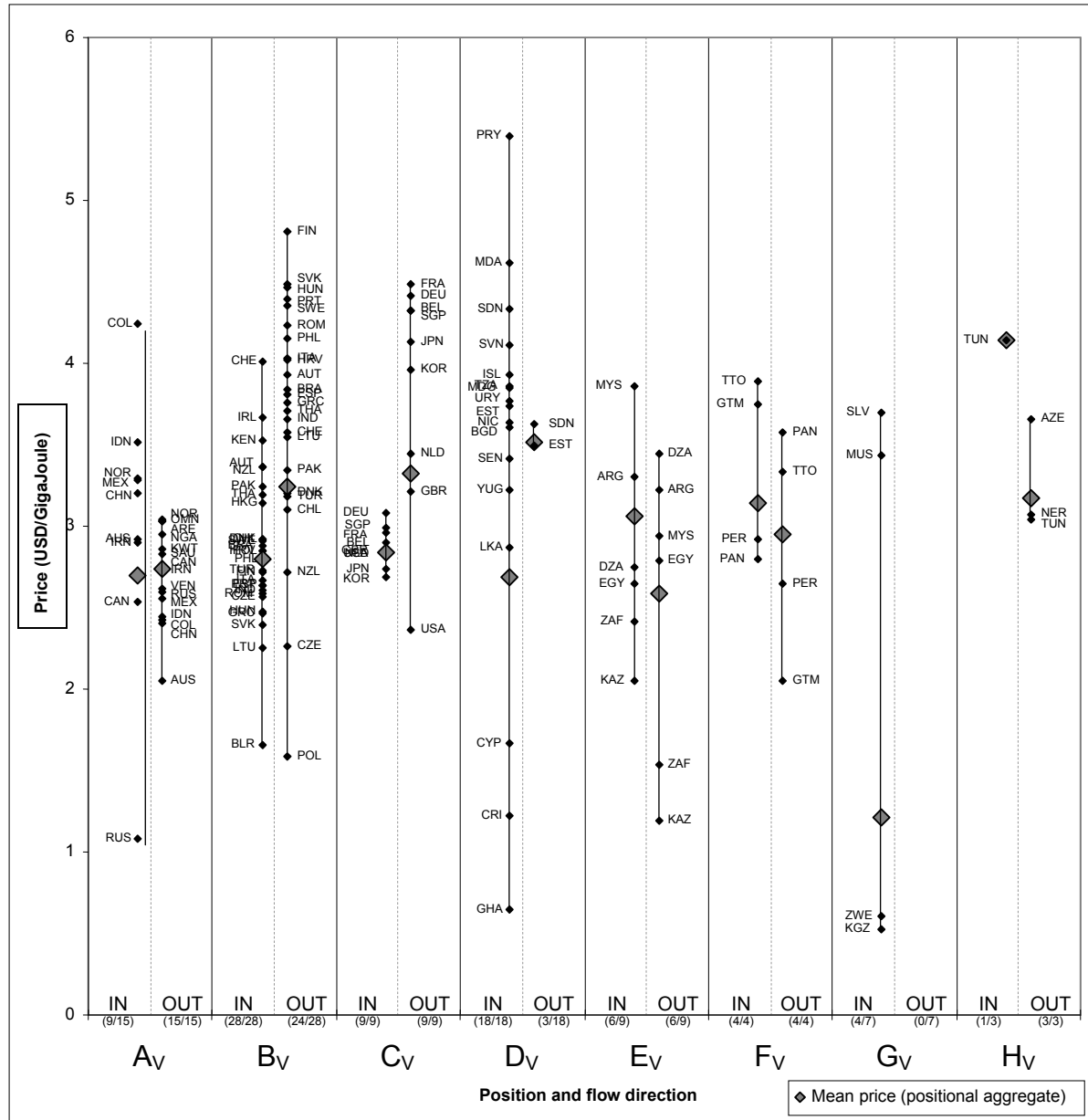

Figure 7.10: Import/export prices of countries in the 8 (fuel value) role-equivalent positions (excluding nations with in-/outflows less than 10 GJ)

Dominating fuel exports with total exports representing 73 percent of total fuel trade, the export revenues for the 15 countries in A_V are within a relatively tight span (2.1-3.0 USD/GJ), with the aggregate mean revenue per gigajoule at 2.7 USD. Oil-exporting Norway obtains 3.0 USD per exported gigajoule, whereas fuel commodity exports from Australia, predominantly coal, only yield 2.1 USD per exported gigajoule. Albeit only representing 7 percent of the total value of fuel trade flows, the import cost span for A_V is larger, although the aggregate mean cost of its imports (2.6 USD/GJ) is at parity with per-gigajoule export revenues. Noticeable, Russia pays on average very little for its energy imports, originating

mainly from Kazakhstan, while Colombia pays more than 4 USD per gigajoule entering its national borders.

C_V is the largest gross importer with 66 percent of all fuel value flows destined for countries within C_V . Despite these large amounts, the gigajoule import cost span is very tight – 2.7-3.1 USD/GJ – with an aggregate positional mean of 2.8 USD per imported gigajoule. While more than half of the exports from C_V are intra-positional trade, C_V also has some noticeable exports to position B_V as well as A_V . With an export value span between 2.4-4.5 USD/Gigajoule, the aggregate mean value of an exported gigajoule from C_V is 3.5 USD, i.e. significantly higher than the corresponding figure for exports from A_V and quite higher than the cost of energy imports.

Similar to C_V , B_V is also primarily a final-consumption position, but the exports from B_V to C_V are significant enough to yield a regular tie (see Figure 7.6). With larger cost spans for its energy imports and exports, B_V pays on average 2.8 USD per imported gigajoule with a corresponding figure for its exports at 3.2 USD.

The more core-like positions of B_V and C_V , and to a smaller extent also A_V , (see Figure 7.6) thus seem to have beneficial price-differentials between their imports and exports: on average, the cost of an imported gigajoule is less than the revenues obtained from an exported gigajoule. The net-exporting position E_V , interpreted as peripheral in the previous structural analysis, has quite a low export price (2.6 USD/Gigajoule on average), significantly lower than the cost of energy imports to E_V (3.1 USD/Gigajoule on average). Furthermore, the export revenue span for countries within E_V is significantly larger than the corresponding span for A_V : while an exported Algerian gigajoule is valued at 3.4 USD, energy exports from Kazakhstan only yields 1.2 USD per exported gigajoule.¹⁷²

Although Trinidad-Tobago is a net-exporter of fuel commodities, value- and energy-wise, position F_V is nevertheless an aggregate net-importing position. In Figure 7.10 above, it can be noted that Panama is the only country in position F_V with a beneficial “throughput rate”, i.e. where the cost for an imported gigajoule is less than the revenues from an exported gigajoule. Typically depicted as a trade gateway, Panama thus has a beneficial throughput ratio, but this assumed geographical advantage is however not reflected in its BDD indices to which we now turn.

According to an intuitive understanding of the thesis hypothesis, a structural advantage should translate into lower resource costs. If the proposed BDD centrality index is a suitable measure of centrality in this context, the hypothesis stipulates that countries with lower BDD import indices (i.e. being relatively more inflow-central) obtain resources at a lower cost than what is the case for countries with higher BDD import indices.

¹⁷² Judging by Figure 7.10, position D_V is indeed contrary to the stated hypothesis, at least when looking at the aggregate positional level, as the average per-joule import cost is far lower than its aggregate per-joule export revenues. However, it can be noted that the import cost span for this position is the largest span among positions. In addition, with only two countries in D_V having gross energy exports exceeding 10 Gigajoules, the positional export revenue figure is not representative for the position at large (which nevertheless has a very small gross energy export). For the two countries in position D_V that have gross flows exceeding 10 Gigajoules – Estonia and Sudan – their respective throughput ratios are however indeed detrimental.

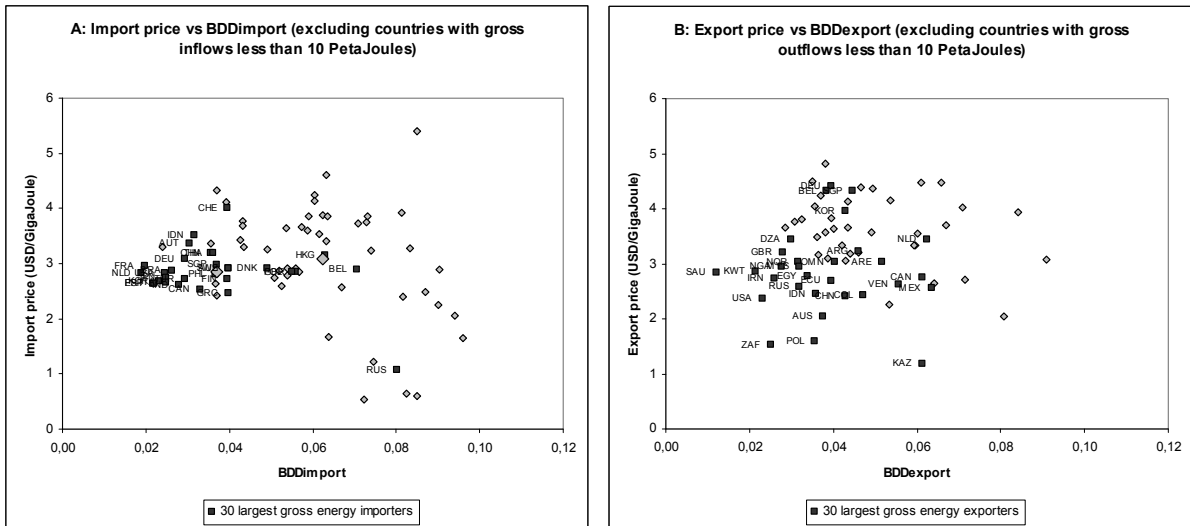

Figure 7.11: Comparing energy prices and value centrality (imports and exports respectively).

However, judging by the scatterplot in Figure 7.11(A), no such trend can be observed for our selection of fuel commodities. Rather, it seems like more central countries pay approximately 2.9 USD per imported gigajoule, while the cost span seems to widen, in both directions, for less import-central (i.e. higher BDD_{Import} indices) countries. As all countries that pay less than 2 USD per imported gigajoule have BDD_{Import} indices higher than 0.06, the scatterplot seems to support quite the opposite from what is stated by the hypothesis.

However, if we make a distinction between the 30 largest gross importers and the remaining 48 countries (excluding countries whose gross imports are less than 10 Petajoules), there is a slight difference between these two sets. It can be noted that the 30 largest gross importers, with a mean national BDD_{Import} index of 0.037, pays 2.9 USD per imported gigajoule, while the latter countries, with a mean BDD_{Import} index of 0.062, plays slightly more: 3.1 USD/GJ.

Turning the focus on exports (Figure 7.11(B)), it would be reasonable that relatively central countries would obtain more revenues for their exports, while less central countries, dependent on a few partners, would obtain less. The scatterplot does not reveal such a relationship. Comparing the 30 largest gross exporters with the remaining 36 countries in Figure 7.11(B), the former are indeed more central than the latter, but it is noteworthy that the mean national revenue for the former is less (2.9 USD/GJ) than for the latter (3.8 USD/GJ). We can thus conclude that, either, centrality is not correlated to fuel commodity prices, or the BDD index is not a suitable measure of centrality in this context.

Conclusion

Using the R-set of actors, extended with the inclusion of Iran, United Arab Emirates and Kazakhstan, this chapter has analyzed the structural properties of the fuel commodity trade network and the trade balances and centrality properties of its actors, using trade flow data on four major fuel commodities. Although excluding a number of relevant commodities, natural gas in particular, an overall conclusion is that net flows of economic value flows in the same direction and at reasonably proportional amounts as net flows of energy contents. In short, the analyses in this chapter yield no indications of any systemic ecological unequal exchange as defined by non-compensated net flows of energy.

What these analyses do indicate is the existence of fairly complex exchange structures, undermining the simple intuitive classification of countries as either net-exporters or net-importers. Instead, there are several different types of net-exporters and net-importers, each of these having specific roles and structural relations with other countries with different roles in the exchange structure of fuel commodity trade.

Furthermore, from the structural mapping of exchange values, we note that a small set of advanced economies plays a central role in the economic exchange network, even though these countries (exempting Great Britain) have no significant endowments of the resources which they so prominently trade with, a phenomenon also reflected in their low centrality scores. However, when switching from the monetary to the biophysical dimension, in this case the net flows of the energy contents of the traded commodities, the resource-endowed net-exporting countries shine through as being more core-like than what was the case when looking at the monetary values of these exchanges. Energy resource flows thus seem to revolve around net-exporting countries rich in fossil fuel endowments, but the value of these trade flows seems rather to revolve around the net-importing, final consumption Western economies.

Alongside these structural findings, it can be noted that the distribution of the selected fossil fuels are highly skewed in favor of the most advanced countries. As seen when looking at aggregate energy flows between role-equivalent positions (Table 7.10), more than half of all energy flows in the network are appropriated by a small set of advanced (post-)industrial economies that only represents 11 percent of the total population of the dataset studied.

The Netherlands seems to have a very unique role in the analyses above. This is not surprising – the Netherlands is indeed a gateway for inflows of fuel commodities to Europe, with a huge throughput of imported fuel commodities obtained from all over the world. While this perhaps is a rudimentary “finding”, it indeed demonstrates the abilities of the techniques and methods in social network analysis to find what is structurally relevant.

Turning to the issue on ecological unequal exchange, there are several indications that support the thesis hypothesis. The core-like net-importing positions – B_V and C_V – do have a beneficial throughput ratio: on average for these positions, the revenue from an exported gigajoule is markedly higher than the cost of an imported gigajoule. For A_V , however, containing the absolute majority of fuel extractive economies, export prices are comparatively low and, albeit imports are of a small magnitude, the throughput ratio for A_V is almost at parity. Compared to these positions, the second largest net-exporting position, E_V , experiences a different situation: its peripheral status in the network of fuel commodity trade correlates to a detrimental throughput ratio, with input costs and low export revenues on a per-gigajoule basis. In short: the results above do support the thesis hypothesis from the viewpoint of the energy net-importing countries found in the core, whereas the relative coreness of the largest net-exporting position A_V does not equate with higher export revenues per exported joule. With the detrimental throughput ratio of the second largest net-exporting, structurally peripheral position, international energy flows seems to benefit consumers more than extractors. The thesis hypothesis thus seems to be correct from the perspective of the final consumers, though only partially for the net-exporting countries.

The BDD scatterplots are however partly in contradiction of the hypothesis. On average, the 30 largest gross importers are more central and have a slight cost-advantage vis-à-vis the remaining countries with less central importers, but there is no direct correlation between

import centrality and the cost of an imported gigajoule. Regarding export centrality, the scatterplot is in “disarray”; no direct trend between export centrality and revenue-per-exported-gigajoule is to be found. Rather, a closer inspection seems to point to the opposite; as previously noted, energy trade seems to be a consumer-driven market as the hypothesis seems to be true only for net-importing positions and countries.

Noticeable, however, when correlating import costs with import centrality is the small cost span across the more central importing countries. Also quite noticeable in Figure 7.10, it seems like the span of per-gigajoule import costs is smaller for core countries than what is the case for less core-like countries (Figure 7.4) and more peripheral positions (Figure 7.6). Core status thus seems to imply a similarity in import prices across core countries, whereas peripheral positions and countries experience higher internal price divergences and detrimental throughput ratios on their imports and exports.

CHAPTER 8

Agricultural commodity trade

One of the most compatible aspects between the world-system perspective and ecological economics is their shared view on system totalities. In both these scholastic lines, national or regional entities are always seen in light of a larger system in which all such entities co-exist and co-evolve. Although an individual sub-entity can demonstrate high standards of living and consumption, the distribution of resources in the system at large represents, borrowing from Hornborg (2003), a zero-sum game. The focus thus naturally turns to distribution with this larger system, rather than the more mainstream belief in non-constrained economic development and infinite increases in resource usage within each such sub-entity, independently of each other.

Although various measures of energy and material flows definitely have their merits in certain ecological-economic contexts, such measures lack any realistic notion of resource availability and total supply: what a “fair” and sustainable amount of global energy and material usage actually amounts to is debatable. Limited in theory, materials come in various forms and utility, and energy is not theoretically limited to incoming sunrays as the breakdown and splitting of hydrocarbon molecules and atoms do supply us, at least for a limited time, with extra energy. In short, it is difficult to conceptualize the ecological limits of the total system – the world-system – using such non-monetary units of accounting.

What is limited, however, is the surface of the planet and its bioproductive areas. Excluding desertification, deforestation, growth in human settlements, land reclamation projects and other anthropogenic processes, the total bioproductive area that sustains planetary life is quite static. Area-based units of accounting (ecological footprints) are thus very promising for measuring both absolute as well as relative levels of resource appropriation as they have a given reference in the totality of the system: with a given system-wide amount of bioproductive land, questions on sustainability, environmental justice and resource distribution are easy to conceptualize and discuss.

This chapter analyzes the network of international trade of 26 primary agricultural goods, calculating gross and net flows, centrality and role structure for up to 100 countries in our dataset, contrasting the monetary dimension of these flows with the bioproductive hectares these correspond to. Combining these structural-analytical results with the value-hectare ratios for imports and exports, the thesis hypothesis on ecological unequal exchange is tested for these primary agricultural goods, deeming these goods as adequate representations of the third Ricardian production factor.

However, instead of using the popular and official version of Ecological Footprint as the area-based unit of accounting, this chapter will present an alternative method. The reason for this, as will be discussed and argued below, is simply that the official version, although pedagogical, has some major drawbacks that make it especially unsuitable for measuring the notion of ecological unequal exchange¹⁷³. Contrary to the previous chapter, this chapter is

¹⁷³ In addition, the official datasets used in Ecological Footprint accounting as published by the Global Footprint Network are not available to the public and was not available on request for this thesis, thus making it virtually impossible to use the official accounting methods and data.

thus somewhat larger as it begins with a presentation of this alternative ecological footprints accounting method. We begin by looking at the official area-based indicator below.

*From ghost acreages to Ecological Footprints*¹⁷⁴

In 1953, the Swedish food scientist Georg Borgström published *Jorden – vårt öde* (*The earth – Our destiny*), complemented by a series of radio lectures concerned with population growth, food production, and the somewhat dire Malthusian fate of mankind as depicted by Borgström. This book and these lectures formed the groundwork for his subsequent book *Mat för miljarder* (1962): the English 1965 translation – *The Hungry Planet* – is what Borgström is most renowned for. Starting off with a critique of monetary evaluations when looking at issues on food security, Borgström introduced the concept of “ghost acreages”, these representing the land-, fish-, and trade acreages demanded by a given population. Without claiming that Borgström was the first to conceptualize resources in terms of bioproductive areas (e.g. Cantillon), he definitely was a major inspiration for the further development of the concept.

In his 1993 book *Living within Limits*, Garrett Hardin refers to Borgström when elaborating on the human appropriation of productive land. “[Assuming] that the imports and exports of the United States are in balance as concerns the area required to produce food and other basic goods”, i.e. assuming a “trade acreage” of zero, Hardin finds that “the average American draws upon the resources of the land to the following extent: Cropland 1.9 acres, Pastureland 2.4 acres, Woodland 2.6 acres, Other land 2.2 acres” (Hardin 1993:122). Thus, except for providing a rough quantitative estimate (using data from World Resources Institute), Hardin separates the account into different land types, and makes his calculation on a per capita basis, though without developing the idea further as a specific indicator of sustainability.¹⁷⁵

At first called the “regional capsule model”, the urban geographer William Rees did the initial development and the subsequent naming (about 1990) of the official Ecological Footprint (EF) concept (Rees 2002). Inverting the carrying capacity concept, Rees used to ask his students what would happen if a city were enclosed by a huge glass dome, and how large such a dome must be to enclose the land and water areas necessary to sustain the resource consumption and waste handling of that city (ibid.:4).

Together with his graduate student Mathis Wackernagel, they developed the EF concept further in a series of papers (Wackernagel 1991; Rees 1992a; Rees 1992b; Rees and Wackernagel 1994; Rees 1996), culminating in the now classical book *Our Ecological Footprint* (Wackernagel and Rees 1996). Since then, the EF concept has disseminated substantially. Endorsed by several organizations, governmental as well as non-governmental. Wackernagel now leads the Global Footprint Network (GFN), an organization working with methodological development and marketing the concept as a viable tool for measuring sustainability. GFN also publishes the official Ecological Footprint of Nations reports,

¹⁷⁴ This overview is by necessity very limited. An excellent account of the conceptual development from Borgström to Wackernagel can be found in Brolin (2006a:271-301)

¹⁷⁵ Wackernagel and Rees began their development of the footprint concept prior to Hardin’s 1993 estimation. It is though unknown (to me) whether Hardin was inspired or influenced by the regional capsule module, the Wackernagel 1991 paper and subsequent work by Rees and Wackernagel. While paying tribute to Hardin as a general inspiration, Rees was unfamiliar with the Hardin estimates of 1993 at the time (personal email communication with Rees, 16th January 2008), reinforcing the perception that Hardin and Rees/Wackernagel formulated their thoughts independently of each other, though substantially more detailed by the latter team.

presenting their findings in cooperation with the annual WWF *Living Planet Reports*, as well as conducting EF analyses on a consultative basis.

As its popularity increased rapidly within as well as outside academia, the EF concept came under increased scrutiny, culminating in the 2000 special issue of *Ecological Economics* 32(3) that focused on the pros and cons of the concept. As Costanza so aptly put it in this issue, the interest in new and important ideas often seems to oscillate for some time before reaching a stable level, something which the EF concept seemed to be caught in at the time of writing, best alleviated through further scientific discussion and diffusion (Costanza 2000:343ff). However, while the debate in this particular issue of *Ecological Economics* was constructive and progressive, the decision was made to classify the actual calculation procedures and underlying data and, through this, many of the more detailed steps for calculating EF and biocapacity accounts for nations. Indeed, the general principles for conducting national EF analysis are publicly available, for instance in the 2004 method paper (see below), but then only explained in fairly general and non-specific terms. Without the specifics of the actual calculation procedures, without actual data (and their sources), and without access to the national conversion factors, it is virtually impossible to replicate, and through this truly understand, how final results are arrived upon and the methodological premises and assumptions which the specific choices of data sources do entail.¹⁷⁶ Development of the EF method is indeed an on-going process, conducted by a team of scholars within the GFN (together with financially contributing partners to GFN), but the lack of transparency and the impossibility to replicate the results and findings of GFN has, sadly, hindered the oscillation predicted by Costanza at a too early stage.

Next, we will look closer at the 2004 method paper that describes the procedure for calculating national ecological footprints. My own critique will be combined with some of the issues raised by other authors. What follows is however not an attempt to encompass all the specifics of the EF concept, nor a comprehensive presentation of all critical inquiries into the concept: excluding the debate concerned with so-called energy land, the text below will focus mainly on the aspects relevant for this chapter on agricultural product flows. As will become evident below, there are some inherent problems with the EF methodology as of 2004, making it problematic to use as a non-monetary measure for such agricultural net flows. The issue on transparency is, however, the major caveat. While “[t]he purpose of [the Global Footprint Network] is to build global Footprint accounting standards with an ‘open source’ approach” (Wackernagel et al 2007:3), the lack of data, data sources, and the possibility to replicate results is not in line with open source practices as found in the world of software development.

National Ecological Footprint methodology as of 2004

The method paper of 2004 (Wackernagel et al 2004) describes the EF method, specifically describing the calculation procedure of the National Footprint Accounts, this representing the cornerstone of all EF practices at all scales. Although the EF concept has been described in slightly different phrasings from time to time, the following definition found in this method paper should encompass the concept ever since its genesis:

¹⁷⁶ GFN recommends that sub-national analyses conforms to the official national results by weighting and adjusting, i.e. benchmarking, non-national results in accordance with the official GFN national results. The national accounts thus play a very significant role in general EF practicing, therefore making it even more important that the full calculation procedure, and all underlying data and their sources, become fully public.

[E]cological Footprint accounts document how much of the annual regenerative capacity of the biosphere, expressed in mutually exclusive hectares of biologically productive land or sea area, is required to renew the resource throughput of a defined population in a given year – with the prevailing technology and resource management of that year. (Wackernagel et al. 2004:4)

There are two principal approaches for calculating EFs: a top-down (compound) and a bottom-up (component) approach. Through life-cycle analyses (LCA) of each relevant good and service, tracking resources needed to produce, consume and discard each good/service, the component-based approach compiles all these results into a national aggregate. Being dependent on accuracy and completeness of LCA analyses, combined with inherent boundary problems of such analyses, the component approach is unsuitable for calculating comprehensive national EF accounts (2004:5). Instead, the authors recommend a compound approach using aggregate national data, data that “captures the resource demand without having to know every single end use” (ibid.). As sub-national EF studies - regional/organizational and/or component-based – are strongly recommended to calibrate results to the official National Footprint Accounts by Global Footprint Network, this in order for non-GFN studies to obtain official GFN approval and certification, the method behind calculating national accounts as presented in the 2004 document represents a central backbone of contemporary EF practices.

National (as well as global) EF accounts consist of two complementary parts: “the ecological supply (or bioproductive areas) and the demand on nature (or Ecological Footprints)” (2004:8). We begin by looking at the specifics of the supply side.

Five major land (and sea) types are included in EF accounts – these, along with their total global availability, are given in Figure 8.1 below. If all of this available bioproductive land were to be equally divided among the 6.3 billion people of the world, each person’s fair earthshare would correspond to a circular area as given in Figure 8.1 below, with a diameter of approximately 150 meters.¹⁷⁷

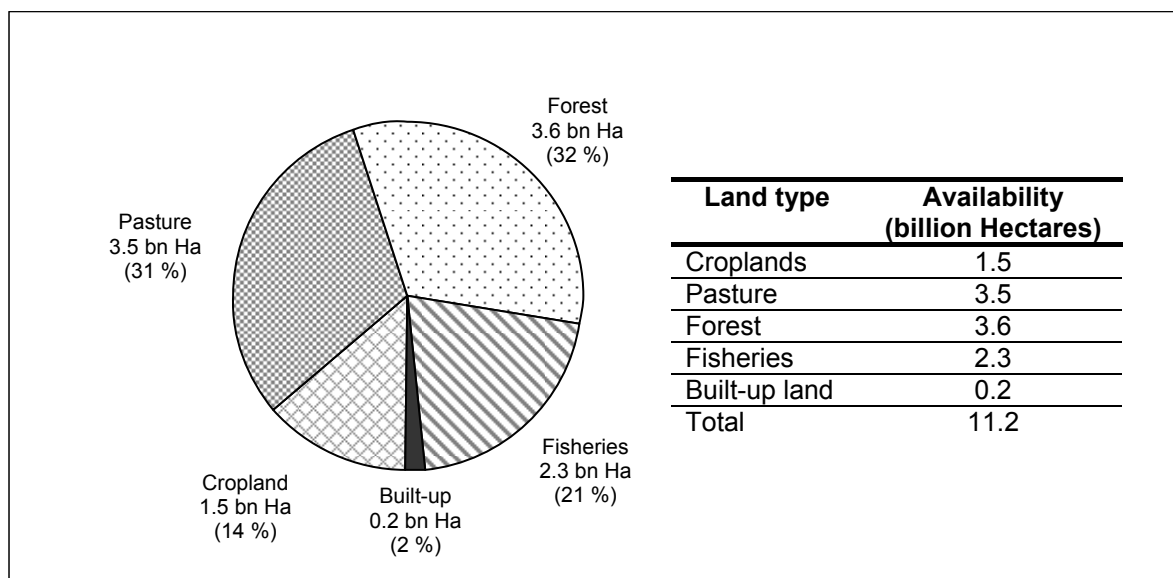

Figure 8.1: Bioproductive land types used in the EF metric, and their respective global availability (Source: Wackernagel et al. 2004:8)

¹⁷⁷ Calculated using land type availability as given in Wackernagel et al (2004:8) and a total population of 6.3 bn people (WWF 2006:28).

Scattered across the globe, endowments of these land types pay no respect to national borders, and the biocapacity of each land type may very well differ between (as well as within) nations. However, instead of keeping the distinction between these different land types, as well as differences in bioproductivity between nations, the unique national mix of these land types, and the unique national bioproductivity of each land type, are converted into a single, one-dimensional measure of bioproductivity/biocapacity through two sets of conversion factors, in Figure 8.2 below exemplified for the cropland type.

Existing crop area [ha]	x	National yield factor (cropland) [-]	x	Equivalence factor (cropland) [gha/ha]	=	National biocapacity (cropland component) [gha]
-------------------------------	---	--	---	--	---	---

Figure 8.2: Calculating national “biocapacity” in the EF methodology (Source: Wackernagel et al (2004:10; Figure 1))

The actually existing hectares of a specific land type is first multiplied with a national yield factor, these factors calculated from yield and production data for several agricultural products for a vast number of countries as collected and compiled by FAO. For each land type for each country, “the yield factor is the ratio between the area a country uses in the production of all goods in a given [land type] category... calculated with national yields, and the area that would be required to produce the same goods with world average yields.” (Wackernagel et al 2004:12). That is, if the cropland of a country were twice as productive as the world average productivity for cropland, the biocapacity cropland area for this country would be twice as its actual (physical) area. Similarly, a country whose croplands have yields lower than the global average would seem to have less land under cultivation than what actually is the case. (Adjusting national yields to global averages can be interpreted as an implicit pro-trade aspect of the EF methodology as it more or less takes for granted a Walrasian all-with-all exchange of ecological resources).

Once having adjusted all land types to global average hectares (albeit still counted in hectares, shown by the non-dimensional unit in this step), each of these land types are subsequently converted into global hectares¹⁷⁸ by multiplying with their corresponding equivalence factors. These factors represents “the world’s average potential productivity of a given bioproductive area [i.e. land type] relative to the world average potential productivity of all bioproductive areas” (ibid.:11). Repeating the procedure in Figure 8.2 for all land types, a total national biocapacity measure is arrived upon by summing the biocapacity of the “global hectares” for each land type.

The principal, explicit objective of EF analysis is to be a measure of (un)sustainability and, through this, to act as a tool for crafting policy guidelines and tracking progress towards sustainability. This is reflected in the discussion on natural capital at the beginning of the 2004 paper, underlining that EF accounts “measure how much of the biosphere’s regenerative capacity is used by the human economy” (ibid.:4). It is thus imperative that the supply side of EF accounts reflect the regenerative capacity of nature – the *interest* from nature’s capital,

¹⁷⁸ “One global hectare is equal to one hectare with a productivity equal to the average productivity of the 11.2 billion bioproductive hectares on Earth. [...] Global hectares are normalized so that the number of actual hectares of bioproductive land and sea on this planet is equal to the number of global hectares on this planet” (Wackernagel et al 2004:9)

rather than the actual withdrawal and spending of this capital – which is exactly what its author claims it does¹⁷⁹:

In providing an overall assessment of the scale of the human economy as compared to that of the biosphere, the Footprint addresses the most pressing underlying question ecological economics can ask: whether ‘economic progress’ as celebrated today is undermining humanity’s ultimate means, natural capital. [Footprint analysis] is one of the few ecological measures that compares human demand to ecological supply. (Wackernagel 1999:318)

This is however not the case under the current EF procedure. Although it says “Biological capacity” on the supply side of the schematic figure in the method paper (Wackernagel et al 2004:10), furthermore referring to this as “regenerative capacity” and “biocapacity” at various parts (ibid.:3, 9), the term “bioproductivity” is used in crucial passages when presenting the EF method, such as in the third assumption on calculating EF accounts:

By weighting each area in proportion to its usable biomass productivity (that is, its potential annual production of usable biomass), the different areas can be expressed in terms of a standardized average productive hectare. These standardized hectares, called ‘global hectares’, represent hectares with the potential to produce usable biomass equal to the world’s potential average of that year. (Wackernagel et al, 2004:6)

The critical keyword here is “potential”. Using national yield data obtained from FAO, weighting these according to the specific basket of production for each country, the “biocapacity” of a country is directly related to what comes out of the ground, using “the prevailing technology and resource management of that year” (ibid.:4). The Faostat yield data takes absolutely no regard of agricultural inputs, nor do these yield factors contain any information whatsoever on whether these yields are obtained in a sustainable way or not, i.e. whether yields are on a long- or short-term basis. The yield data published by Faostat simply state production per hectare, no matter whether this potential production is the interest or the capital of nature. In the case of croplands, this is actually acknowledged in the method paper: the supply components of national EF accounts “do not document degradation from agricultural practices, such as long-term damage from topsoil erosion, salinization, aquifer depletion, and nitrogen runoff” (ibid.:20). In personal email communication (2005), Wackernagel reiterates what biocapacity actually means in the EF concept:

We say biocapacity = what comes “out of the toothpaste” for whatever reason. Irrigation, good soils, fertilizers, etc. But once the input ceases, the bioproductivity goes down. So destructive effects of agriculture will be captured in the future, and we do not need to make assumptions about it. [...] What we measure is actual amounts being generated (whether these amounts can again be generated in the future or not).¹⁸⁰

A viable indicator of sustainability striving to function as an assessment tool and as a guide for policy decisions must, however, be able to identify occurrences of (un)sustainable appropriation of natural resources when they actually occur – not when they indicate that it has already occurred, past a point of no (or hard-obtained) return:

A distinction between sustainable and unsustainable land use seems a minimum condition for any procedure aimed at determining to what extent an activity or region is contributing to (un)sustainable development. This is not to say that such a procedure can easily be implemented,

¹⁷⁹ This perception, that biocapacity refers to the interest of natural capital rather than capital itself, is manifested in virtually all presentations of the EF concept, for instance in one of the main books on Ecological Footprint entitled *Sharing Nature’s Interest* (Chambers et al 2000).

¹⁸⁰ Wackernagel, 28th February 2005; personal email communication.

as it is not always easy to determine what sustainable land entails. Nevertheless, ignoring this question, as the EF procedure does, is worse. (van den Bergh and Verbruggen 1999:65)

It is very true that unsustainable farming practices will be captured in the national biocapacity data of the future, as the short-term high yields will be replaced by the lower yields from long-term depletion of *real* biocapacity (such as circular nutrient cycles, topsoil regeneration, biodiversity maintenance, etc), so an indicator of sustainability must be able to capture unsustainable practices, something that the EF methodology anno 2004 currently fails at. National EF accounts do cover inputs to agriculture: on a national compound level, production and net flows of fertilizers and other agricultural inputs are accounted for. However, such inputs are accounted for on both sides: while being consumed, increasing the compound EF of the nation, this consumption also raises the conceived bioproductivity/biocapacity on the supply side as well.

Lenzen et al (2006) has addressed the above problematique by drawing attention to a number of paradoxes stemming from the above methodological flaw in the EF concept of biocapacity. For agriculture, the authors correctly state that a shift from conventional to organic farming practices indeed is a step towards sustainability. Such a step, they further argue, would however reduce bioproductivity as measured in the EF accounts, narrowing the sustainability buffer or increasing would-be ecological overshoot (ibid.:7).

In the second step of the conversion from actually existing bioproductive hectares to national biocapacity accounts (see Figure 8.2), a static set of equivalence factors are employed – see Table 8.1. These equivalence factors are used to convert vectors containing separate data for each land type into a singular, one-dimensional measure that, similar to the monetary measure of value, makes it much easier to communicate and use as a comparative yardstick. For example, instead of representing Argentina’s per-capita biocapacity of cropland, pastures, forests, and fishing grounds as, respectively, 2.39, 1.91, 1.02 and 0.52 global hectares¹⁸¹, the static equivalence factors in Table 8.1 are used to arrive at a total biocapacity at 5.9 global hectares per capita.

Bioproductive area	Global hectares per hectare
Cropland (overall)	2.1
<i>Primary</i>	2.2
<i>Marginal</i>	1.8
Pasture	0.5
Forest	1.4
Fisheries	0.4
Built-up area	2.2
Hydropower area	1.0
Fossil fuels (Forest)	1.4

Table 8.1: EF equivalence factors for various land types. (Source: Wackernagel et al (2004:12, Table 1))

Extending their argument across different land types, Lenzen et al (2006) note that a transformation from one land type to another could actually increase perceived biocapacity due to different equivalence factors, even though such a transformation is anything but sustainable:

¹⁸¹ All data from Living Planet Report 2006 (WWF 2006:32ff). In these accounts, build-up land in Argentina corresponds to 0.11 hectares per capita: this is included in the cropland land type data as it is assumed that build-up land occupy potential cropland (Wackernagel et al 2004:8,12; WWF 2006:35, note 1,3).

[S]tanding forests are weighted by an equivalence factor of 1.4, but once cleared and turned into plantations of palm oil, they are registered as primary crop land, the equivalence factor of which is 2.2. Moreover, due to the high yields in palm oil, the local [national] yield factor for primary cropland may be positively affected by this change. The conversion of biodiversity-rich tropical forests to monocultures of palm oil thus results in a misleading increase in biocapacity, even though the robustness and long-term regenerative capacity of ecosystems are compromised. (Lenzen et al 2006:8)

Similar to my own arguments above, Lenzen et al state that when “used in isolation, the bioproductivity metric not only provides no ‘early-warning signal’ for looming future problems”, instead arguing that “it may actually provide incentives that *lead* to future problems.” (ibid.:10, original emphasis). Their suggested solution is to include land disturbance factors in the EF biocapacity accounts, in effect penalizing bioproductivity measures that are detrimental to real-world ecological sustainability issues, this adding “crucial information to policy for long-term planning” (ibid.:11). An alternative solution suggested by van den Bergh and Verbruggen (1999:70) is to calculate sustainable and unsustainable land use as two separate, non-overlapping measures, this making the EF measures reflect actually existing land areas rather than, as van den Bergh and Verbruggen argue¹⁸², hypothetical land areas.

With the explicit aim of creating an ecological-economic accounting framework that is easy to comprehend, communicate, and to use comparatively, it is naturally easier to compare singular one-dimensional values with each other than comparing sets/vectors of values representing different land types. However, while the flows and activities in contemporary economic systems very well may be measured in one-dimensional units – monetary values, that is – it is highly problematic, indeed risky, to assume that the human (and non-human) ecological realities and life-spaces, of which economic systems only are a part of, can be expressed in similar one-dimensional units, such as global hectares – no matter how desirable such a unit would be from a pedagogical and communicative point of view. Admitting that similar accounting schemes (such as MIPS) suffer from the same problem (van den Bergh and Verbruggen 1999:64, note 3), the one-dimensionality strength of EF is an even bigger weakness:

[D]ifferent consumption categories are translated into land area...while no account is taken of regional and local features of land types and land use. But the main problem is that physical consumption – land conversion factors are used that function as implicit weights in the conversion as well as the aggregation...reflect[ing] neither relative scarcity changes over time nor variation over space. [...] This means that a fixed rate of substitution is supposed between different categories of environmental pressure. (van den Bergh and Verbruggen 1999:63ff)

As Gudeman pointed out with respect to money, “its power of commensuration, lies in its ability to dissolve distinctions between value schemes or measuring rods, and to create the

¹⁸² Wackernagel (1999) has responded to van den Bergh and Verbruggen, for instance on the argument that the EF concept implies hypothetical rather than real land usages: “A footprint size larger than biocapacity indicates, not ‘hypothetical land,’ ... but the very real existence of overshoot – that is, of humans consuming resources and emitting waste at a rate that could only be sustainable if there were more biocapacity than actually exists.” (ibid.:317). This counter-argument is rather weak on two accounts. First, if EF accounts were to represent non-hypothetical land areas, i.e. concrete, actually existing land areas, there can be no such thing as overshoot. Simply by mentioning the concept of overshoot, it is implicitly underlined that EF are indeed concerned with hypothetical – or at least metaphorical – land areas. Secondly, the term “biocapacity” is used here as a marker for the supply side of EF accounts. As previously noted, with “biocapacity” in the EF accounts reflecting what comes out of the toothpaste, i.e. based on Faostat yield data that ignores inputs and farming practices, the issue of (un)sustainability is regretfully something different from “biocapacity” as used in EF accounts.

fiction that a flattened, comparable world exists” (Gudeman 2001:15). It is doubtful that a similar dissolving of distinctions is something to strive towards when attempting to conceptualize the ecological, non-symbolic realities that the human economy is embedded in, interacts with, and is fully dependent upon. In contrast with the monospherical economy (see chapter 2; see also Hornborg (2007)), we cannot expect natural resources to be equally simple to conceptualize, compare and weigh.

Having dealt with the supply side of the EF equation, we now turn to the demand side and how Ecological Footprints are calculated for primary goods. In the EF context, primary products are defined as “the unprocessed output of a given area, which may be used directly with minimal alteration or be processed into a secondary product. In the case of cropland, pasture and forest, this includes the immediate products of photosynthesis, such as raw fruits and vegetables, forage for livestock, or unprocessed roundwood.” (Wackernagel et al 2004:14). As most goods and services appropriate several different land types, the goods we will be analyzing in this chapter are primary goods following this particular definition. Thus, while a total Ecological Footprint is calculated by aggregating all land type components of occupied areas, the cropland component alone will be focused upon in this chapter.

Similar to how global hectares of bioproductivity are calculated (Figure 8.2 above), the demand side uses a series of conversion factors to arrive at the Ecological Footprint of a primary good – as shown in Figure 8.3 below.

Crops [t/yr]	/	Global crop yield [t/ha/yr]	x	Equivalence factor (cropland) [gha/ha]	=	Occupied area (cropland component) [gha]
-----------------	---	--------------------------------	---	--	---	--

Figure 8.3: Calculating Ecological Footprints (the demand-side) in the EF methodology (Wackernagel et al 2004:10; see also equation at *ibid.*:14)

Contrary to how national Faostat yield factors were employed on the biocapacity (supply) side (see Figure 8.2 above), the demand-side conversion from consumed quantities to appropriated areas uses static, universal conversion factors (second box in Figure 8.3). This has two major implications in the trade-related context of this thesis. First, obviously, “a primary product will have an identical Footprint regardless of its origin” (Wackernagel et al 2004:14). This means that the consumption of a kilogram of beans grown in my own backyard compost heap would result in the same EF value as the consumption of a kilogram of beans flown in from a mechanized, high-intensive agroindustrial farm on the other side of the planet. Not only that, secondly: as *all* primary (cropland) products within the same EF product group¹⁸³ are converted using the same particular global crop yield factor, my local and organic kilogram of green beans would actually have the same consumption EF as a kilogram of tomatoes from intensive farming across the globe. It is unfeasible that these two primary products are measured as being equivalent in resource appropriation: whether a

¹⁸³ In the method paper, it was first a bit unclear whether the primary products “global yield” (in the equation on p. 14 and in the diagram on p. 10) represented global average yields for all primary goods of a specific land type, or if these, similar to the biocapacity (supply), calculated for each individual product category. In mail correspondence (11-12 December 2007), Wackernagel clarified this with “product groups”. Similar to how Faostat (and Comtrade) combine different primary commodities into specific groups, such as “Cereals”, “Roots and tubers” etc, there are similar primary product groups in the EF methodology, groups whose average yield factors are used in Figure 8.3 above. As there is no public information available on the commodities in these GFN product groups, I have chosen to use green beans and tomatoes in the example as they both belong to the same product group in the Faostat database – “Vegetables (incl. melons)” – thus assuming that the EF methodology follows these Faostat groupings. From the Faostat database, it can be noted that 1997 average world yield factors (in tonnes per hectare) were 6.1 for green beans and 26.3 for tomatoes.

consumer chooses to eat locally grown, organic beans or greenhouse tomatoes from the other side of the planet does of course have a significant impact on the natural resource usage of the consumer.

A Ricardian model of trade in ecological footprints¹⁸⁴

Setting up a Ricardian two-actor model of identical 1-hectare countries – a sustainable Beanland and an agroindustrial Tomatoland – demonstrates the dilemma with using a global crop yield factor, also demonstrating the flaw with the biocapacity estimates (see above, and Lenzen et al 2006:7). Let us assume that the national yield of sustainable green-bean-growing in Beanland is 1 mass-unit per hectare (q/Ha), and that the corresponding yield factor for heavy-input Tomatoland-tomatoes is 2 q/Ha, setting the global crop yield in this very small world at 1.5 q/Ha. Measured in global hectares, the “biocapacity” of Beanland would thus only be 2/3 of the actual hectares producing sustainable green beans, while the corresponding biocapacity of Tomatoland would be 1/3 larger than the actual area used for intensive farming of tomatoes.

Using this global crop yield to determine EF (demand-side) appropriation, a mass-unit of green beans and tomatoes would here have identical EF values: 0.67 Ha. Trading half of their respective primary outputs with each other, i.e. at a bean-tomato ratio at 1:2, each country would have EF consumption values of 1.5 global hectares, thus indicating ecological overshoot by sustainable Beanland by 33 percent, while agroindustrial Tomatoland being within its “biocapacity” limit by the same percentage.

If Tomatoland were to increase its “biocapacity”, i.e. by further mechanization, fertilizers and other long-term reductions of actual biocapacity, this would, all by itself, actually increase the ecological overshoot in Beanland while making Tomatoland even more within its national account limits.

If we were to analyze trade flows of a cropland-derived primary product, viewing such flows from the demand side in the 2004 method, we could just as well conduct an analysis of the quantities of net biomass flows: the global crop yield factor would guarantee that we would arrive at identical (proportional) results within each product group. Under a methodological regime that equates the weight of imported primary goods with their appropriation of natural resources, no matter their commodity-specific yield factors, inputs, farming practices, and overall sustainability-aspect, we might as well treat such a trade flow study for what it actually is, i.e. a material flow analysis of biomass, weighting different product groups into an aggregate unit based on what type of products these commodities are (fruits, cereals, roots and tubers, etc) rather than their individual and national-derived yield factors.

From a supply-side, a would-be alternative is to use the EF national yield factors when converting trade flow matrices into net flows of appropriated land. There are however three obstacles for doing so. First, national yield factors for croplands reflect the specific basket of different primary goods grown in each country. Outbound flows of primary (cropland-based) commodities from a country would thus utilize the same conversion factor when translating these outbound quantities into embedded footprints. Exports of unprocessed tomatoes, apples, spinach, saffron, potatoes, coffee, and watermelon would simply be seen as exports of a homogeneous group of primary cropland-derived products. Secondly, using national yield factors on outbound flows assumes that these flows only constitute goods produced within the nation from which the flow originates. While feasible for several countries and primary goods, this should not be taken for granted: outbound trade flows may very well often constitute re-exported imports. Singapore, for instance, exports several primary cropland-

¹⁸⁴ This ecological version of a Ricardian-style 2x2 model could probably be extended, adding other tools and concepts stemming from the classical (and neo-classical) school, perhaps combining traditional Edgeworth diagrams used to examine the monetary division of gains from trade with ecological Edgeworth diagrams reflecting ecological exchange (Edgeworth 1925; see chapter 4). While models such as these often are very unrealistic and hypothetical, they do function quite well to test the foundational viability of a model or a theory and the consequences thereof.

based commodities, but has virtually no agricultural sector (nor corresponding Faostat yield data) at all. Thirdly, most significant, is the issue on data availability and methodological transparency, this being a baseline criteria for a good indicator (Chambers et al 2000:16). The national yield data used in the National Footprint Accounts are regrettably not publicly accessible, nor are the specific details on how they are calculated¹⁸⁵, making the alternative of using the EF national yield factors unviable altogether.

The above critique notwithstanding, the Ecological Footprint concept and the idea it builds upon is one of the most powerful ways to communicate about sustainability and, especially, the global distribution of biospheric resources. By conceptualizing economic goods as the amount of bioproductive land needed to produce (and dispose) the good in question, a non-monetary unit of accounting is obtained which makes intuitive sense for understanding the biophysical limits to the human economy as well as how appropriated resources are divided among different social strata.

However, with the current EF methods being unsuitable for analyzing net transfers of appropriated land between the nations of the world, an alternative methodological approach is needed where the distinctions between individual agricultural goods as well as their presumptive national origins remain intact. Below, such an alternative method is presented that I have chosen to label “Ecological Footprints”: similar to Odum’s “emergy” concept, the terminology reflects that the proposed heuristic/method below allows for the conversion of individual bilateral trade flows of agricultural goods that very well may have fairly complex and diverse origins.

Method and algorithm: Ecological Footprints

Similar to the EF method as stipulated by GFN, the method presented here is concerned with what comes out of the toothpaste, explicitly ignoring managerial practices and inputs. However, no adjustment to global average yields or global hectares is done: instead, detailed national yield and production data is used directly as the explicit aim is to look at net transfers of appropriated land areas – actual geographical areas of nations corresponding to the actual flow of commodities between nations. With the available Faostat data on yields for each commodity and each country, we can thus apply this data to convert Comtrade trade flow quantities into areas of appropriated land, without obscuring the distinction between potatoes and tomatoes, or the differences in national yield factors for a specific crop.

The network of global trade is however quite complex and inter-meshed. Agricultural goods flowing out from a country is not necessarily grown within that country but may very well be re-exports of commodities which in turn come from several different sources, each that in turn have their respective sources, each with different national yield factors. Therefore, the method used here does not take Faostat yield data straight off from the shelf – which nevertheless would be unviable for countries (such as Singapore) trading in cropland commodities while lacking any domestic production thereof. Instead, the Faostat data on national production and yields for different commodities is combined with Comtrade-derived trade flow matrices on quantities for different agricultural goods.

The method is semi-recursive: it calculates modified yield factors for each country and each commodity, factors that subsequently can be used to convert outbound (exported) quantities

¹⁸⁵ It is however indeed Faostat national data on yields, production and area harvested that national yield factors used in EF accounts are calculated from (Wackernagel, 28th February 2005; personal email communication).

into the appropriated land-areas that each of these agricultural flows represents. These modified yield factors are thus the results of not only national production volumes and yield factors as given by Faostat data¹⁸⁶, but also by the production volumes and yield factors of viable national sources of these flows, balanced according to individual import profiles. For this task, I developed a simple java program¹⁸⁷ to calculate such modified national yield factors, using the following parameters and sources as input for each commodity type:

- Yield factors (tons/hectare) – Source: ProdSTAT (FAOSTAT database)
- Production data (tons) – Source: ProdSTAT (FAOSTAT database)
- Total inflow (tons) – Source: Comtrade (Column-sum of quantity flow matrices)
- Total outflow (tons) – Source: Comtrade (Row-sum of quantity flow matrices)
- Trade flow matrix (tons) – Source: Comtrade

Depending on the relational magnitudes of imports, production and exports (see Table 8.2), the algorithm calculates adjusted yield factors to use when converting national exports to footprints.

Profile type¹⁸⁸	Magnitudal relations between imports, production, and exports	Assumption on composition of exported commodities	Yield factors to be used on national outbound flows
LMH	Imports < Production < Exports	Unclear scenario	Mean national yield
LHM	Imports < Exports < Production	Large national production: exports probably constitute internally produced goods.	National yield (If unavailable: Mean national yield)
MHL	Exports < Imports < Production	Large national production: exports probably constitute internally produced goods.	National yield (If unavailable: Mean national yield)
HML	Exports < Production < Imports	Although imports are higher than internal production, exports are assumed to contain internally produced goods rather than re-exports.	National yield (If unavailable: import-based yield estimate)
HLM	Production < Exports < Imports	Imports are higher than production, thus exports are assumed to be re-exports of imported goods.	Import-based yield estimates.
MLH	Production < Imports < Exports	Unclear scenario: exports are higher than imports, which in turn are higher than local production.	Mean national yield

Table 8.2: Conditions for estimating national yield factors for outbound flows of agricultural products.

In certain situations, the magnitudes between imports, internal production, and exports make it difficult to ascertain the actual source of agricultural exports from a country. When exports

¹⁸⁶ Similar to the Comtrade database, Faostat data is given on an annual basis, and identical to how Comtrade trade flow matrices are generated in this thesis, all Faostat data used in this thesis are average values for the 1995-99 period.

¹⁸⁷ The source code for this Java program can be found at <http://www.demesta.com/phdthesis/>

¹⁸⁸ L=Large, M=Medium, S=Small. First letter: imports, second letter: production, third letter: exports. Example: LHM means that internal production volumes are higher than exports, and that exports are higher than imports: exports thus most probably contain goods produced within the country. HLM means that internal production is lower than exports, and that imports are higher than exports – exports are here assumed to be re-exported imports.

are higher than either internal production or imports, it is difficult to say whether the exports contain goods produced internally or previously imported. In these cases, the mean national yield factor¹⁸⁹ for this particular commodity is used to convert exported quantities from a nation into footprints.

If national production of a commodity is higher than imports and exports (profile-types LHM and MHL), respectively, we assume that exported commodities are produced within the national economy, thus using the national yield factors as supplied by FAOSTAT. If national yield factors are missing for the specific commodity and country, the mean national yield factor is used instead. When imports are higher than internal production, the latter higher than exports – the HML profile type – it is also assumed that the exports consist of national produce: national yield factors are thus used here as well. (If national yield data is non-existent, import-based yield factors are used: see below).

In the HLM profile type - when exports are higher than production, and imports are higher than exports – it is assumed that exports in effect are re-exported imports. Thus, even though national yield data might exist for this country and commodity, the yield factor used for converting exports are calculated based on the magnitudes and yield factors of all imports of the commodity to the country in question. However, as these imports that supposedly make up the exports of a nation may, in turn, have yield factors that are import-based, the principal objective of the algorithm developed and deployed here is to backtrack all such flows in order to arrive at yield factors which seem most plausible. As a demonstration, we now turn to how such modified, import-based yield factors for the wheat commodity are calculated.

Calculating “embedded areas” of wheat exports from El Salvador

At the 4-digit level of the Comtrade database, there are two categories for wheat: Durum wheat, unmilled (SITC 0411), and Other wheat (including spelt) and meslin, unmilled (SITC 0412), the total trade flows of the latter being more than twice as large as that of the former. In the Faostat database, however, data on production, yields and area harvested are for wheat in general. Instead of choosing either of the two Comtrade wheat categories at the 4-digit level, these two flow matrices are added together, resulting in an aggregated SITC 041n trade flow matrix that is used when calculating modified yield factors for wheat. Due to the usage of different nomenclatures in Comtrade vis-à-vis FAOSTAT, we will do similar mergings and approximations in what follows when selecting the commodities used in this chapter.

Of the 100 countries in the R-set, 71 countries are exporters of wheat, countries whose yield factors we thus need to estimate. With 64 of these countries representing LHM, MHL, or HML profile types (see Table 8.2), national wheat yield data from Faostat are used for these countries. Seven countries remain – El Salvador, Ghana, Honduras, Hong Kong, Malaysia, Panama, and Singapore – for which import-based yield factors are calculated: below, the first of these countries are used to exemplify the algorithm.

With four import sources and one export destination, the trade flows of wheat from and to El Salvador are given in Figure 8.4 below. From Comtrade, we find four inbound flows of wheat to El Salvador (SLV) – Canada, France, Italy, and USA – each supplying El Salvador with the quantities as indicated below. With production of wheat in these four countries being larger than their exports, we use national yield data for wheat to calculate the appropriated

¹⁸⁹ N.b.: not the mean yield but the mean national yield! That is: the mean value of all available national yield factors, intended to reflect the randomness of the actual source.

area represented by each of these flows. By summing up total imports of wheat – measured in quantities and appropriated areas – we calculate the import-based yield factor of El Salvador by dividing the former with the latter – see dashed box in Figure 8.4 below. This yield factor, reconstructed based on the properties of the wheat imports to El Salvador, are subsequently used to convert the outbound trade flows from El Salvador, from quantities into appropriated areas. The embedded yield factor of the wheat flows exported by El Salvador (here being its import-based yield factor) is therefore estimated at 2.628 tons per hectare, implying that the 1108 tons of wheat from El Salvador to Guatemala is estimated at representing a transfer of 422 hectares.

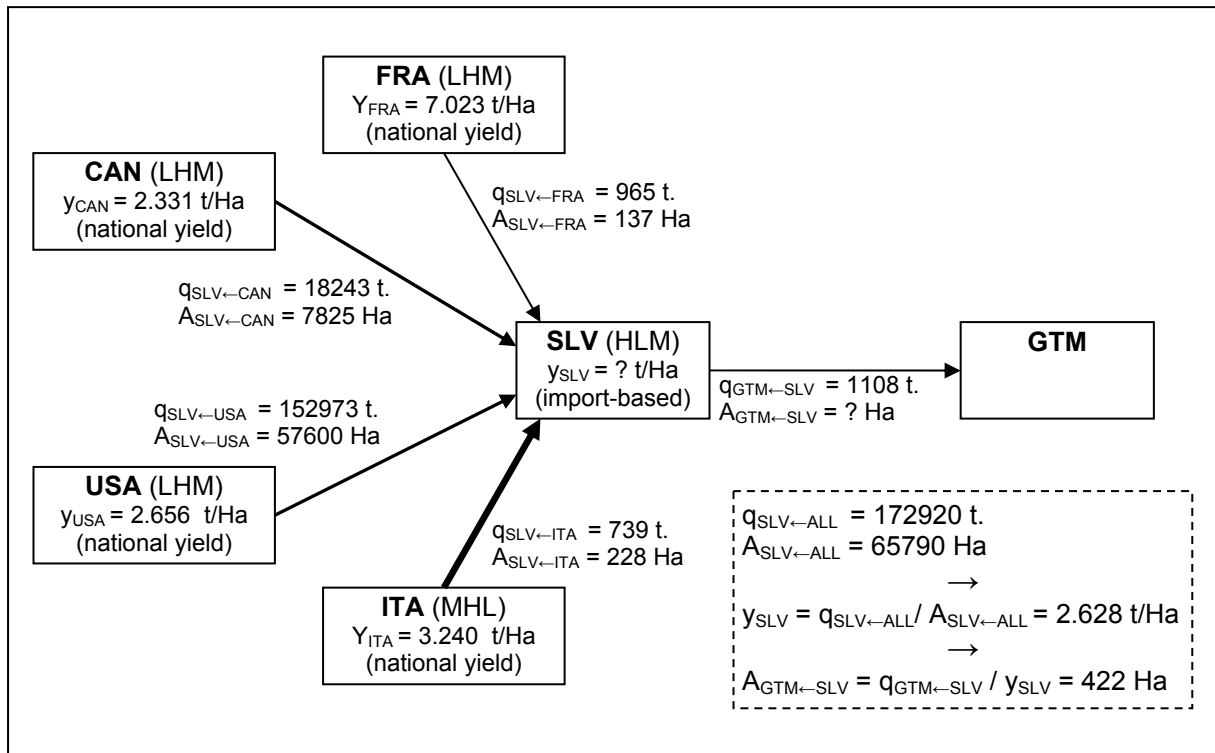

Figure 8.4: Calculating import-based yield factors, exemplified by wheat trade from and to El Salvador.

While the example in Figure 8.4 is a trivial case when import-based yield factors are to be estimated, the calculation procedure for Singapore is somewhat more complex. With five out of the six sources of Singaporean wheat imports coming from countries deemed as producing their exports, wheat exported from Malaysia to Singapore is deemed as, similar to exports from Singapore, being import-based. Thus, the algorithm first calculates a modified yield factor for the wheat exports from Malaysia, subsequently doing the same for Singaporean outflows of wheat (of which the Philippines is the major importer of wheat from Singapore).

As the network of world trade in wheat is relatively non-complex, with only six countries having yield factors calculated based on import flows, the semi-recursive¹⁹⁰ algorithm has no problems in identifying and calculating import-based yield factors as above. However, for several other commodity trade networks – such as rice, soybeans, maize, bananas etc – the algorithm runs into several loop-backs which has to be sorted out manually, in essence allowing the program operator to break such deadlocks by using estimated yield factors for

¹⁹⁰ Technically speaking, the Java algorithm is implemented using a series of repetitive iterations, without using recursive functions. The algorithm does however work in a similar manner as a recursive function, backtracking and “climbing down” a structure in order to arrive at a solution.

already-resolved countries. For all cases where such deadlocks did occur, both the percentual share and absolute volumes of quantities for discarded inbound trade flows were less than one percent of total trade flow quantities used to estimate import-based yield factors.¹⁹¹ Worth noting is that this discarding of insignificant trade flows to break these deadlocks only applies for estimating outbound yield factors, i.e. no intra-R-set trade flows are removed from the subsequent analyses.

The results of the algorithm above consist of (column) vectors for each commodity type, containing yield factor estimations for each R-set country. Subsequently, these vectors are used to convert trade flow matrices of agricultural goods, measured in tons, into flow matrices of actual appropriated land areas, the non-monetary unit used in this chapter to conceptualize and address issues of ecological unequal exchange.

The algorithm presented above has some major shortcomings. First, the set of conditions that determine what type of yield factor to use (see Table 8.2 above) are somewhat blunt: the relative magnitudes of the differences between imports, internal production, and exports are not taken into account in this algorithm. While not done here, it should be easy to complement the algorithm so that outbound yield factor estimations build on a balanced mix between Faostat national yield data and yields as incorporated in import flows^{192,193}. Such a modification would inevitable lead to more lock-ins that, secondly, would underline the need for a mathematically more coherent (and elegant) solution to such lock-ins (using linear system algebra). While the ambition of the algorithm is to generate plausible national yield factors that can be used to map concrete transfers of appropriated areas, the algorithm will hopefully be scrutinized and improved further.

Finally, it is worth pointing out once again that this alternative heuristic has an equally weak relation to sustainability as the official version: excluding agricultural inputs and land management techniques, the area-based unit of accounting presented here is similarly only concerned with what comes out of the toothpaste tube. However, I do argue that this method is more suitable for measuring the third Ricardian production factor as interpreted in its most original form – land – and how the productivity thereof is distributed among the national sub-entities that constitute the world-ecology.

Selecting the agricultural commodities to include

In the previous chapter, the choice of fuel commodities to include was based on their respective significance of total traded volumes and the possibilities to convert trade flow quantities to energy-content. The exchange value of the four fuel commodities selected in this previous chapter represented 75 percent of total fuel commodity trade, while also being easily converted to their non-monetary counterpart using static conversion factors. In this chapter,

¹⁹¹ The algorithm could be developed further, attempting to solve such deadlocks using linear algebra. However, the would-be reduction of calculation errors would not be significant, especially since the algorithm itself can be criticized on other grounds – especially how the different profile types determine what type of yield factor is to be used, instead of weighting different yield factor approaches according to relational differences between imports, internal production, and exports.

¹⁹² In the EF methodology (2004), the conversion factor for converting exports of secondary (post-primary) products into land areas is done by weighting of imports and domestically produced (see 2004:15; 3rd formula).

¹⁹³ In 2009-2010, I conducted an analysis of Sweden's domestic and international land appropriation for the Swedish Environmental Protection Agency. In this analysis, the algorithm was developed further: instead of using the various profile types concerned with imports, domestic production and exports (see Table 8.2), the modified algorithm treated all export flows as a weighted mix between imports and domestically produced crops. As the focus was solely on Sweden, the problems with circular flows was quite manageable.

the selection and non-monetary conversion of agricultural goods is not as straightforward. Instead of using static conversion factors, the algorithm above facilitates nation-specific conversion factors for each agricultural good. This, however, implies that we need to combine Comtrade trade flow data with yield data based on Faostat data, two different databases using slightly different nomenclatures for classifying goods. For example, as was seen in the section above, wheat is a single commodity in Faostat data, while Comtrade has two separate wheat commodities at the 4-digit SITC level: durum wheat (SITC 0411), and other wheat etc (SITC 0412). We thus need to map the two nomenclatures with each other, where data availability in respective database and the possibility and viability to combine the different classification schemes eventually will determine the selection of commodities to include in our analysis. With respect to wheat, the solution is simply to aggregate the two wheat commodity classes into a new aggregated commodity class (SITC 041x). As will become evident below, the viable solution for certain commodity classes can be somewhat more complicated – at times, we will depart from the 4-digit SITC level, instead resorting to Comtrade data at the 5-digit SITC level.

The Faostat database (ProdSTAT) contains data on production quantities for 176 different commodities, complemented with data on yields and harvested areas for 149 of these commodities. In Table 8.3 below, total world production quantities and area harvested for the top 25 commodities can be found, with mean annual values for the 1995-99 period.

A. Production quantity (annual mean, 1995-1999)		B. Area harvested (annual mean, 1995-1999)	
Commodity	Mean (tons)	Commodity	Mean (Ha)
Sugar cane	1 234 048 366	Wheat	220 587 605
Wheat	584 528 993	Rice, paddy	151 937 359
Maize	583 196 585	Maize	139 675 759
Rice, paddy	576 754 610	Soybeans	66 715 591
Alfalfa for forage and silage	488 396 876	Barley	61 488 327
Maize for forage and silage	424 419 820	Sorghum	43 698 439
Potatoes	300 593 487	Millet	36 138 417
Sugar beet	264 602 716	Seed cotton	34 037 006
Vegetables, nec	177 287 600	Cotton lint	34 037 006
Cassava	163 682 482	Cottonseed	34 030 327
Soybeans	143 911 833	Beans, dry	25 298 698
Barley	143 390 177	Rapeseed	24 464 293
Sweet potatoes	136 111 853	Groundnuts, with shell	22 610 224
<i>Beer of Barley*</i>	<i>125 580 186</i>	Sunflower seed	21 013 336
Oil palm fruit	98 748 462	Sugar cane	19 163 856
Tomatoes	95 030 057	Potatoes	18 850 458
<i>Cane sugar, raw, centrifugal*</i>	<i>93 147 249</i>	Maize for forage and silage	17 616 358
Clover for forage and silage	87 876 590	Cassava	16 440 307
Oranges	62 203 916	Alfalfa for forage and silage	16 086 959
Sorghum	61 396 462	Oats	15 165 429
Rye grass for forage & silage	60 966 750	Vegetables, nec	12 935 589
Bananas	59 690 493	Chick peas	11 470 279
Grapes	58 283 120	Coconuts	10 998 650
Watermelons	56 542 754	Rye	10 403 459
Apples	55 740 172	Coffee, green	9 977 240

Table 8.3: World total production and area harvested of the top 20 agricultural commodities. (Source: Faostat ProdSTAT database)

*: As these commodities are semi-processed agricultural goods, there are no data on yields and area harvested for these commodities in the ProdSTAT database.

Measured in total world production quantities, sugar cane production clearly dominates total world output, being more than twice as large as wheat. However, when looking at area

harvested, wheat is at the top of the list while sugar cane production covers less than a tenth of the area used for growing wheat. This reflects the truly extra-ordinary yield factor of sugar cane production; being one of the most efficient photosynthesizers, sugar cane converts up to 2 percent of inbound solar energy to biomass.

A handful of commodities can be found at the top of both lists in Table 8.3 above, particularly wheat, rice, and maize, and with soybeans, barley, sorghum, potatoes, cassava and forage maize/alfalfa also being prominent in both listings. Similar to sugar cane, there are several commodities with disparate rankings with respect to produced quantities and area harvested. Millet, being the 7th largest crop with respect to area harvested, is to be found on the 38th spot when it comes to production quantities. Ranked as the 25th largest commodity with respect to area harvested, green coffee is at place 78 in terms of produced quantities. Being the commodity with the eighth largest production quantities, sugar beet is found at position 33 when it comes to total area harvested. These discrepancies reflect the differences in average yield factors for different cropland commodities, further underlining the importance of treating these commodities separately instead of aggregating them into broader product groups as is done in the official GFN methodology.

In this thesis, the significance of a cropland commodity is however not primarily based on total production quantities or area harvested, but more importantly the net transfer of such bioproductive areas between the nations of the world. Complementing the production and yield data found in ProdSTAT, Faostat also compiles aggregate trade data in their TradeSTAT database, covering 502 different primary and semi-processed agricultural commodities. In Table 8.4 below, 30 agricultural cropland commodities are sorted by (decreasing) total traded quantities in the world, data obtained from the TradeSTAT database¹⁹⁴. This data is complemented by a column with total traded harvested areas for each commodity, calculated using the global average yield factors obtained from the ProdSTAT database. As the TradeSTAT database contains more commodities than is to be found in ProdSTAT database, a handful of commodities in Table 8.4 lack estimates on total traded hectares.

Although wheat and maize are at the top of both lists in Table 8.3, there are some differences between top-produced and top-traded commodities (Table 8.4). Sugar cane, topping world total production, is found way below the scope of Table 8.4, ranked as the 338th largest agricultural good traded, corresponding to a meager net transfer of 835 hectares. Evidently, it is not sugar cane that is traded among the nations of the world, but rather refined products thereof. With traded quantities being approximately a sixth of the top traded commodity wheat, “Sugar raw centrifugal, Sugar and Syrups nec” is the fifth largest commodity traded, representing refined products of sugar cane as well as sugar beet. Similarly, while soybean is the third largest commodity traded, its refined sibling category – soybean cake – is traded in slightly less quantities at rank four in Table 8.4. As soybean cake is a derivative of soybeans, it is easier to convert this agricultural commodity into its soybean-equivalent, a type of conversion that is not as trivial, and which would entail more assumptions, for refined sugar commodities that could originate from either sugar cane or sugar beet.¹⁹⁵

¹⁹⁴ While total global imports also can be obtained from Comtrade, TradeSTAT is used here as its classification nomenclature has a better overlap with the ProdSTAT database and its yield factors.

¹⁹⁵ How many hectares of sugar cane does the trade in raw sugar correspond to? Assuming that all of the traded 21.9 million tons of raw centrifugal sugar originates from sugar cane, this corresponds to 175.1-197.0 million tons of sugar cane (as one ton of raw sugar corresponds to 8-9 tons of sugar cane). With an average global sugar cane yield of 64.39 tons per hectare, the 21.9 million tons of traded raw centrifugal sugar in Table 8.4

Commodity	Total world imports (tons)	Mean world yields (kg/ha)	Total traded areas (ha)
Wheat	120 738 426	2 650	45 559 607
Maize	76 741 312	4 173	18 388 041
Soybeans	38 484 252	2 153	17 872 287
<i>Cake of Soybeans*</i>	35 635 756		
<i>Sugar raw centrifugal, Sugar and Syrups nec*</i>	21 885 072		
Barley	21 248 206	2 340	9 080 523
<i>Waters, Ice Etc*</i>	18 081 884		
<i>Rice, Milled*</i>	15 877 076		
Bananas	13 297 046	15 522	856 680
<i>Sugar, refined*</i>	12 559 456		
<i>Crude Materials*</i>	11 084 684		
<i>Palm oil*</i>	9 805 034		
<i>Flour of Wheat*</i>	8 945 812		
<i>Molasses*</i>	8 506 220		
<i>Food Wastes*</i>	7 875 454		
Potatoes	7 493 896	15 952	469 768
Sorghum	7 060 222	1 404	5 030 382
Rapeseed	7 004 932	1 457	4 806 689
<i>Soybean oil*</i>	6 643 066		
<i>Beer of Barley*</i>	6 241 918		
<i>Food Prep nes*</i>	6 103 368		
Cotton lint	5 496 552	553	9 932 977
<i>Wine*</i>	5 488 744		
<i>Chicken meat*</i>	5 010 596		
Apples	4 919 988	9 293	529 451
Coffee, green	4 793 586	624	7 679 912
<i>Beverage Non-Alc*</i>	4 773 338		
<i>Rubber Nat Dry*</i>	4 710 952		
<i>Malt*</i>	4 698 366		
<i>Gluten Feed&Meal*</i>	4 497 598		

Table 8.4: World total trade (imports) and their corresponding areas of the top 30 agricultural commodities. (Source: Faostat ProdSTAT and TradeSTAT databases)

*: As these commodities are semi-processed agricultural goods, there are no data on yields and area harvested for these commodities in the ProdSTAT database.

Four criteria are used in the selection of commodities to include in this thesis. The first criteria concerns data availability: not only should selected commodities be found in both the Faostat ProdSTAT and Comtrade databases, but also the mapping and combination of their respective nomenclatures have to be theoretically viable. For instance, transforming trade flows of soybean cake into soybean equivalents is theoretically more viable than a similar transformation of refined sugar into the two primary commodities of sugar cane and sugar beet. Secondly, selection is based on their significance in production and, more importantly, the quantities and corresponding areas traded between the nations of the world. The third criteria is based on statistical coverage: that total intra R-set trade flows ($R \leftarrow R$) represent a significant share of total trade, with respect to aggregate world trade found in TradeSTAT as well as the Comtrade world-posts ($R \leftarrow WLD$). The last criteria for selecting agricultural commodities is concerned with theoretical importance from a more intuitive and historical point of view. There are several classical colonial agricultural commodities that often raise a lot of interest among world-system scholars, such as coffee, cocoa, spices, sugar, fruit etc,

corresponds to 2.7-3.1 million hectares of sugar cane cropland, a reasonable amount that still only is a fraction of the traded hectares of wheat, maize and soybean, and an even less fraction of the 105 million traded hectares covered in this chapter.

cash crops that either constitute a large share of exported agricultural goods, or are deemed as structurally important, for several countries.

The selection of commodities to include in this study are given in Table 8.5 below, a selection covering 23 commodities found in TradeSTAT and ProdSTAT, and trade flow matrices for 26 different commodities in the Comtrade database. With total world imports of these 26 commodities to the R-set countries amounting to 77 percent of total reported trade in TradeSTAT, coverage is not complete of these commodities but hopefully adequate to depict a reasonably correct image of their net transfers of appropriated land areas. TradeSTAT import data covers 502 different commodities totaling a quantity of 758 million tons, the absolute majority of these commodities though being refined and processed primary goods, such as the italicized commodities in Table 8.4 above. The distinction between raw and post-harvest processed agricultural goods may indeed be delicate at times - although stemmed tobacco, soybean cake, husked rice and dried legumes can be seen as processed primary goods, these goods are nevertheless included while flour of wheat, roasted coffee and orange juice are missing, all based on the four selection criteria stated above.

Faostat data (TradeSTAT and ProdSTAT)			Comtrade data			Class conversion factor
	Total import [tonnes]	Mean yield [kg/ha]	Commodity code (4-digit SITC)	R←WLD [tonnes]	R←R (% of total imports) [tonnes]	
Wheat	120 738 426	2 650	(0411+0412) (0411) (0412)	86 734 559 24 121 195 62 613 364	82 842 494 (69%) 23 625 505 59 216 989	
Maize	76 741 312	4 173	(0441+0449) (0441) (0449)	63 114 951 2 426 863 60 688 087	62 677 157 (82%) 2 375 971 60 301 186	
Barley	21 248 206	2 340	(0430)	17 723 964	16 394 382 (77%)	
Bananas	13 297 046	15 522	(0573)	13 102 957	12 151 774 (91%)	
Potatoes	7 493 896	15 952	(0541)	7 327 204	7 089 108 (95%)	
Sorghum	7 060 222	1 404	(0453)	6 470 703	6 463 470 (92%)	
Apples	4 919 988	9 293	(0574)	4 506 716	4 344 342 (88%)	
Coffee, green	4 793 586	624	(0711)	4 639 660	3 710 354 (77%)	
Oranges	4 408 784	16 856	(0571)	6 504 112		
Tangerines, etc.	2 130 182	11 142	(05711)	4 341 390	3 815 269 (87%)	
Cocoa beans	2 088 180	479	(05712)	2 114 757	1 847 402 (87%)	
Sunflower seed	2 088 180	479	(0721)	2 136 939	910 322 (44%)	
Sunflower seed	4 131 332	1 226	(2224)	3 918 252	3 039 552 (74%)	
Tobacco, raw	2 063 348	1 590	(1211+1212) (1211) (1212) (1213)*	1 638 977 580 749 1 058 227 246 189	1 449 230 (70%) 488 528 960 702	
Soybeans	38 484 252	2 153	(2222) (0813)	33 530 578 43 850 712	33 445 627 (87%)	
<i>Cake of Soybeans</i>	35 635 756		(08131)	31 299 501	31 202 504 (88%)	1/0.60 (~1.667)
Rice, paddy	2 178 428	3 795	(0421)	2 016 423	1 959 924 (90%)	
Rice Husked	2 131 600		(0422)	1 664 747	1 505 366 (71%)	1/0.78 (~1.282)
Rice, Milled	15 877 076		(0423)	12 215 786	10 246 725 (65%)	1/0.78 (~1.282)
Peas, dry	3 141 058	1 638	(0542)* (05421)	6 568 871 2 859 104	2 578 478 (82%)	
Chick peas	566 140	765	(05422)	487 114	419 810 (74%)	
Beans, dry	2 170 234	663	(05423)	1 743 924	1 476 455 (68%)	
Lentils	856 692	814	(05424)	721 583	645 589 (75%)	
Broad/horse beans, dry	472 254	1 553	(05425) (05429)*	419 154 407 403	405 703 (86%)	
Total world Imports (TradeSTAT):	379 166 964		Total commodity flows covered (Comtrade):		290 621 037 (77% of total imp.)	

Table 8.5: Commodities included in this analysis

As previously mentioned, the wheat trade flow matrix used here is the sum of the two 4-digit SITC categories 0411 and 0412. The total national imports and exports found in this aggregate wheat matrix, in combination with ProdSTAT data on production and yields, are used as input to the previously presented algorithm in the calculation of yield factors of outbound trade flows. The same procedure applies to Maize: here we find two 4-digit SITC categories – 0441 and 0449 – that we aggregate into a maize trade flow matrix prior to yield factor estimations and subsequent network analysis.

For a number of cropland-based commodities in Table 8.5, the mapping between the nomenclatures are straightforward: unmilled barley, bananas, potatoes, sorghum grain, apples, green coffee, cocoa beans, and sunflower seed all have corresponding commodity classes in the nomenclatures of ProdSTAT and Comtrade. Coverage is overall fairly good for these commodities, except for cocoa beans where intra R-set trade only covers 44 percent of total world imports reported in TradeSTAT, this due to Côte d’Ivoire, the largest producer and exporter of cocoa beans, is excluded from the R-set of countries. In the online Comtrade version, 1995-99 data does exist for Côte d’Ivoire, but as an inclusion of this country into the R-set also would imply an inclusion of exports and imports of all other selected commodities for this country, the results of such an effort would nevertheless have a very small impact on the overall analytical results. Instead of merging Côte d’Ivoire into the R-set, and instead of excluding cocoa beans altogether, the available intra-R-set trade of cocoa beans will be used in the analysis, being aware of the low coverage of this commodity and its corresponding lack of net transfers of appropriated cropland.¹⁹⁶

For tobacco, we find two corresponding 4-digit SITC categories, differing in whether the stems on the tobacco leaves have been removed or not. Removing the stems does reduce the weight of tobacco leaves, but this reduction in weight are ignored here, instead creating an aggregate tobacco trade flow matrix combining SITC categories 1211 and 1212. Tobacco refuse, SITC 1213, is ignored altogether – and so are the more significant trade flows of cigars, cigarettes and similar (SITC 1221, 1222 and 1223) which are deemed as manufactured products.

At the 4-digit SITC level, we find a category for Oranges, etc (SITC 0571), with sub-categories for Oranges, fresh or dried (SITC 05711), and Mandarins (including tangerines and satsumas); clementines, wilkings and similar citrus hybrids, fresh or dried (SITC 05712), containing quantities amounting to 67 and 33 percent, respectively, of their common parent 4-digit SITC category. An identical categorical division with the same distributional percentages is found in the ProdSTAT database, although with different yield factors: 16.9 tons per hectare for oranges, and 11.1 tons per hectare for tangerines, mandarins, clementines and similar orange-type commodities. If we use the 4-digit SITC category (0571) from the Comtrade database, we would have to aggregate these two commodity categories in the ProdSTAT database in order to arrive at combined production and yield factors, which would be somewhat problematic as their respective yield factors differ. Although oranges, mandarines, clementines and similar represent a fairly small share of total world trade in

¹⁹⁶ As trade flows from and to Côte d’Ivoire are excluded from the analysis, Sweden has no cocoa bean imports while being a (net) exporter of 63 tons of cocoa beans, valued at 74 kUSD and corresponding to a 129 hectare cocoa bean footprint. The lack of trade data from and to Côte d’Ivoire, and the significance of this particular net outflow of cocoa beans from Sweden, are however quite insignificant in the total flow matrices containing values (V_{Agri}) and cropland areas (L_{Agri}) for all commodities. In comparison to total outflows, the cocoa bean exports from Sweden only accounts for 0.07 percent of the value, and 0.11 percent of the footprint, of its total exports.

selected agricultural goods, making it viable to exclude oranges altogether from the analysis, I have instead chosen to debark from the principle of remaining at the 4-digit SITC level. Instead, we will create separate trade flow matrices for these two Comtrade commodity groups, treating oranges (SITC 05711) and similar orange-related commodities (SITC 05712) as two separate goods, utilizing their respective production and yield data from the ProdSTAT database.¹⁹⁷

Similarly, we find “Legumes, dried, shelled” at the 4-digit SITC level (SITC 0542), with dried peas, chickpeas, beans, lentils and other non-specific varieties at the 5-digit SITC level (SITC 0542x). Faostat states these varieties separately, with yield factors varying from 663 to 1638 kg per hectare, thus making it problematic to clump these together in order to remain at a 4-digit SITC level in Comtrade. Instead, similar to above, the 5-digit SITC level is used here in order to include peas, beans, chickpeas, broad beans (and horse beans), and lentils to the analysis.

Soybeans have distinct categories in Faostat as well as Comtrade (SITC 2222), making it easy to convert the trade flows of this very significant commodity to transfers of cropland. Following soybeans in the list of total traded commodities (Table 8.4) is cake of soybeans, whose total traded quantities are almost at parity with raw soybeans. As soybean cake is a refined product of soybeans, production and yield data in ProdSTAT is only available for soybean. In Comtrade, there is a 4-digit SITC commodity category named “Oilcake, oilseed residue” (SITC 0813), with “Oilcake and other solid residues of oil from soya beans” (SITC 08131) being one of nine commodities at the 5-digit SITC level and corresponding to 71 percent of the total quantities of its parent 4-digit SITC commodity category. To treat the whole SITC 0813 category as soybeans would be misleading as the average yield factors of the various sub-commodities varies significantly, adding to the dilemma that these different 5-digit SITC commodities represent processed primary goods that are unaccounted for in the ProdSTAT database. Excluding soybean cake would however be precarious as it indeed is a significant agricultural commodity in world trade.

In order to integrate soybean cake in our trade flow analysis, we first have to depart once again from the 4-digit SITC principle, instead using the specific soybean cake category (SITC 08131). The oil and protein found in soybean cake typically accounts for approximately 60 percent of the dry weight of soybean, information we can use to convert soybean cake into soybean-equivalents simply by dividing all trade flow quantities of soybean cake with 0.6. Once converted, we can aggregate the soybean commodity category (SITC 2222) with the modified soybean category (SITC 08131), allowing us to treat trade flows of soybean and soybean cake as net transfers of land appropriated for soybean production.

A similar procedure has to be done for trade flows in rice, the final commodity chosen for this analysis. With yield data for paddy rice available in ProdSTAT, the corresponding Comtrade category (SITC 0421) is quite small compared to trade flow quantities of milled and semi-milled rice (SITC 0423), furthermore not including husked rice (SITC 0422) - obviously, the removal of rice husks is the typical post-harvest procedure to paddy rice prior to would-be exports. The weight of the husk typically accounts for 22 percent of the weight of paddy rice, making it possible to convert trade flows of husked rice (SITC 0422) and

¹⁹⁷ On a side note, orange juice (SITC 0591) is a significant world trade commodity, with quantities about half of those for oranges. Deemed a manufactured good, similar to cigarettes vs tobacco, it is excluded from our analysis. Furthermore, converting quantities of orange juice to orange-equivalents is not trivial, as the trade statistics say nothing on whether this orange juice is concentrated or not.

milled/semi-milled rice (SITC 0423) into rice paddy-equivalents by dividing their trade flows with 0.78. Once converted, the three rice-equivalent commodity trade flow matrices are aggregated, ready to be converted into net flows of land appropriated for paddy rice growth.

Evidently, a number of commodities with apparent significance in production and trade are excluded from the analysis. Most significantly, “Sugar raw centrifugal, Sugar and Syrups nec” are missing in our analysis as we simply cannot say whether this originates from sugar cane or sugar beet. It should perhaps be possible to assume the source of traded raw and centrifugal sugar based on national production volumes of sugar cane and sugar beet, but I have nevertheless refrained from doing this as it would constitute a new type of assumption. Furthermore, there are several commodity categories in Comtrade, at the 4- and 5-digit SITC level, that reflects refined sugar cane and sugar beet, making their transformation into raw, unprocessed cane and beet even more intricate.

While yield and production data exists in ProdSTAT for rapeseed, it is combined with colza seed at the appropriate 5-digit SITC level in Comtrade. Rapeseed (*Brassica napus*) and colza seed (*Brassica capestris*) do belong to the same plant family, but as there is no ProdSTAT data on the latter, presumably not included in the rapeseed data in ProdSTAT, we have to exclude rapeseed altogether from the analysis. Spices play an important historical role in almost all accounts of the growth of the contemporary world system, but as the trade quantities and their corresponding areas are quite small, they are excluded in this analysis.

Combining the different trade flow quantity matrices with their respective yield factor vectors (and, in the case for rice and soybean, their static conversion factors), total net transfer matrices of cropland, quantities, and exchange value can be calculated (see below).

Mathematical procedure to obtain total land flow and total value matrices

Q_N : Square matrix containing trade flow quantities (in tons) for SITC commodity N .

Y_N : Square matrix with *inversed* yield factors (i.e. hectares/ton) on the diagonal for SITC commodity N .

L_N : Square matrix containing net transfers of appropriated land (in hectares) for SITC commodity N .

For most commodities, the calculation of net transfers of appropriated land is quite straightforward:

$$L_N = Q_N \times Y_N$$

where $N=0430, 0573, 0541, 0453, 0574, 0711, 05711, 05712, 0721, 2224, 05421, 05422, 05423, 05424, \text{ or } 05425$

For wheat, maize and tobacco, land-equivalents are calculated as follows:

$$L_{041x} = (Q_{0411} + Q_{0412}) \times Y_{041x}$$

$$L_{044x} = (Q_{0441} + Q_{0449}) \times Y_{044x}$$

$$L_{121x} = (Q_{1211} + Q_{1212}) \times Y_{121x}$$

For rice and soybean, a scalar factor is first applied to the appropriate flow matrices prior to calculating the net transfers of land:

$$L_{2222+08131} = (Q_{2222} + c_{\text{SoycakeToSoybean}} \cdot Q_{08131}) \times Y_{2222}$$

$$L_{042x} = (Q_{0421} + c_{\text{HuskedriceToPaddyrice}} \cdot (Q_{0422} + Q_{0423})) \times Y_{0421}$$

where $c_{\text{SoycakeToSoybean}} (=1/0.60)$ and $c_{\text{HuskedriceToPaddyrice}} (=1/0.78)$ are scalar factors for converting soycake and husked/milled rice, respectively, into their soybean and paddy rice equivalents

The total trade matrices of cropland (L_{Total}) and exchange value (V_{Total}), as well as quantities (Q_{Total}) are calculated by aggregation of the individual commodity matrices:

$$L_{\text{Agri}} = \sum L_N ; V_{\text{Agri}} = \sum V_N ; Q_{\text{Agri}} = \sum Q_N$$

The main focus of this chapter is to look at net transfers of economic exchange value and appropriated cropland of all selected commodities, i.e. the contents of the V_{Agri} and L_{Agri} matrices. Prior to this, we will look closer at the composition of commodities making up these total flow matrices. For simplicity, the 5 legume commodities are grouped into a common category, just as oranges (SITC 05711) and its smaller siblings (SITC 05712) are labeled as “Oranges, etc.” in Figure 8.5 below.

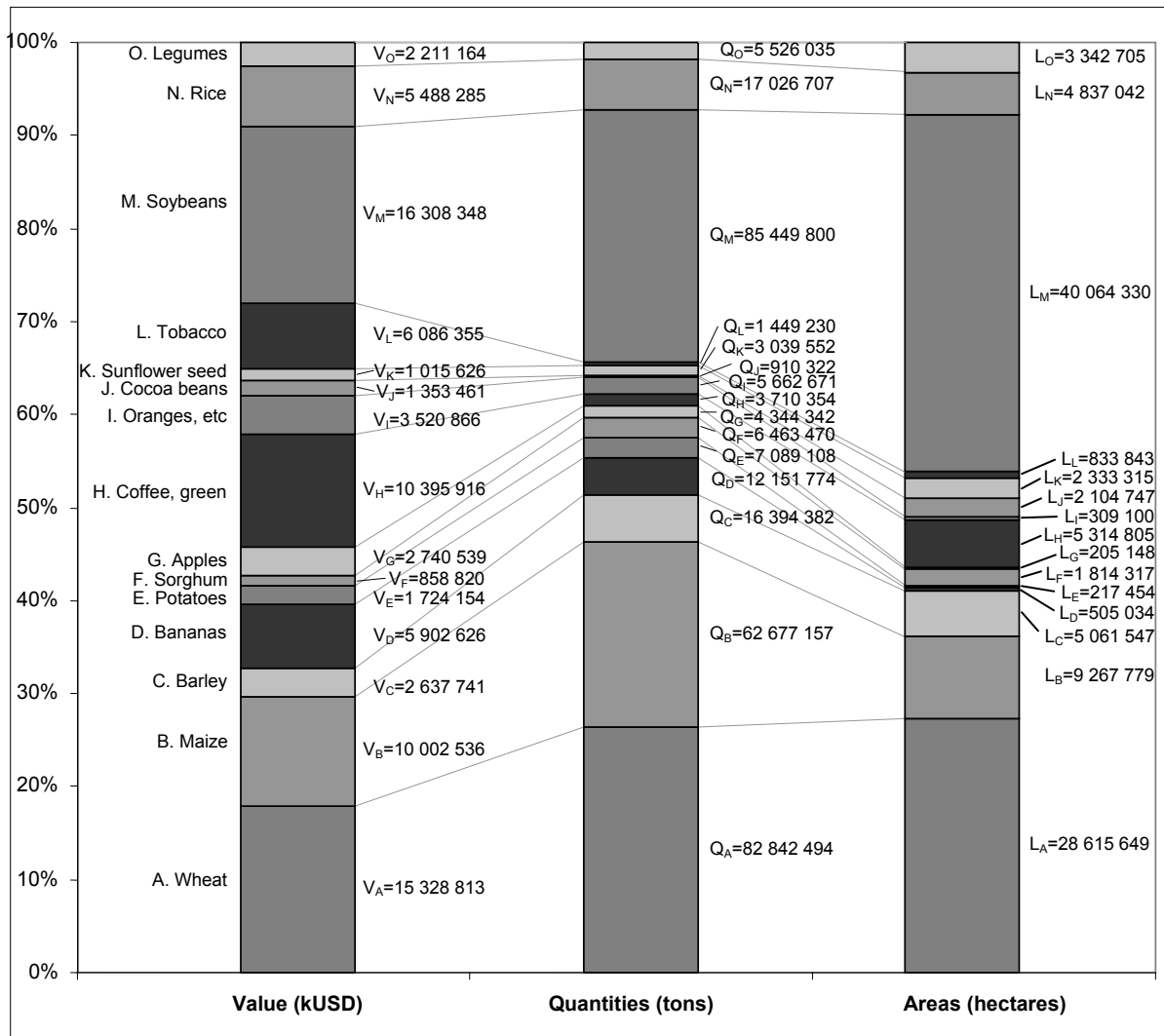

Figure 8.5: Composition of various commodities in the total flow matrices of exchange value, quantities, and appropriated land.

Wheat and soybeans are at approximately equal footing when it comes to total traded values and quantities respectively, each commodity representing 18-19 percent of value traded and 26-27 percent of traded quantities. As shares of total traded areas, soybean has a 13 percent larger share than wheat, the former commodity corresponding to 40 percent of total cropland exchanged between our 100 countries.

For oranges and bananas, the significance shares in total value, total quantities, and total areas represents an opposite trend. Slightly below the total value of traded maize, coffee is the 4th most valuable type of agricultural good analyzed here, corresponding to 12 percent of total traded values, but only accounting for, respectively 1 and 5 percent of total traded quantities and footprints. Tobacco, oranges and, to a lesser extent, apples are similarly

valuable goods, whose shares of total traded volumes are higher than their shares of total quantities and land areas.

The proportional differences in Figure 8.5 between the commodity compositions of total traded quantities vis-à-vis appropriated areas underline the importance of using yield factors on a per-commodity and per-nation basis. If we were to use global cropland factors, as is done on the Footprint/demand side of standard GFN accounts, we would in essence conduct a material flow analysis (MFA) of agricultural goods, albeit stated in (global) hectare units. The data in the L_{Agri} matrix analyzed below is different from mere quantities typecast in spatial, but nevertheless proportional, units.

Although the V_{Agri} and L_{Agri} matrices are the monetary and non-monetary datasets in this chapter, it should be noted that the individual commodity-specific V_N and L_N matrices can be subject to the same analyses as those that follows, either individually or combined in various ways. For instance, it would be interesting to compare the fundamental exchange structures of cereal commodities, predominantly grown in developed (high-income) countries, with traditional colonial goods such as bananas, coffee, fruit and tobacco – such analyses must however be postponed to forthcoming research projects.

Degree centrality: National flows of exchange value and appropriated areas

Using the V_{Agri} and L_{Agri} matrices, Table 8.6 contains the results of a Freeman-style degree centrality analysis, i.e. national trade balances for each country as measured in exchange value and bioproductive areas. A visual representation of the monetary and non-monetary net flows can be found in Figure 8.6 further down.

Import coverage for each country, i.e. aggregated reported import flows as share of total reported imports, is overall very good, with a national mean average at 90 percent. For Estonia, the analysis covers only 38 percent of its total import values for the selected commodities: while being a minor importer, the lack of reported imports of cocoa beans and barley from the non-reporting countries Côte d'Ivoire and Ukraine results in this low Estonian coverage. The import data coverage for Russia, at 69 percent, could be more problematic as its total imports are fairly large, though where Russian imports from the non-reporting country Kazakhstan is absent from the analysis.

Similar to what the case is for fuel commodity flows, the aggregate exports of Japan are infinitesimal compared to its imports, resulting in a top position in Table 8.6. With lower flow magnitudes, South Korea has a similar trade profile as Japan but where the average value per hectare exported of the latter is twice as large as that of South Korea. Not surprisingly, the agricultural goods consumed by these two countries are imported from abroad and are apparently final-destination goods.

With fuel commodity imports and exports for Holland vastly higher than its net flows of fuel value and energy content (see previous chapter), the same brokerage tendency is not as accentuated for Dutch trade in the agricultural commodities selected in this analysis. Instead, Spain and Indonesia seem to be agricultural brokers, with net value imports being significantly lower than their corresponding gross imports and export values. Looking at these trade flows as appropriated croplands, Spain and Indonesia are distinct net importers, with their exported areas being several times lower than its imports: their position as brokers with respect to trade values thus seems to pay off in net imports of appropriated land. This is

quite similar to fuel commodity net flows of value and energy content to Holland: with fuel commodity value exports only being slightly lower than corresponding imports, i.e. apparently acting as a trading gateway of fuel commodities into Europe, Holland is nevertheless a significant net importer of energy joules (see Table 7.5).

Country	Coverage	Exchange value [kUSD]			Appropriated areas [hectares]		
		Import	Export	Net	Import	Export	Net
JPN	97%	8 318 354	41 277	8 277 077	9 652 856	16 657	9 636 199
DEU	88%	6 974 514	2 226 658	4 747 856	5 079 716	2 214 772	2 864 944
KOR	97%	2 749 496	26 205	2 723 291	4 244 766	21 771	4 222 995
GBR	89%	3 746 911	1 082 432	2 664 479	2 872 803	866 933	2 005 869
ITA	90%	3 821 493	1 179 927	2 641 566	4 483 953	275 613	4 208 341
BEL	94%	3 407 902	1 056 864	2 351 038	3 105 997	714 113	2 391 884
NLD	86%	4 266 439	1 922 615	2 343 824	4 429 166	2 178 357	2 250 810
CHN	99%	2 914 881	1 312 601	1 602 280	5 993 924	1 497 371	4 496 553
EGY	97%	1 738 095	220 110	1 517 985	3 054 187	59 667	2 994 520
MEX	100%	2 527 957	1 019 305	1 508 652	3 764 717	754 989	3 009 728
ESP	93%	3 701 152	2 305 127	1 396 025	4 870 268	556 481	4 313 786
SAU	93%	1 387 842	53 063	1 334 779	2 188 100	55 639	2 132 461
DZA	89%	1 115 686	1 805	1 113 881	1 673 959	1 518	1 672 441
MYS	94%	1 200 143	97 016	1 103 127	2 259 295	133 675	2 125 620
PRT	93%	1 127 047	58 434	1 068 613	1 210 237	68 599	1 141 638
POL	86%	1 022 604	66 754	955 850	1 186 525	55 039	1 131 486
IDN	90%	1 900 801	1 165 532	735 269	3 629 069	1 005 808	2 623 261
SWE	97%	722 723	106 413	616 310	393 967	114 347	279 620
CHE	94%	688 436	104 857	583 579	361 659	64 114	297 545
HKG	99%	609 796	28 396	581 400	239 617	35 426	204 192
RUS	69%	1 022 584	497 219	525 365	788 526	2 339 092	-1 550 567
DNK	97%	825 140	308 182	516 958	1 464 740	273 628	1 191 112
PHL	88%	1 037 037	526 259	510 778	1 818 052	62 876	1 755 176
VEN	99%	617 592	133 194	484 398	1 075 041	126 697	948 343
AUT	92%	623 468	163 573	459 895	526 793	134 048	392 746
FIN	94%	462 604	23 854	438 750	238 426	40 356	198 070
BGD	95%	435 453	4 531	430 922	935 499	3 464	932 034
NOR	96%	422 665	38 972	383 693	306 019	104 675	201 345
TUN	92%	392 327	14 466	377 861	700 937	3 374	697 563
SGP	83%	409 028	35 950	373 078	325 273	52 265	273 007
CZE	91%	442 546	75 903	366 643	453 829	118 657	335 172
ISR	95%	507 419	182 451	324 968	744 417	18 440	725 978
NGA	99%	534 680	222 813	311 867	597 815	399 133	198 683
JOR	83%	288 312	3 402	284 910	645 611	1 063	644 548
LKA	97%	308 165	38 421	269 744	720 906	8 674	712 232
PAK	98%	567 046	300 881	266 165	1 443 904	393 919	1 049 985
IRL	95%	325 404	69 073	256 331	307 100	33 360	273 740
PER	98%	552 209	340 289	211 920	983 494	214 286	769 208
SEN	85%	198 704	39	198 665	236 425	71	236 355
TUR	89%	1 106 306	924 212	182 094	1 611 394	966 707	644 687
KWT	93%	175 971	58	175 913	243 539	7	243 532
YUG	87%	191 621	26 893	164 728	135 450	31 324	104 126
SVN	96%	151 122	9 909	141 213	175 679	4 800	170 879
BLR	62%	135 418	2 610	132 808	340 570	4 420	336 149
HRV	93%	162 197	33 287	128 910	132 120	35 439	96 681
SVK	89%	171 748	64 038	107 710	161 874	113 936	47 938
OMN	71%	103 178	338	102 840	190 269	371	189 898
SDN	98%	109 006	19 919	89 087	125 653	233 372	-107 718
TTO	94%	91 965	4 771	87 194	104 967	6 811	98 156
MUS	97%	81 729	734	80 995	115 181	683	114 498
GRC	97%	664 137	584 982	79 155	575 832	235 402	340 430

Country	Coverage [*]	Exchange value [kUSD]			Appropriated areas [hectares]		
		Import	Export	Net	Import	Export	Net
ARM	72%	46 351	1 081	45 270	69 590	1 349	68 240
LTU	83%	68 379	26 284	42 095	73 349	72 009	1 340
BRN	96%	42 477	591	41 886	40 362	954	39 408
MLT	93%	45 090	4 546	40 544	60 768	3 322	57 446
BEN	95%	39 060	607	38 453	52 046	796	51 249
ROM	94%	180 653	145 334	35 319	233 776	338 954	-105 178
ALB	90%	42 810	8 065	34 745	39 959	3 955	36 004
EST	38%	38 208	10 165	28 043	65 818	19 601	46 217
LVA	83%	34 029	7 184	26 845	34 335	12 943	21 392
BRB	86%	22 695	634	22 061	11 524	641	10 883
NER	71%	22 250	1 021	21 229	35 318	1 373	33 944
ISL	96%	19 768	346	19 422	13 004	439	12 566
AZE	50%	35 700	22 871	12 829	159 080	9 847	149 233
MAC	97%	9 461	194	9 267	14 372	46	14 327
CYP	92%	106 679	114 093	-7 414	195 212	14 274	180 938
HUN	89%	336 027	346 711	-10 684	519 528	511 698	7 830
TGO	90%	20 160	31 161	-11 001	35 939	27 958	7 981
NPL	-	0	14 404	-14 404	0	36 923	-36 923
KGZ	67%	27 290	45 609	-18 319	42 936	15 093	27 843
CHL	99%	400 626	420 065	-19 439	622 757	55 632	567 125
DMA	43%	606	26 483	-25 877	303	2 260	-1 957
MDG	89%	25 413	86 862	-61 449	35 760	143 657	-107 897
MDA	78%	14 114	106 256	-92 142	24 829	107 707	-82 878
NIC	97%	75 147	176 320	-101 173	74 333	77 767	-3 434
BOL	100%	60 395	178 665	-118 270	82 618	449 556	-366 939
TZA	85%	63 108	188 769	-125 661	103 540	166 980	-63 440
KEN	96%	156 744	324 642	-167 898	343 194	164 262	178 931
ZAF	95%	508 603	716 272	-207 669	1 014 162	515 283	498 879
NZL	92%	140 452	376 749	-236 297	145 298	28 325	116 973
SLV	100%	132 216	405 357	-273 141	188 957	177 756	11 201
URY	89%	62 163	343 259	-281 096	68 057	492 710	-424 653
UGA	92%	33 413	436 630	-403 217	38 087	256 170	-218 083
PAN	99%	88 682	494 631	-405 949	126 288	53 045	73 243
GHA	88%	68 693	477 108	-408 415	55 801	618 628	-562 826
PRY	99%	33 848	535 560	-501 712	37 339	949 728	-912 389
ZWE	87%	82 045	594 552	-512 507	127 754	153 446	-25 692
HND	96%	110 602	623 613	-513 011	122 938	210 199	-87 261
GTM	100%	128 836	1 061 743	-932 907	214 162	298 907	-84 745
THA	98%	722 123	1 783 801	-1 061 678	1 586 977	2 222 960	-635 983
CRI	99%	207 864	1 496 355	-1 288 491	351 612	286 682	64 931
ECU	98%	179 063	1 860 455	-1 681 392	295 174	657 977	-362 803
IND	83%	285 840	2 158 745	-1 872 905	786 884	5 235 056	-4 448 171
COL	100%	822 452	2 949 192	-2 126 740	1 373 712	853 908	519 804
FRA	81%	2 956 075	5 575 192	-2 619 117	3 917 445	3 726 974	190 472
AUS	70%	182 905	2 808 541	-2 625 636	137 969	6 811 027	-6 673 059
CAN	93%	1 351 253	4 373 630	-3 022 377	1 087 833	8 257 274	-7 169 441
ARG	98%	316 062	5 159 186	-4 843 124	220 361	13 478 541	-13 258 181
BRA	99%	1 800 563	7 300 921	-5 500 358	3 302 628	11 464 307	-8 161 679
USA	90%	6 369 204	23 028 181	-16 658 977	3 723 010	29 185 677	-25 462 667

Table 8.6: Net flows of selected agricultural commodities, between the set of 100 countries, as measured in exchange value and appropriated land, sorted by decreasing net exchange value flows.

*: Aggregate intra-R-set import values of all commodities as percentages of total world imports.

As evident in the scatterplot (Figure 8.6), the net flows of value and appropriated land are overall uni-directional: a net inflow of value typically corresponds to a net inflow of appropriated land, and vice versa. Russia is a notable exception: as a net importer of

agricultural goods as measured in exchange value, it is nevertheless a net exporter of cropland. France and Colombia are found in the opposite quadrant in Figure 8.6; having a positive monetary trade balance, i.e. with the value of exports exceeding that of imports, the foreign soil used by France is larger than the French soil appropriated by foreign consumers. On a per-capita basis (Figure 8.7), Cyprus, Denmark and Belgium are the largest net importers of agricultural cropland, the economic cost of the latter however being more than double that of Denmark. Cyprus has a positive trade value balance in agricultural goods, with export earnings corresponding to 10 USD per capita and a net per capita inflow of cropland of 2,416 square meters. The per-capita scatterplot in Figure 8.7 accentuates the distortions from the general tendency observed in the national net flow scatterplot (Figure 8.6): on a per-capita basis, Dominica and Costa Rica have the largest net value outflows at 359 and 353 US dollars per capita, though with their relatively small net transfers of cropland having different signs. Similar to Costa Rica (and Cyprus), Panama and New Zealand are both net importers of cropland while also having a positive trade value balance, i.e. earning more from their exports than what they spend on their imports.

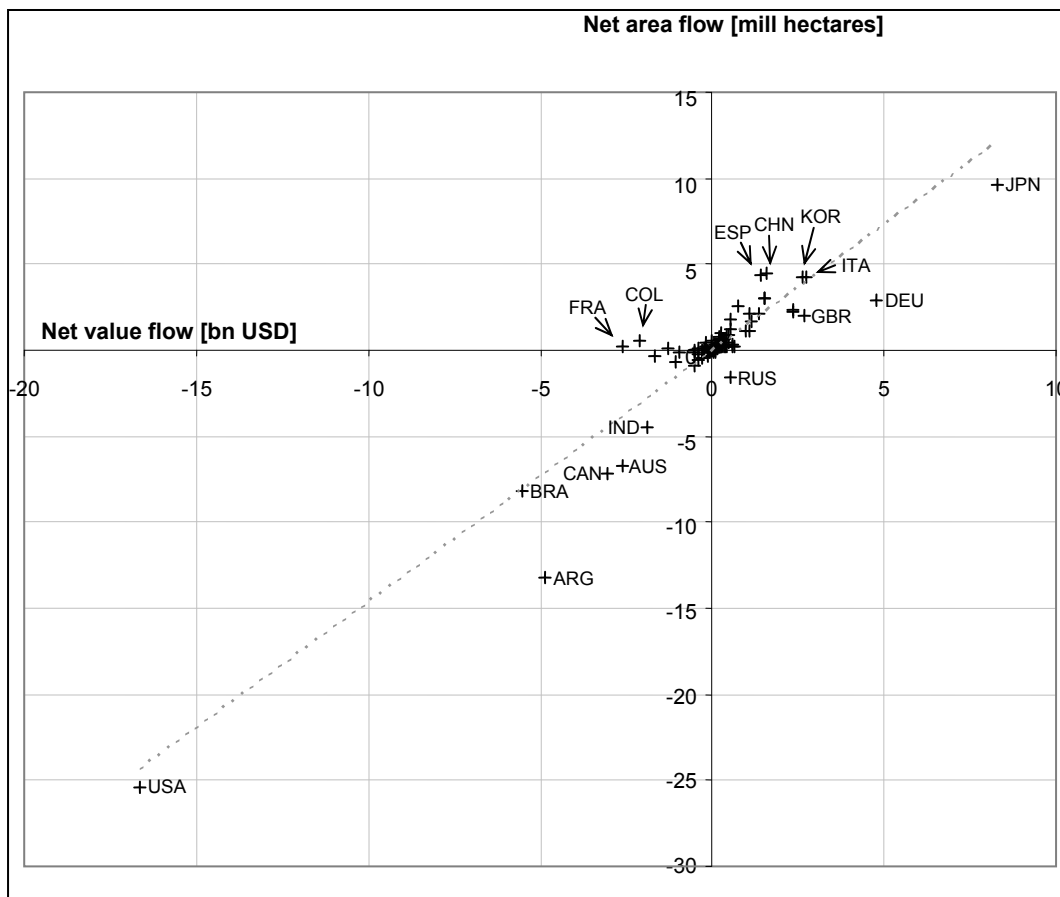

Figure 8.6: Scatterplot of net flows of agricultural commodities – value and appropriated areas.

The more cropland a country is endowed with, the more they export, and the larger are their net value outflows on a per capita basis. Although the per-capita net inflows of economic value is similar for Panama, Ecuador, Australia and Argentina, the net cropland outflows for the latter two countries are significantly larger than for Ecuador, while Panama actually having a net inflow of appropriated land.¹⁹⁸

¹⁹⁸ The per-capita value and area net flow data pairs for these countries are as follows: Panama (-147 USD; 265 m²), Ecuador (-140 USD; -301 m²), Australia (-140 USD; -3559 m²), Argentina (-138 USD; -3767 m²).

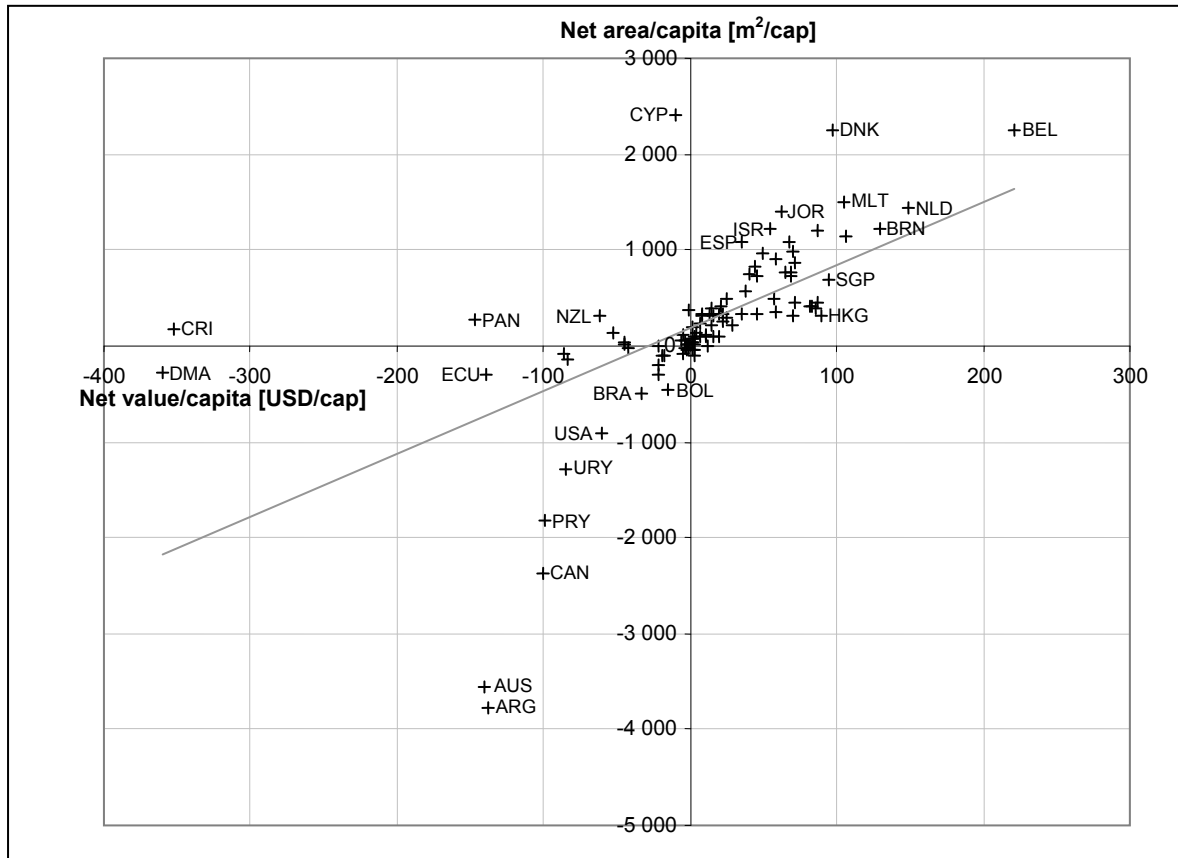

Figure 8.7: Scatterplot of per capita net flows of agricultural commodities – value and appropriated areas.

Contrary to the traditional view on how an economy progresses through various stages, traversing from primary, secondary, and tertiary sectors, contemporary USA is nevertheless the top absolute net exporter of agricultural goods, whether measured in value, in quantities, as well as in appropriated areas. In terms of per-capita net exports of cropland footprints, USA is only surpassed by five countries – Uruguay, Paraguay, Canada, Australia, and Argentina. At the same time, these vast net outflows of US agricultural goods have to be compared with the economic significance of its primary sector: as of 2007, only 0.6 percent of its labor force were engaged in farming, forestry and fishing, a sector that represented a meager 0.9 percent of its total GDP. Nordhaus is indeed correct when pointing to the economic insignificance of the US agricultural sector (see chapter 3), but the net outflows of US agricultural goods is anything but insignificant for its trading partners.

As we saw in Table 8.4, wheat is the most important commodity in world trade of agricultural goods, a commodity whose trade is clearly dominated by USA. The value of US wheat exports corresponds to 31 percent of total wheat traded among the R-set of countries, with its shares of traded quantities and areas at similar shares (30 and 32 percent respectively). Out of 99 possible trading partners, wheat exports from the USA is distributed among 79 countries, Egypt receiving 14.8 percent of US wheat hectares, followed by Japan (13.3), Pakistan (7), Philippines (6.5), Korea (6), Mexico (5.8), and China (5.4). However, as pointed out in the previous network-methodological chapters, the significance of a trade flow depends on point of view. In the case of the 1.37 million wheat hectares going from USA to Egypt, representing 14.8 percent of total US wheat export hectares, this particular trade flow corresponds to 71 percent of all wheat hectares imported by Egypt. Of all the hectares flowing into Pakistan, 83 percent are wheat hectares, with 54 percent of these wheat hectares

originating from USA. For Nigeria, wheat corresponds to 68 percent of its total imported footprint, with 79 percent of this wheat cropland being located in USA. 72 percent of imported Israeli wheat hectares come from its closest ally, i.e. USA, a cropland commodity representing 45 percent of the total footprints being imported to Israel.

The scatterplot in Figure 8.8 relate the wheat component share of total imported hectares with national GDP per capita. Although there are a handful of exceptions, two general tendencies can be noted: countries where wheat constitutes more than half of imported cropland are low-income countries, and wheat imports for high-income countries are typically below a third of total imported hectares.

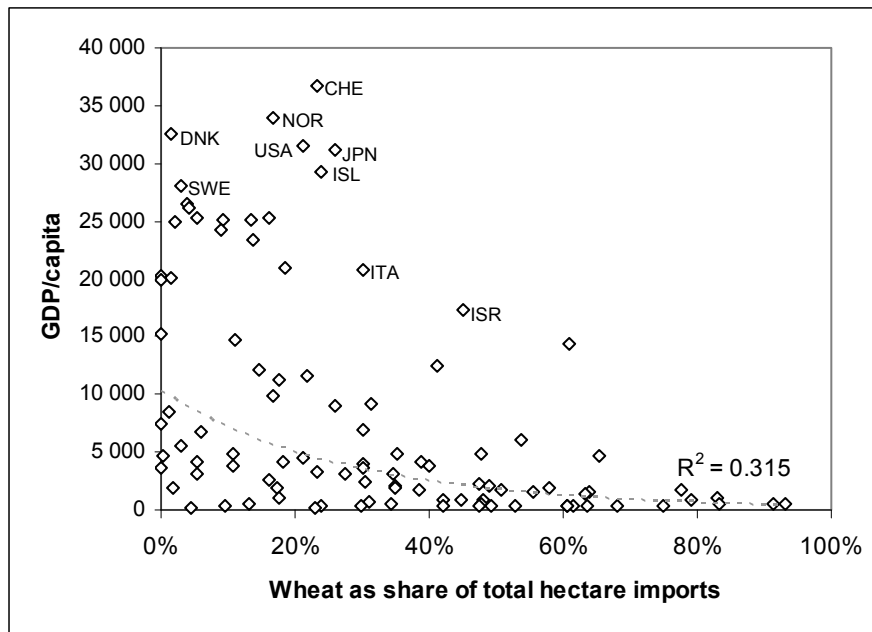

Figure 8.8: Relationship between significance of wheat imports and GDP per capita.

Plotting a similar scatterplot for soybean (Figure 8.9), comparing its share of total import hectares with GDP per capita for our 100 countries, a partly contrasting picture emerges. With notable exceptions, low-income countries typically have a small share of soybean hectares in their imports, while there is a cluster of medium- and high-income countries where soybean represents a very significant share (above 40 percent) of total cropland imports. For Switzerland, topping the GDP-per-capita list, the soybean contents of its imported footprint amounts to 34 percent (being at parity with its wheat imports), contradicting the perceived trend in Figure 8.9 below.

Turning our attention to outbound flows, Figure 8.10 below relates per-capita GDP with traditional cashcrop goods – bananas, coffee, oranges, mandarins etc, cocoa beans, and tobacco – as shares of total hectare exports. With the exception of Switzerland and Kuwait¹⁹⁹, the cash crop share of national hectare exports turns into an indicator of economic well-being: countries where cash crop represents more than a quarter of total hectare exports have a GDP per capita below 5000 USD. Cash crop export shares for central American countries –

¹⁹⁹ Kuwait is a distinct net importer of final-destination agricultural goods, with virtually no exports whatsoever, except for 2.5 hectares of bananas and 4 hectares of tobacco, resulting in its peculiar placement in Figure 8.9. Switzerland is also a net importer of agricultural goods, including these colonial goods, but is a brokering export trader in cocoa beans (~1/5 of imports re-exported) and tobacco (~1/3 of imports re-exported).

Nicaragua, Panama, Honduras, Guatemala, El Salvador, Costa Rica, and Dominica – are all above 85 percent of total exported hectares, countries in this “Fruit-belt” all having GDP per capita below 4000 USD.

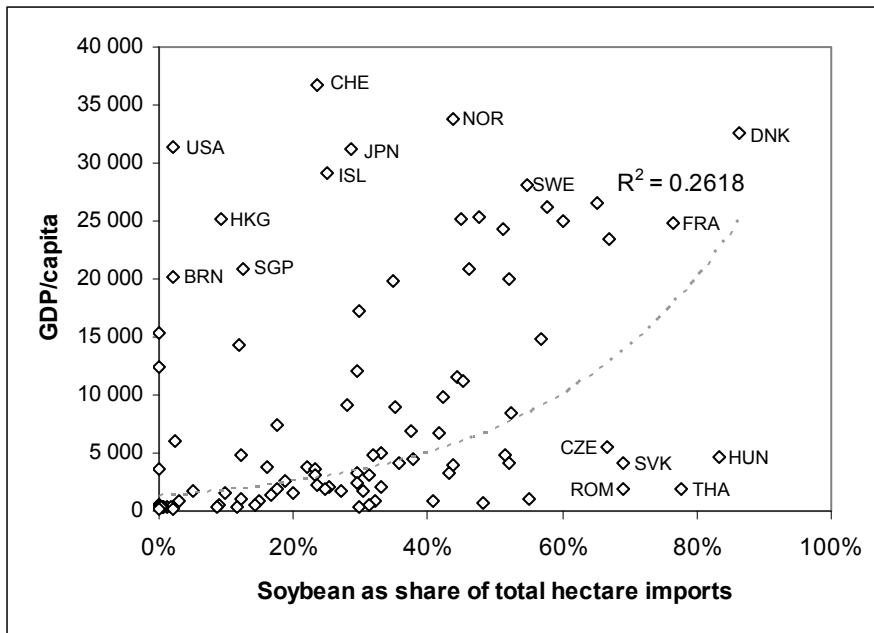

Figure 8.9: Relationship between significance of soybean imports and GDP per capita.

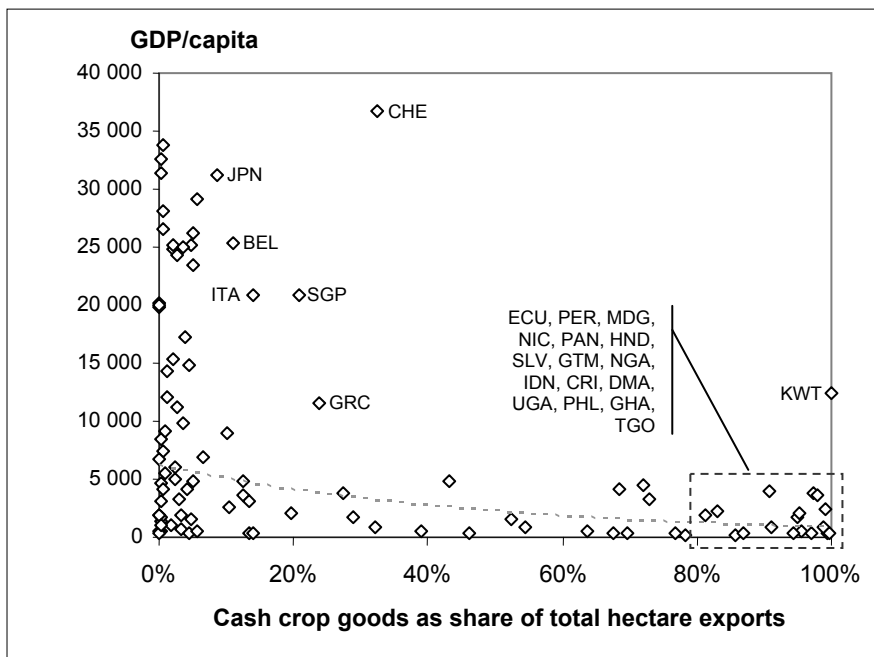

Figure 8.10: Relationship between significance of cash crop exports (bananas, coffee, oranges, mandarins etc, cocoa beans, and tobacco) and GDP per capita.

Evidently, the net flow analysis performed above raises a plethora of interesting follow-up questions, such as would-be correlation between compositions of import/export profiles and economic well-being, net hectare flow analysis between clusters of countries (high- vis-à-vis low-income countries, continents, trade blocks etc), not to mention possible network-analyses performed on flow matrices of individual agricultural commodities. Due to space limitations of this thesis, such studies have to be postponed as we now turn to the core of this chapter,

i.e. centrality and role analysis of the aggregate value and hectare flows between our R-set of countries, and whether these results correlate with occurrences of ecological unequal exchange.

Centrality analysis

Applying the BDD centrality index (see chapter 4) on the value flow matrix V_{Agri} , we arrive at the scatterplot in Figure 8.11. The majority of countries (64) have BDD indices below 0.05 for imports and exports, forming a cluster wherein the proportion of net-importers and – exporters reflects the system-wide proportion. In Table 8.7, a slight difference between net-importers and net-exporters can however be noted with regards to BDD indices: not surprisingly, the distribution of imports for net-importers are slightly wider (lower BDD_{Import} indices) than what is the case for net-exporters, and the opposite relation holds true for net-exporters with regards to export destinations. However, in Table 8.7, it can be noted that the top-five net importers (see Table 8.6) have the lowest BDD indices, even with an average BDD_{Export} index being lower than for the net-exporting group as a whole.

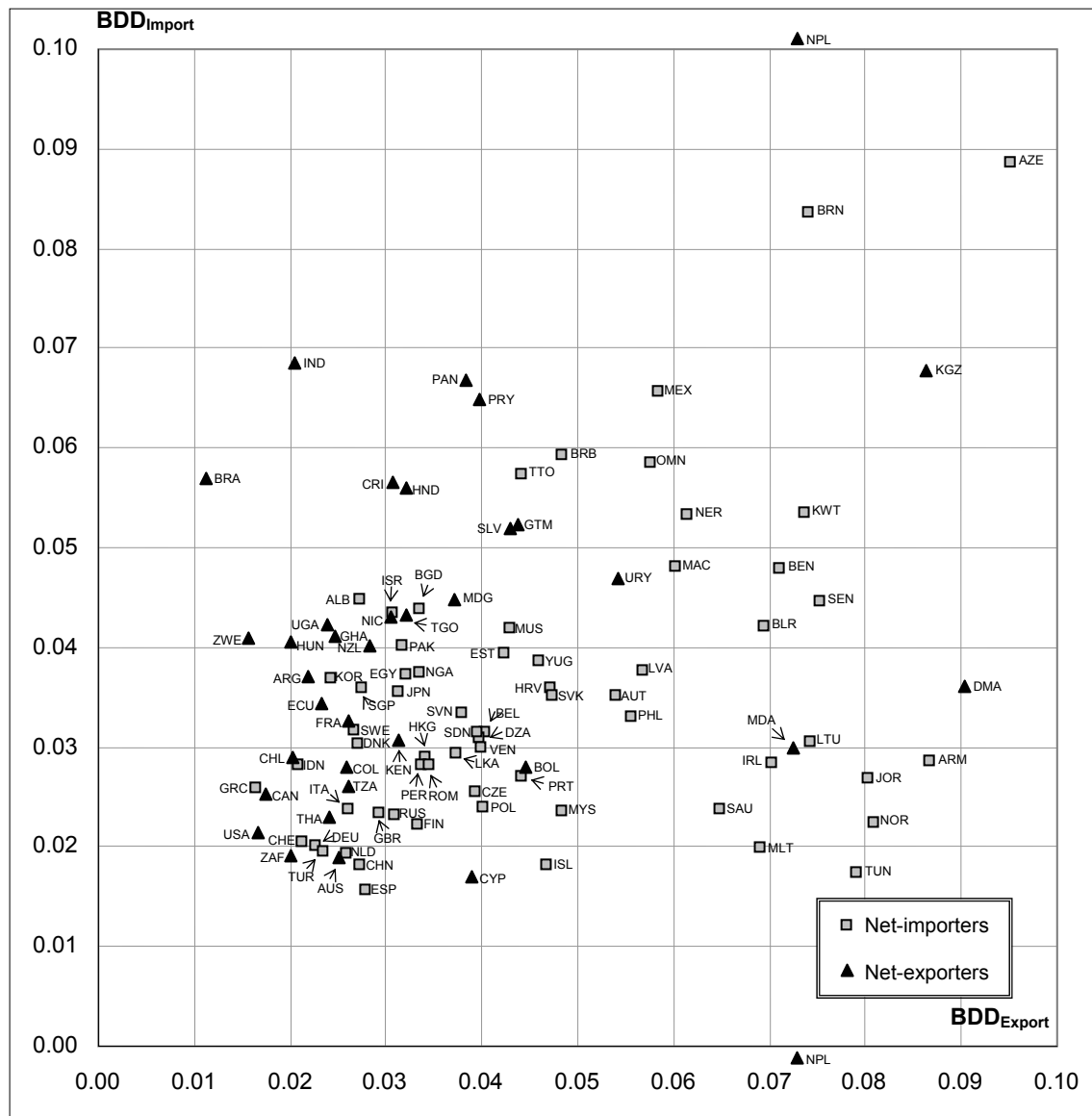

Figure 8.11: Scatterplot: BDD indices for agricultural goods value flow matrix.

	Average BDD indices		
	BDD _{Import}	BDD _{Export}	BDD _{Combo}
Net-importers (N=65)	0.035	0.046	0.058
Net-exporters (N=35)	0.040	0.035	0.053
OECD countries (N=29)	0.028	0.034	0.044
Top-5 net-importers	0.028	0.027	0.039

Table 8.7: Average BDD indices for various sets of countries (agricultural value flows).

While the above-mentioned cluster in Figure 8.11 contains most of the major traders in agricultural goods, as well as several countries with modest gross and net trade flows, some notable exceptions can be found when comparing BDD indices with the degree results in Table 8.6.

Brazil, being the second largest net-exporter of agricultural goods, has the lowest BDD_{Export} index, the value vector of Brazilian exports to other countries thus being the most proportional to the total import volumes of these partner countries. Being the tenth largest gross importer with a total import value at 1.8 billion USD, the sources of Brazilian imports are however far more concentrated than its exports, having a BDD_{Import} index approximately five times the size of its BDD_{Export} index. While placed alongside USA, Argentina, Canada, Australia and France in the degree analysis (Table 8.6). these other major net-exporting countries obtain their relatively large imports from a wider range of sources proportional to how total world exports are distributed, as such being less vulnerable to trade flow disturbances than what is the case for Brazil. India, the 8th largest net exporter, is found fairly close to Brazil in the BDD scatterplot above – however, as import volumes to India are not as significant as what is the case for Brazil, its high BDD_{Import} value should be taken with a grain of salt.

While several of the Fruit-belt countries of Latin America can be found outside the main cluster in Figure 8.11, Nicaragua, Bolivia, and especially Ecuador and Colombia, have relatively small BDD indices for imports and exports. Similar to Brazil, the imports of agricultural goods to Panama, Paraguay, Costa Rica, Honduras, Guatemala and El Salvador are, in decreasing order, not very proportional to the agricultural commodity outlets of the world. Dominica is an interesting exception: while its imports are fairly well-dispersed among the exporting countries of the world, its exports are remarkably concentrated, only superseded by the net-importing Russian satellite Azerbaijan: 69 percent of Dominican exports goes to Great Britain and 88 percent of exports from Azerbaijan flows to Russia, figures whose large deviation from an ideal distribution results in such high BDD_{Export} indices for Dominica and Azerbaijan.

Previously identified as a would-be gateway trader, Spain has the lowest BDD_{Import} index in Figure 8.11, as well as a reasonably low BDD_{Export} index. This is, once again, similar to degree and BDD index results for Dutch trade in fuel commodities (see previous chapter).

Comparing the net flow scatterplots (Figure 8.6 and Figure 8.7) with the BDD indices above gives us a would-be hint on the relationship between centrality (as perceived through low BDD indices) and notions of unequal ecological exchange. While BDD indices for Dominica, Costa Rica, and Panama could point to vulnerable structural locations in the world trade network of agricultural commodities, these countries seem to be involved in ecological unequal exchange – though at the receiving end of the concept (see Figure 8.7). While centrality could point to structural vulnerability, the latter is obviously not automatically translated into ecological exploitation, at least not as conceptualized and measured here. At

the end of this chapter, similar to the previous chapter, is a more thorough analysis of the structural theory of ecological unequal exchange.

We now turn to regular role-analysis, beginning with the V_{Agri} matrix, followed by an analysis of the L_{Agri} matrix.

Regular role-equivalence: the monetary aspect

Coinciding with low and non-existent data coverage (see Table 8.6), a preliminary REGE analysis puts Nepal and Dominica, two fairly small and insignificant countries, in singleton positions. Similar to what was done in the chapter on fuel commodities (see previous chapter), these two countries were removed from the dataset prior to the role-analysis that follows. Applying three iterations of the REGE algorithm on our 98 remaining actors in the V_{Agri} matrix, a subsequent Anova density analysis on the viable number of positions are given in Figure 8.12 below. Judging by the R^2 peaks, it would seem suitable to partition the network into three or five positions. Although the R^2 value reaches its top value at eight positions, I have chosen to partition the network into 9 positions to increase the analytical resolution.²⁰⁰

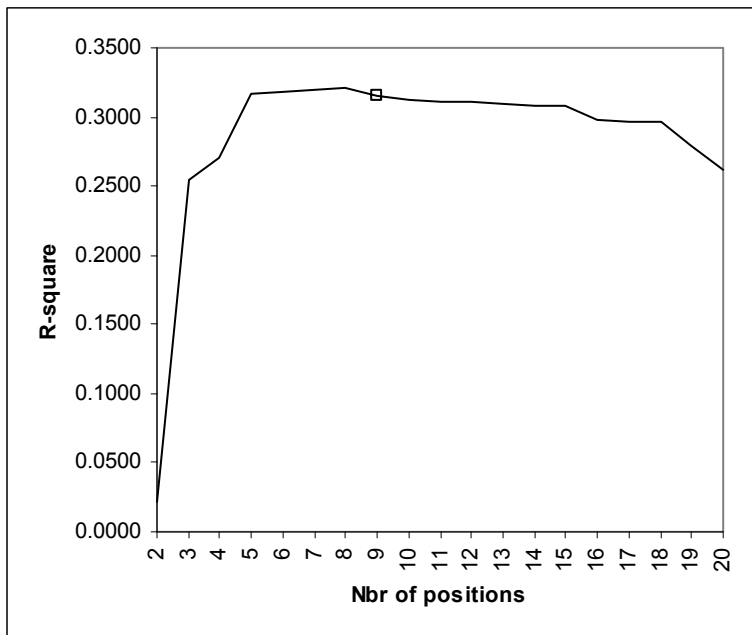

Figure 8.12: Anova-density test for REGE results of agricultural commodity value flows (98 countries) using three iterations.

The nine positions and their respective member countries are found in Table 8.8 below. As early as the 3-positional partition, USA is classified as a singleton position by the REGE algorithm, being by far the most significant, and the most distinct, single actor in the network of global agricultural trade.

The algorithm thus identifies four net-importing positions and five net-exporting positions, the latter including the singleton position of USA with total value net outflows being more than twice that of the second largest net-exporting position E_V . Egypt, Japan, South Korea and Mexico for a position of their own, with net value inflows being more than twice that of position B, the second largest net-importing position.

²⁰⁰ Up until the 9-positional partition, position A_V and D_V are part of the same position.

		GDP [mill USD]	Population	Net value flow [mill USD]
A _V	ARG, AUS, BEL, BRA, CAN, CHN, COL, FRA, DEU, IND, IDN, ITA, NLD, PHL, ESP, THA, TUR, GBR	11 463 174	3 236 849 000	-4 527
B _V	DZA, AUT, CHL, DNK, GRC, HKG, HUN, ISR, MYS, NGA, PAK, PER, PRT, RUS, ZAF, SAU, VEN	1 924 442	632 281 000	8 144
C _V	AZE, BGD, BLR, BEN, BRN, HRV, CZE, FIN, IRL, JOR, KWT, MUS, NOR, OMN, POL, SEN, SGP, SVK, SVN, LKA, SDN, SWE, CHE, TTO, TUN, YUG	1 430 046	333 315 530	6 833
D _V	EGY, JPN, KOR, MEX	4 766 378	329 528 000	14 027
USA	USA	8 774 286	279 026 000	-16 659
E _V	BOL, CRI, CYP, ECU, SLV, GHA, GTM, HND, KEN, NZL, NIC, PAN, PRY, ROM, TZA, UGA, URY, ZWE	271 633	203 502 000	-7 923
F _V	ALB, ARM, BRB, EST, LVA, LTU, MLT, ISL, MAC, NER	49 291	25 028 000	289
G _V	MDG, TGO	5 155	18 819 000	-72
H _V	KGZ, MDA	3 345	9 096 000	-110

Table 8.8: Membership of 98 countries among the 9 role-regular positions of agricultural goods value (as determined by using 3 iterations of the REGE-algorithm on the raw trade data).

The bulk of net-exporting and net-importing countries alike are found in position A_V, representing 64 percent of total population. With 8 out of 18 countries in position A_V are being net-exporters, the REGE algorithm nevertheless deem these countries as having the same role in the studied agricultural trade network. Position B_V, being an aggregate net-importing position, does have three net-exporting countries: Chile, Hungary, and South Africa. Furthermore, Romania, once nicknamed the breadbasket of Europe, is placed alongside net-exporting countries (position E_V), even though Romania actually is a net-importer of agricultural goods as measured in value. Apparently, the direction of net-flows alone does not automatically determine positional membership. Worth noting about position E_V, the largest non-singleton net-exporting position, is that most of the low-income, cash crop-exporting Fruit-belt-countries previously discussed (see Figure 8.10) are to be found here.

Looking at the value of trade flows between and within positions (Table 8.9), position A_V is the source and destination of 54 and 48 percent, respectively, of all trade flow values, out of which 30 percent is intra-positional trade, thus by far being the most cohesive subgroup among the identified positions. Excluding the intra-positional flow of A_V, USA is however the largest source of agricultural commodities, with the value of its net outflows being more than twice the corresponding value for the cash crop position E_V. Perhaps somewhat surprising, position E_V exports more to position A_V than to USA (at 5 and 2 billion USD respectively), although position E_V obtains most of its imports (0.9 billion USD) from USA, slightly more than its imports from position A_V (0.7 billion USD).

Judging by the magnitudes of aggregate inter-positional trade flows in Table 8.9, some interesting patterns of pair-wise positional coupling can be noted. The majority of US exports go to the quartet in position D_V – Egypt, Japan, South Korea, and Mexico – and although the exports from position D_V are very small, half of it goes to USA. Most of the positional exports from position A_V go to B_V, and most of the value of trade flows from B_V goes to A_V, these two positions apparently having significant trade relations. In short, while USA is the most important source of imports for position D_V and (to a lesser extent) E_V, position A_V is the most important source of imports for position B_V and C_V.

	A _V	B _V	C _V	D _V	USA	E _V	F _V	G _V	H _V	Total
A _V	25 423 (30%)	7 352 (9%)	4 486 (5%)	4 440 (5%)	3 287 (4%)	660 (1%)	131 (0%)	27 (0%)	5 (0%)	45 811 (54%)
B _V	2 262 (3%)	611 (1%)	777 (1%)	236 (0%)	330 (0%)	159 (0%)	67 (0%)	9 (0%)	4 (0%)	4 455 (5%)
C _V	313 (0%)	173 (0%)	193 (0%)	25 (0%)	19 (0%)	12 (0%)	31 (0%)	1 (0%)	2 (0%)	769 (1%)
D _V	349 (0%)	151 (0%)	64 (0%)	55 (0%)	658 (1%)	25 (0%)	4 (0%)	1 (0%)	0 (0%)	1 307 (2%)
USA	7 823 (9%)	3 247 (4%)	919 (1%)	10 055 (12%)	n/a (0%)	880 (1%)	70 (0%)	6 (0%)	28 (0%)	23 028 (27%)
E _V	5 014 (6%)	924 (1%)	1 100 (1%)	520 (1%)	2 069 (2%)	170 (0%)	34 (0%)	1 (0%)	2 (0%)	9 834 (11%)
F _V	15 (0%)	7 (0%)	25 (0%)	1 (0%)	2 (0%)	0 (0%)	10 (0%)	0 (0%)	0 (0%)	60 (0%)
G _V	75 (0%)	17 (0%)	20 (0%)	0 (0%)	5 (0%)	0 (0%)	1 (0%)	0 (0%)	0 (0%)	118 (0%)
H _V	10 (0%)	116 (0%)	19 (0%)	0 (0%)	0 (0%)	5 (0%)	1 (0%)	0 (0%)	1 (0%)	152 (0%)
Total	41 284 (48%)	12 600 (15%)	7 602 (9%)	15 334 (18%)	6 369 (7%)	1 911 (2%)	349 (0%)	46 (0%)	41 (0%)	

Table 8.9: Inter- and intra-positional flows of agricultural commodity value [million USD] (with percentages of total flows).

Mapping regular ties between (and within) positions, using the heuristic presented elsewhere (Nordlund 2007), we arrive at the structural map depicted in Figure 8.13. As USA is a singleton position, the probability for regular ties are higher when using criteria-fulfillment formula 1 (Nordlund 2007:62), thus pushing up the criteria-fulfillment percentages for these regular ties.²⁰¹ However, although USA has the most outbound regular ties due to this phenomena, position A_V seems to be the most core-like in Figure 8.13, the latter having a very strong self-tie in combination with the strong regular ties to position B_V and C_V. Self-ties for other positions are either medium, weak or non-existent, reflecting how peripheries are specified in the Galtung typology (see chapter 3 and 5). Position E_V, containing most cash crop-exporting countries (see Figure 8.10), has its only strong regular tie to position A_V, but its weak regular self-tie reflects meager intra-positional trade integration²⁰², even though several of the countries in position E_V are in close geographical proximity to each other. USA is though unique in the network, indeed a central feeding hub of the world, but the coreness indications for position A_V makes it difficult to place any specific world-systemic labels on position A_V and USA. However, labeling positions D_V, F_V, G_V and H_V as agricultural peripheries, and perhaps E_V as some type of semi-periphery, seems more reasonable judging by the structural map in Figure 8.13.

²⁰¹ For singleton positions in normalized outbound regular blockmodels (ORB), the $so_{A,B}$ formula (Nordlund 2007:62, formula (1)) only needs a single regular tie for a criteria-fulfillment at 100 percent for a row-regular tie.

²⁰² Total intra-positional trade for position E_V is only valued at 170 million USD, to be compared with the intra-positional trade for position A_V at 25.4 billion USD (see Table 8.9).

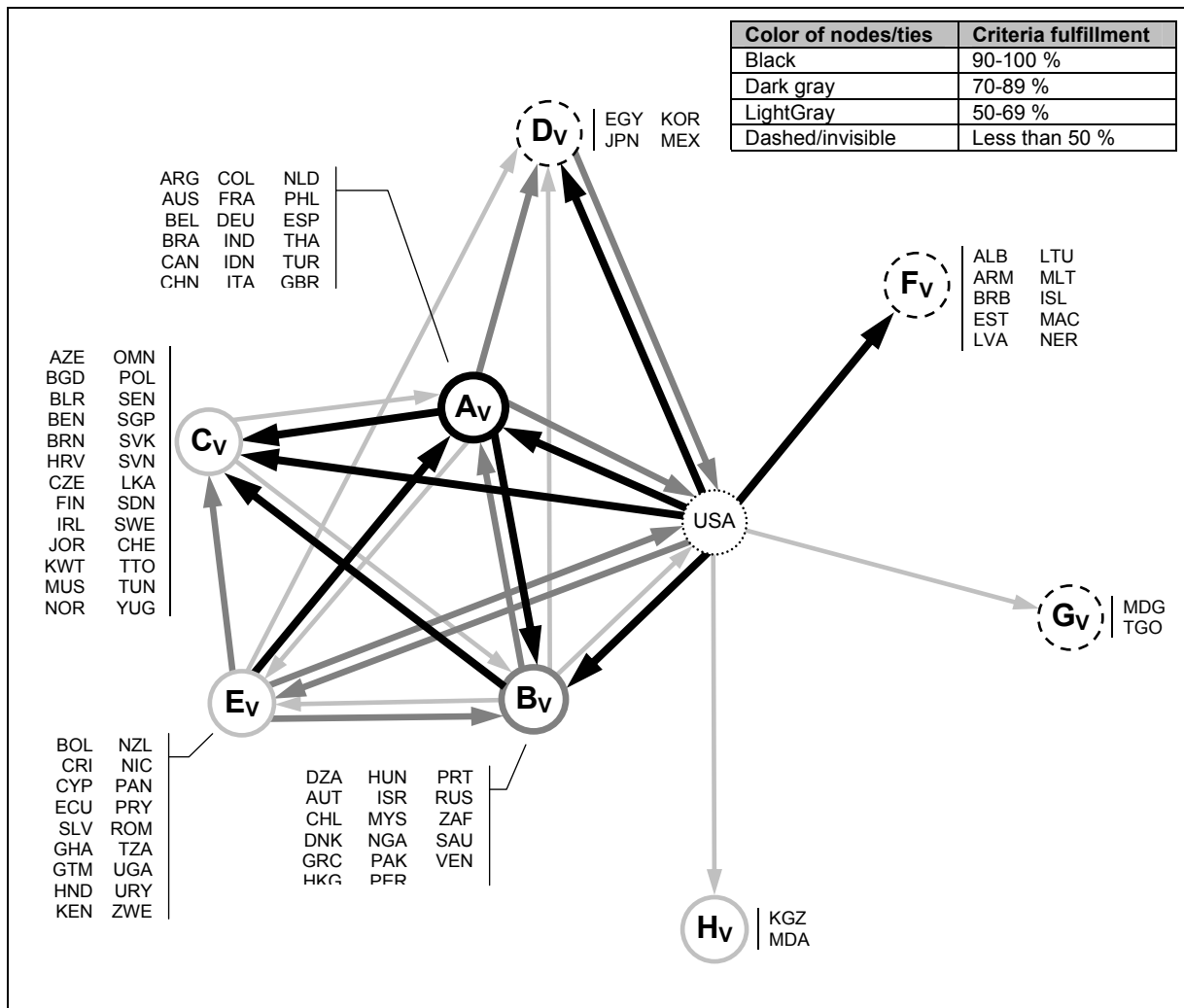

Figure 8.13: Ties within and between the 9 regularly equivalent positions (applying criteria fulfillment formula 1 with a relative cutoff value of ~ 0.0102 ($1/98$)).²⁰³

Calculating average BDD indices for the different positions, we end up with the average positional BDD indices as given in Figure 8.14 below. Having export relations to every other actor in the dataset except Mauritius, similarly importing agricultural goods from 73 out of 97 possible partners, these flows are balanced enough to give USA the lowest BDD indices in Figure 8.14. Position A_v , containing the mix of net-importers and -exporters alike, follows, having the second smallest BDD indices for its aggregate import and export vectors. Worth noting, net-exporting position E_v has a relatively high BDD_{Export} index: on average, countries in position E_v have 48 different export partners, which can be compared with the net-importing positions B_v and D_v having, on average, 46 and 48 export partners, respectively.

While A_v and B_v have approximately similar BDD_{Import} indices, the BDD_{Export} of position B_v is slightly higher. As A_v is a net-exporting position, its lower BDD_{Export} index is expected – however, similarly, it is perhaps expected that position B_v , being a net-importing position, should have a slightly lower BDD_{Import} index. Furthermore, as position E_v contains net-exporting countries (excluding Romania), its BDD_{Export} index should reasonable be a bit lower than what it is – though the three largest net-exporting positions do have the lowest

²⁰³ Coordinates for each position were established by conducting a MDS on a union-symmetrized blockimage containing the criteria-fulfillment percentages. As USA comprises a unique role according to the REGE analysis, its positional self-tie is undefined.

BDD_{Export} indices. However, the relatively high BDD_{Import} index of E_V , containing countries that seem to focus on traditional cash crops, reflects the non-coreness (non-hubness) that the structural map above indicates.

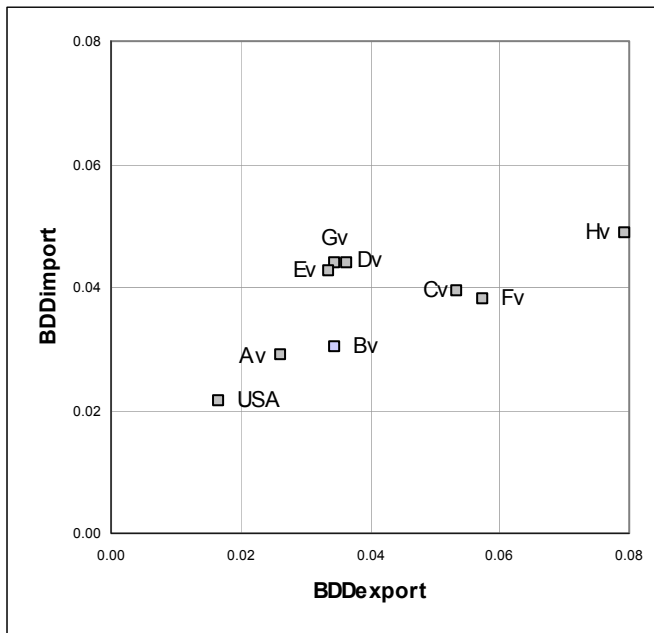

Figure 8.14: Positional BDD indices for each of the 8 positions in the agricultural commodity value flow analysis.

So far, we have analyzed the trade flow exchange values of our selected agricultural goods. We now turn to a role-analysis of the non-monetary units chosen for this chapter, i.e. the L_{Agri} matrix containing bilateral flows of cropland hectares.

Regular role-equivalence: the cropland hectares aspect

Applying 3 iterations of the REGE algorithm on the aggregate cropland flow matrix (excluding Nepal and Dominica), an Anova density test is performed on the resulting REGE coefficients (Figure 8.15). Although the main peak occurs at a 4-positional partition, the R^2 value reaches its maximum at six positions. Nine actors in one of the major positions (C_L – see Table 8.10 below) do form their own position at a 9-positional partition – choosing this partition would thus increase the resolution of the structural mapping, but the R^2 value at this partition is a bit too low to motivate such a partition. Based on the Anova density test alone, I have instead chosen to partition the cropland flow network into six positions, as specified in Table 8.10 below.

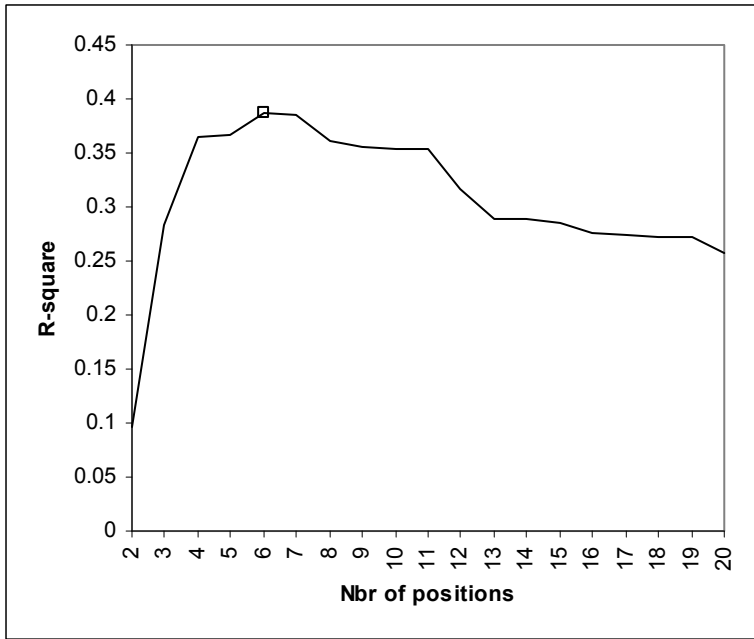

Figure 8.15: Anova-density test for REGE results of agricultural commodity hectare flows (98 countries) using three iterations.

	GDP [mill USD]	Population	Net hectare flow [ha]
A _L BEL, BGD, CHL, CHN, COL, DEU, DNK, DZA, EGY, ESP, GBR, HUN, IDN, ISR, ITA, JOR, JPN, KOR, LKA, MEX, MYS, NGA, NLD, PAK, PER, PHL, POL, PRT, SAU, THA, TUN, TUR, VEN, ZAF	13 698 760	2 933 130 000	64 425 131
B _L ARG, AUS, BRA, CAN, FRA, IND, RUS, USA	12 976 479	1 716 628 000	-66 547 494
C _L AUT, AZE, BLR, CHE, CRI, CYP, CZE, ECU, FIN, GRC, GTM, HKG, HND, HRV, IRL, KEN, KGZ, KWT, NIC, NOR, NZL, OMN, PAN, ROM, SEN, SGP, SLV, SWE, SVK, SVN, TTO, YUG, ZWE	1 870 837	242 619 530	4 453 751
D _L BOL, GHA, MDA, MDG, PRY, SDN, TZA, UGA, URY	77 986	138 426 000	-2 846 823
E _L ALB, ARM, BEN, BRN, EST, LTU, LVA, MAC, MLT, MUS, NER, TGO	53 325	36 102 000	492 047
F _L BRB, ISL	10 363	539 000	23 389

Table 8.10: Membership of 98 countries among the 9 role-regular positions of agricultural goods hectares (as determined by using 3 iterations of the REGE-algorithm on the raw trade data).

Contrary to what was the case when looking at the exchange-value dimension of agricultural trade, USA is no longer a singleton position, instead sharing a similar regular role with the other major cropland net-exporters. However, France is also placed in this aggregate net-exporting position, although it indeed is a minor net-importer of hectares.²⁰⁴

²⁰⁴ In the degree analysis (see Table 8.6), it can be noted that France seems to be a broker in cropland transfer: similar to what was the case for Dutch trade in fuel commodities (see chapter 7). Gross imports and exports are very large for France (at 3.9 and 3.7 million hectares respectively), thus having net-imports of approximately 0.2 million hectares. However, at smaller absolute values, a similar pattern can also be observed for Hungary, El Salvador, Slovakia and Lithuania: spread across several different positions, results from the degree analysis are apparently not directly related to the results from role-analysis.

The members of position A_L , representing more than half of the population in this study, are all net-importers, similar to how all individual net hectare flows from position D_L are outbound flows. Position C_L contains six net-exporting countries although the position is an aggregate net-importer. Worth noting, four of these six net-exporters in position C_L are Latin American cash crop exporters: Ecuador, Guatemala, Honduras, and Nicaragua. Colombia, a net-importer of hectares, is however found in position A_L , and Bolivia, Paraguay and Uruguay, these also being net-exporters of cropland, are found alongside other minor net-exporters in position D_L .

Cropland hectare net flows between and within positions are to be found in Table 8.11 below.²⁰⁵

	A_L	B_L	C_L	D_L	E_L	F_L	Total
A_L	11 536 (11%)	2 760 (3%)	2 442 (2%)	128 (0%)	237 (0%)	7 (0%)	17 109 (16%)
B_L	65 746 (63%)	9 240 (9%)	4 793 (5%)	399 (0%)	303 (0%)	17 (0%)	80 498 (77%)
C_L	2 061 (2%)	879 (1%)	588 (1%)	24 (0%)	65 (0%)	1 (0%)	3 616 (3%)
D_L	2 147 (2%)	1 051 (1%)	181 (0%)	21 (0%)	18 (0%)	0 (0%)	3 419 (3%)
E_L	44 (0%)	21 (0%)	65 (0%)	0 (0%)	14 (0%)	0 (0%)	145 (0%)
F_L	1 (0%)	0 (0%)	0 (0%)	0 (0%)	0 (0%)	0 (0%)	1 (0%)
Total	81 534 (78%)	13 950 (13%)	8 070 (8%)	572 (1%)	637 (1%)	24 (0%)	

Table 8.11: Inter- and intra-positional flows of cropland hectares [1000's hectares] (with percentages of total flows).

Being the destination of 78 percent of all hectare flows, the intra-positional hectare flows for position A_L are not remarkably large, albeit still having the largest amount of intra-positional trade. The largest individual inter-positional flow is the 65.7 million hectares transferred from position B_L to A_L , an area slightly larger than the size of Afghanistan.²⁰⁶ This particular inter-positional flow thus represents almost all of the hectare outflows from the countries in position B_L – only 4.7 million hectares flow from B_L to C_L , which is less than the traded hectares within the B_L position.

The dual flows between A_L and C_L are almost at parity with each other, even though hectare outflows from the latter is much smaller than from the former. For net-exporting position D_L , containing countries whose economies are dominated by the agricultural sector, its hectare outflows go mainly to position A_L , although D_L obtains most of its fairly few imported hectares from the major exporters in position B_L .

The relational structures between the role-equivalent positions are visualized in Figure 8.16 below, using the same heuristic and layout techniques as in previous structural in this thesis.

²⁰⁵ While it might be tempting to compare percentages in this table with the previous data on positional net value flows of value (Table 8.6), such a comparison makes little sense as the positional members differ between the role analyses concerned with exchange values and hectares, respectively.

²⁰⁶ Being the 41st largest country in the world, the size of Afghanistan is 647,500 km², i.e. 64.7 million hectares.

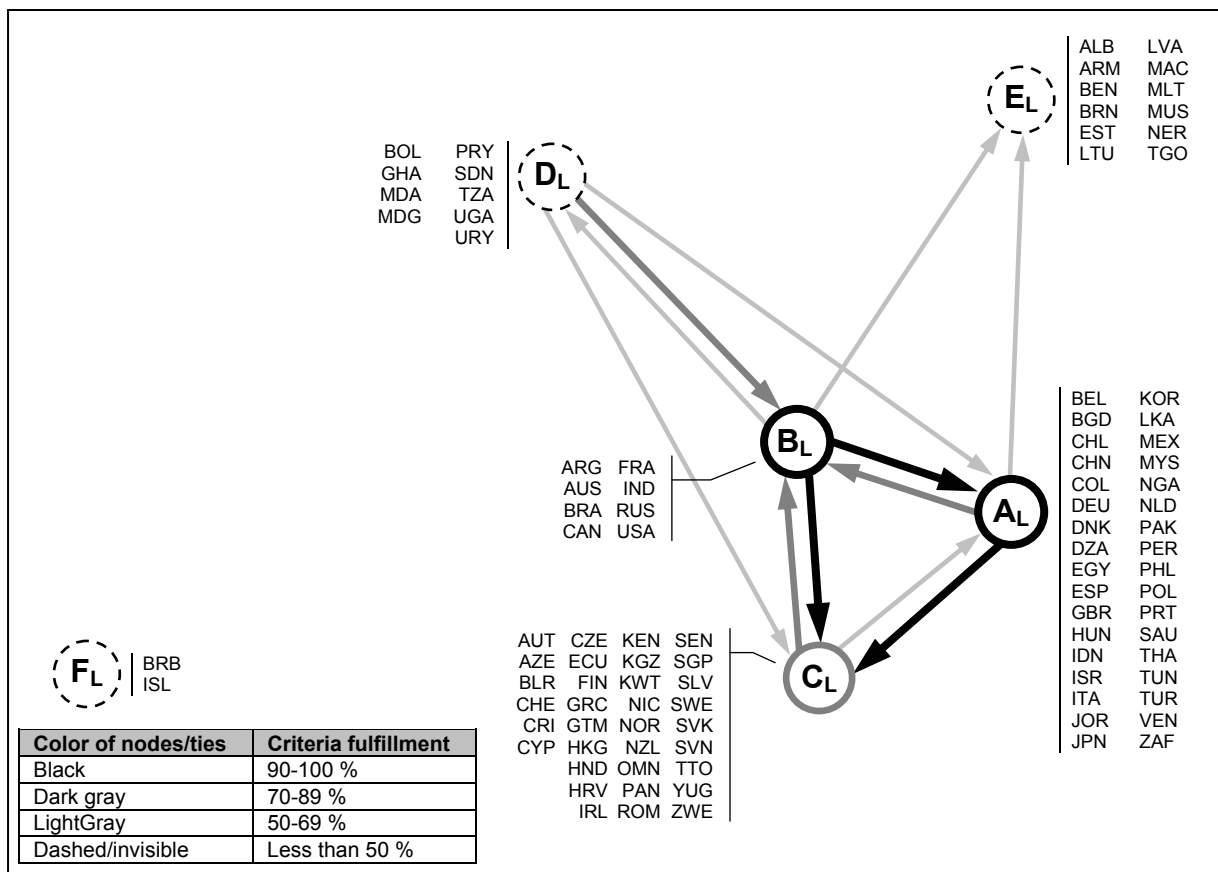

Figure 8.16: Ties within and between the six regularly equivalent positions (applying criteria fulfillment formula 1 with a relative cutoff value of ~ 0.0102 ($1/98$)).

Not surprisingly, the major hectare exporters in position B_L play a crucial role in the network of global hectare flows. Although its intra-positional tie in hectares is relatively modest, the applied heuristic nevertheless identifies this position as being a cohesive subgroup – the same can be said about the medium intra-positional tie for position C_L whose internal cropland flows among its 33 countries only correspond to approximately 588,000 hectares.

If position B_L , and perhaps also A_L , are deemed as core positions in this cropland transfer analysis, D_L , E_L and F_L could perhaps be seen as peripheral positions. However, it is crucial to note that positions A_L and B_L represent a very large share of total population in the dataset, thus stressing the importance of interpreting Figure 8.16 with great care. Rather, it is more informative to compare the differences in roles that countries play in the monetary and non-monetary dimensions of agricultural trade. Comparing positional membership, i.e. formally identified roles, in the transfers of economic exchange values vis-à-vis transfers of cropland hectares, we arrive at the results in Table 8.12 below.²⁰⁷

²⁰⁷ In order to interpret this comparison table as best as possible, it is recommended to simultaneously consult the structural maps concerned with the economic (Figure 8.13) and the ecological dimension (Figure 8.16).

	A _L	C _L	E _L	F _L	D _L	B _L	Net value flows [mill USD]
D _v	EGY, JPN, KOR, MEX						14 027
B _v	CHL, DZA, DNK, HUN, ISR, MYS, NGA, PAK, PER, PRT, SAU, VEN, ZAF	AUT, GRC, HKG				RUS	8 144
C _v	BGD, JOR, LKA, POL, TUN	AZE, BLR, CZE, CHE, FIN, HRV, IRL, KWT, NOR, OMN, SEN, SGP, SWE, SVK, SVN, TTO, YUG	BEN, BRN, MUS		SDN		6 833
F _v			ALB, ARM, EST, LTU, LVA, MAC, MLT, NER	BRB, ISL			289
G _v			TGO		MDG		-72
H _v		KGZ			MDA		-110
A _v	BEL, CHN, COL, DEU, ESP, GBR, IDN, ITA, NLD, PHL, THA, TUR					ARG, AUS, BRA, CAN, FRA, IND	-4 527
E _v		CRI, CYP, ECU, GTM, HND, KEN, NIC, NZL, PAN, ROM, SLV, ZWE			BOL, GHA, PRY, TZA, UGA, URY		-7 923
USA						USA	-16 659
Net hectare flows	64 425 131	4 453 751	492 047	23 389	-2 846 823	-66 547 494	

Table 8.12: Comparison between role positions based on value versus cropland hectares of agricultural commodities (with figures showing aggregate positional net-flows of exchange value and hectares).

Seven countries – Argentina, Australia, Brazil, Canada, France, India and USA – constitute a major hub with respect to both the economic and ecological dimensions of international agricultural trade. All of these (except France) are net-exporters of value as well as hectares: as previously noted, France is instead a net-importer of hectares. The rest of the exchange-value core actors in position A_v are categorized as the semi-core net-importing position A_L. Looking at the previously discussed set of Latin American cash crop-exporters (see Figure 8.10), these countries seem to have the same economic role, though split into two different ecological role-sets. While most of these countries could be deemed as ecological semi-peripheries (see Figure 8.16), several of which enjoy a favorable ecological-economic exchange, Bolivia, Paraguay and Uruguay are quite peripheral in their D_L position. Although Sudan plays the same peripheral ecological role as these latter Latin American countries, being a net-exporter of cropland hectares, Sudan is placed alongside obvious net-importers of value and hectares alike. Russia plays a central role from the ecological perspective, similar to the other top hectare net-exporters, but this is not reflected in its economic role, where Russia seems to play a somewhat less hub-like role.

Hectare unequal exchange vis-à-vis structural positionality

Similar to what was done in the chapter on fuel commodities, we now turn to the core hypothesis in this thesis, i.e. whether there is a relationship between structural positionality and ecological unequal exchange. Following the discussion in chapter 6, ecological unequal exchange is here conceptualized in a form that, I argue, is more in line with Emmanuel's original formulation. Rather than viewing mere net transfers of agricultural commodities and their corresponding bioproductive areas as indicators of ecological unequal exchange, these goods are viewed as representing the third Ricardian production factor, allocated across various national production segments. Contrasting the prices of these production factors, i.e. the monetary value per hectare, with the network-analytical results obtained in this chapter, we can thus empirically test a structural theory of ecological unequal exchange that is slightly more sophisticated than that proposed by Jorgenson (see chapter 6).

Based on positional demographics (Table 8.8) and positional trade flow values (Table 8.9), the most significant position in our dataset is A_V . With 74 percent of total export values and 48 percent of all import values, where intra-positional trade corresponds to 30 percent of all traded primary agricultural goods, A_V contains the major countries within the EU common market. USA, as a singleton position, is also very important: with net exports corresponding to a fifth of total agricultural trade value, USA is the largest positional net-exporter in the dataset. The countries in position E_V are also significant; although positional exports only amounts to 11 percent of totals, the cash crop countries in position E_V constitute the second largest net-exporting position, following USA. In addition to A_V , E_V and USA, the positional imports to B_V , C_V and D_V are significant enough to keep a closer eye on.

Constituting a cohesive subgroup of its own as well as having several in- and outbound regular ties with other positions, the structural mapping (Figure 8.13) indeed depicts position A_V as a core. With large gross imports and exports, though being a relatively small net-importer (see Table 8.8), A_V seems to hold a typical brokerage role, seemingly reinforced by the low centrality scores obtained in the positional centrality analysis above (Figure 8.14). According to the thesis hypothesis, this position should thus have a favorable throughput ratio, i.e. where the revenues per exported hectare would be higher than the cost per imported hectare.

On a positional aggregate mean basis (see Figure 8.17), this does not seem to be the case for A_V regarding agricultural goods: an imported hectare to position A_V costs 0.82 kUSD while an exported hectare only yields 0.73 kUSD. However, although these aggregate mean figures indicate a detrimental throughput ratio for the position, only a third of the 18 countries in position A_V actually have detrimental throughput ratios – Argentina, Australia, Canada, Germany, Great Britain, and the Netherlands. Still, it is noteworthy that the remaining 12 countries in position A_V all have beneficial throughput ratios. Thus, for the majority of countries in position A_V , core status does indeed correspond to a beneficial throughput ratio as stipulated by the hypothesis. Also, similar to the other positions, the cost span for imports to A_V is relatively tight, ranging between 0.36-1.43 kUSD per hectare, whereas the revenue span of exported hectares varies quite significantly between countries.

USA, representing a position of its own, is definitely a core position in the network of agricultural trade. However, USA pays quite a lot for each hectare imported while obtaining very little for each hectare exported. This is indeed contrary to the hypothesis: if there is a relationship between the structural positionality of USA and its involvement in ecological unequal exchange, it is an inverse type of relationship.

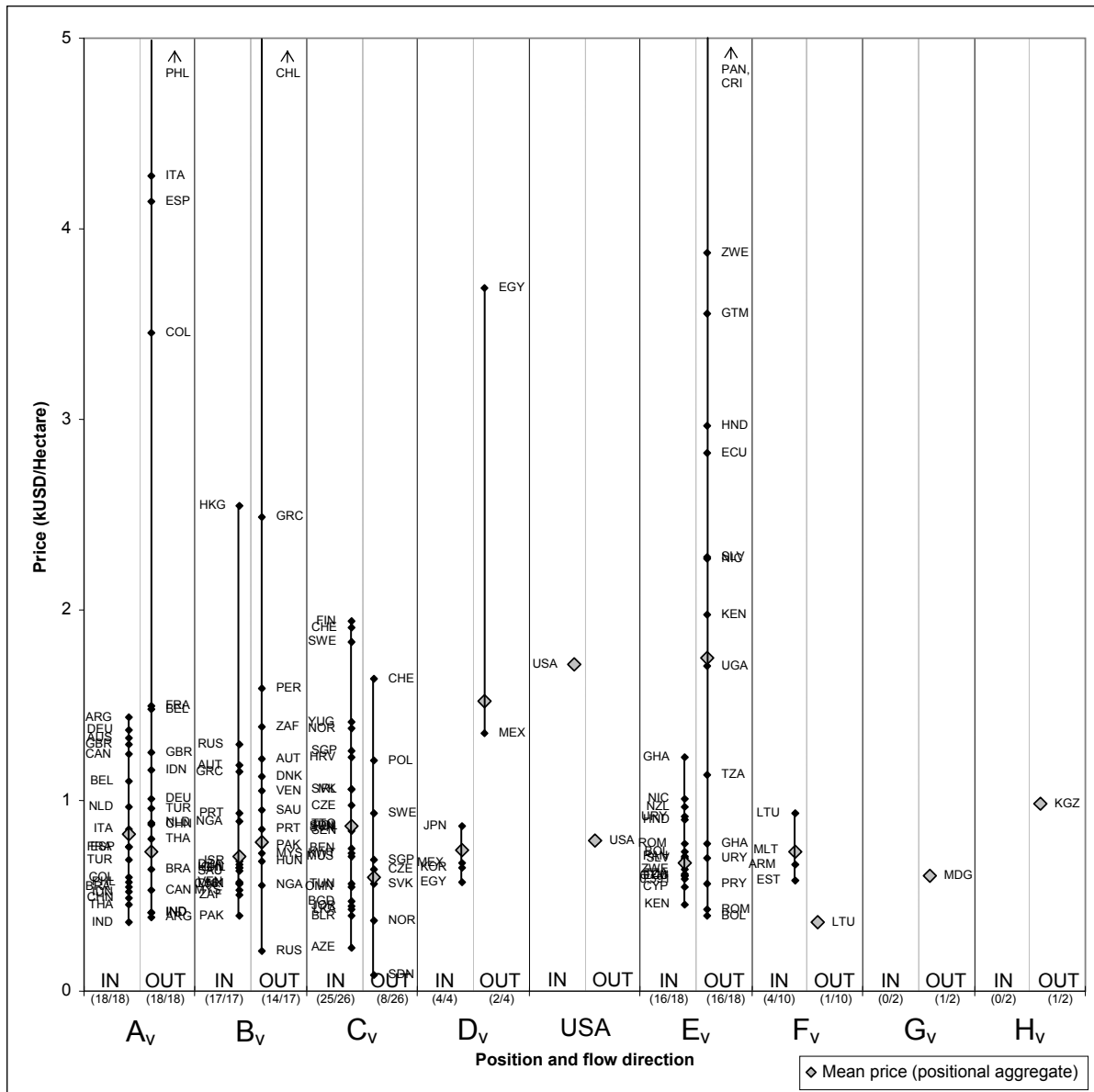

Figure 8.17: Import/export prices of countries in the 9 (agricultural value) role-equivalent positions.

Based on the structural map (Figure 8.13), net-importing position B_V can be interpreted as semiperipheral in this network of primary agricultural goods. On a positional aggregate basis, the average cost per imported hectare is quite low, although the price Hong Kong pays per imported hectare widens the cost span significantly. Albeit exports are relatively restricted, three countries having total exports below 50,000 hectares, the throughput ratio for B_V is slightly beneficial, though where the export revenue span is very wide. More importantly, B_V, similar to E_V, pays relatively little for each imported hectare.

On average, net-importing position C_V pays the most for each imported hectare, but the import cost differentials between positions is relatively small. According to the previous structural mapping, C_V occupies a peripheral position in the agricultural trade network, containing a mixture of country types. As exports from C_V countries are relatively insignificant, its low positional export revenues are equally insignificant for the overall analysis.

Imports to position D_V correspond to almost a quarter of all imports in the dataset. Containing only four countries, the cost span is quite tight with average import costs per hectare being very low. Worth noting, 80 percent of its imports originate from USA (see Table 8.9).

Most striking in Figure 8.17 above is net-exporting position E_V . This position has a very beneficial throughput ratio: on average, this position pays 0.68 kUSD per imported hectare (with a cost span between 0.46-1.23 kUSD/ha) while obtaining, on average, 1.75 kUSD per exported hectare (with a revenue span between 0.40-9.33 kUSD/ha). Three Latin American Fruitbelt countries have detrimental throughput ratios – Paraguay, Uruguay, and Bolivia – whereas Panama, Costa Rica, Guatemala, Honduras, Ecuador, El Salvador and Nicaragua all have very beneficial throughput ratios. The previous structural mapping definitely depicts position E_V as peripheral in the network of agricultural trade, and it is definitely subject to ecological unequal exchange – to its advantage – which contradicts the stipulated hypothesis.

To summarize the findings from Figure 8.17 above, the structural theory of ecological unequal exchange, and its standard interpretation within political ecology and environmental sociology, finds slight support in the analysis above. In addition to the counter-intuitive role of USA as a major net-exporter of bioproductive hectares, core positionality does not automatically translate into advantageous cost-quantity ratios for imports and exports. Instead, the results are ambiguous: although the most significant positions demonstrate throughput ratios that are contrary to how the hypothesis relate this to their structural properties, the majority of countries within A_V do indeed follow the hypothetical relationship between structural advantage and Emmanuelian ecological unequal exchange, being at the receiving end of such unequal exchanges.

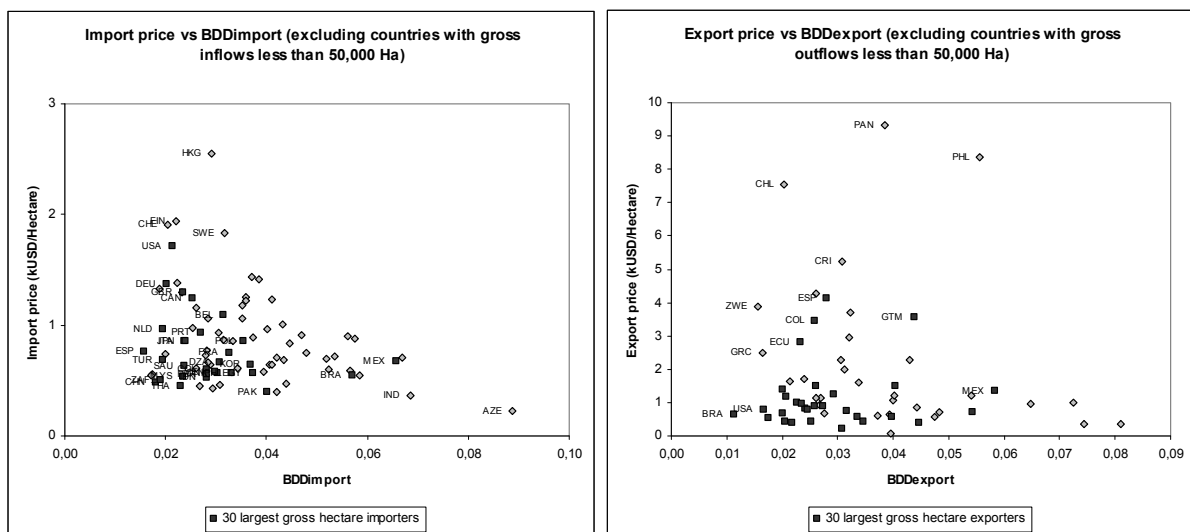

Figure 8.18: Comparing hectare prices with value centrality (imports and exports respectively).

Turning our attention to BDD centrality indices (Figure 8.18), the hypothesis implies that a central position in a trade network would translate into advantageous price relations. Intuitively, it could be expected that a central importer obtains productive hectares at a relative lower cost than what would be the case for not-so-central importers. Examining the scatterplot in Figure 8.18(A), the opposite seems to be the case: countries that pay more than 1 kUSD per imported hectare all have BDD_{Import} indices below 0.05, whereas all those that are less central ($BDD_{Import} > 0.05$) pay less than 1 kUSD per imported hectare.

However, if we compare average values for the 30 largest gross importers with the remaining 55 countries in this scatterplot, import centrality seems to imply lower costs per imported hectare. The largest gross importers have a BDD_{Import} index of 0.029 and obtain their imports, on a national average, at 0.76 kUSD/hectare, while the 55 remaining countries have a mean BDD_{Import} index of 0.038 and pay on average 0.91 kUSD per imported hectare. However, whether we look at either of these subsets or all countries in Figure 8.18(A), the trend is opposite to expectations: the lower the BDD_{Import} index is, the higher the probability that the cost per imported hectare is relatively high. Import centrality results thus run counter to the thesis hypothesis.

Looking at export flows, the hypothesis stipulates that a central exporting country would be able to obtain more revenue per exported bioproductive hectare than what a not-so-central exporter would. A low BDD_{Export} value would thus correlate to high revenues per exported hectare. Examining Figure 8.18(B), there are no clear indications of this hypothetical relationship. The range in revenues per exported hectare is, as previously noted, quite wide, but these ranges are not related to the BDD_{Export} index.

Looking at the 30 largest gross exporters, their mean national BDD_{Export} index is quite low (0.021) while the mean national earnings are 1.2 kUSD per exported hectare. Although the remaining 32 countries have, on average, a higher BDD_{Export} index (0.039), they also have significantly higher revenues: 2.3 kUSD per exported hectare. Furthermore, if the BDD index is a suitable measure of centrality, an examination of Central American Fruitbelt countries also contradicts the thesis hypothesis: with a mean national export centrality of 0.036, these countries obtain, on average, a staggering 4.27 kUSD per exported hectare. Apparently, a low centrality score (using the BDD heuristic) does not translate into low revenues per exported hectare; rather, the only slight trend that can be observed here is inverse to the stated hypothesis on structural positionality and ecological unequal exchange.

In spite of the findings above where a would-be relationship between ecological unequal exchange and structural advantage is weak and, at best, inverse, the trade structure of primary agricultural goods is anything but balanced. USA, through its unique role as a major provider of bioproductive areas, has a significant influence on hectare costs across the whole system. The cold-war strategy on self-reliance and the resulting productivity of the US agricultural sector translates into geopolitical power where adjustments in US domestic agricultural policy have a direct influence on food prices and nutritional standards in the world at large. Based on throughput ratios, i.e. the ratio between per-hectare import costs and export revenues, the results above do to a certain degree find a relationship between structural positionality and ecological unequal exchange, but it is, apart from the majority of individual countries in position A_v , a relationship quite the opposite to the stated hypothesis.

Conclusion

In this chapter, the trade structure of 23 primary edible agricultural goods commodities has been analyzed, covering a large majority (value-, quantity-, and hectare-wise) of primary agricultural trade. Although the majority of traded agricultural goods are semi-processed and refined foodstuffs, the commodities chosen for this study represent 291 out of the 758 million tons of the goods that FAO keeps track of.

Instead of using the official EF methodology as proposed by GFN, an approach that is quite problematic when addressing issues concerned with international trade, an alternative heuristic for measuring the embodied footprints of agricultural trade flows has been

developed and applied in this chapter. Although the proposed heuristic is somewhat crude and highly improvable, it is argued that its usage is more adequate than the official methodology for estimating the net flows of bioproductive areas that trade in agricultural goods represents. Similar to the GFN approach, it takes no account of agricultural inputs, managerial practices and would-be land degradation, but is solely rooted in FaoSTAT yield factors. However, instead of converting trade flows into corresponding “global hectares”, the proposed heuristic uses a semi-recursive algorithm that “backtracks” the various sources, and their respective yield factors, of each bilateral trade flow for each crop variety.

Similar to what was found in the energy analysis (chapter 7), net flows of exchange value and hectares are overall unidirectional, though the anomalies are more pronounced than what was the case in the energy analysis. The degree analysis indicates that the largest net and gross importers are typically developed countries. However, although typical semi-peripheral countries such as Brazil, Argentina, Russia and India are found among the major hectare exporters, so are Australia, Canada and, especially, USA.

Related to the development issue, commodity-specific trends between the compositions of agricultural trade and per-capita GDP were found. Countries whose imports of wheat constitute more than half of their total imports are typically low-income countries, whereas wheat hectare imports only represents a fraction for a developed country. Looking at exports of typical cash crop products, it can equally be noted that countries whose hectare exports almost totally consist of such goods have significantly lower per-capita GDP. Even though the Latin American Fruitbelt countries have a, somewhat surprising, beneficial relation to ecological unequal exchange, it can be noted that their high export concentration of traditional cash crop goods correlate with low per-capita GDP figures.

To a high degree, the structural mapping and centrality analysis reflect the degree analysis: the major net exporters are found within core positions and are, on average, more central than countries within the peripheral net-importing positions. Thus, contrary to what was the case with fuel commodities (chapter 7), the structural mapping of primary agricultural trade seems to have net-exporting countries in core positions.

Although net flows of exchange values and hectares are overall unidirectional, a comparison between the monetary and biophysical role-analyses reveals some interesting findings. Argentina, Australia, Brazil, Canada, France, India and USA are found within the core in the exchange structures of value flows as well as hectare flows; with the exception of France, these countries are net-exporters of both value and hectares. Russia is however only part of the core in the hectare analysis; being a member of the structurally semi-peripheral position B_V , Russia is a net-exporter of hectares while still paying more of its imports than what it obtains from its exports.

Position A_L , a cohesive subgroup that can be interpreted as either a secondary core or a semi-periphery in the structural analysis of hectare flows, is also interesting. Containing net-importing countries, the countries in this relatively large position are scattered across four different positions in the value flow structural analysis (see Table 8.12). Whereas the EU countries (excluding Denmark) within position A_L indeed are core countries in a monetary sense, found in the net-exporting value position A_V , the bulk of the countries in A_L are instead found in semi-peripheral position B_V , followed by the peripheral positions C_V and D_V . Thus, coreness in a monetary sense does not automatically imply coreness in a biophysical/hectare sense.

Regarding the hypothesis on ecological unequal exchange, a relationship between structural positionality and factor costs can partly be found, though quite inconclusive. Supporting the theory, it can be noted that the majority of countries in core position A_V have a beneficial throughput ratio, i.e. these countries obtain more revenues per exported hectare than what they pay per imported hectare. However, on an aggregate level for the A_V position as a whole, the throughput ratio is actually detrimental. For USA, constituting its own core, the throughput ratio is indeed of an ecologically unequal kind, though to the disadvantage of USA as an imported hectare costs vastly more than the revenues obtained from an exported hectare. Position B_V , here interpreted as an agricultural semiperipheral, has a slightly beneficial throughput ratio. The most beneficial throughput ratio can however be noted for position E_V , deemed by the structural mapping as a peripheral position that contains most of the Fruitbelt countries.

This relationship between structural positionality and factor costs, inverse to what is stipulated by the hypothesis, can also partly be noted when looking at the BDD centrality indices. The more balanced the import vector of a country is, the more probably that it pays more per imported hectare. Regarding the BDD export index, there are no general trends to be found regarding hectare costs and export centrality – apart from the contra-intuitive finding that the typical Fruitbelt countries combine non-centrality with high revenues per hectare. Being a novel type of centrality index, the BDD heuristic does indicate the same phenomenon as reflected by the role-structural analysis, i.e. that the relationship between structural positionality and ecological unequal exchange (as reflected in cost differences for the third Ricardian production factor) is typically of an inverse kind, which is nothing else but contrary to the classical perception of ecological unequal exchange within political ecology.

In spite of these observations, there are several aspects – caveats – in this study that might affect the outcomes and interpretations above. First, the yield data used in this thesis takes no account of sustainability, inputs and farming practices: similar to the GFN methodology, this study strictly looks at what comes out of the ground, ignoring resource inputs, emissions, land degradation and other indirect, “virtual” hectares. Despite its very high yield factors, indeed reflecting substantial amounts of inputs, USA is still an exceptional hectare exporter, even without such indirect land usage. If such external inputs and indirect land were to be included in the accounts, assuming that produce from US agriculture contains a significant amount of such ghost acreages (in relation to what is the case for farming practices of US import partners), USA would actually be an even greater net exporter of primary agricultural hectares.

Secondly, this study looks exclusively at primary agricultural goods, whereas semi-processed and finished foodstuffs are excluded as these are deemed as products rather than production factors in this thesis. If we instead depict ecological unequal exchange as net transfers of hectares, and if we strive towards obtaining a complete account of such exchanges, such a study would of course demand that we look at *all* commodities within the food (as well as non-food) sectors of the commodity nomenclature. Even though the Latin American Fruitbelt countries seem to have a beneficial throughput ratio in this study, it can equally be observed that these countries, and other whose exports to a very large extent consist of cash-crop agricultural goods, typically has very low GDP-per-capital figures.

Also, which is typically ignored in footprint accounting schemes, it must be stressed that each hectare is space-bound. Different climates, weather conditions, soil types etc underline that hectares often are non-interchangeable with each other in the real world, where different

crops are bound to certain geographical zones. Such variations, which of course constitute a *raison d'être* for trade in these goods, underline the simplicity of the standard perceptions within political ecology: space (as well as labor time) have local contexts which make it problematic to treat space, such as ecological footprints, as a globally homogeneous, interchangeable and comparable accounting unit. Ecological footprint accounting, such as the one in this chapter, indeed dissolves distinctions and assumes that a flattened, comparable world exists.

Finally, as will be addressed further in the conclusive chapter of this thesis, an inverse relationship between quantified measures of structural advantage vis-à-vis appropriation of natural resources is just as intriguing as if the opposite were to be true. While there are strong theoretical arguments, as well as previous empirical studies, for addressing the relationship between structural positionality and issues on development, unequal exchange and environmental degradation, such a would-be relationship constitutes only one, out of many, possible mechanisms that influence the outcomes that can be empirically analyzed. With the observed trends, inconclusive as they are, being contrary to the stated hypothesis and its inherent perception of the world-ecology, this is something that has to be investigated further.

CHAPTER 9

Concluding discussion

Ever since its genesis in the early 1990's, the Lund school of human ecology has claimed to be multi-disciplinary. Human ecology, similar to world-system analysis as defined by Wallerstein, manifests an inherent disregard for pre-existing disciplinary boundaries within the social sciences, but, in addition, it also transcends the traditional separation between cultural and natural sciences. Particularly the latter is seen as an absolute necessity in order to address the core questions which are of interest for human ecology, i.e. the relationship between man and nature. This approach differs vastly from other social sciences, in particular contemporary economics, the latter which is better defined by its methods, models, axioms and pre-analytical assumptions, rather than a specific area of interest. Perhaps it is not too poetic and far-fetched to say that it is precisely this lack of unique features that constitutes the unique feature of human ecology.

The questions posed by human ecology can at times appear to be ridiculously large in scope – at least as measured in disciplinary overlap. At the same time, the very same questions can also be seen as extraordinarily fundamental and primitive. Paying such little adherence to disciplinary boundaries, human ecology can reassess and dissect prevailing theories and “truths” which, at times, seem better at reflecting certain disciplines than they are at corresponding to observed phenomenon in the non-modeled world. However, in order to construct ideas that stretches across such disciplinary domains, it is imperative to fully understand not only the substance of the specific theorems or ideas of the relevant disciplines, but also their history, as well as their surrounding disciplinary culture. As related to the thesis at hand: it is imperative to fully understand contemporary trade theory – its substance, its syntax, its historical development, and its balance between maps and realities – if we are to study issues on trade and development. The world of ideas and the world of observable phenomenon, such as the skewed global distribution of resources and material want-satisfaction, are intricately intertwined: we make and live both realms continuously.

One of the grand questions asked, and even made visible, by human ecology is the one on ecological unequal exchange. Stemming out of a disciplinary integration of world-system analysis and ecological economics, per se reflecting the anti-Cartesian nature of human ecology, ecological unequal exchange is on most (if not all) occasions depicted as occurrences of some sort of non-compensated net transfers of biophysical resources between partners engaging in trade. As there are stark differences in material welfare around the world, and as global resource transfers almost exclusively are conducted through the market mechanisms of global trade, the concept and its surrounding questions indeed seem worthwhile to examine.

From the viewpoint of economics, the issue on ecological unequal exchange, including its conventional non-ecological predecessors, is a non-issue. As the equality of a market-based exchange is defined by its very existence, unequal exchange is quite the oxymoron. In addition, as economics is concerned with monetary values, any would-be non-monetary, resource-based inequality occurring in an economic exchange is simply incomprehensible – unaddressable – as such measures lie outside the disciplinary and conceptual boundaries of economics.

In the last decade, ecological unequal exchange has been addressed quite extensively by several scholars. Various qualitative and quantitative attempts have been made to identify its occurrence as well as the magnitude and direction of such, usually, if not exclusively, depicted as non-compensated net transfer of biophysical resources. While these studies are important contributions to the issue at hand, there are, I argue, a number of aspects that are well worth thinking about when studying ecological unequal exchange.

First, any attempt to quantify and measure total ecological unequal exchange among various social entities, national states in particular, is an enormous scientific undertaking. The sheer magnitude of such a project with regards to data collection and methodological development is furthermore made even more problematic when it comes to the essences: how to quantify, and compare, natural resources in a manner that makes sense in “both worlds”? That is, even though our economic systems use a comparable one-dimensional unit of accounting – monetary valuations, that is – this does not automatically imply that a similar simplification can be made with respect to the outer, biophysical system.

Secondly, the usage of the concept of ecological unequal exchange typically has few similarities with how unequal exchange was formulated by Emmanuel and its precursors in the Prebisch-Singer theorem. Instead of concerning itself with global differences in factor costs and the resulting trade-distributional outcome of such differences, ecological unequal exchange is more than often seen as net transfers of biophysical resources per se, without providing any specific theory of its underlying mechanisms.

Thirdly, even though the outcome of ecological unequal exchange most likely is reflected in national indicators of biophysical consumption, for instance per-capita energy consumption and ecological footprints of nations, such figures are nevertheless only symptoms of the exchanges that presumably lead to such divergent national figures. If we choose to conceptualize ecological unequal exchange as net transfers of biophysical resources between nations, we are, I argue, better off focusing specifically on such transfers rather than how such transfers are assumed to be reflected in nation-specific attributes.

The last point that should be raised concerns the underlying urge to quantify. Would detailed figures for certain spatiotemporal occurrences of ecological unequal exchange in our historical system really enhance our understanding of global trade and its distributive aspects? Do numbers per se, or do the methodological formalism that yield such quantifications, imply normativity? Does a thermometer explain why someone has a fever?

A simple exercise that, I believe, proves the existence of ecological unequal exchange (in the sense of non-compensated net transfers of biophysical resources) is to open one’s fridge²⁰⁸ and have a look at what is inside. As global resource transfers occur due to the workings of global trade, the magnitudes of one’s consumption, and the geographic range from which resources are obtained, are by themselves, I argue, adequate indicators of the existence of ecological unequal exchange. However, describing this global metabolic rift between the few haves and the many have-nots in miniscule quantitative detail does not really help us to understand why it exists and the mechanisms that uphold such rifts.

This thesis tries to be a contribution to the growing literature on *theories* of ecological unequal exchange. It builds on the structural theory as advanced by Andrew Jorgenson, a

²⁰⁸ No fridge? Well, there you go.

theory that states that economic actors with a positional advantage in exchange networks are at the receiving, beneficial end of ecological unequal exchange. Constituting a non-issue in mainstream economics, the structural analyses done in economic geography provide ample evidence that structures indeed are important for understanding the distributional effects of trade and its perceived gains.

Compared with Jorgenson's work, two major modifications are done in this thesis on how to test this theory. First, methods from the toolbox of social network analysis are applied to identify structural positionality. Using well-established methods for identifying structural roles in networks, as well as a novel heuristic for measuring centrality, this thesis looks at the trade flow networks of two sets of commodities from their monetary as well as biophysical dimensions.

The second modification is concerned with the definition of ecological unequal exchange. Instead of depicting and defining its occurrence as net transfers of biophysical resources, assumed to be reflected in national biophysical measures of consumption, ecological unequal exchange in this thesis is, similar to Emmanuel's original formulation, concerned with factor cost differences. However, instead of looking at differential costs for labor, i.e. wages, this thesis is concerned with the costs of another Ricardian production factor that is ignored in contemporary economics, namely land (natural resources). In this thesis, it is argued that the primary goods chosen for the empirical analysis – fuel commodities and (edible) agricultural crops – constitute adequate representations of this third Ricardian factor of production. By combining the monetary and biophysical flow data to calculate factor costs, subsequently comparing these cost differentials with the structural results obtained from the network analyses, the thesis examines whether countries with a structural advantage pay less per imported resource (and earn more per exported resource) than what is the case for structurally disadvantaged countries. The absolute net and gross flows are thus not what define ecological unequal exchange in this context – rather, in line with the definitional characteristic suggested by Brodin (2006a), it is a theory about factor cost differentials.

While this thesis focuses solely on the structural theory of ecological unequal exchange, this is not to say that other theories – for instance the machine/technology theory offered by Hornborg – are irrelevant. Rather, it would seem more plausible that there are several mechanisms at play in the real world that have generated and maintain the rifts which evidently exist, of which the structural theory very well could reflect one of those mechanisms.

General ecographic findings

Apart from addressing the hypothesis concerned with the structural theory of ecological unequal exchange, the two empirical chapters yield a number of findings, both substantially and methodologically, which are interesting by themselves. National biophysical trade balances are calculated for fuel commodities and primary agricultural commodities, respectively, contrasted with the more conventional monetary trade balances. Structural roles (positions) are identified and populated by the nations of the world, and relationships between (and within) these roles are identified and mapped – for both the monetary and biophysical dimensions of world trade in these goods. Network centrality indices for the various nations (as well as for whole positions) are calculated using a novel centrality heuristic that is developed with the neoclassical all-with-all assumption and the, evidently, high density of global trade networks in mind. While these results constitute steps on the way towards testing

the core hypothesis, these results are by themselves interesting and worthy of further elaboration.

In what follows, the more general findings from the fuel and agricultural commodity studies will be discussed. This will be followed with a discussion on whether, and how, the structural theory of ecological unequal exchange is reflected in the empirical analyses in this thesis.

On monetary and biophysical trade balances

For both fuel and agricultural goods, national net flows of value and biophysical resources (energy content and direct cropland hectares, respectively) are overall unidirectional: a net outflow of energy or hectares does in general imply a net outflow of value, and vice versa. This is particularly true for fuel commodities where there is more or less a linear relationship between the monetary and biophysical trade balances. The only exception is China: as a minor net importer with respect to exchange value, China is nevertheless a net exporter of energy, reflecting a system-wide cost-energy differential between coal vis-à-vis crude oil (and derivatives thereof). As there are differences in utility between solid and liquid fossil fuels, combined with differences in total geological availability, such overall price differences are hardly surprising.

Although a complete analysis of non-compensated net transfers of biophysical resources must cover the complete spectrum of various traded commodities, including trade in non-physical goods and services, contradirectional flows of value and hectares do reveal, for the chosen agricultural commodities, occurrences of this somewhat primitive conceptualization of ecological unequal exchange. Thus, when France, Colombia, Costa Rica, Panama, El Salvador, New Zealand, South Africa, Kenya, Chile, Kyrgyzstan, Togo, Hungary and Cyprus are agricultural net exporters as measured in value, while simultaneously being net importers of hectares, these countries are at the receiving end of ecological unequal exchange (for the specific agricultural goods covered in this study). Similarly, Romania, Sudan and Russia are at the other side: albeit exporting more hectares than what they import, they are still net importers in a monetary sense. Nevertheless, as this study only covers two types of commodities, chosen on the basis of being adequate representations of the third Ricardian production factor, any would-be conclusions regarding this net-transfer-type of ecological unequal exchange is only valid for the specific commodities. As ecological unequal exchange in this thesis is conceptualized differently, the net flow results calculated in this thesis can, at best, only contribute partially to a would-be complete mapping and quantification of global ecological unequal exchange.

For both commodity types, about a third of the countries are net exporters, value- as well as resource-wise, and in both commodity networks, a very pronounced net exporter exists. Energy exports from Saudi Arabia are more than double the energy exports from Russia, the second largest gross exporter, whereas USA and Japan are extremely important importers of energy: albeit USA exports a small share, its net imports are enormous. For agricultural goods, USA is once again a very important player, though this time found at the bottom of the trade balance list. Albeit being a significant importer of foreign hectares, gross exports from USA are so enormous that its net exports are almost twice as large as those of Argentina, the second largest net exporter of hectares. As a developed high-income country, USA is quite the exception as most of the post-industrial developed economies are found at the top of the list, with Japan being the largest net importer, hectare- and value-wise.

The dominance of a few significant actors reveals vulnerabilities in both types of trade networks. Without Saudi exports of fossil fuel, a very large portion of global trade in energy would simply vanish. Without the agricultural exports from USA, a very large share of globally traded hectares would disappear. While the latter might be counterintuitive with respect to how global distribution and appropriation of cropland hectares is perceived within political ecology, USA as a feeder-of-the-world would actually be even more pronounced if indirect land areas were included in these figures. This “biophysical Leontief paradox” can either be ignored, following the example set by neoclassical economics with respect to the original Leontief paradox, or it could be addressed further, even though – or rather, especially since – it contradicts a standard perception on ecological imperialism within political ecology.

On a per-capita basis, Singapore is the largest net importer of energy, and the United Arab Emirates is the largest per-capita net exporter. For agricultural goods, Denmark, Belgium-Luxembourg, and Cyprus are the largest per-capita net hectare importers, each with approximately 2,400 square meters per capita. However, the prices these countries pay for their hectare net imports varies: Belgium pays twice as much as Denmark for each hectare imported, whereas Cyprus actually obtain a net revenue from its trade in agricultural goods. Argentina and Australia have the largest per-capita net export of hectares, but the net revenues these countries gain from their net exports are at parity with those of Panama and Ecuador, the latter whose per-capita imports and exports of hectares are approximately equal (i.e. where gross exports of hectares are at parity with their gross imports).

In the empirical chapters, possible brokers were conceived as countries whose gross flows are larger than their net flows, i.e. reflecting a typical middle-man position. Among the net importers of fuel commodities, Singapore, the Netherlands, Denmark and China have such trading profiles. However, as the analysis in chapter 7 aggregates four different, somewhat non-substitutable fuel commodities, to exchange coal for crude oil can only be seen as brokering in a thermodynamic sense: notably, China is an exporter of coal while importing crude oil. However, for Netherlands and Singapore, the analysis does indicate that these act as brokering gateways. Incidentally, both these countries benefit from this trade: looking at value-per-joule, these countries pay less per imported joule than the revenue they obtain per exported joule.

In the case of agricultural commodities, slightly more countries have these typical broker trading profiles (i.e. where gross imports and exports, respectively, are larger than the net flows). Looking at (value-wise) net importers, Spain, Indonesia, Turkey, Greece, Romania, and Azerbaijan have such trading profiles, whereas the net-exporters Cyprus, Hungary, Chile, and South Africa have similar trade profiles. For the most significant of these countries – Spain – the value-per-hectare cost ratios for imports vis-à-vis exports is very beneficial, but for several others, the ratio is actually detrimental. Still, these aggregate figures do however contain far more commodity types, arguably less substitutable with each other, so brokering in this regard does not necessarily say that much.

In general for agricultural goods, the linearity between the monetary and the hectare trade balances are less pronounced than what is the case for fuel commodities. A handful of countries are actually net earners in their trade in agricultural goods, while simultaneously being net importers of hectares. Apart from China, whose data coverage on crude oil nevertheless is a bit low, the net flows of value and energy content all occur in the same direction for all countries in the study.

On measuring centrality

The national trade balances discussed above constitute a specific measure of centrality known as degree centrality. For dichotomous network datasets, i.e. where ties either are present or absent, degree centrality is calculated by counting the number of ties an actor has to other actors. In valued datasets, degree centrality is calculated by adding the values of these ties, which is precisely how the national trade balances in the empirical chapters were calculated. Degree centrality does have its usages, but the notion of centrality can have a variety of interpretations and meanings: choosing an adequate centrality measure when analyzing a dataset should thus reflect how centrality is conceptualized in the particular dataset under study.

Most of the already-established centrality measures are however only applicable to dichotomous network data, not valued data such as found in trade flow matrices.²⁰⁹ To dichotomize a valued dataset, either using a specific cutoff value or simply by treating all existing trade flows as ties, is however quite problematic. The dichotomization dilemma implicitly put all actors on “equal footing”: as it is erroneous to assume that every country trade the same total volumes, it is quite impossible to use a system-wide absolute value to define and identify what a significant trade flow actually is.

The commodity flow network of the world is very connected, with a large share of all possible bilateral trade ties actually existing. This high degree of connectivity could imply few opportunities for “betweenness”, i.e. actors acting as brokers between others: apparently, judging by the high connectivity, countries do not seem forced to trade with a few partner countries. Therefore, based on the mere existence of all these bilateral trade flows, one could indeed argue that the world-economy must be a perfect market in the neoclassical sense. Such an argument must, however, ignore that the value span between these bilateral trade flows is very large: some actors trade very large volumes, whereas others trade very small volumes. To dichotomize this type of data would be insensitive to these enormous variations in local as well as global views on significant trade ties, undermining any would-be interpretations of results obtained from the more established centrality heuristics.

The centrality index presented in this thesis measures to what extent the imports (exports) of a country are balanced among global exporters (importers). A country whose imports (exports) are spread among global exporters (importers) in proportion to how much these partner countries export (import) in total, is thus deemed as central with respect to its imports (exports). Similarly, a country whose imports (exports) from other countries is not in balance with these partner countries’ contribution to global exports (imports) is subsequently deemed as not-so-central with respect to its imports (exports). Named the Balance Distribution Deviation (BDD) index, the proposed centrality index thus measure to what degree the trade

²⁰⁹ Introduced by Douglas White, the flow betweenness centrality index does however implement a notion of centrality that is designed specifically for valued trade flow data. Although not analyzed further in this thesis, it can nevertheless be noted that this particular index suffers from the same type of value dwarfing which many network-analytical methods dealing with valued networks suffer from. This, however, is not a general drawback with flow betweenness: it all depends on how the notion of centrality is conceptualized. Measuring centrality based on strength-of-ties is interesting in certain situations, but the notion of centrality as used in this thesis is rather focused on patterns-of-ties. As the hypothesis is tested by comparing the centrality index scores with cost *ratios* of imports and exports for all countries, rather than absolute flows, a notion of centrality that captures patterns-of-ties, rather than strength-of-ties, is more relevant in this particular context. If ecological unequal exchange instead was conceptualized in the more traditional sense, i.e. as net transfers of biophysical resources, instead of the Emmanuelian factor-cost variety proposed in this thesis, flow betweenness could indeed be a viable method for measuring broker-related centrality in our trade flow matrices.

vectors of a country deviate from the optimally balanced distributions of its trade ties with total imports and exports for all countries. Based on the assumption of perfect competition, i.e. where each pair of countries has the option to engage in trade with each other, I argue that this notion of centrality is applicable for the particular datasets analyzed in this thesis as it has an implicit bearing on the basic neoclassical assumption of perfect markets – as well as dependency as reflected in trade partner concentration.

Being a novel index, applicable to network data with huge internal value spans, I daresay that the proposed heuristic yields results that seem reasonable and intuitive. For the fuel commodity dataset, Saudi Arabia is identified as the most central exporter, followed by (in order) Kuwait, USA and Iran. Although Saudi Arabia indeed is the largest net and gross exporter of fuel commodities, the rank order of the other export-central countries reveals that the BDD index apparently is independent from the degree centrality, i.e. the national trade balances. Similarly, for agricultural goods, Brazil is a more central exporter than USA, even though the net exports from USA are vastly larger than those of Brazil. As the heuristic measure trade flow significance on a per-actor basis, it does not suffer from the dichotomization dilemma mentioned above that the classical centrality indices suffer from. I thus argue that these national centrality indices calculated in the two chapters constitute a novel set of national attributes that can be used as adequate measures of centrality in a world trade context.

It is however noticeable that the correlation between BDD centrality scores and occurrences of ecological unequal exchange is weak at best, and inverse at worst, but I argue that the implications of this non-correlation has bearing on the hypothesis rather than the centrality index. Conceptions do indeed precede and govern measurements: as the centrality heuristic is based on conceptions of perfect markets, tailor-made for measuring a relevant aspect in our datasets, a disproved hypothesis does not necessarily imply that the measurement and calculation procedure is flawed, but it could simply be that the hypothesis does not hold using this particular notion of centrality. Of course, it could also just as well be that the hypothesis does not hold at all.

On role-structural mapping

Regarding regular role-analysis, the REGE role-identification algorithm used in this thesis is not novel in any way, and neither is it the first time it has been used in world-systemic contexts (see chapter 5). The role-structural analyses in this thesis do however contain some novel features, methodologically as well as substantially. To begin with, the structural analysis of trade flows from a dual perspective – monetary- and biophysical-wise – is, to my knowledge, a novel approach that makes it possible to compare and contrast the ecological and the economic – the material and the mental. Secondly, using an Anova density method to formally determine the optimal number of different roles that exist in a network also differs from previous world-system-oriented role-analyses (see chapter 5), studies where the number of role-sets were heavily influenced by the somewhat pre-analytical idea of a world-system divided into three, role-specific stratum. However, as this thesis looks exclusively at a relatively small selection of commodities, i.e. a small part of a world-economy that only constitute one, albeit important, layer of the contemporary world-system, notions such as core and periphery as used in these analyses only make sense as part of a formal taxonomy to describe network structures in general. Put differently: as the structural analyses in this thesis are explicitly focused on a handful of specific commodities, excluding the other economic and non-economic structures and dynamics that characterizes the modern world-system, there

are no inherent obligation to follow the theoretical assumptions of a trimodal world-system on the sets of “cores” and “peripheries” found in the specific structural maps in this thesis.

Using a novel heuristic for identifying and measuring relations between (and within) role-equivalent sets, the structural maps found in chapter 7 and 8 depict how the various roles in these two primary commodity networks relate to each other. Specified elsewhere (Nordlund 2007), this heuristic is, similar to the BDD centrality index (see chapter 4), sensitive to the large value spans typically found in trade flow data. The structural maps found in chapter 7 and 8 thus exemplify a novel and improved way to operationalize and map the structures of valued network data, whether trade-related or otherwise.

The substantial results from the role-analyses in the two empirical chapters are quite intriguing, raising several interesting follow-up questions. For the economic exchange of fuel commodities (see Figure 7.6), the hub (or core) consists of the largest net importers, including the two, previously identified, brokers of the Netherlands and Singapore. Intra-core trade is substantial, even though these countries (with the exception of Great Britain during this period) are significant net-importers. Economy-wise, the net-exporting countries are however located in what can be interpreted as a semi-peripheral position: whereas its huge exports mainly go to the core countries, intra-positional trade does exist, although at a lower intensity than what is the case for the core countries.

However, if we map the fuel exchange structure from a thermodynamic perspective (see Figure 7.9), the developed net-importers are actually semi-peripheral, whereas the net-exporters occupy the most central, core-like position. Interestingly, the Netherlands is actually positionalized as an energy-wise core. Thus, whereas the economy of international fuel trade seems to revolve around a few developed net-importing countries, as such reflecting a demand-driven world market, the international energy metabolism revolves, not surprisingly, around the net-exporting countries of the world.

The structure of global trade in primary agricultural goods differs from its fuel commodity counterpart. Two core positions are identified in the agricultural value flow network: USA is identified as having a unique role, and a second core position contains countries that trade extensively with each other, with large gross imports and exports resulting in a slight net-export of agricultural commodity values for the position at large. Contrary to the fuel commodity structure, net-importers (value-wise) of primary agricultural goods are rather somewhat semiperipheral, which gives an overall impression of a supply-driven trade structure. However, a position containing the classical cash crop countries in Latin America, and Tanzania, Uganda and Zimbabwe, are located in a non-core position (see Figure 8.13). While trade between the countries in this position is weak, the position has a positive trade balance as their export revenues exceed import costs.

Turning to the structure of hectare flows, a total of six unique roles are identified (see Figure 8.16). The core position contains USA and seven other net-exporting countries. A “semi-core” can also be observed in this structural analysis of global hectare flows: with intra-positional trade being significant enough to yield a regular self-tie for this position, net imports to this position are on parity with the net exports from the other core containing USA et al. Thus, whereas the roles of several countries in the fuel trade network changed depending on whether a monetary or energy filter was applied, the monetary and hectare-wise core in the agricultural goods trade network are held by more or less the same net-exporting countries.

Role-structural analyses and the structural maps for the monetary and ecological dimensions of trade networks can thus yield quite different results. Whereas the *economy* of global fuel trade revolves around the largest net-importers, the energy flow structure revolves around the net energy exporters of the world. Using the lingua of Gereffi (see chapter 6), the structure of global trade in fuel commodities thus seems to be buyer-driven. For agricultural goods, however, the monetary and biophysical structures are more similar, though this time with the net exporters, value- as well as hectare-wise, positioned in the core. Contrary to the fuel trade structure, global trade in primary agricultural goods instead seems to be seller-driven. Similar to what Friedrich List argued, as well as what the post-war studies on deteriorating terms of trade showed (see chapter 2), there seems to be something special about global trade in foodstuffs.

Intriguing results notwithstanding, it is strongly advised to apply a fair amount of interpretational modesty when looking at these, and similarly derived, role-structural maps. As was shown far too often by Kick et al in the first attempts to apply network-analysis to world-system contexts, the temptation to draw too grand conclusions is apparently there. Even though three decades have passed since the first initial combinations of network-analysis and world-system analysis, and even though the methods have evolved significantly, we are nevertheless still at the stage when studies such as this are best aimed at predicting our past.

Apart from modesty, there are also technical limitations on possible interpretations. Not only can relatively small anomalies in network data have a noticeable impact on resulting role-partitions and occurrences of role-structural ties, but the actual REGE algorithm, albeit widely used, does have some inherent drawbacks when applied to valued data. In addition, the number of algorithmic iterations to use does affect the resulting measures of role-equivalence and the subsequent partitioning into discrete sets of actors deemed as role-equivalent. The industry standard is to use three iterations of the REGE algorithm, but the basis for this particular number of iterations is, as far as I know, more based on tradition and computational power of the past, than it has to do with the functioning of the algorithm.

On a more substantive note when it comes to interpretational modesty, it is well worth noting that the specific structural maps presented in this thesis only cover a specific period – 1995 to 1999 – and only a selection of all the flows of value and biophysical resources that constitute the contemporary world of global exchange. Likely, these maps say a lot about these specific commodity networks during this period; possibly, these maps reflect the overall structure of the world-economy in the late 20th century; and maybe, these maps could perhaps also tell us something about the structure of the modern world-system at large.

Reflecting the novelty of network analysis and the on-going methodological development within this field, a handful of new approaches have been developed during the time it has taken to write this thesis. One of these frontiers are represented by the work of Aleš Žiberna (2008): by modifying the original REGE algorithm, Žiberna has implemented an alternative version that takes an actor-based perspective on role-equivalence, in effect putting more emphasis on patterns, rather than strengths, of ties when identifying and measuring regular role-equivalence. Another novel innovation is the approach for identifying role equivalence as suggested by Reichardt and White (2007), implementing objective hypothesis testing and methods for identifying the optimal partitions, an approach that already have been successfully applied to world trade data (*ibid.*). Applying these (and other) novel methodological inventions to world-system and ecographic contexts would most likely

underline what Snyder and Kick proclaimed more than 30 years ago, namely that there seems to be a natural wedding between role-analysis and world-system analysis.

On structural positionality and ecological unequal exchange

The structural theory of ecological unequal exchange states that occurrences of such exchanges, depicted as net-transfers of biophysical resources, is related to structural positionality in the world-system. Proposed, and argued to be proven, by Jorgenson in a series of articles, the theory states that countries with more advantageous positions in trade networks are at the receiving end of such exchanges, at the disadvantage of the less-advantageously positioned countries.

Reframing this structural theory in a way that, I argue, is more in line with the original notion of unequal exchange as proposed by Emmanuel (see chapter 6), this updated structural theory of ecological unequal exchange is tested in the two empirical chapters in this thesis. Whereas Jorgenson interprets his statistical results as being in support of this theory of his, a somewhat contrasting picture emerges in the hypothesis testing of this thesis.

Ecological unequal exchange of fuel commodities

In the role-regular analysis of the value flows in the fuel commodity trade network, a small set of developed, post-industrial countries constitute a core position, these countries, and the position as a whole, being very significant net-importers of fuel. The net-exporters of fuel in the world are found in two less core-like positions, containing, respectively, the most significant and less significant net-exporters. Looking strictly at imports, it can be noted that the per-joule import costs are relatively similar among the largest positions, though with very low import costs for several peripheral countries (see below). However, as the net-exporting positions have very little imports, and as net-importing positions have noticeable exports as well, it perhaps makes more sense to look at throughput ratios, i.e. the differences between (per-joule) import costs and export revenues, when examining a would-be relationship between coreness and ecological unequal exchange at the receiving end.

The (value-wise) core in the fuel exchange structure, containing nine highly significant net-importing developed countries, has a beneficial throughput ratio. The second largest net-importing position, containing the rest of the developed world (as well as several less-developed countries), also has a throughput ratio that is noticeable beneficial. As net-imports to the largest net-exporting position are quite insignificant, its relatively balanced throughput ratio does not really tell us that much, but it can be noted that the per-joule export revenues for the countries endowed with fossil fuels are lower than corresponding figures for the net-importing position. For the second largest net-exporting position, clearly identified as a periphery in the structural mapping, the throughput ratio is indeed detrimental.

Coreness is thus characterized by beneficial throughput ratios, whereas peripheralness seems, albeit slightly less pronounced, to be correlated with detrimental throughput ratios.

Still, the picture that emerges is definitely not as clear as the theory posits. Although the data quality for certain less-developed countries can be put into question, it can be noted that the per-joule import costs for several of these countries are remarkably low. Furthermore, even though the second largest net-exporting position is peripheral and has a detrimental throughput ratio, the throughput ratio for the position containing the bulk of significant net-exporters is actually quite balanced – bearing in mind that its gross imports are quite insignificant. Still, it can definitely be noted that per-joule export revenues differ substantially

between core and periphery in the structure of fuel value commodity trade: whereas per-joule exports from the major net-exporting position is quite low, the per-joule costs of energy re-exports from the core seem to be significantly marked-up.

Turning our attention to the would-be relationship between centrality (as measured using the BDD heuristic) and occurrences of ecological unequal exchange in fuel commodities, the results from this analysis turns out to be partly contradictory to the stated hypothesis. According to the hypothesis, as well as the previous reasoning on exchange structures, we should expect that import-centrality would correspond to lower per-joule import costs, and that export-centrality would correspond to higher per-joule export revenues. There are, however, no clear correlance between per-joule import costs and import centrality, and the relationship between per-joule export revenues and export centrality is even blurrier. One trend that however can be observed is one of price stability: countries that are more central seem to experience similar per-joule import costs. However, the lowest per-joule import costs are actually experienced by not-so-central countries (import-wise). Regarding any would-be relationship between export-centrality and per-joule export revenues, the only discernable result that can be observed is actually inverse to the stated hypothesis: the largest net-exporters are more export-central than the rest of net-exporting countries, but it is noteworthy that the former, on average, actually obtain less income per exported joule than the latter, i.e. quite contrary to the structural theory of ecological unequal exchange.

Ecological unequal exchange of primary agricultural commodities

The structural core in the global trade network of primary agricultural goods consists of the largest EU countries, as well as a handful of other countries around the world: Argentina, Australia, Brazil, Canada, China, Colombia, Indonesia, India, Philippines, and Thailand. Indicative of core status, there are significant amounts of intra-positional trade between the countries in this position which, on an aggregate level, is a minor net-exporter of agricultural commodity value. Remaining at the aggregate level for this core position, its throughput is slightly detrimental, but only a third of these countries have detrimental throughput - Germany, Great Britain, and the Netherlands, as well as Argentina, Australia, and Canada – whereas the remaining twelve countries in the core experience beneficial throughput ratios.

USA plays a very unique role in the trade network of primary agricultural commodities, placed in its own singleton position that perhaps best can be described as a twin-core. Although there are significant inflows to USA, it is first and foremost an exceptionally large exporter, value- and hectare-wise. As an imported hectare costs significantly more than the revenue obtained for an exported hectare, its core-like position is only related to ecological unequal exchange for the selected goods at the non-receiving end, i.e. inverse to the stated hypothesis on ecological unequal exchange.

Almost all of the classical cash-crop-exporting economies are found in a position that best can be described as peripheral. With a singular strong regular tie to the core position and with low volumes of intra-positional trade, this peripheral position nevertheless experience very beneficial throughput ratios. Although a few of these individual countries experience detrimental throughput ratios – Bolivia, Romania, Paraguay, and Uruguay – the majority of these peripheral countries pay less for each imported hectare than what they earn per exported hectare. As a distinct net-exporting position, its experience of ecological unequal exchange, as defined in this thesis, is overall of a beneficial kind for the commodities covered in this study.

Another similarly peripheral position contains an assortment of developed and less-developed countries, a position that is primarily a net-importer. Albeit its exports are relatively insignificant, its throughput ratio is definitely detrimental.

When focusing explicitly on per-hectare import costs, it can be noted that the core-position, including USA, pays a lot more than the more peripheral positions pay per hectare. However, the peripheral position mentioned above, containing the mix of developed and less-developed countries, pay, on average, relatively much per imported hectare. For the countries in this particular position, it can be noted that the developed ones, such as Finland, Switzerland, Sweden, Norway, and Singapore, pay more per imported hectare than the per-hectare import price paid by the less-developed countries, such as Azerbaijan, Belarus, Bangladesh, etc. These indications run counter to what could be expected from both the hypothesis as well as a general intuitive understanding of non-compensated biophysical resource flows within political ecology.

Overall, the results yield no clear trends that indicate whether there is a relationship between structural positionality and ecological unequal exchange of primary agricultural goods, but most indications point to the opposite of what the hypothesis assumes. Core-ness in the global trade network of primary agricultural goods equates with net-exporting countries that, on a positional level, experience detrimental throughput ratios. Peripheries in this structure, representing both net-importing and net-exporting positions and countries, have both detrimental and beneficial throughput ratios. Particularly, it can be noted that typical cashcrop-exporting countries, albeit being quite peripheral in the trade structure, have very beneficial throughput ratios, i.e. where the per-hectare export revenues exceeds the per-hectare import costs. It is true that a majority of the countries in the core position experience beneficial throughput ratios, but for the position as a whole, including the core-sibling net-exporting USA, the throughput ratio is clearly detrimental. Combining these findings, they do rather support the inverse of the thesis hypothesis, i.e. that an advantageous position in the world trade structure does relate to ecological unequal exchange, but in a way that is detrimental, rather than beneficial, to the advantageously positioned.

The centrality analyses for the primary agricultural trade networks also yield no support for the hypothesis, i.e. that a more central country is on the receiving end of ecological unequal exchange. Although no clear trends can be found in the analysis, on average, import-centrality implies relatively higher per-hectare import costs than what is the case for less import-central countries. Regarding export-centrality, the trends are even weaker, indicating no relationship whatsoever between export-centrality and per-hectare export revenues. Comparing the 30 largest net-exporters with the remaining ones does however yield a difference: the former are more central than the latter, but the former do also obtain less revenues per exported hectare than what is the case for the latter. It can also be noted that the traditional cash-crop-exporting countries, notably the Fruitbelt countries in Latin America, combine low export-centrality scores with high per-hectare export revenues, as such indeed being quite inverse to what the hypothesis states.

Summary discussion on the results regarding the thesis hypothesis

In the case of fuel commodities, there are notable indications that indeed support the structural theory of ecological unequal exchange. On a per-joule basis, export revenues exceed import costs for net-importing core countries, whereas peripheral net-exporting countries either have a balanced or detrimental throughput ratio. This buyer-driven structure thus appears to benefit the large net-importing developed countries in the core: even though

they have few, if any, endowments of fossil fuels, their coreness correlates to a significant mark-up in prices for the energy that passes through, and flows within, the core.

Whereas the results lend support for the modified structural theory of ecological unequal exchange in the case of fuel commodities, the corresponding results for primary agricultural commodities mainly point to the inverse of the hypothesis. Whereas the core countries on average pay more per imported hectare than what they earn per exported hectare, the most beneficial throughput ratios are actually to be found in the peripheral positions. Nevertheless, in support of the hypothesis, a majority of the individual countries found in the core do actually have beneficial throughput ratio, but with the significant detrimental throughput ratio of USA, uniquely positioned in what best can be described as a sibling core, the overall interpretation of the agricultural commodity study is actually inverse to what is stipulated by the hypothesis.

Even though neither of the interpretations for respective commodity types are wholly waterproof, they do underline what seems to be a principal difference between these two types of primary goods. As this analysis only contains two types of primary commodities, it cannot be determined which of these two commodity types that reflect a would-be general relationship between structural positionality and factor cost differentials, if any such general relationship exists at all. Still, from a classical political-ecological perspective, the results from the empirical analyses in this thesis reinforces what both Friedrich List, Hans Singer et al noted, i.e. that world trade in primary agricultural goods seems to be governed by other laws and with different outcomes for trade-participating countries than what is the case for other commodities.

In particular, for both fuel and primary agricultural goods, the correlation between centrality (as measured using the novel BDD heuristic) and factor costs is especially weak and, at times, inverse to the hypothesis. This could simply reflect a deficiency with the proposed heuristic, i.e. that it simply cannot capture a notion of centrality that is of relevance in structures of exchange, and indeed, the heuristic has to be tested and evaluated further before it, possibly eventually, can be used and interpreted with more confidence. Nevertheless, my argument is that the centrality heuristic in question does indeed capture a notion of centrality that is of relevance in an exchange-structural context, as it is explicitly concerned with what Condliffe called “alternative outlets”, findings from global commodity chain analysis, and how cores and peripheries are specified by Meier et al, all this while simultaneously taking an actor-based perspective on the significance of trade ties. If this argument of mine holds, it would imply that centrality in exchange structures is not related to ecological unequal exchange as conceptualized in this thesis.

Despite these findings, it has to be stressed what these analyses look at and how ecological unequal exchange is defined in this thesis. I believe there is little doubt that exchange on the global market facilitates occurrences of non-compensated net transfers of resources between different parts of the world, as proven, for instance, by the simple open-your-fridge test. Albeit such a primitive conceptualization of ecological unequal exchange, i.e. depicted as mere net-transfers of biophysical resources (as reflected in national data on biophysical consumption, such as EF figures), very well could correlate to the structural positions identified and the centrality indices calculated in this thesis, the Emmanuelian conceptualization of ecological unequal exchange that explicitly look at cost differentials for the third Ricardian production factor only partly conforms to the stated hypothesis.

Furthermore, once again, it has to be stressed what the analytical results are based upon, i.e. commodity flow data for a selection of different fuel and primary agricultural commodities for the 1995-1999 period. Whether different commodity categories and a different time period would result in different results does, of course, need additional research, particularly for other time periods, similar to the time-series studies of Smith and White (1992) and Mahutga (2006).

Concluding words

At the end of the 19th century, the research interests of George Crisholm and Russell Smith laid the foundations for the academic discipline of economic geography. Separating itself from the science of economics, an academic field that, even in these historical times, abductively turned more and more to its own models and techniques, the art of economic geography was explicitly theory-wary and primarily descriptive. By combining two perspectives – that of economics, and that of geography – a brand new scholarly canvas materialized on which brand new ideas could be painted, using several different brushes and techniques.

In a similar vein, the combination of world-system analysis and ecological economics has generated a new scholarly perspective, containing a canvas that stretches across the Cartesian divide. With the world-systemic explicit disregard for existing social-scientific disciplinary boundaries, combined with the interface between the social and the material provided by ecological economics, a plethora of possible research questions that previously were quite impossible to ask have now been made possible. Sharing several conceptual overlaps, the combination of world-system analysis and ecological economics has turned out to be a successful wedding.

This thesis is concerned with a concept that has become something of a cornerstone in this new scientific cross-breed: ecological unequal exchange. Building on the structural theory of ecological unequal exchange as proposed, and argued to be proven, by Andrew Jorgenson, this thesis approaches and conceptualizes this theory slightly differently. First, it utilizes a set of quantitative tools from social network analysis in order to operationalize and measure the somewhat elusive idea of structural advantage. Whereas the tools for identifying structural roles are well-established, having been applied to world-system contexts several times, this thesis also proposes a novel heuristic for measuring centrality in trade networks. Secondly, instead of looking at national attributes concerned with biophysical consumption, argued to reflect occurrences of net flows of biophysical resources between various countries, the conceptualization of ecological unequal exchange as used in this thesis is, I argue, more faithful to the original formulation of Arghiri Emmanuel. Rather than depicting ecological unequal exchange as mere non-compensated net flows of biophysical resources, ecological unequal exchange and the structural theory thereof is in this thesis concerned with factor cost differentials. Explicitly looking at two types of primary commodities, argued to reflect an oft-forgotten Ricardian production factor, the structural theory of ecological unequal exchange in this thesis is recast as a theory about factor cost differentials among various national segments of global commodity chains. Subsequently, the thesis hypothesis states that such differences depend on structural positionality within trade networks, as reflected in network-analyses of such networks, where advantageously positionalized countries have lower import costs and/or higher export revenues than countries that are positionalized less advantageously.

The hypothesis is partly supported in the empirical analyses of this thesis. For fuel commodities, there are several indications that support the hypothesis, i.e. that structural advantage is related to ecological unequal exchange at the receiving end. For primary agricultural goods, the hypothesis does not hold – on the contrary, there are indications of an inverse relationship. This substantial difference between the two commodity types – fuel and primary agricultural goods – is also reflected in the structural maps obtained from the analyses: where global fuel exchange seems to revolve around the major net-importing countries, the primary agricultural trade structure has a dual core containing an exceptionally large net-exporter – USA – that points to something that best can be described as an ecological Leontief paradox.

The results in this thesis do not necessarily contradict the findings by Jorgenson (and others). There could very well be a correlation between the structural-positional results calculated in this thesis and national attributes reflecting biophysical consumption (such as the GFN-based national Ecological Footprint indices) – such a would-be correlation is not addressed in this thesis – but for the Emmanuelian conceptualization of ecological unequal exchange, there is no support for a would-be general relationship as stipulated by the thesis hypothesis.

In addition to addressing the hypothesis, this thesis has yielded other results for the two commodity types studied here, such as economic and ecological structural maps of trade networks, biophysical trade balances, centrality scores, and factor cost data. Although these ecographic results constitute steps towards addressing the core hypothesis, they are interesting per se, hinting at several possible follow-up-questions and research avenues, both substantially and methodologically.

With partial support for the hypothesis, it seems imperative to conduct further studies where the structural theory of ecological unequal exchange is tested. Apart from studying other time periods than the 1995-1999 one, it would make sense to have a look at other primary commodities, either individually or aggregated into broader commodity groups, using various non-monetary units of accounting. It would perhaps also be interesting to relate a structural theory of unequal exchange to another factor of production not covered in this study: capital goods. Having its own division in the SITC nomenclature, it would however be somewhat problematic to convert capital flows into sensible biophysical measures.

Still, it is of utmost importance to remember what the structural theory of ecological unequal exchange, whether as formulated here or by Jorgenson, actually is: a theory. As such, it may very well be proven to be false. If it eventually turns out to be difficult to build a meaningful theory of ecological unequal exchange, structural or otherwise, or even to measure its occurrence on a more formal non-fridge-based way, this is definitely nothing that could, or should, undermine the novel research field opened up by the combination of world-system analysis and ecological economics at large. Whereas Wallerstein more or less defines cores and peripheries on the basis of a somewhat elusive notion of unequal exchange, I argue that the Chase-Dunnian way is the way to go in the ecological context: cores and peripheries in the world-*ecology* are just as relevant and interesting without actual occurrences and measures of, or a full-fledged theory of, ecological unequal exchange.

Appendix A: Dataset generation and coverage

This appendix specifies how the dataset used in the empirical chapters in this thesis (chapter 7 and 8) were obtained from the Comtrade database.

Comtrade is the world's largest commodity trade database, containing bilateral national trade flow data as reported by national statistical agencies across the world. Maintained and compiled by the United Nations Statistics Division (UNSD), more than one billion commodity flow data records from 1962 and onwards are to be found in the database, with more than 130 countries reporting trade statistics in the year 2003. Aggregate data are published annually in the *Yearbook of International Trade Statistics*, while more detailed data is disseminated through various printed and digital formats as well as through an online web-based query tool²¹⁰.

Published in five-year intervals, the *Personal Computer Trade Analysis System* (PC-TAS) is a CD-ROM containing relatively detailed commodity trade data as well as client software for querying this data. The PC-TAS CD-ROM used in this thesis covers the period 1995-1999, with trade flows coded according to the third revision of the Standard International Trade Classification nomenclature (SITC rev. 3). Similar to other commodity nomenclatures, the SITC nomenclature builds on a hierarchical structure where the detail level increases further down the hierarchy. Figure A.1 below demonstrates how the category Cereals, cereal preparations (SITC 04) is part of a larger commodity division (SITC 0; Food and Live animals), as well as containing several subcategories at the 3-digit SITC level.

SITC n – Main sections	SITC 0n	SITC 04n
0. Food and live animals	00. Live animals	041. Wheat, meslin, unmilled
1. Beverages and tobacco	01. Meat, meat preparations	042. Rice
2. Crude materials, inedible, except fuels	02. Dairy products, birds eggs	043. Barley, unmilled
3. Fuels, lubricants, etc	03. Fish, crustaceans, mollusc	044. Maize, unmilled
4. Edible oils, fats, wax	04. Cereals, cereal preparations	045. Other cereal, unmilled
5. Chemicals, related	05. Vegetables and fruit	046. Meal, flour of wheat, meslin
6. Manufactured goods	06. Sugar, sugar preps., honey	047. Other cereal meals flours
7. Machines, transport equip	07. Coffee, tea, spices	048. Cereal preparations
8. Misc. Manufactured articles	08. Animal feed stuff	
9. Goods not classified by kind	09. Misc edible products, etc	

Figure A.1: SITC main (1-digit) sections and two examples of 2- and 3-digit divisions

The PC-TAS dataset contains commodity data at the 1-, 4- and 5-digit SITC levels, only including trade flows whose economic values are above 50,000 US dollars. Although data at the top (1-digit) level is used to depict overall significance of certain divisions, the trade flow matrices generated and used in the empirical chapters all use data on the 4-, and occasionally the 5-digit, SITC levels.

While the national statistical agencies are asked to report national imports as well as exports, the former type of trade data is generally seen as more reliable and accurate (Durand 1953; Linneman 1966) than reports on export flows. The value of an import flow typically includes cost for insurance and freight (so-called CIF-values) whereas export data usually are expressed as FOB-values (Free on-board). While country A's reported imports from B should be the same as the mirror statistics, i.e. country B's reported exports to A, the differential between CIF- and FOB-values explains parts of the discrepancy usually existing between

²¹⁰ <http://comtrade.un.org/>

mirror data. In the empirical chapters, import values (i.e. including cost for insurance and freight) are used exclusively to compile the analyzed trade flow matrices.

Apart from the economic value of a trade flow, trade flows should also, when applicable and available, be reported as physical quantities. While the values of all trade flows are expressed in the same unit – US dollars – there are a variety of accounting units for physical quantities. Cotton gauze (SITC 6521), for instance, is usually quantified in metric tonnes but there are several countries that instead report their imports in square meters. Likewise, although most countries report the quantity of traded live animals, motor vehicles etc. in metric tonnes, there are countries that instead prefer to quantify these as number of units. For the commodity categories used in this thesis' empirical chapters, all quantities are stated in metric tonnes. These quantities are subsequently transformed into their energy equivalents (in chapter 7 on fuel commodities) and hectares (in chapter 8 on primary agricultural goods).

Although all reported bilateral flows are expressed in terms of their economic values, there are trade flow records that lack data on traded quantities. As the empirical analyses are concerned with both the economic and the biophysical dimensions of global exchange, and the relationships between these two perspectives, the generated trade flow datasets used in this thesis only include trade flows that have data on *both* their exchange value and physical quantity. In the analyses, coverage percentages are calculated that reflect how much of a country's total trade that is discarded, either due to a lack of physical quantity data or due to trade with non-reporting partners (see below).

A total of 100 reporting countries are to be found in the PC-TAS dataset used in this thesis. This set of reporting countries is referred to as the *R-set*. Although a majority of these countries have data for all five years in the period 1995-1999, the number of reported years varies among countries. Figure A.2 below depict how many countries that report certain number of years within this period. As four countries – Benin, Ghana, Nepal, and Sri Lanka – only have data for a singular year in this period, individual results for these countries should be interpreted with care.

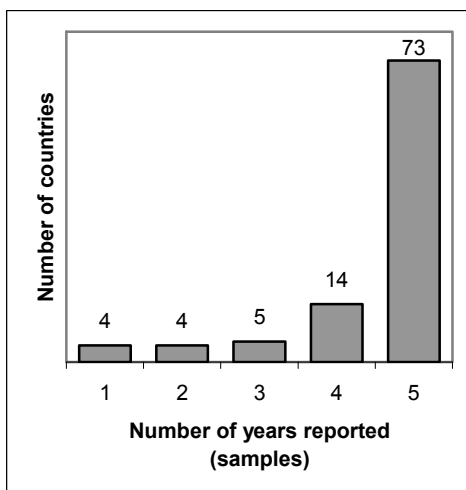

Figure A.2: Number of countries reporting trade data for different number of years

R-set (the set of Reporting countries)

The set of 100 countries which report import and export data to the Comtrade database.

Albania (ALB)	Croatia (HRV)	Indonesia (IDN)	Netherlands (NLD)	Slovakia (SVK)
Algeria (DZA)	Cyprus (CYP)	Ireland (IRL)	New Zealand (NZL)	Slovenia (SVN)
Argentina (ARG)	Czech Rep. (CZE)	Israel (ISR)	Nicaragua (NIC)	Spain (ESP)
Armenia (ARM)	Denmark (DNK)	Italy (ITA)	Niger (NER)	Sri Lanka (LKA)
Australia (AUS)	Dominica (DMA)	Japan (JPN)	Nigeria (NGA)	Sudan (SDN)
Austria (AUT)	Ecuador (ECU)	Jordan (JOR)	Norway (NOR)	Sweden (SWE)
Azerbaijan (AZE)	Egypt (EGY)	Kenya (KEN)	Oman (OMN)	Switzerland ^b (CHE)
Bangladesh (BGD)	El Salvador (SLV)	Korea Rep. (KOR)	Pakistan (PAK)	Tanzania (TZA)
Barbados (BRB)	Estonia (EST)	Kuwait (KWT)	Panama (PAN)	Thailand (THA)
Belarus (BLR)	Finland (FIN)	Kyrgyzstan (KGZ)	Paraguay (PRY)	Togo (TGO)
Belgium ^a (BEL)	France (FRA)	Latvia (LVA)	Peru (PER)	Trinidad Tobago (TTO)
Benin (BEN)	Germany (DEU)	Lithuania (LTU)	Philippines (PHL)	Tunisia (TUN)
Bolivia (BOL)	Ghana (GHA)	Macau (MAC)	Poland (POL)	Turkey (TUR)
Brazil (BRA)	Greece (GRC)	Madagascar (MDG)	Portugal (PRT)	Uganda (UGA)
Brunei Dar. (BRN)	Guatemala (GTM)	Malaysia (MYS)	Romania (ROM)	United Kingdom (GBR)
Canada (CAN)	Honduras (HND)	Malta (MLT)	Russian Fed. (RUS)	Uruguay (URY)
Chile (CHL)	Hong Kong (HKG)	Mauritius (MUS)	South Africa (ZAF)	USA ^c
China (CHN)	Hungary (HUN)	Mexico (MEX)	Saudi Arabia (SAU)	Venezuela (VEN)
Colombia (COL)	Iceland (ISL)	Moldova Rep. (MDA)	Senegal (SEN)	Yugoslavia (YUG)
Costa Rica (CRI)	India (IND)	Nepal (NPL)	Singapore (SGP)	Zimbabwe (ZWE)

NR-set (the set of Non-Reporting countries)

The set of 120 non-reporting countries (and national enclaves) which only appear in the database as partners to reporting countries.

Afghanistan	Christmas Island	Greenland	Micronesia	Somalia
Andorra	Cocos Islands	Grenada	Mongolia	S:t Helena
Angola	Comoros	Guadeloupe	Montserrat	S:t Kitts and Nevis
Anguilla	Congo	Guinea	Morocco	S:t Lucia
Antigua Barbuda	Congo D.R.	Guinea-Bissau	Mozambique	S:t Pierre Miquelon
Aruba	Cook Islands	Guyana	Myanmar	Suriname
Bahamas	Cote D'Ivoire	Haiti	New Caledonia	Syria
Bahrain	Cuba	Iran	N. Mariana Isl.	Taiwan (Prov. China)
Belize	Djibouti	Iraq	Nauru	Tajikistan
Bermuda	Dominican Rep.	Jamaica	Netherlands Antiles	Tokelau
Bhutan	East Timor	Kazakistan	Niue	Tonga
Bosnia Herz.	Equatorial Guinea	Kiribati	Norfolk Island	Turkmenistan
British Ant. Terr.	Eritrea	North Korea	Palau	Turks Caicos Islands
British Ind. Oc. Terr.	Ethiopia	Lao	Papua New Guinea	Tuvalu
British Virgin Island	Faeroe Islands	Lebanon	Pitcairn	Ukraine
Bulgaria	Falkland Islands	Liberia	Qatar	United Arab Emirates
Burkina Faso	Fiji	Libya	Reunion	US Pac. Terr.
Burundi	French Guiana	Macedonia Rep.	Rwanda	Uzbekistan
Cambodia	French Polynesia	Malawi	S:t Vincent Gren.	Wallis and Futuna
Cameroon	French Ant. Terr.	Maldives	Samoa	Vanuatu
Cape Verde	Gabon	Mali	Sao Tome Principe	West Sahara
Cayman Islands	Gambia	Marshall Islands	Seychelles	Vietnam
Central African Rep.	Georgia	Martinique	Sierra Leone	Yemen
Chad	Gibraltar	Mauritania	Solomon Islands	Zambia

Table A.1: Countries appearing in the PC-TAS dataset as divided into reporting and non-reporting countries.

^a: Includes Luxembourg, ^b: Includes Liechtenstein, ^c: Includes Puerto Rico and United States Virgin Island.

The trade flow matrices used in the empirical chapters are mean trade flow values for each reported year, i.e. a floating average. Thus, when it is stated that the imports to country A from country B is 100,000 US dollars, this means that the annual mean flow during the period is 100,000 US dollars, based on the number of existing reported years for the country that reports the import in question. Although the total global trade volumes increased over the period in question, the reported years are nevertheless seen as time-independent samples representing the period as a whole.

With 100 countries (R-set) having reported bilateral trade data, the stated partner countries in this data may very well be with non-reporting countries. These non-reporting countries (NR-set) consists of 120 countries that, although not reporting any imports or exports themselves, are still present in the dataset as trading partners in the bilateral trade flows as reported by the

R-set of countries. In addition²¹¹ to these country-to-country data records, the dataset also contains a *World*-post for each country and commodity, representing the total imports from (or total exports to) all other countries, R-set and NR-set countries alike. The countries in the R- and NR-sets are found in Table A.1 below. For the countries within the R-set, the ISO-standardized 3-letter labels for each country are given; these labels are used as short-hand notations in the structural mappings found in the empirical chapters.

More or less by definition, network analysis is conducted on datasets that contain all possible relations between a given set of actors. Although it is possible to obtain trade flow data between R-set and NR-set countries, based on reported imports and exports of R-set countries, we would not be able to obtain data on trade flows that occur between non-reporting countries. Thus, in order to get a viable and complete dataset to work with, the analyses in this thesis are constrained to the 100 countries that report trade data directly to UNSD/Comtrade, i.e. the R-set of countries.

Aggregating the gross domestic product, the population and the surface area for all countries within the R-set of countries, Table A.2 below compares these figures with global figures for 1998. Judging by these figures, we can conclude that the countries in the R-set represent the bulk of human economic activity and a very large part of the global population.

	R-set	Total*	R-set as % of total
GDP (billion USD)	28,693	29,638	96.8 %
Population (million)	5,089	5,898	86.3 %
Surface area (million km ²)	103.7	133.8	77.5 %

Table A.2: R-set coverage in terms of GDP and population. Source: World Development Indicators 1998 (World Bank), complemented by surface area data from The World Handbook (CIA).

*: Total column represents the 161 countries to be found in World Bank (1998), i.e. less than the 220 countries in Table A.1 above.

²¹¹ Apart from the *World* posts and the 220 countries found in the R- and NR-set, import sources and export destinations can also be represented by any of 12 regional categories (Rest Europe NES, Oceania NES etc), 4 special categories (For ships, Free zones etc), or an *Areas NES* label (where NES stands for Not Elsewhere Specified).

References

- Abel, T. 2007. World-Systems as Complex Human Ecosystems. In Hornborg, A. and Crumley, C. (eds), *The World System and Earth System: Global Socioenvironmental Change and Sustainability since the Neolithic*, pp. 56-73. Walnut Creek, CA: Left Coast Press.
- Amin, S. 1974. *Accumulation on a World Scale: A Critique of the Theory of Underdevelopment*. New York and London: Monthly Review Press.
- Appelbaum, R. P., Smith, D. and Christerson, B. 1994. Commodity Chains and Industrial Restructuring in the Pacific Rim: Garment Trade and Manufacturing. In Gereffi, G. and Korzeniewicz, M. (eds.), *Commodity Chains and Global Capitalism*, pp. 187-204. Westport, CT: Praeger Publishers.
- Ayres, R. U. 1988. *Self-Organisation in Biology and Economics*. Vienna: International Institute for Applied Systems Analysis.
- Bagehot, W. 1880. *Economic Studies*. London: Longmans, Green & Co.
- Bair, J. 2005. Global Capitalism and Commodity Chains: Looking Back, Going Forward. *Competition and Change*, 9(2), pp. 153-180.
- Bairoch, P. 1995. *Economics and World History; Myths and Paradoxes*. Chicago: University of Chicago Press.
- Balassa, B. 1977. *A Stages Approach to Comparative Advantage*. Paper presented at the Fifth World Congress of the International Economic Association, Tokyo, 1977.
- Balassa, B. 1979. The Changing Pattern of Comparative Advantage in Manufactured Goods. *The Review of Economics and Statistics*, 61(2), pp. 259-266.
- Baldwin, R. E. 1971. Determinants of the Commodity Structure of U.S. Trade. *American Economic Review*, 61, pp. 116-146.
- Baran, P. 1957. *The Political Economy of Growth*. New York: Monthly Review Press.
- Baran, P. and Sweezy, P. 1966. *Monopoly Capital: An Essay on the American Economic and Social Order*. New York: Monthly Review Press.
- Barnes, T. J. 1996. *Logics of Dislocation. Models, Metaphors, and Meanings of Economic Space*. New York: The Guildford Press.
- Barnes, T. J. 2003. The Place of Locational Analysis: A Selective and Interpretive history. *Progress in Human Geography*, 27(1), pp. 69-95.
- Barnett, G. A. 2001. A Longitudinal Analysis of the International Telecommunication Network, 1978-1996. *American Behavioral Scientist*, 44(10), pp. 1638-1655.
- Bergesen, A. 1990. Turning World-System Theory on its Head. In Featherstone, M. (ed.), *Global Culture; Nationalism, Globalization and Modernity*, pp. 67-81. London: Sage Publications.
- Bernadelli, H. 1938. The End of the Marginal Utility Theory? *Economica*, New Series, 5(18), pp. 192-212.
- Blanqui, J. A. 1968 [1880] (orig. French ed. 1837). *History of Political Economy in Europe*. New York: Kelley.
- Borgatti, S. P. and Everett, M. G. 1991. Regular Equivalence: Algebraic Structure and Computation. In *Proceedings of the Networks and Measurement Conference*, Irvine: University of California.
- Borgatti, S. P. and Everett, M. G. 1993. Two Algorithms for Computing Regular Equivalence. *Social Networks*, 15(4), pp. 361-376.
- Borgatti, S. P. and Everett, M. G. 1999. Models of Core/Periphery Structures. *Social Networks*, 21(4), pp. 375-395.

- Borgatti, S. P., Everett, M. G. and Freeman, L. C. 2002. *Ucinet for Windows: Software for Social Network Analysis*. Harvard, MA: Analytic Technologies.
- Borgatti, S. P. and Everett, M. G. 2006. A Graph-Theoretic Perspective on Centrality. *Social Networks*, 28(4), pp. 466-484.
- Borgström, G. 1953. *Jorden – Vårt Öde*. Stockholm: Forum.
- Borgström, G. 1962. *Mat för Miljarder*. Stockholm: LT Förlag.
- Borgström, G. 1965. *The Hungry Planet: The Modern World at the Edge of Famine*. New York: Macmillan.
- Borgström-Hansson, C. 2003. *Misplaced Concreteness and Concrete Places: Critical Analyses of Divergent Discourses on Sustainability*. Lund: Studentlitteratur.
- Breiger, R. L. 1981. Structures of Economic Interdependence among Nations. In Blau, P. M. and Merton, R. K. (eds), *Continuities in Structural Inquiry*, pp. 353-380. London and Beverly hills: Sage Publications.
- Brolin, J. 2006a. *The Bias of the World; Theories of Unequal Exchange in History*. Lund: Studentlitteratur.
- Brolin, J. 2006b. *The Bias of the World; Theories of Unequal Exchange in History (extended draft version)*. Available at <http://www.kallebrolin.com/Local%20Images%20Folder/portfoliostills/0TheBiasoftheWorld.pdf> (URL available at the Wikipedia entry on “unequal exchange”)
- Bunge, W. 1966. *Theoretical Geography*. Lund: Royal University of Lund, Dept. of Geography; Gleerup.
- Bunker, S. G. 1984. Modes of Extraction, Unequal Exchange, and the Progressive Underdevelopment of an Extreme Periphery: The Brazilian Amazon, 1600-1980. *The American Journal of Sociology*, 89(5), pp. 1017-1064.
- Bunker, S. G. 1985. *Underdeveloping the Amazon; Extraction, Unequal Exchange, and the Failure of the Modern State*. Chicago, Ill.: University of Chicago Press.
- Bunker, S. G. and Ciccantell, P. S. 1999. Economic Ascent and the Global Environment: World-Systems Theory and the New Historical Materialism. In Goldfrank, W. L., Goodman, D. and Szasz, A. (eds.), *Ecology and the World-System*, pp. 107-122. Westport: Greenwood Press.
- Burghardt, A. F. 1969. The Origin and Development of the Road Network of the Niagara Peninsula, Ontario, 1770-1851. *Annals of the Association of American Geographers*, 59(3), pp. 417-440.
- Burt, R. S. 1994. *Structural Holes*. New York: Academic Press.
- Cairnes, J. E. 1874. *Some Leading Principles of Political Economy Newly Expounded*. New York: Harper & Brothers.
- Cannan, E. 1903 (orig. ed. 1898). *A History of the Theories of Production and Distribution in English Political Economy from 1776 to 1848*. Second edition. London.
- Cantillon, R. 1931 [1755]. *Essai sur la Nature du Commerce en Général*. (English translation by Higgs, H.). London: Macmillan & Co.
- Carley, K. 1991. A Theory of Group Stability. *American Sociological Review*, 56(3), pp. 331-354.
- Castells, M. 2000 [orig. ed. 1996]. *The Rise of the Network Society. Second Edition*. Oxford: Blackwell Publishers Ltd.
- Chambers, N., Simmons, C. and Wackernagel, M. 2000. *Sharing Nature's Interest. Ecological Footprints as an Indicator of Sustainability*. London: Earthscan Publications Ltd.
- Chang, H-J. 2002. Kicking Away the Ladder. In *Post-Autistic Economics Review*, issue no. 15, September 4, 2002, article 3. <http://www.paecon.net/PAEReview/issue15/Chang15.htm>

- Chase-Dunn, C. 1989. *Global Formation. Structures of the World-Economy*. Oxford: Basil Blackwell Ltd.
- Chase-Dunn, C. and Hall, T. 1997. *Rise and Demise; Comparing World-Systems*. Oxford: Westview Press.
- Chase-Dunn, C. and Mann, K. 1998. *The Wintu and their Neighbors: A Very Small World-System in Northern California*. Tuscon: The University of Arizona Press.
- Chisholm, G. G. 1889. *Handbook of Commercial Geography*. London: Longmans, Green & Co.
- Chorley, R. J., and Haggett, P. 1968 [hardcover 1967]. *Socio-Economic Models in Geography*. London: Methuen.
- Condliffe, J. B. 1940. *The Reconstruction of World Trade*. New York: Norton.
- Condliffe, J. B. 1950. *The Commerce of Nations*. New York: Norton.
- Corden, W. M. 1971. *The Theory of Protection*. London: Oxford University Press.
- Cormack, R. M. 1971. A Review of Classification. *Journal of the Royal Statistical Society. Series A (General)*, 134(3), pp. 321-367.
- Costanza, R., Cumberland, J., Daly, H., Goodland, R. and Norgaard, R. 1997. *An Introduction to Ecological Economics*. Boca Raton, FL: CRC Press Lcc.
- Costanza, R. 2000. The Dynamics of the Ecological Footprint Concept, *Ecological Economics*, 32, pp. 341-345.
- Dahlström, K. and Ekins, P. 2006. Combining Economic and Environmental Dimensions: Value Chain Analysis of UK Iron and Steel Flows. *Ecological Economics*, 58(3), pp. 507-519.
- Daly, H. 1996. *Beyond Growth: The Economics of Sustainable Development*. Boston, MA: Beacon Press.
- de Janvry, A. and Kramer, F. 1979. The Limits of Unequal Exchange. *Review of Radical Political Economics*, 11(4), pp. 3-15.
- de Marchi, N. Anomaly and the Development of Economics: The Case of the Leontief Paradox. In Latsis, S. J. 1976. *Method and Appraisal in Economics*, pp. 109-127. Cambridge: Cambridge University Press.
- Denham, W. W. and White, D. R. 2005. Multiple Measures of Alyawarra Kinship. *Field Methods*, 17(1), pp. 70-101.
- Deraniyagala, S. and Fine, B. 2001. New Trade Theory Versus Old Trade Policy: A Continuing Enigma. *Cambridge Journal of Economics*, 25, pp. 809-825.
- Dicken, P. 1998. *Global Shift: Transforming the World Economy*. 3rd edition. London: Paul Chapman Publ Ltd.
- Dixit, A. K. and Stiglitz, J.E. 1977. Monopolistic Competition and Optimum Product Diversity. *The American Economic Review*, 67(3), pp. 297-308.
- Dixit, A. K. and Norman, V. 1980. *Theory of International Trade*. Digswell Place: Cambridge University Press.
- Dixit, A. K. 1986. Trade Policy: An Agenda for Research. In Krugman, P. (ed),. *Strategic Trade Policy and the New International Economics*, pp. 283-304. Cambridge, Mass: MIT Press.
- Doreian, P. 1988. Using Multiple Network Analytic Tools for a Single Social Network. *Social Networks*, 10, pp. 287-312.
- Doreian, P., Batagelj, V. and Ferligoj, A. 2005. *Generalized Blockmodeling*. Cambridge: Cambridge University Press.
- dos Santos, T. 1970. The Structure of Dependence. *The American Economic Review*, 60(2), pp. 231-236.
- Downey, E. H. 1910. The Futility of Marginal Utility. *The Journal of Political Economy*, 18(4), pp. 253-268.

- Durand, E. D. 1953. Country Classification. In Allen, R. G. and Ely, J. E. (eds), *International Trade Statistics*, pp. 117-129. New York: John Wiley.
- Edgeworth, F. Y. 1925. *Papers Relating to Political Economy*. London: Published on behalf of the Royal Economic Society by Macmillan and Co. Ltd.
- Ehrlich, P. 1994. Ecological Economics and the Carrying Capacity of the Earth. In Jansson, A-M., Hammer, M., Folke, C., Costanza, R. (eds.). *Investing in Natural Capital; The Ecological Economics Approach to Sustainability*, pp. 38-56. Washington, D.C.: Island Press.
- Ellsworth, P. T. 1956. The Terms of Trade Between Primary Producing and Industrial Countries. *Inter-American Economic Affairs*, 10, pp. 47-65.
- Emmanuel, A. 1969. *L'échange Inégal: Essais sur les Antagonismes dans les Rapports Économiques Internationaux*. Paris: François Maspero.
- Emmanuel, A. 1972. *Unequal Exchange: A Study of the Imperialism of Trade*. New York & London: Monthly Review Press.
- Emmanuel, A. 1975. Unequal Exchange Revisited. *IDS Discussion Paper*, 77. Brighton: University of Sussex.
- Evans, P. 1979. Beyond Center and Periphery: A Comment on the Contribution of the World System Approach to the Study of Development. *Sociological Inquiry*, 49(4), pp. 15-20.
- Everett, M. G., Boyd, J. P. and Borgatti, S. P. 1990. Ego-centered and Local Roles: A Graph Theoretic Approach. *Journal of Mathematical Sociology*, 15(3-4), pp. 163-172.
- FAO. *ProdSTAT* and *TradeSTAT* database extractions in June 2005. Database available at <http://faostat.fao.org/>
- Faust, K. 1988. Comparison of Methods for Positional Analysis: Structural and General Equivalences. *Social Networks*, 10(4), pp. 313-341.
- Fisher, C. A. 1941. Evolution of the Irish Railway System. *Economic Geography*, 17(3), pp. 262-274.
- Fowler, C., Smale, M. and Gaiji, S. 2001. Unequal Exchange? Recent Transfers of Agricultural Resources and their Implications for Developing Countries. *Development Policy Review*, 19(2), pp. 181-204.
- Frank, A. G. 1967. *Capitalism and Underdevelopment in Latin America: Historical Studies of Chile and Brazil*. 2nd edition. New York: Monthly Review Press.
- Frank, A. G. 1994. The World Economic System in Asia before European Hegemony. *The Historian*, 56(2), pp. 260-276.
- Frank, A. G. and Gills, B. K. (eds.). 1999. *The World System: Five Hundred Years or Five Thousand?* London and New York: Routledge.
- Freeman, L. C. 1979. Centrality in Social Networks: Conceptual Clarifications. *Social Networks*, 1, pp. 215-239.
- Freeman, L. C., Borgatti, S. P. and White, D. R. 1991. Centrality in Valued Graphs: A Measure of Betweenness based on Network Flow. *Social Networks*, 13(2), pp. 141-154.
- Freeman, L. C. 2004. *The Development of Social Network Analysis*. Laguna Beach, CA: BookSurge, LLC.
- Friedmann, H. 1980. Review of The Capitalist World-Economy, by Immanuel Wallerstein. *Contemporary Sociology*, 9(2), pp. 246-49.
- Friedmann, J. and Wolff, G. 1982. World City Formation: An Agenda for Research and Action. *International Journal of Urban and Regional Research*, 6(3), pp. 309-344.
- Fujita, M. and Mori, T. 1996. The Role of Ports in the Making of Major Cities: Self-Agglomeration and Hub-Effect. *Journal of Development Economics*, 49, pp. 93-120.
- Fujita, M., Krugman, P. and Venables A. J. 1999. *The Spatial Economy: Cities, Regions and International Trade*. Cambridge, MA and London: MIT Press.
- Fullbrook, E. (ed.). 2004. *A Guide to What's Wrong with Economics*. London: Anthem Press.

- Fullbrook, E. (ed.). 2007. *Real-World Economics: A Post-Autistic Economics Reader*. London: Anthem Press.
- Galtung, J. 1971. A Structural Theory of Imperialism. *Journal of Peace Research*, 8(2), pp. 81-117.
- Garrison, W. L. 1960. *Connectivity of the Interstate Highway System*. Philadelphia, Pa: Regional Science Association.
- Garrison, W. L. and Marble, D. F. 1962. *The Structure of Transportation Networks*. Evanston, Ill: Transportation Center at Northwestern University.
- Georgescu-Roegen, N. 1971. *The Entropy Law and the Economic Process*. Cambridge, MA: Harvard University Press.
- Gereffi, G., Korzeniewicz, M. and Korzeniewicz, R.P. 1994. Introduction: Global Commodity Chains. In Gereffi, G. and Korzeniewicz, M. (eds.), *Commodity Chains and Global Capitalism*, pp. 1-14. Westport, CT: Praeger Publishers.
- Gereffi, G. 1994. The Organization of Buyer-Driven Global Commodity Chains: How U.S. Retailers Shape Overseas Production Networks. In Gereffi, G. and Korzeniewicz, M. (eds.), *Commodity Chains and Global Capitalism*, pp. 95-122. Westport, CT: Praeger Publishers.
- Gereffi, G. 2005. The Global Economy: Organization, Governance, and Development. In Smelser, N.J. and Swedberg, R. (eds), *The Handbook of Economic Sociology; 2nd Edition*, pp. 160-182. Princeton: Princeton University Press.
- Gereffi, G., Humphrey, J. and Sturgeon, T. 2005. The Governance of Global Value Chains. *Review of International Political Economy*, 12(1), pp. 78-104.
- Graham, F. D. 1923. Some Aspects of Protection Further Considered. *The Quarterly Journal of Economics*, 37(2), pp. 199-227.
- Gudeman, S. 1986. *Economics as Culture: Models and Metaphors of Livelihood*. London: Routledge & Kegan Paul.
- Gudeman, S. 2001. *The Anthropology of Economy: Community, Market, and Culture*. Malden, MA: Blackwell.
- Gylfason, T. and Zoega, G. 2003. *Natural Resources and Economic Growth: The Role of Investments*. CEPR Discussion Paper No. 2743. London: Center for Economic Policy Research.
- Haberler, G., Stonier, A. W. and Benham, F. 1936. *The Theory of International Trade with its Applications to Commercial Policy*. New York: Macmillan.
- Haggett, P. 1965. *Locational Analysis in Human Geography*. London: Edward Arnold Publ. Ltd.
- Haggett, P. and Chorley, R. J. 1969. *Network Analysis in Geography*. London: Edward Arnold Publ. Ltd.
- Halévy, E., Morris, M. and Everett, C. W. 1928. *The Growth of Philosophic Radicalism*. London: Faber & Gwyer Ltd.
- Hanneman, R. A. and Riddle, M. 2005. *Introduction to Social Network Methods*. Riverside, CA: University of California, Riverside (published in digital form at <http://faculty.ucr.edu/~hanneman/>)
- Hardin, G. 1993. *Living within Limits: Ecology, Economics, and Population Taboos*. New York and Oxford: Oxford University Press.
- Hartshorne, R. 1939. *The Nature of Geography. A Critical Survey of Current Thought in Light of the Past*. Lancaster, PA: AAG.
- Harvey, D. 1989. *The Condition of Postmodernity: an Enquiry into the Origins of Cultural Change*. Oxford: Blackwell Publ.
- Hedénus, F. and Azar, C. 2005. Estimates of Trends in Global Income and Resource Inequalities. *Ecological Economics*, 55, pp. 351-364.

- Heintz, J. 2006. Low-Wage Manufacturing and Global Commodity Chains: A Model in the Unequal Exchange Tradition. *Cambridge Journal of Economics*, 30, pp. 507–520.
- Helpman, E. 1981. International Trade in the Presence of Product Differentiation, Economies of Scale, and Monopolistic Competition: A Chamberlinian-Heckscher-Ohlin Approach. *Journal of International Economics*, 11(3), pp. 305-340.
- Helpman, E. and Krugman, P. 1985. *Market Structure and Foreign Trade: Increasing Returns, Imperfect Competition, and the International Economy*. Cambridge MA: MIT Press.
- Henderson, J. V., Shalizi, Z. and Venables, A. J. 2001. Geography and Development. *Journal of Economic Geography*, 1, pp. 81-105.
- Hirschman, A. O. 1992. *Rival Views of Market Society and Other Recent Essays*. Harvard: Harvard University Press.
- Hopkins, T. and Wallerstein, I. 1982. *World-Systems Analysis: Theory and Methodology*. Beverly Hills: Sage Publishing.
- Hopkins, T., Wallerstein, I., Özveren, E. and Pelizzon, S. 1994. Commodity Chains in the Capitalist World-Economy Prior to 1800. In Gereffi, G. and Korzeniewicz, M. (eds.), *Commodity Chains and Global Capitalism*, pp. 17-50. Westport, CT: Praeger Publishers.
- Hornborg, A. 1992. Machine Fetishism, Value, and the Image of Unlimited Good: Towards a Thermodynamics of Imperialism. *Man*, 27(1), pp. 1-18.
- Hornborg, A. 1998. Towards an Ecological Theory of Unequal Exchange: Articulating World System Theory and Ecological Economics. *Ecological Economics*, 25(1), pp. 127-136.
- Hornborg, A. 2001. *The Power of the Machine. Global Inequalities of Economy, Technology, and Environment*. Walnut Creek CA: AltaMira Press.
- Hornborg, A. 2003a. Cornucopia or Zero-sum Game? The Epistemology of Sustainability. *Journal of World-Systems Research*, 9(2), pp. 3-14.
- Hornborg, A. 2003b. The Unequal Exchange of Time and Space: Toward a Non-normative Ecological Theory of Exploitation. *Journal of Ecological Anthropology*, 7, pp. 4-10.
- Hornborg, A. 2006. Footprints in the Cotton Fields: The Industrial Revolution as Time-space Appropriation and Environmental Load Displacement. *Ecological Economics*, 59(1), pp. 74-81.
- Hornborg, A. 2007. Learning from the Tiv; Why a Sustainable Economy would have to be “Multicentric”. *Culture & Agriculture*, 29(2), pp. 63-69.
- Hornborg, A. 2009. Zero-sum world: Challenges in Conceptualizing Environmental Load Displacement and Ecologically Unequal Exchange in the World-system. *International Journal of Comparative Sociology*, 50(3-4), pp. 237-262.
- Hoyle, B. S. (ed.). 1973. *Transport and Development*. London: Macmillan.
- Hoyle, B. S. and Knowles, R. 1998. *Modern Transport Geography. Edition 2*. West Sussex: John Wiley and Sons.
- Hubbell, C. M. 1965. An input-output approach to clique identification. *Sociometry*, 28(4), pp. 377-399.
- Hugill, P. J. 1993. *World trade since 1431*. Baltimore and London: The Johns Hopkins university press.
- Hume, D. 1987 (orig. ed. 1752). *Political Discourses*. Frankfurt/Main: Verl. Wirtschaft u. Finanzen.
- International Monetary Fund. 2009. *World Economic Outlook Database*.
- ITC/UNSD, 2001. *PC-TAS; Trade Analysis System on Personal Computer*. Geneva: International Trade Centre.
- Jorgenson, A. 2003. Consumption and Environmental Degradation: A Cross-National Analysis of the Ecological Footprint. *Social Problems*, 50(3), pp. 374-394.

- Jorgenson, A. 2006. Unequal Ecological Exchange and Environmental Degradation: A Theoretical Proposition and Cross-National Study of Deforestation, 1990-2000. *Rural Sociology*, 71(4), pp. 685-712.
- Jorgenson, A. 2008. Structural Integration and the Trees: An Analysis of Deforestation in Less-Developed Countries, 1990-2005. *The Sociological Quarterly*, 49, pp. 503-527.
- Jorgenson, A. 2009a. The Sociology of Unequal Exchange in Ecological Context: A Panel Study of Lower-Income Countries, 1975-2000. *Sociological Forum*, 24(1), 22-46.
- Jorgenson, A., Austin, K. and Dick, C. 2009b. Ecologically Unequal Exchange and the Resource Consumption/Environmental Degradation Paradox. A Panel Study of Less-Developed Countries, 1970-2000. *International Journal of Comparative Sociology*, 50(3-4), pp. 263-284.
- Kansky, K. J. 1963. *Structure of Transportation Networks: Relationships between Network Geometry and Regional Characteristics*. Chicago, Ill: University of Chicago.
- Keesing, R. M. 1981. *Cultural Anthropology: A Contemporary Perspective*. Fort Worth: Harcourt Brace Jovanovich College Publishers.
- Kentor, J. 2000. *Capital and Coercion: The Economic and Military Processes that have Shaped the World-Economy, 1800-1990*. New York: Garland Press.
- Keynes, J. M. 1936. *The General Theory of Employment*. London: Macmillan and Co.
- Kick, E. L. 1985. *The Form and Operation of the World System*. Boulder, CO: Education Resource Information Center.
- Kick, E. L. 1987. World-system St[r]ucture, National Development, and the Prospects for a Socialist World Order. In Boswell, T. and Bergesen, A. (eds), *America's Changing Role in the World-System*, pp. 127-155. New York: Praeger.
- Kick, E. L., Davis, B., Burns, T. J. and Gubin, O. 1995. International Multiple Networks in World-system Approaches. *International Conference on Social Networks*, 3, pp. 237-248. London: Greenwich University press.
- Kick, E. L. and Davis, B. L. 2001. World-system Structure and Change. An Analysis of Global Networks and Economic Growth across Two Time Periods. *American Behavioral Scientist*, 44(10), pp. 1561-1578.
- Klare, M. 2001. *Resource Wars; The New Landscape of Political Conflict*. New York: Henry Holt and Company.
- Knoke, D. and Kuklinski, J. H. 1982. *Network Analysis*. Beverly Hills, CA: Sage Publications Ltd.
- Knox, P. and Agnew, J. 1998 (orig. ed. 1989). *The Geography of the World Economy. Third edition*. London: Arnold publ.
- Korzybski, A. 1958. *Science and Sanity; An Introduction to non-Aristotelian Systems and General Semantics*. Lakeville, Conn: International Non-Aristotelian Library Pub. Co.; distributed by Institute of General Semantics.
- Krugman, P. 1979. Increasing Returns, Monopolistic Competition, and International Trade. *Journal of International Economics*, 9, pp. 469-479.
- Krugman, P. 1984. Import Protection as Export Promotion: International Competition in the Presence of Oligopoly and Economies of Scale. In Kierzkowski, Henryk. *Monopolistic Competition and International Trade*. Oxfordshire: Clarendon Press.
- Krugman, P. 1990a. *Rethinking International Trade*. Cambridge, Mass: MIT Press.
- Krugman, P. 1990b. *Increasing Returns and Economic Geography*. NBER Working Paper #3275. Cambridge, MA: Department of Economics, MIT.
- Krugman, P. 1991. *Geography and Trade*. Cambridge MA, London: MIT Press.
- Krugman, P. 1993. The Narrow and Broad Arguments for Free Trade. *The American Economic Review*, 83(2), pp. 362-366.

- Krugman, P. 1995. *Development, Geography, and Economic Theory*. Cambridge MA, London: MIT Press.
- Krugman, P. 1998a. Space: The Final Frontier. *Journal of Economic Perspectives*, 12(2), pp. 161-174.
- Krugman, P. 1998b. What's New About the New Economic Geography? *Oxford Review of Economic Policy*, 14(2), pp. 7-17.
- Kruskal, J. B. and Wish, M. 1978. *Multidimensional Scaling*. Sage University Paper Series on Quantitative Applications in the Social Sciences. Beverly Hills, CA: Sage Publications.
- Lancaster, K. 1980. Intra-industry Trade Under Perfect Monopolistic Competition. *Journal of International Economics*, 10, pp. 151-175.
- Lawson, T. 2004. Modern Economics: The Problem and a Solution. In Fullbrook, E. (ed). *A Guide to What's Wrong with Economics*. Anthem studies in political economy and globalization, pp. 21-32. London: Anthem.
- League of Nations. 1942. *The Network of World Trade; A Companion Volume to "Europe's Trade"*. Geneva: League of Nations.
- Lee, N. and Cason, J. 1994. Automobile Commodity Chains in the NICs: A Comparison of South Korea, Mexico, and Brazil. In Gereffi, G., Korzeniewicz, M. (eds.), *Commodity Chains and Global Capitalism*, pp. 223-244. Westport, CT: Praeger Publishers.
- Lehrman, L. L. 2003. Energetic America; The Energy Policy the U.S. Needs. *The Weekly Standard*, Sep 29, 2003, 9(3).
- Lenzen, M., Borgström-Hansson, C. and Bond, S. 2006. *On the Bioproductivity and Land-disturbance Metrics of the Ecological Footprint*. University of Sydney: ISA Research paper 03/06.
- Leontief, W. W. 1954. *Domestic Production and Foreign Trade; The American Capital Position Re-examined*. Genova.
- Lincoln, J. R. and Gerlach, M. L. 2004. *Japan's Network Economy; Structure, Persistence, and Change*. Cambridge: Cambridge University Press.
- Linneman, H. 1966. *An Econometric Study of World Trade Flows*. Amsterdam: North Holland.
- List, F. 1909 (orig. english ed. 1885, orig. german ed. 1841). *The National System of Political Economy. Book IV: The Politics*. London: Longmans, Green, and Co.
<http://www.econlib.org/library/YPDBooks/List/lstNPE.html>
- List, F. 1999 (orig. english ed. 1885, orig. german ed. 1841). *The National System of Political Economy. Book II: The Theory*. Roseville, CA.: Dry Bones Press.
- List, F. 2005 (orig. english ed. 1885, orig. german ed. 1841). *The National System of Political Economy: The Systems and the Politics*. New York: Cosimo Classics.
- Lorrain, F. and White, H.C. 1971. Structural Equivalence of Individuals in Social Networks. *Journal of Mathematical Sociology*, 1, pp. 49-80.
- Love, J. 1980. Raúl Prebisch and the Origins of the Doctrine of Unequal Exchange. *Latin American Research Review*, 15(3), pp. 45-72.
- Luczkovich, J.J., Borgatti, S. P., Johnson, J. C. and Everett, M. G. 2003. Defining and Measuring Trophic Role Similarity in Food Webs Using Regular Equivalence. *Journal of Theoretical Biology*, 220, pp. 303-321.
- Mahutga, M. C. 2006. The Persistence of Structural Inequality? A Network Analysis of International Trade, 1965-2000. *Social Forces*, 84(4), pp. 1863-1889.
- Malmer, N. 1992. A New Name of a Scientific journal – Holarctic Ecology has become Ecography. *Ecography*, 15(1), pp. 1-2.
- Maneschi, A. 2000. *How New is the "New Trade Theory" of the Past Two Decades?* Working paper No. 00-W27. Nashville: Department of Economics, Vanderbilt University.

- Marshall, A. 1895. *Principles of Economics, Volume 1, 3rd edition*. London: Macmillan and Co.
- Marshall, A. 1898. *Principles of Economic, 4th editions*. London: Macmillan and Co.
- Marshall, A. 1930. *The Pure Theory of Foreign Trade. The Pure Theory of Domestic Values*. London: The London School of Economics and Political Science.
- Martin, R. 1999. Editorial: The 'New Economic Geography': Challenge or Irrelevance? *Transactions of the Institute of British Geographers*, 24(4), pp. 387-391.
- Martinez-Alier, J. 1987. *Ecological Economics; Energy, Environment and Society*. Oxford: Blackwell Publ.
- Martinez-Alier, J. 2002. *The Environmentalism of the Poor*. Cheltenham: Edward Edgar Publ. Ltd.
- Marx, K. (with supplement by Mats Dahlkvist and Mats Thorell). 1985 (orig. ed. 1867). *Kapitalet. Första boken. Supplement*. Lund: Arkiv.
- McCarty, H. H. 1940. *The Geographical Basis of American Economic Life*. New York: Harpers and Brothers.
- McCarty, H.H., Hook, J. C., and Knox, D. S. 1956. *The Measurement of Association in Industrial Geography*. Iowa City: Department of Geography, University of Iowa.
- McCulloch, J. R. (ed.). 1954. *Early English Tracts on Commerce*. Cambridge: Cambridge U.P.
- McGrath, C., Blythe, J. and Krackhardt, D. 1997. The Effect of Spatial Arrangement on Judgments and Errors in Interpreting Graphs. *Social Networks*, 19(3), pp. 223-241.
- McNee, R. B. 1959. Relationships of Economics and Economic Geography, *Economic Geography*, 35(3), pp. 189-198.
- Meardon, S. J. 2000. Eclecticism, Inconsistency, and Innovation in the History of Geographical Economics. *History of Political Economy*, 32(1), pp. 325-360.
- Medvedkov, Y. V. 1968. An Application of Topology in Central Place Analysis. *Papers in Regional Science*, 20(1), pp. 77-84.
- Meier, G. M. and Baldwin, R. E. 1957. *Economic Development*. New York: Wiley.
- Milanovic, B. 2005. *Worlds Apart: Measuring International and Global Inequality*. Princeton: Princeton University Press.
- Mill, J. S. 1844. *Essays on Some Unsettled Questions of Political Economy*. Second edition. London: John W. Parker.
- Mill, J. S. 1849a (orig. ed. 1848). *Principles of Political Economy, With Some of their Applications to Social Philosophy*. Volume I. Second edition. London: Longmans, Green, and Co.
- Mill, J. S. 1849b (orig. ed. 1848). *Principles of Political Economy, With Some of their Applications to Social Philosophy*. Volume II. Second edition. London: Longmans, Green, and Co.
- Mill, J. S. 1862 (orig. ed. 1848). *Principles of Political Economy: With Some of their Applications to Social Philosophy*. Volume II. Fifth edition. London: Parker, Son, and Bourn.
- Mitchelson, R. L. and Wheeler, J. O. 1994. The Flow of Information in a Global Economy: The Role of the American Urban System in 1990. *Annals of the Association of American Geographers*, 84(1), pp. 87-107.
- Morgan, T. 1959. The Long-run Terms of Trade between Agriculture and Manufacturing. *Economic Development and Cultural Change*, 8, pp. 1-23.
- Muradian, R., O'Connor, M. and Martinez-Alier, J. 2002. Embodied Pollution in Trade: Estimating the 'Environmental Load Displacement' of Industrial Countries. *Ecological Economics*, 41, pp. 51-67.

- Nakano, T. and White, D. R. 2007. Network Structures in Industrial Pricing: The Effect of Emergent Roles in Tokyo Supplier-chain Hierarchies. *Structure and Dynamics*, 2(3), pp. 62-110.
- Nemeth, R. J. and Smith, D. A. 1985. International Trade and World-system Structure: A Multiple Network Analysis. *Review* [Binghampton], 8(4), pp. 517-560.
- Nordlund, C. 1999. *Ekografi; Centralplatsteori på världssystemnivå*. MA thesis. Lund: Human Ecology Division, Lund University.
- Nordlund, C. 2004. A Critical Comment on the Taylor Approach for Measuring World City Interlock Linkages. *Geographical Analysis*, 36(3), pp. 290-296.
- Nordlund, C. 2006. *International Trade in Fuel Commodities: A Network Approach*. Paper presented at the Workshop on Trade and Environmental Justice, Lund University, 15-16 February, 2006.
- Nordlund, C. 2007. Identifying Regular Blocks in Valued Networks: A Heuristic Applied to the St. Marks Carbon Flow Data, and International Trade in Cereal Products. *Social Networks*, 29(1), pp. 59-69.
- Nurkse, R. 1952. Some International Aspects of the Problem of Economic Development. *The American Economic Review*, 42(2), pp. 571-583.
- Nystuen, J. D. and Dacey, M. F. 1961. A Graph Theory Interpretation of Nodal Regions. *Papers in Regional Science*, 7(1), pp. 29-42.
- Odum, H. T. 1995. *Environmental Accounting: Emery and Environmental Decision Making*. New York: John Wiley & Sons, Inc.
- Ohlin, B. 1933. *Interregional and International Trade*. Harvard Economic Studies, 39. Cambridge, Mass: Harvard University Press.
- Oman, C. P., and Wignaraja, G. 1991. *The Postwar Evolution of Development Thinking*. Houndmills & London: Macmillan, St. Martin's & OECD Development Centre.
- Pérez-Rincón, M. 2006. Colombian International Trade from a Physical Perspective: Towards an Ecological "prebisch thesis". *Ecological Economics*, 59, pp. 519-529.
- Perloff, J. M. 2004. *Microeconomics*. The Addison-Wesley Series in Economics. Boston: Pearson Addison Wesley.
- Polanyi, K. 1957 (orig. ed. 1944). *The Great Transformation*. Boston: Beacon Press.
- Polanyi, K. 1968. *Primitive, Archaic, and Modern Economies; Essays*. Edited by George Dalton. Garden City, N.Y.: Anchor Books.
- Porter, M. 1987. Changing Patterns of International Competition. In Teece, D. J. (ed.), *The Competitive Challenge: Strategies for Industrial Innovation and Renewal*, pp. 22-57. Cambridge, MA: Ballinger.
- Prasch, R. 1996. Reassessing the Theory of Comparative Advantage. *Review of Political Economy*, 8(1), pp. 37-55.
- Prebisch, R. 1950. *The Economic Development of Latin America and its Principal Problems*. New York: United Nations, Dept. of Economic Affairs.
- Puga, D. and Venables, A. J. 1997. Preferential Trading Agreements and Industrial Location. *Journal of International Economics*, 43, pp. 347-368.
- Rees, W. E. 1992a. *Understanding Sustainable Development: Natural Capital and the New World Order*. Vancouver: University of British Columbia. Planning Paper, unpublished manuscript.
- Rees, W.E. 1992b. Ecological Footprints and Appropriated Carrying Capacity: What Urban Economics Leaves Out. *Environment and Urbanization*, 4(2), pp. 121-130.
- Rees, W. E. and Wackernagel, M. 1994. Ecological Footprints and Appropriated Carrying Capacity: Measuring the Natural Capacity Requirements of the Human Economy. In Jansson, A., Hammer, M., Folke C., Costanza, R. (eds.), *Investing in Natural Capital*, pp. 362-390. Washington DC: Island Press.

- Rees, W.E. 1996. Revisiting Carrying Capacity: Area-based Indicators of Sustainability, *Population and Environment*, 17(3), pp. 195-215.
- Rees, W. E. 2002. *Ephiphany, Serendipity, and the Genesis of Ecological Footprint Analysis*. Vancouver: University of British Columbia, unpublished manuscript.
- Ricardo, D. 1996 (orig. 3rd ed. 1821). *Principles of Political Economy and Taxation*. Great minds series. Amherst, New York: Prometheus Books.
- Ricardo, D. 1996 (orig. 1st ed. 1817). Original preface from the first edition. *Principles of Political Economy and Taxation*. Great Minds Series. Amherst, New York: Prometheus Books.
- Rice, J. 2007. Ecological Unequal Exchange: Consumption, Equity, and Unsustainable Structural Relationships within the Global Economy. *International Journal of Comparative Sociology*, 48(1), pp. 43-72.
- Rimmer, P. J. 1967. The Search for Spatial Regularities in the Development of Australian Seaports 1861-1961/2. *Geografiska Annaler. Series B, Human Geography*, 49(1), pp. 42-54.
- Roberts, J. T. and Parks, B. C. 2007. Fueling Injustice: Globalization, Ecologically Unequal Exchange and Climate Change. *Globalizations*, 4(2), pp. 193-210.
- Sacks, M. A., Ventresca, M. J. and Uzzi, B. 2001. Global Institutions and Networks: Contingent Change in the Structure of World Trade Advantage, 1965-1980. *American Behavioral Scientist*, 44(10), pp. 1579-1601.
- Sahlins, M. 1972. *Stone Age Economics*. New York: Aldine de Gruyter.
- Sailer, L. D. 1977-1978. Structural Equivalence: Meaning and Definition, Computation and Application. *Social Networks*, 1(1), pp. 73-90.
- Sampson, S. F. 1969. *Crisis in a Cloister*. PhD dissertation, Cornell University.
- Samuelson, P. A. 1948. International Trade and the Equalisation of Factor Prices. *The Economic Journal*, 58(230), pp. 163-184.
- Schaefer, F. 1953. Exceptionalism in Geography: A Methodological Introduction. *Annals, Association of American Geographers*, 43, pp. 226-249.
- Schwartz, J. E. 1977. An Examination of CONCOR and Related Methods for Blocking Sociometric Data. *Sociological Methodology*, 8, pp. 255-282.
- Scott, J. P. 2000 (orig. 1st ed. 1991). *Social Network Analysis: A Handbook. Second Edition*. London: Sage Publications Ltd.
- Shandra, J., Shor, E. and London, B. 2009. World Polity, Unequal Ecological Exchange, and Organic Water Pollution: A Cross-National Analysis of Developing Nations. *Human Ecology Review*, 16(1), pp. 53-63.
- Shannon, T. R. *An Introduction to the World-system Perspective. 2nd edition*. Westview Press; 2 edition (March 7, 1996)
- Sheppard, E. and Barnes, T. J. (eds.). 2000. *A Companion to Economic Geography*. Oxford and Malden MA: Blackwell Publishers Ltd.
- Sheppard, E. 2001. How 'Economists' Think: About Geography, For Example. *Journal of Economic Geography*, 1, pp. 131-136.
- Sheppard, E. 2002. The Spaces and Times of Globalization: Place, Scale, Networks and Positionality. *Economic Geography*, 78(3), pp. 307-330.
- Short, J., Kim, Y., Kuss, M. and Wells, H. 1996. The Dirty Little Secret of World Cities Research. *International Journal of Urban and Regional Research*, 20, pp. 697-717.
- Sim, F. M. and Schwartz, M. R. 1979. *Does Concor Find Positions?* Paper presented at the Annual Meeting of the Eastern Sociological Society, New York.
- Singer, H. W. 1950. The Distribution of Gains Between Investing and Borrowing Countries. *The American Economic Review*, 40(2), Papers and Proceedings of the Sixty-second Annual Meeting of the American Economic Association (May, 1950). Pp. 473-485.

- Smith, A. 2007 (orig. ed. 1776). *An Inquiry into the Nature and Causes of the Wealth of Nations*. Toronto: Insomniac Press.
- Smith, D. A. and Nemeth, R. J. 1988. An Empirical Analysis of Commodity Exchange in the International Economy: 1965-80. *International Studies Quarterly*, 32(2), pp. 227-240.
- Smith, D. A. and White, D. R. 1992. Structure and Dynamics of the Global Economy: Network Analysis of International Trade 1965-1980. *Social Forces*, 70(4), pp. 857-893.
- Smith, D. A. and Timberlake, M. F. 1995. Conceptualising and Mapping the Structure of the World System's City System. *Urban Studies*, 32, pp. 287-302.
- Smith, D. A. and Timberlake, M. F. 2001. World City Networks and Hierarchies, 1977-1997: An Empirical Analysis of Global Air Travel Links. *American Behavioral Scientist*, 44(10), pp. 1656-1678.
- Smith, D. A. and Timberlake, M. F. 2002. Hierarchies of Dominance among World Cities: A Network Approach. In Sassen, S. (ed.) *Global Networks, Linked Cities*, pp. 117-141. London: Routledge.
- Smith, J. R. 1913. *Industrial and Commercial Geography*. New York: Henry Holt and Co.
- Snyder, D. and Kick, E. 1979. Structural Position in the World System and Economic Growth, 1955-1970: A Multiple-network Analysis of Transnational Interactions. *American Journal of Sociology*, 84(5), pp. 1096-1126.
- So, A. Y. 1990. *Social Change and Development; Modernization, Dependency and World-system theories*. California: Sage Publications.
- Srholec, M. 2006. *Fragmentation and Trade: A Network Perspective*. Paper presented at the 8th ETSG Annual Conference, Vienna, 7-9 September, 2006.
- Steiber, S. R. 1979. The World System and World Trade: An Empirical Exploration of Conceptual Conflicts. *The Sociological Quarterly*, 20(1), pp. 23-36.
- Sundström, T. 1992. Vardandet – Materia och Struktur. In Abrahamsson, K. V., Hällgren, J.-E., Sundström, T. and Sörlin, S. (red), *Humanekologi; Naturens Resurser och Människans Försörjning*, pp. 54-76. Stockholm: Carlsson Bokförlag.
- Sunley, P. 2001. What's Behind the Models? A Review of The Spatial Economy. *Journal of Economic Geography*, 1, pp. 136-139.
- Taaffe, E. J., Morrill, R. L. and Gould, P. R. 1963. Transport Expansion in Underdeveloped Countries: A Comparative Analysis. *Geographical Review*, 53(4), pp. 503-529.
- Taaffe, E. J., Gauthier, H. L., and O'Kelly, M. E. 1996 [orig. 1st ed. 1973]. *Geography of Transportation. Second Edition*. New Jersey: Prentice-Hall.
- Tatemoto, M. and Ichimura, S. 1959. Factor Proportions and Foreign Trade: The Case of Japan. *The Review of Economics and Statistics*, 41(4), pp. 442-446.
- Taylor, P. J. 2001. Specification of the World City Network. *Geographical Analysis*, 33(2), pp. 181-194.
- Tong, X. and Lifset, R. 2007. International Copper Flow Network: A Blockmodel Analysis. *Ecological Economics*, 61, pp. 345-354.
- Toye, J. and Toye, R. 2003. The Origins and Interpretations of the Prebisch-Singer Thesis. *History of Political Economy*, 35(3), pp. 437-467.
- Torrens, R. 1996 (orig.ed. 1815). *An Essay on the External Corn Trade*. Düsseldorf: Verlag Wirtschaft und Finanzen.
- United Nations. 1949a. *Post-war Price Relations in Trade between Under-developed and Industrialized Countries*. UN document no. E/CN.1/Sub.3/W.5. Lake Success, N.Y.: UN Department of Economic Affairs.
- United Nations. 1949b. *Relative Prices of Exports and Imports of Under-developed Countries*. Lake Success, N.Y.: UN Department of Economic Affairs.
- United Nations. 1984. *Land, Food, and People*. Rome: FAO.

- van den Bergh, J. and Verbruggen, H. 1999. Spatial Sustainability, Trade and Indicators: An Evaluation of the Ecological Footprint. *Ecological Economics*, 29(1), pp. 61-72.
- Vance, J. E. 1970. *The Merchants' World: The Geography of Wholesaling*. New Jersey: Prentice Hall.
- Veblen, T. 1909. The Limitations to Marginal Utility. *Journal of Political Economy*, 17(9), pp. 620-636.
- Viner, J. 1937. *Studies in the Theory of International Trade*. New York, London: Harper & Brothers.
- Vinod, R. V., Sukumar, B. and Sukumar, A. 2003. Transport Network Analysis of Kasaragod Taluk, Kerala using GIS. *Indian Cartographer*, 2003, pp. 35-43. Thiruvananthapuram, India: Centre for Earth Science Studies.
- Wackernagel, M. 1991. *Using 'Appropriated Carrying Capacity' as an Indicator: Measuring the Sustainability of a Community*. Report for the UBC Task Force on Healthy and Sustainable Communities. Vancouver: UBC School of Community and Regional Planning.
- Wackernagel, M. and W. E. Rees. 1996. *Our Ecological Footprint: Reducing Human Impact on the Earth*. Gabriola Island BC and New Haven, CT: New Society Publishers.
- Wackernagel, M. 1999. An Evaluation of the Ecological Footprint. *Ecological Economics*, 31, pp. 317-321.
- Wackernagel, M., Monfreda, C., Moran, D., Goldfinger, S., Deumling, D. and Murray, M. 2004. *National Footprint and Biocapacity Accounts 2004: The Underlying Calculation Method*. Global Footprint Network.
- Wackernagel, M., Wermer, P. and Goldfinger, S. 2007. *Introduction to the Ecological Footprint: Underlying Research Question and Current Calculation Strategy*. Entry prepared for the Internet Encyclopaedia of Ecological Economics. Available at <http://www.ecoeco.org/pdf/footprints.pdf>
- Wallerstein, I. 1972. Three Paths of National Development in Sixteenth-century Europe. *Studies in Comparative International Development*, 7(2), pp. 95-101.
- Wallerstein, I. 1974. The Rise and Future Demise of the World Capitalist System: Concepts for Comparative Analysis. *Comparative Studies in Society and History*, 16(4), pp. 387-415.
- Wallerstein, I. 1979. *The Capitalist World-Economy*. Cambridge: Cambridge University Press.
- Wallerstein, I. 1987. World-systems Analysis. In A. Giddens & J. Turner, eds., *Social Theory Today*, pp. 309-324. Cambridge: Polity Press.
- Wallerstein, I. 1995. *Historical Capitalism, with Capitalist Civilization*. London: Verso.
- Wallerstein, I. 1999. *The End of the World As We Know It: Social Science for the Twenty-first Century*. Minneapolis: University of Minnesota Press.
- Wallerstein, I. 2000. *The Essential Wallerstein*. New York: New Press.
- Wallerstein, I. and Hopkins, T. 2000 [1986]. Commodity Chains in the World prior to 1800. In Wallerstein, I. *The essential Wallerstein*, pp. 221-233. New York: New Press. Orig. publ. in *Review*, 1986, Volume 10, pp. 157-170.
- Wallerstein, I. 2004. *World-Systems Analysis: An Introduction*. Durham, North Carolina: Duke University Press.
- Wasserman, S. and Faust, K. 1994. *Social Network Analysis: Methods and Applications*. Cambridge: Cambridge University Press.
- Weber, A., and Carl, J. F. 1929. *Alfred Weber's Theory of the Location of Industries*. Chicago, Ill: University of Chicago Press.
- Weber, M., Parsons, T., and Tawney, R. H.. 1930. *The Protestant Ethic and the Spirit of Capitalism*. London: G. Allen & Unwin.

- Whitbeck, R. H. 1915-1916. Economic Geography: Its Growth and Possibilities. *Journal of Geography*, 14, pp. 284-296.
- Whitbeck, R. H., Finch, V. C. 1924. *Economic Geography*. New York: McGraw-Hill.
- White, D. R. and Reitz, K. P. 1983. Graph and Semigroup Homomorphisms on Networks of Relations. *Social Networks*, 5(2), pp. 193-224.
- White, D. R. and Reitz, K. P. 1985. *Measuring Role Distance: Structural, Regular and Relational Equivalence*. University of California, Irvine (unpublished manuscript).
- White, D. R. and Smith, D. 1988. *Flow centralities: Do they Predict the Economic Rise and Fall of States?* Paper presented at the 1988 Sunbelt Social Networks Conference, San Diego.
- White, H. C., Boorman, S. A. and Breiger, R. L. 1976. Social Structure from Multiple Networks. I. Blockmodels of Roles and Positions. *American Journal of Sociology*, 81(4), pp. 730-780.
- Wolf, E. 1982. *Europe and the People without History*. Berkeley and Los Angeles: University of California Press.
- Wolfe, A. W. 2005. Connecting the Dots Without Forgetting the Circles. *Connections*, 26(2), pp. 107-119.
- World bank 2001. World Development indicators.
- WWF. 2006. *Living planet report 2006*. Switzerland: World Wide Fund for Nature.
- Žiberna, A. 2008. Direct and Indirect Approaches to Blockmodeling of Valued Networks in Terms of Regular Equivalence. *The Journal of Mathematical Sociology*, 32(1), pp. 57-84.

LUND STUDIES IN HUMAN ECOLOGY

1. Alf Hornborg & Mikael Kurkiala, eds, *Voices of the Land: Identity and Ecology in the Margins*, 1998.
2. Alf Hornborg & Gisli Pálsson, eds, *Negotiating Nature: Culture, Power and Environmental Argument*, 2000.
3. Ebba Lisberg Jensen, *Som man ropar i skogen: Modernitet, makt och mångfald i kampen om Njakaffäll och i den svenska skogsbruksidentiteten 1970-2000*, 2002.
4. Pernilla Ouis, *Power, Person, and Place: Tradition, Modernity, and Environment in the United Arab Emirates*, 2002.
5. Per Johansson, *The Lure of Origins: An Inquiry into Human-Environmental Relations; Focused on the "Neolithization" of Sweden*, 2003.
6. Simron Jit Singh, *In the Sea of Influence: A World System Perspective of the Nicobar Islands*, 2003.
7. Carina Borgström Hansson, *Misplaced Concreteness and Concrete Places: Critical Analyses of Divergent Discourses on Sustainability*, 2003.
8. Jutta Falkengren, *Djurens skepnader: Närhet och distans I diskurs och livsvärld*, 2005.
9. John Brolin, *The Bias of the World: Theories of Unequal Exchange in History*, 2006.
10. Michael Moon, *Green Ideology and its Relation to Modernity: Including a Case Study of the Green Party of Sweden*, 2008.