



LUND UNIVERSITY

Calculating signal correlation in lossy dipole arrays using scattering parameters and efficiencies

Li, Hui; Lin, Xianqi; Lau, Buon Kiong; He, Sailing

Published in:

European Conference on Antennas and Propagation (EuCAP), 2013

2013

Document Version:

Peer reviewed version (aka post-print)

[Link to publication](#)

Citation for published version (APA):

Li, H., Lin, X., Lau, B. K., & He, S. (2013). Calculating signal correlation in lossy dipole arrays using scattering parameters and efficiencies. In *European Conference on Antennas and Propagation (EuCAP), 2013* (pp. 519-523). IEEE - Institute of Electrical and Electronics Engineers Inc.. <https://ieeexplore.ieee.org/document/6546321/>

Total number of authors:

4

General rights

Unless other specific re-use rights are stated the following general rights apply:

Copyright and moral rights for the publications made accessible in the public portal are retained by the authors and/or other copyright owners and it is a condition of accessing publications that users recognise and abide by the legal requirements associated with these rights.

- Users may download and print one copy of any publication from the public portal for the purpose of private study or research.
- You may not further distribute the material or use it for any profit-making activity or commercial gain
- You may freely distribute the URL identifying the publication in the public portal

Read more about Creative commons licenses: <https://creativecommons.org/licenses/>

Take down policy

If you believe that this document breaches copyright please contact us providing details, and we will remove access to the work immediately and investigate your claim.

LUND UNIVERSITY

PO Box 117
221 00 Lund
+46 46-222 00 00

Calculating Signal Correlation in Lossy Dipole Arrays Using Scattering Parameters and Efficiencies

Hui Li^{1,2}, Xianqi Lin³, Buon Kiong Lau¹, Sailing He^{2,3}

¹ Department of Electrical and Information Technology, Lund University, Lund, Sweden, hui.li@eit.lth.se

² Center for Optical and Electromagnetic Research, Zhejiang University, Hangzhou, China

³ School of Electromagnetic Engineering, Royal Institute of Technology, Stockholm, Sweden

Abstract— Correlation coefficient, as a critical performance metric of multiple antenna systems, can be calculated from the 3D radiation patterns of the antennas for multipath environments with uniform 3D angular power spectrum. A simpler, faster and lower cost approach uses the antennas' scattering parameters to determine correlation coefficient. However, the method assumes lossless antennas, and hence only achieves good accuracy for antennas with high radiation efficiencies. In this work, a method for calculating correlation coefficients in lossy dipole arrays is proposed, using only the scattering parameters and radiation efficiencies. The method is based on the equivalent circuit of antennas, and it gives a significantly better estimate of the correlation coefficient than the existing methods. The proposed method is also applied to two folded monopole antennas in a compact terminal to demonstrate its effectiveness.

Index Terms—MIMO systems, correlation coefficient, antenna array, mutual coupling, antenna measurements

I. INTRODUCTION

Implementing multiple antennas at both the transmitter and receiver, as required by multiple-input multiple-output (MIMO) technology, can greatly improve the data rates of wireless communication systems [1]. To evaluate the performance of multiple antenna systems, signal correlation among the antennas is a critical parameter. Conventionally, the correlation coefficient of any two antennas for the reference multipath environment of uniform 3D angular power spectrum (APS) can be calculated from the full spherical radiation patterns of these antennas, which include phase and polarization information [2]. However, obtaining antenna patterns is a cumbersome and time-consuming procedure that requires costly and specialized measurement facilities.

A much simpler, faster and lower cost approach was proposed by Blanch *et al.* in [3], where correlation coefficient is calculated in closed form using only the scattering (S) parameters of the antennas as measured with a vector network analyzer. However, the accuracy of the simplified method becomes poor when it is applied to lossy antenna arrays, since it does not take into account antenna losses (i.e., conduction loss and dielectric loss) in deriving the closed form expression. To improve the method for the dual-antenna case, a new parameter of loss correlation was

introduced in [4], and an upper bound of correlation coefficient is provided. The upper bound, calculated using S parameters as well as antenna radiation efficiencies, describes the worst possible correlation performance of the dual-antenna system. However, the upper bound can be too conservative in some cases. Hence, the approach is not intended to provide an accurate estimate of the correlation performance in general.

In this paper, we propose a new method based on equivalent circuits to more accurately estimate correlation coefficients in lossy antenna arrays. This is achieved by assuming that the conduction and dielectric losses of dipole antennas can be represented by a loss resistance at the antenna port. Therefore, the modified equivalent circuit consists of a loss resistor as well as an equivalent lossless circuit. The correlation coefficient of the lossy array can then be calculated from the S parameters of the equivalent lossless circuit using the closed form expression of [3]. Similar to the upper bound of [4], the proposed method requires only S parameters and antenna radiation efficiencies, with the latter being easier to acquire than radiation patterns. The method can be extended to calculate correlation for dipole arrays with more than two elements. Moreover, the method can also be used for other types of antennas than dipoles, such as those used in compact multi-antenna terminals. Due to the requirement of implementing multiple antennas in terminals according to existing and future wireless communication standards [5], the proposed method can contribute to more convenient evaluation of actual terminal performance.

The paper is organized as follows. In Section II, we give a description of the proposed method based on the two-dipole case. Section III shows the numerical results for a two-dipole array, as well as the extension of the method for the four-dipole case. The frequent-domain solver of CST Microwave Studio was used to perform the full-wave antenna simulations in this paper. To show the effectiveness of the method for other antenna types, the correlation coefficient of two folded monopole antennas in a compact terminal (of chassis size 100 mm × 40 mm) was calculated in Section IV. Section V concludes the paper.

II. DESCRIPTION OF THE METHOD

In lossless dual-antenna arrays, the complex correlation coefficient for uniform 3D APS is derived in [3] as

$$\rho_c = \frac{-(S_{11}^* S_{12} + S_{21}^* S_{22})}{\sqrt{(1-|S_{11}|^2 - |S_{21}|^2)(1-|S_{22}|^2 - |S_{12}|^2)}}, \quad (1)$$

where $(\bullet)^*$ and $|\bullet|$ are the complex conjugate and absolute value operators, respectively. The accuracy of (1) is limited when it is applied to lossy antenna arrays, since antenna losses are not considered.

As an improved method that takes into account antenna losses, an upper bound (or guaranteed value) of correlation coefficient is derived in [4] as

$$|\rho_c|_{\text{guaranteed}} = \frac{|2 \operatorname{Re}(S_{11} S_{21}^*)|}{(1-|S_{11}|^2 - |S_{21}|^2) \eta_{\text{rad}}} + \frac{1}{\eta_{\text{rad}}} - 1, \quad (2)$$

where the two antennas are assumed to be identical and η_{rad} is the antenna radiation efficiency. $\operatorname{Re}(\bullet)$ denotes the real part of (\bullet) . Equation (2) provides better estimation; however, it can give a high degree of uncertainty unless the radiation efficiencies are high. Correlation calculations based on both (1) and (2) have been considered in the context of multiple antenna design for MIMO terminals, and they are used in this work to compare with the proposed method.

Equivalent circuits, as an effective way of modeling the impedance behavior of a lossy antenna system, are used to improve correlation estimation in this work. For dipole antennas, their impedance behavior can be approximately represented by a series R-L-C circuit [6]. The circuit model for a dual-dipole array is shown in Fig. 1, where the real part of the self-impedances (Z_{11} and Z_{22}) is divided into two parts: the loss resistances $r_{1,\text{loss}}$, $r_{2,\text{loss}}$ and the radiation resistances $r_{1,\text{rad}}$, $r_{2,\text{rad}}$. $r_{1,\text{rad}}$ and $r_{2,\text{rad}}$ are the real parts of $Z_{11,\text{rad}}$ and $Z_{22,\text{rad}}$, respectively. For simplicity and with no loss in generality, the two antennas and their loads are assumed to be identical, i.e., $r_{1,\text{loss}} = r_{2,\text{loss}} = r_{\text{loss}}$, $r_{1,\text{rad}} = r_{2,\text{rad}} = r_{\text{rad}}$, and $Z_{L1} = Z_{L2} = Z_L$.

In measuring the efficiency of Antenna 1, Antenna 2 is not excited ($V_2 = 0$), and normally loaded with $Z_L = 50\Omega$. Thus, the right part of the equivalent circuit model in Fig. 1 gives

$$k = \frac{|I_1|}{|I_2|} = \left| \frac{Z_{22} + Z_L}{Z_{21}} \right|, \quad (3)$$

where k is a parameter defined for the purpose of calculation.

The dual-antenna system can be described in two different ways. On one hand, it is a two-port network, with Port 2 loaded with Z_L and not excited. On the other hand, it can be considered as a one-port network, where $Z_L = 50\Omega$ is a loss resistance which consumes the accepted power.

When the dual antenna system is considered as a two-port network, the total efficiency of Antenna 1 is expressed

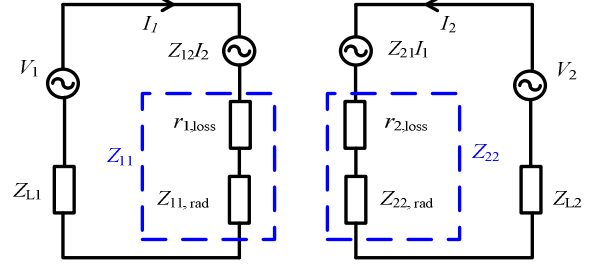

Fig. 1. Equivalent circuit model of a lossy dual-dipole array.

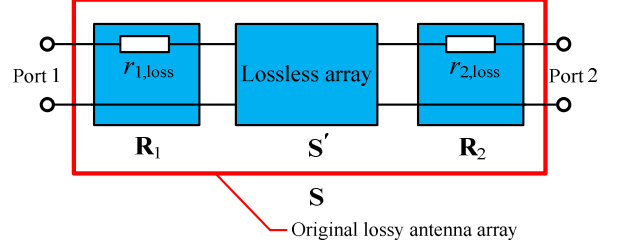

Fig. 2. Cascade network model for a lossy dual-dipole array.

as

$$\eta_{1,\text{tot}} = \eta_{1,\text{rad}} (1 - |S_{11}|^2 - |S_{21}|^2), \quad (4)$$

where the radiation efficiency ($\eta_{1,\text{rad}}$) is calculated with

$$\begin{aligned} \eta_{1,\text{rad}} &= \frac{P_{\text{rad}}}{P_{\text{in}}} = \frac{P_{\text{rad}}}{P_{\text{rad}} + P_{\text{loss}}} \\ &= \frac{|I_1|^2 r_{\text{rad}} + |I_2|^2 r_{\text{rad}}}{|I_1|^2 r_{\text{rad}} + |I_2|^2 r_{\text{rad}} + |I_1|^2 r_{\text{loss}} + |I_2|^2 r_{\text{loss}}} \\ &= \frac{r_{\text{rad}}}{r_{\text{rad}} + r_{\text{loss}}}. \end{aligned} \quad (5)$$

When the dual-antenna system is described as a one-port network, the total efficiency is

$$\eta_{1,\text{tot}} = \eta'_{1,\text{rad}} (1 - |S_{11}|^2), \quad (6)$$

where the radiation efficiency ($\eta'_{1,\text{rad}}$) is different from (5) and is given by

$$\begin{aligned} \eta'_{1,\text{rad}} &= \frac{P_{\text{rad}}}{P_{\text{rad}} + P_{\text{loss}}} \\ &= \frac{|I_1|^2 r_{\text{rad}} + |I_2|^2 r_{\text{rad}}}{|I_1|^2 r_{\text{rad}} + |I_2|^2 r_{\text{rad}} + |I_1|^2 r_{\text{loss}} + |I_2|^2 r_{\text{loss}} + |I_2|^2 \operatorname{Re}(Z_L)}. \end{aligned} \quad (7)$$

Using (3) to (7), the loss resistance is calculated as

$$r_{\text{loss}} = \frac{\eta'_{1,\text{rad}} (1 - \eta'_{1,\text{rad}}) \operatorname{Re}(Z_L)}{(\eta_{1,\text{rad}} - \eta'_{1,\text{rad}})(k^2 + 1)}, \quad (8)$$

in which $\eta_{1,\text{rad}}$ and $\eta'_{1,\text{rad}}$ are calculated with the measured

efficiencies and S parameters using equations (4) and (6).

With the value of r_{loss} obtained, the equivalent circuit in Fig. 1 can be described as a cascade network in Fig. 2. With the S parameters of the original lossy antenna array and the value of r_{loss} , the scattering matrix of the embedded lossless array \mathbf{S}' can be obtained using the transmission (ABCD) matrix. Thus, correlation coefficients of the embedded lossless array, which is equivalent to those of the original lossy dipole array, can be directly calculated with (1).

III. DIPOLE ARRAYS

A. Dual-Dipole Array

In this subsection, the correlation coefficient of a simulated dual-element printed dipole array was obtained with the proposed method (see Fig. 3(a) for detailed geometries). The elements are symmetrically positioned on the substrate such that $Z_{11} = Z_{22}$. The element separation is $\lambda/20$ (7 mm) at the center frequency of 2.15 GHz. The array is implemented on a substrate with a permittivity of 4.2 and a loss tangent of 0.02. The dipoles are made of copper, with an electric conductivity of 5.8×10^7 S/m. The 10 dB impedance bandwidth extends from 2.05 GHz to 2.25 GHz, and the isolation is 4.5 dB at the center frequency, indicating severe mutual coupling. The radiation efficiency of the dipole is 85% at the center frequency.

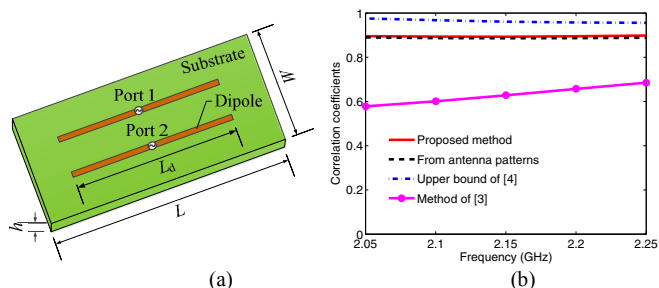

Fig. 3. (a) Geometries of the dual-dipole array. The dimensions are: $W = 40$ mm, $L = 100$ mm, $h = 2$ mm, $L_d = 44$ mm. (b) Magnitude of correlation coefficient for the dual-dipole array over the operating band.

Using the S parameters and antenna efficiencies, the loss resistance of 2.3Ω was calculated at the center frequency. According to Fig. 2 and the ABCD matrix-to-scattering matrix conversion [7], the S parameters of the embedded lossless antenna array were obtained, from which the correlation coefficients are calculated. The correlation coefficients over the operating band are shown in Fig. 3(b). For comparison, the correlation coefficients calculated from the (1) antenna patterns (exact) [2], (2) method of [3], and (3) upper bound of [4] are also shown in Fig. 3(b). It is observed that the proposed method gives the best estimate of the exact value as obtained from the patterns, whereas the method of [3] is too optimistic and the upper bound of [4] is conservative. The advantage of the proposed method

becomes even more obvious when the radiation efficiency is lower.

B. Four-dipole Array

In this subsection, the proposed method is extended for a simulated four-element dipole array, shown in Fig. 4. Unless otherwise stated, the materials and geometries of the four-dipole array are the same as those of the dual-dipole array.

The equivalent circuit model for the four-dipole array is shown in Fig. 5. Compared with the equivalent circuit of dual-dipole array in Fig. 1, the main difference is the number of voltage sources for each antenna element. In general, for an N -element antenna array, there are $(N - 1)$ voltage sources $Z_{ij}I_j$ ($j = 1, \dots, N, j \neq i$) for Antenna i , since each antenna is coupled with all the other antennas.

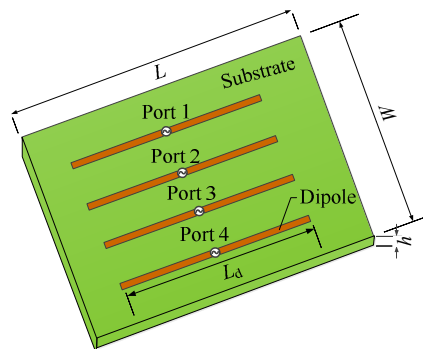

Fig. 4. Geometries of the four-dipole array. The dimensions are: $W = 80$ mm, $L = 100$ mm, $h = 2$ mm, $L_d = 44$ mm.

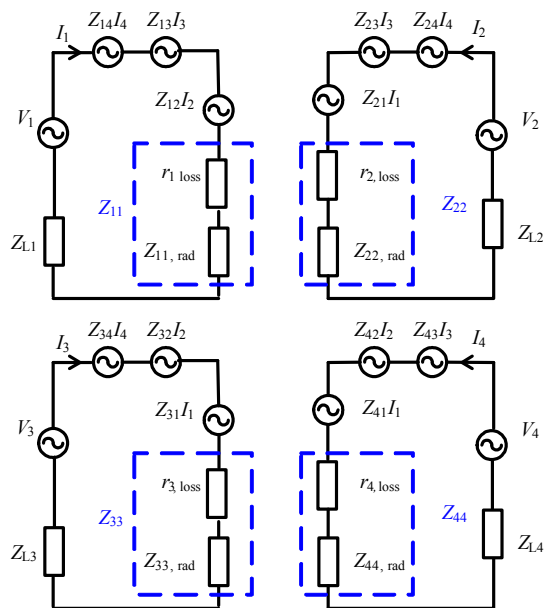

Fig. 5. Equivalent circuit model of a lossy four-dipole array.

When Antenna i is excited, the applied voltage of the other antenna ports is zero, i.e., $V_j = 0$ ($j = 1, \dots, N, j \neq i$). The total efficiency and radiation efficiency when the system is

considered as an N -port network are

$$\eta_{i,\text{tot}} = \eta_{i,\text{rad}} \left(1 - \sum_{j=1}^N |S_{ji}|^2 \right), \quad (9)$$

$$\eta_{i,\text{rad}} = \frac{\sum_{j=1}^N k_{ij}^2 r_{j,\text{rad}}}{\sum_{j=1}^N k_{ij}^2 r_{j,\text{rad}} + \sum_{j=1}^N k_{ij}^2 r_{j,\text{loss}}}, \quad (10)$$

respectively. On the other hand, the total efficiency and radiation efficiency of Antenna i when the array is taken as a one-port network are

$$\eta'_{i,\text{tot}} = \eta'_{i,\text{rad}} \left(1 - |S_{ii}|^2 \right), \quad (11)$$

$$\eta'_{i,\text{rad}} = \frac{\sum_{j=1}^N k_{ij}^2 r_{j,\text{rad}}}{\sum_{j=1}^N k_{ij}^2 r_{j,\text{rad}} + \sum_{j=1}^N k_{ij}^2 r_{j,\text{loss}} + \sum_{j=1, j \neq i}^N k_{ij}^2 \text{Re}(Z_L)}, \quad (12)$$

respectively, where $k_{ij} = |I_j / I_i|^2$.

Similar to the dual-element array, k_{ij} is calculated through the voltage-current relationships of the non-excited ports. For a four-dipole array, assuming that Antenna i is excited whereas Antennas m, n, t are not excited, it can be derived that

$$\begin{bmatrix} k_{im} \\ k_{in} \\ k_{it} \end{bmatrix} = - \begin{bmatrix} Z_{mm} + \text{Re}(Z_L) & Z_{mn} & Z_{mt} \\ Z_{nm} & Z_{nn} + \text{Re}(Z_L) & Z_{nt} \\ Z_{tm} & Z_{tn} & Z_{tt} + \text{Re}(Z_L) \end{bmatrix}^{-1} \begin{bmatrix} Z_{mi} \\ Z_{ni} \\ Z_{ti} \end{bmatrix}. \quad (13)$$

Using (9)-(13), the loss resistances of the four dipoles can then be calculated.

The cascade four-port network is presented in Fig. 6(a), with the relationships of the incoming and outgoing waves for the three blocks described in Fig. 6(b).

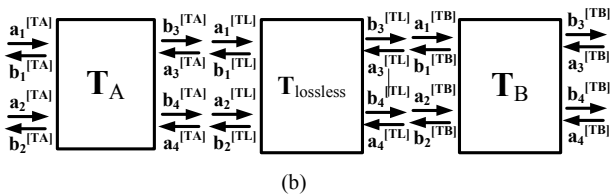
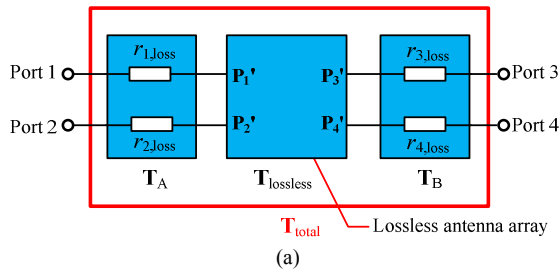

Fig. 6. (a) Cascade network model for a lossy four-element array; (b) Relationship between the incoming and outgoing waves.

The S matrices of the antenna loss are:

$$\mathbf{S}_A = \begin{bmatrix} \frac{r_{1,\text{loss}}}{2Z_0 + r_{1,\text{loss}}} & 0 & \frac{2}{2Z_0 + r_{1,\text{loss}}} & 0 \\ 0 & \frac{r_{2,\text{loss}}}{2Z_0 + r_{2,\text{loss}}} & 0 & \frac{2}{2Z_0 + r_{2,\text{loss}}} \\ \frac{2}{2Z_0 + r_{1,\text{loss}}} & 0 & \frac{r_{1,\text{loss}}}{2Z_0 + r_{1,\text{loss}}} & 0 \\ 0 & \frac{2}{2Z_0 + r_{2,\text{loss}}} & 0 & \frac{r_{2,\text{loss}}}{2Z_0 + r_{2,\text{loss}}} \end{bmatrix},$$

$$\mathbf{S}_B = \begin{bmatrix} \frac{r_{3,\text{loss}}}{2Z_0 + r_{3,\text{loss}}} & 0 & \frac{2}{2Z_0 + r_{3,\text{loss}}} & 0 \\ 0 & \frac{r_{4,\text{loss}}}{2Z_0 + r_{4,\text{loss}}} & 0 & \frac{2}{2Z_0 + r_{4,\text{loss}}} \\ \frac{2}{2Z_0 + r_{3,\text{loss}}} & 0 & \frac{r_{3,\text{loss}}}{2Z_0 + r_{3,\text{loss}}} & 0 \\ 0 & \frac{2}{2Z_0 + r_{4,\text{loss}}} & 0 & \frac{r_{4,\text{loss}}}{2Z_0 + r_{4,\text{loss}}} \end{bmatrix},$$

respectively, and

$$\mathbf{T}_{\text{lossless}} = \mathbf{T}_A^{-1} \mathbf{T}_{\text{total}} \mathbf{T}_B^{-1}. \quad (14)$$

To de-embed the S matrix of the lossless dipole array, the S-parameter and T-parameter conversion proposed in [8] was used. With the values of $\mathbf{S}_{\text{lossless}}$, correlation coefficients between each two antennas were calculated at the center frequency of 2.15 GHz, and presented in Table I. Due to the symmetric placement of the dipole antennas, Antennas 1 and 4 are identical in terms of mutual coupling and efficiencies. Similarly, Antennas 2 and 3 are also identical in this sense. Thus, only four correlation coefficients are shown in the table. It is observed in Table I that the correlation coefficients estimated from the proposed method are close to the exact values calculated from the radiation patterns, whereas the method of [3] even shows a different trend. The upper bound values are not given because the N -element ($N > 2$) solution has not been derived in the existing literature.

TABLE I
CORRELATION COEFFICIENTS OF FOUR-DIPOLE ARRAY

	$ \rho_{c,12} ^2$	$ \rho_{c,13} ^2$	$ \rho_{c,14} ^2$	$ \rho_{c,23} ^2$
Exact value	0.688	0.063	0.096	0.452
Method of [3]	0.348	0.122	0.013	0.335
Proposed method	0.699	0.055	0.116	0.502

IV. MONOPOLE ARRAY

To demonstrate that the proposed method can also be applied to other antenna types and antennas with small ground planes, a folded dual-monopole array with elements positioned (with mirror symmetry) on the two short edges of a mobile chassis was simulated (see Fig. 7). The size of chassis is 100 mm × 40 mm. The monopoles, fed by microstrip lines, are printed on a thin copper layer above a substrate. The conductivity and thickness of the copper layer are 5.8×10^7 S/m and 35 μm , respectively. The substrate has a permittivity of 2.45, a loss tangent of 0.01 and a thickness of 0.8 mm. The detailed geometries of the monopole are provided in [9].

The S parameters are shown in Fig. 8, with an isolation of around 3 dB between 0.8-0.9 GHz. The correlation coefficients calculated with different methods are given in Fig. 9. Similar to the dual-dipole case, the proposed method gives good estimates of the correlation coefficient, whereas the values calculated with the method of [3] and the upper bound of [4] deviate from the exact value.

V. CONCLUSIONS

In this work, a method based on equivalent circuits is proposed for calculating correlation coefficients in lossy antenna arrays. The method aims to provide a simpler, lower cost, and yet accurate way of characterizing the correlation performance of MIMO antennas, with typically lossy terminal antennas being a prime example. Using the radiation efficiencies and S parameters, the equivalent loss resistance can be extracted from the original lossy antenna array, such that a lossless part remains. The correlation coefficient of the original lossy antenna array can then be calculated using the S parameters of the remaining lossless part, using an existing closed form expression. The method has been applied to two-element and four-element dipole antenna arrays, with significantly better accuracy achieved relative to conventional methods. The method also shows good accuracy when applied to a dual-monopole array implemented in a compact MIMO terminal.

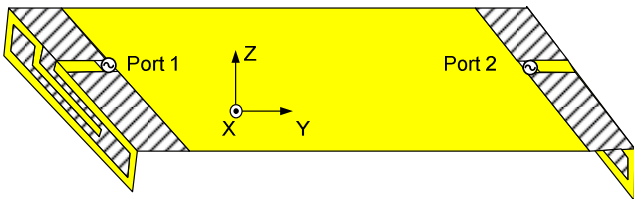

Fig. 7. Geometries of the folded monopole antennas on mobile chassis. Detailed dimensions are available in [9].

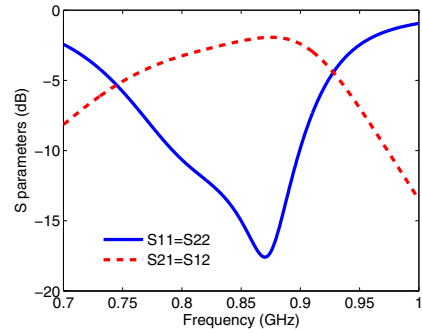

Fig. 8. The S parameters of the two folded monopole antennas on the mobile chassis.

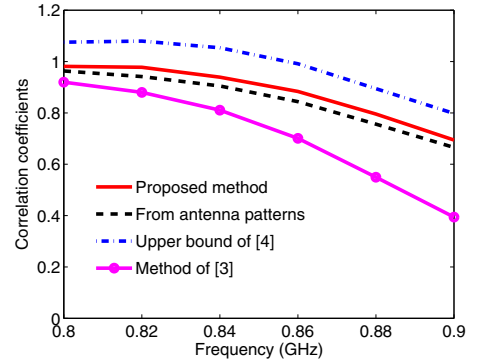

Fig. 9. Magnitude of correlation coefficient for the monopole array on mobile chassis.

REFERENCES

- [1] M. A. Jensen and J. W. Wallace, "A review of antennas and propagation for MIMO wireless communications," *IEEE Trans. Antennas Propag.*, vol. 52, no. 11, pp. 2810-2824, Nov. 2004.
- [2] R. Clarke, "A statistical theory of mobile radio reception," *Bell System Technical Journal*, no. 2, pp. 957-1000, 1996.
- [3] S. Blanch, J. Romeu, and I. Corbella, "Exact representation of antenna system diversity performance from input parameter description," *Electron. Lett.*, vol. 39, No. 9, May. 2003.
- [4] P. Hallbjörner, "The significance of radiation efficiencies when using S-parameters to calculate the received signal correlation from two antennas," *IEEE Antennas Wireless Propag. Lett.*, vol. 4, pp. 97-99, 2005.
- [5] B. K. Lau, "Multiple antenna terminals," in *MIMO: From Theory to Implementation*, C. Oestges, A. Sibille, and A. Zanella, Eds. San Diego: Academic Press, 2011, pp. 267-298.
- [6] L. J. Chu, "Physical limitation of omni-directional antennas," *J. Appl. Phys.*, vol. 19, pp.1163-1175, Dec. 1948.
- [7] D. M. Pozar, *Microwave Engineering*, 3rd Ed, John Wiley and Sons Ltd, 2005.
- [8] J. Frei, X. D. Cai and S. Muller, "Multiport S-parameter and T-parameter conversion with symmetry extension," *IEEE Trans. Microw. Theory Tech.*, vol. 56, no. 11, pp. 2493-2504, Nov. 2008.
- [9] H. Li, B. K. Lau, Z. Ying, and S. He, "Decoupling of multiple antennas in terminals with chassis excitation using polarization diversity, angle diversity and current control," *IEEE Trans. Antennas Propag.*, vol. 60, no. 12, pp. 5947-5957, 2012.