



# LUND UNIVERSITY

## Verifying Fire Safety Design in Sprinklered Buildings

Nystedt, Fredrik

2011

[Link to publication](#)

*Citation for published version (APA):*

Nystedt, F. (2011). *Verifying Fire Safety Design in Sprinklered Buildings*. (LUTVDG/TVBB-3150-SE; Vol. 3150). Lund University, Dept of Fire Safety Engineering and Systems Safety.

*Total number of authors:*

1

### General rights

Unless other specific re-use rights are stated the following general rights apply:

Copyright and moral rights for the publications made accessible in the public portal are retained by the authors and/or other copyright owners and it is a condition of accessing publications that users recognise and abide by the legal requirements associated with these rights.

- Users may download and print one copy of any publication from the public portal for the purpose of private study or research.
- You may not further distribute the material or use it for any profit-making activity or commercial gain
- You may freely distribute the URL identifying the publication in the public portal

Read more about Creative commons licenses: <https://creativecommons.org/licenses/>

### Take down policy

If you believe that this document breaches copyright please contact us providing details, and we will remove access to the work immediately and investigate your claim.

LUND UNIVERSITY

PO Box 117  
221 00 Lund  
+46 46-222 00 00

# Verifying Fire Safety Design in Sprinklered Buildings

*Fredrik Nystedt*

---

Department of Fire Safety Engineering and Systems Safety  
Lund University, Sweden

Brandteknik och riskhantering  
Lunds tekniska högskola  
Lunds universitet

Report 3150, Lund 2011



# **Verifying Fire Safety Design in Sprinklered Buildings**

**Fredrik Nystedt**

**Lund 2011**

# Verifying Fire Safety Design in Sprinklered Buildings

## Verifiering av brandskyddets utformning i byggnader med sprinklersystem

Fredrik Nystedt

Report 3150      ISSN: 1402-3504      ISRN: LUTVDG/TVBB-3150-SE

Number of pages: 140. Illustrations: Fredrik Nystedt

**Keywords:** Fire safety, verification method, performance based design, sprinkler systems, quantitative risk assessment, reliability, design alternatives, design alternatives.

**Sökord:** Brandskydd, verifiering, analytisk dimensionering, sprinklersystem, kvantitativ riskanalys, tekniska byten, tillförlitlighet.

**Abstract:** This report contains a verification method that could be applied when evaluating trail fire safety design in a performance-based code environment. The report is focused on design alternatives (i.e. design alternatives) where fire sprinkler systems have an important role. Three possible verification methods are proposed together with the procedure on how they could be applied in design. The covered methods are both qualitative and quantitative (deterministic as well as probabilistic). In order to get full benefit of a sprinkler system installation, sprinkler performance data is presented together with a new set of tenability criteria in sprinklered buildings and sprinklered design fires. Finally, advice is given on specific design situations where fire sprinklers could allow for design alternatives.

© **Copyright:** Dept. of Fire Safety Engineering and Systems Safety, Lund University, Lund, 2011.

---

Brandteknik och riskhantering  
Lunds tekniska högskola  
Lunds universitet  
Box 118  
221 00 Lund

brand@brand.lth.se  
<http://www.brand.lth.se>

Telefon: 046 - 222 73 60

Department of Fire Safety Engineering  
and Systems Safety  
Lund University  
P.O. Box 118  
SE-221 00 Lund, Sweden

brand@brand.lth.se  
<http://www.brand.lth.se/english>

Telephone: +46 46 222 73 60

## Preface

This report has been prepared within part 2 of a Nordic project on residential fire sprinklers containing three parts

1. Installation rules
2. Fire safety design with sprinklers
3. Water mist systems

The objective of part 2 is to develop a verification method for design alternatives when fire sprinklers (both conventional and residential) are installed in a building. The final goal is to produce a Nordic guideline.

Partners from all Nordic countries participate and represent authorities, research, fire consultants, building and sprinkler industries. Part 2 is coordinated by SP Technical Research Institute of Sweden, Building Technology and Mechanics, through Birgit Östman.

Part 2 is financed by several organisations mainly in Norway and Sweden, but also internationally:

- NOBTA, National Office of Building Technology and Administration, Norway
- OFAS, Information council on automatic extinguishing, Norway
- Innovation Norway
- Brandforsk, The Swedish Fire Research Board
- SBUF, Development Fund of the Swedish Construction Industry
- Sprinklerfrämjandet, Swedish Sprinkler Association
- IFSA, International Fire Sprinklers Association, US

Some organisations have contributed by in kind work, e.g. Bengt Dahlgren Brand & Risk, Brandskyddslaget and COWI.

Representatives from these and other organisations have provided comments on draft versions of the report, which is gratefully acknowledged.



## Summary

This report is a product by a Nordic research initiative with the objective of exploring different fire safety design methods and to give guidance on how to choose a relevant method for a given situation. The methods focus on verifying design alternatives in buildings with fire sprinkler systems. The aim is to enable a more consequent and uniform performance-based design process, which is a result of a specification of methods, performance criteria and design scenarios.

Fire sprinklers add several benefits to a building as the system has a high probability of extinguishing or controlling the fire. Statistics states that the system is able to operate effectively in 90-95 % of all fires large enough to serve a potential threat to the building and its occupants. Prescriptive code requirements recognise these benefits and allow for some design alternatives when sprinklers are introduced. The most common design alternatives are related to extended travel distance, the use of combustible materials and lower fire ratings. The wish list among fire safety professionals on design alternatives is far longer and within a performance-based code requirement, additional design alternatives can be performed as long as the engineer is able to show code compliance. The process, when a trial design solution is to be verified is not fully documented in available design guides, as most of these focuses on single safety objectives and not the overall safety of the building. This report introduces design process to be used when verifying fire safety. The process begins with a qualitative design review and an initial risk screening where a trial fire safety design is established on the basis of fire safety objectives, fire hazards, occupant characteristics and architectural design. A design method (i.e. prescriptive or analytical) is selected, and if analytical design is to be used, the necessary verification prerequisites are established. These prerequisites involve steps of utter importance such as verification requirements, performance criteria, selection of verification method and principles for design review.

When the qualitative design review is complete, the engineer has all the necessary information to start the verification of the trial design. The report proposes the use of three different methods; 1) qualitative assessment, 2) quantitative assessment with deterministic analysis and 3) quantitative assessment with probabilistic analysis. Qualitative risk assessments could only be used if the design is uncomplicated, affects few people and prescriptive solutions are mostly used and therefore quantitative assessment (either deterministic or probabilistic analysis) is most common when verifying trial designs.

The report collects sprinkler performance data to be used in the verification process and it also investigates a few sprinkler-related issues in order to provide a better understanding to utilise the benefits of sprinkler systems in performance-based fire safety design. U.S. statistics are analysed and it is concluded that sprinkler systems operates effectively in 90-95 % of all fire large enough to serve as a threat to the building and its occupants. The main reason for ineffective is water being shut of.

Several full scale experiments show that fire effluents in a sprinklered fire is not of great concern to the occupants. Naturally, visibility will be reduced at sprinkler actuation, but



the toxicity levels are not high enough to become a risk to human life. It is concluded that sprinklers are able to fully protect people outside the room of origin and the system also provide protection to those inside the room of origin who are not intimately involved with the fire. The reduction in risk of fatal injury is 83 % for apartments with wet pipe sprinklers, compared to apartments having no extinguishing equipment.

The traditional approach to treat suppression system is to let the heat release rate assume a constant value at sprinkler actuation. This approach has been developed and proposals are given on both sprinklered design fires as well as tenability criteria to be used in sprinklered buildings. If a deterministic analysis is conducted, the report finds evidence that a so-called robustness scenario could be used to assess whether the building has a sufficient level of safety. The robustness scenario is not as severe as the worst credible scenario in a unsprinklered building and variables as fire growth rate, soot yield as well as maximum exposure of smoke has been altered to give sprinkler system a fair treatment.

A number of design situations are introduced and investigate where sprinklers could be used as a trade-up allowing for design alternatives in other areas. The recognised situations are those related to safety features regarding control fire growth, control smoke spread, limit fire spread within and between buildings and prevent structural collapse. Each design situation is illustrated with findings in literature or rough calculations to support the verification process. One area where future research must focus is on the combination of design alternatives, especially when they relate to different safety barriers. Verifying the combined effect that the trial design has on the overall safety level is a complicated issue as it both relates to the probability of failure of a certain safety function as well as the need to apply a chronological sequence to the problem. The report therefore recognise the benefit of using a more conceptual frame work for risk analysis such as the NFPA Fire Safety Concepts Tree or any relevant risk index method.

## Sammanfattning (extended summary in Swedish)

I början av 2000-talet publicerades skriften "Boendesprinkler räddar liv" i vilken fyra tekniska byten verifierades. Dessa var brännbar fasad i fler än två våningar, minskade krav på skydd mot brandspridning via fönster, minskade krav på ytskikt i bostäder samt ökat gångavstånd till utrymningsväg. Ytterligare ett antal tekniska byten identifierades, men dessa ansågs vara så pass specifika att de inte kunde göras någon allmängiltig verifiering. För dessa tekniska byten skulle analytisk dimensionering användas för att visa att samhällets krav på brandsäkerhet uppfylls. Inga anvisningar gavs för hur en sådan analytisk dimensionering skulle gå utföras.

Just analytisk dimensionering av brandskydd i byggnader har under några år varit ett aktuellt och omdebatterat ämne. Forskning har identifierat flera brister när det gäller verifiering, dokumentation och kontroll av brandskyddsprojekteringar samt föreslagit arbetsmetoder för att komma till rätta med dessa brister. Formerna för projektering med analytisk dimensionering hittills varit både ofullständiga och otydliga och detta projekt inriktar sig på att utveckla en metodik för verifiering av brandskyddets utformning i byggnader med sprinklersystem. Sprinkler och tekniska byten är en fråga som i stort sett handlar om den tillförlitlighet som en sprinkleranläggning har för att lösa en viss skyddsuppgift. När sprinklersystemet fungerar behövs minimalt med annat brandskydd. Problematiken blir därför koncentrerad till att kunna avgöra den minsta möjliga nivån på övriga brandskyddsåtgärder som behövs vid de bränder där sprinklersystemet inte fungerar som avsett. Ett centralt begrepp i sammanhanget är "risk", vilket innebär att säkerheten värderas genom att beakta både sannolikheten och konsekvensen av aktuella scenarier.

När projektören väljer att göra avsteg från de allmänna råden i byggreglerna ska analytisk dimensionering tillämpas, vilket kräver en verifiering av brandsäkerheten. Arbetsgången vid verifiering innebär i stort att projektören först gör en analys av verifieringsbehovet, för att sedan välja verifieringsmetod, ta fram acceptanskriterier och att fastställa former för kontroll av projekteringen. Tre principiellt skilda verifieringsmetoder beskrivs; kvalitativ bedömning, scenarioanalys och kvantitativ riskanalys. Valet av metod styrs av flera faktorer som exempelvis brandskyddslösningens komplexitet och hur konservativt den har valts samt antalet avsteg och tillägg i förhållande till förenklad dimensionering.

Sprinklersystemen påverkar brandförloppet genom att släcka branden alternativt kontrollera dess utveckling. Genom att göra så påverkas den mängd värme, rök och giftiga gaser som branden avger. Försök har visat att sprinklersystemet påverkar brandens utveckling innan dess att förhållandena i brandrummet kan hota människor som befinner sig där. Även om den sprinklerkontrollerade branden producerar en hel del brandgaser så är temperaturen och koncentrationen av giftiga brandgaser så pass låg att det finns gott om tid att utrymma, eller till och med att kvarstanna i rummet. Det har också noterats att aktiveringen av sprinklersystemet orsakar en siktnedsättning, speciellt i nära anslutning till sprinklerhuvudet. Dock är siktförhållandena generellt sätt bättre i en sprinklad byggnad i jämförelse med samma brand i en osprinklad byggnad. Sammanfattningsvis visar försök för boendeliknande miljöer att det produceras en hel del rök, men att denna inte är speciellt giftig eller varm vilket ger en liten påverkan på människor som befinner sig i brandrummet.

Endast de personer som befinner sig i brandens omedelbara närhet bedöms kunna utsättas för allvarlig skada eller dödsfall.

Sprinklersystemet påverkar också brandens effektutveckling vilken i de flesta fall kommer att minska denna rejält. Hur stor minskning beror i huvudsak på brandens storlek när sprinklern aktiverar, vad det är som brinner och hur väl vattnet når branden. Försök gjorda i mindre rum visar att tvåzonsskiktningen upphör efter sprinkleraktivering, men så är inte fallet i större rum. Här har försök visat att skiktningen behålls en bit bort från branden och att brandgaserna därmed kvarstannar i det övre varma brandgaslagret.

Sprinklersystem är tillförlitliga installationer och data från NFPA visar en kombinerad tillförlitlighet, dvs. att sprinklersystemet aktiverar och är effektivt på 90 till 95 %. Den huvudsakliga orsaken till utebliven aktivering är att systemet varit avstängt. Dimensionerande brandscenario och dimensionerande brand är centrala begrepp vid analytisk dimensionering. Statistik och erfarenheter från inträffade bränder visar att konsekvenserna av en brand när sprinklersystemet aktiverar och är effektivt är låga. Personskador inträffar sällan och egendomsskadorna minskas drastiskt. Tillgängliga modeller för analys av brandförlopp kan dessvärre inte beskriva brandförloppet och spridningen av brandgaser på ett tillfredsställande sätt när hänsyn ska tas till sprinkleraktivering. Samtidigt bygger nuvarande angreppssätt på alldeles för konservativa antaganden avseende sprinklersystemets påverkan på effektutvecklingen. I stället för att titta på konsekvenserna av en sprinklerpåverkad brand rekommenderas därför att analysarbetet fokuserar på att undersöka effekterna av ett scenario som ska avgöra hur mycket brandskydd som krävs i händelse av att sprinklersystemet är otillräckligt. Detta scenario är inte lika allvarligt som ett dimensionerande scenario i en byggnad utan sprinkleranläggning, då scenariot endast är aktuellt i 5 till 10 av 100 tillväxande bränder. Därför är det rimligt att branden representerar mer genomsnittliga förhållanden än det s.k. värsta troliga.

För att kunna bestämma när en brand medför en kritisk påverkan för utrymning är det nödvändigt att definiera en maximalt tillåten nivå av brandspecifika variabler som temperatur, sikt och värmestraålning. Nivåerna för dessa variabler anges i ett allmänt råd till byggreglerna och för de flesta byggnader är det ofta nivån på minsta tillåten sikt (10 m i större lokaler) som är dimensionerande. Försök har visat att en aktivering av sprinklersystemet leder till lokala problem med siktbarheten, samtidigt som inga andra nivåer för kritisk påverkan överskridas. En väsentlig fråga är därför om siktbarhet är ett bra mått på kritisk påverkan för bedömning av utrymningssäkerheten i lokaler med sprinklersystem? Om måttet är olämpligt, vore det i så fall bättre att studera toxicitet i stället. Frågorna besvaras nedan i omvänd ordning.

Toxisk påverkan vid brand kan mätas med en s.k. fraktionsdosmodell (Fractional Effective Dose – FED). Om FED-värdet uppgår till 1,0 så innebär det att en person med genomsnittlig känslighet blir medvetslös. Vidare har ett FED-värde på 0,3 rekommenderats utgöra kritisk påverkan för utrymning i några handböcker. Tanken med FED är lockande då brandskyddet i en byggnad kan värderas direkt mot den effekt som en brand har på de personer som befinner sig i byggnaden. Överslagsberäkningar visar att en siktbarhet på 10 m motsvarar ett FED-värde på 0,003 till 0,03, en nivå som i princip inte innebär någon som helst påverkan på personer, även om individen är extremt känslig. Samtidigt innebär detta att ett FED-värde på 0,3 har en sikt som är i princip obefintlig, något som generellt sett inte duger vid dimensionering av utrymningssäkerhet. Korrelationen mellan siktbarhet och FED är således oklar i nuläget och FED-modeller bedöms inte kunna användas i större utsträckning. Det finns dock en situation där ett kriterium baserat på toxicitet kan vara lämpligt. Det handlar om bedömning av utrymningssäkerheten i byggnader där det finns personer som inte kan ta sig ut på egen hand. Dessa bör ha hunnit evakueras med assistans innan dess att deras FED-värde överskridit ett dimensionerande värde, exempelvis 0,3. Även i tunnlar skulle FED kunna vara ett lämpligt dimensioneringskriterium.

I robusthetsscenarioet vore det möjligt att tolerera en sämre siktbarhet och det föreslås därför att siktbarheten inte ska vara mindre än 5 m när detta scenario värderas. En siktbarhet på 5 m ger ingen påtaglig toxisk påverkan ( $FED = 0,006$  till  $0,06$ ) och personer bedöms fortfarande utrymma i den riktning dit de var på väg innan siktnedsättningen. Forskning visar att det krävs en siktbarhet på mindre än 3 m för att utrymmande ska vända om och pröva andra alternativ i någon större utsträckning.

Ett sprinklersystem är dimensionerat för att antingen släcka eller kontrollera en brand. När detta sker utför sprinklersystem en viktig del av brandskyddet i byggnaden, vilket möjliggör tekniska byten med andra brandskyddsåtgärder som normalt hade krävts. Sprinkler kan användas för att lösa följande uppgifter; kontrollera brandens tillväxt, kontrollera spridning av brandgaser, begränsa brandspridning inom och till annan byggnad och förebygga kollaps. Men, sprinkler kan inte; förhindra antändning, möjliggöra utrymning eller möjliggöra räddningsinsats. För de sistnämnda uppgifterna krävs brandskyddsåtgärder som gör det möjligt att effektivt utrymma byggnad och på ett säkert sätt göra en räddningsinsats.

När sprinklersystemets skyddsuppgifter har definierats är det möjligt att gå igenom olika delar av brandskyddet och beskriva på vilket sätt det går att utföra tekniska byten efter det att byggnaden försett med ett sprinklersystem. Nedanstående påstående belyser saken:

- Bränder kan tillåtas att växa snabbare om det finns ett sprinklersystem eftersom branden ändå kommer att kontrolleras eller släckas före den kan orsaka skador på människor. När tekniska byten görs på exempelvis ytskikt är det viktigt att valda material inte minskar sprinklersystemets effektivitet och att en minsta nivå på ytskikt bibehålls. I sammanhanget föreslås att ytskikt med sämre klass än D aldrig accepteras.

- Brandgaser kan tillåtas att spridas i större omfattning i sprinklade byggnader eftersom sprinklersystemet kommer att begränsa den mängd brandgaser som produceras. När tekniska byten görs är det betydelsefullt att beakta både toxicitet och siktbarhet
- Ett sprinklersystem kan ersätta andra brandskyddsåtgärder som verkar för att begränsa spridning av brand mellan brandceller. Verifieringen av det tekniska bytet görs genom att konstatera att sannolikheten för ett otillgängligt sprinklersystem är mindre än den för den ersatta åtgärden.
- Ett sprinklersystem möjliggör också till en reduktion av avskiljande och bärande förmåga, givet att den risken för brandspridning och kollaps hålls inom vad som tolereras som ett resultat av förenklad dimensionering.

## Table of contents

<b>1</b>	<b>INTRODUCTION</b> .....	<b>1</b>
1.1	Background.....	1
1.2	Aim and objectives .....	4
1.3	Method.....	4
1.4	General limitations.....	5
1.5	Overview.....	5
<b>2</b>	<b>NORDIC REGULATIONS ON FIRE SAFETY IN BUILDINGS</b> .....	<b>7</b>
2.1	Hierarchal structure .....	7
2.2	Functional requirements .....	7
2.3	Performance requirements.....	8
2.4	Technical guide for verification .....	9
<b>3</b>	<b>PERFORMANCE-BASED FIRE SAFETY DESIGN</b> .....	<b>11</b>
3.1	Barrier groups and fire safety features .....	11
3.2	The fire safety design process.....	14
3.3	The principle of design alternatives .....	18
<b>4</b>	<b>VERIFYING DESIGN ALTERNATIVES</b> .....	<b>21</b>
4.1	Available methods .....	21
4.2	Prerequisites for verification .....	24
<b>5</b>	<b>VERIFICATION METHODS</b> .....	<b>33</b>
5.1	Qualitative assessment.....	33
5.2	Quantitative assessment with deterministic analysis.....	34
5.3	Quantitative assessment with probabilistic analysis.....	36
<b>6</b>	<b>FIRE SPRINKLER SYSTEMS</b> .....	<b>43</b>
6.1	Sprinkler head characteristics.....	43
6.2	Types of sprinkler systems .....	46
6.3	Sprinklers and fire effluents .....	48
6.4	The effect of sprinklers on the fire development .....	50
6.5	Reliability, performance and effectiveness.....	57
<b>7</b>	<b>PERFORMANCE-BASED DESIGN PREREQUISITES</b> .....	<b>65</b>
7.1	Proposed design fires in sprinklered buildings .....	65
7.2	Tenability criteria in sprinklered fires .....	72
<b>8</b>	<b>DESIGN SITUATIONS</b> .....	<b>77</b>
8.1	Sprinklers as a fire safety feature .....	77
8.2	Design alternatives of interest to fire safety professionals .....	78
8.3	Type of sprinkler system and possible design alternatives .....	80
8.4	Using sprinkler to control fire growth .....	80
8.5	Using sprinklers to control smoke spread within the compartment of fire origin .....	82
8.6	Using sprinklers to limit fire and smoke spread within building and prevent structural collapse .....	83
8.7	Using sprinklers to prevent fire spread to other buildings .....	91

8.8	Combining design alternatives .....	92
<b>9</b>	<b>REFERENCES .....</b>	<b>97</b>
<b>APPENDIX A GUIDANCE ON VERIFYING DESIGN ALTERNATIVES REGARDING CONTROL OF FIRE GROWTH .....</b>		
<b>103</b>		
A.1	Design objectives.....	103
A.2	Performance criteria .....	103
A.3	Methods of verification .....	103
A.4	Step-by-step procedure.....	104
A.5	Special Notes.....	105
<b>APPENDIX B GUIDANCE ON VERIFYING DESIGN ALTERNATIVES REGARDING CONTROL OF SMOKE SPREAD WITHIN THE COMPARTMENT OF FIRE ORIGIN .....</b>		
<b>107</b>		
B.1	Design objectives.....	107
B.2	Performance criteria .....	107
B.3	Methods of verification .....	108
B.4	Step-by-step procedure.....	108
B.5	Special Notes.....	110
<b>APPENDIX C GUIDANCE ON VERIFYING DESIGN ALTERNATIVES REGARDING LIMIT OF FIRE AND SMOKE SPREAD WITHIN BUILDING AND PREVENTING STRUCTURAL COLLAPSE .....</b>		
<b>111</b>		
C.1	Design objectives.....	111
C.2	Performance criteria .....	111
C.3	Methods of verification .....	111
C.4	Step-by-step procedure.....	111
C.5	Special Notes.....	113
<b>APPENDIX D GUIDANCE ON VERIFYING DESIGN ALTERNATIVES REGARDING PREVENTING FIRE SPREAD BETWEEN BUILDINGS</b>		
<b>115</b>		
D.1	Design objectives.....	115
D.2	Performance criteria .....	115
D.3	Methods of verification .....	115
D.4	Step-by-step procedure.....	116
<b>APPENDIX E HUMAN TENABILITY AND BEHAVIOUR IN SMOKE.....</b>		
<b>119</b>		
E.1	Human tenability limits .....	119
E.2	Human behaviour in smoke .....	122
<b>APPENDIX F DETAILS ON PERFORMANCE-BASED DESIGN .....</b>		
<b>125</b>		
F.1	Legislative criteria for successful escape.....	125
F.2	Traditional design approach on suppression effects .....	126

# 1 Introduction

## 1.1 Background

Traditional fire safety regulations could be considered being built up by a number of barriers, being either preventive or protective. Barriers that are intended to work before a specific initiating event takes place (e.g. a fire), serve as a means of prevention. Such barriers are supposed to ensure that the accident does not happen, or at least to slow down the developments that may result in a severe accident. Barriers that are intended to work after a specific initiating event has taken place serve as means of protection. These barriers are supposed to shield the environment and the people in it, from the consequences of the accident.

Svenson (1991) showed how the barrier concept has been applied by practitioners of risk analysis. A barrier was defined as “equipment, constructions, or rules that can stop the development of an accident”. Svenson (1991) provided a distinction between three types of barriers; passive, active, and procedural. Passive barriers, such as fire-rated structures, would always be ready to use. Active barriers, such as fire extinguishing equipment, would require some kind of activation before they could be used. Finally, procedural barriers, such as instructions for use of equipment, would require a mediating agent in order to be effective. A distinction must be made between barrier functions and barrier systems. A barrier function represents a function that could stop the development of an accident, and barrier systems are those systems that are maintaining the barrier functions. Such systems, in case of fire, could be a well-trained fire warden, a fire compartment, an automatic sprinkler system, the firemen’s elevator, etc. The use of the barrier concept should be based on a systematic description of various types of barrier systems and barrier functions. The NFPA “Fire Safety Concepts Tree” (NFPA, 2007) is a good example on the use of the barrier concept to deal with fire risks.

In 1994 the Fire Safety Committee of the Nordic Committee on Building Regulations published a proposed model for a performance-based code for fire safety in buildings (NKB, 1994). The main idea with a performance-based code is to formulate performance requirements which secured the stipulated safety level without dictating detailed design and selection of materials. The general objective in a performance-based code could be (NKB, 1994):

*“Every building and structure shall be constructed in such a way and with such materials, and their fittings and furnishings shall be such that, with regard to their use and situation, they afford satisfactory safety with respect to fire for persons who are present in the building, including secure facilities for the rescue of persons and for fire fighting, and with respect to the spread of fire to buildings and activities both on the same and adjoining plots. Every building and every structure shall be constructed in such a way that they provide acceptable safety against damage to property and the environment.”*

In a performance-based code, compliance with the fire safety regulations can be demonstrated in two ways. Either by constructing the building in accordance with pre-accepted solutions or by means of analyses and/or calculations which document that safety



against fire is satisfactory. The pre-accepted solutions, some-times also referred to as “deemed to satisfy” solutions, are used to simplify the design process and the construction of buildings by eliminating the need of analyses and/or calculations. The uses of analytical tools are hardly desirable or necessary for traditional buildings. The pre-accepted solutions are sometimes also published in a separate handbook and the building is considered safe if these solutions are adopted. On the other hand, those who are in a position to perform analyses and calculations are given a real choice of freedom in establishing a particular fire safety design solution, without having to resort to exemptions or other deviations from the regulations. A building is considered safe irrespective of its design and construction if it complies with the performance-based building code. The selection of design method, i.e. using pre-accepted solutions or analytical tools do both result in building with satisfactory safety in case of fire, as long as the performance requirements are met.

Verification is a central term in a performance-based code. When pre-accepted solutions are adopted, the designer verifies that the building actually has been built according to the specifications of the pre-accepted solutions. The designer does not need to show that the design is safe, as this comes automatically with the use of pre-accepted solutions. The analytical tools are used, verification becomes of utter importance. The designer must use his tools to show that the proposed design solution results in a safety level that is in line with what is accepted by the society, i.e. formulated in the performance requirements of the building code. This process of showing sufficient safety is commonly referred to as verification and could be conducted with a number of different methods, ranging from qualitative screening techniques to extended quantitative analyses.

Most buildings are designed with pre-accepted solutions. But, sometimes a deviation from some of these solutions is in the interest of the builder. This process, when one pre-accepted solution is replaced by another, is generally considered as a design alternative or a design alternative. All design alternatives need to be verified in order to show that the achieved safety level complies with the regulatory requirements. This verification is done by employing analytical tools and the result should be documented and thoroughly reviewed.

Fire sprinkler systems are an essential part of the fire safety features in a building. In most situations, a sprinkler system is not mandatory in Nordic building regulations and the list of possible design alternatives is short when designing with pre-accepted solutions. However, sprinklers are required in some situations. In Finland sprinklers are required for certain wooden buildings and in Norway an automatic fire extinguishing system (which normally means sprinklers) is now mandatory in new buildings like hospitals, care homes, hotels etc. and in residential buildings where the installation of lift is required.

A properly installed and operating fire sprinkler system controls the fire development at an early stage enabling occupants to escape safely as well as preventing fire spread and ensuring the structural stability of the building. One could sometimes hear the argument that there is practically no need for additional fire safety systems in a building when fire sprinklers are installed and when they operate appropriately.

However, fire sprinkler system reliability is not 100 %. Statistics show that the system is unavailable in app. 5-10 of 100 fires, which enlightens the demand of additional fire safety measures. Naturally, all fire safety features have reliabilities less than 100 %, and one of the most important questions to be answered is on how much additional fire safety is needed in buildings with fire sprinkler? This question does not have a straightforward answer, but it is important to answer it when evaluating possible design alternatives on traditional fire safety measures when sprinklers are added to a building. The pre-accepted solutions in the Nordic countries allow for some design alternatives when a building is fitted with fire sprinklers, e.g:

- The maximum travel distance to an escape route could be increased.
- Lower ratings on separating and structural elements
- The use of unprotected wood on outer walls (facades)
- Less requirements on separating distances between buildings in order to prevent fire spread between them.
- Larger maximum size of a fire compartment.

The allowed design alternatives among the pre-accepted solutions do not always follow a clear line of thought. If all design alternatives are combined, there is a reduction in a number of different barrier groups. Longer travel distances results in greater floor area and more people. At the same time outer walls of wood could spread fire to the floors above and to the neighbouring property as well. It is clear that a more scientific approach is needed where with design alternatives explicitly related to a specific barrier group as well as clear guidelines on the combination of trade offs.

The first major Swedish research initiative on residential sprinklers was conducted in the period of 1999-2002. The project resulted in a few scientific publications on the performance of residential sprinklers (e.g. Arvidson (2000) and Nystedt (2003) as well as a handbook containing information and guidelines for the use of residential sprinklers in such occupancies (Östman et al., 2002). The handbook also contains verifications of a few design alternatives that could be adopted when sprinklers are installed. Verified design alternatives were the use of wooden facades, fewer requirements on vertical separating distance between windows, the use of combustible linings and longer travel distance to exits. A few additional design alternatives were also recognised, but it was concluded that these solutions required more verification by the use of fire safety engineering. The handbook did, however, not give any details on how to perform such verification. This report tries to give such guidance.

Fire safety engineering is still a young profession with a high degree of ongoing developments, both regarding design methods and the understanding of fire phenomena as

well as human behaviour. If one compares case studies carried out twelve years ago with those of today, significant differences could be found, e.g. Marberg et al. (1996) vs. Bonthron et al. (2008). These differences most relate to the method of verification, especially on selection of scenarios and the treatment of uncertainties. The fire safety design process with analytical tools has also been more formalised with publications from BSI (2001) and SFPE (2007). However, neither of these publications provides enough practical guidance to the engineer and there is a need for a straightforward guide to be used when verifying a trial design solution. Such guide would need to address suitable methods and their use, as well as provide sufficient data on various design situations.

## **1.2 Aim and objectives**

The objective of this report is to explore different design methods and to give guidance on how to choose a relevant method for a given situation. The methods focus on verifying design alternatives in buildings with fire sprinkler systems and are supposed to be adopted by practitioners, local authorities and regulators. The aim is to enable a more consequent and uniform performance-based design process, which is a result of a specification of methods, performance criteria and design scenarios.

## **1.3 Method**

An initial literature survey was conducted to identify suitable methods, from which a few methods are selected. The use of each suitable method is properly described focusing on both procedure and treatment of uncertainties.

In addition the capabilities and reliability of fire sprinklers were investigated by the use of statistics and experience from fire testing. Building regulations were examined in order to divide available safety measures into barrier groups related to a specific task, e.g. control fire spread within a building.

A system was proposed where the role of fire sprinklers in each identified barrier group is expressed and general ideas on possible design alternatives are introduced. These ideas are developed further for those barrier functions where sprinkler could play an important role.

From the literature study information was gathered on two major sprinkler related design issues – heat release rates in sprinklered fires and life safety criteria in sprinklered fires.

The methods outlined in this report are also evaluated by fire safety professionals providing feed-back on the usability of the approach. These efforts are ongoing and will be documented at a later stage.

## **1.4 General limitations**

This report gives an introduction to three different methods of verification and their use. These methods are not by any means exclusive and other methods could also be used to verify sufficient safety when an analytical approach is adopted. The report present sprinkler statistics based on mostly American data sources as well as fire incident statistics mostly based on Swedish data. The user of this report must verify that the data is applicable to his/her design situation. Otherwise, the user most focus on the methods presented in this report and not the actual figure. The report covers a number of design situations in which some design alternatives are discussed.

Note that the intended use of this report is to verify fire safety design solutions where sprinkler systems are introduced as a key fire safety feature of the building. The report could not be used to verify fire safety design where mandatory requirements on sprinkler system exist and the design solution proposes a design alternative from such a requirement.

Finally, the theories in this report are supposed to be adapted on design situations where comparative criteria could be used. Such design situations are related to those where pre-accepted solutions exists, i.e. most buildings. In Sweden and Norway, some buildings have a mandatory requirement on the used of an analytical approach. Examples of such buildings are those that have a potential of large losses of life and property in the event of fire. Prescriptive design solutions could be adopted, but their application must be decided by the designer who also is responsible for the safety level that they result in. Fire safety design for such building is not covered in this report.

It is the responsibility of the engineer to ensure that chosen fire safety design does not reduce the effectiveness of the sprinkler system, e.g. when combustibile wall coverings are used. The engineer must ensure that the design is comparable with the design sprinkler systems' design criteria.

## **1.5 Overview**

This report contains eight chapters giving the background information for the proposed strategies on how to perform a performance-based design. This information is further developed in the appendices for a more practical use by engineers. Methods for verifying fire safety in buildings with fire sprinkler systems are not unique to such buildings. These methods may be used in all types of fire safety engineering design when the engineer decides to deviate from a prescriptive approach. The first chapters in the report are therefore more general providing important information to the engineer on the issue of verification of fire safety designs.

The 2<sup>nd</sup> chapter “Nordic regulations on fire safety” contains an introduction to the regulatory environment. A hierarchal structure is presented together with details on functional and performance requirements. The 3<sup>rd</sup> chapter “Performance-based fire safety design” discusses various aspects on performance-based design with focus on barrier concepts, design process, the principle of design alternatives.

The 4<sup>th</sup> chapter “Verifying design alternatives” and the fifth chapter “Verification methods” are all about verification of fire safety design solutions. It presents available methods and selects those that are considered appropriate. This chapter also gives the necessary prerequisites to perform a verification of the trial design.

The 5<sup>th</sup> chapter covers the selected verification methods in more detail presenting both the procedure to be applied when using them, as well as a reflection on how uncertainties are treated. The 6<sup>th</sup> chapter “Fire sprinkler systems” provides an introduction to fire sprinkler system as well as up-to-date data on sprinkler performance and reliability. The sixth chapter shows how fire effluents and the fire development are affected by sprinkler systems.

The 7<sup>th</sup> chapter “Performance-based design prerequisites” uses the information provided in the previous chapters in order to present necessary data and prerequisites the performance-based design. Measures on sprinkler system efficiency are calculated, design fires are proposed together with appropriate tenability criterions in sprinklered buildings. The 8<sup>th</sup> chapter “Design situations” investigates various design situations where design alternatives are of interest.

Finally, guidance on practical application is given in separate appendixes together with some guidance on human behaviour in smoke as well as additional details on performance-based fire safety design.

## 2 Nordic regulations on fire safety in buildings

### 2.1 Hierarchal structure

NKB (1978) presents the so called Nordic Five-Level System which is currently used by most performance-based regulatory frameworks and structures. The system is built up by the following hierarchal levels:

1. *Goal*  
The goal addresses the interests of the society
2. *Functional requirement*  
A functional requirement addresses a specific aspect of the building that will contribute to achieve the overall goal.
3. *Performance requirement*  
Performance requirements are the actual requirement that should be met to fulfil the functional requirements. If possible, these requirements should be expressed in quantifiable terms.
4. *Verification*  
This level contains instruction or guidelines for verifying compliance with the performance requirements.
5. *Pre-accepted solutions*  
When designing fire safety in traditional buildings a set of pre-accepted solutions are available in order to simplify the design process and the construction of buildings.

This report describes procedures and methods on the 4<sup>th</sup> level of the hierarchal structure and the sub-sections below describes functional and performance requirements as they are mentioned in NKB (1994) as well as details on available design methods and the fire safety design process.

### 2.2 Functional requirements

NKB (1994) is considered as a framework for a performance-based code and it gives functional and performance requirements for buildings in the event of the outbreak of fire. On the top level (see hierarchal structure in section 2.1), the building law requires that buildings should be safe in the event of fire. This fundamental requirement is made a bit more nuanced with the introduction of functional requirements on construction work stating that:

- The load-bearing capacity can be assumed for a specific period of time.
- The generation and spread of fire and smoke within the construction is limited
- The spread of fire to neighbouring construction works is limited.
- People in the construction on fire can leave it or be rescued by other means
- The safety of fire and rescue service personnel is taken into consideration.

These requirements are practically the same throughout the Nordic countries and it is generally considered that a building must comply with the objectives of each technical

requirement. These requirements could also be found among the “safety in case of fire” requirements of the construction products directive (CPD, 1988) by the European Commission. In order to give more details on which level of safety the society require, a set of performance requirements are introduced. These are presented in section 2.3.

## **2.3 Performance requirements**

### **2.3.1 Stability and load-bearing structures**

NKB (1994) states that a building shall be designed in such way that it has sufficient stability and load-bearing capacity in the event of fire. The term “sufficient” is dependant on building type and use. For some buildings the stability and load-bearing capacity shall be retain during the entire fire sequence. In other buildings, collapse is allowed but not before e.g. the time required for escape, rescue and prevention of fire spread to neighbouring buildings.

### **2.3.2 Development and spread of fire and smoke in the building**

Performance requirements on the development and spread of fire and smoke in the building are divided into four groups (NKB, 1994):

1. The outbreak of fire
2. Development of fire
3. Spread of fire inside the building
4. Fire fighting

Fittings, furnishings and engineering services shall be such or constructed in such a way the risk of outbreak of fire is minimised. Surface materials shall not contribute to the development of a fire in an unacceptable extent. NKB (1994) states that a building shall be divided into fire compartments and compartment groups (fire sections) in such a way that the spread of fire and smoke is reduced or impeded, unless such spread is prevented by other measures.

NKB suggests that a fire should not be able to spread beyond a fire section, given consideration top likely fire fighting input. NKB also suggests that a fire should be maintained within a fire compartments during the time which is necessary for escape and rescue of persons in the fire section. Finally, NKB (1994) recognises that buildings shall have necessary fire fighting equipment and be designed in such a way that the rescue personnel can operate in effective, safe and rapid manner.

### **2.3.3 Spread of fire between buildings**

NKB (1994) states that the danger if fire spread shall be prevented so that the safety of persons is satisfactory and that a fire will not cause unreasonable large economic or social losses.

### 2.3.4 The escape of persons

Buildings shall provide facilities for safe escape and during the time required for escape there shall be no occurrence of heat, fire effluents or other circumstances that will impede escape. NKB (1994) give details on the number of escape routes, the construction of doors leading to escape routes and the escape routes themselves. Some requirements are at least two independent escape routes from each fire compartment, the selection of materials in escape routes and doors in escape routes being possible to open without the use of keys.

### 2.3.5 The safety of rescue personnel

According to NKB (1994) the building must have safe access routes to be used for rescue and fire fighting. The rescue personnel shall have a reasonable chance of locating and extinguishing a fire.

## 2.4 Technical guide for verification

The performance requirements are too imprecise to be used when performing verification with analytical tools. In order to be able to conduct a verification, the NKB (1994) has produced a technical guide that gives details on load combination to be investigated, failure criteria for safety of persons, stability of structures and spread of fire as well as guidance in assessing if the failure criteria are met. Figure 2.1 illustrates a schematic procedure for verification by calculation (the use of analytical tools).

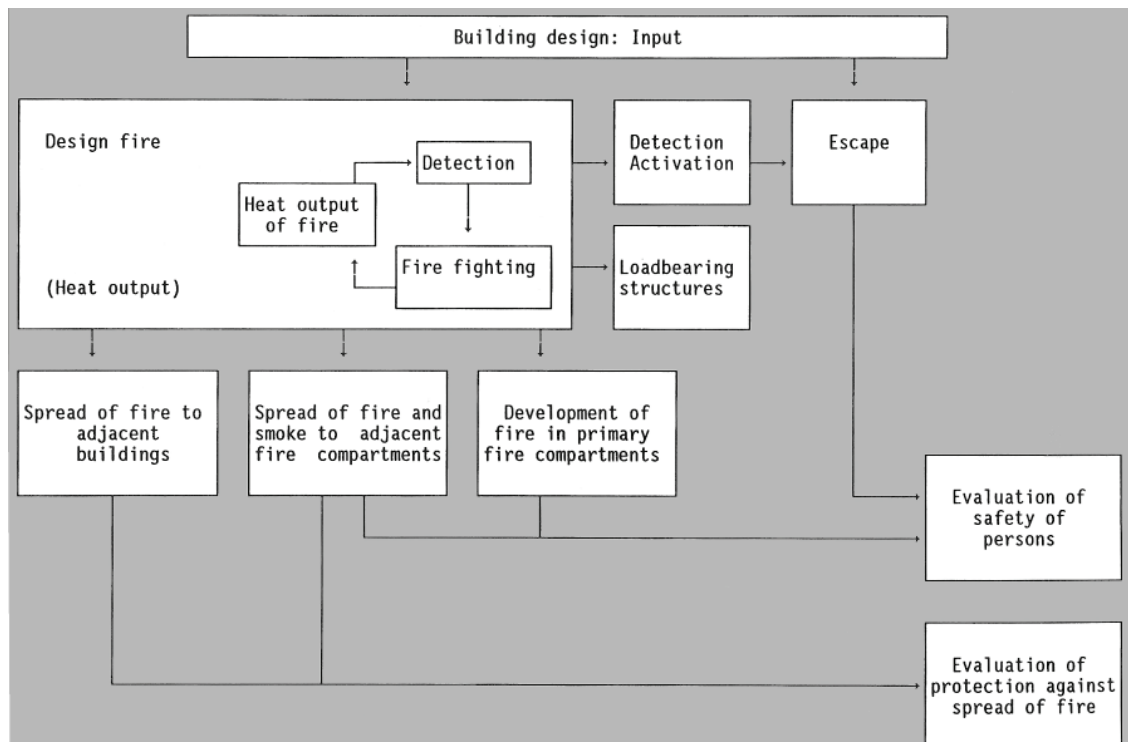

Figure 2.1 Schematic calculation procedure according to NKB (1994).

The verification concept introduced by NKB (1994) is a bit of all or nothing approach where the designer either completely uses pre-accepted solutions or fully employs an analytical approach.



However, as the design procedure has developed over the past 15 years it is more common that the designer uses pre-accepted solutions for the majority of the fire safety features in the building and only uses analytical tools to verify a few trade offs, i.e. deviations from the pre-accepted solutions.

### 3 Performance-based fire safety design

#### 3.1 Barrier groups and fire safety features

Yung (2008) introduces barrier groups when describing and categorising the fire safety features of a building. The structure presented by Yung is related to the development of the fire in the building and uses principles of “defence in depth” to show the relationship between various safety measures. Defence in depth is originally a military term where the defender seeks to delay rather than prevent the advance of an attacker. The term defence in depth is now used in many non-military contexts. Regulations on fire safety use the principle as fire prevention does not focus all the resources only on the prevention of a fire; instead, it also requires the deployment of escape routes, compartmentation, detection, extinguishers etc.

In practice, defence in depth is strongly related to redundancy, i.e. a system that keeps working when a component fails. If one escape route is blocked, the occupants can use the other or if the outbreak of a fire isn't prevented, the fire will remain within the fire compartment. Fire safety in buildings is built up by multiple, redundant, and independent layers of safety systems. This helps to reduce the risk that a single failure of a safety feature could cause a consequences considered to be too severe.

CAENZ (2008) discusses fire safety measures in terms of barriers related to the fire development in a building, i.e., prevent ignition, control fire growth, control smoke spread, limit fire spread within building, prevent fire spread to other buildings, means of escape, facilitate rescue operations and prevent structural collapse. Table 3.1 shows the link between performance requirements in NKB (1994) and the proposed barrier groups.

*Table 3.1 Link between performance requirements and major barrier groups on fire safety.*

Performance requirement	Major barrier group
Stability and load-bearing structures	Prevent structural collapse
Development and spread of fire and smoke in the building	Prevent ignition Control fire growth Control smoke spread Limit fire spread within building
Spread of fire between buildings	Prevent spread to other buildings
The escape of persons	Means of escape
The safety of rescue personnel	Facilitate rescue service operations

The fire safety measures in a building are related to one or more of the phases of fire development and CAENZ (2008) provide the following list of major barrier groups and possible fire safety measures.

- To prevent ignition
  - Control ignition sources (electrical, cooking, smoking materials, machines and equipment etc.).
  - Control items of hazardous fuel.
- To control fire growth
  - Control fuel sources (good housekeeping).
  - Specify suitable covering materials for walls and ceilings.
  - Provide hose reels, extinguishers.
  - Install sprinklers or other suppression systems.
  - Check water supplies in the street for fire service use.
- To control smoke spread
  - Install smoke-stop doors and lobbies
  - Ensure that doors are closed
  - Seal penetrations
  - Provide smoke reservoirs, mechanical vents or natural vents
  - Provide smoke detectors and smoke dampers in ducts
  - Provide automatic controls for an HVAC system
  - Pressurise stairwells
  - Limit quantities of smoke produced by using sprinklers
- To limit fire spread within building
  - Provide compartmentation – fire resistance to walls and floors
  - Ensure that doors are closed
  - Control vertical shafts
  - Seal penetrations
  - Provide fire dampers in shafts
  - Limit the size and geometry of external windows
  - Control the fire by installing sprinklers

- To prevent fire spread to other buildings
  - Limit the size of windows and type of glazing
  - Provide adequate separation distances
  - Ensure stability of external walls
  - Maintain integrity of glazing using drenchers
  - Use adjoining structures as barriers, e.g. car parks.
- Means of escape
  - Provide detection and alarm systems
  - Provide sufficient number of escape routes
  - In large or complex premises provide emergency public address (PA) and emergency warden intercommunication systems (EWIS)
  - Make escape routes of sufficient width
  - Limit the lengths of dead end paths and open paths
  - Provide signs and emergency lighting
  - Practice evacuation procedures
  - Program a security system to release doors when the fire alarm activates
  - Maintain good housekeeping in escape routes
- Facilitate rescue service operations
  - Provide alarms with direct connection to the fire service
  - Provide index panels showing fire location
  - Provide point level identification of fire detectors
  - Provide access for fire appliances
  - Provide fire resistant access within the building
  - Provide for control of lifts
  - Provide a fire control room
  - Check water supplies in the street
  - Ensure that fire hydrants are nearby
  - Provide riser mains within the building
  - Allow for water collection from hazardous substances fires.

- Prevent structural collapse
  - Provide the main structural members with adequate fire resistance
  - Control the extent of the fire through compartmentation
  - Control the fire with sprinklers.
  - Remove hot fire gases by smoke vents.

### 3.2 The fire safety design process

A number of publications, e.g. NKB (1994), BSI BS 7974 (2001), SFPE (2007) and CAENZ (2008), provide information on the fire safety design process. However, these guides focus on design using fire engineering principles (i.e. an analytical approach) and there is a need for an overall description of the design process showing the relationship between the prescriptive and the analytical design approach, as proposed and outlined in Figure 3.1 below.

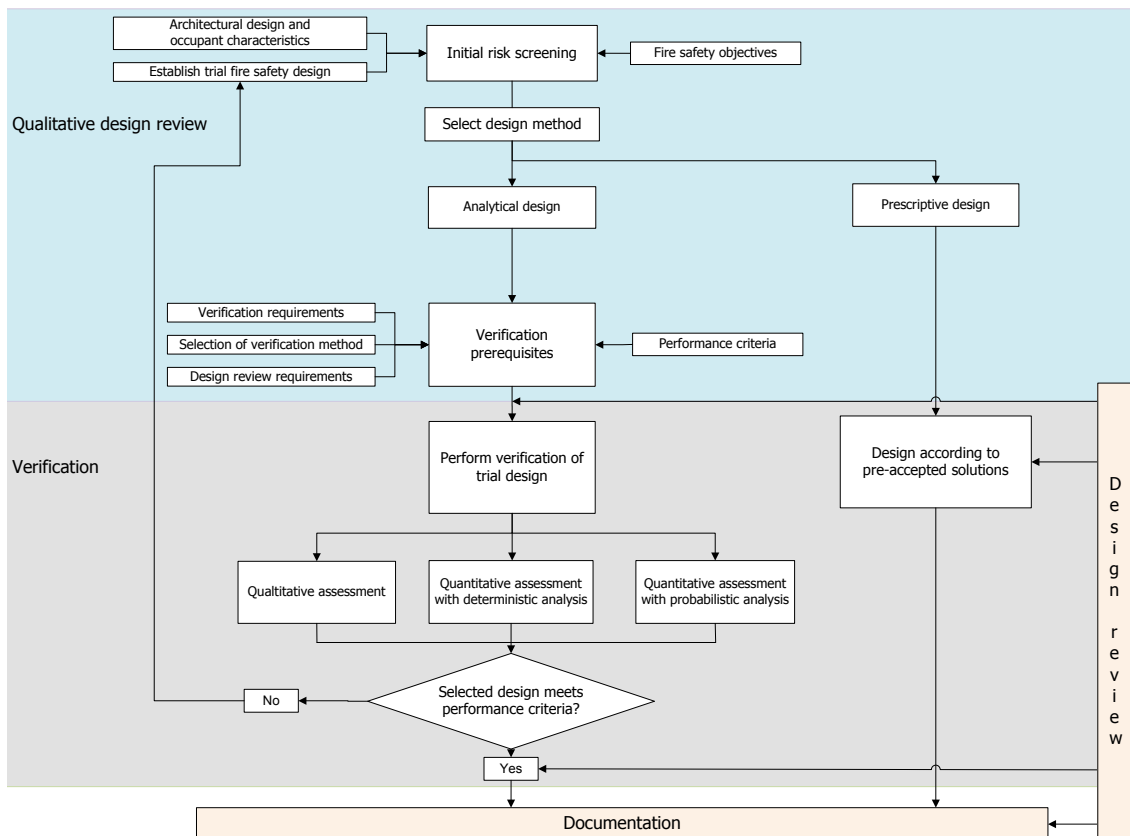

Figure 3.1 Proposed fire safety design process.

The design process in Figure 3.1 is discussed in more detail in the sub-sections below with emphasis on the qualitative design review, verification, design review and documentation.

### **3.2.1 Qualitative design review**

The fire safety design process starts with the qualitative design review and the initial risk screening which should be conducted no matter which principal design method (prescriptive or analytical) that is selected at a later stage. The initial risk screening could vary in extent depending on the complexity of the building and its intended use.

The initial risk screening is conducted by collecting relevant information on e.g. architectural design and occupant characteristics, as well as on specific fire hazards. The following list could be used in the qualitative design review and additional information could be found in BS 7974 (BSI, 2001):

- Architectural design
  - Size, type of construction, number of floors, etc.
  - Available escape routes
  - Fire service response time and accessibility
  - Distance to neighbouring property
- Occupants
  - Number and distribution
  - Mobility and state of wakefulness
  - Familiarity with the building
- Fire hazards
  - Flammable liquids storage
  - Combustible building materials
  - Potential sources of ignition
- Other factors
  - Planning constraints (e.g. listed building of historical interest)
  - Future changes of layout or that may be anticipated
  - Climate factors as snow, wind, rain and extreme temperatures

The selection of principal design method could not take place until the architectural design and the occupant characteristics have been reviewed and a trial design solution has been established. The trial design should involve fire safety features from all relevant major barrier groups (listed in section 3.1). Most commonly the trial design is a combination of prescriptive solutions and measures designed analytically, as shown in Table 3.2.

Table 3.2 Example of a trial design solution.

Barrier	Measure	Requirements
Prevent ignition	Insulation of smoke exhausts	Prescriptive design
	Furniture clothing	Relevant standard
Control fire growth	Incombustible surface finishes	Prescriptive design
Control smoke spread	Smoke management system	Analytical design
Limit fire spread within building	Fire compartmentation	Prescriptive design
Prevent fire spread to other buildings	Separation between buildings	Prescriptive design
Means of escape	Several independent escape routes	Analytical design
	Alarm and notification system	Prescriptive design
	Smoke control	Analytical design
Facilitate rescue service operations	Stand pipes	Prescriptive design
	Fire fighting lift	Analytical design
Prevent structural collapse	Structural steel protected by intumescent paint	Prescriptive design

If a pure prescriptive design solution is selected the design process is finalized by describing relevant deemed to satisfy solutions in the design documentation. However, if there is a need for (or demand of) an analytical approach the design process continues by establishing fire scenarios and the prerequisites for verification. This work consists of an evaluation of the verification requirements, the selection of verification method and the requirements on design review.

The selection of measures to be included in the trial design should be made with a basis in the prescribed design solution, in order to make sure that all necessary aspects on fire safety are being addressed. A "what if?" analysis approach could provide useful assistance in the selection process. Such an analysis would identify the effect of various failures and predictable events. It is also necessary to address common cause failure at this point in the design process. Finding failures that could occur with a common cause is about illustrating dependencies between various safety measures, where one single failure could have a negative effect on several other safety systems. The qualitative design review is concluded by establishing the necessary verification prerequisites, especially the verification requirements.

### **3.2.2 Available design methods**

As mentioned in the previous section and shown in Figure 3.1, two principal methods are available when designing fire safety in a building:

- Prescriptive design
- Analytical design

Prescriptive design use general recommendations and approved documents to establish the fire safety design. The design method does not allow for deviations from these recommendations and documents, and the need for verification is limited. The designer must ensure that the proposed building and its intended use fits in the regulatory system for prescriptive design by considering architectural design, occupant characteristics and relevant fire safety objectives.

Prescriptive design often has its origin in previous building regulations. It is practically the same method for design as the one being used previous to the performance-based building regulations. A number of design alternatives are usually allowed within the scope of prescriptive design and these are well described in the general recommendations in the building regulations. E.g. it is possible to extend the maximum travel distance in Swedish buildings equipped with sprinklers by one third, compared to buildings without sprinklers.

If there is a need for deviations from the prescribed solutions, the engineer could employ an analytical design method to show that the proposed design meets all relevant performance criteria. The objective for the designer is now to verify that the building meets the design criteria by the use of other so called verification methods. But the key point is to show that the regulation requirements still are met.

One of the reasons to deviate from a prescriptive design solution is to achieve a more cost-effective fire safety design by the use of design alternatives (see section 3.3). It is often more cost-effective to derive a fire safety design solutions that is specifically adapted to the building in context. The overall aim of using analytical methods is to achieve more flexibility, keeping the safety level at a sufficient level.

### **3.2.3 Verification**

There are a number of verification methods available when using an analytical approach and the selection of method is dependant on which deviations from the prescribed solutions that are proposed. Most of them are based on the use of risk equivalency. Naturally, all relevant performance requirements must be met in order to show sufficient safety and it is the roll of the designer to verify that the proposed design solution has equivalent safety. Much of the following sections in this report concern the choice and use of relevant verification methods.

### **3.2.4 Design review and documentation**

Analytical design has a need for a more extensive design review than prescriptive design. The main reason for this is that engineer (and the developer) has the full responsibility to ensure that the building complies with the building regulations. The solutions used in



prescriptive design are often published by the building authorities and the developer must only ensure that these solutions have been implemented in the building in a proper manner. The developer has no responsibility to verify that the design has sufficient safety, when using prescriptive methods.

Design review should be carried out throughout the design process and the demands for review should be established at an early stage. The sooner the review is incorporated in the process, the more effective is the fire safety design. The degree of design review depends on the complexity of the proposed solutions and ranges from a simple self-check to the use of an independent third party peer-review. The use of an independent review is a great opportunity for the developer to ensure quality in complicated buildings.

There is a need to document the verification as the process moves forward a final design solution. The first document to be produced is the so called fire engineering design brief, which could be finalised after the qualitative design review. The second document often referred to as the design documentation includes both the design brief and the complete verification of sufficient safety. In order to ensure an effective design process there is a need for a review of the fire engineering design brief before the verification of the trial design is conducted. A review at this early stage minimises potential surprises (and changes to the design) in a later stage of the process. Usually the requirement on the documentation follow the degree of fire safety design complexity and the choice of verification method.

### **3.3 The principle of design alternatives**

The fire safety features of a building are commonly designed by a mixture of prescribed solutions and those derived by the use of analytical methods. Most often, the design solution resulting from the prescriptive method is used as a starting point. If any of these solutions are too expensive or in conflict with other design objectives then modifications are made to varying degrees. Such modifications are referred to as technical design alternatives, i.e. deviations from the prescriptive solutions. The concept of design alternatives is quite simple. One fire safety feature is added to the building and another is subtracted (or minimized), but the overall safety level remains within what is acceptable, see Figure 3.2.

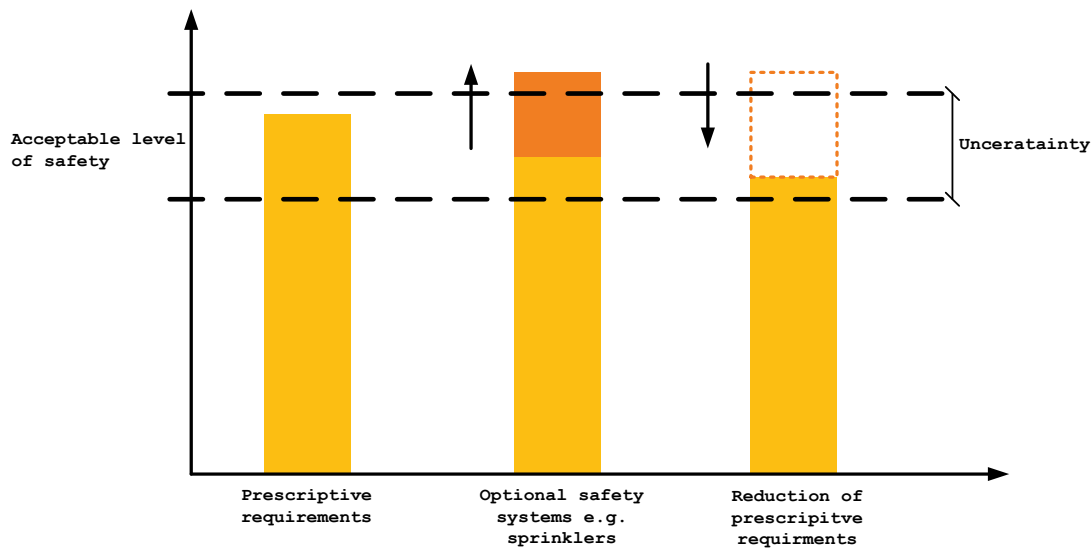

Figure 3.2 Principle of optimisation of fire safety in buildings.

There are a number of reasons for applying design alternatives in the trial fire safety design. Although, for some parts of the building, the prescriptive solutions have advantages as their use is simple, well-known and not very time-consuming. A design solution can therefore often be seen as a combination of the two design methods. In the performance-based environment, adaption is a key element. The fire safety design should be adapted to the specific needs of the building considering various aspects such as architectural design, use, and objectives on occupant safety, property protection as well as cost-effectiveness.

In most cases the focus of the adaption is on presenting a solution, which reduces the building cost and the aim of the adaption is to find the most suitable level of safety for the specific building. Design alternatives is a natural part of the adaption process in order to find a fire safety design solutions that fits both the objectives of the society and the needs of the builder. For example by installing a sprinkler system design alternatives on other safety measures such as compartmentation, fire ratings on load-bearing structures, exit width etc., could be allowed. However, this requires that fire engineering analysis can verify that that the performance requirements in the regulations are met. It is necessary to evaluate how the attributes of the proposed fire features relate to the ones resulting of a prescriptive design solution. Such attributes are e.g. function, human action/performance, complexity of the fire safety strategy, complexity of the fire protection system, flexibility, sensitivity, reliability, and vulnerability (Lundin, 2005).



## 4 Verifying design alternatives

The verification of the trial fire safety design solution is the next step in the analytical design process after the qualitative design review, see section 3.2.2. It is not possible to start the verification prior to the initial risk screening, the selection of principal design method and the agreement on prerequisites for the verification itself. In order to verify the proposed solution a verification method is needed.

### 4.1 Available methods

#### 4.1.1 Screening of suitable methods

There are a number of different methods available to be used when verifying design alternatives. It is not always necessary to conduct a quantitative analysis. Sometimes ranking methods could be applied, but in other situations there is a need to quantify risk and treat uncertainties in a more detailed way. Paté-Cornell (1996) presents a structure for treating uncertainty in a risk analysis and proposes six different levels on how to handle these uncertainties. The levels are outlined below and used to recommend a set of methods to be used when verifying fire safety in buildings designed with analytical tools.

“Level 0” is related to risk screening and failure mode identification. Qualitative risk analysis techniques are adopted such as Preliminary Hazards Analysis (PHA) or Failure Modes and Effects Analysis (FMEA). These techniques are useful to screen risks and propose measures to deal with them. Theoretically, they could be used in decision making when the costs are low and the system is known or to support e.g. a “Vision Zero”-approach. Vision Zero is a safety philosophy inherent in present Swedish road- and street design, striving to create error-tolerance in the road system (Johansson, 2008). Vision Zero is a call for damage reduction, despite the reason causing the incident. Parallels could be drawn to a mandatory requirement of fire sprinklers in buildings where a “forgiving” safety system is put in place that tolerate unsafe human behaviour. The difficulties with these methods are that there is no clear definition of risk and no clear consideration on the magnitude of the risk. The analyses are biased by the practitioners’ preferences and experience.

“Level 1” has its basis in worst case scenarios. The likelihood of the scenarios is not considered in this type of analysis and it could only be used when decisions are made on the basis of the maximum possible loss. There is no clear definition of the term “worst” and no clear limit on how bad things could be if all safety systems malfunction.

“Level 2” contains analyses based on a “quasi-worst cases” also referred to as “worst credible approach”. Such analysis tries to quantify the worst consequence that could occur with a reasonable probability. Methods at this level are used when there are uncertainties related to the definition of the worst case, or when the worst case has such a low probability that it becomes irrelevant.

The analysis is not based on a quantification of probabilities, instead this information is used to select the worst credible scenario, based on e.g. the estimated reoccurrence time (such as the 100 year wave). The major problem with using these methods is that there is no possibility to measure the cost-effectiveness of proposed safety measures. Therefore, prioritising between safety measures could not be done and the level of conservatism is unknown to the decision maker

“Level 3” is based on design scenarios and average values. A traditional method to establish the design scenario is to select the most likely event and use median values to characterise it. Such an approach could lead to an underestimation of the actual risk, as the outcome of the most likely event most often is zero consequences. Naturally, one cannot perform a design where the possibility of safety systems failing to operate is overlooked. The use of average values is more suitable when studying cost-effectiveness, but has the disadvantage that the approach is very sensible to extreme values (large standard deviations). Even though the method incorporates some kind of treatment of probabilities, the outcome is still a single point measure, which does not illustrate the uncertainties in a sufficient way.

“Level 4” has its basis in quantitative (probabilistic) risk assessments, which most often uses risk analysis techniques using an event tree to structure the problem and fault tree analysis for system failure analysis. Several scenarios are studied and related to each other by their respective probabilities. The selection of variables is based on reasonable judgement and it is possible to present the risk with the use of various risk measures. The main advantage to analyses at this level is that it is possible to express the risk as a single measure which makes it possible to illustrate the sensitivity of various parameters to the end result. Additional information could be found in Olsson (1999).

“Level 5” is an extension of the “Level 4”, using the same kind of frame work, but replacing point values with statistical distributions, i.e. using second order uncertainties. Instead of expressing risk with point values, the user could now add confidence intervals related to the result.

The screening of suitable methods based on Paté-Cornell (1996) identifies a set of methods that are available to be used when verifying design alternatives. On an overall level, the methods could be either qualitative or quantitative. Qualitative methods belong to “Level 0”, where screening techniques are used to identify risks and measures to protect the building and its occupants are introduced for each risk. Quantitative methods could belong to any of “Level 1” to “Level 5” depending on how uncertainties are treated. Two sets of quantitative methods are suggested. The first is based on “Level 2” by the use of scenario analyses and the second is based on “Level 4” by using event trees or fault trees. Analysis on “Level 3” and “Level 5” are considered inappropriate in a design situation, the first due to the possibility of underestimating the risk and the latter due to time constraints and an extensive work load. To sum up, any of the following methods could be used:

- Qualitative risk assessment (Level 0), comparative analysis
- Quantitative assessment with deterministic analysis (Level 2), implicit treatment of uncertainties
- Quantitative assessment with probabilistic analysis (Level 4), explicit treatment of uncertainties.

It is also rational to propose these three levels for design as they are familiar to the fire safety profession. The second method is generally known as a scenario-based method as a number of chosen scenarios are analysed to determine safety. The last of the three methods is similar to a traditional quantitative risk analysis approach. Here they all are put in a context of uncertainty treatment.

Brief information on each method is presented in section 4.1.2 to 4.1.4 and guidance in selection of method is given in section 4.2.2. Extensive descriptions are presented in chapter 5.

#### **4.1.2 Qualitative assessment**

The qualitative design review contains an initial risk screening which serves the purpose of identifying relevant fire risks and presents a trial design solution that copes with these risks. As with all analytical design, the qualitative assessment must show that the proposed design is at least equal to the prescribed design solution. This can be done by the use of logic reasoning, statistics, experience, and results from testing. A comparison with building regulations in other countries may also provide a base for the analysis.

Testing is by its nature a quantification of the performance of a safety system, but the method is considered to be used in a qualitative approach as one of the evidences that the proposed solution complies with relevant requirements. Testing is useful when calculation methods are not suited to evaluate the performance of some details in the various fire safety measures, as walls or facades or when a fire separating barrier is design with a light frame constructions cooled by the application of water. These circumstances could call for the use of specific testing.

Verifying the trial design solution by qualitative assessment must, naturally, use well established and documented material e.g. statistics, testing or other related studies and analysis. When logical reasoning is used it is necessary that the uncertainty in the method is kept small enough not to endanger the outcome of the verification. Section 5.1 contains more extensive information on qualitative verification.

#### **4.1.3 Quantitative assessment with deterministic analysis**

The selection of either a deterministic or a probabilistic analysis is not related to the needs of verification. It is mainly influenced by the degree of conservatism that the designer is allowed to have when verifying sufficient safety.

Quantitative verification by the uses of deterministic procedures usually gives a more conservative solution than the one derived by probabilistic procedures. Deterministic analyses are consequence-focused and the performance of the trial design is measures in its ability to show sufficient safety for a number of independent fire scenarios. Section 5.2 contains more extensive information on quantitative verification with deterministic analysis.

#### **4.1.4 Quantitative assessment with probabilistic analysis**

Deterministic analyses presented in section 4.1.3 has certain limitations, e.g. linking the effects when some fire safety measures become unavailable with those scenarios where everything operates as intended. It is not possible to evaluate the overall performance of a safety barrier. The use of a risk analysis technique, such as event tree analysis, can cope with these limitations and give the designer useful information of the importance, probability as well as the consequence of the different scenarios.

There is a strong link between the probabilistic and the deterministic analysis, as the scenarios are practically the same, at least in the far ends of the design problem. But a quantification of risk offers an opportunity to calculate and compare different measures of risk. This leads to an increased opportunity for an adaption of the fire safety measures of the building. Section 5.3 contains more extensive information on verification with probabilistic analysis.

## **4.2 Prerequisites for verification**

The qualitative design review described in section 3.2.1 is finalised by establishing the prerequisites for verification considering verification requirements, available methods, and suitable requirements on design review as well as performance criteria.

### **4.2.1 Identify verification requirements**

Lundin (2005) provides extensive information on how to identify the verification requirements when using an analytical design method. The depth and content of the verification is dependant on a number of variables of which the degree of deviation from the prescriptive design solution is of most importance. The complexity and the robustness of the trial design are also important factors. In order to specify the verification requirements, the designer needs to analyse how the trial design with its proposed design alternatives effect different aspects on fire safety. Lundin (2005) proposes the use of two different tools to complete this task:

1. A tool to analyse the structure of the fire protection system in the building. This is a tool to identify which part of the fire safety strategy is affected by a design alternative. This is done by analysing the structure of the total fire protection system in the building and the impact when the system is changed.

2. A tool to analyse the purpose of the performance requirements. In building legislation and building regulations the purpose must be well understood to ensure that the demands of society in terms of fire safety are fulfilled. If several functional requirements are affected by the design alternative, several analyses may be needed, and different design scenarios and acceptance criteria may be required. This tool is used to establish the various cause-effect relations between each safety measure and the demands in the building regulations.

The first tool focuses on the impact that the proposed changes have on the fire safety strategy, related to a prescriptive solution. Fire sprinkler systems are used to motivate design alternatives on other safety features and it is necessary to show that the added safety system is in a qualitative balance with the subtracted system. The matrix in Figure 4.1 could be used illustrate the effects of design alternatives on the structure of the fire protection system when a solution is compared to the prescriptive requirements. The different barrier groups have been described in section 3.1.

Purpose of the fire safety measure (linked to the major barrier groups)	Trade-off					
	Added measure			Removed measure		
	A <sub>1</sub>	A <sub>2</sub>	...	R <sub>1</sub>	R <sub>2</sub>	...
Measures to prevent ignition						
Measures to control fire growth						
Measures to control smoke spread						
Measures to limit fire spread within a building						
Measures to prevent fire spread to other building						
Allow rapid egress						
Facilitate rescue service operations						
Prevent structural collapse						

Figure 4.1 A tool to identify the effects of design alternatives on the structure of the fire protection system when a solution is compared to the prescriptive requirements. (Adapted from Lundin (2005) and slightly modified).

The practical use of the matrix in Figure 4.1 is simple as removed measures are denoted with a “-“ and added measures are denoted with a “+”. The matrix does not provide the designer with quantitative information, however several conclusions can be drawn (Lundin, 2005):



- By regarding the vertical spread in the position of the + and – signs it is easy to determine whether the design alternative affects one or several types of safety measures. If the spread is significant, the original safety measure is likely to have been replaced by another type of risk-reducing measure belonging to a different barrier group. This calls for an extensive analysis, since the structure of the protection system has been modified. It is necessary to check that the new safety measure provides protection for all the safety objectives covered by that removed.
- If there is imbalance between the total number of + and – signs in the vertical direction the numbers of independent barriers, i.e. the defence in depth, is likely to be reduced. The fire protection required by the prescriptive method is generally designed with defence in depth in mind, which results in a combination of measures aimed at the various major barrier groups. A vertical spread in the signs also indicates that it is important to check whether measures with multiple purposes have been removed without adequate compensation.
- If there is imbalance between the total number of + and – signs in the horizontal direction or in the horizontal and vertical directions, great care must be taken. This is an indication that the protection relies on a smaller number of safety measures, and that the risk of common-cause failure has increased. Each single reduction may appear negligible, but together, they can have serious implications on safety.

Another important aspect in identifying verification requirements is that the purpose of the performance requirement affected by the design alternative is well understood, otherwise it is difficult to choose models and criteria that measure the effect on the safety appropriately. The matrix in Figure 4.2 could be used to assist the designer in identifying the impact of the design alternative on the safety goals represented by functional requirements (see section 2.2).

Functional requirements in NKB (1994)	Trade-off					
	Added measure			Removed measure		
	A <sub>1</sub>	A <sub>2</sub>	...	R <sub>1</sub>	R <sub>2</sub>	...
The load-bearing capacity of the construction can be assumed for a specific period of time						
The generation and spread of fire and smoke within the construction is limited						
The spread of fire to neighbouring construction works is limited						
People in the construction on fire can leave it or be rescued by other means						
The safety of fire and rescue service personnel is taken into consideration						

Figure 4.2 A tool to investigate the effect of removed and added safety measures on the functional requirements. (Adapted from Lundin (2005)).

The purpose of the matrix in Figure 4.2 is to investigate whether the added and removed measures have effects on several technical requirements, which is an indication of multiple purposes of a technical requirement. It is of utter importance to stress that the building regulations do not allow for design alternatives between the different functional requirements. If a “-“ sign appears without any “+” sign for a specific technical requirement this must be interpreted as a warning. One possible consequence of the design alternative is that the safety effect of the measure removed has not been adequately compensated for. The designer must ensure that the trial design solution offers a balance regarding the technical requirements, i.e., both + and – signs in the horizontal direction. The verification could then focus on showing that the safety level is sufficient.

There are some attributes of the fire safety system that could not be evaluated in quantitative terms. Lundin (2005) present such a list containing attributes as function, human action/performance, complexity of the fire safety strategy, complexity of the fire protection system, flexibility, sensitivity, reliability, and vulnerability. The designer needs to address these attributes when comparing the trial design with the prescriptive design solution, by answering questions as:

- Is the effectiveness of the added protection system dependent on human action?
- Is the design alternative characterized by the reduction or elimination of several independent safety measures and replaced by a single measure?
- Is the added safety measure dependent on several sub-systems functioning correctly?
- Does the design alternative have the necessary degree of flexibility to cope with possible fires in the building?

- How sensitive is the fire protection to the use of the building, e.g. when sports arenas are used for exhibitions or concerts?
- How will the function of the protection system be affected by time and to what extent are service and maintenance necessary?
- How vulnerable is the added protection system on power failure, cold and windy conditions, software failure, etc?

When the answer is “Yes” to any of the questions above, the designer needs to be careful on provide information on how to ensure e.g. that human action will be effectuated when needed and to which degree there is a need for more flexibility. Additional information on these attributes is found in Lundin (2005).

#### **4.2.2 Selection of verification method**

The selection of the most suitable verification method is performed after the requirements on the verification have been established, using information provided in section 4.2.1. The verification could be performed by any of the following methods (previously described in section 4.1).

- Qualitative risk assessment
- Quantitative assessment with deterministic analysis
- Quantitative assessment with probabilistic analysis

Qualitative risk assessment has limited applicability and could only be used if the deviations from prescriptive design are limited and the performance of the proposed solution is well documented in e.g. test results, research publications and relevant regulations in other countries. All other design situations demand that the engineer presents “evidence” of equivalent safety.

Such evidence could consist of testing and various levels of quantitative assessment. These methods could naturally be combined with each other. The selection of verification method is mainly influenced by the following variables:

- Voluntarily or required<sup>1</sup> use of an analytical approach.
- The number of design alternatives compared to a prescriptive design solution.
- The complexity and robustness of the trial fire safety design solution.

Qualitative risk assessments could only be used if:

- The design is uncomplicated, affects few people and prescriptive solutions are mostly used.
- Limited and well understood deviation from prescriptive design, where limited deviation is defined as one or two design alternatives.

Quantitative assessment (either deterministic or probabilistic analysis) should be used if:

---

<sup>1</sup> In certain buildings a prescriptive approach to the design of fire safety measures is not valid. In Swedish and Norwegian building regulations this is the case for the design of certain high-risk buildings, such as high-rises and extensive underground structures.

- The design of the building is complicated and “new” solutions to comply with the fire safety objectives are chosen.
- Several and/or dependant fire safety measures are affected by design alternatives.
- Proposed design alternatives affects several major barrier groups.

Complicated objects are referred to as buildings which are large and difficult to survey. The trial design is built up be a number of technical systems with unclear function, purpose and interdependence. If “new” measures are adopted the importance of thoroughly verification is great as there is a lack of experience in the operation of these systems. Additional information on available methods is given in section 4.1.

### 4.2.3 Design review requirements

The purpose of review in the design process is to assure that the design has been properly carried out and analytical design of fire safety has a greater need for design review than prescriptive design. Design review is an issue both for the contractor and designer in terms of internal quality control, and the Authority Having Jurisdiction (AHJ) in order to safeguard the quality from a societal perspective. In Sweden and Norway, the AHJ no longer performs independent review of the design solutions on a detailed level. Instead they are supposed to determine the appropriate level of review for the specific project and can require that the contractor hires an independent third-party controller. Such third-party control is mandatory in Norway unless the building is very simple or small.

The aim of the design review is to check how the designer has approached the design problem, which tools were used, his/her competence and to assess whether the results are reasonable or not. One important task in the review is to question whether the hazard identification, which forms the bases for the verification, covers all the important aspects. There are three possible levels of review that could be used in a project (Lundin, 2005):

1. *Self check* – The designer is responsible for his or her own quality control.
2. *Internal review* – Another designer with at least the same level of competence performs the quality control. This person may work for the same company as the original designer.
3. *Third-party review* – The person performing the peer review should work for another company so as to be considered unbiased. This person should not have been previously involved in the design project

Self check is only applicable when the design approach is straight forward with the use of prescribed solutions in uncomplicated buildings. All projects where design alternatives are suggested and compensated for by the use of e.g. sprinklers, require either internal or third party review.

The need for third-party review is mainly related to buildings where there are large deviations from prescriptive design and when innovative solutions are being applied to complicated buildings. Complicated buildings are defined as those buildings where there is a lack of tradition and experience. If there is a need for third-party review such procedure

would be more successful if an agreement on the following subjects could be established at an early stage:

- Fire safety objectives
- Applicable performance requirements
- Performance criteria
- Design fire scenarios
- Trial fire safety design
- Verification prerequisites
- Assumptions and limitations

#### **4.2.4 Performance criteria**

There are two different sets of performance criteria that could be used to verify that the proposed trial design has sufficient safety:

- Comparative criteria
- Absolute criteria

In a perfect world, the designer could choose between either set of criteria in any design situation, but this is unfortunately not the case. There is a lack of absolute criteria in fire safety design and comparative criteria are practically the only performance criteria available in most design situations.

##### *Comparative criteria*

Comparative analysis could be conducted if a prescriptive solution would be applicable to the building. Such analysis evaluates the performance of the analytical solution in comparison with a prescribed solution, and the following performance criteria could be applied:

- The total fire safety in a building design with analytical methods shall at least have the same performance as the fire safety in a building design with prescriptive methods.
- The building with prescriptive fire safety measures is referred to as a “reference building” and this building must be as similar to the designed building as possible. The buildings should be of equal size and belong to the same service category and safety class.

There is no need to make a direct comparison with the absolute criteria on e.g. life-safety and fire spread. The design is considered safe as long as it performs at least better than pre-accepted solution, when evaluating the appropriate fire scenarios. This is implicit understood as buildings that are designed in accordance with the building regulations must be considered to have a safety level that is tolerable by society.

Comparative criteria are to be used when verifying fire safety with a probabilistic analysis. The calculated risk measures for the proposed design are compared with the same measures for the prescriptive solution. The suggested trial design is acceptable if the level of risk is equal or lower when comparing the two design solutions.

### *Absolute criteria*

Under certain circumstances, the designer could choose to verify the fire safety of a building, without making comparisons with the safety level achieved with prescriptive design. The capability of the fire safety design is assessed by direct evaluation towards the absolute criteria on e.g. untenable conditions for life-safety purposes or limit states for fire spread. The following performance criteria could be applied:

- The fire safety measures of a building, as a result of an analytical design approach, are considered to be sufficient if the limit states for relevant parameters are not exceeded.
- The performance of the proposed design solution shall be evaluated for all relevant fire scenarios.

If escape is possible prior to the onset of untenable conditions, the building is considered safe, even if the required escape time is longer in comparison with a building design with pre-accepted solutions. This is valid for any fire safety feature that is evaluated towards specific performance criteria.



## 5 Verification methods

### 5.1 Qualitative assessment

#### 5.1.1 Procedure

Section 3.2.1 on the initial risk screening as a part of the qualitative design review proposes the use of a “what-if?” approach to select and perform a quick evaluation of the trial design solution. Such an approach could also be adopted when verifying a trial design with qualitative assessment. The initial risk screening gives answers to the following questions:

- Which possible fire scenarios could occur in the building?
- Which fire safety measures are suitable to deal with these fire scenarios?

By conducting a qualitative verification an additional question should be addressed:

- What proofs show that the trial fire safety design is satisfactory?

The verification is performed in three steps; structure, prove and document. A clear structure of the verification task ensures that the analysis is complete and knowledge-based. The key question on “sufficient safety” is answered by the collection of proof and the whole process should be documented thoroughly, answering the questions raised above.

A well-structured verification problem is easier to overlook and to control. It is preferable to start of with the major barrier groups presented in section 3.1 and present which measures that have been established for each of the barriers. The performance of all safety measures that deviates from the prescribed solution must be well understood and based upon previous experience related to occurred fires, testing and analyses.

Most fire safety measures in the building are based on the prescribed solution and the designer only needs to ensure that the proposed building and its use is within the scope of prescriptive design. However, more extensive proof must be presented for the design alternatives that are made. The performance of the proposed solution is qualitatively measured against the performance of the prescribed solution.

In some occasions there are no pre-accepted solutions available to specific construction details, e.g. the design of fire stops within a combustible construction or with the design of a rescue elevator. In such occasions, it is possible that quantitative methods are unsuitable to derive system specification. The designer is then forced to rely upon expert judgement or specifications in the building regulations of other countries. Some sources in the collection of proof in qualitative verification are:

- Design guides published by professional organisations.
- Building regulations on prescriptive design in other countries.
- Results from fire testing published either by research institutes or in well recognised journals.

The designer must show that the proof is valid by checking that prerequisites and performance criteria are in line with relevant national regulations. The total fire risk in a building could also be expressed semi-quantitatively by the use of risk index methods



(Watts, 2008). Fire risk indexing systems are heuristic models of fire safety. They constitute various processes of analysing and scoring hazard and other system attributes to produce a rapid and simple estimate of relative fire risk. They are also referred to as rating schedules, point schemes, ranking, numerical grading, and scoring. The methods are developed by the use of expert judgement and a hierarchic structure is built up by defining policies, objectives and strategies, as well as parameters and their attributes (Magnusson et al., 1998).

### **5.1.2 Treatment of uncertainties**

All verification methods require a treatment of relevant uncertainties. A strong adaption of the performance of the various fire safety features to the building and its use, should generally be avoided as the qualitative method do not allow for any evaluation of interdependencies among safety features. The design specifications must therefore have a higher degree of conservatism and it is necessary to check how the proposed design alternative affects the attributes of the fire safety system as described in section 4.2.1.

## **5.2 Quantitative assessment with deterministic analysis**

This section provides details on the use of a deterministic analysis, which indeed leads to a more conservative design of the fire safety system compared to a probabilistic approach. The safety level is not explicitly calculated. Instead, sufficient safety is shown by meeting acceptance criteria for a number of pre-defined fire scenarios.

A fire scenario is defined by SFPE (2007) as a sequence of possible events and set of conditions that describe the development of a fire and the spread of combustion products throughout the building. Fire scenarios describe factors critical to the outcome of fires, such as ignition sources, the nature and configuration of the fuel, fire characteristics, ventilation, fire protection features, location and characteristics of occupants, etc.

### **5.2.1 Procedure**

The qualitative design review described in section 3.2.1 contains the establishment of verification prerequisites where Figure 4.1 and Figure 4.2 are used to get a basic idea on the needs of verification. Quantitative verification is used to explicitly measure the performance of the fire safety system towards specified fire scenarios. The verification is performed in four steps; structure, estimate consequences, compare with acceptance criteria and document.

Details on necessary fire scenarios are provided in chapter 8 and there is a need to adapt the relevant fire scenarios to the building. The number of design fire scenarios is related to the design alternatives and which major barrier groups that these relate to.

The designer is free to use any suitable method for the estimation of consequences as each scenario is evaluated. If the design problem is related to life safety and successful escape a traditional comparison of available safety egress time vs. required safety egress time is used,

cf. Appendix F.1. Similar calculations could be used when evaluating the performance of other e.g. load-bearing structures and fire spread between buildings.

The evaluation of risk when using scenario analysis is done by comparing the proposed design either with a reference building designed according to a prescriptive solution or with absolute criteria. Each scenario is evaluated independently and all individual performance criteria must be met. Finally, the verification is included in the fire protection documentation.

### 5.2.2 Treatment of uncertainties

Calculations always have some degree of uncertainty which could be related to models, input data, etc. Point estimates in the scenario analysis belong to a distribution of possible values from which the “most likely” or the “reasonable worst” have been selected. A suitable method of treating uncertainties is done in a sensitivity analysis. A sensitivity analysis should examine the following (IFEG, 2005):

- Variation of the inputs
- How the magnitude of simplification influences the outcome
- The reliability of technical systems
- The influence of open doors, improper measures, etc.

An adequate technique for a sensitivity analysis is the switch-over analysis (Notarianni & Parry, 2008). Switchover analysis is a parametric analysis where one or more inputs is varied to find the values of the inputs that would cause a change in the value of the outcome criteria strong enough to change the final decision, i.e. the building has sufficient safety. A proposed use of this method is outlines below.

- All variables and parameters that are believed to have influence on the result of the scenario analysis are identified. Such parameters are heat release rate, fire growth rate, smoke yield, fire location, detection times, response times, travel times, the availability of escape routes, the operability of detectors, sprinklers, smoke vents, passive barriers, etc.
- A switchover analysis is conducted where the variables and parameters above are varied to find which values that will cause the building to become “unsafe”.
- The designer evaluates the results and gives estimates on the probability that there will be a switchover of the final decision.

The sensitivity analysis is finalised by a discussion on whether the safety margin is sufficient given the information on possible causes of switchover. If not, changes to the adopted design must be made.

Sometimes, the lack of knowledge is such that it is impossible to quantitatively evaluate the uncertainty. The designer is then forced to take measures to minimise the variability or increase the level of robustness in the proposed trial design. When using a competitive analysis it is not necessary to treat those variables that have the same value in both the analytical design and the prescriptive design.

There might be a need to switch to a quantitative risk assessment if the uncertainties are significant. This verification method allows for a quantitative treatment of the uncertainties by replacing point values with statistical distributions and the degree of conservatism could probably be reduced.

Using the proposed method for the deterministic analysis there is no need for the use of safety factors. This might be seen as strange but the choices of values for the calculations are based on the principle of conservatism. This means that the design on average is oversafe to include more unlikely events, e.g. the evacuation margin is positive. The problem with this approach, as mentioned in section 4.1.1 is that the probability of failure is not known. If it is necessary to know the degree of conservatism it is recommended to use the risk analysis approach presented in the following section or safety margins.

### 5.3 Quantitative assessment with probabilistic analysis

Verification by the use of deterministic analysis has several weaknesses often forcing the proposed design to be too conservative. Deterministic analysis cannot evaluate the relationship between different scenarios and the probability and consequence of each individual scenario. A probabilistic method, e.g. event tree analysis, does not have the same weaknesses as the scenario analysis and it is possible to get a better understanding of the outcome of possible scenarios and their relative importance.

#### 5.3.1 Methods and measures

A probabilistic risk analysis is based on the following three questions (IEC, 1995):

- What can go wrong?
- How likely is this to happen?
- What are the consequences?

The first question is scenario-related and following two questions deals with the probability and the consequences for each scenario<sup>2</sup>. The contribution to the total risk is expressed as a function of the individual scenarios, as shown in Equation [5.1].

$$R_{tot} = \sum \{s_i, p_i, c_i\} \quad \text{Equation [5.1]}$$

---

<sup>2</sup> A definition of a fire scenario is presented in section 5.2.

Where:

$R_{tot}$  = the total risk

$s_i$  = the sequence of events in scenario  $i$

$p_i$  = the probability of scenario  $i$

$c_i$  = the consequence of scenario  $i$

Equation [5.1] originates from Kaplan and Garrick (1981) and is commonly referred to as the “risk triplet”. Naturally, the number of possible fire scenarios in a building is very large. Therefore, the engineer needs to choose a number of design scenarios that gives a fair representation of the total risk.

These design scenarios should be carefully selected, ensuring that the necessary aspects on fire safety are covered. The total risk in the building is approximated by the sum of the risks of each design scenario as shown in Equation [5.2].

$$R_{tot} \approx \sum_{i=1}^n \{s_i, p_i, c_i\} \quad \text{Equation [5.2]}$$

Where:

$n$  = number of design scenarios

There are only a small number of models that are capable of expressing the total risk of fire in a building, and these models are too complicated to be used in practice. The main reason for the complexity of the models is that risk is measured differently, depending on which barrier group that is studied. Successful escape measures the escape possibility and limiting fire spread measures the risk of fire separation barrier failure.

Combining these different measures of risk into one single measure of total risk is utterly complicated, and could only be done by the use of techniques as multi attribute utility analysis (CCPS, 1995). When methods of total risk is either too complicated or too simple the designer needs to perform an analysis of the fire risk at a sub level related to each barrier group. Sufficient safety (acceptable levels of risk) is then estimated for each barrier function, i.e. to allow for rapid egress or limit fire spread. The total fire risk is considered acceptable if each sub-system meets its performance criteria.

In the risk analysis procedure it is often necessary to examine a large number of scenarios with different chains of events. Each final event, outcome or scenario can be assigned a probability of occurrence. In order to structure the possible event sequences arising from an initial event, the event tree approach may be used. Event trees are logic diagrams, which can be used to illustrate the sequence of events involved in ignition, fire development and control, as well as the course of escape. Event tree analysis can take into account both human behaviour and the reliability of installed fire protection systems. An example of an event tree is presented in Figure 5.1.

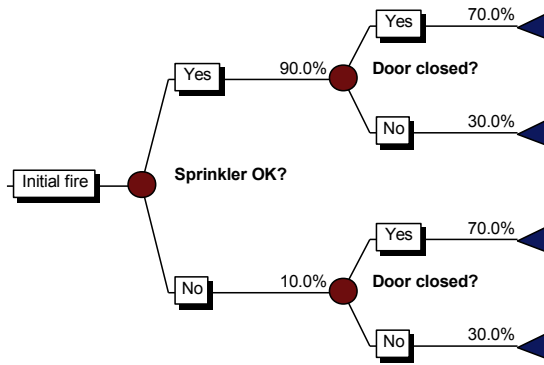

Figure 5.1 An event tree for a simple fire risk analysis. Note that the values in the tree are only chosen for illustrating the principle.

Risk analyses with event trees are based on a high number of deterministic scenario outcome estimates, but the method is still considered probabilistic. When a large number of sub-scenarios are considered, each with its individual probability, this will lead to a probabilistic measure of the risk (Frantzich, 1998). The risk for each scenario is calculated by multiplying the probability of the sub-scenario by its consequences. The total risk associated with a building is the sum of the risks for all scenarios in the event tree.

Events that are covered in the event trees are normally related to the fire safety measures of the building, which could be either passive or active fire protection systems. Examples are the availability of detection systems, sprinkler system, notification systems and door-shutters.

It is also possible to include organisational safety measures and the possibility that the fire blocks any escape route. The selection of events to be included in the event tree must be made on the basis of the initial risk screening and the proposed trial design.

Fault tree analysis is another risk analysis technique to be used in a quantitative risk assessment. Fault trees relates to event tree in such manner as they often could be used to derive the frequency of the initiating event, i.e. the outbreak of a fire in the building. Fault trees could also be used to estimate the likelihood of failure for individual events in the event tree, such as sprinkler system unavailable, etc. The fault tree has its basis in the top event, for which the frequency (or likelihood) should be calculated. By investigating which events that need to occur, either individually or in combination with each other, the fault tree receives its branches. Figure 5.2 shows a basic event tree on sprinkler water unavailability.

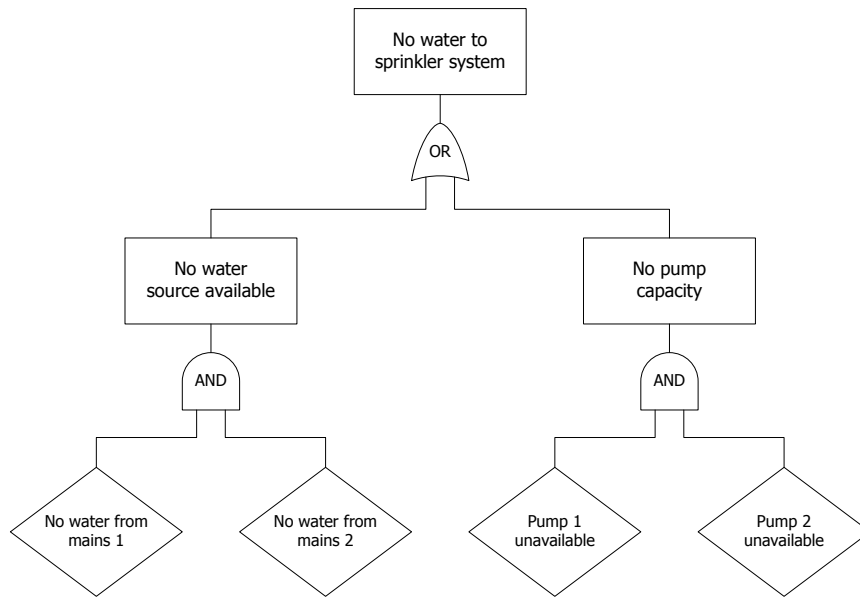

Figure 5.2 Fault tree for the top event “No water to sprinkler system”.

The reason for no water being delivered to the sprinkler system could be either that there is no available water source or there is no pump capacity, which is illustrated by an “or-gate” in Figure 5.2. Both water mains must be unavailable at the same time if no water should be delivered, which is illustrated by an “and-gate”. Also, both pumps must be unavailable when fire water is needed, if there should be no pump capacity.

Risks could be measured and quantified in a number of ways. When fault trees are used, risk is expressed in a unit related to the top event, e.g. the probability of sprinkler failure in the event of fire or the probability of fire spread through a separating barrier. In event trees, three measures of risk could explicitly be calculated, i.e. the “individual” risk, the average risk and the, so called, risk profile. The individual risk is defined as the likelihood (when a fire occurs) that at least one person will be exposed to untenable conditions. The average risk is the weighed sum of the probability and consequence of each scenario in the event tree and the risk profile is a graphical illustration of the outcome. The calculation procedure of these risk measures is shown in Table 5.1 below.

Table 5.1 Triplets (scenario, probability and consequence) for the event tree in Figure 5.1.

Scenario	Probability (given fire occurrence)	Consequence (people exposed to untenable conditions)
Sprinkler available Door closed	$0.90 \times 0.70 = 0.63$	0
Sprinkler available Door open	$0.90 \times 0.30 = 0.27$	0
Sprinkler unavailable Door closed	$0.10 \times 0.70 = 0.07$	2
Sprinkler unavailable Door open	$0.10 \times 0.30 = 0.03$	4

The individual risk could be calculated by summarising the probability of each individual scenario that has a consequence that is at least one person being exposed to untenable conditions, as shown in Equation [5.3] below.

$$IR = \sum_{i=1}^n p_i | c_i > 0 \tag{Equation [5.3]}$$

The individual risk in the example listed in Table 5.1 is thus  $0.07 + 0.03 = 0.10$  given that a fire occurs in the building. This could be interpreted as nine of ten fires lead to successful escape and one of ten fires causes unwanted exposure of some people. The average risk in Table 5.1 is calculated by Equation [5.4].

$$AR = \sum_{i=1}^n p_i \cdot c_i \tag{Equation [5.4]}$$

Using Equation [5.4] gives an average risk of  $0.63 \times 0 + 0.27 \times 0 + 0.07 \times 2 + 0.03 \times 4 = 0.26$ , which could be interpreted as the expected number of people being exposed to untenable conditions if there is a fire in the building. The risk profile is the final measure of risk, based on Table 5.1 that is shown in this report. In order to draw a risk profile, the scenarios needs to be sorted in order by the magnitude of the consequence, which already have been done in Table 5.1. The risk profile a counter cumulative distribution function (CCDF) of the risk and Table 5.2 provides the necessary data.

Table 5.2 Data to be used when drawing the risk profile (based on information from Table 5.1 and Figure 5.1).

Scenario	Consequence	Probability	CDF <sup>3</sup>	CCDF <sup>4</sup>
Sprinkler available Door closed	0	0.63	0.63	0.27
Sprinkler available Door open	0	0.27	0.90	0.10
Sprinkler unavailable Door closed	2	0.07	0.97	0.03
Sprinkler unavailable Door open	4	0.03	1.00	0.00

The risk profile is shown in Figure 5.3 where it is clear that the probability of a consequence of at least one (1) is 0.10, which is the same as the individual risk calculated with Equation [5.3]. The average risk is the mass centre of the risk profile.

<sup>3</sup> In probability theory and statistics, the Cumulative Distribution Function (CDF) describes the probability that a real-valued random variable X with a given probability distribution will be found at a value less than or equal to x.

<sup>4</sup> Sometimes, it is useful to study the opposite question and ask how often the random variable is above a particular level. This is called the Complementary Cumulative Distribution Function (CCDF) or exceedance, and is defined as;  $CCDF = 1 - CDF$ .

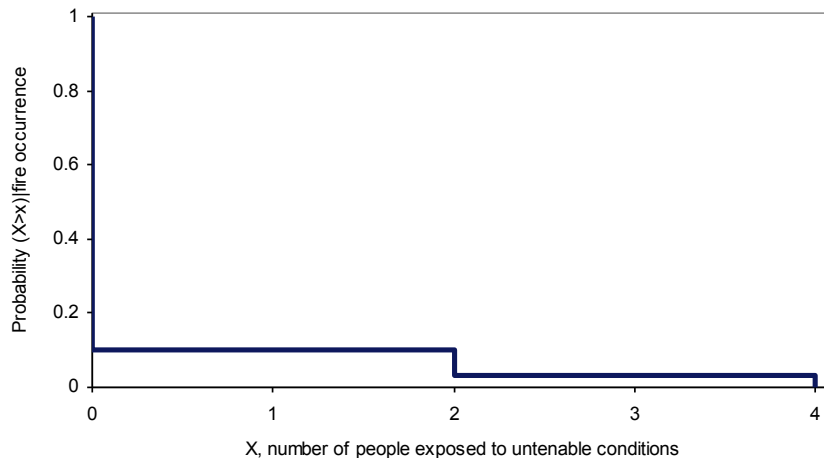

Figure 5.3 Risk profile for the event tree in Figure 5.1, based on information in Table 5.2.

### 5.3.2 Procedure

Quantitative assessment with probabilistic analysis is performed in four steps; structure, estimate consequences, estimate and evaluate risk and document. The structuring of the verification is based on the initial risk screening where possible scenarios to be included in the event tree are derived and analysed. Events to be included in the event tree could be divided into two main categories:

- Events related to the fire development.
- Events related to safe egress.

Example of events related to the fire development, i.e. the growth of the fire, the spread of smoke and the spread of fire, are the presence of an extinguishing system, the location of the fire and open/closed doors. These events are essential in order to illustrate the effectiveness of certain key fire safety features, as well as preventive organisational measures. Events related to safe egress could be the availability of smoke detection and warning systems and the possibility of blocked escape routes.

When each scenario has been established based on the sequence of relevant events, the designer must provide reliable probability data for each event. Such data should preferably be based on statistics or by engineering judgement. When the necessary probability data have been established, the probabilities of the scenarios could be calculated. One of the major difficulties in using event trees in fire safety engineering is the lack of data on e.g. the availability of a specific safety system. Many data sources are based on data of systems design for more than 40 years ago (BSI 7974:2003 part 7). It is also very hard to understand how “successful performance” has been measured.

Consequences are estimated with the same procedure as outlined in section 5.2 on the scenario analysis. The methods are identical in terms of consequence estimation and differ only when probabilities for each scenario is introduced. Therefore, a scenario analysis could always be developed to a quantitative risk assessment, and vice versa.

The estimation and evaluation of risk is done by the use of comparative performance criteria (see section 4.2.4). Risk measures as a result of the trial design are compared with



risk measures derived from a reference building, designed according to prescriptive requirements. The following risk measures are suitable to use in the comparison.

- The individual risk
- The risk profile
- The average risk

When two risk profiles are compared it is not always evident which of them that has the lowest risk. If the curves do not cross each other, the lowest of them is the preferable alternative. But, if they interfere with each other, Lundin (2005) proposes that the average risk should be used to decide which of them that is the safest.

### **5.3.3 Treatment of uncertainties**

The use of event tree analysis to estimate the risk of fire in a building is considered to treat uncertainties in a more explicit way than any other of the proposed verification methods. The event tree technique, allows for an evaluation of the sensitivity of many parameters. For example, doors could be left open or closed, escape routes could be blocked, detection systems and sprinklers could fail etc. The event tree could also consider fire development and smoke spread. Although the event tree technique includes sensitivity analysis, the engineer must be very cautious when defining the tree so that all relevant events are incorporated (Olsson, 1999).

There are two major uncertainties that are related to event tree analyses. First, it is difficult to overlook if all relevant scenarios have been included in the event tree, and second the estimation of individual probabilities of each event is often based on sparse data. The event tree must include all events relevant to the outcome of a certain fire. The estimation of the scenario outcome should represent a worst-credible case within each scenario.

One important task in the sensitivity analysis is to investigate whether reasonable changes to assigned probability data cause a switchover of the findings. Naturally, the uncertainties related to the estimation of consequences are the same in the quantitative risk assessment as in the scenario analysis. These uncertainties must be treated in the same manner as proposed in section 5.2.2.

## 6 Fire sprinkler systems

This chapter gives a brief overview of sprinkler characteristics and types of fire sprinkler systems. Information on sprinkler effectiveness and reliability is provided as well as details on the use of sprinklers as a fire safety feature. Sections 6.1-6.2 are mainly based on information provided by CAENZ (2008). A separate working package in the current research project includes an extensive literature study on the performance of fire sprinkler systems in various situations. This literature study is available online (Jensen, 2010).

### 6.1 Sprinkler head characteristics

Sprinkler systems are designed around the performance characteristics of sprinkler heads. A sprinkler head is a thermally operated valve, with a fusible element to hold a valve shut. When the fusible element reaches a specific temperature, the sprinkler operates, opening the valve and producing a spray of water. The water distribution pattern depends on the type of deflector fitted. Sprinkler heads can be generally described by a number of characteristics:

- Water distribution characteristics, e.g. Spray type, extended coverage, etc.
- Installation orientation, e.g. upright, pendent, sidewall.
- Orifice size.
- Temperature rating and thermal sensitivity.

#### 6.1.1 Method of operation and response

There are two basic types of fusible elements for sprinklers, these being the frangible bulb and the fusible link. As a generalisation, frangible bulb sprinklers are most commonly used in Europe and the frangible bulb is a sealed glass bulb that contains an alcohol-based solution that contains an air bubble within it. As the temperature rises, the liquid expands and the pressure increases in the glass bulb. When it is heated further, the pressure rise will burst the bulb, allowing the valve to leave the orifice and the water to flow. The operating temperature is controlled by the unique characteristics of the sprinkler bulb. Sprinkler head operating temperatures range from 57° C to 260° C.

In addition to the sprinkler's operating temperature, its thermal characteristics are measured by its responsiveness. Its responsiveness is measured by the time the sprinkler takes to operate when plunged into a heated air stream. The most common measure of responsiveness is termed its Response Time Index (RTI). RTI is independent of the sprinkler's rated operating temperature.

The RTI-value is not the only factor related to the sensitivity of the sprinkler head. When discussing terms as sprinkler response the RTI-value is combined with the heat conductivity properties of the sprinkler head. Figure 6.1 shows three broad ranges of sprinkler sensitivity: standard, special, and fast response.

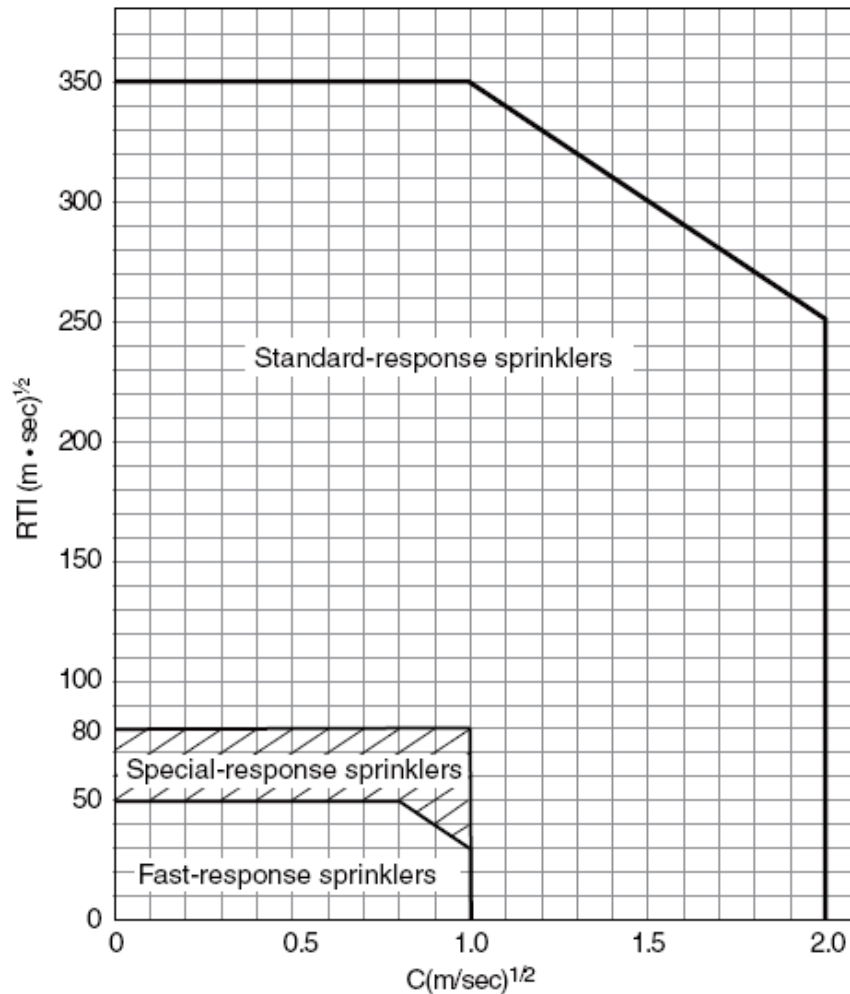

Figure 6.1 International Sprinkler Sensitivity Ranges, Response Time Index (RTI) versus Conductivity (C). Adopted from ISO (2004).

Figure 6.1 shows three broad ranges of sprinkler sensitivity: standard, special, and fast response. Traditional sprinkler hardware falls into the standard-response category. The fast-response category is used for “new” types of sprinklers for which fast response is considered important. The special-response category is used for special types of sprinklers that may be installed, including some of the extended coverage sprinkler heads.

### 6.1.2 Control vs. suppression

The majority of sprinkler systems are designed to control a fire by cooling fire gases, the fire surface and pre-wetting surrounding material to stop it spreading. The design intent is that the fire is finally extinguished by the fire service or staff using portable equipment. In reality, in many cases, the design intent is exceeded, and the fire is actually extinguished by the sprinkler system (CAENZ, 2008 and Lindsten, 2009). This is probably related to the fact that the fire size at sprinkler actuation is much smaller than the design coverage area and supported by statistics stating that 95 % of all fires active four or fewer sprinkler heads (Hall, 2010).

Most sprinklers are referred to as “Control Mode” sprinklers. Certain types of sprinklers are designed to extinguish fires and these are termed “Suppression Mode” sprinklers or “Early

Suppression Fast Response” sprinklers. Currently, Suppression Mode sprinklers are only manufactured for storage occupancies.

### **6.1.3 Distribution patterns**

There are three common types of deflectors fitted to sprinklers. These are conventional pattern, spray pattern and sidewall pattern. Each produces a slightly different distribution pattern. Conventional pattern sprinklers are designed to produce a spherical discharge pattern with some water being thrown up to the ceiling. Spray pattern sprinklers produce a hemispherical discharge below the plane of the deflector, with little or no water being discharged onto the ceiling. Sidewall pattern sprinklers are designed for installation along the walls of a room close to the ceiling. In addition, there are a number of special sprinklers for specific applications, including window sprinklers, attic sprinklers, etc.

### **6.1.4 Types of sprinkler heads**

Recessed sprinklers are standard pendant spray sprinklers that have been installed using an adjustable recessed escutcheon to be positioned just below the ceiling surface with the body above, and thus be less obtrusive. However, this means that baffling from light fittings, etc., is a greater problem. The impact of installing the sprinkler in this application on responsiveness is not well understood, and usually ignored. Some approvals bodies will not list heads installed in this manner as Fast Response.

Concealed sprinklers are a specially constructed unit that is mounted above the ceiling surface, with a flush cover plate on the ceiling. The cover plate is held with fusible tabs that release at a lower temperature than the sprinkler bulb rating. When the cover plate releases, the sprinkler deflector drops below the ceiling ready to spray water when the sprinkler bulb fuses. As with recessed sprinklers, some approval bodies do not list concealed sprinklers as Fast Response. If the fire design requires the use of Fast Response sprinklers to achieve the design objectives, the validity of the design assumptions in the model need to be verified if concealed sprinklers are being proposed.

Residential sprinklers are designed and tested to control fire in a residential room. They have a more sensitive bulb or fusible element and a discharge trajectory that wets the walls much higher than a standard spray type sprinkler. They are available in pendant and horizontal sidewall types. Recessed and concealed residential sprinklers are also available. Because of the flat trajectory and low water flows, residential heads are particularly sensitive to ceiling obstructions, construction and geometry, including lights and ceiling fans. The main purpose of residential sprinklers is to protect people, giving property protection a second priority. There are three essential criteria that a residential fire sprinkler system shall comply with:

- Ceiling temperature should not exceed 315° C.
- The temperature at a height of 1.6 m above the floor should not exceed 93° C.
- The criteria above should be fulfilled with a maximum of two activated sprinkler heads.

The first criteria aims at preventing flash-over and the second criteria ensures a safe environment for people as they evacuate from the fire compartment. The last criterion indicates that the other criteria could be met by using a limited water source.

Suppression Mode sprinklers are special, large orifice sprinklers designed to deliver a water discharge that is intended to suppress fires. Until recently, they were designated as Early Suppression Fast Response (ESFR) sprinklers. The rapid operation, coupled with the high volume discharge, enable these sprinklers to suppress fires in high-pile storage racks without in-rack sprinklers. They are sensitive to obstructions, and their installation rules must be carefully adhered to, to ensure that they will successfully suppress any fires.

Extended coverage sprinklers are spray pattern sprinklers that are designed to protect areas larger than standard coverage areas using standard spray sprinklers. The use of these sprinklers may offer a reduction in the costs in installing sprinkler systems. However, their use may not be practicable, due to coordination issues with structural and architectural features, or services such as lights and the like.

Dry sprinklers have the water valve separated from the heat sensitive element and the deflector by a drop pipe. This allows the sprinkler to be in a low temperature area while the water filled pipework is in a space outside the cold area so the water will not freeze. They are used for the protection of freezers and unheated concealed spaces on wet pipe systems,

Special application sprinklers are available to address specific risks, for example:

- Window Sprinklers – which have been fire tested to provide equivalents to fire ratings on glazed surfaces
- Attic Sprinklers – designed to protect long narrow pitched storage spaces.
- Corridor Sprinklers – designed to minimise the numbers of sprinklers required to protect hotel or apartment building corridors.

## **6.2 Types of sprinkler systems**

### **6.2.1 Hazard classification**

It is necessary to classify the fire hazard of occupancy to establish the design parameters for a satisfactory sprinkler system. This is usually done in approved documents like sprinkler standards, cf. EN 12845:2009. The density of water discharge and expected maximum area of operation are the main criteria for a sprinkler system that will control and/or extinguish a fire. There are three main hazard classes for commercial sprinklers based on past experience, fire tests and statistics:

1. Extra Light Hazard (ELH)

Extra light hazard occupancies are non-industrial premises where the amount and combustibility of the contents is low.

2. Ordinary Hazard (OH)

Ordinary hazard occupancies are commercial and industrial premises involved in the handling, processing and storage of mainly ordinary combustible materials unlikely to develop intensely burning fires in the initial stages.

### 3. Extra High Hazard (EHH)

Extra high hazard risks are those commercial and industrial occupancies having high fire loads. As the height of goods is increased, the density of water application has to be increased to cope with the expected fire.

Residential buildings include rest homes, hotels or motels and boarding houses. Residential sprinkler systems can be installed at a lower cost compared to commercial sprinkler. Cost savings result from design criteria, water supply requirements, and valving arrangement.

#### **6.2.2 Piping (wet or dry)**

A wet pipe sprinkler installation is one that has all pipes from the water supply through the control valves to sprinklers permanently filled with water under pressure. This is the usual type of sprinkler system and as water is available throughout the system, it can effectively control a fire with the least delay.

The dry pipe sprinkler installation has the pipes above the control valves charged with air or nitrogen under sufficient pressure to prevent the entry of water. On the operation of a sprinkler, the compressed gas escapes, allowing the control valves to operate and fill the system with water. When a sprinkler operates in a dry system, there is a time delay before water reaches the open sprinkler, and starts to control the fire. Given that the delay will result in a larger fire, which will require greater volumes of water to effect control, most sprinkler standards require that the designer accounts for this by increasing the design area of discharge.

#### **6.2.3 Sprinkler spacing and location**

The spacing of sprinklers is dependent on which class of system is to be installed, and the type of sprinklers to be used. The installation criteria may be nominated in standards, or may be defined in the sprinkler manufacturer's data sheet. Sprinklers perform two functions. They both detect the fire and spray water. The primary means of actuation is via convection from the ceiling jet. To gain best detection the sprinklers should be within 50 to 150 mm of the ceiling. If the sprinklers are located a greater distance below the ceiling, they will operate later.

The spacing of sprinklers in relation to beams is governed by the depth of the beam and the allowable distances are often given in tabular form in a standard. The maximum distance of sprinklers from walls is normally half the design spacing. The requirements of the listing data (for special sprinklers) must be followed and not varied.

### **6.3 Sprinklers and fire effluents**

Purser (2001) has conducted a few experiments to evaluate life threat (time to loss of tenability) in sprinklered fires and compared these with the life threat in equivalent unsprinklered fires. Nowadays, sprinkler systems are normally a part of the life safety strategy of the building by preventing (or minimising) exposure of occupants to fire or fire effluent. When Fast Response sprinklers are used in buildings such as these, there is a greater probability that occupants may come into contact with effluent from sprinklered fires while evacuating to a place of safety.

The purpose of the experiments conducted by Purser (2001) is to assess the extent of possible hazards to occupants of an enclosure from sprinklered fires, in relation to their escape and survival capabilities. The experiments cover three realistic examples of general classes of unsprinklered and sprinklered fire scenarios occurring in buildings:

- Large building enclosure with smoke venting
- Enclosed shop without venting
- Full scale domestic fire experiments

Purser (2001) states that the sprinkler systems were highly effective in extinguishing the fires rapidly, before conditions could develop which could threaten the occupants. Although there was significant smoke logging, levels of heat and toxic products were low, so there would have been ample time for occupants to escape without suffering serious injury. Further general conclusions are that sprinklers may result in some impairment of visibility during the early stages after sprinkler activation, particularly in the close vicinity to the sprinklered area. However the use of sprinklers in general produces less loss of visibility than an equivalent unsprinklered fire in spaces contaminated with fire effluent. There is a considerable benefit in terms of improved tenability resulting from a considerable decrease in heat and concentrations of irritant and asphyxiant gases.

Williams et al. (2005) present the findings from a research project focused on assessing the effectiveness of fire sprinklers in residential premises. The intention of the project was to assess the survivability in sprinklered buildings, as well as comparing differences between the sprinklered and the non-sprinklered building. Typical domestic fire scenarios such as lounge room fire, bedroom fire and kitchen fire were investigated in a series of experiments.

The basic findings was that sprinklers worked well and resulted in fires which were quickly extinguished before they could became large enough and produce enough heat and toxic gases to endanger the lives of people who might have been in the room containing the fire or elsewhere in the apartment/house. However, there was significant smoke obscuration.

Williams et al. (2005) show that the sprinklered lounge room fire was very quickly extinguished before it became dangerous. Although the smoke density in the fire room was high, concentrations of toxic gases and levels of heat were low, so there would have been ample time for occupants to make their escape without injury. Table 6.1 summarises the results of the lounge room fire.

*Table 6.1 Lounge room fire in a sprinklered and a non-sprinklered apartment.*

Variable	Non-sprinklered	Sprinklered
Peak temperature	Exceeded 400° C	125° C (less than 20 s)
Peak carbon monoxide	30,000 ppm	700 ppm
Minimum oxygen	2 %	19 %
Peak HCN	200 ppm	Very low
Peak HCl	250 ppm	Very low
Peak smoke obscuration	More than 5 OD/m	More than 5 OD/m

The sprinklered bedroom fire resulted in some spread of smoke during the early stages, but the fire was extinguished before conditions became dangerous. See Table 6.2 for a comparison of the bedroom fire for the sprinklered and non-sprinklered case.

*Table 6.2 Bed room fire in a sprinklered and a non-sprinklered apartment.*

Variable	Non-sprinklered	Sprinklered
Peak temperature	Exceeded 500° C	110° C (less than 5 s)
Peak carbon monoxide	4,000 ppm	1,000 ppm
Minimum oxygen	12 %	19 %
Peak HCN	Low	Very low
Peak HCl	Low	Very low
Peak smoke obscuration	More than 5 OD/m	2,5-3,0 OD/m

Williams et al. (2005) also investigate the potential effect of sprinkler systems on a chip pan fire corresponding to a typical kitchen fire scenario. The findings were that the unsprinklered chip pan fire in the kitchen produced large flames which damaged the ceiling and a nearby cupboard, burning for much longer than the sprinklered fire, and produced considerable amounts of smoke and heat in the kitchen. The fire did not spread, and went out when the oil was all burned. For the sprinklered test the fire grew until large flames developed, after which the sprinklers triggered and quickly and safely extinguished the fire. The sprinklered chip pan fire therefore burned for a much shorter time than the



unsprinklered fire, resulting in less smoke and heat spreading through the maisonette and less opportunity for damage to nearby combustible items in the kitchen.

The main general conclusions from the research project (Williams et al., 2005) were that sprinklers cooled fire gases sufficiently that the occupants of the room of origin would not have experienced extreme pain due to convected heat. Loss of consciousness would not have occurred in the apartment if room doors were left open, but could be the case in small closes rooms. Visibility was lost in all the fires (with and without sprinklers) after 5-7 minutes, i.e. prior to sprinkler actuation. It was therefore concluded that sprinkler actuation had no effect on the visibility. The sprinkler system enables to maintain tenable conditions (apart from visibility) in all rooms except the fire room. The same effect is noted in non-sprinklered buildings by closing the door of the room of origin. Without sprinklers the time difference between loss of consciousness and death is app. 1 minute. In all of the sprinklered fires, death would not have occurred. This fact is supported by calculations performed by Nystedt (2003) from where Table 6.3 is adapted.

*Table 6.3 Probability and time to certain conditions occurring in a small fire compartment with closed doors for a typical residential fire scenario (Nystedt, 2003).*

	Time to loss of consciousness	Time to death
None-sprinklered	1.5 min	2.0 min
Sprinklered	6 min	<sup>5</sup>

## 6.4 The effect of sprinklers on the fire development

### 6.4.1 Single (small) room experiments

Madrzykowski & Vettori (1992) studied the effect of sprinklers on the heat release rate in a number of experiments. Their aim was to develop an algorithm for sprinkler efficiency. Figure 6.2 is taken from the paper by Madrzykowski & Vettori.

---

<sup>5</sup> Please note that lethal conditions only occur in case of the sprinkler system being unavailable, which arbitrary is considered to be 5 % (i.e. the probability of death in a sprinklered building).

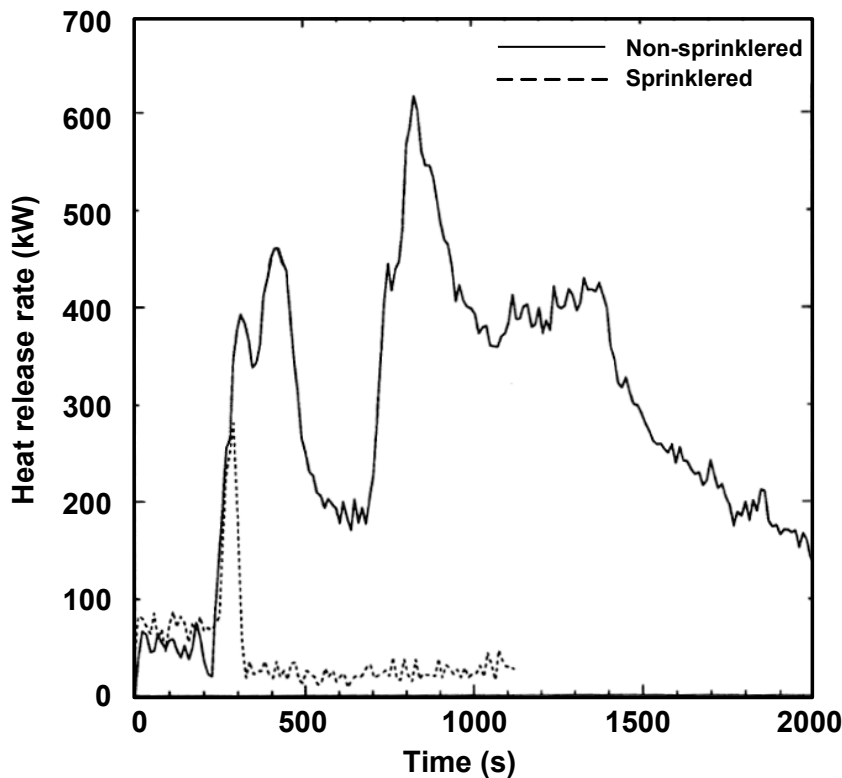

Figure 6.2 Illustration of sprinkler effect on the fire development for a sofa fuel package (adapted from Madrzykowski & Vettori, 1992).

Madrzykowski & Vettori (1992) developed an expression to be used in order to quantify the reduction of the heat release rate after sprinkler actuation, which is valid for light occupancy hazards and a sprinkler spray density of 0.07 mm/s or greater.

$$Q(t) = Q_{act} \exp^{0.0023t} \quad \text{Equation [6.1]}$$

Where:

$Q(t)$  = Heat release rate at a given time after sprinkler actuation, kW.

$Q_{act}$  = Heat release rate at sprinkler actuation, kW.

$t$  = time after sprinkler actuation, s.

Evans (1993) used the data Madrzykowski & Vettori to develop a correlation where the water density is an explicit input variable as shown in below.

$$Q(t - t_{act}) = Q(t_{act}) \exp \left[ \frac{-(t - t_{act})}{3.0(w)^{-1.85}} \right] \quad \text{Equation [6.2]}$$

Where:

$Q(t)$  is the time-dependent heat release rate, kW

$t$  is the time, s

$t_{act}$  is the time at which the sprinkler is activated, s and

$w$  is the water density, mm/s per m<sup>2</sup>.

Sekizawa et al. (1997) performed an investigation on the environment in the room after the actuation of the sprinkler. The study shows that sprinkler actuation causes well-stirred conditions in the room. The initial two-zone description of the fire scenario is no longer valid. In most cases, sprinkler actuation decreases visibility (as shown in Figure 6.3) and in some cases there is an increase in the concentration of carbon monoxide. This is due to the extensive amount of water vapour produced when water is applied to the fire. The rise in carbon monoxide concentration could be explained by reduced combustion efficiency.



Figure 6.3 Smoke layer characteristics, prior and after sprinkler actuation (Kumar, 2006).

Schönberg (2000) carried out ten full-scale experiments in order to investigate whether residential sprinklers had the capability to reduce the production of toxic gases enough to save human lives. The results of the experiments show that the production of carbon dioxide and carbon monoxide is much lower compared to a fire where sprinklers were not fitted. The oxygen concentration was found to be at a much higher level, and the temperature in the fire room was decreased rapidly after sprinkler actuation. Schönberg also points out that the radiation from the upper layer could cause burns prior to the actuation of sprinkler. It was also concluded that the visibility is very low after actuation.

#### 6.4.2 Multi (or large) room experiments

The experiments by Schönberg (2000) were carried out in a room with a floor area of 14 m<sup>2</sup> and a ceiling height of 2.6 m. In such a small room it is obvious that a single sprinkler head will cause a great deal of turbulence resulting in “well stirred” conditions and very low visibility. However, these experiments do not answer how a sprinkler affects the conditions in the room, away from the spraying sprinkler. Experiments conducted by Crocker et al. (2010) studied the impact of sprinklers sprays on the fire induced doorway flow. Based on 34 experiments in a room with a floor area of 48 m<sup>2</sup> and a ceiling height of 2,4 m, they concluded that a spraying sprinkler reduced the mass flows at the doorway while maintaining two stratified layers away from the sprinkler spray. Temperature measurements from both an unsprinklered and a sprinklered case are shown in Figure 6.4.

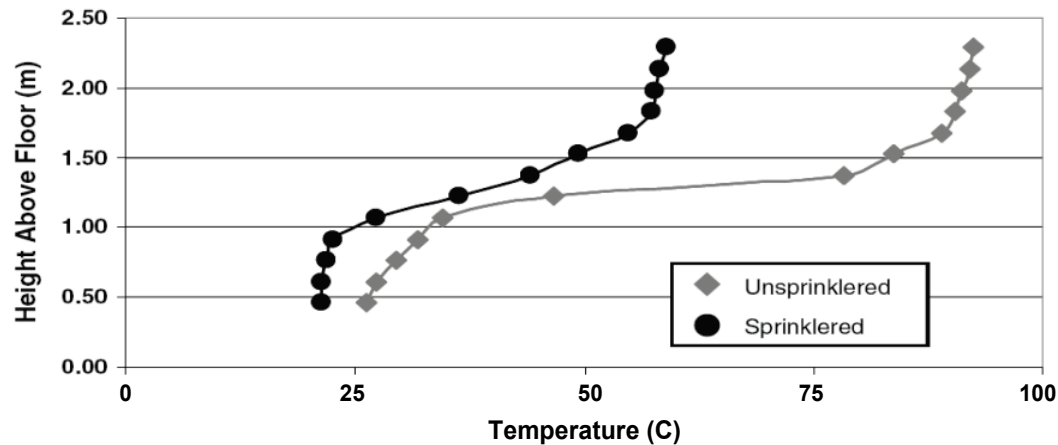

Figure 6.4 Temperature measurements inside the compartment away from the spraying sprinkler showing two distinct stratified layers in both the unsprinklered and sprinklered cases. (Adapted from Crocker et al. (2010)).

Sprinklered fires and smoke control has been examined through various research activities in the 1990s. Klote (1990) concludes that a quick response sprinkler will result in minimal smoke spread, if the fire is unshielded, even though there is no smoke management system in place. He also concludes a sprinklered fire that is not rapidly extinguished will produce significant amount of smoke and that smoke control could be useful in these occasions. The possibility of shielded fires is significant in most premises and Lougheed (1997) examines the expected size of shielded fires in sprinklered office buildings. Some findings from the experiments are that peak heat release rates of up to 800 to 900 kW were measured for tests that initially involved two shielded areas (desk/table). The heat release subsequently decayed exponentially, with heat release rates of 100 to 200 kW measured 25 to 30 minutes after ignition. Lougheed (1997) concludes that there could be a need for smoke control in sprinklered buildings, but additional research is necessary to determine if the smoke produced in a sprinklered fire could harm people and making escape unsuccessful.

Lougheed et al. (2000) and Lougheed et al. (2001) continued to work on smoke movement in large sprinklered buildings such as shopping malls. The examined fires in the test series were typical of those that occur in retail stores in malls and included clothing and toys in boxes located in display units, and stored or displayed bulk goods, such as paper towels (see Figure 6.5). A primary objective of the project was to address concerns that smoke cooled by the sprinklers in retail spaces connected to malls could travel downward, where it could endanger people evacuating the building. The sprinklered fires had three distinct phases, i.e. fire growth and sprinkler actuation, steady fire, and decay. Sprinkler heads activated within a few minutes and the fire went in to the steady phase a short time after actuation. Due to shielding effects it took quite some time (up to 20 minutes) before the decay phase was initiated. During the steady phase a smoke layer formed in the mall area. As the decay phase progressed, the smoke was cooled to near or below ambient temperature. The cool smoke was mixed throughout the fire compartment losing its buoyancy.

Results from the study indicate that, during the initial stages (fire growth and steady phases) of a sprinklered retail fire scenario, the smoke entering the mall area is hot and rises towards the ceiling. A smoke management system using mechanical exhaust could be used to remove this smoke. During the decay phase of the fire scenario, the smoke optical density for the smoke in the secondary space approached or exceeded tenability limits. The rapid mixing of smoke throughout the fire compartment in or near the opening into the mall area during this phase could trap any occupants still in the area. However, the extent of the smoke zone was limited and occurred after occupants should have evacuated the fire zone.



Figure 6.5 Toy display with shielded area and bulk display of paper towels (adapted from Loughheed et al. (2002)).

Loughheed et al. (2000) raises one important question still to be answered, i.e. whether or not the non-buoyant smoke poses a potential hazard and if the sprinkler system provides effective smoke management for fires in adjacent space during this stage of a fire. Conclusions from the experiments by Purser (2001) and Williams et al. (2005) indicate that tenable conditions (apart from visibility) could be maintained by sprinklers.

### 6.4.3 The BRE test series

The Building Research Establishment in the UK (BRE, 2002) has conducted a project that characterised fires for design purposes. The aim of the project was to obtain quantitative data on the growth rates of a number of realistic design fires so that data can then be exploited by fire safety engineers, designers and regulators in the design of fire safety systems. A database was established containing fire characteristics on heat release rates, smoke production rates, CO / CO<sub>2</sub> ratios and gas concentration levels with and without sprinklers in operation for 11 realistic fire scenarios. The sprinklered tests were carried with a maximum of four sprinklers operating with a total flow rate of 270 litres per minute and with a pressure of 0.6 bar at the sprinkler heads. This corresponds to a coverage of app. 12 m<sup>2</sup> per sprinkler head and a delivered water density of app. 5 mm per minute. The sprinkler system was designed according to Ordinary Hazard Class III, as defined by the British Standard BS5306 (BSI, 2009). Sprinkler actuation occurred when the fires reached heat release rates between 0.5 and 2 MW and the test series show that fires with a heat release of less than 5 MW at sprinkler actuation most often are extinguished by the

sprinkler system. The Swedish Fire Sprinkler Association (Sprinklerfrämjandet) has financed a study where the output from the BRE design fires has been examined in order to evaluate the difference between sprinklered and unsprinklered fires (Lindsten, 2009). A summary of the findings is given in Table 6.4 where the immediate effect is defined as the effect on the fire development immediate after sprinkler actuation. Secondary effects are those that occur when water has been distributed on the fire for a certain amount of time.

Table 6.4 The effect of sprinklers on the heat release rate (Lindsten, 2009).

Test	Immediate effect	Secondary effect
Open Plan Office	Reduced HRR	HRR reduced by 50 % after 1 min
Luggage	Increased HRR by 25-50 %	HRR reduced by 50 % after 2-3 min
Reception	Reduced HRR	Extinguished after 2 min
Carpets	Reduced HRR	Extinguished after 1 min
Sports clothing	Increased HRR by 25 %	Extinguished after 2 min
Pallets	HRR kept constant	None
Adventure Play Area	Reduced HRR	Extinguished after 2 min
Boxes	HRR kept constant	None
Soft toys	Reduced HRR	Extinguished after 2 min

Lindsten (2009) concludes that the fire is extinguished by the sprinkler system in 50 % of the fire tests. Three tests result in reduced heat release rate and the heat release rate is kept constant at sprinkler actuation in two of the tests.

A Danish master's thesis (Bek, 2009) also performs an evaluation of the BRE test series, similar to the one done by Lindsten (2009). Bek concludes that the sprinkler system most often is able to reduce the heat release and he derives to an analytical expression for a "normal fire scenario" to illustrate this effect. In the normal fire scenario the fire is reduced to 80 % of the heat release rate at sprinkler actuation, but not below 500 kW. Bek (2009) uses three phases for the suppression effect by sprinklers:

- Control phase - the time from sprinkler activation to the heat release rate starts to decay.
- Decay phase - the time when the heat release rate has been reduced by 80 % or to a value of 500 kW.
- Extinguishment - the time when the fire is less than 100 kW.

Bek (2009) uses a fairly conservative estimate on the length of the control phase (150 s), based on the fire test of "Boxes" i.e., corrugated cardboard boxes filled with packing materials, mainly polystyrene chips and expanded foam mouldings, see Figure 6.6.



Figure 6.6 Photographs from the boxes fire test (adapted from BRE (2002)).

In order to compare the effects from the sprinklers, the heat release rate curves from the BRE tests have been adjusted so the time for actuation is at the same position i.e. at approximately 320 seconds, Figure 6.7. The figure also includes the fire phases described by Bek (2009). The control phase, i.e. the time until the heat release starts to decay is most likely shorter than the 150 s proposed by Bek (2009). A less conservative approach would be to assume a length of the control phase to a maximum of 60 s.

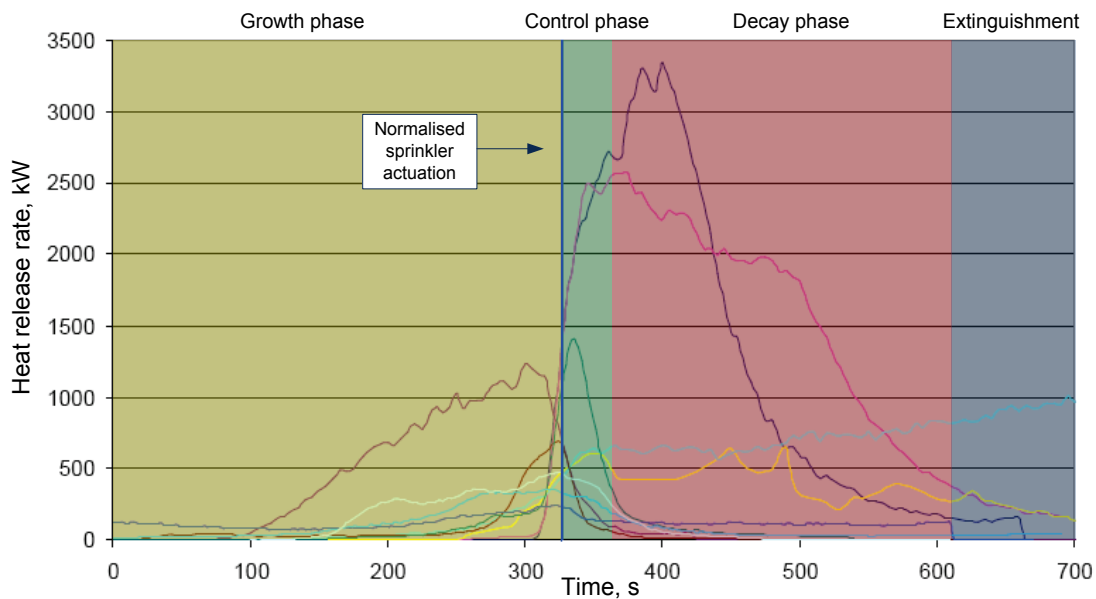

Figure 6.7 Heat release rate, prior and after sprinkler actuation for the complete BRE test series (BRE, 2002).

## 6.5 Reliability, performance and effectiveness

Reliability, performance and effectiveness are central parameters that need to be addressed when considering the effect that a sprinkler system has when it is fitted into building. The more frequent the system operates and is effective, the more weight can be given to the system when verifying a trial design.

### 6.5.1 Elements of reliability

Bukowski et al. (2002) discuss different elements of reliability of fire protection systems and how their definitions. They define reliability is an estimate of the probability that a system or component will operate as designed over some time period. The term unconditional reliability is an estimate of the probability that a system will operate “on demand.” A conditional reliability is an estimate that two events of concern, i.e., a fire and successful operation of a fire safety system occur at the same time.

Bukowski et al. (2002) use a term called operational reliability, i.e. a measure of the probability that a fire protection system will operate as intended when needed. The operation reliability is a measure of component or system operability and it does not take into account the possibility that system design do not match the fire hazards in the building. Therefore there is a need to provide additional information on the likelihood that the fire development is within the design boundaries. Such measure of reliability is defined by Bukowski et al (2002) as the “performance reliability”, i.e. a measure of the adequacy of the system design. A common approach to describe performance of a sprinkler system is to use terms as Required Density Delivered (RDD) and Actual Density Delivered (ADD). If a sprinkler system ought to be successful, the ADD must exceed the RDD, as shown in Figure 6.8.

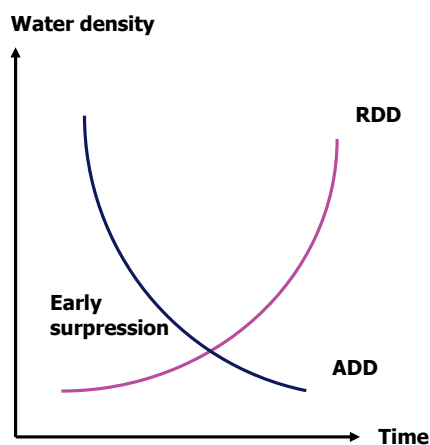

Figure 6.8 Correlation between Required Density Delivered (RDD) and Actual Density Delivered (ADD).

In fire safety design it is the combination of operational reliability and performance reliability that is of most interest. It is not possible to only study how often a sprinkler system operates as design as information on the performance in the actual fire is crucial to decide if the system has been successful or not. Hall (2010) combines measures of operational reliability (percent where equipment operated) with measures of performance



reliability (percent effective of those that operated) to an overall measure of effectiveness (percent where equipment operated effectively), see Figure 6.9.

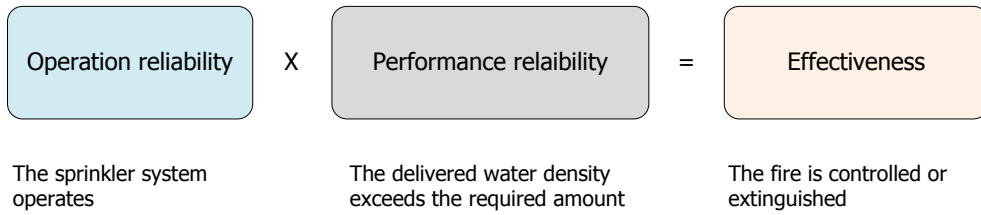

Figure 6.9 Definition of sprinkler effectiveness.

Section 6.5.2 below provides some data on sprinkler performance and effectiveness using the terms and definitions provided in the section.

### 6.5.2 Reliability data

Bukowski et al. (2002) state that most data on sprinkler reliability is on the so called operational reliability as defined in section 6.5.1. Some sources also provide information on the likelihood that the fire actually is extinguished or controlled, but they are few in number. Available sources on reliability show a remarkable variability in the likelihood of successful sprinkler operation. A literature survey presented by Malm and Pettersson (2008) give figures ranging from 38 to 99.5 %. This wide range is troubling and emphasis must be made to collect and report statistics in a transparent and fair way. The most likely cause of the flaws is the fact that the collection of statistics do not recognise whether or not the fire was large enough to activate the sprinkler system or if the sprinkler system failed to operate when the fire was large. U.S. statistics presented by Hall (2010) indicates that the fire is too small to activate sprinkler heads in 44 to 87 % of the fires. If this information is not considered in the collection of data, the reliability figures will be quite misleading.

This report will mainly be used in the fire safety design process where new sprinkler installations are fitted in a building. Therefore, one must use as fresh reliability data as possible. Hall (2010) contains one of the most extensive sources on up-to-date sprinkler reliability data as the report thoroughly examines how the system responds to a fire and the reasons for ineffectiveness if that is the case. Hall (2010) will therefore be used as the main reference for this report, see Table 6.5 and Table 6.6 below. What is worth noting is that a large portion of the fires either self-extinguish or is extinguished by manual intervention.

Another aspect to consider when assessing the appropriate reliability figures to a specific fire design is if the system is designed in complete accordance with the standard (e.g. EN 12845) or if there are notable deviations. The data provided in this section is based on sprinkler systems that in large are designed according to a standard or other specification. The designer must investigate any deviations that would effect the system reliability and effectiveness.

Table 6.5 Sprinkler equipment reliability and effectiveness (Hall, 2010).

Property use	Fire too small to activate system	Operated	Effective when operated	Combined performance
Public assembly	70 %	97 %	97 %	94 %
Educational <sup>6</sup>	85 %	75 %	100 %	75 %
Health care	83 %	90 %	99 %	89 %
Apartments	61 %	96 %	99 %	96 %
Hotels	70 %	88 %	99 %	87 %
Store or office	64 %	96 %	99 %	95 %

The combined performance in Table 6.5 is equal to the reliability times the effectiveness and is considered the most useful and appropriate summary statistics for sprinkler systems.

Table 6.6 Major reasons for sprinkler systems not to operate (Hall, 2010).

Property use	System shut off	Inappropriate system type of fire	Lack of maintenance	Manual intervention defeated system	System component damaged
Public assembly <sup>7</sup>	67 %	4 %	8 %	20 %	0 %
Educational	No data available				
Health care	No data available				
Apartments <sup>8</sup>	57 %	18 %	3 %	21 %	2 %
Hotels	No data available				
Store or office	70 %	5 %	8 %	17 %	0 %

Hall (2010) present statistical data allowing for a comparison of the percentage of fires not being confined to the room of origin in buildings with no automatic extinguishing equipment and in buildings with sprinklers of any type. Table 6.7 also shows information on the likelihood that the sprinkler system did not operate effectively.

<sup>6</sup> There is a large difference on the likelihood of the sprinkler system operating effectively in educational properties when comparing data from Hall (2009) and those presented by Hall (2010). The reason for this is methodological changes between the two reports.

<sup>7</sup> The data in Hall (2010) sums up to 99 % for public assembly properties.

<sup>8</sup> The data in Hall (2010) sums up to 101 % for residential properties (home, including apartments).

Table 6.7 Percentage of flame damage outside room of origin (Hall, 2010).

Property use	With no automatic extinguishing equipment	With sprinklers of any type	Sprinkler system did not operate effectively <sup>9</sup>
Public assembly	23 %	5 %	10 %
Educational	10 %	2 %	32 %
Health care	8 %	1 %	13 %
Apartments	24 %	3 %	6 %
Hotels	13 %	3 %	9 %
Store or office	29 %	7 %	6 %

One could notice a positive difference between the percentage of fires having an extent outside of room of origin and the percentage of fires where the sprinkler system did not operate effectively. The majority of the fires have no extension of flames outside the room, despite the presence of a sprinkler system. Naturally, this is a result of other fire safety measures as well as human intervention with the fire.

Jensen et al. (2010) provides evidence on performance of sprinklers in fire by a compilation of accessible sources. The report addresses sprinklers, residential sprinklers and water mist for protection of residential, care, hospital, office, education and retail type of buildings. The information provided by Jensen et al. (2010) could be used as a knowledge base for anyone interested in sprinkler performance in various situations.

### 6.5.3 Analysis of effectiveness related to performance requirements

Section 2.3 list performance requirements on fire safety in buildings and this section analyses available sprinkler data (presented in section 6.5.2) in terms of sprinkler systems' ability to assist in fulfilling these requirements on fire safety. This section is mainly for illustrative purposes and three performance requirements are covered; development of fire, spread of fire inside the building and the escape of persons. The first two performance requirements both relates to the functional requirement on "development and spread of fire and smoke in the building" and the third performance requirement is related "people in the construction on fire can leave it or be rescued by other means".

#### *Development if fire*

The development of fire within the room of origin could be limited by a number of fire safety features. But, if the fire is not kept small, there is a high probability that the fire will spread outside the room of origin. Data provided by Hall (2010) could be used to assess this probability by dividing the percentage of fires spreading beyond the room of origin with the percentage of fires not being kept small.

<sup>9</sup> Note that the figures in Table 6.7 are based on "sprinkler systems of any kind" and a direct comparison with figures in Table 6.5 which contain data on "wet pipe sprinklers" is not possible.

The result is presented in Table 6.8 for buildings that neither have sprinkler systems or any other automatic extinguishing equipment.

*Table 6.8 Probability of fire spread beyond room of origin if the fire is not kept small. Data are valid for buildings with no automatic extinguishing equipment.*

Property use	Probability of fire spread outside room of origin if fire is not kept small
Public assembly	77 %
Educational	67 %
Health care	47 %
Apartments	62 %
Hotels	43 %
Store or office	81 %

The relative low numbers in hotels is probably related to the fact that each individual hotel room is its own fire compartment. This could also explain the low number for health care properties, but there is also a possibility that the presence of staff may have a positive influence on the likelihood of fire spread. The relative importance of the sprinkler system to limit fire spread within the fire compartment is less in some buildings compared to others. But, the fire sprinkler system is not aware of where it is installed and such statements are not of interest when verifying fire safety. However the operational reliability and effectiveness is dependant on the building use and must be treated individually for the various building types.

*Spread of fire inside the building*

There is limited information available on the performance of Swedish sprinkler systems to reduce the spread of fire. However, it is possible to derive the likelihood of fire spread beyond the room of origin from Swedish incident statistics. Johansson (2003) present at simplified event tree based methodology (see Figure 6.10) for structuring incident statistics in order to derive the probability of various stages in the fire development.

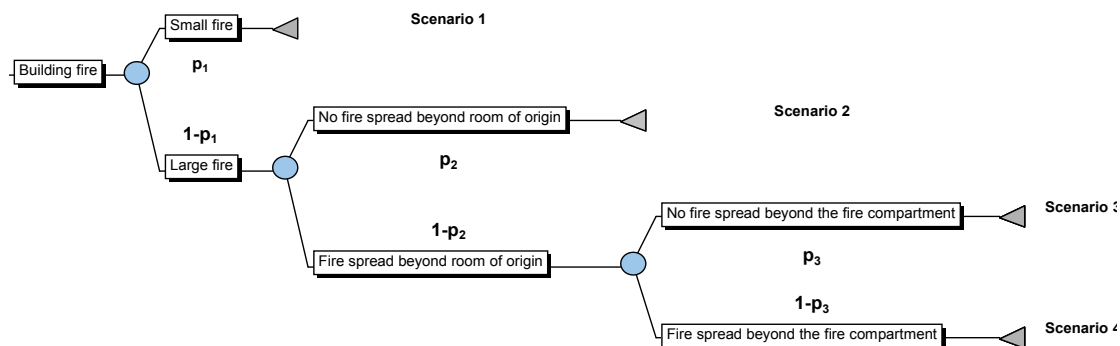

*Figure 6.10 Event tree illustrating different fire scenarios (Johansson, 2003).*

A small fire is a fire that in the incident statistics is considered to be either too small to become large, extinguished at an early stage or self-extinguished. If the fire becomes large, the fire is considered to reach flash-over and become fully developed only if it is spread beyond the room of origin. When this scenario occurs the fire could either stay within the fire compartment or continue to spread to another fire compartment. Fire sprinklers have the opportunity to stop the fire from becoming fully developed and is therefore considered as an additional barrier as shown in Figure 6.11 below.

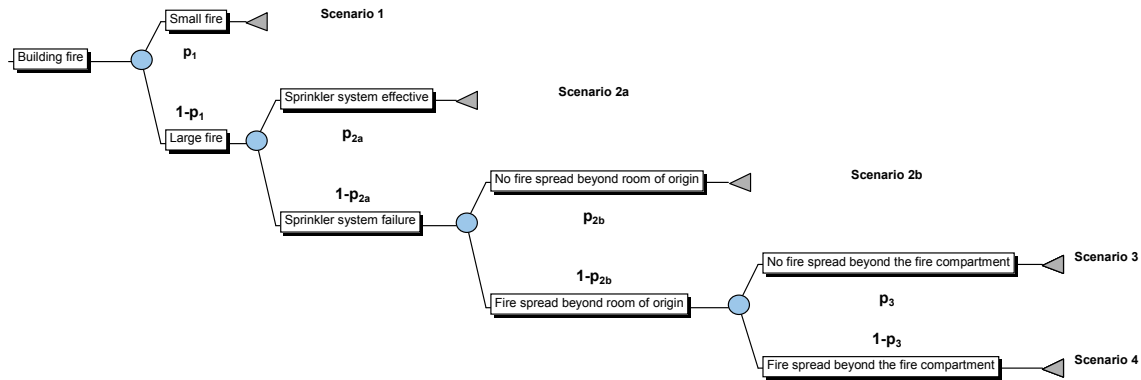

Figure 6.11 Event tree illustrating different fire scenarios with fire sprinklers.

Table 6.9 presents the probabilities for each scenario as defined in Figure 6.10 based on incident statistics from 1996-2008.

Table 6.9 Probability of different fire scenarios based on Swedish incident statistics from 1996-2008.

Property use	Small fire (S 1)	No fire spread beyond room of origin (S 2)	No fire spread beyond fire compartment (S 3)	Fire spread to other fire compartments (S 4)
Public assembly	44.9 %	26.4 %	15.6 %	13.1 %
Educational	56.1 %	23.5 %	11.6 %	8.8 %
Health care	79.3 %	13.3 %	6.2 %	1.2 %
Apartments	49.0 %	28.5 %	19.4 %	3.1 %
Hotels	65.7 %	20.5 %	8.8 %	5.0 %
Store/office	53.3 %	25.8 %	13.7 %	7.2 %

Information in Table 6.9 could be used to calculate the likelihood that the fire does not spread beyond the room of origin by adding the figures for S 1 and S 2. Consequently, the likelihood that the fire does not spread beyond the fire compartment is the sum of S 1 to S 3. There are numerous factors influencing whether a fire will end in any of the scenarios described above. Such factors are fire separating structures as well as the response of the rescue service and building occupants.

When using the figures in design, care must be taken to ensure that the data is valid. Sprinkler performance data in section 6.5 can be used to calculate estimated probabilities on fire spread in sprinklered buildings. The probability of sprinkler system operating and being effective ( $P_{2a}$ ) is given in Table 6.5. The result is outlined in Table 6.10.

*Table 6.10 Estimated probabilities of different fire scenarios, with or without fire sprinklers.*

Property use	No fire spread beyond room of origin		No fire spread beyond fire compartment of origin	
	No sprinklers	Sprinklers	No sprinklers	Sprinklers
Public assembly	71.3 %	98.3 %	86.9 %	99.2 %
Educational	79.6 %	94.9 %	91.2 %	97.8 %
Health care	92.6 %	99.2 %	98.8 %	99.9 %
Apartments	77.5 %	99.1 %	97.0 %	99.9 %
Hotels	86.1 %	98.2 %	95.0 %	99.4 %
Store/office	79.1 %	99.0 %	92.8 %	99.6 %

The figures in Table 6.10 indicates that the traditional fire safety measures (as a result of prescriptive design) gives a safety level that could be considered effective in terms of reducing the likelihood of fire spread beyond the compartment of origin. Only three (3) of one hundred (100) fires in apartment buildings will spread to another fire compartment, even though there are no sprinklers present.

Sprinklers, however, do provide additional safety with a probability of fire spread to another fire compartment in the range of 0.1 % to 1 %. The data on sprinkler efficiency provided in Table 6.10 could be used when assessing how effective sprinklers are in comparison with other safety measures when verifying design alternatives related to the barrier groups on limit fire spread within building and preventing structural collapse. The designer must recognise the difference in sprinkler efficiency among various types of occupancies.

#### *Escape of persons (or rescued by other means)*

Fire sprinklers are effective in reducing the risk of death in the event of fire. U.S. statistics from 2003-2007 states that the death rate per 100 fires was 83 % lower with wet pipe sprinklers than with no automatic extinguishing equipment (Hall, 2010). The number is calculated from a death rate of 7.8 per 1,000 fires in residential properties with no extinguishing equipment and a death rate when wet pipe sprinkler are installed of 1.3 per 1,000 fires. Dividing 1.3 with 7.8 gives a reduction in death rate 16.7 % of the initial value (i.e. a reduction of 100 % - 16.7 % = 83.3 %).

Data in section 6.5.2 (Table 6.5) states that sprinklers in residential properties operates effective in of 96 % the fires large enough to activate the system. With a reduction in death rate of app. 83 %, it could be assumed that fire sprinklers alone have a probability of saving lives of app. 87 % (0.83 / 0.96). Only 13 % of all fires will result in fatal injury despite the system operating effective. Such high efficiency in providing a non-lethal environment in the event of fire ought to be considered in fire safety design.

Hall (2010) reports a few factors that would allow for fatal injury, despite sprinklers operating effective is irrational actions (e.g. return back into the building after safely escaping), victims intimately involved with the fire (e.g. clothing on fire) or victims with who are unusually vulnerable to fire effects (e.g. older adults).

## **7 Performance-based design prerequisites**

This chapter deals with two important aspects in performance-based fire safety design of buildings equipped with automatic fire sprinkler systems. The first aspect is on design fires and the second aspect is on tenability criteria. These aspects are an essential part of the evaluation of life-safety as well as protection of property. The design fire is the so called “load” that puts stress on the fire safety features and the tenability criteria is the amount of stress that the building can cope with, without suffering unwanted consequences in the event of fire.

### **7.1 Proposed design fires in sprinklered buildings**

The fire tests performed by BRE (2002) as well as considering the analysis done by both Lindsten (2009) and Bek (2009), it is possible to conclude that the traditional approach on suppression effects (see Appendix F.2) too conservative for most applications. If the sprinkler system is effective, such a design fire is too large compared to a real fire in the building, not giving the sprinkler system the appropriate credit. On the other hand, such a design fire is too small if the sprinkler system is unavailable. A possible solution is to replace the traditional approach with two types of design fires. One that take into account the suppression effects of the sprinkler system in an realistic way, and a second design fire that provides enough robustness in case of the sprinkler system being unavailable.

#### **7.1.1 Life-safety**

As the benefit from using a suitable sprinkler system it is proposed, as an initial approach, that there is no need to analyse a scenario where sprinkler operates effectively. In smaller fire compartments, i.e. regular offices, residential properties (homes, apartments, hotels, etc.) and smaller health care units, the untenable condition on visibility might be exceeded, even when sprinkler operates. However, the possibility of escaping in a well-known environment is still considered acceptable as occupants unable to escape can remain in the fire compartment in up to one hour without suffering of severe consequences.

Large fire compartments require a special attention to those issues that are related to the loss of visibility. Low visibility could cause disorientation and psychological stress. In addition, the turn-back rate by the evacuees is eminent when the visibility drops below a certain level as well as the potential of trip and fall incidents.

However, both the safety in the sprinklered and non-sprinklered scenario could be assessed by analysing only one of the scenarios. If the building complies with the so called “robustness scenario” one could assume that it has satisfactory performance in the sprinklered scenario as well. This simplification is valid only if the sprinkler system is activated prior to a heat release rate of 5 MW as this heat release rate is considered to be the maximum heat release rate that the sprinkler system could operate effectively at (see section 6.4). The designer could use design fires according to Table 7.1 together with the sprinkler head characteristics and an appropriate actuation model to assess if the sprinkler head will activate at a heat release lower than 5 MW.



Table 7.1 Proposed fire growth rate to be used when assessing time to sprinkler actuation.

Building use	Fire growth rate <sup>10</sup>
Office and school	Medium
Dwelling, hotel, health care unit	Fast
Public assembly hall, shop	Fast

Table 7.2 presents the available fire growth rates according to the classification done by NFPA (1991). The work by NFPA (1991) assumed that the energy release rate of a fire increase proportionally with the square of time as shown in Equation [7.1].

Table 7.2 Fire growth parameters (NFPA, 1991).

Classification	Fire growth rate, kW/s <sup>2</sup>
Slow	0.0029
Medium	0.012
Fast	0.047
Ultra-fast	0.188

$$Q = \alpha t^2 \quad \text{Equation [7.1]}$$

Where:

$Q$  = the heat release rate, kW.

$\alpha$  = the fire growth rate, kW/s<sup>2</sup> (see Table 7.2).

$t$  = time, s.

The  $t^2$  parameters represent fire growth starting with a reasonably large flaming ignition source. With a smaller source, there is an incubation period before established flaming occurs (BSI, 2001). The incubation period or pre-burning time varies depending on which item is ignited. A fibrous material ignited by a cigarette has a relatively long pre-burning time, compared with the ignition of a flammable liquid when the pre-burning time is zero. Measurements made by Högländer & Sundström (1997) showed that the incipient phase ended when the fire had reached 50 kW. The corresponding value given by Buchanan (2001) is 20 kW or a fire with a diameter of 0.2 m.

The  $t^2$  concept has been questioned by a number of authors as it is considered to have an unclear correlation to the fire development in real fires. Högländer & Sundström (1997) have derived design fires for pre-flashover fires by considering characteristic heat release rates of building contents. They used statistics from the CBUF (Combustible Behaviour of Upholstered Furniture) project to define a heat release rate (HRR in kW) equations for both public and domestic fires in upholstered furniture, where  $t$  is expressed in minutes:

$$Q_{public} = 1500 \exp(-0.2(t - 4)^2) \quad \text{Equation [7.2]}$$

<sup>10</sup> See Table 7.2 for information on fire growth rate constants.

$$Q_{domestic} = 2500 \exp(-0.4(t-3)^2) \quad \text{Equation [7.3]}$$

The equations above have a safety factor of 2, based on the average measured peak HRR. The time to reach peak HRR has been divided by two. Since the fire model treats uncertainty by statistical simulation (see Section 4.2), it more interesting to write the equation without safety factors, as shown below where  $a$  and  $b$  are lognormally distributed constants given in Table 7.3.

$$Q_{public} = a \exp(-0.2(t-b)^2) \quad \text{Equation [7.4]}$$

$$Q_{domestic} = a \exp(-0.4(t-b)^2) \quad \text{Equation [7.5]}$$

*Table 7.3 Values of peak HRR ( $a$ ) and time to reach peak HRR ( $b$ ) for public and domestic fires.*

Building use	Constant	Value ( $\pm$ one standard deviation)
Public	a	727 $\pm$ 465 kW
	b	490 $\pm$ 439 s
Domestic	a	1278 $\pm$ 719 kW
	b	339 $\pm$ 278 s

The data in Table 7.3 indicates that there is a large variation in both the peak heat release rate as well as the time to reach the peak. The difference between the results obtained using an approach including safety factors compared to direct treatment of uncertainties is shown in Figure 7.1.

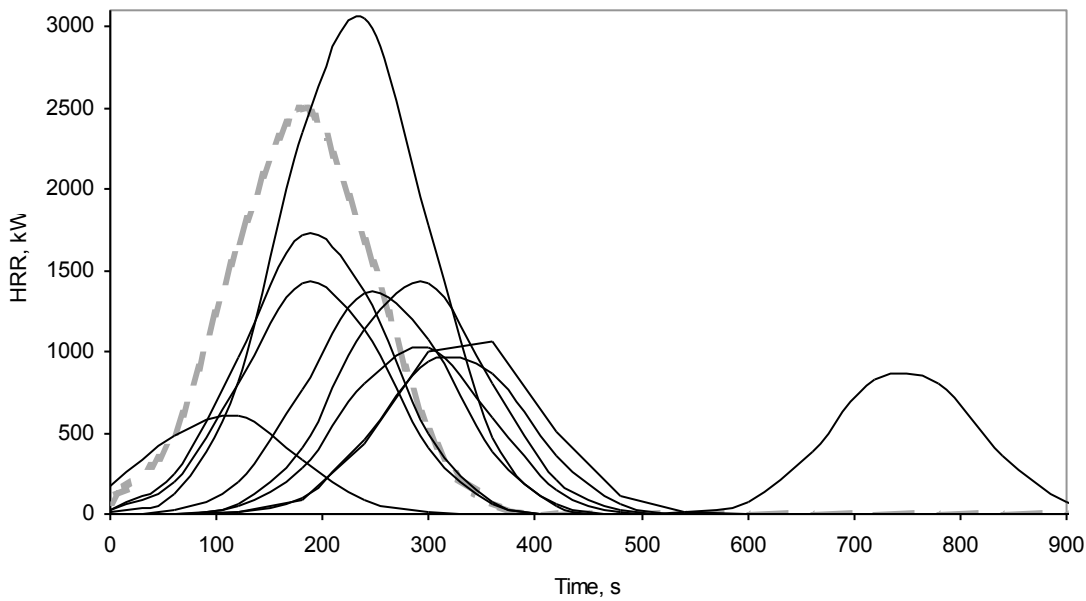

Figure 7.1 HRR curves for the design fire in domestic buildings when using where the hatched graph is the curve when safety factors are adopted and all other graphs are example of curves when the natural variability in the fire development is taken into account.

It would be possible to transform the data provided by Högländer & Sundström (1997) to fire growth rates as both the peak HRR and the time to reach the peak is known. Equation [7.1] could be rearranged to:

$$\alpha = \frac{Q_{peak}}{t_{peak}^2} \tag{Equation [7.6]}$$

If average data from Table 7.3 are used this would result in a fire growth rate of 0,003 kW/s<sup>2</sup> for public buildings and 0,011 kW/s<sup>2</sup> for domestic buildings. But, average data is not of interest in a design situation. Therefore 10,000 iterations of Equation [7.6] have been calculated by the use of Monte Carlo simulation. The result is shown in Table 7.4 where the percentiles of standardised fire growth rates are given.

Table 7.4 Percentile of fire growth rates being faster or equal to the standardised value.

Fire growth rate	Domestic buildings	Public buildings
Slow (0,003 kW/s <sup>2</sup> )	86.3 %	60.6 %
Medium (0,012 kW/s <sup>2</sup> )	57.3 %	27.6 %
Fast (0,047 kW/s <sup>2</sup> )	24.6 %	7.9 %
Ultrafast (0,19 kW/s <sup>2</sup> )	5.4 %	1.2 %

Table 7.1 indicates a design value of 0.047 kW/s<sup>2</sup> for both domestic and public buildings. This represents the app. the 75<sup>th</sup> percentile in domestic buildings and the 92<sup>nd</sup> percentile in public buildings, as shown in Table 7.4. But, as the data from Högländer & Sundström (1997) is for furniture and not furnishing, which probably is a more likely and severe fire

scenario, the figures are only indicative. The approach developed by Högländer & Sundström (1997) is only valid for the first item ignited. In a real situation, the fire will spread to other objects which will contribute to the heat release rate and the design fire must also reflect this. The initial fire will cause the ignition of both wall coverings and adjacent items. The concept of Högländer & Sundström has a maximum heat release rate of 2.4 MW in domestic fires, which could be considered more valid than the use of their concept in public buildings. Common fire scenarios in domestic environments typically involve upholstered furniture, but fires in such furniture in public buildings seldom are considered to cause great damage in comparison with fires in other building contents.

Since both approaches have their limitations it is assumed to be a more conservative to use the predefined fire growth rates and the  $t^2$  concept. This is supported by the fact that the  $t^2$  concept allows for fire spread and not just considers the initial fire. BSI PD 7974:2003 part 1 (BSI, 2001) provides design fire growth rates for various building use. Most growth rates are characterised as “medium” and only shops are considered to have a fast fire growth rate. It could be questionable that a medium fire growth rate would be considered a representative value for building use with residential characteristics, especially when considering the findings by Högländer & Sundström (1997). Therefore, the design values in Table 7.1 have been modified when compared to BSI (2001).

#### *The sprinklered design fire*

When the engineer uses quantitative assessment with probabilistic analysis there might be a need to quantify the sprinklered design fire. Probabilistic methods work best if the performance of both “successful” and “non-successful” is compared. In a deterministic analysis an analysis of this scenario is not necessary, as the robustness scenario alone provides sufficient safety. The sprinklered design fire is described below:

- Design fire when sprinkler activates at a heat release rate of less than 5 MW.
  - The heat release rate remains constant during 1 min.
  - During the next 1 min the heat release rate is decreased linear to one third of the heat release rate at the time of sprinkler actuation.
  - The heat release rate is kept constant at this level in order to consider that the system does not always completely put out the fire.
- Design fire when sprinkler activates at a heat release rate of more than 5 MW.
  - The heat release rate should remain constant at the time of sprinkler activation.

Again, time to sprinkler actuation should be assessed with a fire growth according to Table 7.1 and an appropriate actuation model. It is not recommended to use computer models with built-in sprinkler-compensating modules, as most of these models are, today, not yet fully verified for sprinklered fires.. Instead calculations are performed with a manual reduction in heat release rate based on information in this section.

*The robustness scenario*

The robustness scenario in a sprinklered building is less severe than the ordinary design fire in a non-sprinklered building. One must remember that the robustness scenario only occurs if the sprinkler system is unavailable, which happens in app. 5% to 10% of every growing fire according to the sprinkler reliability data presented in section 6.5. The fire growth rate and the maximum heat release rate to be used in the robustness scenario depend on the use of the building. The robustness scenario does not allow for any considerations concerning the suppression effect that the sprinkler system might have. The system is assumed to fail completely.

Unfortunately it is not possible to give a precise design fire growth rate for the robustness scenario as such information must be based on data that ensures that the overall safety level in a sprinklered building is the same or better than the safety level in a non-sprinklered building. Eurocode EN 1991-1-2 (European Standard, 2002) proposes a reduction to 60 % of the initial design fire load when evaluating load-bearing capacity. A similar approach would be suitable for life-safety evaluation, but this is a task for future research activities involving extensive calibration.

The proposed design approach is to reduce the fire growth rate from the so called worst credible value to a more average value, i.e. using a less severe fire. The logic behind this approach is that the coexistence between sprinkler unavailability and a worst credible fire has such a low probability that it is beyond what is considered to be a reasonable design fire. There have only been a few attempts to categorise the fire growth rates in public buildings. Angerd & Frantzich (2002) presents findings from a study where the distribution of the fire growth rate has been characterised for retail stores. The study indicates that app. 14 % of the fires has a growth rate that is equal to or larger than “fast” (0.047 kW/s<sup>2</sup>). However the quality of the data is not sufficient for practical application in fire safety design.

If it is hard to decide on an appropriate fire growth rate, it is possible to alter other variables related to the ASET calculation for the robustness scenario. The soot yield, i.e. the fraction of burnt fuel that forms soot, is one of the most important variables except from growth rate and maximum heat release rate when analysing smoke filling in an enclosure. A Danish guide on proper use of CFD-models (Jacobsen et al. 2009) defines three categories of fuel to be used in field modelling of fire, see Table 7.5. Cellulose material is represented by wood and plastic material is represented by polyurethane.

*Table 7.5 Fuel properties for CFD analysis (Jacobsen et. al., 2009).*

Variable	Light	Average	Severe
Amount cellulose material	95 %	90 %	80 %
Amount of plastic material	5 %	10 %	20 %
Energy released per unit mass of oxygen consumed, kJ/kg	15,498	16,224	17,809
Soot yield, kg/kg	0.009	0.013	0.02
CO yield, kg/kg	0.004	0.006	0.009

One could argue that the “severe” conditions would be used as the design value in buildings that has no sprinkler system and that the “average” conditions could be used for the robustness scenario in a sprinklered building. Notably, the values provided by Jacobsen et al. (2009) are fairly low compared to observations made in experimental studies of combustion behaviour of upholstered furniture. The recommendation by BRANZFIRE in New Zealand is a soot yield of 0.07 g/g of soot according to Robbins and Wade (2007). Therefore, the engineer needs to verify that the data in Table 7.5 is accurate for the fuels present in the building.

Even though there are difficulties in assigning an appropriate fire growth rate to the robustness scenario, it is likely to be more successful on the maximum heat release rate. For smaller fire compartments (e.g. in offices, schools, dwellings, hotel and health care units) a maximum heat release rate of 5 MW is considered. The 5 MW fire is commonly seen as a maximum heat release rate for smaller rooms such as those in offices, apartments and health care units. Lai et al. (2010) observe such a maximum heat release rate in their office fire experiments and Morgan et al. (1984) propose a design fire for unsprinklered building within this range. Large fire compartments in e.g. retail stores and assembly buildings would require a larger maximum heat release rate and a value of 10 MW is proposed. A fire size of 10 MW could be found for shopping centres in the work carried out by the Australian Fire Code Reform Centre (1998b). Note that that the smaller design fire is not valid for all scenarios in e.g. a hotel or an office. Fire scenarios in restaurants and assembly areas of such buildings should use the 10 MW maximum heat release rate.

### **7.1.2 Fire compartment integrity and load-bearing structures**

When designing fire safety with analytical methods, the possibilities of design alternatives between sprinkler and fire ratings is more a question on probabilities than on consequences. Therefore, a quantification of the fire development in sprinklered buildings is unnecessary regarding to fire compartment integrity and load-bearing structures.

BS 7974 part 3 (BSI, 2001) allows for certain relaxations when characterising fire conditions in terms of time equivalence (load-bearing structures) or the heat flux from flames from openings. BS 7974 and Eurocode EN 1991-1-2 (European Standard, 2002) enable the designer to reduce the design fire load to 60 % of the initial design value when a building is equipped with sprinklers. BS 7974 also allows for a reduction of heat flux from a fire compartment by 50 % when evaluating the necessary separation distance between buildings (to prevent fire spread).

No information has been found on the possibility to reduce the fire load in sprinklered buildings when evaluating the appropriate ratings on fire separating structures, which would be similar to what is allowed for load-bearing structures in Eurocode EN 1991-1-2 (European Standard, 2002).

## 7.2 Tenability criteria in sprinklered fires

### 7.2.1 Toxicity vs. visibility

ISO/TS 1357:2002 suggest a use of  $FED = 0.3$  as a definition of untenable conditions in the event of fire. But the FED concept could not replace the untenable conditions for escape given in Appendix E.1.5 without further research. A value of  $FED = 0.3$ , where actually 10 % of a population could become unconscious (see Table E. 4 in Appendix E.1.5) is probably not inline with legislative requirements on “successful escape in the event of fire”. However, some situations require alternative measures than visibility to assess the consequences of a certain fire scenario. This could be the case when evaluating life-safety in e.g. care homes and hospitals.

Another situation that calls for alternative definitions of untenable conditions based on exposure rather than impaired visibility is buildings with fire sprinklers. Section 6.4 describes the conditions in an enclosure where sprinklers are activated. One consequence of sprinkler actuation is a reduced visibility, which necessarily does not mean that the conditions are to be considered untenable. It is fairly uncomplicated to assess the corresponding FED-values in a room with a visibility of e.g. 5 and 10 m. This could be done by calculate the burnt mass that causes a certain visibility and then calculate the corresponding FED-value for a specific exposure time. Equations from Klote & Milke (2002) are given below.

$$m_f = \frac{K}{2.303\delta_m S} \quad \text{Equation [7.7]}$$

$$FED = \frac{m_f t}{LCt_{50}} \quad \text{Equation [7.8]}$$

Where:

$m_f$  = mass concentration of fuel burnt to cause a visibility  $S$ ,  $\text{g/m}^3$ .

$K$  = proportionality constants,  $K = 8$  for illuminated exit signs and  $K = 3$  for reflecting signs and  $K = 2$  for building components.

$\delta_m$  = mass optical density,  $\text{m}^2/\text{g}$ .

$S$  = visibility, e.g. 5 or 10 m.

$t$  = exposure time, min

$LCt_{50}$  = lethal exposure dose from test data,  $\text{g/m}^3 \text{ min}$ .

Sample calculations are made for the burning of wood and polyurethane with mass optical densities (Quintiere, 1998) and lethal exposure doses (Purser, 2008) given in Table 7.6 below.

Table 7.6 Input data to sample calculations on toxicity vs. visibility

Material	Mass optical density, m <sup>2</sup> /g	Lethal exposure dose, g/m <sup>3</sup> min.
Wood	0.037	3120
Polyurethane	0.326	1390

The results of the sample calculations are shown in Table 7.7. The calculation procedure is shown below for wood, 10 m visibility with reflective exit signs and 10 min of exposure.

$$m_f = \frac{3}{2.303 \cdot 0.037 \cdot 10} = 3.52 \text{ g/m}^3 \quad \text{Equation [7.9]}$$

$$FED = \frac{m_f t}{LCt_{50}} = \frac{3.52 \cdot 10}{3120} = 0.01 \quad \text{Equation [7.10]}$$

Table 7.7 Estimated toxicity for a 10 minute exposure.

Material	Reflective signs		Illuminated signs	
	5 m vis.	10 m vis.	5 m vis.	10 m vis.
Wood	0.022	0.011	0.060	0.030
Polyurethane	0.006	0.003	0.015	0.008

The values in Table 7.7 range from FED = 0.003 to FED = 0.06, with insignificant to sub-incapacitating effects on people. Mowrer et al. (2002) state that a FED-value of 0.1 represents approximately 3 % COHb, a level which is not considered to have any effect on the majority of the population. The authors consider such a value to be an acceptable design criterion. A visibility criterion of 10 m is common in public buildings and Table 7.7 shows that the calculated FED-values are app. 10 times lower than the design criterion proposed by Mowrer et al. (2002), even though tenability criterion on visibility is exceeded.

Is visibility not an indirect measure of toxicity? The discussion above indicates that this might not be the case. Even if we extend the visibility criterion to tolerate a visibility as low as 3 m, the corresponding FED-value still falls in the range of 0.01-0.03 for plastic fuels. A visibility of less than 3 m corresponding to a smoke density of 0.33 OD/m, is considered to be the average density at which people turn back rather than continue through smoke-logged areas (Bryan, 2008). The conclusion is that FED-values are only appropriate to use when evaluating occupant safety in premises where the occupants are not able to escape by themselves. Such premises are e.g. institutional buildings, hospitals and care homes. FED-values could also be used in buildings where escape through smoke is a necessity, i.e. tunnels.

## 7.2.2 Differences between sprinklered and non-sprinklered buildings

One of the main conclusions of the literature study in section 6.3 considering fire effluents in sprinklered environments is that even though visibility drops below 10 m, other tenability limits are seldom exceeded. The legislative criteria on tenability to ensure



successful escape are exceeded at practically the same time in a sprinklered and a non-sprinklered building. But as conditions worsen and approach the tenability limit for unconsciousness the gap widens. When lethal conditions are considered the gap is indefinite. These facts are schematically illustrated in Figure 7.2 below showing the conditions for a fixed location in the room.

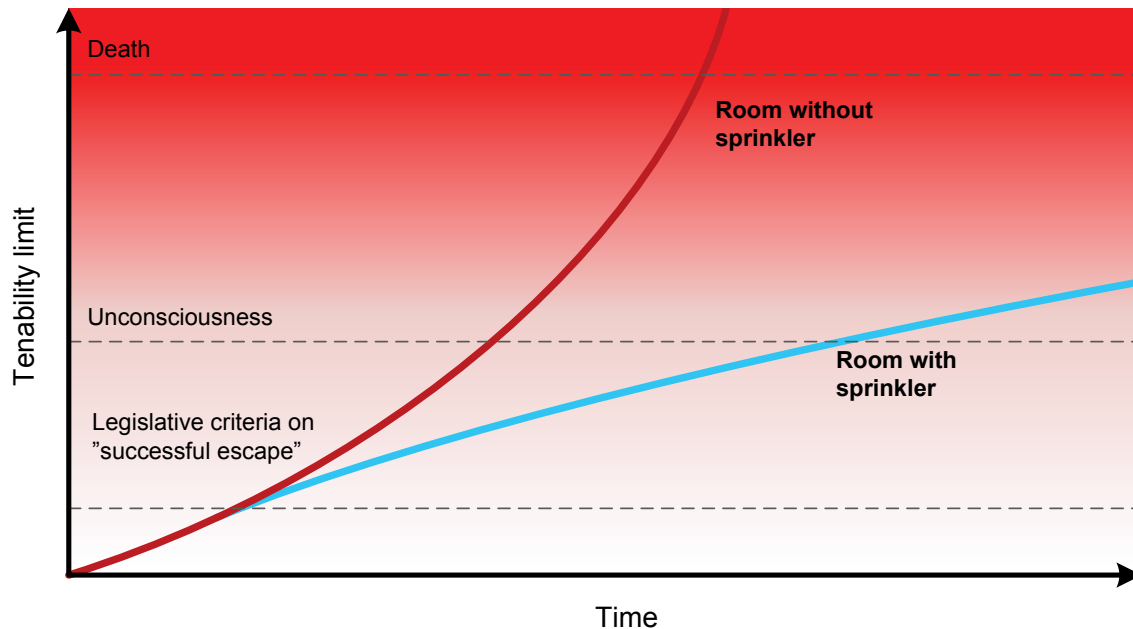

Figure 7.2 Relationship between “time” and different “tenability limits” for a fixed location with a sprinklered and a non-sprinklered room.

Reported tests in section 6.3 indicated that lethal conditions are unlikely in a sprinklered room when the system operates effectively so it can be assumed that the tenability levels is strictly lower in this case. The shape of the curves may have the characteristics indicated in the figure, but that has to be verified further.

The legislative requirements on untenable conditions for escape (see Appendix F.1) recognises these escalating conditions in the fire compartment by assuring that escape should be finalised prior to incapacitation of the occupants. It could be assumed that there is an arbitrary safety factor (i.e. the time difference between the onset of untenable conditions and the time at which the occupant become incapacitated) in the legislative requirements. The calculations on toxicity levels at untenable levels of visibility in section 7.2.1 indicate that the safety factor is app. 10 times. But, the time to reach incapacitation is relatively short.

### 7.2.3 Proposed design criteria

Based on information on the difference between sprinklered and non-sprinklered buildings given in section 7.2.2 as well as fundamentals on human behaviour in smoke in Appendix E.2, the following tenability criteria are proposed for sprinklered buildings.

*Small fire compartments – sprinklered design fire*

There is no need to analyse the sprinklered design fire in smaller fire compartments, i.e. regular offices, residential properties (homes, apartments, hotels, etc.) and smaller health care units. Therefore, there is no need for a tenability criterion.

*Small fire compartments – robustness scenario*

The design criterion when analysing the consequences when the sprinkler system is unavailable, is that successful escape should be effectuated before the toxicity level measured as a FED-value exceeds 0.3. Analyses are not required for buildings following the “Protection-in-Place” principle<sup>11</sup>, as residential premises and hotels. See Section 7.1.1 on design fires in sprinklered buildings and Appendix E.1.5 on the calculation of Fractional Effective Dose (FED).

*Large fire compartments – sprinklered design fire*

There is no need to analyse the sprinklered design fire in larger fire compartments, when a deterministic analysis is performed. Therefore, there is no need for a tenability criterion.

*Large fire compartments – robustness scenario*

The design criterion when analysing the consequences when the sprinkler system is unavailable, is that successful escape should be effectuated before the visibility is less than 5 m (optical density of 0.2 OD/m). Select an appropriate design fire by following the guidance in section 7.1.1.

The basis of the proposed design criteria is the fundamental differences between sprinklered and unsprinklered rooms, where there is a significant increase in the time to reach fatal injury between the two types of rooms. Lowering the visibility criterion to 5 m would still enable safe escape as the turn back rate of occupants is not eminent until visibility drops below 3 m (see Appendix E.2).

---

<sup>11</sup> The “Protection-in-Place” principle is a safety strategy aiming at having only the occupants immediately threatened by the fire to leave the building. A key feature in this principle is the containment of the fire in small units, i.e. fire compartments. Apartment buildings and hotels are typical buildings where the prescriptive requirements enforces the “Protection-in-Place”-principle.



## 8 Design situations

This chapter provides a few ideas and approaches that could be suitable when verifying fire safety design in various situations. The purpose is to provide examples and theories for the engineer to use when evaluation design alternatives.

### 8.1 Sprinklers as a fire safety feature

Fire sprinklers are designed to either control or suppress the fire, as mentioned in section 6.1. By doing so, fire sprinklers, fulfil an important task in the building fire safety system, enabling design alternatives from other traditional fire safety measures. Section 3.1 provides an extensive list on barrier groups and safety measures. Table 8.1 uses this structure to evaluate whether fire sprinklers is a suitable safety measure in a specific barrier group.

*Table 8.1 Evaluation of fire sprinklers as a safety measure for a specific barrier group.*

Barrier group	Design alternative with sprinkler possible?
Prevent ignition	No
Control fire growth	Yes
Control smoke spread	Yes
Limit fire spread within building	Yes
Prevent fire spread to other buildings	Yes
Means of escape	No
Facilitate rescue service operations	No
Prevent structural collapse	Yes

Table 8.1 is based on information on sprinkler performance presented in section 6.3 and 6.4. CAENZ (2008) supports these statements in their checklist on principal fire protection features. To sum up, Table 8.1 shows that fire sprinklers can be used to allow design alternatives from safety features regarding control fire growth, control smoke spread, limit fire spread within and between buildings and prevent structural collapse. Despite the presence of sprinklers, the building must be designed to have a minimum set of means for escape for the occupants to execute rapid egress. Examples of such measures are sufficient exit width, signage, emergency lighting, notification systems, etc. Fire sprinklers cannot replace such barriers, but they could be used to lower some requirements within the group when balancing the ASET vs. RSET equation (see Appendix F.1).

Fire sprinkler could not replace means necessary to facilitate rescue service operations. Such measures are needed especially in case of sprinkler failure and must be kept at an appropriate level. Note that the measures included in this barrier group are those related to rescue operations within the building. Some countries do allow for design alternatives regarding e.g. reduced fire flow and longer hydrant spacing as well as longer distance from fire stations, narrower streets, fewer parking restrictions, longer cul-de-sacs, reduced turnaround radius, etc.

When considering the performance of fire sprinklers on each barrier it is possible to compile a list of statements that are valid when working with fire sprinklers and design alternatives:

- Fires could be allowed to grow more rapidly in the presence of fire sprinklers as they will be controlled or extinguished before they causes harm to people.
  - Chosen materials must not reduce the effectiveness of the fire sprinklers, i.e. the system must still meet its design criteria.
  - A certain set of material characteristics is still required.
- Smoke spread could be allowed to some extent in the presence of fire sprinklers as they will limit the quantities of smoke produced by the fire.
  - Toxicity as well as visibility issues must be addressed.
- Sprinklers could replace other fire safety features in the “limit fire spread within building” barrier group.
  - The probability of sprinkler failure must be less than the probability of failure of the replaced features.
- From a more global perspective, fire sprinklers would allow for lower ratings on fire separating and load-bearing structures.
  - The “national” level of fire damage and building collapse must be kept within the range of acceptable risk.

## **8.2 Design alternatives of interest to fire safety professionals**

A questionnaire was sent to a wide range of consultants, industry and research representatives in the Nordic countries, asking them to provide a list of design alternatives that they considered interesting when installing fire sprinklers in a building. 30 organisations responded to the questionnaire and their answers are summarised in the list below. The list is not exclusive and should only be considered as an example of possible design alternatives that the fire safety professionals are interested in. The design alternatives are not fully verified and have been grouped to the relevant major barrier group (see section 3.1 for additional information on theses barrier groups):

*Means of escape<sup>12</sup>*

- Increased distance to escape routes and increased length between fire doors in escape routes.
- Increased allowable number of occupants in a fire compartment.
- Extended coverage of detectors.

*Control of fire growth*

- Lower requirements on claddings and surface finishes.
- Wood constructions in ceilings and wooden facades.
- Increased amount of stored combustible material.

*Control smoke spread*

- Lower requirements on smoke ventilation.
- No need of fire-rated fans in the HVAC-system.

*Limit fire spread within building*

- Reduced fire resistance of separating structures and elevator doors.
- Extended maximum size of a fire compartment.
- No need to insulate ducts.
- Reduced requirements on glazing and doors, e.g., EI to E and 60 min to 30 min.
- No need of fire rated windows in inner corners and reduced requirements on vertical distance between windows in different fire compartments.
- A fire compartment may cover more than two floors and more than one type of building use could be allowed within the same fire compartment.

*Prevent structural collapse*

- Decreased fire resistance of load bearing structures, e.g. R 90 to R 60.

Section 8.1 discusses sprinkler as a fire safety feature and Table 8.1 in that section states that fire sprinkler are suitable as a design alternative to all the design alternatives proposed in the questionnaire. The verification of a single design alternative is not that difficult, but the more design alternatives that are combined the more complexity is added to the verification task.

---

<sup>12</sup> Naturally, design alternatives related to the barrier group “means of escape” do not make egress swifter. But, as fire sprinkler lengthens the available safe egress time, it is possible to slow down the escape process with some design alternatives. Design alternative related to this major safety barrier is discussed in Section 8.5 on the control of smoke spread.

Section 8.4 to section 8.6 below discusses verification of design alternatives related to specific design situations, i.e., control fire growth, control smoke spread, limit fire spread and prevent structural collapse. Section 8.7 gives useful information on verification when combining design alternatives related to different major fire safety barrier groups.

### **8.3 Type of sprinkler system and possible design alternatives**

Section 6.2 describes various types of sprinkler systems, outlining two different groups namely conventional and residential fire sprinkler systems. The methods for verifying the safety level of trial designs is independent of the type of sprinkler system used. It is assumed that a sprinkler system designed according to the appropriate standard (e.g. NFPA 13, EN 12845 or NFPA 13R and INSTA 900-1) is suitable to control/suppress a fire in that location.

Conventional fire sprinkler systems are built with a higher degree of robustness than residential fire sprinkler system. These increased requirements on the system are necessary to cope with the diverse fire scenarios that could take place in these buildings. On the other hand, residential fire scenarios are well defined and occur in rooms with smaller geometry. Therefore, these systems have a high degree of success as shown in section 6.5.

Most standards on residential fire sprinkler systems (INSTA 900-1 and NFPA 13R) allows for a limited water source, e.g. a duration of 10 or 30 minutes, compared to conventional systems which require a duration of 60 or 90 minutes. However, if a design alternative includes a design alternative on measures that limits fire spread within and between buildings or prevents structural collapse, in buildings with residential sprinklers, the duration of the water source needs to be extended. The duration should then be comparable with the requirements in EN 12845 using an appropriate hazard classification.

INSTA 900-1 proposes an increase in minimum design discharge density when design alternatives are introduced in a building. There is no clear evidence that supports the need for an increase in discharge density in general. But, the design alternative may be such that it requires an increase as the principal hazard classification is altered. However, it must be the responsibility of the designer to design a sprinkler system that can cope with the potential fires in the building. In many cases, the basic need of water discharge meets the requirements.

### **8.4 Using sprinkler to control fire growth**

The main reason for control of materials in the building regulations is to ensure that a small fire will not continue to grow too rapidly so that successful escape will not be possible to effectuate. The statement on sprinkler influence on this barrier group presented in section 8.1 is that:

*Fires could be allowed to grow more rapidly in the presence of fire sprinklers as they will be controlled or extinguished before they causes harm to people.*

Research presented in section 6.4 supports this statement as fire sprinklers effectively limits the fire size at variety of fire growth rates. It is important that materials that produces too

much smoke and flaming droplets should not be allowed as surface finish or cladding. The Swedish Building Regulations (BBR, 2008) states that materials used as surface finishes should at least comply with Euroclass D. A Euroclass D rating is considered to have “acceptable contribution to fire” and wood products with a thickness of more than 10 mm and a density of more than 400 kg/m<sup>3</sup> belong to this class. In most cases the contents of a building have more influence on the size and growth rate of a fire than the fabric of the walls and ceilings. This is certainly true in small rooms where the linings play a minor part in the overall safety of the building. It is probably only necessary to avoid linings having a high flame spread or heat release rate that might encourage early flash-over in the room. Early flash-over would increase the danger to occupants elsewhere (BSI, 2008). Combustible linings in Euroclass C or D will result in a more severe fire as it continues to grow and eventually spread to the linings.

Most fires in smaller rooms or fire compartments result in untenable conditions prior to the ignition of the linings (Nystedt, 2003). The initial fire will most likely start in the building content and grow due to the spread to additional combustible parts of the contents. Arvidson (2000) has conducted fire tests for a residential fire scenario where the fire development as well as the fire effluents has been measured for a non-sprinklered scenario with linings in Euroclass B and a sprinklered scenario with linings in Euroclass D. The source of ignition was an upholstered armchair. The residential fire sprinkler system manages to control the fire despite the combustible linings and the major conclusion presented by Arvidson (2000) is that the fire is less severe in the sprinklered scenario with combustible linings than it is in the non-sprinklered scenario with linings that has very limited contribution to the fire. Australian research (Fire Code Reform Centre, 1998a) showed that life safety is not threatened by the use of combustible linings (comparable to Euroclass D) in residential apartments or in public corridors, when they are equipped with fire sprinklers. Fire Code reform Centre (1998a) recommends to allow for reductions in fire-rating of the linings when building are fitted with sprinklers as shown in the list below.

- Escape routes<sup>13</sup> should have stringent requirements on the linings on walls and ceiling, corresponding to Euroclass B or better.
- Public corridors in apartment buildings, hotels, offices, shops and schools could have linings in Euroclass D.
- Public corridors in health care facilities and public assembly buildings (theatres, halls, etc.) should have linings in Euroclass C
- Specific areas in all buildings could have linings in Euroclass D.

---

<sup>13</sup> Escape routes are either exits (doors or windows) leading to the outside or fire separated stairwells and corridors leading to an exits to the outside.



However, the Fire Code Reform Centre (1998a) also recognises that even in buildings protected by sprinklers, it is important to ensure that sprinklers are not overwhelmed by rapid fire spread via highly flammable materials. This supports the requirement not to use materials with worse combustion behaviour than Euroclass D. BSI (2008) states that in very large rooms e.g. in open plan offices or shops the highest standard of wall lining performance is not generally necessary. This is due to the facts that there is a choice of escape routes and the wall area is usually small compared to the plan area.

In some premises, the role of the claddings and finishes could not be assumed to have little influence on the escape capabilities. Examples of such premises are assembly buildings as night clubs, theatres and restaurants. Normally, due to life safety purposes the surface flame spread and heat release rate characteristics of the lining material in fire compartments containing a large amount of occupants should be of a high class in circulation spaces. The main reason for this is to prevent fire propagation in these spaces, which could affect the means of escape significantly.

If combustible linings are fitted onto the walls for larger fire compartments, the designer must ensure that the fire development is not too severe. It is necessary to alter the proposed design fires in Section 7.1.1 by increasing the fire growth rate by e.g. one class. The result would be a design fire in an office moving from a medium growth rate to a fast growth rate, or the design fire growth rate in a shop being ultra-fast instead of fast.

The designer needs must take measure to protect the escape routes and circulation spaces from rapid fire propagation. The designer must also consider the possibility of the fire becoming too severe for the sprinkler system, if there are circumstances resulting in long actuation times.

## **8.5 Using sprinklers to control smoke spread within the compartment of fire origin**

Fire sprinklers reduce the fire development and the quantities of smoke produced by the fire. Less smoke enables the designer to perform design alternatives on other safety measures that traditionally are in place to control smoke spread (see section 3.1). The statement on sprinkler influence on this barrier group presented in Section 8.1 is that:

*Smoke spread could be allowed to some extent in the presence of fire sprinklers as they will limit the quantities of smoke produced by the fire.*

Research presented in section 6.3 supports this statement as the smoke should be assumed to be “harmless” when sprinklers operate effectively. The control of smoke spread is initially focused on maintaining the escape routes of the building available to be used for evacuation. Two different design situations could be identified based on this fact. The first covers how fire sprinkler could allow for longer egress times as the available safe egress time increases. The other design situation is more related to the possibility of blocking escape routes by smoke and endanger occupants in other rooms or fire compartment. The first design situation is covered in this section, and the other is similar to the control of fire spread and is covered in section 8.6. The design situation where fire sprinklers are used to control the spread of smoke within a fire compartment is the most commonly used in

analytical design of the fire safety of the building. Appendix F.1 introduces the ASET vs. RSET concept and as sprinkler increases the ASET, the RSET could also be increased.

The designer is free to either verify that design equation in Appendix F.1 is fulfilled by the use of a scenario analysis, or by the use of a comparative quantitative risk analysis. Chapter 5 provides guidance on the use of the different verification methods. However, a scenario analysis is believed to be the most used methodology. Section 7.2 provides information of tenability criteria and section 7.1.1 give details on the design fires to be applied when verifying the egress capabilities.

## **8.6 Using sprinklers to limit fire and smoke spread within building and prevent structural collapse**

The questionnaire resulted in several wishes on reduction of fire ratings in sprinklered buildings. BSI (2008) states that a sprinkler system in most instances it will assist in controlling the fire. The fire resistance (both separating and load-bearing) of the compartment walls and floors can therefore be reduced in a sprinklered building or compartment. The statements on sprinkler influence on these barrier group presented in Section 8.1 is that:

*Sprinklers could replace other fire safety features in the “limit fire and smoke spread within building” barrier group, given that the probability of sprinkler failure is less than the probability of failure of the replaced features.*

*From a more global perspective, fire sprinklers would allow for lower ratings on fire separating and load-bearing structures. The “national” level of fire damage and building collapse must be kept within the range of acceptable risk.*

Sprinkler system efficiency is estimated in section 6.5 where the probability of flashover within the room of fire origin could be quantified. When flashover is prevented, the thermal load on the separating structure will be too low to cause fire spread.

### **8.6.1 Reliability data**

It is quite difficult to find suitable reliability data on various fire safety measures, especially those related to doors, smoke vents and fire separating structures. BSI 7974:2003 part 7 (BSI, 2001) provides some data to be used for design purposes which are presented in Table 8.2 below.

Table 8.2 Reliability data on passive fire systems

Passive fire systems	
Probability that fire-resisting structures will achieve at least 75 % of the designated fire resistance standard	Masonry walls 0.75
	Partition walls 0.65
	Glazing 0.4
Probability of fire doors being blocked open	General value 0.3
Probability of self-closing doors failing to close correctly on demand (excluding those blocked open)	General value 0.2

A study from New Zealand (Platt, 1994) shows that there is spread between documented fire resistance according to the standard fire tests and the measured performance. A construction performs app. 1.10-1.25 time better than its rating, with a coefficient of variation between 5 to 13 %. Higher fire ratings have smaller coefficient of variation than lower ratings. Table 8.3 presents the findings by Platt (1994).

Table 8.3 Statistical information on fire resistance.

Fire rating	Measured performance	Coefficient of variation	Performance / rating
R 30	37.4	12.6 %	1.25
R 60	70.1	9.4 %	1.17
R 90	99.9	6.8 %	1.11

The information provided in Table 8.3 is enough to perform a statistical analysis on the probability that a certain fire rated structure does not withstand a fire as long as it is rated for. Platt (1994) suggests the use of a log normal distribution to describe the fire resistance, which gives the following results:

- The probability that a construction with a fire rating of 30 min has a performance that is less than its rating is 4.5 %.
- The probability that a construction with a fire rating of 60 min has a performance that is less than its rating is 5.4 %.
- The probability that a construction with a fire rating of 90 min has a performance that is less than its rating is 6.7 %.

### 8.6.2 Fire loads

Appendix E to Eurocode EN 1991-1-2 (European Standard, 2002) present fire loads for different occupancies as shown in Table 8.4.

Table 8.4 Fire load densities ( $\text{MJ}/\text{m}^2$  floor area) for different occupancies (adapted from EN 1991-1-2 (European Standard, 2002)).

Occupancy	Average	80 % Fractile
Dwelling	780	948
Hospital (room)	230	280
Hotel (room)	310	377
Office	420	511
Classroom of a school	285	347
Shopping centre	600	730

The fire load is considered to belong to a Gumbel distribution<sup>14</sup> and Figure 8.1 shows the complementary cumulative distribution function (CCDF) of the fire load for shopping centres.

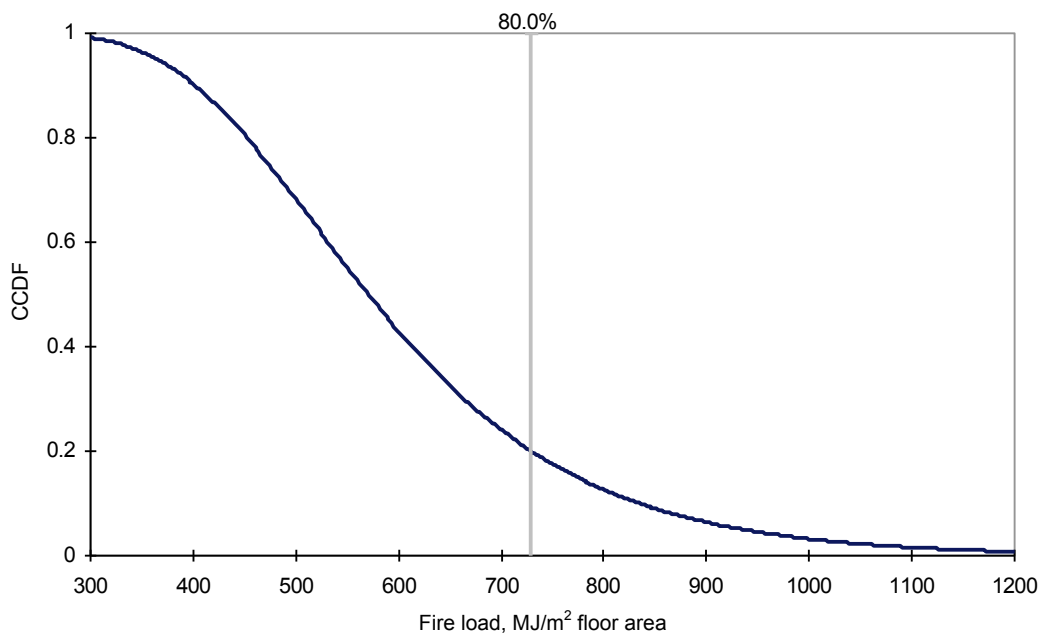

Figure 8.1 CCDF (showing the probability of  $x \text{ MJ}/\text{m}^2$  or higher) for the fire load in a shopping centre. Please note that the 80 % fractile corresponds to the design fire load in the building ( $730 \text{ MJ}/\text{m}^2$  floor area in this case).

### 8.6.3 Design approach on limiting fire spread and preventing structural collapse within building

Eurocode EN 1991-1-2 (European Standard, 2002) contains a calculation method to assess equivalent time of fire exposure, which could be considered a possible solution to

<sup>14</sup> The Gumbel distribution is a type of extreme value distribution.

“translate” the fire load, material properties and ventilation factors in a specific room to a equivalent time related to the standard fire exposure. EN 1991-1-2 also provides information on the statistical distribution of the fire load in different occupancies which makes it possible to calculate a statistical distribution of the equivalent time of fire exposure. By analysing this distribution it is possible to assess the probability that a fire in the occupancy will last longer than the fire-rating of the separating construction.

$$t_{\text{equivalent}} = q_f \cdot k_b \cdot w_f \quad \text{Equation [8.1]}$$

Where

$t_{\text{equivalent}}$  = equivalent time of fire exposure, min.

$q_f$  = the fire load, MJ/m<sup>2</sup> floor area.

$k_b$  = material properties, 0.07 min m<sup>2</sup> / MJ.

$w_f$  = ventilation factor, 1.5 (conservative estimate according to CIB (1986)).

There are known limitations to the time equivalence concept and the method are not recognised as a design method in all countries, e.g. Sweden. Law (1973) developed the concept and stated that it could only be applied where the structural element behaviour can be characterised by a single temperature. Thus, it is acceptable for protected steelwork, unprotected steelwork and concrete where the fire performance is dependent only on the temperature of the reinforcement. The concept cannot be used for concrete columns or timber. Nevertheless, the method serves a purpose when illustrating how to use probabilistic methods for verifying safety.

When the distribution of the fire load is used to calculate the equivalent time of fire exposure with Equation [8.1] it is possible to study the probability that fire duration will exceed the rating of the separating or load-bearing elements. The list below is an example valid for shopping centres.

- The probability that the fire duration is longer than 30 min is 99.99 %.
- The probability that the fire duration is longer than 60 min is 83 %.
- The probability that the fire duration is longer than 90 min is 31 %.
- The probability that the fire duration is longer than 120 min is 7 %.

These probabilities are only valid if the fire is left “untouched” and in reality the fire service has great importance on the likelihood of fire spread. The calculated probability on fire spread in a shopping centre (fire rating of EI 60) is 83 %, which could be compared with the measured probability of 3 % according to data in section 6.5. It is therefore necessary to take fire service intervention into account when considering possible design alternatives.

A design would be considered to have satisfactory safety if the probability of collapse in a sprinklered building (with design alternative on the fire rating) is the same as in a non-sprinklered building with prescriptive requirements on fire ratings:

$$P_{\text{failure|sprinklered} \cap EI \ XX} = P_{\text{failure|non-sprinklered} \cap EI \ YY} \quad \text{Equation [8.2]}$$

$$P_{\text{failure}} = P_{\text{flashover}} \cdot P(S > R) \quad \text{Equation [8.3]}$$

The design approach will be illustrated in the example below related to lower requirements on separating as well as load-bearing constructions.

*Can fire sprinklers allow for a reduction from EI 60 to EI 30 in a shopping centre?*

The probability that the fire is not contained within the fire compartment protected by fire sprinklers and with a fire rating of EI 60 is calculated by using Equation [8.3] with data from Table 6.9.

$$P_{failure} = P_{flashover} \cdot P(S > R) = 1.2\% \cdot 83\% = 1.0\%$$

The probability that the fire is not contained within the fire compartment protected by fire sprinklers and with a fire rating of EI 30 is calculated by using Equation [8.3] with data from Table 6.9.

$$P_{failure} = P_{flashover} \cdot P(S > R) = 0.1\% \cdot 99.99\% = 0.1\%$$

Fire sprinkler and EI 30 have a performance that is app. 10 times better than a rating of EI 60 without fire sprinklers.

*Can fire sprinklers allow for a reduction from R 90 to R 60 in an office building?*

Let us consider an office with a floor area of app. 100 m<sup>2</sup> with a ceiling height of 2.4 m. The opening factor is presumed to be 0.04. The fire load density in this office is given in Table 8.4 and by using Equation [8.1] it is possible to calculate the maximum fire load to prevent the fire duration to exceed the fire rating.

- The fire load must not exceed 571 MJ/m<sup>2</sup> if the fire should have duration shorter than 60 min (in the standard fire test).
- The fire load must not exceed 857 MJ/m<sup>2</sup> if the fire should have duration shorter than 90 min (in the standard fire test).

The Gumbel distribution on the fire load in dwellings gives a probability that the fire load exceeds 571 MJ/m<sup>2</sup> (60 min fire duration) of 11.4 % and a probability of exceeding 857 MJ/m<sup>2</sup> (90 min fire duration) of 0.65 %. There likelihood of failure is app. 17 times higher if the fire rating is lowered to R 60 compared to R 90. This must be compensated by the reduced probability of flashover offered by the sprinkler system. The reliability of the sprinkler system in an office building is 96 % given that the fire is large enough to activate the system.

Even though the fire becomes fully developed, other safety measures could prevent a collapse. The fire service could be successful in their attempt to control the fire or the fire could run out of fuel. It is reasonable to assume that there are no differences between the studied buildings the possibilities of successful rescue service response, or that the fire will remain small. The event trees in Figure 8.2 and Figure 8.3 illustrates the design problem leading to collapse.

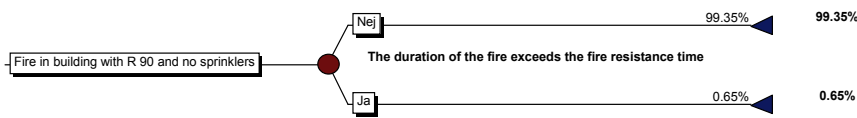

Figure 8.2 Event tree on collapse in a building with R 90 and no sprinkler system.

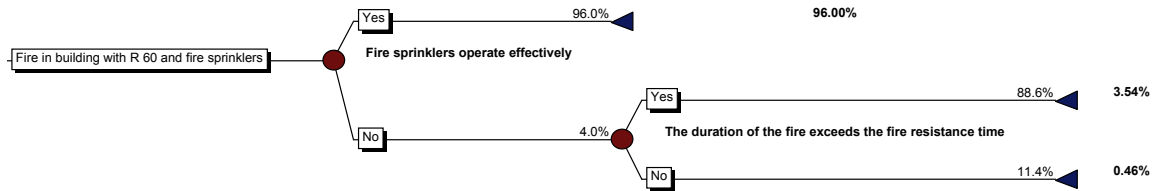

Figure 8.3 Event tree on collapse in a building with R 60 and fire sprinklers.

The probability of collapse, .i.e. the likelihood that the fire duration exceeds the fire resistance time, in a building with a fire sprinkler system and R 60 ratings on load-bearing structures is 0.46 %. This should be compared to 0.65 % in a building without fire sprinklers and a rating on load-bearing structures of R 90. It is therefore verified that a building with fire sprinklers and R 60 offers at least the same amount of safety as a building with R 90 and no sprinkler system.

The approach is solidly theoretical and the verification is performed within the same framework as the performance achieved when using results from standardised testing. The approach has an implicit link to behaviour under real fire conditions. But, the relationship with the actual structural load under the event of fire and the capacity of the structure is unclear. Thus, the uncertainty and variability of the system is not fully known.

### 8.6.4 Design approach on control of smoke spread within building

A common design problem in high-rise buildings is to verify whether or not the building is considered to be safe when built with fire sprinklers and one single staircase. Naturally, the evaluation of risk in such design situations is based on the current level of safety in the national building regulations and the example provided in the section should be considered as an illustration of a methodology, rather than a complete verification that the trial design is considered to be safe. Let the example in Table 8.5 show the method when verifying a design alternative related to control of smoke spread

Table 8.5 Means of escape from a building according to the pre-accepted solution and the trial design.

Reference building with pre-accepted solution	Trial design
One fire and smoke safe staircase	Fire sprinklers
One smoke safe staircase	Single means of escape with on fire and smoke safe staircase

The main task for the sprinkler system in this case would be to provide protection for the single means of escape. The verification can only be done by the use of quantitative risk analysis techniques where the safety levels of the two design solutions (i.e. the reference building and the trial design) are compared with each other.

*Likelihood of successful escape in the reference building*

The reference building has access to one fire and smoke safe staircase (SC1) and one smoke safe stair ase (SC2). Staircase SC1 is separated by a protected lobby and pressurisation of the stairwell. Staircase SC2 do not have any pressurisation, but is placed in the same protected lobby. There are door shutters on apartment doors and on doors leading to the staircases.

The escape routes from the floor of fire origin are blocked if:

- There is a fire that is not extinguished at an early stage.
- The door shutter to the apartment of fire origin does not close.

The escape routes from the other floors are blocked if:

- There is a fire that is not extinguished at an early stage.
- The door shutter to the apartment of fire origin does not close.
- The door shutter to staircase SC2 do not close.
- The door shutter to staircase SC1 do not close.
- The pressurisation of staircase SC1 is unsuccessful.

The likelihood of blocked escape routes is easily calculated as the “fault tree” only contains “AND-gates”, where the probability of the top event equals to the product of all initiating events. Input data to the calculations are gathered from Section 6.5 and from BSI 7974:2001 part 7 (BSI, 2001):

- The probability of a fire not being extinguished at an early stage is 53 % in apartment buildings.
- The probability that a door shutter do not close is 10 %
- The probability of unsuccessful pressurisation is assumed to be 5 %
- The probability of both staircases being unavailable is calculated to  $10 \% \times (10 \% \times 5 \%) = 0.05 \%$ .
- The probability of unsuccessful escape from the floor of origin is  $53 \% \times 10 \% = 5.3 \%$  and the probability of unsuccessful escape from other floors are  $5.3 \% \times 0.05 \% = 0.00265 \%$ .



*Likelihood of successful escape in the trial design*

In the trial design one staircase SC2 is replaced by fire sprinklers. The design of the remaining staircase is the same as in the reference building for staircase SC1. There are door shutters on both apartment doors and the staircase.

The escape routes from the floor of fire origin are blocked if:

- There is a fire that is not extinguished at an early stage.
- The residential fire sprinkler system is unavailable (or ineffective).
- The door shutter to the apartment of fire origin does not close.

The escape routes from the other floors are blocked if:

- There is a fire that is not extinguished at an early stage.
- The residential fire sprinkler system is unavailable (or ineffective).
- The door shutter to the apartment of fire origin does not close.
- The door shutter to staircase SC1 do not close.
- The pressurisation of staircase SC1 is unsuccessful.

Calculations on probabilities follow the same methodology as described for the reference building. The likelihood of unsuccessful sprinkler operation is assumed to be 1 % based on information in section 6.5 (Table 6.5).

The probability of unsuccessful escape from the floor of origin is  $53 \% \times 10 \% \times 1 \% = 0.053 \%$  and the probability of unsuccessful escape from other floors are  $0.053 \% \times 10 \% \times 5 \% = 0.000265 \%$ .

*Comparison of possibilities of successful escape*

The calculations on probabilities of blocked escape routes shows that the escape route from the floor of origin is 100 times less in the trial design and the overall escape possibility is 10 times better. If the principle of optimisation presented in section 3.3 it would be optional to make additional design alternatives on the control of smoke spread. One such design alternative could be the removal of the door shutters on the apartment doors. Or, the designer could choose to “save” the increased level of safety provided by the sprinklers in the barrier group in order to perform design alternatives in other groups, such as limit fire spread or prevent structural collapse.

A similar approach to verify whether fire sprinklers could replace door shutters in health care facilities (nursing homes). Nursing homes are residential like buildings where the occupants are in need of assisted escape due to impaired mobility. The building contains apartments linked to a joint corridor leading to the escape routes. The apartments as well as the corridor are independent fire compartments. However, due to the daily use of the building, door shutters on the apartment doors are impractical. Could fire sprinklers replace these door shutters and still provide satisfactory means of escape? The verification must in this case study the number of people being unable to escape before conditions become untenable as well as the likelihood of occurrence. The designer should present and

compare measures as individual as well as average risk. Design criteria are given in section 7.2 and section 7.1.1

## 8.7 Using sprinklers to prevent fire spread to other buildings

Barnett (1988) states that spread of fire to other buildings can be prevented by providing walls with sufficient fire resistance to remain in place for the duration of the fire. Walls should have windows small enough to control radiation to neighbouring property. CAENZ (2008) states that flashover is not an issue in buildings with sprinkler systems. Hence the spread of fire is not such a problem. The statement by CAENZ is not providing a complete description of the fire risks associated with fire spread. Certainly, the statement is correct when sprinklers are available, but it provides no protection at all when sprinkler fails to operate effectively.

Section 6.5.3 concludes that sprinklers are highly effective in preventing fire spread within the building. But, it is not possible to exclude fire separating structures within a building only because sprinklers are installed. Therefore it could not be possible to totally exclude means of protection in place to prevent fire spread between buildings. Reductions in fire ratings or separation distance could probably be motivated as sprinklers operate effectively in app. 95 % of fires that has the potential to cause fire spread<sup>15</sup>. In comparison, a wall with a fire rating of 90 minutes will be able to withstand the entire fire duration in 99.35 % of all fires in office buildings (see calculations in section 8.6.3). The calculations in section 8.6.3 do not take into account that there are any doors or penetrations in the fire wall that reduces the probability of preventing fire spread significantly in comparison with a solid wall. However, openings and penetrations are allowed in fire walls resulting in an uneven risk of fire spread among those buildings that are designed in accordance with prescriptive requirements. A fire sprinkler system can easily compete with the effectiveness of self-closing doors in terms of maintaining the fire within the compartment of origin. But, the suppression system will not provide the same level of protection as a solid brick wall. The presence of openings and penetrations in fire separating structures is therefore crucial to the possibility of using fire sprinklers as a design alternative.

BSI (2001) gives some guidance on how to estimate the need of separating distance when a building is equipped with sprinklers. The recommendation is to reduce the thermal radiation from openings by 50 % to 42 kW/m<sup>2</sup> for enclosure with characteristics as residential, office, assembly and recreation. For shops, commercial, industrial, storage and other non-residential premises a value of 84 kW/m<sup>2</sup> should be used. Received radiation should not exceed 15 kW/m<sup>2</sup> in order to prevent fire spread (BBR, 2008). Several design guides provides details on calculation of configuration factors and received radiation.

From a probabilistic point of view, it would be interesting to analyse the risk of fire spread between two buildings, both equipped with fire sprinklers and non-combustible façade

---

<sup>15</sup> 95 % is the probability of sprinklers operating effective in offices, which together with apartments are the buildings where design alternatives on fire safety features to prevent fire spread are most common. The corresponding value for apartments is 96 %.

materials. Sprinkler systems designed in accordance with e.g. EN 12845 require independent water pumps a redundancy in water source.

Fire spread is assumed to take place if both sprinkler systems fail to operate effectively. The failure rate for an office sprinkler system is 5 %, resulting in a probability of combined failure of 0.25 %. Such figure is very low and comparable with the probability of a solid wall with a fire rating of 90 minutes.

Thus, the designer has two options when verifying design alternatives related to prevent fire spread to other buildings. If only one building is equipped with sprinklers, the procedure recommended by BSI (2001) seems appropriate. If both buildings have an automatic sprinkler system, the sample calculations provided in the sections show that the probability of fire spread is sufficiently low compared to the protection provided by prescriptive requirements.

Caution must be raised when residential fire sprinkler systems are used as they normally do not have redundancy in the water source. If there are interdependency between the sprinkler systems in the two buildings, a fault tree can be used to investigate if the water source has sufficient reliability. If the sprinkler systems have common causes of failure, the safety level to prevent fire spread is the same as the individual sprinkler system being able to operate effectively. The reduced frequency caused by the non-dependency between the sprinkler systems cannot be taken into account.

## **8.8 Combining design alternatives**

Combining design alternatives is a complex issues, especially if the design alternative is related to more than one barrier group. The complexity is due to the fact that there is no clear and straightforward approach to evaluate the total fire safety of a building, which would be of interest when design alternatives refer to different barrier groups. However, there are conceptual frameworks that could be used to illustrate the links and connections between different fire safety features and barriers (NFPA, 2007). Consider the case described in the example below and the subsequent discussion in relation to fire safety barriers and redundancy:

*A trial fire safety design solution is proposed where the apartment building is fitted with a residential fire sprinkler system and the following design alternatives are introduced:*

- *Combustible surface finishes (wood) on walls in apartments.*
- *Combustible façade material (wood).*
- *The design of the HVAC-system is dependant on sprinkler systems' ability to reduce the fire development.*

The example contain design alternatives related to two barrier groups, i.e. “control fire growth”, “limit fire spread within building”. All design alternatives are individually motivated by the performance of the sprinkler system and its' effect on the fire development. When looking at each design alternative separately it is quite easy following the approaches presented in section 8.4-8.6. But, how should the designer perform verification when design alternatives are combined?

Section 4.2.1 introduces two tools (developed by Lundin (2005)) that could be used to identify the verification requirements. One tool focuses on analysing the structure of the fire protection system in the building and the other tool is related to the purpose of the performance requirements in the building legislation. The description of these tools contains some information on the combination of design alternatives and how this affects the verification of the trial design. One key issue is robustness which is related to what other barriers are in place to protect people and the building. The trial design in the example above relies upon the sprinkler system to operate effectively for the fire barriers to fulfil the performance requirement. The design alternatives are considered to have an acceptable performance as long as the sprinkler system is available which is in app. 96 of 100 fires (see data in section 6.5). The example above will be used to qualitatively illustrate the meaning of robustness by describing what will happen in the building in 4 of 100 fires when the sprinkler system is unavailable.

*Combustible linings results in a more severe fire development when unprotected wood is allowed for on the walls. An apartment contains large quantities of combustible material and adding combustible linings play a minor part in the initial fire development where the time frame for successful escape exists. Combustible linings do not endanger the performance of the fire separating structure (EI 60) which is likely to fulfil its task despite the increased fire load.*

*A wooden façade will make fire spread to the floors above more severe. Flames would extend from windows and spread to the façade and to the fire compartments above. The outer wall is fitted with fire stops and the joints in the wall have been carefully designed to prevent fire spread. The fire spread must take place on the outside of the wall which increases the possibility of the rescue service to limit the spread. The presence of combustible linings do not increase the risk of fire spread as there is enough combustible material within the apartment to have a fully developed, ventilation-controlled fire.*

*Smoke can spread through the HVAC-system, but is constantly being diluted. Calculations show that people have app. 30 min to leave their apartment without suffering FED-values large enough to impair escape. All apartments are equipped with smoke alarm, allowing for early notification of the upcoming danger.*

The example above illustrate that there are other safety barriers in place to minimize fire damage when the sprinkler system is unavailable. It is always useful to describe potential failures related to prescriptive design for an appropriate reference building and comparing failure rates and consequences. Self-closing doors between fire compartments have a failure rate far higher than the one for a sprinkler system. A comparison of failure events between the two designs could therefore be a valuable decision tool. Clearly, it is difficult to evaluate the combination of design alternatives and the designer has to be careful in analysing the combined effects. The main reason for this difficulty is that each barrier group has its own set of risk measure and there is no single measure available to express the total fire risk.

As a first attempt to grasp the effects in this situation a semi-quantitative method like an index method providing an over-all measure of building safety may be applicable. One such method is FRIM-MAB, i.e. Fire Risk Index Method – Multi-storey Apartment Buildings (Karlsson, 2000).

The method considers active and passive fire safety measures, measures to allow for safe egress and rescue operations as well as maintenance issues. The method covers both the safety of people and the safety of the property. This approach may provide an initial input to the analysis task which today still is considered undeveloped. Watts (2008) provides additional information regarding the general description of index methods.

Another suitable approach that could be adopted is the Fire Safety Concepts Tree presented in the standard NFPA 550 (NFPA, 2007). The Fire Safety Concepts Tree is a general qualitative guide to fire safety. It assists in showing various elements that should be considered and their interrelationships. The top level of the Fire Safety Concepts Tree introduces two fire safety objectives:

1. Prevent fire ignition
2. Manage fire impact

Subsequently, these objectives contain sublevels. E.g., manage fire impact has two major branches; manage fire and manage exposed as shown in Figure 8.4. Managing fire could be done by controlling combustion process, suppress fire or control fire by construction.

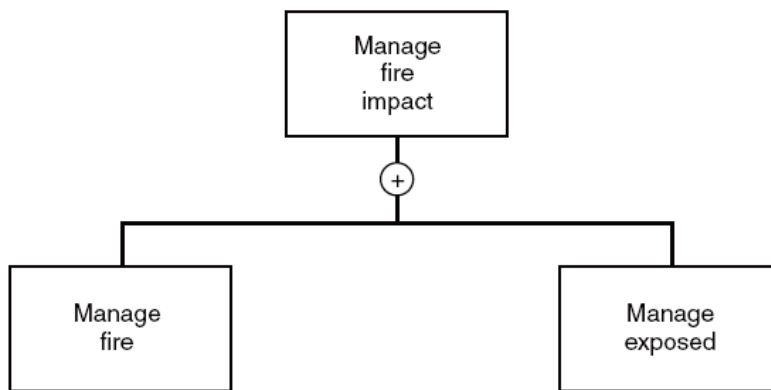

Figure 8.4 Major branches of “Manage fire impact”. The (+) sign in the gate means that the top level can be achieved by either one of the branches. A (·) would indicate that both branches are needed to achieve a balanced safety level. (Adopted from NFPA, 2007).

The Fire Safety Concepts Tree provides a guide to identifying design strategies that may provide an equivalent of safety. “Or” gates indicate where more than one means of accomplishing a strategy in the tree is possible. A decrease in the quality or quantity of one input to an “or” gate can be balanced by an increase in another input to the same gate. This is the fundamental principle of using design alternatives in building design.

However, if the design alternatives are connected through an “and” gate this would indicate that the combination of design alternatives and trade-ups is invalid. The “and” gate indicates that the removed safety feature is compensated by an increase of an incompatible safety feature. The presences of “or” gates in the tree indicate where alternative strategies exist and where redundancies can be built into the design to improve reliability. This process of analysing objectives and decomposing them is effectively represented by the Fire Safety Concepts Tree, where each of the specific fire safety concepts is explicitly linked to the higher level objective or goal.

To illustrate problems associated with multiple trade offs an example is presented. Section 6.5.3 shows that sprinklers are highly effective in preventing fire spread, both within the fire compartment and beyond it. When only focusing on e.g. the probability of fire spread to another fire compartment fire sprinkler increases the safety by a factor of 15-30, depending on likelihood of sprinklers operating effectively. This reduction in risk of fire spread opens for design alternatives on other safety measures that prevent fire spread. Section 8.6 gives details on such design alternatives, but one complication of combining design alternatives are noted here based on the illustration in Figure 8.5 below.

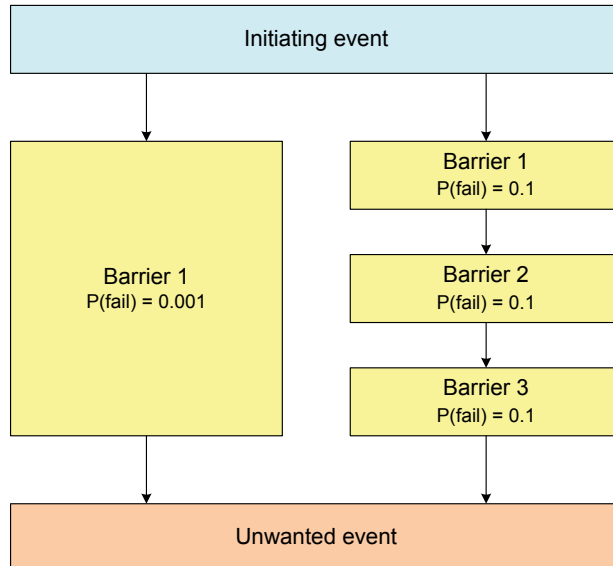

Figure 8.5 Two safety systems providing the same risk of the unwanted event.

The first safety system has one barrier with a probability of failure of 0.001. The second safety system has three independent barriers each having a probability of failure of 0.1. The second safety system thus has the same probability of the unwanted event, i.e.  $0.1^3 = 0.001$ . Are these safety systems equal? If one ought to measure only the probability of failure, the answer is yes. A failure of 0.001 with one barrier is equal to the failure of three barriers having a combined probability of failure of the same value. But if one ought to evaluate e.g.

the time until failure, the result could differ a lot. If the barrier in the single barrier system is of on/off type, then it either operates with 100 % effectiveness or it does not operate at all. Compare such a barrier to the multiple barrier safety system where the unwanted event does not occur until all three barriers have failed. If the system is designed with consideration of redundancy this would be the case. Such a system has a failure time that most likely is longer than what the single barrier system would have. From this point of view, the systems are not equal, despite having the same probability of failure.

The example illustrates one of the important factors that need to be considered when combining design alternatives. Naturally, one could express risk as a probability distribution of the failure time and compare these distributions between the two safety systems. Such procedure would result in an expected time until failure and not just a probability that the failure will occur. The possibility to reduce ratings on load-bearing structures in sprinklered buildings is a question similar to the one discussed above. In a building without fire sprinklers, the load-bearing structure will keep their capacity for a specific time. This time is relatively unknown as ratings are based on exposure in a standardised test method. Nevertheless, it is assumed that people will escape safely before the occurrence of collapse.

If the fire ratings are reduced in a sprinklered building there will be two different scenarios. The first, when the sprinkler system operates effectively will have infinite load-bearing capacity. The second, when the sprinkler system is unavailable will have a load-bearing capacity that is lower than the prescribed solution. How low could be determined by either the time required for escape and rescue, or the rating required having the same total level of collapse. There is no straightforward answer on how to combine design alternatives. The most appropriate approach, given the current level of knowledge and experience, is to follow the procedure described by Lundin (2005) and presented in section 4.2.1

## 9 References

Anderson, R.A., Watson, A.A., Harland, W.A., *Strathclyde pathology study*, Med. Sci. Law, 21, 175, 1981.

Angerd, M., Frantzich, H., *The use of uncertainty analysis in performance based design*, Proceedings from the 4<sup>th</sup> International Conference on Performance-Based Codes and Fire Safety Design Methods, Society of Fire Protection Engineers, 2002.

Arvidson, M., *An Initial Evaluation of Different Residential Sprinklers using HRR Measurements*, SP Rapport 2000:18, The Technical Research Institute of Sweden (SP), Borås, 2000.

Barnett, C.R., *Fire separation between external walls of buildings*, Proceedings from 2<sup>nd</sup> International Symposium on Fire Safety Science, Tokyo, 1988.

Bek, P., *Sprinkleranlægs brandeffektdæmpende egenskab*, Master i Brandsikkerhed, DTU Byg, Danmarks Tekniske Universitet, Kgs. Lyngby, 2009. (*In Danish*)

Bonthron, C., Delin, M., Korostenski, T., Lundin, J., *Fire safety design of a high-rise apartment building – the Swedish case study*, Proceedings from the 7<sup>th</sup> International Conference on Performance-Based Codes and Fire Safety Design Methods, Society of Fire Protection Engineers, 2008.

*Boverkets byggregler (BBR)*, BFS 1993:57 med ändringar t.o.m. BFS 2008:6, Swedish National Board of Housing, Building and Planning, Karlskrona, 2008. (*In Swedish*)

British Standards Institution (BSI). *Fire safety engineering principles for the design of buildings*. BS 7974:2001, London, 2001.

British Standards Institution (BSI). *Code of practice for fire safety in the design, management and use of buildings*. BS 9999:2008, London, 2008.

British Standards Institution (BSI). *Fire extinguishing installations and equipment on premises*. Commissioning and maintenance of portable fire extinguishers – Code of practice. BS 5306-3:2009, London, 2009.

Bryan, J.L., *Behavioural Response to Fire and Smoke*, Chapter 3-11, The SFPE Handbook of Fire Protection Engineering, 4<sup>th</sup> edition, National Fire Protection Association, Quincy, 2008.

Buchanan, A.H., *Fire engineering design guide*, 2<sup>nd</sup> edition, University of Canterbury, Christchurch, 2001.

Building Research Establishment (BRE) Ltd., *Design Fires Database*, v. 1.2, 2002.

Bukowski, R. W.; Budnick, E. K.; Schemel, C. F., *Estimates of the Operational Reliability of Fire Protection Systems*, Fire Protection Strategies for 21<sup>st</sup> Century Building and Fire Codes Symposium. Proceedings. Society of Fire Protection Engineers and American Institute of Architects. September 17-18, 2002, Baltimore, MD, 111-124 pp, 2002.

CAENZ, see New Zealand Centre for Advanced Engineering.



Center for Chemical Process Safety of the American Institute of Chemical Engineers (CCPS). *Tools for Making Acute Risk Decisions with Chemical Process Safety Applications*, New York, 1995.

CIB, *Design guide for structural safety*, Fire Safety Journal 10, Elsevier Science Limited, 1986.

CPD, *The construction products directive*, Council Directive 89/106/EEC of 21 December 1988 on the approximation of laws, regulations and administrative provisions of the Member States relating to construction products.

Crocker, J.P., Rangwala, A.S., Dembsey, N.A., LeBlanc, D.J., *Investigation of Sprinkler Sprays on Fire Induced Doorway Flows*, Fire Technology, 46, pp. 347–362, Springer Science, 2010.

European Standard, *Eurocode 1: Actions on structures - Part 1-2: General actions - Actions on structures exposed to fire*, EN 1991-1-2, November 2002.

European Standard, *Fixed firefighting systems. Automatic sprinkler systems. Design, installation and maintenance*, EN 12845, 2009.

Fire Code Reform Centre, *Fire performance of wall and ceiling lining materials*, CRC Project 2 – Stage A, Fire Performance of Materials, Project Report FCRC – PR 98-02, Fire Code Reform Research Program, FCRC, Sydney, 1998a.

Fire Code Reform Centre, *Fire safety in shopping centres*, Final research report. Project 6, Fire Code Reform Research Program, FCRC, Sydney, 1998b.

Frantzich, H., *Uncertainty and Risk Analysis in Fire Safety Engineering*, Report 1016, Dept. of Fire Safety Engineering, Lund University, Lund, 1998.

Hall, J.R., *U.S. Experience with Sprinklers and other Fire Extinguishing Equipment*, Fire Analysis and Research Division National Fire Protection Association, February 2010.

Höglander K., Sundström B., *Design fires for pre-flashover fires*, SP Report 1997:36, Swedish National Testing and Research Institute, Borås, 1997.

INSTA 900-1, *Residential sprinkler systems – Part 1: Design, installation and maintenance*, 2009.

International Electrotechnical Commission (IEC): International Standard 60300-3-9, Dependability management – Part 3: Application guide – Section 9: *Risk analysis of technological systems*, Geneva, 1995.

*International Fire Engineering Guidelines* (IFEG). International Code Council (USA), National Research Council (Canada), Department of Building and Housing (New Zealand), Australian Building Codes Board, 2005.

International Organization for Standardization (ISO), Technical Specification ISO/TS 13571:2002, *Life-threatening components of fire – Guidelines for the estimation of time available for escape using fire data*, Geneva, 2002.

- International Organization for Standardization (ISO), *Fire protection -- Automatic sprinkler systems - Part 1: Requirements and test methods for sprinklers*, ISO 6182-1:2004, Geneva, 2004.
- Jacobsen, A., et al., *CFD Best Practice – guideline*, Copenhagen, 2009. (In Danish)
- Jensen, G., Haukø, A-M., *Sprinkler Performance Knowledge Base*, COWI Fire Research Report no. 02/2010, COWI A/S, Oslo, 2010.
- Jin, T., *Visibility through fire smoke*, Journal of Fire and Flammability 9(2):135-155, 1978.
- Jin, T., *Studies of emotional instability in smoke from fires*, Journal of Fire and Flammability 12(2):130-142, 1981.
- Jin, T., Yamada, T., *Experimental study on human emotional instability in smoke filled corridor*, Journal of Fire Sciences 8(2):124-134, 1990.
- Johansson, H. *Decision Analysis in Fire Safety Engineering – Analysing Investments in Fire Safety*. Report 1026, Dept. of Fire Safety Engineering, Lund University, Lund, 2003.
- Johansson, R., *Vision Zero – Implementing a policy for traffic safety*, Safety Science, Vol. 47, Issue 6, pp. 826-831, 2008.
- Kaplan, S., & Garrick, B.J., *On the Quantitative Definition of Risk*. Risk Analysis, Vol. 1, No. 1, 1981.
- Karlsson, B., *Fire Risk Index Method – Multi-storey Apartment Buildings*, Trätek, Rapport I0009025, Stockholm, 2000.
- Klote, J.H., *Fire experiments of zoned smoke control at the Plaza Hotel in Washington, DC*. NISTIR 90-4253. Gaithersburg, Md.: National Institute of Standards and Technology, 1990.
- Klote, J.H., Milke, J.A., *Principles of Smoke Management*, American Society of Heating, Refrigerating and Air-Conditioning Engineers, Atlanta, 2002.
- Kumar, S., *CFD Modelling of Fires – RANS versus LES*, Fire Research Station, The Fire Division of BRE, Great Britain, 2006.
- Lai, C-M., Ho, M-C., Lin, T-H., *Experimental Investigations of Fire Spread and Flashover Time in Office Fires*, Journal of Fire Sciences, vol. 28, Sage Publications, May 2010.
- Law, M., *Prediction of fire resistance*, in Symposium no. 5, Fire Resistance Requirements for Buildings – A New Approach, London, 1973.
- Lindsten, J. *Analys av brandförsök utförda av BRE angående effekt-kurvor vid sprinklade och osprinklade brandförlopp*, Brandkonsulten AB, 2009. (In Swedish)
- Lougheed, G.D., *Expected size of shielded fires in sprinklered office buildings*, ASHRAE Transactions, Vol. 103, Pt. 1, American Society of Heating, Refrigerating and Air-Conditioning Engineers, Inc., 1997.
- Lougheed, G.D., McCartney, C., Taber, B.C., *Smoke Movement for Sprinklered Fires*, ASHRAE Transactions, Volume 106, pp. 605-619, 2000.

- Lougheed, G.D., McCartney, C., Taber, B.C., *Sprinklered Mercantile Fires*, ASHRAE Transactions, Volume 107, pp. 730-743, 2001.
- Lougheed, G.D., McCartney, C., *Malls, sprinklers and smoke : is smoke in a shopping mall atrium more of a problem that we bargained for?*, Canadian Consulting Engineer, v. 43, no. 3, pp. 23-24, May 2002.
- Lundin, J. *Safety in Case of Fire – The Effects of Changing Regulations*, Dept. of Fire Safety Engineering, Lund University, Lund, 2005.
- Madrzykowski, D., Vettori, R., *A sprinkler fire suppression algorithm*, Journal of Fire Protection Engineering, Vol 4, No 4, Society of Fire Protection Engineers, 1992.
- Magnusson, S-E., Rantatalo, T., *Risk Assessment of Timberframe Multistorey Apartment Buildings – Proposal for a Comprehensive Safety Evaluation Procedure*, Report 7004, Dept. of Fire Safety Engineering, Lund University, Lund, 1998.
- Malm, D., Pettersson, A-I., *Reliability of Automatic Sprinkler Systems – an Analysis of Available Statistics*, Report 5270, Dept. of Fire Safety Engineering, Lund University, Lund, 2008.
- Marberg P. A., Frantzich, H., Jönsson, R., Lundin, J., Rantatalo, T., *The Swedish Case Study, Fire Safety Design for a Multitenant Business Occupancy*, Rapport 3083, Brandteknik, Lunds universitet, Lund, 1996.
- Morgan, H.P., Hansell, G.O., *Fire Sizes and Sprinkler Effectiveness in Offices -- Implications for Smoke Control Design*, Fire Safety Journal, 8 (1984/85) pp. 187 – 198, 1984.
- Mowrer, F., Brannigan, V., Purser, D., *A Probabilistic Approach to Tenability Criteria*, Proceedings from the 4th International Conference on performance-Based Codes and Fire Safety Design Methods, Society of Fire Protection Engineers, 2002.
- National Fire Protection Association (NFPA), *Guide for Smoke Management Systems in Malls, Atria and Large areas*, NFPA 92B, Quincy, 1991.
- National Fire Protection Association (NFPA), *Fire Safety Concepts Tree*, NFPA 550, Quincy, 2007.
- National Fire Protection Association (NFPA), *Standard for the installation of sprinkler systems*, NFPA 13, Quincy, 2010a.
- National Fire Protection Association (NFPA), *Standard for the installation of sprinkler systems in residential occupancies up to and including four stories in height*, NFPA 13R, Quincy, 2010b.
- New Zealand Centre for Advanced Engineering (CAENZ), *Fire Engineering Design Guide*, 3<sup>rd</sup> edition, Christchurch, 2008.
- Nordic Committee on Building Regulations (NKB), *Structure for Building Regulations*, Report nr. 34, 1978.
- Nordic Committee on Building Regulations (NKB), *Performance Requirements for Fire Safety and Technical Guide for Verification by Calculation*, Report nr. 1994:07 E, 1994.

- Notarianni, K.A., Parry, G.W., *Uncertainty*, Chapter 5-4, The SFPE Handbook of Fire Protection Engineering, 4<sup>th</sup> edition, National Fire Protection Association, Quincy, 2008.
- NRC, see U.S. Nuclear Regulatory Commission.
- Nystedt, F., *Deaths in Residential Fires - an Analysis of Appropriate Fire Safety Measures*, report 1026, Department of Fire Safety engineering, Lund University, 2003.
- Olsson, F., *Tolerable Fire Risk Criteria for Hospitals*, Report 3101, Dept. of Fire Safety Engineering, Lund University, Lund, 1999.
- Ondrus, J., *Brandförlopp*, Institutionen för brandteknik, Lunds universitet, Lund, 1990. *(In Swedish)*
- Ordinance on Technical Requirements for Construction Works*, etc (BVF), SFS 1994:1215. *(In Swedish)*
- Paté-Cornell, M.E. *Uncertainties in risk analysis: Six levels of treatment*, Reliability Engineering and System Safety, Vol. 54, 1996.
- Platt, D.G., *Fire resistance of barriers in modelling fire spread*, Fire Safety Journal 22, pp. 399-407, Elsevier Science Limited, 1994.
- Purser, D.A., *Toxic product yields and hazard assessment for fully enclosed design fires*, Polymer International, Volume 49 Issue 10, pp 1232 – 1255, Society of Chemical Industry, 2000.
- Purser, D.A., *Sprinklers and fire effluents – methods for assessing life threat from sprinklered fires*, Preliminary draft, dated 2001-07-11, ISO TC92/SC3 WG2, International Organization for Standardization (ISO), Geneva, 2001.
- Purser, D.A., *Toxicity assessment of combustion products*, Chapter 2-6, The SFPE Handbook of Fire Protection Engineering, 4<sup>th</sup> edition, National Fire Protection Association, Quincy, 2008.
- Quintiere, J.G., *Principles of Fire Behavior*, Delmar Publishers, 1998.
- Robbins, A.P., Wade, C.A., *Soot Yield Values for Modelling Purposes – Residential Occupancies*, BRANZ Study Report 185. BRANZ Ltd, Porirua, New Zealand, 2007.
- Schönberg, S., *Fullskaleförsök av brand i ett rum med boendesprinkler*, Rapport 5061, Avdelningen för brandteknik, Lunds universitet, Lund, 2000. *(In Swedish)*

Sekizawa, A., Takemoto, A., Kozeki, D., Yanai, E., Suzuki, K., *Experimental study on fire hazard before and after sprinkler actuation*, 13<sup>th</sup> meeting of the UNJR panel on Fire Research and Safety, March 13-20, 1996, National Institute of Standards and Technology, Gaithersburg, USA, 1997.

Society of Fire Protection Engineers (SFPE), *SFPE Engineering Guide to Human Behavior in Fire*, Bethesda, 2003.

Society of Fire Protection Engineers (SFPE), *SFPE Engineering Guide to Performance-Based Fire Protection*, 2<sup>nd</sup> edition, Bethesda, 2007.

SS-EN 12845:2004, *Fixed firefighting systems - Automatic sprinkler systems - Design, installation and maintenance*. Stockholm: Swedish Standards Institute, 2004.

Sugawa, O., Kawagoe, K., Ozaki, K., Sato, H. and Hasegawa, K., *Full-scale test of smoke, leakage from doors of a high-rise apartment*, KICT Report No. 58. Kajima Institute of Construction Technology, Tokyo, 1985, Japan.

Svenson, O., *The accident evolution and barrier function (AEB) model applied to incident analysis in the processing industries*, Risk Analysis, 11(3), pp. 499-507, 1991.

U.S. Nuclear Regulatory Commission, *Regulations: Title 10, Code of Federal Regulations, Part 50--Domestic Licensing Of Production And Utilization Facilities, Appendix A - General Design Criteria for Nuclear Power Plants*, 2010.

Yung, D., *Principles of Fire Risk Assessments in Buildings*, John Wiley & Sons Ltd., 2008.

Vose, D. *Risk Analysis - A Quantitative Guide*, John Wiley and Sons, New York, 2000.

Watts, J. M., *Fire Risk Indexing*, Chapter 5-10, The SFPE Handbook of Fire Protection Engineering, 4<sup>th</sup> edition, National Fire Protection Association, Quincy, 2008.

Williams, C., Fraser-Mitchell, J., Campbell, S., Harrison, R., *Effectiveness of sprinklers in residential premises*, Section 1: Summary report, Project report number: 204505, Building Research Establishment (BRE) Ltd., 2005.

## **Appendix A Guidance on verifying design alternatives regarding control of fire growth**

This chapter contains guidance on verifying design alternatives regarding control of fire growth within a fire compartment. Details on this design situation are found in section 8.4. It is not possible to conduct a verification of a design alternative based solitary on this guidance. The engineer needs to be familiar with the complete content of this report, especially the fourth chapter on “Verifying design alternatives” and the fifth chapter on “Verification methods”.

### **A.1 Design objectives**

The overall objective is to limit the generation and spread of fire and smoke within the construction. This is effectuated by having fittings and furnishings constructed in such a way the risk of outbreak of fire is minimised. Surface materials shall not contribute to the development of a fire in an unacceptable extent. When a building is fitted with a fire sprinkler system, fires could be allowed to grow more rapidly as they will be controlled or extinguished at a later stage.

### **A.2 Performance criteria**

The design objectives in section A.1 could be met by assuring that sprinklers are not overwhelmed by rapid fire spread via highly flammable materials. Therefore, it is not recommended to use materials with worse combustion behaviour than Euroclass D.

### **A.3 Methods of verification**

A qualitative assessment is sufficient in smaller fire compartments as there is documented proof that fire sprinkler provide a safer environment in the case of fire, despite having combustible surface finishes.

A qualitative assessment could be sufficient for larger fire compartments as well. Especially if the recommendations given by Fire Code Reform Centre (1998a):

- Fire isolated exits should have stringent requirements on the linings, corresponding to Euroclass B or better.
- Public corridors should have linings in Euroclass C.
- Other areas in all buildings could have linings in Euroclass D.

A quantitative assessment is necessary if the proposed trial design incorporates a greater an extensive use of combustible linings that deviates from the recommendations by Fire Code Reform Centre (1998a). If the fire growth rates presented in section 7.1.1 are used, the engineer should increase the growth rate by a factor 1.67 for the robustness scenario. This increase neutralises the “discount” given by the presence of fire sprinklers.

## **A.4 Step-by-step procedure**

This section describes a step-by-step procedure to verify design alternatives regarding control of fire growth within the room of fire origin. The procedure is schematic and the engineer needs to gather detailed information from other chapters in this report as well as from external sources,

1. Describe the design alternative in terms of type of material and placement.
2. Compare, in qualitative terms, the proposed design alternative with the prescriptive requirements in the building code.
3. Do a rough assessment on how the chosen material will affect the fire development at an initial state of the fire.
  - a. Are combustible materials used in the vicinity of escape routes?
  - b. Are combustible materials used in ceilings or on walls where the upper smoke layer could cause fire spread?
  - c. Remember that measure to control the fire growth primarily are to protect occupants by enabling sufficient time for escape as well as being able to use portable fire extinguishers.
4. Select the appropriate verification method.
  - a. A qualitative analysis provides the necessary level of verification, if the recommendations given in section A.3 are followed.
  - b. A quantitative analysis may be required if there are deviations from the recommendations given in section A.3.
5. A qualitative analysis requires no additional assessments and the engineer should document the verification by following the procedures described in section 4.1.2 and section 5.1.
6. A quantitative analysis needs further assessment to ensure that proposed design solution offers a sufficient level of safety. Such assessments involves the steps outlined below and the procedure is similar to the analysis required if there are design alternatives regarding control of smoke spread, described in Appendix B. Note that the verification focuses on ensuring that safe escape can be effectuated in the event of fire.
  - a. Select appropriate fire scenarios that recognises the added of accelerating fire development caused by the use of combustible materials.
    - i. The robustness scenario, described in section 7.1.1, could still be used, but the “average” fire development in the building is altered by the use of combustible materials.
    - ii. The fire scenario is defined by a fire growth rate, smoke yield and a maximum heat release rate.
  - b. Assess the available time for escape (ASET) by the use of an appropriate model on fire and smoke transport.

- c. Assess the required safe egress time (RSET) by an appropriate model that takes into account detection times, human response and travel times to safe exists. Remember that the use of combustible materials may influence the availability of exit routes.
- d. Compare ASET with RSET. Sufficient safety to escape from fires is provided if ASET is larger than RSET.
- e. Repeat step a) to e) above if it is necessary to study additional fire scenarios. This could be a fact if the designer is unable to select which fire scenario that puts most stress on the safety features of the building, or if different combustible materials are used.
- f. Perform a sensitivity analysis to investigate if the trial design is involved with significant uncertainties.
  - i. If both design values as well as the description of scenarios are conservative, the need of a quantitative sensitivity analysis is probably less compared to the use of more average values. It is the level of conservatism that decides the extent of the sensitivity analysis.
  - ii. Safety factors are not necessary in a conservative design approach with a well described robustness scenario.

7. Document the verification and perform design review.

## **A.5 Special Notes**

Generally, combustible surface finishes should be avoided in ceilings in most buildings. If the trial design considers the use of unprotected combustible surface finishes in ceilings, it is necessary to thoroughly analyse how the performance of the sprinkler system is affected. There is a risk of activating more sprinkler heads, exceeding the design parameters of the system.





## **Appendix B Guidance on verifying design alternatives regarding control of smoke spread within the compartment of fire origin**

This chapter contains guidance on verifying design alternatives regarding control of smoke spread within the compartment of fire origin. Details on this design situation are found in section 8.5. It is not possible to conduct a verification of a design alternative based solitary on this guidance. The engineer needs to be familiar with the complete content of this report, especially the fourth chapter on “Verifying design alternatives” and the fifth chapter on “Verification methods”. Useful information is also given in section 7.1.1 on “proposed design fires in sprinklered buildings” and in 7.2.3 on “proposed design criteria for tenability”.

### **B.1 Design objectives**

The overall objective is to limit the generation and spread of smoke within the construction in order for people to be able to escape or be rescued by other means. There is a strong relationship between the allowable quantities of smoke and the means of egress from the compartment of fire origin. If the means of egress has large capacity, the fire could be allowed to produce for smoke, and vice versa. When a building is fitted with a fire sprinkler system, the means of egress could probably be reduced, as the sprinkler system will extend the available safe egress time.

### **B.2 Performance criteria**

#### **B.2.1 Smaller fire compartments**

Occupants who are not able to escape without assistance should not be exposed to a toxicity level higher than  $FED = 0.3$ , when the “robustness scenario” in section 7.1.1 is analysed. Occupants who are able to escape unassisted are considered to have sufficient safety in sprinklered buildings, if the travel distances to escape routes do not exceeds one third of the maximum distance proposed by the prescriptive solution. E.g. if the prescriptive requirement is a maximum travel distance of 30 m, a sprinklered building is considered safe if the maximum travel distance is less than  $30 + 30 \times 1/3 = 40$  m.

#### **B.2.2 Larger fire compartments**

The available safe egress time (ASET) must be longer than the required safe egress time (RSET), when evaluating occupant safety in larger fire compartments. The available safe egress time is dependant on the fire development, the configuration of the building and the selected fire safety features. The visibility is not allowed to be less than 5 m (optical density of 0.2 OD/m).

## **B.3 Methods of verification**

### **B.3.1 Smaller fire compartments**

A qualitative assessment is sufficient in smaller fire compartments where occupants are able to escape without assistance. Naturally, basic means of egress must be in place such as those required by the prescriptive design solution. The design alternative of interest in these buildings is extended travel distance to escape routes, causing longer egress times. However, extending the travel distance to more than one third of the maximum allowable distance<sup>16</sup> according to prescriptive design, calls for a need of a quantitative assessment (see below).

A quantitative assessment on the possibility of successful (assisted) escape is required where occupants cannot escape by themselves, or when a large deviation from prescriptive design is proposed (see above). The designer starts by quantifying the outcome of the design fire given in section 7.1.1. The time to reach the performance requirement stated in section B.2.1 is denoted and compared to the required egress time. Appendix E.1.5 give additional information on the assessment of FED-values. The egress time should be quantified using appropriate models and data as those published by SFPE (2003).

If the design fails to provide sufficient safety for the design fire, the engineer needs to review the trial design and either shorten the egress time or extending the time to reach untenable conditions.

### **B.3.2 Larger fire compartments**

Larger fire compartments require a quantitative analysis to verify that the trial design offers sufficient safety in terms of control of smoke spread. As for smaller fire compartments, the design equation is about balancing the available safe egress time with the required safety egress time. The quantitative analysis should be carried out as described in section B.3.1 with performance requirements according to section B.2.2.

## **B.4 Step-by-step procedure**

This section describes a step-by step procedure to verify design alternatives regarding control of smoke spread within the room of fire origin. The procedure is valid for trial design that e.g. uses extended travel distances to escape routes. The procedure is schematic and the engineer needs to gather detailed information from other chapters in this report as well as from external sources.

1. Describe the trial design with emphasis on measures that influence the spread of smoke within the fire compartments and the available means of escape. Use the list provided in section 3.1 as inspiration.
2. Compare, in qualitative terms, the proposed design alternative with the prescriptive requirements in the building code:

---

<sup>16</sup> There is no need to verify fire safety if the deviation in a sprinkler building on the maximum travel distance is increased by less than a third in relation to the prescriptive requirement, i.e. 40 m in a building where 30 m is allowed in a non-sprinklered building and 60 m in a building where 45 m is allowed.

3. Select the appropriate verification method.
  - a. A qualitative assessment is sufficient if the deviation from the prescriptive requirement is less than the commonly used extension of one third of the prescriptive requirement, i.e. no more than 45 m for most buildings.
  - b. A quantitative assessment is required if:
    - i. The extension of travel distance is larger than one third of the prescriptive requirement.
    - ii. Escape cannot be effectuated without assistance.
4. A qualitative analysis requires no additional assessments and the engineer should document the verification by following the procedures described in section 4.1.2 and section 5.1.
5. A quantitative analysis needs further assessment to ensure that proposed design solution offers a sufficient level of safety. Such assessments involves the steps outlined below and the procedure is similar to the analysis required if there are design alternatives regarding control of fire growth, described in Appendix A. Note that the verification focuses on ensuring that safe escape can be effectuated in the event of fire.
  - a. Select appropriate fire scenarios:
    - i. The robustness scenario, described in section 7.1.1, could be used in a deterministic analysis.
    - ii. The fire scenario is defined by a fire growth rate, smoke yield and a maximum heat release rate.
  - a. Assess the available time for escape (ASET) by the use of an appropriate model on fire and smoke transport.
  - b. Assess the required safe egress time (RSET) by an appropriate model that takes into account detection times, human response and travel times to safe exists.
    - i. Design criteria for assisted escape are given in section B.2.1.
    - ii. Design criteria for escape when the deviation from the prescriptive requirements calls for a quantitative analysis are given in section B.2.2.
  - c. Compare ASET with RSET. Sufficient safety to escape from fires is provided if ASET is larger than RSET.
  - d. Repeat step a) to e) above if it is necessary to study additional fire scenarios. This could be a fact if the designer is unable to select which fire scenario that puts most stress on the safety features of the building.

- e. Perform a sensitivity analysis to investigate if the trial design is involved with significant uncertainties.
  - i. If both design values as well as the description of scenarios are conservative, the need of a quantitative sensitivity analysis is probably less compared to the use of more average values. It is the level of conservatism that decides the extent of the sensitivity analysis.
  - ii. Safety factors are not necessary in a conservative design approach with a well described robustness scenario.
6. Document the verification and perform design review.

## **B.5 Special Notes**

A fire in a sprinklered building does result in reduced visibility due to the turbulence caused by the application of water on the fire as well as the production of steam when the fire is extinguished or controlled. Therefore, it is unavoidable that occupants need to move through smoke. Movement through smoke has two major issues.

- The first is whether people will actually move (or continue to move) through smoke, or whether they will turn back and choose an alternative action leading away from the smoke.
- The second issue is the speed of movement. As visibility decreases, people will move more slowly.

Section 7.2 provides additional details on these issues.

## **Appendix C Guidance on verifying design alternatives regarding limit of fire and smoke spread within building and preventing structural collapse**

This chapter contains guidance on verifying design alternatives regarding limit of fire and smoke spread as well as preventing structural collapse. Details on these design situations are found in section 8.6. It is not possible to conduct a verification of a design alternative based solitary on this guidance. The engineer needs to be familiar with the complete content of this report, especially the fourth chapter on “Verifying design alternatives” and the fifth chapter on “Verification methods”.

### **C.1 Design objectives**

The overall objective is either to limit the spread of fire and smoke within the construction, or to assure that the load-bearing capacity is guaranteed for a specific period of time. This is normally taken care of by dividing the building into fire compartments with a specific fire resistance, or by protecting structural members from thermal load. When a building is fitted with a fire sprinkler system, most fires are extinguished or controlled at an early stage. Flashover is thus prevented and separating structures as well as structural members will fulfil their respective tasks.

### **C.2 Performance criteria**

The probability of failure, i.e. the likelihood of smoke spread, fire spread and collapse must be lower or the same as in a suitable reference building. It is also possible to use the expected time to failure as a risk measure.

### **C.3 Methods of verification**

Reductions in fire ratings could only be verified by the use of a quantitative assessment with probabilistic analysis. The engineer needs to use a suitable risk analysis technique, such as fault tree analysis or event tree analysis to prove that the probability of failure is less as a result of the proposed design, when comparing with a suitable reference building. The reference building should be designed according to the prescriptive requirements. Verification must be done by using comparative criteria, as no absolute criteria on the likelihood of fire spread or structural collapse are available.

### **C.4 Step-by-step procedure**

This section describes a step-by step procedure to verify design alternatives regarding limit smoke and fire spread between fire compartments as well as reductions design alternatives on measures regarding prevention of structural collapse. The procedure below focuses on structural collapse, but its principle can be used for other design alternatives as well. The

procedure is schematic and the engineer needs to gather detailed information from other chapters in this report as well as from external sources.

1. Describe the trial design with emphasis on measures that in place to prevent fire and smoke spread, or structural collapse. Use the list provided in section 3.1 as inspiration.
2. Compare, in qualitative terms, the proposed design alternative with the prescriptive requirements in the building code.
  - a. Where are lower fire ratings of interested?
  - b. Are there other safety systems, sprinklers excluded, to prevent unwanted action?
3. Verification can only be done by using probabilistic models with the use of risk analysis techniques as fault trees and event trees, which ever are most suitable.
4. A probabilistic analysis can be formed by establishing a design equation and calculate the probability that the design criterion is exceeded. Design equations could be based on:
  - a. Critical temperature
    - i. This is the simplest form of analysis as no direct response of the structure to the thermal load is calculated.
    - ii. E.g., if the temperature criterion, e.g. 450° C for a unprotected steel construction for a load factor of 66 % or less isn't exceeded, the design is considered to be safe.
  - b. Comparing actual load with structural resistance.
    - i. This is a more complex analysis as it requires a quantification of the response of the structure to the thermal stress.
    - ii. Collapse is a fact if the stress (load) exceeds the resistance (capacity).
  - c. Time equivalence<sup>17</sup>
    - i. This concept allows for a comparison of the safety in a building with the safety achieved by the use of products with certain fire ratings (derived from standardised testing).
    - ii. The time equivalence concept has several limitations, which are discussed in section 8.6.3.
5. The procedure of the probabilistic quantitative analysis is outlined below.
  - a. Assess the probability that sprinklers operate effective in the actual building. Data from section 6.5.2 can be used.
  - b. Assess the probability that the design criterion is exceeded in the event of fire and sprinkler unavailability.
    - i. Any design criterion described in step 4) above could be applied.

---

<sup>17</sup> Note that the time equivalence concept is not amended in the Swedish adaption of Eurocode EN 1991-1-2.

- ii. Chosen fire ratings are directly linked to the probability of exceeding design criteria.
  - c. Assess the probability that the design criterion is exceeded in the event of fire in an unsprinklered reference building with fire ratings according to prescriptive requirements.
  - d. Calculate the conditional probability that the design criteria is exceeded and that the sprinkler system is unavailable.
  - e. Compare the probability of collapse for the reference building and the actual building. These probabilities are assessed in step c) and d) above.
  - f. Perform a sensitivity analysis to investigate if the trial design is involved with significant uncertainties. If design values are conservative, the need of a quantitative sensitivity analysis is probably less compared to the use of more average values. It is the level of conservatism that decides the extent of the sensitivity analysis.
6. Document the verification and perform design review.

## **C.5 Special Notes**

It could be necessary to have a minimum fire resistance time, despite that the probability of failure is satisfactory in the comparative analysis, even though the structures are design without specific fire resistance.

The robustness of such design is related to the so-called single failure criterion commonly used in nuclear engineering (NRC, 2010). A single failure means an occurrence which results in the loss of capability of a barrier to perform its intended safety functions. The consequences of single barrier failures must be addressed in the analysis. Such analysis is often performed as a comparative analysis between the proposed design and the prescriptive requirements. Naturally, barriers with equal function and reliability could be left out of the analysis.





## **Appendix D Guidance on verifying design alternatives regarding preventing fire spread between buildings**

This chapter contains guidance on verifying design alternatives regarding preventing fire spread between buildings. Details on these design situations are found in section 8.7. It is not possible to conduct a verification of a design alternative based solitary on this guidance. The engineer needs to be familiar with the complete content of this report, especially the fourth chapter on “Verifying design alternatives” and the fifth chapter on “Verification methods”.

### **D.1 Design objectives**

The overall objective is to prevent fire spread to other buildings. This is normally taken care of by using fire walls, limit window sizes or having sufficient separation distances. When a building is fitted with a fire sprinkler system, most fires are extinguished or controlled at an early stage. Flashover is thus prevented and the risk for fire spread to adjacent buildings is reduced significantly.

### **D.2 Performance criteria**

#### **D.2.1 Deterministic analysis**

Received radiation shall not be greater than 15 kW/m<sup>2</sup> at the nearby building.

#### **D.2.2 Probabilistic analysis**

The probability of fire spread should be lower or the same as in a suitable reference building.

### **D.3 Methods of verification**

#### **D.3.1 Deterministic analysis**

A deterministic analysis is suitable in a design situation where the actual building is protected by sprinklers, but there are no sprinkler systems in nearby property. The radiation from openings could be reduced by 50 % if a building has a sprinkler system. Verification is then performed by calculating received radiation at the nearby building and comparing the value with the design criterion in section D.2.1.

Note that this simplified concept has limited applicability. E.g. it cannot be used when the façade material is combustible, as a fully developed fire most likely will spread to the outer wall resulting in higher inbound radiation to the nearby property.

### D.3.2 Probabilistic analysis

A probabilistic analysis with a quantification of probability of fire spread is suitable when the actual building as well as other nearby buildings is equipped with sprinklers. For systems designed according to e.g. EN 12845, verification is simple as these systems are considered to provide a sufficient level of safety in if the water source is redundant. Buildings with residential sprinklers require special attention and an assessment on the possibility of common cause failures.

### D.4 Step-by-step procedure

This section describes a step-by step procedure to verify design alternatives regarding the spread of fire between buildings. The procedure is schematic and the engineer needs to gather detailed information from other chapters in this report as well as from external sources.

#### *Initial steps*

- I. Describe the trial design with emphasis on measures that in place to prevent fire spread to other buildings.
  - a. Is there a fire wall? Does the wall have any openings?
  - b. Which window size is used?
  - c. How long is the separation distance to nearby buildings?
  - d. Are nearby buildings equipped with sprinklers?
- II. Compare, in qualitative terms, the proposed design alternative with the prescriptive requirements in the building code.

#### *Deterministic analysis<sup>18</sup>*

1. Define parameters and variables necessary to assess received radiation at nearby building.
  - a. It is assumed that the fire is fully developed, .i.e. it involves the entire fire compartment.
  - b. Only constructions with verified fire rating will limit radiation towards nearby buildings.
  - c. Windows are assumed to be open and doors could be assumed to be closed.
2. Decide the appropriate radiation from openings, i.e.  $42 \text{ kW/m}^2$  for enclosure with characteristics as residential, office, assembly and recreation and  $84 \text{ kW/m}^2$  for shops, commercial, industrial, storage and other non-residential premises.
3. Calculate configuration factor based on window sizes and separation distance.
4. Assess received radiation based on configuration factor and radiation from openings.

---

<sup>18</sup> The description is mainly based on a method provided by BSI (2001).

5. Compare received radiation with the design criterion. If the design criterion is met, continue to step 6), otherwise change trial design and repeat the procedure.
6. Perform a sensitivity analysis to investigate if a fire in any other fire compartment would result in more severe conditions.
7. Document the verification and perform design review.

*Probabilistic analysis*

1. Describe the type of sprinkler system used in both buildings. Emphasis must be put on identifying common causes of failure that could result in both sprinkler systems being unavailable at the same time.
2. If it is concluded that the sprinkler systems are designed in accordance with NFPA 13 or EN 12845, with redundant water source, there is no need for additional verification. The safety level in most buildings is comparable with a 90 minute fire wall.
3. If common causes of failure on the water source are identified, additional analysis is required.
  - a. The risk of fire spread from a reference building to nearby buildings must be quantified.
  - b. A fault tree analysis could be necessary to perform in order to investigate the reliability of the water source.
  - c. The risk of sprinkler failure should be lower to the risk of fire spread in the reference scenario. If not, there is a need to adjust the trial design and repeat the procedure.
4. Document the verification and perform design review.



## Appendix E Human tenability and behaviour in smoke

### E.1 Human tenability limits

Fire-induced injuries and death are related to one of the following causes (Ondrus, 1990).

- Heat, which could result in direct burns and/or heat shock.
- Inhalation of carbon monoxide.
- Lack of oxygen.
- Inhalation of smoke and other species produced by combustion.
- Panic, shock or structural failure.

#### E.1.1 Heat

Heat causes burns, heat shocks and dehydration. If a human is exposed to heat, especially in combination with high humidity, there is a considerable risk of unconsciousness and death. The human body can be seriously affected by temperatures as low as 60° C, if the exposure time is long and the air is saturated (e.g. when water is applied to the fire). Temperatures around 140° C can only be tolerated for a few minutes time but result in severe burns (Purser, 2000).

#### E.1.2 Carbon monoxide

Carbon monoxide is produced in all fires, irrespective of what is on fire and which phase the fire has reached. Carbon monoxide combines with haemoglobin in the blood to form carboxyhaemoglobin (COHb). The formation of COHb reduces the body's ability to transport oxygen. Carbon monoxide is easily taken up by the tissues in the lungs. The proportion of COHb continues to increase as long as carbon monoxide is inhaled. It is the percentage COHb that determines the effect this narcotic gas will have on the body. In a pathological study by Anderson et al. (1981) it was found that lethal levels of COHb (> 50%) were found in 54% of all fire fatalities. Seven of ten had concentrations high enough to cause unconsciousness. Table E. 1 describes how different concentrations of COHb affect the body (Purser, 2008).

*Table E. 1 Human response to carbon monoxide.*

Concentration	Response
15-20% COHb	Confusion
30-40% COHb	Unconsciousness
50-70% COHb	Death

Carbon monoxide is thus of particular interest as it is always present in fires and it reduces the ability of the occupants to escape ability as it causes confusion and unconsciousness, and it is the prime cause of fire deaths.

### E.1.3 Oxygen deficiency

As the fire develops the concentration of oxygen decreases. When the oxygen concentration becomes sufficiently low, a person will become unconscious. The time until unconsciousness develops is a function of the occupant's activity and the oxygen concentration in the room. Table E. 2, which is taken from Ondrus (1990), gives information on the effect of reduced oxygen concentration.

Table E. 2 Response to reduced oxygen concentration in the air.

Oxygen content	Physiological effect
21%	None
17%	Increased breathing, reduced muscle strength
14%	Minimum level for successful escape
12%	Dizziness, headache, fatigue
9%	Unconsciousness
6%	Death within 6-8 min

### E.1.4 Toxic products

Smoke is a mixture of combustion products, aerosols and soot. Table E. 3 shows the toxic effect of some fire gases other than carbon monoxide. In most fires, these gases will not be the direct cause of death, hydrogen cyanide excepted. Nevertheless, these contribute to decreasing the time to untenable conditions are reached. For example, carbon dioxide increases the breathing rate, speeding up the accumulation of other toxic gases. At CO<sub>2</sub> concentrations below 3 %, there will be no significant increase in breathing rate. At 3 %, the breathing rate is doubled and at 5 %, it is increased by three times. These levels of carbon dioxide will shorten the time before an occupant becomes unconscious by 50 and 67 %, respectively.

Table E. 3 Effect of combustion gases.

Gas	Effect
<i>Carbon dioxide (CO<sub>2</sub>)</i> Produced in all fires	Toxic at high concentrations. Stimulates increased breathing rate
<i>Hydrogen cyanide (HCN)</i> Produced in incomplete combustion of wool, nylon and polyurethane	The victim is suffocated to death. Toxic concentrations are commonly found in fire victims.
<i>Nitrogen dioxide (NO<sub>2</sub>)</i> Produced in fires involving clothing and cellulose products	Very irritating to the lungs. Can cause immediate death.

### E.1.5 Fractional Effective Dose

Purser (2008) published a set of equations that can be used to assess how toxic gases affect the human body. The concept is based on calculating a Fractional Effective Dose (FED). The values of FED range from zero and up where a value of one (1) indicates loss of consciousness. The value of FED increases continuously and does not decline, even if the occupant is, for example, exposed to fresh air. Some situations do require an evaluation of e.g. time to incapacitation or even death. In such cases it is possible to use FED-values from Table E. 4 below together with Equation [E.1] to Equation [E.3].

Table E. 4 Interpretation of different FED values (Mowrer et al., (2002).

FED	Effect	COHb	Comment
0.01	Insignificant	0.3 %	
0.1	Sub-incapacitating	3 %	
0.3	Incapacitating, people unable to escape by themselves	9 %	10 % unconscious
1.0	Sub-lethal, unconsciousness	30 %	50 % unconscious
2.0	Lethal	60 %	

Carbon monoxide is the most important narcotic gas, but the presence of carbon dioxide will increase the respiratory minute volume considerably. FED equations are given below:

$$\%COHb = 3.317 \cdot 10^{-5} (ppmCO)^{1.036} (RMV)t \quad \text{Equation [E.1]}$$

$$F_{E_{CO}} = \frac{\%COHb}{D} \quad \text{Equation [E.2]}$$

$$RMV = \exp(0.2496 \cdot \%CO_2 + 1.9086) \quad \text{Equation [E.3]}$$

Where:

$\%COHb$  = the concentration of carboxyhaemoglobin in the blood, %.

$ppmCO$  = the concentration of carbon monoxide in the room, ppm.

$t$  = the time of exposure, min

$RMV$  = the respiratory minute volume, l/min.

$F_{E_{CO}}$  = the accumulated effect of carbon monoxide. When  $F_{E_{CO}} = 1$  the occupant will be unconscious or dead.

$D$  = the concentration of  $\%COHb$  required to cause a certain effect (see Table E. 4).

$\%CO_2$  = the concentration of carbon dioxide in the room, %.



## E.2 Human behaviour in smoke

Japanese researchers (Sugawa et al., 1985, Jin, 1978, Jin, 1981 and Jin et al., 1990) have conducted research on escape in smoke-filled environments. Walking speed decreased with increased smoke density. Walking speed decreased from approximately 1.2 m/s in the clear corridor to 0.3 m/s (and feeling their way along the walls) for a non-irritant smoke of an optical density of 0.55 /m and for an irritant smoke of an optical density of approximately 0.2 /m. Their conclusions were that the upper level of smoke concentration that began to seriously worry the residents was about 0.1-0.15 /m. Full-scale building tests quoted by Purser (2008) showed that 30 % of people would rather turn back than continue to search for an exit at an optical smoke density of 0.33 /m, see Figure E. 1 below.

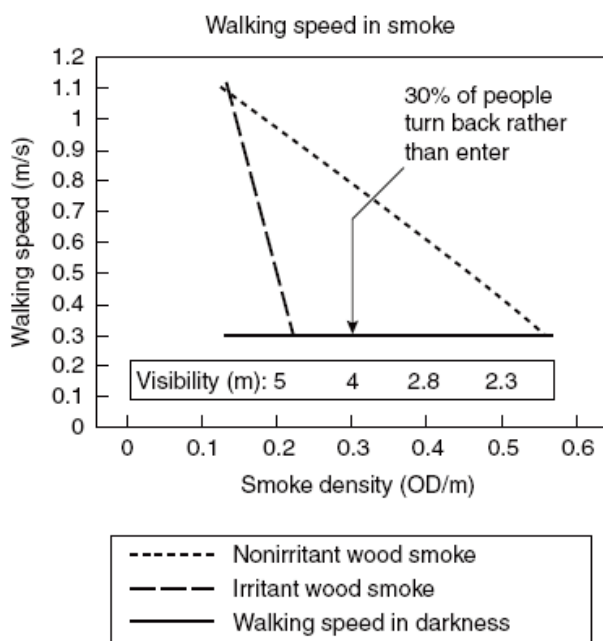

Figure E. 1 Walking speeds in non-irritant and irritant smoke (Adapted from Purser (2008))

Purser (2008) also summarises reported effects of smoke on visibility and behaviour as shown in Table E. 5.

Table E. 5 Reported effects of smoke on visibility and behaviour (Adapted from Purser (2008)).

Smoke Density and Irritancy OD/m	Approximate visibility (diffuse illumination)	Reported effects
None	Unaffected	Walking speed 1.2 m/s
0.5	2 m	Walking speed 0.3 m/s
0.2	Reduced	Walking speed 0.3 m/s
0.33	3 m approx.	30 % would turn back rather than enter

Purser (2008) suggests that small spaces with short travel distances to exits may have less stringent tenability criteria if occupants are familiar with the building. For large spaces it

may be necessary to set more stringent tenability limits, particularly if occupants are likely to be unfamiliar with the building and need to be able to see much further in order to orient themselves to find exits. The suggested tenability limits reported by Purser (2008) are an optical density of 0.2 OD/m (visibility 5 m) in small enclosures and short travel distances. In large enclosures and long travel distances an optical density of 0.08 OD/m (visibility 10 m) is proposed.



## Appendix F Details on performance-based design

### F.1 Legislative criteria for successful escape

All building regulations require that people should be able to leave the building without getting harmed in the event of fire. Successful escape is often defined with the ASET and RSET concept as shown below:

$$ASET > RSET \quad \text{Equation [F.1]}$$

Where:

*ASET* = Available Safe Egress Time (related to the fire development).

*RSET* = Required Safe Egress Time (related to escape arrangements).

The endpoint of an ASET design calculation is the time when the conditions in the building are considered untenable for escape. Building codes define untenable conditions in the low range of possible damage to humans with arbitrary (and unknown) safety margins to conditions that could cause incapacitation. This is shown in worked examples by Purser (2008) where the level of obscuration exceeds the tenability limit prior to other effects such as irritancy, burns and asphyxia. Table F. 1 gives an example of untenable conditions to be used when defining the ASET endpoint.

*Table F. 1 Untenable conditions when evaluating the safety of persons (NKB, 1994).*

Parameter	Criteria
Visibility	<p>Visibility no less than 3 m in the primary fire compartment.</p> <p>Visibility no less than 10 m in escape routes.</p>
Thermal	<p>Less than 1 kW/m<sup>2</sup> in continuous radiation intensity.</p> <p>A short-term (6 seconds) radiation intensity of maximum 10 kW/m<sup>2</sup>, radiation: a maximum radiant energy of 60 kJ/m<sup>2</sup> in addition to the energy from a radiation of 1 kW/m<sup>2</sup>.</p>
Temperature	Air temperature not higher than 60 °C

Low visibility is not an immediate threat to the people in the building. But, low visibility causes longer escape times and therefore more exposure to toxic fire effluents. NKB (1994) states that there is no need to evaluate to toxic effects if the requirements on visibility are met.

## F.2 Traditional design approach on suppression effects

A constant heat release rate after sprinkler actuation is a conservative estimate for many applications and the traditional approach on a sprinklered design fire uses this conservative approach (CIBSE, 2003). The design fire is estimated as the size the fire has grown to at the moment of sprinkler actuation. Figure F. 1 illustrates the concept.

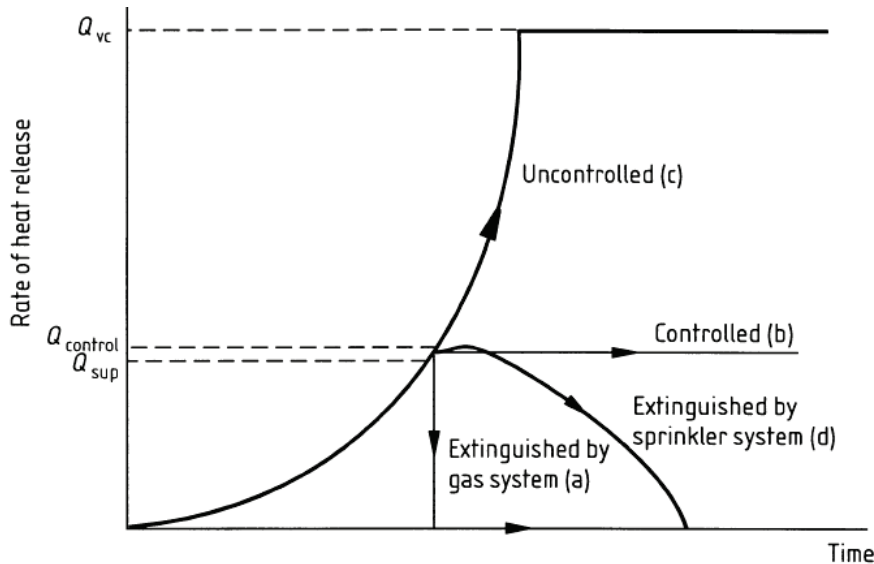

- $q_{vc}$  is the rate of heat release under ventilation-controlled conditions
- $q_{sup}$  is the rate of heat release at which suppression activates
- $q_{control}$  is the rate of heat release at which the fire can be controlled

Figure F. 1 Effect of suppression (adapted from BSI (2001)).

The time to sprinkler operation is crucial in determining the maximum size that a sprinklered fire will result. The activation time depends upon the fire growth rate, sprinkler location and sprinkler sensitivity. When the smoke plume rises from a fire it is mixed with air from the surroundings which causes it to cool. The longer the distance from the fire to the sprinkler, the lower will be the temperature that reaches the sprinklers. Cooler fire gases results in longer activation times.

Sprinkler sensitivity is dependant on the sprinkler head characteristics, mainly the Response Time Index (RTI) and the activation temperature. Sprinkler heads used for life safety purposes normally has a RTI-value of less than  $50 \text{ (ms)}^{1/2}$  and an activation temperature of less than  $68^\circ \text{ C}$ .