



LUND UNIVERSITY

Perturbation-based Control of Industrial Fed-batch Bioprocesses

Johnsson, Ola

2015

Document Version:

Publisher's PDF, also known as Version of record

[Link to publication](#)

Citation for published version (APA):

Johnsson, O. (2015). *Perturbation-based Control of Industrial Fed-batch Bioprocesses*. [Doctoral Thesis (compilation), Department of Automatic Control]. Department of Automatic Control, Lund Institute of Technology, Lund University.

Total number of authors:

1

General rights

Unless other specific re-use rights are stated the following general rights apply:

Copyright and moral rights for the publications made accessible in the public portal are retained by the authors and/or other copyright owners and it is a condition of accessing publications that users recognise and abide by the legal requirements associated with these rights.

- Users may download and print one copy of any publication from the public portal for the purpose of private study or research.
- You may not further distribute the material or use it for any profit-making activity or commercial gain
- You may freely distribute the URL identifying the publication in the public portal

Read more about Creative commons licenses: <https://creativecommons.org/licenses/>

Take down policy

If you believe that this document breaches copyright please contact us providing details, and we will remove access to the work immediately and investigate your claim.

LUND UNIVERSITY

PO Box 117
221 00 Lund
+46 46-222 00 00

Perturbation-based Control of Industrial Fed-batch Bioprocesses

Ola Johnsson



LUND
UNIVERSITY

Department of Automatic Control

PhD Thesis
ISRN LUTFD2/TFRT--1112--SE
ISBN 978-91-7623-596-6 (print)
ISBN 978-91-7623-597-3 (web)
ISSN 0280-5316

Department of Automatic Control
Lund University
Box 118
SE-221 00 LUND
Sweden

© 2015 by Ola Johnsson. All rights reserved.
Printed in Sweden by Holmbergs i Malmö AB.
Lund 2015

Abstract

The topic of this thesis is bioprocess control, more specifically control of industrial-scale microbial fed-batch bioprocesses. Its focus is therefore on methods which are easy to implement in an industrial setting, which gives certain limitations on sensors, actuators and control systems.

The main part of the work in the thesis concerns control of the microbial substrate uptake rate by manipulation of the feed rate of liquid substrate to the bioprocess. This is an important parameter for improving process yields, as too low feed rates cause starvation of the microorganisms while too high rates lead to production of undesirable by-products. By-product formation decreases metabolic efficiency and the by-products have inhibiting effects on microbial growth and production. At high concentrations these can even halt growth completely, leading to process failure.

Due to large batch-to-batch variations and the complexity of the processes, model-based control can be difficult to use in this type of system. The approach used in this thesis circumvents this problem by utilizing perturbations in the feed rate. It has previously been shown that the metabolic state with regard to substrate uptake rate can be determined by analysing the perturbation response in the dissolved oxygen level of a microbial process. In this thesis, the concept is developed through the use of perturbations at a predefined frequency. This provides a number of advantages and allows for estimation of the metabolic state through observing the perturbation frequency in the measured signal.

The concept has been tested experimentally in industrial pilot and production scale. It has been demonstrated that a controller based on this concept can be used to compensate for batch-to-batch variations in feed demand and can rapidly compensate for changes in the demand. It has also been shown that the method can be used for monitoring and control in bioprocesses with a volume over 100 m³, using a low-complexity estimation algorithm suited for industrial use.

The thesis also concerns mid-ranging control in non-stationary processes. A modified mid-ranging controller suited for such processes is proposed,

which allows control signals to increase in unison during the course of a fed-batch process while maintaining the advantages of classical mid-ranging control. The concept can for instance be used for control of dissolved oxygen, an important process parameter in many bioprocesses. It has been successfully used for this purpose in pilot scale alongside the type of perturbation-based feed rate controller which is the main topic of this thesis, also showing how the latter can be used in conjunction with other control systems.

Preface

As a graduate student in automatic control with a background in biotechnology, bioprocess control has naturally been a great interest to me. Bringing together the fields of automatic control, biotechnology and industrial process technology can be difficult, as these have to a great extent developed separately. It can however also be very rewarding as there are many interesting problems and opportunities for development in the intersection between these fields.

From the outset, my aim has been to work with methods which are relevant and useful in practice and can be implemented for the purposes for which they were intended. In doing so, the one thing which has always been important is simplicity and I believe there are few things which are more satisfying than finding simple solutions to complex problems.

Naturally, this thesis is written from an automatic control perspective. I have however sought to write it so that it can also be of interest for people from a biotechnology background seeking to use automatic control in a process biotechnology context.

Acknowledgements

First of all I would like to thank my main supervisor, Tore Hägglund, who has always been extremely encouraging of my work and trusted me enough to give me a great deal of freedom in how to perform my research. It has always been a pleasure to develop my thoughts and ideas through discussions with him.

My co-supervisors also deserve a great deal of thanks. Gunnar Lidén has helped me a lot through the discussions I have had with him, in which I have both learnt much and sometimes realized how little I know. Charlotta Johnsson has often provided valuable new perspectives on my work, she was also the one who opened my eyes to automatic control in the first place.

My industrial supervisor Jonas Andersson has done an amazing work supporting the research cooperation between Novozymes and Lund University needed for my project by initiating it, establishing it at the company and getting me into contact with people there who could help me or would be interested in my work. He has also given me many important comments on my work and communicated it from the perspective of someone who knows both Novozymes, bioprocess technology and my research. Without him, this work would not have been possible.

My colleagues at the Department of Automatic Control have been a great source of ideas, inspiration and amusement. I have been fortunate to share offices with Björn Olofsson, Jerker Nordh and Jonas Dürango, with whom I have had many interesting and enjoyable discussions on our research and other topics which I will miss. I am grateful both to Björn and to Anders Mannesson for proof-reading this thesis. The people in the process control group have made conferences and meetings both interesting and fun; a special thanks goes to Anna Lindholm, Martin Hast and Olof Garpinger for conferences and other occasions which I am sure we will all remember. I would also like to give a special thanks to everyone who has presented their licentiate theses during my time at the department, I am sure all those it concerns understand why.

Karl Johan Åström's interest in my work has been a great encouragement and his advice in the various research problems I have discussed with him is much appreciated. I am also grateful to the administrative staff, Eva Westin, Ingrid Nilsson, Mika Nishimura and Monika Rasmusson, who through their constant helpfulness have contributed greatly to making things run smoothly. Leif Andersson has kindly provided his typography skills in the making of this thesis.

My work has been conducted in cooperation with Novozymes, which has granted me many new perspectives and possibilities for my research. Beyond my supervisor Jonas, a large number of people there have made my research interesting and enjoyable and I would like to mention some of them specifically. Stuart Stocks has been a great source of support, knowledge and ideas throughout the whole project, aiding me in both big and small matters. He has always been happy to share his thoughts on my work, which I have always appreciated. Frederik Riisgaard has been invaluable both in helping me run my experiments in production scale and in making it possible to implement my methods there. Both he and Daniel Sahlin have been of much help and great to work with in the implementation process. Martin Eriksen has always been extremely reliable, skilful and helpful when I have done experiments in 20 liter scale, even helping me in the middle of the night when I have been running chemostats. And I am very grateful to my friend Anna Askbåge who helped me get into contact with Novozymes and has offered me many pleasant lunchtime discussions there over these years.

Friends and family have cheered me on throughout this work, I am grateful to you all. Finally and most importantly, I would like to thank Sara for always supporting me and Wilhelm for all the joy he has brought.

Financial support

Financial support for this project is gratefully acknowledged from the Process Industrial Centre at Lund University (PIC-LU) supported by the Swedish Foundation for Strategic Research (SSF), from Process Industrial IT and Automation (PiiA) supported by VINNOVA, from the Lund Center for Control of Complex Engineering Systems (LCCC) supported by the Swedish Research Council and from Novozymes A/S.

Contents

1. Introduction	11
1.1 Contents and contributions of the thesis	13
2. Bioprocesses for industrial production	17
2.1 Microbial metabolism in a process perspective	17
2.2 The industrial stirred-tank bioprocess	25
2.3 The fed-batch mode of operation	29
2.4 Bioreactor monitoring and control	30
3. Feed demand estimation using frequency content analysis	33
3.1 Basic principles of the method	33
3.2 A simplified process model for FCA	35
3.3 A simple FCA design	38
3.4 Implementation in pilot scale	40
3.5 Implementation in production scale	42
4. Mid-ranging control of dissolved oxygen in a bioprocess	45
4.1 The challenge in non-stationary processes	46
4.2 Handling non-stationarity	46
4.3 Dissolved oxygen control	46
4.4 Implementation in pilot scale	48
5. Conclusions	50
Bibliography	52
Paper I. Feed rate control in fed-batch fermentations based on frequency content analysis	57
1 Introduction	58
2 Theoretical aspects	60
3 Controller details	62
4 Materials and methods	64
5 Results and discussion	67
6 Conclusions	73
References	75

Paper II. Modelling of the oxygen level response to feed rate perturbations in an industrial scale fermentation process	79
1 Introduction	80
2 Materials and methods	82
3 Results and discussion	86
4 Conclusions	98
5 Nomenclature	99
References	100
Paper III. A mid-ranging control strategy for non-stationary processes and its application to dissolved oxygen control in a bioprocess	105
1 Introduction	106
2 Industrial bioprocesses	106
3 Control strategies	109
4 Materials and methods	110
5 Results and discussion	113
6 Conclusions	117
References	120
Paper IV. On-line detection of oxidative saturation using frequency response in industrial scale bioprocesses	123
1 Introduction	124
2 Theory	124
3 Materials and methods	126
4 Results and discussion	132
5 Conclusions	136
References	137
Paper V. Feed rate control in an industrial production-scale bioprocess using a low-complexity estimator of feed demand	141
1 Introduction	142
2 Theory	144
3 Materials and methods	146
4 Results and discussion	149
5 Conclusions	149
References	151

1

Introduction

Human utilization of microorganisms began before 6600 BCE [McGovern et al., 2004] although the microbes themselves were not observed until more than 8000 years later, by the Dutch scientist Antonie van Leeuwenhoek in the 17th century CE. In the era between these events, although their precise nature was unknown, their existence was suspected and both the ancient Romans [Hooper and Ash, 1934] and renaissance scholars [Nutton, 1990] rightfully accused them of causing diseases. Their fermentative abilities have however been appreciated since ancient times and a multitude of deities related to the fermentation process and its products are known to have been worshipped [Jordan, 2004].

Biotechnology emerged as a separate discipline in the early 20th century, when a scientific approach was applied to traditional fermentation fields such as brewing and cheese-making and a new view of microorganisms as biological machines developed. Early bioprocesses were used to produce food and animal feed as well as bulk chemicals and penicillin, which revolutionized modern medicine [Bud, 1989]. From the 1970s and onwards, genetic engineering has opened up new opportunities for biotechnology by allowing modifications of the genome of organisms to give these new properties [Cohen et al., 1973]. This has enabled modern industrial biotechnology with its vast and ever increasing possibilities and number of products.

The aim of the industrial production bioprocess is to reliably ensure the highest possible product output at lowest possible cost. In order to achieve this, the host microorganism must be provided with an environment which is as well suited as possible to its current purpose [Lidén, 2002]. Achieving this is unsurprisingly no easy task as biochemical reactions are highly complex, with a vast number of states whose interactions occur at many different levels. Only thanks to modern systems biology have scientists begun to understand this huge network of interactions which makes up life. The lack of detailed knowledge has however not deterred pioneers of biotechnology and procedures for how to run industrial bioprocesses have developed based on practical experience.

Automatic control is a powerful tool for enabling and improving processes of very diverse types. Feedback control can be highly useful in systems where many unknown factors may influence the output, such as industrial bioprocesses, as it allows compensation for measured errors regardless of their source. Better system models with fewer unknown factors will typically allow for better feedback control however. Naturally, good measurements or estimates of the variables to be controlled are required for appropriate control action and the availability of such signals can be a critical limitation on control performance.

The choice of feedback controller for a system depends not only on the desired output and the system's properties in themselves but also on many other factors such as expected disturbances, which measurements are available and how reliable these are. In a complex system such as a bioprocess, multiple control objectives of varying complexity and importance to the process need to be achieved.

The bioprocesses considered in this work are run in fed-batch mode. This means that both the biomass and the liquid volume in the process increase over time since a nutrient feed is added throughout the process. This is a common mode of operation in industry [Villadsen et al., 2011] but one which requires certain considerations, as the desired state of the system as well as its dynamics change over time [Lidén, 2002]. Control structures and objectives must therefore be designed with this in mind.

In this thesis, work pertaining to feed rate control in bioprocesses is presented. The work has been done in the perspective of large-scale industrial production bioprocesses, which provide some important challenges not only due to their size but also because of limitations in process modelling and sensing [Shimizu, 1993]. The availability of relevant historical data can also be limited, as new processes are developed to meet new demands and it is of importance to achieve high productivity from the start.

In such a setting it is desirable to, if possible, maintain a low complexity in controllers. This is motivated by a desire to keep the computational burden of the process control software low and to make it possible for persons without a background in automatic control to use and modify them. It is a common experience in industry that advanced control systems are used until they are suspected of causing a problem. At this point they are switched off because it is not known how to adjust them properly or find out if they are in fact the source of the problem. Other desirable controller traits are robustness to process variations and use of standard measurements which are commonly available in industrial processes.

The core concept in this thesis is the use of periodic perturbations in the process input. These give rise to responses in measurements, which allows for estimation of states which can not be measured directly. The simplicity of this concept and its low requirements on measurements and modelling

makes it attractive for industrial use. However, the effects of scale must be considered in the choice of perturbation.

A smaller section of this thesis concerns the use of mid-ranging control in non-stationary processes such as fed-batch bioprocesses. A modified mid-ranging control structure is proposed which allows actuator signals to increase in unison when compensating for the changing process state.

The research presented in this thesis has been performed in collaboration with Novozymes, a biotechnology company with its origins and headquarters in Denmark. The company was founded in 2000 when it was split off from the pharmaceutical company Novo Nordisk. Novozymes is currently the world's largest producer of industrial enzymes and is estimated to hold about half of the global enzyme market as per the company's annual report [Novozymes, 2015]. These products are formed by microorganisms in large-scale bioprocesses; many of them are produced in bioreactors with a volume greater than 100 m^3 , which have been the focus of much of the research presented in this thesis.

1.1 Contents and contributions of the thesis

This thesis consists of five chapters and five papers. This section describes the contents of the chapters, the contributions of each paper to the field and the contributions of each author to the papers.

Chapter 2

This chapter provides a short background to the type of process studied in this thesis. It describes the key biochemical mechanisms, the industrial production bioprocess as a whole as well as different approaches to bioprocess control.

Chapter 3

In this chapter it is shown how periodic perturbations in the feed rate can be used to estimate the current feed demand in a bioprocess, through measurement of the corresponding frequency in the dissolved oxygen signal. A low-complexity estimator design, based on a simplified process model, is given. Results from implementation of the concept for feed rate control in both pilot scale and production scale processes are shown.

Chapter 4

This chapter describes a method for mid-ranging control of dissolved oxygen in a fed-batch bioprocess, through use of agitator speed and aeration rate as actuators. As the process is non-stationary, it is not desirable to maintain a constant level of either control signal. A modification of the conventional

mid-ranging control strategy is therefore required to enable the actuators to act in unison.

Chapter 5

This chapter provides a short summary of the findings of this thesis. It also briefly discusses their application and possible future development of the methods which have been developed within the frame of the thesis.

Paper I

Johnsson, O., J. Andersson, G. Lidén, C. Johnsson and T. Hägglund (2013).

“Feed rate control in fed-batch fermentations based on frequency content analysis”. *Biotechnology Progress* **29**:3, pp. 817–824.

This paper presents a new method for controlling aerated fed-batch bioprocesses and shows its implementation in pilot scale. The method is based on the same basic principles as the previously known probing control strategy but expands the concept using a frequency response approach, enabling continuous on-line tracking of feed demand and not requiring rectangular feed rate pulses.

O. Johnsson came up with the idea for the method, wrote the software for its implementation, designed and performed the experiments for evaluating it and was the main author of the manuscript. J. Andersson, G. Lidén, C. Johnsson and T. Hägglund discussed the strategy and experimental results with O. Johnsson and assisted in writing the manuscript. J. Andersson also provided technical input regarding the processes in which the method was implemented.

Paper II

Johnsson, O., J. Andersson, G. Lidén, C. Johnsson and T. Hägglund (2015).

“Modelling of the oxygen level response to feed rate perturbations in an industrial scale fermentation process”. *Process Biochemistry* **50**:4, pp. 507–516.

In this paper, modelling of feed and oxygen dynamics based on frequency response experiments in an industrial production-scale bioprocess is described. Experimental results show the feasibility of perturbation-based control strategies in the process and that for certain perturbation frequencies and amplitudes, a simple model can be used to describe the response dynamics.

O. Johnsson came up with the idea for the study, designed and performed the experiments, performed the analysis of resulting data and modelling of the process and was the main author of the manuscript. J. Andersson,

G. Lidén, C. Johnsson and T. Häggglund discussed the experiment design, results and modelling with O. Johnsson and assisted in writing the manuscript.

Paper III

Johnsson, O., D. Sahlin, J. Linde, G. Lidén and T. Häggglund (2015). “A mid-ranging control strategy for non-stationary processes and its application to dissolved oxygen control in a bioprocess”. *Control Engineering Practice* **42**, pp. 89–94.

This paper describes a modification to the conventional mid-ranging control structure which retains its low complexity while making it suitable for use in non-stationary processes. This can be used for instance in control of dissolved oxygen in a bioreactor by simultaneous manipulation of agitator speed and aeration rate, which can save energy as well as provide a baseline for dissolved oxygen when used in conjunction with perturbation-based feed rate control. A successful pilot-scale implementation of such a controller is also shown.

O. Johnsson came up with the idea for the controller design, supervised its implementation and was the main author of the manuscript. D. Sahlin and J. Linde implemented the controller and performed all experiments. G. Lidén and T. Häggglund discussed the concept with O. Johnsson and assisted in writing the manuscript.

Paper IV

Johnsson, O., K. Hvalkof Andersen, J. Andersson, G. Lidén and T. Häggglund (2015). “On-line detection of oxidative saturation using frequency response in industrial scale bioprocesses”. Submitted to *Process Biochemistry*.

The work described in this paper focuses on the adaptation of a probing strategy based on frequency response to process monitoring in industrial-scale bioprocesses. It is shown in experiments that the frequency response of such a process can be used to determine the current metabolic state of the process and hence to track the feed demand, using a simple algorithm suited for implementation in industrial process control systems.

O. Johnsson planned the study, developed the estimation algorithm to make it suitable for use in this context, performed experiments, analysed the resulting data and was the main author of the manuscript. K.H. Andersen suggested the type of algorithm to use and made its original design. J. Andersson, G. Lidén and T. Häggglund discussed the experiment design and results with O. Johnsson and assisted in writing the manuscript.

Paper V

Johnsson, O., F. K. Riisgaard, D. Sahlin, G. Lidén and T. Hägglund. “Feed rate control in an industrial production-scale bioprocess using a simple estimator of feed demand”. Manuscript.

In this paper, the implementation of closed-loop feed rate control using a probing strategy based on frequency response in an industrial production-scale bioprocess is described. It is shown experimentally that this frequency response method can achieve sufficiently fast and accurate estimates of the feed demand in this scale, that it can be used along with a regular PI controller for feedback control of the feed rate during the exponential growth period.

O. Johnsson oversaw the development and implementation of the controller and estimator, set their parameters, performed experiments and was the main author of the manuscript. F. Riisgaard and D. Sahlin tested the implementation to ensure its correct operation, aided in developing it and assisted in performing experiments. G. Lidén and T. Hägglund discussed the principles behind the method with O. Johnsson and assisted in writing the manuscript.

Additional publications

Another related publication by O. Johnsson, not included in this thesis, is listed below.

Johnsson, O., J. Andersson and C. Johnsson (2011). “Probing control in *B. licheniformis* fermentations”. In: *Proceedings of the 18th IFAC World Congress*, pp. 7132–7137.

2

Bioprocesses for industrial production

The bioprocess shows a high level of complexity with many different levels, all of which interact with each other. At the lowest level is the microorganism and its internal workings as well as its interactions with its surroundings, this level relates to the fields of biochemistry and genetics. A number of transport processes occur in the medium, the environment of the microorganisms, and these interactions between forces and molecules are related to fluid dynamics and transport phenomena. At the next level are the physical components of the bioreactor itself, whose mechanical properties will influence and set limits for the process. In an industrial setting the operation of a bioprocess is also constrained by issues such as scheduling and, ultimately, economy.

2.1 Microbial metabolism in a process perspective

Using microorganisms for production allows for a number of desirable process features. Not only can microorganisms produce a variety of products, which are often not possible to synthesize in purely synthetic chemical processes, but they also act under mild temperature and pressure conditions. This leads to low energy requirements and puts lower demands on the process equipment. Compared to many chemical processes, the usage of toxic and environmentally harmful compounds is also normally low.

It is possible to re-design and improve microbial production processes using genetic engineering. This is typically done by inserting one or more genes encoding a desired protein into a production host organism with suitable properties, such as high growth and production rates.

A large array of host organisms are used today in industrial bioprocesses, some more common than others. They all belong to one of the following groups: bacteria, yeasts, fungi, insect cells and mammal cells. The organisms in these groups have different properties making them suitable for different

Table 2.1 The different types of cells used as industrial production hosts, outlining some of their relevant properties [Demain and Vaishnav, 2009] and providing examples of strains. Post-translational modifications are changes to proteins which occur after their amino acid sequence has been formed.

Organism type	Properties	Common examples
Bacteria	High growth rates	<i>Escherichia coli</i>
	DNA easily modified	<i>Bacillus subtilis</i>
	No post-translational modification of proteins	<i>Bacillus licheniformis</i>
Yeasts	High growth rates	<i>Saccharomyces cerevisiae</i>
	Some post-translational modification of proteins	<i>Pichia pastoris</i>
Filamentous fungi	Good protein secretion	<i>Aspergillus niger</i>
	Some post-translational modification of proteins	<i>Trichoderma reesei</i>
Insect cells	Post-translational modification of proteins	<i>Spodoptera frugiperda</i>
	Less characterized than other hosts	
Mammalian cells	Post-translational modification of proteins Expensive to grow	Chinese Hamster Ovary (CHO) cells

purposes as outlined in table 2.1. Bacteria are prokaryotes while the other groups are eukaryotes; the principle difference between these is that the latter have organelles, internal subcompartments such as a cell nucleus and mitochondria. Generally, simpler organisms are better for achieving high yields at low costs but are limited in what types of products they can make.

Many microorganisms have very short generation times, for some types commonly used in industrial processes these are in the range between 30 and 120 minutes under suitable conditions [Prescott et al., 2005] but generation times as low as 10 minutes have been reported for the *Pseudomonas natrie-*

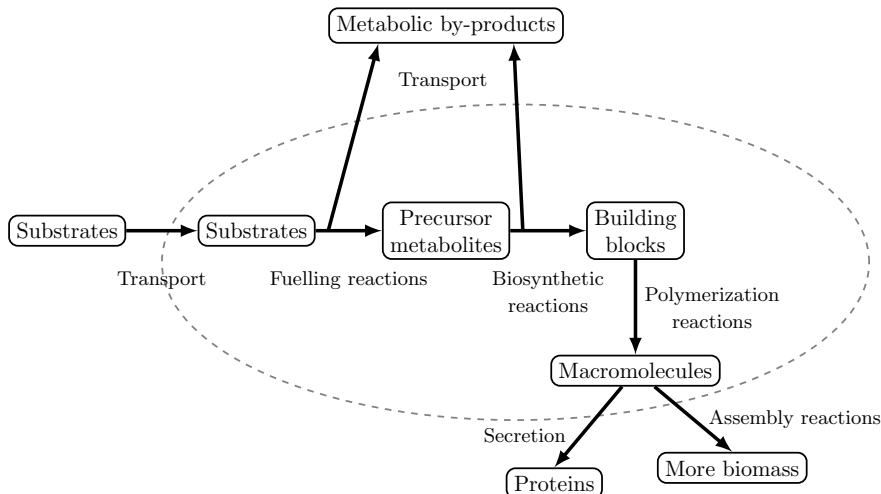

Figure 2.1 The major steps in cellular metabolism, adapted from [Villadsen et al., 2011, p. 22]. The dashed line indicates the cell border. Substrate uptake and fuelling reactions are catabolic, while biosynthetic and polymerization reactions are anabolic. Metabolic by-products can in some cases be re-consumed as substrates.

gens species [Eagon, 1962]. Under optimal conditions their numbers increase exponentially and due to their short generation times the total biomass can sometimes increase to several times its starting value in less than an hour. This is a desirable feature in industrial processes, as it means that only a small number of organisms (the inoculum) must be present at the start of the process in order to achieve high productivity within a short time.

The metabolism of an organism can be divided into two principal parts, catabolism and anabolism. Catabolism involves the uptake of compounds which can supply the organism with the raw materials and energy required for its metabolism and the transformation of these into energy carriers and precursor metabolites. The most common example of the former is adenosine triphosphate (ATP); the latter are small metabolites such as pyruvate and acetyl-coenzyme A [Villadsen et al., 2011]. Most microorganisms are chemoorganoheterotrophic meaning that organic compounds which are consumed by the organism serve as their source of energy and electrons as well as carbon, an important raw material for the organism [Prescott et al., 2005]. Anabolism involves the creation of larger compounds such as proteins, phospholipids and carbohydrates from the precursor metabolites and energy carriers produced in catabolism [Villadsen et al., 2011]. Figure 2.1 provides an overview of the major steps in cellular metabolism.

Microorganisms can respond to oxygen in a number of different ways. Some are obligate aerobes, meaning that they require oxygen to grow, while others are facultative anaerobes and can switch between aerobic and anaerobic metabolism. Some are aerotolerant and can grow in an aerobic environment although they do not utilize oxygen while some are obligate anaerobes and are harmed by oxygen; microaerophilic microorganisms require oxygen at low concentrations but are harmed by it at atmospheric levels [Prescott et al., 2005]. Metabolism which utilizes oxygen is termed oxidative and that which does not is termed fermentative; oxidative metabolism allows for more efficient use of energy-containing substrates and is therefore often desirable in industrial processes. For the same reason, facultative anaerobes will metabolize substrates oxidatively rather than fermentatively in the presence of oxygen although fermentative metabolism would also be possible.

Substrate uptake kinetics

The specific microbial uptake rate of a compound is affected by the concentration of the compound as well as other factors such as the current metabolic state and concentrations of inhibiting substances. A model for substrate uptake when utilizing a single rate limiting substrate can be derived from the widely used, empirical Monod model for biomass growth given in (2.1), where C_s is the concentration of the substrate, μ is the specific biomass growth rate, μ_{\max} its maximum and K_s is a saturation constant [Villadsen et al., 2011]. The biomass yield on the substrate, Y_{xs} , can be added to give the specific substrate uptake as in (2.2) where r_s is the specific uptake rate of substrate and $r_{s,\max}$ its maximum. To give the simplest possible model Y_{xs} can be regarded as constant, but it is well known that it depends on a number of factors such as μ and the model can be expanded to take this into account [Zeng and Deckwer, 1995].

$$\mu = \mu_{\max} \frac{C_s}{C_s + K_s} \quad (2.1)$$

$$r_s = \frac{\mu_{\max}}{Y_{xs}} \frac{C_s}{C_s + K_s} = r_{s,\max} \frac{C_s}{C_s + K_s} \quad (2.2)$$

Alternatives to the Monod model exist, which share its basic trait of an uptake rate which increases monotonically from zero to a maximum uptake rate for increasing substrate concentrations. A number of modifications to the Monod model have also been suggested to allow incorporation of for instance substrate and product inhibition effects [Villadsen et al., 2011].

The central pathways of carbohydrate metabolism

The central catabolic pathways of many oxygen-utilizing microorganisms are similar in several respects, with key functionalities (pathways) such as glycolysis, tri-carboxylic acid (TCA) cycle and oxidative phosphorylation which can be seen universally. Many variations in these exist however, providing some degree of difference in the abilities and limitations of different organisms. The catabolic pathways of 6-carbon sugars (hexoses), a preferred substrate type for many microbial strains, are outlined here.

Glucose is the most common hexose in nature and the standard sugar substrate. Other hexoses can be metabolized in similar ways after some initial transformation steps. The key steps in the glucose metabolism of *B. licheniformis* are summed up in figure 2.2, most of these apply generally to oxidative microbial metabolism.

The first pathway in glucose catabolism is glycolysis (see figure 2.2), it is the only part of glucose catabolism which does not require the presence of oxygen. In glycolysis, glucose is first phosphorylated into glucose-6-phosphate which can either be diverted into a separate reaction network termed the pentose phosphate (PP) pathway or metabolized in the glycolysis where it is converted and further phosphorylated into fructose-1,6-phosphate. This intermediate is split up into two 3-carbon compounds which eventually both end up as glyceraldehyde-3-phosphate (GAP). GAP is then converted through a series of reaction steps into pyruvate, the end product of glycolysis. The phosphorylation in the first part of glycolysis depletes two units of adenosine triphosphate (ATP), the general energy carrier of the cell, per unit of glucose. The reactions from GAP to pyruvate enables the forming of four units of ATP per unit of glucose, giving a net gain of two units of ATP per unit of glucose. Two units of NADH, a carrier of reductive power used in catabolism, are also formed per unit of glucose [Villadsen et al., 2011].

The PP pathway is a flexible reaction network used for several purposes. Its intermediates can be withdrawn to be used in creation of various structures, for instance DNA and certain amino acids. When its intermediates are not withdrawn its function purely becomes production of NADPH, a carrier of reductive power used in anabolism [Villadsen et al., 2011].

Pyruvate can be further metabolized in the TCA cycle (see figure 2.2). Pyruvate is entered through conversion into acetyl-coenzyme A (acetyl-CoA) which combines with oxaloacetate to form citrate. Citrate is further converted to other compounds through a series of reactions which ends with oxaloacetate. If no intermediates of the cycle are withdrawn, the two pyruvate units corresponding to one unit of glucose yield ten units of reductive power carriers. In *B. licheniformis* this is six units of NADH, two units of NADPH and two units of FADH_2 , another reductive power carrier used in catabolism.

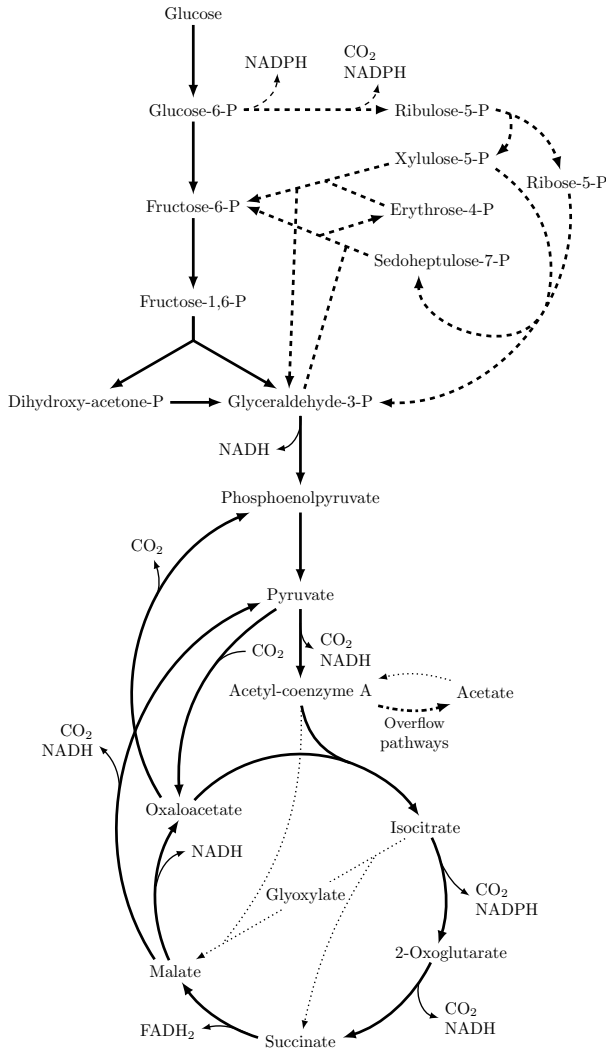

Figure 2.2 A schematic illustration of the central oxidative carbohydrate metabolism in *B. licheniformis*, adapted from [Tännler et al., 2008, p. 8] and [Villadsen et al., 2011, p. 31]. The pentose phosphate pathway is indicated by dashed lines, the glyoxylate cycle by dotted lines and overflow pathways by a dash-dotted line. P indicates a phosphate group and a number in connection to it indicates its location on the carbon structure. Some pathways and intermediaries are left out for simplicity and the reactions of oxidative phosphorylation are not shown.

Each unit of glucose also yields two units of guanosine triphosphate (GTP), an energy carrier similar to ATP but used for more specific purposes. A separate but similar pathway, the glyoxylate cycle, incorporates many of the steps of the TCA cycle. It has the purpose of replenishing oxaloacetate when compounds in the cycle are withdrawn for biosynthetic purposes and allows the organism to utilize two-carbon carbohydrates such as acetate as substrates, as shown in figure 2.2 [Berg et al., 2002].

One purpose of the TCA cycle is to enable use of its intermediates as precursors for cell synthesis; under anaerobic conditions this is its only purpose and its activity is very low [Villadsen et al., 2011]. Under aerobic conditions, for microorganisms with respiratory systems, the reductive power carriers produced in the TCA cycle can be oxidized through use of oxygen to produce ATP. This mechanism is termed oxidative phosphorylation. A unit of NADH can theoretically yield three units of ATP while a unit of FADH₂ can yield two. Although the yields are lower in practice, this nonetheless means that the yield of ATP on the carbohydrate substrate when oxygen can be utilized is many times higher than that of glycolysis alone [Villadsen et al., 2011].

In the absence of oxygen or a respiratory system, the microorganism must metabolize pyruvate fermentatively. This can be done in different ways depending on the type of organism, the end product is one or several small organic compounds such as lactate, formate, acetate and ethanol [Villadsen et al., 2011].

Overflow metabolism

When the concentration of the carbohydrate substrate is high, a phenomenon labelled overflow metabolism can occur where fermentation metabolites are produced despite aerobic conditions. This effect has been seen in for instance the common industrial production organisms *Saccharomyces cerevisiae* [Sonnleitner and Käppeli, 1986], *Escherichia coli* [Luli and Strohl, 1990] and *Bacillus licheniformis* [Voigt et al., 2004]. The explanation for this is that the rate of oxidative metabolism is limited; when the carbohydrate uptake rate is high, not all of the consumed carbohydrate substrate can be metabolized oxidatively. Instead, some of it is directed into fermentative pathways despite the presence of oxygen. This occurs at substrate uptake rates above a certain threshold, termed the critical substrate uptake rate, and as the uptake of substrate increases more of it is directed into the fermentative pathways. As the rate of oxidative metabolism does not increase further when the substrate uptake rate is increased above its critical level, the oxygen uptake rate remains constant [Villadsen et al., 2011]. The regulatory mechanisms behind overflow metabolism, in which enzymes facilitating different reactions are repressed or activated, are so far not fully understood

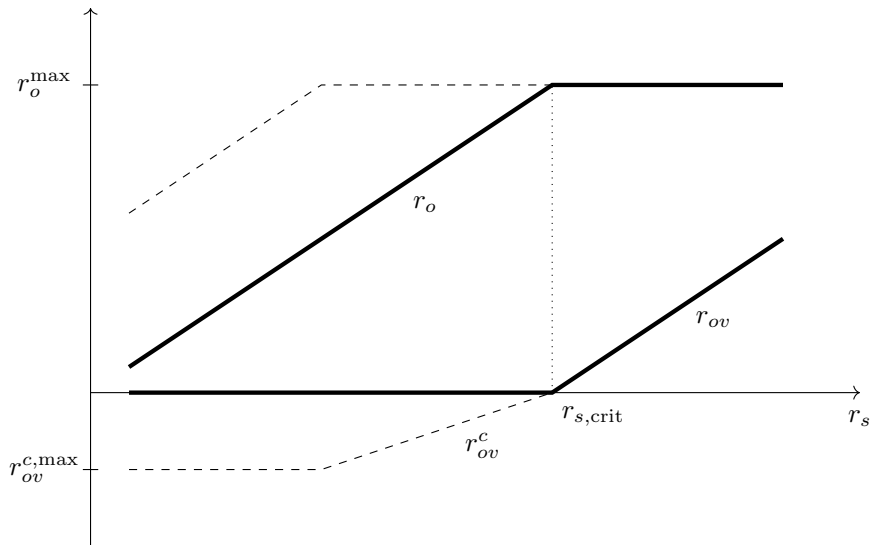

Figure 2.3 The relation between specific substrate uptake rate r_s and the rates of specific oxygen uptake r_o and overflow metabolite production r_{ov} . This shows the saturation of oxidative metabolism at $r_{s,crit}$, which is marked with a dotted line. Dashed lines indicate the specific rate of overflow metabolite uptake r_{ov}^c , which will only occur if overflow metabolites are present and the substrate uptake rate is sufficiently low, and the correspondingly increased oxygen uptake rate. Adapted from [Åkesson, 1999, p. 20].

although they have been studied extensively for instance in *E. coli* [Valgepea et al., 2010].

The limitation in oxidative metabolism can be modelled as a saturation, where an increased specific substrate uptake rate r_s is connected to an increase in specific oxygen uptake rate r_o up to the critical uptake rate $r_{s,crit}$. The actual relationship is however more complex and dependent on other factors [Kleman and Strohl, 1994]. The parameter $r_{s,crit}$ corresponds to the maximal specific oxygen uptake rate $r_{o,max}$, as changes in substrate uptake rate above this level will not influence the oxygen uptake rate. This simplified relationship is illustrated in figure 2.3.

From a productivity point of view, overflow metabolism is undesirable as it decreases biomass and product yield [El-Mansi, 2004] and also due to the nature of the end products of the overflow pathways, here termed overflow metabolites. These are organic acids or alcohols, which are typically harmful to the organism and can both inhibit growth [Luli and Strohl, 1990] and reduce production of desired products [Jensen and Carlsen, 1990]. At high

enough concentrations, overflow metabolites can cause complete process failure due to their harmful effects. In many organisms, such as *B. licheniformis*, overflow metabolites can be used as substrates and re-metabolized oxidatively when the uptake rate of the main substrate is low [Tännler et al., 2008]. This can limit their harmful effects, assuming that the uptake rate of the main substrate does not remain high.

Product formation

Product formation can occur through a great number of different metabolic pathways, which can be more or less active in different stages of growth. A distinction is made between primary and secondary metabolites; the former are compounds formed as a direct result of microbial growth, while production of the latter is not directly coupled to growth and typically occurs in the late stages of a cultivation when growth has ceased.

In many cases, the desired product of a bioprocess is a secondary metabolite. If so, in the case of genetically engineered organisms, a key gene needed for production is commonly designed so that its activation requires the presence of a certain compound in the medium; such a compound is referred to as an inducer. The inducer is not present at the start of the process, meaning that the microorganisms will not devote energy to production of this secondary metabolite and can instead use it for faster growth. When the biomass concentration has become sufficiently high, the inducer is added and metabolism is switched from growth to product formation. A classical example of this approach is induction of the lac-operon in *E. coli*, by for example isopropylthiogalactoside (IPTG) [Jacob and Monod, 1961].

2.2 The industrial stirred-tank bioprocess

The industrial bioreactor is designed to provide a means of efficient microbial growth and production while being robust, safe and cheap to run. To achieve this it must provide a suitable environment for the microbial processes for which it is used.

Most bioreactors used in industry are designed for submerged processes, meaning that microbial growth takes place in a free-flowing liquid medium encased by the bioreactor, although solid-state processes where the medium is solid have gained interest in the last two decades [Thomas et al., 2013]. A bioreactor for submerged processes in industrial production is typically near-cylindrical and can have a volume up to several hundred cubic metres [Hermann, 2003].

The most common type of bioreactor for submerged processes is the stirred-tank reactor (STR) [Paul et al., 2004], in which one or more agitators are used to stir the liquid medium in order to facilitate transportation of vari-

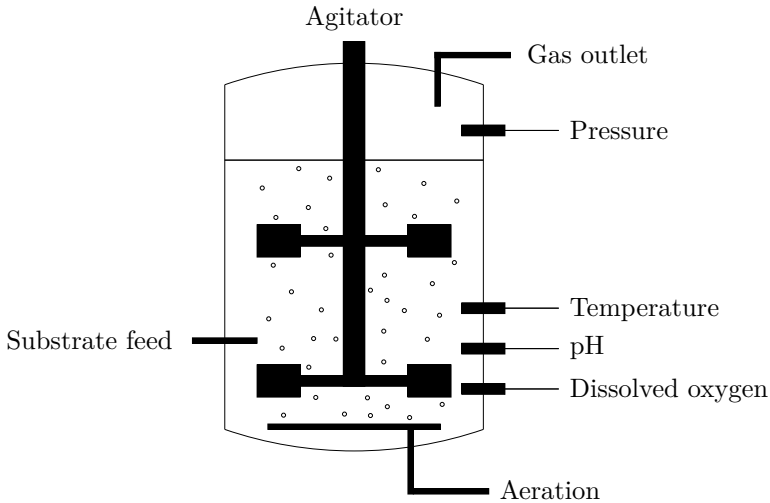

Figure 2.4 Overview of a stirred-tank bioreactor. Substrate is added through a port while air is introduced through a sparger at the bottom. An agitator mixes the liquid medium and allows efficient mass transfer. *In-situ* measurements typically include dissolved oxygen, pH, temperature and gas pressure.

ous compounds within it. This type of bioreactor is illustrated in figure 2.4, giving the general design as well as detailing some important components and common measurements. Other types of submerged bioreactors are air-lift and bubble column bioreactors, both of which utilize gas flow to achieve sufficient mixing and therefore do not use agitators.

Mixing and homogeneity

In all types of submerged bioreactors it is desirable to achieve good mixing, meaning that spatial inhomogeneities are small. This is typically quantified through mixing time, the time it takes to achieve a predefined level of homogeneity, for which low values are naturally sought. Even in a case where mixing times are low in most of the bioreactor, there may exist “dead zones” where mixing is very slow. Appropriate design of the bioreactor and its stirrers is required to achieve short mixing times and no dead zones.

Mixing does not only serve to ensure that the process is spatially homogeneous, but also to enhance various transport processes which are required for the bioprocess such as transfer of heat energy, oxygen, carbon dioxide and substrate. These mixing and transport issues become more important as bioreactor volume increases, requiring a high energy input through stirring [Villadsen et al., 2011].

In industrial-scale bioreactors, inhomogeneities in the process are to be expected as it is not practically feasible to supply enough mixing power to achieve near-homogeneity; this is known to have a negative effect on product quality [Schmidt, 2005] and process yields [Takors, 2012]. Assuming ideal mixing with no turbulent regions, mixing can be described as a linear first-order process. It is however well known that effects of turbulence can be expected in bioreactors, giving less straightforward mixing dynamics [Villadsen et al., 2011].

Aeration and gas composition

For STR bioprocesses requiring the presence of oxygen, air is typically added through a sparger at the bottom of the reactor. The air can be mixed with pure oxygen to increase oxygen transfer to the biomass, but in industry this is avoided if possible for economic reasons. Gas is let out through a tube near the top of the reactor; as oxidative metabolism leads to consumption of oxygen and emission of carbon dioxide, the levels of the former are lower and the levels of the latter higher in the outlet gas than in the inlet. Dissolved oxygen in the medium can be measured on-line using electrodes or optodes.

Transportation of gaseous compounds such as oxygen can be separated into different steps, diffusion from the gas bubbles to the liquid medium and diffusion and mixing in the liquid medium. Transportation of a compound A from the gas phase to the liquid phase depends on the volumetric mass transfer coefficient $k_l a$ and a driving force which is the difference between the current concentration of the compound in the liquid phase c_A and its saturation concentration c_A^* . The saturation concentration is the concentration of the compound when at equilibrium with the gas phase. This relationship is expressed in (2.3), where q_A is the volumetric transfer rate of the compound. $k_l a$ consists of the mass transfer coefficient k_l which is the transfer rate per area and the specific surface area a [Villadsen et al., 2011].

$$q_A = k_l a (c_A^* - c_A) \quad (2.3)$$

The coefficient $k_l a$ is increased through higher rates of stirring and aeration, while increasing the total pressure or the relative amount of the compound in the gas phase increases c_A^* . A low value of c_A also increases mass transfer, although at very low levels this can have negative effects on the microbial uptake of the compound.

The gas pressure in a bioreactor is typically measured in the headspace, the space above the liquid medium in the reactor. It is controlled by manipulating the outlet gas flow and is preferably slightly higher than atmospheric pressure as this both increases the concentration of dissolved oxygen and decreases the risk of contamination in the reactor. This puts some demands on the construction of the bioreactor but the very high pressures used in

some chemical reactors [Al-Dahhan and Duduković, 1995] are not seen in bioreactors, which are typically designed to withstand a maximum pressure of around 3 atmospheres [Chisti, 1992].

The gas passing through the outlet of the bioreactor is termed off-gas, its composition can be determined using gas analysis methods such as infrared sensors for CO₂, paramagnetic sensors for O₂ and mass spectrometry for multiple compounds. Together with measurement of the gas flow, this can provide the current oxygen uptake rate (OUR) and carbon dioxide emission rate (CER). This type of measurement is sometimes used in industrial processes [Gnoth et al., 2008], although sampling frequencies can be low in cases where one mass spectrometer is used to analyse off-gas from multiple bioreactors.

Temperature and pH

Microbial metabolism often leads to changes in the pH value of the medium. Most often, pH is decreased due to excretion of weak organic acids from the microorganisms. Similarly, the reactions of metabolism as well as the viscous dissipation of stirrer energy generate heat. Microorganisms typically have a rather small pH and temperature span within which they can maintain their highest growth and productivity [Rosso et al., 1995; Villadsen et al., 2011] and it is therefore important to monitor these parameters, which can be done on-line using electrodes. Acid or base is added to compensate for changes in pH while excess heat is cooled off through a cooling jacket on the outside of the bioreactor and/or cooling coils inside the bioreactor, through which cold water is pumped.

Composition of the liquid medium

Microbial growth requires that a number of different nutrients are available for uptake by the microorganisms. The substrate must include a carbon source, which is very often also the energy source, as well as a nitrogen source, trace metals and essential vitamins. Other compounds may inhibit microbial growth, some of which are produced by the microorganisms themselves. The concentrations of these compounds should of course be kept low if possible. In some cases a substrate is inhibiting at high concentrations, which might require a tradeoff between nutrient supply and inhibition. Carbohydrates are excellent sources of carbon and energy; they are typically the main substrate, while nitrogen can be supplied through addition of base if ammonia (NH₃) is used.

Bioprocess media are commonly separated into two types, defined and complex. Defined media consist of specified chemicals in known amounts, meaning that the exact composition is known. Complex media, in contrast, consist of raw materials whose exact composition is not known such as

molasses or soy meal. Furthermore the composition of complex substrates can vary from one batch to another. Although defined media allow for greater precision in the design of the medium, complex media are typically much cheaper which makes them attractive in industrial applications [Zhang and Greasham, 1999].

On-line measurement of the main substrate in a bioreactor is possible in some applications [Luli et al., 1987; Brooks et al., 1988], but traditional methods requiring sample withdrawal are considered difficult to use in industrial applications due to robustness problems [Johnston et al., 2002]. Infrared spectroscopy has enabled new types of non-invasive on-line measurements but precision and detection limits are so far not sufficient for precise control; glucose measurements with a standard error of 260 mg/L have been reported [Navrátil et al., 2005] while for instance *E. coli* has a reported threshold for overflow metabolism at 30 mg/L [Schmidt, 2005]. Further, due to the multitude of compounds often present in complex media, measurement of one carbohydrate source is not always sufficient to determine the total availability of carbohydrates in the medium. Equipment for such measurements is therefore rarely used in industrial processes [Gnoth et al., 2008].

Biomass concentration is an important process state which can be measured using for instance capacitance probes [Fehrenbach et al., 1992], in-situ microscopy [Bittner et al., 1998] and near infrared (NIR) probes [Kiviharju et al., 2007], all with different advantages and limitations. Direct measurement of the biomass concentration is however not common in industrial applications [Gnoth et al., 2008]. The biomass concentration can also be estimated from more commonly available measurements through a soft-sensing approach using artificial neural networks (ANNs) [Chen et al., 2004].

As described in section 2.1, overflow metabolism leads to excretion of by-products into the medium. The concentrations of these overflow metabolites can be measured in some applications [Rocha and Ferreira, 2002; Landgrebe et al., 2010] but similar to substrate measurements, the equipment needed for such measurements is not usually used in industrial processes [Gnoth et al., 2008].

2.3 The fed-batch mode of operation

A stirred-tank bioprocess can be performed in one of three different modes [Villadsen et al., 2011]:

- **Batch mode**, where all substrate used in the process is present in the starting medium and no addition of substrate occurs after the process is started.

- **Fed-batch mode**, where feed containing one or several substrates is added throughout the process.
- **Continuous mode**, where feed is added and medium withdrawn throughout the process.

It is typically the addition of feed containing the main carbon source and the withdrawal of liquid medium which determines what mode a bioprocess is considered to be run in. A process is considered batch or fed-batch also when sparged with air and using a gas outlet, as well as adding acid and base to maintain a desired pH.

Industrial bioprocesses are often run in fed-batch mode. This has some advantages over batch processes, such as avoiding substrate inhibition and enabling control of microbial growth and production through varying the rate of feed addition to the process, while being easier to operate than continuous bioprocesses. By supplying substrate at a suitable rate, fast growth and production can be maintained while avoiding production of undesired by-products due to overflow metabolism.

A typical fed-batch bioprocess can be divided into two phases. In the first phase, the amount of biomass and its corresponding feed demand is low and this constrains the desired feed rate if overflow metabolism is to be avoided. In this phase microbial growth should ideally be as fast as possible; after a short period at the start of the phase where the microorganisms adjust to the medium in the bioreactor, they can grow exponentially. Therefore, this phase is commonly referred to as the phase of exponential growth.

In the second phase the amount of biomass has grown high and microbial growth must be constrained due to transport limitations in the bioreactor. Typically, either the oxygen transport capacity is not sufficient to supply a larger biomass with enough oxygen or the heat transport capacity is not sufficient to cool off a larger biomass in order to avoid an increase in temperature. The onset of this phase commonly coincides with induction in cases where it is used.

2.4 Bioreactor monitoring and control

As described in section 2.2, some of the physical variables of the bioreactor can be measured although not all measurements are always available. The measurements usually available in industrial bioprocesses are pH, dissolved oxygen (*DO*), temperature and gas pressure; sometimes the fraction of oxygen and carbon dioxide in the off-gas is also measured [Gnoth et al., 2008]. This means that many variables which are of interest for monitoring and control, such as metabolic states, can not be measured directly and estimation of these from available measurements is often needed.

The substrate concentration and hence the rate of substrate feed addition in a fed-batch process has wide-ranging effects on microbial metabolism, as outlined in section 2.1. As the substrate concentration and its effects on microbial growth and production can not be easily measured it is a critical and difficult parameter to control and many approaches for this exist.

Soft sensors

Estimation of unknown states can be done using observers, where a model is used to deduce unknown parameters from known ones. Such a combination of sensors and software-based observers is commonly termed software sensor or soft sensor [Luttmann et al., 2012].

The models used can be mechanistic or semi-mechanistic, using known physical and biochemical relationships and possibly empirical ones as well to estimate the unknown states. These relationships are sometimes very simple and static models can be sufficient, such as the calculation of OUR and CER from mass spectrometry and gas flow data, but more complex dynamic models can be used for estimation of for instance biomass, substrate and product concentrations. A well-designed mechanistic model allows for monitoring of a process even when its parameters are changing and can facilitate process understanding, although this type of model requires good knowledge of the process and can be time-consuming to design [Luttmann et al., 2012].

Models can also be data-driven, meaning that they are based on previous data from the process to give empirical relationships between parameters. This can be as simple as engineering correlations founded in analysis of data, but more advanced and flexible methods such as artificial neural networks have gained interest in the last 20 years. Such black-box models have the advantage of simplicity in application and can be used to describe complicated nonlinear relationships for which no mechanistic model exists, although they are naturally limited to the training data used for designing them and are not suited for extrapolation beyond that dataset [Gnoth et al., 2008]. Even simple models of this type can give good estimates of biomass concentrations in fed-batch bioprocesses [Jenzsch et al., 2006].

Combinations of mechanistic and data-driven models, termed hybrid models, also exist which combine the features of both. This allows for simple mechanistic relationships such as mass balances to be used where these are known, while less well-known process dynamics are modelled using data-driven methods [Gnoth et al., 2008]. While giving the advantages of both approaches, the drawbacks of both are also kept to some extent. Models of this type can give good estimates of biomass and product concentrations in fed-batch bioprocesses [Gnoth et al., 2006].

Perturbation-based methods

When existing measurements and models are not sufficient for achieving the desired performance in monitoring and control, one method for resolving this problem is to excite the process by introducing perturbations to the system. This approach has some similarities to many system identification methods in that more information about the process is gleaned by observing its response to perturbations, but in a monitoring and control context the identification of process parameters must be performed repeatedly as their values can vary over time.

One type of perturbation-based method is extremum-seeking control, in which the controller uses a dither signal to seek out the maximum or minimum of an objective function. The simplest type of extremum-seeking method requires no model of the system at all and uses only the system's response to a sinusoidal dither signal to determine the local gradient of the objective function, although use of models can improve their performance [Dochain et al., 2011].

Another type of perturbation-based method is the probing strategy [Åkesson, 1999], where the controller switches between controlling and performing perturbations in order to find a saturation point in the system. The response to a perturbation is used to determine the controller action until the next perturbation. This strategy can be used for finding and tracking a saturation point in a process, such as the saturation of oxidative metabolism in bioprocesses. It has been demonstrated to perform well for this purpose, in a scale up to 12 m³ [Velut et al., 2007]. The perturbations used are typically square pulses on the feed rate [Åkesson, 1999; Velut, 2005; de Maré, 2006] or briefly stopping feeding altogether [Henes and Sonnleitner, 2007]. An approach using exponential ramping during pulses has also been suggested and can determine the current state in relation to the saturation in a more precise manner [Schaepe et al., 2014]. The probing strategy has the advantage of requiring very little knowledge about the process and requires few measurements, only *DO* or *OUR* in the case of feed rate control in bioprocesses, however the step changes used can be difficult to perform in industrial-scale processes.

3

Feed demand estimation using frequency content analysis

The strategy which is here termed frequency content analysis (FCA) is essentially a modified type of probing control and is based on the original probing strategy described by Åkesson et al. [1997]. Its aims are the same, estimation of the substrate feed demand in a bioprocess to enable on-line tracking of it. Its core principles are also the same, perturbing the feed rate of the process and quantifying the dissolved oxygen (DO) response to estimate the demand.

The perturbations and the quantification of them are however quite different and more similar to simple extremum-seeking schemes [Dochain et al., 2011] in that rather than halting the controller to perform a single pulse and evaluate the response to it, a repeating perturbation is applied at a pre-defined frequency and the response is evaluated at each sampling point. The name of the strategy relates to the fact that it is the content of the perturbation frequency in the measured signal which is used to estimate the system's state.

3.1 Basic principles of the method

The core principle behind the FCA strategy is illustrated in figure 3.1, which shows how the response to a sinusoidal perturbation sent through a saturation varies depending on the system's current state in relation to the saturation. The response is similar to that of a linear system with varying gain; the difference is the overtones caused by the saturation nonlinearity. The response at the perturbation frequency can however be used to quantify the system's

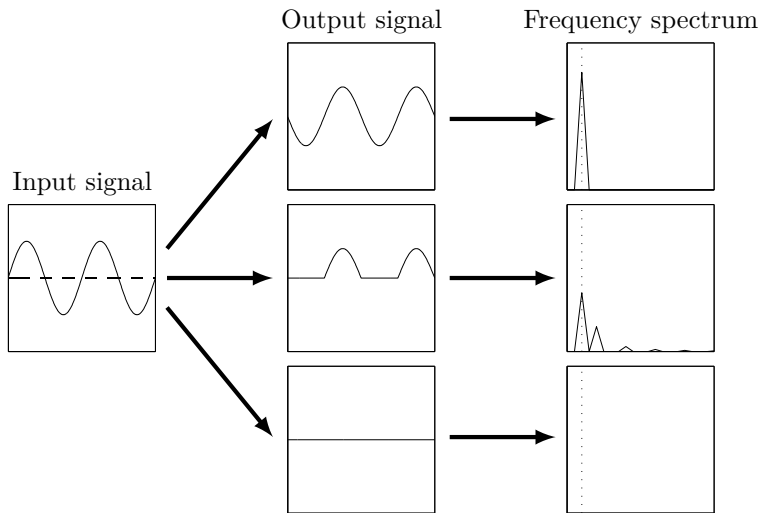

Figure 3.1 Illustration of the FCA core principle, showing input and output signals over time and power spectral density over frequency. The base level of the input signal is indicated by a dashed horizontal line in the input signal graph and the relevant frequency is marked by a vertical dotted line in the frequency spectrum graph. In the uppermost case, the base level of the input signal is far below the saturation level so the saturation is not active. An unsaturated response is therefore seen in the output, this gives the maximum power spectral density at the relevant frequency. In the middle case, the base level is just at the saturation level and the response is affected by the saturation, which is also seen in the frequency spectrum. In the lowermost case, the base level is far above the saturation level so no response is seen in the output signal and hence not in the frequency spectrum.

proximity to the saturation. In the case of feed demand estimation in bioprocesses, the input signal is the feed rate and the output is *DO* or *OUR*; here *DO* will be considered as the output signal as has been the case within the frame of this work.

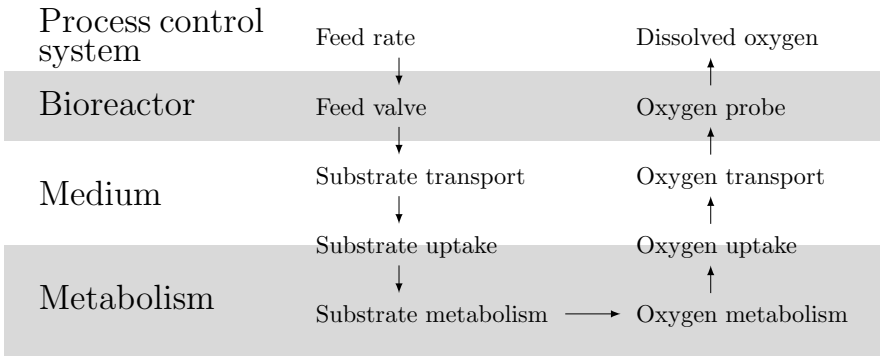

Figure 3.2 The chain of dynamics connecting feed rate (F) and dissolved oxygen level (DO) in a bioprocess. This is a simplified description, as feedback connections and more complicated relationships exist such as the effects of DO on the metabolism.

3.2 A simplified process model for FCA

The relationship between feed rate (F) and DO in a bioprocess is not limited to the saturation in oxidative capacity. Rather, a whole chain of dynamics determine this relationship as illustrated in figure 3.2. The time scales of the different dynamics can vary significantly however and it is possible to simplify the dynamic process model by assuming pseudo-steady state in some of them and lumping some of them together.

Neglecting mixing dynamics and assuming that all of the substrate added through the feed is consumed by the biomass gives the mass balance $FC_{s,\text{in}} = VXr_s$ where $C_{s,\text{in}}$ is the substrate concentration in the feed, V is the liquid volume, X is the biomass concentration and r_s is the specific substrate uptake rate. Further, assuming that no production or consumption of overflow metabolites occur and that the substrate required for maintenance of the biomass is negligible, the relationship between specific substrate uptake rate and specific oxygen uptake rate r_o is $r_o = Y_{os}r_s$ where Y_{os} is the oxidative yield constant on the substrate. If the oxygen concentration in the liquid is at pseudo-steady state, $VXr_o = Vq_o$ where q_o is the volumetric flow of oxygen meaning that the microbial oxygen uptake is matched by the transport of oxygen to the liquid. Combining these expressions with (2.3), the relationship (3.1) between feed rate and dissolved oxygen level is given, for a case where the effects of mixing dynamics and the saturation in oxidative metabolism are not taken into account.

$$Vkl\alpha(DO^* - DO) = Y_{os}FC_{s,\text{in}} \quad (3.1)$$

From this follows the relationship given in (3.2) between the feed rate perturbation amplitude ΔF around the base level F_0 and the amplitude of its unmodified dissolved oxygen response, ΔDO_u , from a base level DO_0 .

$$\frac{\Delta(DO^* - DO_u)}{DO^* - DO_0} = \frac{\Delta F}{F_0} \quad (3.2)$$

For constant DO^* , $\Delta(DO^* - DO_u) = -\Delta DO_u$. This gives a relationship between ΔF and ΔDO_u as per (3.3).

$$\Delta DO_u = -\frac{DO^* - DO_0}{F_0} \Delta F \quad (3.3)$$

To provide a more complete model of an industrial bioprocess, its dynamics must also be considered. Optical probes, or optodes, for dissolved oxygen measurement are well described by first-order dynamics [Glazer et al., 2004] and modern optodes can have time constants below 30 seconds. The feed flow in a bioreactor is commonly controlled by a PI controller manipulating a feed valve, to counteract friction and other disturbances in the valve. Assuming that friction can be successfully counteracted, a closed-loop valve control system can be regarded as a linear first-order system with a time constant which can be as low as a few seconds.

Substrate and oxygen transport through the liquid medium are ideally linear processes, however this assumes ideal mixing. For production-scale bioprocesses, mixing is known to be non-ideal but this does not mean that a linear model cannot be used to describe the mixing dynamics for perturbations of given amplitudes and frequencies. Paper II shows that even in such processes, it can be possible to approximate the relationship between perturbation and response by a linear second-order model for certain perturbation frequencies and amplitudes. This can be viewed as substrate and oxygen mixing dynamics, lumped together with other dynamics of the process such as those of the feed valve, metabolism and DO probe, each being well described by linear first-order models given these constraints.

Substrate uptake can be described using different nonlinear models, as described in section 2.1. However, linearization of the dynamics can give good local approximations of these dynamics. An example is the data reported for *E. coli* in [Xu et al., 1999], the Monod relationship given there is shown in figure 3.3. For this relationship the onset of overflow metabolism occurs at a substrate uptake rate of $0.54 \text{ g g}^{-1}\text{h}^{-1}$, at which a linear approximation of the Monod relationship gives a good fit locally.

Lumping microbial uptake dynamics as well as valve and probe dynamics with the mixing effects and considering only the response at the perturb-

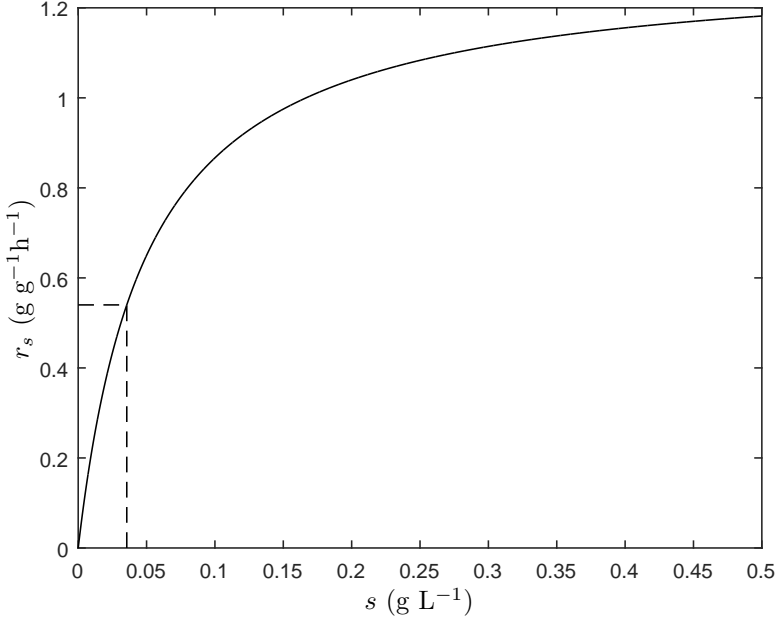

Figure 3.3 The Monod relationship between substrate concentration and specific substrate uptake rate for *E. coli* given in [Xu et al., 1999, table 3 (data from figure 2)]. The onset of overflow metabolism at a specific substrate uptake rate of $0.54 \text{ g g}^{-1} \text{ h}^{-1}$ and its corresponding substrate concentration of 0.036 g L^{-1} are indicated by dashed lines.

ation frequency ω , the response modified by the effects of mixing dynamics and the oxidative saturation is $\Delta DO(\omega) = K_{\text{sat}} K_{\text{mix}}(\omega) \Delta DO_{\text{u}}$ where $K_{\text{sat}}, K_{\text{mix}}(\omega) \in [0, 1]$. Adding this to the model in (3.3) gives a relationship between the amplitude of the perturbation and that of the response as per (3.4). The total mixing gain at the relevant frequency, $K_{\text{mix}}(\omega)$, is as per (3.5) where K_s, T_s, K_o and T_o are the static gains and time constants of the substrate and oxygen mixing dynamics respectively. $K_{\text{mix}}(\omega)$ can be determined experimentally for a given bioreactor as done in paper II.

$$\Delta DO(\omega) = -K_{\text{sat}} K_{\text{mix}}(\omega) \frac{DO^* - DO_0}{F_0} \Delta F \quad (3.4)$$

$$K_{\text{mix}}(\omega) = \left| \frac{K_o K_s}{(i\omega T_o + 1)(i\omega T_s + 1)} \right| \quad (3.5)$$

3.3 A simple FCA design

Analysis of the content of the relevant frequency in the output to determine the system's proximity to the saturation can be done through measuring the power spectral density at this frequency in the frequency spectrum or by estimating the gain at this frequency. A simple way of doing the latter, derived from the correlation method for system identification through frequency analysis as described by Ljung [1999], is given in paper IV.

The correlation method itself is designed for finding the gain $|G_0(e^{i\omega})|$ and phase $\phi = \arg(G_0(e^{i\omega}))$ of a linear time-invariant (LTI) system G_0 , at the frequency ω by perturbing its input signal with a sinusoidal as per (3.6). This gives a sinusoidal response in the system output as per (3.7), where $v(t)$ is noise and $r(t)$ is a transient.

$$u(t) = \alpha \cos(\omega t) \quad (3.6)$$

$$y(t) = \alpha |G_0(e^{i\omega})| \cos(\omega t + \phi) + v(t) + r(t) \quad (3.7)$$

In the original formulation, for identification of a constant gain, the terms I_C and I_S are defined as per (3.8) and (3.9) respectively.

$$I_C(T) = \frac{1}{T} \int_T y(t) \cos(\omega t) dt \quad (3.8)$$

$$I_S(T) = \frac{1}{T} \int_T y(t) \sin(\omega t) dt \quad (3.9)$$

Inserting (3.7) into these yields (3.10) and (3.11) respectively [Ljung, 1999].

$$\begin{aligned} I_C(T) &= \frac{\alpha}{2} |G_0(e^{i\omega})| \cos(\phi) + \alpha |G_0(e^{i\omega})| \frac{1}{2T} \int_T \cos(2\omega t + \phi) dt \\ &\quad + \frac{1}{T} \int_T v(t) \cos(\omega t) dt \end{aligned} \quad (3.10)$$

$$\begin{aligned} I_S(T) &= \frac{\alpha}{2} |G_0(e^{i\omega})| \sin(\phi) + \alpha |G_0(e^{i\omega})| \frac{1}{2T} \int_T \sin(2\omega t + \phi) dt \\ &\quad + \frac{1}{T} \int_T v(t) \sin(\omega t) dt \end{aligned} \quad (3.11)$$

The second and third terms in (3.10) and (3.11) go towards 0 as T goes towards infinity, assuming that the noise does not contain a pure periodic component of frequency ω . This allows straightforward estimation of the system gain $|G_0(e^{i\omega})|$ as shown in (3.12).

$$\frac{\sqrt{I_C^2(T) + I_S^2(T)}}{\alpha/2} = \frac{\alpha/2 |\hat{G}_0(e^{i\omega})| \sqrt{\sin^2(\phi) + \cos^2(\phi)}}{\alpha/2} = |\hat{G}_0(e^{i\omega})| \quad (3.12)$$

In an FCA context, the system gain can be used to determine how much the oxidative saturation influences the response and hence the feed demand. However, a number of modifications to the method are required to follow a time-varying gain.

In order to track the current value of $|G_0(e^{i\omega})|$ rather than estimating its average value, the integration in (3.8) and (3.9) is replaced by low-pass filtering. The output of filtering is, when considered in the time domain, a weighted sum of previous outputs and current and previous inputs as in (3.13). Discrete-time integration is a special case of filtering where the current input is added to the current output, as seen in (3.14). In these expressions u is the input, y is the output, k is the cycle number and N the filter order. A stable low-pass filter accumulates the input similarly to an integrator but v and w are chosen so that the contribution of input samples diminishes over time, meaning that newer input values have a larger effect on the output.

$$y_{\text{filt},k} = \sum_{i=k-N}^{k-1} v_i y_{\text{filt},i} + \sum_{j=k-N}^k w_j u_{\text{filt},j} \quad (3.13)$$

$$y_{\text{int},k} = y_{\text{int},k-1} + u_{\text{int},k} \quad (3.14)$$

As T can obviously not be arbitrarily large for a time-varying system the second and third terms in (3.10) and (3.11) can not be disregarded, they can however be handled in different ways. A notch filter tuned for the frequency 2ω can be used to attenuate the second term. In the case where the gain of a saturation nonlinearity is determined, this also has the advantage of attenuating the first overtone caused by the saturation which is seen in figure 3.1. The third term can be attenuated using a low-pass filter, assuming that the noise is of high-frequency character.

In cases where low-frequency noise also occurs, so that a constant baseline for the output signal cannot be maintained and the signal will instead drift, a high-pass filter can similarly be added to attenuate such noise. Noise which occurs at the perturbation frequency can however, by design, not be attenuated using such methods.

To compensate for the effects on system gain other than the saturation, it is necessary to scale the calculated response by these factors. Using $|\hat{G}_0(e^{i\omega})| = \frac{\Delta DO(\omega)}{\Delta F}$ and the model given in (3.4), the saturation gain can be estimated as per (3.15).

$$\hat{K}_{\text{sat}} = -\frac{1}{K_{\text{mix}}(\omega)} \frac{F_0}{DO^* - DO_0} |\hat{G}_0(e^{i\omega})| \quad (3.15)$$

3.4 Implementation in pilot scale

In the study described in paper I, a version of the FCA strategy based on observing the frequency spectrum of the DO signal was implemented in pilot scale fed-batch bioreactors. The reactors were of the type described by Albæk et al. [2008], with a volume of 0.550 m^3 , controlled using the DeltaV control system which was connected to a computer running the feed rate controller in Matlab.

The substrate feed was added in discrete pulses rather than as a continuous feed and the DO signal was measured to determine whether the processes were over- or underfed. As the feed pulse frequency was known to vary somewhat, the summed power spectral density over a band around the pulse frequency in the DO signal was used as the measure of the response. A PI controller with its gain as a nonlinear function of the current feed rate F was used to control the feed rate based on the measured response. DO was controlled to a baseline using agitator speed AG and aeration rate AR , the controller was set to be sufficiently slow that the DO response to feed pulses was not significantly affected by it.

Although the estimation method only used the size of the response in DO as the measure of feed demand, it could detect the presence of excess substrate and rapidly decrease the feed rate in response to this. Figure 3.4 shows data from an experiment where excess substrate was added at three points in time to provoke overflow metabolism so that the controller response could be observed.

A case where the FCA controller is of particular interest is when the starting biomass is low or growth in the exponential phase takes longer time than expected to start. This scenario was studied through decreasing the inoculum to $1/8$ of its normal volume, thus creating a situation where the starting biomass was lower than normal. The FCA-based controller was compared to a reference which would not detect and respond to overflow metabolism, this is illustrated in figure 3.5. The FCA-based controller did not increase the feed rate during the first hours due to the low feed demand and hence gave slower biomass growth during this stage. In the reference process, acetate was accumulated to levels where it inhibited biomass growth and after 18 hours a complete process failure occurred in the reference process due to acetate accumulation. The FCA-based controller achieved a higher biomass concentration at the end of the exponential growth phase while avoiding process failure.

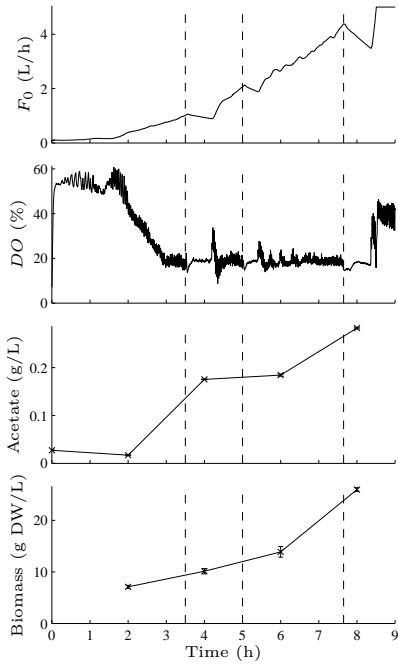

Figure 3.4 Experiment showing the response to excess substrate during the exponential growth phase. At three points in time during the experiment, marked by vertical dashed lines, a pulse of additional substrate was added to the bioreactor. In all cases, the response in DO was decreased which caused a nearly immediate decrease in feed rate. Although some amount of acetate is accumulated it is below harmful levels and the biomass increases as would be desired.

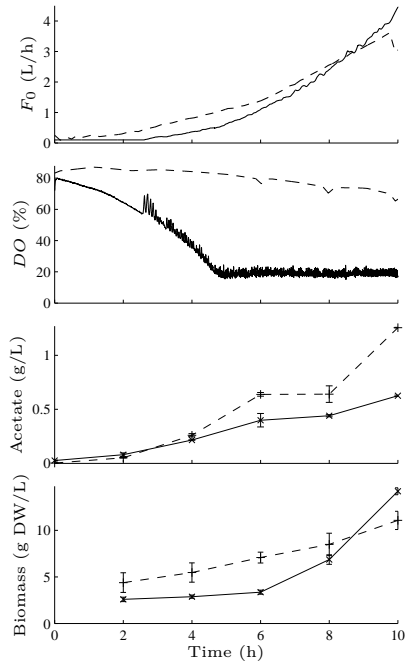

Figure 3.5 Experiment with decreased inoculation volume, data from the process controlled by FCA are shown using solid lines while those from the reference process are marked by dashed lines. The biomass in the FCA-controlled process starts lower and grows slower during the first hours, but as acetate accumulates in the reference it inhibits growth and the FCA-controlled process ends up with higher biomass concentration and feed rate as well as lower acetate levels.

3.5 Implementation in production scale

In the study described in paper V, a version of the FCA method based on the estimation algorithm described in section 3.3 was implemented in a production scale fed-batch bioreactor with a volume greater than 100 m³. The implementation was done in the SattLine process control system used at the production site. In this process no *DO* baseline was maintained and instead *DO* would instead be decreasing during the exponential growth phase until it reached a predefined minimum level, which would cause the FCA-based feed rate controller to deactivate. DO_0 was determined by notch-filtering the *DO* signal to attenuate the perturbation frequency.

A PI controller using F_0 as its actuator signal was used to control \hat{K}_{sat} ; controller parameters and a suitable setpoint were determined using data from paper IV, where samples had been taken for off-line analysis to determine the concentrations of sucrose and acetate in the liquid medium. Data from paper IV showed a clear correlation between \hat{K}_{sat} and the presence of these compounds, as seen in figure 3.6. The amplitude of the feed rate perturbation relative to the current unperturbed feed rate, $\alpha = \frac{\Delta F}{F_0}$, was set to 0.2 in paper IV but was changed to 0.4 in paper V to ensure a clear response.

An experiment where the FCA-based controller was used to control the feed rate during the exponential growth rate showed that the controller acted as would be desired; the relevant data from the experiment are displayed in figure 3.7. At the start of the experiment additional feed was added, corresponding to approximately 1.5 hours of feeding at the current rate. This caused overflow metabolism and the oxidative capacity of the biomass was saturated during the first 5.5 hours of the experiment due to accumulated sucrose and acetate, hence F_0 was set to its minimum value. When these substances were depleted the estimated feed demand and hence also the feed rate increased rapidly until a feed rate near the current feed demand was reached shortly after 6 hours. After this point, the feed rate increased more slowly to compensate for an increasing feed demand caused by biomass growth until *DO* became sufficiently low that the FCA-based controller was switched off automatically at 8 hours. At this point, the unperturbed feed rate had increased to six times its starting value and no accumulation of sucrose or acetate was seen after the first increase in feed rate.

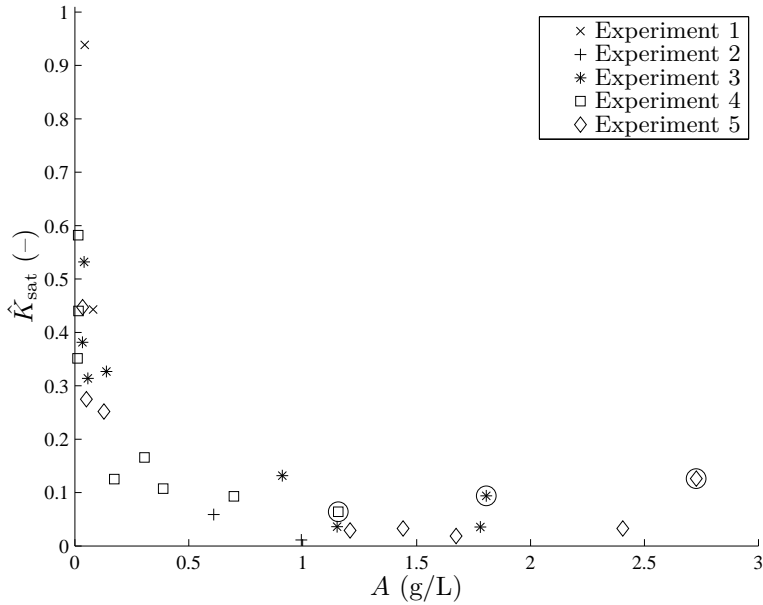

Figure 3.6 \hat{K}_{sat} over A , the highest of sucrose and acetate concentration at each point, from five experiments in the pre-study. The three measurements which are marked by circles were taken when microbial metabolism switched from consumption of sucrose to consumption of acetate, which appears to give a strong temporary effect in DO . A clear trend can be observed in the data, particularly when the three marked measurements are exempted, where higher values of \hat{K}_{sat} indicate lower values of A up to a \hat{K}_{sat} value of 0.2 above which A is near-zero.

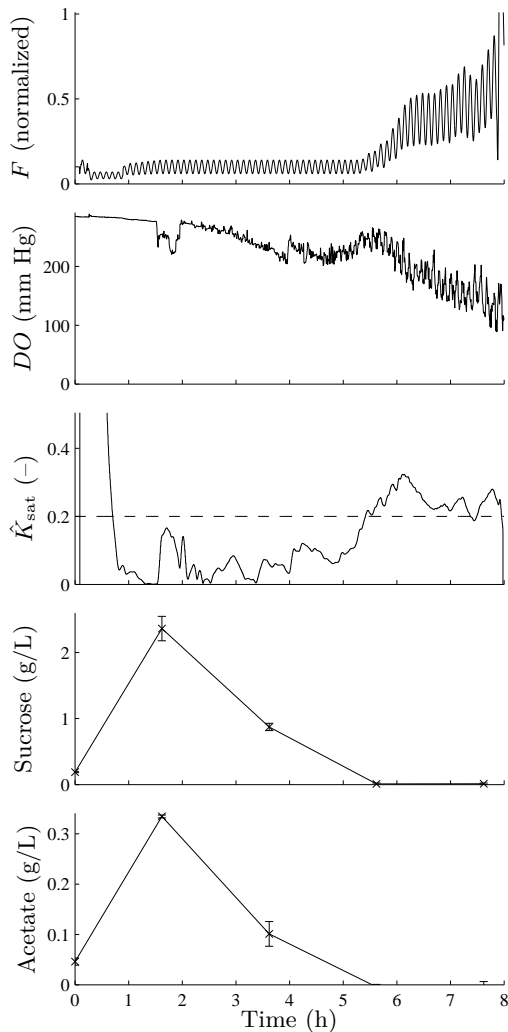

Figure 3.7 Results from an experiment using an FCA-based controller in a bioreactor with volume greater than 100 m^3 . The dashed line in \hat{K}_{sat} indicates its setpoint. Between 1.5 and 2 hours the agitator was repaired which caused a temporary decrease in DO , it did however not appear to affect the experiment beyond this. The increase in F started at 5.5 hours, when sucrose and acetate were no longer present in significant amounts. At 8 hours, when the unperturbed feed rate had increased to six times its starting value, the FCA-based controller was automatically switched off due to decreased DO .

4

Mid-ranging control of dissolved oxygen in a bioprocess

Mid-ranging control is a simple control structure for control of one variable using two actuators. It can simply be described as using the primary actuator to regulate the controlled variable while the secondary actuator is used to prevent the first one from saturating. It is commonly used in industry [Allison and Ogawa, 2003] and is sometimes labelled valve-position control as this is a classical example of its usage. The structure of a mid-ranging controller is given in figure 4.1.

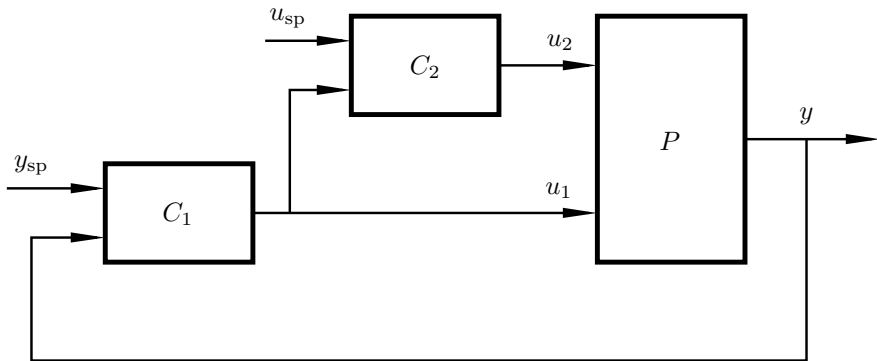

Figure 4.1 The classical mid-ranging controller structure, using two controllers C_1 and C_2 to control the process P . The effects of the actuator signals u_1 and u_2 on the controlled variable y can be additive, which is the simplest case, but they may also interact in other ways.

Ideally, the actuator used to regulate the controlled variable is fast and thus able to rapidly compensate for variations. It does not need to have a wide range within which it can operate as the secondary actuator will seek to control it to the middle of its operating range, hence the name of the method. Conversely, the second actuator does not have to be fast but should preferably have a large operating range. In such a set-up, the mid-ranging control structure allows for the advantages of both actuators to be combined to give a controller with rapid actuation as well as a large operating range.

4.1 The challenge in non-stationary processes

Mid-ranging control is useful for keeping the controlled variable at its setpoint when the process it acts on is near steady-state. However for a non-stationary process where the actuators can be expected to go from one end of their operating range to the other over the course of their operation, the mid-ranging scheme is not as suitable. This can occur when the process is exposed to a disturbance whose magnitude increases over time; the problem is illustrated in figure 4.2 where a ramp disturbance is used. As seen there, the controllers will take turns increasing to counteract the disturbance. When it is desirable to have them increase in unison, this set-up will therefore not give satisfactory performance.

4.2 Handling non-stationarity

A minor modification to the mid-ranging controller structure is proposed in paper III, which makes it suitable for controlling a non-stationary system where the actuator signals should act in unison. The secondary controller is set to control the primary actuator to the secondary actuator's value, possibly with an offset and/or scaling, instead of to a constant setpoint. The modified mid-ranging set-up is illustrated in figure 4.3.

4.3 Dissolved oxygen control

In an aerobic bioprocess, control of dissolved oxygen (DO) is critically important. The most important objective is to avoid DO limitation, which is typically achieved by using a setpoint for DO well above zero. It is however also desirable not to keep DO higher than necessary, as this requires a higher power input.

DO can be controlled through a number of process inputs, the most obvious ones being agitator speed AG and aeration rate AR . It can also be controlled through gas pressure and through addition of pure oxygen

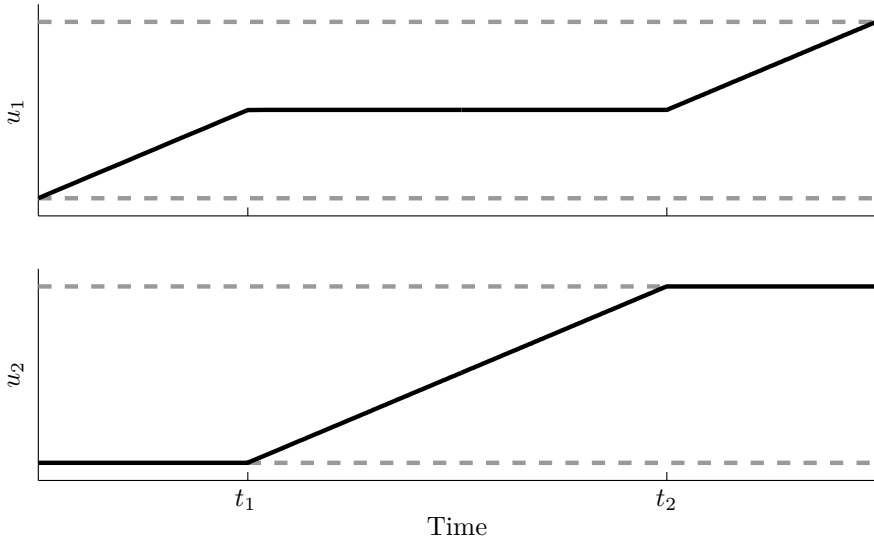

Figure 4.2 Actuator signals in a simulated mid-ranging controller set up as per figure 4.1. The process is $y = u_1 + u_2 + d$ where d is a ramp disturbance, both controllers are of PI type with constraints on their outputs and high gains. Limits of the actuator signals are indicated by dashed grey lines. Before t_1 and after t_2 , only u_1 acts to counter the ramp disturbance while between these points in time only u_2 is acting.

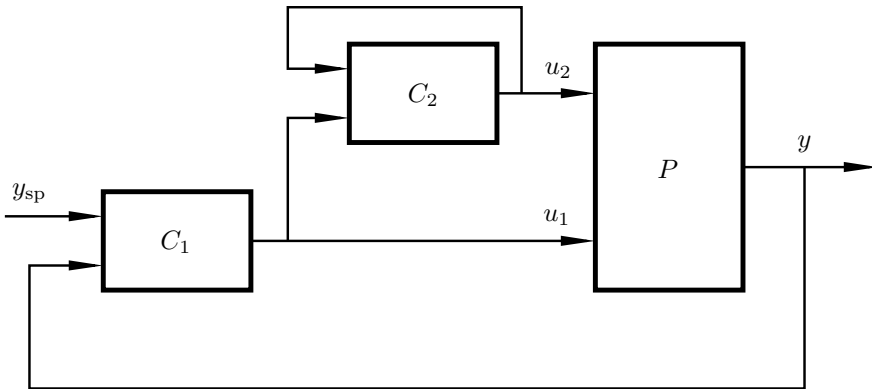

Figure 4.3 The mid-ranging controller structure, adjusted for control of a non-stationary system. The set-up is similar to that in figure 4.1 but rather than controlling u_1 to a fixed level, the secondary controller C_2 seeks to control u_1 to follow u_2 . An offset and/or scaling factor between the actuator signals can be included in C_2 .

in the gas inlet, for practical reasons these methods are often not desirable however. In the case where AG and AR can be used to control DO , this gives a system with two inputs and one output for which mid-ranging control can be considered.

In the case of a fed-batch process, oxygen consumption will increase significantly throughout the first phase of the process and increased levels of AG and/or AR are needed to maintain DO at its setpoint. This makes the mid-ranging strategy for non-stationary processes interesting for this type of system.

Oxygen transfer through a liquid medium can be described as in (4.1), where q_o is the volumetric mass transfer rate of oxygen, k_l is the mass transfer coefficient, a is the specific surface area and DO^* is the dissolved oxygen level when at equilibrium with the gas phase. Hence, DO^* the highest possible oxygen concentration given the current oxygen pressure in the gas phase.

$$q_o = k_l a (DO^* - DO) \quad (4.1)$$

$k_l a$ depends on AG and AR in a multiplicative manner, their relationship can be expressed as in (4.2). The exponents a and b can vary significantly in different settings, typical values are $a \in [1.14, 2]$, $b \in [0.025, 0.4]$ [Villadsen et al., 2011]. The multiplicative relationship means that increasing them in unison is desirable, rather than one at a time.

$$k_l a \propto AG^a \cdot AR^b \quad (4.2)$$

4.4 Implementation in pilot scale

The mid-ranging controller for non-stationary systems was implemented for DO control in pilot-scale bioreactors with a volume of 0.550 m^3 , of the type described by Albæk et al. [2008], controlled using the DeltaV control system which was connected to a computer running the mid-ranging controller in Matlab. Agitation was used as the primary control loop and aeration as the secondary. This was motivated by the effect of the former on DO being faster and AG also having a greater effect when actuator values are the same as its exponent in (4.2) has a higher value.

Both controllers were of PI type using gain scheduling based on AG . The primary control loop was tuned using the lambda tuning rules as described by for instance Åström and Hägglund [2006], with $T_{c1} = T$. The secondary control loop was manually tuned to act at low frequencies and not interfere with the primary control loop. An offset was added to the secondary controller setpoint, as it was considered beneficial to allow AG to increase to a certain level before AR was raised.

The results of an experiment utilizing the mid-ranging DO controller in conjunction with a feed rate controller of the type described in section 3.4

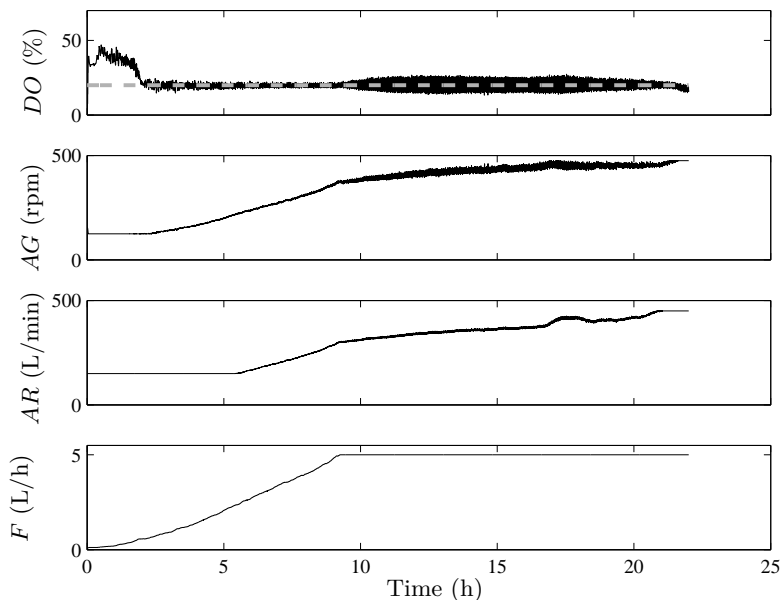

Figure 4.4 Experiment using the mid-ranging controller and a probing feed rate controller. The DO setpoint of 20 % is shown as a dashed line in the DO graph. AG and AR rise in unison and maintain a desired offset for as long as possible. The DO baseline is well maintained over time.

are shown in figure 4.4. As seen there, the controller achieves its objective of maintaining DO setpoint following while AG and AR increase in unison. Variations seen in DO are caused by the substrate feed, which was applied in a pulse-wise manner and was used by the feed rate controller. It was therefore not desirable to counteract them and the DO signal was notch-filtered to attenuate the pulse frequency before the signal was passed to the controller.

5

Conclusions

The frequency content analysis (FCA) method proposed in this thesis develops the probing control strategy through the use of a repeated perturbation at a given frequency. This allows for simple quantification of the response through the content of the relevant frequency in the measured signal. The response is evaluated at each sampling point, rather than performing a perturbation and waiting for its response to appear.

As probing control has very low requirements on modelling and sensing, the concept is well suited for industrial applications. FCA-based monitoring and control is suitable for large-scale processes, as repeated perturbations of for instance sinusoidal shape can easily be followed by actuators in such processes. Another advantage of the method is that the DO base level, DO_0 , is easily obtained by attenuating the perturbation response using a notch filter.

In this thesis, the application of the FCA concept has been tested experimentally in industrial pilot and production scale. It has been shown that the concept can be used to achieve good estimates of the current feed demand in the process, also when a complex medium is used. Simple controllers using these estimates to control the feed rate can give fast and appropriate responses to variations in the feed demand, also in production scale where the response is delayed due to long mixing times.

The method is based on a concept which does not depend on knowing the composition of the liquid medium or the values of metabolic parameters and is relatively insensitive to these, although variations in the sensitivity to overflow metabolism can have an impact. This means that the method is easy to transfer to processes utilizing different microbial strains and media and to compare the outcomes in these.

The factor which has the most significant impact on the method in large-scale bioreactors is mixing, which depends on bioreactor geometry and stirring. Longer mixing times do not only give a slower system response, the response can also be strongly attenuated unless the perturbation frequency is decreased. This means that for implementing the method in a bioprocess

for which reactor geometry and stirring is different from that of processes it has previously been used in, a pre-study should be performed to determine the gain and speed of the unsaturated system response.

In a bioprocess using FCA-based control of the feed rate, suitable actuators for dissolved oxygen control are the agitator speed and aeration rate. In such a set-up, mid-ranging control is a suitable control structure. However, the classical mid-ranging control structure is not suited for control of non-stationary processes when it is desirable to have the actuator signals increase in unison, for instance due to multiplicative effects of these.

A modified mid-ranging structure is proposed in this thesis, where the secondary controller seeks to have the actuator signals follow each other. The modification is minor and does not add to the complexity of the control structure; an offset and/or scaling factor between the actuator signals can also be added.

The proposed control structure has been implemented for control of the dissolved oxygen level in pilot-scale bioprocesses, combined with an FCA-based feed rate controller. The results show that the modified mid-ranging control structure performs as intended and maintains a desired offset between actuator signals for as long as possible. This set-up also demonstrates how an FCA-based controller can easily be used without having its perturbations interfere with other control systems, by notch filtering signals to attenuate the perturbation frequency before they are used for control.

Possible future developments of the FCA method include the use of multi-frequency perturbations to increase the rate at which the current system state can be estimated. However, the choice of frequencies has to be considered carefully. This also adds to the complexity of the method, which may have an impact on its suitability for use in an industrial context.

Another possible development of the findings of this thesis is to utilize the transient seen in the dissolved oxygen signal when microbial metabolism switches from production of overflow metabolites to consumption of these. Incorporating this into a model of microbial metabolism can allow for better monitoring and control of the metabolic state during the initial phase of a fed-batch bioprocess.

Use of more detailed mixing models has the potential to improve the performance of the method; for use in other bioreactor types than stirred tank reactors, mixing models for these should be studied. As long as mixing effects are taken into account, there is conceptually nothing which hinders the FCA method from being used in a wide range of microbial production processes in industry.

Bibliography

- Åkesson, M. (1999). *Probing control of glucose feeding in Escherichia coli cultivations*. PhD thesis ISRN LUTFD2/TFRT-1057-SE. Department of Automatic Control, Lund Institute of Technology, Sweden.
- Åkesson, M., P. Hagander and J. P. Axelsson (1997). “A pulse technique for control of fed-batch fermentations”. In: *Proceedings of the 1997 IEEE International Conference on Control Applications*, pp. 139–144.
- Albæk, M. O., K. V. Gernaey and S. M. Stocks (2008). “Gassed and un-gassed power draw in a pilot scale 550 litre fermentor retrofitted with up-pumping hydrofoil B2 impellers in media of different viscosity and with very high power draw”. *Chemical Engineering Science* **63**:24, pp. 5813–5820.
- Allison, B. J. and S. Ogawa (2003). “Design and tuning of valve position controllers with industrial applications”. *Transactions of the Institute of Measurement and Control* **25**:1, pp. 3–16.
- Åström, K. J. and T. Hägglund (2006). *Advanced PID control*. ISA - The Instrumentation, Systems, and Automation Society, Research Triangle Park, North Carolina, United States of America.
- Berg, J. M., J. L. Tymoczko and L. Stryer (2002). *Biochemistry*. 5th ed. W.H. Freeman and Company, New York, New York, United States of America.
- Bittner, C., G. Wehnert and T. Scheper (1998). “In situ microscopy for on-line determination of biomass”. *Biotechnology and Bioengineering* **60**:1, pp. 24–35.
- Brooks, S. L., R. E. Ashby, A. P. F. Turner, M. R. Calder and D. J. Clarke (1988). “Development of an on-line glucose sensor for fermentation monitoring”. *Biosensors* **3**:1, pp. 45–56.
- Bud, R. (1989). “History of biotechnology”. *Encyclopedia of Life Science*.
- Chen, L. Z., S. K. Nguang, X. M. Li and X. D. Chen (2004). “Soft sensors for on-line biomass measurements”. *Bioprocess and Biosystems Engineering* **26**:3, pp. 191–195.

- Chisti, Y. (1992). "Build better industrial bioreactors". *Chemical Engineering Progress* **88**:1, pp. 55–58.
- Cohen, S. N., A. C. Chang, H. W. Boyer and R. B. Helling (1973). "Construction of biologically functional bacterial plasmids in vitro". *Proceedings of the National Academy of Sciences* **70**:11, pp. 3240–3244.
- Al-Dahhan, M. H. and M. P. Duduković (1995). "Catalyst wetting efficiency in trickle-bed reactors at high pressure". *Chemical Engineering Science* **50**:15, pp. 2377–2389.
- de Maré, L. (2006). *Feeding strategies based on probing control for E. coli and V. cholerae Cultivations*. PhD thesis ISRN LUTFD2/TFRT-1076-SE. Department of Automatic Control, Lund Institute of Technology, Sweden.
- Demain, A. L. and P. Vaishnav (2009). "Production of recombinant proteins by microbes and higher organisms". *Biotechnology Advances* **27**:3, pp. 297–306.
- Dochain, D., M. Perrier and M. Guay (2011). "Extremum seeking control and its application to process and reaction systems: a survey". *Mathematics and Computers in Simulation* **82**:3, pp. 369–380.
- Eagon, R. G. (1962). "Pseudomonas natriegens, a marine bacterium with a generation time of less than 10 minutes". *Journal of Bacteriology* **83**:4, pp. 736–737.
- Fehrenbach, R., M. Comberbach and J. Petre (1992). "On-line biomass monitoring by capacitance measurement". *Journal of biotechnology* **23**:3, pp. 303–314.
- Glazer, B. T., A. G. Marsh, K. Stierhoff and G. W. Luther III (2004). "The dynamic response of optical oxygen sensors and voltammetric electrodes to temporal changes in dissolved oxygen concentrations". *Analytica Chimica Acta* **518**:1, pp. 93–100.
- Gnoth, S., M. Jenzsch, R. Simutis and A. Lübbert (2006). "Product formation kinetics in a recombinant protein production process". In: *Proceedings of the 10th international IFAC symposium on computer applications in biotechnology*. Vol. 1, pp. 197–202.
- Gnoth, S., M. Jenzsch, R. Simutis and A. Lübbert (2008). "Control of cultivation processes for recombinant protein production: a review". *Bioprocess and Biosystems Engineering* **31**:1, pp. 21–39.
- Henes, B. and B. Sonnleitner (2007). "Controlled fed-batch by tracking the maximal culture capacity". *Journal of Biotechnology* **132**:2, pp. 118–126.
- Hermann, T. (2003). "Industrial production of amino acids by coryneform bacteria". *Journal of Biotechnology* **104**:1, pp. 155–172.

- Hooper, W. D. and H. B. Ash (1934). *De re rustica*. Harvard University Press, Cambridge, Massachusetts, United States of America.
- Jacob, F. and J. Monod (1961). “Genetic regulatory mechanisms in the synthesis of proteins”. *Journal of molecular biology* **3**:3, pp. 318–356.
- Jensen, E. B. and S. Carlsen (1990). “Production of recombinant human growth hormone in *Escherichia coli*: expression of different precursors and physiological effects of glucose, acetate, and salts”. *Biotechnology and Bioengineering* **36**:1, pp. 1–11.
- Jenzsch, M., R. Simutis, G. Eisbrenner, I. Stückerath and A. Lübbert (2006). “Estimation of biomass concentrations in fermentation processes for recombinant protein production”. *Bioprocess and biosystems engineering* **29**:1, pp. 19–27.
- Johnston, W., R. Cord-Ruwisch and M. Cooney (2002). “Industrial control of recombinant *E. coli* fed-batch culture: new perspectives on traditional controlled variables”. *Bioprocess and Biosystems Engineering* **25**:2, pp. 111–120.
- Jordan, M. (2004). *Dictionary of gods and goddesses*. 2nd ed. Infobase Publishing, New York, New York, United States of America.
- Kiviharju, K., K. Salonen, U. Moilanen, E. Meskanen, M. Leisola and T. Eerikäinen (2007). “On-line biomass measurements in bioreactor cultivations: comparison study of two on-line probes”. *Journal of industrial microbiology & biotechnology* **34**:8, pp. 561–566.
- Kleman, G. L. and W. R. Strohl (1994). “Acetate metabolism by *Escherichia coli* in high-cell-density fermentation.” *Applied and environmental microbiology* **60**:11, pp. 3952–3958.
- Landgrebe, D., C. Haake, T. Höpfner, S. Beutel, B. Hitzmann, T. Scheper, M. Rhiel and K. F. Reardon (2010). “On-line infrared spectroscopy for bioprocess monitoring”. *Applied microbiology and biotechnology* **88**:1, pp. 11–22.
- Lidén, G. (2002). “Understanding the bioreactor”. *Bioprocess and Biosystems Engineering* **24**:5, pp. 273–279.
- Ljung, L. (1999). *System Identification: Theory for the User*. 2nd ed. Prentice Hall, Upper Saddle River, New Jersey, United States of America.
- Luli, G. W., S. M. Schlasner, D. E. Ordaz, M. Mason and W. R. Strohl (1987). “An automatic, on-line glucose analyzer for feed-back control of fed-batch growth of *Escherichia coli*”. *Biotechnology techniques* **1**:4, pp. 225–230.
- Luli, G. W. and W. R. Strohl (1990). “Comparison of growth, acetate production, and acetate inhibition of *Escherichia coli* strains in batch and fed-batch fermentations”. *Applied and Environmental Microbiology* **56**:4, pp. 1004–1011.

- Luttmann, R., D. G. Bracewell, G. Cornelissen, K. V. Gernaey, J. Glassey, V. C. Hass, C. Kaiser, C. Preusse, G. Striedner and C.-F. Mandenius (2012). “Soft sensors in bioprocessing: a status report and recommendations”. *Biotechnology Journal* **7**:8, pp. 1040–1048.
- El-Mansi, M. (2004). “Flux to acetate and lactate excretions in industrial fermentations: physiological and biochemical implications”. *Journal of Industrial Microbiology and Biotechnology* **31**:7, pp. 295–300.
- McGovern, P. E., J. Zhang, J. Tang, Z. Zhang, G. R. Hall, R. A. Moreau, A. Nuñez, E. D. Butrym, M. P. Richards, C.-s. Wang et al. (2004). “Fermented beverages of pre-and proto-historic China”. *Proceedings of the National Academy of Sciences of the United States of America* **101**:51, pp. 17593–17598.
- Navrátil, M., A. Norberg, L. Lembrén and C.-F. Mandenius (2005). “On-line multi-analyzer monitoring of biomass, glucose and acetate for growth rate control of a *Vibrio cholerae* fed-batch cultivation”. *Journal of Biotechnology* **115**:1, pp. 67–79.
- Novozymes (2015). *The Novozymes Report 2014*.
<http://report2014.novozymes.com>. Accessed 2015-11-23.
- Nutton, V. (1990). “The reception of Fracastoro’s Theory of contagion: the seed that fell among thorns?” *Osiris*, pp. 196–234.
- Paul, E. L., V. Atiemo-Obeng and S. M. Kresta (2004). *Handbook of industrial mixing: science and practice*. Wiley, Hoboken, New Jersey, United States of America.
- Prescott, L. M., J. P. Harley and D. A. Klein (2005). *Microbiology*. 6th ed. McGraw–Hill companies, Inc., New York, New York, United States of America.
- Rocha, I. and E. Ferreira (2002). “On-line simultaneous monitoring of glucose and acetate with FIA during high cell density fermentation of recombinant *E. coli*”. *Analytica Chimica Acta* **462**:2, pp. 293–304.
- Rosso, L., J. Lobry, S. Bajard and J. Flandrois (1995). “Convenient model to describe the combined effects of temperature and pH on microbial growth.” *Applied and environmental microbiology* **61**:2, pp. 610–616.
- Schaepe, S., A. Kuprijanov, R. Simutis and A. Lübbert (2014). “Avoiding overfeeding in high cell density fed-batch cultures of *E. coli* during the production of heterologous proteins”. *Journal of Biotechnology* **192**, pp. 146–153.
- Schmidt, F. R. (2005). “Optimization and scale up of industrial fermentation processes”. *Applied Microbiology and Biotechnology* **68**:4, pp. 425–435.
- Shimizu, K. (1993). “An overview on the control system design of bioreactors”. In: *Measurement and Control*. Springer, pp. 65–84.

- Sonnleitner, B. and O. Käppeli (1986). "Growth of *Saccharomyces cerevisiae* is controlled by its limited respiratory capacity: formulation and verification of a hypothesis". *Biotechnology and Bioengineering* **28**:6, pp. 927–937.
- Takors, R. (2012). "Scale-up of microbial processes: impacts, tools and open questions". *Journal of biotechnology* **160**:1, pp. 3–9.
- Tännler, S., S. Decasper and U. Sauer (2008). "Maintenance metabolism and carbon fluxes in *Bacillus* species". *Microbial cell factories* **7**:1, p. 19.
- Thomas, L., C. Larroche and A. Pandey (2013). "Current developments in solid-state fermentation". *Biochemical Engineering Journal* **81**:1, pp. 146–161.
- Valgepea, K., K. Adamberg, R. Nahku, P.-J. Lahtvee, L. Arike and R. Vilu (2010). "Systems biology approach reveals that overflow metabolism of acetate in *Escherichia coli* is triggered by carbon catabolite repression of acetyl-CoA synthetase". *BMC systems biology* **4**:1, p. 166.
- Velut, S. (2005). *Probing control. Analysis and design with application to fed-batch bioreactors*. PhD thesis ISRN LUTFD2/TFRT-1072-SE. Department of Automatic Control, Lund Institute of Technology, Sweden.
- Velut, S., A. Castan, K. A. Short, J. P. Axelsson, P. Hagander, B. A. Zditosky, C. W. Rysenga, L. De Maré and J. Haglund (2007). "Influence of bioreactor scale and complex medium on probing control of glucose feeding in cultivations of recombinant strains of *Escherichia coli*". *Biotechnology and Bioengineering* **97**:4, pp. 816–824.
- Villadsen, J., J. Nielsen and G. Lidén (2011). *Bioreaction engineering principles*. Springer, New York, New York, United States of America.
- Voigt, B., T. Schweder, D. Becher, A. Ehrenreich, G. Gottschalk, J. Feesche, K.-H. Maurer and M. Hecker (2004). "A proteomic view of cell physiology of *Bacillus licheniformis*". *Proteomics* **4**:5, pp. 1465–1490.
- Xu, B., M. Jahic and S.-O. Enfors (1999). "Modeling of overflow metabolism in batch and fed-batch cultures of *Escherichia coli*". *Biotechnology progress* **15**:1, pp. 81–90.
- Zeng, A.-P. and W.-D. Deckwer (1995). "A kinetic model for substrate and energy consumption of microbial growth under substrate-sufficient conditions". *Biotechnology progress* **11**:1, pp. 71–79.
- Zhang, J. and R. Greasham (1999). "Chemically defined media for commercial fermentations". *Applied Microbiology and Biotechnology* **51**:4, pp. 407–421.

Paper I

Feed rate control in fed-batch fermentations based on frequency content analysis

Ola Johnsson, Jonas Andersson, Gunnar Lidén,
Charlotta Johnsson and Tore Hägglund

Abstract

A new strategy for controlling substrate feed in the exponential growth phase of aerated fed-batch fermentations is presented. The challenge in this phase is typically to maximize specific growth rate while avoiding the accumulation of overflow metabolites which can occur at high substrate feed rates. In the new strategy, regular perturbations to the feed rate are applied and the proximity to overflow metabolism is continuously assessed from the frequency spectrum of the dissolved oxygen signal. The power spectral density for the frequency of the external perturbations is used as a control variable in a controller to regulate the substrate feed. The strategy was implemented in an industrial pilot scale fermentation set up and calibrated and verified using an amylase producing *Bacillus licheniformis* strain. It was shown that a higher biomass yield could be obtained without excessive accumulation of harmful overflow metabolites. The general applicability of the strategy was further demonstrated by implementing the controller in another process utilizing a *B. licheniformis* strain currently used in industrial production processes. Also in this case a higher growth rate and decreased accumulation of overflow metabolites in the exponential growth phase was achieved in comparison to the reference controller.

© 2013 American Institute of Chemical Engineers. Printed with permission. Published in *Biotechnology progress*. The article has been modified to fit the current format.

1. Introduction

Many production microorganisms in the biotechnology industry show overflow metabolism, that is, the excretion of metabolic by-products such as ethanol, acetate and lactate, at high substrate uptake rates [Tempest and Neijssel, 1979]. This is well-known for the commonly used bacterium *Escherichia coli* [Neijssel et al., 1980] and the yeast *Saccharomyces cerevisiae* [Sonnleitner and Käppeli, 1986] but also for the bacterium *Bacillus licheniformis* which for instance is a host organism for amylase production [Voigt et al., 2004]. Overflow metabolism allows for increased short-term growth, but is undesirable in many industrial processes [El-Mansi, 2004]. The by-products not only decrease the yield directly by diverting substrate but furthermore often influence the process negatively by inhibition effects caused by the by-products; a well-known example is the inhibitory effects on growth caused by too high concentrations of acetic acid [Luli and Strohl, 1990]. These compounds can not only inhibit growth but also reduce the production of heterologous proteins [Jensen and Carlsen, 1990]. Each of these effects may severely impact the productivity of fed-batch fermentations.

In fed-batch production processes it is therefore important to maintain a feed rate low enough to avoid overflow metabolism. At the same time, as high feed rate as possible is desired to obtain a high volumetric productivity. The challenge in feed rate control is thus to find a feed rate which gives as high growth rate as possible, while avoiding the saturation in oxidative capacity or other rate limiting steps in the respiratory metabolism.

The maximum desirable feed rate is determined by overflow metabolism only in the first phase of the fed-batch cultivation, before oxygen or heat transfer limitations set in. This first phase will here be referred to as the exponential growth phase. At sufficiently high biomass concentration, the oxygen demand of the microorganisms for maintaining exponential growth at the desired specific growth rate will exceed the oxygen transfer capacity of the fermentor system. From this point and onwards, the maximum allowable substrate feed rate will simply be determined by the maximum volumetric oxygen transfer rate. It deserves to be pointed out that although the overflow metabolism problem is mostly relevant in the exponential growth phase, this phase is highly critical for the entire process. Overflow metabolism or carbon starvation in the exponential growth phase can have a severe inhibiting effect on cell growth and product formation and can even cause a complete process failure in the latter phase of the process.

In practice, it is difficult to obtain an optimal feed rate for three reasons. The first reason is that the optimal feed rate depends on the total amount of biomass, which increases exponentially, meaning that the rate spans a large range. Secondly, the concentrations of biomass, substrate and overflow metabolite can be difficult to measure *in-situ*. Finally, even if the biomass

concentration is precisely monitored, its maximum oxidative capacity can vary due to metabolic shifts [Swartz, 1996].

Observers (software incorporating a model of the system to make estimates of its state from various measurements) can be developed to estimate these concentrations, but require a well-tuned model and typically require some measurements for which good *in-situ* probes are not widely used today such as substrate concentration and/or assumptions of constant yield parameters [Ch eruy, 1997; Seli teanu et al., 2008; Dewasme and Vande Wouwer, 2008; Riesenber  and Guthke, 1999; Gnoth et al., 2008]. A further complication is that industrial processes typically utilize complex media containing several carbon sources, meaning that even if the concentration of the principal carbon source could be measured reliably, it would not necessarily be sufficient to predict when overflow metabolism occurs due to the presence of additional carbon sources. Another option for obtaining good process control is to use artificial neural networks (ANN) and similar methods. These are popular in some implementations, but have the disadvantage that they require large amounts of historical data from the process in order to be useful [Riesenber  and Guthke, 1999; Gnoth et al., 2008].

An alternative strategy, which circumvents these problems, is to instead measure the system response to variations in the feed rate, a so-called “probing control” approach [ kesson, 1999]. A suitable response variable is the dissolved oxygen saturation (DO) in the fermentation broth, as consumption of oxygen is directly coupled to the occurrence of overflow metabolism. Robust, fast and precise probes for measuring dissolved oxygen are routinely used in the fermentation industry, making this a highly suitable measurement upon which to base feed rate control.

The DO response to perturbations in the feed rate has been used for control purposes by  kesson [1999] and, with some modifications, by for instance Whiffin et al. [2004], Velut [2005], de Mar  [2006] and Henes and Sonnleitner [2007]. Common for all of these strategies is that tracking of the optimal feed rate is not continuous. Instead, singular perturbations are performed and after such a perturbation, the DO response is evaluated and the feed rate changed at a discrete point in time. After a certain delay, during which DO values are not used to track the optimal feed rate, a new perturbation is performed and the process is repeated. This typically gives a piecewise linear feed rate trend.

In the current work, a different method of analysis of the response to external feed rate perturbations is used. The frequency spectrum of the DO signal is calculated and the power spectral density for frequencies close to that of the externally applied disturbances is used to derive a control variable upon which to base a regulator. This allows continuous tracking of the optimal feed rate and avoids the risk inherent in probing control that a disturbance in DO during a pulse will have a significant effect on the feed rate. The method

Table 1. Nomenclature.

	Symbol	Unit
Controller variables		
Dissolved oxygen saturation	DO	%
Content of relevant frequency	C	Power units
Relevant frequency of perturbations	ω_{rel}	Hz
Feed rate	F	L/h
Controller parameters		
Sampling frequency	h	Hz
Filter length	m	Sampling points
Frequency band width	d	Hz
Controller gain	K	L/h/power units
Controller integral time	T_i	s
Off-line measurements		
Substrate concentration	s	g/L
Acetate concentration	A	g/L
Biomass concentration	X	g/L

has been implemented, tuned and demonstrated in pilot scale (0.550 m³) fed-batch production of amylase using a model strain of *B. licheniformis* as well as in a second proprietary fermentation process. The fermentations were characterized in terms of overflow metabolites, biomass yield and volumetric productivities.

2. Theoretical aspects

2.1 Nomenclature

Throughout this work, a number of different parameters are used to describe the system and the controller. Their descriptions and units can be found in table 1.

2.2 Basic principles of the controller

The dynamics from the input signal (feed rate) to output signal (DO measurement) mainly depend on five processes: substrate delivery, substrate mixing, microbial uptake of substrate and oxygen, oxygen mixing and oxygen measurement. Mixing can be described using first order dynamics, and the dynamics of substrate delivery and oxygen measurement can be included in this process. The kinetics of the oxidative metabolism in an aerobic environment is well described by a saturation kinetics model, as the oxygen uptake rate r_o is determined by and stoichiometrically coupled to the substrate uptake rate r_s , as long as the maximum oxidative capacity of the cell is not exceeded. The substrate uptake rate at which the maximum r_o is exactly reached at fully respiratory conditions is referred to as $r_{s,\text{crit}}$. This is illus-

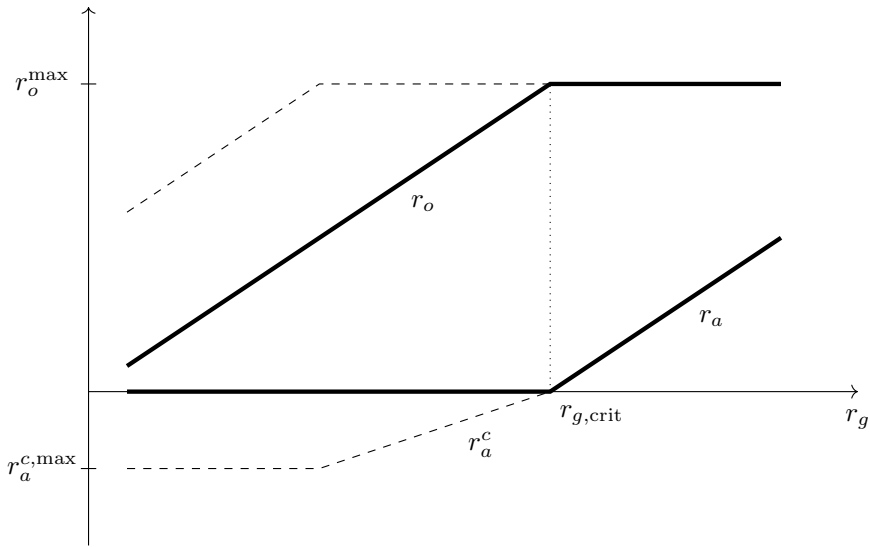

Figure 1. The relation between glucose uptake rate r_g and the rates of oxygen uptake r_o and acetate production r_a , showing the limitation of oxidative metabolism at $r_{g,crit}$ which is marked with a dotted line. Dashed lines indicate uptake of acetate, which can only occur if acetate is present and the glucose uptake rate sufficiently low [Åkesson, 1999].

trated in figure 1 for a case in which glucose (g) is the limiting substrate and acetate (a) the overflow metabolite, as in many *B. licheniformis* processes.

As perturbations to the feed rate occur the substrate concentration in the broth will change, which in turn will lead to a change in substrate uptake rate. This will lead to one of three different outcomes:

1. r_s is at all points above $r_{s,crit}$. As the oxidative capacity is limiting, no change in r_o will be observed.
2. r_s crosses $r_{s,crit}$ at least once during the perturbation. A change in r_o will occur, but will be limited by the saturation.
3. r_s is at all points below $r_{s,crit}$. The saturation will have no influence on the outcome and the change in r_o will be the highest possible (limited only by the amplitude of the perturbation).

For outcome 2, the size of the change in r_o is related to the distance from r_s to $r_{s,crit}$. For outcomes 1 and 3, it is possible to determine which of these that has occurred, giving the sign and minimum value of the distance from r_s to $r_{s,crit}$. The principle behind the control strategy is that perturbations to

the feed rate can be repeated with a known time interval (that is, the signal has a known, constant frequency). The output signal will have a different shape than the input signal, but its frequency will be the same.

Rather than using the *DO* signal directly to determine the effect of the perturbations, as done in the probing control strategy [Åkesson, 1999], the frequency spectrum of the *DO* signal is here obtained through Fourier transformation and studied. As noise in the *DO* signal typically occurs in a different frequency band than that of the perturbations, these are easily separated and it becomes possible to get a direct measure of the influence of the perturbations. A larger content of the relevant frequency indicates that the average value of r_s over time is below $r_{s,\text{crit}}$, while a smaller content indicates that r_s is on average above $r_{s,\text{crit}}$. This means that a controller provided with a suitable setpoint for the content of the relevant frequency can be used to keep r_s at $r_{s,\text{crit}}$ using the feed rate as the manipulated variable.

3. Controller details

The content of a certain frequency in a signal can be described by its power spectral density (*PSD*). To dampen the effect of minor process disturbances, the summed *PSD* of a small band of frequencies around the relevant frequency was used rather than that of one specific frequency (figure 2). Furthermore, to reduce noise this value was filtered using a very simple filter giving the average value over a predefined interval of sampling points as the output. To achieve a good measurement of the system's response to perturbations, the sampling points used by the filter should cover at least one period of the perturbation and preferably more, this is however a tradeoff against the speed of the controller as including more data points will make the filter respond more slowly to changes in the process. The relationship given in (1), where PSD_ω denotes the power spectral density of a frequency ω and d is the predefined size of the frequency band around the relevant frequency ω_{rel} , shows the calculation of the frequency content C at the current sampling point k , filtered over m points. Using the variable C to determine the status of the process will be referred to as frequency content analysis (FCA).

$$C_k = \frac{1}{m} \sum_{i=k-m}^k \left(\sum_{\omega=\omega_{\text{rel}_i-d/2}}^{\omega_{\text{rel}_i+d/2}} PSD_{\omega_i} \right) \quad (1)$$

A small value of C indicates that the system is close to the saturation caused by oxidative limitation whereas a large value indicates that the system is far below this level (figure 1) and therefore, in order to control the feed rate of the process using FCA it is natural to employ proportional feedback control. Such control is typically coupled with integral control in order

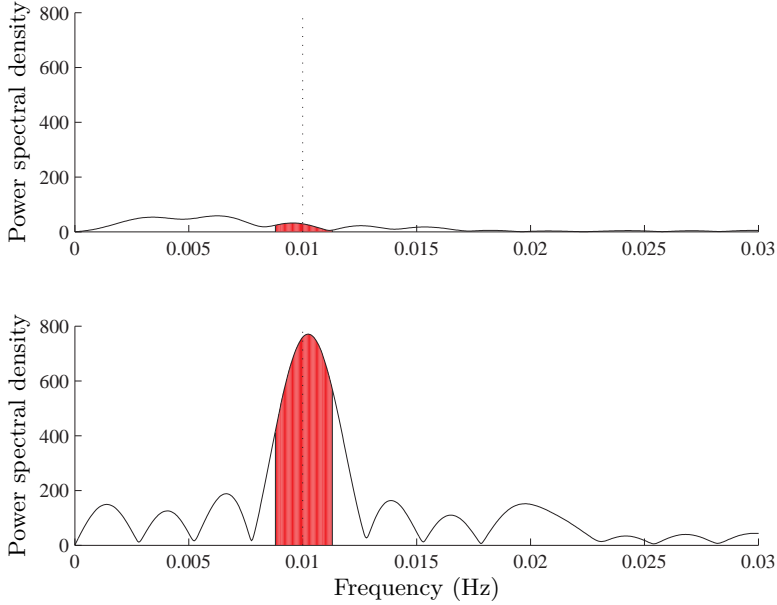

Figure 2. Frequency spectra of the DO signal. The upper diagram is from a point in time when perturbations have little influence on DO , while the lower diagram is from a point where perturbations have large influence. C , the summed content of frequencies in a band around the frequency of the perturbations in the input (in this case 0.01 Hz, marked with a dotted line), is shown as a shaded area.

to avoid static errors. In this implementation the microbial consumption of feed can be considered as a disturbance on the system and as this disturbance follows microbial growth, meaning that it increases exponentially, an integrating controller will not be sufficient to avoid static errors. This was not considered a major problem as the true aim of the controller was not to follow a setpoint for C but to increase the feed rate to keep up with the demands of the exponentially growing consumption without excessive overflow metabolism. Nonetheless, to partially counteract the exponentially growing consumption, an integral term was added. The main solution used to solve this problem was however to add gain scheduling to the controller.

The expression (2) shows how the feed rate, F , is changed based on C and its setpoint C_{sp} . Its form is similar to that of a discrete-time proportional-integral (PI) controller with sampling rate h , gain K and integral time T_i .

A gain scheduling factor, here chosen as in (3), is necessary as the dynamics of the process change with increasing volume and biomass concentration.

$$F_k = \frac{K}{h} \left((C_{\text{sp}} - C_k) + \frac{h}{T_i} \sum_{1 \leq j \leq k} (C_{\text{sp}} - C_j) \right) \quad (2)$$

$$K = K_0 \sqrt{\frac{F_{k-1}}{F_{\text{min}}}} \quad (3)$$

To avoid dissolved oxygen limitation while also avoiding an unnecessarily high agitator speed (*AG*) or aeration rate (*AR*) a parallel control system is run controlling *DO* (using a setpoint of 20 %) using *AG* and *AR* as manipulated variables. A PI controller using gain scheduling based on the *AG* value is used to control *AG*, when it reaches its maximum value the PI controller switches to controlling *AR* instead. In difference to the original probing control scheme, the *DO* controller and the feed rate controller are active at the same time. Instead, the parameters of the *DO* controller are set so that it is comparatively slow and will not significantly influence perturbations in *DO* at the relevant frequency. This is possible as the feed rate controller based on FCA does not require strict adherence to the baseline defined by the *DO* setpoint. The FCA controller is only used until the maximum capacity of the fermentor (oxygen transfer, pH regulation and/or cooling capacity) is reached. At this point the exponential growth phase is over and overflow metabolism is no longer a major issue.

4. Materials and methods

4.1 Fermentation equipment

A number of 0.550 m³ pilot scale fermentors (0.350 m³ fill volume) described in [Albæk et al., 2008] were used. The feed system of each fermentor is discontinuous, with pulses of feed liquid being injected into the fermentor at a rate and with a volume intended to achieve the same total feed volume as the integral of the feed rate setpoint curve. While this makes it practically impossible to implement a sine wave perturbation on the feed rate, which would be the most natural thing to do for frequency response analysis, the feed pulses themselves can be seen as regular perturbations if they are performed with a constant (or near-constant) time interval.

The control system for feed addition allows for some variation in the time between each feed pulse. As outlined in section 2, the controller can handle some variation in frequency but in order to avoid too large variations a minimum time of 100 seconds between pulses is enforced.

4.2 Strain and growth conditions

In all experiments except where noted otherwise, the recombinant amylase-producing *B. licheniformis* strain SJ4628, derived from DN286 [Fleming et al., 1995], was used. This is an older, low-yielding industrial strain developed by Novozymes A/S. In one series of experiments a newer, high-yielding strain currently used by Novozymes A/S was used to study whether the strategy could easily be transferred to processes using other strains.

For propagation, frozen bacteria were grown on agar plates and then used to inoculate a seed fermentor of the same type as the main fermentors, using 300 kg of a medium containing: soy meal, 110 g/kg; $\text{Na}_2\text{HPO}_4 \cdot 2\text{H}_2\text{O}$, 5 g/kg; antifoam agent (Pluronic/Dowfax 63 N10), 1.67 mL/kg. The seed fermentor was run for 16 hours at 37° C, pH 7 (± 0.2), using linear ramps for agitator speed and aeration rate starting at 125 rpm and 180 L/min and reaching 375 rpm and 300 L/min at 10 hours after which these were constant.

Except where noted otherwise, 33 kg broth from the seed fermentor was used to inoculate the main fermentors. In fermentations utilizing the SJ4628 strain, 300 kg of a defined medium was used and the fermentors were fed with 64 % w/w glucose. The medium contained: K_2HPO_4 , 7 g/kg; $\text{Na}_2\text{HPO}_4 \cdot 2\text{H}_2\text{O}$, 7 g/kg; K_2SO_4 , 5 g/kg; $\text{MgSO}_4 \cdot 7\text{H}_2\text{O}$, 4 g/kg; $(\text{NH}_4)_2\text{SO}_4$, 4 g/kg; citric acid, 0.78 g/kg; CaCO_3 , 1 g/kg; trace metal mix, 0.5 g/kg. The trace metal mix contained 16 % w/w $\text{MnSO}_4 \cdot \text{H}_2\text{O}$, 63 % w/w $\text{FeSO}_4 \cdot 7\text{H}_2\text{O}$, 7 % w/w $\text{CuSO}_4 \cdot 5\text{H}_2\text{O}$, 14 % w/w $\text{ZnSO}_4 \cdot 7\text{H}_2\text{O}$. In fermentations utilizing the proprietary strain, a complex, proprietary medium was used and the fermentors were fed with 64 % sucrose.

4.3 Software implementation

The fermentors were controlled using the commercial DeltaV process control system, which allowed on-line measurement of dissolved oxygen saturation (DO), pH, temperature (T) and the concentration of oxygen and carbon dioxide in the outlet gas, allowing for calculation of oxygen uptake rate (OUR) and carbon dioxide emission rate (CER). The script used to control the fermentors was developed in MATLAB and run on a separate computer, using an MX OPC server to allow it to write setpoints to and read measured data from the DeltaV system. The controller was used to control the feed rate (F), the aeration rate (AR) and the agitator speed (AG) of the processes. PSD of the frequencies in the DO signal was calculated using the Fast Fourier Transform (FFT) function in MATLAB. 2000-point FFT was used over an interval of 100 datapoints, to increase smoothness of the calculated frequency spectrum.

For all experiments, the following parameters were used: $h = 0.5$ Hz, $m = 100$ sampling points, $d = 0.0025$ Hz. The value of m was chosen so that the filter would include two periods of the perturbation; this was considered

a suitable tradeoff between noise rejection and speed. The perturbation frequency ω_{rel} varied but was in general between 0.009 and 0.01 Hz, the reason for this being that the feeding mechanism used in the fermentors only allowed poor following of its desired value which was 0.01 Hz.

4.4 Experiment design

Experiments were performed with the purpose of regulator tuning, evaluation of the process control strategy and testing its generality as described later in this section. Where applicable, comparisons to a reference controller currently used in industrial fermentations were made; the reference controller utilized a PI design regulating DO by manipulating F , with predefined ramps limiting the maximum and minimum values of F during the exponential growth phase.

Regulator tuning Analysis of data from previous fermentations indicated that a C_{sp} of 400 would be suitable to achieve fast growth without excessive production of overflow metabolites. Three fermentations were performed using a similar set-up with C_{sp} set to 400, 500 and 600 respectively. During the exponential growth phase, the parameters K and T_i were tuned manually to achieve smooth, yet fast, control of the feed rate.

Evaluation of the strategy To evaluate the strategy, three fermentations using a standard set-up were performed; two utilizing the FCA feeding strategy and one reference, using a control system currently implemented in industrial processes of this type. A similar evaluation, with one fermentation utilizing FCA control and one reference fermentation, was also performed in a set-up where the inoculation volume was 1/8 of its normal value to simulate a situation where the viable cells in the inoculation volume are fewer or the lag phase longer than expected. This can normally cause severe inhibition of cells due to excessive accumulation of acetate. In a final fermentation, large pulses of feed were added at certain points in time via a separate feeding system to study the controller's response to accumulated glucose.

Test of generality The FCA strategy was tested on a strain currently used in industrial production processes rather than the strain used for developing the strategy. Two fermentors employed the FCA strategy and a third was used as a reference. The aim was to test whether the control strategy could easily be transferred to such processes and give the same performance as in processes using SJ4628, and to assess its performance in a process using complex medium.

4.5 Off-line measurements

Off-line measurements of substrate and acetic acid were made using enzymatic kits: sucrose by "Sucrose Assay Kit", Sigma, Product code SCA-20; glucose by "D-Glucose", R-biopharm, Cat. No. 10 716 251 035; acetate by

“Acetic acid”, R-biopharm, Cat. No. 10 148 261 035. Cell concentration was calculated through measurement of cell dry mass, performed as follows. 7–10 g cell broth was poured in a pre-dried, weighed test tube and total weight was noted. The remaining volume of the tube was filled with distilled water, it was centrifuged at 2800 rpm for 20 minutes, the pellet was rinsed with distilled water and centrifuged again at 2800 rpm for 20 minutes after which the pellet was dried in an oven overnight. Cell dry weight concentration was defined as the weight of the pellet divided by the weight of the broth. Three samples were made for each measurement point in each fermentation. Dry weight measurements were not carried out for two hours after inoculation as non-bacterial solid matter from the inoculation volume would distort measurements greatly, an effect which may also be present to a smaller extent in measurements from two hours and forward.

5. Results and discussion

5.1 Regulator tuning

Over the first 3.5 hours of the fermentations, manual tuning of the controller took place in order to give a smooth trajectory of F (figure 3). Based on the shape of this feed rate curve, tuning was considered successful. Glucose and acetate levels were low in all fermentations as seen in figure 3, indicating that values of C_{sp} in the chosen interval (400 – 600) would not give excessive overflow metabolism. For future experiments a C_{sp} value of 400 was therefore chosen, as higher values would give more conservative feed profiles. In the fermentation labelled FCA 1:2 volumetric growth of biomass was significantly slower than in the others, with a very long lag phase after inoculation. This does however not influence the conclusions drawn from this experiment.

5.2 Evaluation of the strategy

The two FCA-controlled fermentations gave very similar results, with almost identical feed rate curves as can be seen in figure 4, showing that the FCA strategy provides good repeatability of fermentations. A comparison between these two and the reference showed that while neither gives any major acetate accumulation, the increase in biomass concentration from 2 to 10 hours was 33 % respectively 24 % higher (cell dry weight) in the FCA-controlled fermentations compared to the reference, whereas none of the fermentations exhibit excessive production of acetate (figure 4). It is important to note that the controller is not designed with the purpose of C to reach its reference value, rather it is the difference between these which drives the increase in F .

In the set-up using 1/8 of the normal inoculation volume, the FCA-controlled fermentation showed a considerably lower slope of the feed rate than that of the reference initially (figure 5). Acetate accumulation in the

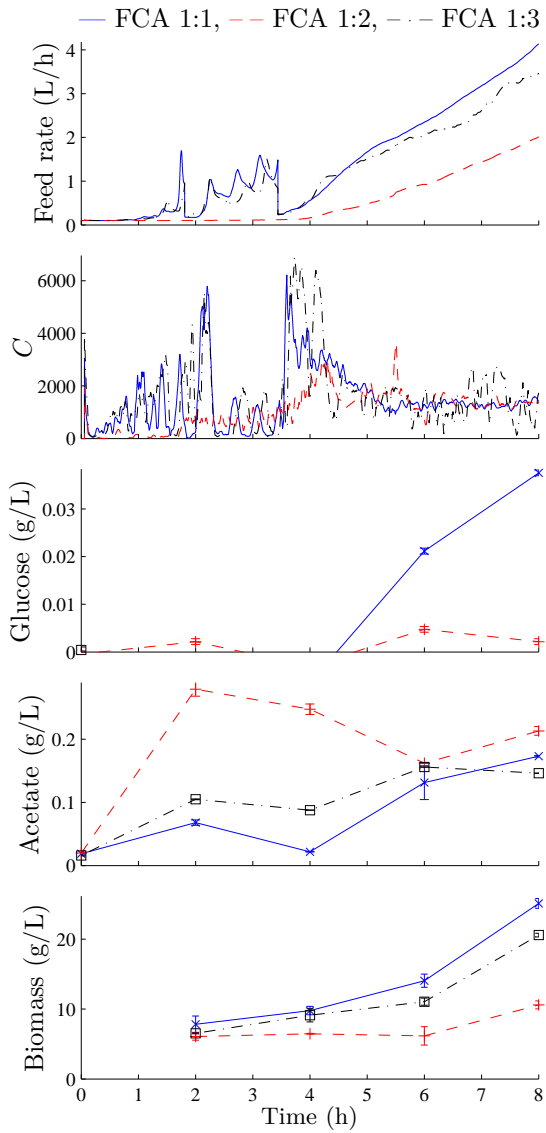

Figure 3. Exponential growth phase of fermentations FCA 1:1–1:3, all of which were controlled using the FCA controller using different setpoints. From 0 to 3.5 hours tuning of the feed rate controller was performed; after 3.5 hours tuning was considered successful based on the behaviour of the feed rate curve after this point.

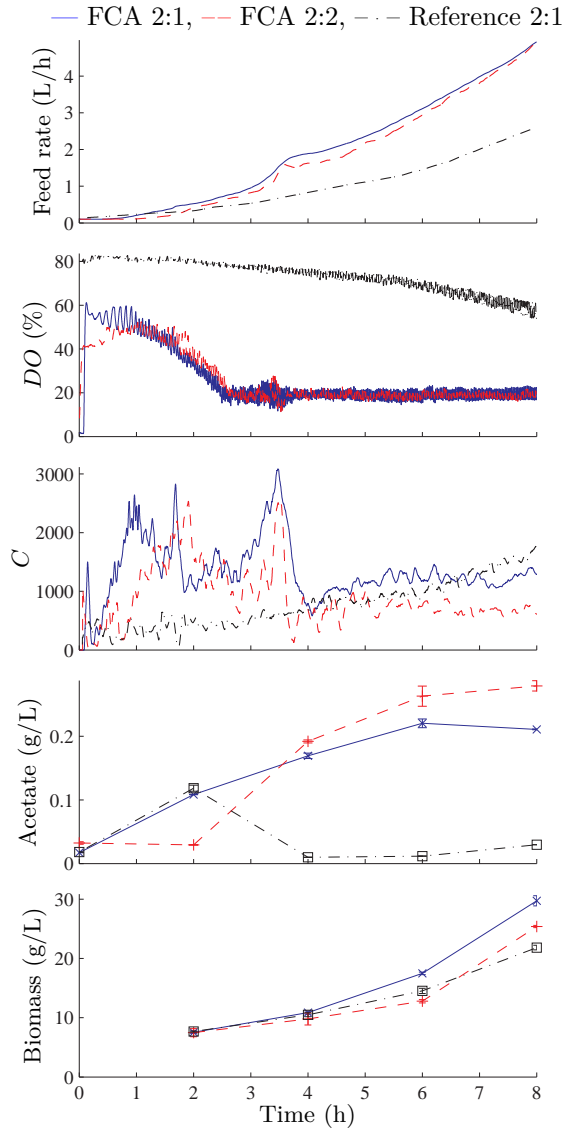

Figure 4. Fermentations FCA 2:1 and 2:2 were controlled using the FCA controller ($C_{sp} = 400$), while the fermentation titled Reference 2:1 used the reference control strategy to enable a comparison. Glucose was measured at the same points in time as acetate and was below the detection limit (0.8 mg/L) at all points.

FCA-controlled fermentation was higher than in the standard set-up but was kept below levels considered harmful, this was due to the uptake rate of acetate in this organism being low and C_{sp} not being perfectly adjusted to the process. In the reference fermentation high concentrations of acetate (>1 g/L) were accumulated (figure 5). Although initial biomass was higher in the reference, the increase in biomass concentration was significantly slower than in the FCA-controlled fermentation towards the end of the exponential growth phase when acetate levels were high, as can be seen in figure 5. This indicates that growth was inhibited by acetate; at 18 hours after inoculation, this caused complete process failure in the reference fermentation. This shows that while the standard controller cannot respond to overflow metabolism, the FCA controller can do so and avoid excessive accumulation of overflow metabolites caused by it, thereby avoiding process failure.

In the fermentation where large feed pulses were added externally, the controller responded by decreasing the feed rate within 5 minutes after an external feed pulse, showing that it can rapidly detect the onset of overflow metabolism (figure 6). After the feed added by the pulse was consumed, the feed rate increased again without oscillations. It returned to a value close to where, tracing an exponential growth profile, it would be had the pulse not been added and continued following an exponential profile. This shows that the controller can also rapidly detect that overflow metabolism has ceased and switch back to increasing the feed rate at a pace suitable for keeping up with the increasing biomass concentration.

Two of the feed additions in this fermentation occurred 30 minutes or less before an acetate measurement point (at 4 and 8 hours); these points show increased acetate levels but not harmfully so, despite the volume of extra feed added being very high compared to the feed rate. For instance, at 3.5 hours 0.75 L was added while the feed rate was 1 L/h, meaning that the additional amount was equivalent to the total feed added during 45 minutes at that feed rate. The response to the pulse at 3.5 hours, whose size corresponds to 45 minutes of feeding at the current feed rate, was over in less than one hour indicating an efficient controller response.

Theoretically, the most efficient controller response would be to completely switch off the controlled feed as soon as extra feed was added and then immediately return it to levels corresponding to exponential growth when the extra feed had been consumed. This indicates that there is some room for improvement of the controller, so that the gain for negative changes of F is higher. This can be accomplished using a nonlinear transformation of C , although finding the most suitable transformation would require extensive system identification and tuning.

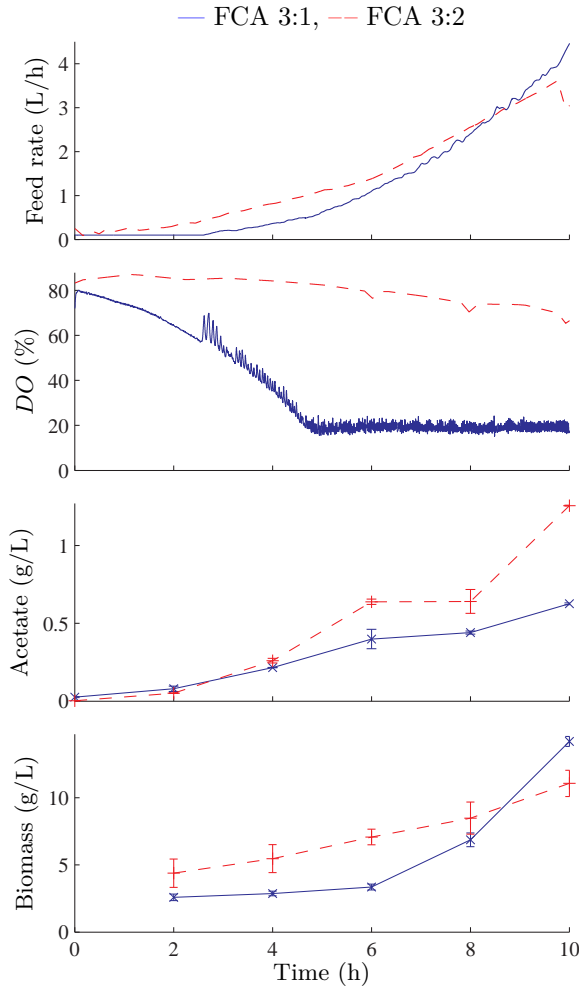

Figure 5. Controller behaviour in fermentations with decreased inoculation volume, simulating a situation where the viable cell concentration in the inoculum is lower than expected or the lag phase of the organisms is longer than expected. Fermentation FCA 3:1 was controlled using the FCA controller and Reference 3:1 by the reference strategy. In both fermentations, the inoculation volume was 1/8 of its normal value in order to challenge the FCA controller and enable a comparison to the reference during these conditions.

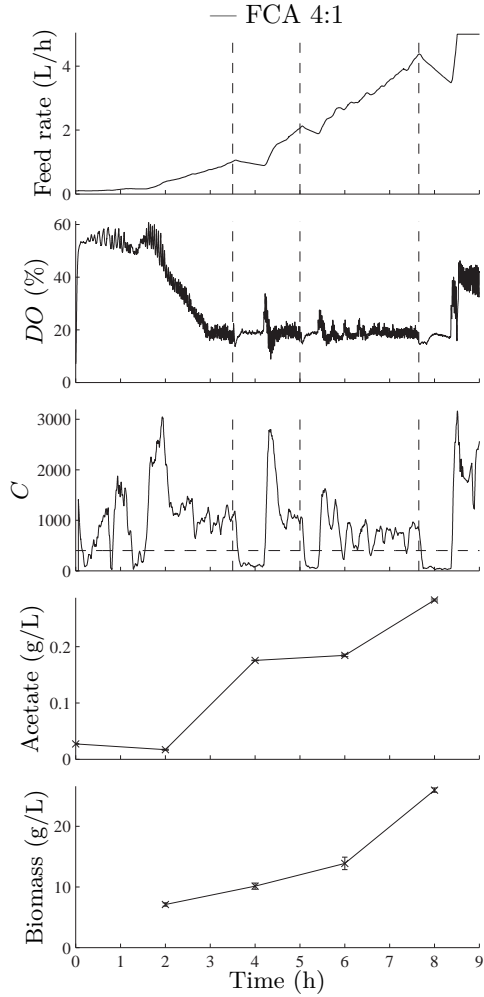

Figure 6. Study of the controller response to excess substrate. In fermentation FCA 4:1, external additions of feed were used to disturb the process in order to study the FCA controller’s response to such disturbances. For C , a horizontal dashed line indicates the setpoint. Vertical dashed lines in the plots of F , DO and C indicate the times for external feed additions. After each external addition of feed, the fast dynamics in DO disappeared (seen as less “noise” in the DO signal), indicating that the regular feed pulses do not cause a response. Hence, C was lowered to a value well below its setpoint for a while and during this period F was decreased.

5.3 Test of generality

In the first four hours of these fermentations, tuning of the feed rate controller proved necessary as the increase in biomass concentration was significantly faster than in previous fermentations. The FCA strategy could detect the presence of complex medium at the start of the fermentation, shown by very low values of C early in the fermentation, which ensures that F is kept at its minimum to minimize overflow metabolism (figure 7).

Due to the complex medium containing carbon sources for the bacteria, some overflow metabolism is unavoidable and all fermentations show accumulation of low levels of acetate during the first 2 hours after inoculation as seen in figure 7. However, the FCA-controlled fermentations moved away from overflow metabolism and showed decreased acetate levels sooner than the reference.

Volumetric productivity of biomass is higher in the fermentations using the FCA strategy (biomass concentration at the onset is about the same as in the reference but 30 % higher at 8 hours). This, along with low acetate levels, shows that the oxidative capacity has been utilized efficiently while excessive overflow metabolism has been avoided.

6. Conclusions

In this study a new feeding strategy for aerated fed-batch fermentations has been presented, aimed at giving as high levels of oxidative metabolism as possible in the exponential growth phase while avoiding excessive overflow metabolism leading to undesirably high levels of by-products. Its basic principle is the same as for the pre-existing probing control strategy and has the advantage that only dissolved oxygen measurements are needed, but it improves this concept by use of frequency analysis. This allows continuous tracking of a feed rate corresponding to the substrate uptake rate and decreases the sensitivity to disturbances compared to probing control as disturbances occurring at most frequencies do not affect the measurements.

A simple feed rate controller based on this strategy has been tested in pilot scale fermentations (0.550 m³), which has shown that it can achieve a significantly higher volumetric productivity of biomass than in a reference process while production of harmful by-products has been minor. For fermentations with a lower initial viable cell mass, it can detect the decreased feed demand and adjust the feed rate accordingly, where the reference controller (used today in industrial fermentations of this type) causes complete process failure through excessive formation of overflow metabolites. The controller response to excess substrate in the medium has been tested and it has been shown that it can detect and compensate for this by temporarily decreasing the feed rate. While there is room for improvement of the controller

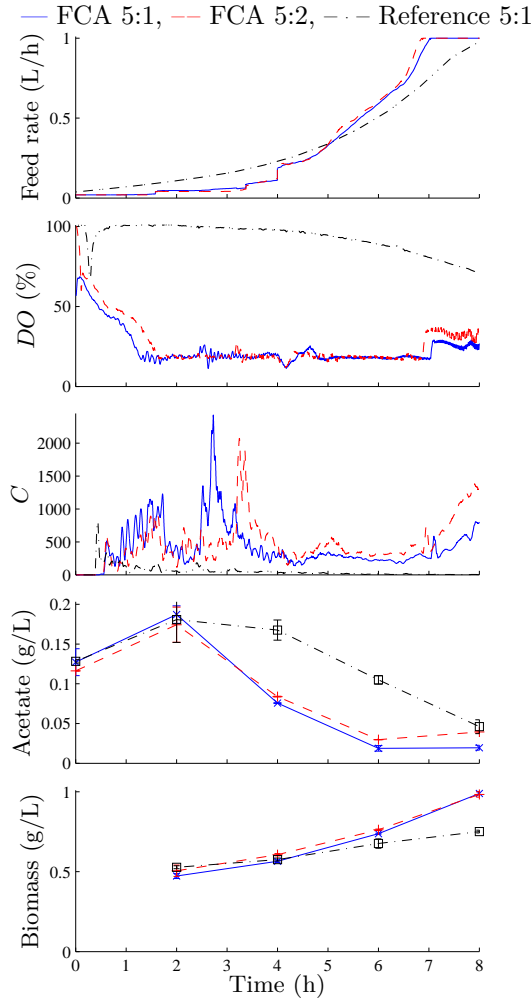

Figure 7. FCA control applied to a current production process scaled down to pilot scale. Fermentations FCA 5:1 and FCA 5:2 used the FCA strategy, while Reference 5:1 used the reference strategy. From 0 to 4 hours re-tuning of the FCA controller was necessary in order to adjust it as the *B. licheniformis* strain used here was faster-growing than that which the controller was previously tuned for, which caused discrete changes to the feed rate. Re-tuning was not necessary in the reference fermentation as its parameters could be altered on beforehand to suit this process, using *a priori* knowledge. In the fermentations using the FCA controller, F reached its highest allowed level at 7 hours; this limit was set so that saturation of the fermentor’s oxygen and heat transport capacity was avoided.

by tuning and by finding a suitable nonlinear transformation of the measured variable, the new concept as such has shown itself successful.

Although most practical testing has been carried out in a process using an old production strain from Novozymes A/S growing on defined medium, one series of experiments was carried out in a process utilizing an industrial strain currently used in large-scale enzyme production growing on complex medium to study the feasibility of the strategy in such processes. The strategy gave significantly higher growth of biomass in this process as well, although re-tuning of controller parameters was necessary as this strain is faster-growing than the old strain.

Acknowledgements

This work was carried out within the framework of the Process Industrial Centre at Lund University (PIC-LU) and supported by the Swedish Foundation for Strategic Research (SSF) and the Lund Centre for Control of Complex Engineering Systems (LCCC), in cooperation with the Novozymes A/S fermentation pilot plant in Bagsværd, Denmark where all fermentations were performed.

References

- Åkesson, M. (1999). *Probing control of glucose feeding in Escherichia coli cultivations*. PhD thesis ISRN LUTFD2/TFRT-1057-SE. Department of Automatic Control, Lund Institute of Technology, Sweden.
- Albæk, M. O., K. V. Gernaey and S. M. Stocks (2008). “Gassed and un-gassed power draw in a pilot scale 550 litre fermentor retrofitted with up-pumping hydrofoil B2 impellers in media of different viscosity and with very high power draw”. *Chemical Engineering Science* **63**:24, pp. 5813–5820.
- Chérny, A. (1997). “Software sensors in bioprocess engineering”. *Journal of Biotechnology* **52**:3, pp. 193–199.
- de Maré, L. (2006). *Feeding strategies based on probing control for E. coli and V. cholerae Cultivations*. PhD thesis ISRN LUTFD2/TFRT-1076-SE. Department of Automatic Control, Lund Institute of Technology, Sweden.
- Dewasme, L. and A. Vande Wouwer (2008). “Adaptive extremum-seeking control applied to productivity optimization in yeast fed-batch cultures”. In: *Proceedings of the 17th IFAC World Congress*, pp. 9713–9718.

- Fleming, A. B., M. Tangney, P. Jørgensen, B. Diderichsen and F. G. Priest (1995). "Extracellular enzyme synthesis in a sporulation-deficient strain of *Bacillus licheniformis*." *Applied and Environmental Microbiology* **61**:11, pp. 3775–3780.
- Gnoth, S., M. Jenzsch, R. Simutis and A. Lübbert (2008). "Control of cultivation processes for recombinant protein production: a review". *Bioprocess and Biosystems Engineering* **31**:1, pp. 21–39.
- Henes, B. and B. Sonnleitner (2007). "Controlled fed-batch by tracking the maximal culture capacity". *Journal of Biotechnology* **132**:2, pp. 118–126.
- Jensen, E. B. and S. Carlsen (1990). "Production of recombinant human growth hormone in *Escherichia coli*: expression of different precursors and physiological effects of glucose, acetate, and salts". *Biotechnology and Bioengineering* **36**:1, pp. 1–11.
- Luli, G. W. and W. R. Strohl (1990). "Comparison of growth, acetate production, and acetate inhibition of *Escherichia coli* strains in batch and fed-batch fermentations". *Applied and Environmental Microbiology* **56**:4, pp. 1004–1011.
- El-Mansi, M. (2004). "Flux to acetate and lactate excretions in industrial fermentations: physiological and biochemical implications". *Journal of Industrial Microbiology and Biotechnology* **31**:7, pp. 295–300.
- Neijssel, O. M., G. P. M. A. Hardy, J. C. Lansbergen, D. W. Tempest and R. W. O'Brien (1980). "Influence of growth environment on the phosphoenolpyruvate: glucose phosphotransferase activities of *Escherichia coli* and *Klebsiella aerogenes*: a comparative study". *Archives of Microbiology* **125**:1-2, pp. 175–179.
- Riesenberg, D. and R. Guthke (1999). "High-cell-density cultivation of microorganisms". *Applied Microbiology and Biotechnology* **51**:4, pp. 422–430.
- Selişteanu, D., E. Petre, C. Marin and D. Şendrescu (2008). "Estimation and adaptive control of a fed-batch bioprocess". In: *Proceedings of the International Conference on Control, Automation and Systems (ICCAS 2008)*, pp. 1349–1354.
- Sonnleitner, B. and O. Käppeli (1986). "Growth of *Saccharomyces cerevisiae* is controlled by its limited respiratory capacity: formulation and verification of a hypothesis". *Biotechnology and Bioengineering* **28**:6, pp. 927–937.
- Swartz, J. R. (1996). *Method of determining propensity of dissolved oxygen instability*. Patent. US 5487980.
- Tempest, D. W. and O. M. Neijssel (1979). "Overflow metabolism in aerobic micro-organisms". *Biochemical Society Transactions* **7**:1, pp. 82–85.

- Velut, S. (2005). *Probing control. Analysis and design with application to fed-batch bioreactors*. PhD thesis ISRN LUTFD2/TFRT-1072-SE. Department of Automatic Control, Lund Institute of Technology, Sweden.
- Voigt, B., T. Schweder, D. Becher, A. Ehrenreich, G. Gottschalk, J. Feesche, K.-H. Maurer and M. Hecker (2004). “A proteomic view of cell physiology of *Bacillus licheniformis*”. *Proteomics* **4**:5, pp. 1465–1490.
- Whiffin, V. S., M. J. Cooney and R. Cord-Ruwisch (2004). “Online detection of feed demand in high cell density cultures of *Escherichia coli* by measurement of changes in dissolved oxygen transients in complex media”. *Biotechnology and Bioengineering* **85**:4, pp. 422–433.

Paper II

Modelling of the oxygen level response to feed rate perturbations in an industrial scale fermentation process

Ola Johnsson, Jonas Andersson, Gunnar Lidén,
Charlotta Johnsson and Tore Hägglund

Abstract

A study of the feasibility of perturbation-based control methods in industrial fed-batch fermentations based on experiments in industrial production scale bioreactors ($>100 \text{ m}^3$) is presented, as well as modelling of the relation between substrate feed rate and dissolved oxygen level in such a process. Several different types of perturbation-based control methods have been suggested for control of this type of process but it has been reported that perturbations in the feed rate may cause decreased productivity in fermentations. The results of this study show that perturbations in the feed rate of production scale fermentations can achieve significant dissolved oxygen level responses without decreased productivity. A model based on data for dissolved oxygen responses and a simulation using a simple observer are given, showing that it is possible to model industrial mixing dynamics in a simple way and that this can be used for perturbation-based on-line estimation of the metabolic state of the system with regard to overflow metabolism. A frequency region where the model can be used has been identified, indicating which frequencies would be suitable for perturbation-based control in industrial fermentations.

1. Introduction

In industrial fermentations, high volumetric productivity and product yield are highly desirable. To achieve a high productivity in a fed-batch fermentation, it is typically desirable to go from a low starting biomass concentration to a high biomass concentration in as short time as possible. However it is often not desirable to have high substrate concentrations even though this will lead to high specific substrate uptake and growth rates. This is due to the effects of a series of metabolic reactions labelled as overflow metabolism, caused by inhibition of the oxidative metabolism, which leads to the production of by-products at high substrate uptake rates [Tempest and Neijssel, 1979]. These by-products, such as ethanol, acetate and lactate, are commonly harmful to the organism; a well-known example is the inhibitory effects on growth caused by high levels of acetate [Luli and Strohl, 1990] but such compounds can not only inhibit growth but also reduce production of heterologous proteins [Jensen and Carlsen, 1990].

Although overflow metabolism allows for fast short-term growth it is regarded as an undesirable trait both due to the inhibitory effects of the by-products and because substrate is diverted into producing these [El-Mansi, 2004]. Overflow metabolism occurs both in model organisms such as the bacterium *Escherichia coli* [Neijssel et al., 1980] and the yeast *Saccharomyces cerevisiae* [Sonnleitner and Käppeli, 1986] and in other commonly used industrial microorganisms such as *Bacillus licheniformis* [Voigt et al., 2004].

In fed-batch fermentation processes, overflow metabolism can be avoided by maintaining a sufficiently low feed rate. The challenge in controlling the feed rate of such processes is therefore to keep the feed rate as high as possible to get a high volumetric productivity, while not exceeding the rate over which overflow metabolism occurs.

In a fed-batch fermentation, avoiding overflow metabolism will only limit the feed rate in the first phase of the process before oxygen or heat transfer limitations occur. After this point, these factors will give a stricter limitation of the feed rate than the avoidance of overflow metabolism would. In this first phase the biomass concentration can increase exponentially and it will therefore be referred to as the exponential growth phase. It must be pointed out that although the exponential growth phase may only make up a small fraction of the duration of the process sequence, this phase can be critical for the entire process. Both overflow metabolism and carbon starvation can have a strong inhibiting effect on cell growth and product formation, potentially leading to a complete process failure in the latter phase of the process, and in the exponential phase these two must be balanced against each other. The undesired effects of excessive overflow metabolism are demonstrated in [Johnsson et al., 2013]. Therefore, in order to ensure high productivity

without risking process failure, it is of high importance to ensure that the feed rate is set so that excessive overflow metabolism is avoided throughout the whole exponential growth phase.

There are several problems in achieving an optimal feed rate during the exponential growth phase. One is that as the optimal feed rate depends on the total amount of biomass, which increases exponentially, the feed rate must span a large range. The major difficulty is however one of sensing; concentrations of biomass, substrates and overflow metabolites can be difficult to measure *in-situ*, meaning that estimation of the metabolic state with regard to overflow metabolism becomes difficult. Although sensors for some of these exist and can be used in fermentations with chemically defined media [Bittner et al., 1998; Rocha and Ferreira, 2002], the measurement problem can become significantly more difficult when using complex media as is typically the case in industrial production fermentations. Even in situations where biomass concentration can be measured or estimated in a precise manner, the maximum oxidative capacity depends on oxygen and overflow metabolite concentrations in the medium [Konstantinov et al., 1990] and can vary due to metabolic shifts [Swartz, 1996].

Several different approaches to the problem of finding the best feed rate while avoiding overflow metabolism exist today. One well-known approach to this type of problem, where the parameter to control cannot be measured directly, is to use observer-based regulators. Observers utilize software sensing, including a model of the system allowing on-line estimations of unmeasured states [Luttmann et al., 2012]; the accuracy of such estimations depends on the accuracy of the model used. Although many interesting methods for estimating the states of and controlling this type of system exist, they typically require measurements for which fast and reliable *in-situ* measurements are not commonly available in industrial production processes today such as concentrations of substrate and biomass in the fermentation medium or concentrations of oxygen and carbon dioxide in the outlet gas and/or assumptions of constant yield parameters [Luttmann et al., 2012; Chérury, 1997; Selişteanu et al., 2008; Dewasme and Vande Wouwer, 2008; Dewasme et al., 2011; Riesenbergh and Guthke, 1999; Gnoth et al., 2008; Warth et al., 2010; Vargas et al., 2012]. In addition, in production processes with complex media, measurements of the principal substrate are not sufficient to determine the specific substrate uptake rate as several other substrates may be available for uptake.

Data-driven methods, such as artificial neural networks (ANNs), can to some extent be used to create observers requiring fewer nonstandard measurements. These can be used to achieve good control of bioprocesses, but require large amounts of historical process data for tuning them [Riesenbergh and Guthke, 1999; Gnoth et al., 2008]. Although this needs not be a problem

when using them to improve control in processes of which many batches have already been run, it makes implementation more difficult in processes which are rapidly developed and changed.

Our previous research in fermentation control has focused on utilizing periodic perturbations in the feed rate of fed-batch fermentations to determine its metabolic state with regard to overflow metabolism and to control the fermentation process based on this [Johnsson et al., 2013]. Using periodic perturbations to determine the state of a system and how to control it is known from for instance perturbation-based extremum-seeking control [Dochain et al., 2011], from which algorithms have been developed intended for control of fed-batch processes where overflow metabolism is a concern [Dewasme et al., 2011; Vargas et al., 2012]. The research presented here has some similarity to such schemes but is, like our previous work, based on the principles utilized by for instance Åkesson et al. [1999], de Maré et al. [2003] and Velut et al. [2007].

The aims of this research have been threefold. Firstly, to determine whether periodic perturbations in the feed rate of a large industrial production fermentation could yield detectable variations in output signals without decreasing product yield significantly; it has been reported that variations in the feed rate of a laboratory-scale fed-batch process can decrease both its biomass and product yield [Lin and Neubauer, 2000]. Secondly, to develop a model of the relation between feed rate and dissolved oxygen level in the process, as the latter is a measurement for which on-line probes are available and can be found in typical industrial bioreactors for aerobic processes [Alford, 2006] and modern dissolved oxygen probes allow for fast and robust measurements [Glazer et al., 2004]. Thirdly, to utilize the model in an observer for on-line estimation of the system's metabolic state.

2. Materials and methods

2.1 Theory

Considering the feed rate of liquid substrate (F) as the input signal and dissolved oxygen (DO) measurements as the output signal, the dynamics of the fed-batch fermentation process can be regarded as containing a series of phenomena as follows.

1. Substrate mixing, which determines the rate at which substrate is transported to the cells.
2. Microbial uptake of substrate and oxygen, which determines the consumption rates of these compounds.

3. Oxygen mixing, which determines the rate at which oxygen is transported to the cells.
4. Dissolved oxygen (DO) probe dynamics, which determines the response time of the measured DO signal.

Oxygen mixing dynamics can be regarded as divided into two parts, diffusion of oxygen from gas bubbles into the liquid phase and mixing of oxygen in the liquid phase to distribute it in the medium.

Ideally, mixing of feed and oxygen in the liquid phase can be regarded as linear time-invariant (LTI) processes of first order. It is known however that in large-scale mixed tanks, tank and impeller geometry can have significant effects on mixing dynamics which can require advanced models to describe [Paul et al., 2004]. Diffusion of oxygen from gas bubbles can be considered as a first-order LTI process [Villadsen et al., 2011] and typical dissolved oxygen probe dynamics have been showed to be near first-order [Glazer et al., 2004].

As the dynamics of microbial substrate and oxygen uptake are considerably faster than mixing dynamics in industrial-scale bioreactors, microbial dynamics will be at pseudo-steady state in such processes and can be approximated into their static form. Microbial uptake of substrate and oxygen, as well as production of overflow metabolites, has been studied to a large extent and biochemical models to describe this exist. Such models can contain a large number of parameters [Dauner and Sauer, 2001], meaning that fitting them to a certain strain can be difficult. However, models considering only the relations between uptake rates can be made considerably simpler.

The static relationship between substrate and oxygen uptake can be regarded as a saturation, where increasing substrate uptake rates lead to increased oxygen uptake rates until limitation of the oxidative metabolism sets in and production of overflow metabolites occur (the Crabtree effect) [Sonnleitner and Käppeli, 1986; Dewasme and Vande Wouwer, 2008]. This saturation effect is not dependent on the types of overflow metabolites; this is of significance as the exact compounds produced in overflow metabolism are not always known [Voigt et al., 2004].

As outlined earlier in this section, the system can ideally be regarded as a number of first-order LTI processes and a saturation. This model of the system can be simplified by lumping together oxygen mixing in the liquid, oxygen diffusion and DO probe dynamics. As illustrated in figure 1, this gives a model with two first-order processes and a saturation yielding four model parameters in total.

Ideally, F should be controlled so that the substrate concentration in the bioreactor gives a substrate uptake rate r_s equal to the critical substrate uptake rate for overflow metabolism, $r_{s,crit}$. It is however not necessary to completely avoid production of overflow metabolites; for instance, acetate concentrations below 1 g/L appear to have little or no effect on *E. coli* growth

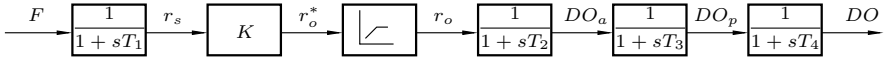

(a) The full process model, including a saturation and four first-order LTI processes.

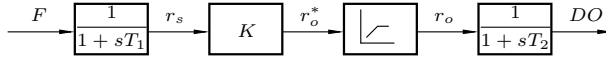

(b) The simplified process model, including a saturation and two first-order LTI processes.

Figure 1. The full and simplified process model structures. This shows how the full model of the system is simplified into a form with two first-order LTI processes and a static saturation.

in fed-batch fermentations [Luli and Strohl, 1990]. This means that a varying value of F , causing r_s to vary, could possibly be used to determine the system's metabolic state with regard to overflow metabolism without influencing the process yield negatively. This would require that variations in F small enough that process yield is unaffected can achieve variations in output signals which can be separated from noise.

2.2 Bioreactor

Experiments were performed in industrial production bioreactors at the Novozymes A/S site in Kalundborg, Denmark. These are cylindrically shaped bioreactors similar to what is described in [Li et al., 2000] with a volume of more than 100 m^3 , stirred by multiple axial agitators. Feed is added through ports in the upper half, while air is inserted through a sparger at the bottom. Dissolved oxygen in the medium is measured by a probe positioned near the bottom of the bioreactor, in experiment 1 and 2 this was an electrode while in experiment 3 and 4 it was an optode (an optical sensor device).

The feed rate to a bioreactor is controlled to its setpoint by an internal control loop measuring the feed rate and controlling the position of a valve in the feed stream. This internal loop was re-tuned to allow it to keep up with rapid variations in the feed rate setpoint.

2.3 Microorganism and culture conditions

The microorganism used in all experiments is a recombinant *B. licheniformis* strain originating from Ca63 expressing Subtilisin.

For inoculation, cells were added from an inoculation stock and grown in an inoculation flask. This was subsequently added to an aerated seed bioreactor with a medium similar to the inoculum medium described in [Kaasgaard et al., 2004]. The cells were grown until the end of the exponential growth phase, determined by observing the oxygen uptake rate trend over time, and then transferred to the main bioreactor.

In the main bioreactor, a complex fermentation medium similar to that used in [Van Putten et al., 1996] was used. The fermentation temperature and pH were kept constant throughout the perturbation periods and the culture was continuously fed carbohydrate, while at all times maintaining a measured *DO* level above 20 % saturation. pH was controlled through addition of NH_3 , meaning that further addition of a source of nitrogen was not needed as the amount added through pH control together with that present in the initial medium was sufficient for it to exist in non-limiting concentrations during the whole process.

2.4 Software

On-line control and measurement of the processes was performed with a sampling period of 6–12 seconds. As the process supervision system was unable to provide measurements with even sampling interval, interpolation between sampling points was necessary. Analysis of data was performed in Matlab, where the nonlinear grey-box model estimation methods in the System Identification Toolbox were used for fitting models to data and for creating a nonlinear estimator for the system.

2.5 Experiment design

In all experiments, sinusoidal waves were superimposed on F , a set-up similar to that used in some perturbation-based extremum-seeking control schemes. Wave amplitude varied between 20 and 170 L/min and wave frequency varied between 2.5 and 20 mHz in order to determine for which settings a response in the dissolved oxygen signal could be achieved. In the fourth experiment no variation of the frequency was done, as a suitable frequency region was known when it was performed. The productivity of all fermentations was evaluated to determine whether the oscillations in the feed rate would have a significant effect on these.

The first and third experiments were performed towards the end of fermentations, when biomass concentration is high and the feed uptake rate is far from the critical one, to allow for modelling of the system without interference from the saturation in oxidative metabolism. The third experiment also included step changes in F_{sp} .

The second and fourth experiments were performed during the exponential growth phase at the start of fermentations, as this phase is of greatest interest for avoiding overflow metabolism and the fermentation may be more sensitive to variations in F in this phase than in the later phase.

3. Results and discussion

The result analysis in this study focuses to a large extent on the relationship between F and DO . Mean values are removed from these to allow fitting of transfer function models.

3.1 Perturbation responses and process robustness

F and DO for all four experiments are shown in figure 2, giving an overview of input and output data. A detailed view of the last part of experiment 1 is shown in figure 3, illustrating that responses to perturbations are visible in the DO signal, significantly higher than the noise level and easy to distinguish frequency-wise.

The results of experiments 2 and 4 are of particular relevance when studying process robustness as they were performed at the start of fermentations, when these can be expected to be more sensitive to disturbances due to the lower biomass concentration. Although perturbations in F during the exponential growth phase of experiment 2 do not give rise to variations in DO , this can be attributed to the oxidative metabolism being saturated during this phase; immediately after the exponential increase in F is stopped at 5.5 hours, clear responses in DO can be seen. If the appearance of a response in DO was due to increased biomass or feed rate in itself this response should be proportional to F , this not being the case indicates that it is due to saturation of the oxidative metabolism. In experiment 4 some perturbation responses can be seen towards the end of the exponential growth phase, indicating a move away from overflow metabolism at this time.

In all four fermentations no significant decrease in productivity (defined as product activity at the end of the fermentation) was seen, as shown in figure 4. This indicates that the robustness of the process to periodic variations in F is high and it is possible to achieve responses in DO without influencing productivity negatively.

3.2 Modelling

Although feed rate perturbations give rise to significant variations in DO , this is not necessarily sufficient to fit a simple model to data. Data from the two experiments performed at the end of fermentations were used so that the oxidative saturation would not have an effect on modelling. This means that using previous modelling assumptions, the model of the ideal system should be on the general form given as a transfer function in (1), meaning a second-order LTI system.

$$DO(s) = \frac{K}{(1 + sT_1)(1 + sT_2)} F(s) \quad (1)$$

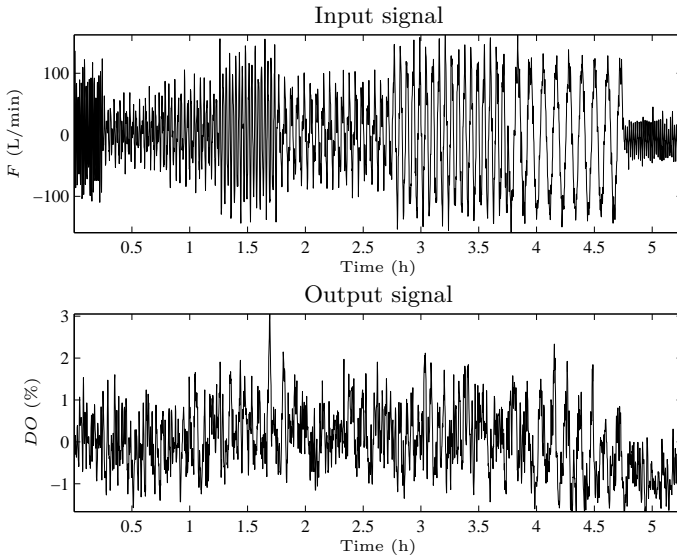

(a) Input and output for the first experiment, at the end of a fermentation. Mean values are removed to allow fitting of transfer function models.

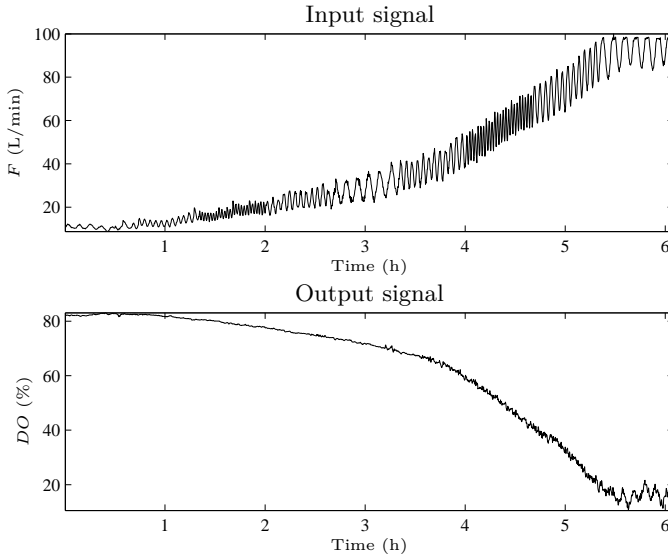

(b) Input and output for the second experiment, in the exponential growth phase.

Figure 2. Input F and output DO . This shows all four frequency response experiments performed in industrial production scale (continued on next page).

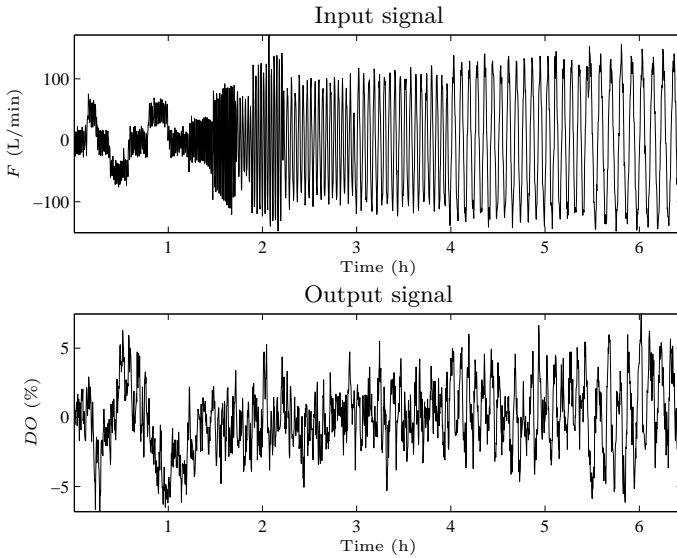

(c) Input and output for the third experiment, at the end of a fermentation. Mean values are removed to allow fitting of transfer function models.

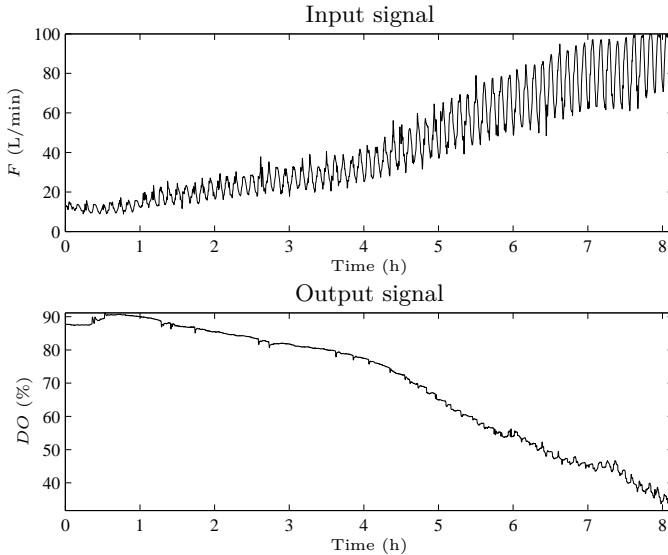

(d) Input and output for the fourth experiment, in the exponential growth phase.

Figure 2. (Continued)

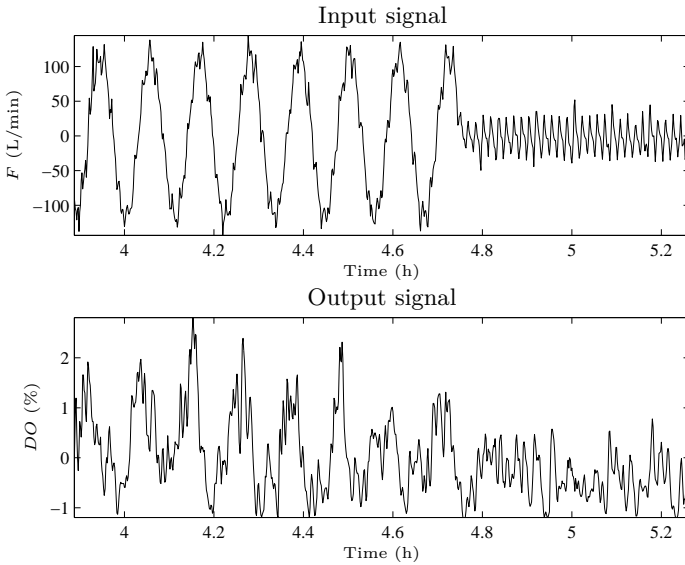

(a) Detailed view of input F and output DO for the last part of the third experiment. In the first region where F is perturbed this gives rise to significant variations in DO with the same frequency as the perturbation, while in the second region where F is nearly constant with only minor variations due to the internal feed rate control loop no such response is seen. Mean values are removed to allow fitting of transfer function models.

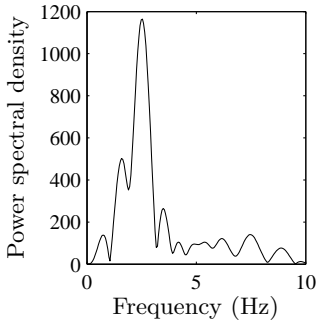

(b) Frequency spectrum of the DO signal when perturbed by a 2.5 mHz sine wave. The signal has a high content of the perturbation frequency.

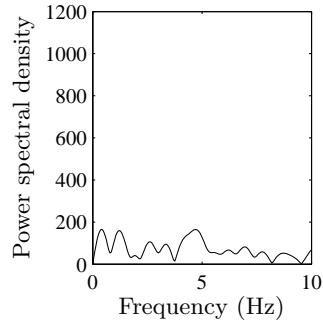

(c) Frequency spectrum of the unperturbed DO signal.

Figure 3. Comparison of perturbed and unperturbed DO . This shows that a clear response to the perturbations in F can be seen, when compared to the unperturbed system.

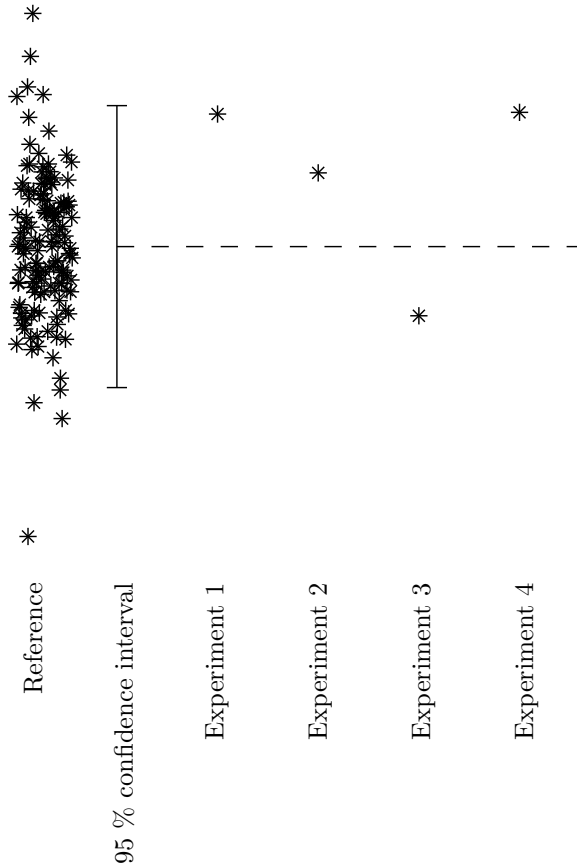

Figure 4. Productivity for the four experiments compared to a batch of 139 reference fermentations, with a 95 % confidence interval for the references and a dashed line indicating their average productivity. The productivities for all four experiments are within the confidence interval.

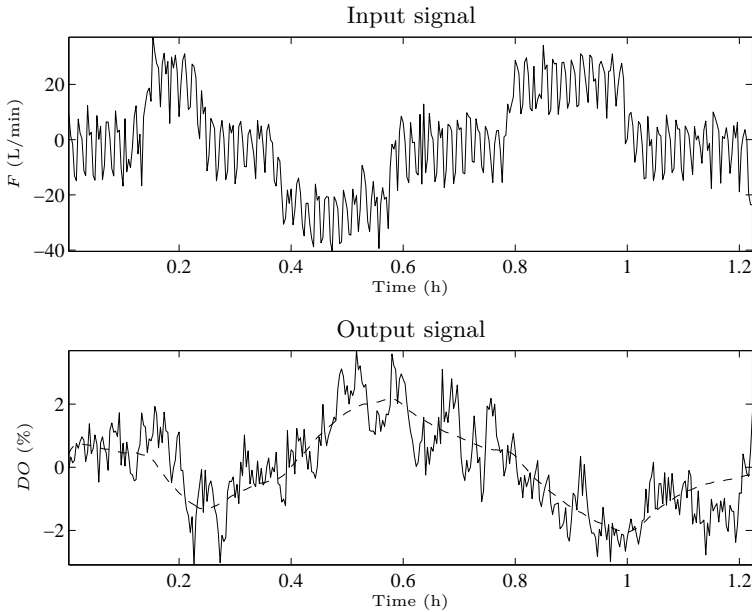

Figure 5. Fitting of the model to input-output data from step responses. Full lines are measured data, a dashed line indicates model output. Mean values have been removed to allow fitting of transfer function models. The best fit, shown in the figure, is 42.66 % and is given for $T_1 = 27.81$ s, $T_2 = 400.12$ s, $K = -0.11323$ % / (L/min).

For determining the static gain K of the model, studying low-frequency behaviour and in particular the response to step changes is suitable. Fitting the model to data from the step changes of F_{sp} at the start of experiment 3, as illustrated in figure 5, suggests the value $K = -0.11$ % DO / (L feed / min) for the equipment used in this experiment.

Step responses, acting on low frequencies, are not well suited for describing the dynamic behaviour of a process at higher frequencies. This means that although they can be relied on to provide a fairly accurate estimate of process gain, the estimations of the time constants T_1 and T_2 are not as reliable. Responses to sinusoidal perturbations such as those employed during most of experiments 1 and 3 are however suitable for determining system characteristics at their respective frequencies.

The model could not be well fitted to data over all perturbation frequencies (2.5–20 mHz, corresponding to period times of 400–50 s), indicating that it could not be used to describe process behaviour in the whole frequency

range. This is not surprising, as this would require ideal mixing. A set of common models were fitted to data: unstructured models of ARX, ARMAX, Output error and Box-Jenkins type [Madsen, 2008] (orders 1–8) to determine to what extent the use of unstructured models could improve fit to data and structured process models of order 1–3 on transfer function form with and without a zero and/or time delay to determine whether structured models of similar complexity as (1) could improve model fit. None of the models gave a good fit to all data and as no model could describe process behaviour across all frequencies, the following areas were investigated:

1. Whether the model in (1) could be used within a limited frequency range, indicating that it could be used to describe the process response to perturbations of certain frequencies.
2. Whether other model structures could give a better fit to data within a limited frequency range or give a similar fit while being simpler, indicating that the model structure can be improved.

For each perturbation frequency, model fitting was performed for all model types in the set as well as for the model suggested in (1). For all structured models in experiment 3, the value of K was set to the value determined by the step response experiment when modelling based on data from this experiment. As a different probe was used in experiment 1, it was calibrated differently and the value of K found in experiment 3 could not be relied on in that case. Labelling for structured models is given in table 1, the model in (1) is labelled as PP. A summary of model fitting results for data from experiments 1 and 3 can be seen in table 2 and 3 respectively, showing that for all model types the fit is low at perturbation frequencies of 5 mHz and higher. Several of the model types have significantly better fit to data at frequencies 3.33 and 2.5 mHz, indicating that they may describe system dynamics more accurately in this frequency range. Fit is defined as how well the variance of data is explained by the model, using (2) where a fit of 100 % would indicate that the model describes all of the variance of the data.

$$\text{Fit to data} = 100 \left(\frac{1 - \|DO - DO_{model}\|_2}{\|DO - \bar{DO}\|_2} \right) (\%) \quad (2)$$

This is investigated further by fitting models to data corresponding to these input frequencies in the third experiment. Results of this model fitting are shown in table 4 and illustrated in figure 6. With the model in (1) as a starting point, the following conclusions can be drawn:

- Replacing one pole with a time delay gives approximately the same fit (PD).
- Removing one pole and adding a zero deteriorates the fit somewhat (PZ).

- Structured models with a greater number of parameters achieve a somewhat better fit.
- Reducing the number of parameters by using a double pole deteriorates the fit somewhat. Of the two-parameter models (P, 2P and 3P), this gives the by far best fit.
- High-order unstructured models can improve the fit somewhat.

Figure 6a shows that it is possible to model the system response to perturbations in a satisfactory manner. Although there is significant high-frequency noise leading to a lower model fit, the oscillations caused by the perturbations are modelled well. Figure 6b shows that the outputs of the illustrated models are very similar. Therefore, as has been seen in table 4, it can be concluded that not much accuracy is lost when constraining the two-pole model to having a double pole.

3.3 Simulation

As the model in (1) is based on ideal mixing it can be concluded that for input frequencies of 3.33 and 2.5 mHz, process dynamics can be well approximated by those of ideal mixing in the bioreactor. This strongly implies that the model holds in the whole spectrum between these frequencies, while the model can not be used to accurately describe the system response at higher input frequencies due to non-ideal mixing effects being more prominent at

Table 1. Labelling for structured models. This provides a nomenclature for structured models used in this work.

Model structure	Symbol	Transfer function form
One pole	P	$\frac{K}{1 + sT}$
Two independent poles	PP	$\frac{K}{(1 + sT_1)(1 + sT_2)}$
Three independent poles	PPP	$\frac{K}{(1 + sT_1)(1 + sT_2)(1 + sT_3)}$
Double pole	2P	$\frac{K}{(1 + sT)^2}$
Triple pole	3P	$\frac{K}{(1 + sT)^3}$
Zero	Z	$(1 + sT_z)$
Time delay	D	e^{-sL}

Table 2. Comparison of results for model fitting for experiment 1. The expression for model fit is given in (2). For unstructured models, orders 1–8 were used and the best fit is shown. Labelling for structured models is given in table 1.

Model type	Perturbation frequency (mHz)			
	20	10	5	2.5
	Fit to data (%)			
Unstructured				
ARX	11	3.7	4.9	35
ARMAX	16	4.5	4.9	41
Output error	19	4.5	5.5	41
Box-Jenkins	24	7.8	6.0	42
Structured				
P	8.3	0.58	2.6	27
PD	11	2.0	4.4	33
PZ	8.3	0.58	3.2	32
PDZ	11	2.0	4.4	33
2P	4.1	3.2	4.2	33
3P	11	3.5	4.2	33
PP	4.1	3.2	4.2	33
PPD	14	3.3	4.3	33
PPZ	11	3.3	4.3	33
PPDZ	14	3.3	4.3	33
PPP	11	3.5	4.2	33
PPPD	14	3.5	4.2	33
PPPZ	15	3.7	4.4	33
PPPDZ	15	3.7	4.4	33

these frequencies. It can also be concluded that although assuming similar time constants for feed and oxygen dynamics decreases the model’s degree of freedom, it does not decrease model fit to data by a lot.

The total substrate and oxygen fluxes into the biomass, that is, the total uptake rates of all biomass in the bioreactor, are $\nu_s = VXr_s$ and $\nu_o = VXr_o$, respectively. Including the saturation in oxidative metabolism into the model as per figure 1(b) and defining the saturation as $r_o = \min(r_s, r_{s,\text{crit}})$ gives a nonlinear model with one unknown parameter to estimate, the critical substrate uptake flux $\nu_{s,\text{crit}} = VXr_{s,\text{crit}}$. Fitting this model to on-line data gives a nonlinear observer and by estimating ν_s in relation to $\nu_{s,\text{crit}}$ in this manner, a controller can be constructed for controlling F to give a desired value of ν_s .

Table 3. Comparison of results for model fitting for experiment 3. The expression for model fit is given in (2). For unstructured models, orders 1–8 were used and the best fit is shown. Labelling for structured models is given in table 1.

Model type	Perturbation frequency (mHz)					
	16.7	10	6.67	5	3.33	2.5
	Fit to data (%)					
Unstructured						
ARX	7.7	11	5.4	14	36	48
ARMAX	18	16	13	23	40	55
Output error	20	16	13	23	40	55
Box-Jenkins	21	17	13	24	40	57
Structured						
P	0.0	4.9	0.93	3.8	19	39
PD	2.4	9.6	1.7	10	31	47
PZ	0.0	8.2	1.6	11	35	47
PDZ	2.5	9.6	1.7	11	35	47
2P	5.8	9.0	2.7	11	34	42
3P	5.7	5.4	0.16	3.5	14	17
PP	8.7	9.2	2.7	11	35	47
PPD	11	9.6	2.9	11	35	47
PPZ	9.5	9.5	3.7	11	35	47
PPDZ	13	9.6	3.7	11	35	47
PPP	5.7	9.9	0.97	11	35	47
PPPD	5.9	10	1.7	11	35	47
PPPPZ	5.9	9.9	1.7	11	36	47
PPPDZ	5.9	10	1.7	11	36	47

No long-term accumulation of substrate will occur as long as the maximum substrate uptake rate $r_{s,\max}$ is not exceeded. When this occurs, maximal overflow metabolism will also occur and for a controller which can avoid long-term overflow metabolism it follows that long-term accumulation of substrate will also be avoided. Hence, it can be assumed that the relation between F and VXr_s will only depend on mixing dynamics.

To illustrate how the model can be used for estimation of the metabolic state with regard to overflow metabolism, allowing control of the feed rate based on this estimation, we provide a simple example.

Using an *in silico* model of the system in figure 1(b), the system was perturbed using a sine wave with amplitude $A = 4$ L/min and frequency $\omega = 3.33$ mHz. White noise with an amplitude equivalent to 10 % of the

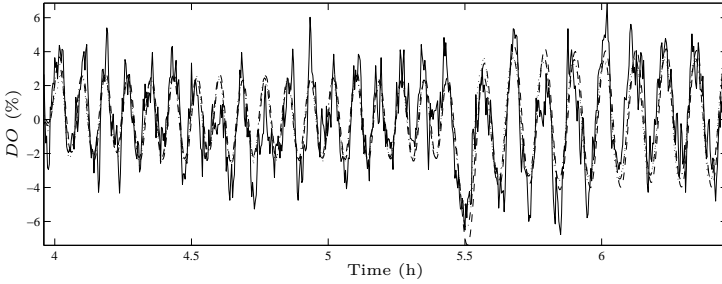

(a) Model outputs and measured output.

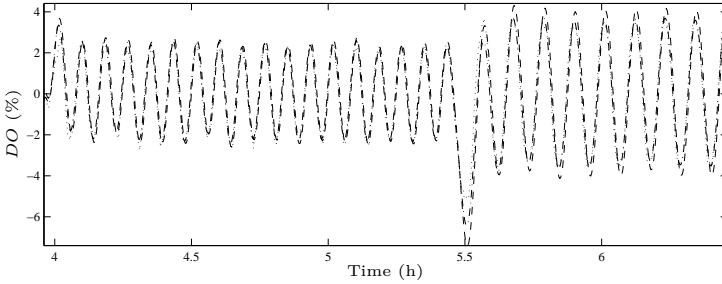

(b) Model outputs.

Figure 6. Illustration of model fit to output data for perturbation frequencies 3.33 and 2.5 mHz in experiment 3. A full line indicates measured data, a dashed line the model in (1), a dash-dotted line a model with a double pole and a dotted line the best unstructured model (an 8th order Box-Jenkins model). Mean values have been removed to allow fitting of transfer function models.

amplitude in unsaturated oscillations in DO was added to the system output to simulate process disturbances. An estimator using the same nonlinear grey-box model approach used for analysis of experimental data was employed to determine values for the saturation variable $\nu_{s,\text{crit}}$. The system used a sampling period of 10 seconds and a 600 second window for the estimator.

This simple approach has two drawbacks. First, it assumes a constant value of $\nu_{s,\text{crit}} - F$ throughout the estimation window, meaning that it will give an averaged value over the time period in the window although it is in fact the latest value which is of interest. Ideally, $\nu_{s,\text{crit}} - F$ should be allowed to vary within the window using recursive methods. Second, it gives rise to oscillations in the estimate following the oscillations in DO , requiring a filter which introduces an additional delay. However, high performance is not sought for here, merely a proof of concept.

Table 4. Comparison of results for model fitting for data corresponding to input frequencies 3.33 and 2.5 mHz in experiment 3. The expression for model fit is given in (2). For unstructured models, orders 1–8 were used and the best fit is shown. Labelling for structured models is given in table 1.

Model type	Fit to data (%)
Unstructured	
ARX	43
ARMAX	44
Output error	44
Box-Jenkins	44
Structured	
P	30
PD	42
PZ	41
PDZ	42
2P	38
3P	14
PP	42
PPD	42
PPZ	42
PPDZ	42
PPP	42
PPPD	42
PPPZ	42
PPPDZ	42

Performance of the estimator when using a constant value for the unperturbed feed rate and a predefined ramp for the values of $\nu_{s,\text{crit}}$ are shown in figure 7. This shows a delay in estimations as expected but variations in $\nu_{s,\text{crit}}$ can be tracked. The maximal value of $|\nu_{s,\text{crit}} - F|$ which can be tracked is proportional to the amplitude of the perturbations in F . For perturbation amplitudes proportional to the current feed rate, $A = k_p F$, this relation becomes

$$|\nu_{s,\text{crit}} - F|_{\text{max}} = k_d k_p F$$

For time constants as given in this model, $k_d = 0.45$. This means that for $k_p = 0.3$, deviations up to 13.5 % of the current unperturbed feed rate can be tracked accurately. If $\nu_{s,\text{crit}}$ deviates from F by more than this the estimator can determine whether the value is above or below this interval, corresponding to no saturation effect and full saturation respectively, but not the actual value. This is a fundamental limitation in this type of perturbation-based approach.

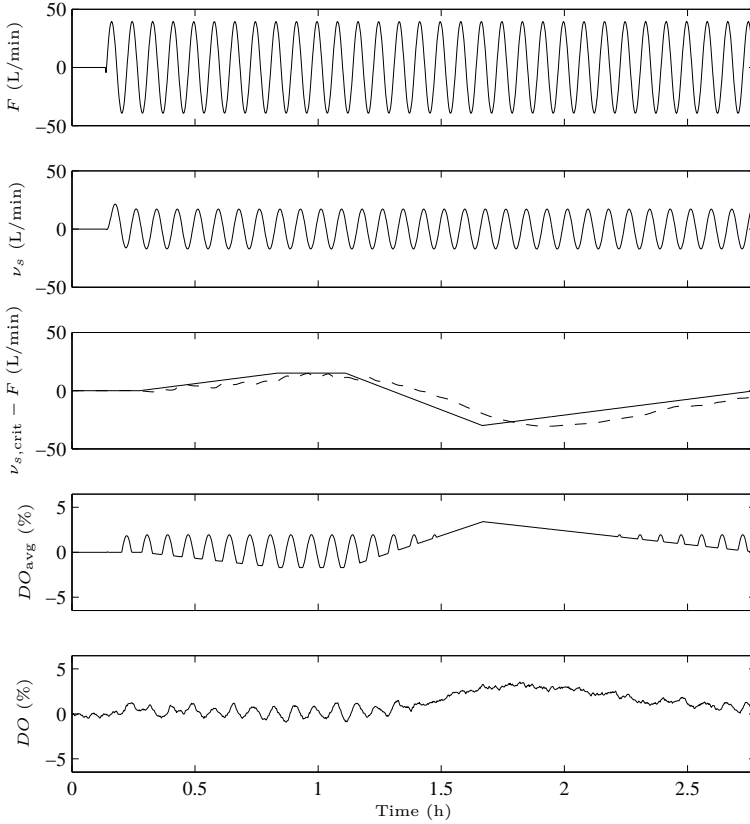

Figure 7. Outcome for the estimator. F is the input signal, ν_s is the substrate uptake rate, $\nu_{s,\text{crit}} - F$ is the remaining oxidative capacity (negative values indicate that the capacity is exceeded by the unperturbed feed rate) where a full line indicates the actual value and a dashed line the estimated value, DO_{avg} is an average dissolved oxygen level in the bioreactor and DO is the measured dissolved oxygen level.

4. Conclusions

First, this work shows that it is possible to employ perturbations in the feed rate to achieve measurable responses in the dissolved oxygen signal of a large-scale ($>100 \text{ m}^3$) industrial fed-batch fermentation without decreasing its productivity, showing that perturbation-based methods are viable in such processes.

Second, it shows that a simple model for mixing dynamics in the relation between feed rate and dissolved oxygen can give good fitting to experimental data from industrial-scale fermentations. Models of the suggested type can be incorporated into advanced biochemical models to simulate large-scale mixing effects and used in development of perturbation-based control strategies for this type of process. As it is a 2nd order LTI model it offers an easy way of comparing results in different scales with regard to feed rate and dissolved oxygen relationships and can easily be implemented in many types of computational tools and process monitoring software. A suitable frequency region for perturbations to the input signal in the industrial scale fermentation process has been identified as well, which is of importance for the implementation of perturbation-based control strategies.

Third, a simple observer utilizing the suggested model is given to illustrate how it can be used for on-line process surveillance and control.

5. Nomenclature

Throughout this work, a number of different parameters are used to describe the system and the controller. Their descriptions and units can be found in table 5.

Table 5. Nomenclature.

Variable	Symbol	Unit
Biomass concentration	X	g / L
Liquid medium volume	V	L
Feed rate	F	L / min
Specific substrate uptake flux	r_s	L / (min g)
Substrate uptake flux	ν_s	L / min
Critical specific substrate uptake flux	$r_{s,crit}$	L / (min g)
Critical substrate uptake flux	$\nu_{s,crit}$	L / min
Specific oxygen uptake flux	r_o	L / (min g)
Oxygen uptake flux	ν_o	L / min
Unsaturated specific oxygen uptake flux	r_o^*	L / (min g)
Unsaturated oxygen uptake flux	ν_o^*	L / min
Average dissolved oxygen in medium	DO_{avg}	% of maximum
Measured dissolved oxygen level	DO	% of maximum

Acknowledgements

This work was carried out within the framework of the Process Industrial Centre at Lund University (PIC-LU) and supported by the Swedish Foundation for Strategic Research, in cooperation with Novozymes A/S. The first, fourth and fifth authors are members of the LCCC Linnaeus Center at Lund University.

References

- Åkesson, M., P. Hagander and J. P. Axelsson (1999). “A probing feeding strategy for *Escherichia coli* cultures”. *Biotechnology Techniques* **13**:8, pp. 523–528.
- Alford, J. S. (2006). “Bioprocess control: Advances and challenges”. *Computers & Chemical Engineering* **30**:10, pp. 1464–1475.
- Bittner, C., G. Wehnert and T. Scheper (1998). “In situ microscopy for on-line determination of biomass”. *Biotechnology and Bioengineering* **60**:1, pp. 24–35.
- Chérury, A. (1997). “Software sensors in bioprocess engineering”. *Journal of Biotechnology* **52**:3, pp. 193–199.
- Dauner, M. and U. Sauer (2001). “Stoichiometric growth model for riboflavin-producing *Bacillus subtilis*”. *Biotechnology and Bioengineering* **76**:2, pp. 132–143.
- de Maré, L., L. Andersson and P. Hagander (2003). “Probing control of glucose feeding in *Vibrio cholerae* cultivations”. *Bioprocess and Biosystems Engineering* **25**:4, pp. 221–228.
- Dewasme, L., B. Srinivasan, M. Perrier and A. Vande Wouwer (2011). “Extremum-seeking algorithm design for fed-batch cultures of microorganisms with overflow metabolism”. *Journal of Process Control* **21**:7, pp. 1092–1104.
- Dewasme, L. and A. Vande Wouwer (2008). “Adaptive extremum-seeking control applied to productivity optimization in yeast fed-batch cultures”. In: *Proceedings of the 17th IFAC World Congress*, pp. 9713–9718.
- Dochain, D., M. Perrier and M. Guay (2011). “Extremum seeking control and its application to process and reaction systems: a survey”. *Mathematics and Computers in Simulation* **82**:3, pp. 369–380.
- Glazer, B. T., A. G. Marsh, K. Stierhoff and G. W. Luther III (2004). “The dynamic response of optical oxygen sensors and voltammetric electrodes to temporal changes in dissolved oxygen concentrations”. *Analytica Chimica Acta* **518**:1, pp. 93–100.

- Gnoth, S., M. Jenzsch, R. Simutis and A. Lübbert (2008). “Control of cultivation processes for recombinant protein production: a review”. *Bioprocess and Biosystems Engineering* **31**:1, pp. 21–39.
- Jensen, E. B. and S. Carlsen (1990). “Production of recombinant human growth hormone in *Escherichia coli*: expression of different precursors and physiological effects of glucose, acetate, and salts”. *Biotechnology and Bioengineering* **36**:1, pp. 1–11.
- Johnsson, O., J. Andersson, G. Lidén, C. Johnsson and T. Hägglund (2013). “Feed rate control in fed-batch fermentations based on frequency content analysis”. *Biotechnology Progress* **29**:3, pp. 817–824.
- Kaasgaard, S., N. Banke and K. Uhre Hansen (2004). *MPG added to fermentation*. Patent Application. Version A2. WO 2004/003187 A2.
- Konstantinov, K. B., N. Nishio and T. Yoshida (1990). “Glucose feeding strategy accounting for the decreasing oxidative capacity of recombinant *Escherichia coli* in fed-batch cultivation for phenylalanine production”. *Journal of Fermentation and Bioengineering* **70**:4, pp. 253–260.
- Li, Z. J., V. Shukla, A. P. Fordyce, A. G. Pedersen, K. S. Wenger and M. R. Marten (2000). “Fungal morphology and fragmentation behavior in a fed-batch *Aspergillus oryzae* fermentation at the production scale”. *Biotechnology and Bioengineering* **70**:3, pp. 300–312.
- Lin, H. Y. and P. Neubauer (2000). “Influence of controlled glucose oscillations on a fed-batch process of recombinant *Escherichia coli*”. *Journal of Biotechnology* **79**:1, pp. 27–37.
- Luli, G. W. and W. R. Strohl (1990). “Comparison of growth, acetate production, and acetate inhibition of *Escherichia coli* strains in batch and fed-batch fermentations”. *Applied and Environmental Microbiology* **56**:4, pp. 1004–1011.
- Luttmann, R., D. G. Bracewell, G. Cornelissen, K. V. Gernaey, J. Glassey, V. C. Hass, C. Kaiser, C. Preusse, G. Striedner and C.-F. Mandenius (2012). “Soft sensors in bioprocessing: a status report and recommendations”. *Biotechnology Journal* **7**:8, pp. 1040–1048.
- Madsen, H. (2008). *Time series analysis*. Chapman & Hall/CRC, Boca Raton, Florida, United States of America.
- El-Mansi, M. (2004). “Flux to acetate and lactate excretions in industrial fermentations: physiological and biochemical implications”. *Journal of Industrial Microbiology and Biotechnology* **31**:7, pp. 295–300.
- Neijssel, O. M., G. P. M. A. Hardy, J. C. Lansbergen, D. W. Tempest and R. W. O’Brien (1980). “Influence of growth environment on the phosphoenolpyruvate: glucose phosphotransferase activities of *Escherichia coli* and *Klebsiella aerogenes*: a comparative study”. *Archives of Microbiology* **125**:1-2, pp. 175–179.

- Paul, E. L., V. Atiemo-Obeng and S. M. Kresta (2004). *Handbook of industrial mixing: science and practice*. Wiley, Hoboken, New Jersey, United States of America.
- Riesenberg, D. and R. Guthke (1999). “High-cell-density cultivation of microorganisms”. *Applied Microbiology and Biotechnology* **51**:4, pp. 422–430.
- Rocha, I. and E. Ferreira (2002). “On-line simultaneous monitoring of glucose and acetate with FIA during high cell density fermentation of recombinant *E. coli*”. *Analytica Chimica Acta* **462**:2, pp. 293–304.
- Selişteanu, D., E. Petre, C. Marin and D. Şendrescu (2008). “Estimation and adaptive control of a fed-batch bioprocess”. In: *Proceedings of the International Conference on Control, Automation and Systems (ICCAS 2008)*, pp. 1349–1354.
- Sonnleitner, B. and O. Käppeli (1986). “Growth of *Saccharomyces cerevisiae* is controlled by its limited respiratory capacity: formulation and verification of a hypothesis”. *Biotechnology and Bioengineering* **28**:6, pp. 927–937.
- Swartz, J. R. (1996). *Method of determining propensity of dissolved oxygen instability*. Patent. US 5487980.
- Tempest, D. W. and O. M. Neijssel (1979). “Overflow metabolism in aerobic micro-organisms”. *Biochemical Society Transactions* **7**:1, pp. 82–85.
- Van Putten, A. B., F. Spitzenberger, G. Kretzmer, B. Hitzmann, M. Dors, R. Simutis and K. Schügerl (1996). “Improvement of the production of subtilisin Carlsberg alkaline protease by *Bacillus licheniformis* by on-line process monitoring and control in a stirred tank reactor”. *Journal of Biotechnology* **49**:1, pp. 83–93.
- Vargas, A., L. Dewasme, J. Moreno and A. Vande Wouwer (2012). “A simple output-feedback controller for fed-batch cultures of microbial strains with overflow metabolism”. In: *Proceedings of the International Symposium on Advanced Control of Chemical Processes (ADCHEM 2012)*, pp. 934–939.
- Velut, S., A. Castan, K. A. Short, J. P. Axelsson, P. Hagander, B. A. Zditosky, C. W. Rysenga, L. De Maré and J. Haglund (2007). “Influence of bioreactor scale and complex medium on probing control of glucose feeding in cultivations of recombinant strains of *Escherichia coli*”. *Biotechnology and Bioengineering* **97**:4, pp. 816–824.
- Villadsen, J., J. Nielsen and G. Lidén (2011). *Bioreaction engineering principles*. Springer, New York, New York, United States of America.
- Voigt, B., T. Schweder, D. Becher, A. Ehrenreich, G. Gottschalk, J. Feesche, K.-H. Maurer and M. Hecker (2004). “A proteomic view of cell physiology of *Bacillus licheniformis*”. *Proteomics* **4**:5, pp. 1465–1490.

- Warth, B., G. Rajkai and C.-F. Mandenius (2010). "Evaluation of software sensors for on-line estimation of culture conditions in an *Escherichia coli* cultivation expressing a recombinant protein". *Journal of Biotechnology* **147**:1, pp. 37–45.

Paper III

A mid-ranging control strategy for non-stationary processes and its application to dissolved oxygen control in a bioprocess

Ola Johnsson, Daniel Sahlin, Johanna Linde,
Gunnar Lidén and Tore Hägglund

Abstract

In this study a modified mid-ranging strategy is proposed where the controller for the secondary manipulated variable uses its own output as its setpoint, possibly with an offset and/or re-scaling. This modification allows the manipulated variables to increase in unison so that the mid-ranging advantage of utilizing the fast dynamics of the primary controller to regulate the process can be achieved also in non-stationary processes, while not adding complexity to the controller. The proposed control strategy has been implemented in pilot-scale (0.550 m³) industrial bioprocesses where it is used to control the dissolved oxygen level by manipulating agitator speed and aeration rate. The controller is demonstrated to perform well in these, outperforming a reference controller which has previously been shown to give satisfactory control performance. It is also shown in similar experiments that the strategy can easily be adapted to control dissolved oxygen in bioprocesses where the feed rate is controlled using an extremum-seeking controller. The proposed strategy is generally applicable to non-stationary processes where a mid-ranging approach is suitable.

1. Introduction

In an aerobic bioprocess, maintaining aerobic conditions in the liquid medium is important to ensure efficient microbial growth and production. Oxygen transfer through the medium is more efficient at low oxygen concentrations [Garcia-Ochoa and Gomez, 2009] so maintaining a low yet non-zero oxygen concentration is therefore desirable, meaning that well-designed control which allows for lower set-points can improve process efficiency [du Preez and Hugo, 1989]. When using oxygen control in conjunction with other control systems it can also be highly important that a steady baseline in the oxygen level is maintained, so that disturbances in oxygen concentration do not influence these other systems [Åkesson and Hagander, 1999].

Mid-ranging control is a commonly used approach for control of a single variable using two manipulated variables (process inputs). Although model predictive control (MPC) can be more suitable to handle complex systems, mid-ranging control is often preferred due to its simplicity [Allison and Ogawa, 2003]. The control of oxygen concentration in a biotechnical process in a stirred-tank reactor can be regarded as such a process, where the manipulated variables are agitator speed and aeration rate. There are other variables which can be used to influence the oxygen concentration, such as oxygen concentration of inlet air and total pressure, but these are often not practical to use.

Many industrial bioprocesses are performed as fed-batch and are therefore non-stationary [Rani and Rao, 1999]. This causes certain difficulties with regard to mid-ranging control as it is then typically not desirable to maintain one manipulated variable at a predefined level for as long as possible, which is the aim of classical mid-ranging control. In this study, a modification to the classical mid-ranging scheme for the purpose of adapting it to non-stationary processes is proposed and evaluated in the context of oxygen control in a fed-batch industrial bioprocess.

2. Industrial bioprocesses

In an industrial bioprocess, the aim is commonly to maximize microbial growth and/or production of some compound produced by microorganisms. To achieve this in an efficient manner, it is necessary to maintain a suitable environment for the microorganisms at all times. This is commonly done by using stirred-tank bioreactors, where microorganisms are grown in a liquid medium which is stirred to achieve an even spatial distribution of compounds in the medium.

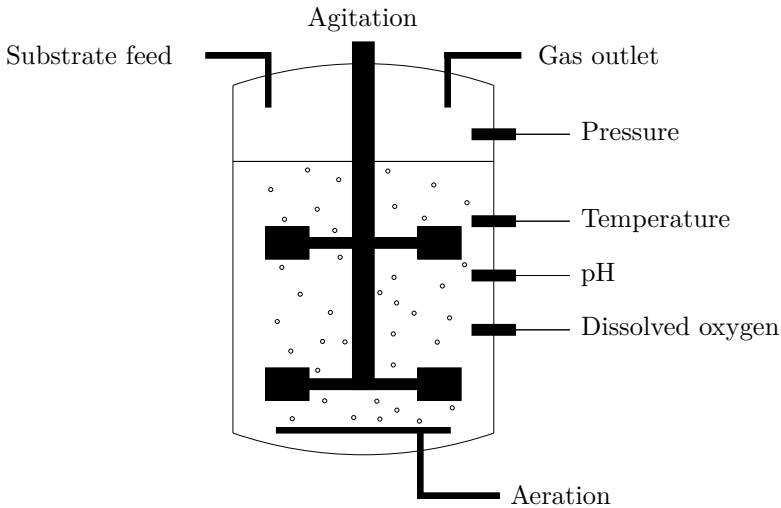

Figure 1. Illustration of a typical fed-batch bioreactor. Liquid substrate is added continuously while air is introduced through a sparger at the bottom of the tank. Agitation ensures that the liquid medium is suitably mixed and the air bubbles small enough to allow efficient oxygen transfer. Temperature, pH and dissolved oxygen concentration are monitored continuously, while the oxygen and carbon dioxide concentrations in the gas outlet are analyzed by a mass spectrometer. Total pressure is controlled by varying the gas outlet flow, temperature through cooling and pH through addition of acid/base.

2.1 Fed-batch bioprocesses

In order to control microbial growth a limiting compound, that is, one which does not exist in excess in the medium, can be added by means of a continuous feed throughout the process. This mode of operation is termed fed-batch and is commonly used in large-scale industrial bioprocesses today [Lidén, 2002]. An illustration of a fed-batch bioreactor showing some common measurements and actuators is given in figure 1.

A fed-batch bioprocess can be divided into at least two distinct phases, an initial growth phase in which microbial growth is emphasized followed by a production phase where as much as possible of the product compound is produced. During the growth phase, exponential growth of the biomass at a high rate is desired as a higher biomass concentration will be able to generate more product. The growth phase ends when the mass transfer capacity of the bioreactor limits biomass growth, meaning that if the biomass would increase further it would not be possible to supply oxygen at a high enough rate, transport away heat fast enough or some other transport limitation occurs.

This leads to a change in control objective and typically means that it is necessary to decrease the substrate feed rate to limit growth.

2.2 Oxygen dynamics in a fed-batch bioreactor

Exponential growth of microorganisms can in the right environment be very rapid, with a doubling time lower than 10 minutes [Eagon, 1962]. This means that in the case of microorganisms using oxygen as a substrate, termed aerobes, the oxygen consumption during the initial growth phase of a fed-batch bioprocess will be exponentially increasing at a high rate.

Maintaining a steady concentration of oxygen above zero in the liquid bioreactor medium is required in aerobic bioprocesses, as oxygen deficiency leads to either cessation of growth (obligate aerobes) or less efficient metabolism as well as production of undesirable by-products (facultative anaerobes) [Villadsen et al., 2011]. As the consumption of oxygen increases with both biomass concentration and specific growth rate, the supply of oxygen must also increase to maintain a desired concentration. The supply of oxygen can be described as in (1), where q_o is the volumetric mass transfer rate of oxygen, k_l is the mass transfer coefficient, a is the specific surface area, C_o^* is the oxygen concentration when at equilibrium with the gas phase and C_o is the current oxygen concentration [Villadsen et al., 2011].

$$q_o = k_l a (C_o^* - C_o) \quad (1)$$

As seen in (1) the oxygen supply is determined by several factors, which can be manipulated in order to vary the supply. In a stirred-tank reactor (STR) $k_l a$ can be increased by increasing the aeration rate and the agitator speed, but it is also possible to increase the transfer by increasing the partial pressure of oxygen in the gas phase and hence C_o^* or decreasing the dissolved oxygen level C_o . However, increasing the partial pressure of oxygen in the gas phase is often not feasible as it either requires increased total pressure which increases strain on the bioreactor or addition of pure oxygen which is costly compared to using pure air. Decreasing C_o does not come with these practical limitations but brings the process closer to oxygen deficiency, meaning that better control is required to avoid this undesirable state.

Empirical correlations for the effects of aeration (AR) and agitation (AG) on $k_l a$ exist, but coefficient values will vary depending on the size and geometry of the bioreactor. Most of them can be written in the form given in (2), where u_s is the superficial gas flow (proportional to aeration rate), P_g/V_l is the power input per volume of gassed medium and k , α and β are coefficients which will depend on medium properties [Villadsen et al., 2011].

$$k_l a = k \cdot u_s^\alpha \left(\frac{P_g}{V_l} \right)^\beta \quad (2)$$

A correlation between the power input into gassed medium P_g and the power input into ungassed medium P was suggested by Hughmark [1980], as given in (3) where V_l is the liquid volume, g is the acceleration of gravity and d_s and w_s are the diameter and width of the stirrer respectively.

$$P_g = P \cdot 0.1 \left(\frac{AR}{AG \cdot V_l} \right)^{-1/4} \left(\frac{AG^2 \cdot d_s^4}{g \cdot w_s \cdot V_l^{2/3}} \right)^{-1/5} \quad (3)$$

The power input into ungassed medium, P , can be expressed as in (4) where N_p is the dimensionless power number which depends on the viscous and inertial forces and ρ_l is the density of the liquid.

$$P = N_p \cdot \rho_l \cdot AG^3 \cdot d_s^5 \quad (4)$$

Relations (3) and (4) give that the power input per volume of gassed medium relates to AG and AR as in (5).

$$\frac{P_g}{V_l} \propto AG^{2.85} \cdot AR^{-0.25} \quad (5)$$

Villadsen et al. [2011] give examples of coefficient values in (2) for different settings, the values for α are in the range 0.2 – 0.5 and the values for β are 0.4 – 0.7. Inserting this into (2) and using the relation in (5), it can be seen that $k_l a$ depends on AG and AR as in (6) where a is in the range 1.14 – 2.00 and b is 0.0250 – 0.400. As the exponent for AG is at least 2.85 times greater than that for AR , variations in AG will have a larger impact on $k_l a$. In a setting where a primary control variable should be chosen, AG is therefore the most suitable choice.

$$k_l a \propto AG^a \cdot AR^b \quad (6)$$

3. Control strategies

For a process with two inputs and one output, mid-ranging control as illustrated in figure 2 is a classical solution to the control problem. Utilizing the first input to control the output directly and the second input to control the first, it allows for rapid control of the process output through one of the inputs while the other input ensures that the first does not become saturated. Mid-ranging control is a simple control structure which is widely implemented in industry today [Haugwitz et al., 2005]. It has been known for long and is described by Shinskey [1988] who terms it valve positioning control (VPC), since one common use of it is to control a liquid flow using two valves of different sizes. For non-stationary processes, however, classical mid-ranging control can be unsatisfactory as keeping one process input at a constant level for as long as possible may not be desirable.

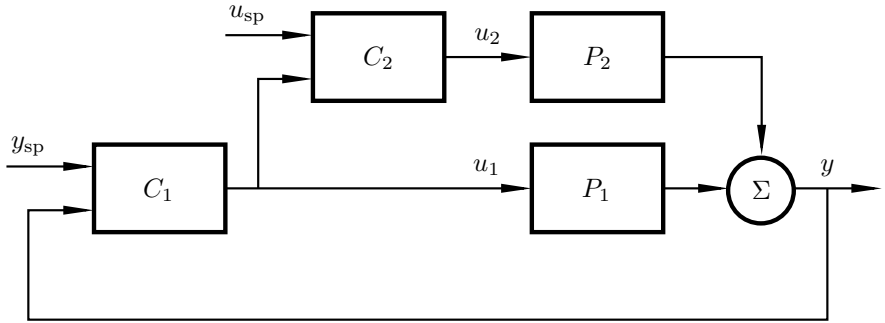

Figure 2. Classical mid-ranging control of a process with two inputs and one output. C_1 is used to regulate the controlled variable y to y_{sp} using u_1 while C_2 is used to control the value of u_1 to u_{sp} using u_2 . P_1 and P_2 describe the process dynamics for inputs u_1 and u_2 respectively, the model assumes that these are decoupled.

We here propose a strategy for control of a non-stationary process where it is desirable to maintain the process inputs at similar levels or with a constant scaling factor or offset between them. This strategy employs a mid-ranging approach, with minor modifications compared to classical mid-ranging control which in no way add to the complexity of the controller. The key idea is to use one process input to control the process output and the other to control the first input in a way similar to mid-ranging control, but using the value of the second input as the setpoint for the first input. This scheme is illustrated in figure 3. Controlling the difference between the input signals to a non-zero value is merely a matter of adding a constant offset to one of the inputs of the second controller. Similarly, adding a scaling factor to one of the inputs to the secondary controller (C_2) allows controlling the inputs to different levels. As minimum and maximum levels of inputs are typically well known, calculation of offset and scaling factors is a trivial matter even if they are not normalized to 0–100 %.

4. Materials and methods

4.1 Fermentation equipment and growth conditions

Pilot scale bioreactors with a volume of 0.550 m³ (0.350 m³ fill volume) of the same type as described in [Albæk et al., 2008] were used in all experiments.

The microbial strain used in the experiments was the recombinant amylase-producing *Bacillus licheniformis* strain SJ4628, derived from DN286 [Fleming et al., 1995]. This is an industrial strain developed by Novozymes A/S. 24 kg medium from a seed bioreactor was used to inoculate

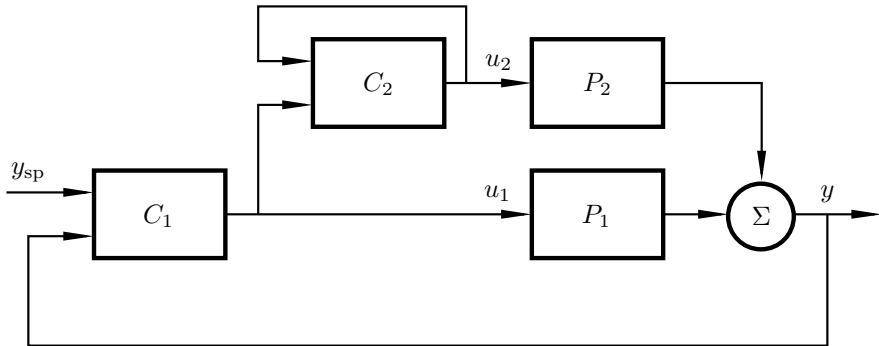

Figure 3. The proposed strategy for control of non-stationary processes. C_1 is used to regulate the controlled variable y to y_{sp} using u_1 while C_2 is used to control the value of u_1 to u_2 using u_2 . P_1 and P_2 describe the process dynamics for inputs u_1 and u_2 respectively, the model assumes that these are decoupled.

the bioreactors at the start of each experiment. 300 kg of a defined starting medium was used and the bioreactors were fed with 64 % w/w glucose.

4.2 Software implementation

The bioreactors were controlled using the commercial DeltaV process control system which allowed on-line measurement of dissolved oxygen saturation (DO), which is a measure of C_o given as the saturation percentage of oxygen in the liquid medium. 100 % corresponds to the dissolved oxygen concentration when the liquid is in equilibrium with air.

Other measured variables include pH, temperature (T) and the concentration of oxygen and carbon dioxide in the outlet gas. The latter two, together with gas flow rate measurements, allow for calculation of oxygen uptake rate (OUR) and carbon dioxide emission rate (CER). Although these are not directly related to the results of this study, they were monitored to ensure that no unexpected deviations occurred during the experiments.

The script implementing the controller was developed in Matlab and run on a separate computer, using an MX OPC server to allow it to write set-points to and read measured data from the DeltaV system. The controller was used to control the feed rate (F), the aeration rate (AR) and the agitator speed (AG) of the processes. The sampling and control period was 2 seconds in all experiments.

4.3 Experiment set-up

Two experiments were performed to evaluate the performance of the control strategy and two reference experiments were performed to allow a compar-

ison to a reference strategy. The reference strategy is the split-range method described by Johnsson et al. [2013] where AG is used to control DO until it saturates, at which point AR is used instead until it saturates too.

In the evaluated DO control strategy, controller set-up was done as follows. AG was used to directly regulate DO to a setpoint of 20 % and was controlled using a proportional-integral (PI) controller. AR was used in the secondary loop to regulate AG and was also controlled by a PI controller. The choice of AG as the primary manipulated variable was due to the knowledge that the dynamics of its effects on DO are faster than those of AR . All PI controllers used were on the form given in (7), which for the implementation were discretized into the form in (8) where h is the sampling interval and k is the current sampling instance. In the implementation, a conditional integration scheme was also used for anti-windup.

$$U(s) = K \frac{sT_i + 1}{sT_i} E(s) \quad (7)$$

$$u(k) = K \left(e(k) + \frac{h}{T_i} \sum_{n=1}^k e(n) \right) \quad (8)$$

Controller design and tuning was done based on a series of modelling experiments in which the system response to step changes in AG and AR were evaluated from different starting levels of the control signals. In these experiments DO was controlled between step changes using only a PI controller for AG so that a baseline of 20 % DO saturation was maintained, while AR was held constant at values varying between experiments.

From step responses in DO first-order time delay (FOTD) models were fitted to the system, meaning that the parameters K_p , T and L in the transfer function process model (9) were determined. As it is known that the effects on DO of AG and AR are not additive, a series of local FOTD models were created. These were used in conjunction with a gain scheduling set-up to tune a PI controller for the primary control loop according to the lambda tuning rules as described by for instance [Åström and Häggglund, 2006], with $T_{cl} = T$. It was found that the level of AR had no clear effect on the model parameters and therefore only gain scheduling based on AG was required. The secondary controller was manually tuned to act only at low frequencies so that it would not interfere with the primary control loop and also used gain scheduling based on the step response experiments.

$$P(s) = \frac{K_p}{sT + 1} e^{-sL} \quad (9)$$

The AG setpoint was set to the current value of AR plus an offset as described in section 3. In addition, the setpoint was given a maximum value

equal to 95 % of the maximum AG so that the slower aeration rate controller would saturate just before the agitator speed controller. Agitation and aeration were limited to 125 – 475 rpm and 150 – 450 L/min respectively, due to the physical constraints of the system.

In one reference and one evaluation experiment, the feed rate was controlled to follow predefined ramps. In the others, a feed rate controller similar to that used in Johnsson et al. [2013] was used in which the DO response to pulses in the feed rate at a predefined frequency of 10 mHz was used to evaluate the current metabolic state of the process and control the feed rate based on this. This controller utilizes the saturation-like effect seen in oxygen consumption when overflow metabolism occurs, meaning that the oxygen response to feed variations decreases, to ensure that the feed rate is close to the critical feed rate for overflow metabolism. Hence, a high growth rate is achieved while no long-term accumulation of overflow metabolites occur. In all experiments, a maximum limitation on the feed rate at 5 L/h was employed. The experimental set-up when using the extremum-seeking feed rate controller is schematically shown in figure 4.

When using the feed rate controller the evaluated DO control strategy was modified by addition of a notch filter, which attenuates the frequency of the feed rate pulses from the measured DO signal sent to the AG controller without affecting other frequencies, hence allowing fast control without removal of the feed pulse responses in DO needed for the feed rate controller's evaluation of the metabolic state. The notch filter used here was second order, with a transfer function $H(s)$ as per (10) with a Q-factor of 3, meaning that for the nominal perturbation frequency ω_0 of 10 mHz the filter bandwidth is 3.33 mHz.

$$H(s) = \frac{s^2 + \omega_0^2}{s^2 + \frac{\omega_0}{Q}s + \omega_0^2} \quad (10)$$

In practice, the frequency of the feed rate perturbations varied somewhat but this was tracked by the notch filter to ensure that the highest damping occurred at the perturbation frequency.

5. Results and discussion

Results of all experiments are shown here as graphs of DO , AG , AR and F over time. It should be noted that due to the perturbations in feed rate used by the extremum-seeking feed rate controller, it is here not desirable to achieve a low standard deviation in DO . Since the deviations from the setpoint will determine the behaviour of this controller the aim of the dissolved oxygen controller is rather to achieve a steady baseline, meaning good setpoint following over longer periods of time.

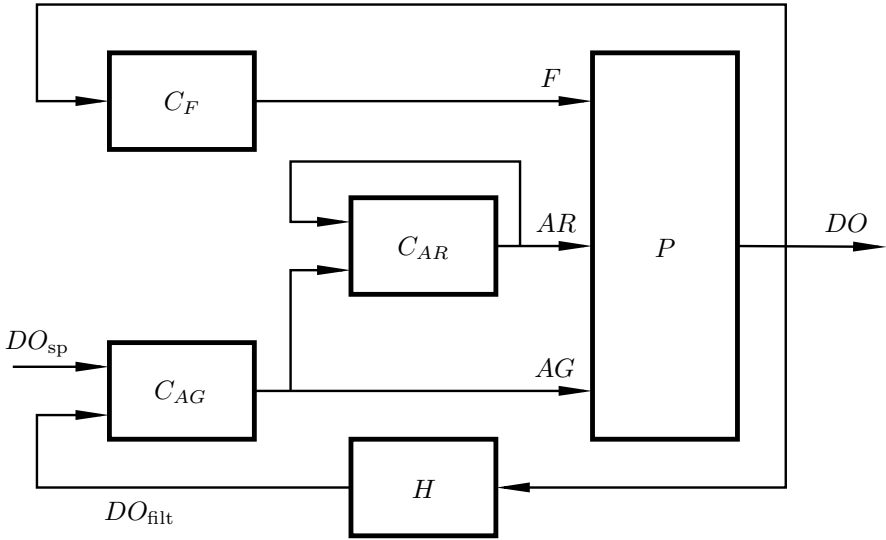

Figure 4. The set-up for control of the bioprocess. The DO signal is both used by the extremum-seeking feed rate controller C_F and notch-filtered in H to be used by the mid-ranging DO controller. C_{AG} is used to regulate the notch-filtered DO , DO_{filt} , to DO_{sp} using AG while C_{AR} is used to control the value of AG to AR using AR .

In all experiments, DO is initially above the setpoint and does not reach it until after a few hours. This is not due to the controllers but rather the built-in constraints of the process, as with a low biomass concentration DO will be high even when AG and AR are at their respective minima. This effect is seen in all processes of this type, as with a low starting biomass and hence low oxygen consumption rate it will take some time until oxygen consumption reaches a level where a major part of the added oxygen is consumed. If the minima are relatively high and the starting biomass relatively low, the effect will become more pronounced.

5.1 Experiments using static feed rate ramps

As shown in figure 5, the mid-ranging controller achieves its aim of maintaining a steady baseline (average value at the setpoint) over time, except for between 7 and 8 hours when an error in the implementation occurred. This was due to an erroneous modification done to the controller script at this time, intended to make its computations more efficient but causing it to crash and need re-starting, it is therefore not related to the performance of the controller itself. The control signals AG and AR rise in unison as desired and the fast process response to AG can be fully exploited until both signals

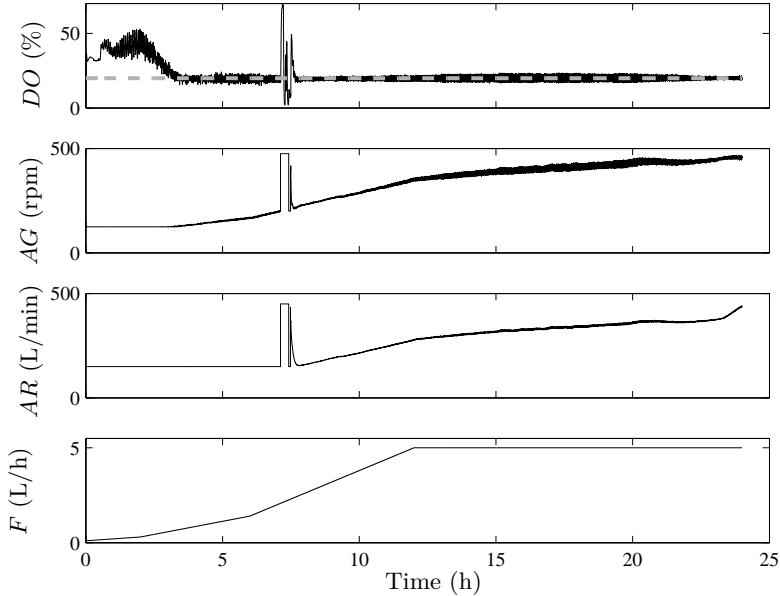

Figure 5. Experiment using the mid-ranging controller and predefined feed rate ramps. The DO setpoint of 20 % is shown as a dashed line in the DO graph. AG and AR rise in unison and maintain a desired offset for as long as possible. Except for between 7 and 8 hours where an implementation error occurred, the DO baseline is well maintained over time.

reach their maxima due to the mid-ranging set-up. The outcome of the reference split-range controller is shown in figure 6, where a small deviation in the DO baseline is seen when changing control signal.

5.2 Experiments using extremum-seeking feed rate control

The controllers employed here are similar to those in section 5.1 but with a notch filter added to the mid-ranging controller as described in section 4.3. The outcome of the evaluation experiment as seen in figure 7 shows that the proposed mid-ranging control strategy for non-stationary processes performs well also in this case, similar to the outcome in section 5.1. The reference split-range controller also shows similar performance to when a static feed ramp is used, as seen in figure 8.

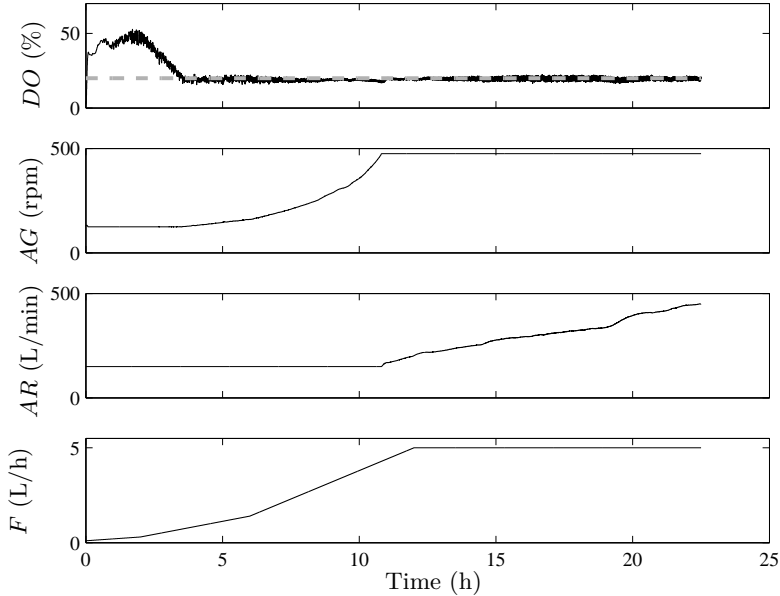

Figure 6. Experiment using the reference split-range controller and predefined feed rate ramps. The DO setpoint of 20 % is shown as a dashed line in the DO graph. As the DO controller is a split-range controller, AG is first increased and then AR . A small deviation in the DO baseline can be seen when switching from one control signal to the other.

5.3 Quantitative evaluation of results

To evaluate the performance of the mid-ranging controller, more specifically its ability to maintain a stable baseline for DO over time, DO data from all experiments was low-pass filtered using a first-order filter with a cutoff frequency of 0.1 mHz to remove short-term deviations caused by feed pulses as attenuation of these is not desirable here. A visual comparison of the DO data from the different experiments can be seen in figure 9, clearly demonstrating that the mid-ranging controller can maintain a DO baseline with only minor deviations.

The root mean square and maximum deviation from the setpoint in DO for all experiments are given in table 1, showing that the mid-ranging controller gives low values for both root mean square and maximum deviations. In comparison, the reference controller gives deviations which are 3–6 times greater than those of the corresponding mid-ranging controllers. This shows that although the reference controller is known to be sufficiently good to

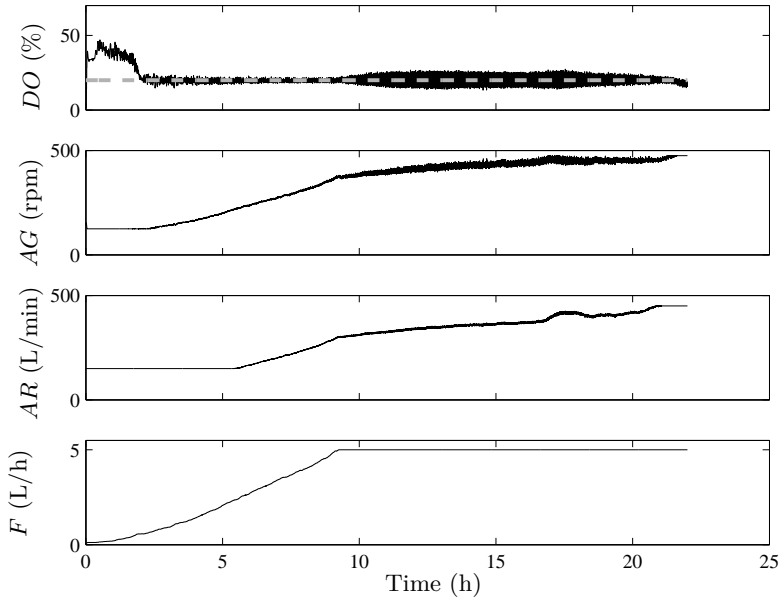

Figure 7. Experiment using the mid-ranging controller and an extremum-seeking feed rate controller. The DO setpoint of 20 % is shown as a dashed line in the DO graph. AG and AR rise in unison and maintain a desired offset for as long as possible. The DO baseline is well maintained over time.

control bioprocesses when used in conjunction with a feed controller, the mid-ranging controller performs better and could be used to improve control of this type of bioprocess.

6. Conclusions

In this work a simple modified mid-ranging control strategy has been proposed for use in non-stationary processes where it is desirable to vary two manipulated variables in unison, without limiting controller performance by for instance making them follow each other exactly. The modified mid-ranging controller has been successfully implemented in fed-batch bioprocesses and shown to perform well in regulating the dissolved oxygen concentration in these with agitator speed and aeration rate as manipulated variables, a typical example of a non-stationary industrial process.

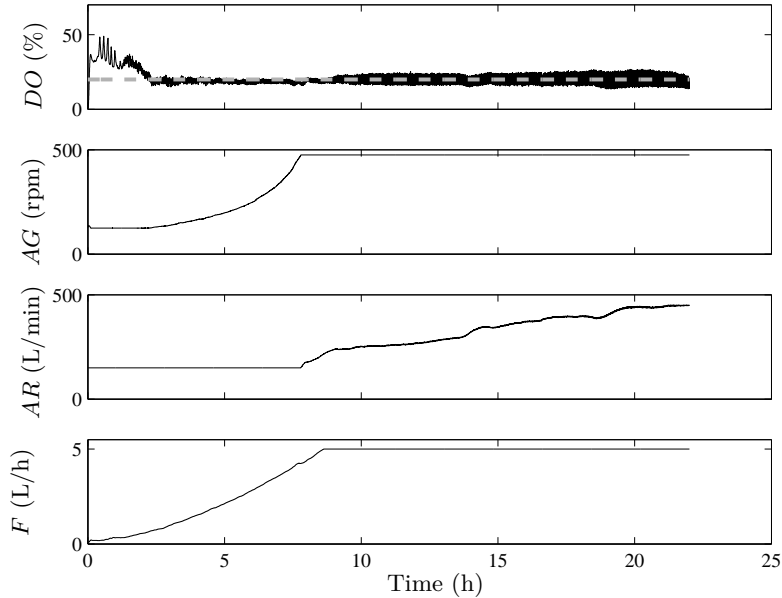

Figure 8. Experiment using the reference split-range controller and an extremum-seeking feed rate controller. The DO setpoint of 20 % is shown as a dashed line in the DO graph. As the DO controller is a split-range controller, AG is first increased and then AR . A small deviation in the DO baseline can be seen when switching from one control signal to the other.

Table 1. Deviations in low-pass filtered DO data. The root mean square and maximum deviation for all experiments are shown. All numbers given are in DO percentage units.

Experiment	Root mean square deviation	Maximum deviation
Mid-ranging with feed ramp	0.17	0.38
Reference with feed ramp	0.79	1.77
Mid-ranging with feed controller	0.11	0.36
Reference with feed controller	0.51	1.19

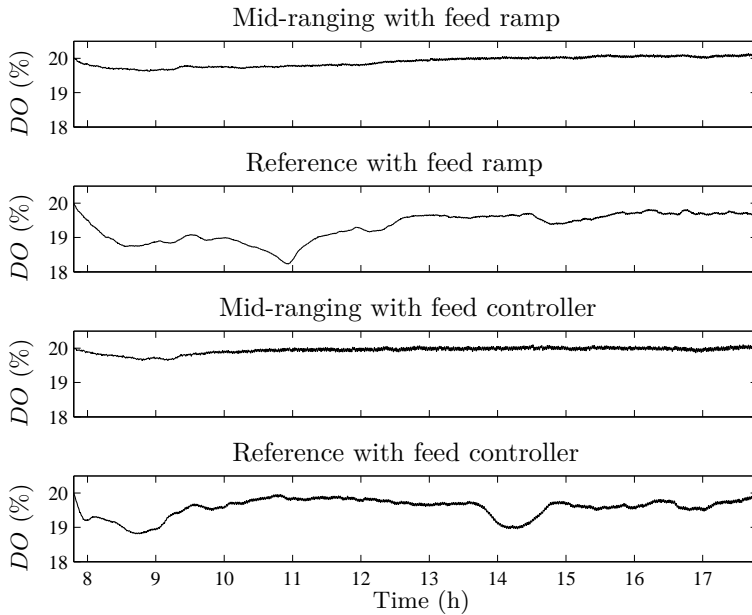

Figure 9. Low-pass filtered DO data from all experiments. The time interval (7.8–17.8 h) was chosen so that the deviation caused by an implementation error (see figure 5) would not influence the outcome while providing a good view of the experiments as a whole.

Evaluation was done using both predefined ramps and an extremum-seeking feedback regulator for feed rate control while dissolved oxygen is controlled using the proposed modified mid-ranging controller. In comparison to a split-range controller, which has previously been shown to perform satisfactorily together with the feedback feed rate controller in question, the modified mid-ranging strategy was shown to perform better.

The principle of the proposed controller is not specific for the process in which it has been implemented in this study. It can be generally applied to non-stationary processes where one process output is controlled using two inputs.

Acknowledgements

This work was carried out in cooperation with Novozymes A/S and all experiments were done at the Novozymes pilot plant in Bagsværd, Denmark. The first and fifth authors are members of the LCCC Linnaeus Center at Lund University.

References

- Åkesson, M. and P. Hagander (1999). “A gain-scheduling approach for control of dissolved oxygen in stirred bioreactors”. In: *Proceedings of the 14th IFAC World Congress*, pp. 505–510.
- Albæk, M. O., K. V. Gernaey and S. M. Stocks (2008). “Gassed and un-gassed power draw in a pilot scale 550 litre fermentor retrofitted with up-pumping hydrofoil B2 impellers in media of different viscosity and with very high power draw”. *Chemical Engineering Science* **63**:24, pp. 5813–5820.
- Allison, B. J. and S. Ogawa (2003). “Design and tuning of valve position controllers with industrial applications”. *Transactions of the Institute of Measurement and Control* **25**:1, pp. 3–16.
- Åström, K. J. and T. Hägglund (2006). *Advanced PID control*. ISA - The Instrumentation, Systems, and Automation Society, Research Triangle Park, North Carolina, United States of America.
- du Preez, J. C. and A. B. Hugo (1989). “An electronic controller for maintaining low dissolved oxygen levels in a bench-top fermentor”. *Biotechnology Techniques* **3**:5, pp. 289–294.
- Eagon, R. G. (1962). “*Pseudomonas natriegens*, a marine bacterium with a generation time of less than 10 minutes”. *Journal of Bacteriology* **83**:4, pp. 736–737.
- Fleming, A. B., M. Tangney, P. Jørgensen, B. Diderichsen and F. G. Priest (1995). “Extracellular enzyme synthesis in a sporulation-deficient strain of *Bacillus licheniformis*.” *Applied and Environmental Microbiology* **61**:11, pp. 3775–3780.
- Garcia-Ochoa, F. and E. Gomez (2009). “Bioreactor scale-up and oxygen transfer rate in microbial processes: an overview”. *Biotechnology Advances* **27**:2, pp. 153–176.
- Haugwitz, S., M. Karlsson, S. Velut and P. Hagander (2005). “Anti-windup in mid-ranging control”. In: *Proceedings of the 44th IEEE Conference on Decision and Control and European Control Conference (CDC-ECC 2005)*, pp. 7570–7575.

- Hughmark, G. A. (1980). “Power requirements and interfacial area in gas-liquid turbine agitated systems”. *Industrial & Engineering Chemistry Process Design and Development* **19**:4, pp. 638–641.
- Johnsson, O., J. Andersson, G. Lidén, C. Johnsson and T. Häggglund (2013). “Feed rate control in fed-batch fermentations based on frequency content analysis”. *Biotechnology Progress* **29**:3, pp. 817–824.
- Lidén, G. (2002). “Understanding the bioreactor”. *Bioprocess and Biosystems Engineering* **24**:5, pp. 273–279.
- Rani, K. Y. and V. R. Rao (1999). “Control of fermenters – a review”. *Bioprocess Engineering* **21**:1, pp. 77–88.
- Shinskey, F. G. (1988). *Process control systems: application, design and tuning*. 3rd ed. McGraw-Hill, Inc., New York, New York, United States of America.
- Villadsen, J., J. Nielsen and G. Lidén (2011). *Bioreaction engineering principles*. Springer, New York, New York, United States of America.

Paper IV

On-line detection of oxidative saturation using frequency response in industrial scale bioprocesses

Ola Johnsson, Karsten Hvalkof Andersen, Jonas Andersson,
Gunnar Lidén and Tore Hägglund

Abstract

On-line monitoring and control of the feed demand in fed-batch bioprocesses can be a significant problem, particularly in industrial processes where complex media are often used, detailed models are difficult to come by and only few measurements are commonly available. In this study, a method for on-line estimation of feed demand by tracking of the oxidative saturation in metabolism was developed and implemented in industrial production-scale bioprocesses ($>100 \text{ m}^3$). Sinusoidal feed rate perturbations were used and by analysis of the dissolved oxygen response good estimates of substrate and by-product levels, and hence the feed demand, were obtained. The method has very low demands on sensing and computational equipment, as it utilizes simple calculations with a low computational cost and needs only measurement of dissolved oxygen, and requires very little *a priori* knowledge of the process. This makes it particularly suitable for monitoring and control of the feed demand in an industrial setting.

1. Introduction

In an industrial bioprocess the chemical environment of the microorganisms will influence their growth and productivity, one of the major factors in this being substrate availability. A very common mode of operation in bioprocesses is fed-batch [Villadsen et al., 2011] where the main substrate, typically a sugar which serves as the main carbon and energy source, is fed in a controlled manner so that microbial growth can be regulated. The principle problem in feed rate regulation is that while a too low availability of substrate will lead to decreased growth and productivity, a too high availability will lead to production of undesirable by-products such as ethanol, acetate and lactate through a biological mechanism termed metabolic overflow [Tempest and Neijssel, 1979].

Although it allows for faster short-term growth, metabolic overflow decreases biomass and product yields as it diverts substrate into by-product formation. These by-products are typically harmful to the organism, a well-described case of which is the inhibitory effects on growth caused by acetate [Luli and Strohl, 1990]. As this has significant negative long-term effects in an industrial bioprocess, metabolic overflow is an undesirable trait [El-Mansi, 2004]. The overflow mechanism has been seen and described in main industrial production organisms such as *Escherichia coli* [Neijssel et al., 1980], *Saccharomyces cerevisiae* [Sonnleitner and Käppeli, 1986] and *Bacillus licheniformis* [Voigt et al., 2004].

In the current work, it is investigated whether the dissolved oxygen response to sinusoidal feed rate perturbations can be used to monitor overflow metabolism on-line in production-scale bioprocesses, utilizing a low-complexity estimator of the current metabolic state. In such case, this would enable industrial implementation of feedback control strategies to avoid accumulation of overflow metabolites with its associated negative effects on yield and stability.

2. Theory

The control problem in fed-batch feed rate control is mainly a problem of sensing. Typically the liquid concentration of biomass, substrate and overflow metabolites as well as other parameters will vary significantly over the course of the process, particularly in the initial stage of a bioprocess when exponential growth can occur. Although on-line measurements of some of these are possible in bioprocesses utilizing chemically defined media [Bittner et al., 1998; Rocha and Ferreira, 2002], measurements in industrial-scale bioprocesses with complex (non-synthetic) media are significantly more difficult and usually not done. Similarly, off-gas analysis can be used to provide in-

formation regarding the metabolic state but in industrial applications such measurements are usually not available [Gnoth et al., 2008] and can be of low frequency due to sharing of analytical devices which decreases their reliability. Furthermore, the effect of liquid concentrations on important metabolic parameters can sometimes be complex and difficult to predict [Swartz, 1996]. The batch to batch reproducibility of such processes is typically low and modelling to predict such variations is difficult. Data-driven models can be used to create observers which allow for successful control of processes even with few online measurements, but require large amounts of historical data and are therefore limited to processes for which such data are available [Gnoth et al., 2008].

One approach for sensing in a fed-batch bioprocess is the probing strategy, used by for instance Åkesson et al. [1999], de Maré et al. [2003] and Velut et al. [2007], in which perturbations are superimposed on the feed rate (F) and the response in the dissolved oxygen (DO) level is used to determine the current feed demand in the process in order to maintain a high feed rate while avoiding excessive overflow metabolism. This strategy utilizes the saturation of oxidative metabolism which coincides with the onset of overflow metabolism and controllers using this core principle have been used in processes utilizing for instance *E. coli* [Åkesson et al., 1999], *Vibrio cholerae* [de Maré et al., 2003] and *S. cerevisiae* [Henes and Sonnleitner, 2007]. The strategy has seen some new developments by for instance Schaepe et al. [2014], suggesting among other things measurements of oxygen in off-gas rather than dissolved oxygen which however requires similarly fast and reliable measurements of off-gas content.

A method using the same probing principle but utilizing regular feed rate perturbations to enable a frequency-response approach, similar to perturbation-based extremum-seeking control [Dochain et al., 2011], has been shown to give good performance in pilot-scale (0.550 m^3) industrial processes [Johnsson et al., 2013]. This method has the important practical advantage that it only requires measurement of the dissolved oxygen level in the liquid medium, which is a standard on-line measurement in industrial bioprocesses [Alford, 2006; Gnoth et al., 2008]. Modern probes for dissolved oxygen provide fast and robust measurements [Glazer et al., 2004], which can be fully utilized in such a strategy. Methods using this principle have however so far not been applied to production-scale processes, which provide certain challenges such as the effects of large-scale mixing dynamics on the perturbation response. A study in industrial production-scale bioreactors has however shown that in a defined frequency and amplitude range the dissolved oxygen response to sinusoidal feed rate perturbations can be described by second-order linear dynamics. In addition, it was shown that such perturbations did not noticeably harm the process [Johnsson et al., 2015]. This indicates the possibility of using a modified probing strategy in an industrial setting.

3. Materials and methods

3.1 Process model

The metabolic overflow effect causing by-product formation can at its core be described as a saturation in the system. Increasing substrate uptake rates give cause to increasing oxygen uptake rates up to a point where the oxidative metabolism saturates and the oxygen uptake rate does not increase further. Beyond this point, increased substrate uptake instead leads to production of overflow metabolites which are excreted into the medium. If the oxidative metabolism is not saturated by the main substrate and these by-products are present, the overflow metabolites can be consumed and the remaining oxidative capacity used to utilize these as substrates. This metabolic relationship is illustrated in figure 1, where the microorganism is assumed to consume sucrose and produce acetate as its overflow metabolite.

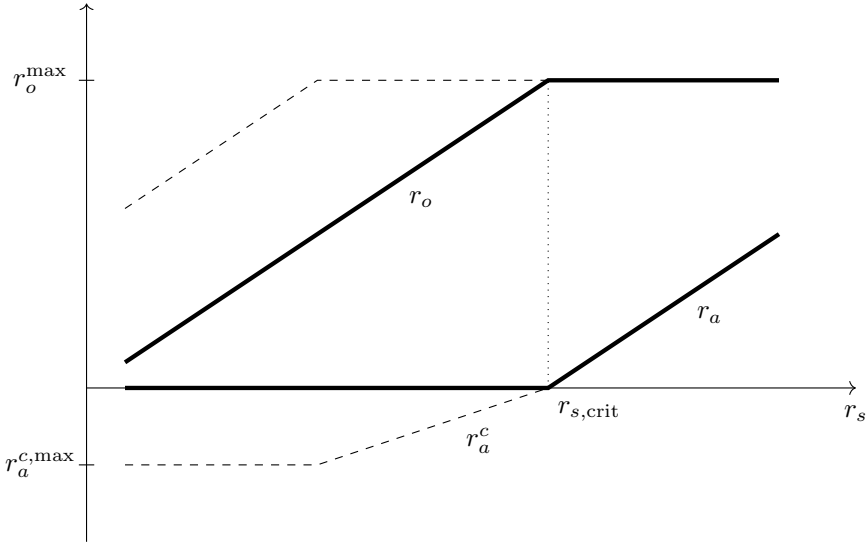

Figure 1. The relation between specific sucrose uptake rate r_s and the specific rates of oxygen uptake r_o and acetate production r_a . This shows the saturation of oxidative metabolism at $r_{s,crit}$, which is marked with a dotted line. Dashed lines indicate the specific rate of acetate uptake r_a^c and the correspondingly increased oxygen uptake, which will only occur if acetate is present and the substrate uptake rate sufficiently low [Åkesson et al., 2001].

Although these relationships describe a steady-state situation which does not capture dynamic metabolic effects, it can be assumed that the time scale of such effects is significantly shorter than that of transport dynamics in an industrial-scale bioreactor. This means that the microbial metabolism will be at pseudo-steady state and hence its dynamics can be neglected. A second-order dynamic model using this assumption has been shown to describe the effects of feed and oxygen uptake in industrial scale [Johnsson et al., 2015], which can be seen as feed and oxygen mixing dynamics each being of first order.

For maximal utilization of the oxidative capacity and minimal by-product formation, r_s should be as close as possible to the critical specific substrate uptake rate $r_{s,\text{crit}}$ which marks the onset of overflow metabolism. This corresponds to a critical substrate feed rate F_{crit} as in (1) where X is the biomass concentration, V is the liquid volume and $C_{s,\text{in}}$ is the substrate concentration in the feed. As the biomass concentration and volume change over time and $r_{s,\text{crit}}$ can vary due to metabolic variations [Swartz, 1996], F_{crit} will vary over the course of a fed-batch process and can not be estimated using standard on-line measurements. This is further complicated by overflow products also being used as substrates.

$$F_{\text{crit}} = r_{s,\text{crit}} \frac{XV}{C_{s,\text{in}}} \quad (1)$$

Assuming no production or consumption of overflow metabolites and negligible maintenance energy of the biomass, the relationship between specific substrate and oxygen uptake is determined only by the oxidative yield coefficient on the substrate Y_{os} , that is $r_o = Y_{os}r_s$. Assuming that substrate and oxygen are at pseudo-steady state in the liquid medium, neglecting mixing dynamics and using the volumetric mass transfer relationship $q_o = k_l a(DO^* - DO)$, this gives the relationship in (2). The dissolved oxygen response to a feed rate perturbation ΔF is denoted ΔDO ; when the response is unmodified with regard to saturation and mixing effects it is denoted ΔDO_u . The relation between ΔDO_u and ΔF is as per (3) where F_0 and DO_0 are the unperturbed feed rate and dissolved oxygen level respectively, as $\Delta(DO^* - DO) = -\Delta DO$ for constant DO^* . Δ denotes the variation in the variable caused by the perturbation.

$$Vk_l a(DO^* - DO) = Y_{os} F C_{s,\text{in}} \quad (2)$$

$$\frac{\Delta(DO^* - DO_u)}{DO^* - DO_0} = \frac{\Delta F}{F_0} \Rightarrow \Delta DO_u = -\frac{DO^* - DO_0}{F_0} \Delta F \quad (3)$$

Assuming linear first-order mixing dynamics for both substrate and oxygen, the total mixing gain K_{mix} at the perturbation frequency ω is as per (4) where K_s , T_s , K_o and T_o are the static gains and time constants of the substrate and oxygen mixing dynamics respectively. K_{mix} can be determined experimentally for a given bioreactor as done by Johnsson et al. [2015]. As $\Delta DO = K_{\text{sat}} K_{\text{mix}}(\omega) \Delta DO_u$, the relationship between ΔF and ΔDO is as per (5).

$$K_{\text{mix}}(\omega) = \left| \frac{K_o K_s}{(i\omega T_o + 1)(i\omega T_s + 1)} \right| \quad (4)$$

$$\Delta DO(\omega) = -K_{\text{sat}} K_{\text{mix}}(\omega) \frac{DO^* - DO_0}{F_0} \Delta F \quad (5)$$

3.2 Principles of the monitoring method

The current state of the system with regard to the metabolic saturation is determined by observing the response in DO to sinusoidal perturbations in F . The concept is illustrated in figure 2, showing three characteristic states of the system, although the system can also be at any state between these. As seen in equation (5) the saturation and the variable gain dependent on $DO^* - DO_0$ and F_0 are the only nonlinear components of the system. The latter of these is easily compensated for as its value can be calculated when DO^* , DO_0 and F_0 are known.

A simple and well-known approach for determining the system gain $|G_0|$ and phase ϕ at a frequency ω , based on the response to sinusoidal perturbations, is the so-called correlation method [Ljung, 1999]. In its original form it can be used to determine a constant gain of a system, but with some modifications it can be used to track a varying gain. Using a sinusoidal input as in (6) over a time interval T , the response of a linear system will also be sinusoidal as per (7) where $v(t)$ is noise and $r(t)$ is a transient.

$$u(t) = \alpha \cos(\omega t) \quad (6)$$

$$y(t) = \alpha |G_0(e^{i\omega})| \cos(\omega t + \phi) + v(t) + r(t) \quad (7)$$

In the original formulation, for identification of a constant gain, the terms I_C and I_S are defined as per (8) and (9) respectively.

$$I_C(T) = \frac{1}{T} \int_T y(t) \cos(\omega t) dt \quad (8)$$

$$I_S(T) = \frac{1}{T} \int_T y(t) \sin(\omega t) dt \quad (9)$$

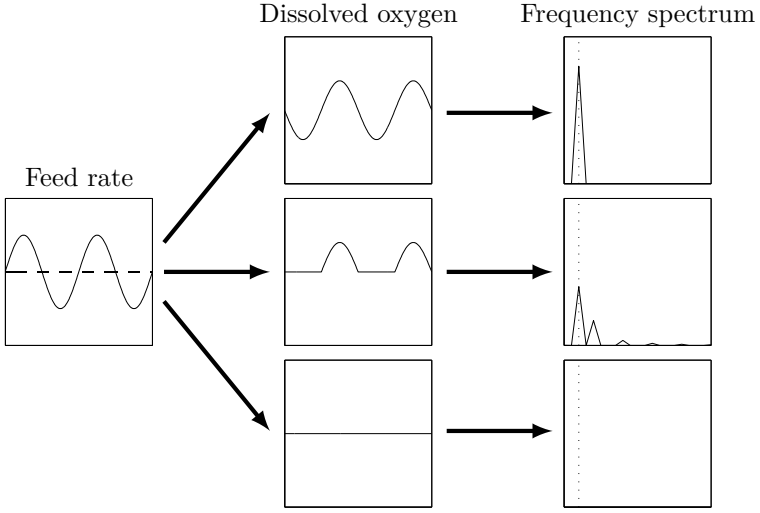

Figure 2. Illustration of the monitoring principle, showing feed rate and dissolved oxygen over time and the frequency spectrum of the latter. A dashed line in the feed rate indicates its base level. In the frequency spectrum, a dotted line indicates the frequency of the perturbations. In the uppermost case, $r_s \ll r_{s,\text{crit}}$ so the saturation is not active and an unsaturated response in *DO* is seen, this gives the maximum power spectral density at the relevant frequency. In the middle case, $r_s = r_{s,\text{crit}}$ and the response in *DO* is affected by the saturation, which is also seen in the frequency spectrum. In the lowermost case, $r_s \gg r_{s,\text{crit}}$ so no response is seen in *DO* and hence not in the frequency spectrum.

Inserting (7) into these yields (10) and (11) respectively [Ljung, 1999].

$$\begin{aligned}
 I_C(T) &= \frac{\alpha}{2} |G_0(e^{i\omega})| \cos(\phi) + \alpha |G_0(e^{i\omega})| \frac{1}{2T} \int_T \cos(2\omega t + \phi) dt \\
 &\quad + \frac{1}{T} \int_T v(t) \cos(\omega t) dt
 \end{aligned} \tag{10}$$

$$\begin{aligned}
 I_S(T) &= \frac{\alpha}{2} |G_0(e^{i\omega})| \sin(\phi) + \alpha |G_0(e^{i\omega})| \frac{1}{2T} \int_T \sin(2\omega t + \phi) dt \\
 &\quad + \frac{1}{T} \int_T v(t) \sin(\omega t) dt
 \end{aligned} \tag{11}$$

The second and third terms in (10) and (11) go towards 0 as T goes towards infinity, assuming that the noise does not contain a pure periodic

component of frequency ω . This allows straightforward estimation of the static system gain $|G_0(e^{i\omega})|$ as shown in (12).

$$\frac{\sqrt{I_C^2(T) + I_S^2(T)}}{\alpha/2} = \frac{\alpha/2|\hat{G}_0(e^{i\omega})|\sqrt{\sin^2(\phi) + \cos^2(\phi)}}{\alpha/2} = |\hat{G}_0(e^{i\omega})| \quad (12)$$

However, for a time-varying system it is clear that T can not be arbitrarily large and that a current rather than average value of $|\hat{G}_0(e^{i\omega})|$ must be sought. As the former means that the second and third terms in (10) and (11) can not be disregarded, these must instead be negated through other means. A notch filter at the frequency 2ω attenuates the second term, while the third is attenuated in the low-pass filtering assuming that the noise $v(t)$ is high-frequency. Low-frequency noise can be attenuated by addition of a high-pass filter, making the method highly insensitive to drift in the measured signal. Replacing the integration in (8) and (9) by low-pass filtering means that newer values will be assigned higher weight and enables tracking of a varying gain. In the case of the bioprocess and its metabolic saturation, low-pass filtering will also attenuate overtones caused by the saturation as seen in figure 2.

The saturation gain K_{sat} as described in (5) is estimated as per (13), where DO_0 is given by notch-filtering the measured DO signal to attenuate the perturbation response. A set-up for the method is illustrated in block diagram form in figure 3, showing that the method requires only very simple mathematical operations. This means that it can be implemented for on-line use in an industrial process monitoring system even if its computational capacity and ability to perform more advanced operations is limited.

$$\begin{aligned} \hat{K}_{\text{sat}} &= \frac{1}{K_{\text{mix}}(\omega)} \frac{F_0}{DO^* - DO_0} \frac{\Delta DO(\omega)}{\Delta F} \\ &= \frac{1}{K_{\text{mix}}(\omega)} \frac{F_0}{DO^* - DO_0} |\hat{G}_0(e^{i\omega})| \end{aligned} \quad (13)$$

3.3 Experiments

Experiments were performed in industrial production bioreactors at the Novozymes A/S site in Kalundborg, Denmark. The reactors were of the same type as used by Johnsson et al. [2015]. These are cylindrically shaped bioreactors with a volume of more than 100 m³, stirred by multiple axial agitators.

The initial medium was similar to that in [Van Putten et al., 1996] and contained a complex hydrocarbon source. The added feed contained sucrose, which is the main source of hydrocarbon in the process. Feed was added through ports in the upper half of the bioreactor, while air was inserted through a sparger at the bottom.

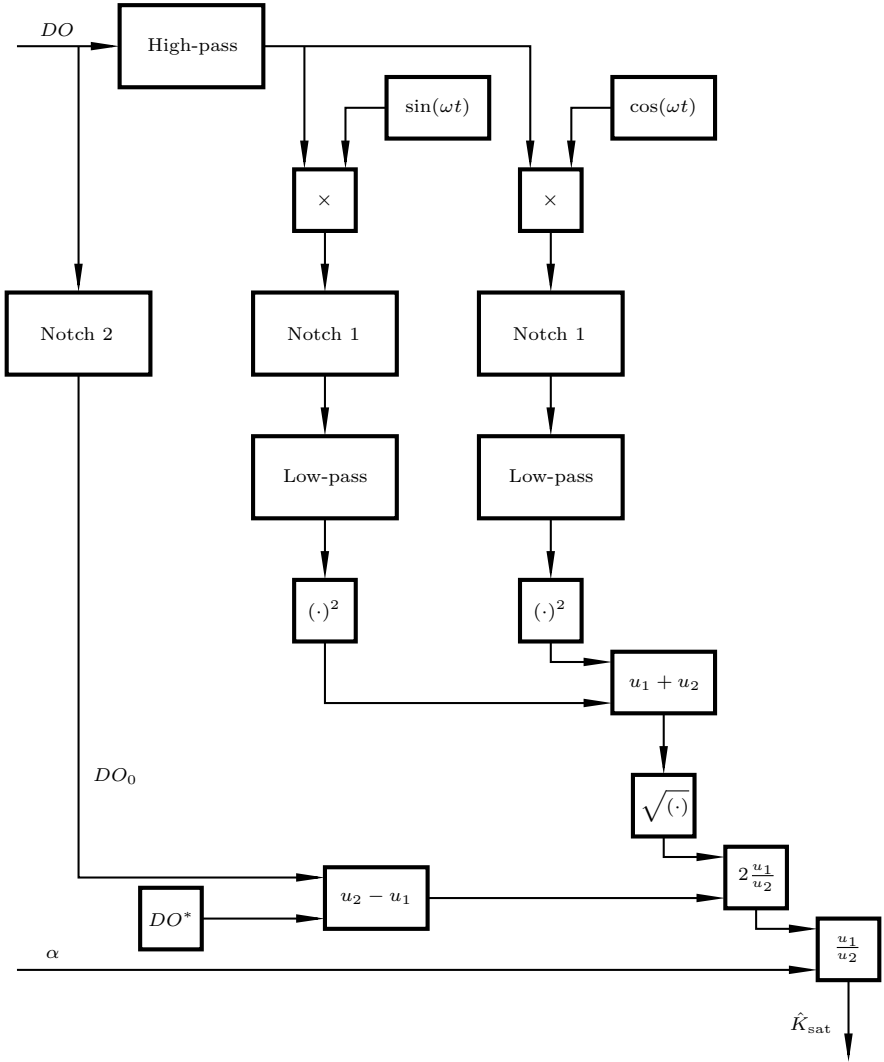

Figure 3. A set-up for the monitoring method, which requires only simple calculations. The inputs are DO and the relative perturbation amplitude $\alpha = \frac{\Delta F}{F_0}$, but DO^* must also be known. The perturbation frequency is denoted ω . In operations using two input signals, the first (uppermost) is labelled u_1 and the second (lowermost) u_2 . The notch filters labelled Notch 1 attenuate the frequency 2ω and that labelled Notch 2 attenuates ω .

The feed rate to each bioreactor was controlled to its setpoint by an internal control loop measuring the feed rate and controlling the position of a valve in the feed stream. These internal loops were set to enable them to keep up with rapid variations in the feed rate setpoint.

Experiments were performed in two types of processes using different industrial strains of *B. licheniformis*, both producing subtilisin type proteases. Two experiments were performed using strain 1 and three using strain 2.

In all experiments, the feed rate F was set to follow a predefined ramp during the first 7–9 hours of the process. A sinusoidal perturbation with period time 400 seconds (a frequency of 2.5 mHz) and amplitude 20 % of the current unperturbed feed rate was superimposed on the feed rate to give excitation of the system. The choice of frequency and amplitude was guided by the results and conclusions of Johnsson et al. [2015], where it was seen that perturbations with these properties gave clear sinusoidal responses when the oxidative metabolism was unsaturated.

On-line data was sampled at 10 second intervals. The most important variable measured on-line was the dissolved oxygen concentration DO in the medium, which was measured by an optode positioned near the bottom of the bioreactor. The optode used was of a standard commercially available type with a time constant shorter than 30 seconds; its response time was evaluated before experiments to ensure that it would not impact this application significantly.

Samples for off-line analysis were taken at one-hour intervals. Off-line analysis consisted of measurement of biomass concentration (c_X), sucrose concentration (c_s) and acetate concentration (c_a). The biomass concentration was calculated from dry weight measurements; sucrose and acetate concentrations were measured using enzymatic kits, R-Biopharm Cat. No. 10 139 041 035 and 10 148 261 035 respectively.

4. Results and discussion

In all five experiments, DO displayed changing characteristics over time which could be analyzed using the correlation method described previously to determine the DO response to the feed rate perturbations. The estimated saturation gain, \hat{K}_{sat} , was compared to the concentrations of biomass, main substrate (sucrose) and acetate in the liquid medium to draw conclusions regarding the relationships between these.

In the first experiment on-line data up to 5 hours into the process was lost due to an error in the logging system and in the second experiment off-line sampling was only possible during the first 2 hours, both of these experiments used strain 1. Although this limits the amount of useful data from these experiments, the data yielded can nonetheless be compared to

data from other experiments. In experiments three to five, using strain 2, on- and off-line data could be collected from at least the first 8 hours of the processes. Data for F and DO as well as biomass, sucrose and acetate concentrations and \hat{K}_{sat} are displayed in figure 4.

As seen in figure 4, all experiments are characterized by an initial peak in sucrose concentration, which causes overflow metabolism and hence acetate accumulation during the first 3–5 hours of each experiment. After the sucrose has been consumed, consumption of acetate begins. When neither sucrose nor acetate is present at high levels, the characteristics of the DO signal become markedly different as a sine wave with the same frequency as that in F appears. This is as expected based on the assumption that the metabolism is no longer saturated here. The changing characteristics lead to a significant increase in the value of \hat{K}_{sat} , indicating that this signal captures the metabolic state of the system.

As can also be seen, an early peak in \hat{K}_{sat} occurs between 2 and 5 hours when the value of DO changes rapidly at one point. As can be seen by comparing DO and acetate data in figure 4, this occurs at the time when the metabolism switches from acetate production to acetate consumption. From a metabolic perspective, it can be expected that switching from one type of metabolism to another leads to a temporary decrease in metabolic rates while this change takes place. This therefore indicates strongly that detection of a sharp peak in \hat{K}_{sat} can be used to determine on-line when this shift occurs.

When either sucrose or acetate is present at high levels the oxidative metabolism will be saturated, unsaturated metabolism will only occur when both concentrations are low. To investigate whether \hat{K}_{sat} can provide a measurement of the current metabolic state, it should therefore be compared to the current availability of these substrates. A simple measure of substrate availability is the maximum of these two concentrations at each point in time, here labelled A , defined as in (14).

$$A = \max(c_s, c_a) \quad (14)$$

A plot of \hat{K}_{sat} over A for all five experiments is given in figure 5, where a clear trend in the relationship between these can be observed. It can be seen that a value of \hat{K}_{sat} above 0.2 indicates a value of A below 0.15 g/L and a \hat{K}_{sat} value below 0.05 indicates that A is 1 g/L or higher. In the region between these values of \hat{K}_{sat} a trend can be observed where higher values of \hat{K}_{sat} relate to lower values of A . The three measurements which are affected by the early peak in \hat{K}_{sat} are exempted from these groupings. The data points from experiments 1 and 2 agree well with those from experiments 3 to 5, meaning that the two different processes studied here show similar characteristics with regard to \hat{K}_{sat} .

This result shows that \hat{K}_{sat} can be used to estimate substrate availability

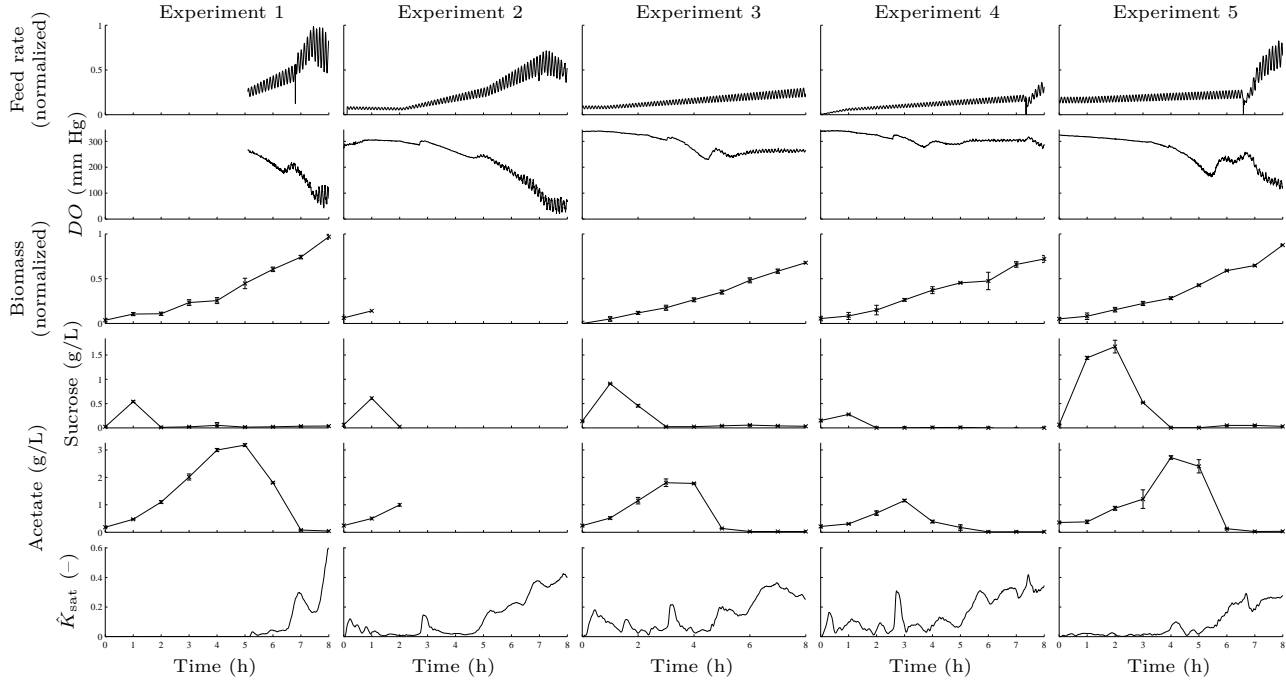

Figure 4. Results from all five experiments. The data shown here is the feed rate setpoint (normalized), the dissolved oxygen signal measured on-line, off-line measurements of biomass (normalized), sucrose and acetate concentrations and \hat{K}_{sat} .

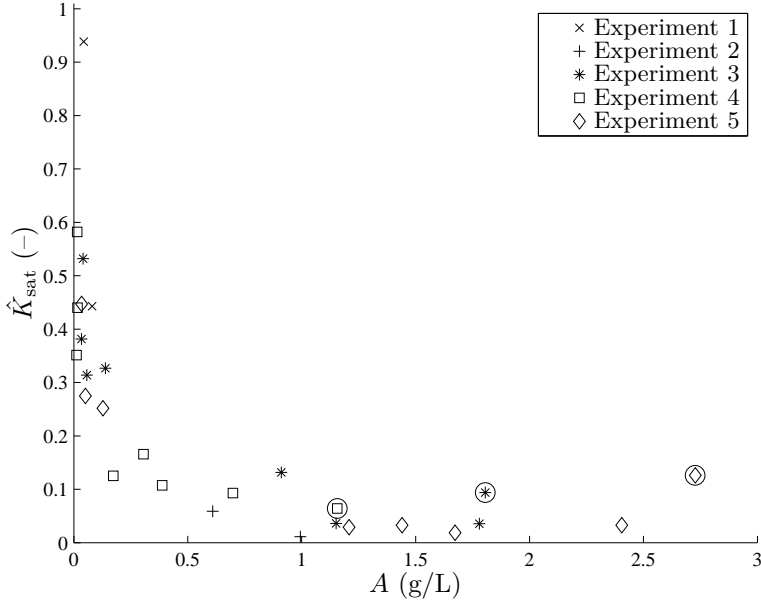

Figure 5. \hat{K}_{sat} over A . Data is taken from all experiments, included are all data points from which both \hat{K}_{sat} and off-line measurements are available. The three measurements which are affected by the early peak in \hat{K}_{sat} are marked by circles. Exempting these, a clear trend can be observed in the data where higher values of \hat{K}_{sat} indicate lower values of A , up to a \hat{K}_{sat} value of 0.2. Above this value, A is near-zero.

and the degree of saturation of the oxidative metabolism. Values of A above 1 g/L can not be clearly distinguished from each other, indicating that at these levels the oxidative metabolism is saturated during the whole perturbation cycle. This is of course dependent on the amplitude of the perturbations in the input. Although there is no clear trend in A for high values of \hat{K}_{sat} , based on the metabolic model a higher value would indicate that the current substrate uptake rate is far below its critical value. This means that no overflow metabolites are produced but also that the oxidative metabolism is not fully utilized.

The most desirable values of \hat{K}_{sat} would be those which are as low as possible without increasing A significantly. This could for instance correspond to a normalized value of around 0.2 in the case exemplified in figure 5, depending on the sensitivity of the organism to high levels of overflow metabolites. This would constitute a suitable setpoint for a controller manipulating the

unperturbed feed rate to control \hat{K}_{sat} in order to achieve maximal utilization of the oxidative metabolism while minimizing accumulation of overflow metabolites.

As shown by Johnsson et al. [2013], even simple controllers can be used for growth control using the response to feed rate perturbations. Such a simple controller would temporarily give an undesired response during the peak in \hat{K}_{sat} seen in connection to the switch from production to consumption of overflow metabolites. This effect can be diminished by heavier filtering of \hat{K}_{sat} , but another possibility would be to add logic to the controller to enable detection of this peak and using it to enhance the controller, as it provides additional information regarding the state of the system.

5. Conclusions

This study has shown that the dissolved oxygen response to feed rate perturbations can be used to estimate the substrate availability and hence the metabolic state in industrial-scale fed-batch bioprocesses. A simple scheme for quantifying the dissolved oxygen response on-line is proposed. This allows for extraction of a signal which can be used both for on-line monitoring of substrate availability and as a controlled variable by a closed-loop feed rate controller. A clear relationship between output signal and substrate availability has been observed in experiments, allowing for accurate estimates. Although an exception to this relationship occurs when the metabolism switches from production of overflow metabolites to consumption of these, this observation can also be utilized to provide further insight into the current metabolic state. A controller using this principle can give high utilization of the oxidative metabolism and hence efficient growth, as well as avoidance of excessive overflow metabolism which might otherwise cause process failure. This is of high relevance in an industrial setting, where a single process failure can equal loss of large monetary values.

This approach allows for monitoring and control of the metabolic state using only an oxygen sensor, to achieve a high microbial growth rate without accumulation of overflow metabolites. This is particularly useful in industrial bioprocesses where the availability and usefulness of advanced sensors is highly limited. The ability to directly monitor and control the metabolic state rather than only the liquid concentrations of certain compounds is however a desirable trait in all bioprocesses where the relationships between microbial uptake, growth and excretion rates are not clearly defined.

Acknowledgements

This work was supported by the strategic innovation program PiiA at the Swedish Governmental Agency for Innovation Systems. The work was carried out in cooperation with Novozymes A/S and all experiments were done at the Novozymes production site in Kalundborg, Denmark. The first and fifth authors are members of the LCCC Linnaeus Center at Lund University.

References

- Åkesson, M., P. Hagander and J. P. Axelsson (1999). “A probing feeding strategy for *Escherichia coli* cultures”. *Biotechnology Techniques* **13**:8, pp. 523–528.
- Åkesson, M., P. Hagander and J. P. Axelsson (2001). “Probing control of fed-batch cultivations: analysis and tuning”. *Control Engineering Practice* **9**:7, pp. 709–723.
- Alford, J. S. (2006). “Bioprocess control: Advances and challenges”. *Computers & Chemical Engineering* **30**:10, pp. 1464–1475.
- Bittner, C., G. Wehnert and T. Scheper (1998). “In situ microscopy for on-line determination of biomass”. *Biotechnology and Bioengineering* **60**:1, pp. 24–35.
- de Maré, L., L. Andersson and P. Hagander (2003). “Probing control of glucose feeding in *Vibrio cholerae* cultivations”. *Bioprocess and Biosystems Engineering* **25**:4, pp. 221–228.
- Dochain, D., M. Perrier and M. Guay (2011). “Extremum seeking control and its application to process and reaction systems: a survey”. *Mathematics and Computers in Simulation* **82**:3, pp. 369–380.
- Glazer, B. T., A. G. Marsh, K. Stierhoff and G. W. Luther III (2004). “The dynamic response of optical oxygen sensors and voltammetric electrodes to temporal changes in dissolved oxygen concentrations”. *Analytica Chimica Acta* **518**:1, pp. 93–100.
- Gnoth, S., M. Jenzsch, R. Simutis and A. Lübbert (2008). “Control of cultivation processes for recombinant protein production: a review”. *Bioprocess and Biosystems Engineering* **31**:1, pp. 21–39.
- Henes, B. and B. Sonnleitner (2007). “Controlled fed-batch by tracking the maximal culture capacity”. *Journal of Biotechnology* **132**:2, pp. 118–126.
- Johnsson, O., J. Andersson, G. Lidén, C. Johnsson and T. Hägglund (2013). “Feed rate control in fed-batch fermentations based on frequency content analysis”. *Biotechnology Progress* **29**:3, pp. 817–824.

- Johnsson, O., J. Andersson, G. Lidén, C. Johnsson and T. Hägglund (2015). “Modelling of the oxygen level response to feed rate perturbations in an industrial scale fermentation process”. *Process Biochemistry* **50**:4, pp. 507–516.
- Ljung, L. (1999). *System Identification: Theory for the User*. 2nd ed. Prentice Hall, Upper Saddle River, New Jersey, United States of America.
- Luli, G. W. and W. R. Strohl (1990). “Comparison of growth, acetate production, and acetate inhibition of *Escherichia coli* strains in batch and fed-batch fermentations”. *Applied and Environmental Microbiology* **56**:4, pp. 1004–1011.
- El-Mansi, M. (2004). “Flux to acetate and lactate excretions in industrial fermentations: physiological and biochemical implications”. *Journal of Industrial Microbiology and Biotechnology* **31**:7, pp. 295–300.
- Neijssel, O. M., G. P. M. A. Hardy, J. C. Lansbergen, D. W. Tempest and R. W. O’Brien (1980). “Influence of growth environment on the phosphoenolpyruvate: glucose phosphotransferase activities of *Escherichia coli* and *Klebsiella aerogenes*: a comparative study”. *Archives of Microbiology* **125**:1-2, pp. 175–179.
- Rocha, I. and E. Ferreira (2002). “On-line simultaneous monitoring of glucose and acetate with FIA during high cell density fermentation of recombinant *E. coli*”. *Analytica Chimica Acta* **462**:2, pp. 293–304.
- Schaepe, S., A. Kuprijanov, R. Simutis and A. Lübbert (2014). “Avoiding overfeeding in high cell density fed-batch cultures of *E. coli* during the production of heterologous proteins”. *Journal of Biotechnology* **192**, pp. 146–153.
- Sonnleitner, B. and O. Käppeli (1986). “Growth of *Saccharomyces cerevisiae* is controlled by its limited respiratory capacity: formulation and verification of a hypothesis”. *Biotechnology and Bioengineering* **28**:6, pp. 927–937.
- Swartz, J. R. (1996). *Method of determining propensity of dissolved oxygen instability*. Patent. US 5487980.
- Tempest, D. W. and O. M. Neijssel (1979). “Overflow metabolism in aerobic micro-organisms”. *Biochemical Society Transactions* **7**:1, pp. 82–85.
- Van Putten, A. B., F. Spitzenberger, G. Kretzmer, B. Hitzmann, M. Dors, R. Simutis and K. Schügerl (1996). “Improvement of the production of subtilisin Carlsberg alkaline protease by *Bacillus licheniformis* by on-line process monitoring and control in a stirred tank reactor”. *Journal of Biotechnology* **49**:1, pp. 83–93.

- Velut, S., A. Castan, K. A. Short, J. P. Axelsson, P. Hagander, B. A. Zditosky, C. W. Rysenga, L. De Maré and J. Haglund (2007). “Influence of bioreactor scale and complex medium on probing control of glucose feeding in cultivations of recombinant strains of *Escherichia coli*”. *Biotechnology and Bioengineering* **97**:4, pp. 816–824.
- Villadsen, J., J. Nielsen and G. Lidén (2011). *Bioreaction engineering principles*. Springer, New York, New York, United States of America.
- Voigt, B., T. Schweder, D. Becher, A. Ehrenreich, G. Gottschalk, J. Feesche, K.-H. Maurer and M. Hecker (2004). “A proteomic view of cell physiology of *Bacillus licheniformis*”. *Proteomics* **4**:5, pp. 1465–1490.

Paper V

Feed rate control in an industrial production-scale bioprocess using a low-complexity estimator of feed demand

Ola Johnsson, Frederik K. Riisgaard, Daniel Sahlin,
Gunnar Lidén and Tore Hägglund

Abstract

In this study, the implementation of a method for feed rate control in an industrial-scale bioprocess is described. A bacterial fed-batch process for heterologous protein production in a bioreactor with volume greater than 100 m³ was chosen for the implementation. The controller is based on estimating the current feed demand through observing the system response to a sinusoidal perturbation in the feed rate. This approach requires minimal knowledge of the biochemical parameters of the organism and the only measurement needed is the dissolved oxygen level which is a standard measurement in industrial bioprocesses.

The method circumvents multiple problems connected to feed demand estimation, such as the effects of complex medium and metabolic shifts in the cell culture, by directly estimating the available capacity of the oxidative metabolism. The main challenge in this implementation is large-scale mixing effects, which give longer lag times and decreases the perturbation response. In this study, it is however shown that the feed demand estimation is sufficiently fast and precise that a desirable controller response can be achieved even when combining the estimator with a regular PI controller.

1. Introduction

Fed-batch processes, both chemical and biotechnical, have an advantage over batch-processes in that the rate of reaction can be controlled by regulating the inlet feed. For microbial processes, the inlet feed typically contains the main carbon and energy source for growth and/or product formation. Fed-batch operation is common in industry and is often combined with an initial batch phase [Villadsen et al., 2011]. Control of the inlet feed rate is however not trivial, as the biomass and hence the feed demand grows over time. Other factors such as the concentrations of oxygen and certain metabolic by-products, as well as the current metabolic state of the organisms, also influence the feed demand.

If the feed rate is low compared to the demand, starvation effects will occur and lead to decreased growth and productivity. A higher feed rate gives higher specific substrate uptake rates which is beneficial as it stimulates growth and/or product formation. However, when the uptake rate becomes too high this causes production of by-products such as acetate, lactate or ethanol. This mechanism is termed overflow metabolism and the by-products are referred to as overflow metabolites.

Although it allows for faster short-term growth, overflow metabolism causes decreased biomass and product yields as substrate is diverted to by-product formation. In addition to this, many overflow metabolites are known to inhibit microbial growth [Luli and Strohl, 1990] and production of heterologous proteins [Jensen and Carlsen, 1990]. Overflow metabolism is therefore considered an undesirable phenomenon in industrial processes [El-Mansi, 2004]. It is known to occur in many types of organisms, examples include widely used industrial production organisms such as *Escherichia coli* [Neijssel et al., 1980], *Saccharomyces cerevisiae* [Sonnleitner and Käppeli, 1986] and *Bacillus licheniformis* [Voigt et al., 2004].

For long-term growth and productivity, the feed rate should ideally be such that the specific substrate uptake rate is just below the limit for overflow metabolism, which is here termed the critical substrate uptake rate. The feed demand can however vary greatly over the course of a fed-batch bioprocess, particularly during the period of exponential biomass growth seen at the start of such a process, and the batch-to-batch variation in growth rates and other factors can be significant. This means that predefined feed rate ramps are unsuitable and relatively small variations in the process can lead to feed rates which are far too high or too low. Feedback control of the substrate feed rate is therefore highly desirable.

A major limitation in feedback control of bioprocesses, particularly in an industrial context, is sensing. It would be desirable to measure the liquid concentrations of biomass, substrate and by-products directly but although this can be possible in some cases [Luttmann et al., 2012], such measurements are

for practical reasons not commonly seen in industry. Use of complex medium such as yeast or plant extract also makes some such measurements more difficult. In addition, it means that even when the concentration of the main substrate can be measured this might not be enough to give a true measure of substrate availability. The measurements which are usually available in industry are pH, dissolved oxygen, temperature, total gas pressure and sometimes the oxygen and carbon dioxide content in the gas outlet [Gnoth et al., 2008].

First-principles models can be used to estimate relevant system states from measurements in bioprocesses [Sundström and Enfors, 2008], although this is considered time-consuming [Luttmann et al., 2012]. Another possibility is the use of data-driven models, where historical data from the process is used for model creation. An example of this is artificial neural networks (ANNs), which have been shown to work well for bioprocess monitoring [Jenzsch et al., 2006] and can be combined with known fundamental relationships in the system to create hybrid models [Gnoth et al., 2006]. This type of data-driven model can be very easy to create, but has a significant limitation in that it is only suited for use within the range of the data it has been created with and should not be used for extrapolation [Gnoth et al., 2008]. This means that the data-driven approach can be suitable for processes for which much historical data exists, but limits its usefulness in those which are new or constantly developed.

Perturbation-based methods provide a different approach to the measuring and estimation problem. Here, the process input is perturbed in order to glean information regarding the current process state. One such type of method is probing control, which measures the response to square pulses in the input signal to determine the system's state with regard to a saturation [Åkesson and Hagander, 2000]. This method requires only measurement of dissolved oxygen and can be used to control the feed rate in bioprocesses so that the substrate uptake rate follows the trajectory of the critical uptake rate and has been implemented for this purpose in a scale up to 12 m³ [Velut et al., 2002]. For large-scale implementation the use of square pulses is however undesirable as they can be difficult to realize.

A frequency response method using the same principles has been suggested [Johnsson et al., 2013] and it has been demonstrated that it can be used for estimation of feed demand in industrial bioprocesses with a volume greater than 100 m³ [Johnsson et al., 2015b]. Prior to the current study, this or any similar method has however not been used for feedback control in processes of this scale and it has not been shown whether the feed demand estimates are sufficiently fast and accurate to achieve acceptable feed rate control performance.

2. Theory

The metabolic overflow effect can be modelled as a saturation in the system, where specific oxygen uptake rate r_o follows substrate uptake rate r_s up to a point $r_{s,crit}$. Above this point no further increase in r_o is seen, as the oxidative capacity of the biomass is saturated and excess substrate is metabolized non-oxidatively. The non-oxidative metabolism causes production of undesirable by-products, which can however be re-consumed if excess oxidative capacity becomes available.

Ideally, the feed of substrate to the bioreactor should be such that the specific substrate uptake rate is equal to $r_{s,crit}$ at all times. However, this parameter changes over the course of a fed-batch process due to biomass concentration and the microbial metabolism and cannot be measured directly.

2.1 Estimation method

The current feed demand, here defined as the feed rate corresponding to $r_s = r_{s,crit}$, can be estimated from the dissolved oxygen response to feed rate perturbations by determining the effect of the saturation in oxidative metabolism on the response. The principle is illustrated for a sinusoidal perturbation in figure 1, showing how the dissolved oxygen response at the perturbation frequency is affected by the saturation level.

The relationship between a feed rate perturbation F_p and dissolved oxygen response DO_p at the perturbation frequency ω can be described as in equation (1) [Johnsson et al., 2015b]. F_0 and DO_0 are the unperturbed feed rate and dissolved oxygen level respectively, where the former is known while the latter can be determined by notch-filtering the measured DO signal to attenuate the perturbation frequency. DO^* is the dissolved oxygen level when in equilibrium with the gas phase, which can be either calculated based on physical relationships or measured in a bioprocess before inoculation has occurred. K_s , T_s , K_o and T_o are the gains and time constants of the substrate and oxygen mixing dynamics respectively and can be determined experimentally as done by Johnsson et al. [2015a], while Ψ_{sat} is the effect of the saturation nonlinearity.

$$DO_p(s) = -\frac{K_o}{sT_o + 1} \frac{DO^* - DO_0}{F_0} \Psi_{sat} \frac{K_s}{sT_s + 1} F_p(s) \quad (1)$$

The system in (1) is linear except for the saturation and the effects of variations in $DO^* - DO_0$ and F_0 . It therefore follows that for a sinusoidal perturbation as per (2), for which variations in $DO^* - DO_0$ and F_0 over a period are small enough to be regarded as negligible, the unsaturated dissolved oxy-

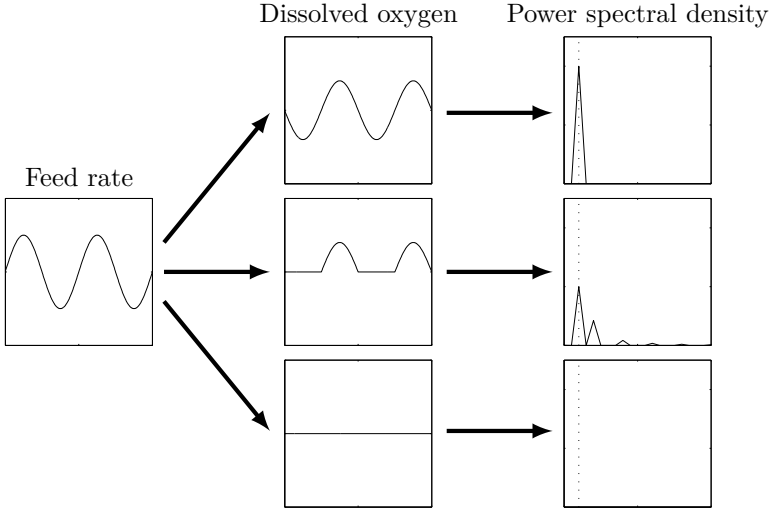

Figure 1. Illustration of the feed demand estimation principle, showing feed rate and dissolved oxygen over time and the power spectral density over frequency. In the latter, a dotted line indicates the frequency of the perturbations. In the uppermost case, $r_s \ll r_{s,\text{crit}}$ so the saturation is not active and an unsaturated response in DO is seen, this gives the maximum power spectral density at the relevant frequency. In the middle case $r_s = r_{s,\text{crit}}$ and the response in DO is affected by the saturation, which is also seen in the frequency spectrum. In the lowermost case, $r_s \gg r_{s,\text{crit}}$ so no response is seen in DO and hence not in the frequency spectrum.

gen response will be as per (3). ΔF and ΔDO denote the amplitude of the perturbation and the response, respectively.

$$F_p = \Delta F \sin(\omega t) \quad (2)$$

$$DO_p = \Delta DO(\omega) \sin(\omega t + \varphi) \quad (3)$$

When only observing the response at the perturbation frequency the saturation nonlinearity can be regarded as a time-varying gain, $\Psi_{\text{sat}} = K_{\text{sat}} \in [0, 1]$, which can be estimated as per (4). From this, it follows that the process gain at the perturbation frequency, $\frac{\Delta DO(\omega)}{\Delta F}$, can be used to determine the metabolic state of the system with regard to overflow metabolism.

$$\hat{K}_{\text{sat}} = \left| \frac{(i\omega T_o + 1)(i\omega T_s + 1)}{K_o K_s} \right| \frac{F_0}{DO^* - DO_0} \frac{\Delta DO(\omega)}{\Delta F} \quad (4)$$

A simple algorithm for tracking $\frac{\Delta DO(\omega)}{\Delta F}$ has been described by Johnsson et al. [2015b]. It is based on the classical correlation method for frequency response system identification [Ljung, 1999] but incorporates a number of changes to facilitate tracking of a varying response amplitude rather than finding a constant value of it. The modified method replaces integration of previous estimates with low-pass filtering, so that the varying response can be tracked, and the relation between the filter cutoff frequency ω_0 and perturbation frequency ω is an important tuning parameter for the estimation algorithm. A low cut-off frequency gives a slower estimator, less sensitive to disturbances, while a high cutoff frequency makes tracking faster and thus allows good following of a more rapidly changing system state.

3. Materials and methods

3.1 Feed rate controller

The feed demand estimator and a controller for manipulation of the unperturbed feed rate F_0 were implemented in the SattLine system used for monitoring and control of the process. A sinusoidal perturbation F_p was superimposed on F_0 , with frequency 2.5 mHz and amplitude ΔF proportional to the current F_0 value. The estimator and controller set-up is illustrated in figure 2. The proportionality factor $\alpha = \frac{\Delta F}{F_0}$ was set to 0.4 in this implementation, as previous experiments indicated that lower values would give an insufficient response at low feed rates (data not shown). The relative cutoff frequency of the estimator, ω_0/ω , was set to 1/8 as analysis of data from [Johnsson et al., 2015b] indicated that this gave a good tradeoff between speed and accuracy.

For control of the feed rate, a standard proportional-integral (PI) controller was used. During the exponential growth phase of a fed-batch bioprocess, the feed rate should in theory increase exponentially to give the appropriate amount of feed at all times and avoid both starvation effects and overflow metabolism. Although a PI controller cannot perfectly track such an effect, the duration of the exponential growth is limited meaning that control errors can be kept within acceptable limits. The PI controller has the important advantages of being very widely used and accepted in industry. This means that there are standard modules for its implementation in industrial process control systems and process operators are familiar with it, making widespread application in an industrial context easier than for more advanced controller types.

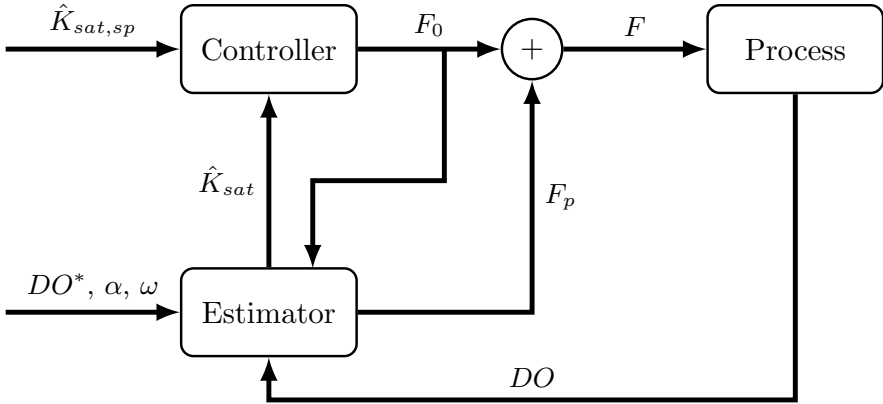

Figure 2. The set-up of the estimator and controller, showing the inputs and outputs of each. The estimator also acts as generator for the feed rate perturbation F_p .

As the gain of the system is proportional to $\frac{DO^* - DO_0}{F_0}$, gain scheduling based on the inverse of this expression is ideal. However, this is not possible in the current implementation due to software limitations and hence a simplification was necessary. In this case, one may assume that the substrate and oxygen uptake rates are stoichiometrically connected at a fixed yield. This means that F_0 and $DO^* - DO_0$ will be linearly related during the process, hence a constant controller gain can be used. The PI controller was tuned based on previous studies on the same process type [Johnsson et al., 2015a; Johnsson et al., 2015b] and experience from other feed rate controllers used on this process type. The setpoint for \hat{K}_{sat} was set to 0.2 as a previous study had shown that this was the lowest value of the saturation gain for which no significant overflow metabolism occurred.

As the controller determines the feed demand based on the critical substrate uptake rate, it can be used in the exponential growth phase of the process where this is the critical limitation on the feed rate. After this phase the process is constrained by the rate at which oxygen can be supplied, as aerobic conditions need to be maintained. Therefore, control is switched to a different controller after DO has decreased past a fixed limit to ensure that oxygen limitation will not occur.

3.2 Experiment set-up

The experiment was performed in an industrial production bioreactor at the Novozymes A/S site in Kalundborg, Denmark, of the same type as used by Johnsson et al. [2015a]. These are cylindrically shaped bioreactors with a

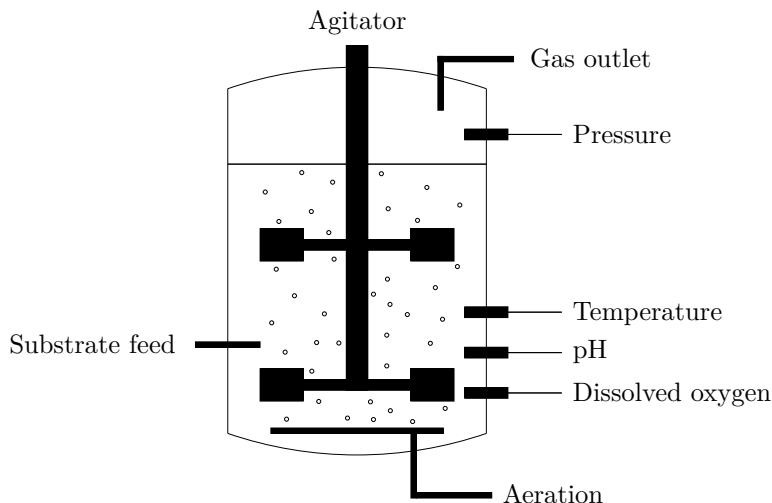

Figure 3. Overview of the type of bioreactor used in this study. Substrate is added through a port in the side of the bioreactor while air is introduced through a sparger at the bottom. An agitator mixes the liquid medium and allows efficient mass transfer. Dissolved oxygen as well as some other process-critical parameters are measured *in-situ*.

volume of more than 100 m³, stirred by multiple axial agitators. An industrial strain of *B. licheniformis* producing a heterologous protein was used.

A feed containing sucrose, which is the source of hydrocarbon in the process, was added through a port in the side of the bioreactor, while air was inserted through a sparger at the bottom. Dissolved oxygen in the medium was measured by an optode of a standard commercially available type, positioned near the bottom of the bioreactor. The time constant of the dissolved oxygen optode was significantly lower than the sampling time of the estimator and its dynamics were known to not have a significant influence on measurements in this application. An illustration of the type of bioreactor used here is given in figure 3.

The feed rate to the bioreactor was controlled to its setpoint by an internal control loop measuring the feed rate and controlling the position of a valve in the feed stream. This internal loop was tuned to enable it to keep up with rapid variations in the feed rate setpoint. On-line data was sampled at 30 second intervals, the most important variable measured on-line being dissolved oxygen concentration *DO* which was used for estimation of current feed demand. The response time of the *DO* probe was evaluated to ensure that it would not impact this application. Samples of the liquid medium were taken for determination of sucrose and acetate levels.

4. Results and discussion

An overview of the results is given in figure 4. A large addition of sucrose feed occurred at the start of the experiment (not seen in data), the added feed corresponded to approximately 1.5 hours of feeding at the current rate and was added over a few minutes. Therefore, accumulated sucrose and acetate were present during the first 5.5 hours of the process meaning that the oxidative metabolic capacity was saturated during this period. The feed rate controller therefore maintained the minimum feed rate, which is the desirable response in this situation. Due to an error in the initialization of the estimator, very large values of \hat{K}_{sat} were seen during the first 30 minutes. During this period F was however constrained by a maximum allowed value set for it, meaning that this had no impact on the outcome of the experiment.

After 5.5 hours, substrate and by-product concentrations were close to zero and the feed demand increased rapidly. The feed rate was increased over one hour until it corresponded to the current feed demand, from 6.5 to 8 hours it then increased at a slower rate as the feed demand increased with growing biomass. At 8 hours DO had decreased sufficiently that the controller based on feed demand estimation was switched off. F_0 had then increased to six times its starting value and, as no accumulation of sucrose or acetate had occurred at 7.5 hours, no significant overflow metabolism had occurred after the feed rate was first increased.

5. Conclusions

The experimental results of this study show that the method for feed demand estimation used here is fast and precise enough to be used for closed-loop control of the feed rate in an fed-batch bioprocess with a volume over 100 m³. Despite the limitations introduced by large-scale mixing dynamics, the controller can perform as desired. The mixing effects do however constrain the choice of relative perturbation amplitude at low feed rates, indicating that the mixing dynamics contain a nonlinearity giving lower process gain for very low perturbation amplitudes.

These results demonstrate that the method can be used in an industrial application and that sufficiently good control performance can be achieved even with a standard PI controller. It has been demonstrated that the controller can reach and maintain a feed rate near the estimated feed demand in the exponential growth phase. The same method for estimation of the feed demand can be used with other controller designs which, if these are more suited to handling the non-stationary nature of the fed-batch process, would presumably allow for improved control performance.

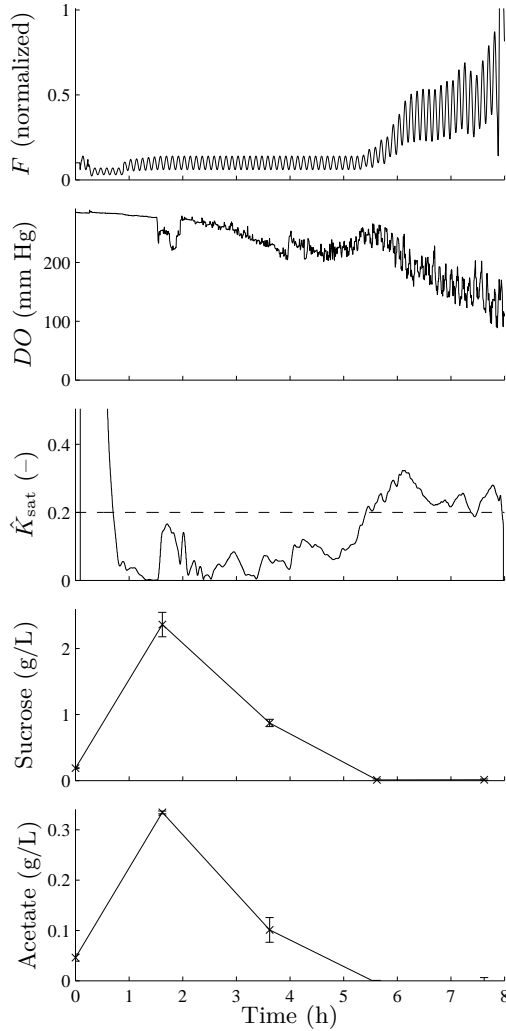

Figure 4. Results from the experiment. Between 1.5 and 2 hours the agitator was repaired which caused a temporary decrease in DO , it did however not appear to affect the experiment beyond this. The increase in F started at 5.5 hours, when sucrose and acetate were no longer present in significant amounts. At 8 hours, when the unperturbed feed rate had increased to six times its starting value, the controller based on feed demand estimation was automatically switched off due to decreased DO .

Acknowledgements

This work was supported by the strategic innovation program PiiA at the Swedish Governmental Agency for Innovation Systems. The work was carried out in cooperation with Novozymes A/S and all experiments were done at the Novozymes production site in Kalundborg, Denmark. The first and fifth authors are members of the LCCC Linnaeus Center at Lund University.

References

- Åkesson, M. and P. Hagander (2000). “A simplified probing controller for glucose feeding in *Escherichia coli* cultivations”. In: *Proceedings of the 39th IEEE Conference on Decision and Control*. Vol. 5, pp. 4520–4525.
- Gnoth, S., M. Jenzsch, R. Simutis and A. Lübbert (2006). “Product formation kinetics in a recombinant protein production process”. In: *Proceedings of the 10th international IFAC symposium on computer applications in biotechnology*. Vol. 1, pp. 197–202.
- Gnoth, S., M. Jenzsch, R. Simutis and A. Lübbert (2008). “Control of cultivation processes for recombinant protein production: a review”. *Bioprocess and Biosystems Engineering* **31**:1, pp. 21–39.
- Jensen, E. B. and S. Carlsen (1990). “Production of recombinant human growth hormone in *Escherichia coli*: expression of different precursors and physiological effects of glucose, acetate, and salts”. *Biotechnology and Bioengineering* **36**:1, pp. 1–11.
- Jenzsch, M., R. Simutis, G. Eisbrenner, I. Stückrath and A. Lübbert (2006). “Estimation of biomass concentrations in fermentation processes for recombinant protein production”. *Bioprocess and biosystems engineering* **29**:1, pp. 19–27.
- Johnsson, O., J. Andersson, G. Lidén, C. Johnsson and T. Hägglund (2013). “Feed rate control in fed-batch fermentations based on frequency content analysis”. *Biotechnology Progress* **29**:3, pp. 817–824.
- Johnsson, O., J. Andersson, G. Lidén, C. Johnsson and T. Hägglund (2015a). “Modelling of the oxygen level response to feed rate perturbations in an industrial scale fermentation process”. *Process Biochemistry* **50**:4, pp. 507–516.
- Johnsson, O., K. Hvalkof Andersen, J. Andersson, G. Lidén and T. Hägglund (2015b). “On-line detection of oxidative saturation using frequency response in industrial scale bioprocesses”. Submitted to *Process Biochemistry*.
- Ljung, L. (1999). *System Identification: Theory for the User*. 2nd ed. Prentice Hall, Upper Saddle River, New Jersey, United States of America.

- Luli, G. W. and W. R. Strohl (1990). “Comparison of growth, acetate production, and acetate inhibition of *Escherichia coli* strains in batch and fed-batch fermentations”. *Applied and Environmental Microbiology* **56**:4, pp. 1004–1011.
- Luttmann, R., D. G. Bracewell, G. Cornelissen, K. V. Gernaey, J. Glassey, V. C. Hass, C. Kaiser, C. Preusse, G. Striedner and C.-F. Mandenius (2012). “Soft sensors in bioprocessing: a status report and recommendations”. *Biotechnology Journal* **7**:8, pp. 1040–1048.
- El-Mansi, M. (2004). “Flux to acetate and lactate excretions in industrial fermentations: physiological and biochemical implications”. *Journal of Industrial Microbiology and Biotechnology* **31**:7, pp. 295–300.
- Neijssel, O. M., G. P. M. A. Hardy, J. C. Lansbergen, D. W. Tempest and R. W. O’Brien (1980). “Influence of growth environment on the phosphoenolpyruvate: glucose phosphotransferase activities of *Escherichia coli* and *Klebsiella aerogenes*: a comparative study”. *Archives of Microbiology* **125**:1-2, pp. 175–179.
- Sonnleitner, B. and O. Käppeli (1986). “Growth of *Saccharomyces cerevisiae* is controlled by its limited respiratory capacity: formulation and verification of a hypothesis”. *Biotechnology and Bioengineering* **28**:6, pp. 927–937.
- Sundström, H. and S.-O. Enfors (2008). “Software sensors for fermentation processes”. *Bioprocess and Biosystems Engineering* **31**:2, pp. 145–152.
- Velut, S., L. de Maré, J. P. Axelsson and P. Hagander (2002). “Evaluation of a probing feeding strategy in large scale cultivations”. *Department of Automatic Control, Lund Sweden*.
- Villadsen, J., J. Nielsen and G. Lidén (2011). *Bioreaction engineering principles*. Springer, New York, New York, United States of America.
- Voigt, B., T. Schweder, D. Becher, A. Ehrenreich, G. Gottschalk, J. Feesche, K.-H. Maurer and M. Hecker (2004). “A proteomic view of cell physiology of *Bacillus licheniformis*”. *Proteomics* **4**:5, pp. 1465–1490.