



LUND UNIVERSITY

Comparison of hygrothermal measurements and calculations in a multi-family wooden house on the north-eastern coast of Sweden

Mundt Petersen, Solof

2013

[Link to publication](#)

Citation for published version (APA):

Mundt Petersen, S. (2013). *Comparison of hygrothermal measurements and calculations in a multi-family wooden house on the north-eastern coast of Sweden*. (Report TVBH; Vol. 3055). Byggnadsfysik LTH, Lunds Tekniska Högskola. <http://www.byfy.lth.se/publikationer/tvbh-3000/>

Total number of authors:

1

General rights

Unless other specific re-use rights are stated the following general rights apply:

Copyright and moral rights for the publications made accessible in the public portal are retained by the authors and/or other copyright owners and it is a condition of accessing publications that users recognise and abide by the legal requirements associated with these rights.

- Users may download and print one copy of any publication from the public portal for the purpose of private study or research.
- You may not further distribute the material or use it for any profit-making activity or commercial gain
- You may freely distribute the URL identifying the publication in the public portal

Read more about Creative commons licenses: <https://creativecommons.org/licenses/>

Take down policy

If you believe that this document breaches copyright please contact us providing details, and we will remove access to the work immediately and investigate your claim.

LUND UNIVERSITY

PO Box 117
221 00 Lund
+46 46-222 00 00

Comparison of hygrothermal measurements and calculations in a multi-family wooden house on the north-eastern coast of Sweden

S. Olof Mundt-Petersen

Report TVBH-3055, Lund 2013
Building Physics, LTH



LUND
UNIVERSITY

Comparison of hygrothermal measurements and calculations in a multi-family wooden house on the north-eastern coast of Sweden

S. Olof Mundt-
Petersen Licentiate
thesis

Building Physics LTH
Lund University
P.O. Box 118
SE-221 00 Lund
Sweden

ISRN LUTVDG/TVBH--13/3055--SE(245)
ISSN 0349-4950
ISBN 978-91-88722-46-1
©2013 S. Olof Mundt-Petersen

Preface

This report was compiled at the Department of Building Physics, Lund University, Sweden, as part of the “Framtidens trähus” (Wood framed buildings of the future) project and my doctoral studies.

The study was carried out in cooperation with SP Technical Research Institute of Sweden and the Swedish wooden house company Martinsons. I would specially like to thank Håkan Risberg at Martinsons and Lars Olsson and Simon Dahlquist at SP for their valuable cooperation while carrying out the measurements. I would also like to thank my supervisor Jesper Arfvidsson and co-supervisors Lars-Erik Harderup and Petter Wallentén who have supported me while working on this project and for reviewing the report.

Lund 2013-02-15

S. Olof Mundt-Petersen

Summary

This report presents measurements of relative humidity, temperature and moisture content carried out in a seven-storey wooden framed house in the north part of the Swedish east coast during the period March 2009 to December 2011. The report also presents blind WUFI 5.0 calculations using the same measurement positions and carried out during the same period under as similar boundary conditions as possible.

Measurements and calculation results of relative humidity in the studied positions are also evaluated and compared to the risk conditions for mould growth by using the Folos 2D visual mould chart.

The measurement results, calculated results and comparisons between the measurements and calculations have been evaluated using Folos 2D visual mould charts which show the deviations between measured and calculated values. These are briefly discussed at the end of the report. The results from measurements, calculations and comparisons between measured and calculated values will be used and further evaluated in future studies and research projects.

Contents

| | |
|--|-----|
| Preface..... | 3 |
| Summary | 5 |
| 1 Introduction..... | 9 |
| 1.1 Background..... | 9 |
| 1.2 Aim..... | 9 |
| 1.3 Limitations | 9 |
| 1.4 Intended readers | 9 |
| 2 Method | 10 |
| 2.1 Blind comparison between measured and calculated values | 10 |
| 3 Materials..... | 10 |
| 4 Measuring and calculation periods | 11 |
| 5 Boundary and initial conditions for calculations | 11 |
| 5.1 Outdoor climate boundary condition data..... | 11 |
| 5.2 Indoor climate boundary condition data..... | 16 |
| 5.3 Air change rate/ Ventilation in air gap behind the cladding | 16 |
| 5.4 Roof and attic boundary conditions | 16 |
| 6 Studied house and positions | 17 |
| 7 Results – Walls on the fourth, fifth and sixth floor | 25 |
| 7.1 Position 1n..... | 25 |
| 7.2 Position 2n..... | 31 |
| 7.3 Position 3n..... | 37 |
| 7.4 Position 4ö..... | 43 |
| 7.5 Position 5ö..... | 49 |
| 7.6 Position 6ö..... | 55 |
| 7.9 Position 9s..... | 61 |
| 7.10 Position 10s | 67 |
| 7.11 Position 11v | 73 |
| 7.13 Position 13v | 79 |
| 7.14 Position 14ö..... | 85 |
| 7.15 Position 15ö..... | 91 |
| 7.16 Position 16ö..... | 97 |
| 8 Results – Exterior façade air gap on the fifth and sixth floor | 103 |
| 8.11 Position 11-5v-exterior façade | 103 |

| | |
|--|-----|
| 8.11 Position 11-5v-air gap | 111 |
| 8.14 Position 14-5n-exterior façade | 119 |
| 8.14 Position 14-5n-air gap | 127 |
| 8.15 Position 15-5ö exterior façade | 135 |
| 8.15 Position 15-5ö-air gap | 143 |
| 8.22 Position 22-6s-exterior façade | 151 |
| 8.22 Position 22-6s-air gap | 159 |
| 9 Results – Cold attic space on top of the sixth floor | 167 |
| 9.D Position D | 167 |
| 9.E Position E | 175 |
| 9.I Position I | 183 |
| 9.J Position J | 191 |
| 10 Results – Parallel roof on top of the seventh floor | 199 |
| 10.K Position K | 199 |
| 10.L Position L | 205 |
| 10.M Position M | 213 |
| 10.N Position N | 221 |
| 10.O Position O | 227 |
| 10.S Position S | 235 |
| 11 Discussion and analysis of the results | 243 |
| 11.1 Walls | 243 |
| 11.2 Attic | 243 |
| 11.3 Roof | 244 |
| 12 Conclusions | 244 |
| 13 References | 245 |

1 Introduction

This report presents measurements of relative humidity (RH), temperature (T) and moisture content (MC) in a number of positions in the studied house. Measurements of relative humidity and temperature are also compared with blind WUFI 5.0 calculations. Measured moisture contents have also been compared with blind WUFI 5.0 calculated values in positions where this was possible. The risk of mould growth has also been evaluated in the studied positions.

This study is part of the Swedish research project “Framtidens trähus” (Wood framed buildings of the future) and was mainly carried out in a cooperation between Lund University, SP Technical Research Institute of Sweden and the Swedish wood house construction company Martinsons.

The report only includes a brief discussion based on the results. The results of measurements, calculations and comparisons between measured and calculated values will be used and further evaluated in future studies and research projects.

A separate report (Mundt-Petersen, S.O., 2013) has also been compiled which includes a broad analysis, discussion and conclusions with regard to the comparisons between measured and blind WUFI 5.0 calculated values. This report also discusses the possibility of using WUFI 5.0 in the Swedish design process for Swedish constructions and Swedish climate conditions (Mundt-Petersen, S.O., 2013).

1.1 Background

The project “Wood framed buildings of the future” started in November 2007. In 2008 and 2009 several wireless sensors were installed in five differently designed wood framed houses during the construction process. The sensors measured temperature, RH and MC in order to make it possible to evaluate the climate conditions and risk of mould growth in different positions in different wood framed constructions (Framtidens trähus, 2012).

1.2 Aim

The aim of this report is to present the measurement results for temperature, RH and MC in the studied positions in the studied house. The report also aims to present comparisons between measurements and blind calculations of temperature and RH, and MC where possible, carried out using the transient heat and moisture calculation tool WUFI 5.0 (Mundt-Petersen, S.O., 2013). Furthermore, the report aims to evaluate the risk of mould growth in the studied positions.

1.3 Limitations

There are a number of limitations and sources of error with regard to the measurements, comparisons of measured and calculated values and evaluations of the mould growth risk. These limitations are described in a separate report (Mundt-Petersen, S.O., 2013).

1.4 Intended readers

This report has been written for the Swedish wooden construction companies that participated in the “Wood framed buildings of the future” project and whose wooden constructions were studied.

2 Method

The comparisons between measured and calculated values were blind comparisons, i.e. they were verified without knowing the measurement results before the comparisons with the unadjusted calculated results were made. More detailed descriptions of the measurement method, the construction of the calculation model and the method of comparison between the measured and calculated values are provided in a separate report (Mundt-Petersen, S.O., 2013).

Measurements of temperature, RH and MC are presented in Folos 2D visual mould charts and additional charts together with comparisons with the blind WUFI 5.0 calculations and evaluations of the risk of mould growth. The Folos 2D visual mould chart is described in more detail in a separate report (Mundt-Petersen, S.O., 2012). Additional charts also show measured moisture content and, if it was possible, calculated moisture content. Vapour contents were calculated from measured and calculated values and compared. If there was a lack of measured values, the vapour content is shown as zero. There are also additional charts showing the magnitude of deviation between measured and calculated temperature and relative humidity.

Results from positions where the measuring sensor initially failed are not presented and consequently there are gaps in the numbering sequence of the measurement positions.

2.1 Blind comparison between measured and calculated values

Initially, measuring sensors for temperature, relative humidity and moisture content were mounted at different depths and locations in the walls during the construction phase. The construction phase was monitored to establish any possible deviations between the drawings and the real conditions in the built walls. Hourly measurements of temperature, relative humidity and moisture content for each specific position were then separately stored by a measurement collector, inaccessible to the persons involved in evaluating the calculation tool.

When the measurements were carried out, calculation models of each studied position were made. The calculation models were based on drawings and photos from the construction phase with the intention of reflecting as real conditions as possible. In 2012, blind calculations were carried out for each studied position without knowing the measured results. After the blind calculations had been completed and sent to the measurement collector, the previously inaccessible measurements were retrieved and compared to the calculated values.

Note that it was possible to make adjustments to the calculation models to achieve better correlation between the measured and calculated values in almost all the studied positions. However, this was not done since this was a blind verification.

3 Materials

The presented measurements, comparisons of measurements and calculations and evaluations of the risk of mould growth were carried out in a multi-family house in Skellefteå on the northern Swedish east coast built by the Swedish wood company Martinsons. The building was a seven-floor multi-family house with total 16 apartments. The ground construction area was 329 m² and the total living area was 1520 m² in studied house. The house was built on a concrete ground slab with wooden wall and slab frames made of massive cross laminated timber (CLT) and a wooden roof frame. The wood frame was mounted January to June 2009. The house was inhabited in July 2009.

4 Measuring and calculation periods

Measurements started in different times depending on when and where studied positions in walls and attic were constructed. Most of the measurements in walls started 29 April 2009 when the wall elements were mounted at the construction site. Measurements in the roof mainly started 8 May 2009 when the sensors were mounted in the roof.

Calculations were carried out from 29 April 2009 in all studied positions. Since the measurements starts at different times, and it might be lack of initial measuring results, the comparisons starts at the time where measuring data were available. Initial calculation period stabilizes the calculation and deals with possible influences of incorrect initial conditions.

Indoor climate measurements were only possible to carry out in one apartment at the sixth floor and in the storage area at the seventh penthouse floor starting June 2010. Further indoor climate measurements were not possible since inhabitants in the other apartment did not accept measurement sensors in their apartments. Used indoor climate conditions were only based on measured climate in the apartment. Comparisons from May 2009 to June 2010 may be uncertain since uncompleted indoor climate are used.

Measuring sensors were mounted by SP Trä Skellefteå that also has collected measuring data. During some periods there were problems regarding local transmission of measuring data from the measuring sensors to the local measurement data collector (Sandberg, K., 2011). Some measuring positions therefore lack long periods of measured data.

5 Boundary and initial conditions for calculations

The climate boundary conditions and initial conditions aim to reflect as real conditions as possible during the measuring period. Specific parameters and initial set values are presented in a separate report (Mundt-Petersen, S.O., 2013). The materials used are also listed separately (Mundt-Petersen, S.O., 2013). However, the materials used are briefly presented in connection with the WUFI 5.0 model for each separate position.

The in- and outdoor climate boundary conditions used are presented below. This is done together with a comparison and check against other available climate data in the area. The methods for finding additional climate data during periods when this is lacking, in order to provide complete in- and outdoor climate boundary conditions, are described in a separate report (Mundt-Petersen, S.O., 2013). Comparisons and checks regarding other available climate are also described in the same report (Mundt-Petersen, S.O., 2013).

5.1 Outdoor climate boundary condition data

The boundary conditions data used for each parameter are presented below. The charts also include a comparison with other available climate data. The amount of supplemented data, which were the same amount of lack of data, is given in percent for each year for each climate parameter.

Outdoor short-wave radiation absorption, dependent on color, is assumed to be 0.2 (white) on walls and 0.88 on roofs (bitumen black roof paper).

Note that hourly climate data was used in the calculations and three-hourly data was used in order to check the hourly data. In some cases the three-hourly data was also used to supplement periods of lacking data, as described in a separate report (Mundt-Petersen, S.O., 2013). Micro climate data available from own mounted sensors was only used in order to check possible deviations and defects in the hourly data.

The hourly outdoor climate used was mainly captured from the local climate station in Skellefteå city. This climate data were translated from 30 minutes data to 1 h data by taking each second 30 minutes value. Three-hourly data in order to compare with used data was captured from the climate station Bjuröklubb located in the archipelago outside Skellefteå. Since there were lacks of rainfall data from the climate station in Skellefteå city climate data for rainfall were taken from the climate station Bjuröklubb. Hourly global radiation data was captured from Luleå 130 km north of Skellefteå since there were no available global radiation data in Skellefteå. Furthermore, diffuse radiation readings were created from a model based on global radiation (Mundt-Petersen, S.O., 2013).

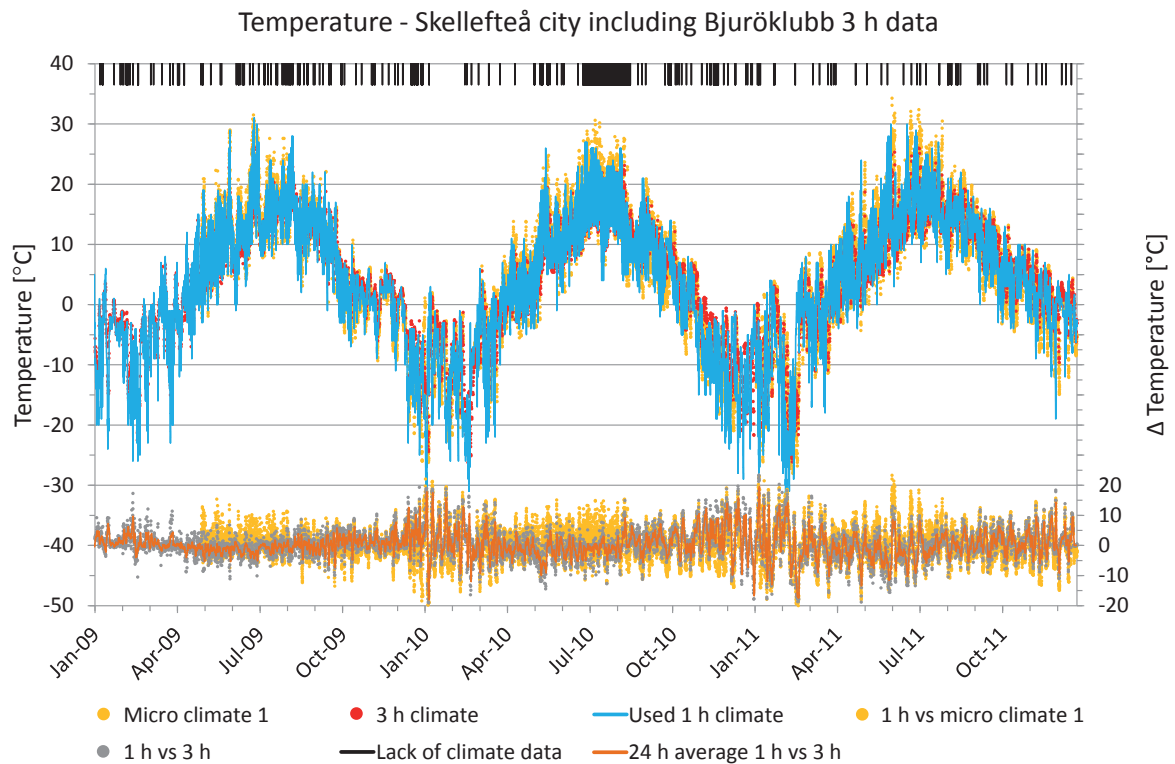

Figure 5.1.1. Used temperature data compared with other available climate data. Lack of data, in percent, that was supplemented: 2009 – 2.02 %, 2010 – 5.71 %, 2011 – 0.76 %.

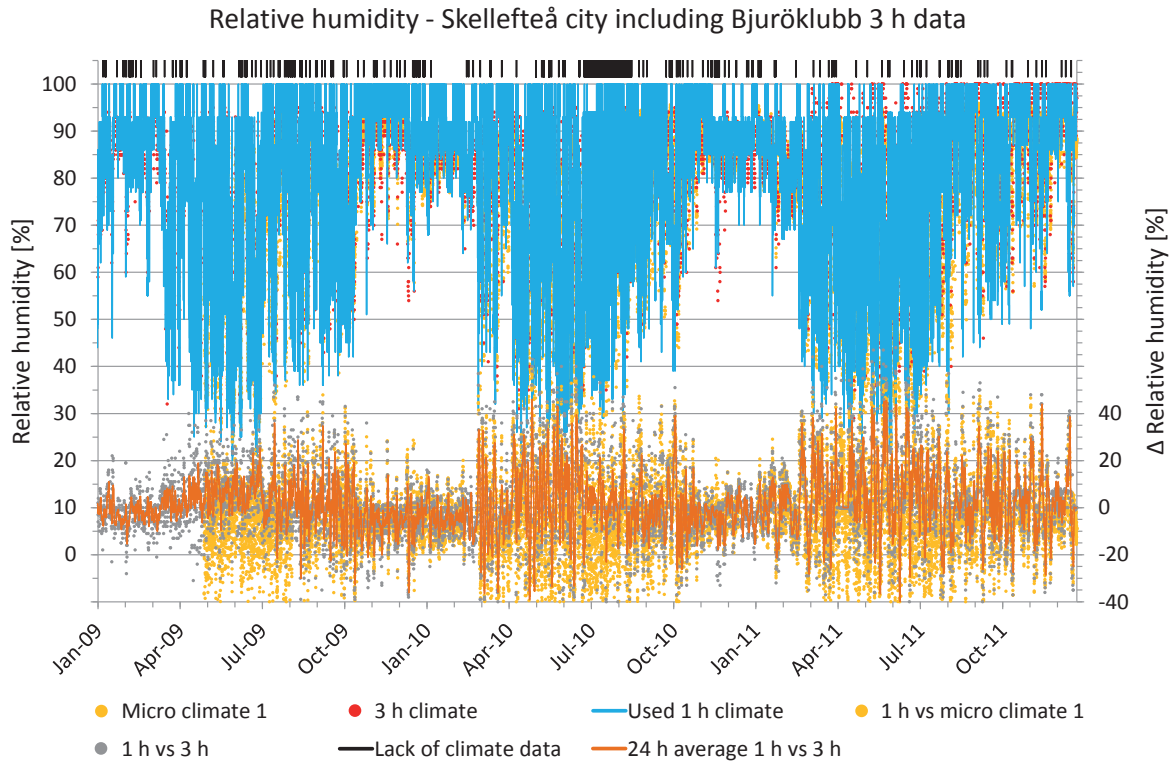

Figure 5.1.2. Used RH data compared with other available climate data. Lack of data, in percent, that was supplemented: 2009 – 2.02 %, 2010 – 5.71 %, 2011 – 0.78 %.

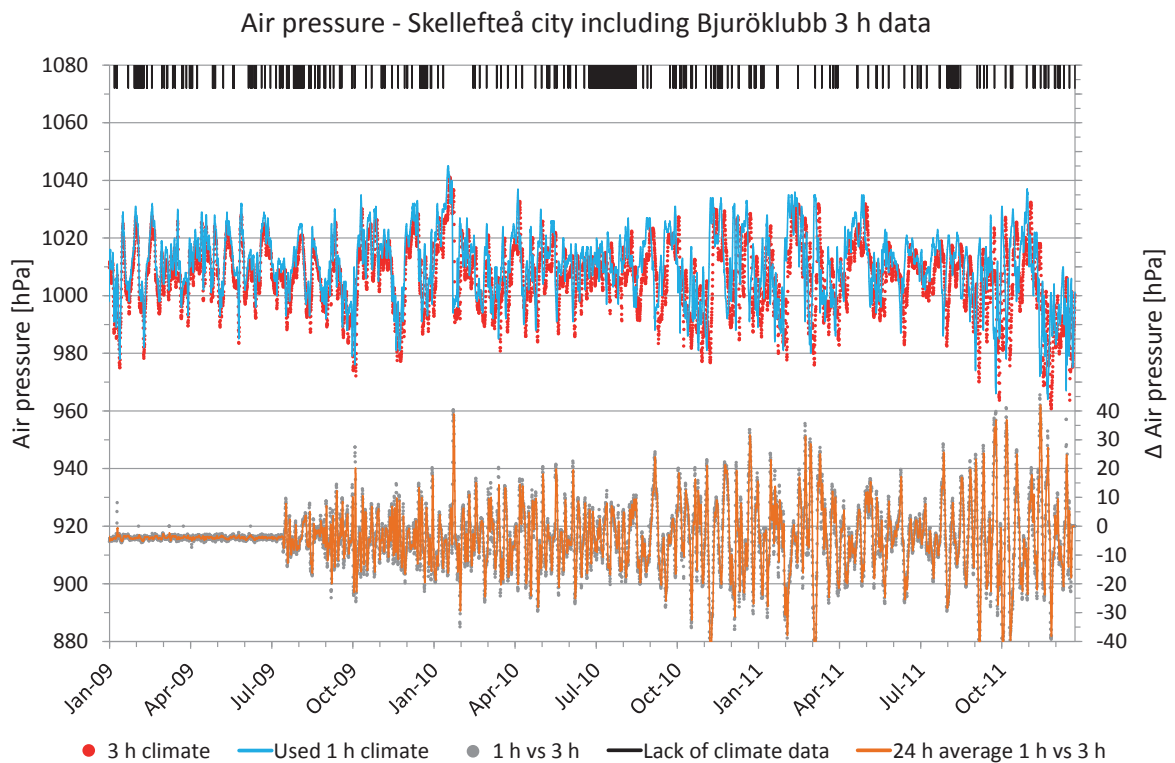

Figure 5.1.3. Used air pressure data at weather station height above sea level compared with other available climate data. Lack of data, in percent, that was supplemented: 2009 – 2.97 %, 2010 – 8.69 %, 2011 – 1.08 %.

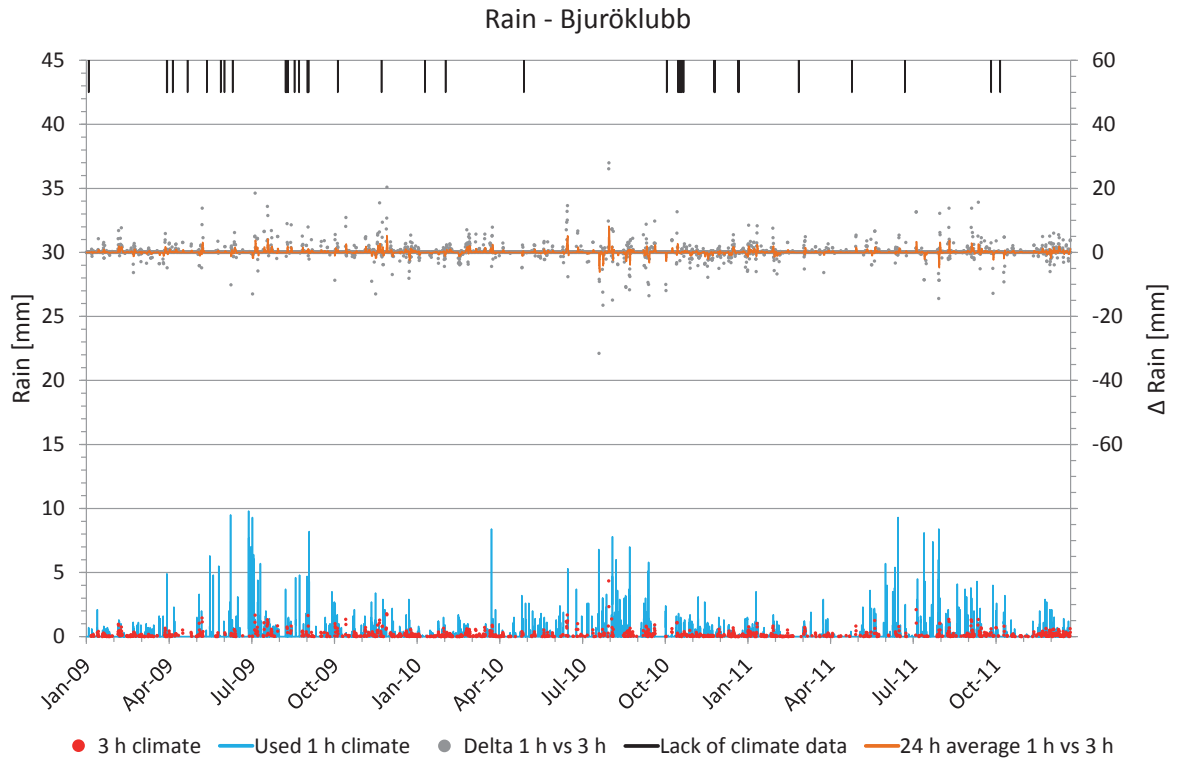

Figure 5.1.4. Used rainfall data compared with other available climate data. Lack of data, in percent, that was supplemented: 2009 – 0.68 %, 2010 – 0.47 %, 2011 – 0.27 %.

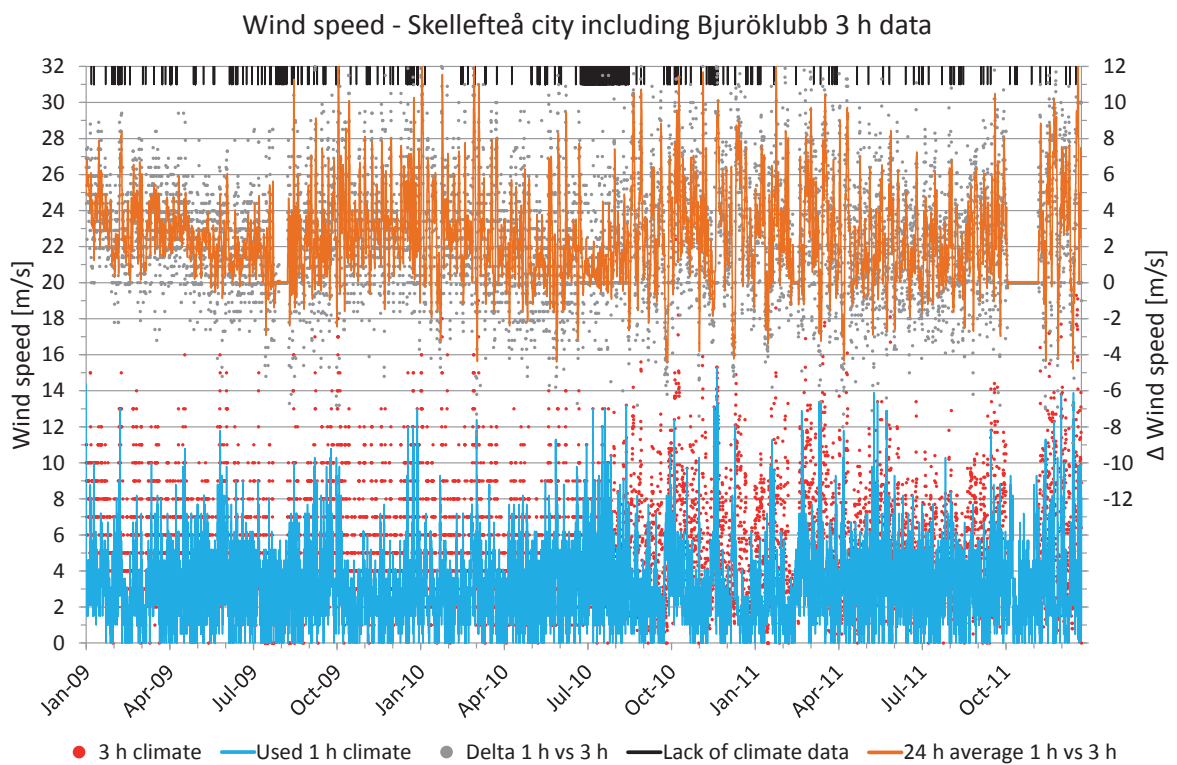

Figure 5.1.5. Used wind speed data compared with other available climate data. Lack of data, in percent, that was supplemented: 2009 – 2.08 %, 2010 – 5.72 %, 2011 – 0.78 %.

Wind direction - Skellefteå city including Bjuröklubb 3 h data

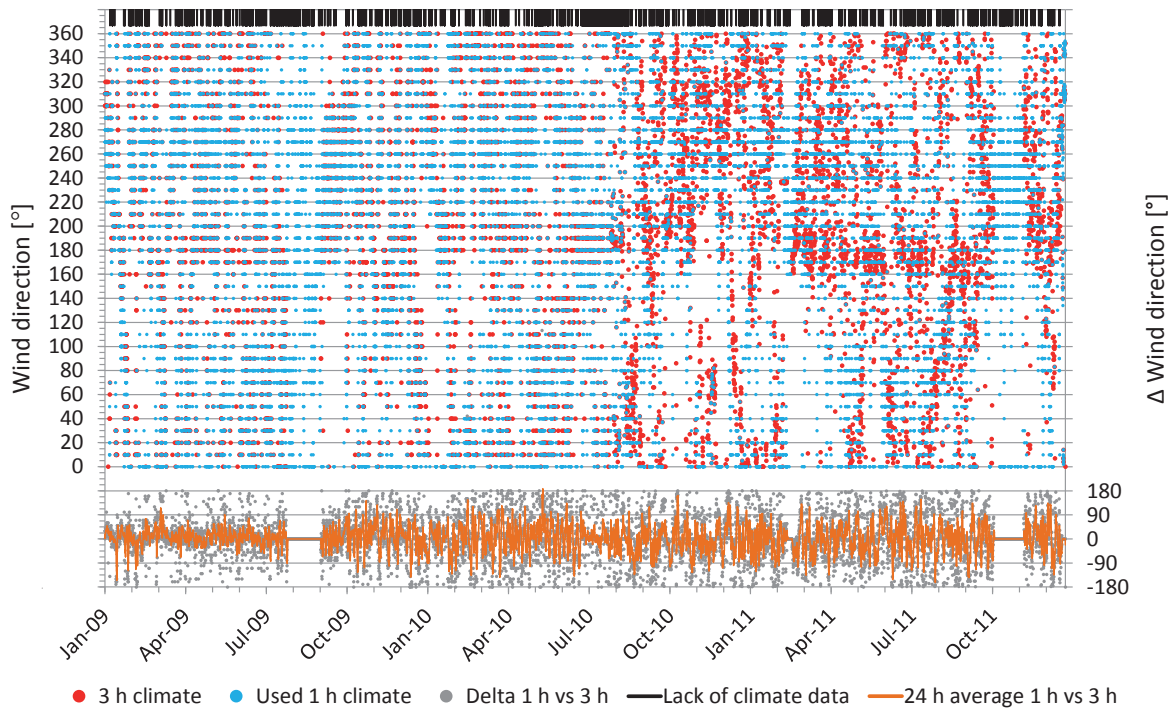

Figure 5.1.6. Used wind direction data compared with other available climate data. Lack of data, in percent, that was supplemented: 2009 – 4.98 %, 2010 – 8.30 %, 2011 – 3.64 %.

Global and diffuse radiation - Luleå

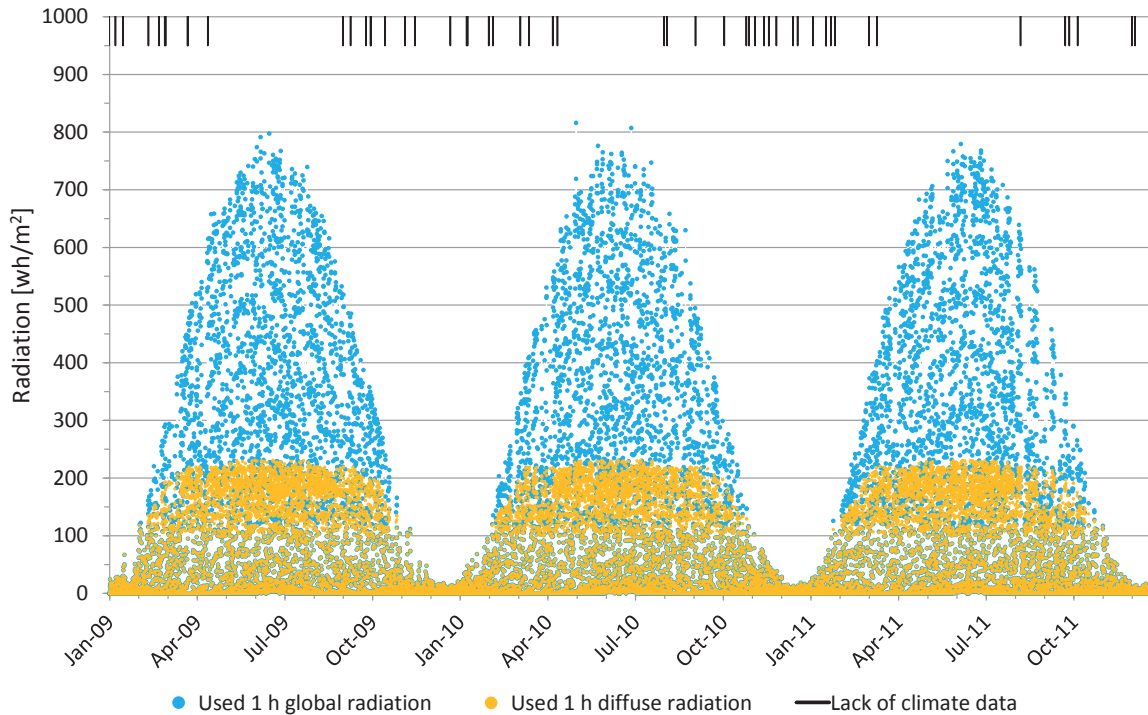

Figure 5.1.7. Used global and diffuse radiation data. Lack of global radiation data, in percent, that was supplemented: 2009 – 0.21 %, 2010 – 0.24 %, 2011 – 0.16 %. Diffuse radiation data was created from global radiation data (Mundt-Petersen, S.O., 2013).

5.2 Indoor climate boundary condition data

The indoor climate boundary conditions used are presented below. Used indoor climate were created from measurement in the living room in the west apartment on the sixth floor. The sensor location from where indoor climate is measured was shown in the drawings in next chapter which show studied positions. No further indoor measurements were possible since inhabitants in another apartment did not accept measurement sensors in their apartments. Indoor climate measurements started in June 2010. Comparisons between measured and calculated values before June 2010 may therefore be uncertain since used climate boundary conditions are uncertain. The fact that measured indoor climate, from which indoor climate is developed, not always is carried out in apartments that are adjacent to studied walls, also creates uncertainties. Periods with lack of data have been supplemented as described in a separate report with the addition that following years data were used in case of longer periods with lack of data (Mundt-Petersen, S.O., 2013).

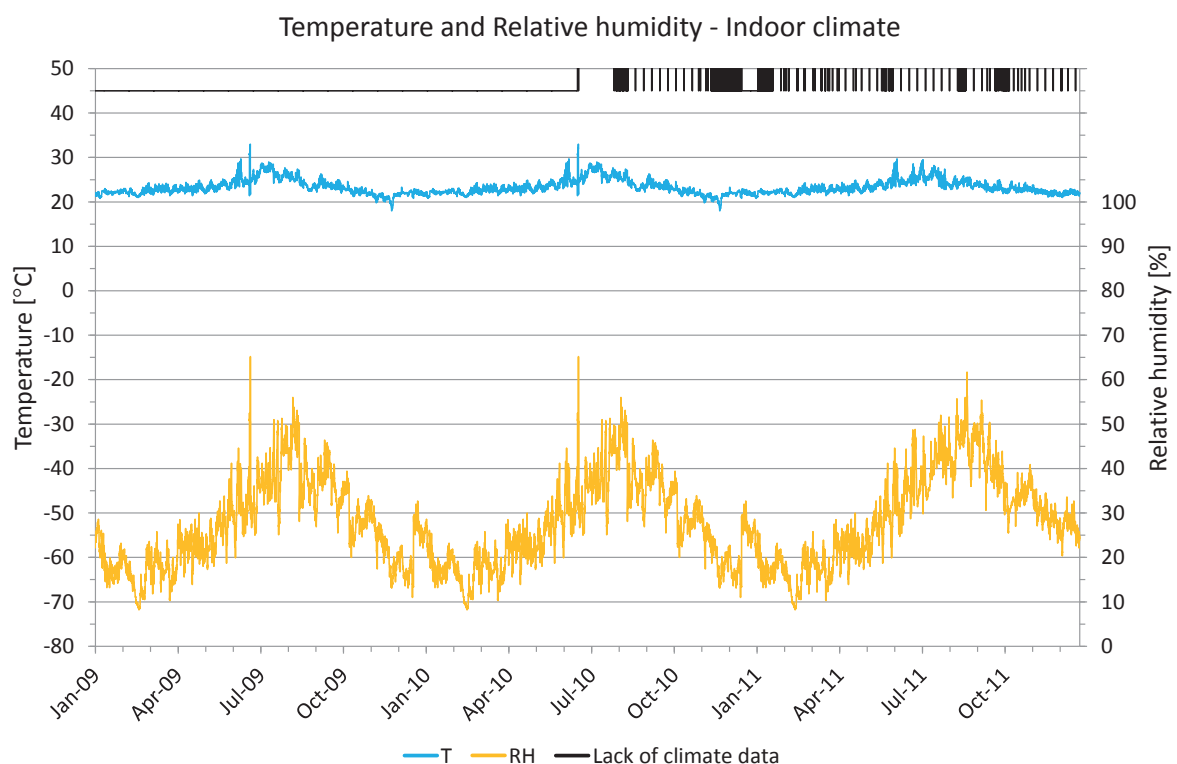

Figure 5.2.1. Used indoor temperature and relative humidity data. Lack of data, in percent, that was supplemented: 2009 – 100 %, 2010 – 56.04 %, 2011 – 5.90 %.

5.3 Air change rate/ Ventilation in air gap behind the cladding

Previous studies show that the air flow in the air gap varies depending on several of factors (Falk 2013). However, if the air change rate (ACH) in the air gap is high enough to handle all potential moisture in the gap, the influence of a higher ACH in the air gap is negligible (Hägerstedt 2010A, Hägerstedt 2011). Previous studies show that an air flow of 30 ACH in the air gap is reasonable in the case of ventilated air gaps behind the cladding. An air flow of 30 ACH has therefore been used in the walls studied in this report (Hägerstedt 2010A, Hägerstedt 2010B).

5.4 Roof and attic boundary conditions

The building has two different roofs with two different roof designs. One part was full insulated parallel roof with a ventilated air gap close to the outer tongued and grooved wood located below

the roof membrane. This roof has a roof angle of 12 degrees where one part was directed towards north and one part directed towards south. The air gap was treated as a ventilated air gap with an air change rate of 30 ACH, as used in the façade air gap.

The other roof has a roof angle of 3.5 degrees and a rather small cold attic space the outer tongued and grooved wood located on the inside of the roof membrane. There are two cold attics spaces like this which was separated from each other, one to the north and one to the south. Total ventilation volume in each cold attic space was estimated to 15 m³. Previous studies show that 3 ACH was a relevant air ventilation rate in well ventilated attics (Walker, I.S., 1995). This provides the total ventilation rate of 45 m³/h. In the WUFI 5.0 calculation model the ventilated layer is set to 0.05 m in the roof calculations. The attic area of 44 m² with a height of 0.05 m gives a ventilation volume of 2.2 m³. This provides that real ventilated air volume of 45 m³/h which could transport moisture corresponds to 20.5 ACH in a 0.05 m high air layer. However, in order to make calculated values comparable with the roof with an air gap, an air change rate of 30 ACH have been used in the calculation model.

6 Studied house and positions

The locations of the studied positions are shown in the figures on the following pages. In connection with each studied position a more detailed specification and drawing of the position is also given. In some cases photos, showing the sensor, are provided in the results chapter in connection with the part in which each studied position is presented in detail.

The locations of the studied positions were mainly chosen for two reasons. One was to study the positions where previous knowledge and experience had shown a high frequency of damage. The second was to have a couple of positions in a row at different depths in the wall in order to obtain purer measurements and more reliable conditions in order to verify the WUFI 5.0 calculation tool.

The choice of the studied house and its location was governed by the potential for new-build houses from the housing company participating in the study.

Sensor 1n - Wall (N)
Inner part of the wall in the installation layer on the inside of the vapour barrier

Sensor 2n - Wall (N)
Inner part of the wall on the outisid of the vapour barrier and massive wood

Sensor 14-5n-airgap - Wall (N)
Air gap behind the facade panel

Sensor 3n - Wall (N)
Outer part of stud

Sensor 10s - Wall (S)
Outer part of beam below the window

Sensor 22-6s-exterior facade - Wall (S)
Outside of the facade panel

Sensor 14-5n-exterior facade - Wall (N)
Outside of the facade panel

Sensor 11v - Wall (W)
Outer part of beam below the window

Sensor 11-5v-airgap - Wall (W)
Air gap behind the facade panel

Sensor 11-5v-exterior facade - Wall (W)
Outside of the facade panel

Sensor 9s - Wall (S)
Outer part of beam below the window

Sensor 15-5ö-exterior facade - Wall (E)
Outside of the facade panel

Sensor 13v - Wall (W)
Outer part of beam below the window

Sensor 15-5ö-airgap - Wall (E)
Air gap behind the facade panel

Sensor 6ö - Wall (E)
Outer part of stud

Sensor 5ö - Wall (E)
Inner part of the wall on the outisid of the vapour barrier and massive wood

Sensor 22-6s-airgap - Wall (S)
Air gap behind the facade panel

Sensor 15ö - Wall (E)
Outer part of beam below the window

Sensor 16ö - Wall (E)
Outer part of beam below the window

Positions marked N-NID (Number-Number, Direction), ex 9-3s, show location of measuring sensors on the facade in the parallel research project Wood build

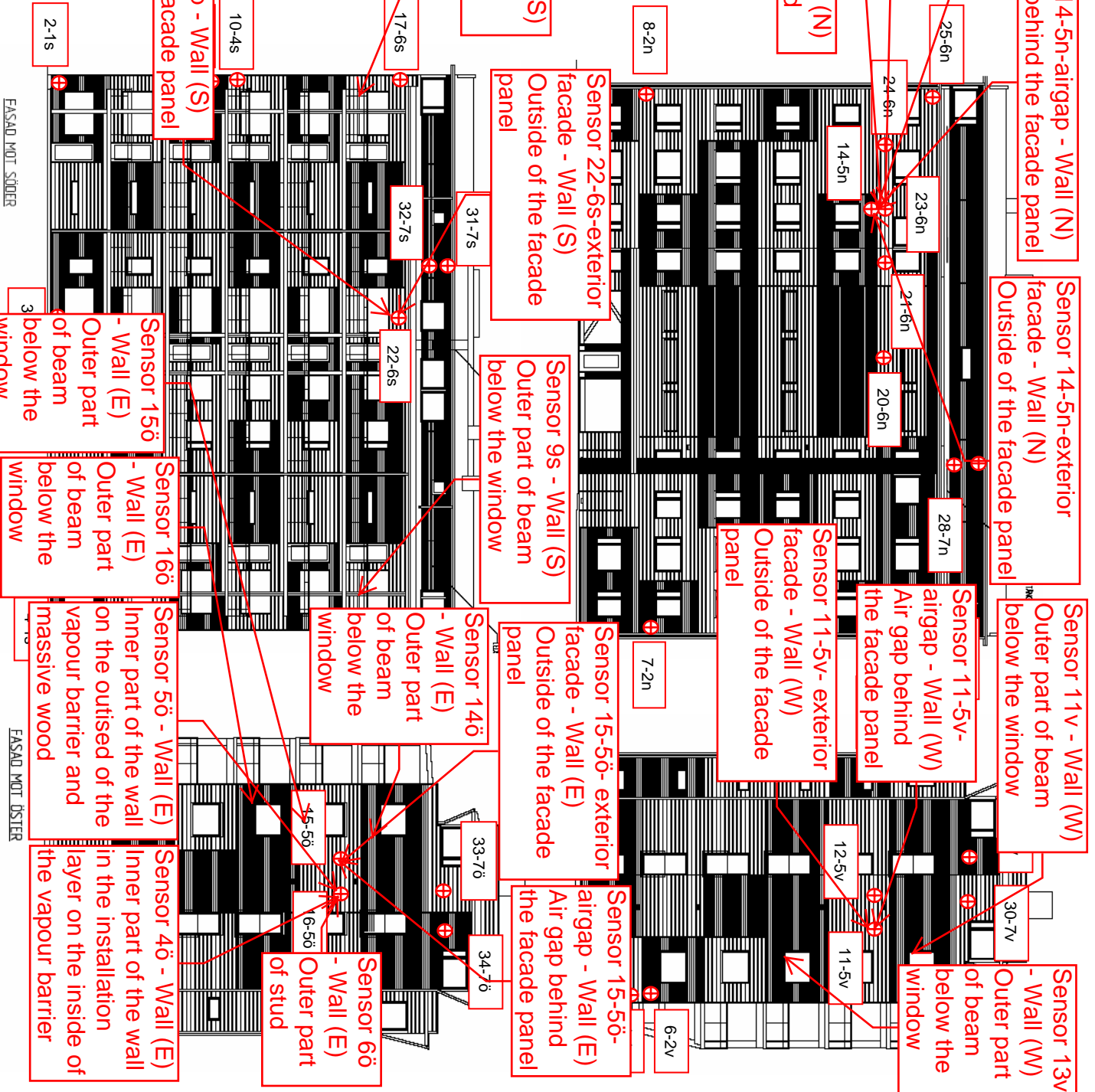
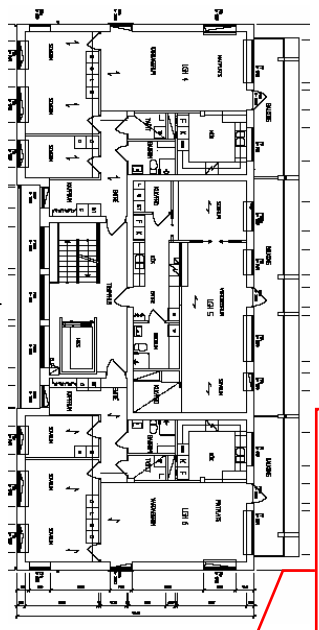
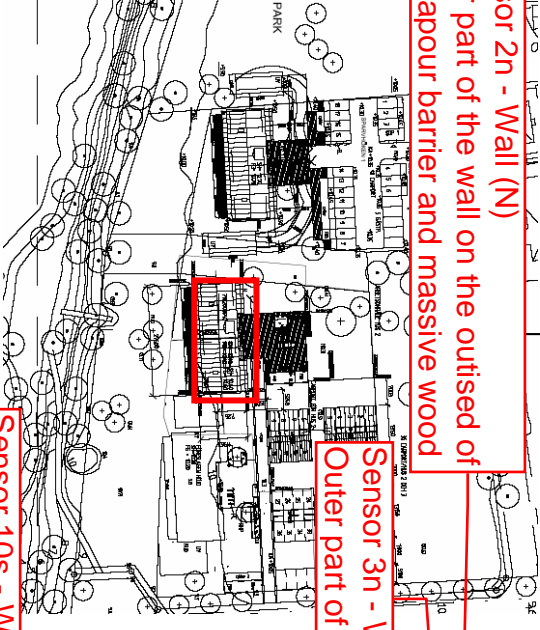

FASAD MÖT SÖDER

FASAD MÖT ÖSTER

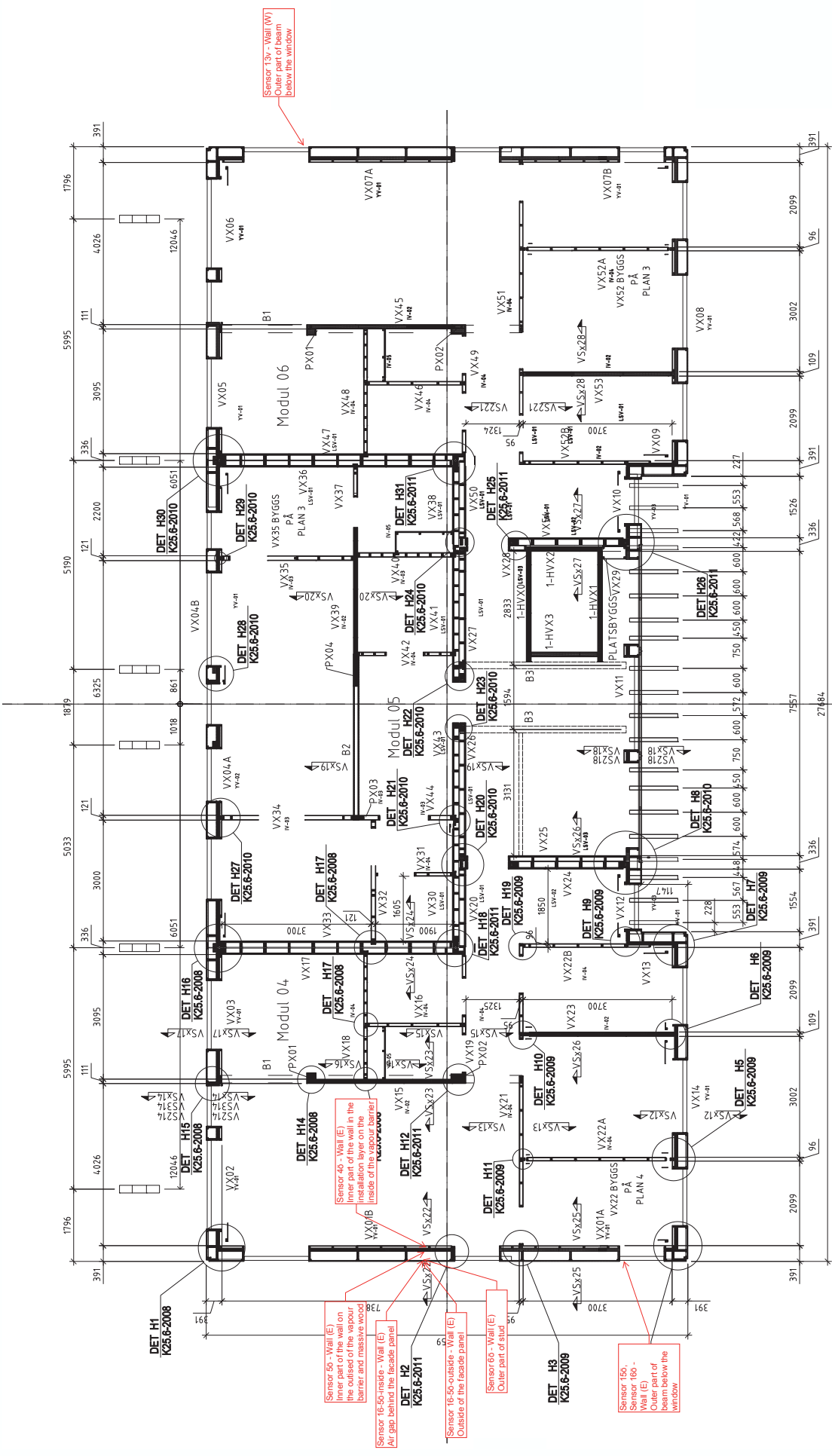

Sensor 13 - Wall (W)
Outer part of beam
below the window

Sensor 55 - Wall (E)
Inner part of the wall on
the outside of the vapour
barrier and massive wood
barrier

Sensor 40 - Wall (E)
Inner part of the wall in the
installation layer on the
inside of the vapour barrier

Sensor 16-50-inside - Wall (E)
Air gap behind the facade panel

Sensor 16-50-outside - Wall (E)
Outside of the facade panel

Sensor 60 - Wall (E)
Outer part of stud

Sensor 150,
Sensor 160 -
Wall (E)
Outer part of
window
below the
window

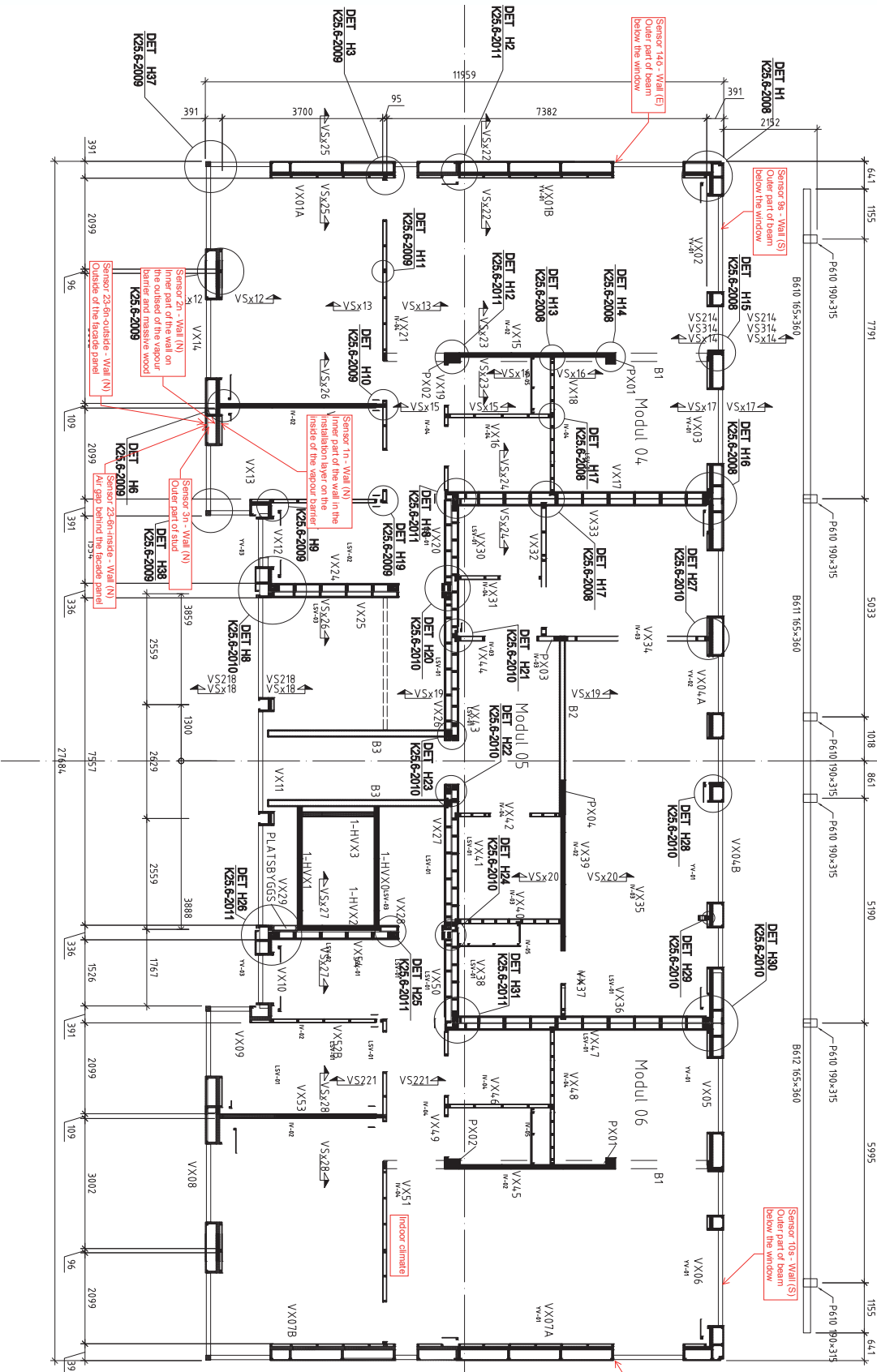

Sensor 14g - Wall (E)
Outer part of beam
Below the window

DET H1
K25.6-2008
Sensor 9a - Wall (S)
Outer part of beam
Below the window

Sensor 21 - Wall (N)
Inner part of the wall on
the outside of the vapour
barrier and massive wood

Sensor 23a - outside - Wall (N)
Outside of the facade panel

Sensor 11 - Wall (N)
Inner part of the wall in the
installation layer on the
inside of the vapour barrier

Sensor 23b - inside - Wall (N)
At top behind the facade panel

Sensor 18s - Wall (S)
Outer part of beam
Below the window

Sensor 11v - Wall (W)
Outer part of beam
Below the window

Indoor climate

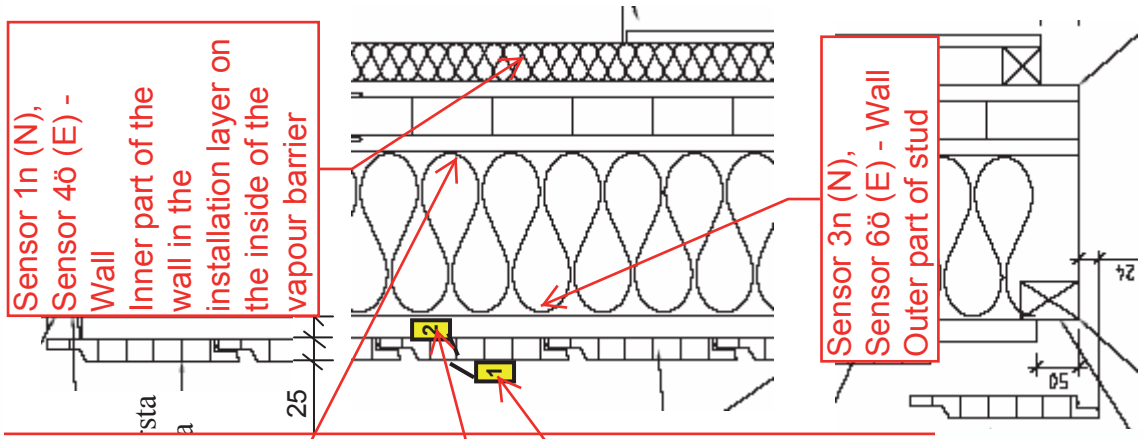

Sensor 1n (N),
Sensor 4ö (E) -
Wall
Inner part of the
wall in the
installation layer on
the inside of the
vapour barrier

Sensor 3n (N),
Sensor 6ö (E) - Wall
Outer part of stud

Sensor 2n (N),
Sensor 5ö (E) -
Wall
Inner part of the
wall on the outised
of the vapour
barrier and
massive wood

Sensor 23-6n-inside (N),
Sensor 16-5ö-inside (E) -
Wall
Air gap behind the facade
panel

Sensor 23-6n-outside (N),
Sensor 16-5ö-outside (E) -
Wall
Outside of the facade panel

sta
a
25

24
Ø5

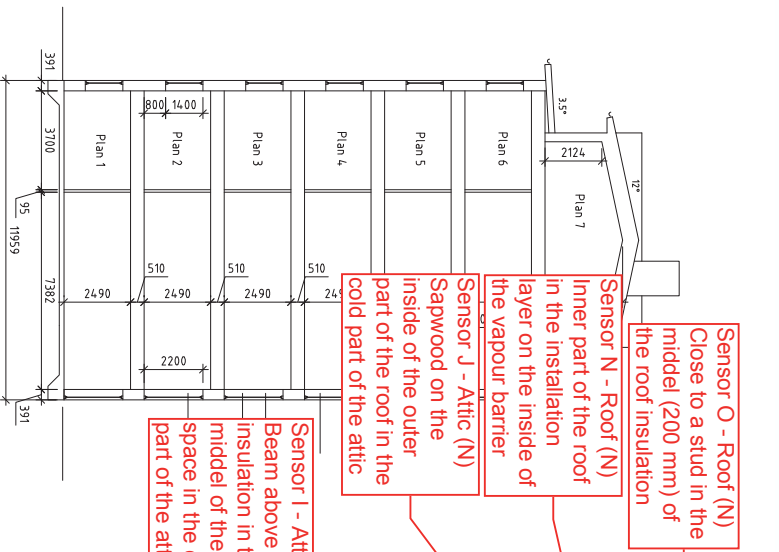

Sensor O - Roof (N)
Close to a stud in the middle (200 mm) of the roof insulation

Sensor N - Roof (N)
Inner part of the roof in the installation layer on the inside of the vapour barrier

Sensor J - Attic (N)
Sapwood on the inside of the roof in the cold part of the attic

Sensor I - Attic (N)
Beam above the insulation in the middle of the air space in the cold part of the attic

SEKTION A-A

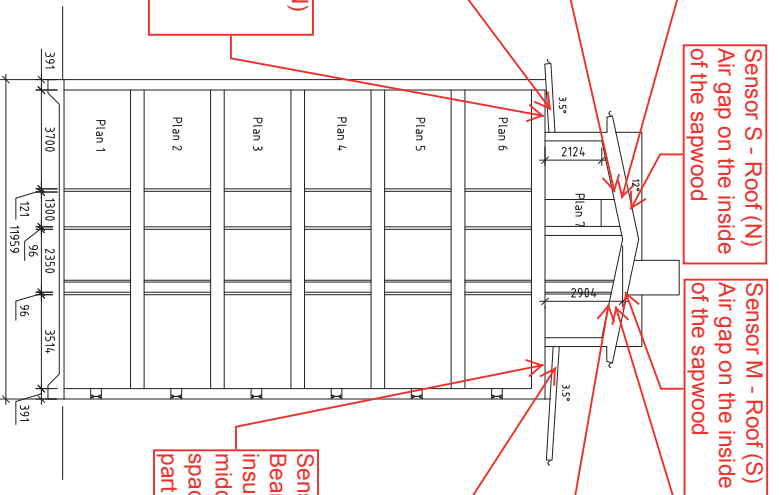

Sensor S - Roof (N)
Air gap on the inside of the sapwood

Sensor M - Roof (S)
Air gap on the inside of the sapwood

Sensor D - Attic (S)
Beam above the insulation in the middle of the air space in the cold part of the attic

SEKTION B-B

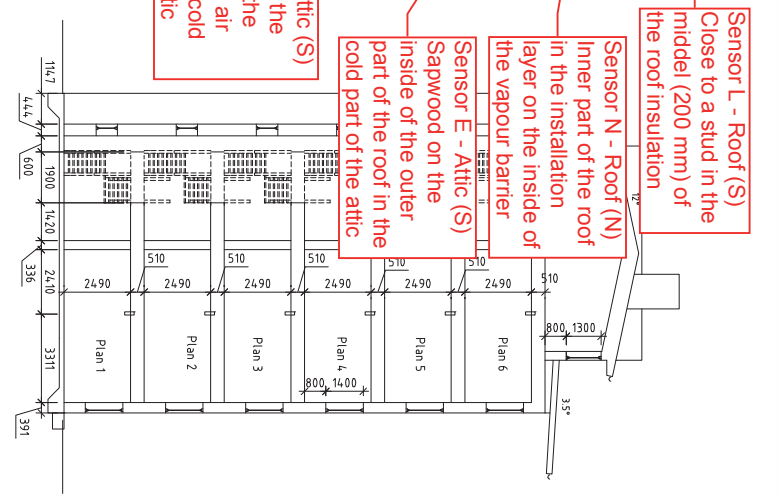

Sensor L - Roof (S)
Close to a stud in the middle (200 mm) of the roof insulation

Sensor N - Roof (N)
Inner part of the roof in the installation layer on the inside of the vapour barrier

Sensor E - Attic (S)
Sapwood on the inside of the roof in the cold part of the attic

SEKTION C-C

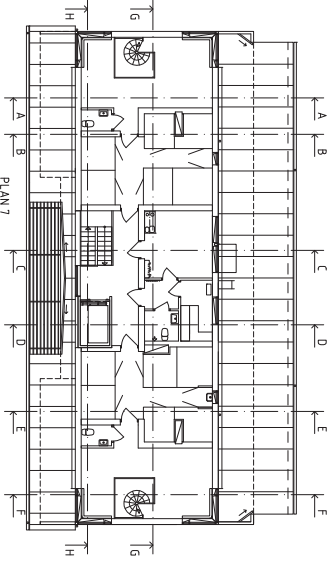
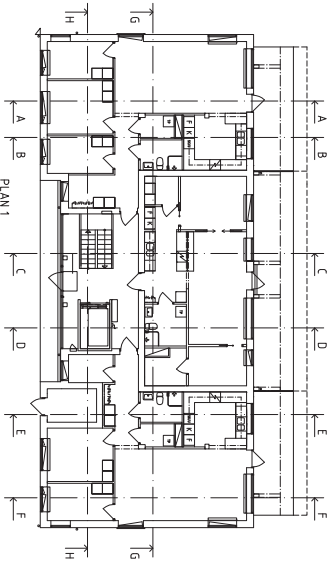

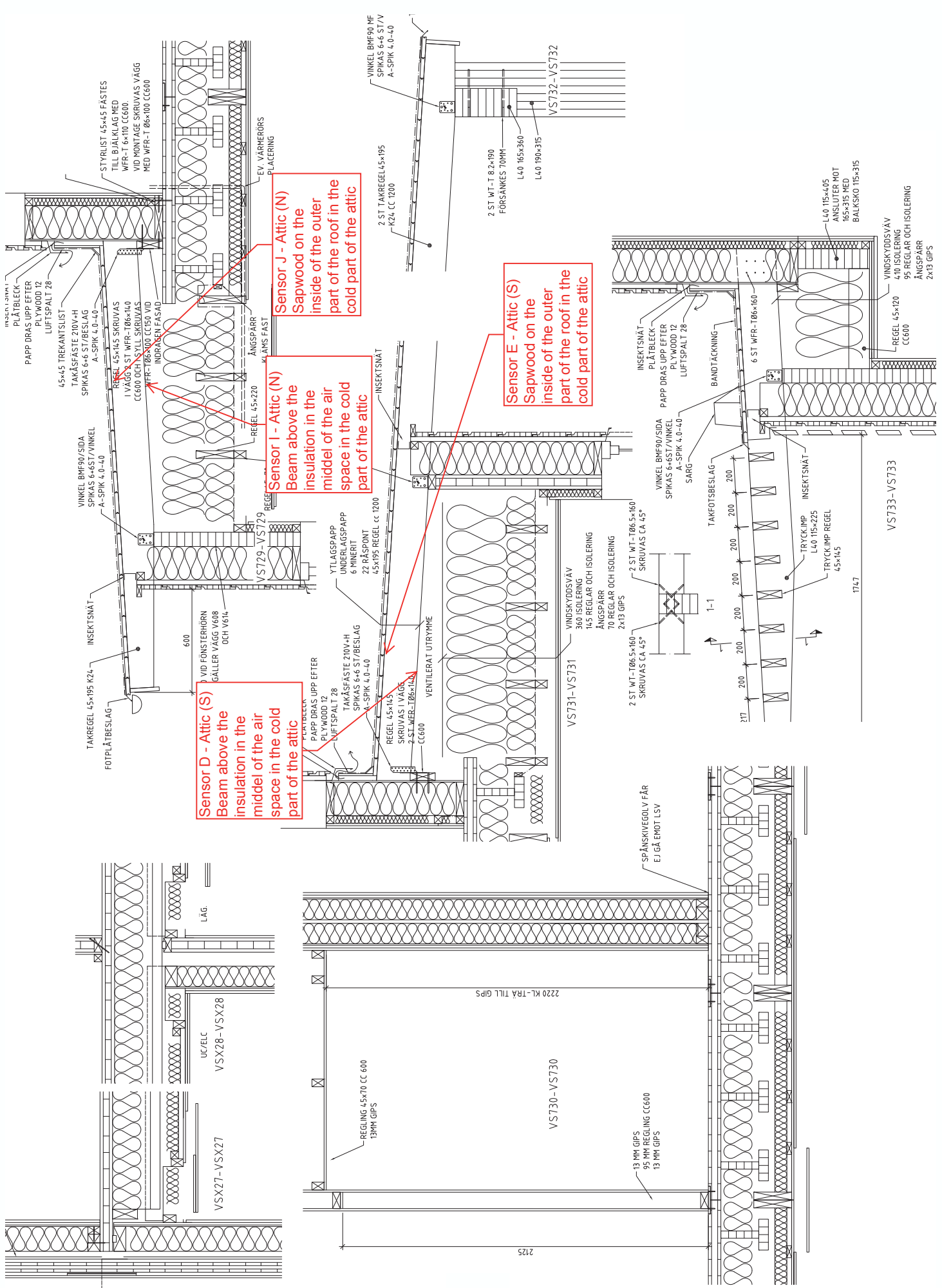

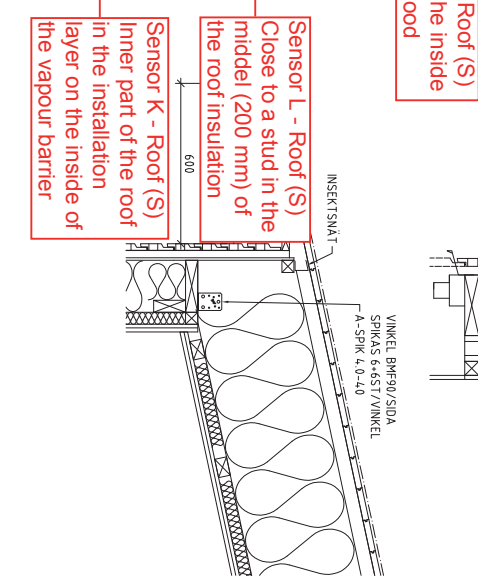
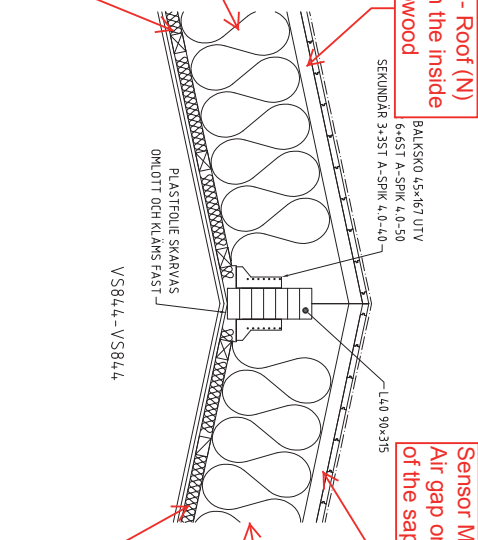
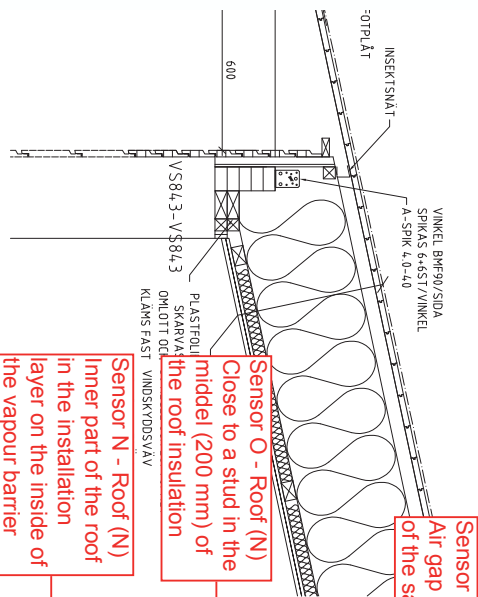
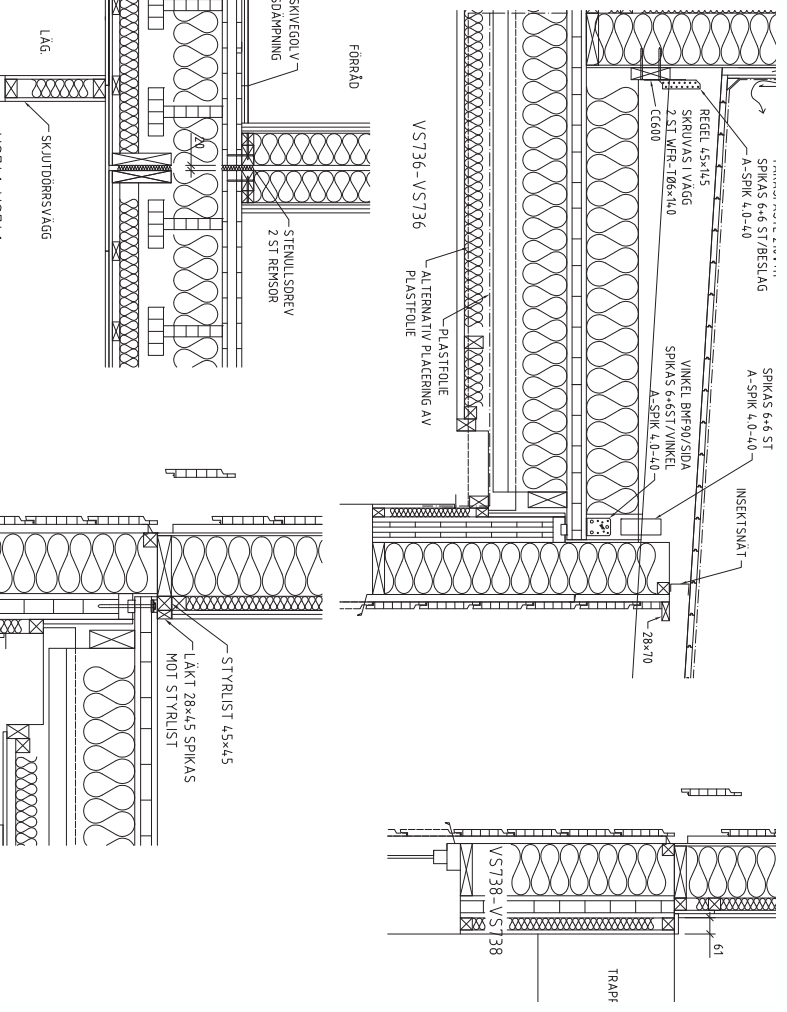
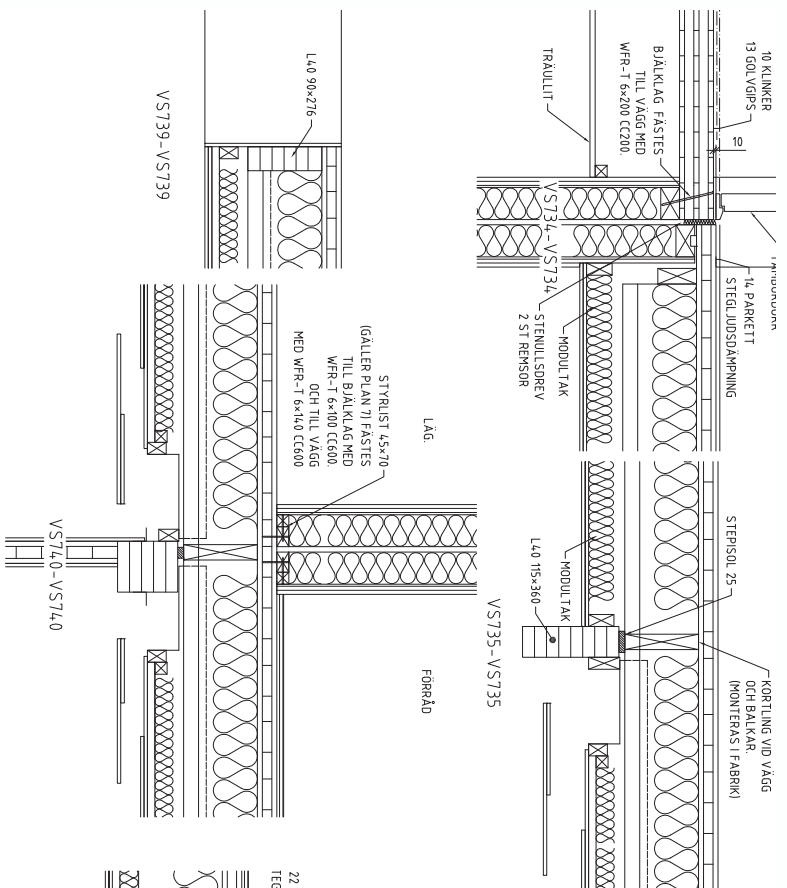

Sensor O - Roof (N)
Close to a stud in the middle (200 mm) of the roof insulation

Sensor S - Roof (N)
Air gap on the inside of the sapwood

Sensor M - Roof (S)
Air gap on the inside of the sapwood

Sensor L - Roof (S)
Close to a stud in the middle (200 mm) of the roof insulation

Sensor N - Roof (N)
Inner part of the roof in the installation layer on the inside of the vapour barrier

7 Results – Walls on the fourth, fifth and sixth floor

7.1 Position 1n

The locations of the measured and calculated position are shown in the drawings and figures below. The studied position is located in a wall that is facing north on the sixth floor.

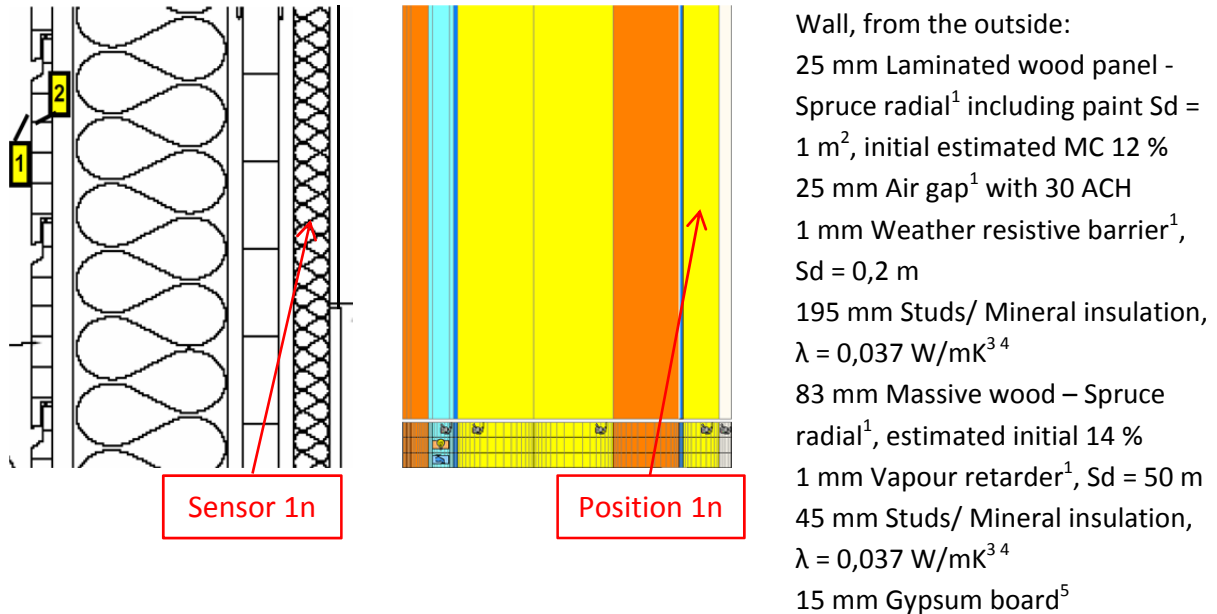

Figure 7.1.1. Vertical cross sectional drawing and WUFI calculation model showing the studied position. 1. IBP, 2012, 2. Nevander, L-E., 1994, 3. IEA Annex 24, 1996, 4. Paroc, 2002, 5. Krus, M., 1996.

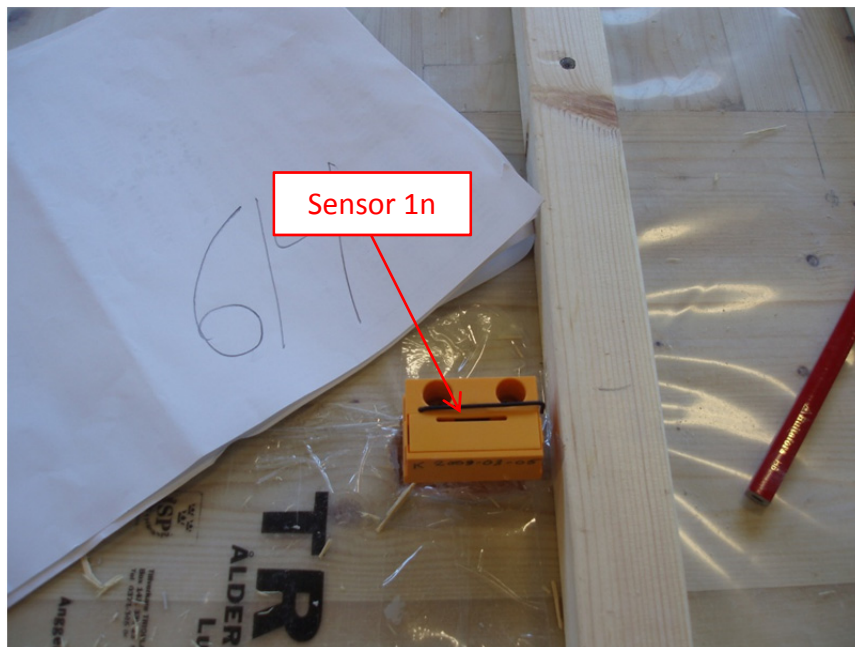

Figure 7.1.2. Location of the studied position. Photo: SP Trä Skellefteå.

A perfect match between the measured and calculated values cannot be expected due to e.g. the influence of two- and three-dimensional effects and the accuracy of the sensors.

Year 2009

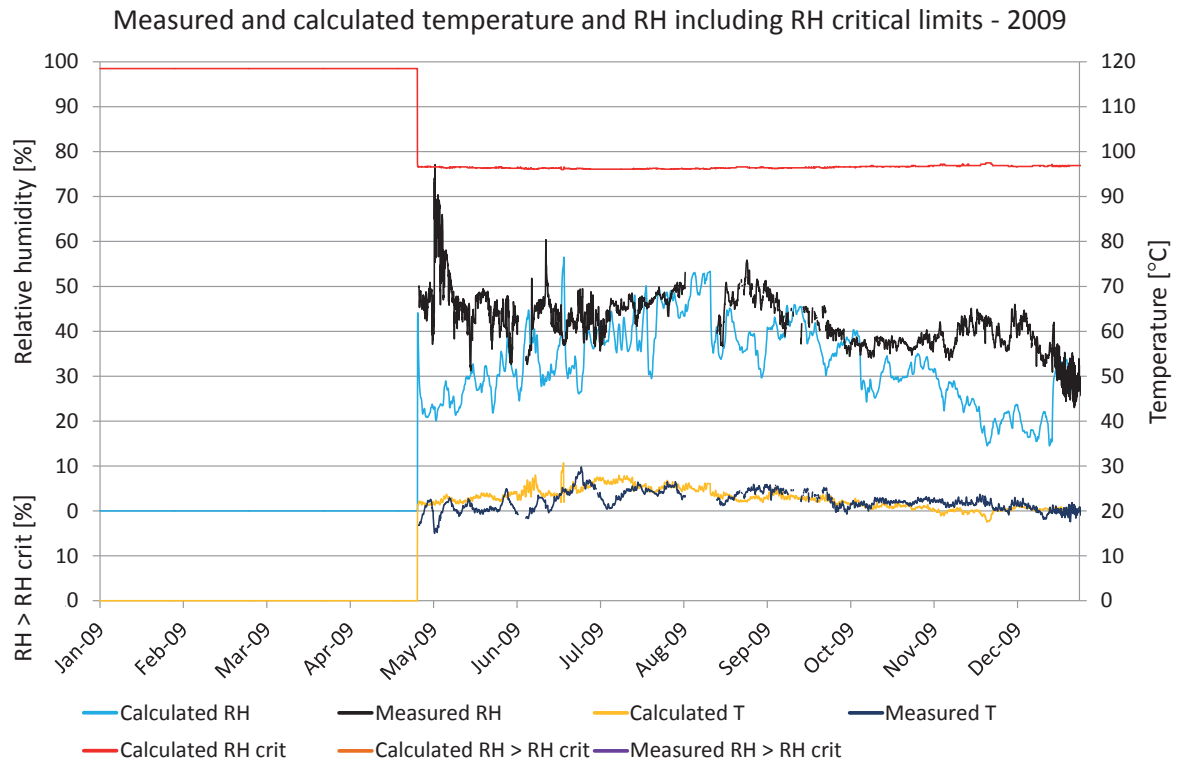

Figure 7.1.3. Comparisons between measured and calculated temperature and relative humidity. Calculated temperature (yellow), measured temperature (dark blue), calculated RH (turquoise), measured RH (black), RH_{crit} for calculated values (red), calculated $RH > RH_{crit}$ (light brown), measured $RH > RH_{crit}$ (purple).

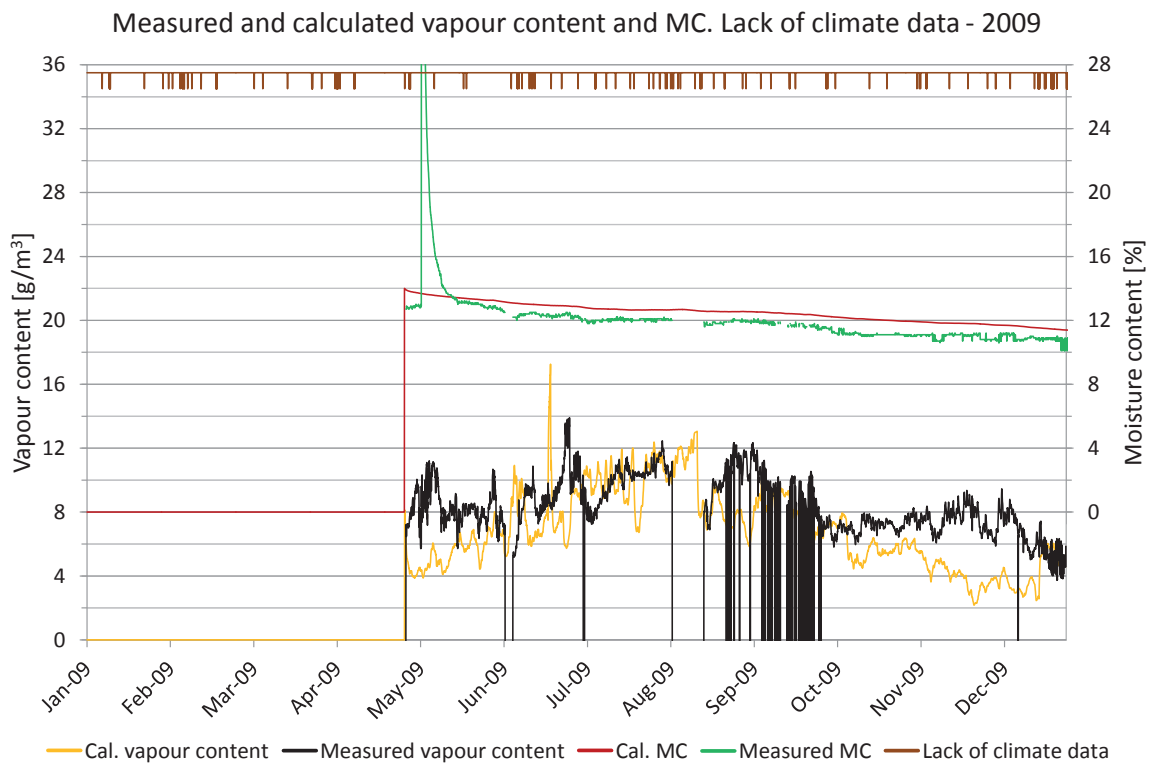

Figure 7.1.4. Measured moisture content, periods lacking climate data and comparisons of vapour content. Vapour content for calculated values (yellow) and measured values (black). Moisture content for calculated values (red) and measured values (green), periods with lack of climate data (brown).

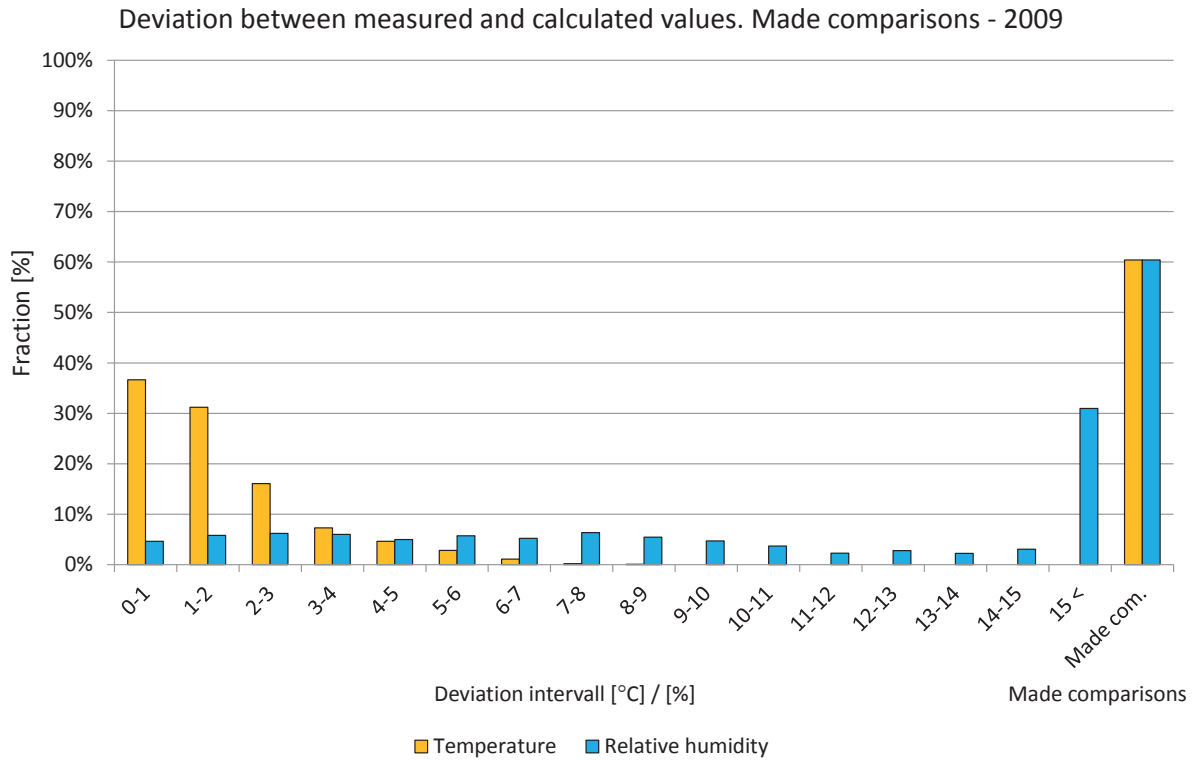

Figure 7.1.5. Deviations in comparisons shown in intervals from 0 to 15 °C or %. The two right-hand bars show the percentage of comparisons during the year. Temperature (yellow) and relative humidity (light blue).

Year 2010

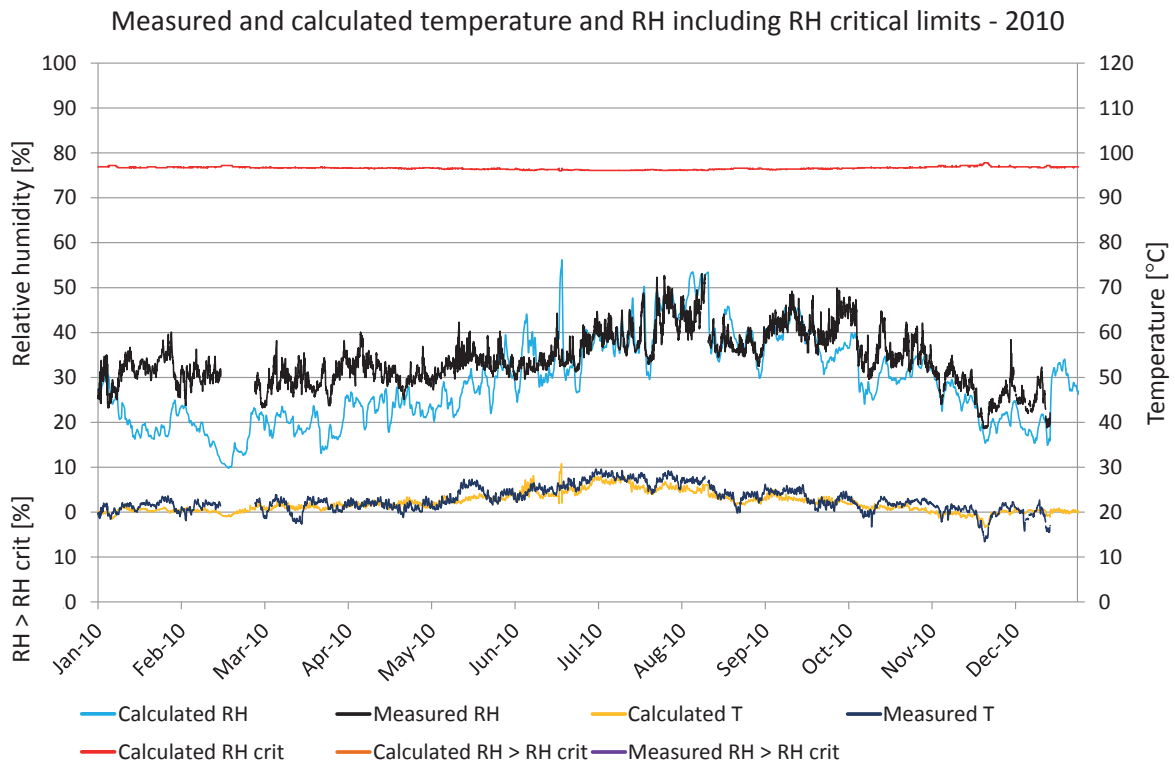

Figure 7.1.6. Comparisons between measured and calculated temperature and relative humidity. Calculated temperature (yellow), measured temperature (dark blue), calculated RH (turquoise), measured RH (black), RH_{crit} for calculated values (red), calculated $RH > RH_{crit}$ (light brown), measured $RH > RH_{crit}$ (purple).

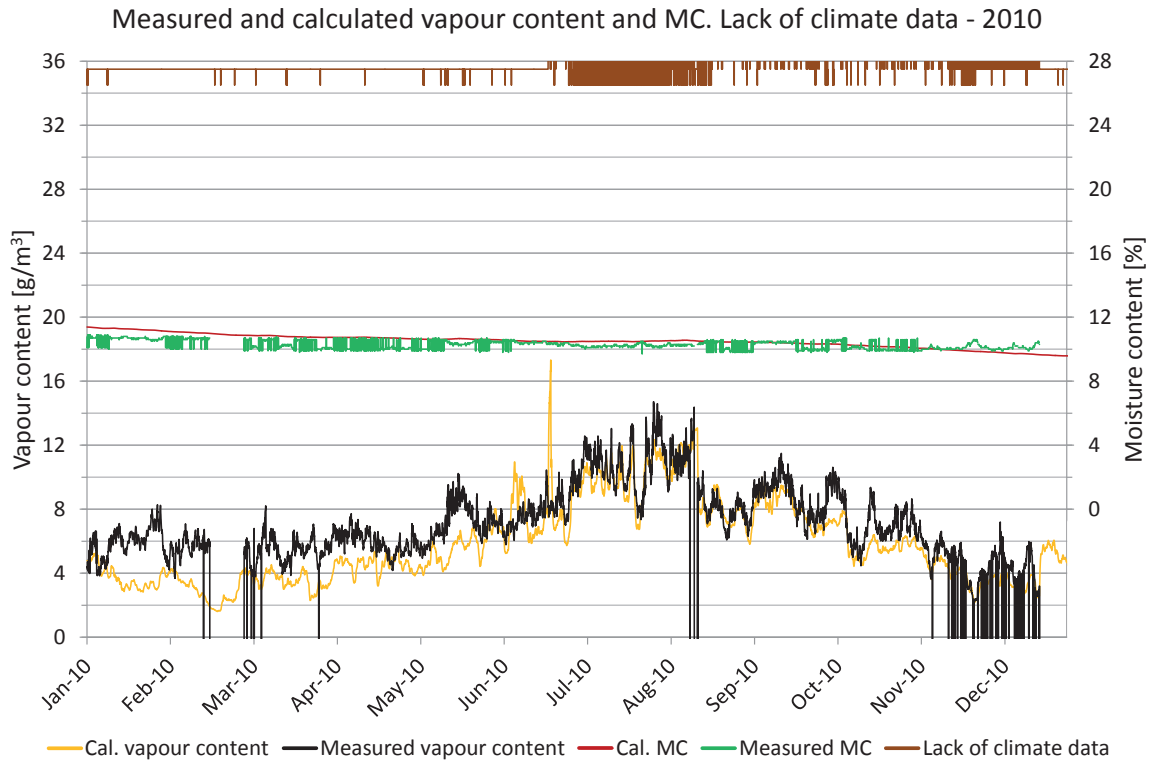

Figure 7.1.7. Measured moisture content, periods lacking climate data and comparisons of vapour content. Vapour content for calculated values (yellow) and measured values (black). Moisture content for calculated values (red) and measured values (green), periods with lack of climate data (brown).

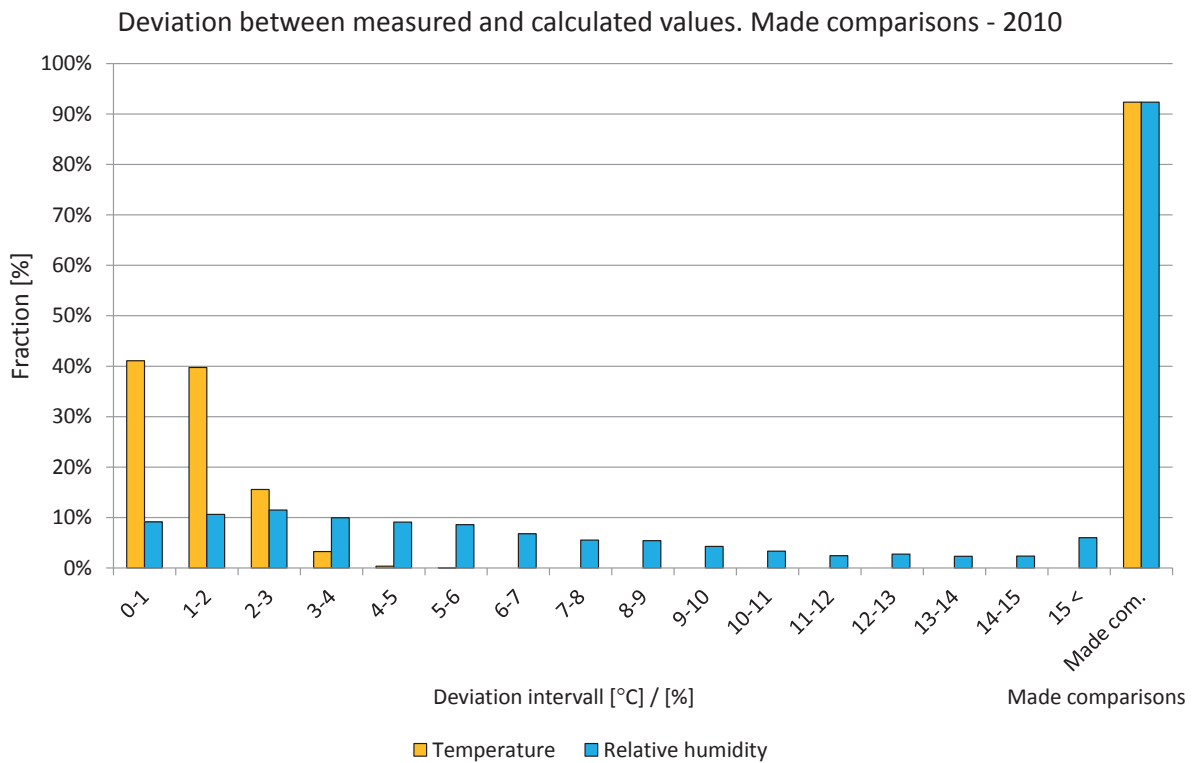

Figure 7.1.8. Deviations in comparisons shown in intervals from 0 to 15 °C or %. The two right-hand bars show the percentage of comparisons during the year. Temperature (yellow) and relative humidity (light blue).

Year 2011

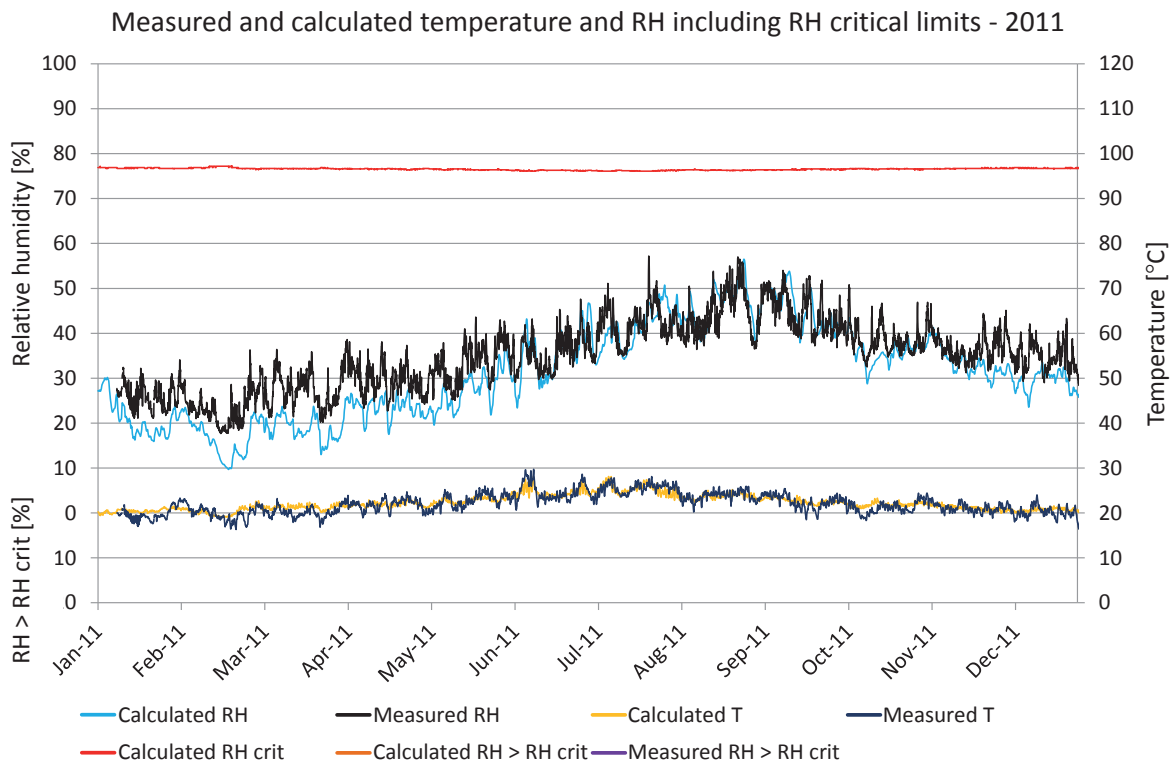

Figure 7.1.9. Comparisons between measured and calculated temperature and relative humidity. Calculated temperature (yellow), measured temperature (dark blue), calculated RH (turquoise), measured RH (black), RH_{crit} for calculated values (red), calculated $RH > RH_{crit}$ (light brown), measured $RH > RH_{crit}$ (purple).

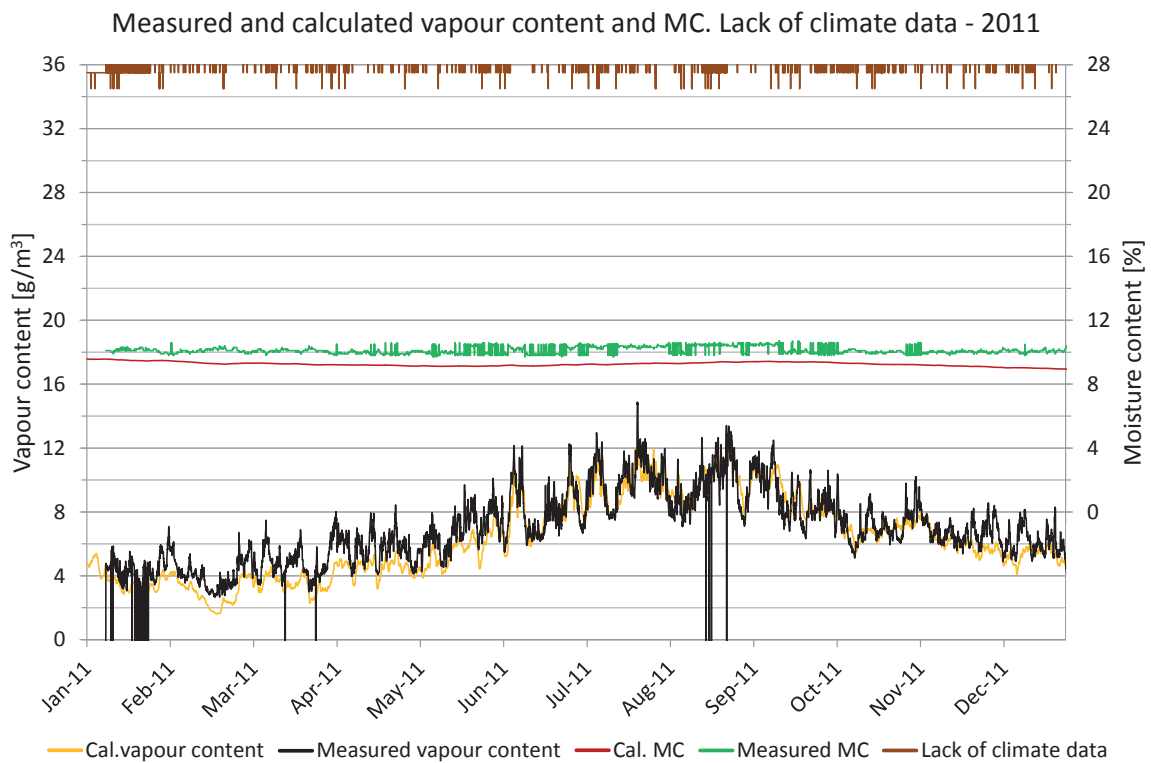

Figure 7.1.10. Measured moisture content, periods lacking climate data and comparisons of vapour content. Vapour content for calculated values (yellow) and measured values (black). Moisture content for calculated values (red) and measured values (green), periods with lack of climate data (brown).

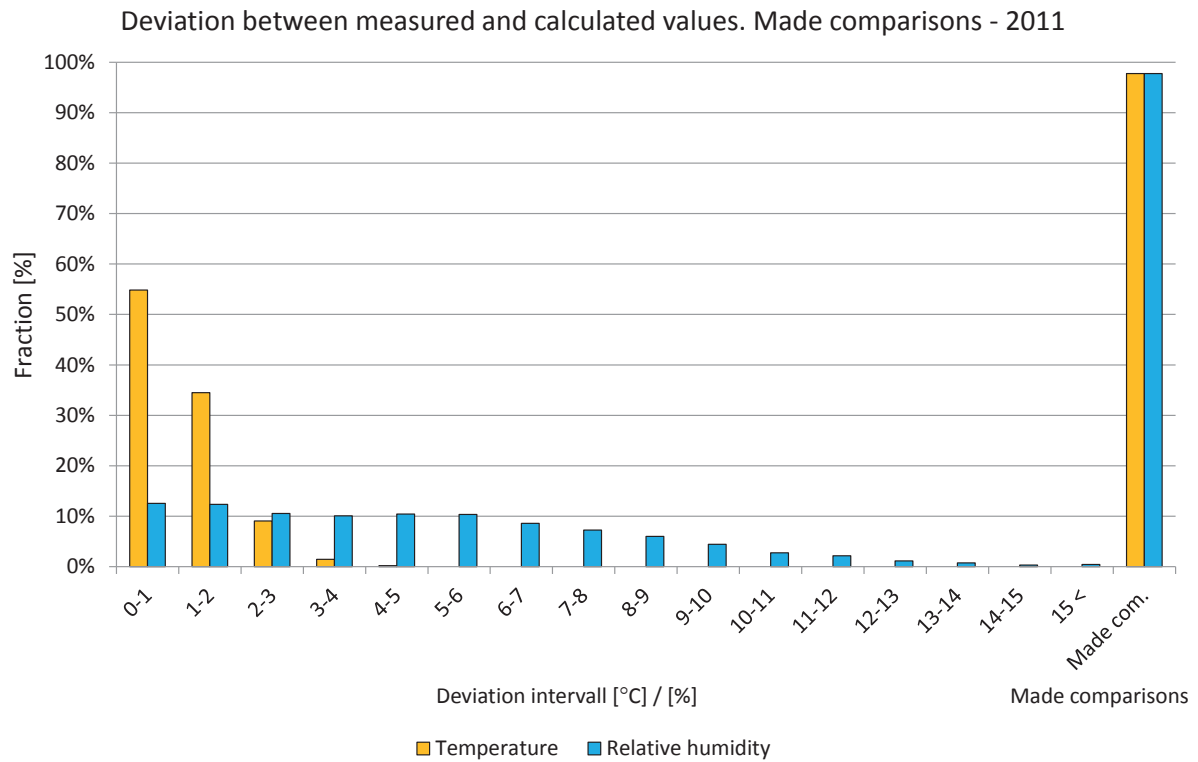

Figure 7.1.11. Deviations in comparisons shown in intervals from 0 to 15 °C or %. The two right-hand bars show the percentage of comparisons during the year. Temperature (yellow) and relative humidity (light blue).

7.2 Position 2n

The locations of the measured and calculated position are shown in the drawings and figures below. The studied position is located in a wall that is facing north on the sixth floor.

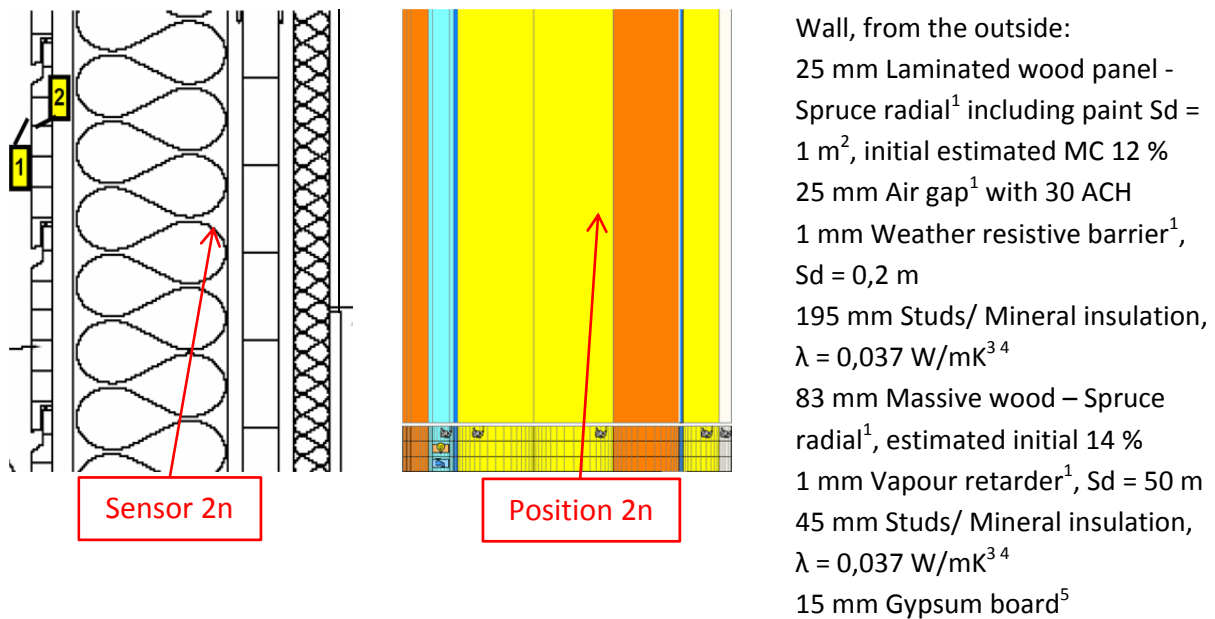

Figure 7.2.1. Vertical cross sectional drawing and WUFI calculation model showing the studied position. 1. IBP, 2012, 2. Nevander, L-E., 1994, 3. IEA Annex 24, 1996, 4. Paroc, 2002, 5. Krus, M., 1996.

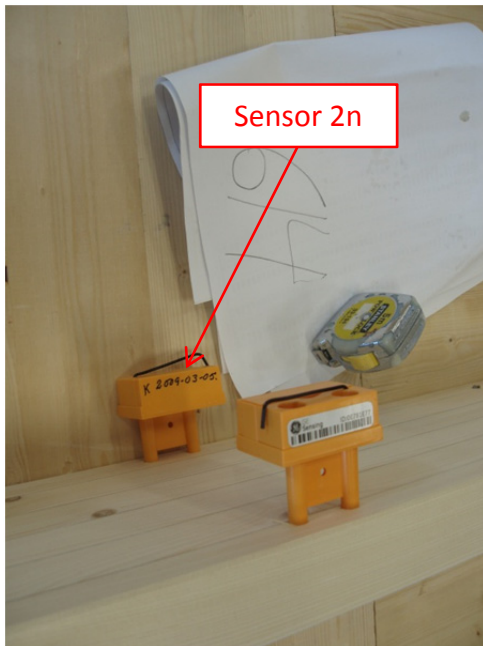

Figure 7.2.2. Location of the studied position. Photo: SP Trä Skellefteå.

A perfect match between the measured and calculated values cannot be expected due to e.g. the influence of two- and three-dimensional effects and the accuracy of the sensors.

Year 2009

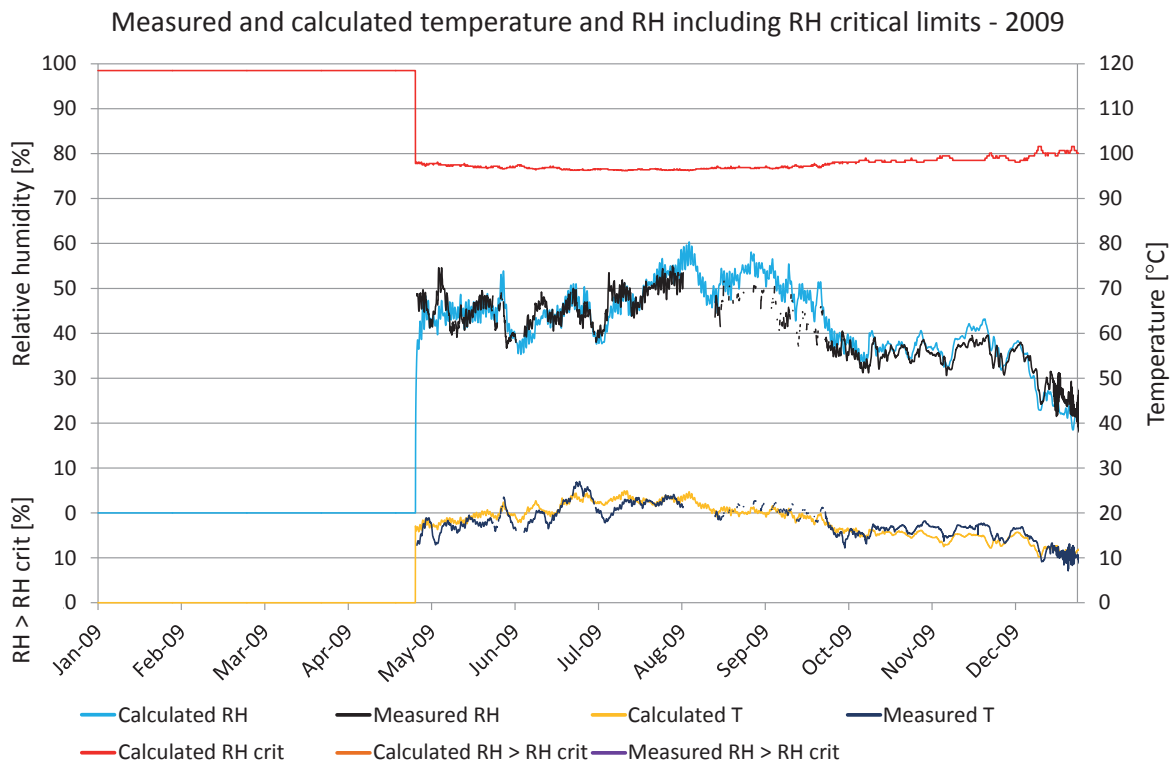

Figure 7.2.3. Comparisons between measured and calculated temperature and relative humidity. Calculated temperature (yellow), measured temperature (dark blue), calculated RH (turquoise), measured RH (black), RH_{crit} for calculated values (red), calculated $RH > RH_{crit}$ (light brown), measured $RH > RH_{crit}$ (purple).

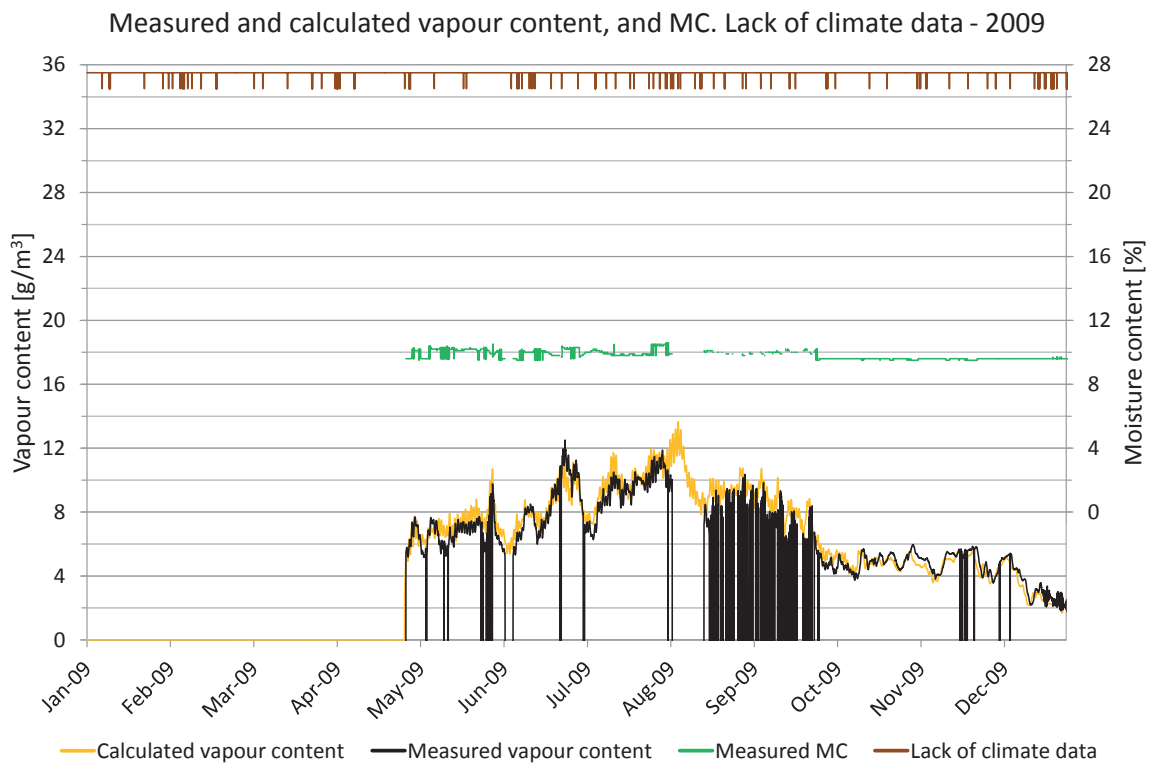

Figure 7.2.4. Measured moisture content, periods lacking climate data and comparisons of vapour content. Vapour content for calculated values (yellow) and measured values (black). Moisture content (green), periods with lack of climate data (brown).

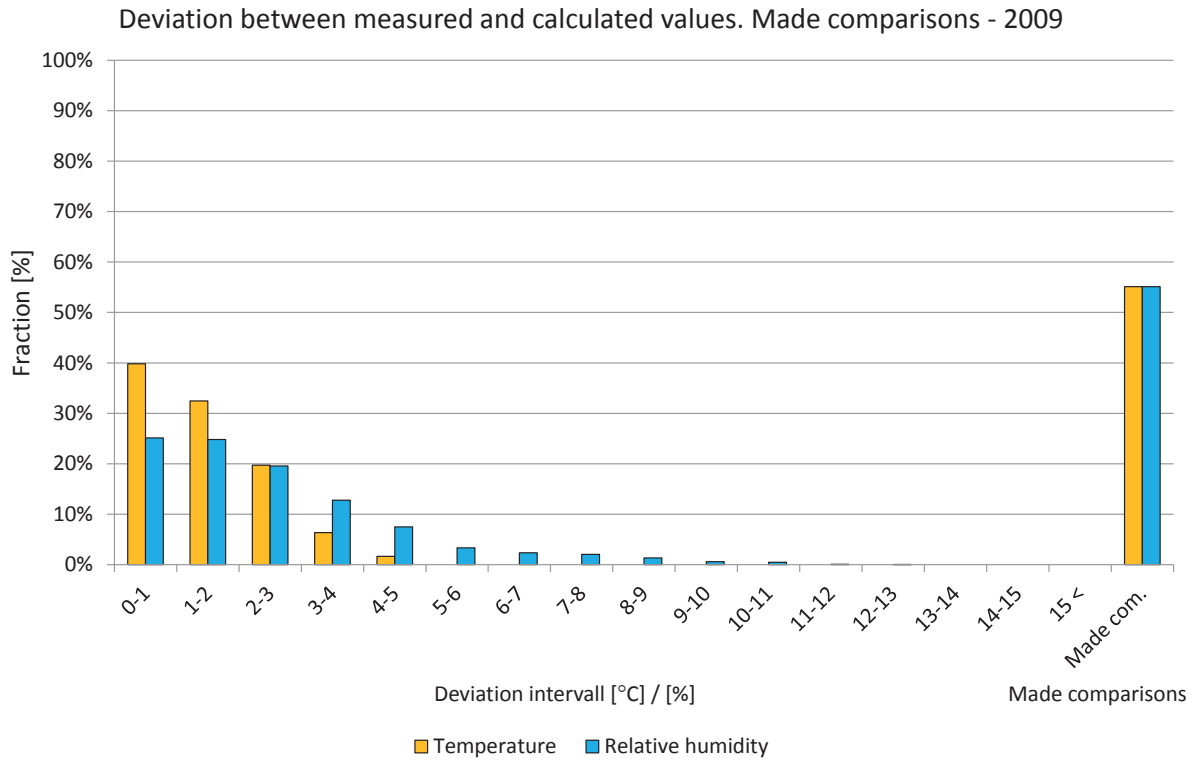

Figure 7.2.5. Deviations in comparisons shown in intervals from 0 to 15 °C or %. The two right-hand bars show the percentage of comparisons during the year. Temperature (yellow) and relative humidity (light blue).

Year 2010

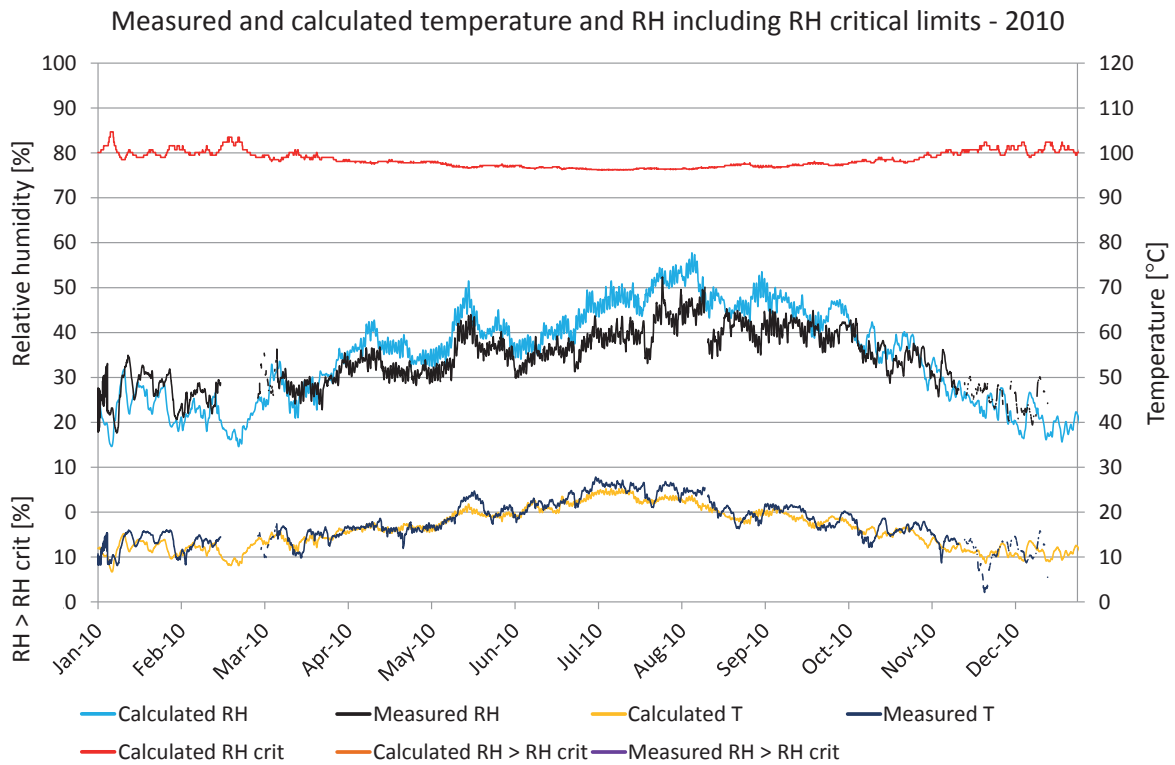

Figure 7.2.6. Comparisons between measured and calculated temperature and relative humidity. Calculated temperature (yellow), measured temperature (dark blue), calculated RH (turquoise), measured RH (black), RH_{crit} for calculated values (red), calculated $RH > RH_{crit}$ (light brown), measured $RH > RH_{crit}$ (purple).

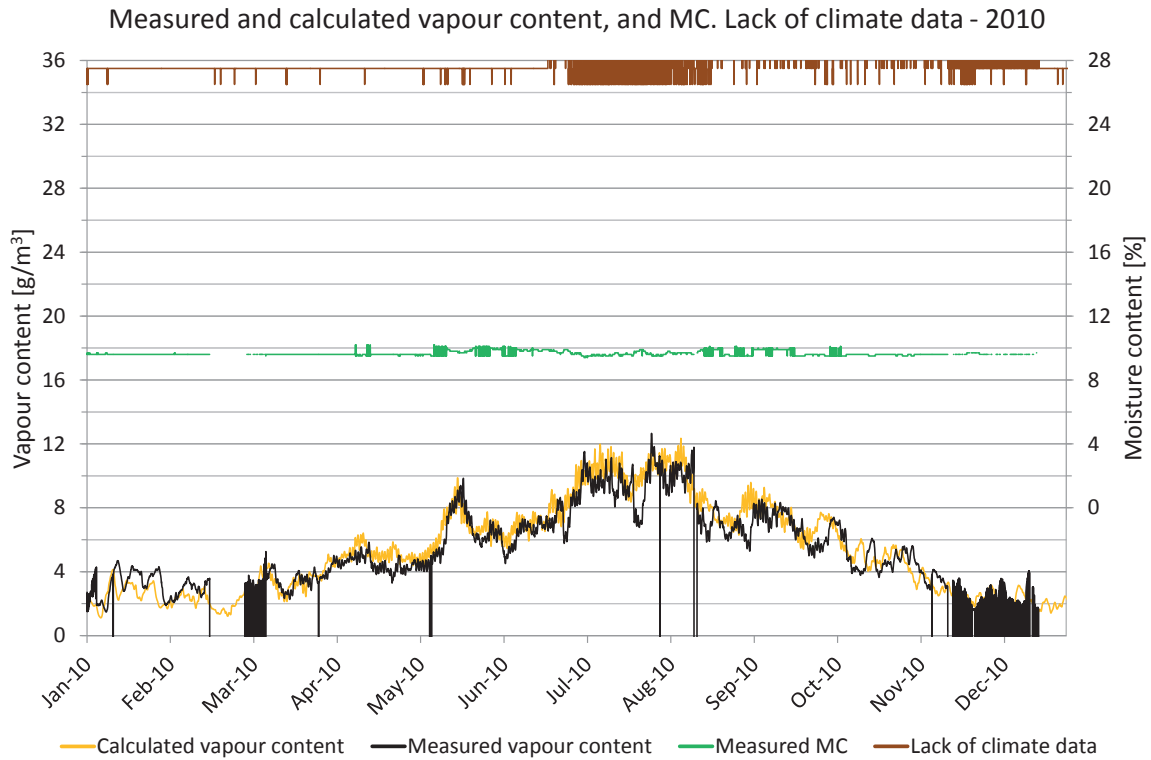

Figure 7.2.7. Measured moisture content, periods lacking climate data and comparisons of vapour content. Vapour content for calculated values (yellow) and measured values (black). Moisture content (green), periods with lack of climate data (brown).

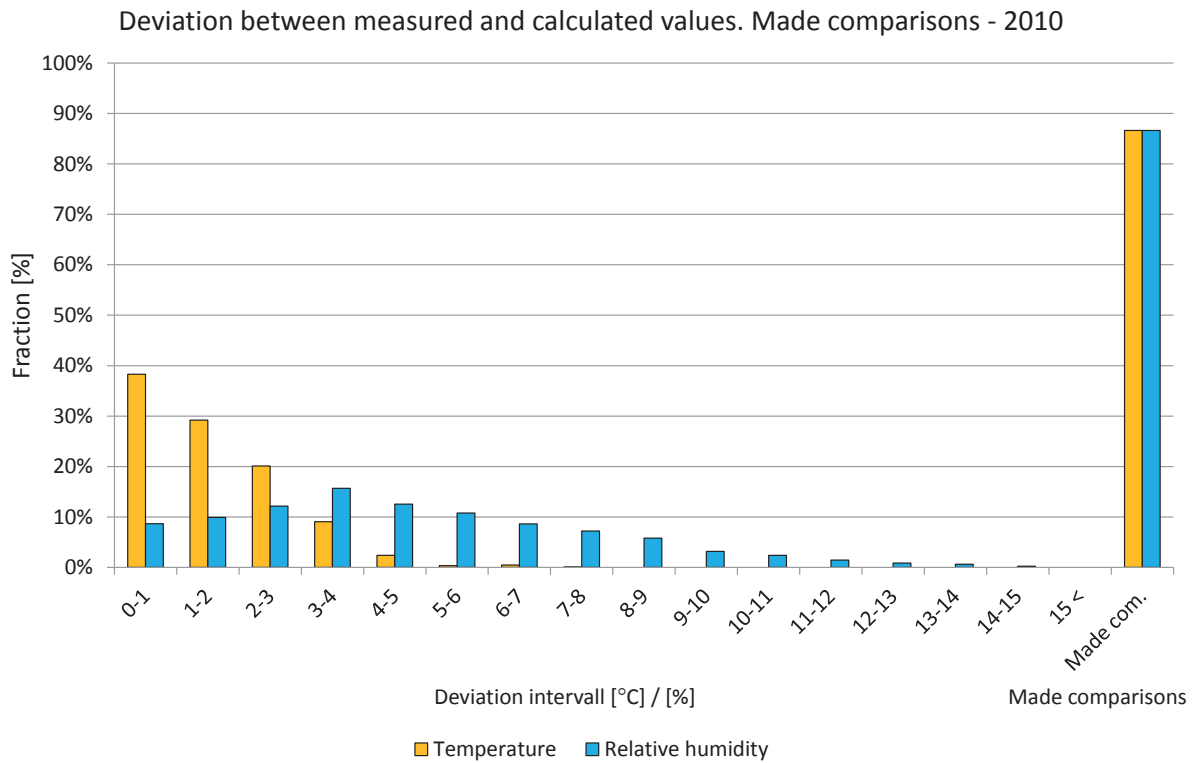

Figure 7.2.8. Deviations in comparisons shown in intervals from 0 to 15 °C or %. The two right-hand bars show the percentage of comparisons during the year. Temperature (yellow) and relative humidity (light blue).

Year 2011

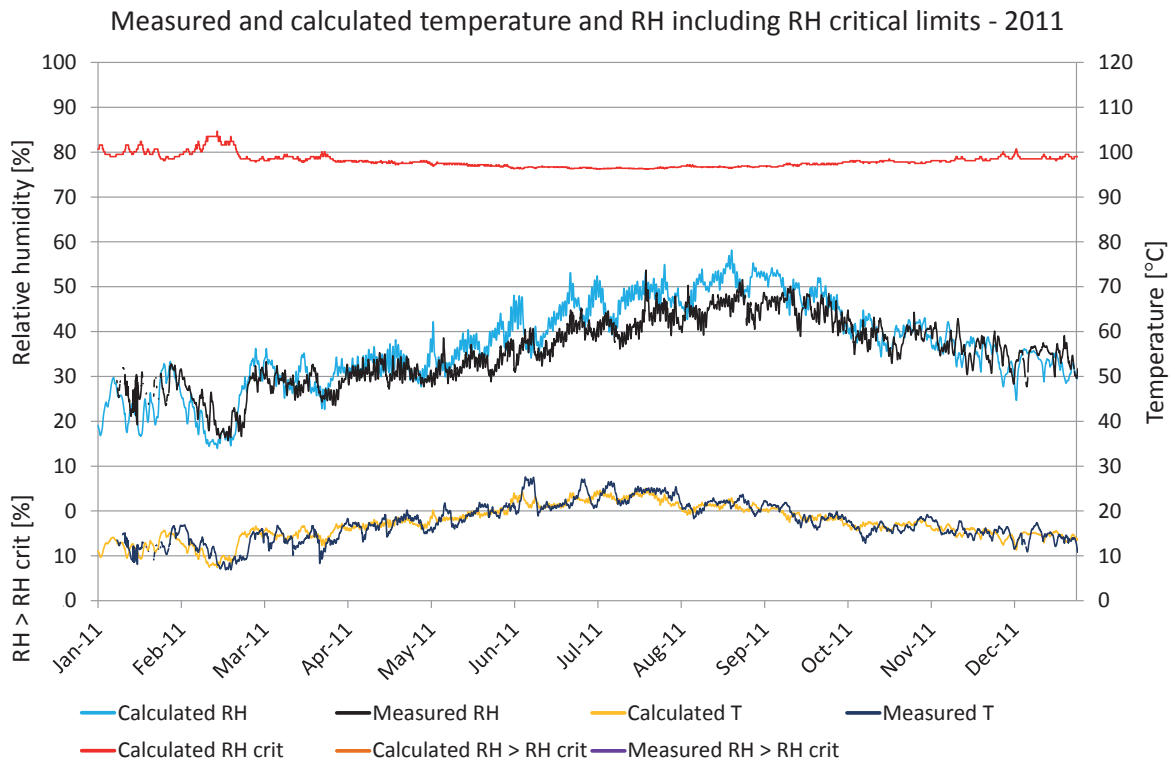

Figure 7.2.9. Comparisons between measured and calculated temperature and relative humidity. Calculated temperature (yellow), measured temperature (dark blue), calculated RH (turquoise), measured RH (black), RH_{crit} for calculated values (red), calculated $RH > RH_{crit}$ (light brown), measured $RH > RH_{crit}$ (purple).

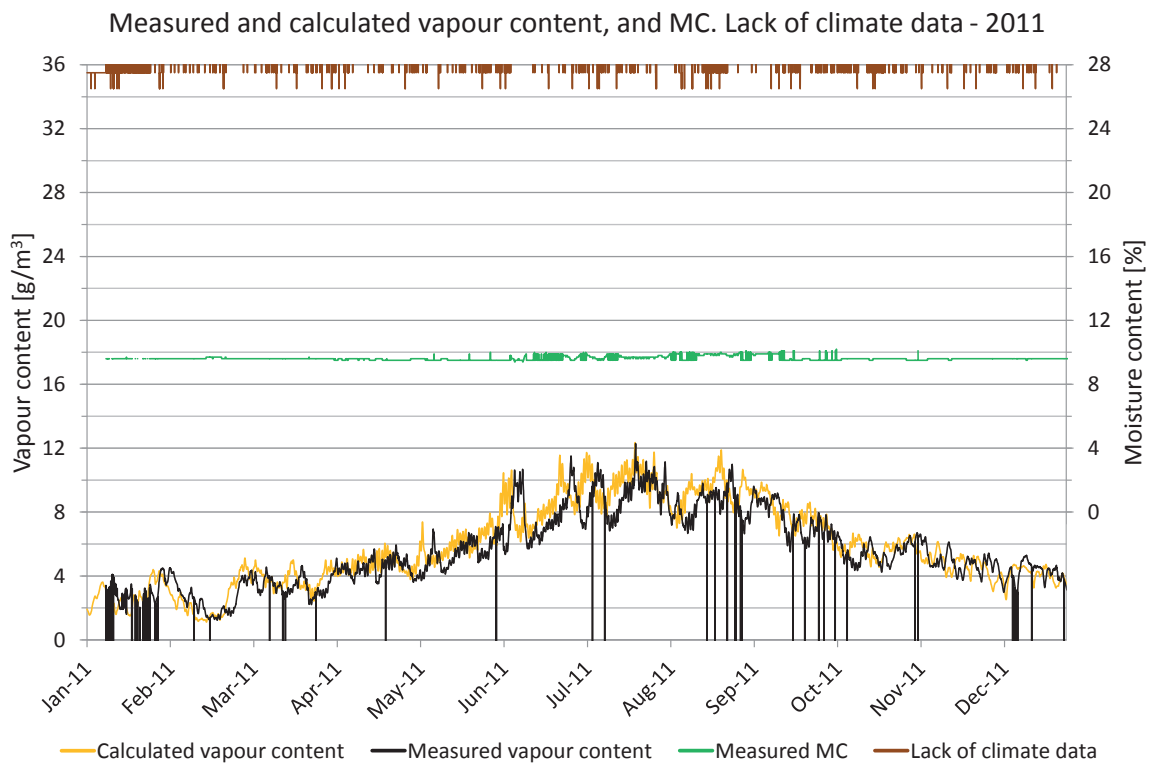

Figure 7.2.10. Measured moisture content, periods lacking climate data and comparisons of vapour content. Vapour content for calculated values (yellow) and measured values (black). Moisture content (green), periods with lack of climate data (brown).

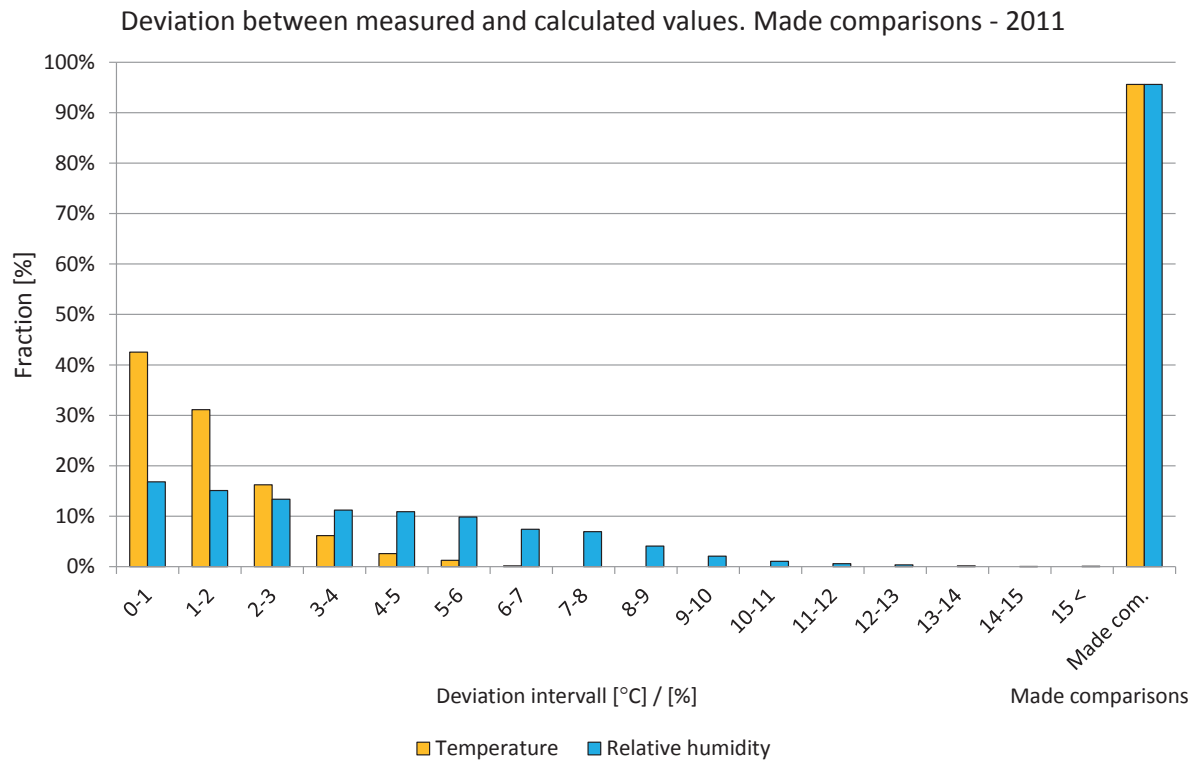

Figure 7.2.11. Deviations in comparisons shown in intervals from 0 to 15 °C or %. The two right-hand bars show the percentage of comparisons during the year. Temperature (yellow) and relative humidity (light blue).

7.3 Position 3n

The locations of the measured and calculated position are shown in the drawings and figures below. The studied position is located in a wall that is facing north on the sixth floor.

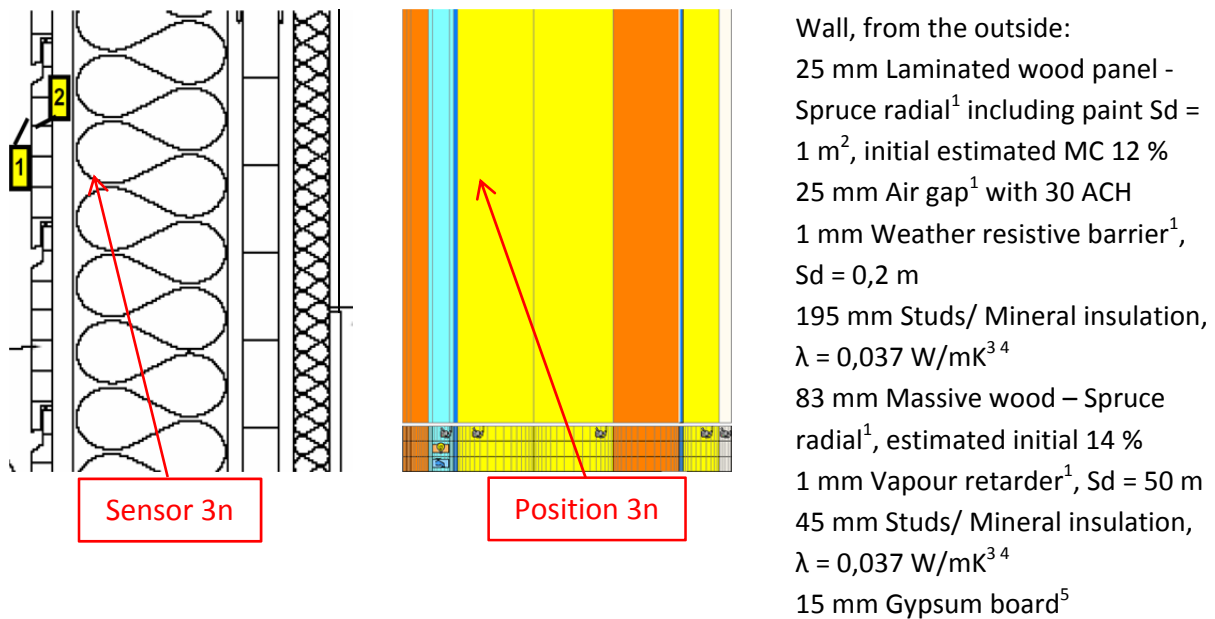

Figure 7.3.1. Vertical cross sectional drawing and WUFI calculation model showing the studied position. 1. IBP, 2012, 2. Nevander, L-E., 1994, 3. IEA Annex 24, 1996, 4. Paroc, 2002, 5. Krus, M., 1996.

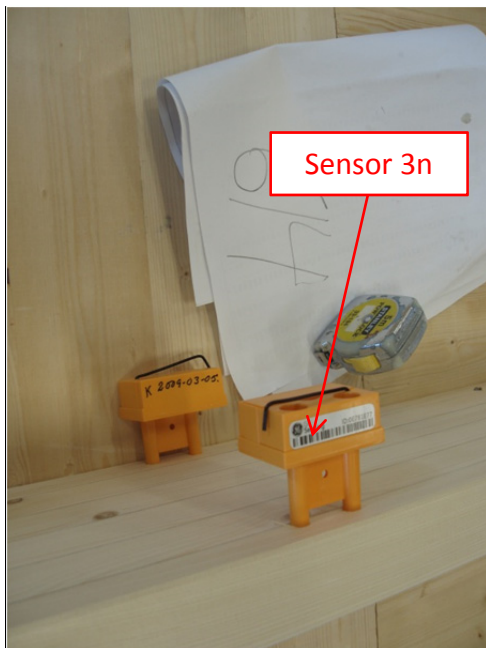

Figure 7.3.2. Location of the studied position. Photo: SP Trä Skellefteå.

A perfect match between the measured and calculated values cannot be expected due to e.g. the influence of two- and three-dimensional effects and the accuracy of the sensors.

Year 2009

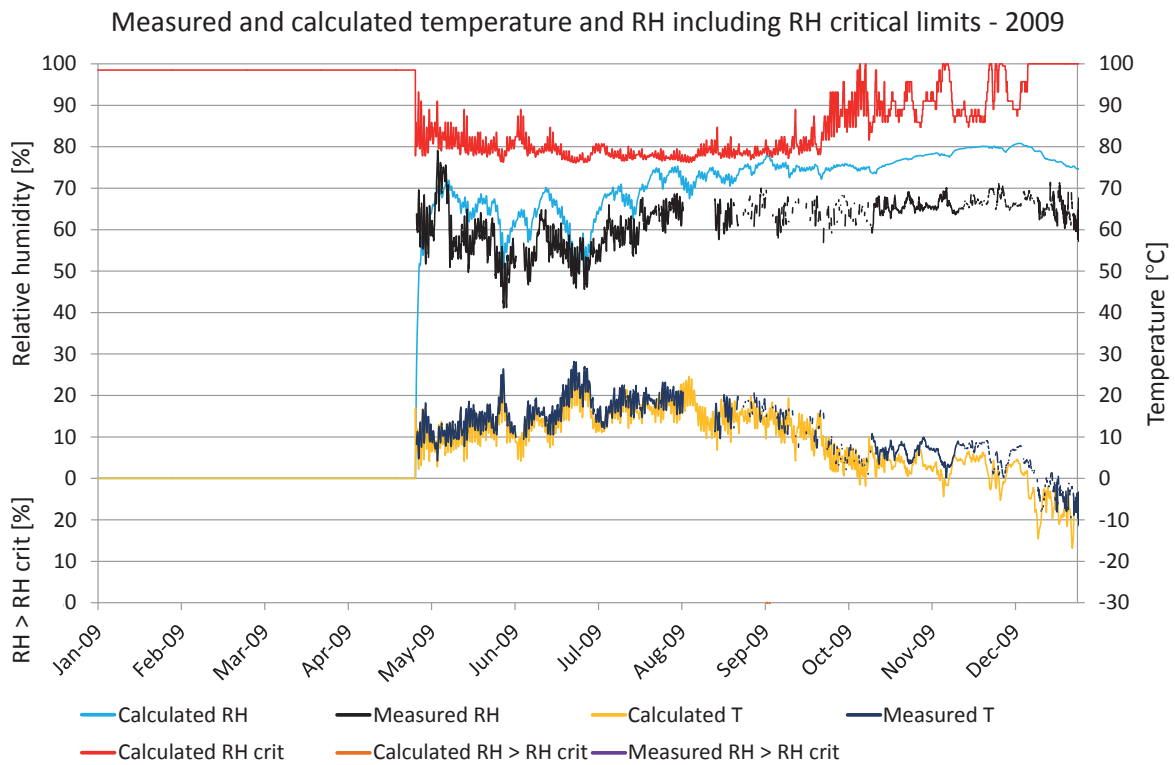

Figure 7.3.3. Comparisons between measured and calculated temperature and relative humidity. Calculated temperature (yellow), measured temperature (dark blue), calculated RH (turquoise), measured RH (black), RH_{crit} for calculated values (red), calculated $RH > RH_{crit}$ (light brown), measured $RH > RH_{crit}$ (purple).

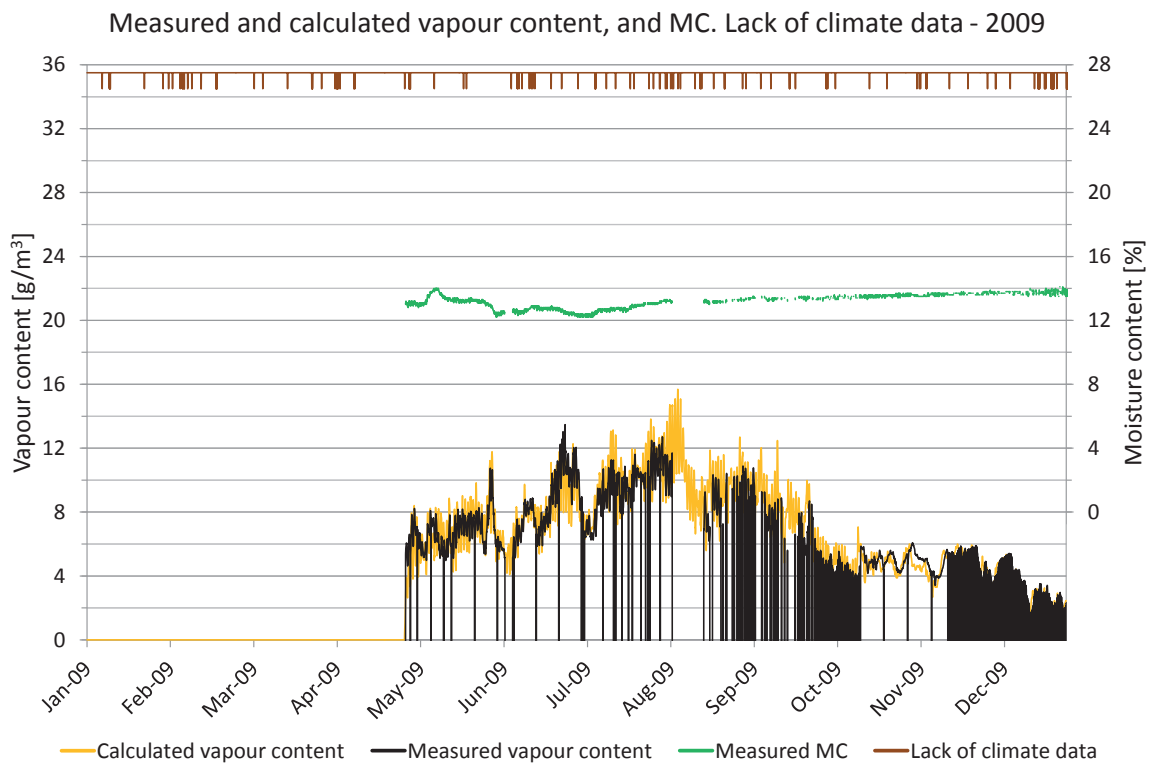

Figure 7.3.4. Measured moisture content, periods lacking climate data and comparisons of vapour content. Vapour content for calculated values (yellow) and measured values (black). Moisture content (green), periods with lack of climate data (brown).

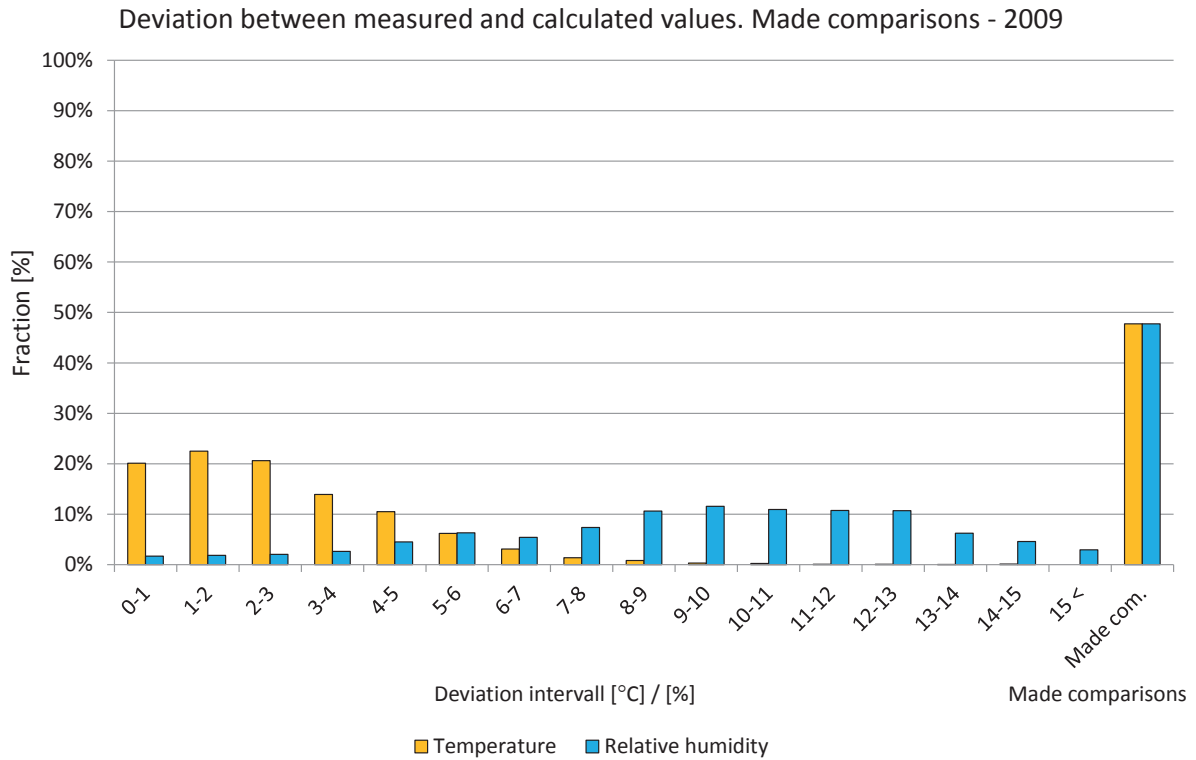

Figure 7.3.5. Deviations in comparisons shown in intervals from 0 to 15 °C or %. The two right-hand bars show the percentage of comparisons during the year. Temperature (yellow) and relative humidity (light blue).

Year 2010

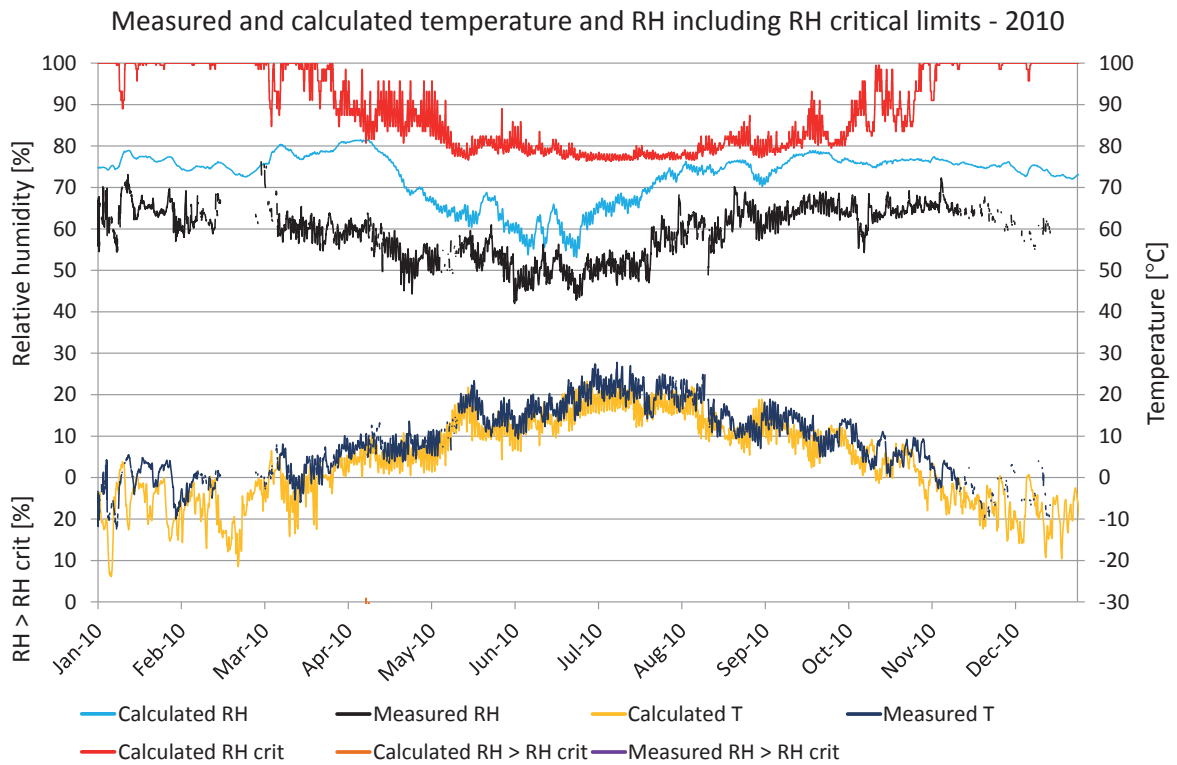

Figure 7.3.6. Comparisons between measured and calculated temperature and relative humidity. Calculated temperature (yellow), measured temperature (dark blue), calculated RH (turquoise), measured RH (black), RH_{crit} for calculated values (red), calculated $RH > RH_{crit}$ (light brown), measured $RH > RH_{crit}$ (purple).

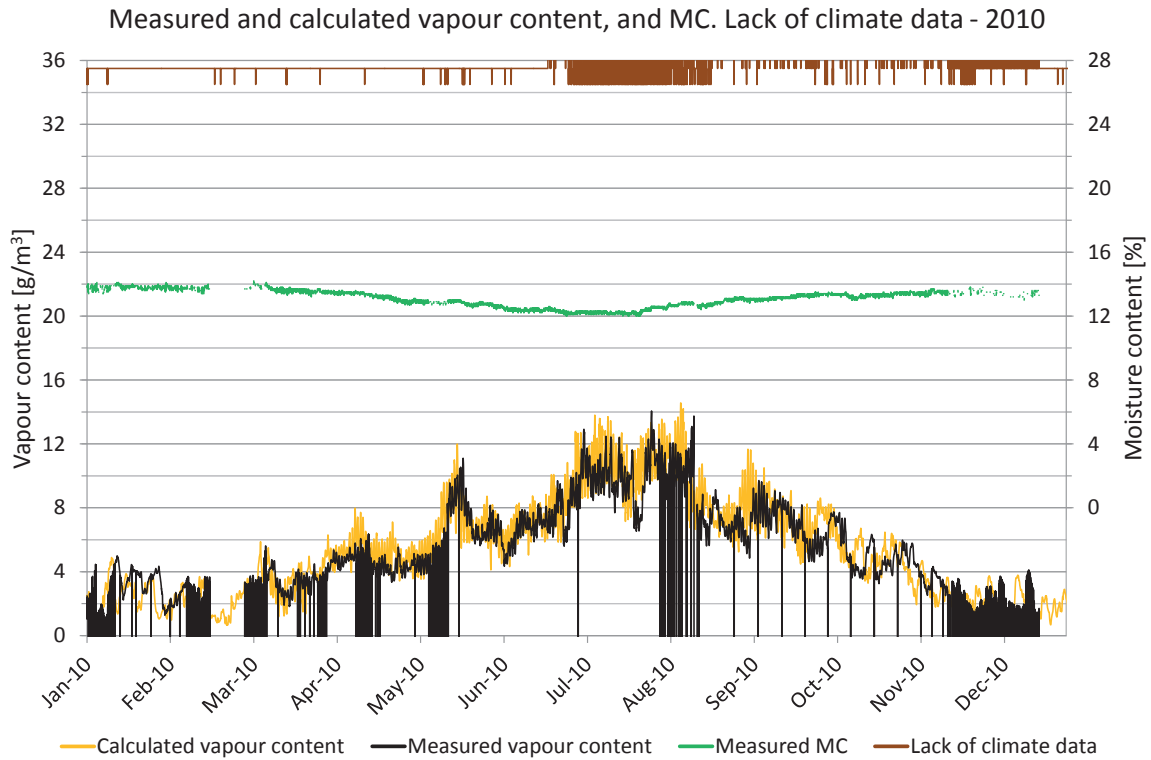

Figure 7.3.7. Measured moisture content, periods lacking climate data and comparisons of vapour content. Vapour content for calculated values (yellow) and measured values (black). Moisture content (green), periods with lack of climate data (brown).

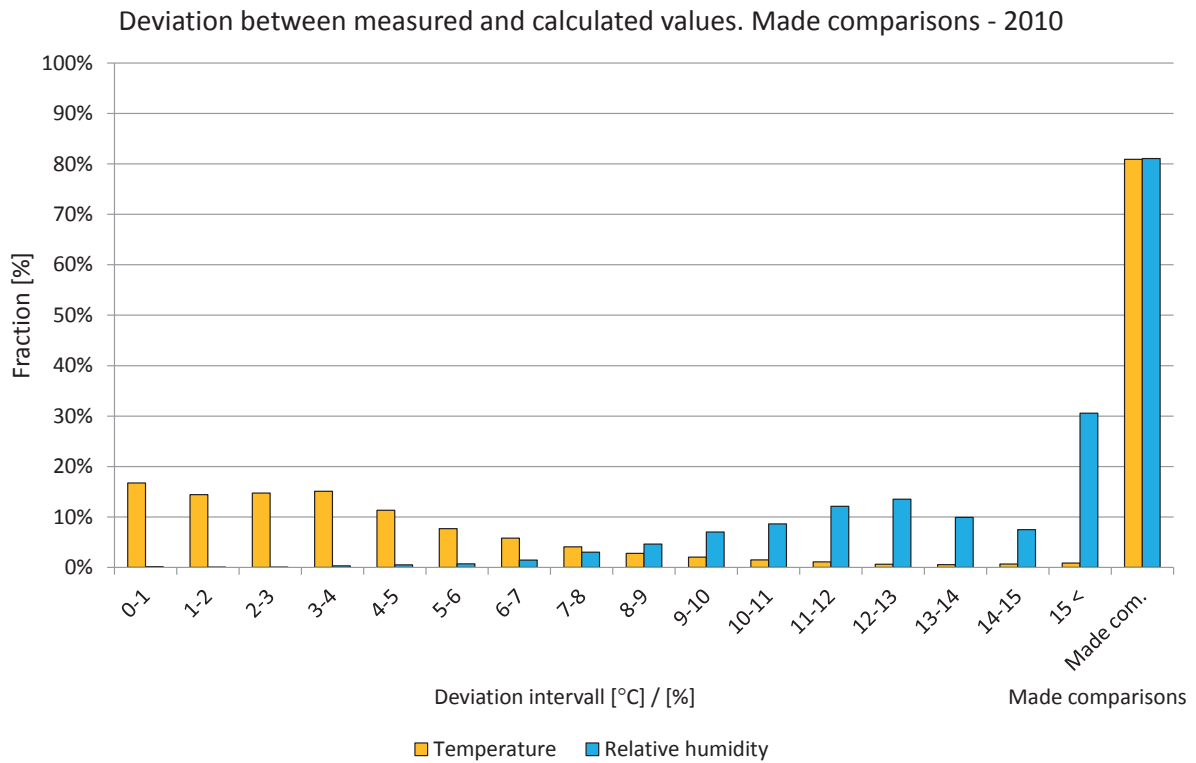

Figure 7.3.8. Deviations in comparisons shown in intervals from 0 to 15 °C or %. The two right-hand bars show the percentage of comparisons during the year. Temperature (yellow) and relative humidity (light blue).

Year 2011

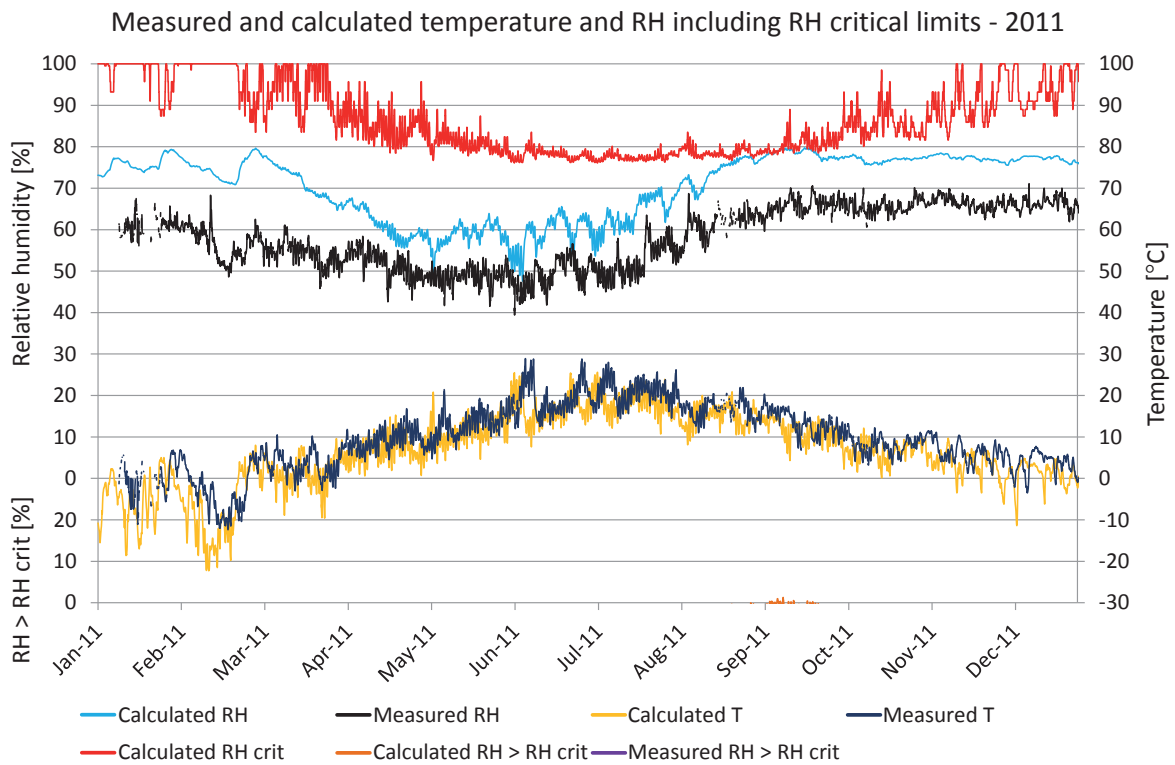

Figure 7.3.9. Comparisons between measured and calculated temperature and relative humidity. Calculated temperature (yellow), measured temperature (dark blue), calculated RH (turquoise), measured RH (black), RH_{crit} for calculated values (red), calculated $RH > RH_{crit}$ (light brown), measured $RH > RH_{crit}$ (purple).

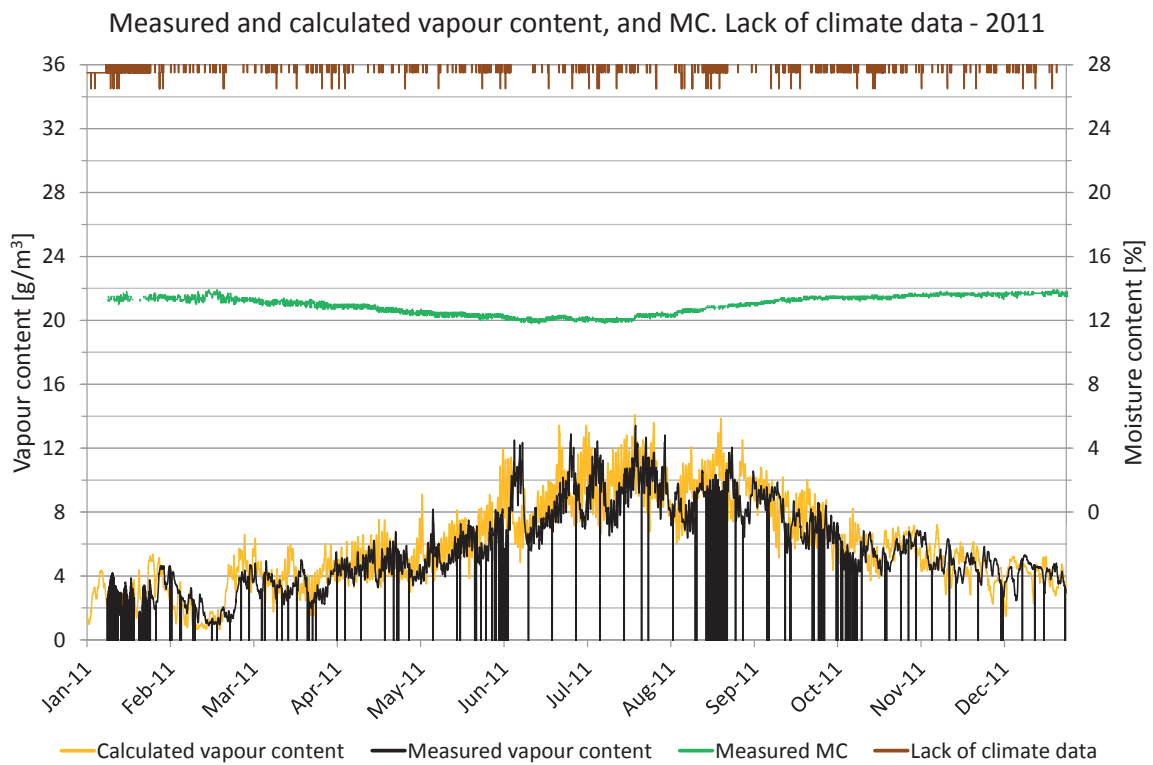

Figure 7.3.10. Measured moisture content, periods lacking climate data and comparisons of vapour content. Vapour content for calculated values (yellow) and measured values (black). Moisture content (green), periods with lack of climate data (brown).

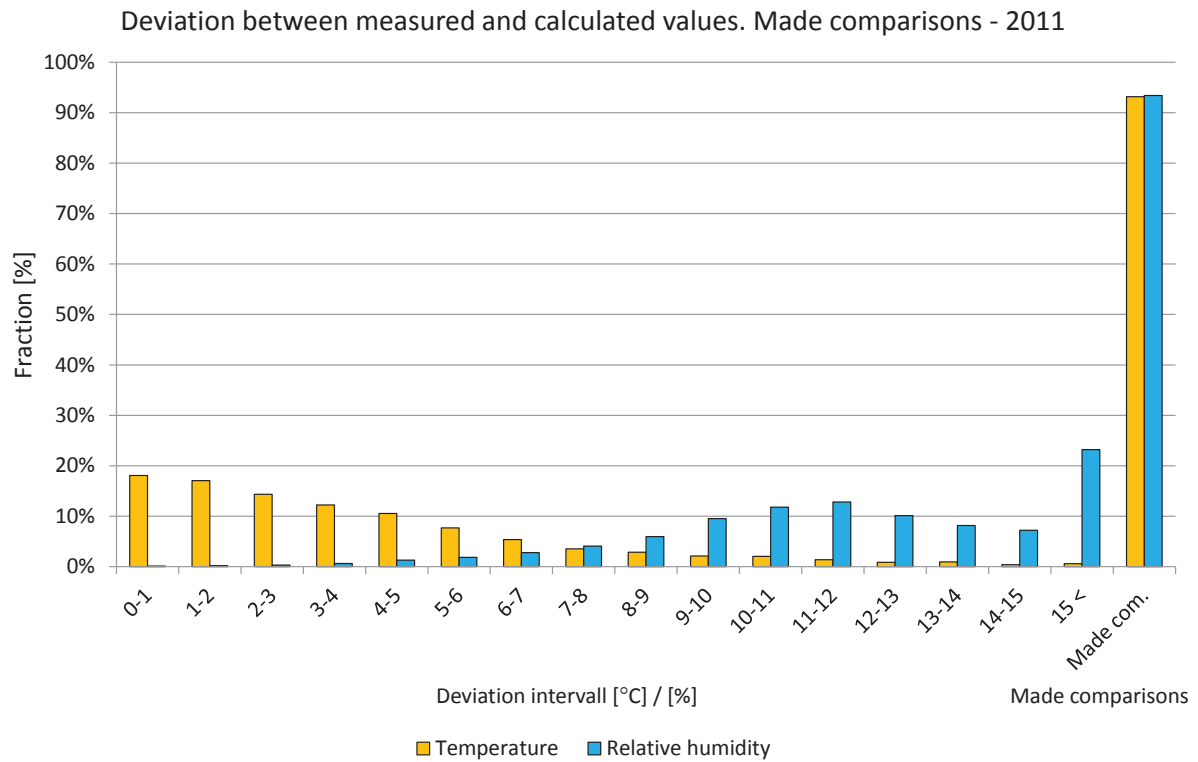

Figure 7.3.11. Deviations in comparisons shown in intervals from 0 to 15 °C or %. The two right-hand bars show the percentage of comparisons during the year. Temperature (yellow) and relative humidity (light blue).

7.4 Position 4ö

The locations of the measured and calculated position are shown in the drawings and figures below. The studied position is located in a wall that is facing east on the fifth floor.

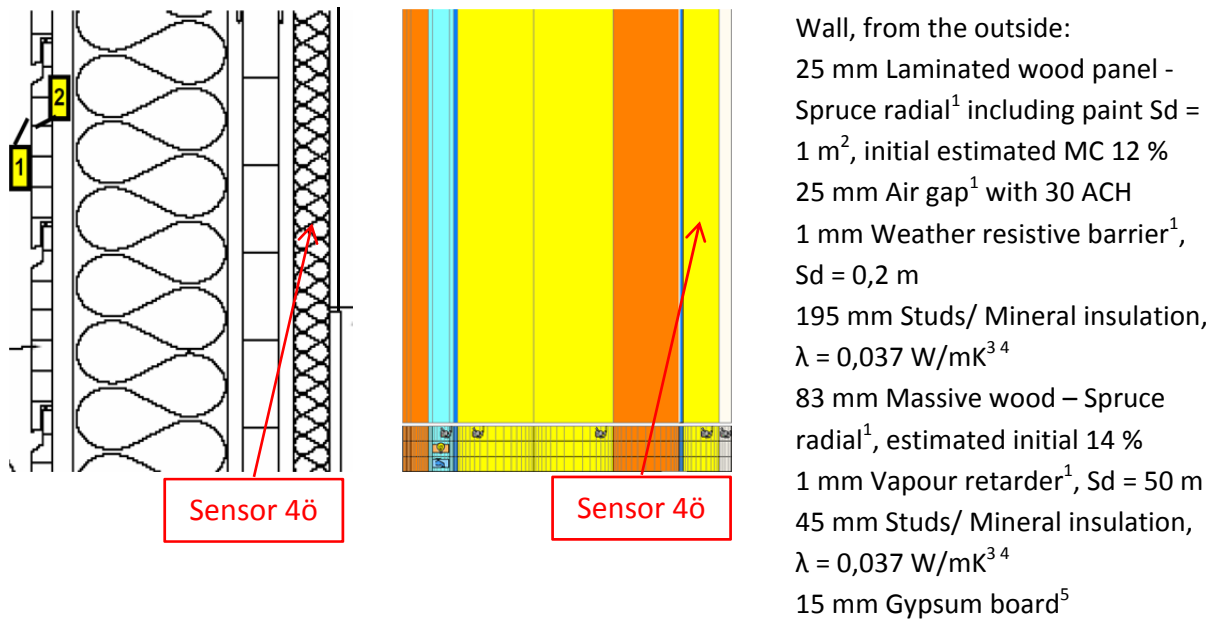

Figure 7.4.1. Vertical cross sectional drawing and WUFI calculation model showing the studied position. 1. IBP, 2012, 2. Nevander, L-E., 1994, 3. IEA Annex 24, 1996, 4. Paroc, 2002, 5. Krus, M., 1996.

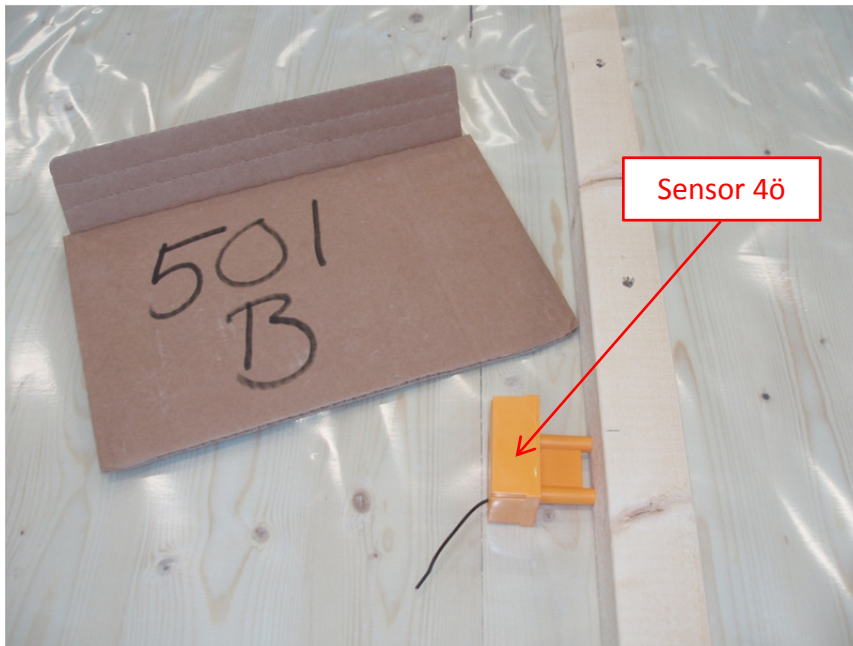

Figure 7.4.2. Location of the studied position. Photo: SP Trä Skellefteå.

A perfect match between the measured and calculated values cannot be expected due to e.g. the influence of two- and three-dimensional effects and the accuracy of the sensors.

Year 2009

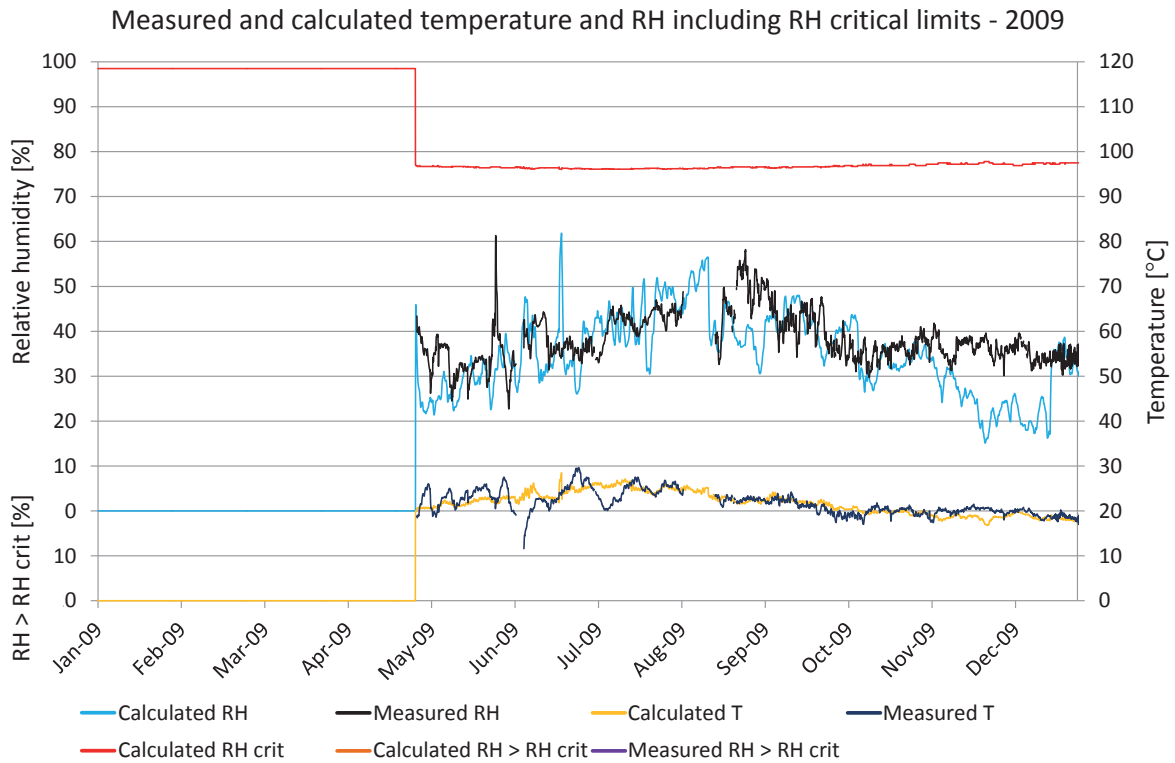

Figure 7.4.3. Comparisons between measured and calculated temperature and relative humidity. Calculated temperature (yellow), measured temperature (dark blue), calculated RH (turquoise), measured RH (black), RH_{crit} for calculated values (red), calculated $RH > RH_{crit}$ (light brown), measured $RH > RH_{crit}$ (purple).

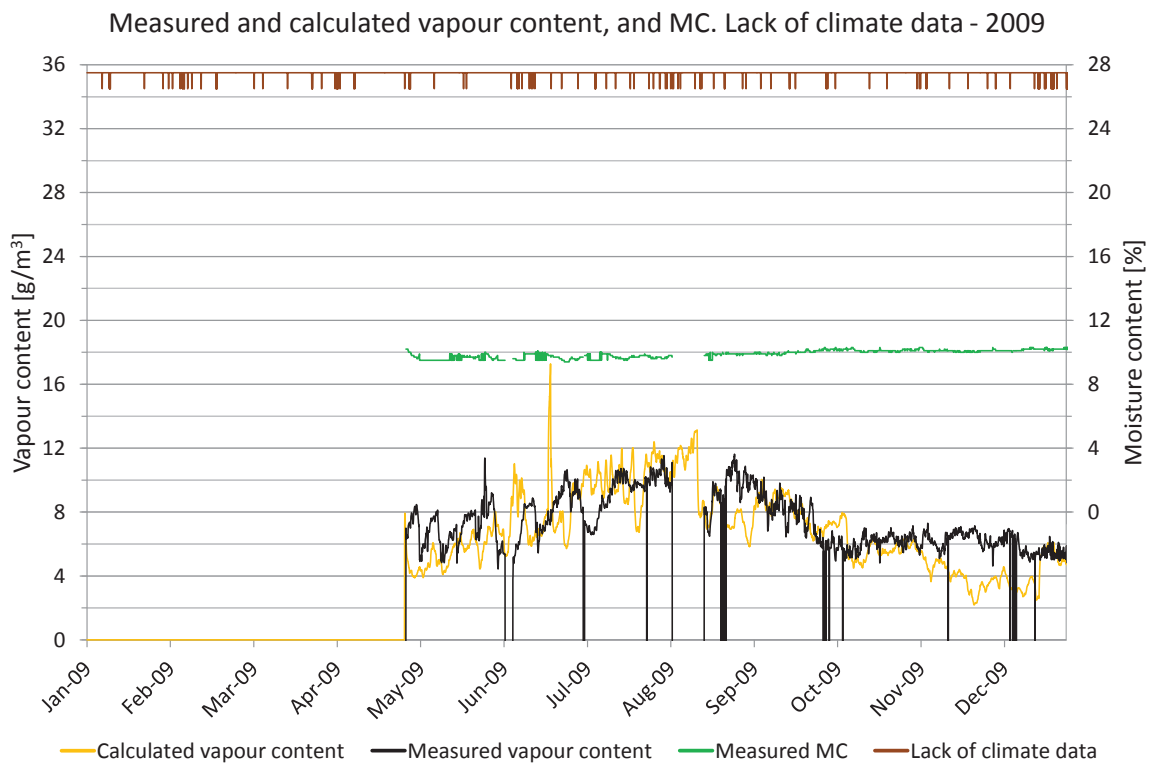

Figure 7.4.4. Measured moisture content, periods lacking climate data and comparisons of vapour content. Vapour content for calculated values (yellow) and measured values (black). Moisture content (green), periods with lack of climate data (brown).

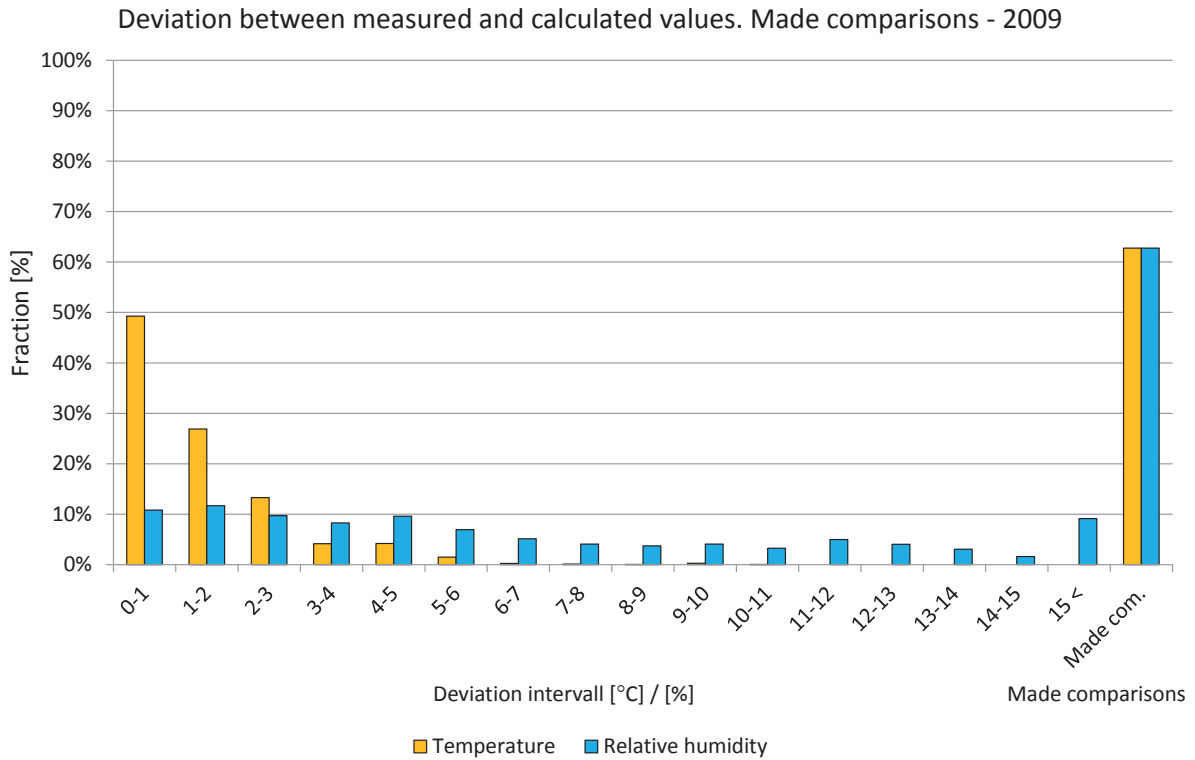

Figure 7.4.5. Deviations in comparisons shown in intervals from 0 to 15 °C or %. The two right-hand bars show the percentage of comparisons during the year. Temperature (yellow) and relative humidity (light blue).

Year 2010

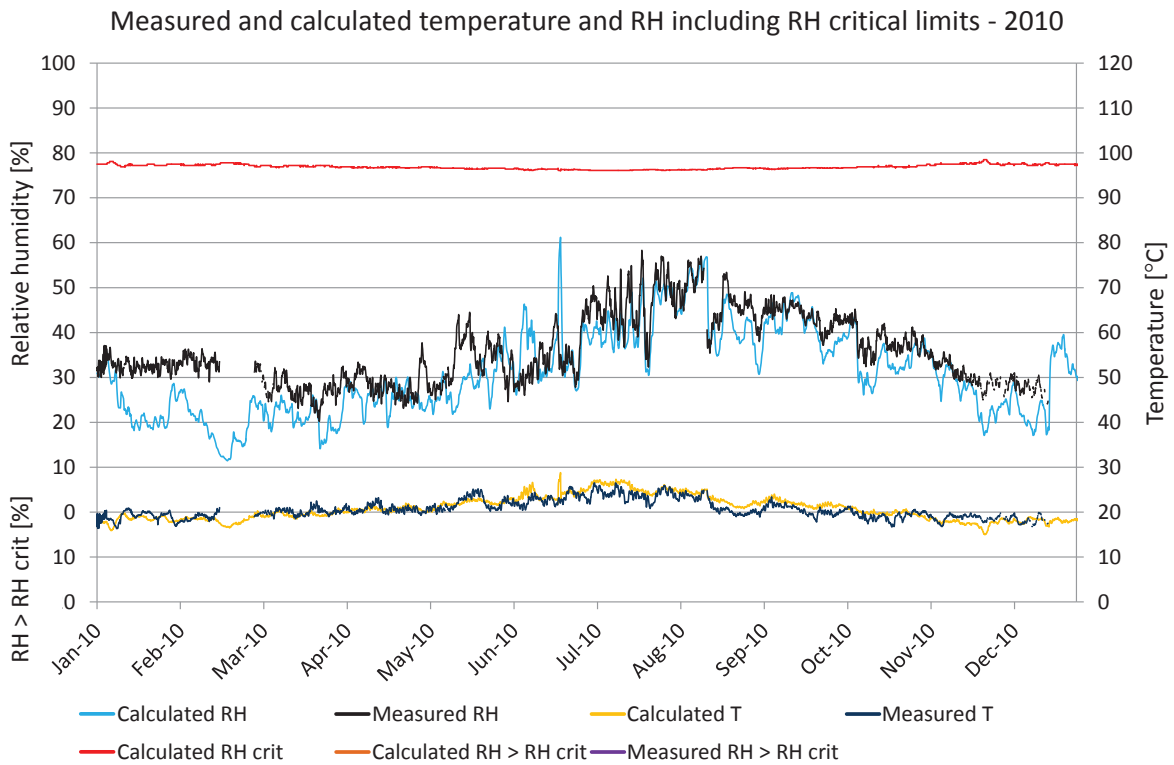

Figure 7.4.6. Comparisons between measured and calculated temperature and relative humidity. Calculated temperature (yellow), measured temperature (dark blue), calculated RH (turquoise), measured RH (black), RH_{crit} for calculated values (red), calculated RH > RH_{crit} (light brown), measured RH > RH_{crit} (purple).

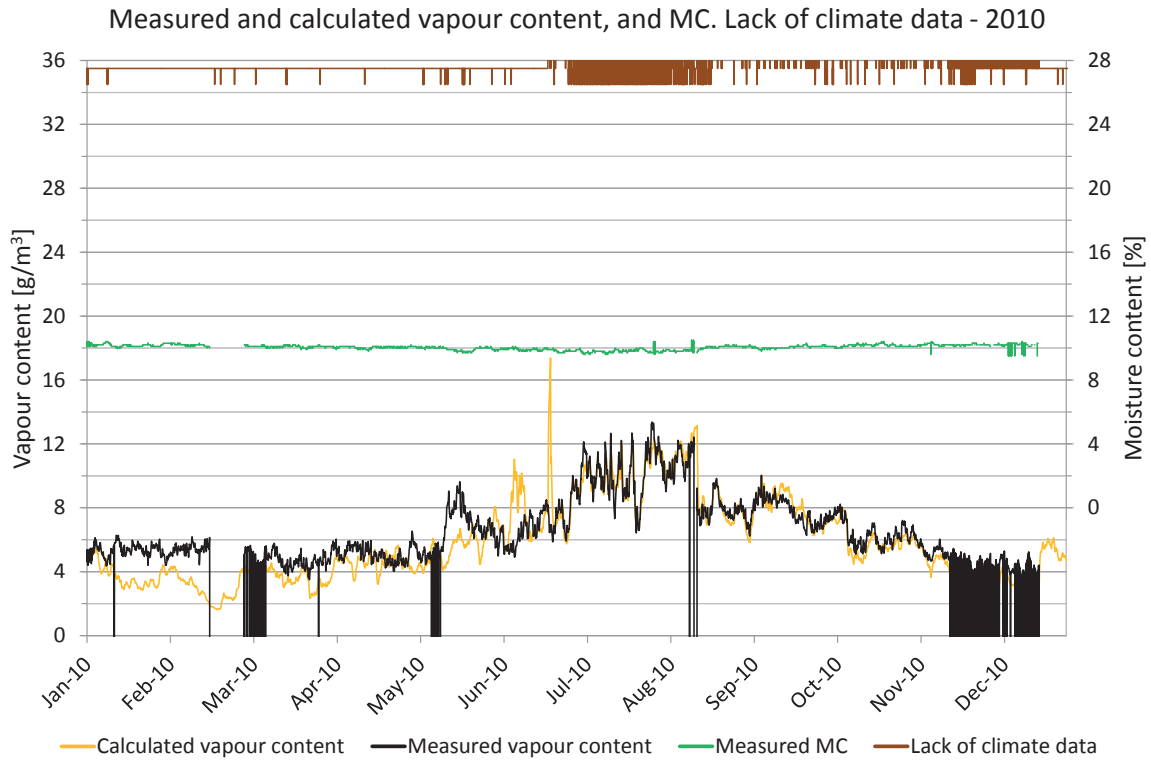

Figure 7.4.7. Measured moisture content, periods lacking climate data and comparisons of vapour content. Vapour content for calculated values (yellow) and measured values (black). Moisture content (green), periods with lack of climate data (brown).

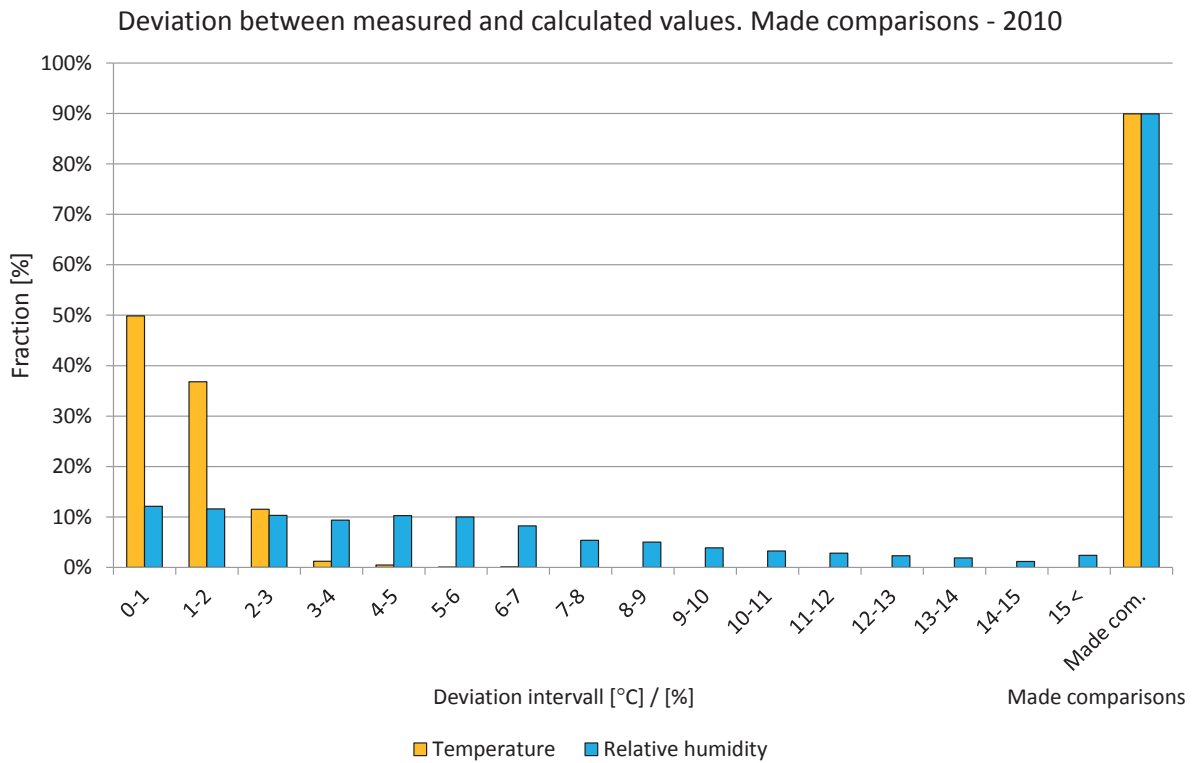

Figure 7.4.8. Deviations in comparisons shown in intervals from 0 to 15 °C or %. The two right-hand bars show the percentage of comparisons during the year. Temperature (yellow) and relative humidity (light blue).

Year 2011

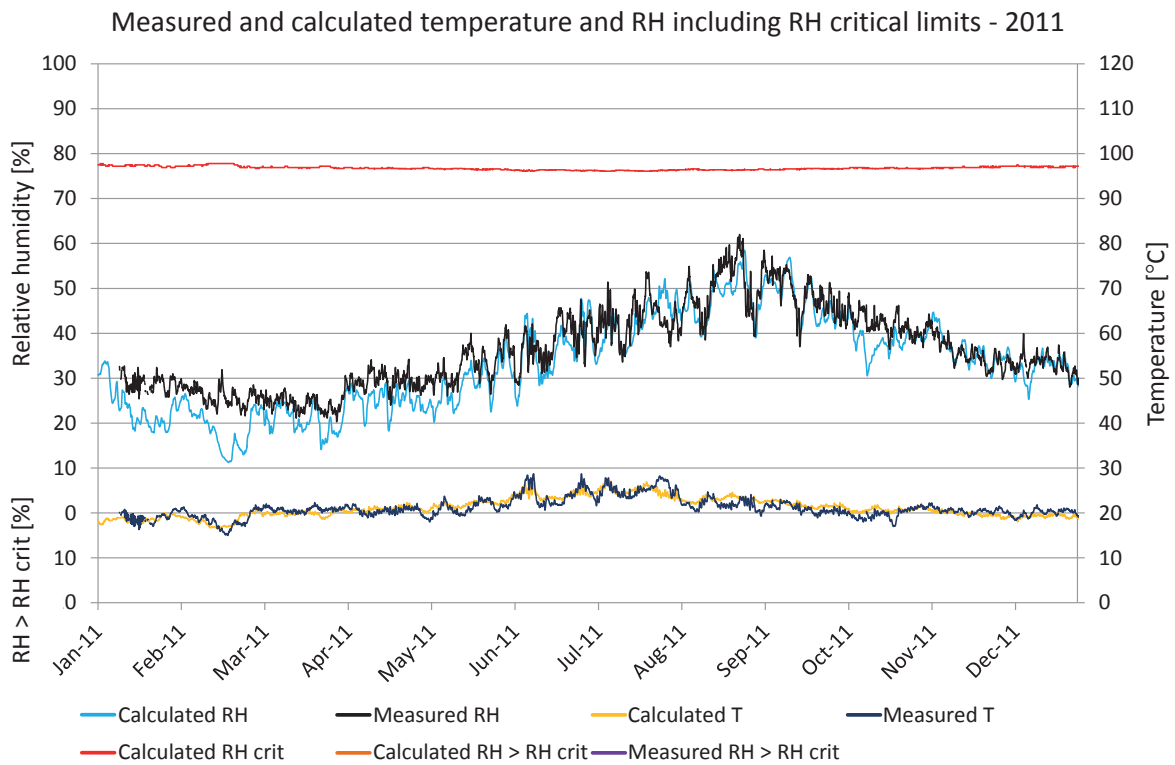

Figure 7.4.9. Comparisons between measured and calculated temperature and relative humidity. Calculated temperature (yellow), measured temperature (dark blue), calculated RH (turquoise), measured RH (black), RH_{crit} for calculated values (red), calculated $RH > RH_{crit}$ (light brown), measured $RH > RH_{crit}$ (purple).

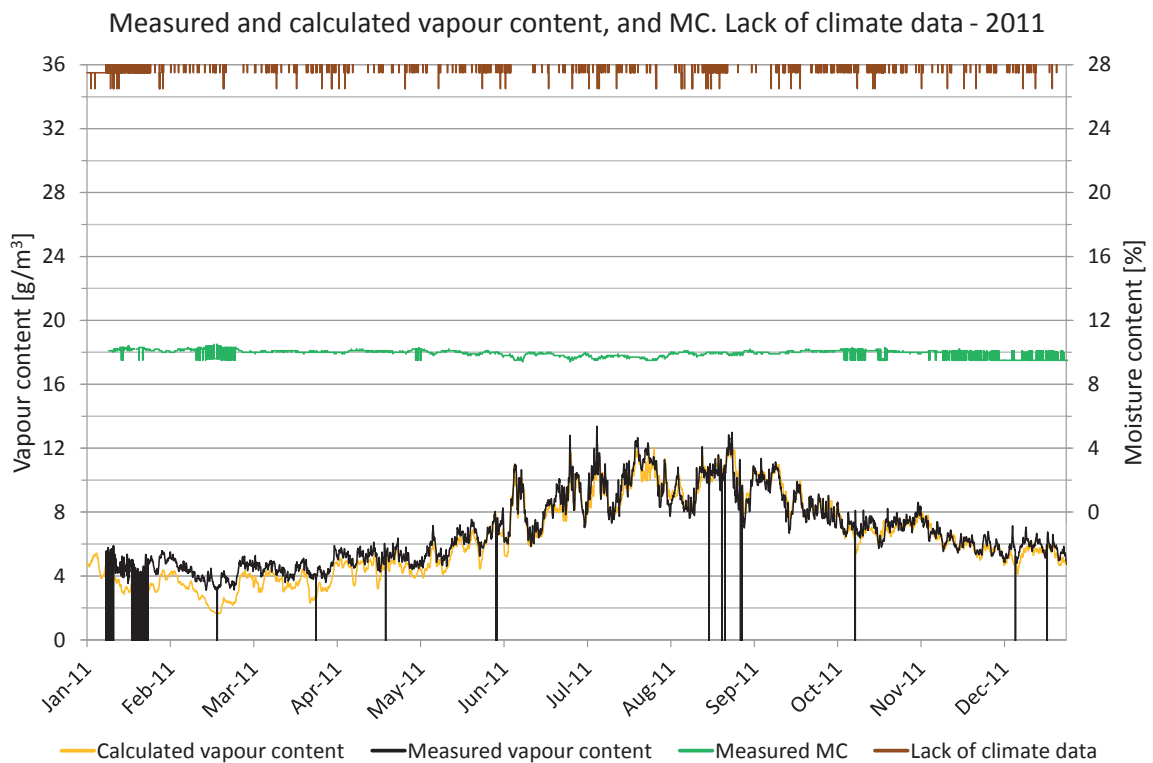

Figure 7.4.10. Measured moisture content, periods lacking climate data and comparisons of vapour content. Vapour content for calculated values (yellow) and measured values (black). Moisture content (green), periods with lack of climate data (brown).

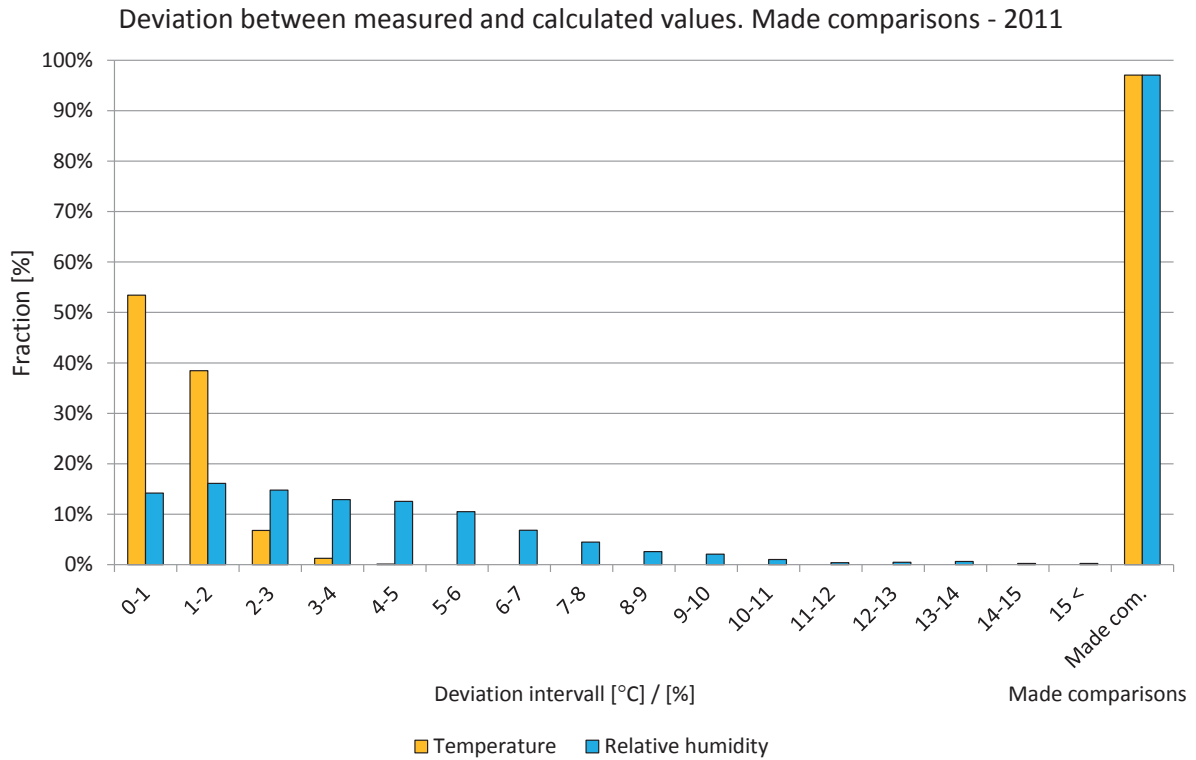

Figure 7.4.11. Deviations in comparisons shown in intervals from 0 to 15 °C or %. The two right-hand bars show the percentage of comparisons during the year. Temperature (yellow) and relative humidity (light blue).

7.5 Position 5ö

The locations of the measured and calculated position are shown in the drawings and figures below. The studied position is located in a wall that is facing east on the fifth floor.

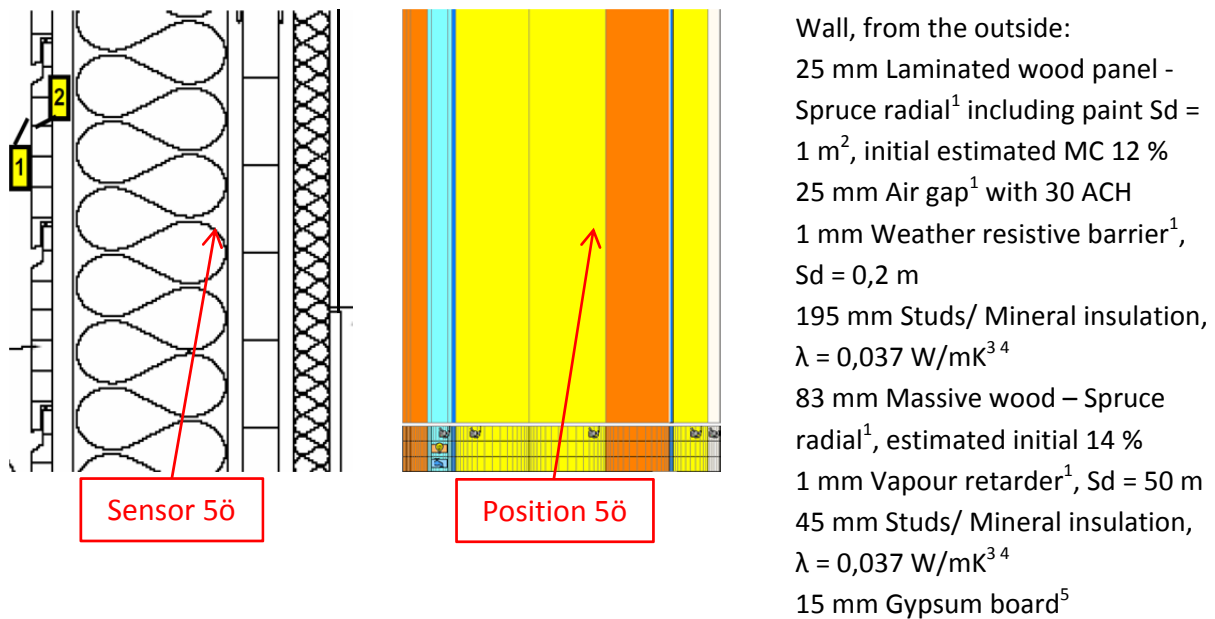

Figure 7.5.1. Vertical cross sectional drawing and WUFI calculation model showing the studied position. 1. IBP, 2012, 2. Nevander, L-E., 1994, 3. IEA Annex 24, 1996, 4. Paroc, 2002, 5. Krus, M., 1996.

A perfect match between the measured and calculated values cannot be expected due to e.g. the influence of two- and three-dimensional effects and the accuracy of the sensors.

Year 2009

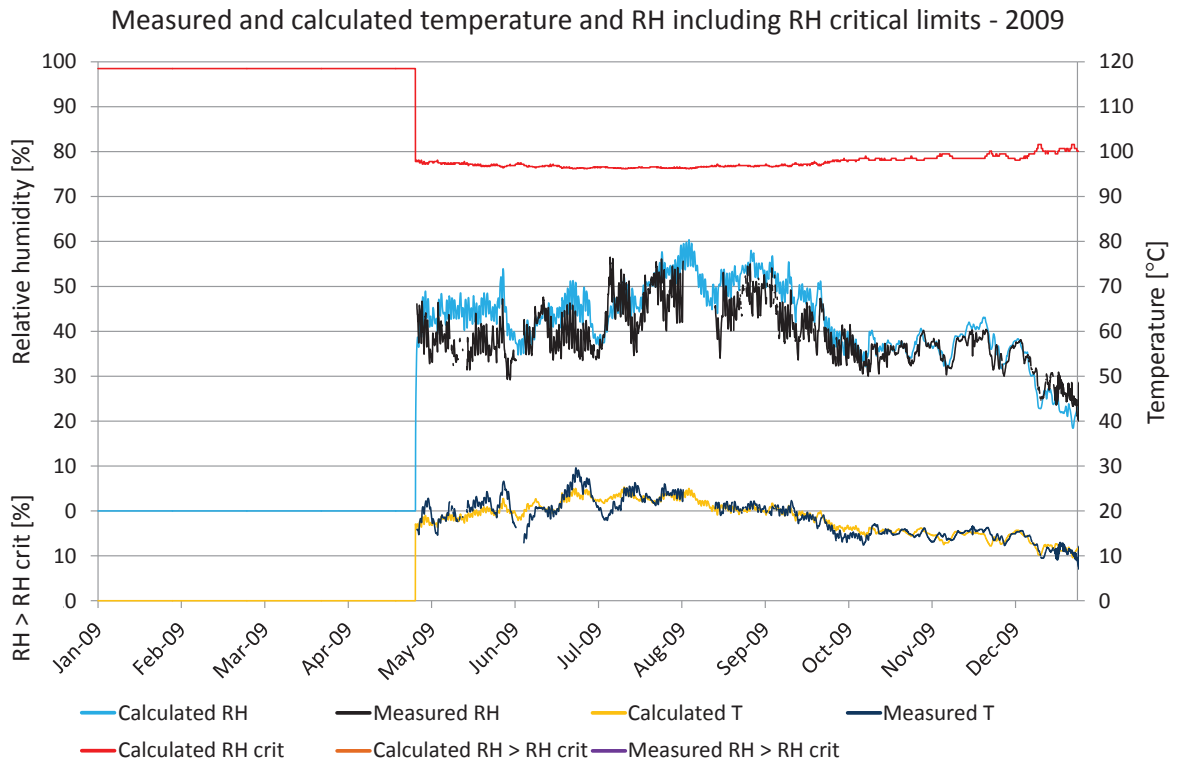

Figure 7.5.2. Comparisons between measured and calculated temperature and relative humidity. Calculated temperature (yellow), measured temperature (dark blue), calculated RH (turquoise), measured RH (black), RH_{crit} for calculated values (red), calculated $RH > RH_{crit}$ (light brown), measured $RH > RH_{crit}$ (purple).

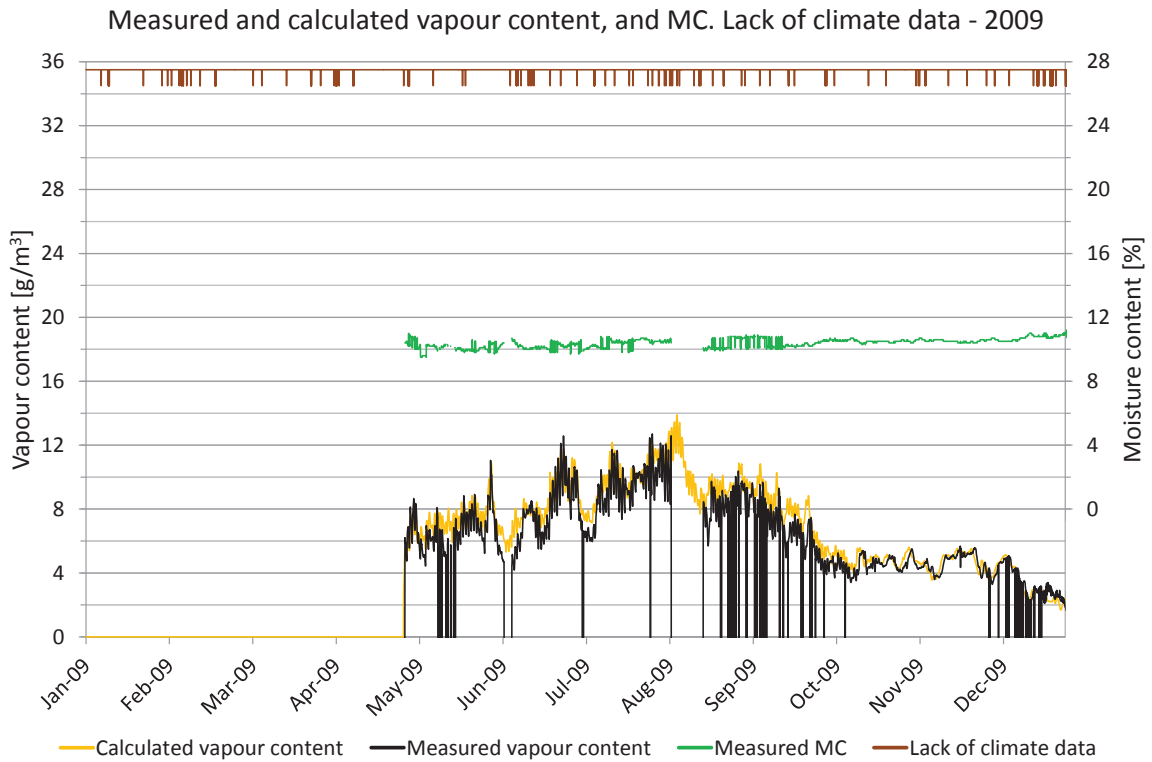

Figure 7.5.3. Measured moisture content, periods lacking climate data and comparisons of vapour content. Vapour content for calculated values (yellow) and measured values (black). Moisture content (green), periods with lack of climate data (brown).

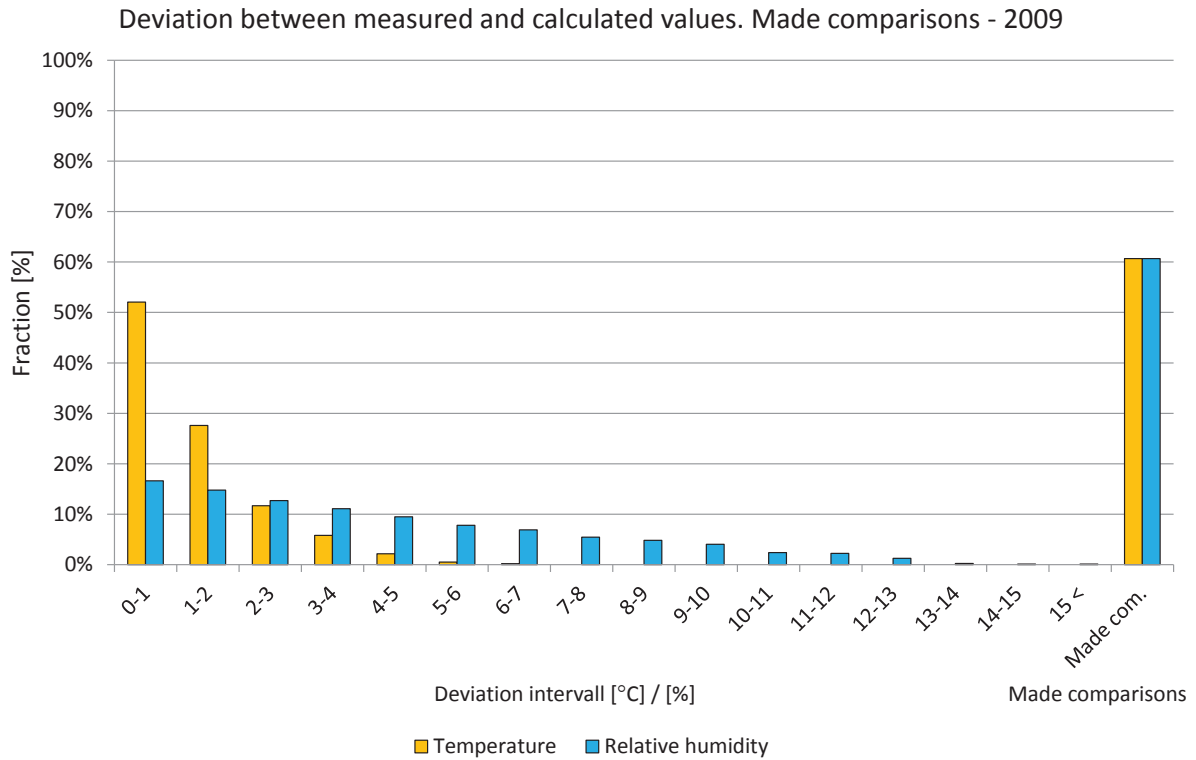

Figure 7.5.4. Deviations in comparisons shown in intervals from 0 to 15 °C or %. The two right-hand bars show the percentage of comparisons during the year. Temperature (yellow) and relative humidity (light blue).

Year 2010

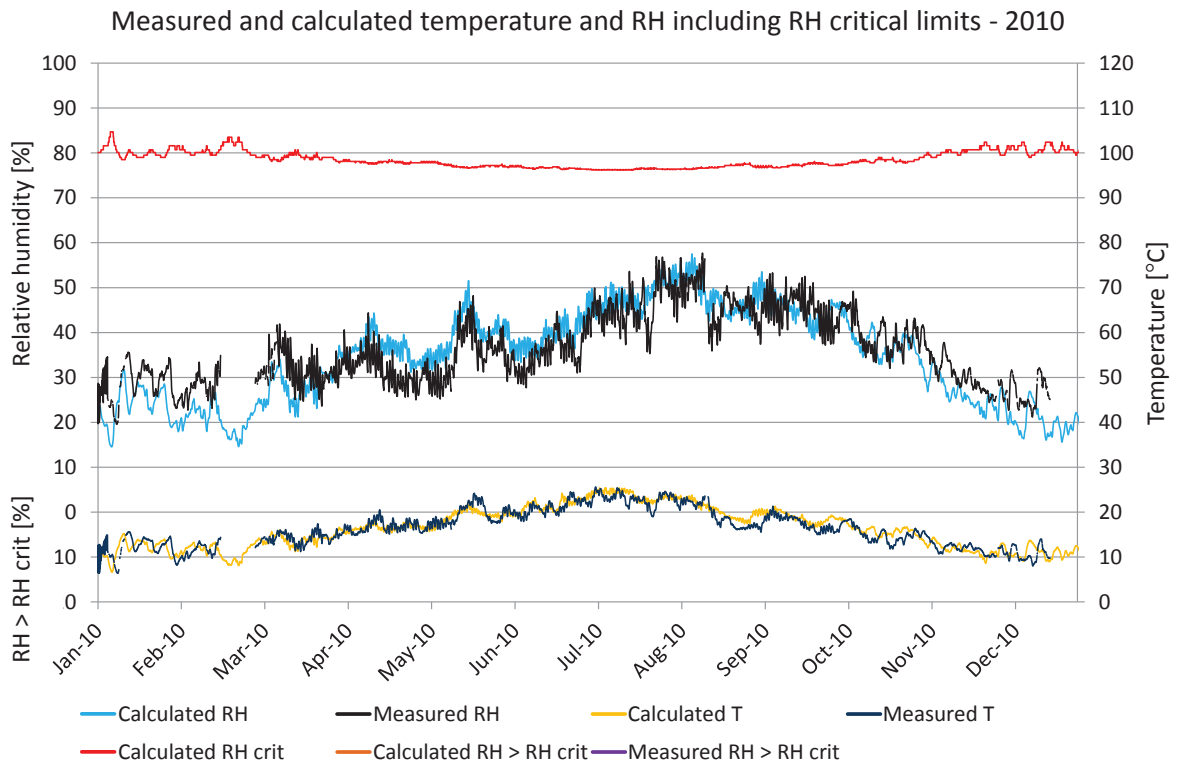

Figure 7.5.5. Comparisons between measured and calculated temperature and relative humidity. Calculated temperature (yellow), measured temperature (dark blue), calculated RH (turquoise), measured RH (black), RH_{crit} for calculated values (red), calculated $RH > RH_{crit}$ (light brown), measured $RH > RH_{crit}$ (purple).

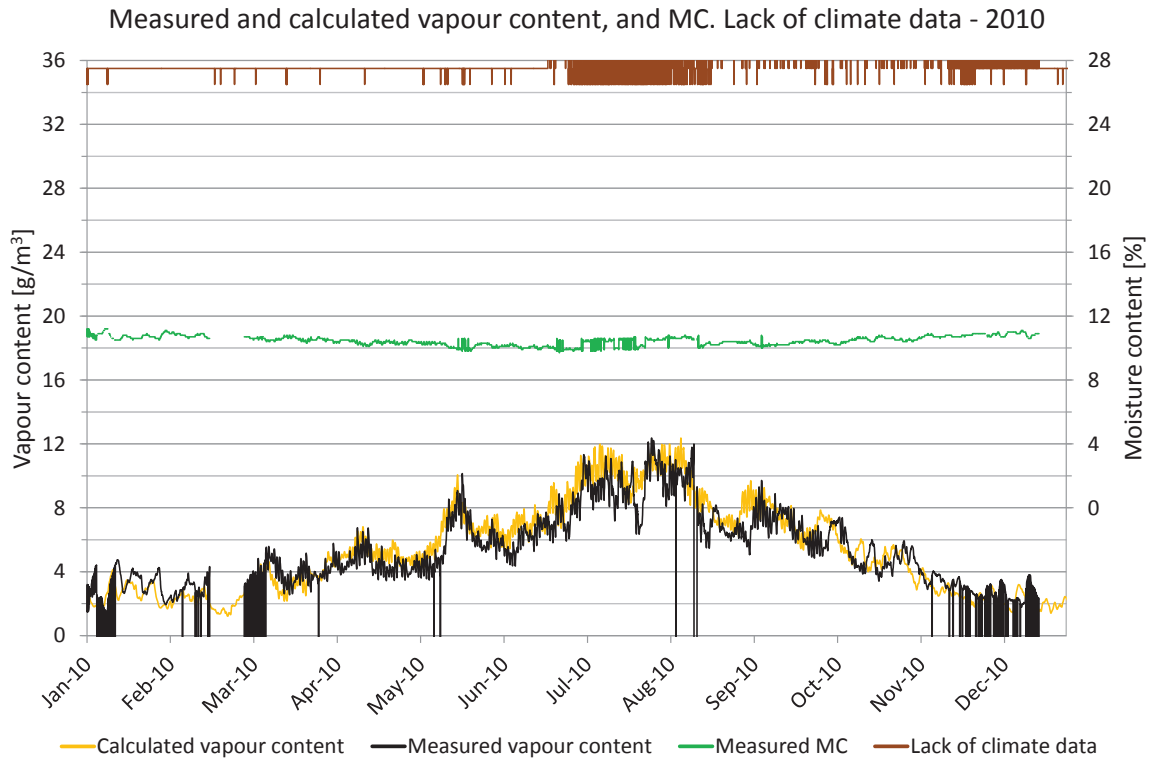

Figure 7.5.6. Measured moisture content, periods lacking climate data and comparisons of vapour content. Vapour content for calculated values (yellow) and measured values (black). Moisture content (green), periods with lack of climate data (brown).

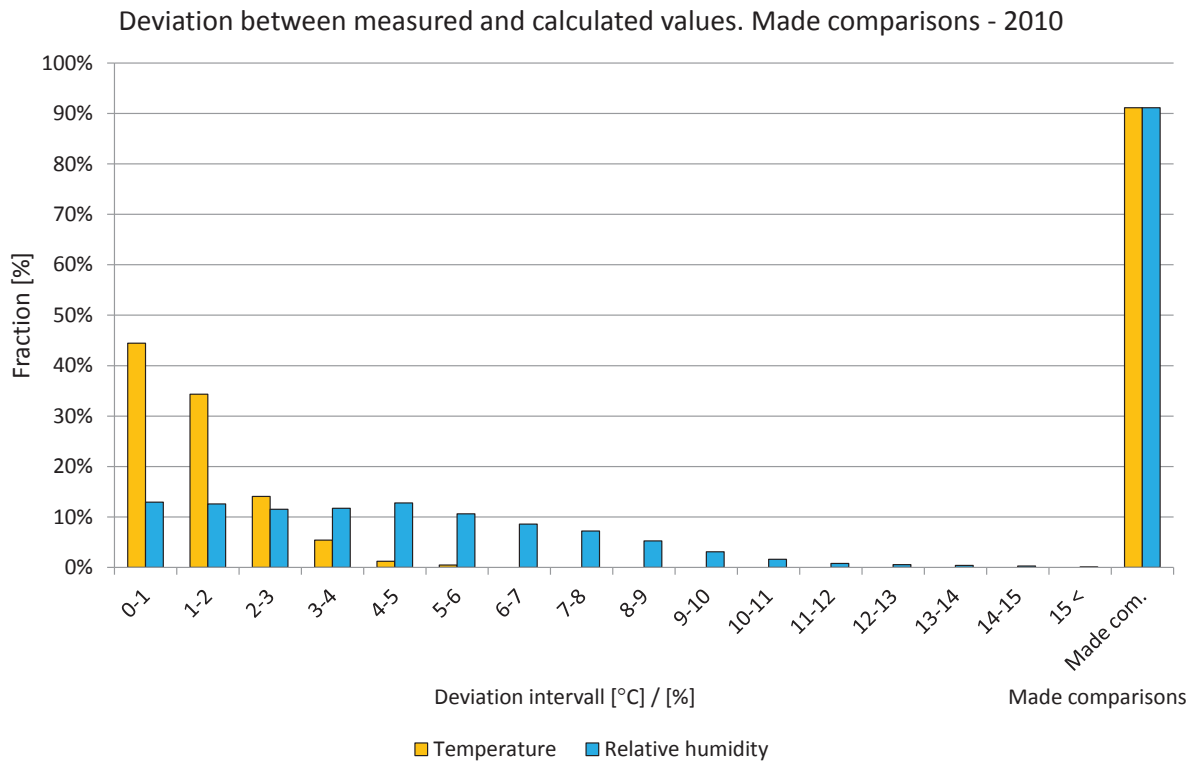

Figure 7.5.7. Deviations in comparisons shown in intervals from 0 to 15 °C or %. The two right-hand bars show the percentage of comparisons during the year. Temperature (yellow) and relative humidity (light blue).

Year 2011

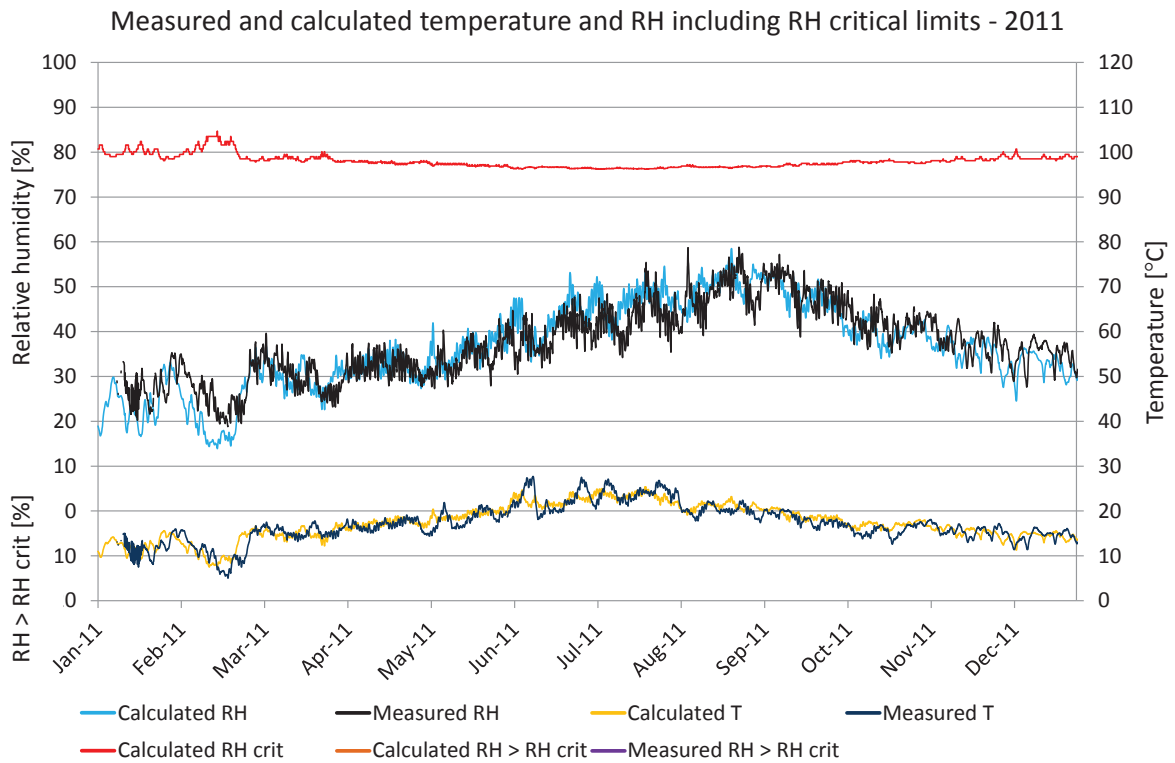

Figure 7.5.8. Comparisons between measured and calculated temperature and relative humidity. Calculated temperature (yellow), measured temperature (dark blue), calculated RH (turquoise), measured RH (black), RH_{crit} for calculated values (red), calculated $RH > RH_{crit}$ (light brown), measured $RH > RH_{crit}$ (purple).

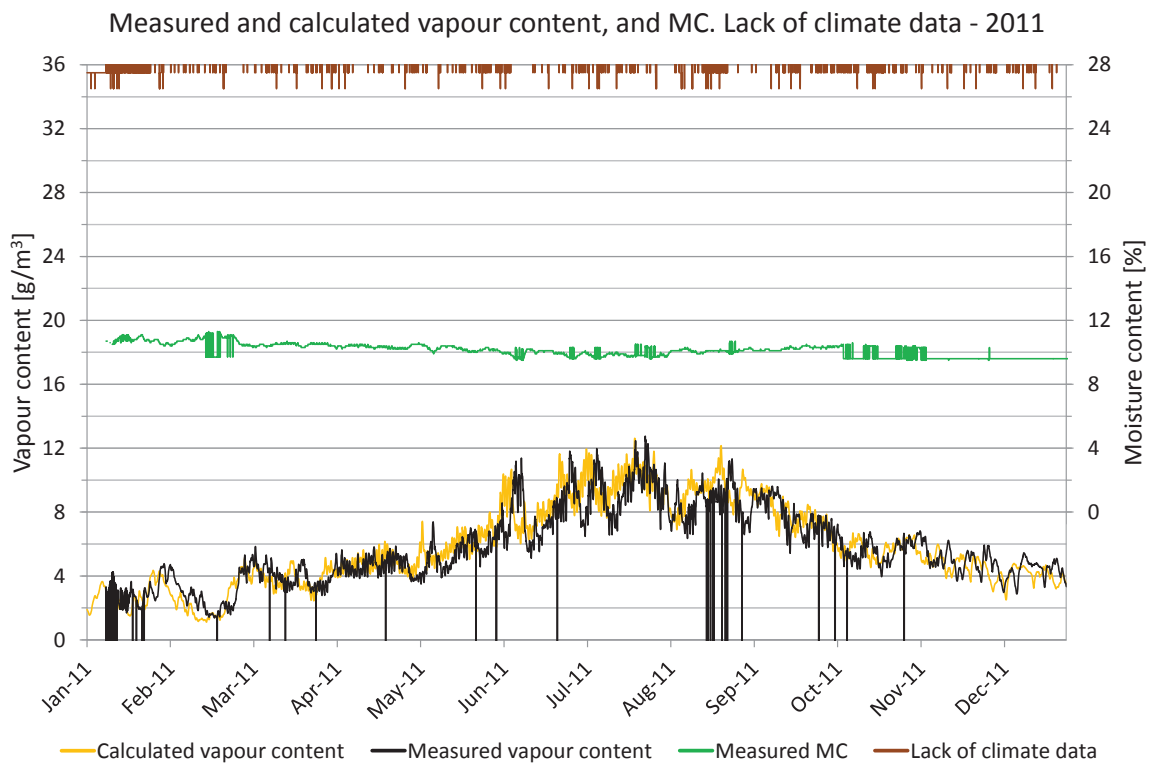

Figure 7.5.9. Measured moisture content, periods lacking climate data and comparisons of vapour content. Vapour content for calculated values (yellow) and measured values (black). Moisture content (green), periods with lack of climate data (brown).

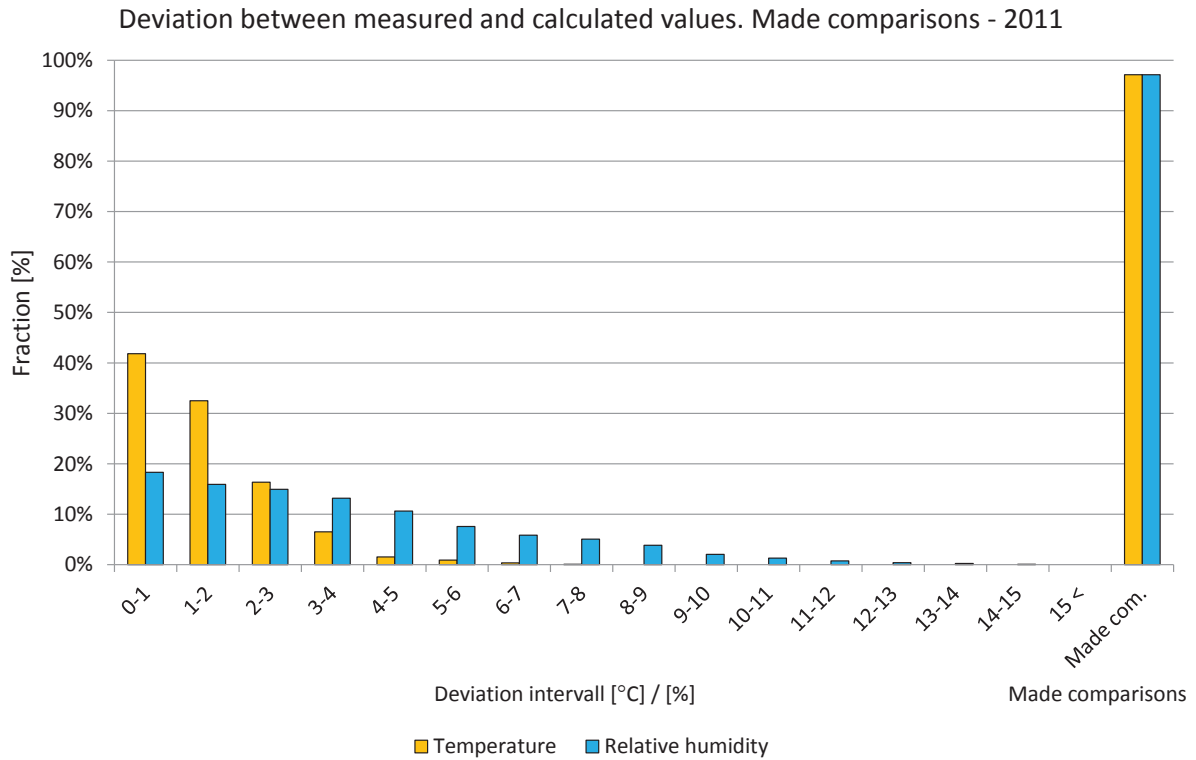

Figure 7.5.10. Deviations in comparisons shown in intervals from 0 to 15 °C or %. The two right-hand bars show the percentage of comparisons during the year. Temperature (yellow) and relative humidity (light blue).

7.6 Position 6ö

The locations of the measured and calculated position are shown in the drawings and figures below. The studied position is located in a wall that is facing east on the fifth floor.

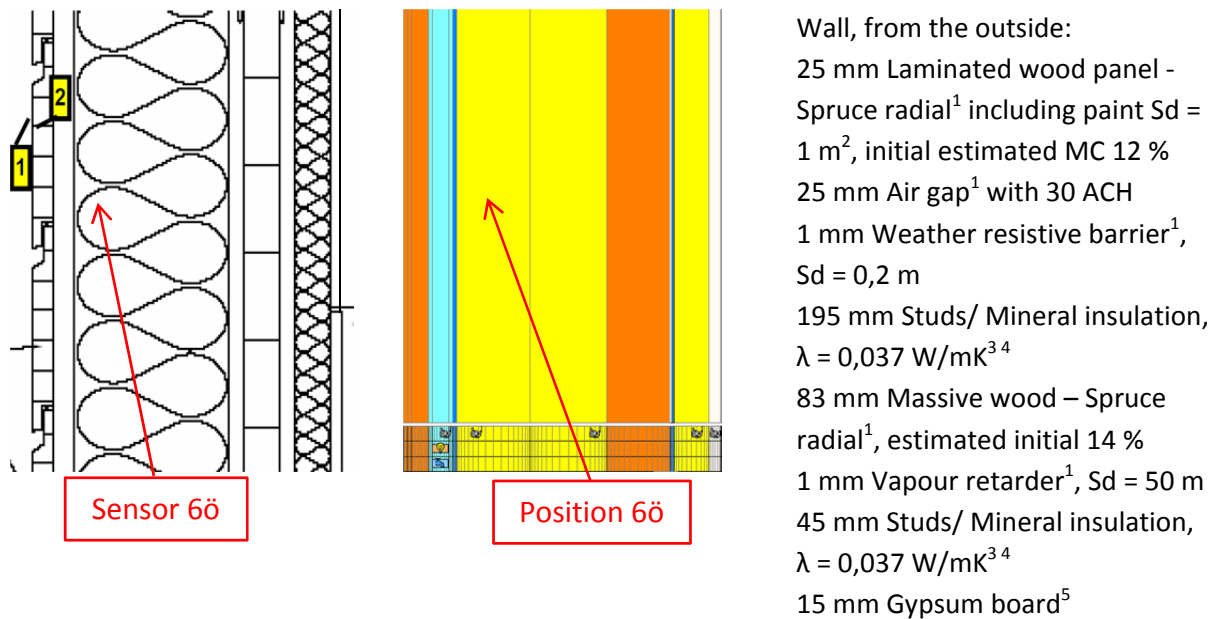

Figure 7.6.1. Vertical cross sectional drawing and WUFI calculation model showing the studied position. 1. IBP, 2012, 2. Nevander, L-E., 1994, 3. IEA Annex 24, 1996, 4. Paroc, 2002, 5. Krus, M., 1996.

A perfect match between the measured and calculated values cannot be expected due to e.g. the influence of two- and three-dimensional effects and the accuracy of the sensors.

Year 2009

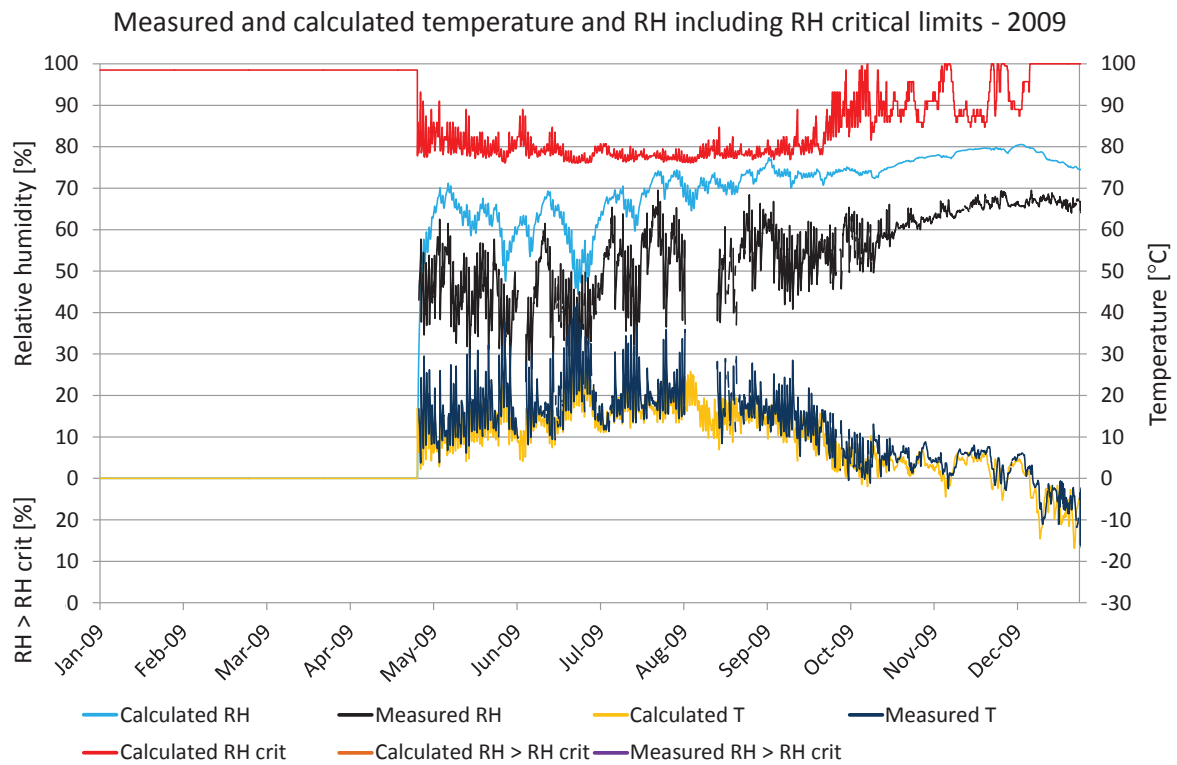

Figure 7.6.2. Comparisons between measured and calculated temperature and relative humidity. Calculated temperature (yellow), measured temperature (dark blue), calculated RH (turquoise), measured RH (black), RH_{crit} for calculated values (red), calculated $RH > RH_{crit}$ (light brown), measured $RH > RH_{crit}$ (purple).

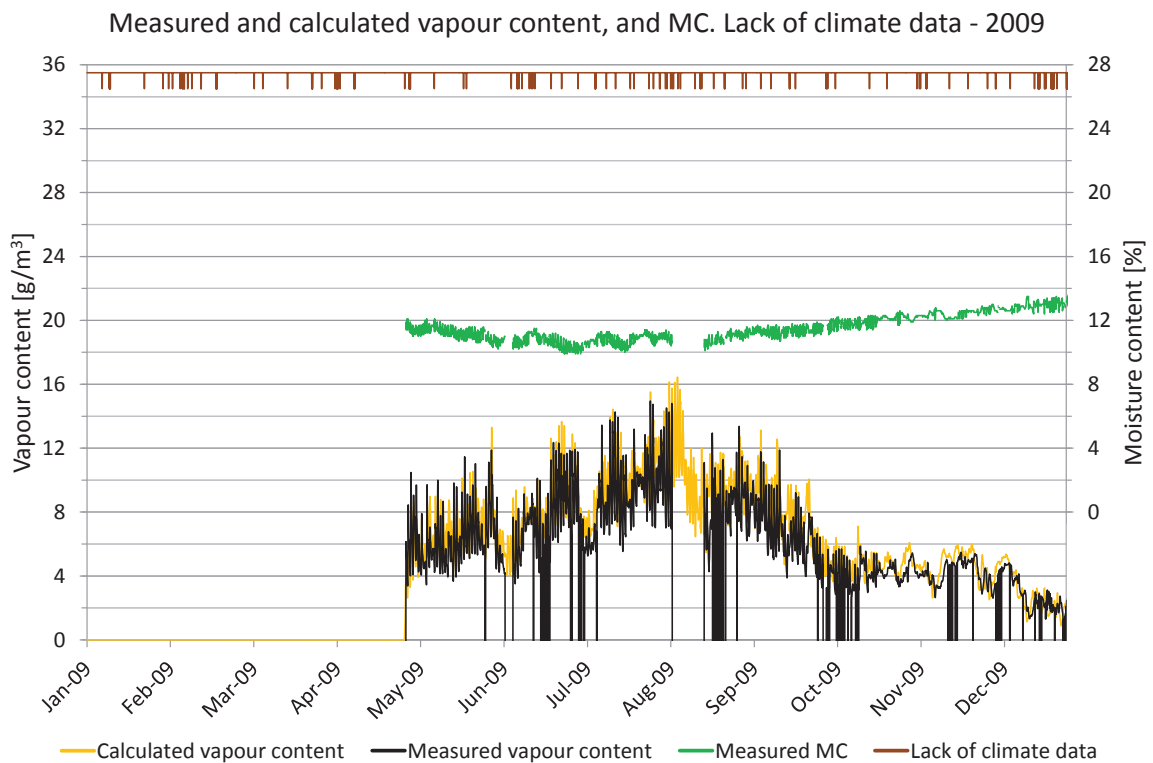

Figure 7.6.3. Measured moisture content, periods lacking climate data and comparisons of vapour content. Vapour content for calculated values (yellow) and measured values (black). Moisture content (green), periods with lack of climate data (brown).

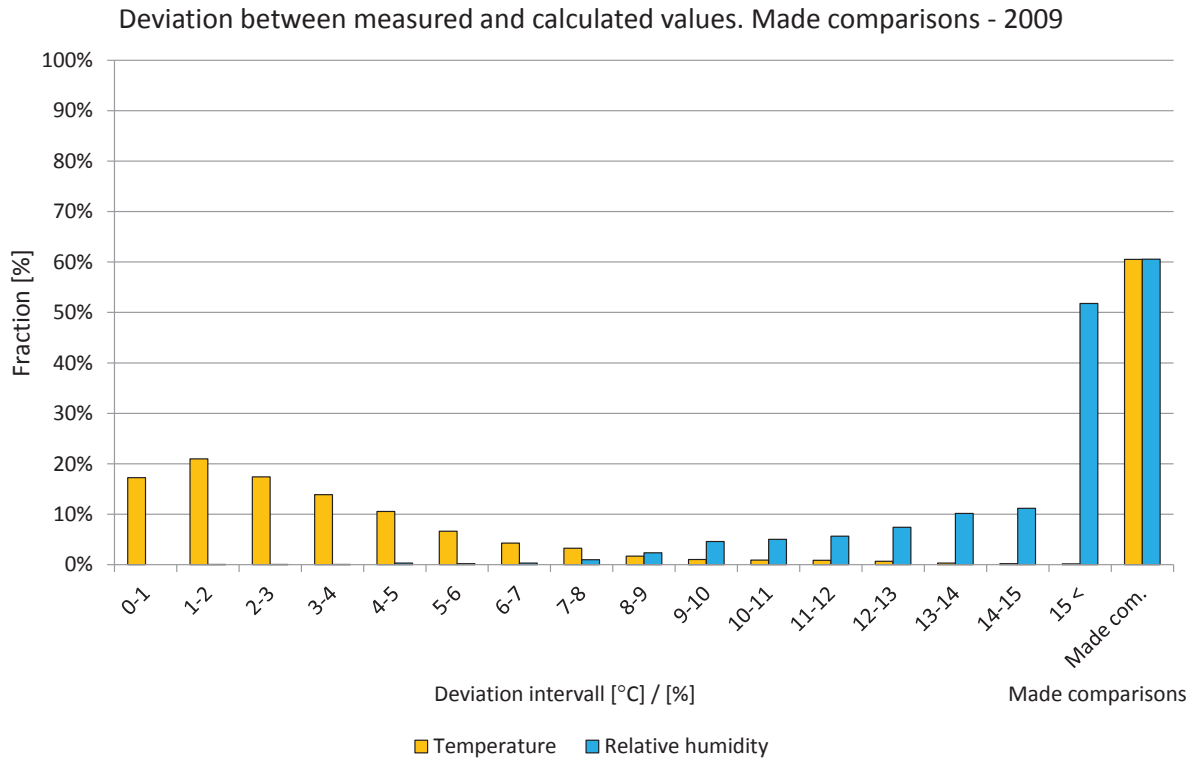

Figure 7.6.4. Deviations in comparisons shown in intervals from 0 to 15 °C or %. The two right-hand bars show the percentage of comparisons during the year. Temperature (yellow) and relative humidity (light blue).

Year 2010

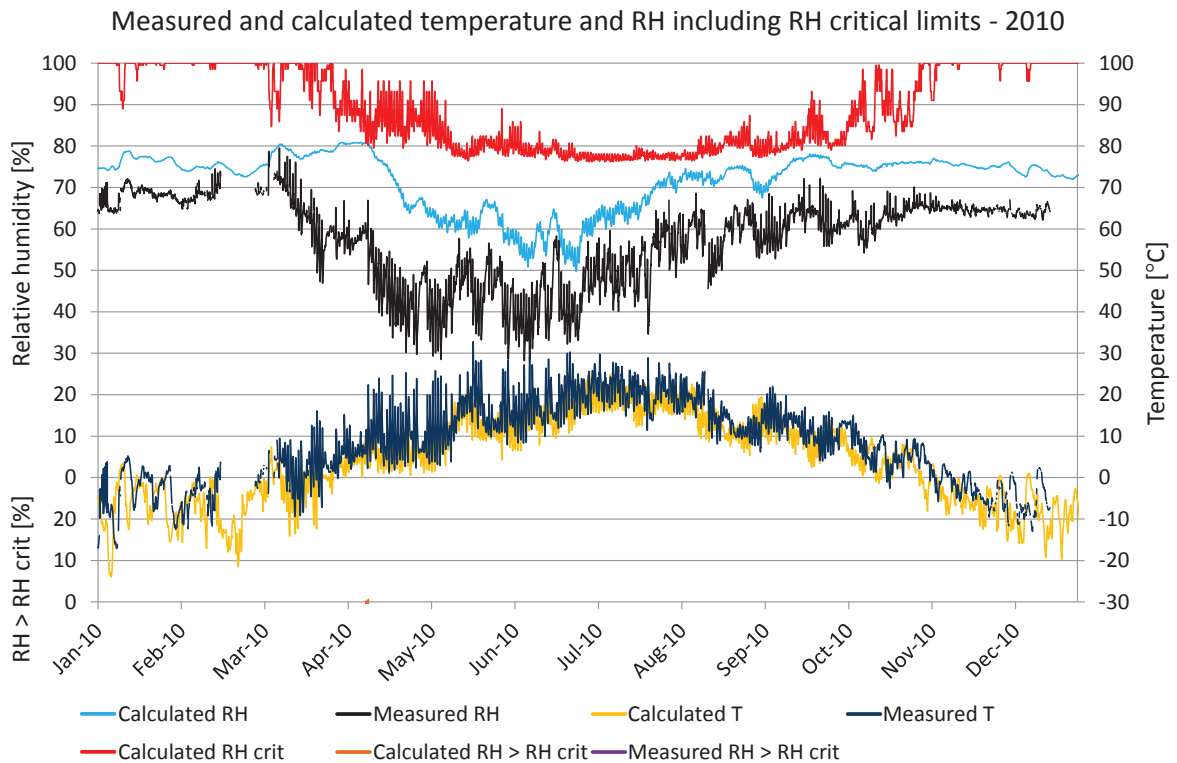

Figure 7.6.5. Comparisons between measured and calculated temperature and relative humidity. Calculated temperature (yellow), measured temperature (dark blue), calculated RH (turquoise), measured RH (black), RH_{crit} for calculated values (red), calculated RH > RH_{crit} (light brown), measured RH > RH_{crit} (purple).

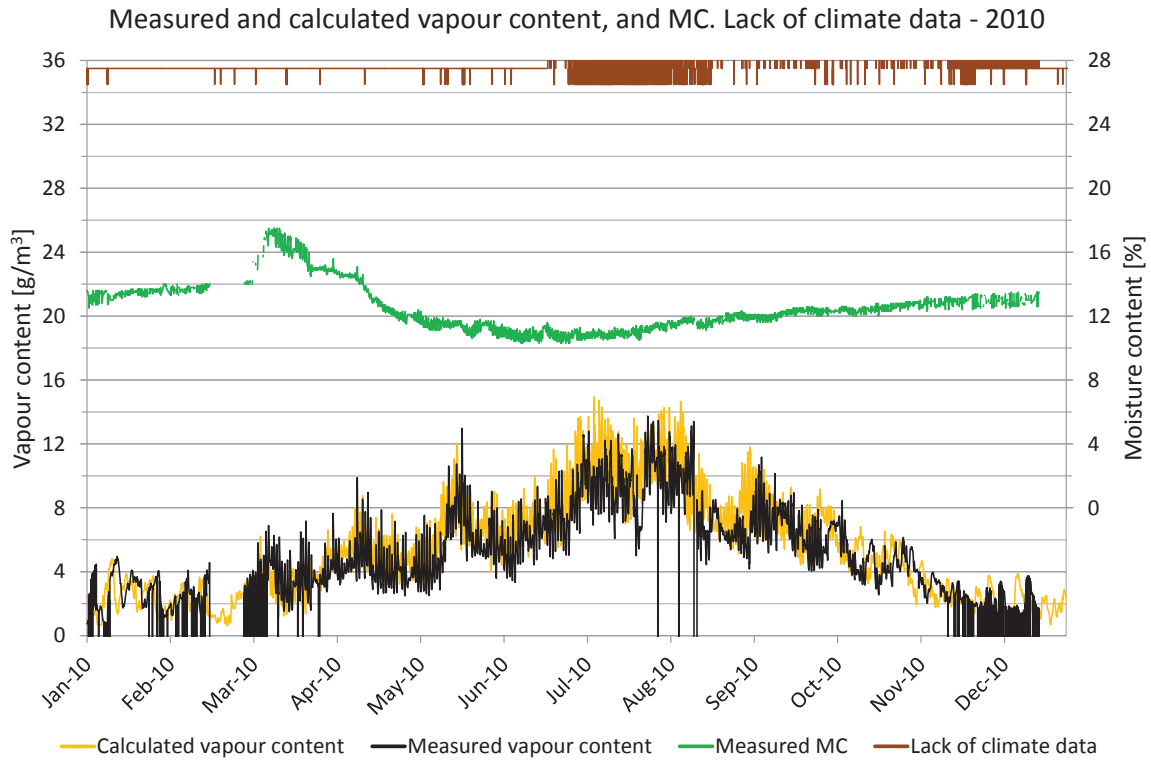

Figure 7.6.6. Measured moisture content, periods lacking climate data and comparisons of vapour content. Vapour content for calculated values (yellow) and measured values (black). Moisture content (green), periods with lack of climate data (brown).

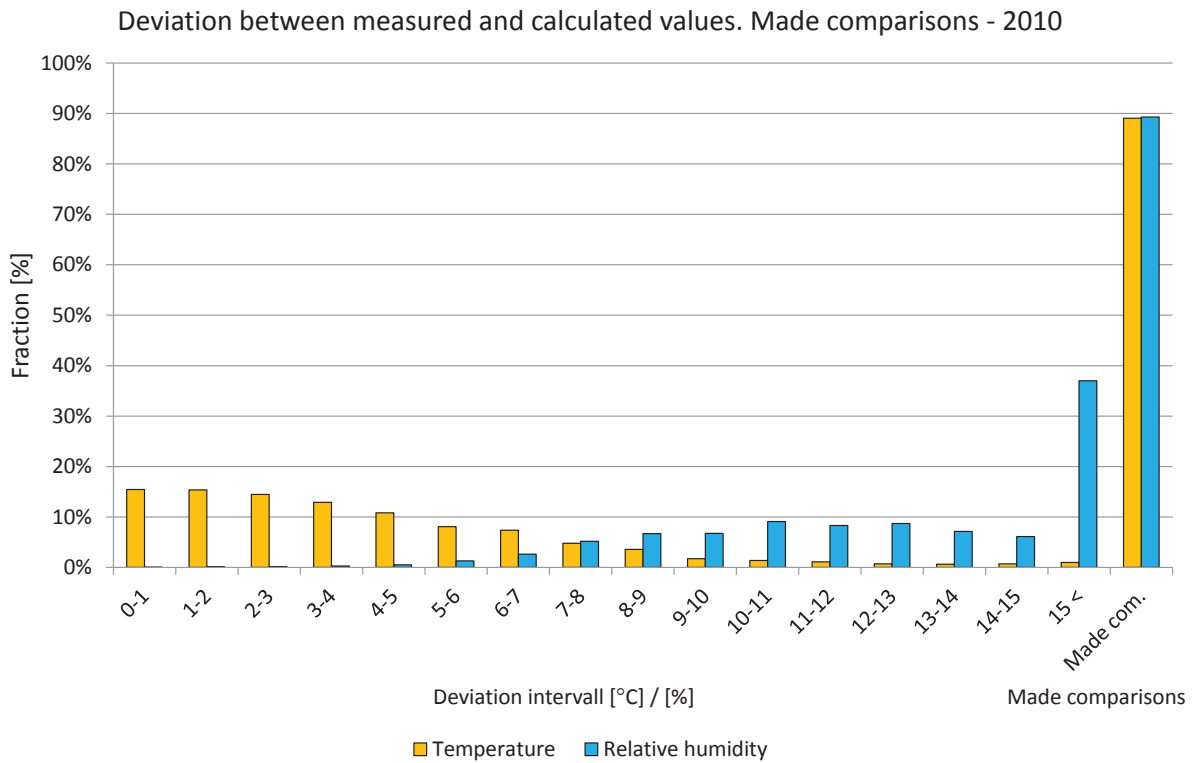

Figure 7.6.7. Deviations in comparisons shown in intervals from 0 to 15 °C or %. The two right-hand bars show the percentage of comparisons during the year. Temperature (yellow) and relative humidity (light blue).

Year 2011

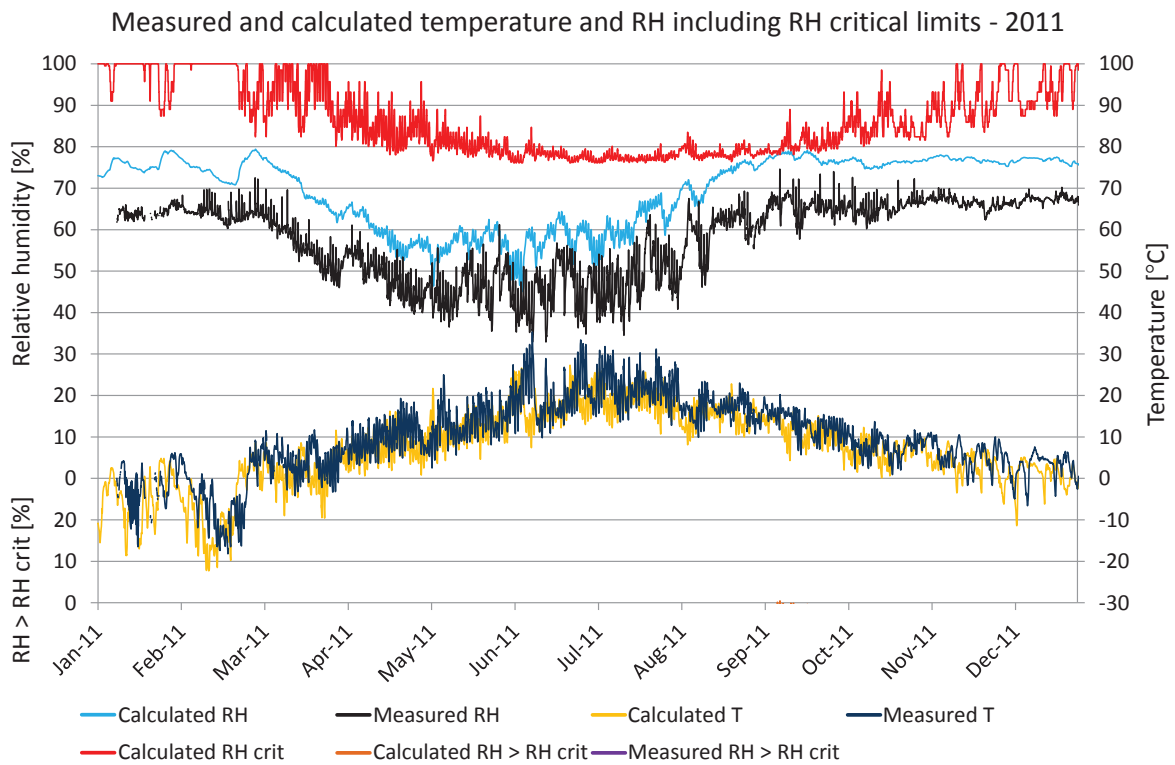

Figure 7.6.8. Comparisons between measured and calculated temperature and relative humidity. Calculated temperature (yellow), measured temperature (dark blue), calculated RH (turquoise), measured RH (black), RH_{crit} for calculated values (red), calculated RH > RH_{crit} (light brown), measured RH > RH_{crit} (purple).

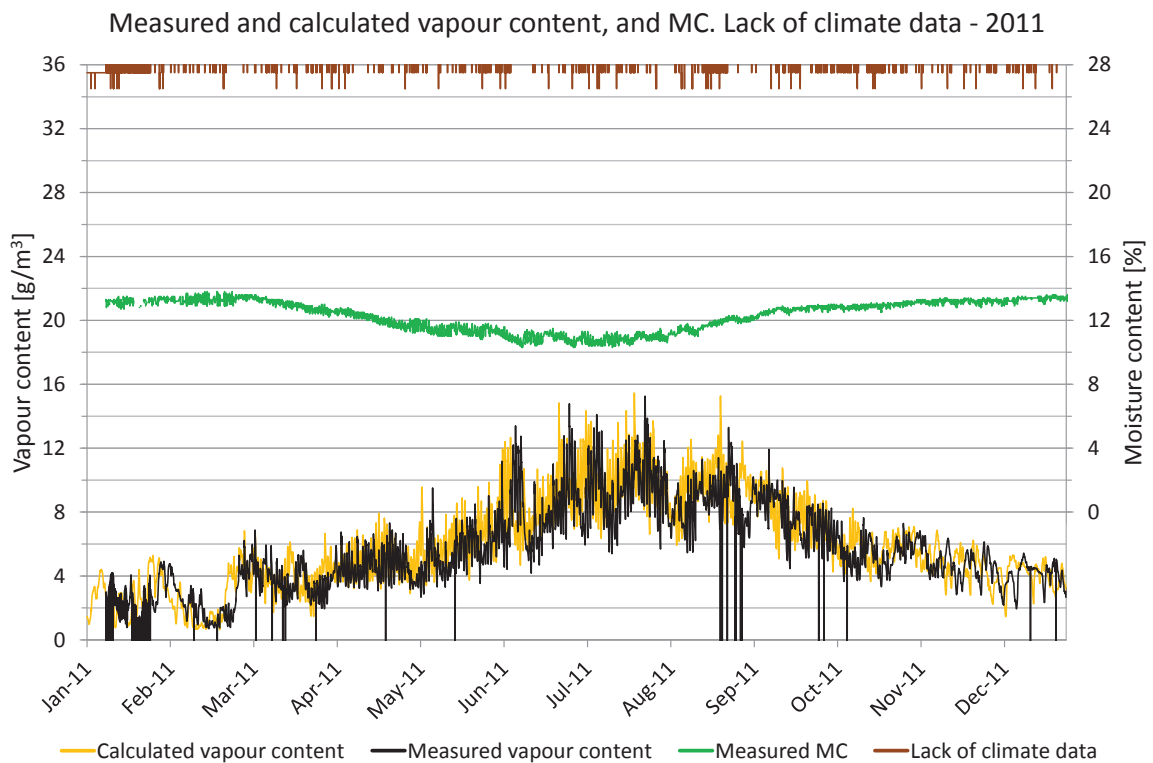

Figure 7.6.9. Measured moisture content, periods lacking climate data and comparisons of vapour content. Vapour content for calculated values (yellow) and measured values (black). Moisture content (green), periods with lack of climate data (brown).

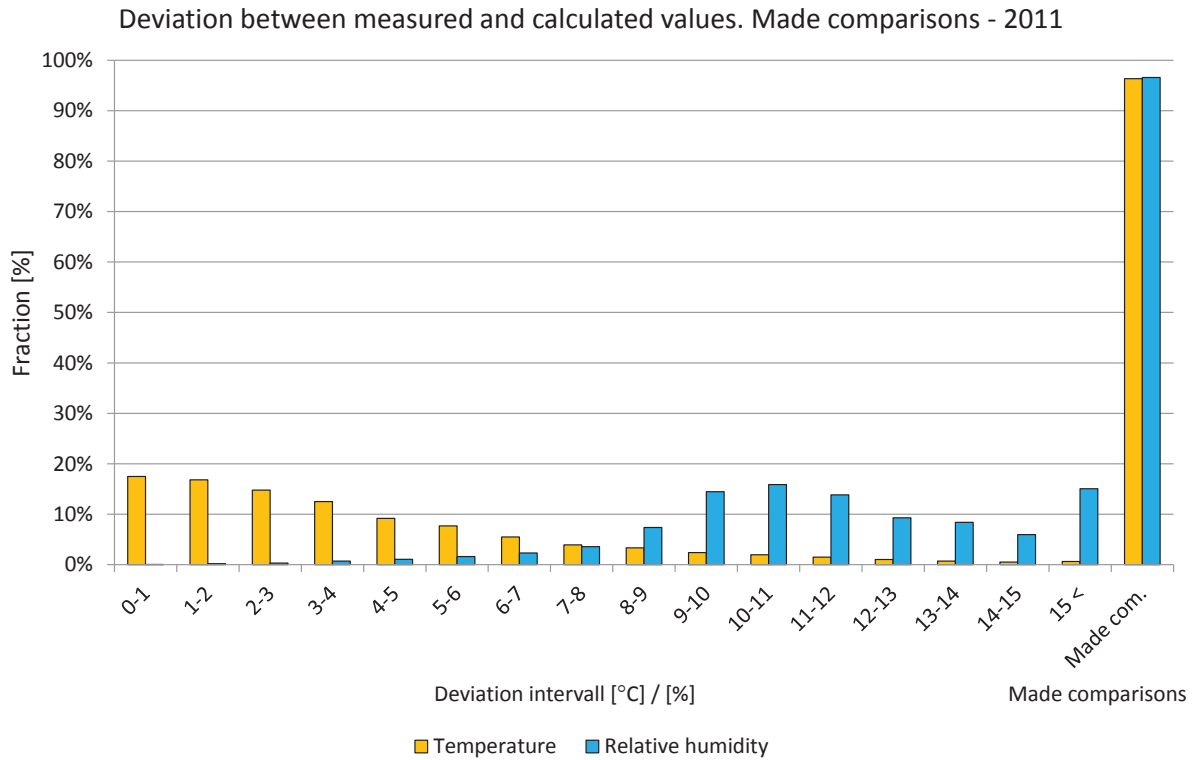

Figure 7.6.10. Deviations in comparisons shown in intervals from 0 to 15 °C or %. The two right-hand bars show the percentage of comparisons during the year. Temperature (yellow) and relative humidity (light blue).

7.9 Position 9s

The locations of the measured and calculated position are shown in the drawings and figures below. The studied position is located below a window in a wall that is facing south on the sixth floor.

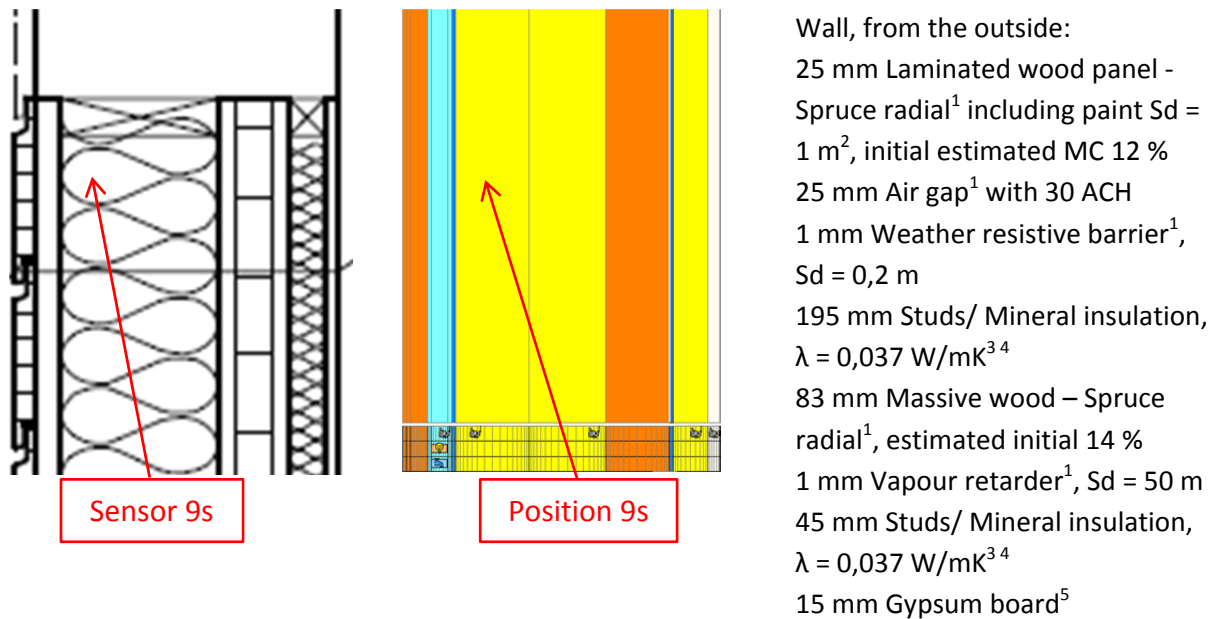

Figure 7.9.1. Vertical cross sectional drawing and WUFI calculation model showing the studied position. 1. IBP, 2012, 2. Nevander, L-E., 1994, 3. IEA Annex 24, 1996, 4. Paroc, 2002, 5. Krus, M., 1996.

A perfect match between the measured and calculated values cannot be expected due to e.g. the influence of two- and three-dimensional effects and the accuracy of the sensors.

Year 2009

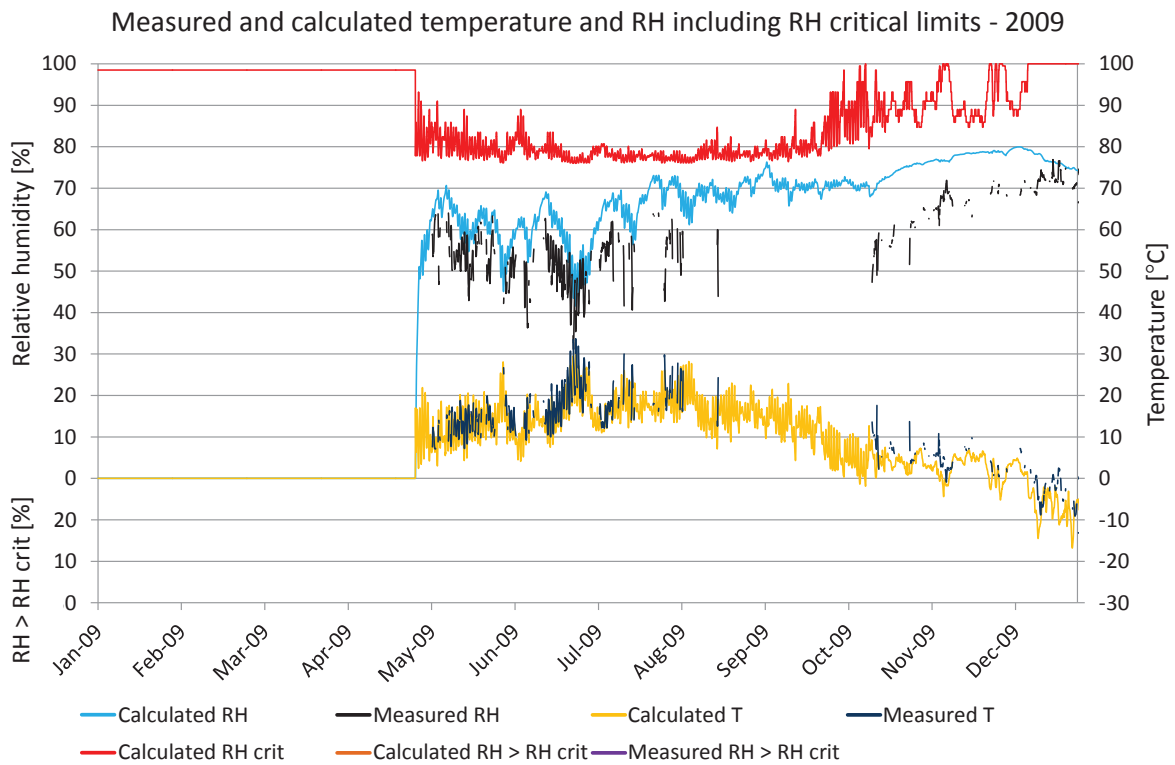

Figure 7.9.2. Comparisons between measured and calculated temperature and relative humidity. Calculated temperature (yellow), measured temperature (dark blue), calculated RH (turquoise), measured RH (black), RH_{crit} for calculated values (red), calculated $RH > RH_{crit}$ (light brown), measured $RH > RH_{crit}$ (purple).

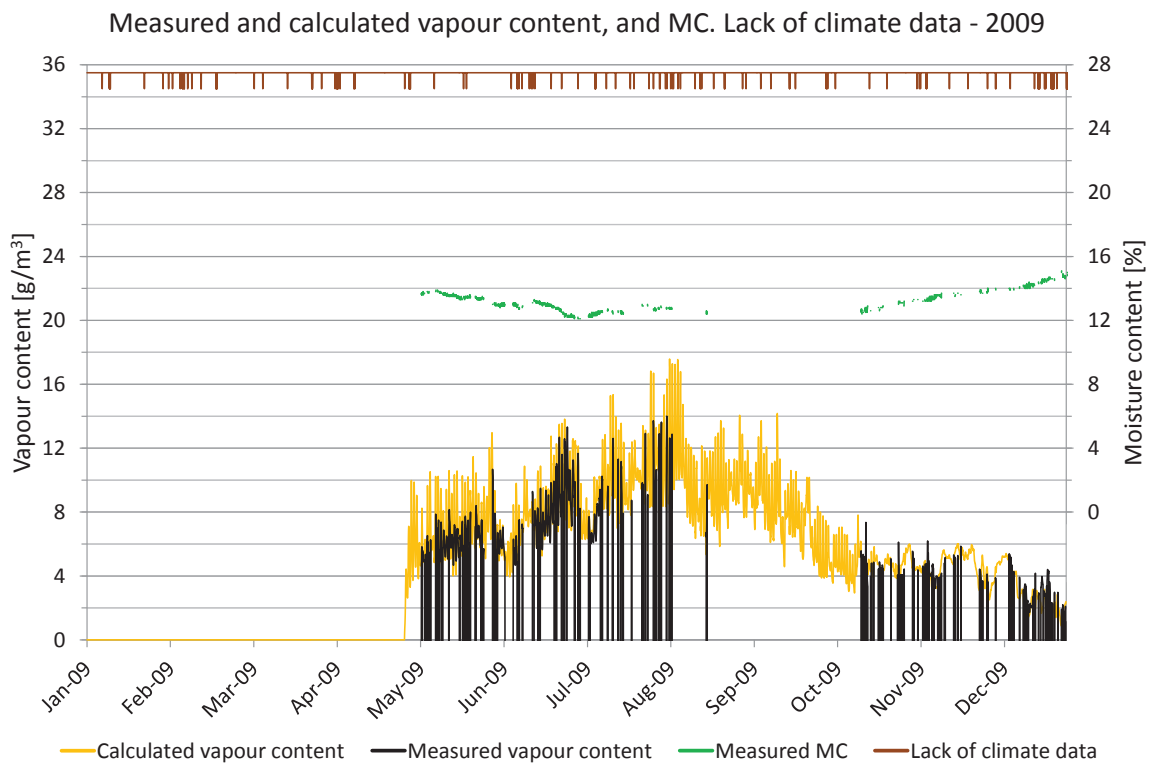

Figure 7.9.3. Measured moisture content, periods lacking climate data and comparisons of vapour content. Vapour content for calculated values (yellow) and measured values (black). Moisture content (green), periods with lack of climate data (brown).

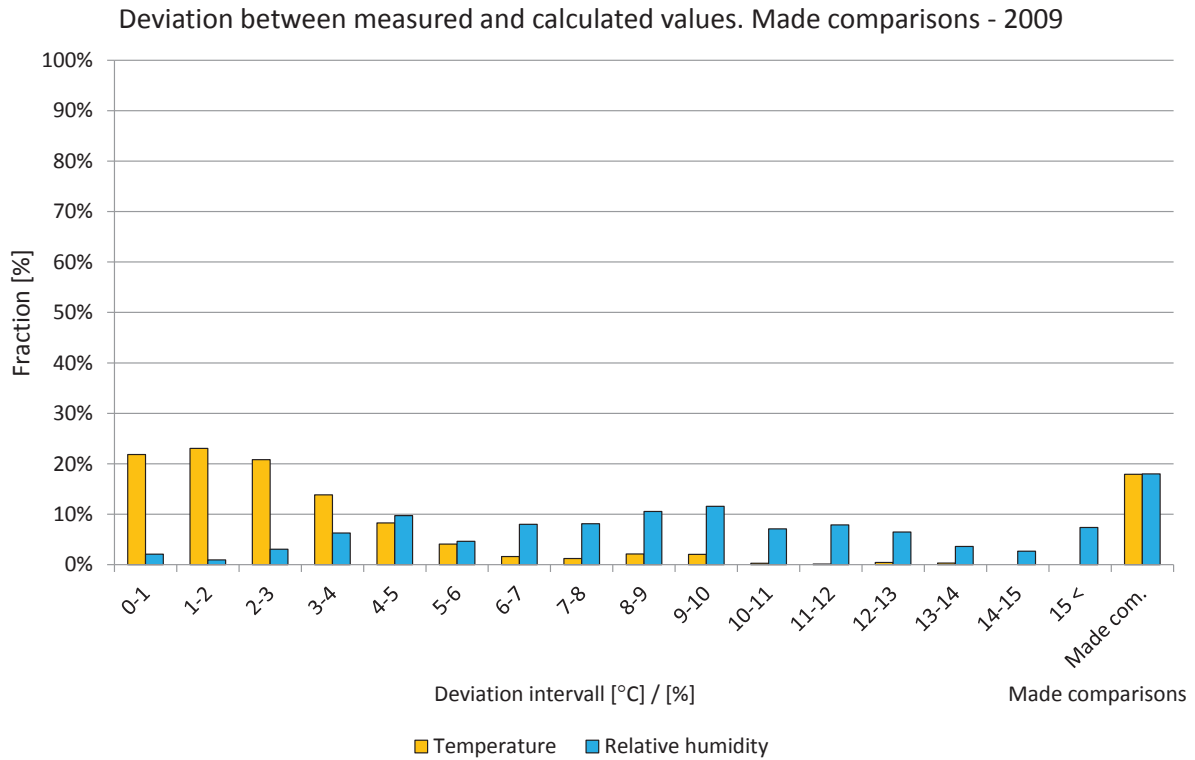

Figure 7.9.4. Deviations in comparisons shown in intervals from 0 to 15 °C or %. The two right-hand bars show the percentage of comparisons during the year. Temperature (yellow) and relative humidity (light blue).

Year 2010

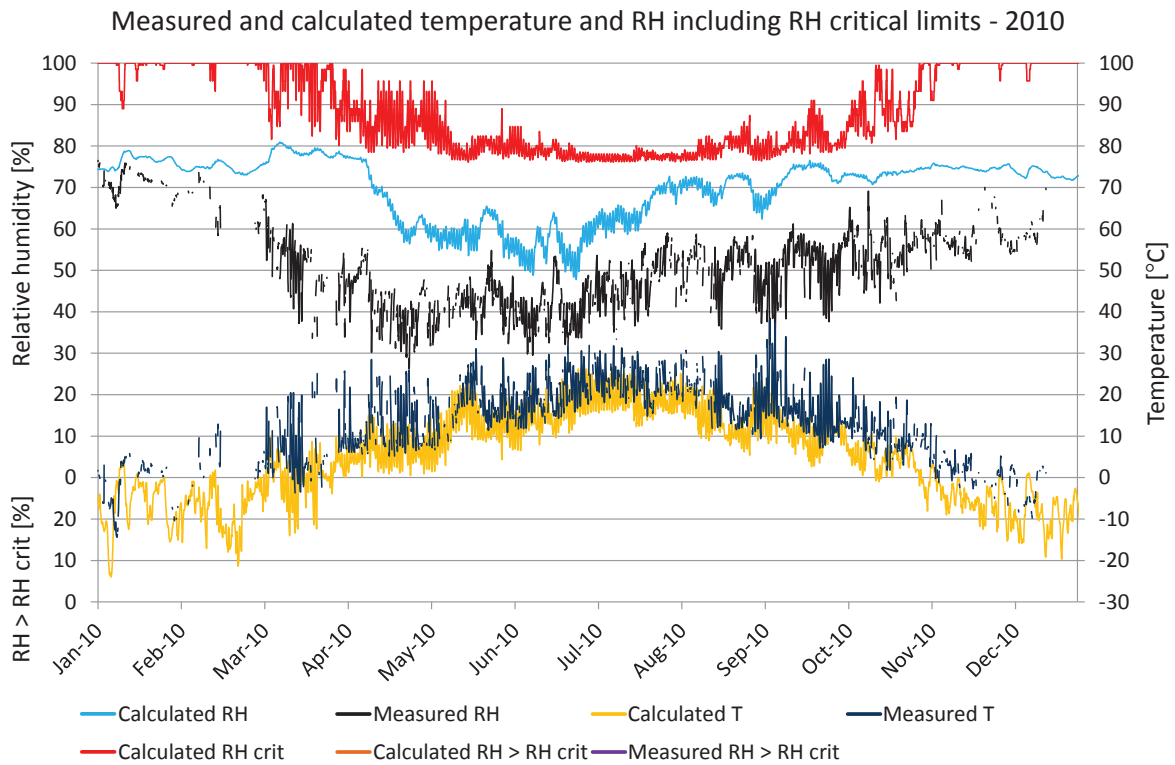

Figure 7.9.5. Comparisons between measured and calculated temperature and relative humidity. Calculated temperature (yellow), measured temperature (dark blue), calculated RH (turquoise), measured RH (black), RH_{crit} for calculated values (red), calculated $RH > RH_{crit}$ (light brown), measured $RH > RH_{crit}$ (purple).

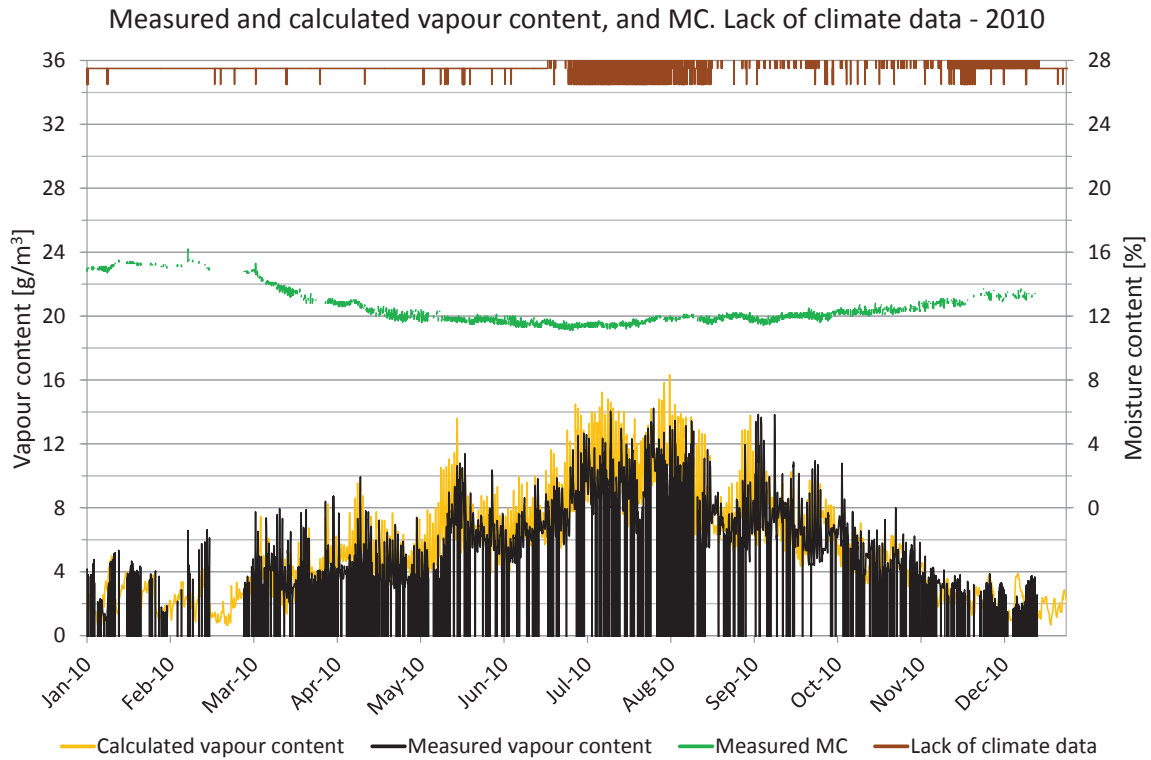

Figure 7.9.6. Measured moisture content, periods lacking climate data and comparisons of vapour content. Vapour content for calculated values (yellow) and measured values (black). Moisture content (green), periods with lack of climate data (brown).

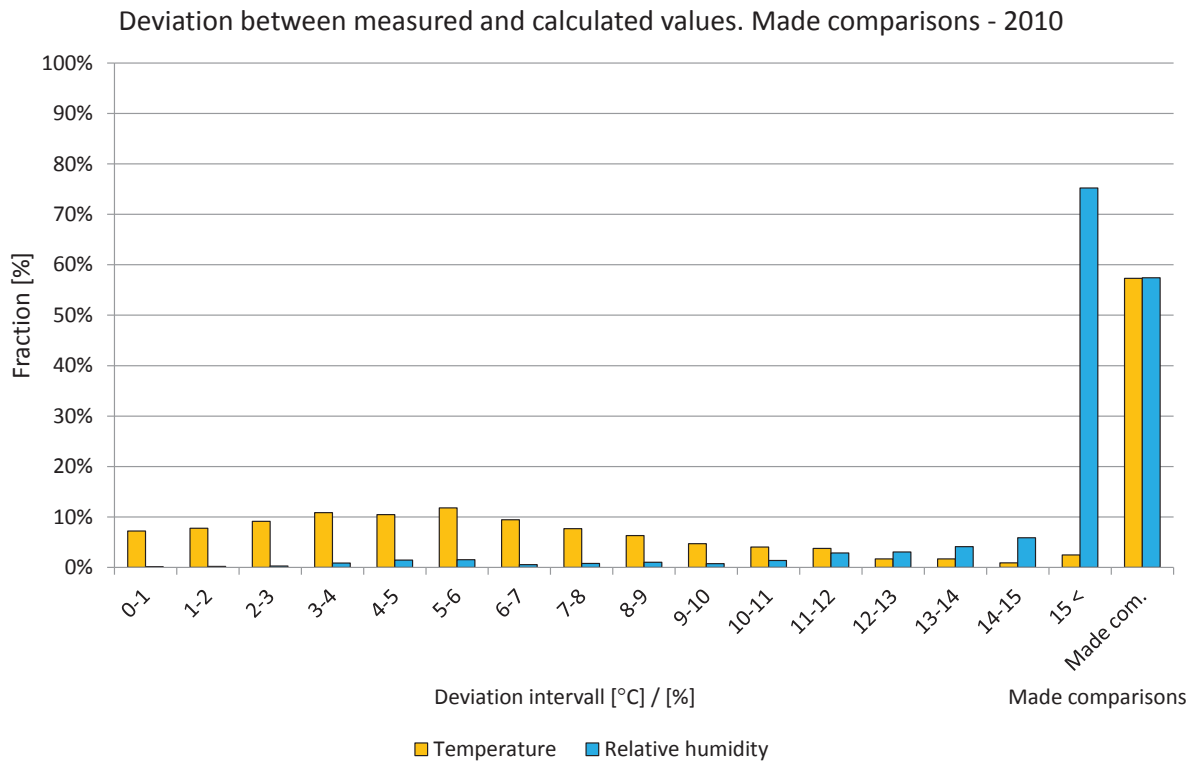

Figure 7.9.7. Deviations in comparisons shown in intervals from 0 to 15 °C or %. The two right-hand bars show the percentage of comparisons during the year. Temperature (yellow) and relative humidity (light blue).

Year 2011

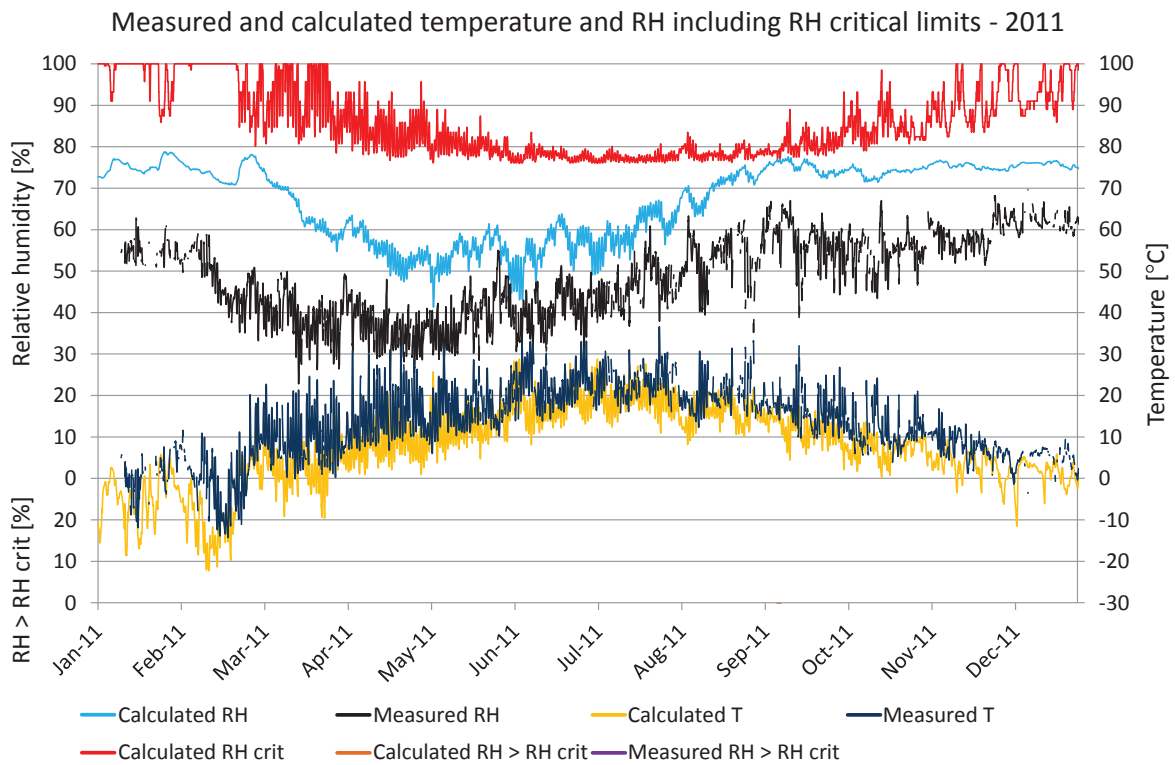

Figure 7.9.8. Comparisons between measured and calculated temperature and relative humidity. Calculated temperature (yellow), measured temperature (dark blue), calculated RH (turquoise), measured RH (black), RH_{crit} for calculated values (red), calculated RH > RH_{crit} (light brown), measured RH > RH_{crit} (purple).

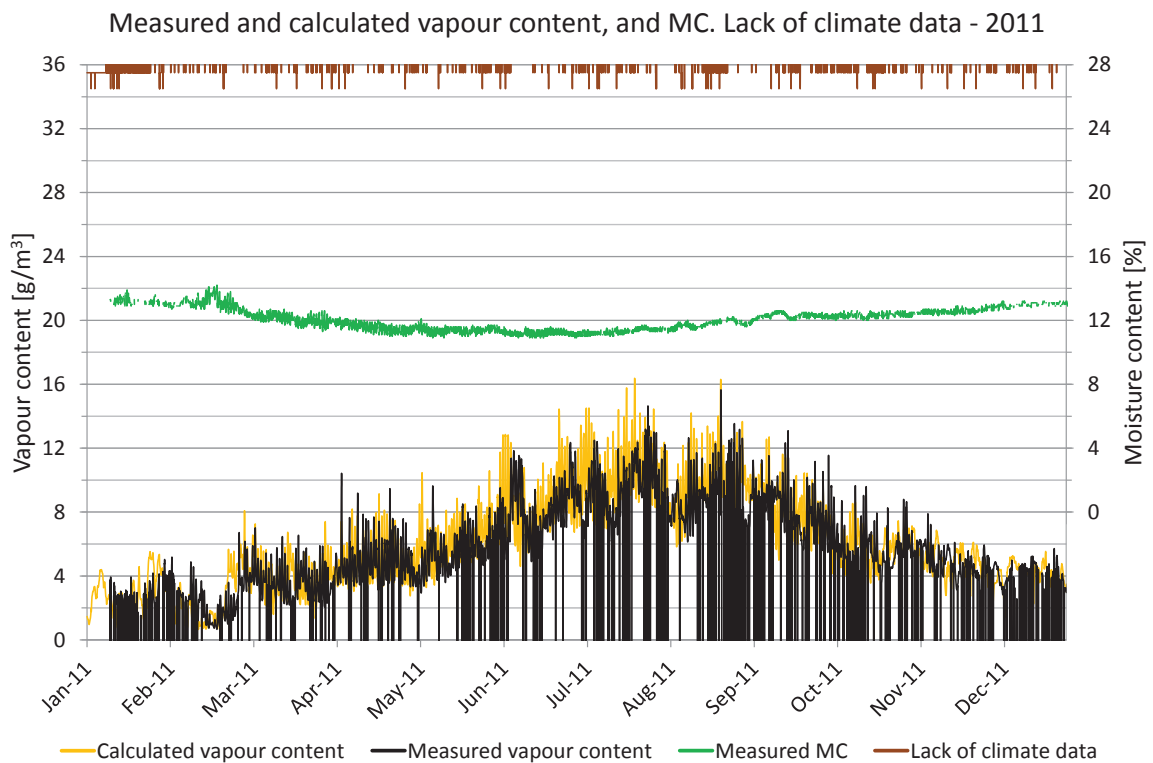

Figure 7.9.9. Measured moisture content, periods lacking climate data and comparisons of vapour content. Vapour content for calculated values (yellow) and measured values (black). Moisture content (green), periods with lack of climate data (brown).

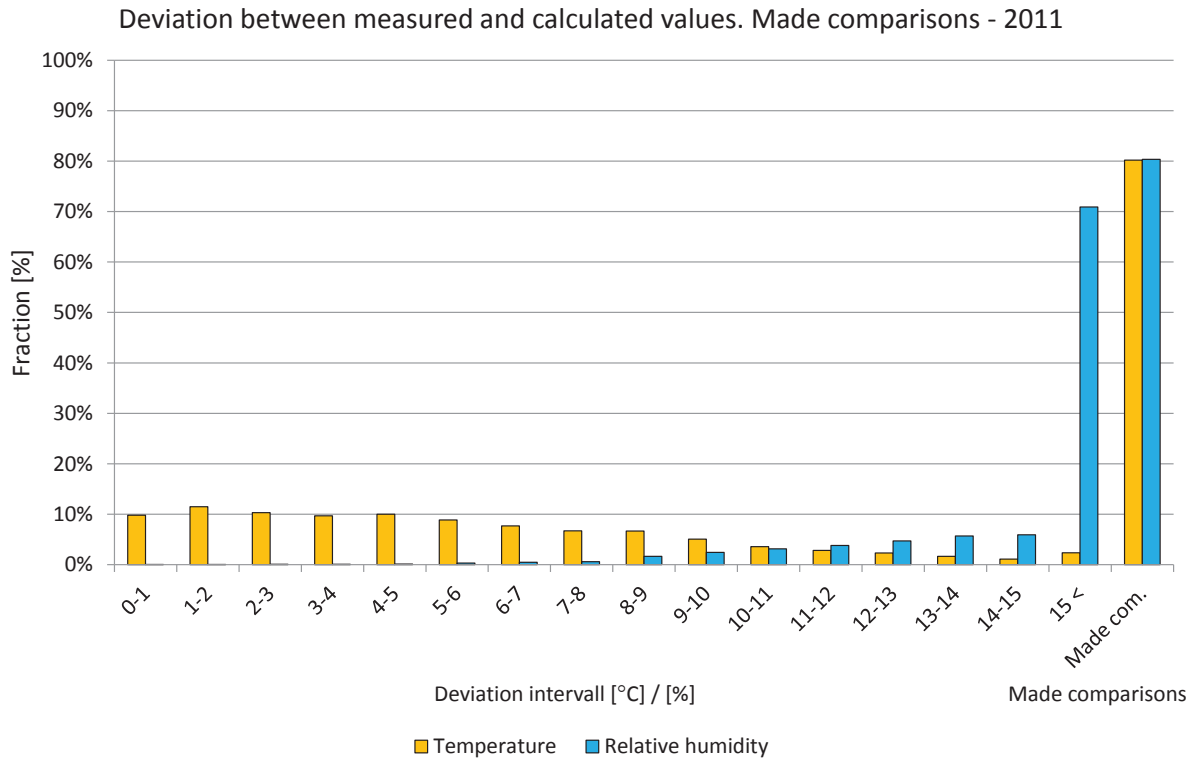

Figure 7.9.10. Deviations in comparisons shown in intervals from 0 to 15 °C or %. The two right-hand bars show the percentage of comparisons during the year. Temperature (yellow) and relative humidity (light blue).

7.10 Position 10s

The locations of the measured and calculated position are shown in the drawings and figures below. The studied position is located below a window in a wall that is facing south on the sixth floor.

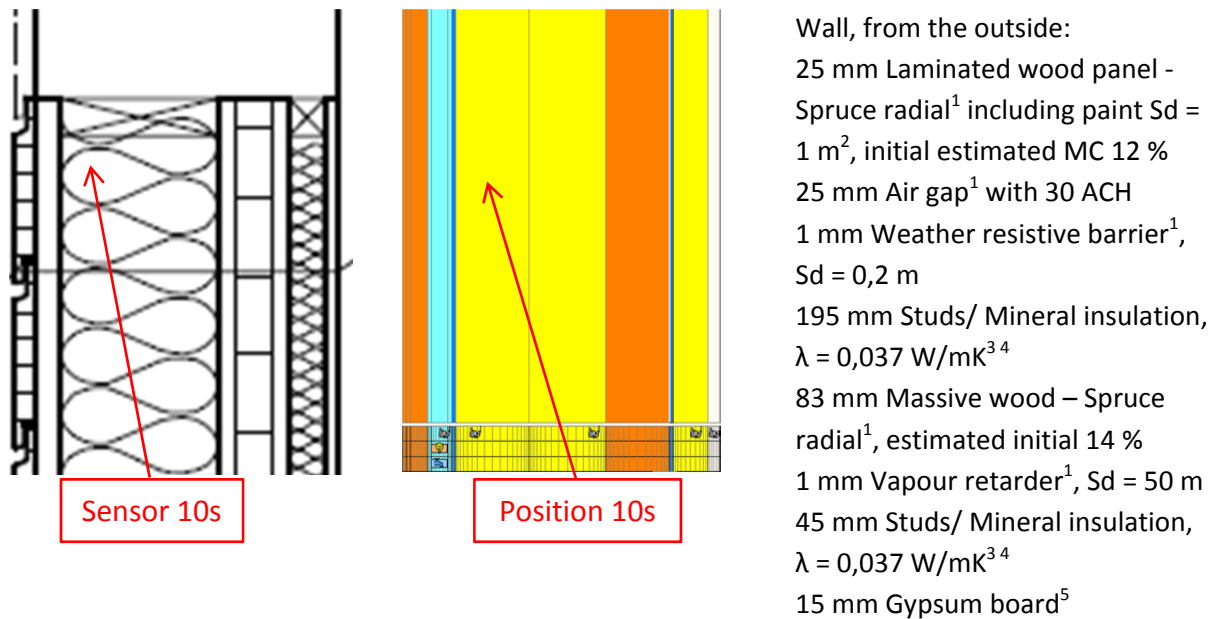

Figure 7.10.1. Vertical cross sectional drawing and WUFI calculation model showing the studied position. 1. IBP, 2012, 2. Nevander, L-E., 1994, 3. IEA Annex 24, 1996, 4. Paroc, 2002, 5. Krus, M., 1996.

A perfect match between the measured and calculated values cannot be expected due to e.g. the influence of two- and three-dimensional effects and the accuracy of the sensors.

Year 2009

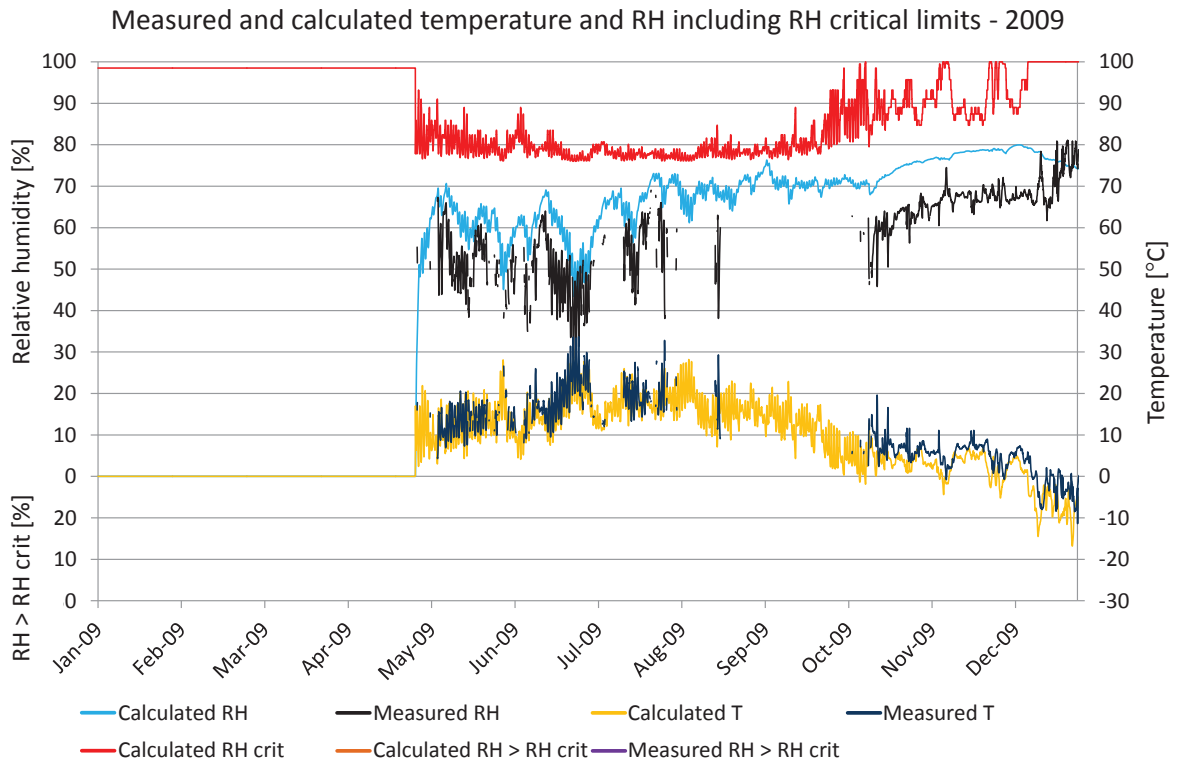

Figure 7.10.2. Comparisons between measured and calculated temperature and relative humidity. Calculated temperature (yellow), measured temperature (dark blue), calculated RH (turquoise), measured RH (black), RH_{crit} for calculated values (red), calculated RH > RH_{crit} (light brown), measured RH > RH_{crit} (purple).

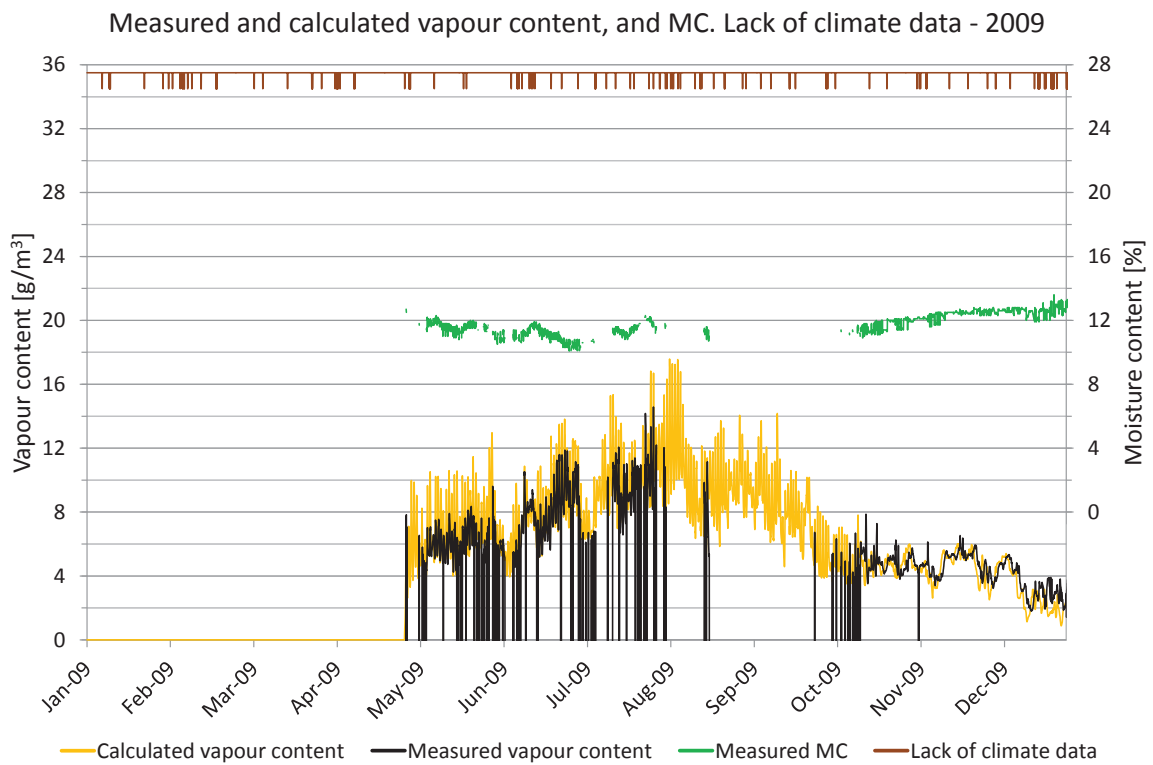

Figure 7.10.3. Measured moisture content, periods lacking climate data and comparisons of vapour content. Vapour content for calculated values (yellow) and measured values (black). Moisture content (green), periods with lack of climate data (brown).

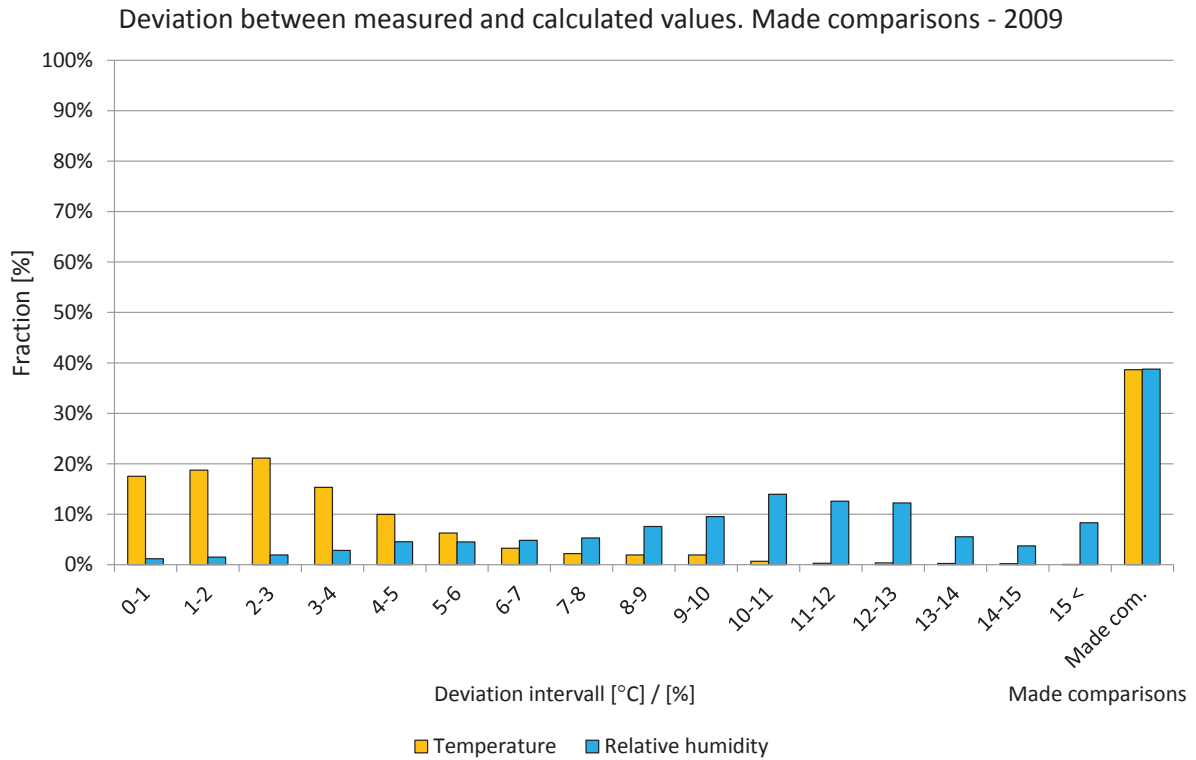

Figure 7.10.4. Deviations in comparisons shown in intervals from 0 to 15 °C or %. The two right-hand bars show the percentage of comparisons during the year. Temperature (yellow) and relative humidity (light blue).

Year 2010

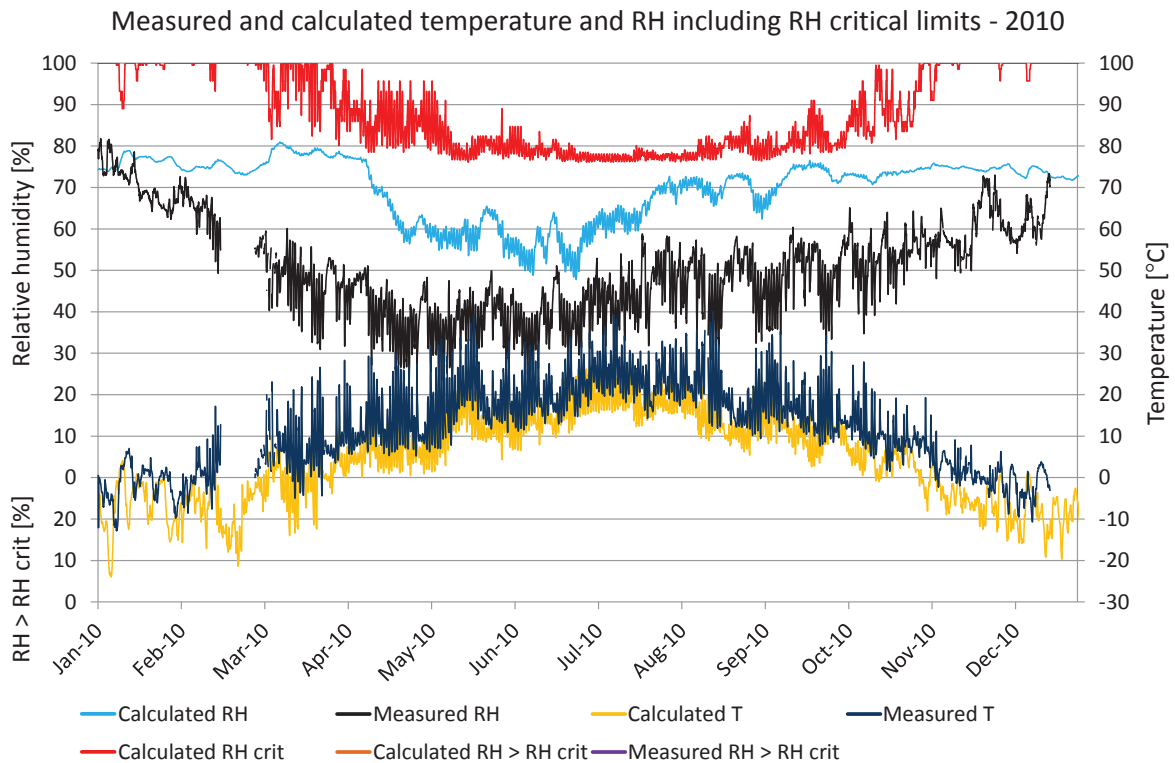

Figure 7.10.5. Comparisons between measured and calculated temperature and relative humidity. Calculated temperature (yellow), measured temperature (dark blue), calculated RH (turquoise), measured RH (black), RH_{crit} for calculated values (red), calculated $RH > RH_{crit}$ (light brown), measured $RH > RH_{crit}$ (purple).

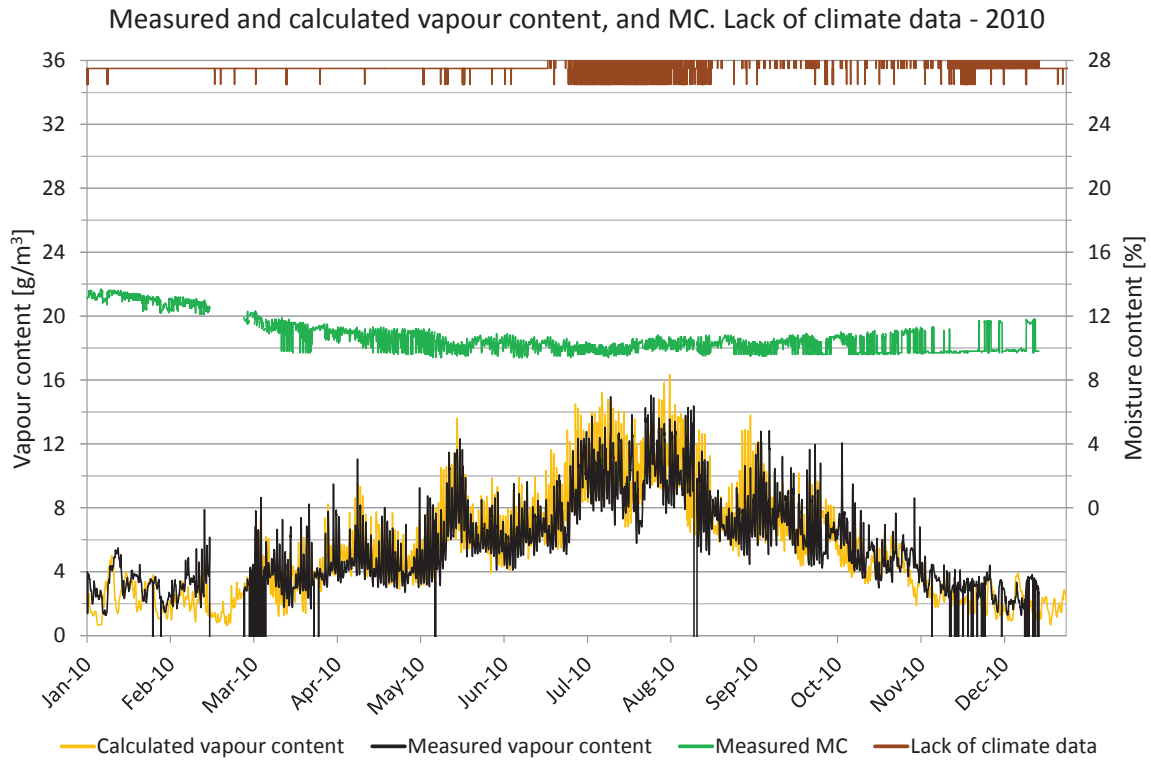

Figure 7.10.6. Measured moisture content, periods lacking climate data and comparisons of vapour content. Vapour content for calculated values (yellow) and measured values (black). Moisture content (green), periods with lack of climate data (brown).

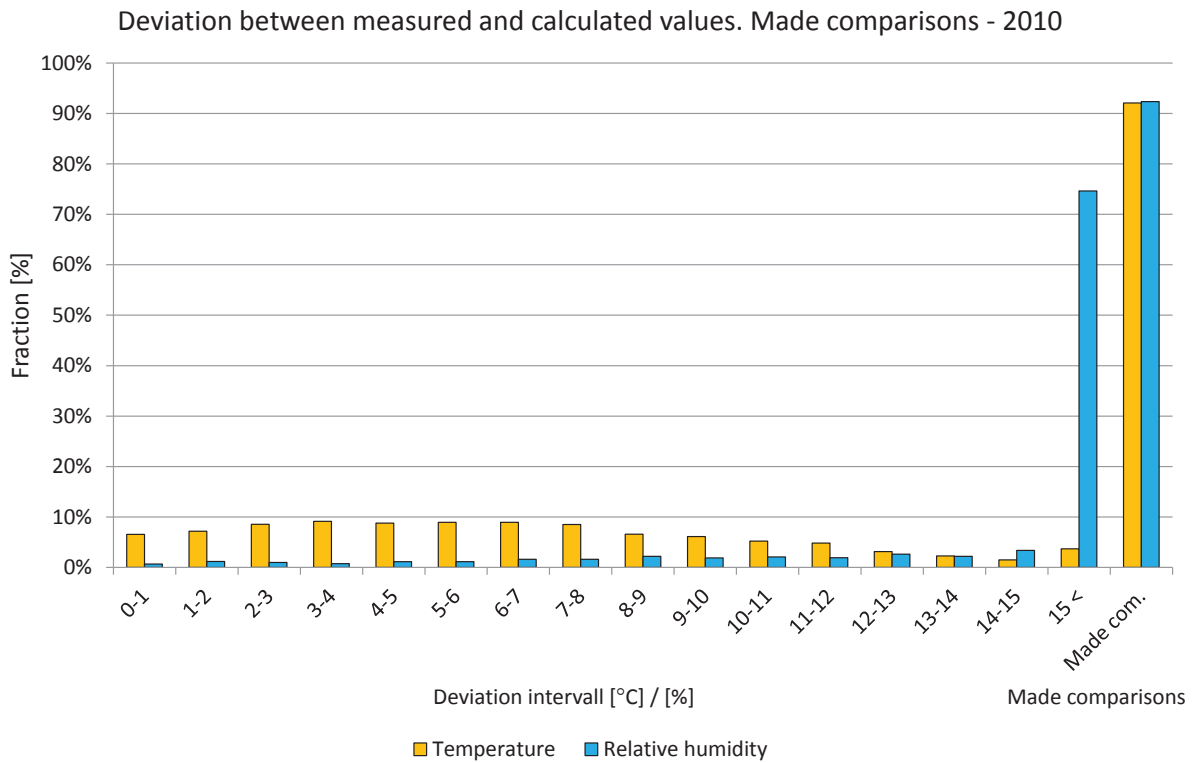

Figure 7.10.7. Deviations in comparisons shown in intervals from 0 to 15 °C or %. The two right-hand bars show the percentage of comparisons during the year. Temperature (yellow) and relative humidity (light blue).

Year 2011

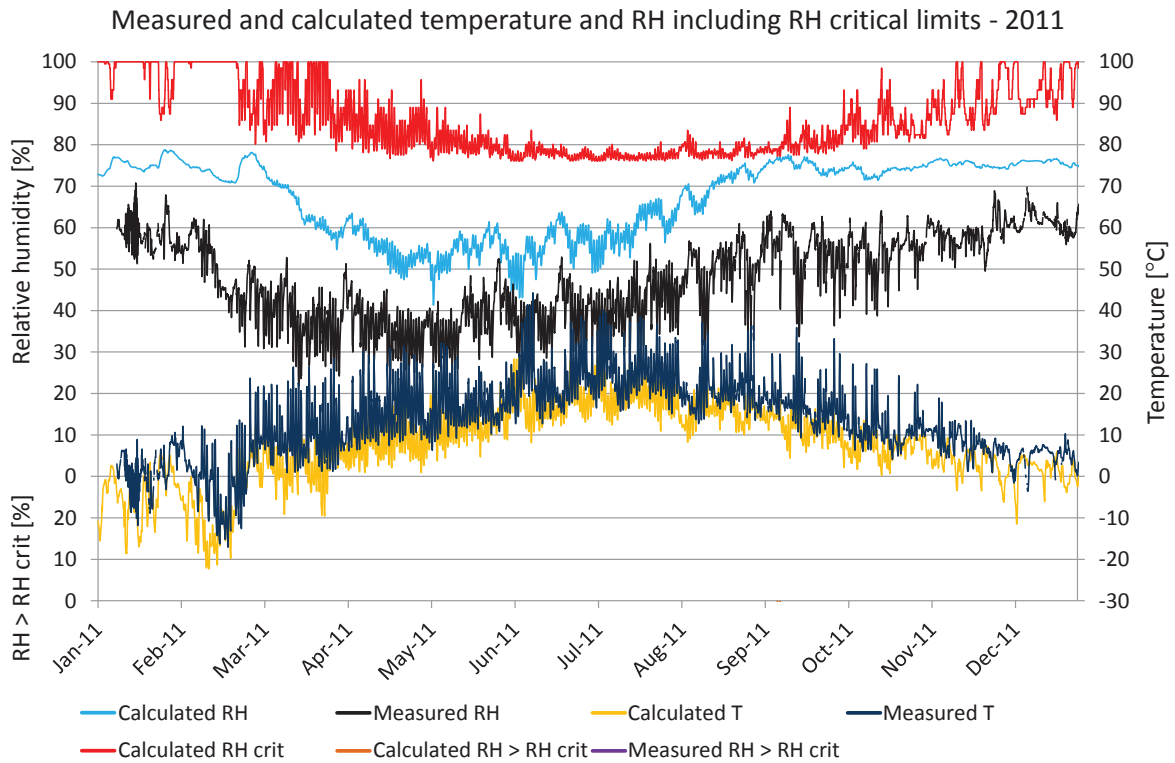

Figure 7.10.8. Comparisons between measured and calculated temperature and relative humidity. Calculated temperature (yellow), measured temperature (dark blue), calculated RH (turquoise), measured RH (black), RH_{crit} for calculated values (red), calculated RH > RH_{crit} (light brown), measured RH > RH_{crit} (purple).

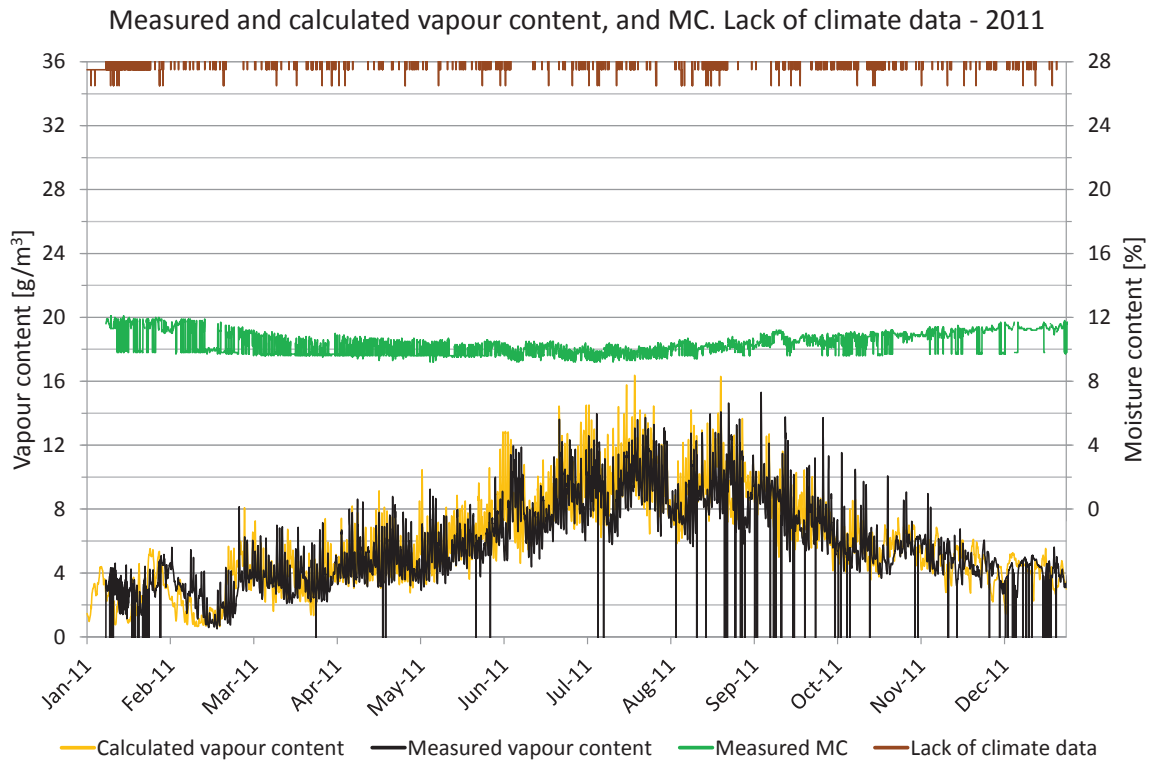

Figure 7.10.9. Measured moisture content, periods lacking climate data and comparisons of vapour content. Vapour content for calculated values (yellow) and measured values (black). Moisture content (green), periods with lack of climate data (brown).

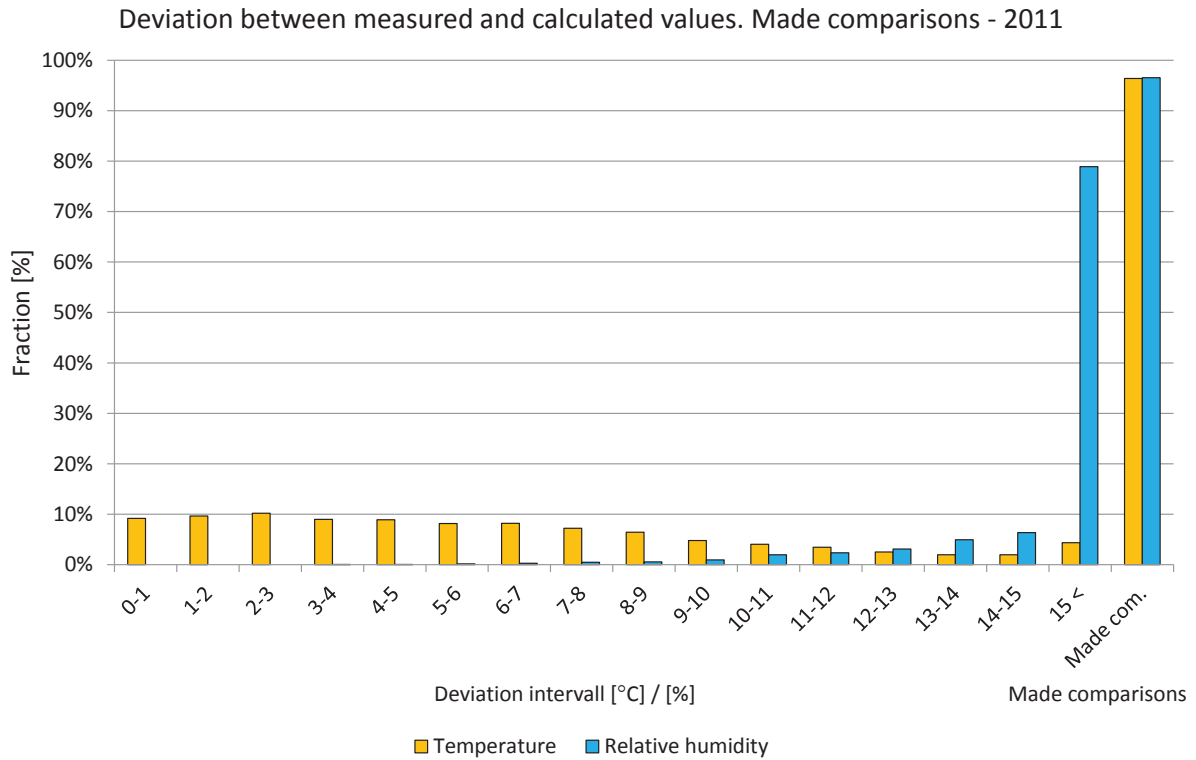

Figure 7.10.10. Deviations in comparisons shown in intervals from 0 to 15 °C or %. The two right-hand bars show the percentage of comparisons during the year. Temperature (yellow) and relative humidity (light blue).

7.11 Position 11v

The locations of the measured and calculated position are shown in the drawings and figures below. The studied position is located below a window in a wall that is facing west on the sixth floor.

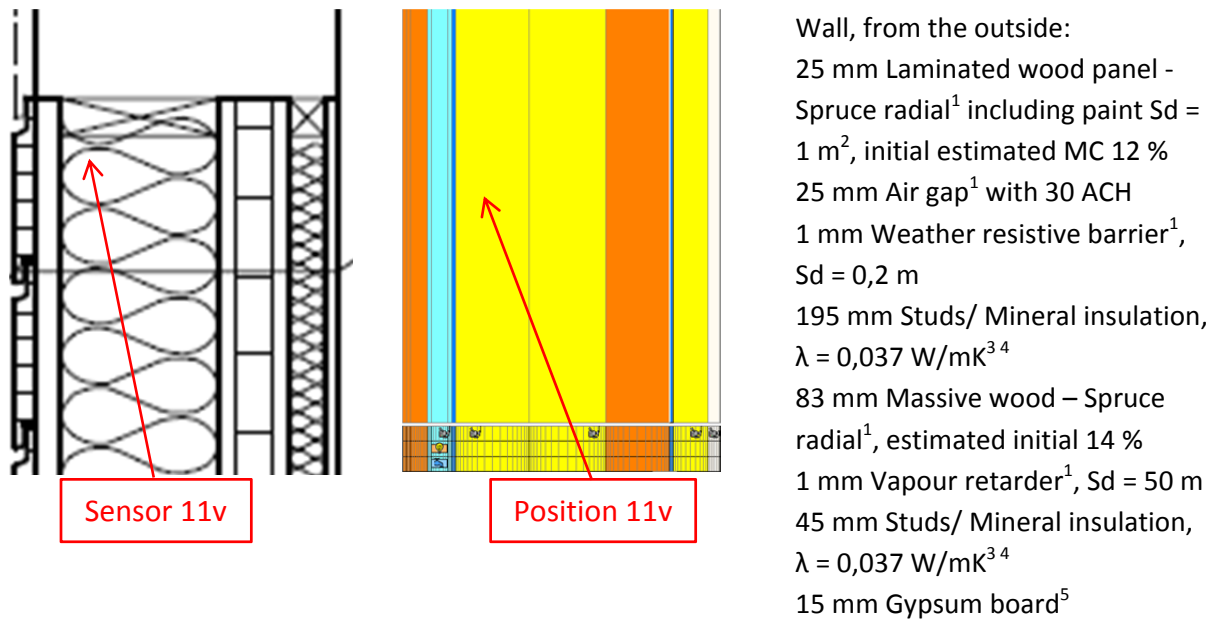

Figure 7.11.1. Vertical cross sectional drawing and WUFI calculation model showing the studied position. 1. IBP, 2012, 2. Nevander, L-E., 1994, 3. IEA Annex 24, 1996, 4. Paroc, 2002, 5. Krus, M., 1996.

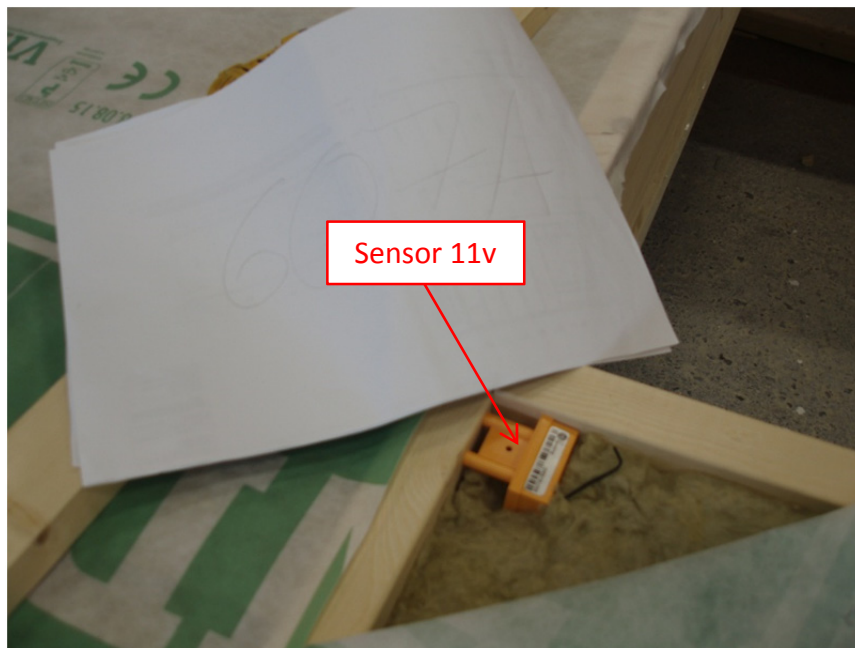

Figure 7.11.2. Location of the studied position. Photo: SP Trä Skellefteå.

A perfect match between the measured and calculated values cannot be expected due to e.g. the influence of two- and three-dimensional effects and the accuracy of the sensors.

Year 2009

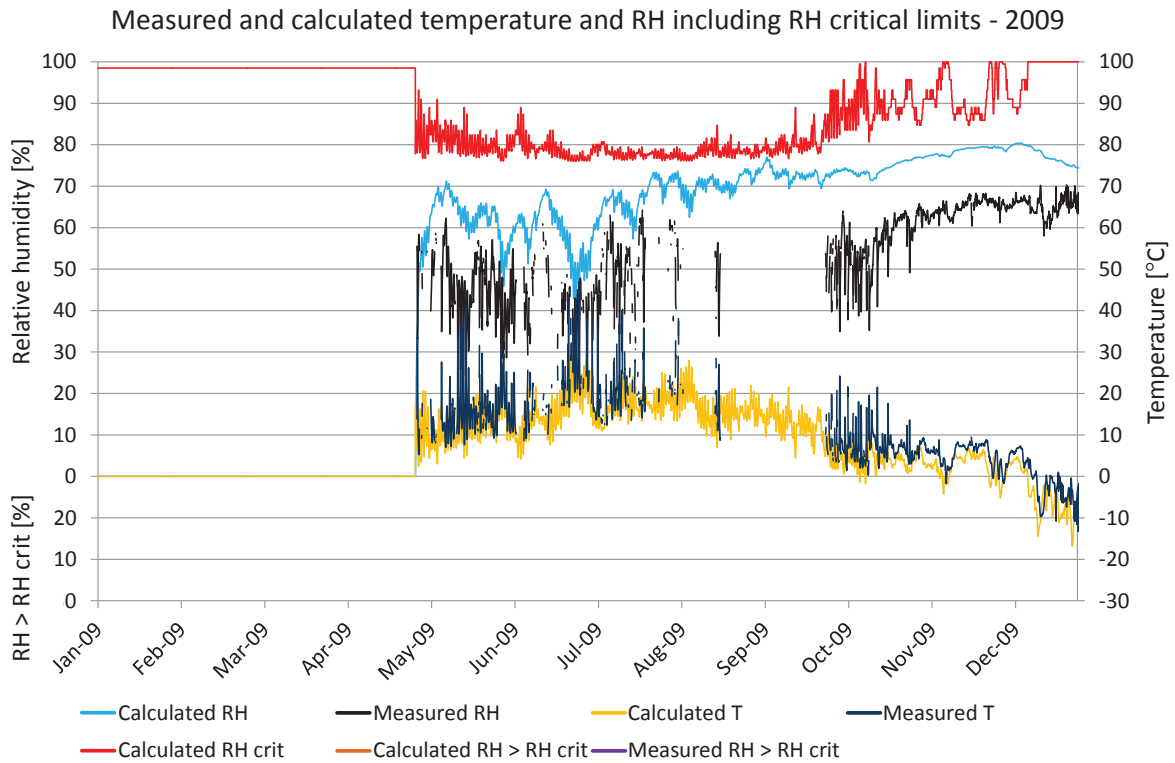

Figure 7.11.3. Comparisons between measured and calculated temperature and relative humidity. Calculated temperature (yellow), measured temperature (dark blue), calculated RH (turquoise), measured RH (black), RH_{crit} for calculated values (red), calculated $RH > RH_{crit}$ (light brown), measured $RH > RH_{crit}$ (purple).

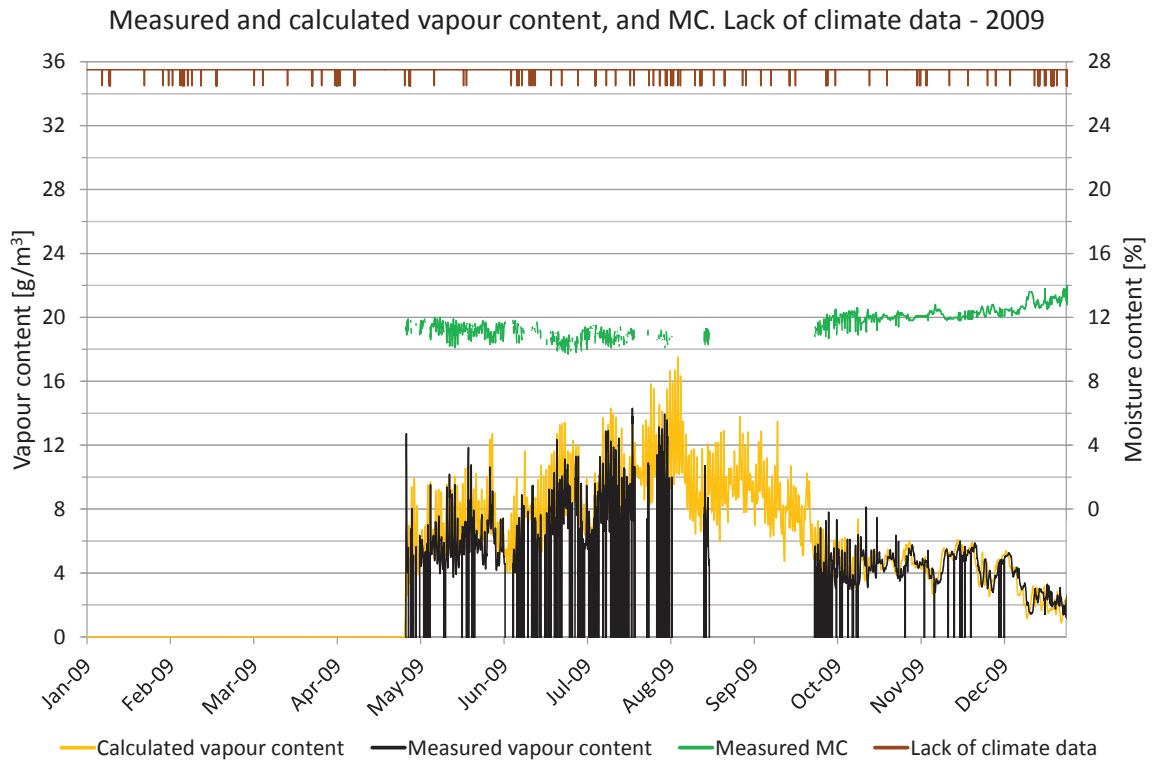

Figure 7.11.4. Measured moisture content, periods lacking climate data and comparisons of vapour content. Vapour content for calculated values (yellow) and measured values (black). Moisture content (green), periods with lack of climate data (brown).

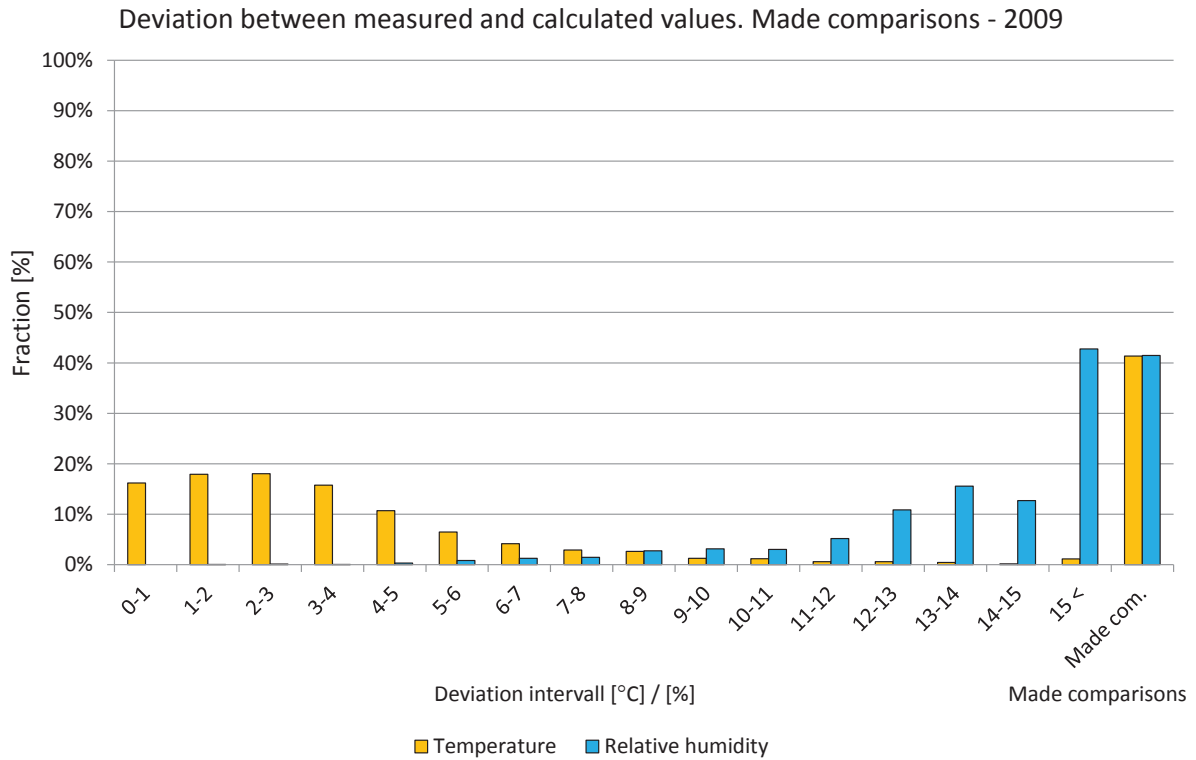

Figure 7.11.5. Deviations in comparisons shown in intervals from 0 to 15 °C or %. The two right-hand bars show the percentage of comparisons during the year. Temperature (yellow) and relative humidity (light blue).

Year 2010

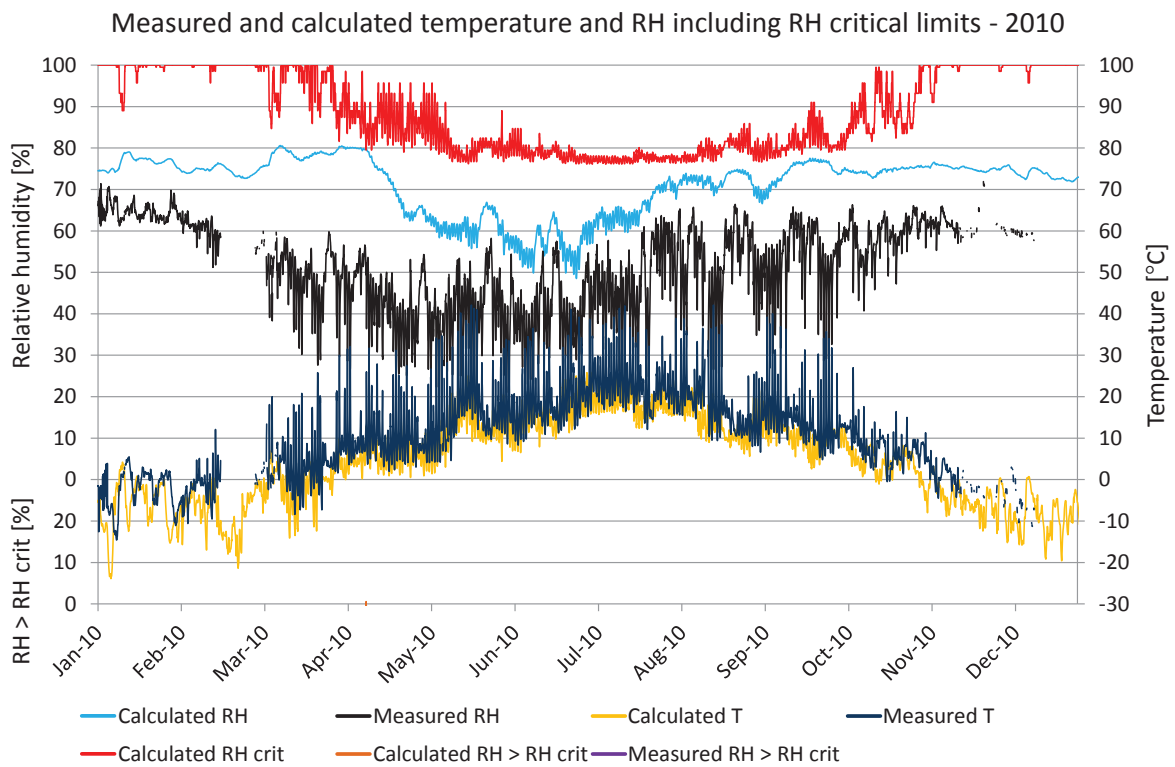

Figure 7.11.6. Comparisons between measured and calculated temperature and relative humidity. Calculated temperature (yellow), measured temperature (dark blue), calculated RH (turquoise), measured RH (black), RH_{crit} for calculated values (red), calculated $RH > RH_{crit}$ (light brown), measured $RH > RH_{crit}$ (purple).

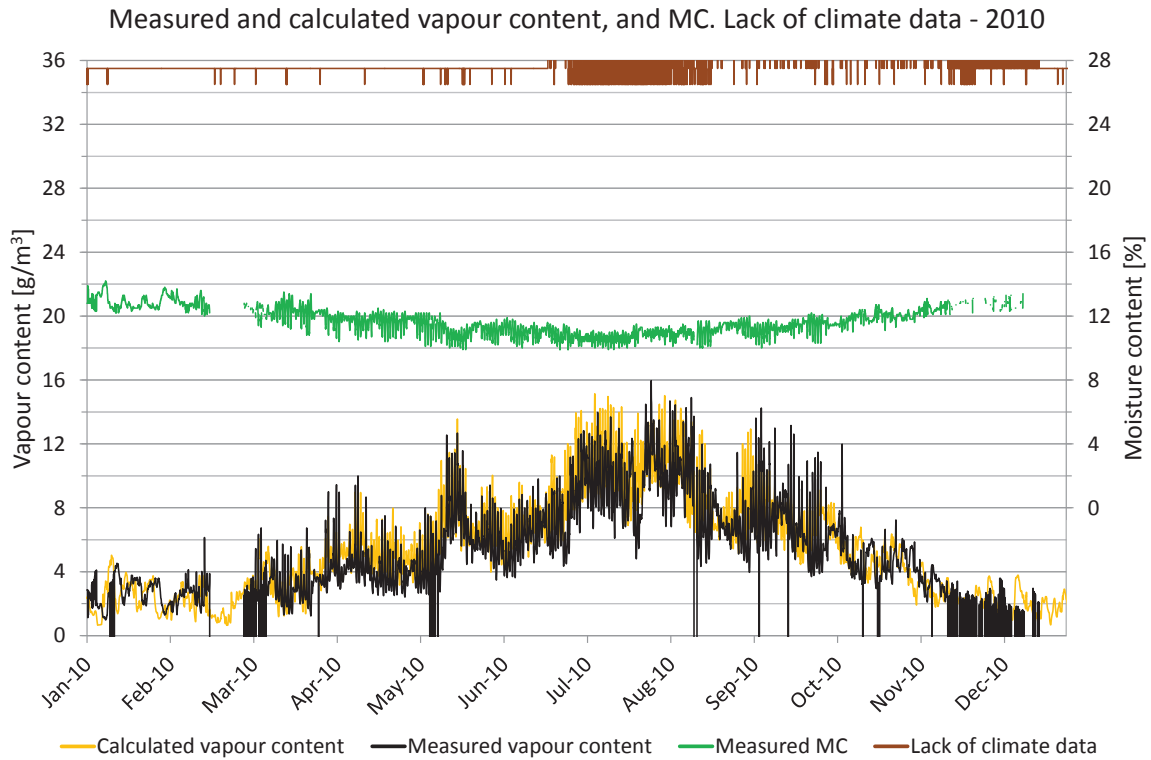

Figure 7.11.7. Measured moisture content, periods lacking climate data and comparisons of vapour content. Vapour content for calculated values (yellow) and measured values (black). Moisture content (green), periods with lack of climate data (brown).

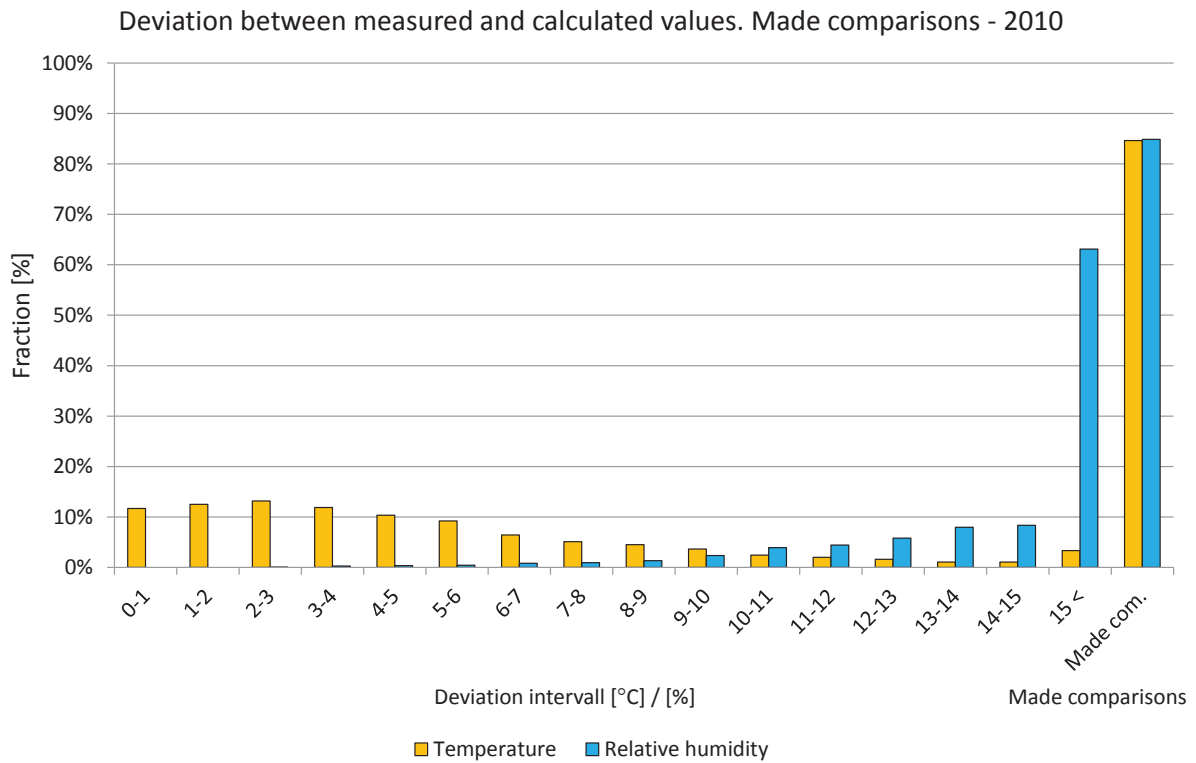

Figure 7.11.8. Deviations in comparisons shown in intervals from 0 to 15 °C or %. The two right-hand bars show the percentage of comparisons during the year. Temperature (yellow) and relative humidity (light blue).

Year 2011

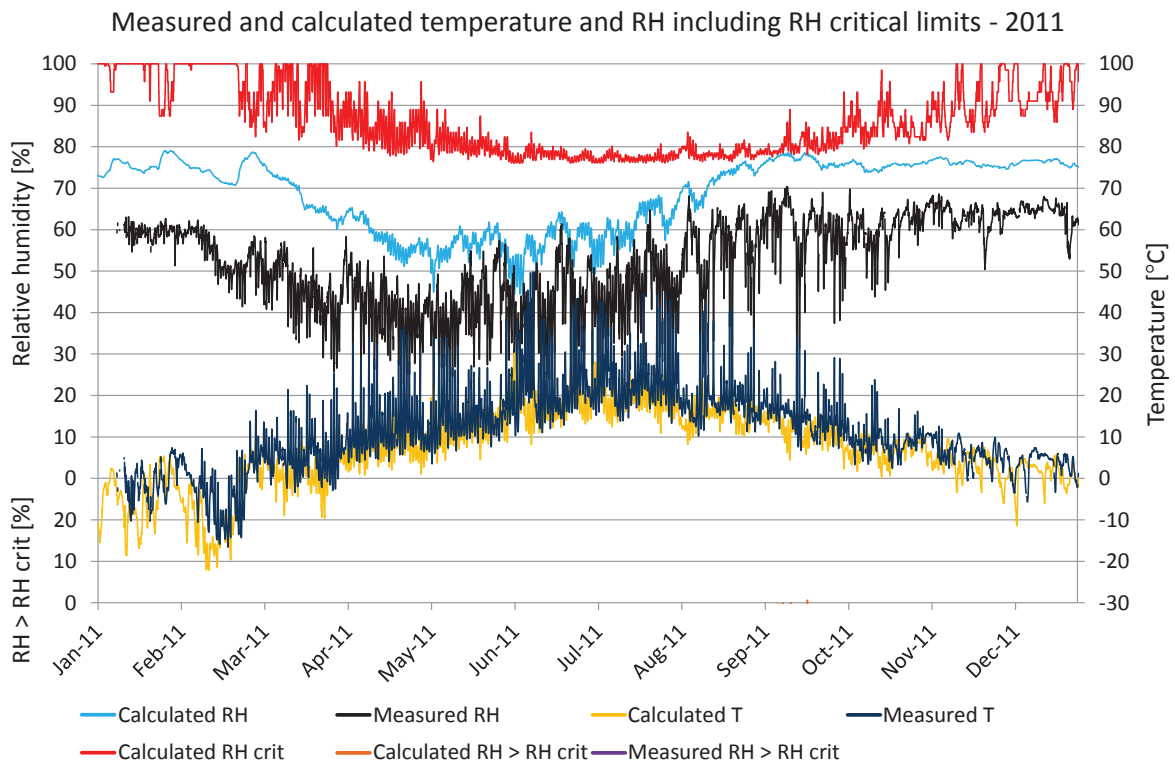

Figure 7.11.9. Comparisons between measured and calculated temperature and relative humidity. Calculated temperature (yellow), measured temperature (dark blue), calculated RH (turquoise), measured RH (black), RH_{crit} for calculated values (red), calculated $RH > RH_{crit}$ (light brown), measured $RH > RH_{crit}$ (purple).

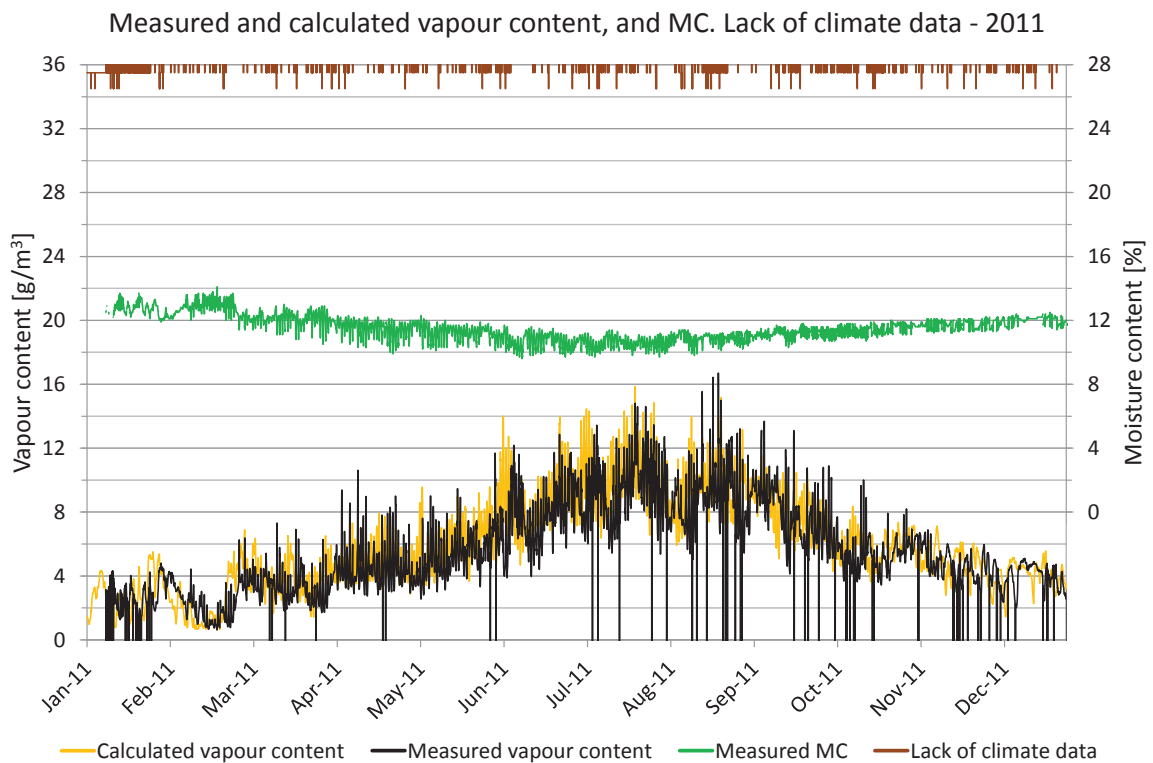

Figure 7.11.10. Measured moisture content, periods lacking climate data and comparisons of vapour content. Vapour content for calculated values (yellow) and measured values (black). Moisture content (green), periods with lack of climate data (brown).

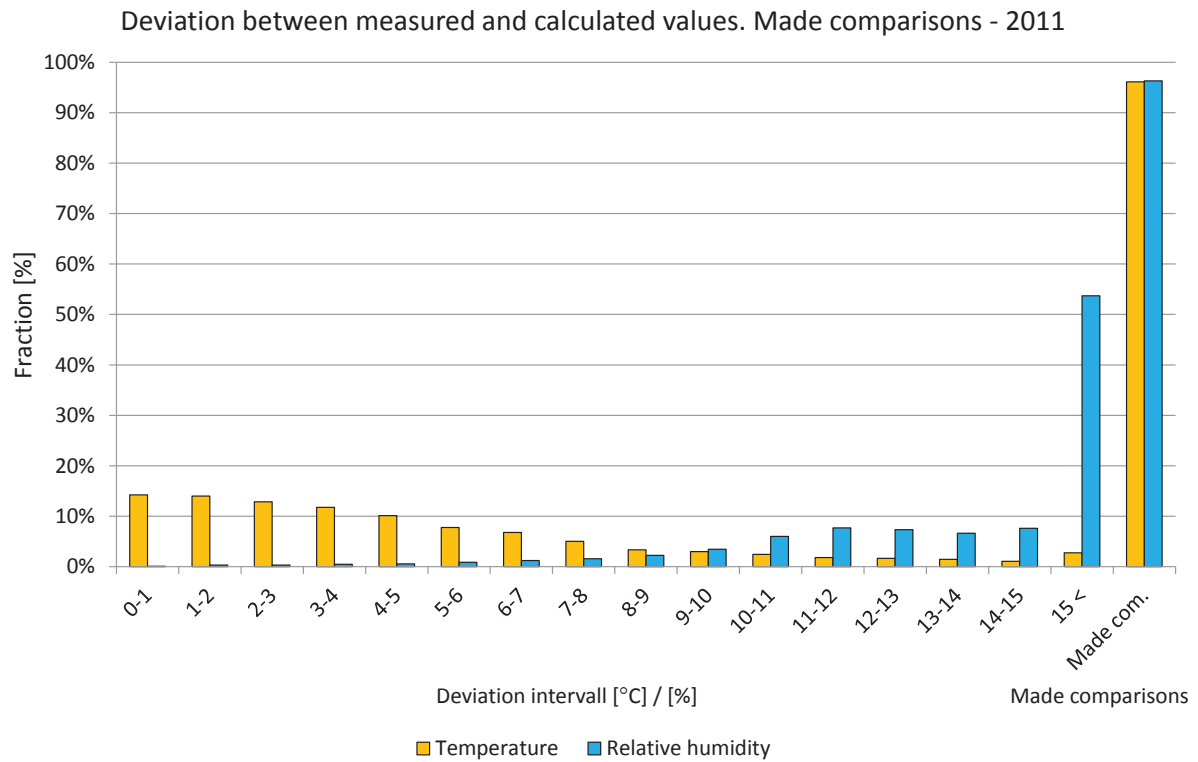

Figure 7.11.11. Deviations in comparisons shown in intervals from 0 to 15 °C or %. The two right-hand bars show the percentage of comparisons during the year. Temperature (yellow) and relative humidity (light blue).

7.13 Position 13v

The locations of the measured and calculated position are shown in the drawings and figures below. The studied position is located below a window in a wall that is facing west on the fourth floor.

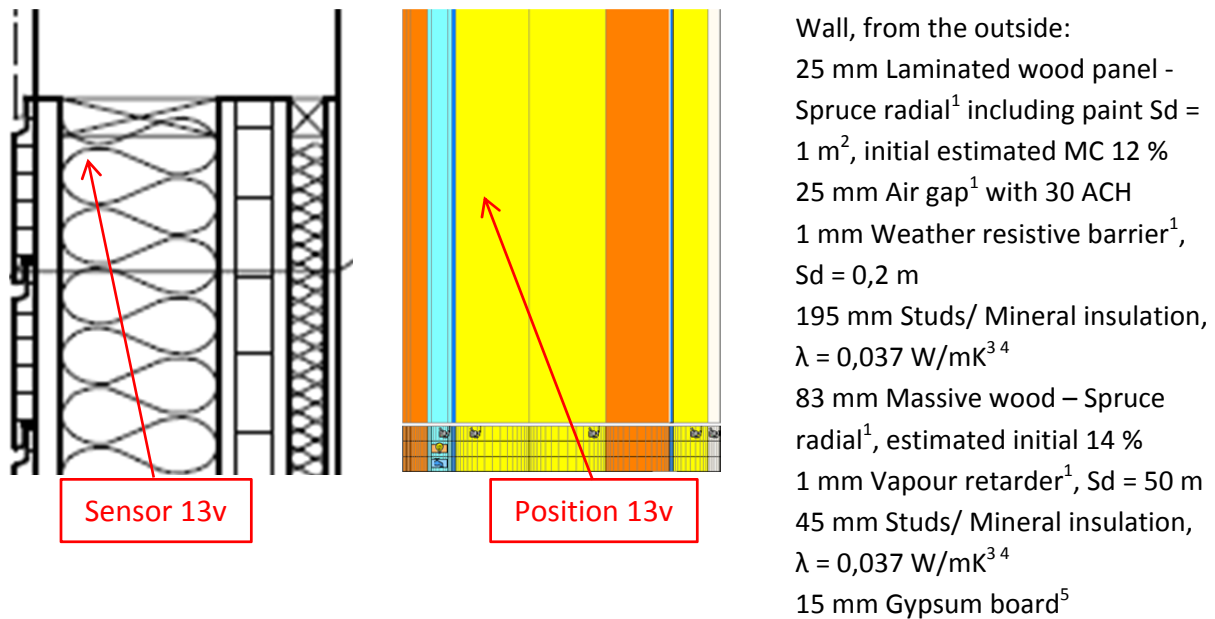

Figure 7.13.1. Vertical cross sectional drawing and WUFI calculation model showing the studied position. 1. IBP, 2012, 2. Nevander, L-E., 1994, 3. IEA Annex 24, 1996, 4. Paroc, 2002, 5. Krus, M., 1996.

A perfect match between the measured and calculated values cannot be expected due to e.g. the influence of two- and three-dimensional effects and the accuracy of the sensors.

Year 2009

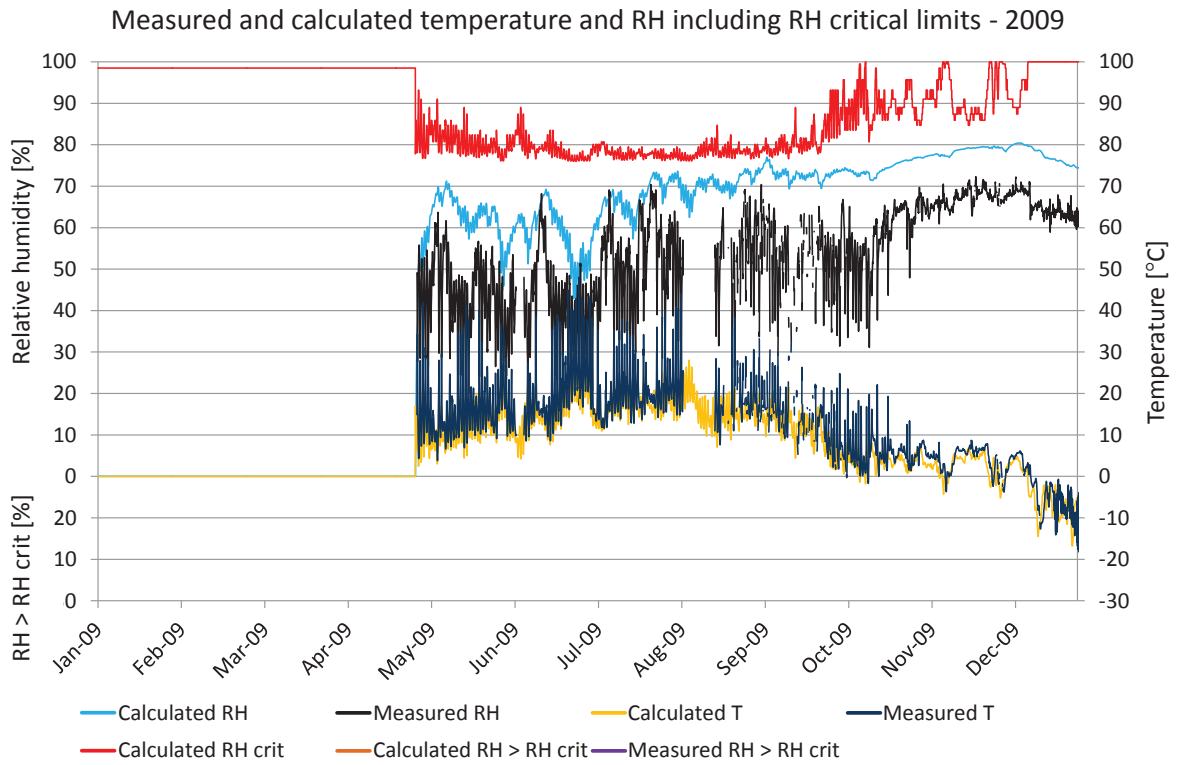

Figure 7.13.2. Comparisons between measured and calculated temperature and relative humidity. Calculated temperature (yellow), measured temperature (dark blue), calculated RH (turquoise), measured RH (black), RH_{crit} for calculated values (red), calculated RH > RH_{crit} (light brown), measured RH > RH_{crit} (purple).

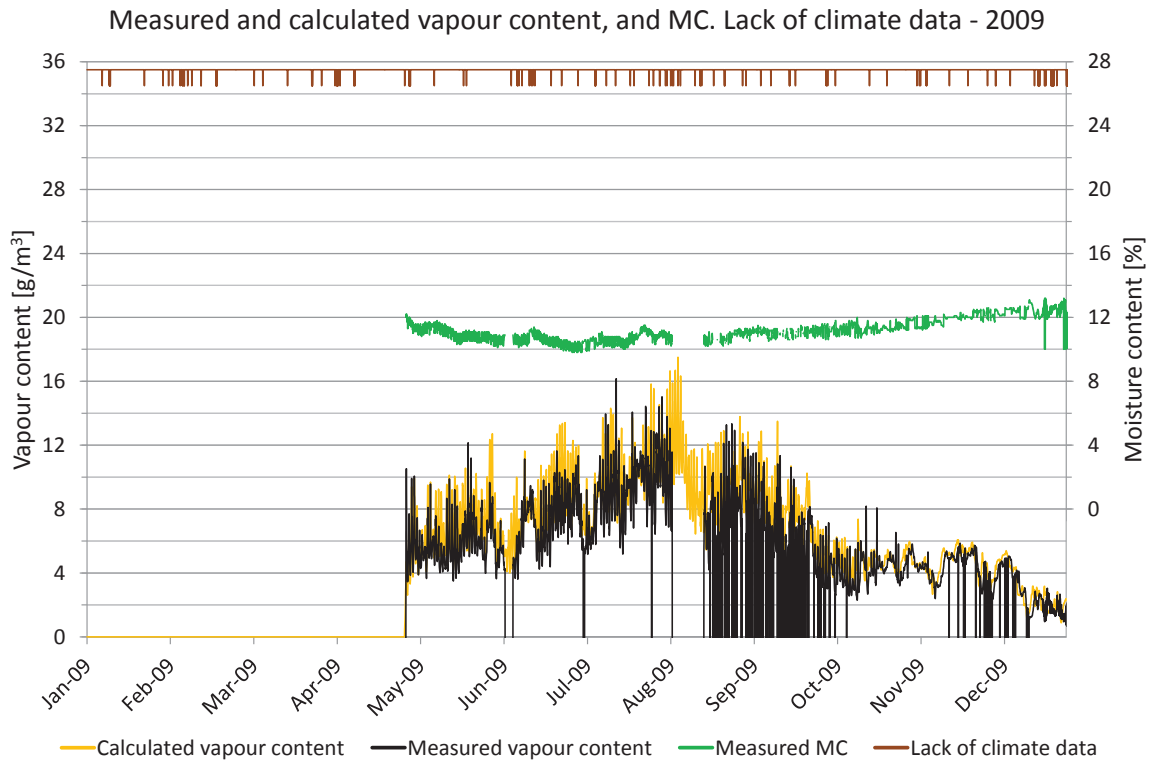

Figure 7.13.3. Measured moisture content, periods lacking climate data and comparisons of vapour content. Vapour content for calculated values (yellow) and measured values (black). Moisture content (green), periods with lack of climate data (brown).

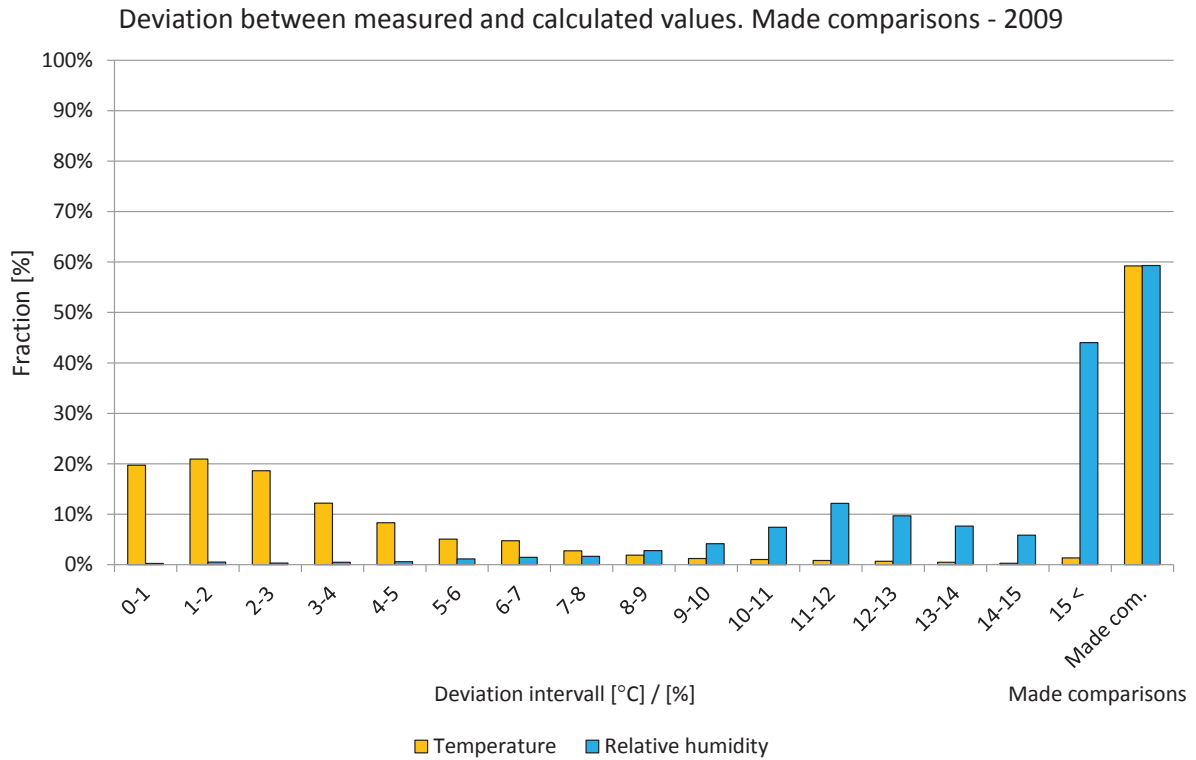

Figure 7.13.4. Deviations in comparisons shown in intervals from 0 to 15 °C or %. The two right-hand bars show the percentage of comparisons during the year. Temperature (yellow) and relative humidity (light blue).

Year 2010

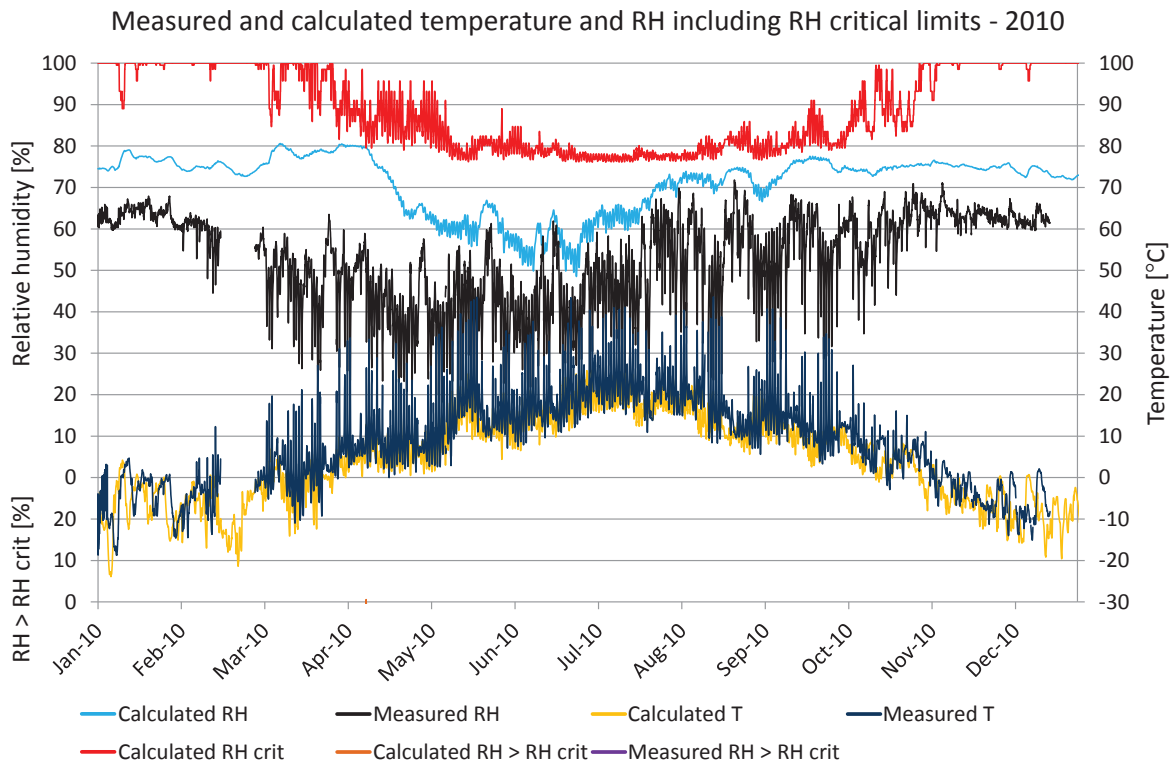

Figure 7.13.5. Comparisons between measured and calculated temperature and relative humidity. Calculated temperature (yellow), measured temperature (dark blue), calculated RH (turquoise), measured RH (black), RH_{crit} for calculated values (red), calculated $RH > RH_{crit}$ (light brown), measured $RH > RH_{crit}$ (purple).

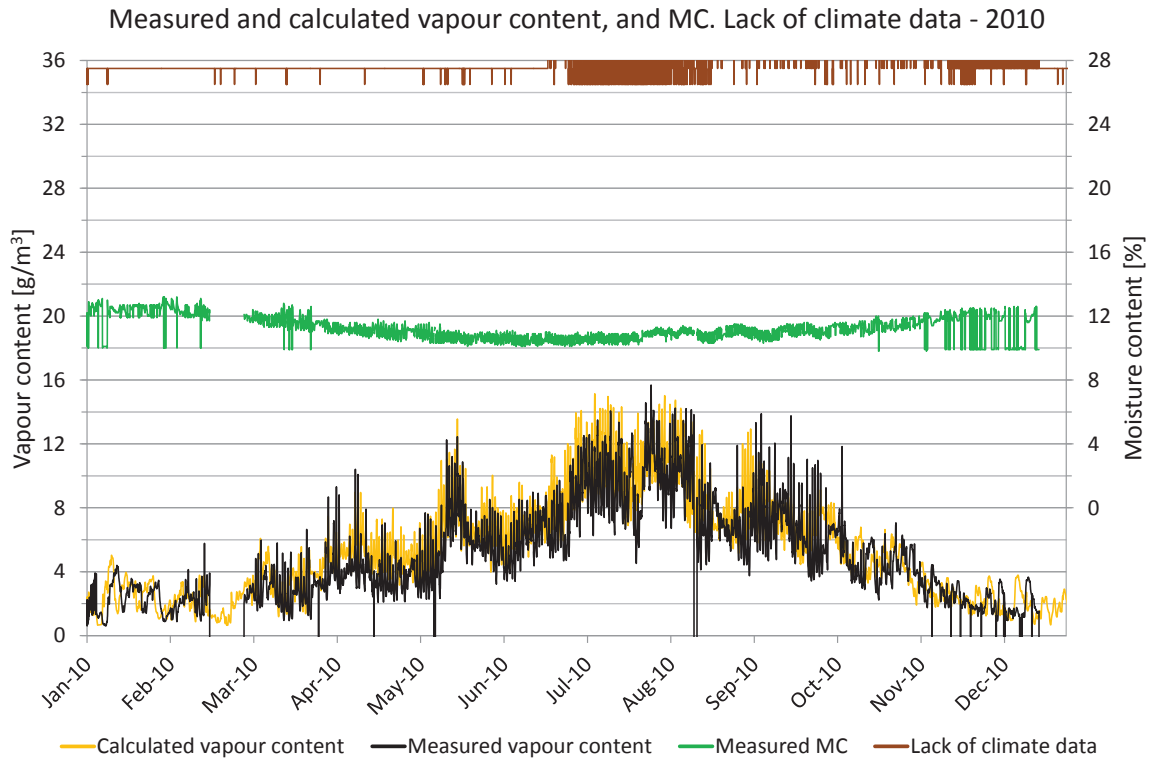

Figure 7.13.6. Measured moisture content, periods lacking climate data and comparisons of vapour content. Vapour content for calculated values (yellow) and measured values (black). Moisture content (green), periods with lack of climate data (brown).

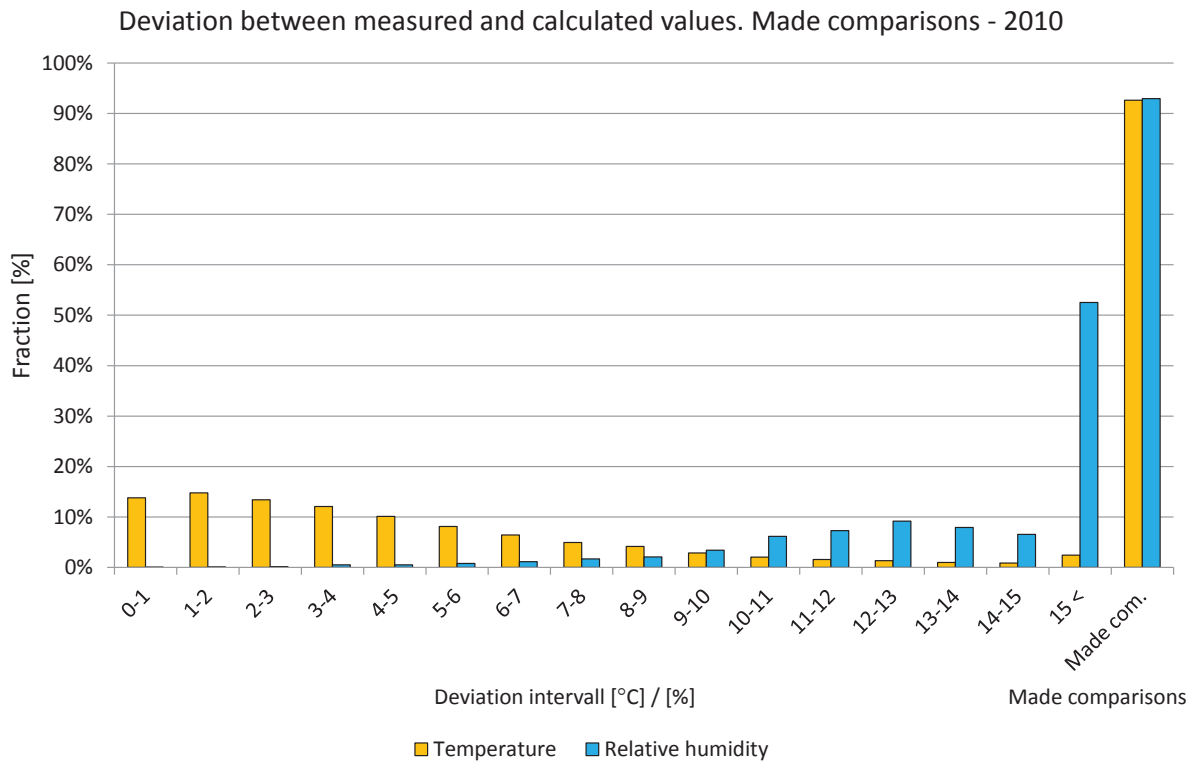

Figure 7.13.7. Deviations in comparisons shown in intervals from 0 to 15 °C or %. The two right-hand bars show the percentage of comparisons during the year. Temperature (yellow) and relative humidity (light blue).

Year 2011

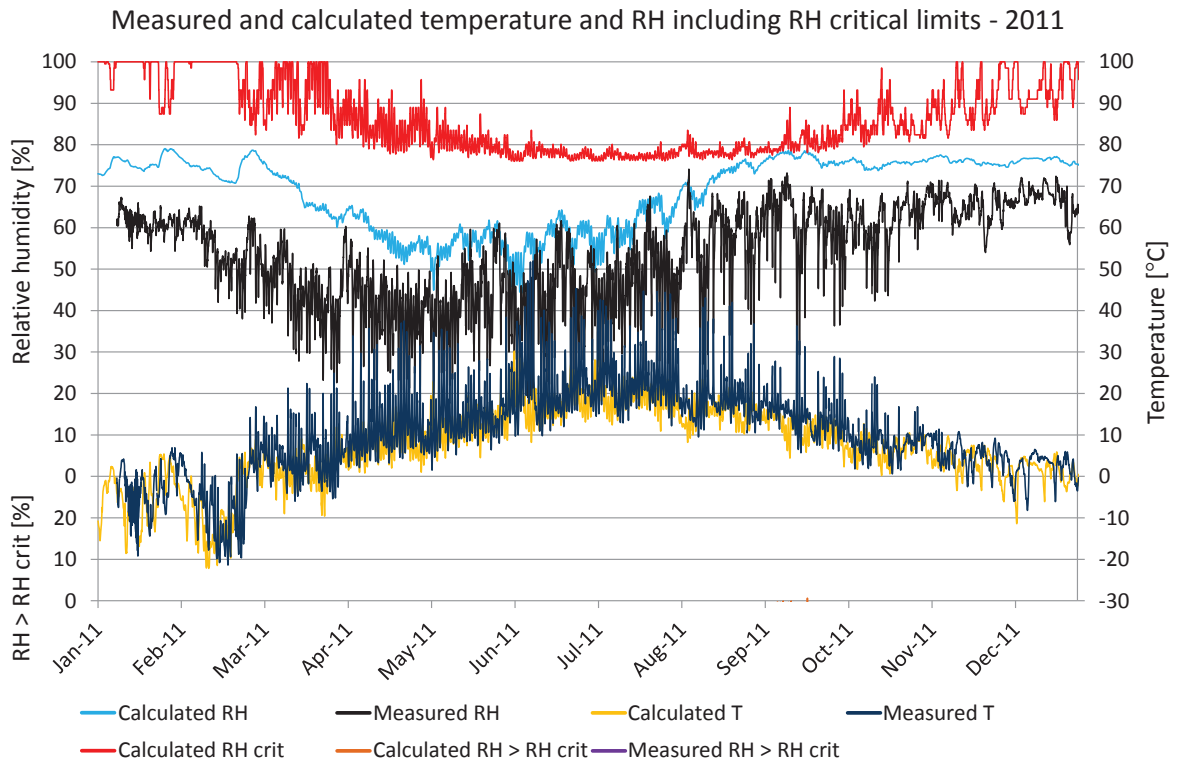

Figure 7.13.8. Comparisons between measured and calculated temperature and relative humidity. Calculated temperature (yellow), measured temperature (dark blue), calculated RH (turquoise), measured RH (black), RH_{crit} for calculated values (red), calculated $RH > RH_{crit}$ (light brown), measured $RH > RH_{crit}$ (purple).

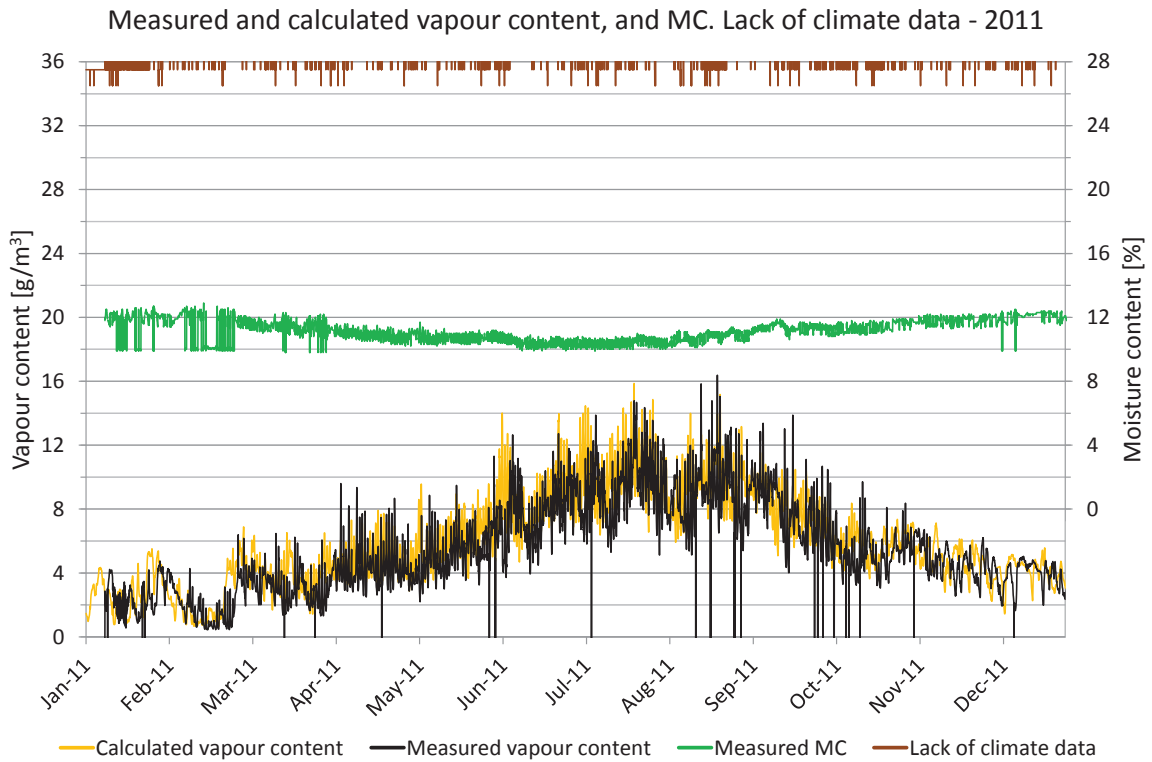

Figure 7.13.9. Measured moisture content, periods lacking climate data and comparisons of vapour content. Vapour content for calculated values (yellow) and measured values (black). Moisture content (green), periods with lack of climate data (brown).

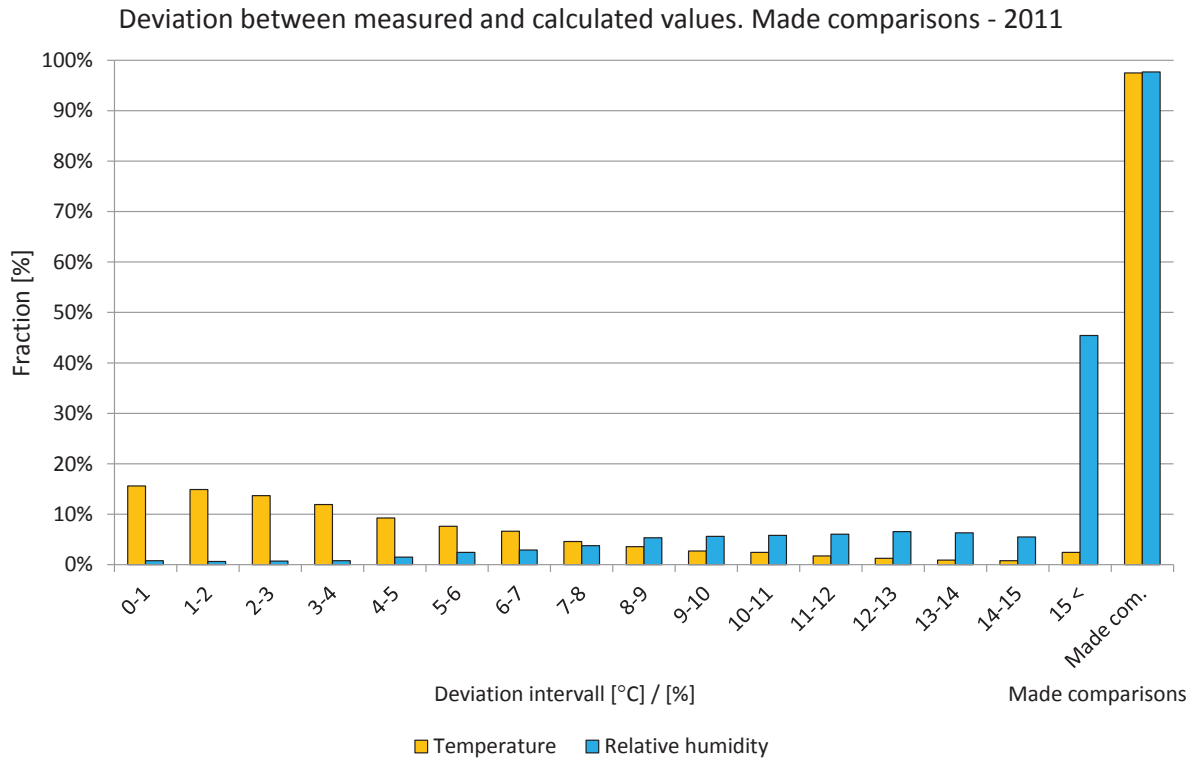

Figure 7.13.10. Deviations in comparisons shown in intervals from 0 to 15 °C or %. The two right-hand bars show the percentage of comparisons during the year. Temperature (yellow) and relative humidity (light blue).

7.14 Position 14ö

The locations of the measured and calculated position are shown in the drawings and figures below. The studied position is located below a window in a wall that is facing east on the sixth floor.

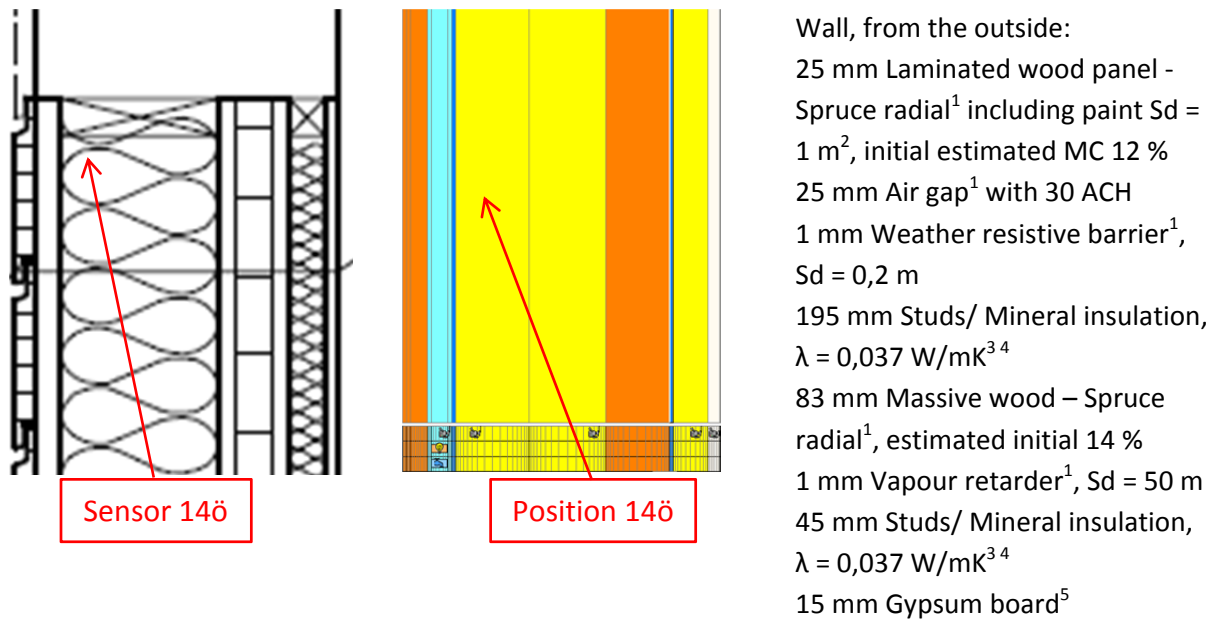

Figure 7.14.1. Vertical cross sectional drawing and WUFI calculation model showing the studied position. 1. IBP, 2012, 2. Nevander, L-E., 1994, 3. IEA Annex 24, 1996, 4. Paroc, 2002, 5. Krus, M., 1996.



Figure 7.14.2. Location of the studied position. Photo: SP Trä Skellefteå.

A perfect match between the measured and calculated values cannot be expected due to e.g. the influence of two- and three-dimensional effects and the accuracy of the sensors.

Year 2009

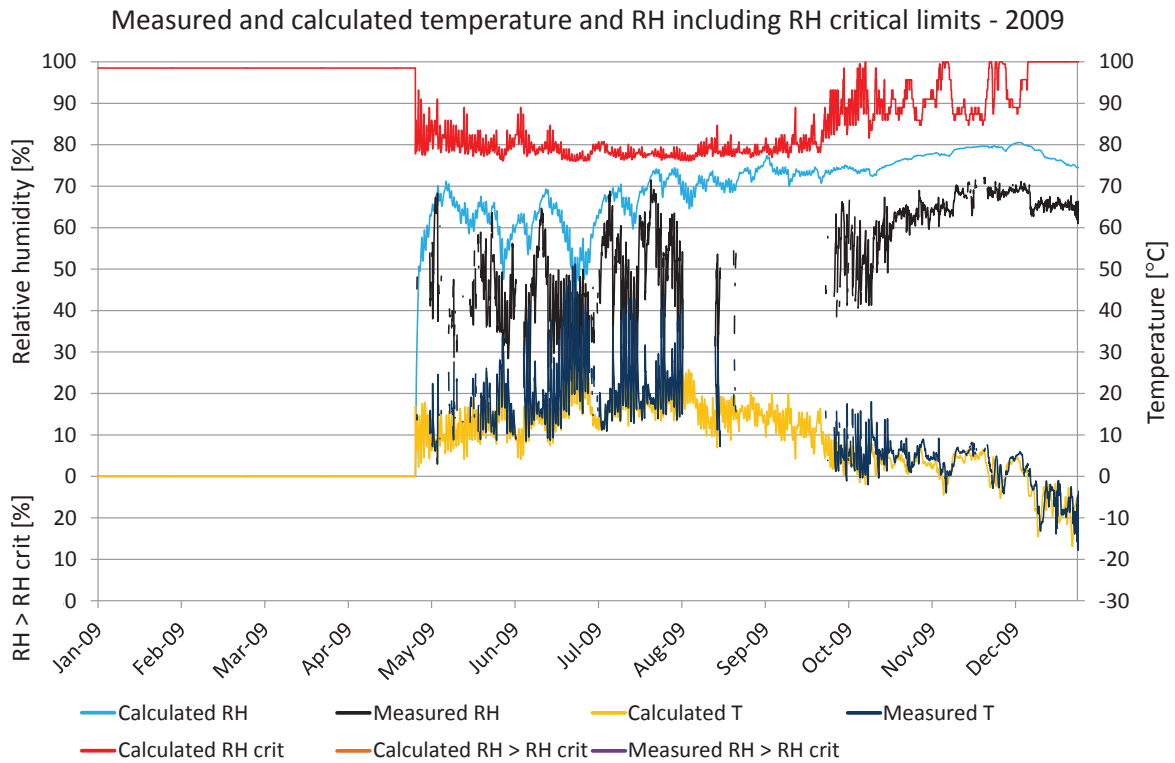

Figure 7.14.3. Comparisons between measured and calculated temperature and relative humidity. Calculated temperature (yellow), measured temperature (dark blue), calculated RH (turquoise), measured RH (black), RH_{crit} for calculated values (red), calculated $RH > RH_{crit}$ (light brown), measured $RH > RH_{crit}$ (purple).

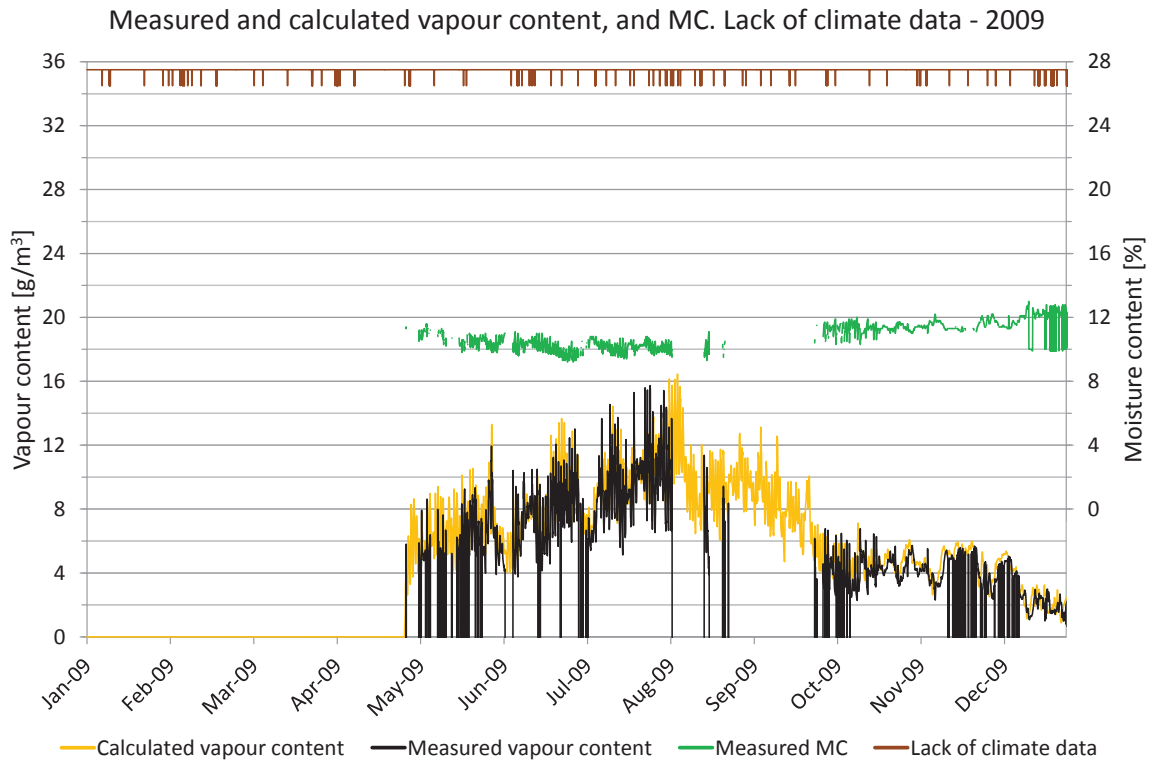

Figure 7.14.4. Measured moisture content, periods lacking climate data and comparisons of vapour content. Vapour content for calculated values (yellow) and measured values (black). Moisture content (green), periods with lack of climate data (brown).

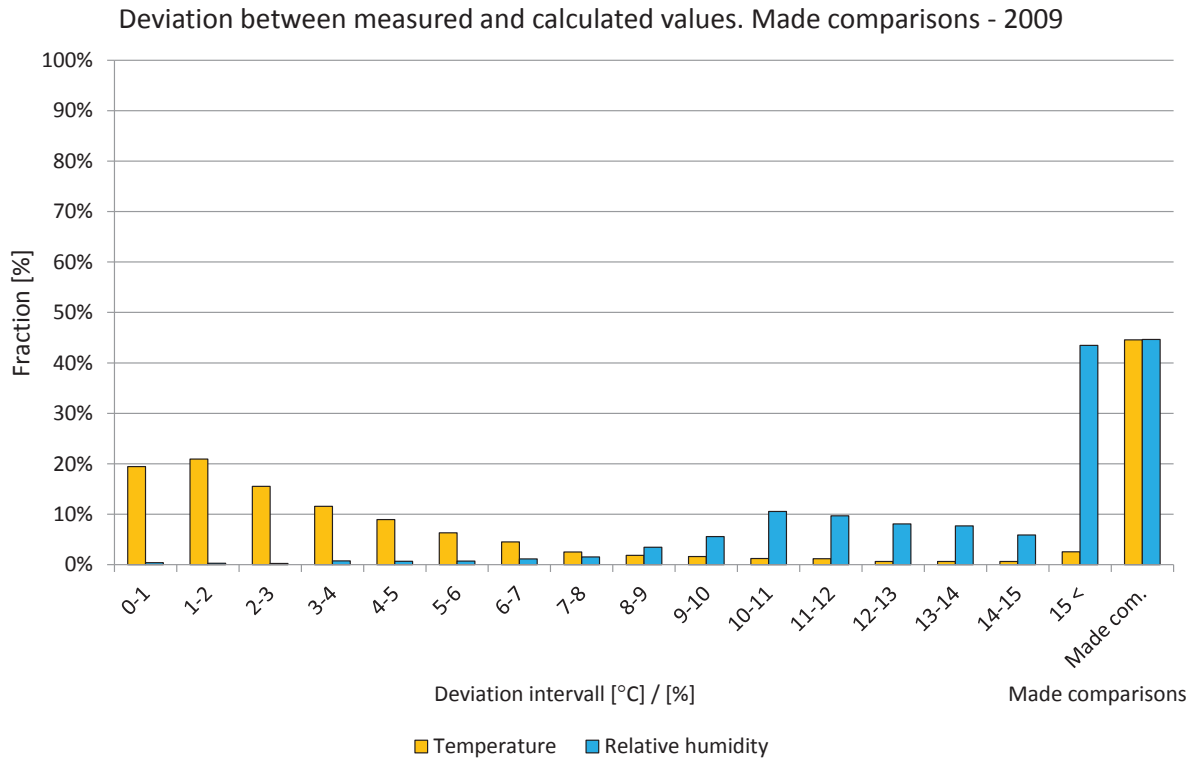

Figure 7.14.5. Deviations in comparisons shown in intervals from 0 to 15 °C or %. The two right-hand bars show the percentage of comparisons during the year. Temperature (yellow) and relative humidity (light blue).

Year 2010

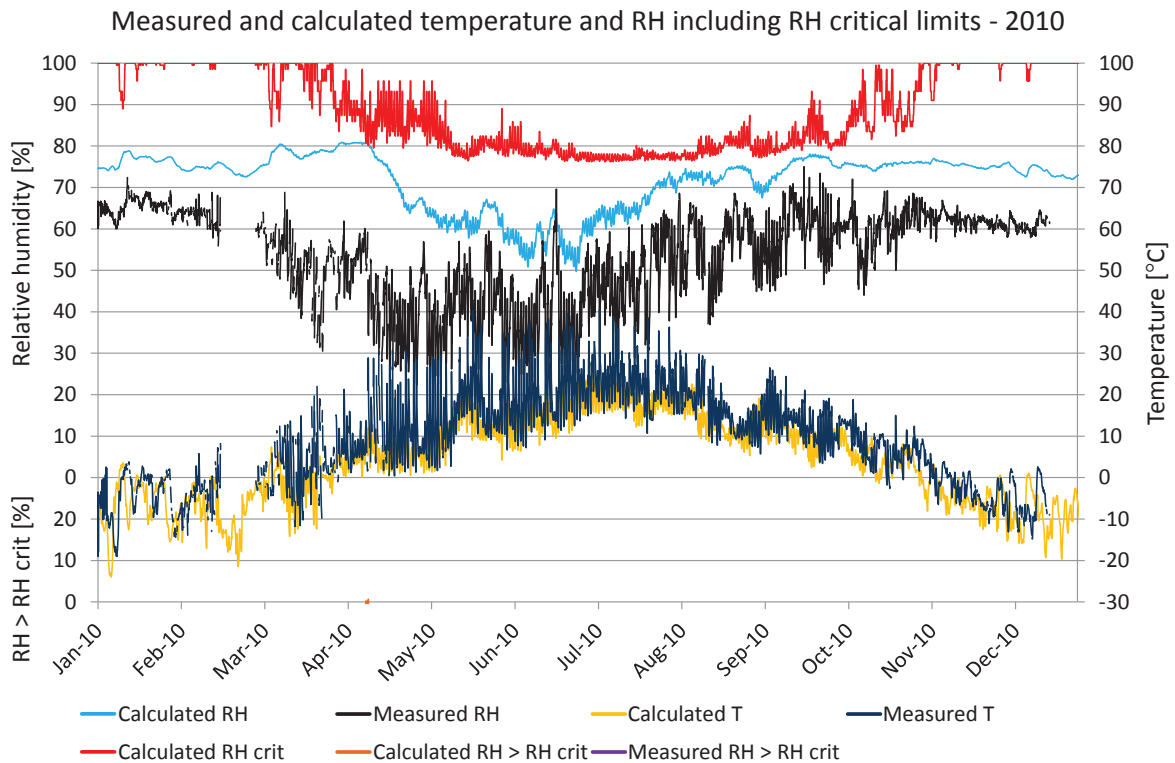

Figure 7.14.6. Comparisons between measured and calculated temperature and relative humidity. Calculated temperature (yellow), measured temperature (dark blue), calculated RH (turquoise), measured RH (black), RH_{crit} for calculated values (red), calculated $RH > RH_{crit}$ (light brown), measured $RH > RH_{crit}$ (purple).

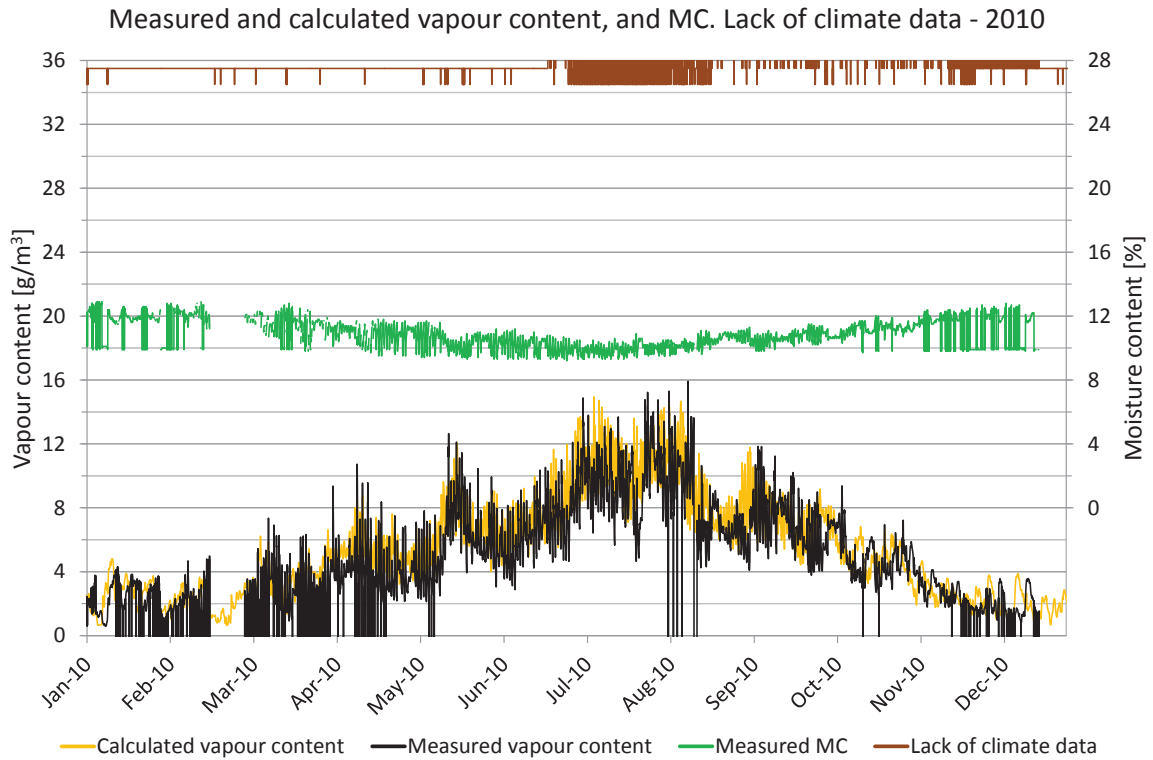

Figure 7.14.7. Measured moisture content, periods lacking climate data and comparisons of vapour content. Vapour content for calculated values (yellow) and measured values (black). Moisture content (green), periods with lack of climate data (brown).

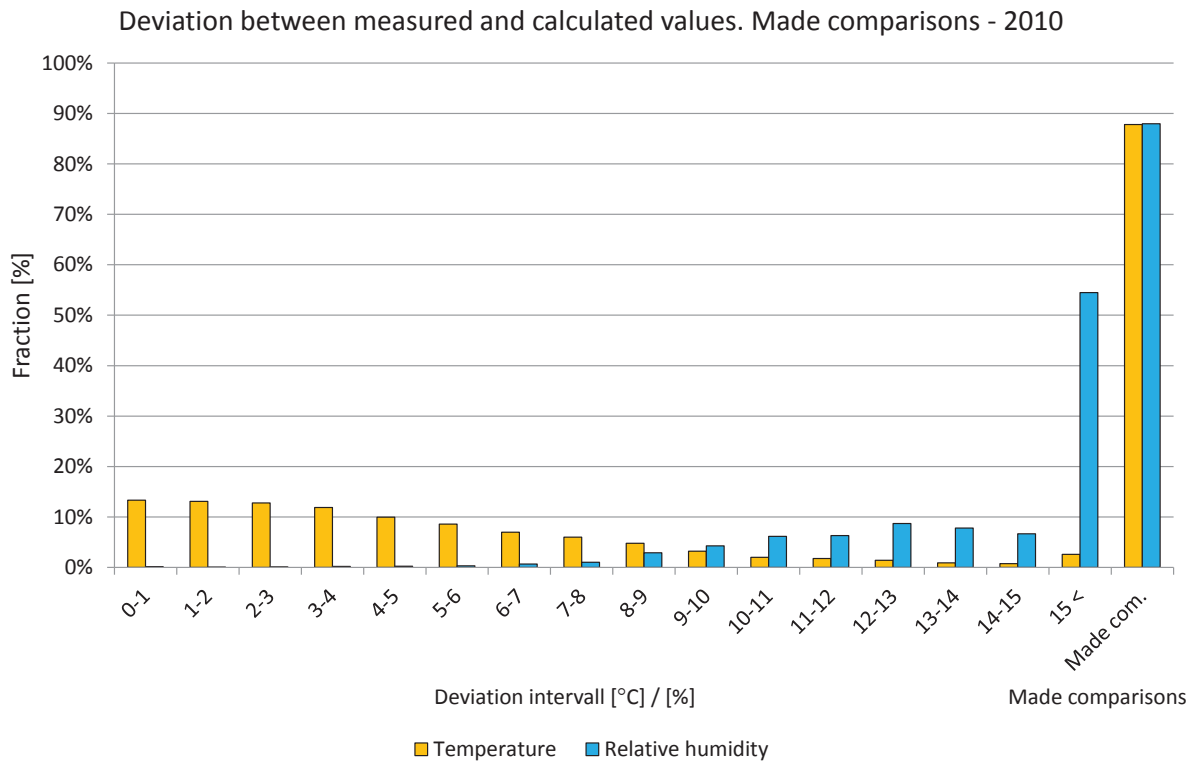

Figure 7.14.8. Deviations in comparisons shown in intervals from 0 to 15 °C or %. The two right-hand bars show the percentage of comparisons during the year. Temperature (yellow) and relative humidity (light blue).

Year 2011

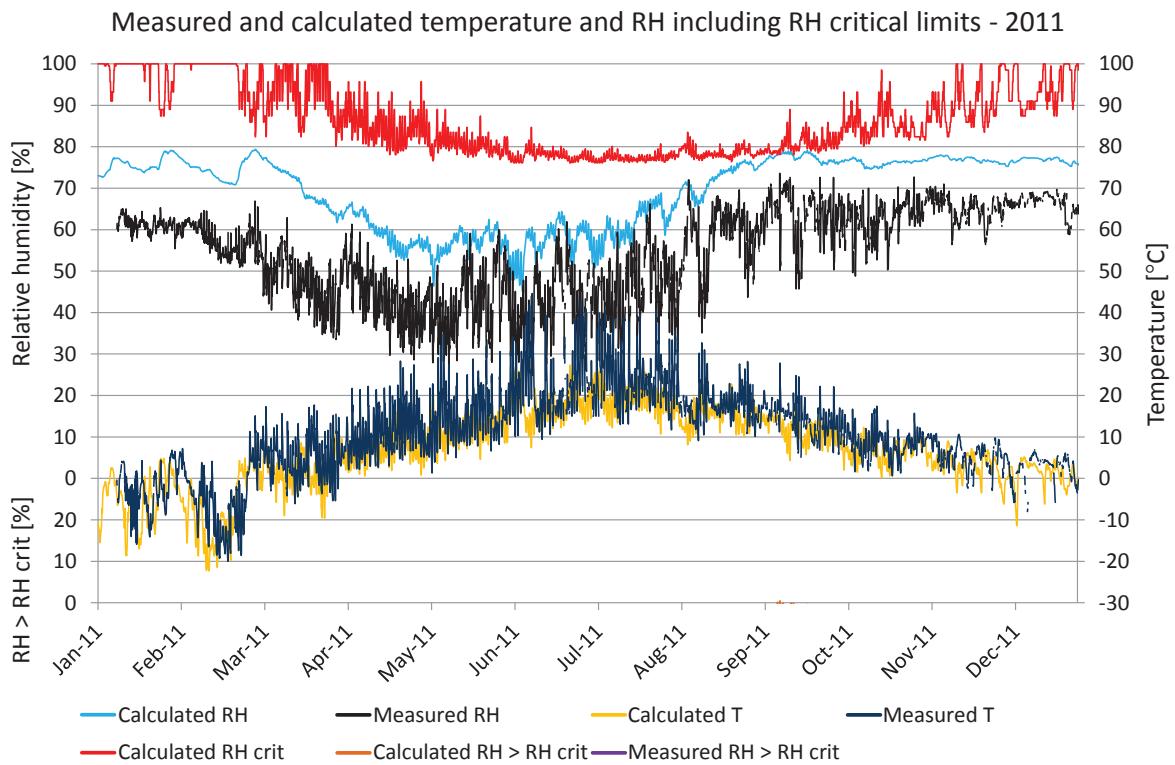

Figure 7.14.9. Comparisons between measured and calculated temperature and relative humidity. Calculated temperature (yellow), measured temperature (dark blue), calculated RH (turquoise), measured RH (black), RH_{crit} for calculated values (red), calculated RH > RH_{crit} (light brown), measured RH > RH_{crit} (purple).

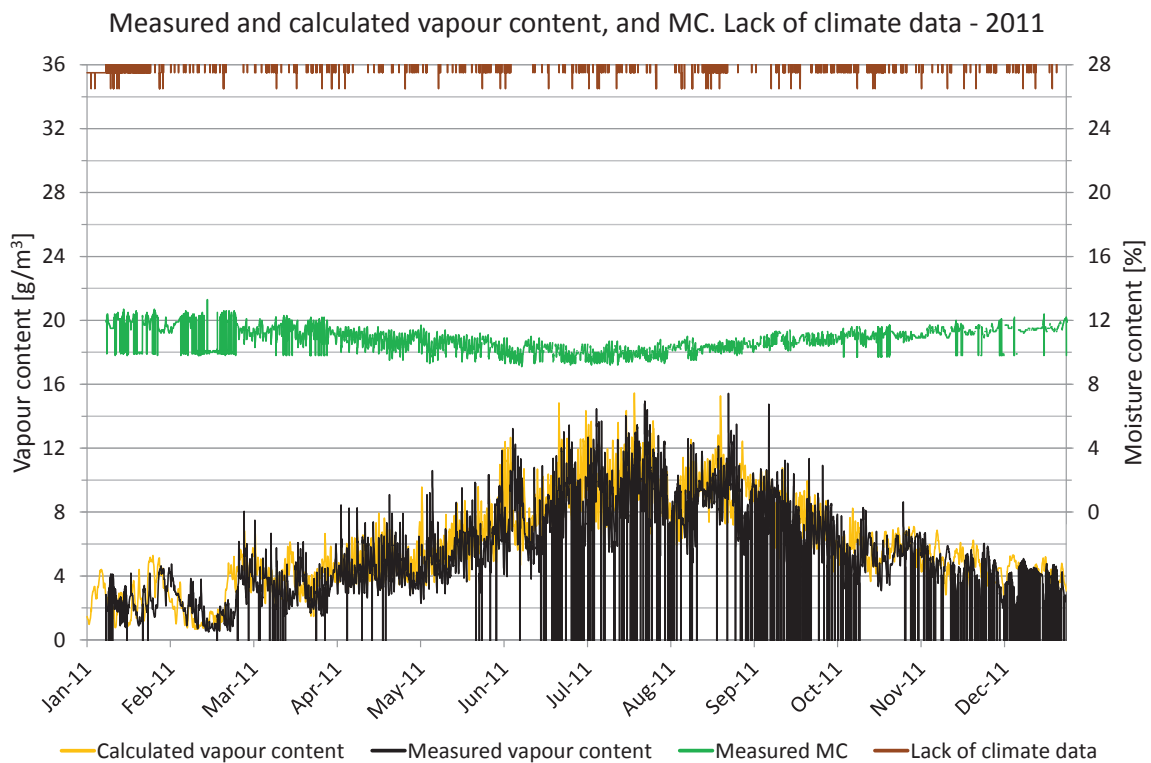

Figure 7.14.10. Measured moisture content, periods lacking climate data and comparisons of vapour content. Vapour content for calculated values (yellow) and measured values (black). Moisture content (green), periods with lack of climate data (brown).

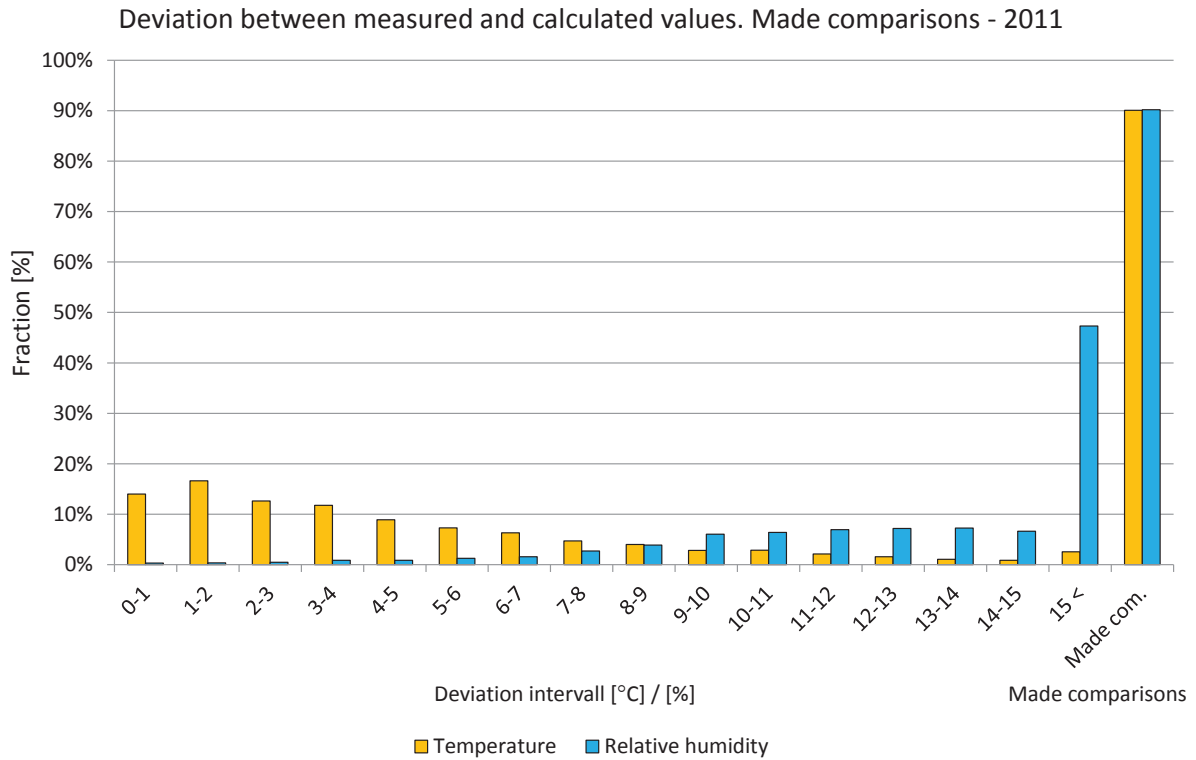

Figure 7.14.11. Deviations in comparisons shown in intervals from 0 to 15 °C or %. The two right-hand bars show the percentage of comparisons during the year. Temperature (yellow) and relative humidity (light blue).

7.15 Position 15ö

The locations of the measured and calculated position are shown in the drawings and figures below. The studied position is located below a window in a wall that is facing east on the fifth floor.

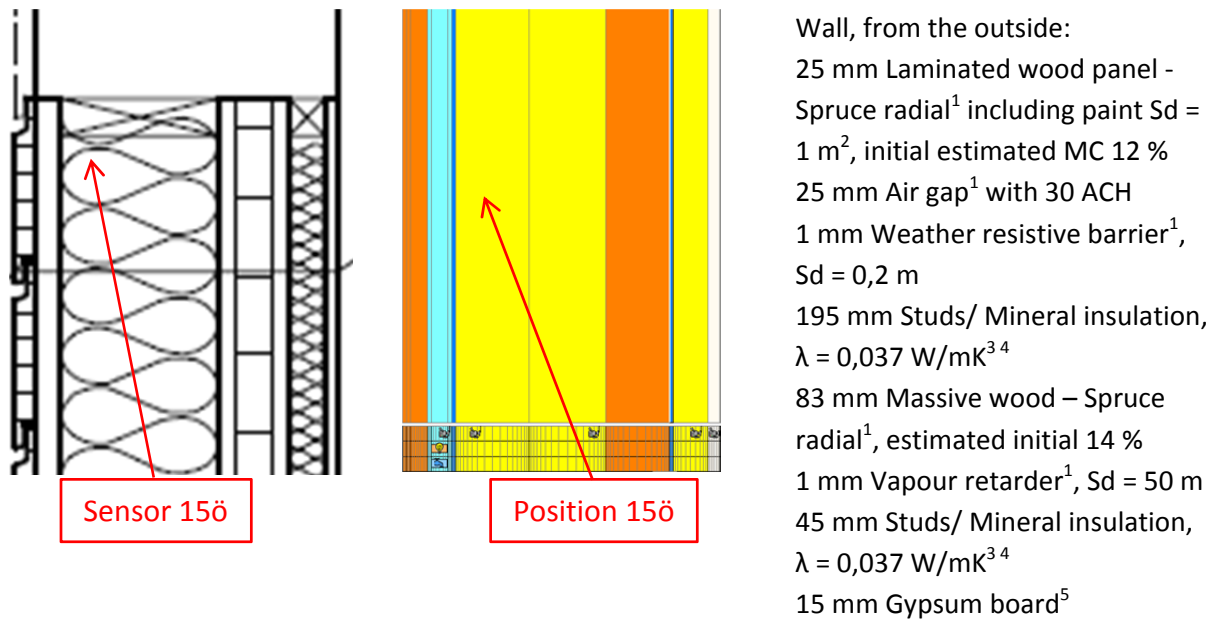

Figure 7.15.1. Vertical cross sectional drawing and WUFI calculation model showing the studied position. 1. IBP, 2012, 2. Nevander, L-E., 1994, 3. IEA Annex 24, 1996, 4. Paroc, 2002, 5. Krus, M., 1996.

A perfect match between the measured and calculated values cannot be expected due to e.g. the influence of two- and three-dimensional effects and the accuracy of the sensors.

Year 2009

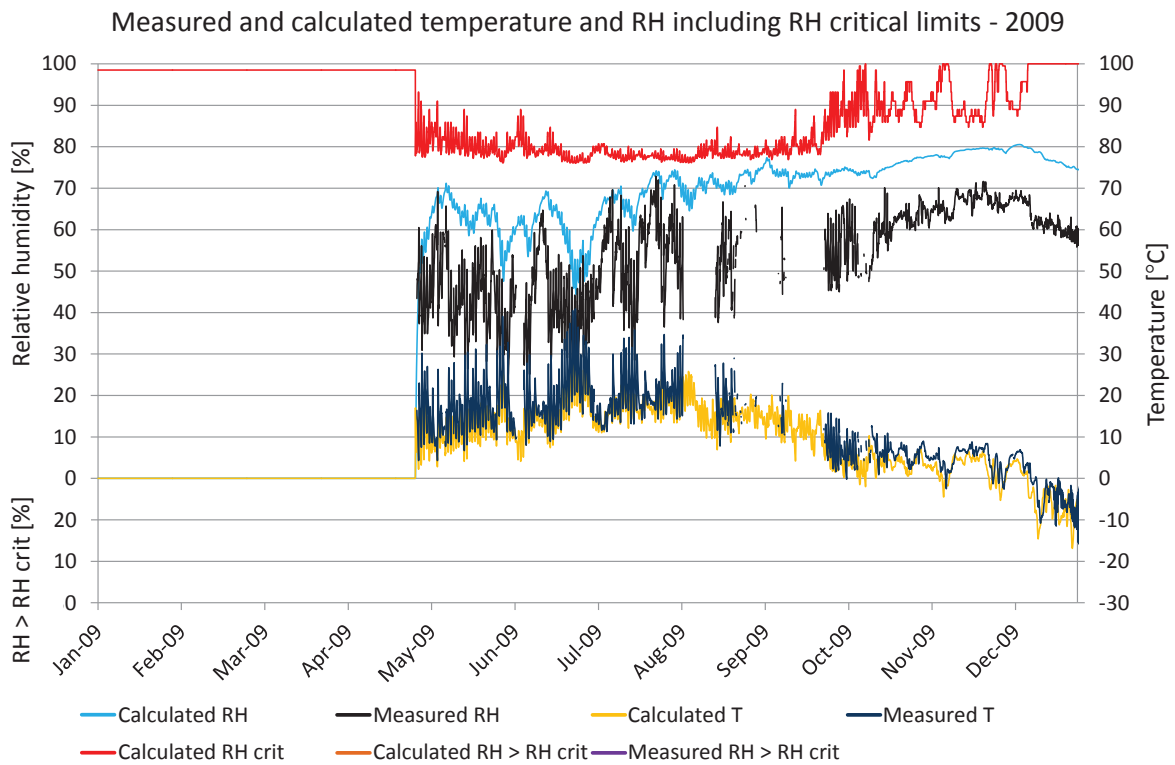

Figure 7.15.2. Comparisons between measured and calculated temperature and relative humidity. Calculated temperature (yellow), measured temperature (dark blue), calculated RH (turquoise), measured RH (black), RH_{crit} for calculated values (red), calculated $RH > RH_{crit}$ (light brown), measured $RH > RH_{crit}$ (purple).

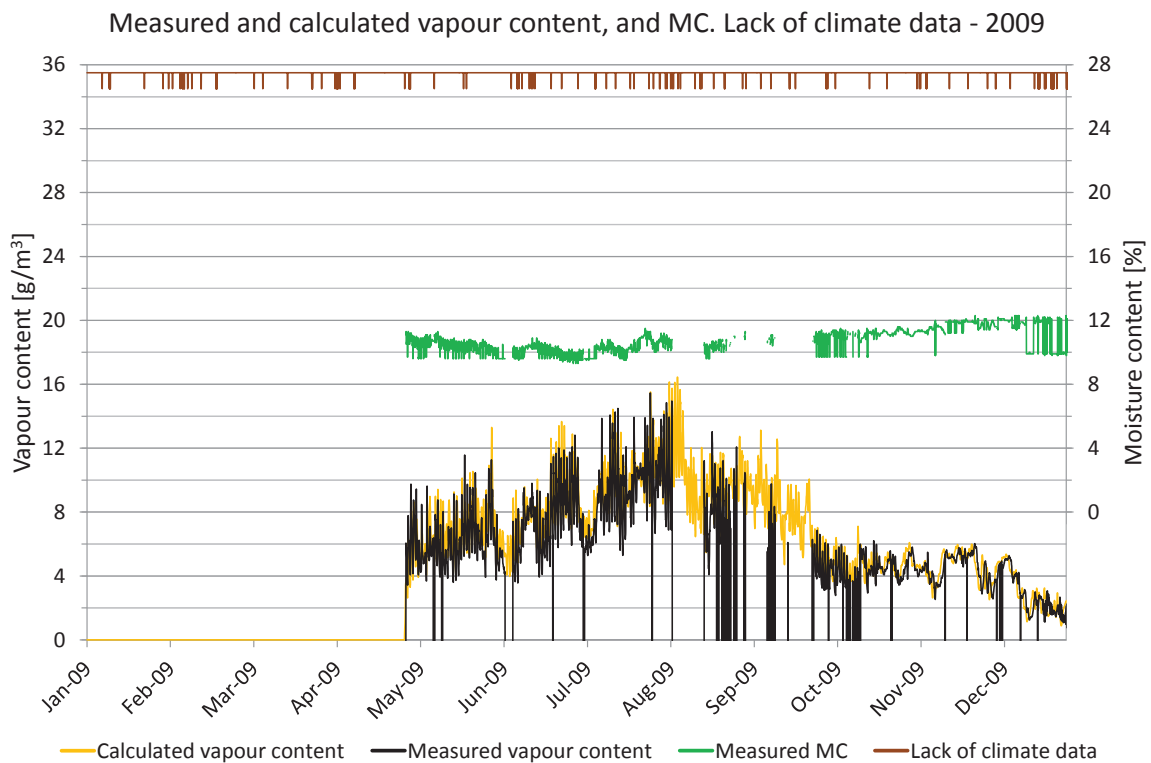

Figure 7.15.3. Measured moisture content, periods lacking climate data and comparisons of vapour content. Vapour content for calculated values (yellow) and measured values (black). Moisture content (green), periods with lack of climate data (brown).

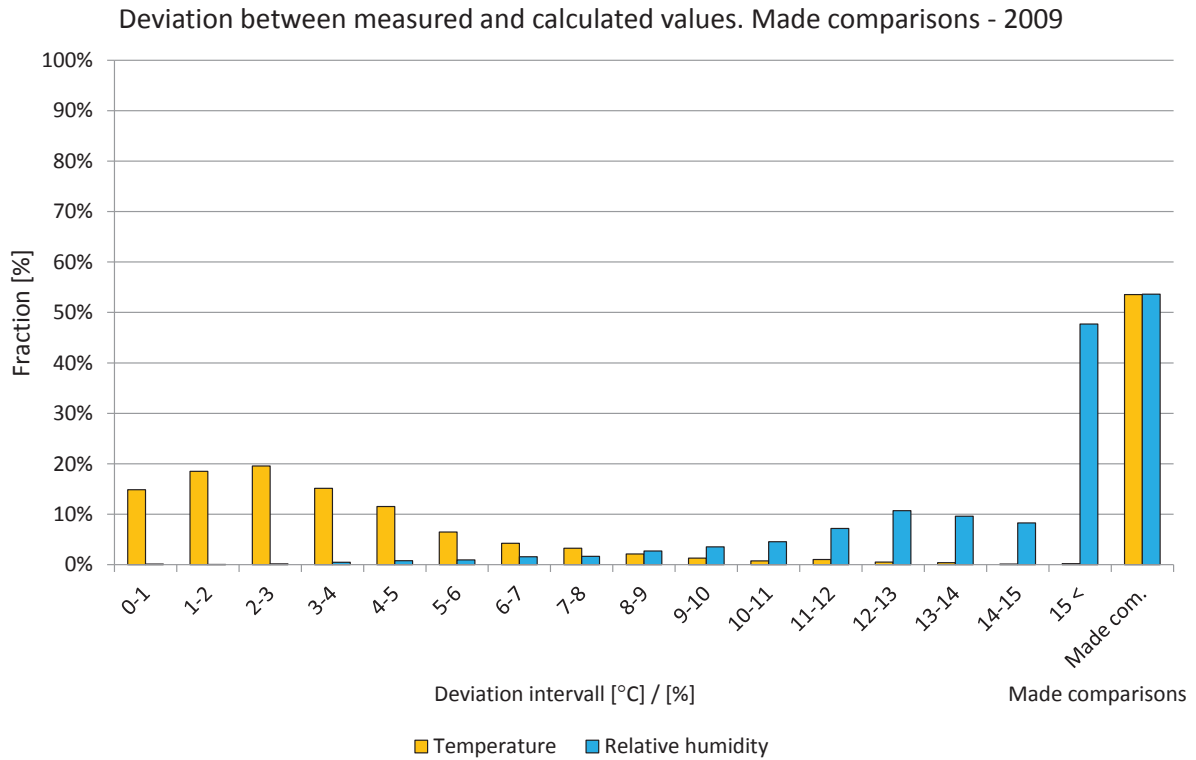

Figure 7.15.4. Deviations in comparisons shown in intervals from 0 to 15 °C or %. The two right-hand bars show the percentage of comparisons during the year. Temperature (yellow) and relative humidity (light blue).

Year 2010

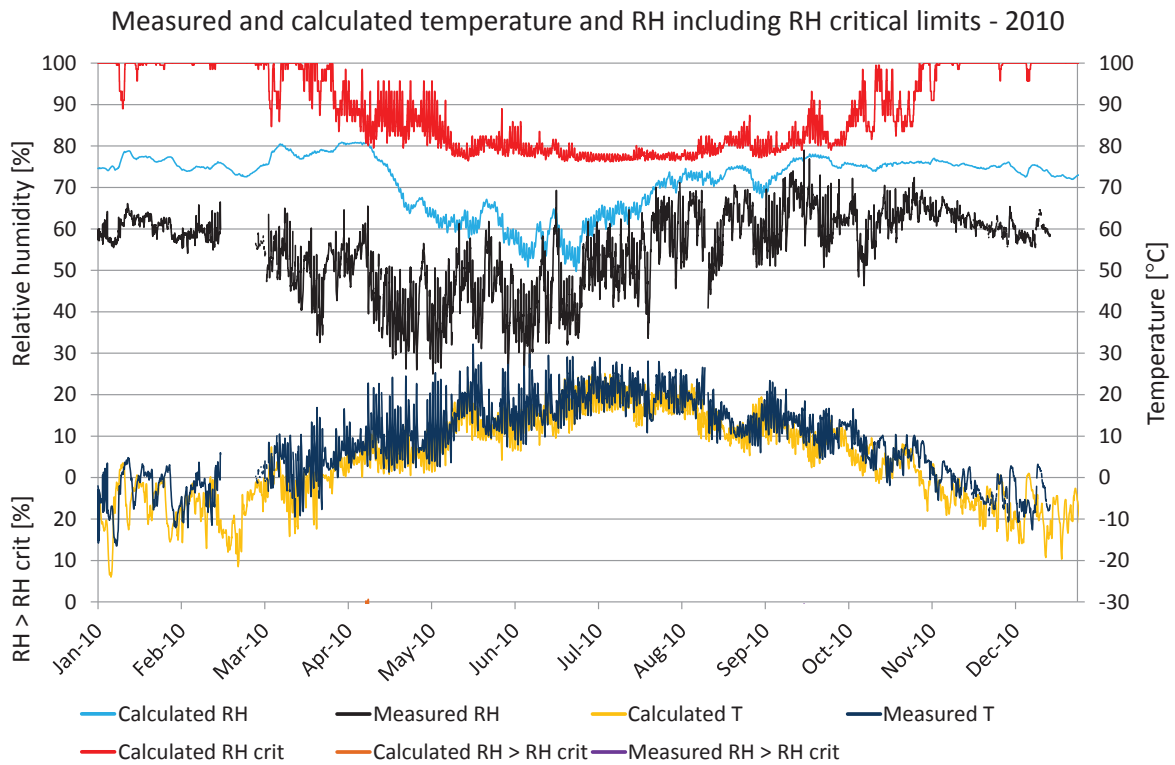

Figure 7.15.5. Comparisons between measured and calculated temperature and relative humidity. Calculated temperature (yellow), measured temperature (dark blue), calculated RH (turquoise), measured RH (black), RH_{crit} for calculated values (red), calculated $RH > RH_{crit}$ (light brown), measured $RH > RH_{crit}$ (purple).

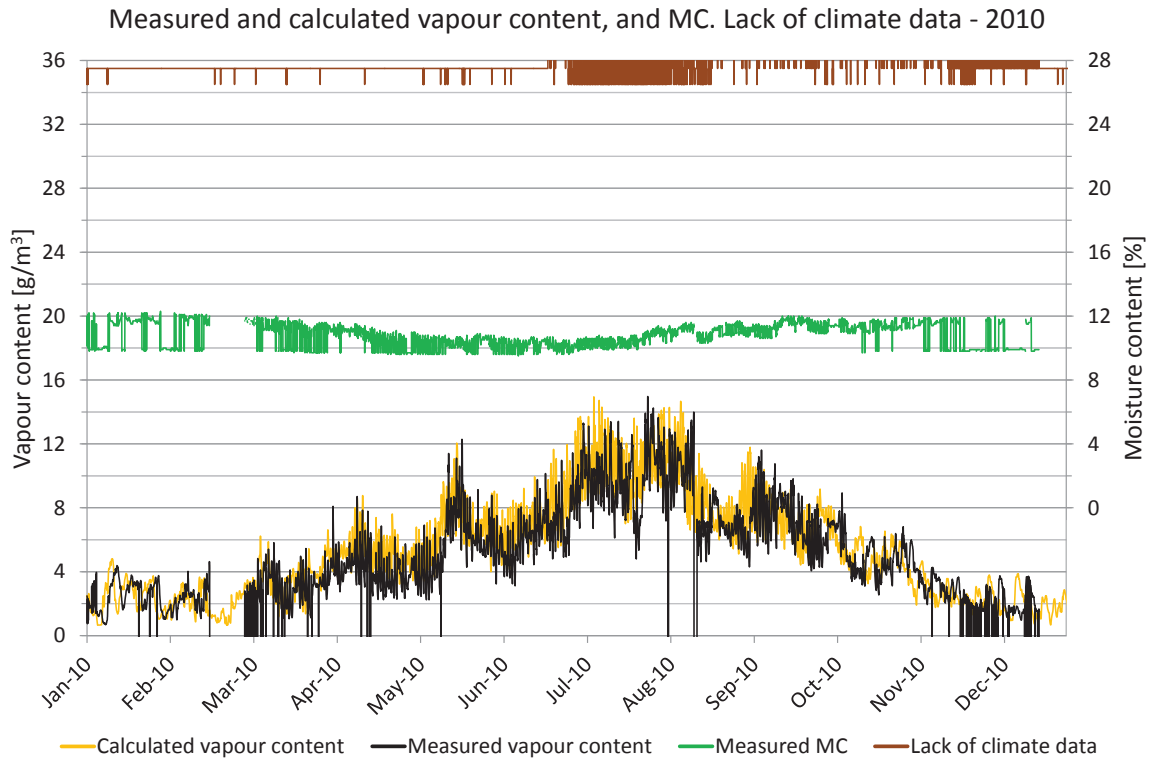

Figure 7.15.6. Measured moisture content, periods lacking climate data and comparisons of vapour content. Vapour content for calculated values (yellow) and measured values (black). Moisture content (green), periods with lack of climate data (brown).

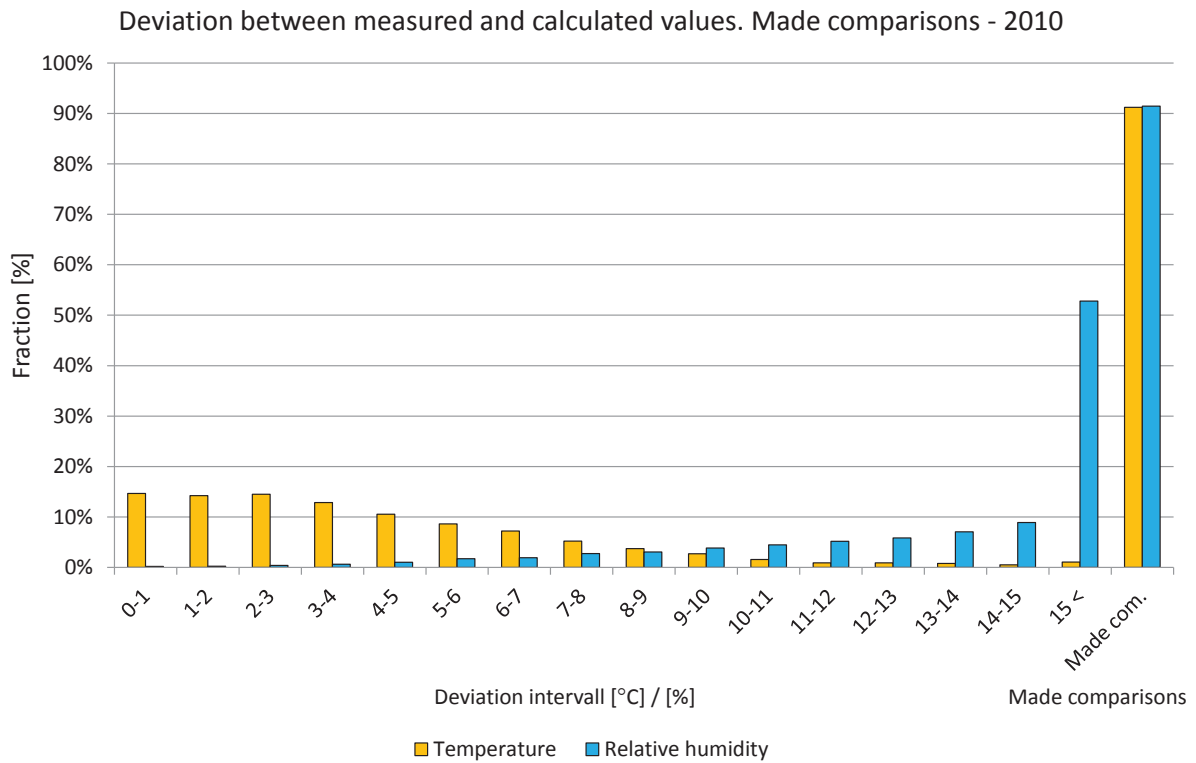

Figure 7.15.7. Deviations in comparisons shown in intervals from 0 to 15 °C or %. The two right-hand bars show the percentage of comparisons during the year. Temperature (yellow) and relative humidity (light blue).

Year 2011

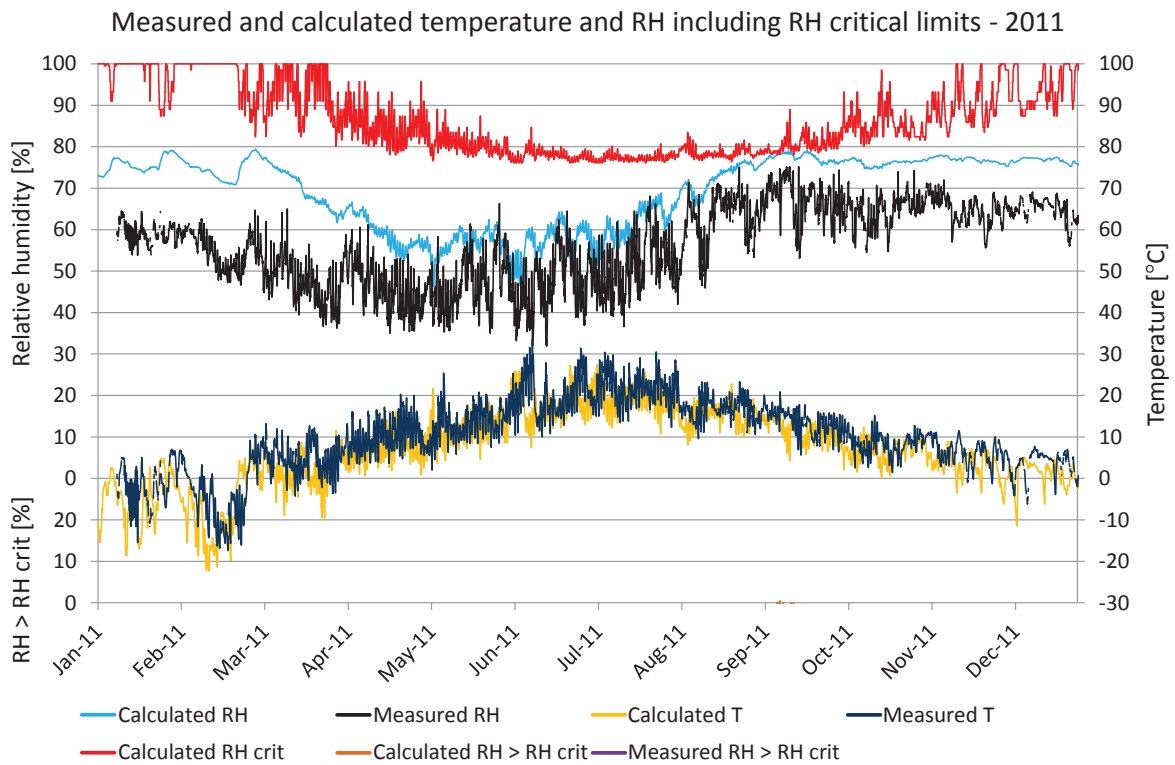

Figure 7.15.8. Comparisons between measured and calculated temperature and relative humidity. Calculated temperature (yellow), measured temperature (dark blue), calculated RH (turquoise), measured RH (black), RH_{crit} for calculated values (red), calculated RH > RH_{crit} (light brown), measured RH > RH_{crit} (purple).

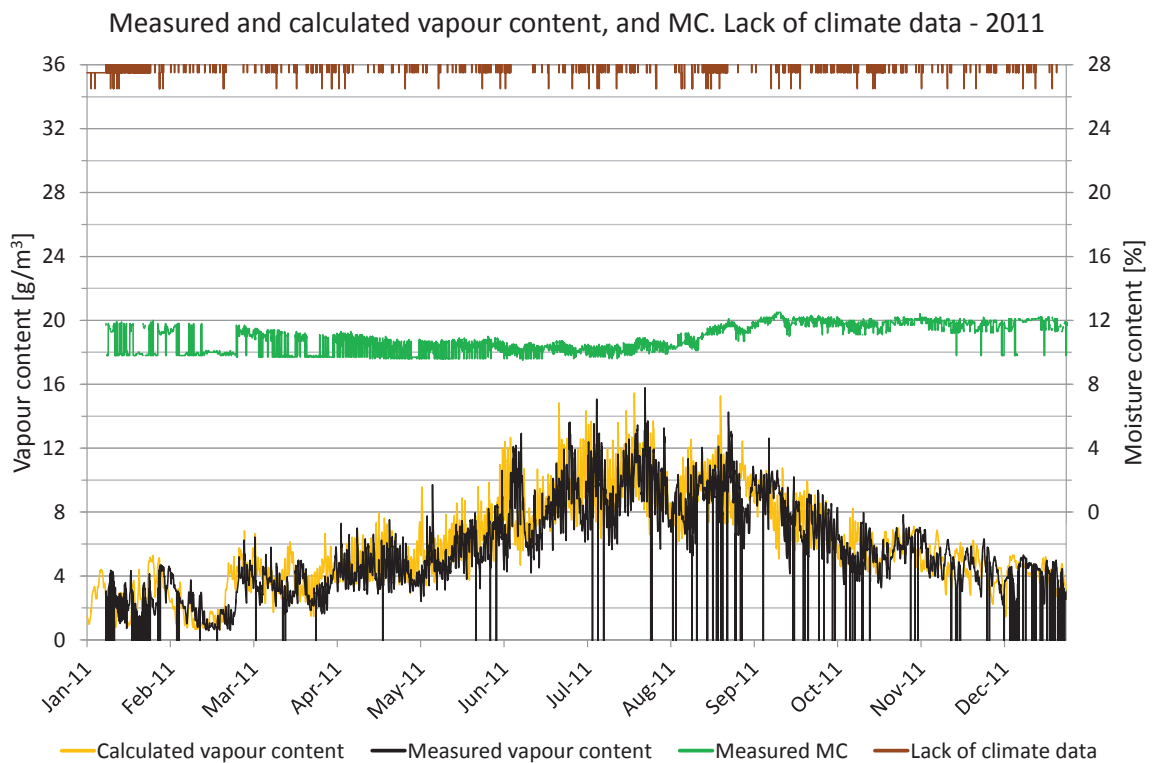

Figure 7.15.9. Measured moisture content, periods lacking climate data and comparisons of vapour content. Vapour content for calculated values (yellow) and measured values (black). Moisture content (green), periods with lack of climate data (brown).

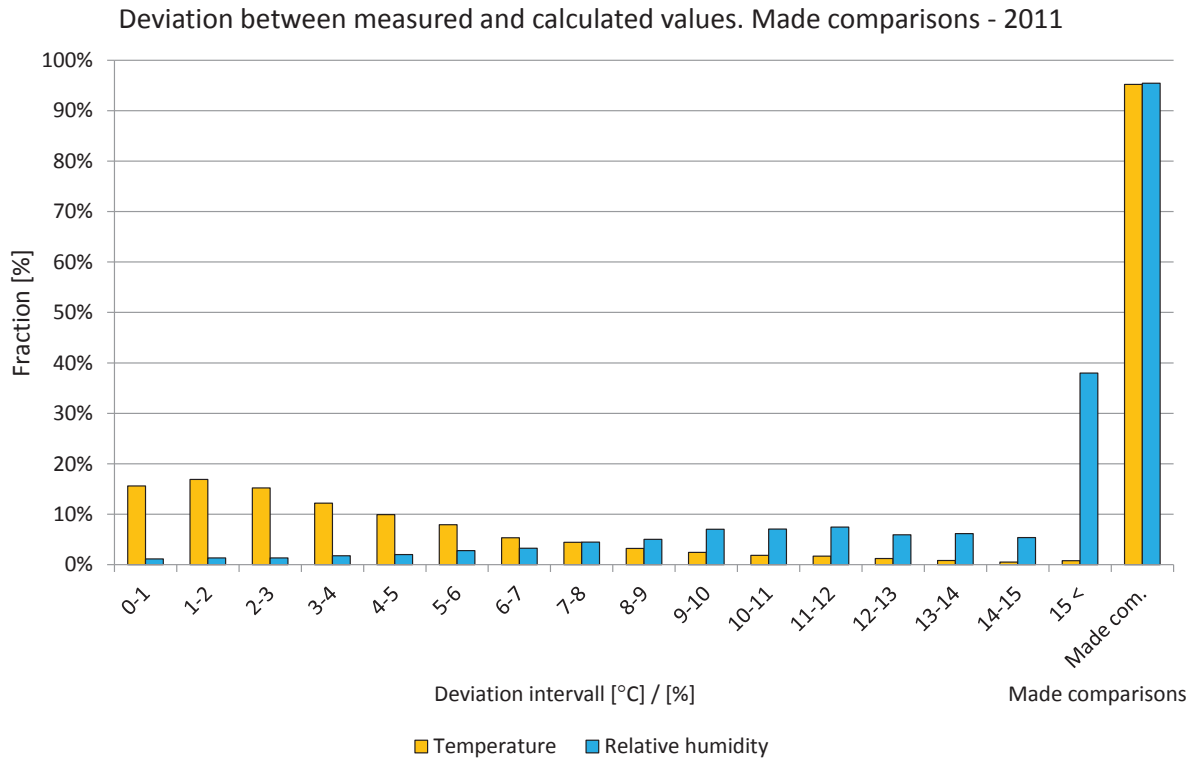

Figure 7.15.10. Deviations in comparisons shown in intervals from 0 to 15 °C or %. The two right-hand bars show the percentage of comparisons during the year. Temperature (yellow) and relative humidity (light blue).

7.16 Position 16ö

The locations of the measured and calculated position are shown in the drawings and figures below. The studied position is located below a window in a wall that is facing east on the fourth floor.

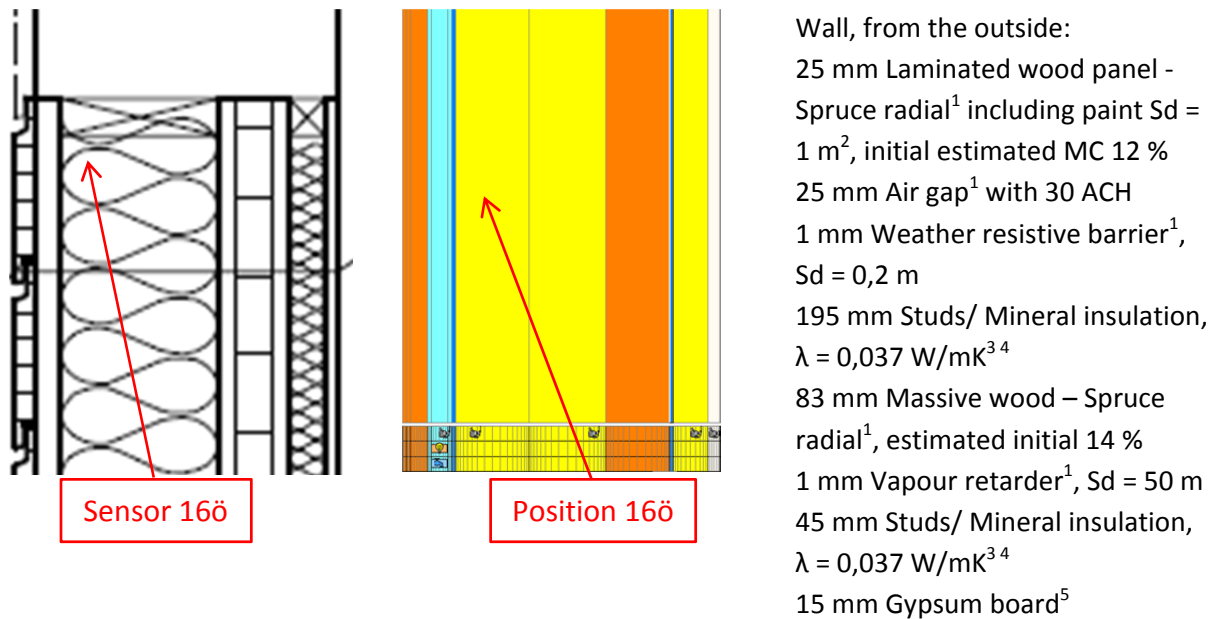

Figure 7.16.1. Vertical cross sectional drawing and WUFI calculation model showing the studied position. 1. IBP, 2012, 2. Nevander, L-E., 1994, 3. IEA Annex 24, 1996, 4. Paroc, 2002, 5. Krus, M., 1996.

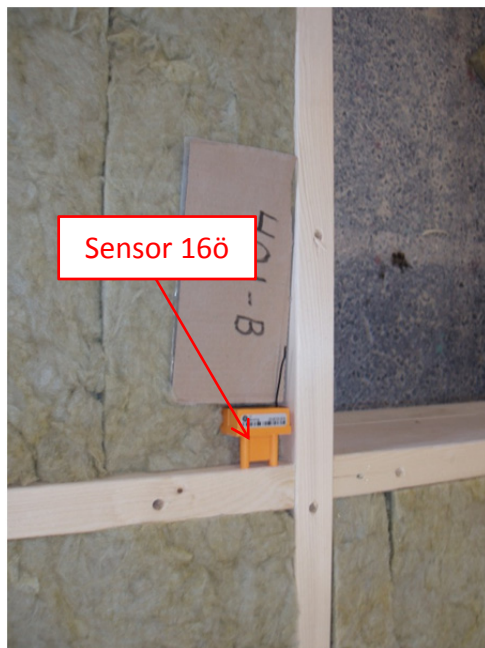

Figure 7.16.2. Location of the studied position. Photo: SP Trä Skellefteå.

A perfect match between the measured and calculated values cannot be expected due to e.g. the influence of two- and three-dimensional effects and the accuracy of the sensors.

Year 2009

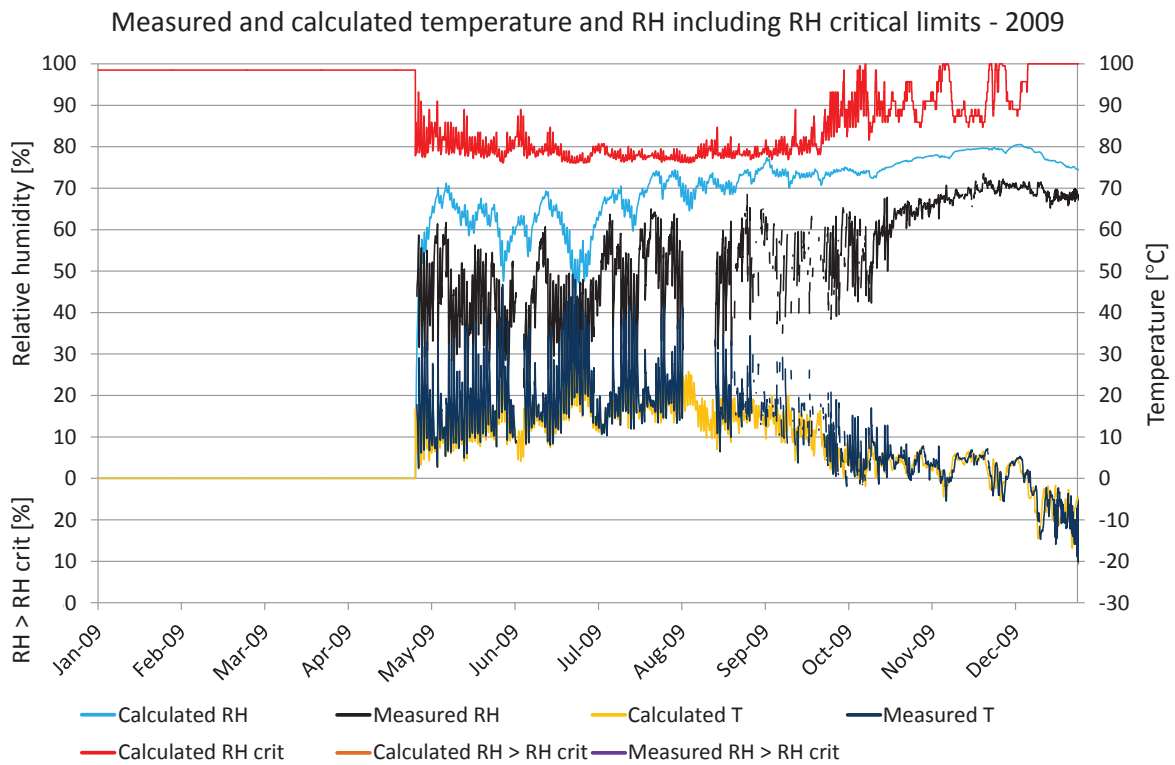

Figure 7.16.3. Comparisons between measured and calculated temperature and relative humidity. Calculated temperature (yellow), measured temperature (dark blue), calculated RH (turquoise), measured RH (black), RH_{crit} for calculated values (red), calculated $RH > RH_{crit}$ (light brown), measured $RH > RH_{crit}$ (purple).

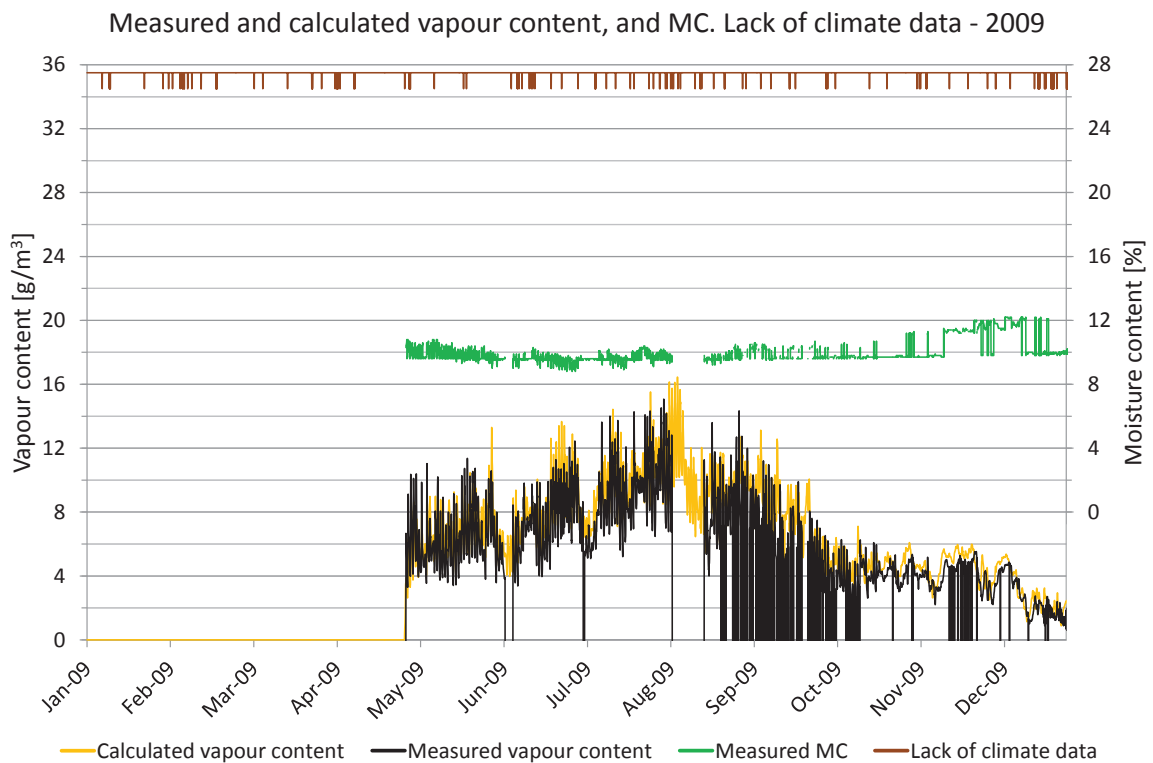

Figure 7.16.4. Measured moisture content, periods lacking climate data and comparisons of vapour content. Vapour content for calculated values (yellow) and measured values (black). Moisture content (green), periods with lack of climate data (brown).

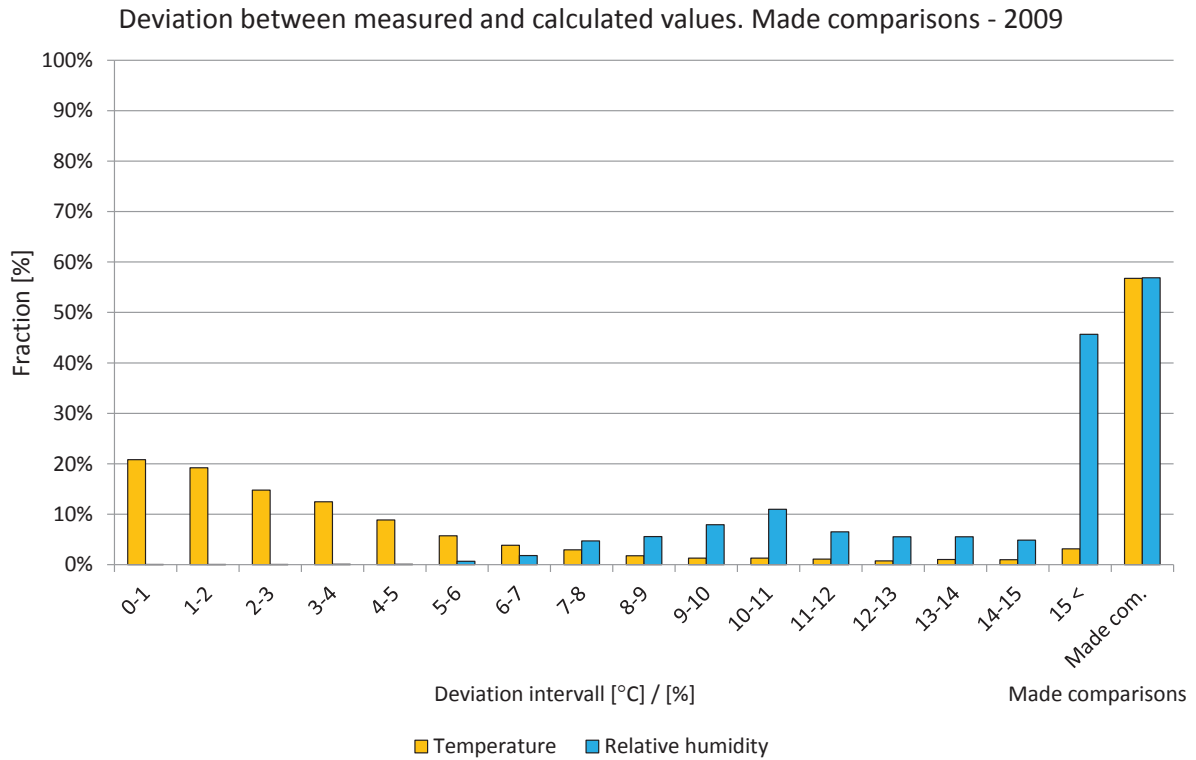

Figure 7.16.5. Deviations in comparisons shown in intervals from 0 to 15 °C or %. The two right-hand bars show the percentage of comparisons during the year. Temperature (yellow) and relative humidity (light blue).

Year 2010

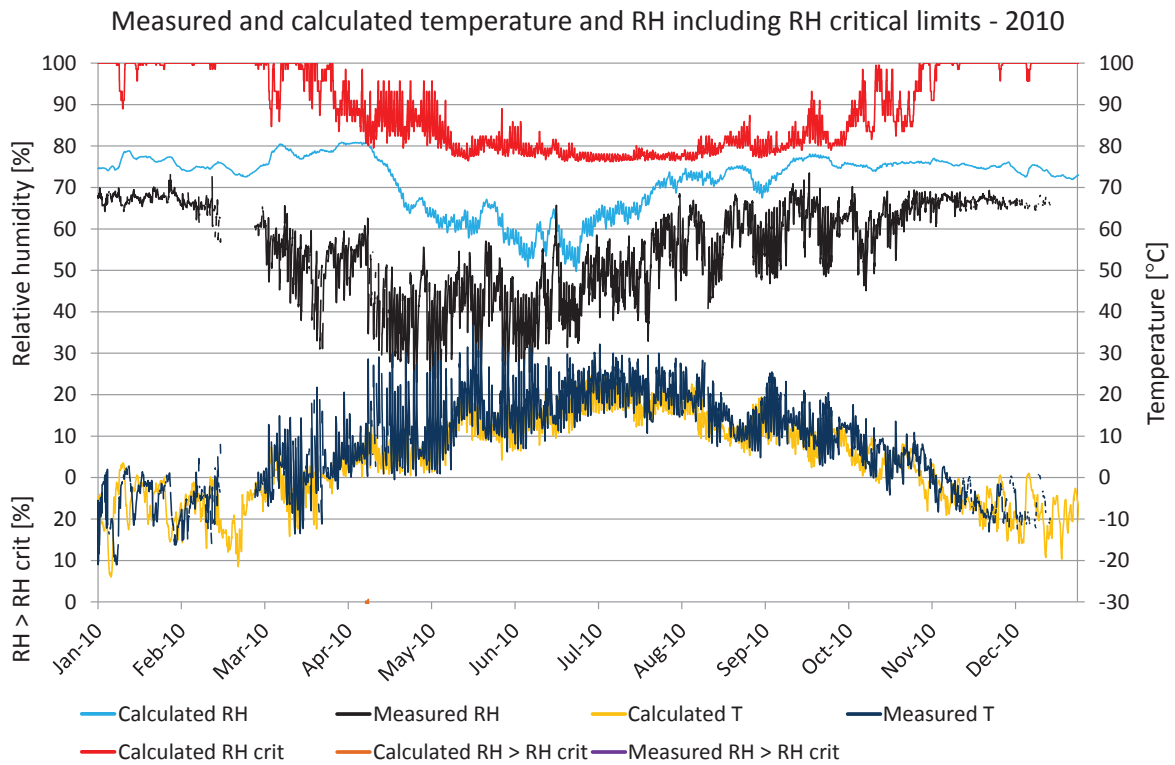

Figure 7.16.6. Comparisons between measured and calculated temperature and relative humidity. Calculated temperature (yellow), measured temperature (dark blue), calculated RH (turquoise), measured RH (black), RH_{crit} for calculated values (red), calculated $RH > RH_{crit}$ (light brown), measured $RH > RH_{crit}$ (purple).

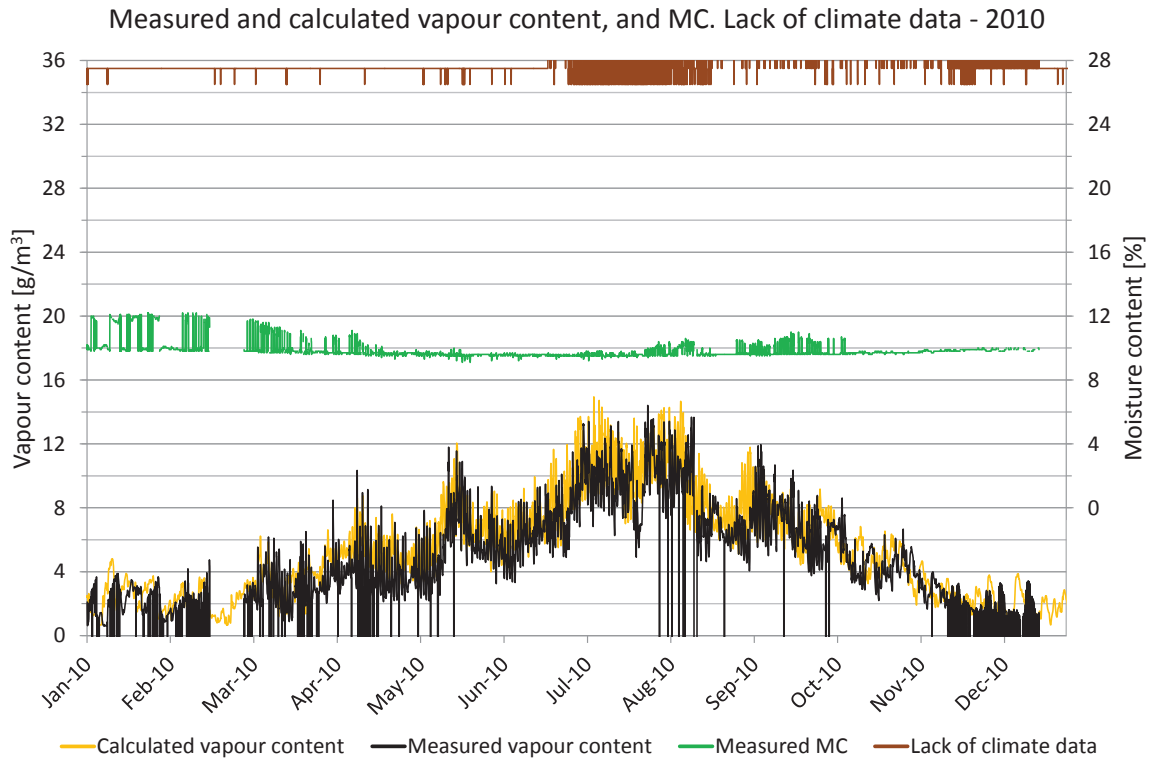

Figure 7.16.7. Measured moisture content, periods lacking climate data and comparisons of vapour content. Vapour content for calculated values (yellow) and measured values (black). Moisture content (green), periods with lack of climate data (brown).

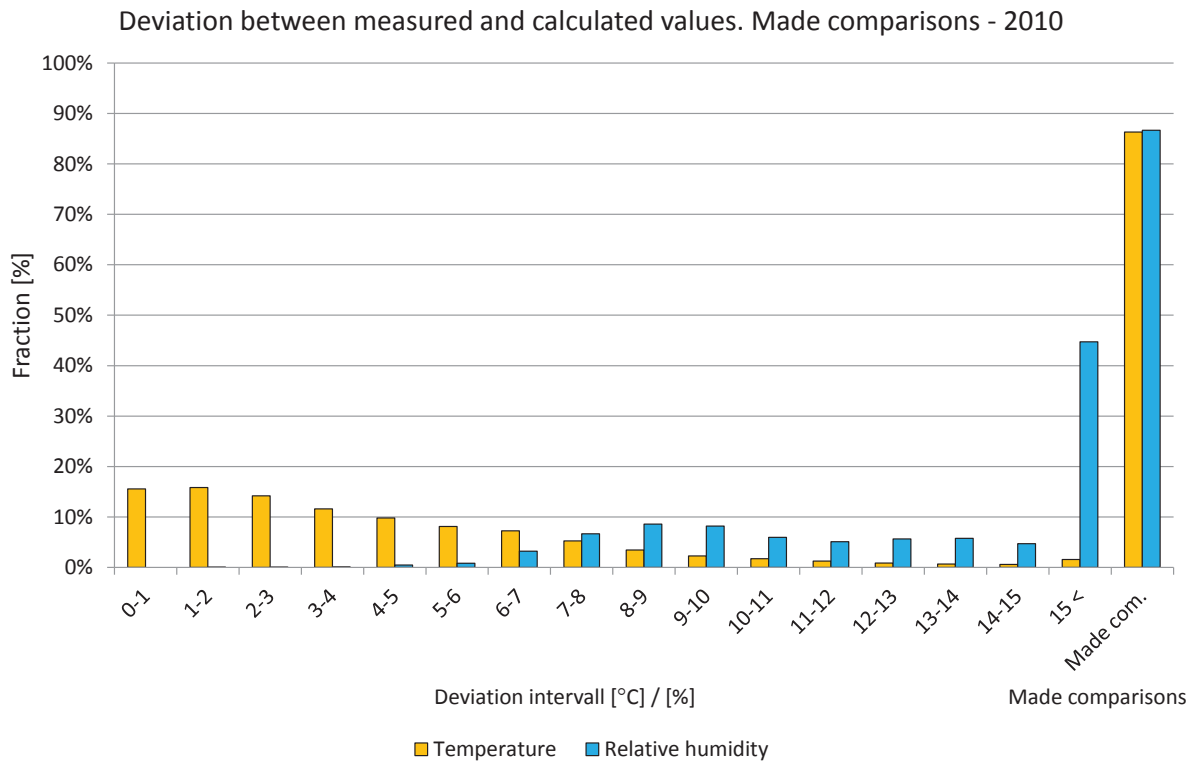

Figure 7.16.8. Deviations in comparisons shown in intervals from 0 to 15 °C or %. The two right-hand bars show the percentage of comparisons during the year. Temperature (yellow) and relative humidity (light blue).

Year 2011

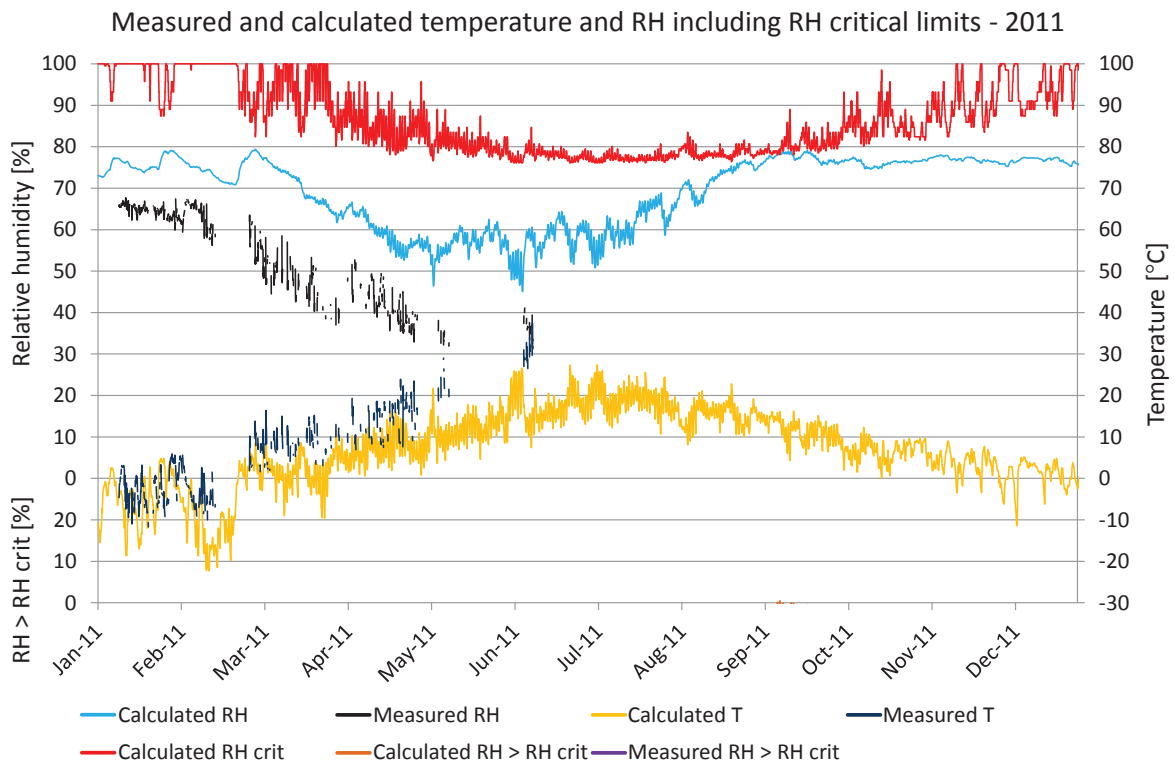

Figure 7.16.9. Comparisons between measured and calculated temperature and relative humidity. Calculated temperature (yellow), measured temperature (dark blue), calculated RH (turquoise), measured RH (black), RH_{crit} for calculated values (red), calculated RH > RH_{crit} (light brown), measured RH > RH_{crit} (purple).

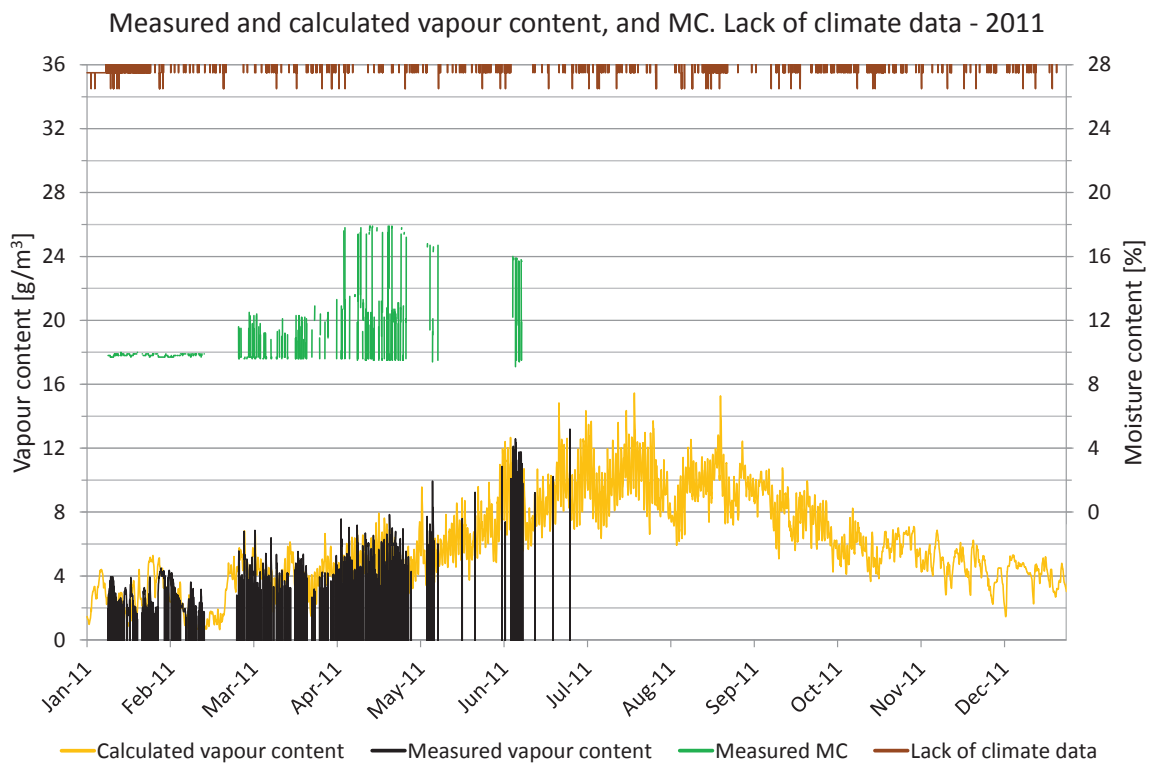

Figure 7.16.10. Measured moisture content, periods lacking climate data and comparisons of vapour content. Vapour content for calculated values (yellow) and measured values (black). Moisture content (green), periods with lack of climate data (brown).

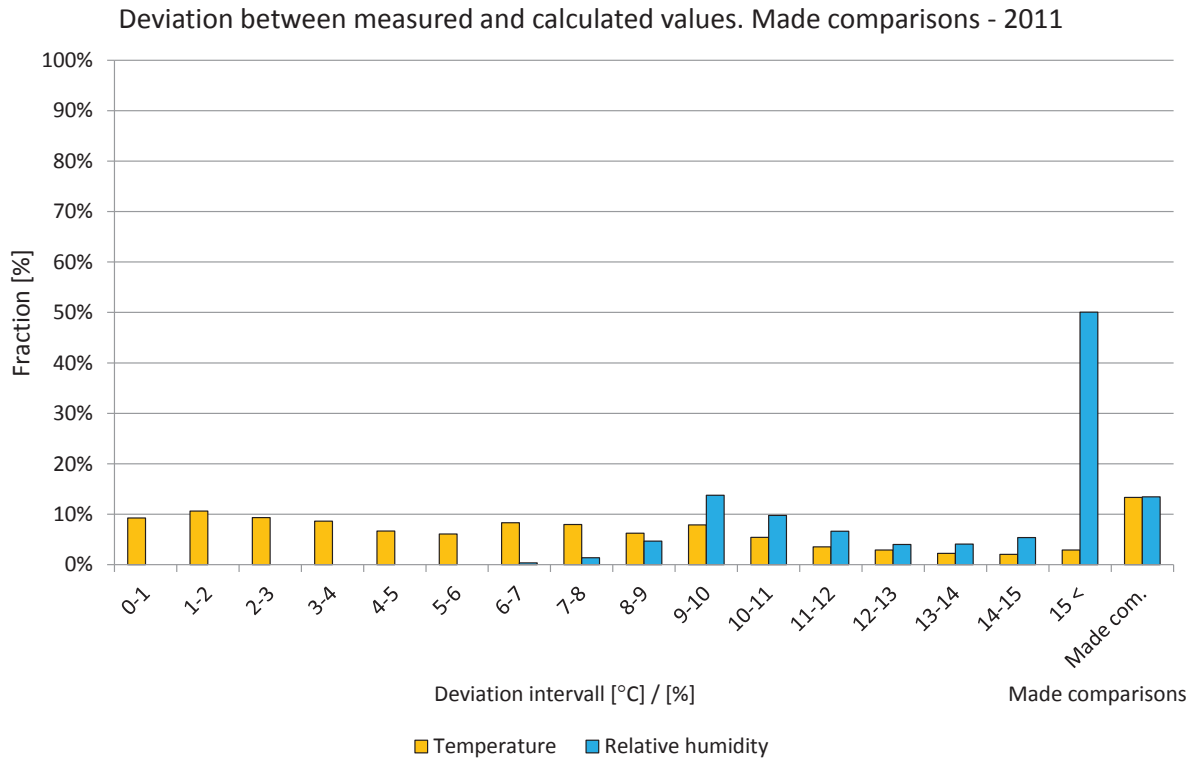

Figure 7.16.11. Deviations in comparisons shown in intervals from 0 to 15 °C or %. The two right-hand bars show the percentage of comparisons during the year. Temperature (yellow) and relative humidity (light blue).

8 Results – Exterior façade and air gap on the fifth and sixth floor

8.11 Position 11-5v-exterior façade

The locations of the measured and calculated position are shown in the drawings and figures below. The studied position is located on the exterior façade panel on a wall that is facing west on the fifth floor.

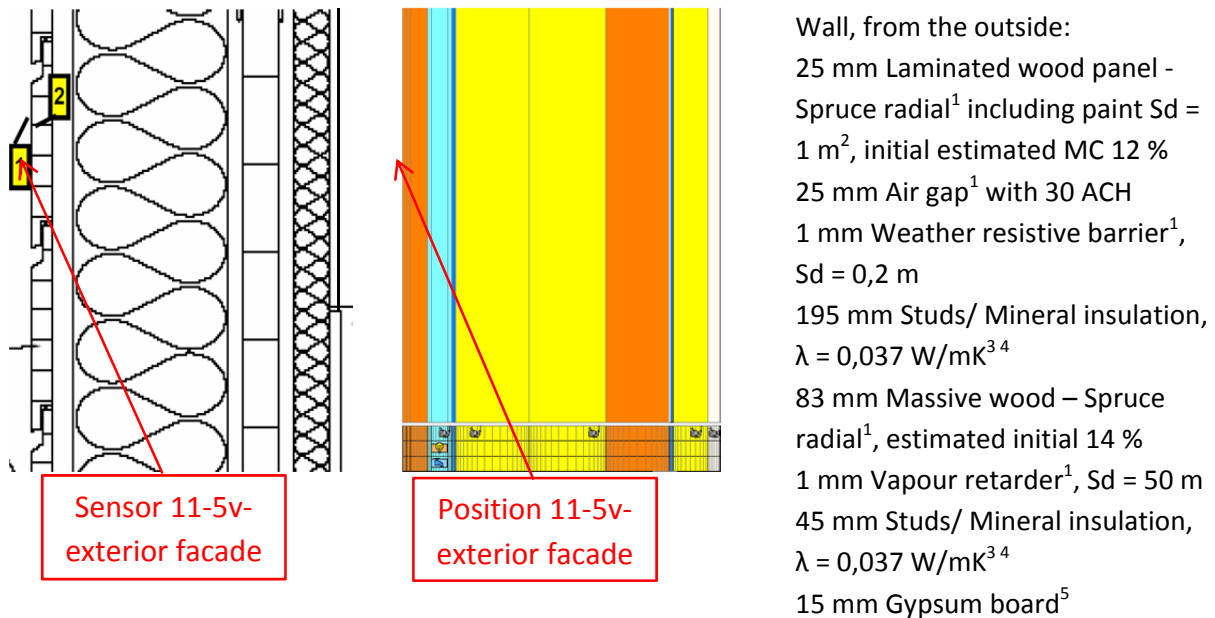

Figure 8.11-5v-exterior.1. Vertical cross sectional drawing and WUFI calculation model showing the studied position. 1. IBP, 2012, 2. Nevander, L-E., 1994, 3. IEA Annex 24, 1996, 4. Paroc, 2002, 5. Krus, M., 1996.

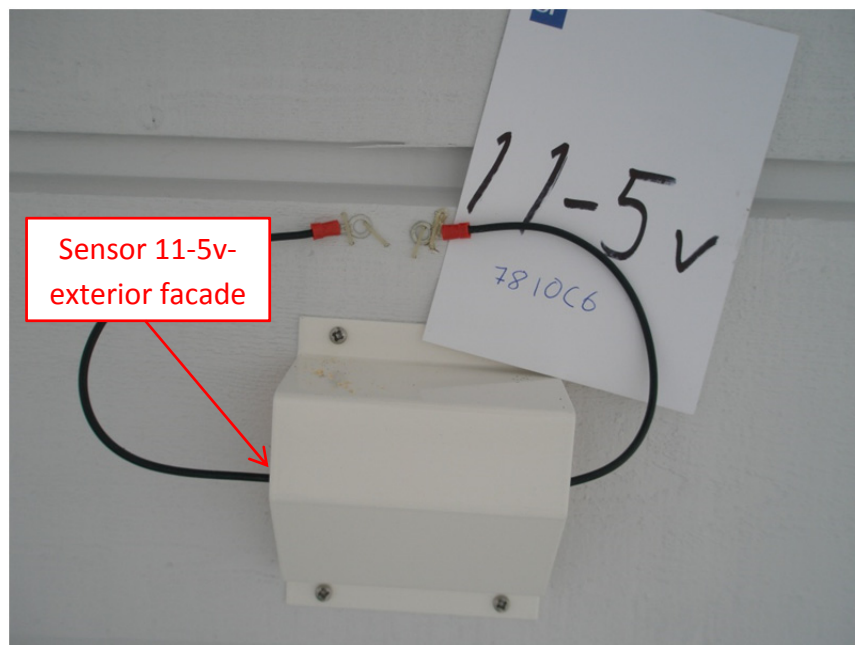

Figure 8.11-5v-exterior.2. Location of the studied position. Photo: SP Trä Skellefteå.

A perfect match between the measured and calculated values cannot be expected due to e.g. the influence of two- and three-dimensional effects and the accuracy of the sensors.

Year 2009

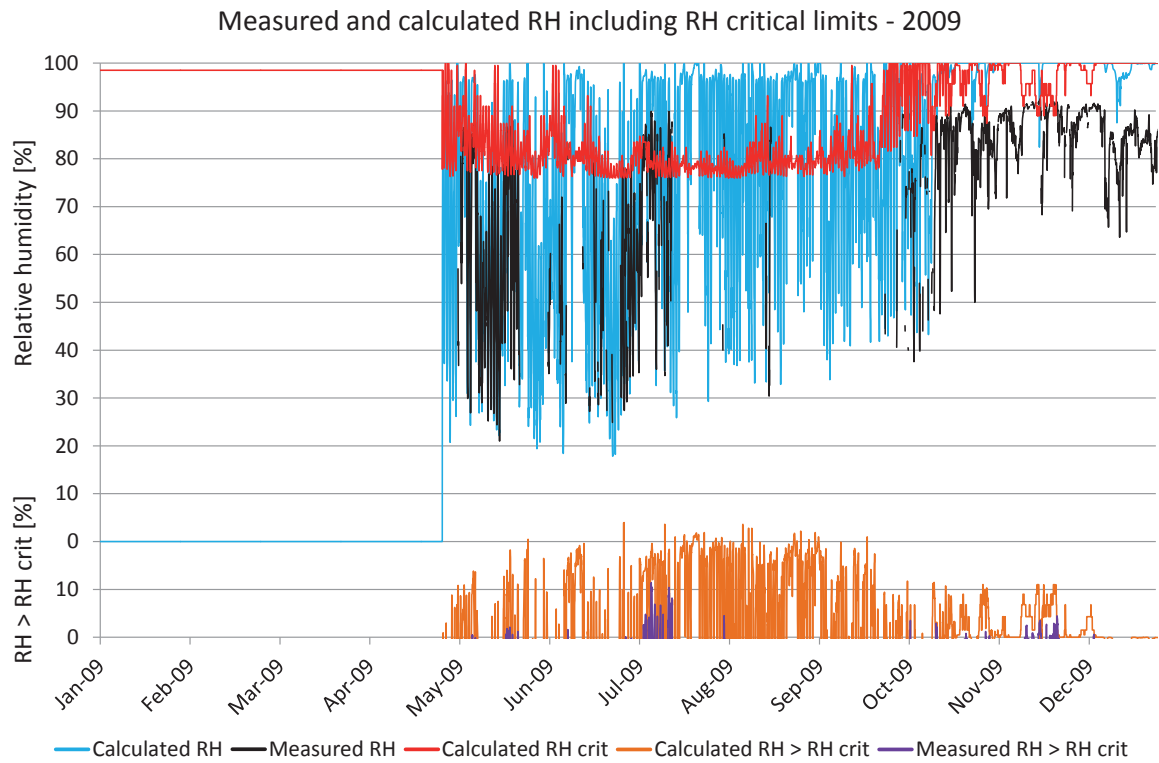

Figure 8.11-5v-exterior.3. Comparisons between measured and calculated relative humidity. Calculated RH (turquoise), measured RH (black), RH_{crit} for calculated values (red), calculated $RH > RH_{crit}$ (light brown), measured $RH > RH_{crit}$ (purple).

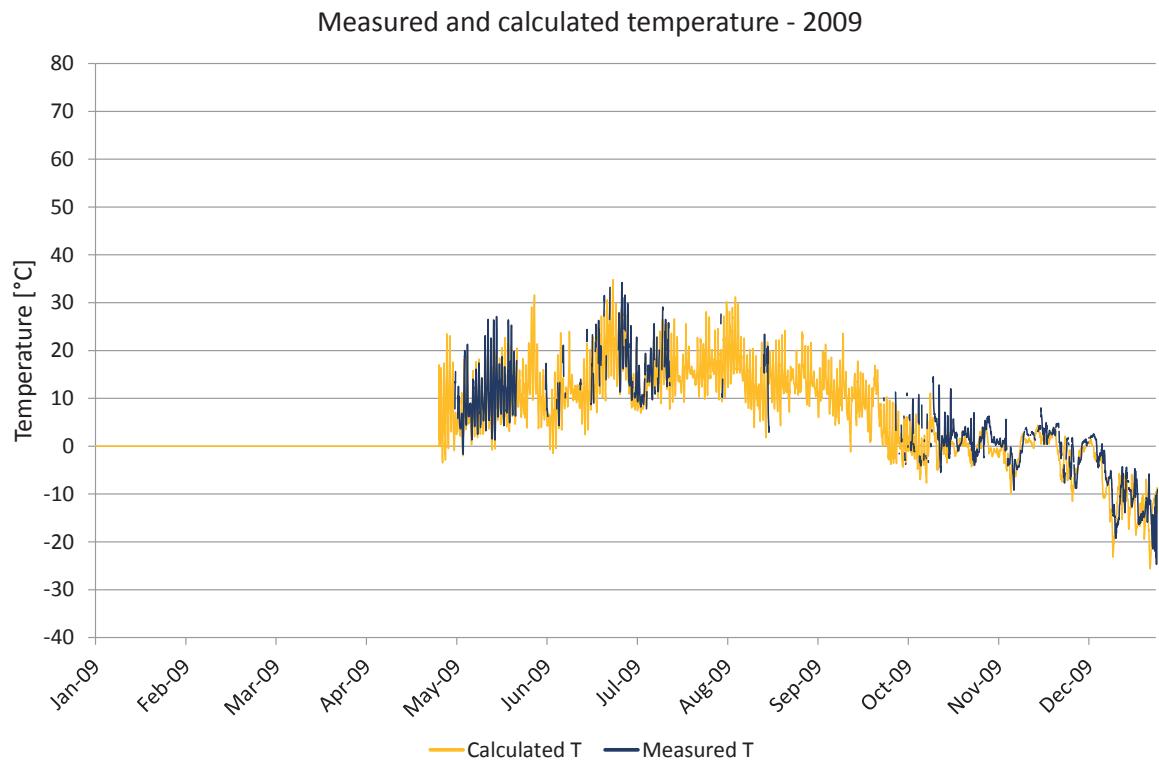

Figure 8.11-5v-exterior.4. Comparisons between measured and calculated temperature. Calculated temperature (yellow), measured temperature (dark blue).

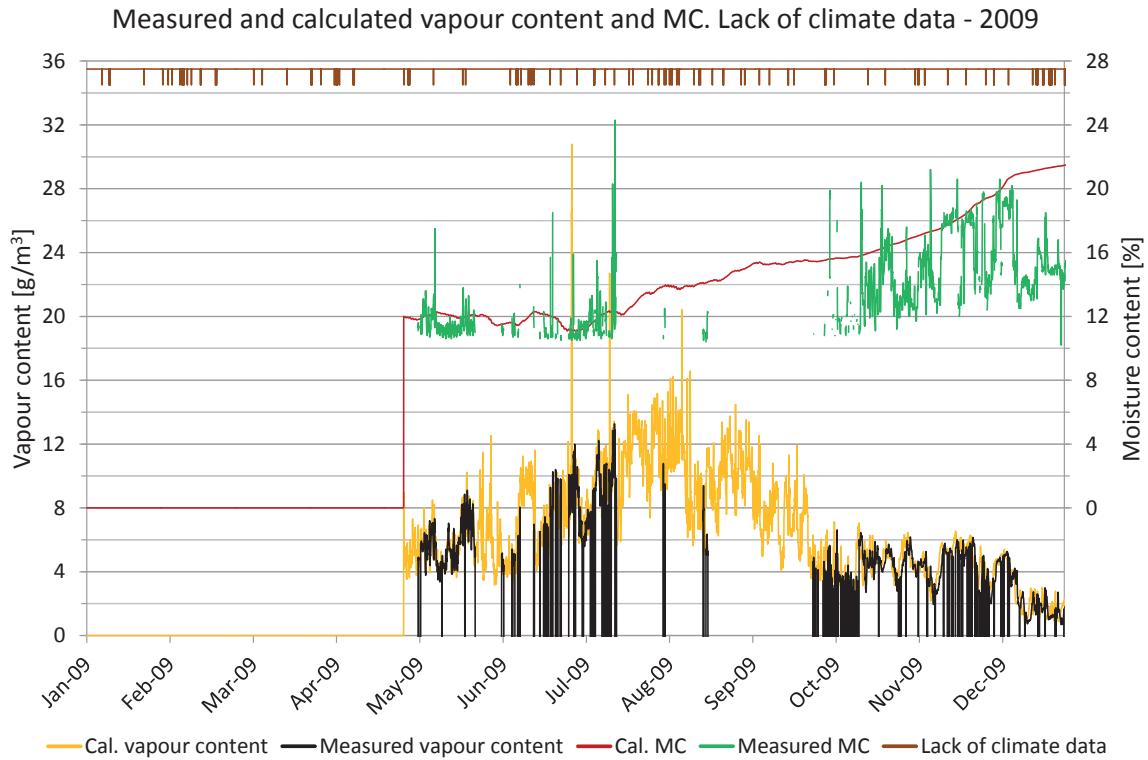

Figure 8.11-5v-exterior.5. Measured moisture content, periods lacking climate data and comparisons of vapour content. Vapour content for calculated values (yellow) and measured values (black). Moisture content for calculated values (red) and measured values (green), periods with lack of climate data (brown).

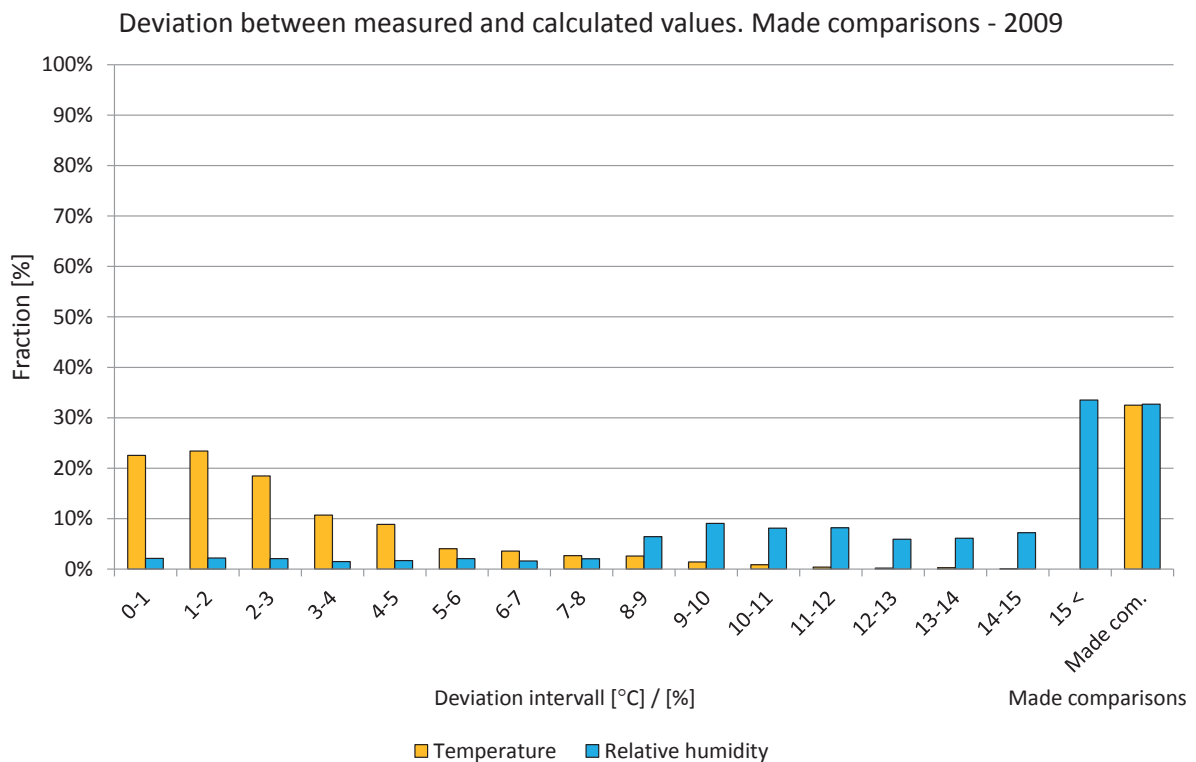

Figure 8.11-5v-exterior.6. Deviations in comparisons shown in intervals from 0 to 15 °C or %. The two right-hand bars show the percentage of comparisons during the year. Temperature (yellow) and relative humidity (light blue).

Year 2010

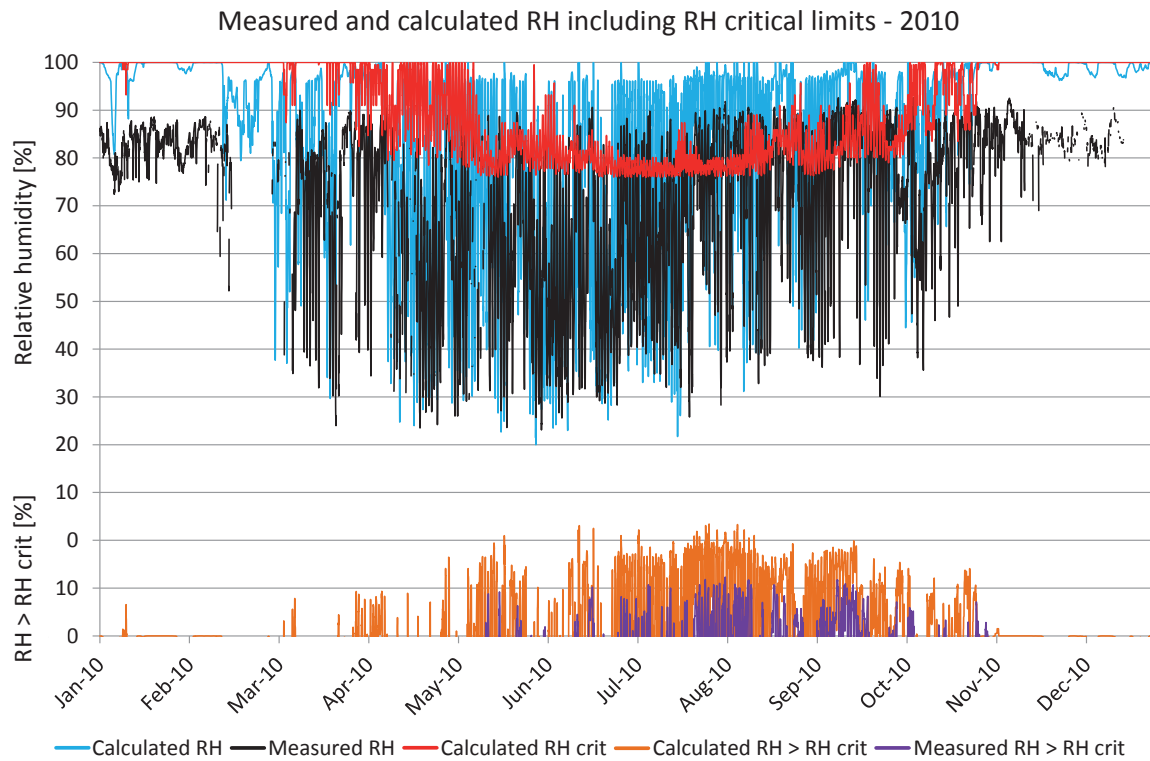

Figure 8.11-5v-exterior.7. Comparisons between measured and calculated relative humidity. Calculated RH (turquoise), measured RH (black), RH_{crit} for calculated values (red), calculated $RH > RH_{crit}$ (light brown), measured $RH > RH_{crit}$ (purple).

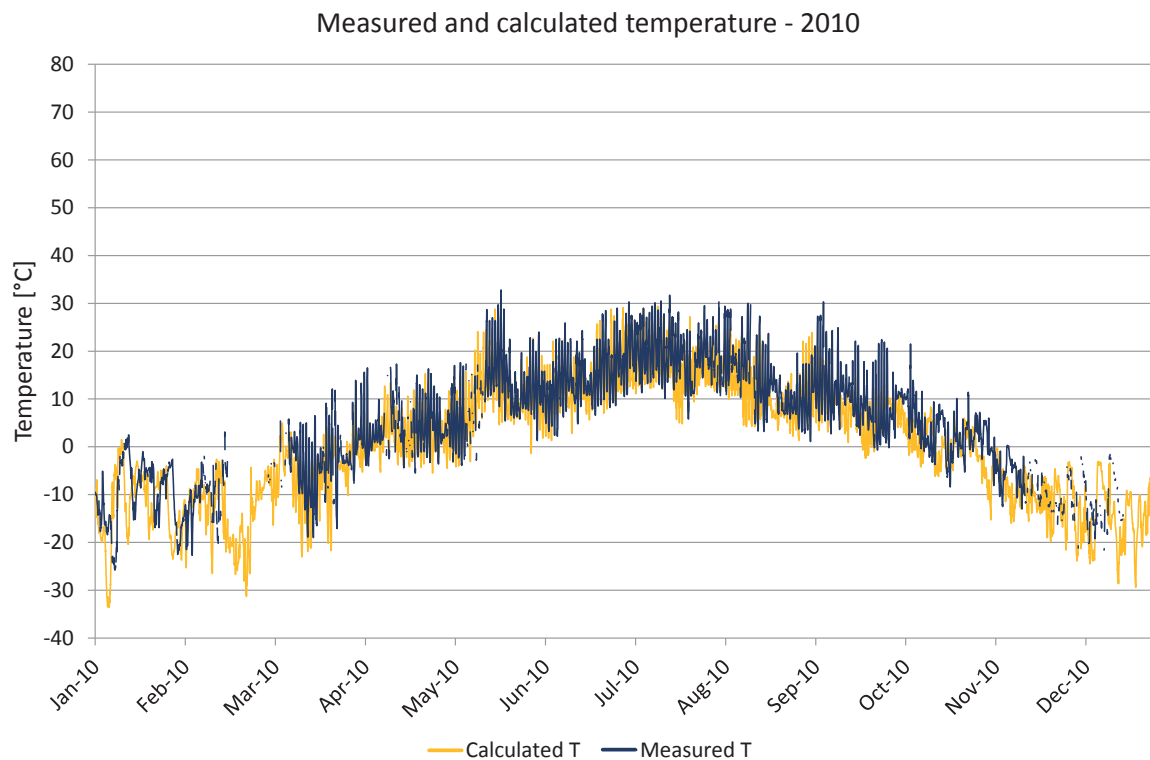

Figure 8.11-5v-exterior.8. Comparisons between measured and calculated temperature. Calculated temperature (yellow), measured temperature (dark blue).

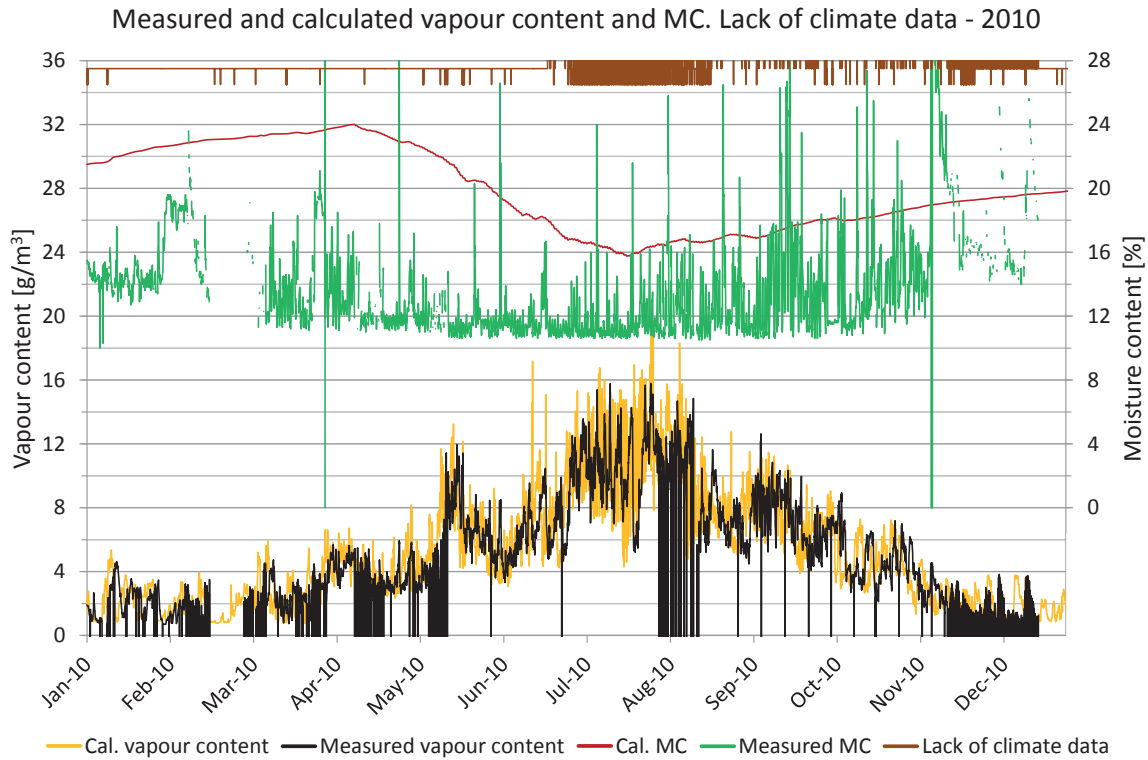

Figure 8.11-5v-exterior.9. Measured moisture content, periods lacking climate data and comparisons of vapour content. Vapour content for calculated values (yellow) and measured values (black). Moisture content for calculated values (red) and measured values (green), periods with lack of climate data (brown).

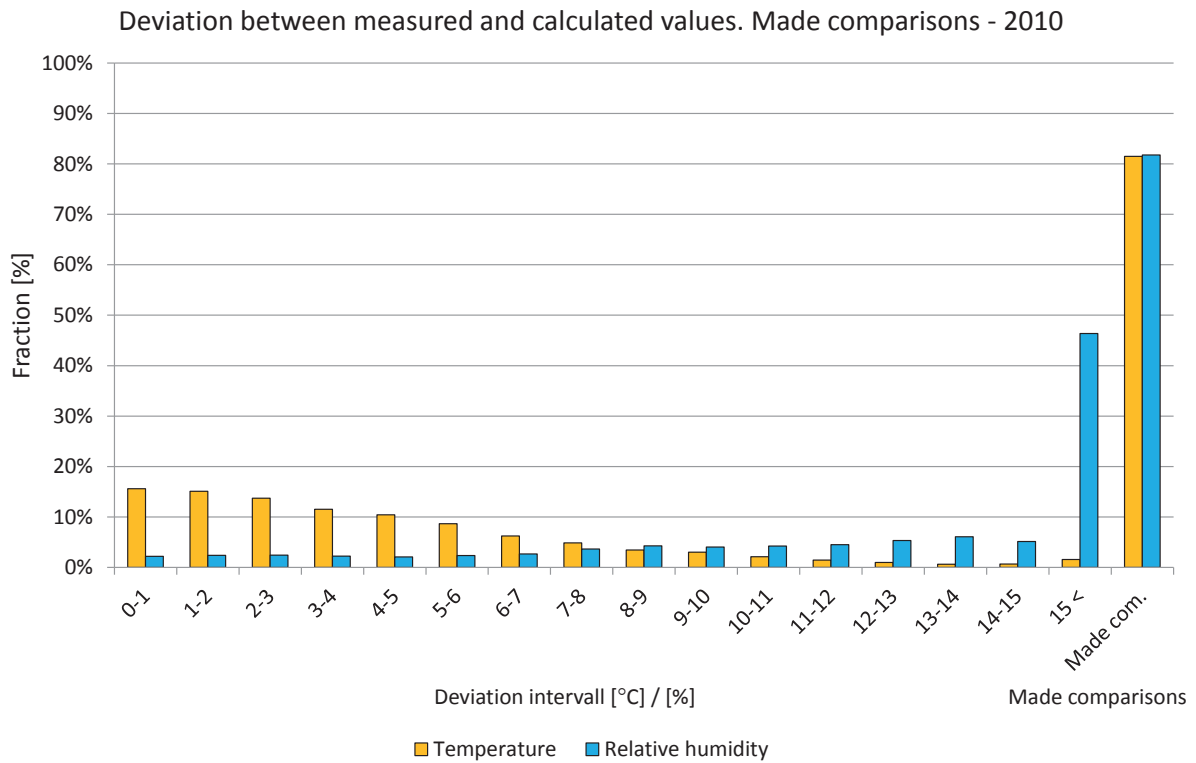

Figure 8.11-5v-exterior.10. Deviations in comparisons shown in intervals from 0 to 15 °C or %. The two right-hand bars show the percentage of comparisons during the year. Temperature (yellow) and relative humidity (light blue).

Year 2011

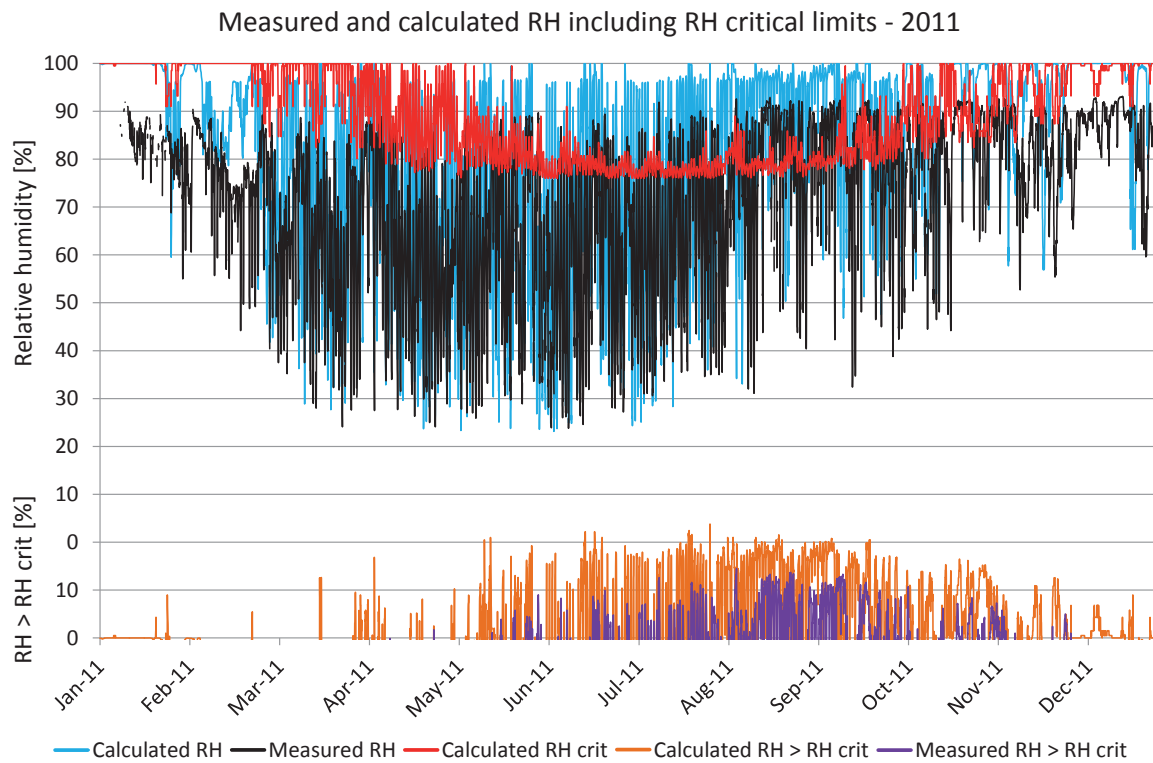

Figure 8.11-5v-exterior.11. Comparisons between measured and calculated relative humidity. Calculated RH (turquoise), measured RH (black), RH_{crit} for calculated values (red), calculated $RH > RH_{crit}$ (light brown), measured $RH > RH_{crit}$ (purple).

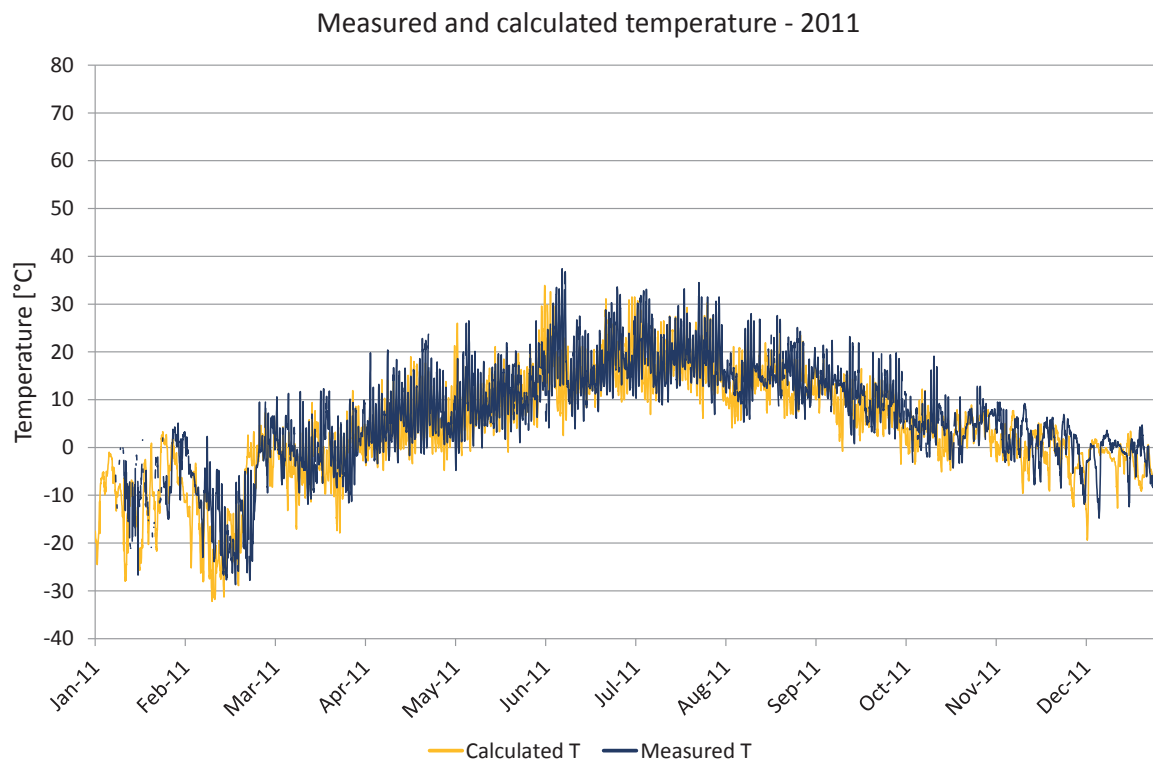

Figure 8.11-5v-exterior.12. Comparisons between measured and calculated temperature. Calculated temperature (yellow), measured temperature (dark blue).

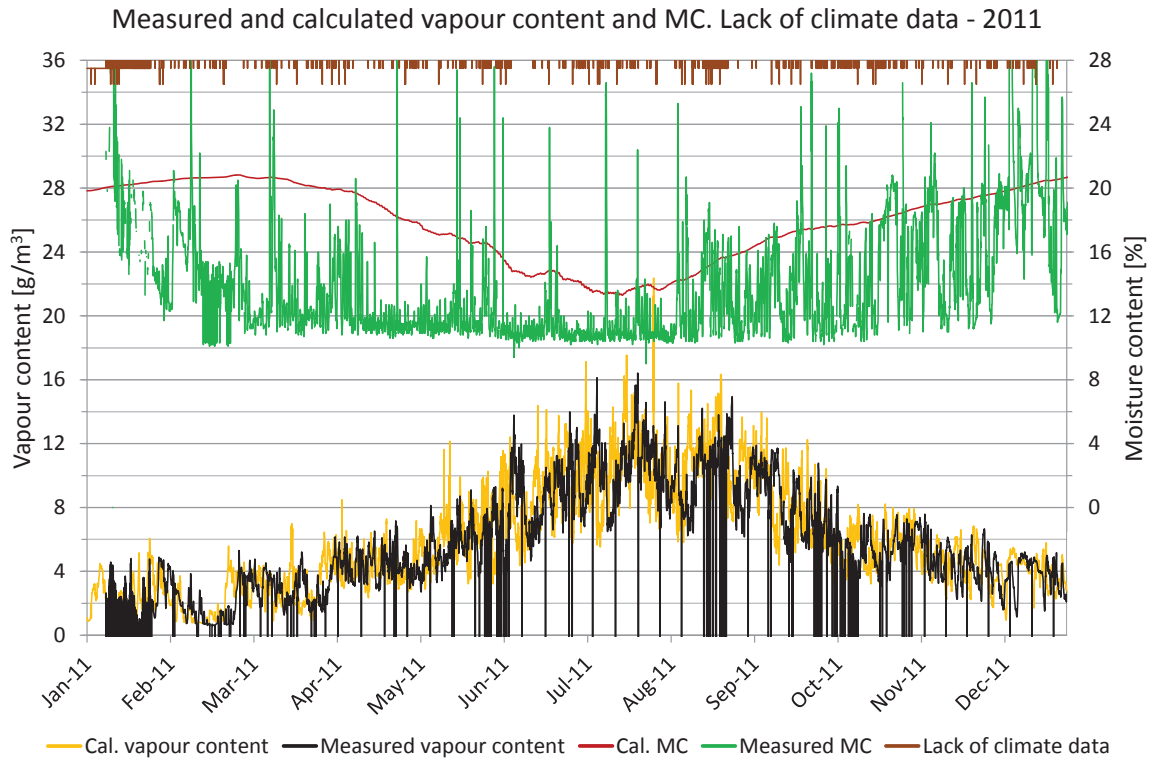

Figure 8.11-5v-exterior.13. Measured moisture content, periods lacking climate data and comparisons of vapour content. Vapour content for calculated values (yellow) and measured values (black). Moisture content for calculated values (red) and measured values (green), periods with lack of climate data (brown).

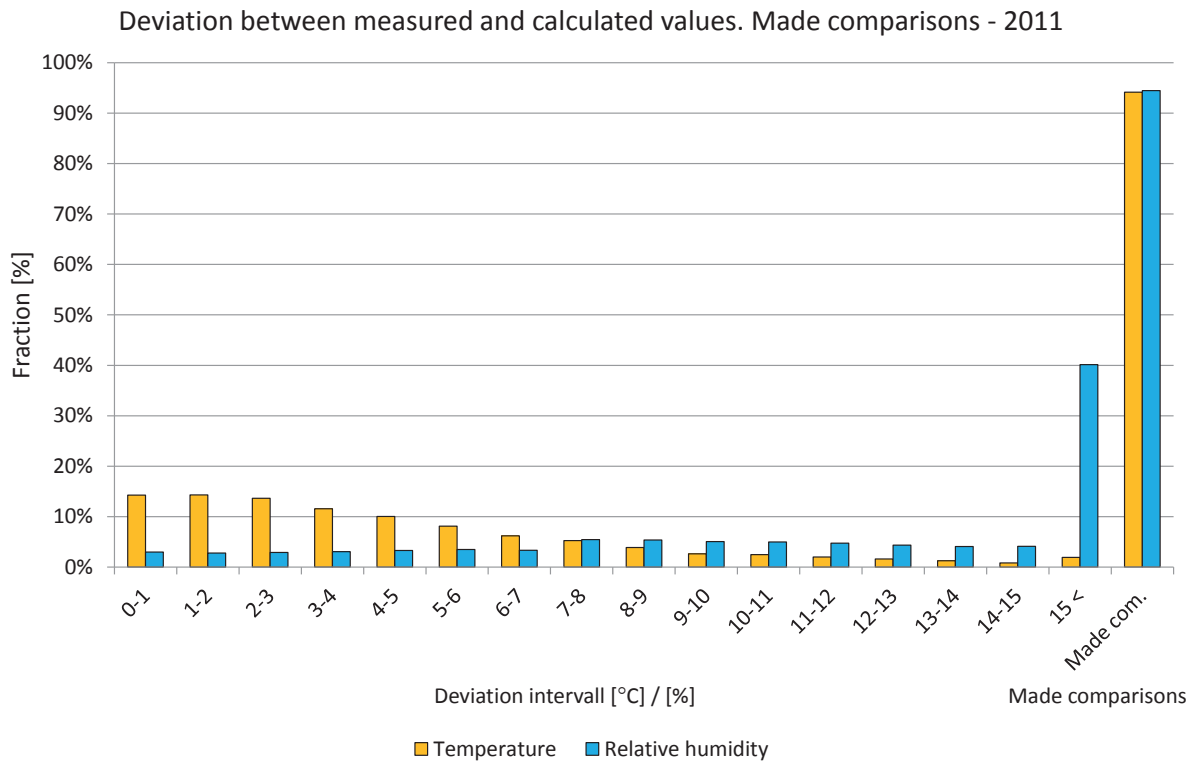

Figure 8.11-5v-exterior.14. Deviations in comparisons shown in intervals from 0 to 15 °C or %. The two right-hand bars show the percentage of comparisons during the year. Temperature (yellow) and relative humidity (light blue).

8.11 Position 11-5v-air gap

The locations of the measured and calculated position are shown in the drawings and figures below. The studied position is located in the air gap behind the façade panel in a wall that is facing west on the fifth floor.

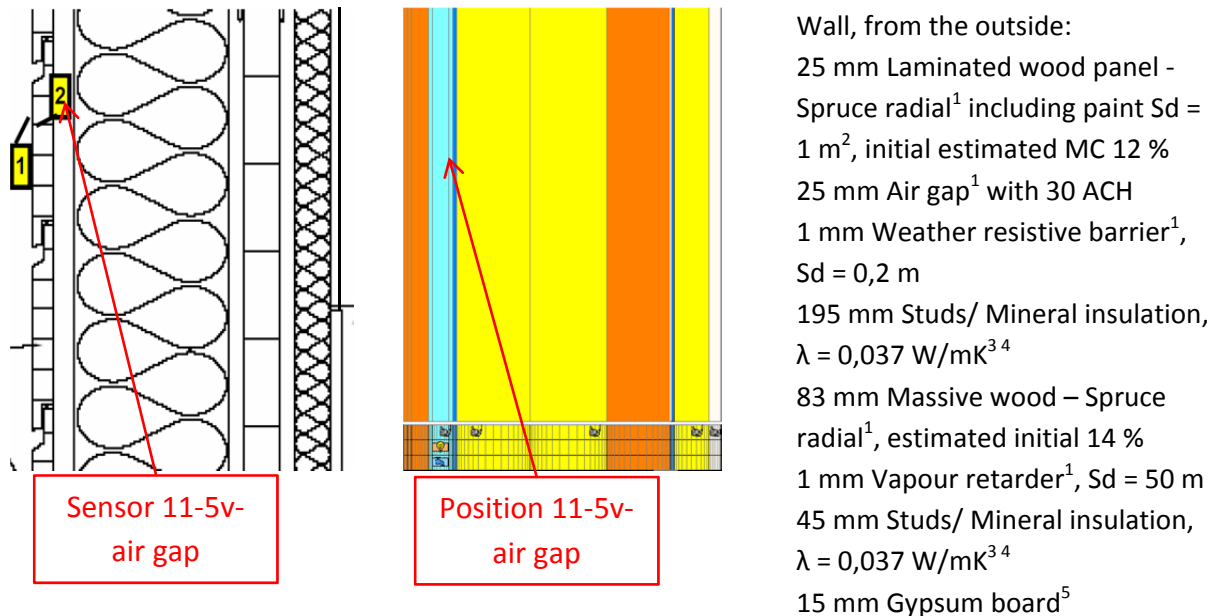

Figure 8.11-5v-air gap.1. Vertical cross sectional drawing and WUFI calculation model showing the studied position. 1. IBP, 2012, 2. Nevander, L-E., 1994, 3. IEA Annex 24, 1996, 4. Paroc, 2002, 5. Krus, M., 1996.

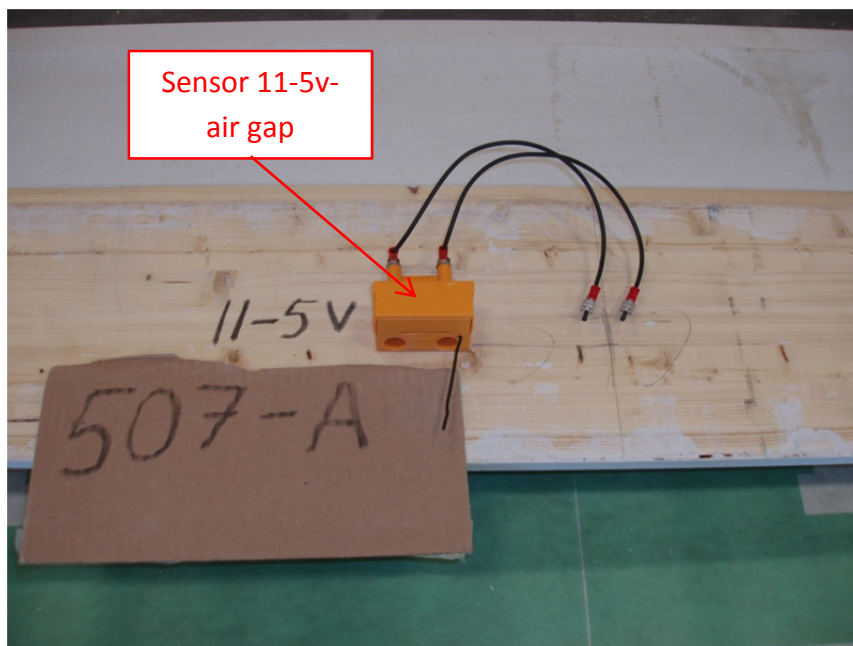

Figure 8.11-5v-air gap.2. Location of the studied position. Photo: SP Trä Skellefteå.

A perfect match between the measured and calculated values cannot be expected due to e.g. the influence of two- and three-dimensional effects and the accuracy of the sensors.

Year 2009

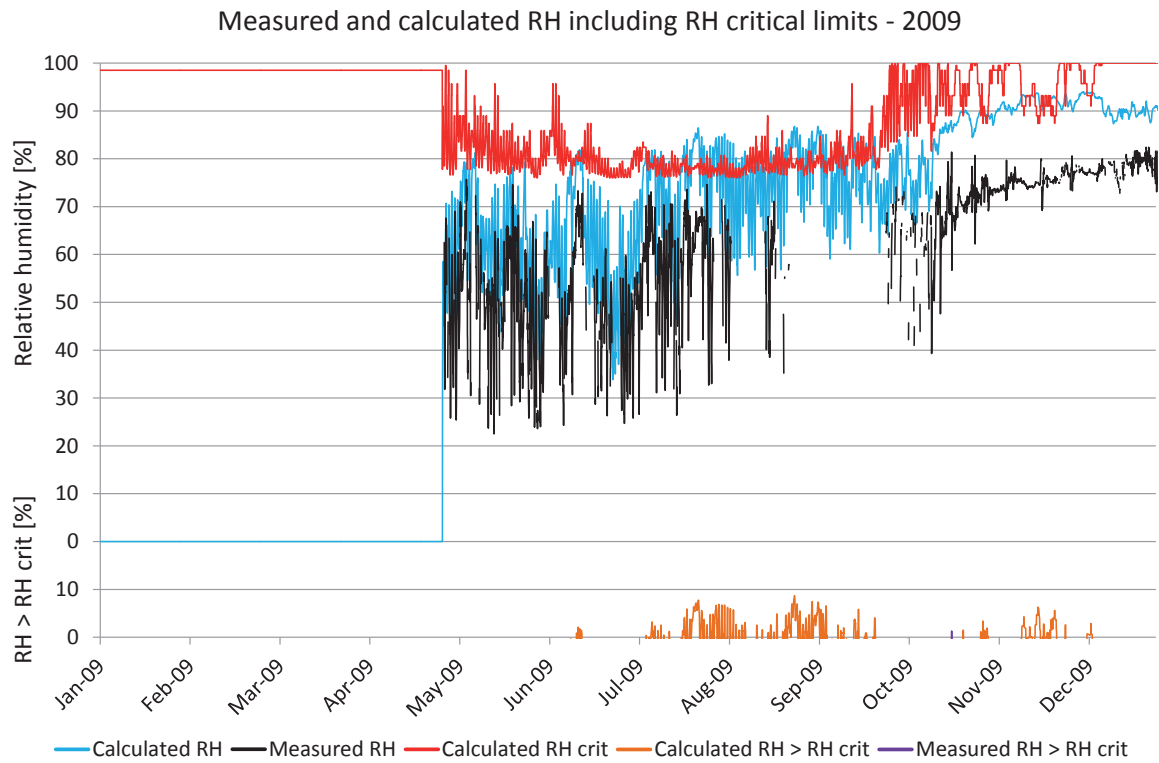

Figure 8.11-5v-air gap.3. Comparisons between measured and calculated relative humidity. Calculated RH (turquoise), measured RH (black), RH_{crit} for calculated values (red), calculated $RH > RH_{crit}$ (light brown), measured $RH > RH_{crit}$ (purple).

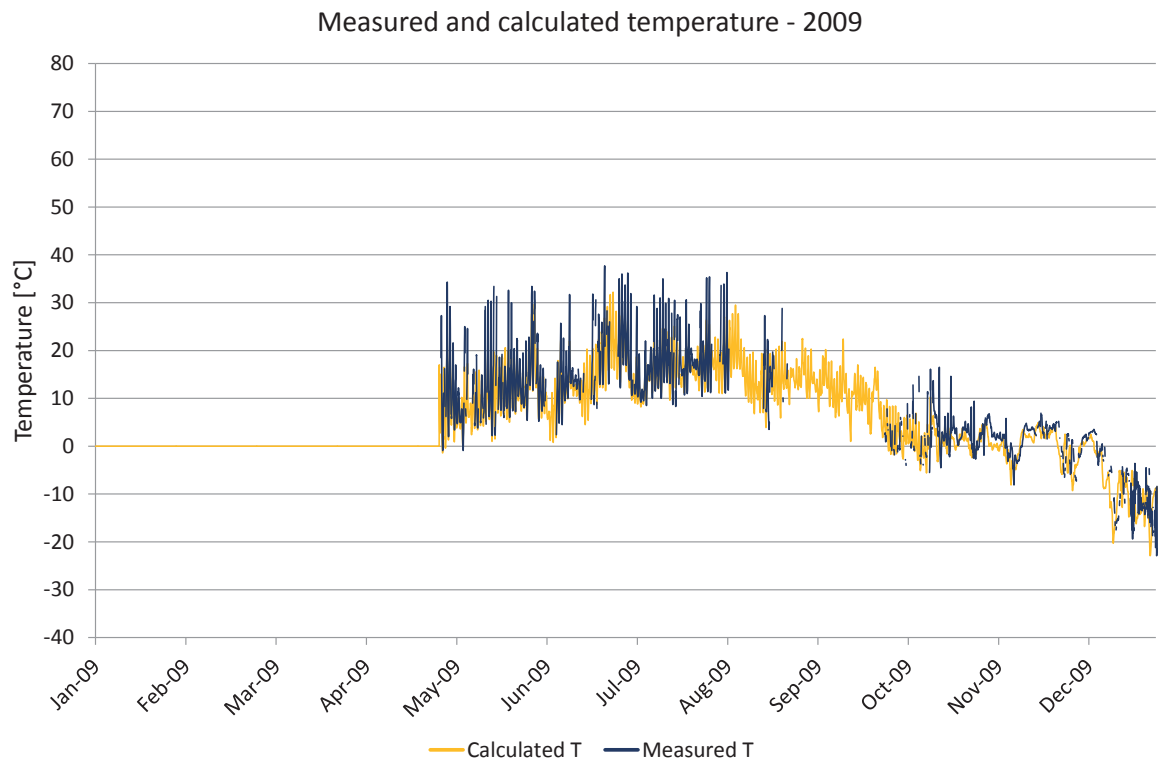

Figure 8.11-5v-air gap.4. Comparisons between measured and calculated temperature. Calculated temperature (yellow), measured temperature (dark blue).

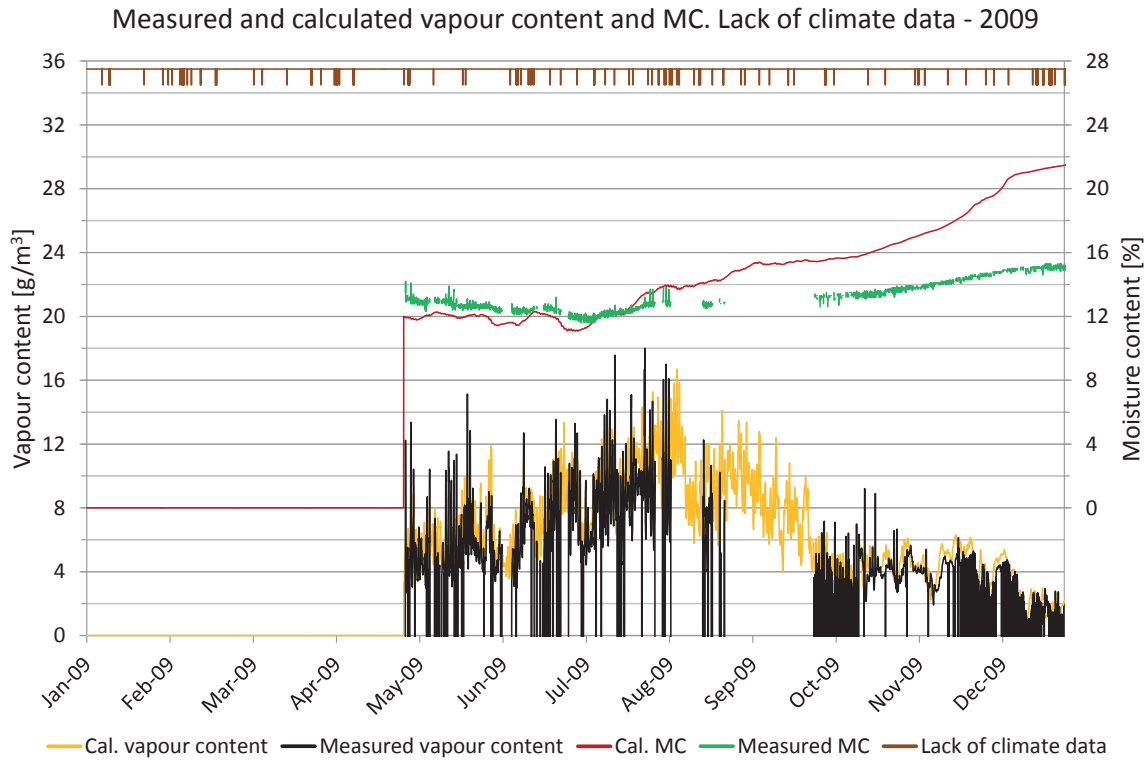

Figure 8.11-5v-air gap.5. Measured moisture content, periods lacking climate data and comparisons of vapour content. Vapour content for calculated values (yellow) and measured values (black). Moisture content for calculated values (red) and measured values (green), periods with lack of climate data (brown).

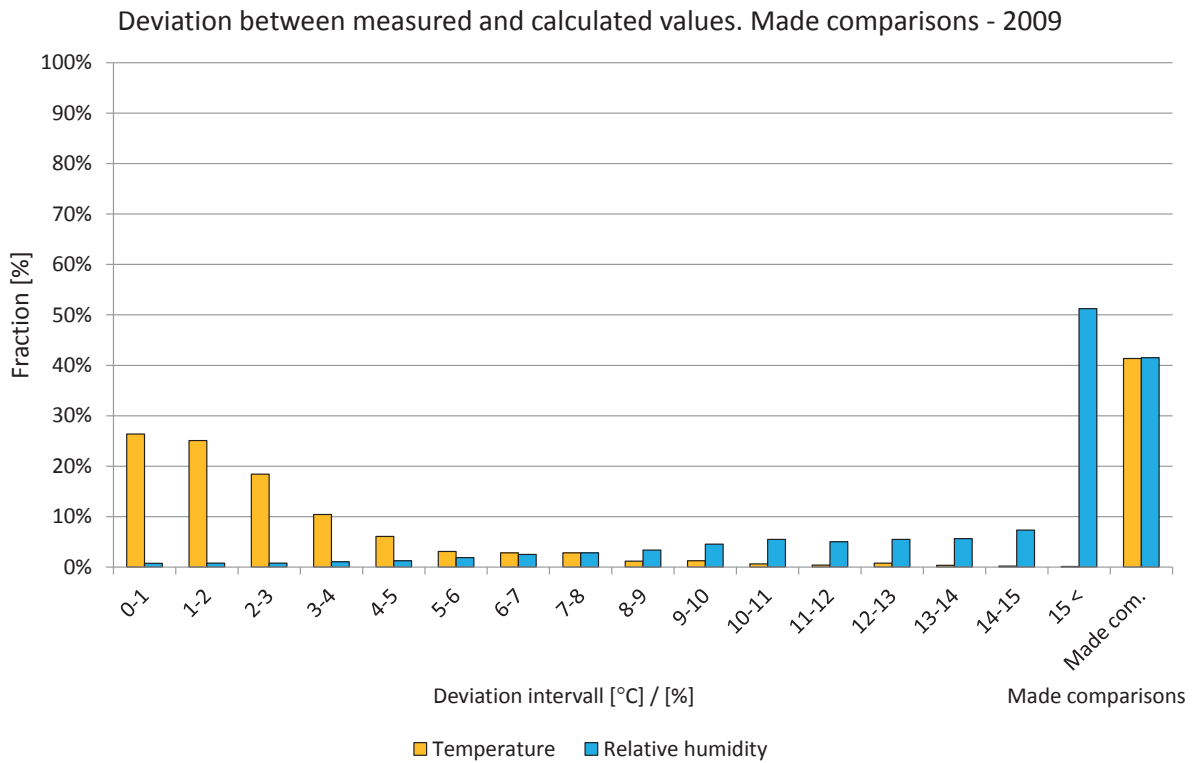

Figure 8.11-5v-air gap.6. Deviations in comparisons shown in intervals from 0 to 15 °C or %. The two right-hand bars show the percentage of comparisons during the year. Temperature (yellow) and relative humidity (light blue).

Year 2010

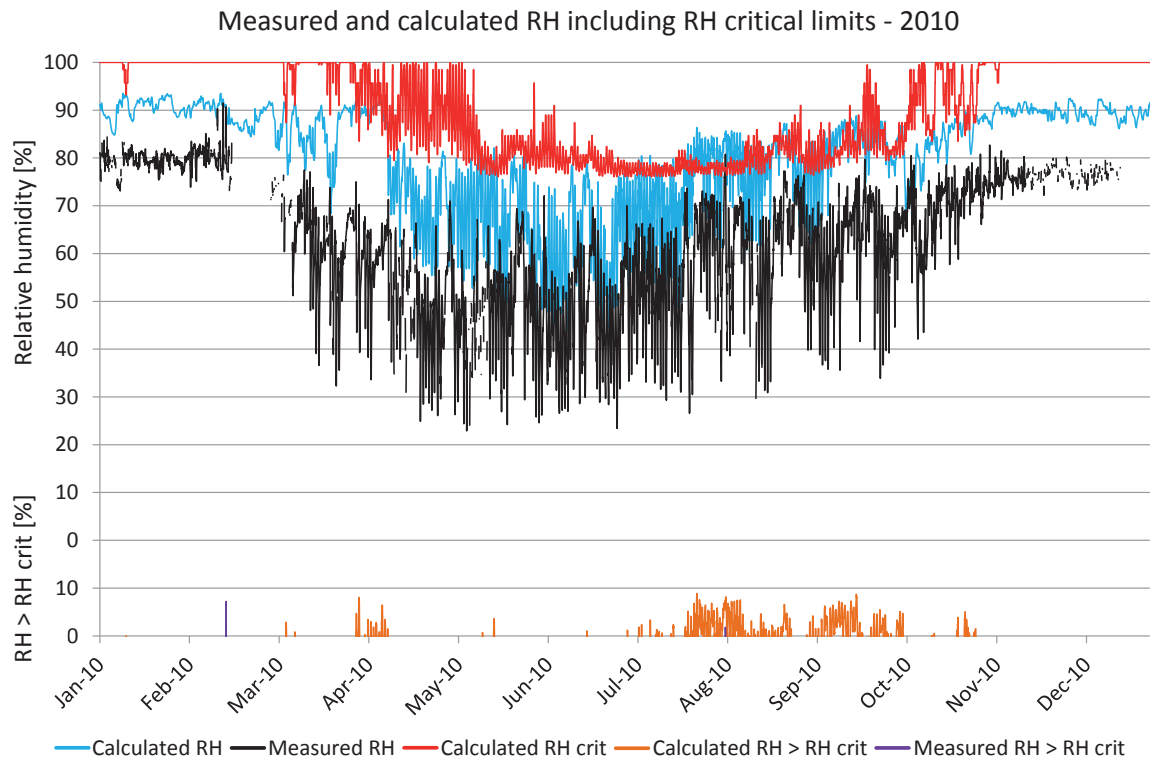

Figure 8.11-5v-air gap.7. Comparisons between measured and calculated relative humidity. Calculated RH (turquoise), measured RH (black), RH_{crit} for calculated values (red), calculated $RH > RH_{crit}$ (light brown), measured $RH > RH_{crit}$ (purple).

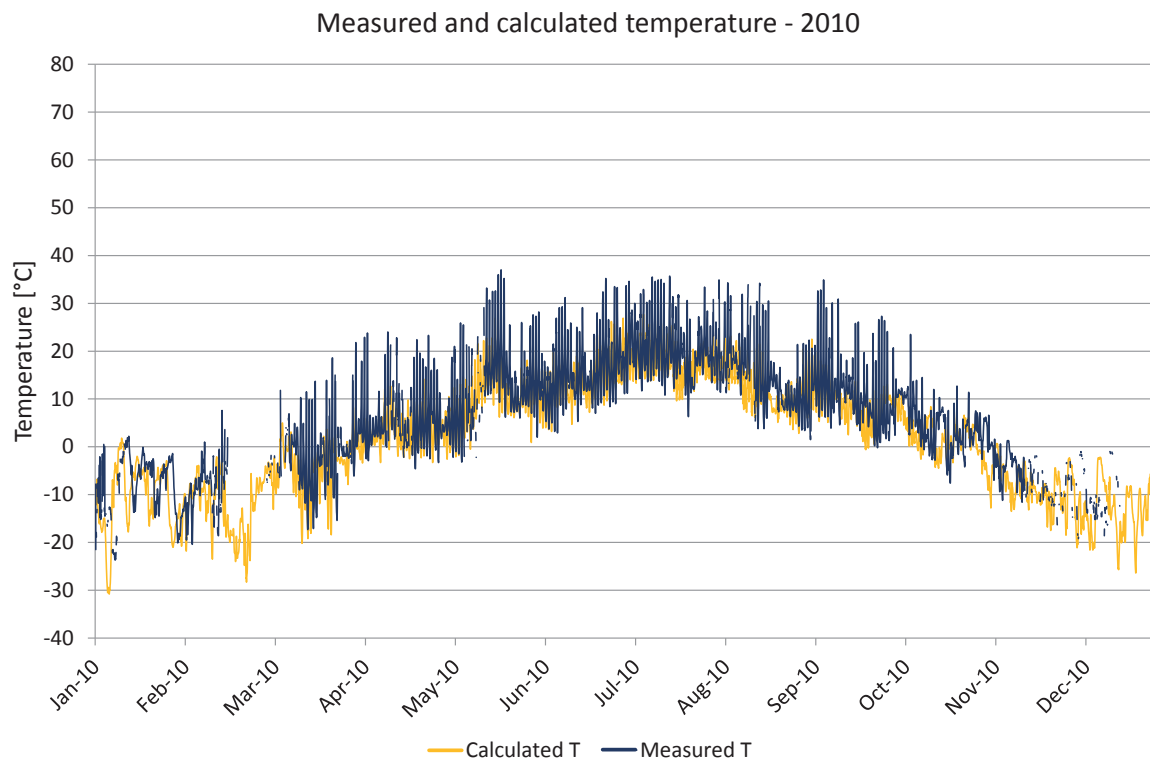

Figure 8.11-5v-air gap.8. Comparisons between measured and calculated temperature. Calculated temperature (yellow), measured temperature (dark blue).

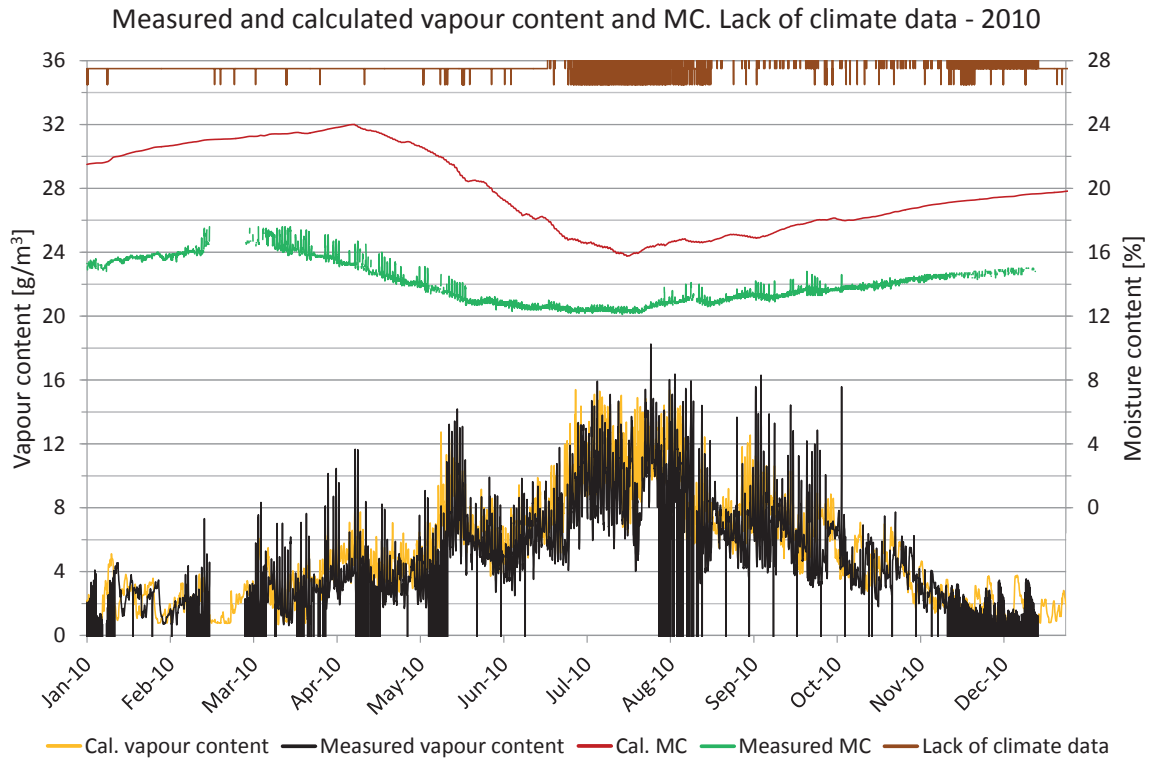

Figure 8.11-5v-air gap.9. Measured moisture content, periods lacking climate data and comparisons of vapour content. Vapour content for calculated values (yellow) and measured values (black). Moisture content for calculated values (red) and measured values (green), periods with lack of climate data (brown).

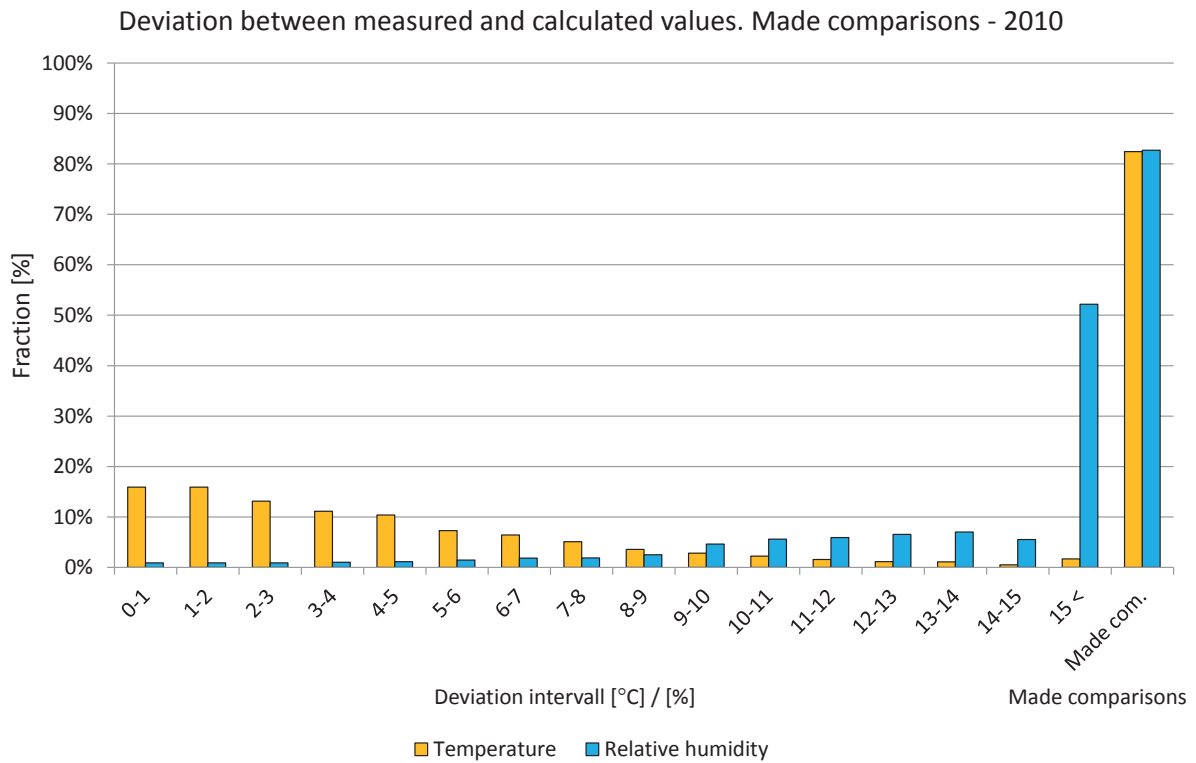

Figure 8.11-5v-air gap.10. Deviations in comparisons shown in intervals from 0 to 15 °C or %. The two right-hand bars show the percentage of comparisons during the year. Temperature (yellow) and relative humidity (light blue).

Year 2011

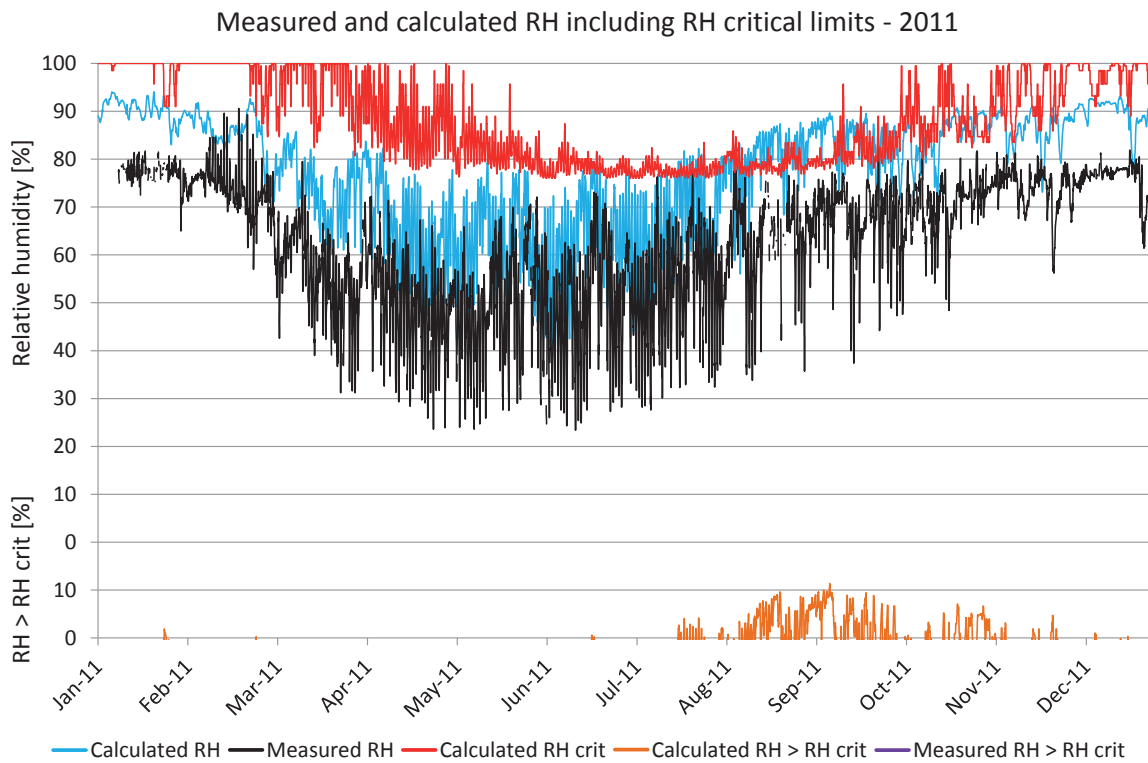

Figure 8.11-5v-air gap.11. Comparisons between measured and calculated relative humidity. Calculated RH (turquoise), measured RH (black), RH_{crit} for calculated values (red), calculated $RH > RH_{crit}$ (light brown), measured $RH > RH_{crit}$ (purple).

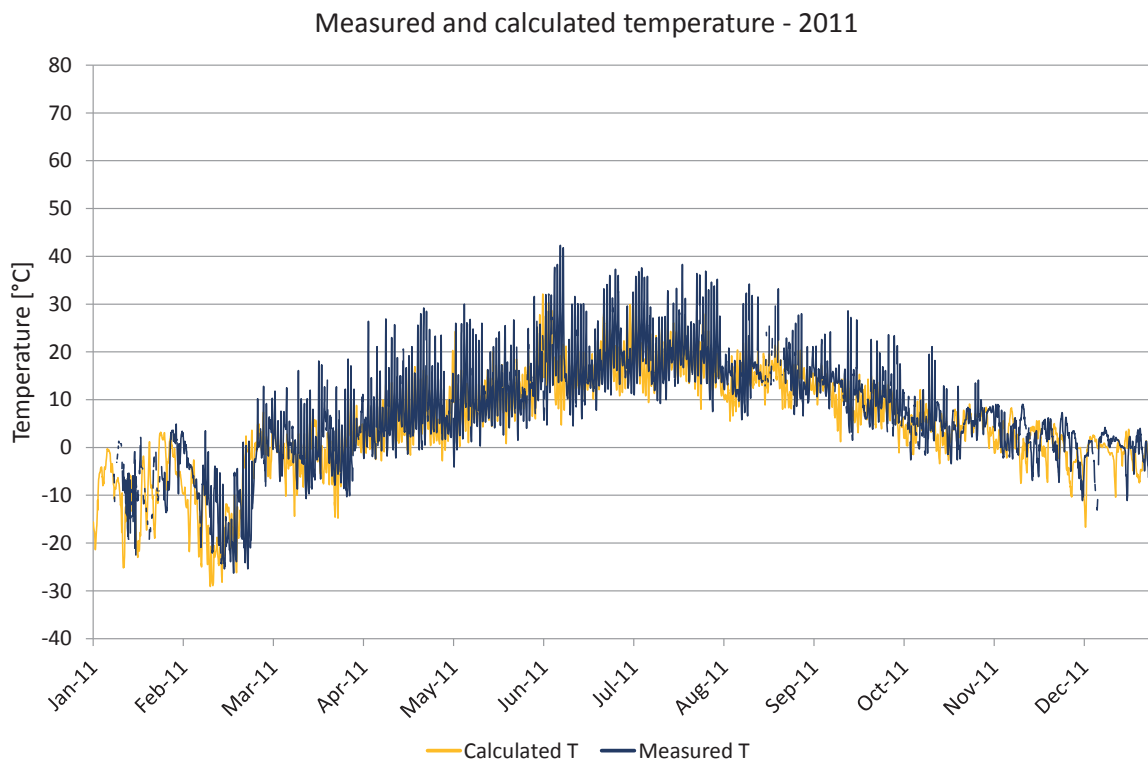

Figure 8.11-5v-air gap.12. Comparisons between measured and calculated temperature. Calculated temperature (yellow), measured temperature (dark blue).

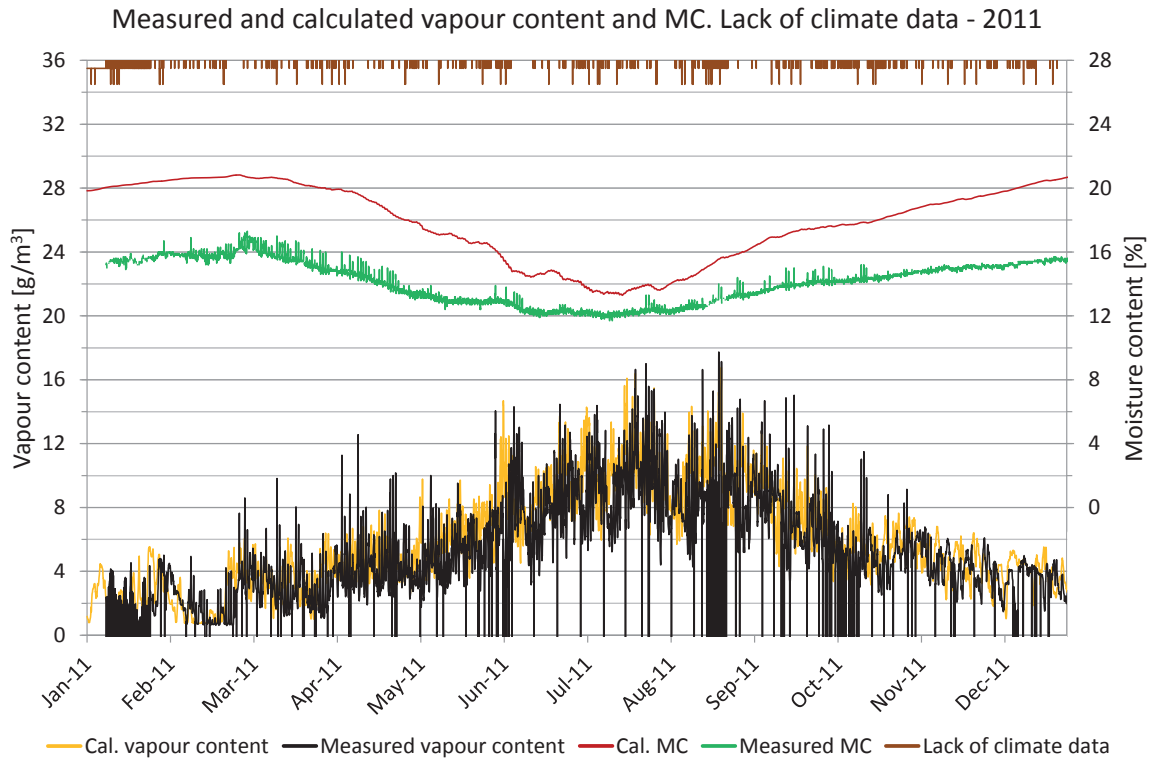

Figure 8.11-5v-air gap.13. Measured moisture content, periods lacking climate data and comparisons of vapour content. Vapour content for calculated values (yellow) and measured values (black). Moisture content for calculated values (red) and measured values (green), periods with lack of climate data (brown).

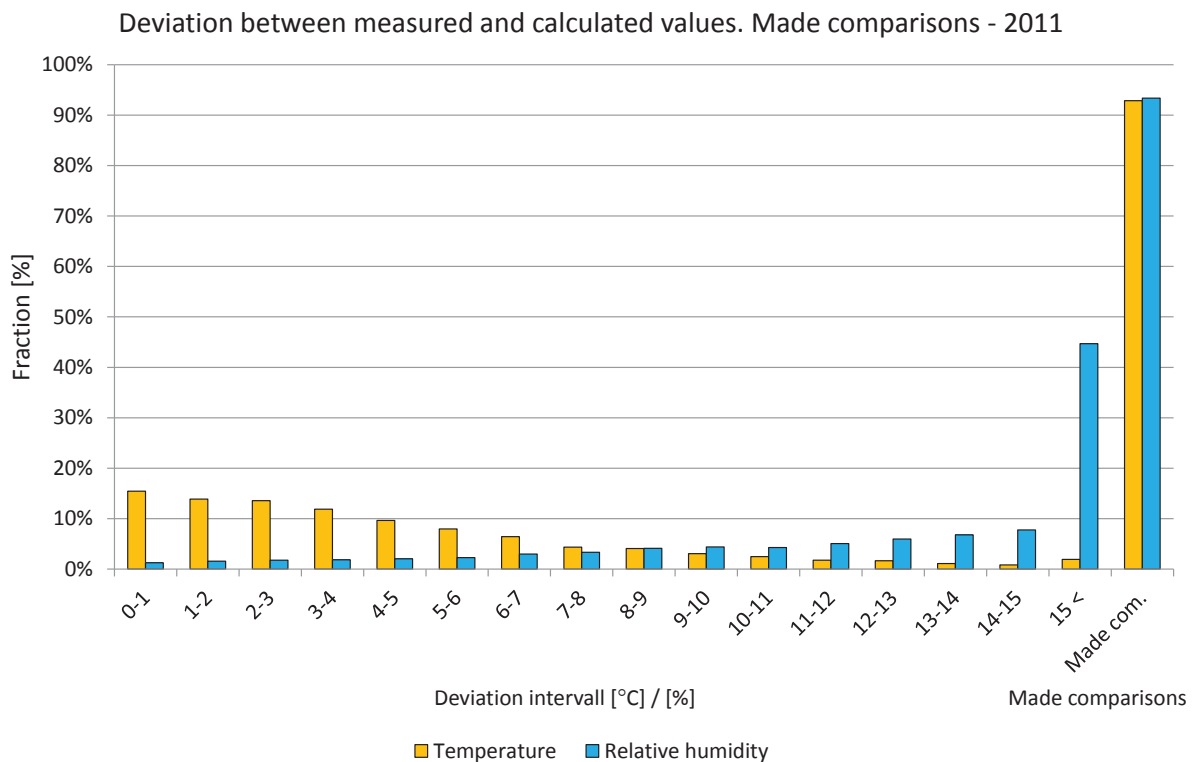

Figure 8.11-5v-air gap.14. Deviations in comparisons shown in intervals from 0 to 15 °C or %. The two right-hand bars show the percentage of comparisons during the year. Temperature (yellow) and relative humidity (light blue).

8.14 Position 14-5n-exterior façade

The locations of the measured and calculated position are shown in the drawings and figures below. The studied position is located on the exterior façade panel on a wall that is facing north on the fifth floor. Measured temperature and relative humidity were used in the quality control of used outdoor climate. The comparison could therefore not be seen as a blind comparison.

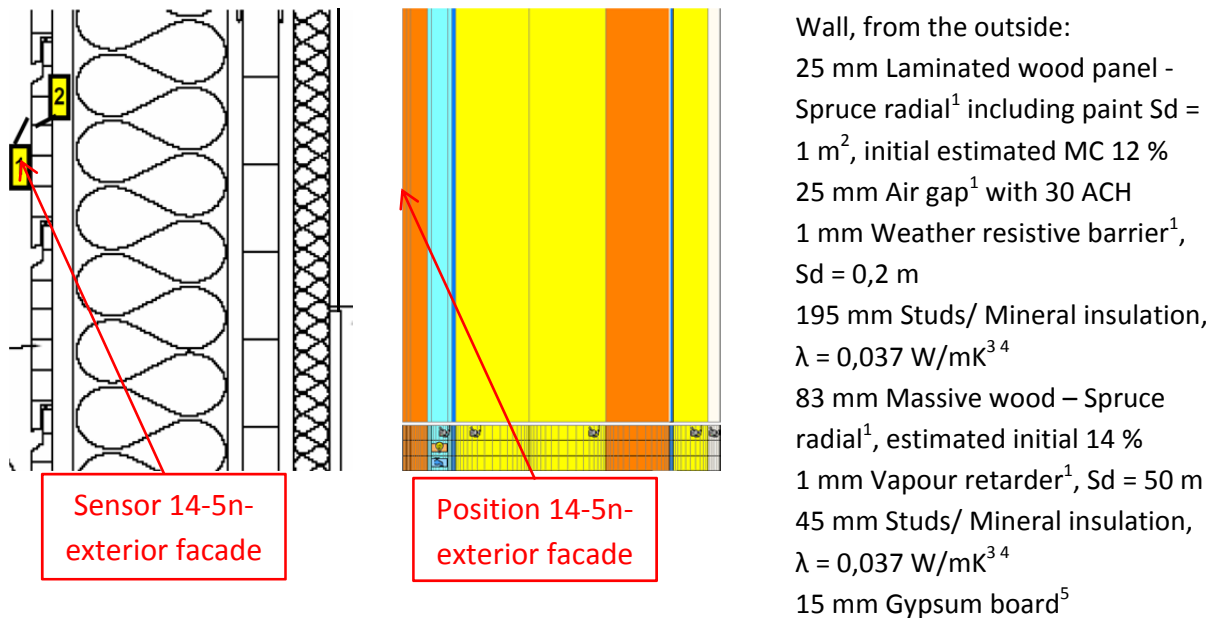

Figure 8.14-5n-exterior.1. Vertical cross sectional drawing and WUFI calculation model showing the studied position. 1. IBP, 2012, 2. Nevander, L-E., 1994, 3. IEA Annex 24, 1996, 4. Paroc, 2002, 5. Krus, M., 1996.

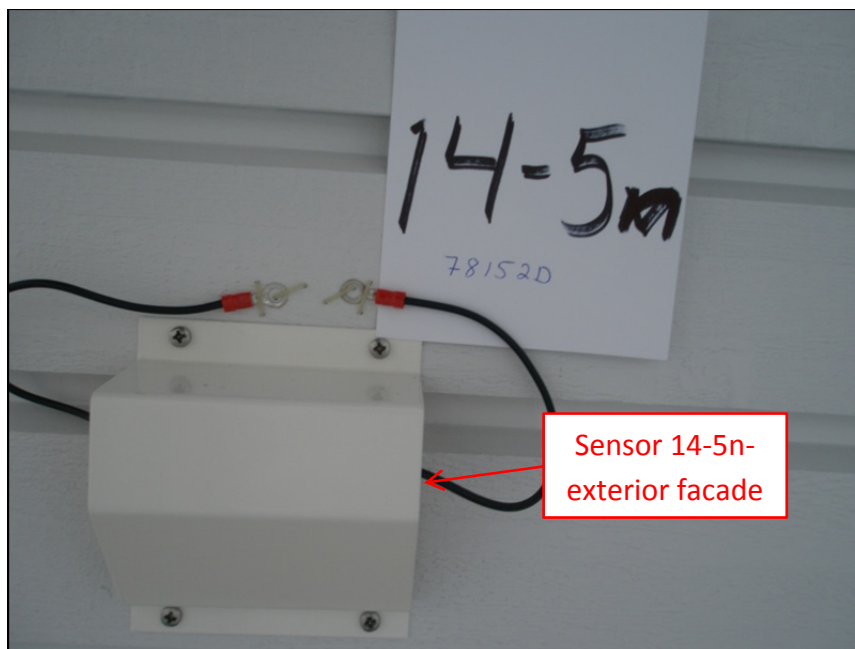

Figure 8.14-5n-exterior.2. Location of the studied position. Photo: SP Trä Skellefteå.

A perfect match between the measured and calculated values cannot be expected due to e.g. the influence of two- and three-dimensional effects and the accuracy of the sensors.

Year 2009

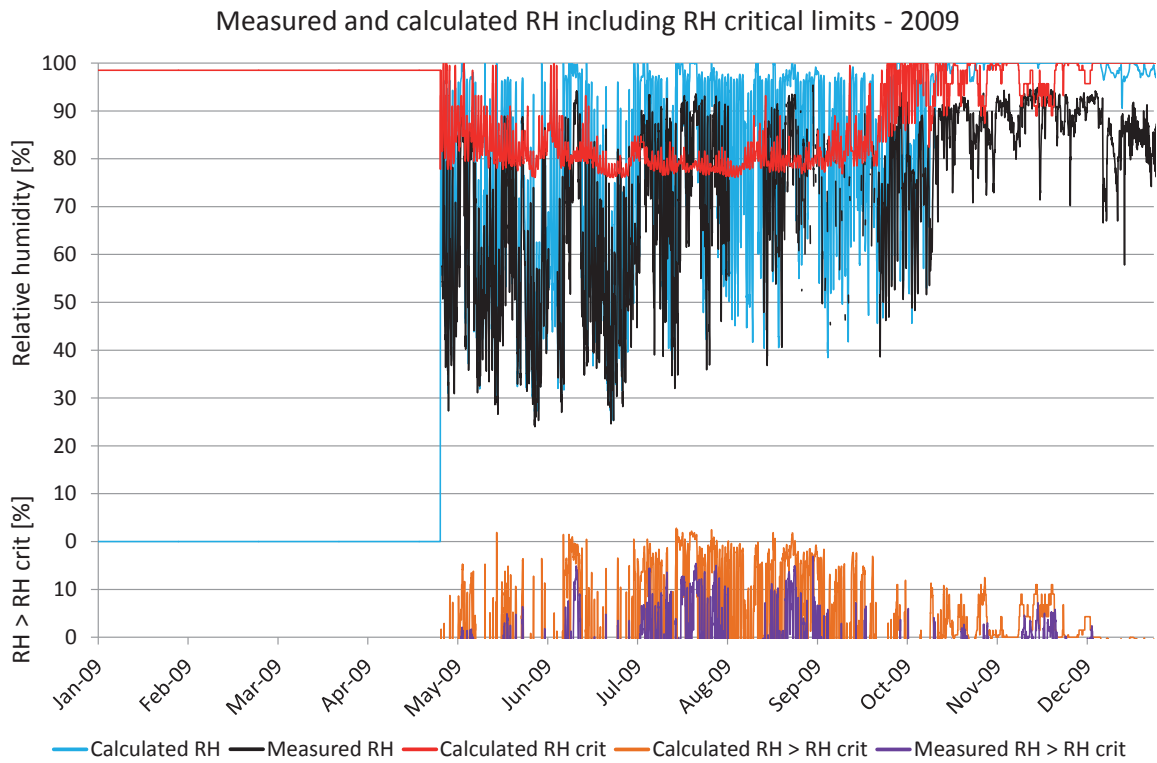

Figure 8.14-5n-exterior.3. Comparisons between measured and calculated relative humidity. Calculated RH (turquoise), measured RH (black), RH_{crit} for calculated values (red), calculated $RH > RH_{crit}$ (light brown), measured $RH > RH_{crit}$ (purple).

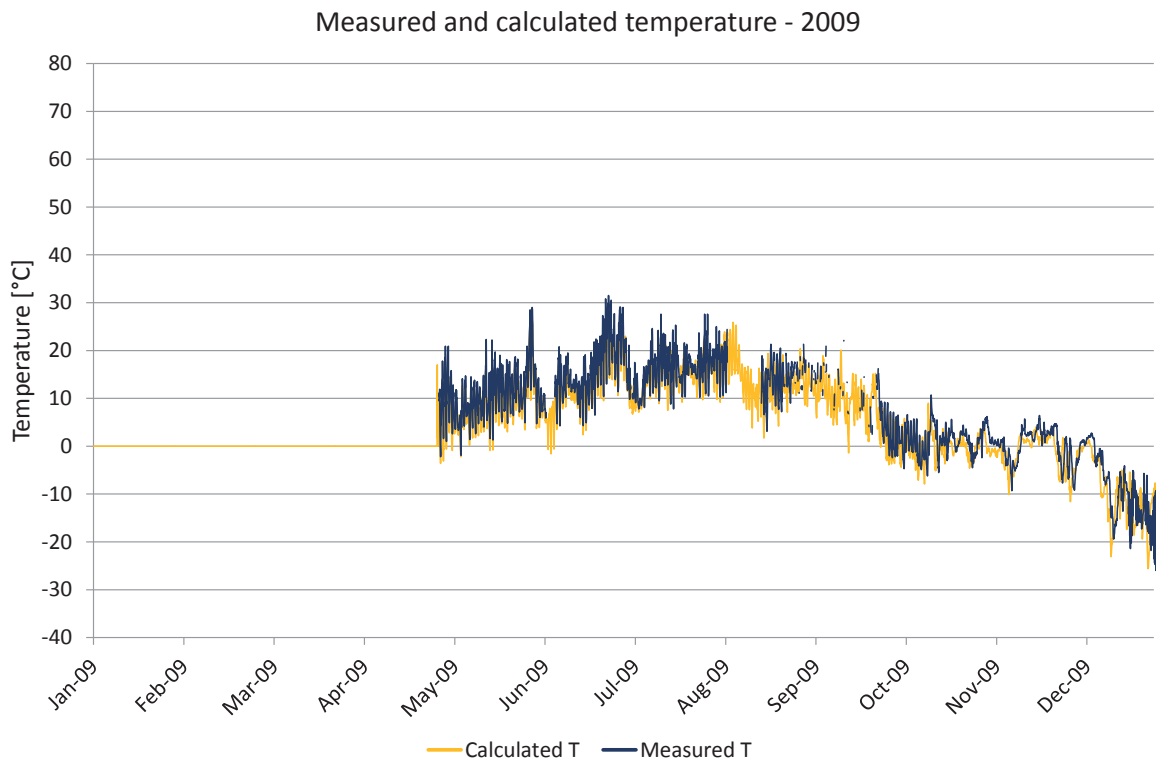

Figure 8.14-5n-exterior.4. Comparisons between measured and calculated temperature. Calculated temperature (yellow), measured temperature (dark blue).

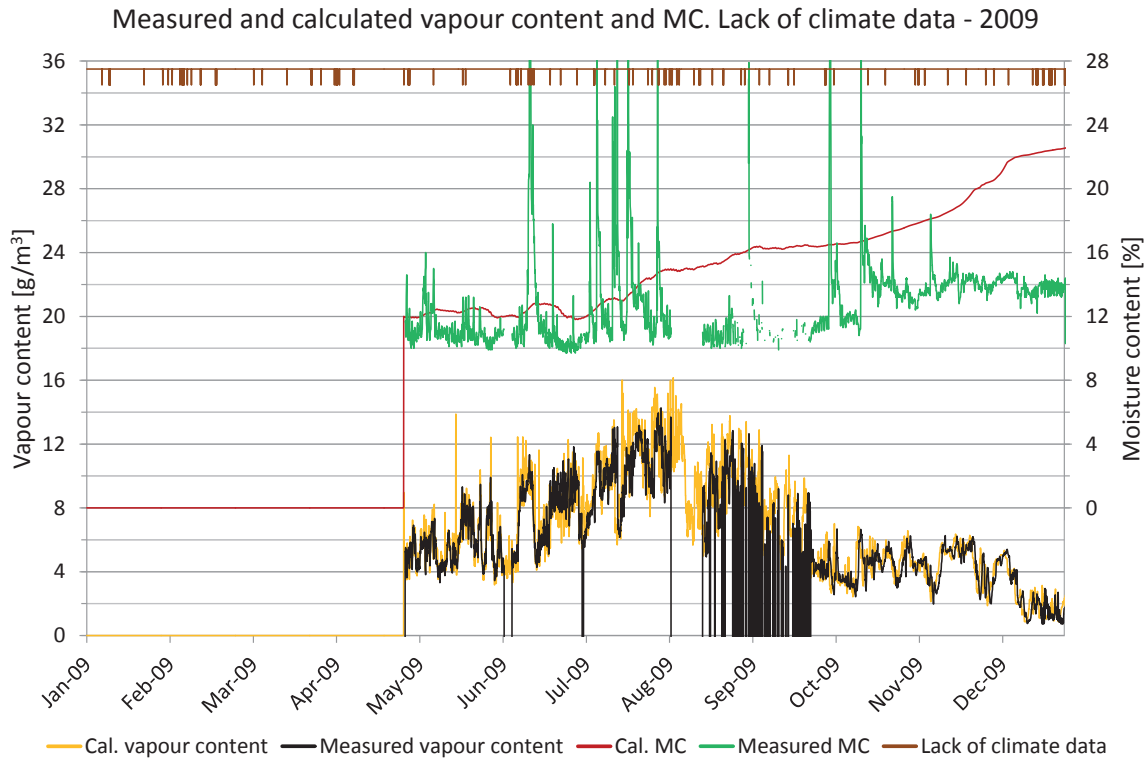

Figure 8.14-5n-exterior.5. Measured moisture content, periods lacking climate data and comparisons of vapour content. Vapour content for calculated values (yellow) and measured values (black). Moisture content for calculated values (red) and measured values (green), periods with lack of climate data (brown).

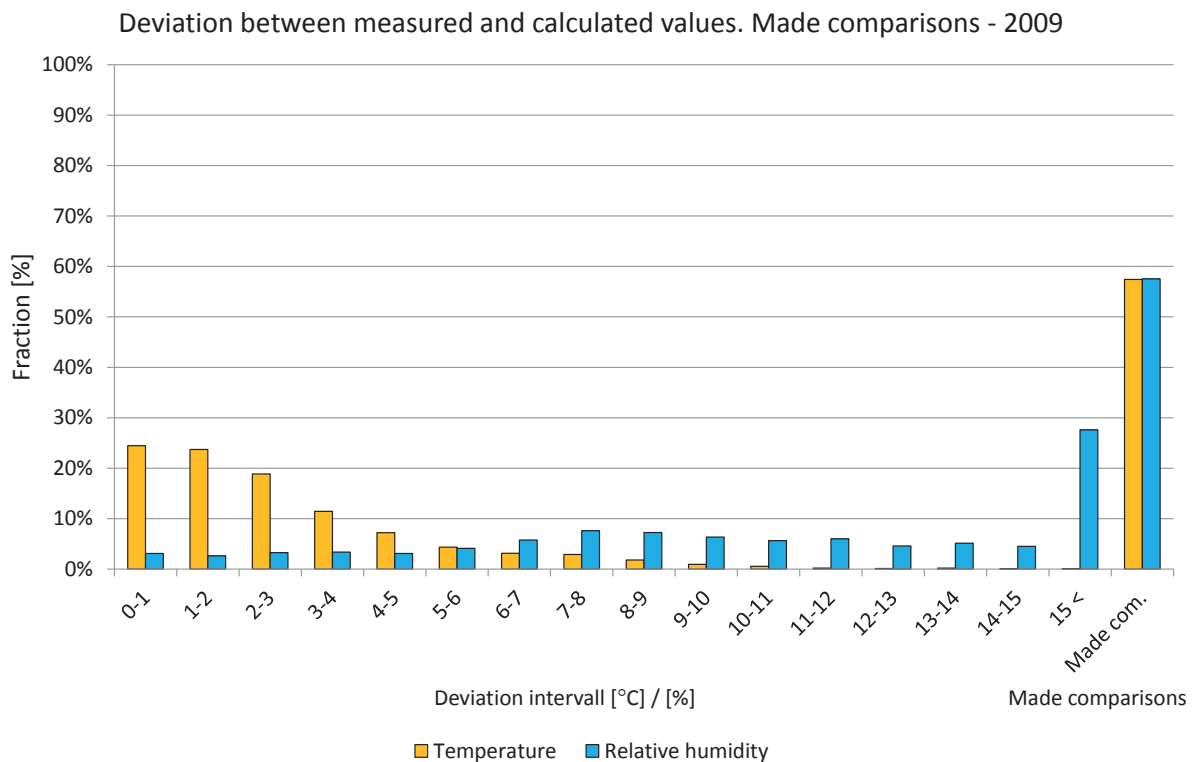

Figure 8.14-5n-exterior.6. Deviations in comparisons shown in intervals from 0 to 15 °C or %. The two right-hand bars show the percentage of comparisons during the year. Temperature (yellow) and relative humidity (light blue).

Year 2010

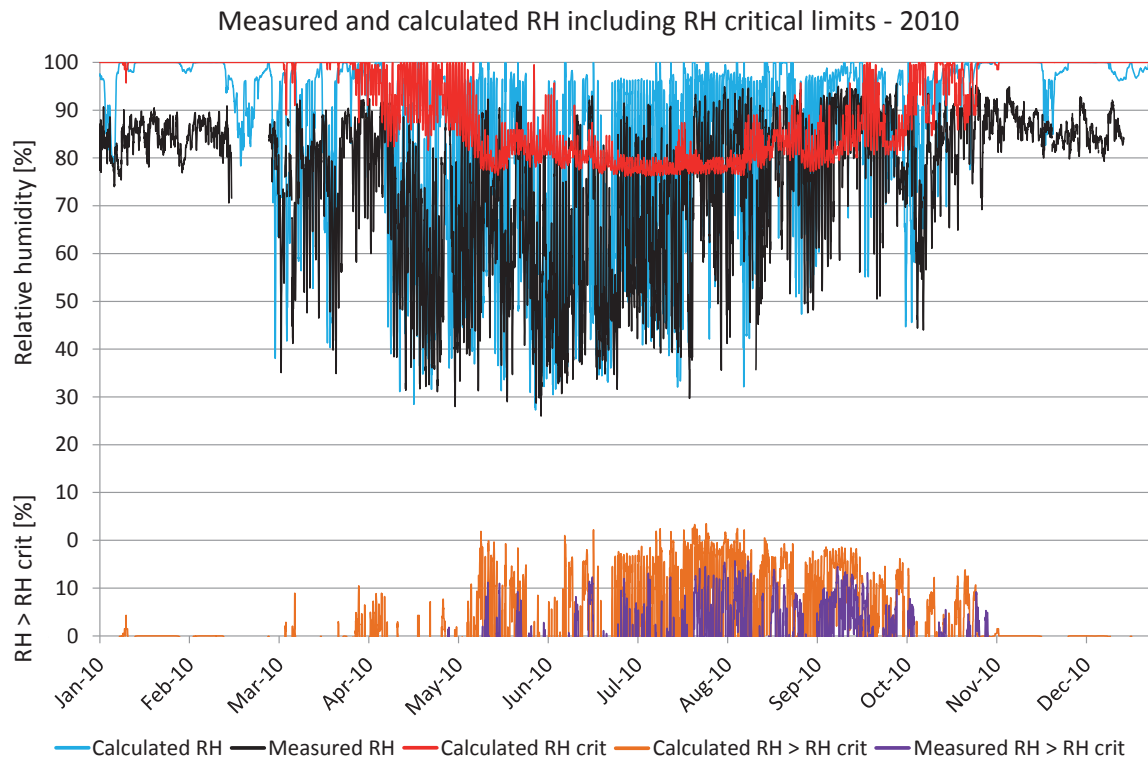

Figure 8.14-5n-exterior.7. Comparisons between measured and calculated relative humidity. Calculated RH (turquoise), measured RH (black), RH_{crit} for calculated values (red), calculated $RH > RH_{crit}$ (light brown), measured $RH > RH_{crit}$ (purple).

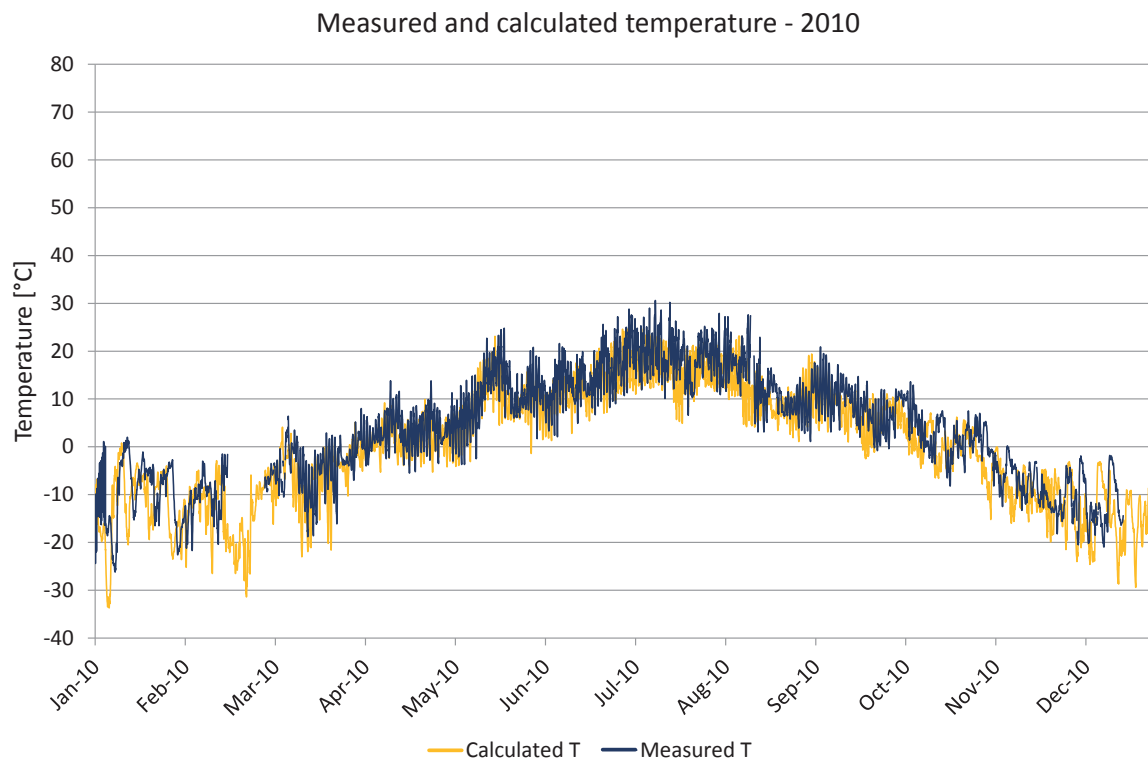

Figure 8.14-5n-exterior.8. Comparisons between measured and calculated temperature. Calculated temperature (yellow), measured temperature (dark blue).

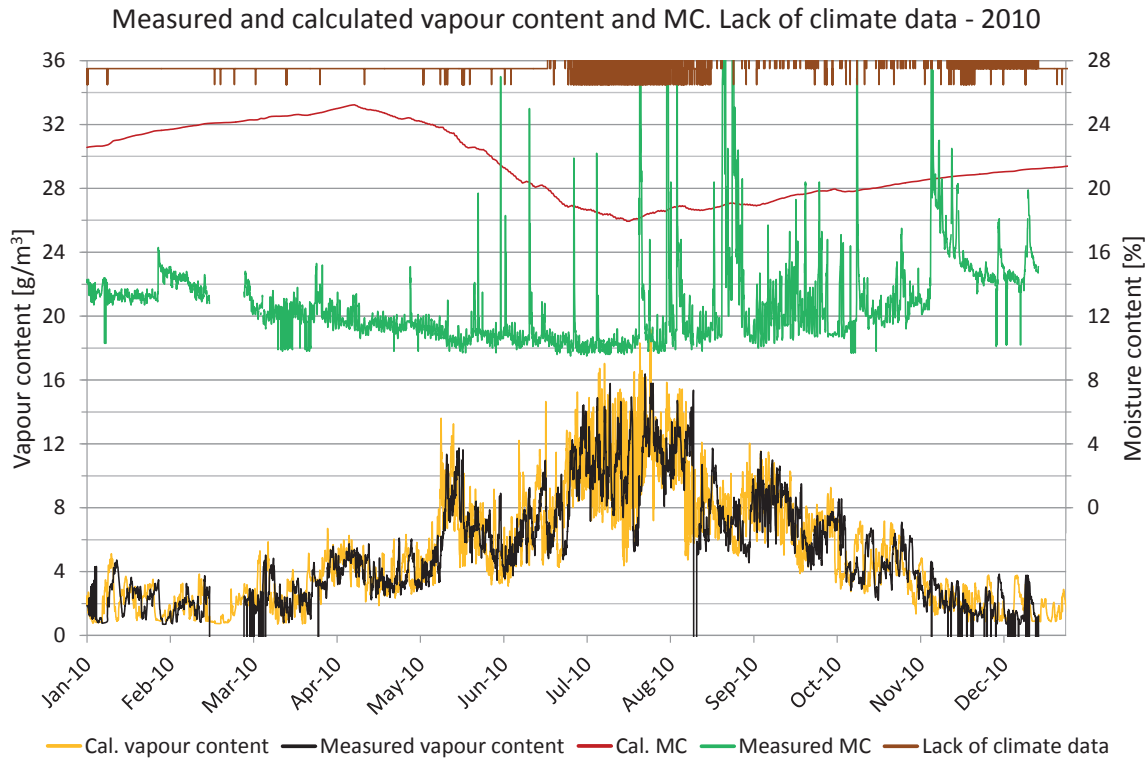

Figure 8.14-5n-exterior.9. Measured moisture content, periods lacking climate data and comparisons of vapour content. Vapour content for calculated values (yellow) and measured values (black). Moisture content for calculated values (red) and measured values (green), periods with lack of climate data (brown).

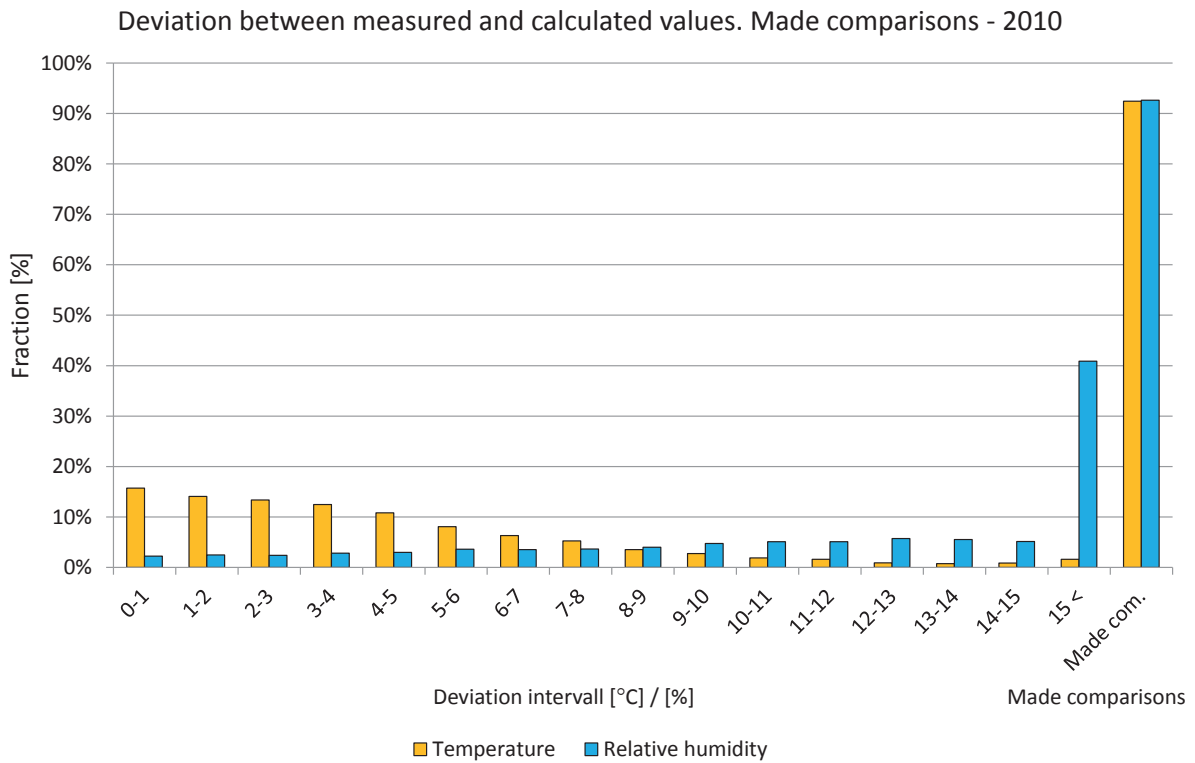

Figure 8.14-5n-exterior.10. Deviations in comparisons shown in intervals from 0 to 15 °C or %. The two right-hand bars show the percentage of comparisons during the year. Temperature (yellow) and relative humidity (light blue).

Year 2011

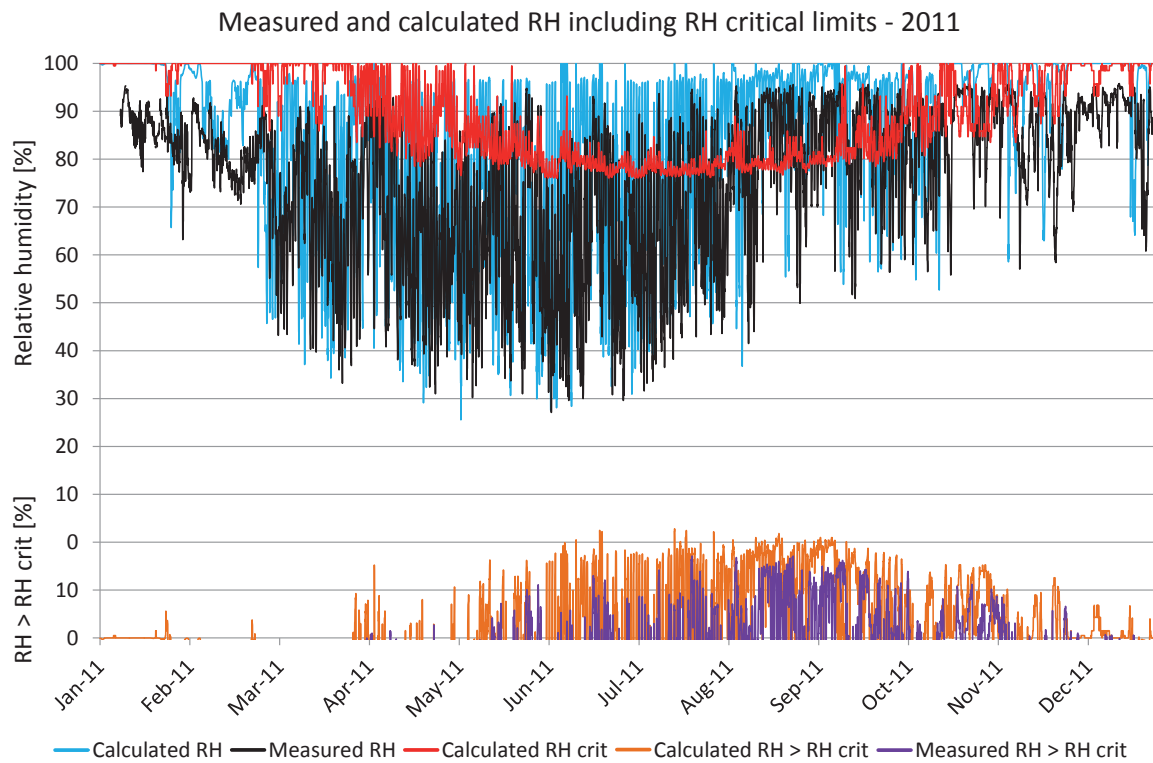

Figure 8.14-5n-exterior.11. Comparisons between measured and calculated relative humidity. Calculated RH (turquoise), measured RH (black), RH_{crit} for calculated values (red), calculated $RH > RH_{crit}$ (light brown), measured $RH > RH_{crit}$ (purple).

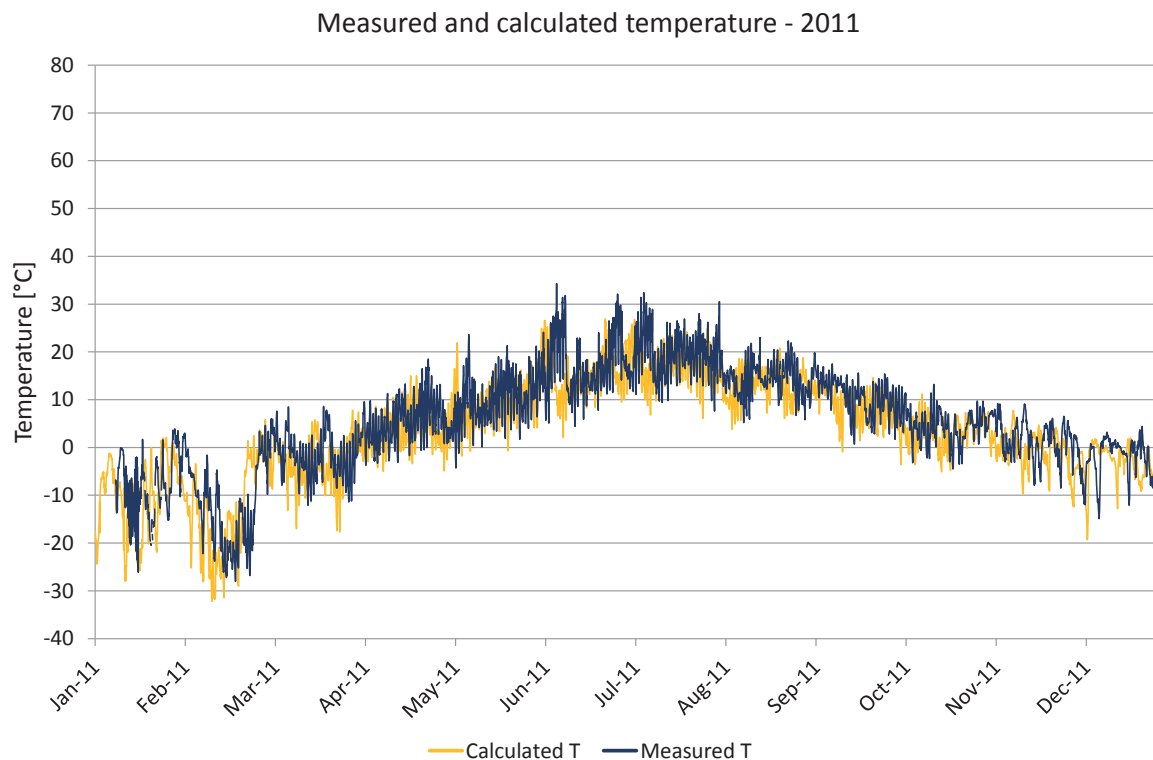

Figure 8.14-5n-exterior.12. Comparisons between measured and calculated temperature. Calculated temperature (yellow), measured temperature (dark blue).

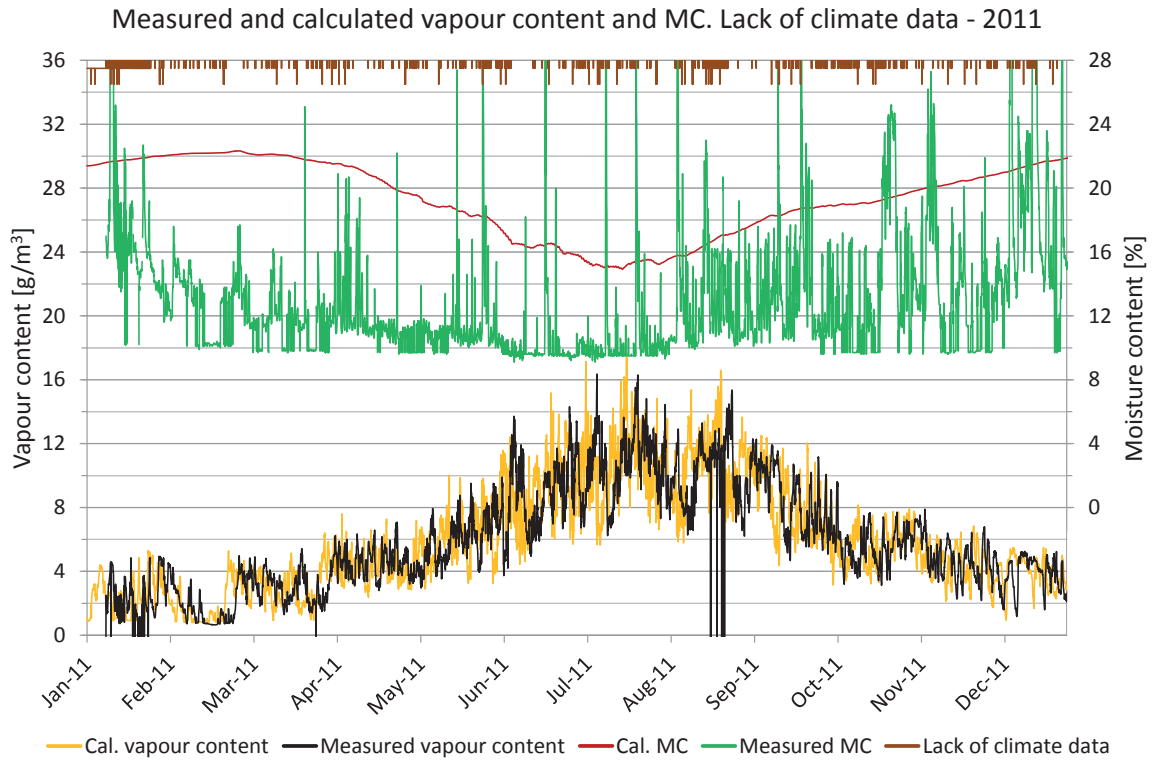

Figure 8.14-5n-exterior.13. Measured moisture content, periods lacking climate data and comparisons of vapour content. Vapour content for calculated values (yellow) and measured values (black). Moisture content for calculated values (red) and measured values (green), periods with lack of climate data (brown).

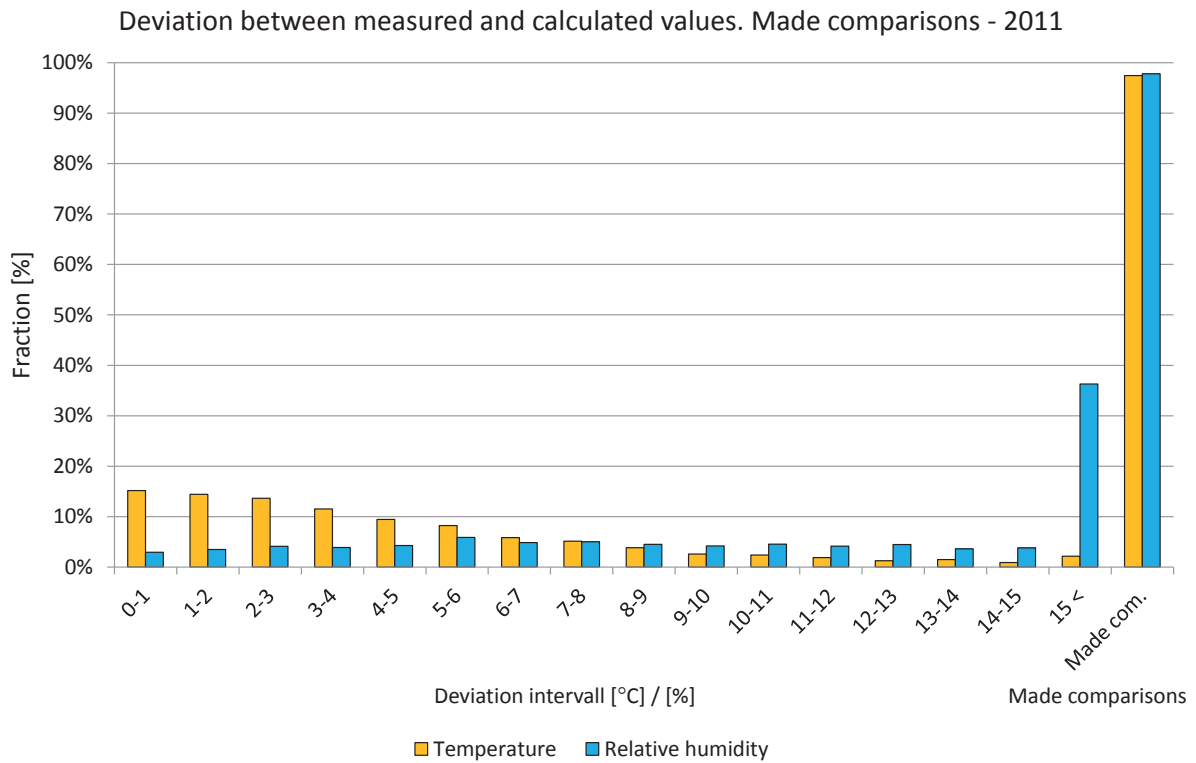

Figure 8.14-5n-exterior.14. Deviations in comparisons shown in intervals from 0 to 15 °C or %. The two right-hand bars show the percentage of comparisons during the year. Temperature (yellow) and relative humidity (light blue).

