



LUND UNIVERSITY

Zephyr : passive climate controlled repositories : storage facilities for museum, archive and library purposes

Christoffersen, Lars D.

1996

[Link to publication](#)

Citation for published version (APA):

Christoffersen, L. D. (1996). *Zephyr : passive climate controlled repositories : storage facilities for museum, archive and library purposes*. [Licentiate Thesis, Division of Building Physics]. Byggnadsfysik LTH, Lunds Tekniska Högskola.

Total number of authors:

1

General rights

Unless other specific re-use rights are stated the following general rights apply:

Copyright and moral rights for the publications made accessible in the public portal are retained by the authors and/or other copyright owners and it is a condition of accessing publications that users recognise and abide by the legal requirements associated with these rights.

- Users may download and print one copy of any publication from the public portal for the purpose of private study or research.
- You may not further distribute the material or use it for any profit-making activity or commercial gain
- You may freely distribute the URL identifying the publication in the public portal

Read more about Creative commons licenses: <https://creativecommons.org/licenses/>

Take down policy

If you believe that this document breaches copyright please contact us providing details, and we will remove access to the work immediately and investigate your claim.

LUND UNIVERSITY

PO Box 117
221 00 Lund
+46 46-222 00 00

LUND UNIVERSITY
Dept. of Building Physics

LUNDS TEKNISKA HÖGSKOLA
Inst. för Byggnadsteknik
Avd. för Byggnadsfysik

RAPPORT TVBH-3028



ZEPHYR

Passive Climate Controlled Repositories

Storage Facilities for Museum, Archive and Library Purposes

Lars D. Christoffersen

Reprints of all or parts of this thesis is allowed if credit is given to the author, the company and the institution by use of following reference:

Christoffersen, L.D. (Birch & Krogboe A/S, Consultants and Planners). ZEPHYR Passive Climate Controlled Repositories. Department of Building Physics, Lund University, Sweden. June 1995.

ISRN LUTVDG/TVBH-96/3028--SE(1-139)
ISBN 91-88722-06 6

For further information or discussions please contact the author.

Birch & Krogboe A/S
Consultants and Planners
Att.: Lars D. Christoffersen
Teknikerbyen 34
DK-2830 Virum
Tel.: +45 45 95 55 55
Fax.: +45 45 95 55 65
E-mail: ldc@bicro.dk

ZEPHYR

Passive Climate Controlled Repositories

Storage Facilities for Museum, Archive and Library Purposes

Lars D. Christoffersen

A collaborative project between:



Lund University, Sweden
Department of Building Physics



NATIONALMUSEET
The National Museum of Denmark
Conservation Department

B&K

Birch & Krogboe A/S
Birch & Krogboe Consultants & Planners

Acknowledgements

My best thanks to the Reference Group for their never failing interest and involvement in the project. The members of the reference group are professor Arne Elmroth and assistant professor Kenneth Sandin from the Department of Building Physics at Lund University in Sweden, Jørgen Nordqvist, Head of Conservation Department and Tim Padfield, Head of Laboratory from the Danish National Museum, Axel Rubinstein, Division Manager in Crone & Koch A/S and Søren Svare, Division Manager (Education and Culture) in Birch & Krogboe A/S.

My special thanks to Birgitte Rolf Jacobsen, Head of Secretariat for The Nordic Fund for Technology and Industrial Development at the Danish Academy of Technical Sciences for exceptional support during the entire project period.

The ZEPHYR Simulation Model is developed under close supervision of Johan Claesson, associate professor at Lund University, Department of Building Physics. I greatly appreciate this close collaboration.

My thanks and appreciation also to a group of persons, too numerous to mention, who have contributed to the completion of this thesis through discussions, proofreading and more.

Preface

This report is the thesis of the research and development project entitled:

Development of a Resource Saving Concept for the Establishment
of a Climate Suitable for the Storage of Objects Worthy
of Preservation in Storerooms at Museums and in Archives.

In short: The ZEPHYR project.



Zephyr, the west wind, was worshipped as a god by the ancient Greeks and Romans. The west wind blows from the sea and creates well-being during its proceeding as its temperature and humidity are constant. Thus it forms a contrast to the time of year and compensates the climate by being warm in the winter and cool in the summer.

It is precisely such an equalizing of the variations of the indoor climate in repositories¹ which is the aim of this project. However, not achieved by the wind but by a conscious use of building physics.

The description of ZEPHYR is given by the meteorologist and philosopher Theophrast (300 B. C.) in his work "About the Winds".

This project is born within the framework of the Nordic Industrial Research Education. One of the main tasks of the Nordic Fund for Technology and Industrial Development is to extend the contacts between companies and universities, with special reference to encouraging the transfer of technology

¹ The use of the term "Repository" instead of "Storage Facility" is meant to underline that it refers to the proper storage volume, which is only a part of a storage facility.

and expertise between the Nordic countries. This business is done by offering financial support to research and development projects in companies in the Nordic countries. These projects must include the Nordic Industrial Research Education of an employed candidate, and the education must take place at a university in another Nordic country. If the nature of a Nordic Industrial Research Education project makes it relevant, a third party - another company or university or a relevant institution - can be involved in the collaboration.

Therefore, Nordic Industrial Research Education is a research education with a vocational approach.

This project was financed by The Nordic Fund for Technology and Industrial Development and the Danish company Birch & Krogboe A/S, Consultants and Planners. The financial means from the Nordic Fund are granted by The Nordic Industrial Research Education Committee and administrated by The Danish Academy of Technical Sciences.

The project is effected in collaboration between the Department of Building Physics at the University of Lund in Sweden, The Conservation Department at the Danish National Museum and Birch & Krogboe A/S, Consultants and Planners.

This thesis is primarily a thesis in Building Physics, but the character of the topic is so that it involves museum and archive techniques and practices. Therefore some of the contents can seem superfluous to some readers, but it can be important background information to others.

This thesis is prepared in fulfilment of the requirements for a Licentiate thesis from the University of Lund in Sweden.

Antonio Vivaldi, 1678-1741

The Four Seasons - Spring

"Spring has come and joyfully the birds welcome it
with cheerful song, and the streams at the breath
of Zephyrs flow swiftly with sweet murmuring"

Sonnet which originally accompanied the work

Table of Contents

Abstract	10
Sammenfatning (Danish Summary)	12
1 Introduction	14
2 Aim	17
3 Working Method	18
4 A Repository.....	19
5 Demands on the Storage Environment	23
5.1 Standards and Guidelines	23
5.2 Deterioration processes	25
5.2.1 Biodeterioration	
5.2.2 Chemical Deterioration	
5.2.3 Mechanical Deterioration	
5.3 Preventive Conservation	32
5.4 Summary	32
6 Humid Air and Hygroscopic Materials	34

7 The Actual Indoor Climate in some Repositories	38
7.1 Examples of Mechanical Climate Control	38
7.1.1 A Library Repository	
7.1.2 A Museum Repository	
7.2 Examples of Passive Climate Control	40
7.2.1 Skokloster Castle, Sweden	
7.2.2 The Kronomagasin at Gripsholm Castle, Sweden	
7.2.3 A Museum Repository	
7.3 Summary	45
8 The Passive Climate Control Principle.....	46
9 The Regional Archive of Schleswig-Holstein	48
9.1 History	48
9.2 The Repository	50
9.3 Building Physical Guidelines	54
9.4 The Operational Experiences	56
10 The Measurements	57
10.1 Aim	57
10.2 Measuring Equipment	57

10.3 The Results	60
10.3.1 The Schleswig Climate	
10.3.2 The Indoor Climate	
10.3.3 Air Change Rate Measurement	
10.3.4 A Heating Experiment	
10.4 The Results Related to the Building Physical Guidelines	76
11 The Influence of the Operating Conditions on the Passive Climate Controlled Storage Environment	77
11.1 Building and Contents	77
11.1.1 The Physical Framework	
11.1.2 Work Places	
11.1.3 Density of Storage	
11.1.4 Conditioning of objects	
11.2 Technical Installations	79
11.2.1 Lighting	
11.2.2 Other Energy Supplies	
11.2.3 Ventilation and Air-Leakage	
11.3 The presence of persons	81
11.3.1 Cleaning	
11.3.2 Staff	

12 The ZEPHYR Simulation Model	82
12.1 Introduction	82
12.2 Aim	82
12.3 Mathematical and Physical Basis	83
12.3.1 The Model	
12.4 The Thermal Model	85
12.4.1 The Steady-State Component	
12.4.2 Periodic Heat Flow in a Homogenous Slab	
12.4.3 The Periodic Thermal Process	
12.5 The Humidity Model	95
12.5.1 The Steady-State Component	
12.6 The Calculation Example	103
12.6.1 The Thermal Conditions	
12.6.2 The Humidity Conditions	
12.6.3 Comparison of Calculated and Measured Data	
12.7 Advantages of the Model	108
12.8 Parameter Study	111
13 Summarizing Results	113

14 The ZEPHYR Repository Concept.....	115
14.1 The ZEPHYR Concept	115
14.2 Building Structure	115
14.2.1 Outer Walls	
14.2.2 Roof	
14.2.3 Inner Walls, Ceilings and Floors	
14.2.4 Building Moisture	
14.2.5 Service Areas	
14.3 Management	118
15 Conclusions	119
Nomenclature	121
References.....	123
Appendices	128
Appendix 1	128
Description of the System/Equipment used for Measurements at the Regional Archive, Germany of Schleswig-Holstein	
Appendix 2	131
Air Change Rate Measurement report	
Appendix 3	133
Reduction of Network	

Abstract

This work is the result of a research and development project. The aim is to improve the possibilities of using passive climate control for museum, archive and library repositories.

Passive climate control implies that the repository is built and arranged so the thermal and hygroscopic properties of the building and its contents creates a good stable indoor climate. Passive climate control also ensures that the temperature and relative humidity stay within the acceptable ranges. It is an alternative to the traditional mechanical climate control with humidifiers, dehumidifiers and cooling and heating installations controlled by complex control and adjustment technology. The mechanical method has been used since the late fifties, from time to time with varying degrees of success.

The knowledge of the thermal and hygroscopic interaction between a building and its contents, influenced by a certain local climate, is further developed in this project. Therefore, theoretical studies and measurements carried out at the Regional Archive of Schleswig-Holstein, which is passive climate controlled, are completed. On this basis a calculation model has been developed, which makes it possible to do parameter studies of the climatic influence of the building structures and the building materials. The results of the measurements are used to compare the theoretical performance of the building with the actual performance. Taking the operational conditions into consideration, the building can be designed to be the framework of a stable storage environment at low operating costs and a minimal energy consumption.

A new constant is defined: The Buffering Capacity Factor. It is a factor that defines materials capabilities in buffering (stabilizing indoor climate) thermal or humidity variations.

Due to this, the principles of the ZEPHYR Climate Controlled Repositories is introduced and so is the concept *Sustainable Storage*.

Sammenfatning (Danish Summary)

Denne rapport er resultatet af et forsknings- og udviklingsprojekt. Projektets formål er at forbedre mulighederne ved udnyttelsen af passiv klimatisering i forbindelse med (op-)bevaring af museums-, arkiv- og biblioteksmateriale i dertil indrettede magasiner.

Passiv klimatisering indebærer, at magasinbygningen opføres og indrettes således, at de samlede termiske og fugttekniske egenskaber af bygningen og dens indhold udnyttes til fordel for en god stabilitet i indeklimaet. Ligeledes medfører passiv klimatisering en betydelig sikkerhed for, at temperaturen og den relative luftfugtighed ikke overskrider de acceptable grænser.

Passiv klimatisering er et alternativ til den traditionelle metode med klimaanlæg med komplekse styrings- og reguleringsmekanismer for befugtning, affugtning, køling og opvarmning. Den traditionelle metode har været anvendt siden slutningen af 50'erne med en til tider svigtende succes.

Kendskabet til det termiske og fugtmæssige samspil mellem en bygning og dens indhold under påvirkning af et givet udeklima er søgt uddybet i projektet. Dette er gjort gennem teoretiske studier og målinger gennemført på Landsarkivet for Schleswig-Holstein, da dette arkiv er passivt klimatiseret. På baggrund af dette forbedrede kendskab er der udviklet en beregningsmodel, som skal gøre det muligt at gennemføre parameterstudier af konstruktionselementers og byggematerialers betydning for klimatiseringen. De udførte målinger er brugt til en sammenligning af det teoretiske opbevaringsmiljø med det faktisk forekommende miljø. Derigennem kan bygningen under hensyntagen til de aktuelle driftsbetingelser designes, så den vil danne rammen om et godt opbevaringsmiljø med begrænsede driftsomkostninger og et minimalt energiforbrug til følge.

En ny materialekonstant er udviklet: Buffer-evne faktoren. Denne faktor definerer et materials evne til at optage og afgive fugt eller varme og derved medvirker til at stabilisere indeklimaet.

Konceptet for dette kaldes passiv klimatisering efter ZEPHYR-metoden, og derved er begrebet *bæredygtig opbevaring* introduceret.

1 Introduction

The wish to collect, preserve and keep art and culture-historical values (relics, documents, books etc.) for the benefit of the future, demands storage facilities where the objects are accessible for examination and research and at the same time secured against theft, vandalism, decomposition and fire.

In this connection storage condition standards have existed for several years, and they indicate different storage condition guidelines for different categories of material. "Standards" should here be understood in a wider sense than international or national standards and the concept comprises guidelines as well as customs described in the technical literature on museums etc.

Over the years, in order to improve former standards, the preparation of new standards has been marked by the idea that e.g. the acceptable temperature and relative humidity ranges should be more narrow than prescribed by the former standards.

The technological development since the fifties has caused a continuous improvement in the performance of the mechanical airconditioning plants, which to some degree has promoted the appearance of the increasingly restrictive demands on the climatic storage conditions. The same attention has not been paid in describing the actual needs for the objects stored.

As a result of the increasingly restrictive demands in these "standards", modern buildings for storage and display of museum objects and documents have been provided with airconditioning plants of high complexity.

As long as the demands on the climatic storage conditions match the quality of the airconditioning plant, and vice versa, the plant can succeed in maintaining the stipulated values within the specified limits, but it demands a close and qualified supervision and maintenance of the plant. There is, however, a very great disadvantage in installation and operating costs for advanced mechanical airconditioning plants.

In spite of these technical efforts it is realized that the decomposition of the objects in these storage environments has not necessarily been minimized. In the light of these observations the theory has been developed to the effect that other factors than merely the temperature and humidity levels and intervals should be brought into focus. Also the speed of changes (gradients) and fluctuations (frequencies) within these intervals might contribute to the decomposition rate. Decomposition is among others caused by light, moisture, heat and pests and it is unavoidable, because chemical reactions will always take place and the risk of biological activity will always be latent. So, it is not a question of decomposition or not, but of achieving the minimum decomposition rate.

Storage facilities without any mechanical airconditioning installations and with preservative climates have always existed. One of the "modern" examples is the Cologne Cathedral.

Historical documents have been stored in the basement under the Cologne Cathedral for several hundred years and they are in a very good state of preservation. The Cologne principle in archive building, which includes building physics in the climate control process, is based on the knowledge of the Cathedral basement environment. It has a number of weaknesses which have lead to a number of very bad examples of archive repositories. The Cologne principle will be thoroughly discussed in chapter 7 of this report.

The repositories at the Regional Archive of Schleswig-Holstein in Germany are built along the lines of what today is called the Schleswig model in archive building. The Schleswig model is a re-developed Cathedral basement

environment model. In consequence of the planning of this archive a lot of questions were raised, and it was realized that additional research and development were needed. A lot of the questions were pointed towards the building physical field and this is the background for the ZEPHYR project.

2 Aim

The scientific aim of the ZEPHYR research and development project is in this first phase to map the thermal and moisture interactions caused by the outdoor climate, the building physical qualities of a repository and the physical properties of the materials being stored. Part of the aim is, on this background, to develop a mathematical model that can be used for the description of the thermal and moisture interactions between the outdoor climate, the building, the indoor climate and the objects stored.

The purpose, as far as development and application are concerned, is to develop methods - in connection with planning and design of repositories for museum, archive or library purposes - to obtain appropriate climate conditions by a conscious utilization of building physics with low energy consumption, low operation and maintenance efforts, and where initial and operation costs are optimum, in the perspective of the economy in the whole life cycle.

It is also a purpose of this project to create a combination of stable temperature and humidity storage conditions and sustainable storage.

The frames for this project are all aspects of building physics and preservation of museum, archive and library objects. In order to stay within the frames of this project, it is deliberately and in spite of the high relevance, decided to keep the financial calculations and considerations out of it. The project is limited to deal with storage of objects that can stand storage temperatures up to approximately 20°C. This means that storage of paperbased documents, furniture, textiles and paintings, which make up the largest quantity in most repositories in museums and archives is taken into account. This means also that storage of objects with special climatic demands are left out of this work, e.g. photographic materials.

3 Working Method

The working method is comprising university studies, study tours and participation in conferences in order to go more thoroughly into the main subjects: building physics, storage technique and deterioration processes.

The more specific work was divided into the following special topics:

Literature studies and analyses of the scientific basis of the demands on the storage environment (especially temperature and humidity) in repositories.

Acquisition and evaluation of indoor climatic data from different storage facilities. Through case studies the advantages and disadvantages of mechanical and passive climate control are accentuated.

Development and use of a computer program for passive storage environment simulations.

Studying the theoretical considerations of deterioration.

Determining the theoretical considerations of the interactive impact of the outdoor climate, the constructions and the stored materials on the indoor climate.

Determining the influence of the operational conditions on the indoor climate.

Developing the ZEPHYR repository concept.

All measurements are planned and carried out by the author.

4 A Repository

Generally a repository is only one part of an entire storage facility. Storage facilities can be much more than repositories, namely laboratories for conservation, restoration and photography, examination and registration rooms, cleaning rooms, interim storerooms, package rooms, delivery entrance/exit, facilities for visiting researchers, offices and staff rooms. In a well planned storage facility all working places should be kept outside the repository and human presence in the repository should only occur for the purpose of collecting or replacing things or for cleaning the rooms.

A repository is a place where objects can be put away for a period of time (for a short time or for ages) and then be brought to light. A good repository is a place where objects are kept safely and protected against natural disaster, acts of war, theft, vandalism, fire, soiling and contamination and where the access to any item is easy. The good repository makes also the framework of an ideal storage environment which secures the minimum decomposition of the objects. Some museums are gathering objects from a certain time e.g. the Middle Ages in the same storeroom, but this gives some trouble because of the wide range of materials with different ideal storage conditions. Therefore, with the actual multiplicity of standards it is nowadays necessary with storerooms, where objects are sorted into material categories.

This project is dealing with repositories for museum, archive and library purposes. The need for good storage facilities and the necessity of keeping the operating costs low makes it very important that the repository is adapted to its purpose. There are for instance several factors that make a museum repository different from an archive or library repository: The stored materials, the accessibility of the items, the shelving etc.

Logistics is a very important parameter. It is essential to have short, quick and safe access routes within the storage facility and between the storage facility and for instance the exhibition areas or the repository and the borrower desk in a library. A rule of thumb says that large objects must be stored close to the ground and that smaller objects can be stored in multi-storied buildings with lifts. In some cases tall rooms with mezzanine floors can be of some advantage.

Museum repositories are characterized by concepts like seldom-used collections, study collections and open collections. How to handle these collections is part of the collection management, which also includes registration of each object and an organized supervision of the storerooms, the storage environments, the collections and where it is possible to identify inexpedient conditions.

Museum collections are generally characterized by wide variations in the size of the objects and the shelving must be arranged to accommodate these factors. Some objects are too big for shelves and must be stored on the floor. Shelves, cupboards, drawers and boxes are the most common storage systems, but also pallet racking is gaining in this field. In some very special cases computer-controlled paternoster systems are used for large homogeneous collections e.g. clothes and banners.

Museum objects consist of organic material like textiles, wood, paper, leather and plastic materials and of inorganic materials like glass, metals, minerals. The physical properties of these materials are widely different and their response to changes in temperature or relative humidity vary accordingly. Some objects are made up of only one material, but many are made of mixed materials. If objects are completely or just partly painted, varnished or gilded it could cause even larger differences in the physical properties.

An archive repository is characterized by documents, mostly on paper. But also other kinds of materials can be found in archives. Parchment, microfilms, magnetic tapes, documentary films, sealing wax are found in archives. New

materials are brought into the archives by the information technology in the form of digital storage media like CD-ROM. Paper can be stored in cardboard boxes in an up-right or horizontal position. Paper stored in unwrapped stacks is also seen, but is generally not recommended as surfaces may be influenced adversely.

Some documents are in great demand and therefore called high-frequency documents. This can be census papers and parish registers. Some documents are normally low-frequency material, but a political or historical topic given special attention can, because of social changes or an anniversary, change into high-frequency documents.

Mobile shelving, which is very space efficient, is common in archive repositories. Mobile shelving can provide at least twice as much storage volume as fixed shelving on the same storage area. Shelves with fixed aisles are sometimes preferred for special formats or for high-frequency documents.

Some, usually fairly small, areas of an archive repository can be open for public admittance. This demands shelves with fixed aisles.

Because of a limited variation in size and formats in an archive repository, one could imagine completely computer controlled repositories with robots collecting and replacing stored material - almost like computer controlled paternoster systems.

Contrary to museum objects, which have widely different shapes, archival material has only a few standardized formats and they are even uniformly packed. Archival material of mixed materials are primarily books, which consist of paper, glue, thread and various bookbinding materials, but even ink on paper can be considered to be a mixed archival material.

A library repository is very much similar to an archive repository except that normally a very large part of a library is open storage.

The stored material in an archive repository is typically very hygroscopic and very densely stored and therefore an immense buffer for moisture. The same applies to libraries, but the density is lower because shelving with fixed aisles is more common. The size of the surface area of a hygroscopic material is important for the ability of taking up or giving off moisture, and because of the uniformity of archive and library objects the size of the surface area is easy to determine. The surface area of museum objects is much more difficult to determine, and this also applies to the physical properties.

5 Demands on the Storage Environment

5.1 Standards and guidelines

In connection with the storage of art and historical objects, standards have existed for several years which indicate different guidelines for different categories of material. In this connection "standards" should be understood in a wider sense than international or national standards and they comprise guidelines as well as customs described in the technical literature on museums, archives and libraries.

As a result of the increasingly restrictive demands in these "standards", most modern buildings for storage and display of museum objects or documents have been provided with air-conditioning plants of high complexity. Most of these plants are well designed and can, as long as they are in good repair and run by qualified personnel, fulfil the demands of maintaining the stipulated values within the specified limits.

The literature indicates a great spectrum of recommendations on the indoor climate for storage of different materials, but sometimes also for the same material. Most of the recommendations are just dealing with ranges of temperature and relative humidity, but some add demands on the air quality (dust, chemical components etc.) and maximum levels for lights.

Generally, detailed scientific reasons for the formulation of the mentioned standards are missing, e.g. the stipulated demands on climatic parameters, their tolerances and critical fluctuations. Most of these standards are based on experience, local climate and cost or in another word "feasibility" [Michalski, 1993].

Reference	Temperature °C	Relative Humidity %
Thomson, G. 1978	Low	45-65
Baynes-Cope, A.D. 1981	13-18	55-65
Wilson, W.K. and Wessel, C.J. 1984	20-21	25-30
Alkærsig et al., 1986	15-20	45-55
British Standards Institution, 1989	13-18	55-65
Riksarkivet förfatningssamling, 1994	16-20	30-50
ISO, 1995	14-20	45-55

Table 1 Recommended temperature and relative humidity in storage rooms for paper and parchment.

Table 1 shows the recommended temperature and relative humidity in seven different references for paper and parchment.

Also, more overall recommendations (for archives) are given, such as :
 "The Climate must be suitable for the preservation of documents, and the aim is - at reasonable costs - to maximize the lifetime of the documents"
 [Byggnadsstyrelsen, 1986].

The different specifications listed in Table 1 are just an example of the bewilderment in setting up the environmental demands for storage of paper and parchment. Different contexts for the standards, referred to in Table 1, can be the main cause for the different specification e.g. may one author attach importance to chemical deterioration and another to mechanical deterioration.

Similar bewilderment can be observed where demands are set up for other types of materials.

5.2 Deterioration processes

Setting up demands for the storage environment in archives, libraries and museums is absolutely reasonable as it has been observed that the deterioration rate is increased when some environmental parameters have exceeded certain values. The environmental parameters, especially temperature and relative humidity, are factors which can induce biological, chemical and mechanical deterioration.

5.2.1 Biodeterioration

Biodeterioration is decomposition caused by biological activity. Mould fungi, bacteria, insects, mice, rats, birds and even larger animals cause deterioration, some more often than others.

Animals like mice or larger animals are kept out of most repositories merely because of their size. Insects is a large problem for many museums. Insects do not have to be local species, and formation of exotic species can occur because of hibernating eggs or chrysalises in e.g. ethnographic objects. This kind of deterioration can be reduced to a minimum by careful cleaning of objects before storage and applying different kinds of traps and of course by a close monitoring of repositories and collections.

It is impossible to prevent the very small and airborne fungi spores and bacteria germs from entering repositories. On the other hand fungi and bacteria need special conditions to develop.

Bacteria need very high moisture content in the affected material. Therefore bacteria attacks are very rare in museums, archives and libraries.

Mould is growing when germination of mould spores or production of mould mycelium occurs. The factors controlling mould growth have been found to be [Snow et al., 1944]:

- The relative humidity:
Relative humidity is the most important parameter concerning mould growth. Between 75% and 100% RH mould growth will take place on susceptible organic materials at a relatively high pace. Within the range of 65% to 75% mould can only develop very slowly. Below 65% mould growth generally will not take place. How the mould growth will progress depends very much on the type of mould species present.
- The balance and type of nutrients provided:
The best conditions for mould growth occur when the balance and type of nutrients provided fit the mould species present. Some mould species demand a special nutrient composition in the growth medium.
- The temperature:
Mould growth can take place within a temperature range of -7°C to 55°C [Neuhauser & Schata, 1994], but the optimum range is 18°C to 35°C . The risk of mould growth is decreasing with decreasing temperature (Figur 1) [Nevander & Elmarsson, 1994].

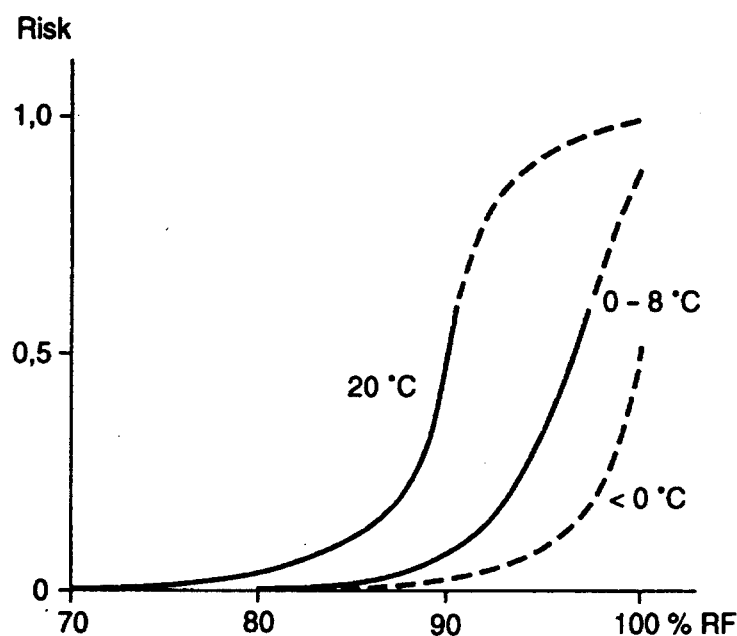

Figur 1 The risk of mould growth on wood in relation to the temperature. The risk is decreasing with decreasing temperature [Nevander & Elmarsson, 1994].

Additionally, pH is a relevant growth factor, as most fungi prefer an acidic environment [Neuhauser & Schata, 1994].

It is generally believed that darkness and stagnant air alone can cause mould growth. This understanding is based on observations and taken into account in the fight against mould growth.

Mould growth can very often, when it occurs, be found in a corner of a room, inside or behind cupboards or on the back of paintings. These observations can easily but wrongly be related to stagnant air and darkness. The explanation is rather that the concerned places due to thermal bridges are a little colder than the surroundings and because of that the relative humidity is locally higher and the risk for mould growth is increased. If a repository is well insulated, the thermal gradients in the rooms are negligible and if large and quick variations in the indoor climate are prevented the mould growth can be prevented.

Light is believed to be an inhibitor to mould growth. It is correct that UV-light is an inhibitor or even a killer of fungi, but UV-light is due to its damaging effect e.g. fading colours, absolutely unwanted in a repository.

In a repository objects are stored for a long period of time. All types of mould species are present to a certain extent and the balance and type of nutrients provided fit very well to a large number of mould fungi.

Table 1, Table 2 shows a survey of the conditions for growth of 16 different mould fungi relevant for the archive environment. The temperature in repositories is almost always within the range of 5-30°C but often the temperature is set to a value that complies with human comfort. Therefore the temperature is close to or within the optimum range for mould growth.

Controlling the relative humidity to a value lower than 65% is therefore the by far most important method of preventing biodeterioration by mould.

Fungi	Growing Conditions				
	Temperature in °C			pH	RH %
	Min.	Max.	Optim		
Alternaria tenuis Alternaria alternata	2-5	35	20-30	2,7-8	85-99
Aspergillus amstelodami	15	42	23-40		75
Aspergillus flavus	3-4	42-50	35-37		80-96
Aspergillus fumigatus Aspergillus fischeri Wehmer	10-12	52-55	37-43	3-8	85-99
Aspergillus niger	6-8	45-47		1,5-9,8	88-98
Aspergillus ochraceus			28-32		80-98
Aspergillus repens	4-5	38-40	25-27	1,8-8,5	65-92
Aspergillus ruber	5	42	22-38		71-99
Aspergillus versicolor	3-5	37-40	25-30	3-8	75-95
Aureobasidium pullulans Pullularia pullulans	5	35	25		
Botrytis cinerea	2-12	33-35	22-25	2-8	93
Cladosporium herbarum	-7-5	30-32	24-25	3,1-7,7	85-98
Penicillium brevicompactum	-3	32	20	2-6	83-100
Penicillium chrysogenum Penicillium notatum	-3	34	18-30		82-100
Penicillium frequentans		35		3,8-4,4	
Pencillicum purpurogenum Wallemia sebi	5	40	24-38		75-97

Table 2 Growing Conditions for Archive Relevant Fungi [Neuhauser & Schata, 1994].

Preventing biodeterioration by means of toxic chemicals [Ayerst, 1968] such as DDT and Methoxychlor etc., of which several recently have been known to be carcinogenic, has been a widespread method in "preventive conservation". Today this causes immense problems for many museums when handling and cleaning these contaminated objects.

5.2.2 Chemical deterioration

The predominant factors controlling chemical processes are temperature and moisture and therefore also very important factors in connection with chemical deterioration.

Relative atmospheric humidity controls the moisture content of materials with hygroscopic properties.

Metals, glass or other materials without hygroscopic properties have a very thin water film on the surface attracted by impurities and imperfections. The thickness of this film is dependent on the relative humidity. The moisture present on the surface or in the pores is a medium for ion migration, dissolutions of salts and it is an inexhaustible source of oxygen because of the oxygen equilibrium between water and air. Some of the chemical deterioration processes caused by these effects of relative humidity can take place within the entire relative humidity range [Erhardt & Mecklenburg, 1994], but they are steeply accelerating with increasing relative humidity.

Organic materials like cellulose and proteins are also exposed to chemical deterioration within most of the relative humidity range, even at relative humidities below 25% [Michalski, 1993; Erhardt & Mecklenburg, 1994].

Chemical processes are very dependent on temperature. Most reaction rates are steeply accelerating with increasing temperature. A rule of thumb says a doubling of the reaction rate every time the temperature is increased with 10°C. Therefore, in order to minimize chemical deterioration temperature and relative humidity should be kept as low as possible.

The air quality is also an important parameter in the storage environment. High concentration of some chemicals e.g. formaldehyde, formic acid, acetaldehyde, acetic acid [Grzywacz and Tennent, 1994] and sulphurdioxide can increase the deterioration rate for many materials. These pollutants, which can occur in high concentrations in industrial areas and cities or can degas from

paint or other materials used for storage cabinets and shelves. These pollutants must be taken into account when designing a repository and they are actually enclosed in some standards.

5.2.3 Mechanical deterioration

Mechanical deterioration occurs not only when an object is exposed to shocks and vibrations, but also when the object is being handled, e.g. a book being opened etc.

The effect of changes in temperature can also be a cause of mechanical deterioration. Most materials change size and shape when the temperature is changed, but not to the same extent. Table 3 shows some examples of both the thermal and the moisture expansibility of a few different materials. So, relatively large tensions can occur between two materials held together, e.g. a material with a painted surface, when the temperature is changed. Even in a homogeneous material large oscillating tensions between the surface and the material below can occur, when the surface is exposed to fluctuating temperatures.

Material	Thermal expansibility 10^{-6} m/m per °C	Moisture expansibility 10^{-6} m/m per %RH
Pine (fibredirection: ≠)	5	20-40
Pine (fibredirection: ⊥)	34	800-1200
Copper	17	-
Glass	6-9	-
Marble	4-16	-
PVC	50-200	-

Table 3 The temperature and moisture depending expansibility for some different materials [Nevander and Elmarsson, 1994; Nielsen, 1992].

Changes in relative humidity can cause mechanical deterioration on hygroscopic materials. The moisture related changes in size and shape are tied up in the hygroscopic properties of the actual material. Because of differences in the hygroscopic properties large oscillating tensions can occur between two materials held together (Table 3). As for temperatures, fluctuating relative humidity can cause tensions between the surface and the material below.

Fluctuating temperatures and/or relative humidities are consequently stressing most objects exposed to them. If the amplitude and the gradient of these fluctuations are large enough and the fluctuations are running over a sufficient period of time, the result can be fatigue fractures and cracks.

The vulnerability of most objects is furthermore depending on the temperature and moisture content of the objects.

Low temperatures or/and low moisture content make many materials hard and brittle and more vulnerable to handling and it can cause stresses in objects of mixed materials with different properties, which in turn can cause cracks and peeling etc.

High temperatures or/and high moisture content make many materials soft. This can in combination with stress cause relaxation and thus irreversible changes in the physical structure of objects. The appropriate humidity level depends on the type of collection and the frequency with which the objects or documents are handled.

Seldom used collections can stand up to lower temperature and relative humidity values under storage conditions than study collections. However, none of them can stand up to high values, which means that the objects are more soft, which will, due to released tensions, increase the risk of irreversible mechanical damages.

5.3 Preventive Conservation

Preventive conservation of museum collections, books and archival material involves more than being aware of the deterioration by pests and handling etc - it is also risk assessment and risk management and a part of collection and museum management.

Risk assessment is identifying the risks and estimating the magnitude of every risk factor. An example could be identifying the agents of deterioration and to estimate how strongly they affect the deterioration processes.

Risk management is to take the appropriate and most cost-effective measures against all the risks [Waller, 1994].

Preventive conservation is managing all the aspects of care, storage, access, handling, environment and job safety [Clavir, 1994] in a way where repeating expensive restorations causing an inevitable loss of information and originality, is replaced by cost-effective measures, like close supervision, use of regular maintenance programs and determine levels of security that can meet the assessed risks.

Nevertheless prevention is better than cure.

5.4 Summary

To summarize, a good storage environment is always a compromise between a number of factors, but in general the state of a collection and the type of collection must be the basis for the demands on the storage environment.

A chemically vulnerable collection and collections which are seldom used should be kept at low temperature and low relative humidity within the ranges given by standards, whereas more frequently used collections, because of the risk of mechanical damages should be kept at the high end of the ranges.

The range of acceptable relative humidities is 30-60% for normal, well-preserved materials and the inevitable variations should be kept as small as possible.

The acceptable temperature range is hard to define, but the temperature and the temperature variations should be kept as low and small as possible.

6 Humid Air and Hygroscopic Materials

This chapter is included in order to remind about the facts about temperature, relative humidity and moisture content of air, and of hygroscopic materials as well.

Temperature is an expression of the energy contained in a medium e.g. air. The temperature can be given in different units but degrees Celsius ($^{\circ}\text{C}$) is used in this work.

The moisture content of air saturated with water vapour depends on the air temperature and the air pressure. The higher the air temperature the more water the air can contain. The air pressure which in indoor/outdoor climate terms is called the atmospheric pressure naturally varies within a narrow range where variations are of less importance to the moisture content. The moisture content of saturated air at a certain temperature can be found in tables or be calculated by means of equations. The moisture content can be stated in quantity of water per quantity of dry air (kg/kg) or in quantity of water per air volume (kg/m^3).

When air is not saturated (or dry) it always contains a certain quantity of water vapour called the absolute humidity or the moisture content. When the air is heated or cooled without evaporation or condensation the absolute humidity remains unchanged (kg/kg).

The relative humidity is the ratio between the quantity of water vapour present in the atmosphere and the quantity of water vapour in saturated atmosphere at the same temperature. If the air is completely dry the relative humidity is 0 and if it is saturated it is 1. The relative humidity is often given in percent (0-100%)

By means of a psychrometric chart (Figure 2) or by equations the relations between temperature, moisture content and relative humidity can be found. Much information can be extracted from the psychrometric chart, but basically it indicates the relations between the temperature (dry-bulb temperature) of the air in a room and the relative humidity (percentage saturation) and absolute humidity (moisture content) of the air.

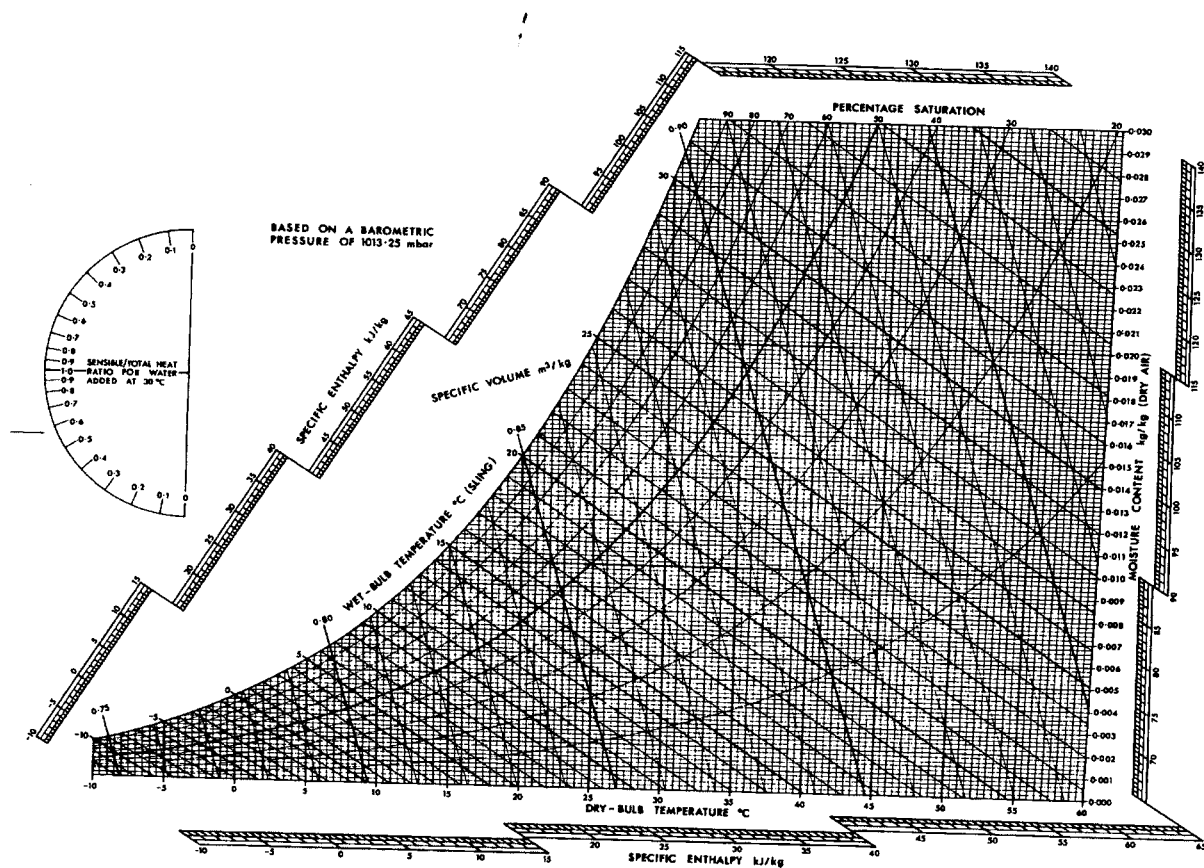

Figure 2 A psychrometric chart.

The most important and basic lesson to be learned from the psychrometric chart is the fact that if the absolute humidity is constant and the temperature is increased, the relative humidity will decrease and if the temperature is decreased, the relative humidity will increase.

A hygroscopic material is a porous material where moisture from the sur-

rounding air can penetrate the material and stick to the internal surfaces. The amount of water absorbed by a hygroscopic material depends on the hygroscopic properties of the actual material and on the relative humidity in the surrounding air. This can be described by sorption isotherms. The sorption isotherms for a material include one isotherm for the desorption situation (drying up) and one for the absorption situation (taking up water). Figure 3 shows the sorption isotherms for brick and concrete [Match].

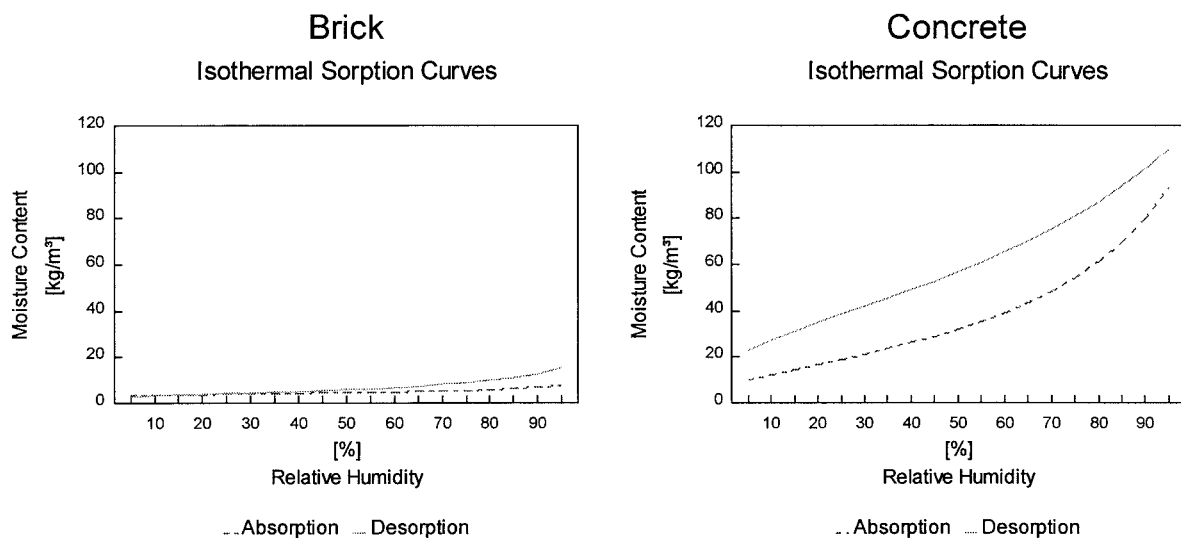

Figure 3 Sorption isotherms for brick and concrete.

The sorption isotherms for brick and concrete are quite different. An increase in relative humidity up to approximately 95% for brick means that brick is only taking up a small amount of water. Due to the slope of the curves for concrete, concrete will take up a larger amount of water.

If it comes to the ability of stabilizing an indoor climate it is not enough to look at the sorption isotherms because the penetration depths must be taken into account. The penetration depth is the time dependent distance from the surface influenced by fluctuations to the depth where the fluctuations no longer occur. If the sorption isotherms are multiplied by the penetration depth the *Buffering Capacity Factor* can be stated.

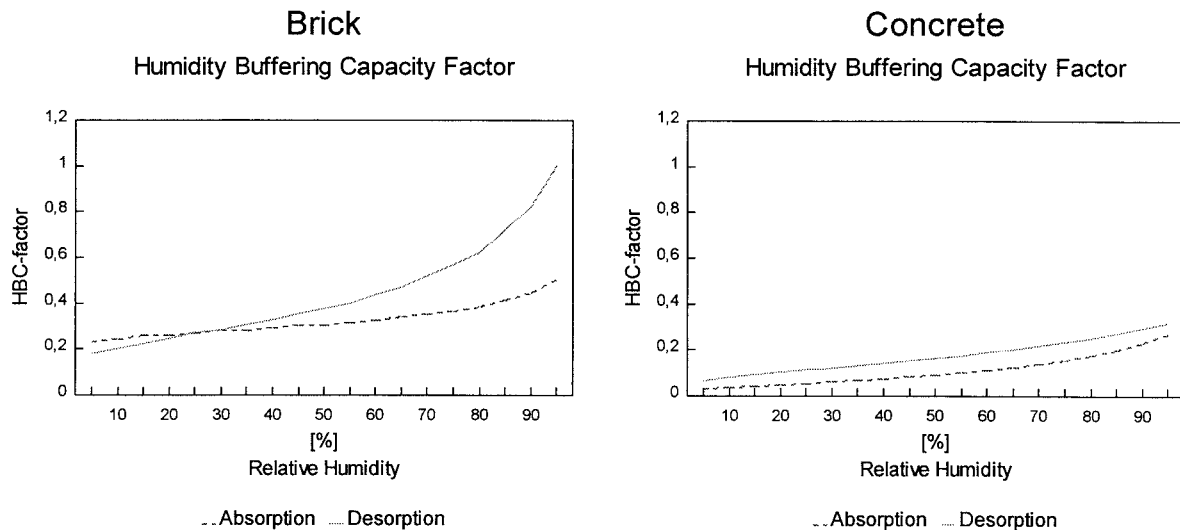

Figure 4 The Humidity Buffering Capacities for brick and concrete.

The humidity buffering capacity factor is calculated and illustrated in Figure 4. As it appears the slope of the brick-curve shows a larger gradient than the concrete-curve and the brick has therefore a better HBC-factor. A detailed analysis shows that brick can take up approximately 60% more water than concrete when the relative humidity is changed.

The Buffering Capacity Factor has been developed during this work. The HBC-factor is defined as the moisture content of a certain material in equilibrium with a certain relative humidity multiplied by the penetration depth for a one year circle in relation to the moisture content of brickwork in equilibrium with 95% relative humidity. The HBC-factor is therefore depending on the relative humidity.

$$\frac{w_{\text{brickwork}}(95\%)}{w(\text{RH}) \times d_p} \quad (1)$$

7 The Actual Indoor Climate in some Repositories

This chapter is an examination of the actual indoor climate in some examples representing the two principles: the passive and the mechanical climate control. The used data is recorded by the institution itself. The most commonly used measuring instrument is the thermohygrograph using hair as relative humidity sensor. The following climatic data must therefore be accepted as having a relatively low reliability due to the use of thermohygrographs. It is a well-known fact that a thermohygrograph is reliable when it comes to recording fluctuations but less so when it comes to recording levels of relative humidity in particular [Brown, 1994].

The following examples shall be understood as illustrations of the climatic problems in many repositories and not as a scientific evidence of what is best: A passive or a mechanical climate controlled repository.

7.1 Examples of mechanical climate control

7.1.1 A library repository

Figure 5 is a one-week recording of the indoor climate in a new library storage facility fitted with an airconditioning plant, which can humidify, dehumidify, cool and heat the ventilation air (fully airconditioned). The demands for this store say $18\pm 2^{\circ}\text{C}$ and 45-55 %. As it appears from the figure that these demands are almost fulfilled, if the recording can be considered to be reliable. The relative humidity curve shows an oscillating process which is due to the plant control. The oscillating relative humidity process is probably not damaging in a short-term perspective but on the long-term it is inexpedient.

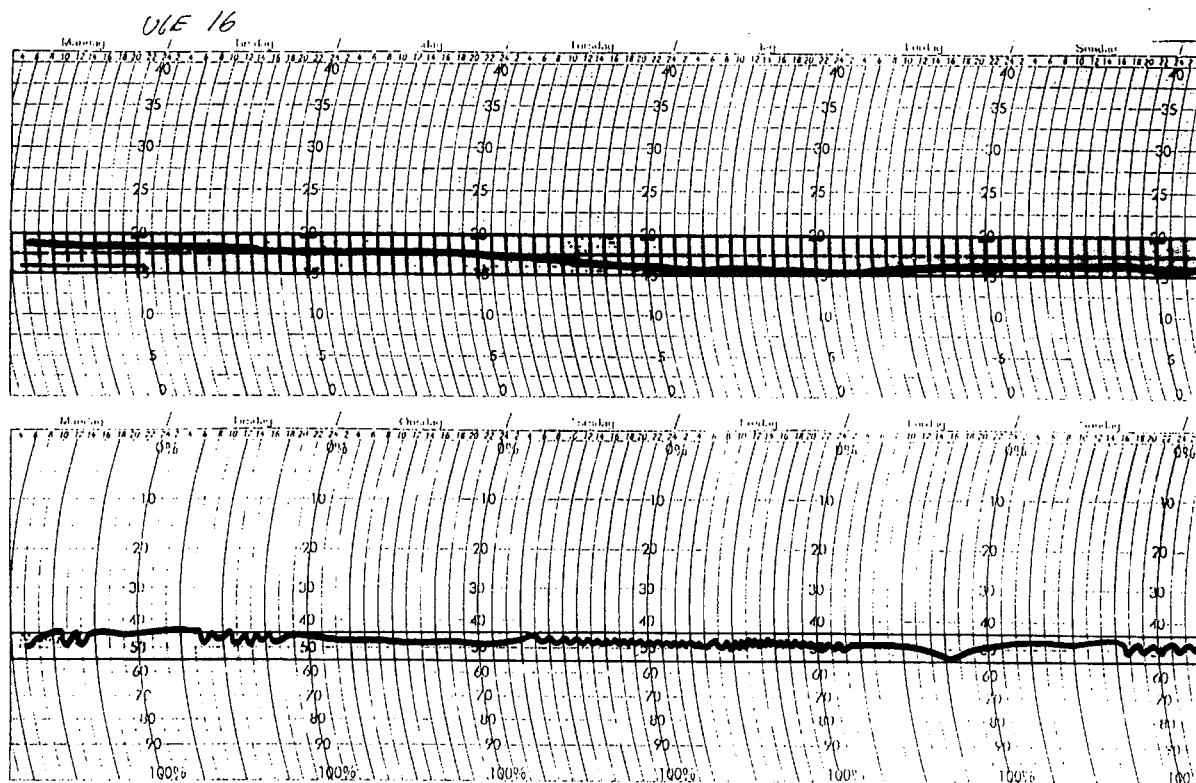

Figure 5 A one-week registration of temperature (the top curve) and relative humidity (the bottom curve) in a library repository.

7.1.2 A museum repository

The second example (Figure 6) is a museum storage facility, fully airconditioned with a 13-year-old plant, which is maintained to secure against breakdowns. The demands say $19 \pm 1^\circ\text{C}$ and 45-55% relative humidity. As it appears from the figure the relative humidity fluctuates between 45% and 67% with variations up to 15%-points in less than 6 hours. Of the recording it also appears that the temperature goes up to approximately 23°C .

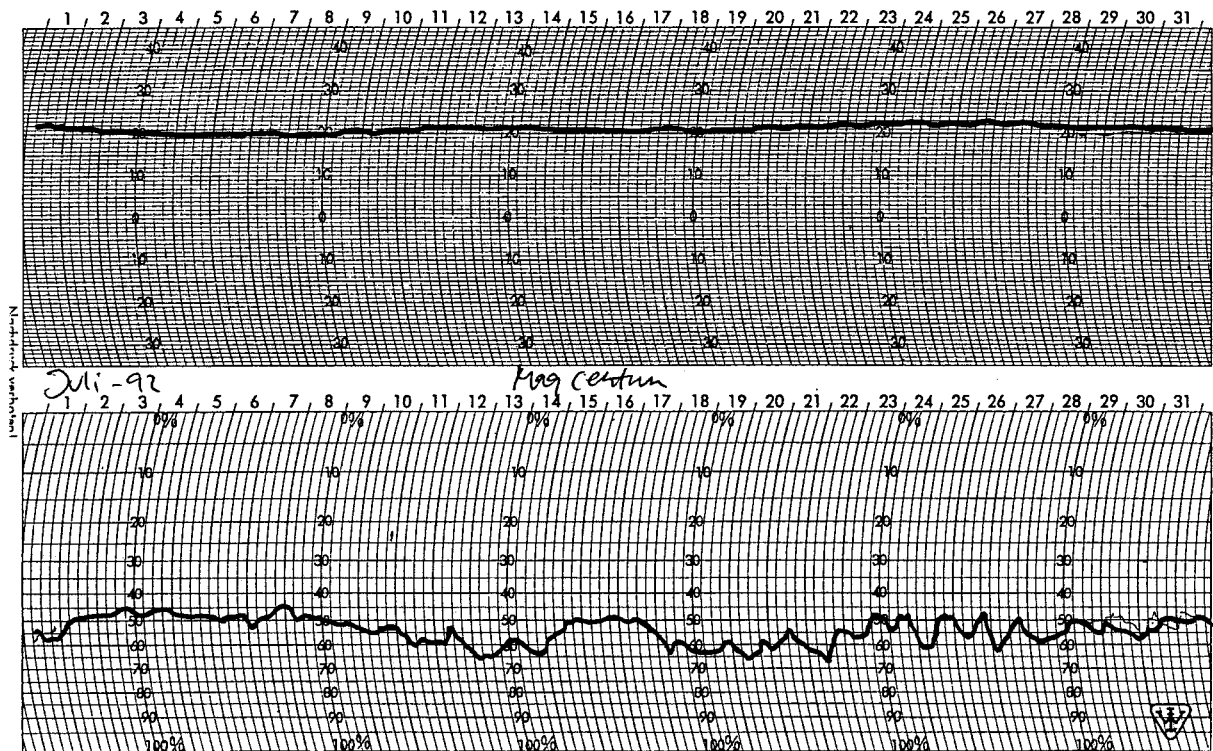

Figure 6 A one-month registration of temperature (the upper curve) and relative humidity (the bottom curve) from a museum repository.

7.2 Examples of passive climate control

Passive climate control means that the indoor climate can be influenced by the way of using the building, but no active contributions e.g. heating or cooling etc. are made in order to achieve a certain environment.

7.2.1 Skokloster Castle, Sweden

Skokloster Castle is a museum which is the essence of the history of the European civilization [Rangström et al., 1980]. The castle is from the 17th century and it houses approximately 50,000 objects, including the 30,000 books in the library.

The castle is an example of passive climate control where the levels and variations of temperature and relative humidity have exceeded every demand

in any standard. In spite of that all the collections of paintings, books, furniture, textiles, arms and workman and farmer tools seem to be well-preserved.

Some investigations of the impact of the outdoor climatic variations on the indoor climate have been made by a group of researchers from the Swedish Museum of Nordic Civilization (Nordiska Museet) and the Swedish Corrosion Institute [Bergh & Foghelin, 1989].

The indoor temperature varies on a yearly basis within the range of -15 and up to +25°C. Short-term fluctuations are very limited because of the heavy constructions buffering the temperature.

The indoor relative humidity varies between 35 and 98% through the year. The humidity buffer of the solid brick walls and the contents of the building dampen the short-term fluctuations.

The fluctuations in temperature and relative humidity that occur have close relations to the wind velocity and direction, but the fluctuations are so small that the risk of condensation on interior surfaces is eliminated [Bergh & Foghelin, 1989], and that should be the main cause for the objects not having deteriorated. The temperature is relatively low most of the year.

7.2.2 The Kronomagasin at Gripsholm Castle, Sweden

The Kronomagasin is an old granary which is planned to be used for storage of museum objects. This building suffers from the same phenomenon as many other historic buildings: Moisture transport from the ground due to capillary suction and diffusion. The typical consequence of this kind of problem is a humid climate in the lower floors of the building whereas upper floors are less strained. The recordings are carried out at the bottom floor.

As it appears from Figure 7 and Figure 8, the indoor climate, both temperature and relative humidity, is very stable. In the winter situation (mid-February) (Figure 7) the relative humidity is very high (> 90 %RH) due to a combination of low temperature (-5-0°C) and moisture strain, but in the summer situation (mid-June) (Figure 8), where the temperature has risen to approximately 15°C the relative humidity is, due to moisture strain from the ground, still higher than 80 %RH.

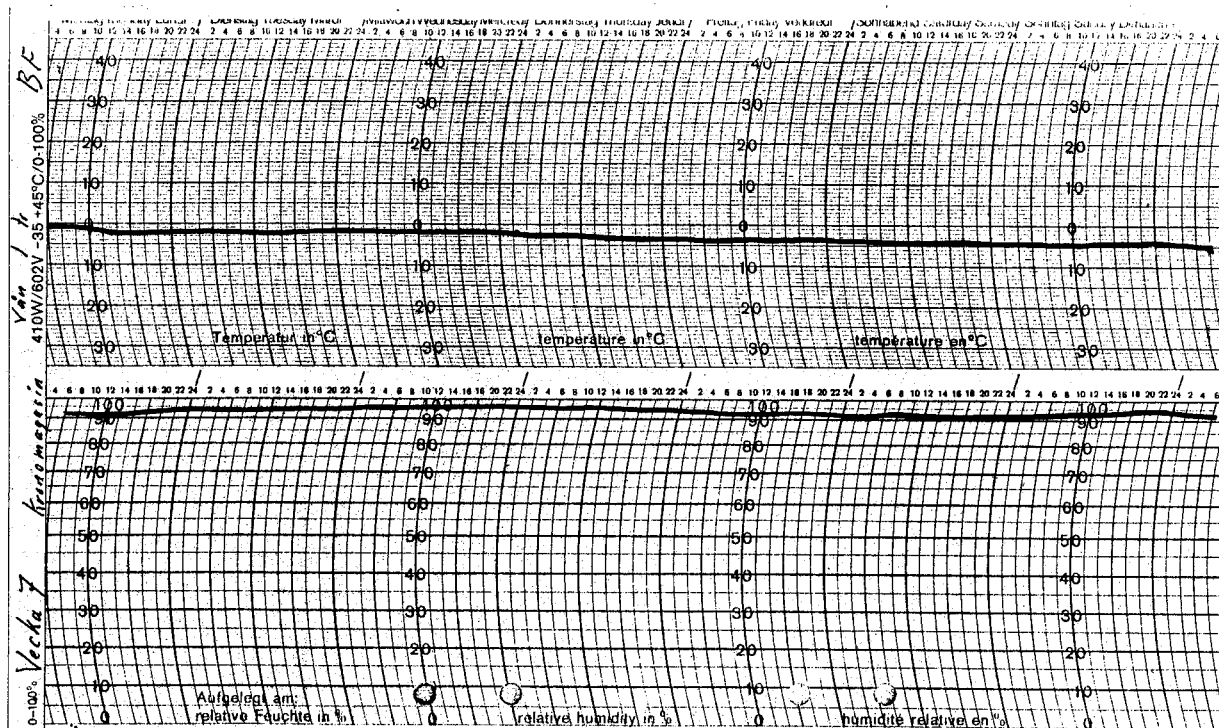

Figure 7 A one-week (winter) registration of the temperature (the upper curve) and the relative humidity (the bottom curve) in an old granary at Gripsholm castle.

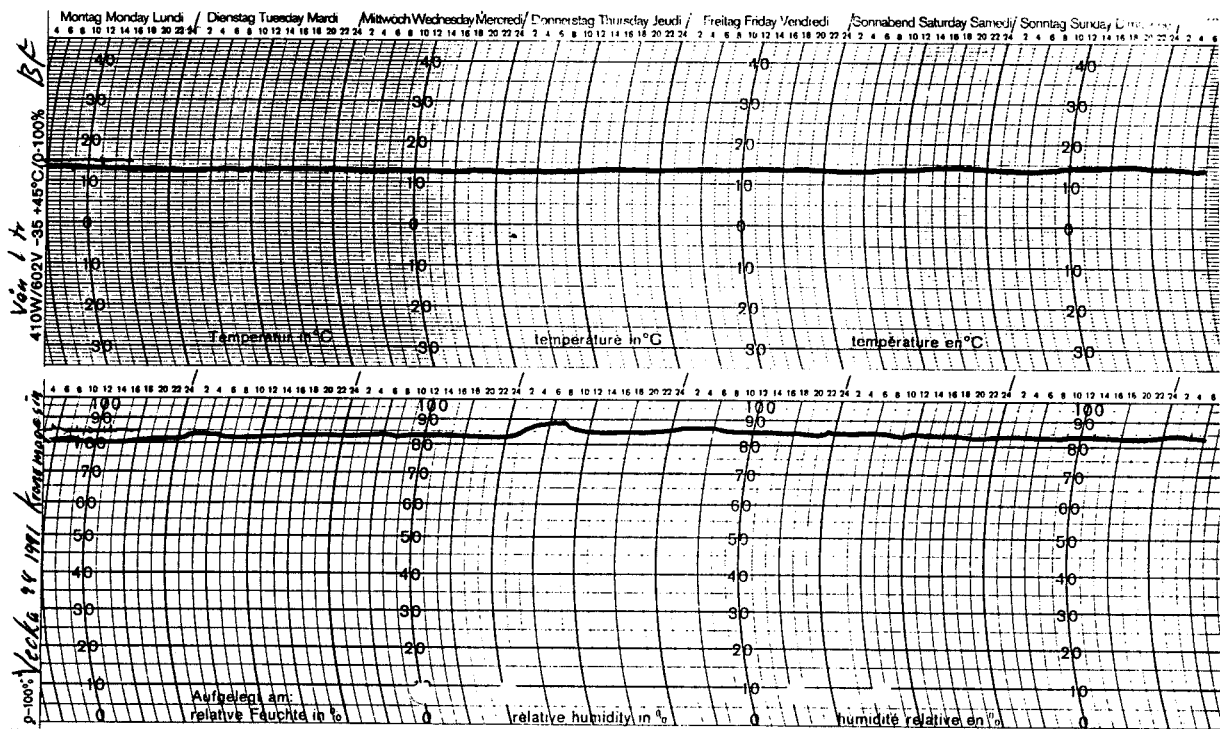

Figure 8 A one-week (summer) registration of the temperature (the upper curve) and the relative humidity (the bottom curve) in an old granary at Gripsholm castle.

7.2.3 A museum repository

This example is also a historic and very heavily built (brickwork) warehouse, where the indoor climate is very stable. The recordings which appear from Figure 9 and Figure 10 are carried out on the 5th floor of the building, which lies above the capillary suction height. In the winter (at the beginning of January) (Figure 9) the relative humidity is high (75 %) due to the low indoor temperature of approximately -5°C . In the summer (mid-June) (Figure 10) the relative humidity is approximately 60 %, which indicates that the environment is not strained by moisture suction at this level. The storage environment in the lower floors are generally more humid and damages (mould growth) on vulnerable objects are, according to the curator, observed from time to time.

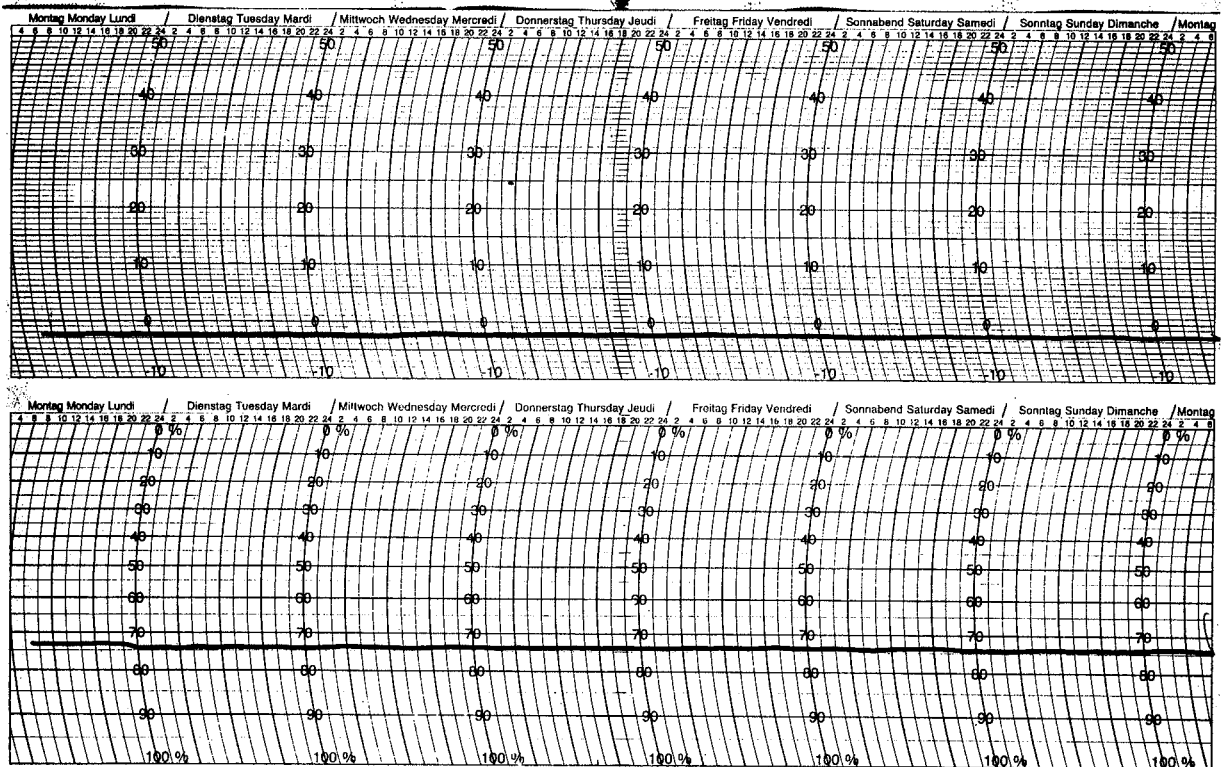

Figure 9 A one-week (winter) recording of the temperature (the upper curve) and the relative humidity (the bottom curve) in an old museum repository.

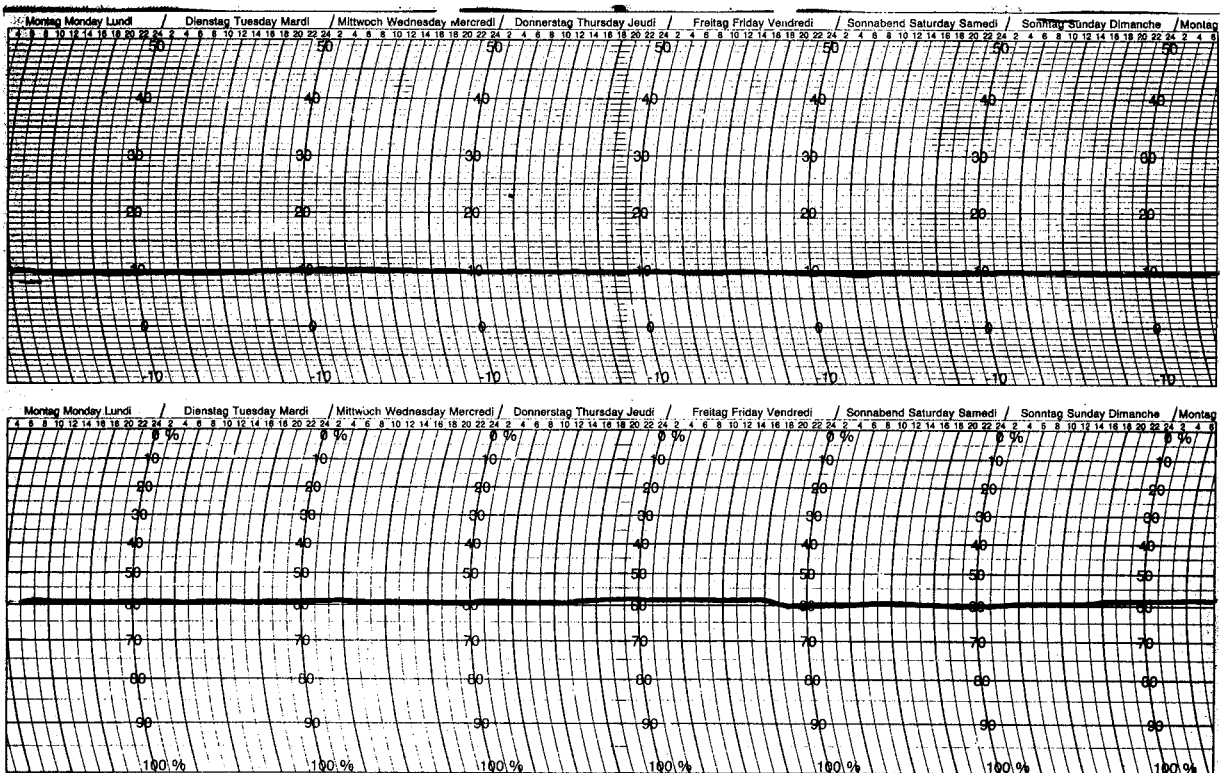

Figure 10 A one-week (summer) recording of the temperature (the upper curve) and the relative humidity (the bottom curve) in an old museum repository.

7.3 Summary

It can be summarized that mechanical airconditioning installations can fulfil the demands on a good storage environment, especially when the installations are well-designed and closely monitored by a well-trained and skilful operator and meticulously maintained. But the mechanical airconditioning plants often do not operate properly due to failing operation instructions and unsatisfactory maintaining and heavy costs of maintaining the installations to a level where they can comply with the strict demands. The disadvantages of using these often very complex installations are primarily of an environmental and economic nature: high energy consumption and high operating costs and then the sometimes less than perfect reliability of such installations. An airconditioning plant normally operates with an air change rate of 1-6 air changes per hour or even higher rates in order to fulfil the storage environmental requirements and the requirements for human comfort. This means that the buffer effect on the temperature and relative humidity of the building structure (which acts relatively slowly) is eliminated.

Passive climate control is a design principle where it is important for the engineer to be aware of how the building is used and it is important for the user to be aware of any activities that could possibly have an unintended and inexpedient effect on the indoor climate. It is likewise very important that a passive climate controlled building is in good repair and does not suffer from capillary suction of moisture from the ground. The building must be relatively airtight in order to minimize the influence of outdoor climatic fluctuations.

The described problems are typical for many repositories, but as mentioned in the introductory to this chapter it is not the meaning of this chapter point out what principle is best. But the idea that passive climatization can be more safe (no breakdowns) and can cause a more stable climate than the mechanical principle are corroborated.

8 The Passive Climate Control Principle

When the Municipal Archive (Stadtarchiv) in Cologne was built in 1971 it was chosen not to use any kind of mechanical ventilation or airconditioning in order to maintain the specified climatic conditions. At that time it was a step against the trend.

Through several centuries historical documents have been stored in the basement under the Cologne Cathedral and they were in a very good state of preservation. The idea was to transfer the building physical qualities of the cathedral to the new archive in order to establish the same storage environment [Stehkämper, 1971].

The Cologne principle is therefore based on a structure consisting of solid walls of masonry (49 cm) with an outside cover of a granite slab. Between the masonry wall and the granite slab there is a 7 cm air gap. The inside of the walls are covered with a lime mortar plaster.

The Cologne principle is actually not really passive climate controlled because it is heated and it is also based on the idea that airing is needed in the repository, which demands that a qualified person of the staff opens the narrow windows when the outside air is not too moist or too dry [Stein, 1992].

This principle seems to be working quite well but it has two weaknesses; the need for qualified persons that can manage the airing and the fact that the energy use is too large after the heavy increase in energy prices in the seventies.

The "Cologne principle" became the model in European archive building [Stein, 1992]. Two archives in the Netherlands, Zwolle, 1978 and the National Archive in Haag, 1980 and the National Archive of Switzerland in Zürich, 1985 were built on the Cologne principle, but not in agreement with it. The temperature and humidity buffering parts of the outer walls were built thinner and the missing parts were replaced by insulation. The heavy facades in Cologne were in Zürich replaced by aluminium sheets and the airing was in Haag managed by a mechanical ventilation plant deliberately chosen to have a too small capacity.

The deviances from the principle appears to be fatal to the storage environment [Stein, 1992], which have been too moist, too warm and too fluctuating.

Subsequently four archives in Germany and two in Austria were built on the Cologne principle but not quite in real agreement with it. No windows, vapour barriers, insulation and computer controlled ventilation have been tried out, but without any success [Stein, 1992].

Since the first step towards a new Regional Archive in Schleswig-Holstein it was realised that the Cologne Principle had to be reconsidered and developed into a less energy consuming principle.

It was recognized that the thermal and humidity buffer in the outer wall should be very large and that the outer walls, the roof and the walls against occupied areas (offices etc.) within the building should be well-insulated. Calculations made it clear that the uncontrolled air change rate caused by air leakage should by advantage be as low as possible.

The wish to keep the air change rate as low as possible made it necessary to secure that any possible production of pollutants (human bioeffluents, pollutant production from deteriorating materials and degassing from stored materials or building materials) inside the repository would be so low that the pollutant would be carried out by the after all leaking air.

9 The Regional Archive of Schleswig-Holstein

9.1 History

The Regional Archive of Schleswig-Holstein is situated in Schleswig in the Northern part of Germany (Figure 11). The Prince's Palace (Prinzenpalais) is the residence of the Regional Archive.



Figure 11 Map of Germany.

Earlier the Archive resided at the Gottorp Castle also situated in Schleswig. During the late eighties the Prince's Palace went through a comprehensive rebuilding, and today the Prince's Palace houses exhibits and some offices for the Regional Archive. Just behind the Palace there is a new building, called

the "Grand Piano" (because of the shape of the building) with more offices for the staff and room for researchers. The second new building is the repository (Figure 12). The Architects accountable for the rebuilding is Schramm, Pempelfort, v. Bassewitz, Hupertz in Hamburg

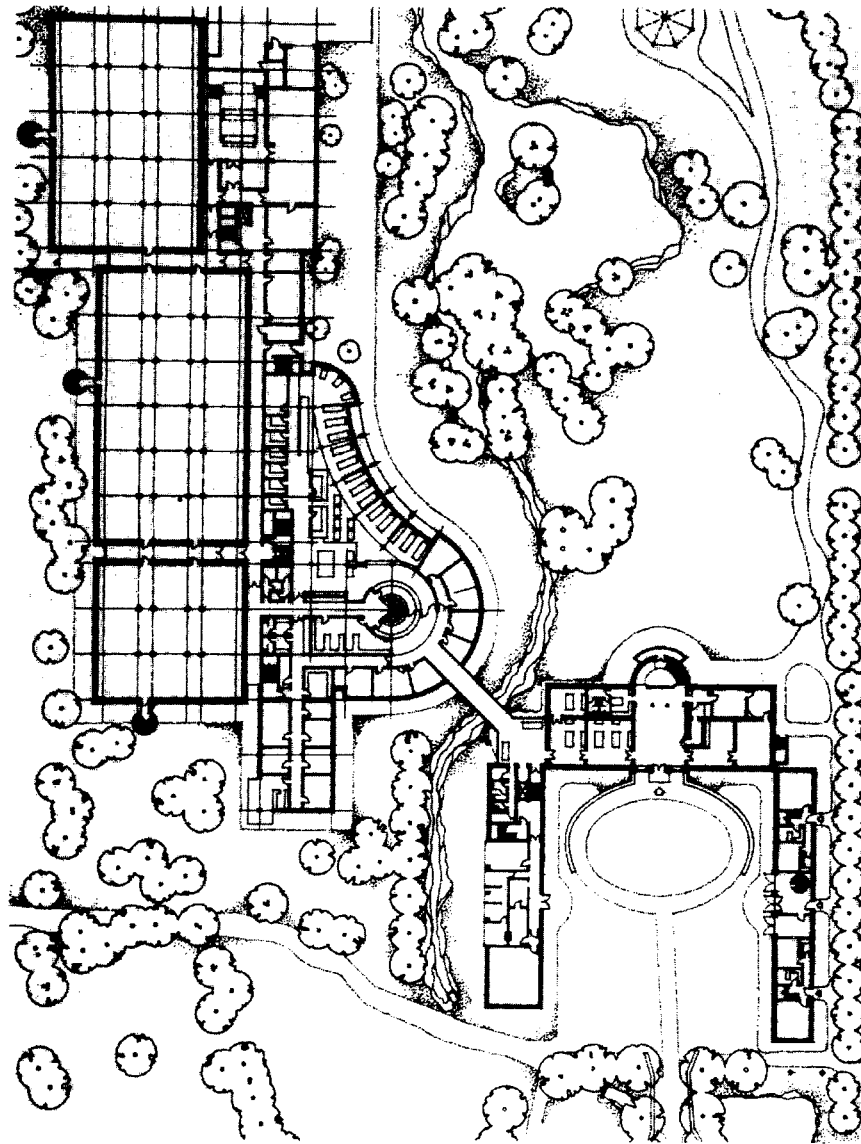

Figure 12 An overview of the group of buildings for the Regional Archive of Schleswig-Holstein.

▲
Storage
Facilities

▲
The
Grand Piano

▲
The
Prince's Palace

9.2 The Repository

The Repository at the Regional Archive of Schleswig-Holstein is 10,000 m² distributed on 4 stories. Figure 13 shows the repository building from the back.



Figure 13 The repository building seen from the back.

The repository is split up into storerooms of approximately 900 m² each, which again are split into sections of approximately 150 m² (Figure 14). The purpose of this sectioning is fire safety where the sections make up separate fire compartments. The sections are parted by masonry walls and sliding doors. In order to keep the air change rate as low as possible there are air locks between the service area and the storerooms and the emergency exits from the storerooms consist of double doors opening into an outdoor staircase tower. During the day, when the staff, in order to collect and replace documents, pass through the storerooms, they open the sliding doors between the sections.

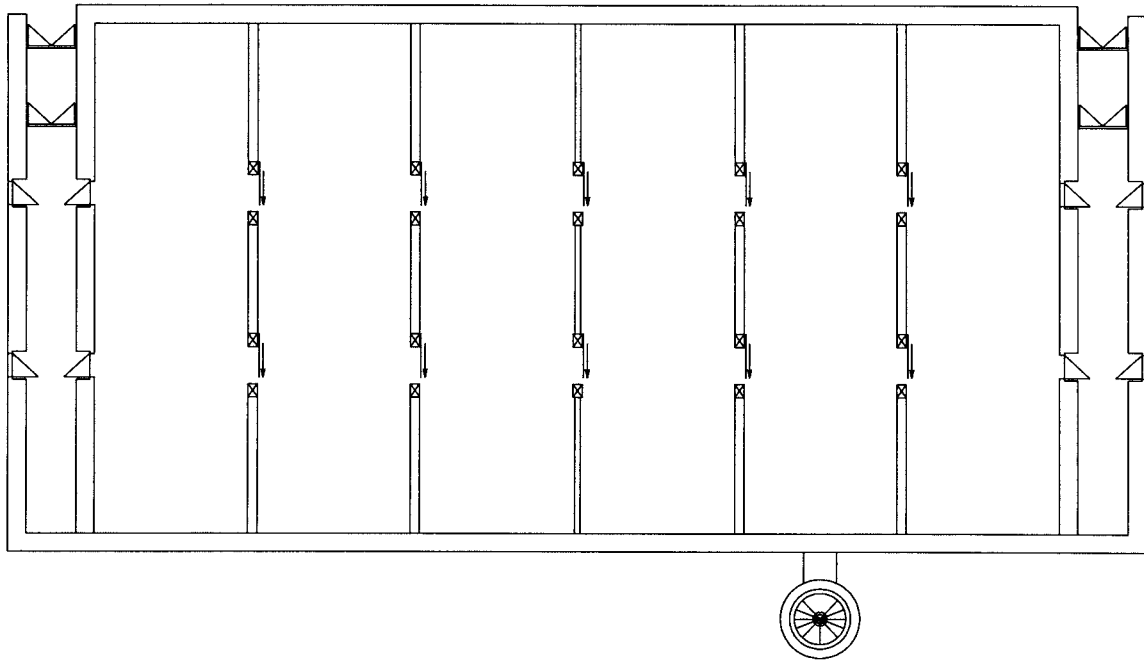

Figure 14 A storeroom at the Regional Archive of Schleswig-Holstein. The storerooms are split into six sections parted by masonry walls and sliding doors. Notice the access area with the air locks.

At closing time the electric circuit to the storerooms is broken for fire safety reasons and the sliding doors are closed automatically. If a smoke alarm is given during daytime or the circuit is broken for other reasons, the sliding doors are likewise closed automatically.

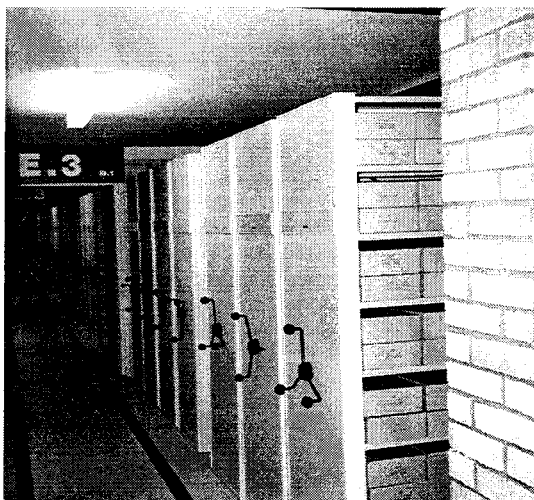

Figure 15 A view of the interior of a storeroom.

The storerooms contain mostly paper-based documents, more than 23,000 meters of shelves. Add to that 20,000 maps, 450,000 meters of documentary films, 150,000 photos and quite a lot more.

Almost all of the archival material is stored in archive boxes of cardboard on hand-operated mobile shelves (Figure 15).

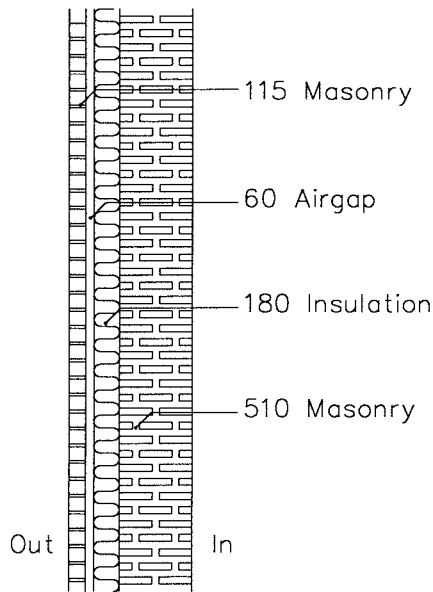

Figure 16 General sketch of the outer wall.

The outer walls, which are 860 mm thick, are constructed of 510 mm of massive brickwork on the inside, with 180 mm mineral wool on the outside. The insulation is protected against rain and solar radiation by a ½-stone thick facade of brickwork (Figure 16). The insulation and the facade are separated by a 60 m air gap. This air gap is passively ventilated by the stack effect between the open vertical joints in the masonry facade (Figure 17 and Figure 18).

The inner walls, facing the service area, are identical to the outer walls except for the air gap, which is left out.

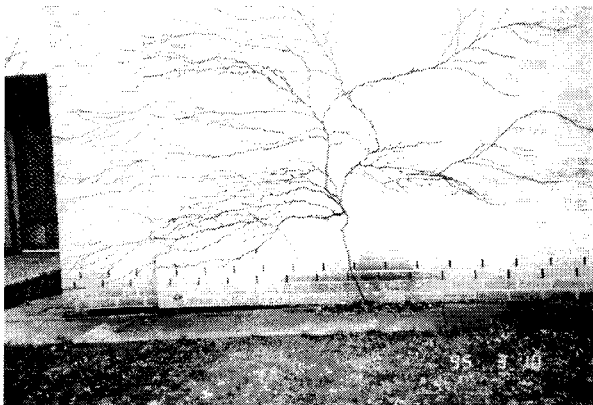

Figure 17 The open vertical joints at the plinth for ventilation of the air gap in the wall

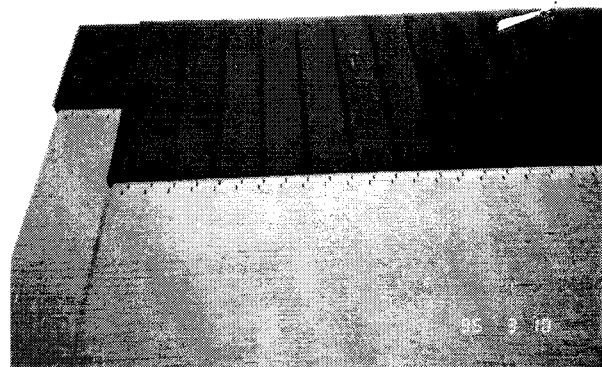

Figure 18 ... and the similar joints just below the roof construction.

The roof is a concrete slab insulated with 300 mm of mineral wool on the outside. This construction is covered by a roof construction (Figure 19). The space between is passive, but effectively ventilated with outdoor air by means of the stack effect between openings in the wall/roof joint and the roof ridge.

The repository is made without windows in order to avoid deterioration of archival material by UV-radiation, inexpedient heat loss and inexpedient heat gain from solar radiation.

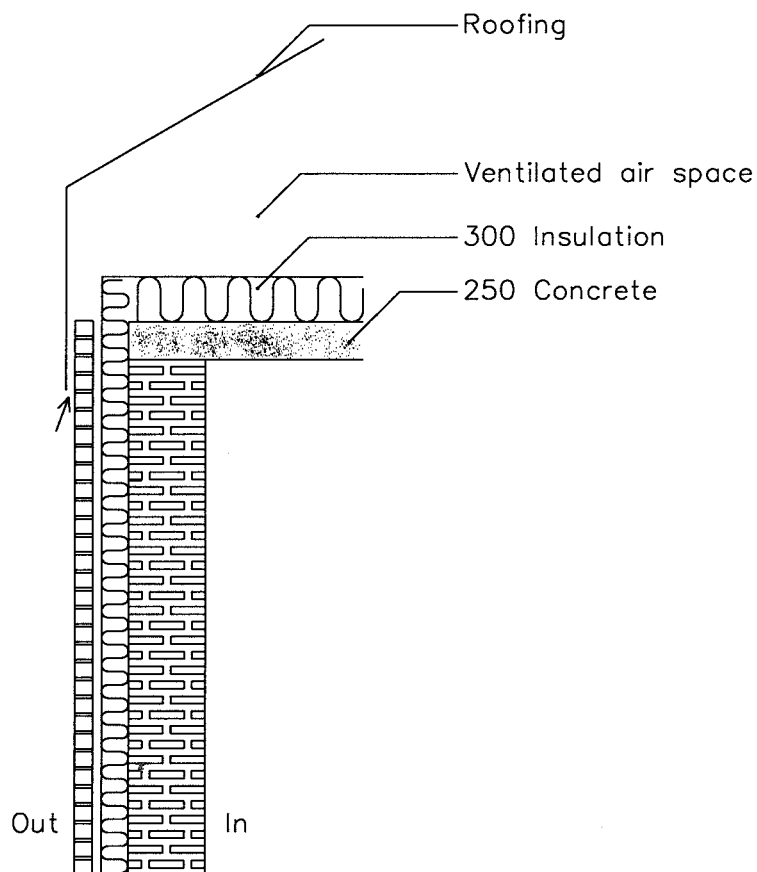

Figure 19 General sketch of the roof construction.

The combination of a building structure still loaded with water from the construction processes and the fact that it has to run with a very low air exchange demands a great deal of attention before taking the building into use. The building moisture must be dried out before the building is "closed". The archive was therefore drying up over a period of 2½ years.

The repository is equipped with a low-temperature central heating installation, which is the only artificial way of controlling the relative indoor humidity.

Because of the heavily insulated walls which increase the risk of overheating the repository, it is necessary to keep the internal heat production as low as possible. Therefore all lighting is low-energy fluorescent (UV-filtered) light. Furthermore, there are no permanent workplaces in the repository and the staff is expected to make their stay in the storerooms as short as possible. When the staff leaves a storeroom, all lights must be switched off using a switch on the service area side of the storeroom.

9.3 Building Physical Guidelines

From the first initiative, archive management, architecture, storage environment, running costs and building physics were integrated concepts of the planning and design. Building physical guidelines for the repository building were worked out on this basis.

The building physical guidelines contain descriptions of the building with detailed analyses of the component parts of the construction and statements of the physical demands on building materials and construction design [Birch & Krogboe, 1980]. The building physical demands and some additional demands on lighting, time spent by staff in the rooms, shelving etc. are stated on basis of the required climatic performance of the repository building combined with the monthly average values of outdoor temperature and humidity.

The predicted indoor climate is stated on the basis of a direct connection between the monthly average absolute moisture content of the outdoor air and the indoor air. In order to keep the relative humidity within the limits of 40-60% the temperature should be regulated to a higher temperature that would secure a slowly varying indoor relative humidity.

Without taking the influence of thermal and humidity buffer of the stored material into account, it was therefore planned that the storerooms should be heated to an indoor temperature slowly varying from 12°C in February to an absolute maximum of 22°C in August (should preferably not exceed 20°C) in

order to comply with the limits for the relative humidity. The relative humidity would then be allowed to vary slowly within the range from 40% in March to 55-60% in July. Table 4 shows the monthly average values of the relative humidities wanted and the resulting indoor temperatures.

MONTH	Indoor temperature [°C]	Indoor relative humidity [%]
January	12	40
February	12	40
March	13	40
April	13	50
May	16	55
June	19	55-60
July	22	55-60
August	22	55
September	20	55
October	17.5	50
November	13.5	50
December	13	45

Table 4 The predicted monthly average indoor temperature and relative humidity [Birch & Krogboe, 1980].

Referring to the building physical guidelines the prescribed building structure should dampen the indoor temperature variations over a period of 3×24 hours to a factor 1/50 of the outdoor temperature variations. No relative humidity variation damping factor is described. The building structure will in addition to the temperature and humidity variation damping properties also have an ability to delay the phase of variations. This phenomenon is not paid any attention in relation to the predicted indoor climate.

9.4 The Operational Experiences

The new archive facilities were put into use in 1991. After a short period with a failing heating strategy which result in too high temperatures in the storerooms, the heat was cut off and has not been in use for at least 4 years. However, the actual indoor temperature has more or less proceeded as predicted, but the indoor relative humidity has been much more stable. The actual indoor climate is thoroughly dealt with in Chapter 10.

To ensure that the working environment is healthy, air quality measurements were carried out in January 1993 at the request of the archive management. The measurements on a number of harmful (to people) gases were carried out by an environment laboratory (Hanseatisches Umweltbüro, Lübeck) without finding any increased concentrations. Unfortunately the results of these measurements are no longer available, except the CO₂-measurements which say concentrations in the storerooms between 0.01-0.03% [Hanseatisches Umweltbüro, 1993]. This means that in spite of the presence of 1 or 2 persons (1-2 hours a day) the CO₂-concentrations are not exceeding the actual threshold limiting concentration of 0.1%. The CO₂-concentration in atmospheric air is 0.03%. The lower values in indoor air are probably caused by the CO₂-absorption in the constructions related to the carbonatization going on.

Before the building was taken into use, the storerooms were cleaned-up. Some persons from the cleaning staff complained about difficulties in breathing, palpitations and hot flashes when they had worked in the rooms even for short times. This could be explained by some kind of psychic stress caused by entering a room though locks where no sounds can be heard from the outside. It could also be the indoor climate which gives the remarkable feeling of an inert room. This feeling could be caused by the missing asymmetrical radiation (all surfaces have almost the same temperature), which occurs in almost any other indoor climate.

10 The Measurements

10.1 Aim

The storage building at the Regional Archive of Schleswig-Holstein was built in a way, where actually very few factors are controlling the indoor climate and where disturbing factors are very few and can be identified.

Because of these very special conditions for a building in use, this place is very suitable for a scientific survey of the moisture and heat transport in a completely passive climate controlled environment. Therefore it was chosen to carry out detailed measurements as an important part of this work. Measurements were started in March 1994 in order to monitor the moisture and heat interactions between the building structure, the contents of the building and the outdoor climate.

10.2 Measuring Equipment

The measuring equipment consists of a programmable datalogger collecting data from five temperature and humidity sensors and one thermocouple. For more detailed information on the measuring equipment see appendix 1.

Data are recorded every 10 minutes. This very high frequency is chosen because of the wish to observe short-time fluctuations, caused by doors being opened or closed, lights switched on or off etc.

The datalogger is recording temperature and relative humidity measured by sensors located in (Figure 20):

- The outdoor air.
Placed on the outer wall approximately 3 m above the ground. Facing south, which means that the sensor was negatively influenced by solar radiation.
- The air gap in the wall.
- The centre of the inner part of the outer wall.
Placed 20 cm from the inside.
- The indoor air.
Placed 2.3 m above the floor in the centre of the room.
- In an archive box.
Placed 1.5 m above the floor.
- The surface temperature of the radiator.

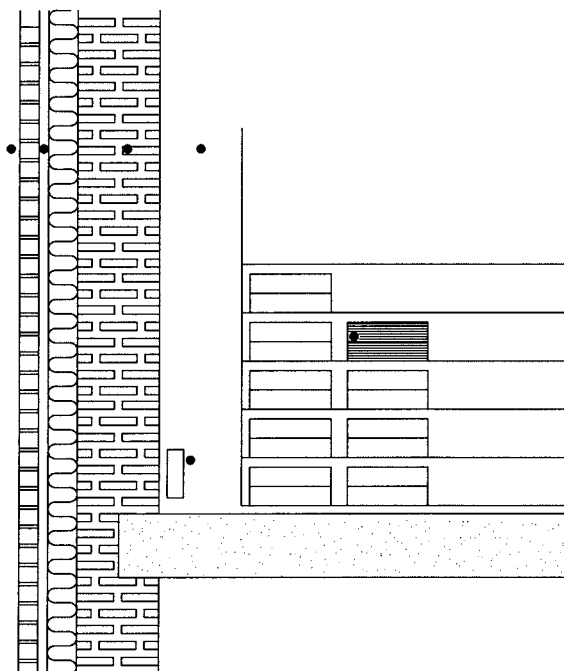

Figure 20 General sketch of sensor locations. All sensors are marked by: ●.

Altogether the 22 data given below are recorded every 10 minutes:

- Initial number, year, day number of year and time.
- Battery voltage (back-up battery).
- Internal datalogger temperature.
- Radiator temperature.
- Temperature and relative humidity of every one of the 5 sensor locations.
- Absolute moisture content of every one of the 5 sensor locations. Not measured, but computed by the datalogger from the measured temperatures and relative humidities.

The outdoor relative humidity sensor was unfortunately ruined by white frost. The missing data are replaced by data from a local weather station in Schleswig, supplied by the German National Weather Service (Deutscher Wetterdienst).

10.3 The Results

The measurements have been carried out for more than 2 years. Data are continuously recorded over this period and the chain of observations is unbroken, except for 2 short periods with data transmission problems, one in July '95 and one in November '95.

10.3.1 The Schleswig Climate

The Schleswig climate is characterized by moderate temperatures between 0 and 17°C and relative humidities between 75 and 92 % in monthly average values over the period 1931-1960 [DMI, 1994].

The climate for the last 2 years has been characterized by two summers with some very hot periods, with temperatures up to 33°C.

Figure 21 and Figure 22 show the monthly average values of the temperature and the moisture content of the "normal" year and the actual recorded monthly average values [DWD, 1996] of the period April 1994 to October 1995.

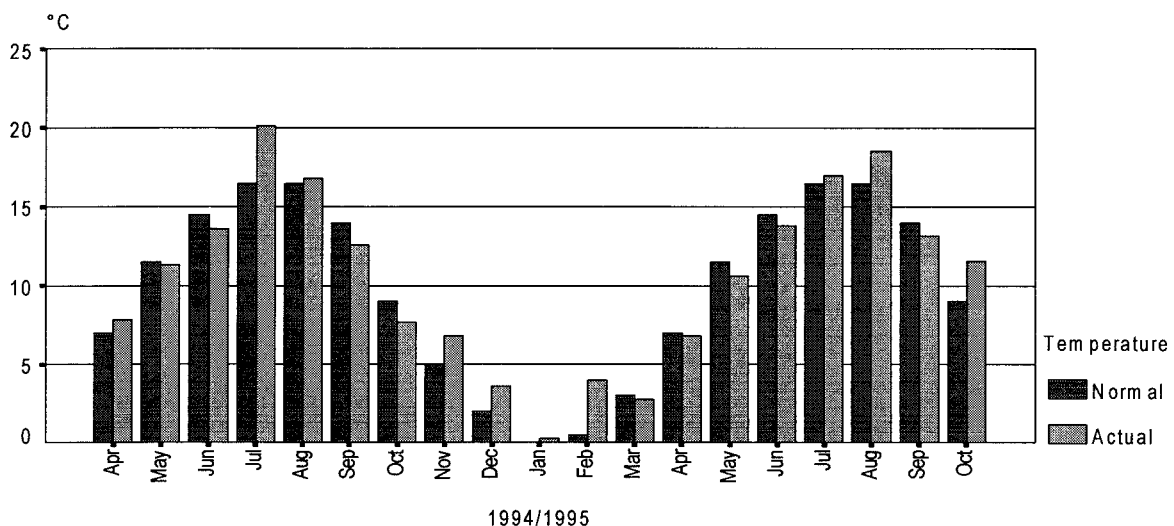

Figure 21 The Schleswig climate.

The monthly average temperatures of the "normal" year compared to the actual recorded monthly average values.

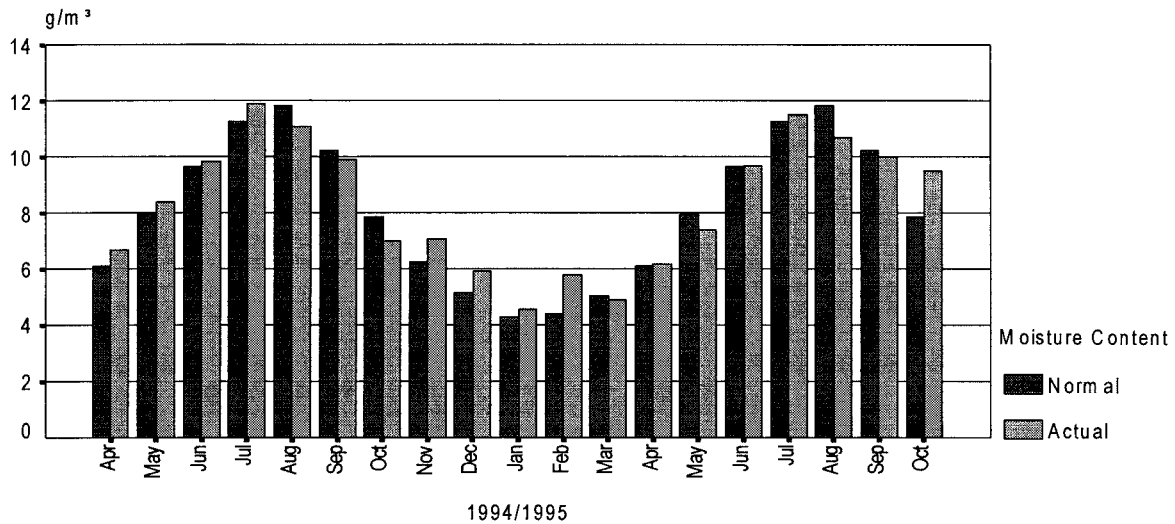

Figure 22 The Schleswig climate.

The monthly average moisture content of the outdoor air of the "normal" year versus the actual recorded monthly average values.

Because of some very hot periods over this 2 years period, the average temperature (10.5°C) is no less than 0.6°C higher than a normal year temperature and the moisture content (8.3 g/m^3) of the outdoor air is 0.2 g higher per m^3 .

10.3.2 The Indoor Climate

The indoor temperature in the repository varies from 14.5 to 20.5°C , with the minimum at the end of March and maximum at the end of August. Figure 23 shows the room temperature over the measuring period compared to the outdoor temperature. The indoor temperature curve is almost perfectly similar to a sinusoidal function, except that the time between a minimum and the next maximum (the heating period) is only 5 months, instead of 6 months. The corresponding cooling period is 7 months, so in spite of this behaviour the total time of one heating and one cooling period is, of course, still one year. The explanations to this phenomenon are the fact that the outdoor temperature is not an absolute perfectly sinusoidal function and that the indoor average temperature is higher than the outdoor average temperature and that the

emitted heat from lighting is in phase with the increasing outdoor temperature during the heating season and is in the opposite phase during the cooling season.

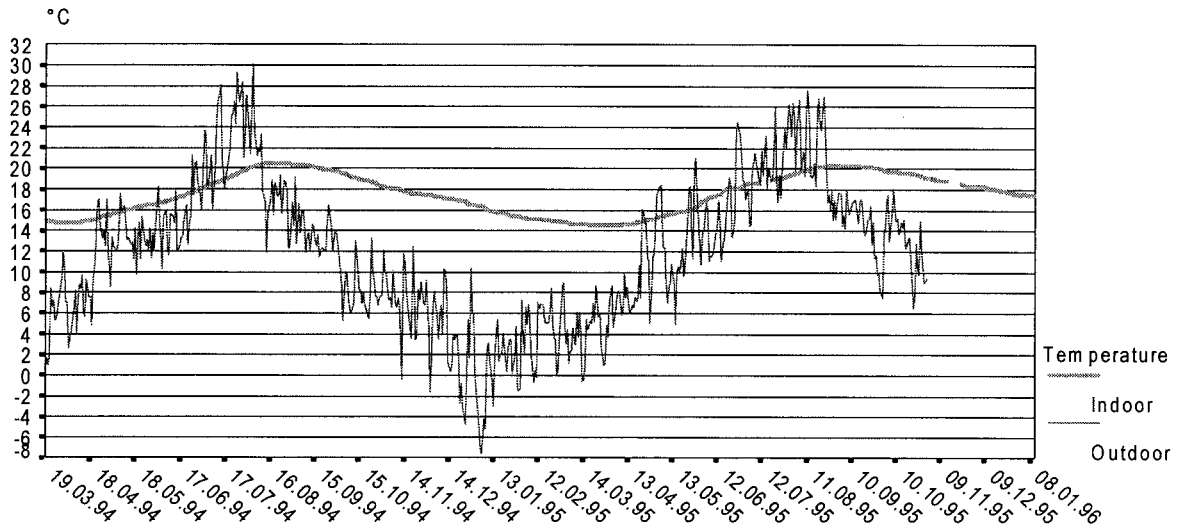

Figure 23 The Regional Archive of Schleswig-Holstein. Storage room 2 (groundfloor). Indoor temperature compared to the outdoor temperature.

The relative humidity varies from approximately 56 % at the beginning of the period to 62 % in September, 1995 (Figure 24). The proceeding of the relative humidity shows a smaller increase during the entire period, which can

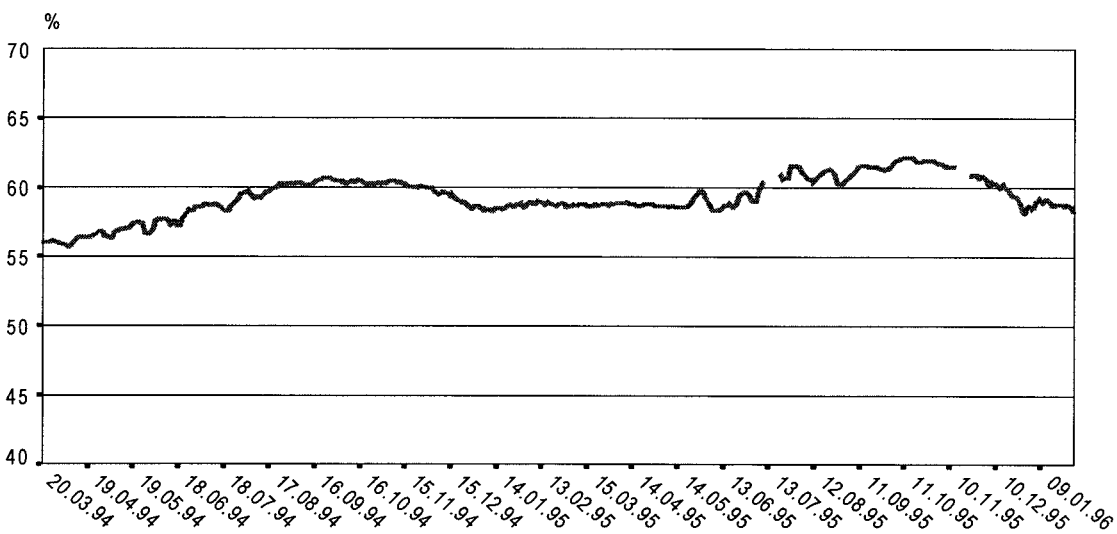

Figure 24 The Regional Archive of Schleswig-Holstein. Storage room 2 (groundfloor). Indoor relative humidity.

be explained by the extreme outdoor climate conditions during the measurement period. Furthermore the course of the relative humidity curve is relatively uneven which is related to the dependence on the temperature and the absolute humidity. Even smaller changes in these parameters will influence strongly on the relative humidity.

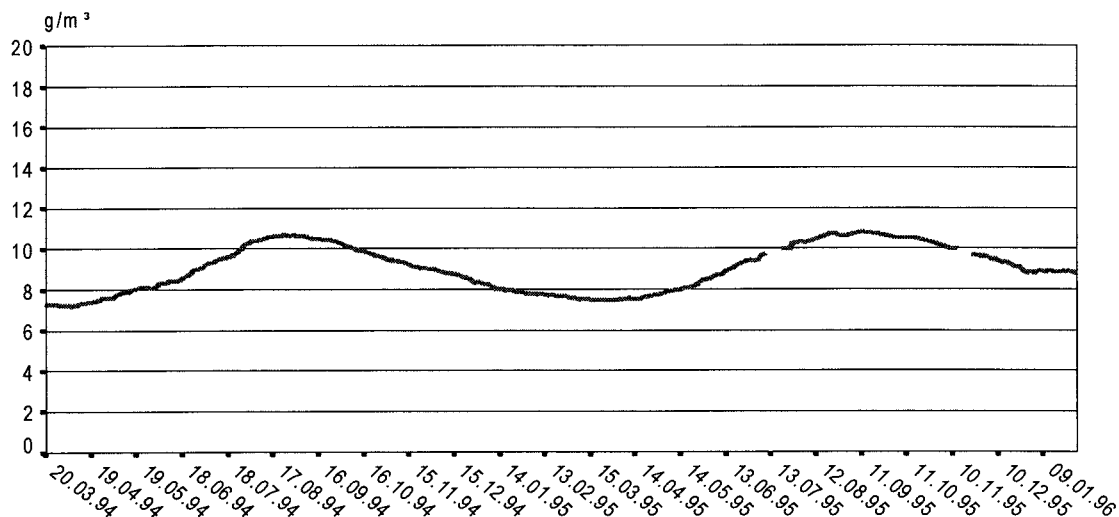

Figure 25 The Regional Archive of Schleswig-Holstein. Storage room 2 (groundfloor). Absolute humidity of the indoor air.

The absolute humidity curve (Figure 25) of the indoor air is very much similar to the temperature curve as it shows an almost perfect sinusoidal function. The short-time fluctuations in relative humidity is however primarily caused by the use of the repository and the way it happens.

Every morning on a working day the staff enters the storage rooms at approximately 7:15. On this round, the sliding doors between the six sections (fire compartments) in every storage room are opened. In the evening the doors are automatically closed again.

As it will be described in the next chapter the main cause of the air change is the emergency exits, which are placed in one of the sections in every storeroom. The emergency exit in the actual storeroom is placed in the same section where the measurements are carried out. Therefore, this section has a

much larger air change rate than the other sections, and is therefore more exposed to outdoor climatic variations and the absolute moisture content can therefore, at a given moment, be a little different from the absolute moisture content of the other sections. This has furthermore been visually confirmed by dosing smoke close to the emergency exit door.

This routine results in some small but unwanted fluctuations in the indoor climate. Figure 26 shows the indoor temperature and the air temperature inside a box over a period of 10 days in March and April 1995.

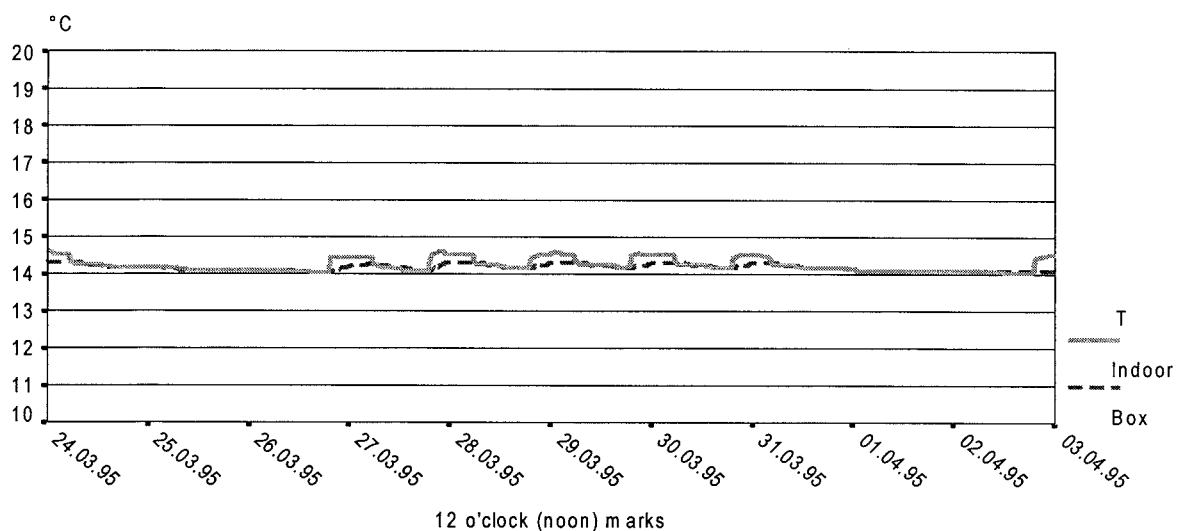

Figure 26 The Regional Archive of Schleswig-Holstein. Storage room 2 (groundfloor). Temperature changes in the room air and inside the archive box caused by opening and closing the sliding doors between the sections in the storage room.

The result of the way the building is used can, as it appears from Figure 26, be recognized in changes in temperature and so in changes in relative humidity (Figure 27). When the doors are opened, the differences in temperature and moisture content between the sections will be released and the changes in temperature and moisture level occur.

As the relative humidity is in equilibrium with the moisture content of a hygroscopic material like paper these changes in relative humidity cause an oscillating moisture transport in and out of the paper.

In spite of the very small fluctuations in relative humidity occurring in the storage room, the archive boxes have a remarkable influence on the storage conditions affecting the archive material.

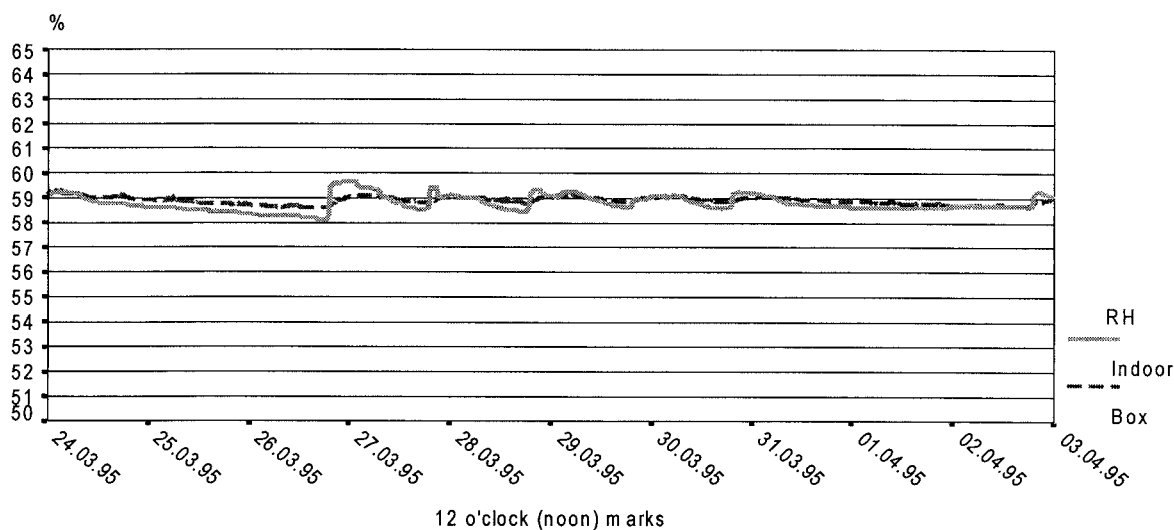

Figure 27 The Regional Archive of Schleswig-Holstein. Storage room 2 (groundfloor). Relative humidity changes caused by opening and closing doors between sections in the storage room.

The fluctuations inside the box are considerably restrained relative to those outside the box. The amplitude of the fluctuations outside the boxes is reduced by approximately 2/5 inside the boxes. There are two main reasons for this phenomenon. The boxes are made of thick untreated cardboard material, which is a very hygroscopic material and therefore has a very good capability of taking up and giving off moisture relative to the fluctuating relative humidity. The boxes are furthermore relatively airtight, so the relation between a small air volume inside a box and the large area of the archive material buffering the fluctuations, gives a considerable effect.

10.3.3 Air Change Rate Measurement

A factor which was not specifically known was the air change rate and it was obvious that measurements were necessary. An air change rate measurement was made in a storage room in the center of the repository building (Storage

room 2, Groundfloor level). The measurement was made as an average measurement over a period of 24 hours on April 24, 1994. The average outdoor climate situation during this investigation was cloudy and a steady wind. The average outdoor temperature was 13.3°C and a relative humidity of 61%.

Tracer gas technique using Concentration Decay Method was used for this measurement. A certain amount of tracer gas was dosed into every six sections of the storeroom. After approximately 6 hours, the tracer gas, according to the multichannel monitoring (one measuring channel for every section), had reached almost the same concentration in every section.

Figure 28 shows the measured concentration decay curve from the same section where all other measurements are carried out. A peak appears after approximately 3 hours. At that time the sliding doors between the sections are closed. The peak is raised because the tracer gas concentration in the actual section is a little higher than in the other sections. At 16 hours another peak appears. This one indicates that the concentration in the actual section now

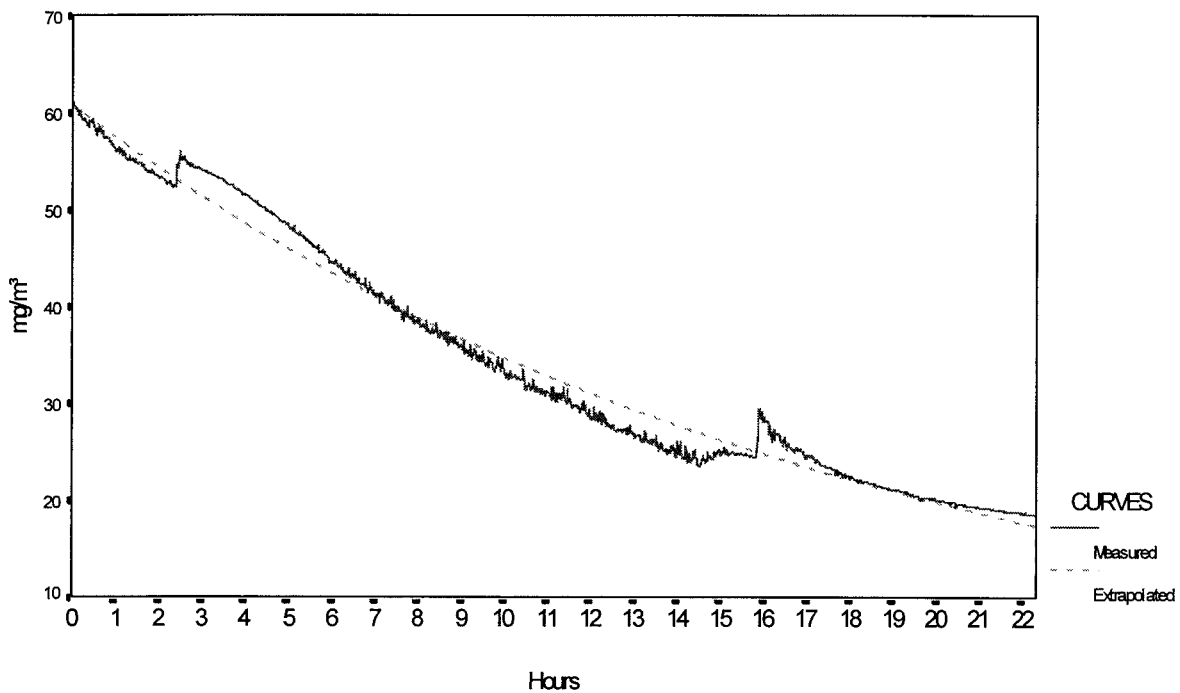

Figure 28 The measured concentration decay curve. The extrapolated decay curve is used for the air change rate calculation.

has become lower than in the other sections. This means that the air change rate must be higher in the actual section than in the other sections.

The average air change rate over a period of 22 hours was, according to the extrapolated decay curve, determined to be 0.05 times per hour. For further information see appendix 2.

10.3.4 A Heating Experiment

In some situations with special tightened demands the principles of passive climate control cannot work alone and must be supported by some kind of active relative humidity control. Control of the relative humidity in rooms with very low natural air change rates can take place in two ways. It can be controlled by adjusting the temperature or by adjusting the moisture content of the air.

Adjustment of the moisture content of the air can take place by the following two measures:

Dehumidifying or humidifying with mechanical installations.

The relative humidity of the air is controlled to a certain setpoint. This can affect the indoor temperature.

Using ventilation with outdoor air.

Moisture is supplied into or out of the room when needed by supplying humid or dry (relative to the indoor air) outdoor air. This can affect the indoor temperature.

Adjustment of the temperature can take place using the following three measures:

Controlling to a certain relative humidity setpoint.

Cooling or heating installations are used in order to reach the relative humidity setpoint. The risk is that the temperature can exceed the acceptable temperature range.

Controlling to a certain temperature setpoint.

Cooling or heating installations are used in order to reach the temperature setpoint. The risk is that the relative humidity can exceed the acceptable relative humidity range.

Constantly giving off a certain amount of energy.

This will raise the indoor temperature to a level higher than the ambient temperature and therefore lower the relative humidity level.

Problems with controlling the relative humidity of the air in a repository by temperature adjustments is often caused by failing temperature and humidity sensors. A phenomenon called *positive feedback* related to the physical properties of the hygroscopic contents of a repository is also described as a problem.

Positive feedback is described by Padfield & Jensen, 1990 and Padfield, 1996 as the effect of an increasing relative humidity caused by heating. When controlling the relative humidity to a certain setpoint in a museum store filled with hygroscopic materials by heating, the result could be "violently oscillating temperature". When stored materials like paper, wood and leather are getting warmer they can not hold back the same amount of water and the water is given off to the surrounding air. If the air change rate is very low or the store is completely loaded with hygroscopic materials the result could be an increasing relative humidity caused by heating - the positive feedback effect.

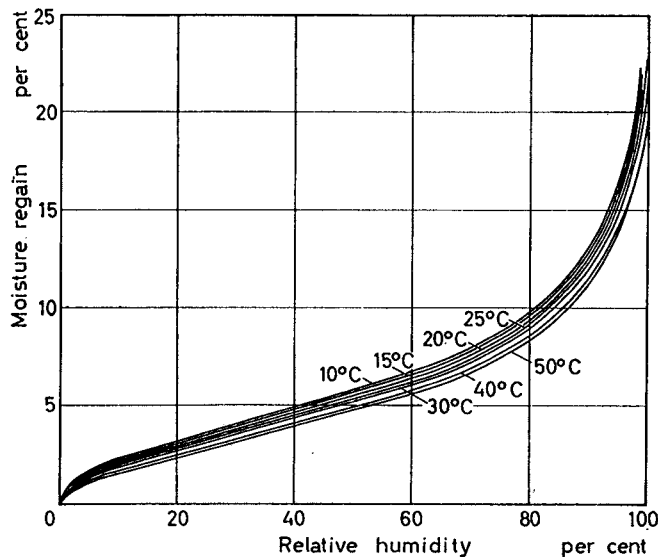

Figure 8. Effect of temperature (10–50°C) on sorption isotherms for cotton

Figure 29 An illustrative example of the temperature effect on sorption isotherms (cotton).

The positive feedback effect is therefore a result of the temperature depending sorption properties of hygroscopic materials. Figure 29 is an illustrative example of the temperature effect on some sorption isotherms. The figure shows the isotherms for cotton which has almost the same properties as cellulose [Hearle and Peters, 1960] (the main component of paper).

The theory of the positive feedback effect can be illustrated by the following theoretical example:

In Figure 30 two sorption isotherms for a hygroscopic material are shown. The material is stored at a temperature of 15°C and 40% relative humidity and the material is in equilibrium with these conditions - this is point A at the figure. If the temperature is increased to 25°C the pointer shall be moved to the 25°C-curve. The difference between the two curves is that the material cannot hold back the same amount of water at 25°C as at 15°C. If at the same time, the material is hermetically sealed in an inert container it can only give off this water to the surrounding air and the air inside the material. When the amount of water in the container is constant, the pointer shall be moved horizontally from point A to point B. This means that the relative humidity inside the container is increased to 60% due to a temperature increase.

If some of the water could escape from the container the pointer should be moved to a point still on the 25°C-curve but a point below point B.

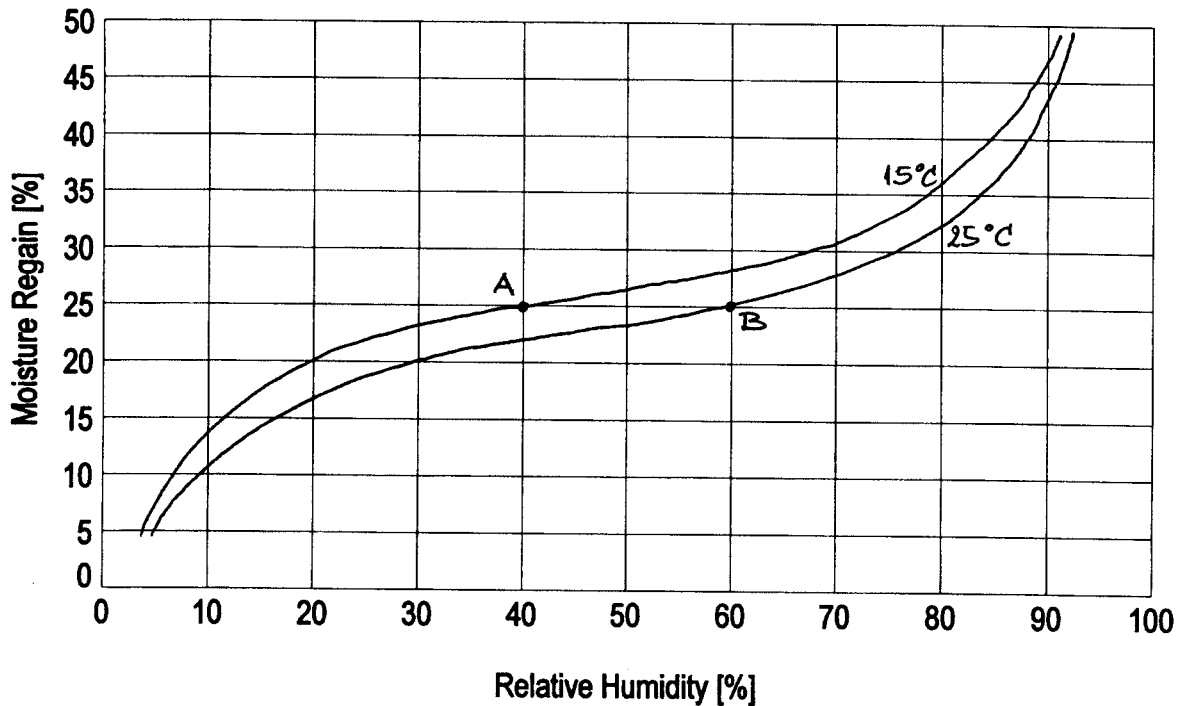

Figure 30 The positive feedback effect in relation to the temperature effect on sorption isotherms.

A heating experiment was carried out in February 1996 in order to monitor the consequences on the moisture balance of increasing the temperature in a storeroom, especially to observe if there should arise some signs of positive feedback on the moisture conditions from the stored materials.

The heating experiment was carried out in the same storeroom at the Regional Archive of Schleswig-Holstein as the other measurements described in this chapter. The room has been completely passive climate controlled for at least 4 years. The pre-experiment climatic conditions in the storeroom were a stable temperature of 17.6 °C (Figure 31) and an average relative humidity of 59% (Figure 33). The climate was completely passive controlled until February 1th, 1996. This date is marked by the first (from the left) vertical reference line in Figure 31. Figure 31 shows the indoor temperature, the temperature of the air gap in the wall and the radiator surface temperature.

During the period between the first and second vertical reference lines (8 days) the storeroom was heated to a temperature setpoint of 19°C. The temperature is raised by approximately 1.5°C.

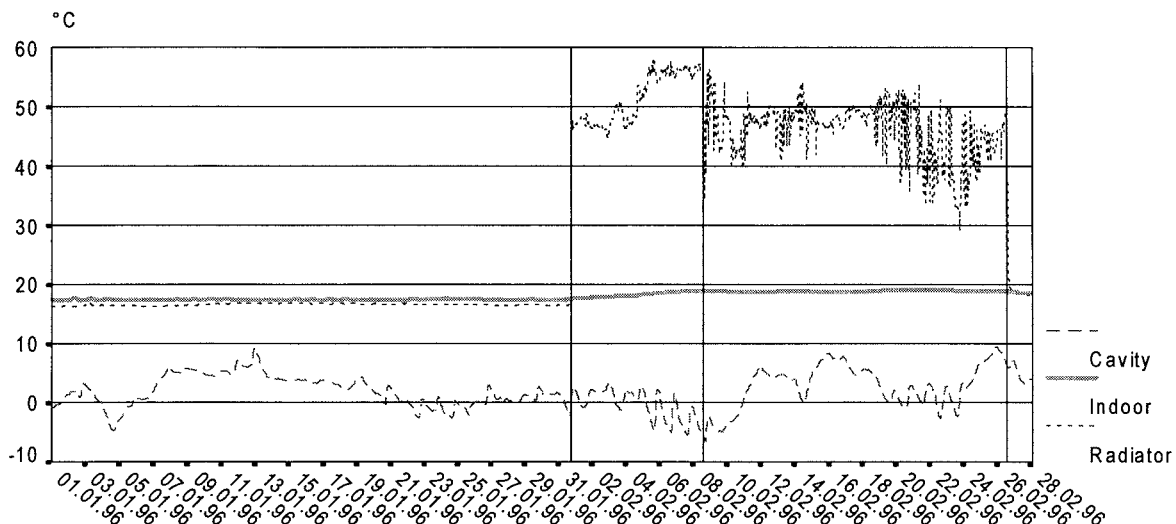

Figure 31 The course of the temperature in the air gap of the outer wall, the radiator surface temperature and the indoor temperature.
Vertical reference lines (from the left): Heating on, temp. setpoint reached, heating off.

Comments on Figure 31.

Some deviating observations can be made in the figure. The indoor temperature and the temperature inside the archive box are, until the heating experiment is started a little different, approximately 0.5°C. This deviation can be caused by the fact that they are not placed at the same level in the room or the fact that the indoor temperature sensor is placed in the middle of the room and the box is placed closer to the outer wall. The cause of this deviation cannot be established, as the deviation falls within the reliability of the sensors.

The temperatures of the indoor air and the inside of the box are increased 1.5-2°C during the experiment, but the temperature inside the wall is increased by approximately 3°C. This is not caused by an increasing temperature in the air gap, which shows approximately the same average temperature before and during the experiment (Figure 31). The cause is that the radiator is placed on the outer wall close to the place where the sensor inside the wall is placed.

Between the second and third vertical reference lines (18 days), the temperature was kept constant. After the third reference line the climate control is again running passively.

Figure 32 is a more detailed than Figure 31 and shows the temperature in the masonry wall, the indoor air temperature and the temperature inside an archive box.



Figure 32 The course of the temperature in the masonry wall, the indoor temperature and inside an archive box.

Vertical reference lines (from the left): Heating on, temp. setpoint reached, heating off.

The relative humidity courses during the heating experiment in the wall, the indoor air and the archive box (Figure 33), are all changing to a lower relative humidity level and they show no direct signs of the positive feedback effect.

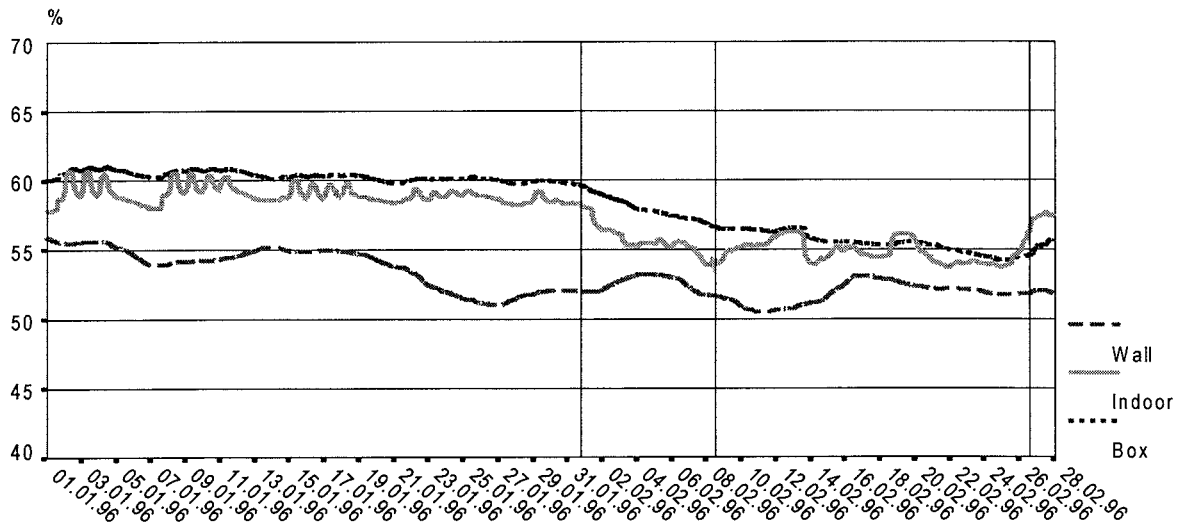

Figure 33 The course of the relative humidity in the masonry wall, the indoor temperature and inside an archive box.

Vertical reference lines (from the left): Heating on, temp. setpoint reached, heating off.

Some more detailed analysis of the measured indoor relative humidity versus a calculated relative humidity has been carried out. The calculated relative humidity is calculated from an assumed fixed absolute humidity¹ of the indoor air and the measured indoor temperature.

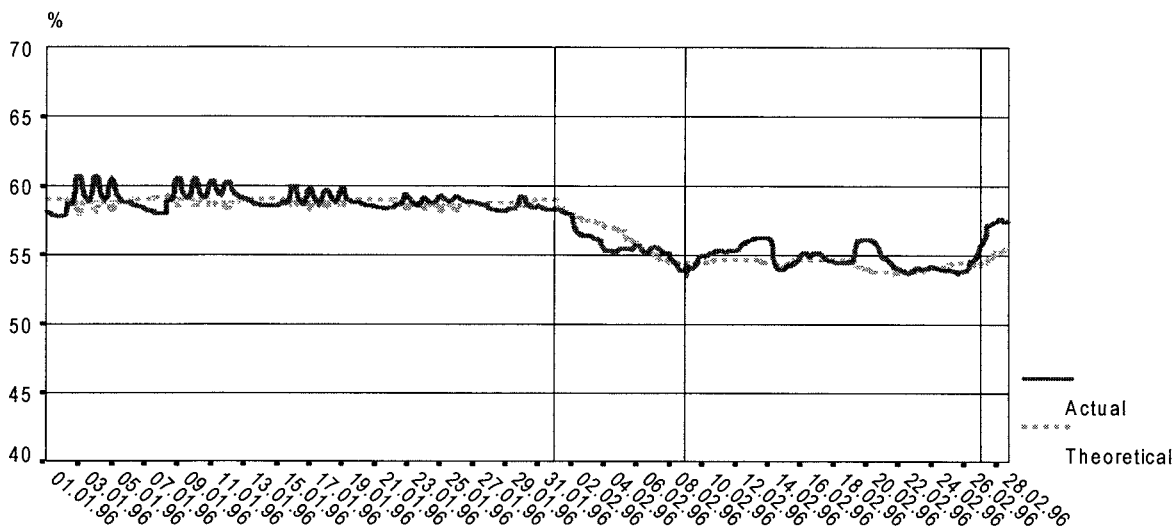

Figure 34 Comparison of the actual measured indoor relative humidity and the theoretical indoor relative humidity. Vertical reference lines (from the left): Heating on, temp. setpoint reached, heating off.

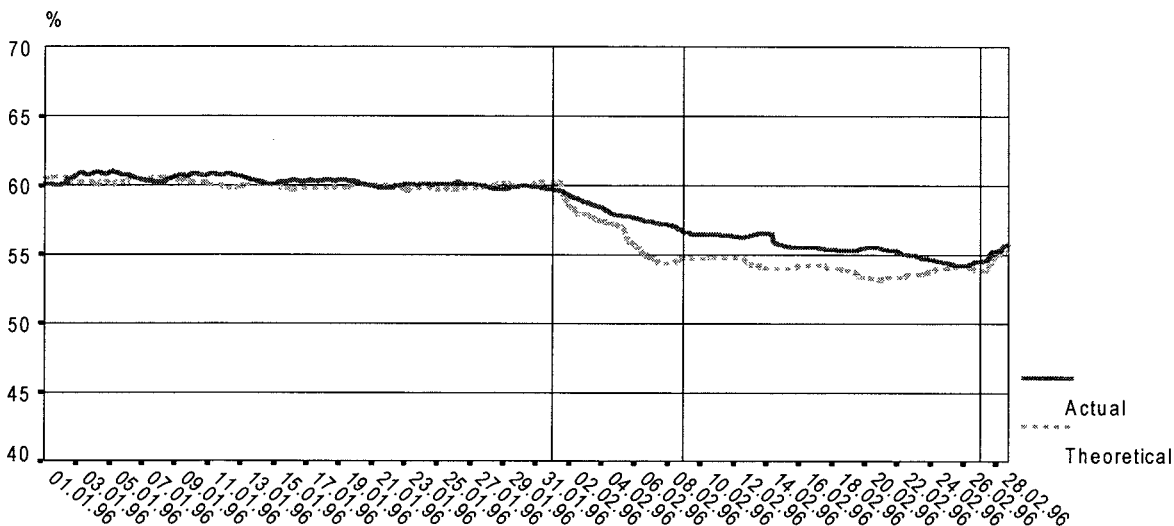

Figure 35 Comparison of the actual measured relative humidity inside an archive box and the theoretical relative humidity. Vertical reference lines (from the left): Heating on, temp. setpoint reached, heating off.

¹Through studies of the course of the absolute indoor air humidity it has been stated that the fixed value is well described by the average value of the last two weeks before the experiment.

The course of the measured indoor relative humidity course reveals that it is practically identical to the theoretical relative humidity (Figure 34). This means that the positive feedback effect on the indoor climate was not observed during this short period.

On the other hand the climate inside the archive box shows a minor positive feedback effect (Figure 35). While the courses of the temperatures in the box and the indoor air go together during the heating experiment, the measured relative humidity curve does not follow the calculated curve. When the heating is on the curves split up and the measured relative humidity curve proceeds at a higher level than the calculated curve. This means that the air inside the archive box is supplied with moisture, which only can be given off from the box itself and its contents. Approximately one day before the experiment is ended the two curves meet again, which means that a new moisture equilibrium between the exposed surface of the paper and the air inside the box is reached.

The course of the relative humidity measured in the masonry wall (Figure 36) shows a significant positive feedback effect. During the entire process the actual curve is in the opposite phase of the calculated curve. This means that if the temperature goes up then the relative humidity is likewise increased and if the temperature decreases then the relative humidity decreased as well.

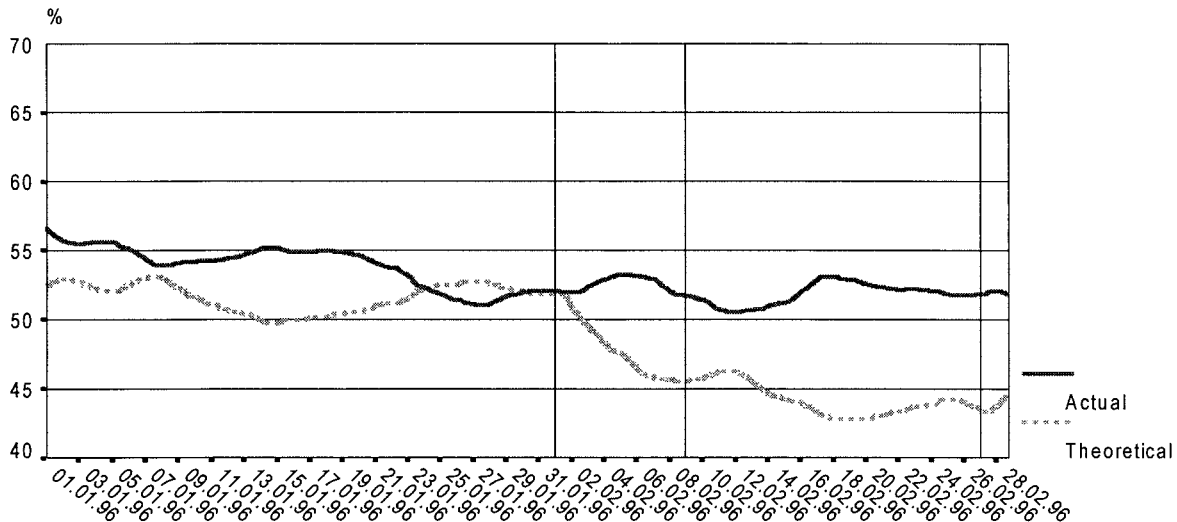

Figure 36 Comparison of the actual measured relative humidity in the masonry wall and the theoretical relative humidity.

Vertical reference lines (from the left): Heating on, temp. setpoint reached, heating off.

In the actual experiment it seems that the positive feedback effect is negligible in proportion to the air change rate even if the actual air change rate is in the order of 0.05 changes per hour and the hygroscopic contents of the storage room is one third of the total volume. The amount of water released due to the positive feedback is so small that it can be transported out of the building by the air change.

The air change rate of the archive box is assumed to be zero and the air volume inside is approximately 10% of the box volume, the rest is paper material. The moisture capacity of the air is extremely low in relation to the moisture capacity of the paper mass. Therefore the relative air humidity inside the box is controlled by the temperature outside the box and the moisture content of the archive material including their average diffusion properties. This situation is even more significant when it comes to a very small air volume completely surrounded by a hygroscopic material - like inside the masonry wall. The positive feedback effect is here significant due to the lack of air change and a really heavy moisture capacity of the masonry in relation to the moisture capacity of the few cm³ of air.

The conclusions of this heating experiment must be that the positive feedback effect from materials with hygroscopic properties on temperature variations is a phenomenon which can be observed. This effect can, however, only be observed if the air change rate is adequately low and if the ratio between the hygroscopic capacity and the humidity capacity of the surrounding air is adequately high.

10.4 The Results Related to the Building Physical Guidelines

As it appears from Figure 23 the indoor temperature is very stable within any short period, but on a yearly basis the temperature is varying in almost the same way as predicted in the Building Physical Guidelines - a slowly varying temperature course. In the guidelines the monthly average indoor temperatures were stated on the basis of a need for heating, but the actual measured temperatures are reached without heating. Instead the heat supply comes from the use of light.

The relative humidity (Figure 25) was slowly increased during the measuring period but it did not vary to the same extent as predicted. This variation was effectively restrained by the immense buffer capacity of the archival material and the building masses.

The two summers of 1994 and 1995 which were marked by some very hot and humid periods have had an influence on the indoor climate which has lead to a higher average temperature and to the increasing relative humidity.

11 The influence of the Operating Conditions on the Passive Climate Controlled Storage Environment

The procedures of operating a passive climate controlled repository are closely related to the type of repository and to the building itself. Therefore, when planning and designing a repository building, it is very important to take the adequate procedures into account.

Some procedures can have a great effect on the storage environment e.g. work places inside the repository, cleaning procedures etc. which supply moisture and heat to the repository in an uncontrolled way. This chapter is an examination of these procedures and frameworks.

11.1 Building and Contents

11.1.1 The Physical Framework

The physical framework must not encourage a behaviour which can be in conflict with the passive climate controlled principle.

An example could be if the office sections in a museum were placed away from the exhibition areas and the staff could take a short cut through the repository. This would cause an increase in the climatic fluctuations and maybe an unwanted admission of moisture and heat, which would be an unnecessary strain on the storage environment.

11.1.2 Work Places

Neither permanent nor temporary workplaces should be found in repositories. If workplaces were put up in a repository, the climate would have to meet the demands for human comfort instead of obliging the preventive conservation of the stored objects and the indoor climate would constantly be influenced by the heat and moisture.

Rooms for research, study, cleaning and rooms for sorting material before it is brought into the repository, should be located outside the storerooms.

This is in agreement with normal standards on storage facility management.

11.1.3 Density of Storage

According to the results of the heating experiment in chapter 9 the hygroscopic contents of a passive climate controlled repository contains a certain amount of moisture which has a great influence on the storage environment. The moisture content of the stored materials could be too small or too large and then the environment could therefore be too dry or too humid.

The contents of a repository can even have a large effect on the stability of the storage environment, especially if the mass is big and if the contents have good hygroscopic properties, the long-term stability can be good. The surface area of the contents exposed to the indoor air can have a great effect on the short-term stability. It is therefore preferable if the material is stored densely, but with air between the objects.

The most densely loaded repositories are found in archives and libraries where the stored materials can occupy up to approximately 40% of the volume. In museum repositories the occupation degree will normally not exceed 10-15% of the volume. As the archive material is so dense stored the exposed surface area, which is very important to the buffering capacity, will be smaller than

the exposed surface area in a museum repository. The exposed surface area is however not necessarily an active surface. The material could have no hygroscopic properties or it could be painted or varnished which reduces the buffering capacity.

Low density storage with a large exposed and active surface, typically a museum repository, has good capabilities in damping short-term fluctuations and a high density storage with a small exposed, but active surface, which is typical for archive repositories has good capabilities in damping long term fluctuations.

11.1.4 Conditioning of Objects

Before putting material into the repository it is important to secure that the material has a suitable moisture content that matches the demanded relative humidity inside. If too dry or too moist material is stored it can, depending on the amount, make the indoor air humidity decrease or increase to an unacceptable level.

Especially when taking a new repository into use and the rooms are filled with objects which have been stored in other places the objects must have a suitable moisture content.

11.2 Technical Installations

11.2.1 Lighting

The heat from light can be a disturbing factor in the heat balance if the heat given off is larger than needed. It is a matter of internal heat production versus the heat loss from the building. If the building is well-insulated, sectioning of light installations and automatic cut-off will be needed in order to keep the temperature within the specified limits.

The installed light effect is typically 8-10 W/m² in a repository. If the insulation and the rest of the building structure is designed for lights being on for two hours a day, the average heat production from lights is equal to a constant heat production of approximately 500 W in a 1,000 m² repository - 5 days a week. If the light is on for eight hours a day, instead of two hours, the constant heat production is approximately 2,000 W. This heat production could cause overheating.

11.2.2 Other Energy Supplies

Energy supplies other than heat production supplied by lighting, must be taken into account when designing a repository. Heat transfer from service and office areas can be of great influence. If the repository lies next to or above a service or office area the walls must be properly insulated.

Technical installation without any purpose in the repository must not be found.

11.2.3 Ventilation and Air-Leakage

In many cases ventilation can be avoided, but if a certain air exchange should be needed, it must be controlled in such a way that it supports the building physics in the climate control instead of taking it over.

A certain natural air exchange is inevitable, but it must be kept as low as possible and at least below 0.1 air changes per hour because it has a destabilizing effect on the indoor climate.

11.3 The Presence of Persons

11.3.1 Cleaning

In order to avoid excessive admission of moisture to the repository the cleaning program must be laid down to comply with the facts that no one brings soil into the storage rooms and that no soiling activities take place. In the light of this only dry cleaning like vacuum cleaning is necessary.

Washing floors and other surfaces should only take place at long intervals e.g. every five or ten years and with as little water as possible. Wet surfaces must be wiped off immediately after washing and active dehumidification could be necessary.

11.3.2 Staff

The motivation and attitude of the staff and their understanding and respect towards the climate control principle is a very important parameter in passive climate control.

Many technical measures can be taken in order to reduce the influence of moisture admission, the internal heat production and the air exchange, but if the staff are not capable of contributing with adequate performance, the consequence might be a more fluctuating indoor climate or an indoor climate drifting away from the acceptable ranges.

12 The ZEPHYR Simulation Model

The general reference used for this chapter is Claesson & Hagentoft, 1994.

12.1 Introduction

During the design process of a passive climate controlled repository it is necessary to calculate how changes in e.g. the construction or the shelving will influence on the indoor temperature and humidity conditions. Parameter studies are an important tool when designing the right building for the purpose and the actual outdoor climate. In order to make parameter studies easier, some kind of computer aided simulation, on the basis of a mathematical model of the physical interactions between the outdoor climate, the building and the contents of the building, is necessary.

12.2 Aim

The aim was to develop an analytical and reliable model for moisture and temperature calculations, that should make it possible to make appropriate estimates of the designed indoor climate in a passive climate controlled repository. In order to confirm the adequacy of the model, the indoor climate conditions in the repositories at the Regional Archive of Schleswig-Holstein (see chapter 8) is simulated by means of a computer program. The appropriate simulation tool was a combination of two PC programs: The spreadsheet program Lotus123 and Mathcad. The simulations is compared to the measured conditions and the model is validated on this background.

By nature, any mathematical computerized model is based on simplifications,

which can cause certain deviations between the actual conditions and the simulated results.

12.3 Mathematical and Physical Basis

The model is a one-dimensional combined steady-state and periodic analogue network model. The model is turned into a transient "room"-model by using sinusoidal functions as input for the description of the yearly course of outdoor temperature and humidity. Complex-valued periodic solutions are very suitable for this kind of calculations.

12.3.1 The Model

The choice of using the analogue network model instead of a numerical model is motivated by the fact that the network easily gives the exact impression of every influential part of the system, consisting of the building structure and its contents.

In the model the actual building is simplified. The simplified building, illustrated in Figure 37, consists of a wall construction of two layers of different materials (e.g. insulation and brickwork). The outer layer is protected against driving rain and radiation from the sun and towards the sky by a weather screen (dashed line). All other boundaries (dashed line) of the room have no energy or moisture exchanges to the outside. The internal parts of the construction (internal walls, roofs and floors) and the contents (stored material) of the rooms are participating elements of the model whose heat and moisture capacities are taken into account. The air change rate (outdoor air) and internal heat production caused by lighting are likewise taken into account.

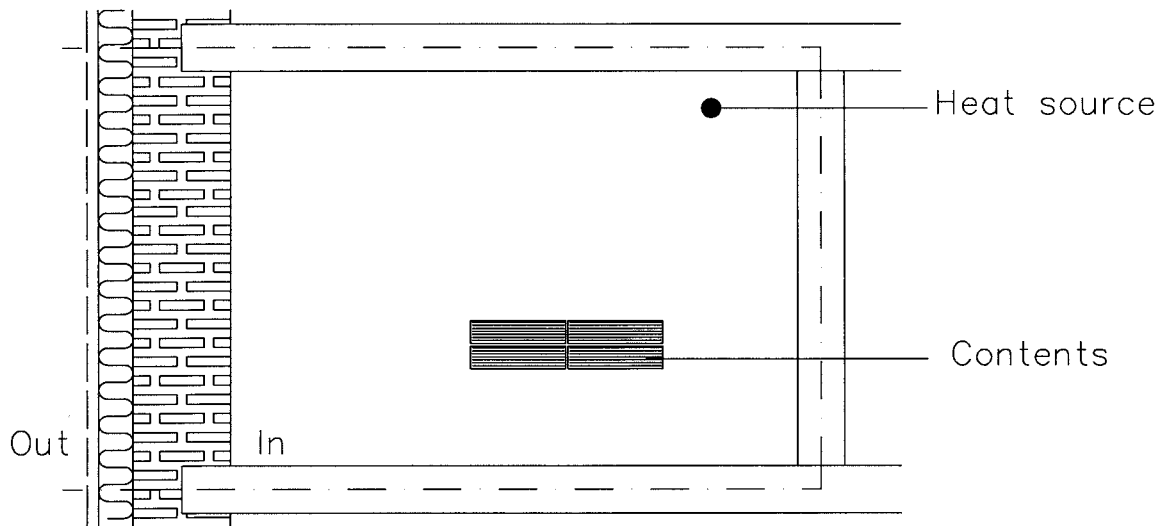

Figure 37 General sketch of the basic building framework used for the simulation model.

The steady-state network model consists of a number of graphical elements representing nodes, resistances, conductances and prescribed boundary values and prescribed flows. A mathematical relation is appointed to every graphical element.

A node represents the unknown value (e.g. temperature or moisture state), which is to be determined or the known value, which then is indicated by specification of the value and called a boundary node. A node is also a graphical representation of a balance equation. In a steady-state case the total flow to a node is zero. A node is graphically represented by a dot (•).

The flow (Q) between two nodes is determined by a conductance or a resistance, named K and R respectively ($R=1/K$) and the temperature or humidity gradient (equation 1 and 2), but with the same graphical element. The graphical element is shown for the thermal case.



$$Q = K(T_1 - T_2) \quad (2)$$

$$Q = \frac{T_1 - T_2}{R} \quad (3)$$

A prescribed flow at a boundary is graphically represented by a circle with an arrow indicating the flow direction.

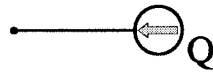

12.4 The Thermal Model

Considering the steady-state outdoor and indoor temperature as pure sinusoidal variations they can be expressed as:

$$T_e(t) = T_{e0} + T_{e1} \cos\left(\frac{2\pi}{t_p} t - \varphi_e\right) \quad (4)$$

$$T_i(t) = T_{i0} + T_{i1} \cos\left(\frac{2\pi}{t_p} t - \varphi_i\right) \quad (5)$$

Here, t_p is the period of time, which can be for example one year ($t_p = t_y$). In this study t_p is always one year.

T_{i0} is the mean indoor temperature of the period t_p . The amplitude of the indoor temperature is T_{i1} , and the phase is φ_i .

The maximum indoor temperature ($T_{i0}+T_{i1}$) is obtained for:

$$t_{\max} = nt_p + \frac{\varphi_i}{2\pi}t_p \quad (n=1,2,3,\dots) \quad (6)$$

and the minimum ($T_{i0}-T_{i1}$) half a period later.

12.4.1 The steady-state component

The steady-state components are equal to the average over the period t_p . The indoor, the outdoor temperature and the steady-state flow can be expressed as:

$$T_{e0} = \frac{1}{t_p} \int_0^{t_p} T_e(t) dt \quad (7)$$

T_e is the outdoor temperature.

$$T_{i0} = \frac{1}{t_p} \int_0^{t_p} T_i(t) dt \quad (8)$$

T_i is the indoor temperature.

$$Q_{i0} = \frac{1}{t_p} \int_0^{t_p} Q_i(t) dt \quad (9)$$

Q_i is the internal heat production, e.g. from lights.

This gives the heat balance equation:

$$K_w(T_{e0}-T_{i0})+K_v(T_{v0}-T_{i0})+Q_{i0} = 0 \quad (10)$$

K_w [W/K] is the total thermal conductance of the wall, here (equation 10) represented by a two-layer construction of insulation (index: ins) and brick-work (index: bw):

$$K_w = \frac{A_w}{\frac{1}{\alpha_e} + \frac{L_{ins}}{\lambda_{ins}} + \frac{L_{bw}}{\lambda_{bw}} + \frac{1}{\alpha_i}} \quad (11)$$

The equivalent thermal conductance associated with the ventilation is:

$$K_v = \rho_{air} c_{air} nV_i \quad (12)$$

$\rho_{air} c_{air}$ [J/m³K] is the heat capacity of the air per unit volume and nV_i [m³/s] the ventilation flow rate.

According to equation 9 the steady-state temperature gives the following thermal conductance network:

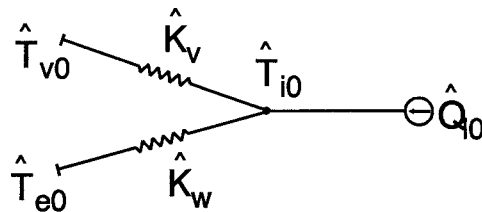

Figure 41 The steady-state thermal conductance network.

The indoor mean temperature calculated on the basis of equation 9 is then:

$$T_{i0} = \frac{T_{e0} K_w + T_{v0} K_v + Q_{10}}{K_w + K_v} \quad (13)$$

12.4.2 Periodic Heat Flow in a Homogenous Slab

Periodic solutions using the very convenient complex-valued notation is dealt with in Claesson & Hagetoft, 1994: Section 4.3. The temperature $T(x,t)$ through a slab is represented by a complex-valued amplitude $\hat{T}(x)$ and a time factor $e^{i\omega t}$:

$$T(x,t) \sim \hat{T}(x)e^{i\omega t} \quad \omega = \frac{2\pi}{t_p} \quad (14)$$

The heat conduction equation for $\hat{T}(x)$ becomes:

$$\frac{d^2\hat{T}}{dx^2} = \frac{i\omega}{a}\hat{T} \quad (15)$$

$a (= \lambda/\rho c \text{ [m}^2/\text{s]})$ is the thermal diffusivity of a slab. The coefficient $i\omega/a$ may be written as:

$$\frac{i\omega}{a} = \frac{2\pi i}{at_p} = \left(\frac{1+i}{d_p}\right)^2 \quad d_p = \sqrt{\frac{at_p}{\pi}} \text{ [m]} \quad (16)$$

d_p is the periodic thermal penetration depth (Figure 42).

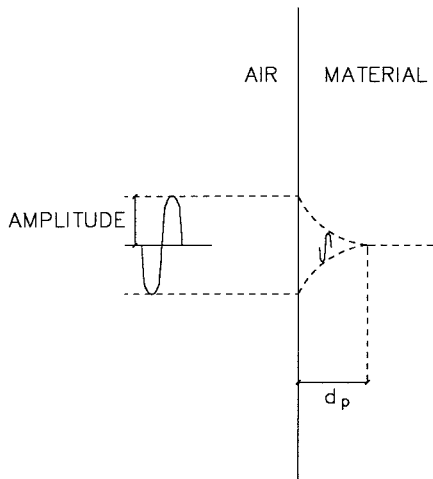

Figure 42 A periodic oscillating temperature will penetrate an exposed material. The amplitude of the oscillation is damped by the material and will decline with the distance from the exposed surface. The penetration depth is the depth where the temperature of the material is no longer influenced by the oscillation. The penetration depth depends on the physical properties of the material and the frequency of the oscillation. Hygroscopic materials exposed to an oscillating humidity show the same effect.

The solutions of equation 14 are of the following type:

$$\hat{T}(x) \sim e^{\frac{\pm(1+i)x}{d_p}} \quad (17)$$

The complex-valued amplitude of the heat flux for a slab with the area A is:

$$\hat{Q}(x) = -A\lambda \frac{d\hat{T}}{dx} \quad (18)$$

A slab ($0 < x < L$) of a homogenous material with the thermal conductivity λ and the thermal diffusivity a . The temperature varies periodically on both sides (mod: Modulus of the complex-valued equation within the square brackets):

$$T(0,t) = T_1 \cos(\omega t - \varphi_1) = \text{mod}[T_1 e^{-i\varphi_1} e^{i\omega t}] \quad (19)$$

$$T(L,t) = T_2 \cos(\omega t - \varphi_2) = \text{mod}[T_2 e^{-i\varphi_2} e^{i\omega t}] \quad (20)$$

The complex-valued temperatures are \hat{T}_1 and \hat{T}_2 :

$$\hat{T}_1 = T_1 e^{-i\varphi_1} \quad \hat{T}_2 = T_2 e^{-i\varphi_2} \quad (21)$$

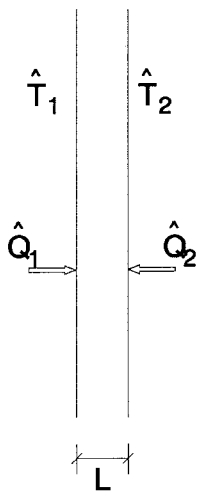

\hat{Q}_1 and \hat{Q}_2 [W] denote the complex-valued amplitudes of the heat flow into the slab. According to Claesson & Hagentoft, 1994 :

$$\hat{Q}_1 = \hat{K}_a \hat{T}_1 + \hat{K}_t (\hat{T}_1 - \hat{T}_2) \quad (22)$$

$$\hat{Q}_2 = \hat{K}_a \hat{T}_2 + \hat{K}_t (\hat{T}_1 - \hat{T}_2) \quad (23)$$

Where:

$$\hat{K}_a = \frac{A\lambda(1+i)}{d_p} \tanh\left(\frac{(1+i)L}{2d_p}\right) \quad (24)$$

$$\hat{K}_t = \frac{A\lambda(1+i)}{d_p} \frac{1}{\sinh\left(\frac{(1+i)L}{d_p}\right)} \quad (25)$$

The ordinary calculation methods for complex-valued hyperbolic functions are used.

The relations can be represented by a complex-valued thermal conductance network for the periodic response of the slab. Index "a" indicates that the conductance refers to the thermal capacity. Index "t" refers to the thermal resistance.

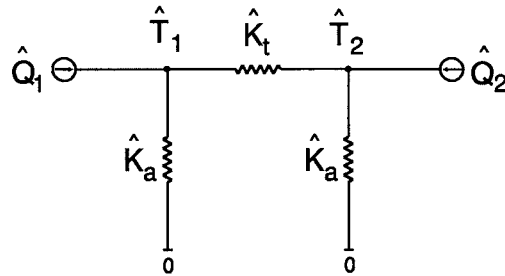

Figure 44 The complex-valued thermal conductance network for a homogenous slab.

For a slab exposed to the same temperature on both sides the heat flow can be expressed as:

$$\hat{Q}_1 = \hat{K}_a \hat{T}_1 \quad (26)$$

The limit, when the penetration depth d_p is much larger than the slab thickness L , is of interest in the present applications. The following approximations can be made:

$$\sinh\left(\frac{(1+i)L}{d_p}\right) \approx \frac{(1+i)L}{d_p}, \quad \tanh\left(\frac{(1+i)L}{2d_p}\right) \approx \frac{(1+i)L}{2d_p} \quad (27)$$

Equations (24) and (25) then become:

$$\hat{K}_a \approx \frac{A\lambda(1+i)}{d_p} \frac{(1+i)L}{2d_p} = \frac{AL}{2} \rho c \omega i \quad (28)$$

$$\hat{K}_t \approx \frac{A\lambda(1+i)}{d_p} \frac{1}{\frac{(1+i)L}{d_p}} = \frac{A\lambda}{L} \quad (29)$$

The conductance \hat{K}_t becomes equal to the (steady-state) thermal conductance. When the temperature is the same on both sides of the slab ($\hat{T}_1 = \hat{T}_2$):

$$2\hat{Q}_1 = 2\hat{K}_1\hat{T}_1 \approx AL\rho c\omega i \quad (30)$$

The heat flow is then given by the capacity of the slab multiplied by ωi ($= 2\pi i/t_p$).

12.4.3 The Periodic Thermal Process

The next issue to consider is the periodic component of the thermal process. The outdoor and indoor temperatures vary periodically:

$$T_e(t) = T_{e1} \cos(\omega t - \varphi_e) \quad (31)$$

$$T_i(t) = T_{i1} \cos(\omega t - \varphi_i) \quad (32)$$

This component is to be added to the steady-state one. A periodic component of the heat contribution from light Q_1 is left out, but it can easily be included, if necessary.

The thermal process of the periodic component involves the heat flow through the outside wall, the ventilation, and the inside capacities of the stored material (paper), the inner walls of brickwork, the concrete roof and floor, and the heat capacity of the inside air. Index "a" indicates that the conductance refers to the thermal capacities.

The complete thermal conductance network of the periodic variations becomes:

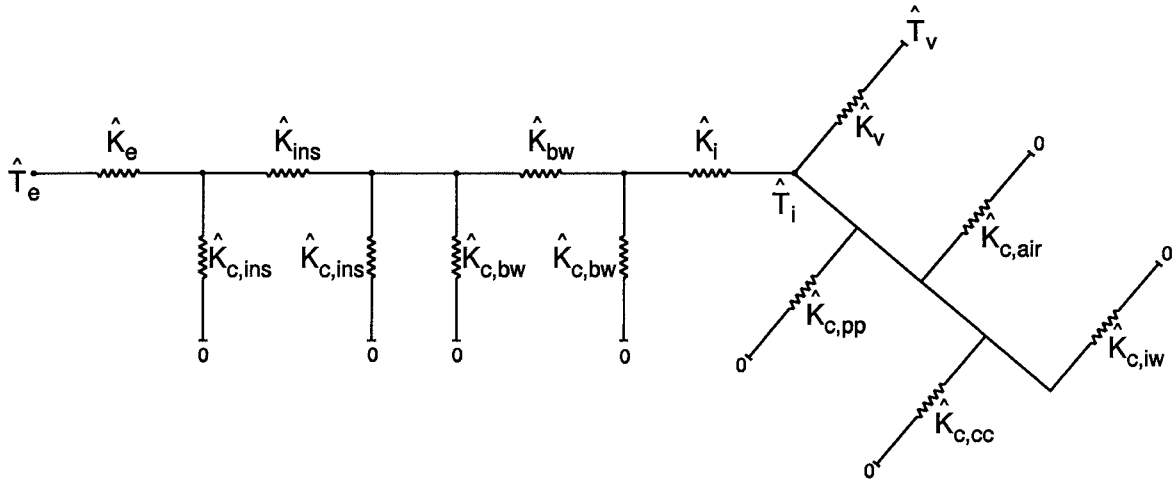

Figure 45 The periodic thermal conductance network.

The complete network (Figure 45) can be reduced to a weighted factor \hat{F}_w on the outdoor temperature (\hat{T}_e) and a reduced network (Figure 46). For more detailed information about the reductions see appendix 3.

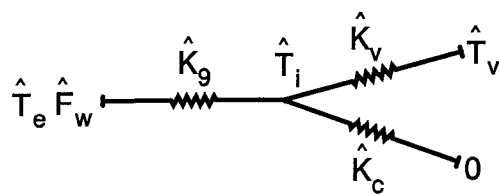

Figure 46 Reduced periodic thermal conductance network.

Where:

$$\hat{F}_w = \frac{\hat{K}_e}{\hat{K}_e + \hat{K}_{c,ins}} \frac{\hat{K}_7}{\hat{K}_7 + \hat{K}_{c,ins} + \hat{K}_{c,bw}} \frac{\hat{K}_8}{\hat{K}_8 + \hat{K}_{c,bw}} \quad (33)$$

Some new conductances are created during the reduction procedure. Equation (34) to (36) are defining these new conductances.

$$\hat{K}_7 = \frac{(\hat{K}_e + \hat{K}_{c,ins}) \hat{K}_{ins}}{\hat{K}_e + \hat{K}_{c,ins} + \hat{K}_{ins}} \quad (34)$$

$$\hat{K}_8 = \frac{(\hat{K}_7 + \hat{K}_{c,ins} + \hat{K}_{c,bw}) \hat{K}_{bw}}{\hat{K}_7 + \hat{K}_{c,ins} + \hat{K}_{c,bw} + \hat{K}_{bw}} \quad (35)$$

$$\hat{K}_9 = \frac{(\hat{K}_8 + \hat{K}_{c,bw}) \hat{K}_i}{\hat{K}_8 + \hat{K}_{c,bw} + \hat{K}_i} \quad (36)$$

and the resulting conductance of the heat capacity of the contents of the building, the internal walls, the floors and the indoor air is:

$$\hat{K}_c = \hat{K}_{c,pp} + \hat{K}_{c,iw} + \hat{K}_{c,cc} + \hat{K}_{c,air} \quad (37)$$

The different conductances related to the constructions and the indoor air are:

$$\hat{K}_{c,pp} = i \frac{2\pi}{t_p} V_{pp} \rho_{pp} c_{pp} \quad (38)$$

$$\hat{K}_{c,iw} = i \frac{2\pi}{t_p} V_{iw} \rho_{bw} c_{bw} \quad (39)$$

$$\hat{K}_{c,cc} = i \frac{2\pi}{t_p} A_{hd} \frac{L_{cc}}{2} \rho_{cc} c_{cc} \quad (40)$$

$$\hat{K}_{c,air} = i \frac{2\pi}{t_p} V_{air} \rho_{air} c_{air} \quad (41)$$

The periodically varying indoor temperature can then be calculated by:

$$\hat{T}_i = \frac{\hat{T}_e \hat{F}_w \hat{K}_g + \hat{T}_v \hat{K}_v}{\hat{K}_g + \hat{K}_v + \hat{K}_c} \quad (42)$$

12.5 The Humidity Model

No moisture production takes place inside the simplified building.

It is most convenient to use the absolute humidity in the humidity model as the yearly average outdoor absolute humidity is the same as the yearly average indoor absolute humidity. This means that the steady-state moisture component inside the building is the same as the one outside.

According to Figure 37 the total moisture balance becomes:

$$[v_e(t) - v_i(t)]V_{air} \cdot n = V_{air} \frac{dv_i}{dt} + G_{w,pp} + G_{w,ow} + G_{w,cc} + G_{w,iw} \quad (43)$$

G_w is the total moisture flow rate of the concerned material.

A steady-state component and a pure sinusoidal variation of the absolute humidity gives the following equations for the outdoor humidity (equation (44)) and for the indoor humidity (equation (45)):

$$v_e(t) = v_{e0} + v_{e1} \cos\left(\frac{2\pi t}{t_p} - \phi_e^v\right) \quad (44)$$

$$v_i(t) = v_{i0} + v_{i1} \cos\left(\frac{2\pi t}{t_p} - \phi_i^v\right) \quad (45)$$

Assuming the moisture diffusion is a one-dimensional process, the diffusion equation becomes:

$$\frac{\partial}{\partial t}[w(\phi)] = \frac{\partial}{\partial x}(D_v \frac{\partial v}{\partial x}) \quad \phi = \frac{v}{v_s(T)} \Rightarrow \frac{\partial}{\partial t}[w(\phi)] = \frac{\partial w}{\partial \phi} \frac{1}{v_s(T)} \frac{\partial v}{\partial t} \quad (46)$$

which gives:

$$\frac{1}{D_w} \frac{\partial v}{\partial t} = \frac{\partial^2 v}{\partial x^2} \Rightarrow D_w = \frac{D_v v_s(T)}{\frac{\partial w}{\partial \phi}} \quad (47)$$

The equations governing the temperature and moisture processes are similarly governed as they have the following corresponding quantities:

$$v \sim T \quad D_v \sim \lambda \quad D_w \sim a$$

The absolute humidity matches the temperature, the moisture diffusion coefficient matches the heat conductivity and the moisture diffusivity matches the thermal diffusivity [Claesson and Hagentoft, 1994].

12.5.1 The Steady-State Component

The outdoor and indoor steady-state components are the integral of the absolute humidity over the period t_p :

$$v_{e0} = \frac{1}{t_p} \int_0^{t_p} v_e(t) dt \quad (48)$$

$$v_{i0} = \frac{1}{t_p} \int_0^{t_p} v_i(t) dt \quad (49)$$

Assuming that the process is a perfectly periodic process and that the mean values of the outdoor and indoor moisture contents are the same ($v_{e0} = v_{i0}$), the periodic variations are:

$$v_e(t) = v_{e1} \cos(\omega t - \phi_e^v) \quad (50)$$

$$v_i(t) = v_{i1} \cos(\omega t - \phi_i^v) \quad (51)$$

This component is to be added to the steady-state component. In complex-valued form:

$$v_o(t) \sim \hat{v}_o e^{i\omega t} \quad \hat{v}_o = v_{o1} e^{-i\phi_{o1}^v} \quad (52)$$

$$v_i(t) \sim \hat{v}_i e^{i\omega t} \quad \hat{v}_i = v_{i1} e^{-i\phi_{i1}^v} \quad (53)$$

In a slab of a homogenous solid material, we have:

$$v(xt) \sim \hat{v}(x) \cdot e^{i\omega t} \quad (54)$$

The moisture diffusion equation for \hat{v} becomes:

$$\frac{d^2 \hat{v}}{dx^2} = \left(\frac{1+i}{d_{pw}}\right)^2 \cdot \hat{v}(x) \quad (55)$$

where d_{pw} is the penetration depth of the periodic moisture variation:

$$d_{pw} = \sqrt{\frac{D_w t_p}{\pi}} \quad (56)$$

The diffusivity (D_w) and $dw/d\phi$ are approximately constant in the actual humidity range.

The temperatures of the indoor solid materials are essentially equal to the temperature of the indoor air $T_i(t)$.

This means that $v_s(T) = v_s(T_i)$ and that the moisture diffusivity D_w varies somewhat:

$$D_{w0} = \frac{D_v v_s(T_{i0})}{\frac{d\omega}{d\phi}} \quad (57)$$

The average value $v_s(T_i) = v_s(T_{i0})$ is used.

The moisture flow conductance network for the periodic variation is analogous to the thermal process, except for the exterior and interior heat transfer coefficients. The network becomes:

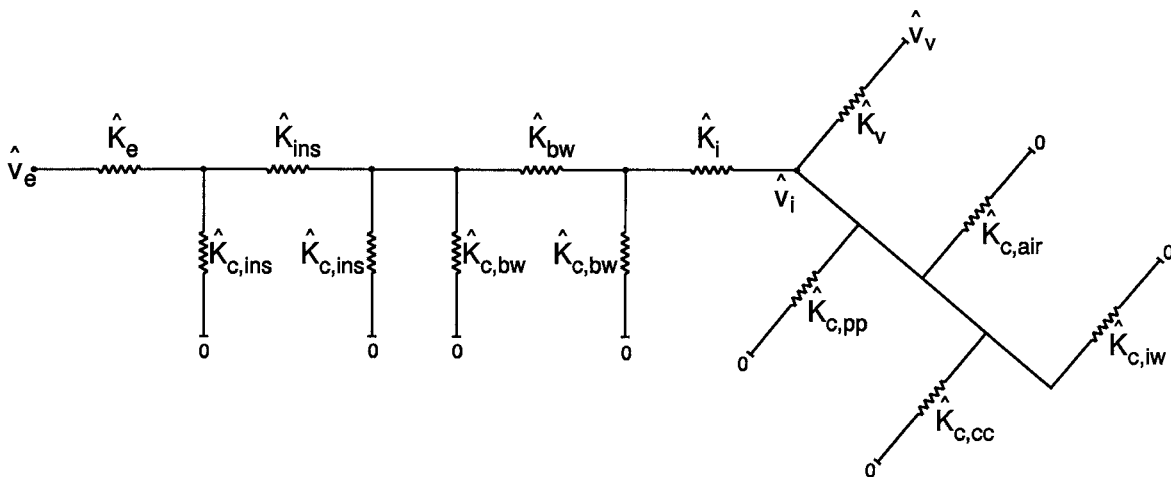

Figure 47 The periodic moisture conductance network.

The index c indicates that the conductance refers to the moisture capacity of the material.

The moisture flow conductances (surface resistance) of all solid surfaces are neglected. The conductances of the insulation in the outer wall are:

$$\hat{K}_{c,ins} = \frac{A_w D_{v,ins} (1+i)}{d_{pw,ins}} \tanh\left(\frac{(1+i)L_{ins}}{d_{pw,ins}}\right) \quad (58)$$

$$\hat{K}_{ins} = \frac{A_w D_{v,ins} (1+i)}{d_{pw,ins}} \cdot \frac{1}{\sinh\left(\frac{(1+i)L_{ins}}{d_{pw,ins}}\right)} \quad (59)$$

The conductances of the brick wall section of the outer wall are:

$$\hat{K}_{c,bw} = \frac{A_w D_v (1+i)}{d_{p,bw}} \tanh\left[\frac{(1+i)L_{bw}}{d_{p,bw}}\right] \quad (60)$$

$$\hat{K}_{bw} = \frac{A_w D_v (1+i)}{d_{p,bw}} \frac{1}{\sinh\left[\frac{(1+i)L_{bw}}{d_{p,bw}}\right]} \quad (61)$$

The conductance for the ventilation is equal to nV_{air} .

$$K_v^m = nV_{air} \quad (62)$$

If the paper in the archive is regarded as a one-dimensional slab with a one-dimensional moisture flow only, with a thickness L_{pp} and an exposed surface area A_{pp} , the conductance of the paper mass is:

$$\hat{K}_{pp} = \frac{A_{pp} D_{v,pp} (1+i)}{d_{pw,pp}} \tanh\left(\frac{(1+i)L_{pp}}{2d_{pw,pp}}\right) \quad (63)$$

It should be noted that the surface area A_{pp} and the thickness L_{pp} must to be regarded as "effective" values. The moisture flow is imagined to be zero at the midpoint (centre) $x = L_{pp}/2$ of the paper slab.

The concrete floor and roof and the inner brick walls have the indoor value \hat{v}_i on both sides and so the conductances become:

$$\hat{K}_{cc} = \frac{A_{cc}D_{v,cc}(1+i)}{d_{pw,cc}} \tanh\left(\frac{(1+i)L_{cc}}{2d_{pw,cc}}\right) \quad (64)$$

$$\hat{K}_{bw,i} = \frac{A_{bw,i}D_{v,bw}(1+i)}{d_{pw,bw}} \tanh\left(\frac{(1+i)L_{bw,i}}{2d_{pw,bw}}\right) \quad (65)$$

The conductance \hat{K}_{air} gives the moisture capacity of the air volume of the archive:

$$\hat{K}_{air} = \frac{i2\pi}{t_p} V_{air} \quad (66)$$

The periodic moisture conduction network (Figure 47) can be reduced. In the reduced network (Figure 48) conductances for the insulation, the brick wall, the capacity of the brick wall, the ventilation, and the capacities of the building and the contents are taken into account.

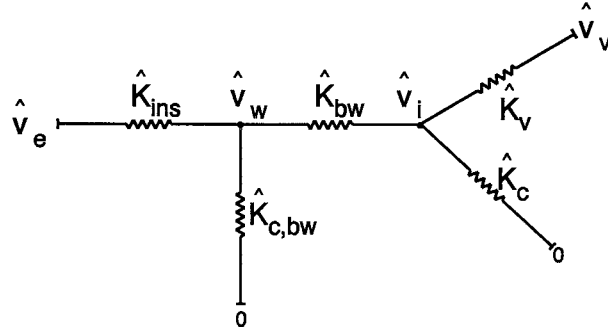

Figure 48 Reduced periodic moisture conductance network.

\hat{K}_c is the total moisture capacity of the internal part of the building including the contents.

Equation (58) and (59) can furthermore be reduced to a non-periodic solution as the penetration depth for the periodic moisture variation is very much larger than the thickness of the insulation and because the insulation has an insignificant moisture capacity.

$$\hat{K}_{ins} = \frac{A_w D_v}{L_{ins}} \quad (67)$$

According to Figure 48, the following two balance equations for \hat{v}_i and \hat{v}_w can be expressed:

$$\hat{K}_v(\hat{v}_v - \hat{v}_i) + \hat{K}_c(0 - \hat{v}_i) + \hat{K}_{bw}(\hat{v}_w - \hat{v}_i) = 0 \quad (69)$$

$$\hat{K}_{ins}(\hat{v}_e - \hat{v}_w) + \hat{K}_{c,bw}(0 - \hat{v}_w) + \hat{K}_{bw}(\hat{v}_i - \hat{v}_w) = 0 \quad (70)$$

The solution to these balance equations regarding \hat{v}_i is:

$$\hat{v}_i = \hat{v}_e \left[\frac{\hat{K}_v(\hat{K}_{bw} + K_{ins} + \hat{K}_{c,bw}) + \hat{K}_{bw}K_{ins}}{(\hat{K}_{bw} + \hat{K}_c + \hat{K}_v)(\hat{K}_{bw} + K_{ins} + \hat{K}_{c,bw}) - \hat{K}_{bw}} \right] \quad (71)$$

12.6 The Calculation Example

This calculation example is based on data from a storeroom (groundfloor level) in the repository building at the Regional Archive of Schleswig-Holstein.

The input data are the measured temperature (mean: 10.3°C, ampl.: 9.1°C) and absolute humidity (mean: 7.8 g/m³, ampl.: 4.0 g/m³) values from the air gap in the outer wall. These values are chosen as external values because of the simplified computer model which does not take the weather screen of the outer wall into account. The temperature and absolute humidity values of the ventilation air are chosen to be the actual measured [DWD, 1996] outdoor values (mean: 10.5°C, ampl.: 10.9°C) (mean: 7.8 g/m³, ampl.: 4.0 g/m³). The air change rate is 0.05 changes per hour.

12.6.1 The Thermal Conditions

The steady-state component of the model gives a mean indoor temperature of 17.0°C against which the measured indoor temperature is 18.7°C.

The average heat loss through the well-insulated outer wall is very limited and the constant heat production of 225 W from lights would cause a larger rise in the mean indoor temperature than the 8.4°C, if it wasn't for the ventilation. It is assumed that the daily average time with lights on is 1 hour per working day.

The periodically varying component of the model gives an indoor temperature amplitude of 2.6°C and a phase displacement which lags 78 days after the outdoor temperature.

All capacities in the building have no, or only a very limited, influence on the temperature phase. What displaces the phase is the resistances of the insulation and the ventilation. The real temperature amplitude dampers are the thermal capacities of the building and the contents.

The actual values of the mean temperature, the temperature amplitude and the temperature phase displacement are compared to the calculated values, and the deviations are determined (Table 5).

Temperature	Measured	Calculated	Deviation
Mean [°C]	18.7	17.0	-1.7
Amplitude [°C]	2.3	2.6	+0.3
Phase delay [days]	45	78	+33

Table 5 The measured and calculated values of mean temperature, amplitude and phase displacement inside the repository.

Figure 49 is a graphical presentation of Table 5 and it shows the sinusoidal functions which represent the outdoor temperature (large amplitude) and the measured (upper curve) and the calculated temperatures.

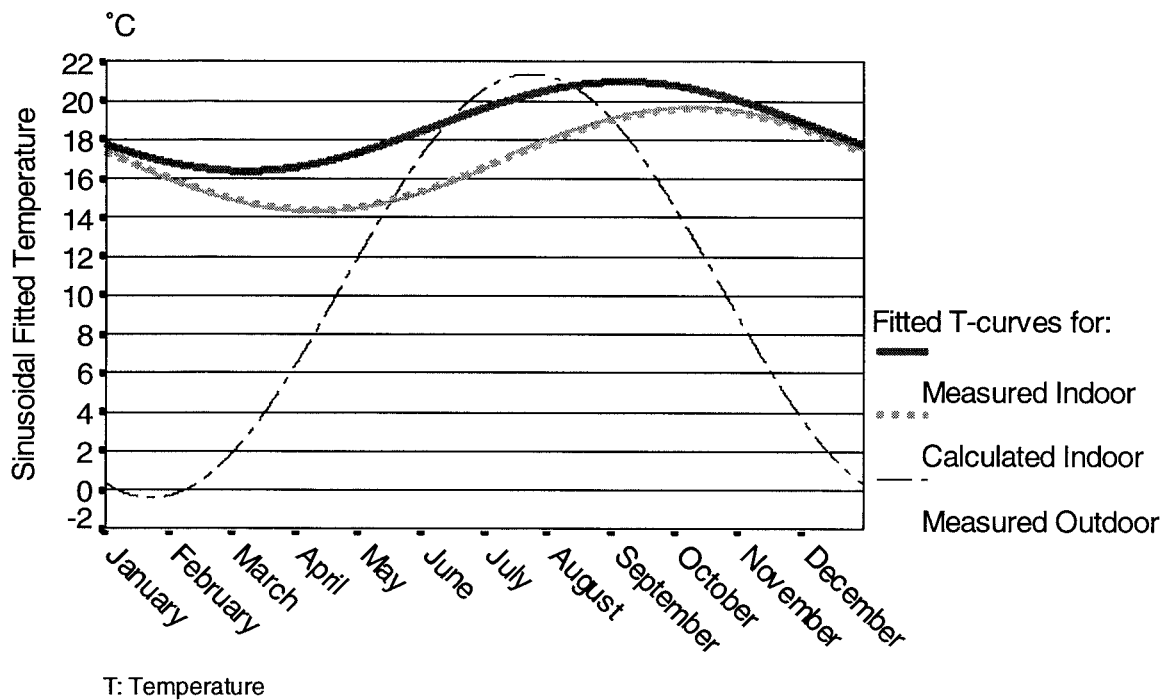

Figure 49 The calculated and the measured indoor temperature and the measured outdoor temperature (sinusoidal functions).

12.6.2 The Humidity Conditions

Table 6 shows the coefficients of the measured and calculated sinusoidal functions of the absolute humidity conditions inside the repository.

Abs. humidity	Measured	Calculated	Deviation
Mean [g/m ³]	9.2	7.8	-1.4
Amplitude [g/m ³]	1.8	1.2	-0.6
Phase delay [days]	45	44	-1

Table 6 The measured and calculated values of the mean absolute humidity, amplitude and phase displacement inside the repository.

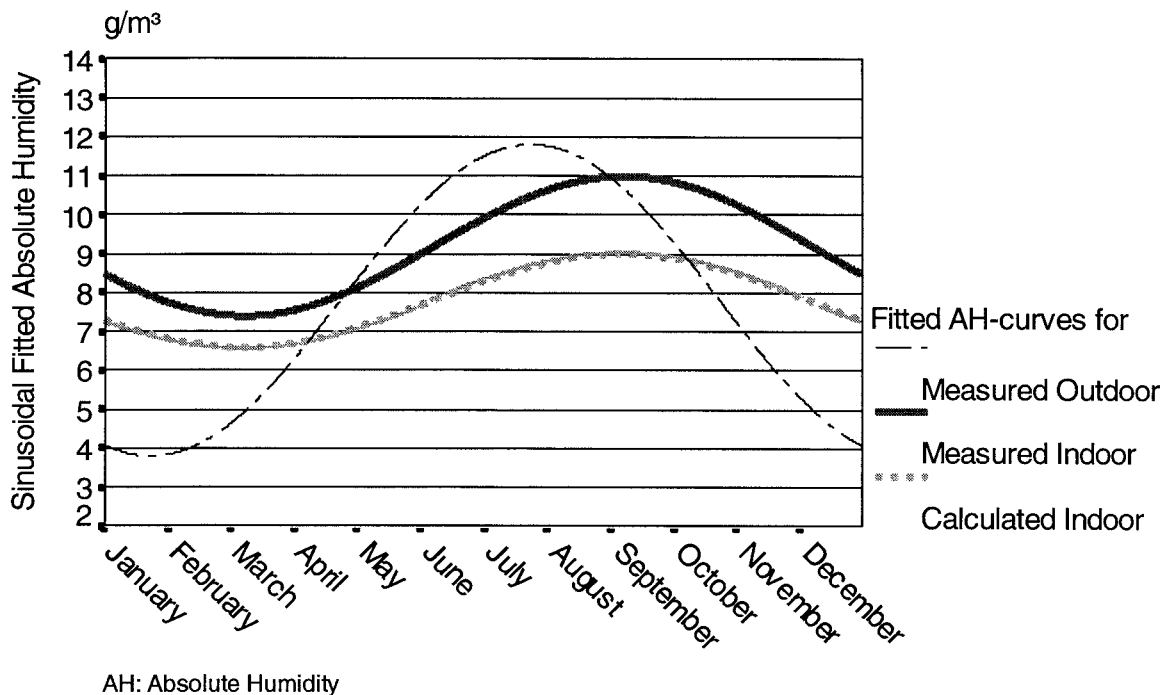

Figure 50 The calculated indoor and the measured outdoor absolute moisture content (sinusoidal functions).

Figure 50 is a graphical presentation of Table 6 and it shows the sinusoidal functions which represent the outdoor absolute humidity and the measured and the calculated absolute humidities.

12.6.3 Comparison of Calculated and Measured Data

In the calculation example the calculations made by the model are compared to the measured data recorded at the Regional Archive of Schleswig-Holstein. The result of the comparison of the thermal conditions shows a large deviation in the phase delay, while the amplitudes match quite well. The calculated indoor mean temperature is a little lower than the measured, which can be explained by heat supply from persons and from the service area, which are not taken into account in the calculation program. The deviations can also be a result of a varying air change rate.

The comparison of the measured and calculated humidities is marked by a good agreement in phase delays and a relatively good agreement in amplitudes. The measured mean absolute moisture content of the indoor air contains 1.4 grams of water per m³ more than the mean absolute moisture content of the outdoor air, which was predicted also to be the mean indoor value. The reasons can be that moisture is brought in by humid documents, or by moisture production from persons, or moisture supply from the service area, or even residual building moisture.

There are furthermore good reasons to suppose that the deviations are connected to the uncertain estimates of among other things: air change rates, the exposed surface area of the objects and the physical properties of the materials.

12.7 Advantages of the Model

The primary advantage of the model is its analytical possibilities. The indoor climate in a room with passive climate control is formed by the building itself together with a number of influences. By using network sketches and by indicating the value of every conductance in the network, a general view can be formed of the truly influential parts of the building components and the truly influential effects on the building. The model can easily and simply be modified in order to observe the effects of new parameters. This allows parameter studies to improve the building design and the operational conditions, in order to reach or get as close as possible to the ideal indoor temperature and humidity conditions.

The analytical quality of the model can even be helpful in indicating the consequences of special actions.

The following example illustrates the analytical qualities of the model. The example is based on the network used for humidity calculations based on the Schleswig archive as described in Chapter 12.6.2. Figure 51 shows the network with the modulus values of all conductances in the network. A complex valued figure ($r \cdot e^{i\theta}$) is given by a modulus (r) and an amplitude (θ). i is the complex-valued imaginary unit. Modulus gives the magnitude of the complex-valued figure (in this case the conductances) and it therefore indicates the influence of the actual conductance in the network.

As it will appear from Figure 51 the moisture capacity of the paper is of particular importance to the indoor climate. The humidity capacity of the horizontal divisions (concrete) also has a relatively high influence on the stability of the indoor climate.

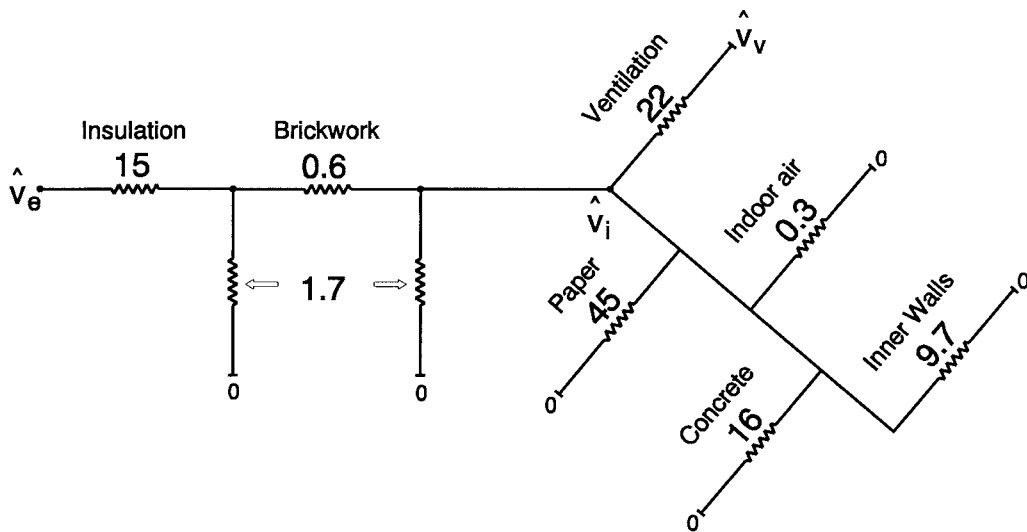

Figure 51 The humidity calculation network for the Schleswig archive. The modulus of the complex valued conductances, which relate to the actual conditions in the archive are stated.

A ventilation rate (air leakage) of 0.05 air changes per hour is a very low ventilation rate, but in spite of that it has, according to the modulus value, a relatively large impact on the indoor humidity conditions. How this impact will change when the ventilation rate is changed is very interesting. The network in Figure 52 represents the very same conditions as Figure 51, except for the fact that the air change rate is changed to 0.5 air changes per hour. The modulus value of the ventilation conductance is increased and now forms by far the most influential element on the indoor humidity conditions. The air change rate is increased ten times and so is the conductance value.

As no other parameters than the air change rate are changed, none of the other conductances will change. The result is that the air leakage, which is a disturbing element on the indoor climate, has become relatively more influential than the buffer capacities (the stabilizing elements) of the paper, the concrete floors and the inner walls.

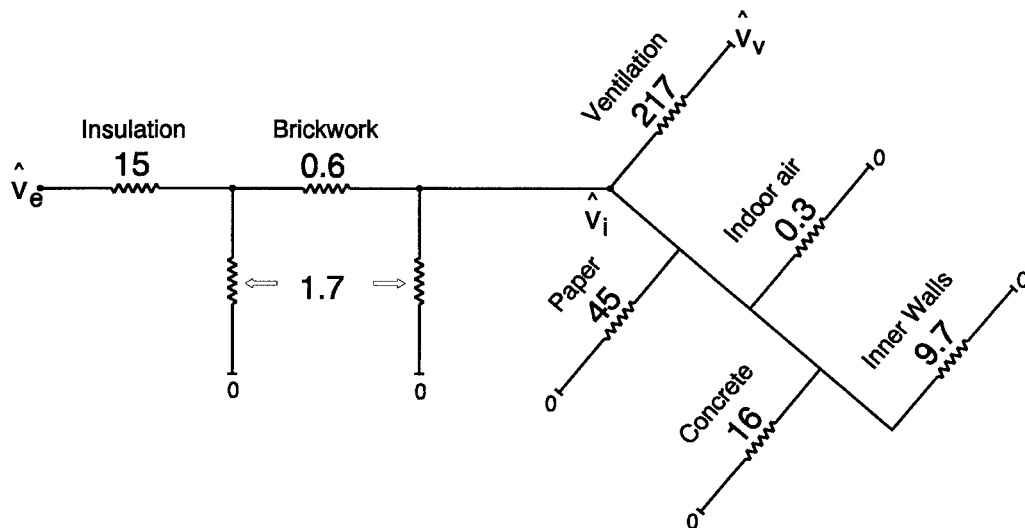

Figure 52 The humidity calculation network for the Schleswig archive. The value of the ventilation conductance is increased and now forms the most influential element on the indoor humidity conditions.

The example in Figure 52 illustrates the importance of having an air change rate caused by air leakage which should be kept to a minimum when the stability of the indoor climate is essential.

Another advantage of this model is the simple way of stating the outdoor climate. By means of the monthly average values of temperature and absolute humidity, simple sinusoidal functions can be used for the further calculations. The result of the calculations are given in some new sinusoidal functions describing the indoor climate. This model is therefore particularly interesting when it comes to describing how the indoor temperature and humidity will proceed over a period of one year and not so interesting when it comes to describing the actual indoor temperature on a particular day.

12.8 Parameter Study

By the use of the calculation program the influence of some parameters are studied. Table 7 shows the results of this parameter study. The first line gives the calculated values of the actual situation in the Schleswig archive.

PARAMETER STUDY Changed element	Temperature			Humidity		
	Mean	Ampl.	Delay	Mean	Ampl.	Delay
	[°C]	[°C]	[Days]	[g/m³]	[g/m³]	[Days]
<i>Actual Situation</i>	17.0	2.6	78	7.8	1.2	44
Air Change Rate: 0.1 h-1	14.6	3.5	72	7.8	1.7	37
Air Change Rate: 0.5 h-1	11.3	8.7	37	7.8	3.3	13
Empty Storeroom	17.0	3.6	72	7.8	1.9	28
Lighting +10%	17.7	2.6	78	7.8	1.2	44
Lighting +25%	18.7	2.6	78	7.8	1.2	44

Table 7 The results, given as mean values, amplitudes and phase delays, of parameter studies on the Schleswig archive done by the calculation program.

The second and third lines show the consequences of higher air change rates. Primarily the amplitudes increase with increasing rates and the delay in the variations in the indoor and outdoor air get shorter. The mean indoor temperature decreases and gets closer to the mean outdoor temperature with an increasing rate.

If the storeroom were empty it would mean that the indoor conditions are not damp as much as if the room is filled. The mean values are therefore unchanged, but the amplitudes are larger and the phase delays are shorten.

If the use of light is increased it means that the mean indoor temperature is increased but there is no change in the amplitude or variation delay as well as the absolute humidity is unchanged.

The temperature model and the humidity model are not integrated at the actual stage. It is therefore impossible to determine what changes in parameters mean to the indoor relative humidity. Even small changes in temperature and absolute humidity can cause large and unwanted variations in the relative humidity.

13 Summarizing Results

Demands on the indoor climate in museum, archive and library repositories are in general based on varying scientific qualities and are often determined by intuition and tradition and are not dealing with one of the matters causing deterioration - the fluctuating temperature and relative humidity.

In fairness it must be said that in recent years a lot of scientific investigations have been done on the deterioration processes of different kinds and combinations of materials. The results of these investigations are closely related to laboratories and therefore it will still take several years before these results are widely accepted and can be adapted to standards, guidelines or recommendations.

The actual indoor climate occurring in many repositories is often not in agreement with the original demands. This is a fact that occurs in both mechanical and passive climate controlled repositories. The reasons are often related to insufficient operating and maintenance programs for the mechanical installations or building structures, which are based on the wrong building techniques or badly maintained.

The Regional Archive of Schleswig-Holstein (Germany) is an example of a passive climate controlled storage environment. Measurements done in the repositories indicates that the indoor climate shows a slow yearly variation in temperature and relative humidity. The yearly temperature cycle goes from 14.5 to 20.5°C and the relative humidity cycle from 56 to 62 %. Especially the relative humidity is much more stable than predicted during planning and design phases. The deviation between reality and predictions depends on the restricted possibilities that were used in simulating the indoor climate conditions at that time.

In order to improve these possibilities an analogue simulation model has been developed. The model explains the thermal and moisture interactions between the building structure, the indoor air and the stored material, when the building is exposed to an actual outdoor climate. The model is based on an electric analog network model where the model building is affected by sinusoidal variations representing the outdoor air temperature and moisture content. Three parameters describe temperature respectively humidity: The mean value, the amplitude and the phase describes the yearly average values and the variations away from the average values and at what time of year the maximum and minimum values occur. The result of using this model for simulations is the indoor climate represented by another three values of mean value, amplitude and phase. The model is compared towards the measurements carried out at The Regional Archive of Schleswig-Holstein. It shows relatively good agreement. The main advantage of the model is the analytical qualities which make it possible to determine the truly influential parts of the building components and the truly influential effects on the building.

14 The ZEPHYR Repository Concept

The aim of this chapter is to concretize and apply the theory in passive climate control of repositories for The ZEPHYR Repository Concept.

14.1 The ZEPHYR Concept

The concept must, in order to comply with the principles of preventive conservation, embrace the building structure and the facility management as well as the storage management. This means the handling and storing of objects must be taken into account when planning and designing a repository built for passive climate control.

Some circumstances e.g. extreme outdoor climate or building regulations or internal pollutant production can necessitate some kind of mechanical installations. According to the ZEPHYR concept these installations must work and support the physical properties of the building and the stored material.

The following presentation of the concept is a general description based on repository buildings for the temperate climate zone, but the principle can be adapted to other climatic zones eventually by the use of some kind of mechanical installations.

14.2 Building Structure

If building materials chosen for the outer walls have the appropriate material physical properties and the thickness of the walls is determined due to this, variations in outdoor humidity do not affect the indoor climate through the

outer walls. But the inevitable natural air change caused by leaks combined with temperature gradients and/or pressure gradients and opening/closing doors brings the outdoor variations to affect the stability of the indoor climate.

Therefore, the building must be built as airtight as possible. This can be achieved by having no windows and having air locks at all entrances to every storeroom.

It must, on the other hand, be secured that no pollutants is accumulated in the repository. It can therefore be necessary to ventilate the repository and if so, it should be done by a controlled ventilation plant.

14.2.1 Outer Walls

The outer walls must be divided into two sections. The outermost section must act as the first climate shield protecting the inner part against driving rain and solar radiation. The most important physical property of the climate shield will be a large heat capacity or a low thermal conductivity. The climate shield is able to moderate temperature variations in the air gap based on at least one of these properties combined with the ventilation of the air gap. Between the sections an air gap shall prevent moisture transport from the climate shield to the inner part by capillary suction or proper water flow. The air gap must be effectively ventilated with outdoor air in order to keep a low humidity level in the wall.

The inner part has two quite complex functions. It must act as a damper on the varying climate in the air gap and it must make up a resistance against heat conduction and vapour diffusion. The thermal resistance can be obtained by a layer of insulating material and the diffusion resistance can be obtained by the construction material itself. Vapour barriers must be avoided as such barriers would cause troubles when drying up building moisture at the end of the construction period. All building materials must have a good Humidity Buffering Capacity Factor (HBC-factor).

14.2.2 Roof

The roof must be a "cold roof" construction which means that the roof, like the outer wall is separated into the two sections, the climate shield and the climate dampening inner part. The attic must be well-ventilated so the incoming solar radiation on the outer climate shield does not cause extremely high temperatures in the attic.

The inner part of the roof construction must be well-insulated and be able to effectively dampen even the yearly variations in humidity in the outdoor air entering the attic. The building materials must have a good Humidity Buffering Capacity Factor (HOC-factor).

14.2.3 Inner Walls, Ceilings and Floors

The inner walls, ceilings and floors should, as parts of the inside of the repository, act like a buffer of heat and humidity and through that be one of the passive measures in damping down the indoor changes in relative humidity and temperature, so all building materials must have a good Humidity Buffering Capacity Factor (HOC-factor). This means that these interior construction elements should be made of building materials which have the appropriate moisture and heat transport and capacity qualities. These qualities depends on the preconditions for the actual repository building, for instance the environmental demands, the local climate, the way using of the building and must be determined through calculations and parameter studies.

14.2.4 Building Moisture

Building moisture from the construction processes of the repository must be taken really seriously. It must be ensured that the building is fully dried up to a certain moisture content where the building is in a humidity equilibrium with a relative air humidity within the required range.

If there is any remaining building moisture it will have the effect that when the repository is left to passive climate control, the relative humidity of the indoor air would be too high.

14.2.5 Service Areas

The strictest demand of the ZEPHYR Repository Concept is that no working places, neither permanent nor temporary, must be situated inside the storerooms. Therefore the service areas of the storage facility must have rooms for handling, sorting and examination of objects located outside but vicinity of the storerooms.

This means that even the logistics of the building must be well-planned in order to ensure the optimum storage environment.

14.3 Management

Facility management which includes plans for operating and maintaining the building, cleaning procedures etc. and storage management which includes material specific or chronological storage, environmental demands, shelving etc. are integrated matters of the ZEPHYR Concept. Add to that education of staff.

15 Conclusions

The Schleswig principle of passive climate controlled repositories has become one of the bigger steps in the trend towards cost-effective and sustainable storage of our cultural heritage.

The principles of ZEPHYR Passive Climate Control are based on the Schleswig principle and in the light of studies in building physics and the physical properties of materials, it has, due to this work, become possible to make estimates of the storage environment with a sufficient accuracy.

In addition this study has led to the following conclusions:

Setting up demands on the storage environment will always be a matter of compromise, because there are no exact temperature or relative humidity levels and ranges that secure at the same time the lowest biological, chemical and mechanical deterioration rates.

It is recommended that the demands on the storage environment should be determined regarding the state of preservation of the objects and the vulnerability of the objects towards biological, chemical and mechanical deterioration processes.

Indoor temperature variations are caused by penetration of outdoor variations through walls and roofs and by ventilation. According to the penetration depth of a periodically cycling temperature will determine to which extent the whole mass of the building and the stored materials are taking part in damping the temperature variations.

The mean indoor temperature level in a ZEPHYR repository will normally be

higher inside than the mean outdoor temperature because of the heat supply from lighting. So the indoor temperature depends very much on the use of light. Sectioning, adequate use of the building and staff performance habits are very important factors too.

As regards the penetration depth of periodically cycling humidity, only a thin surface layer takes part in damping humidity variations. So the active surface area and the moisture capacities of building materials and stored material are very important factors in damping humidity variations.

Storing objects in boxes has a considerable effect in damping stressing climatic fluctuations.

The yearly average moisture content level should be the same inside as outside the repository because no moisture production is supposed to take place inside the building.

The ZEPHYR Simulation Model has been developed and the validation shows a good agreement between measured and calculated data.

Nomenclature

T	Temperature	°C
K	Conductance	
L	Thickness	m
Q	Heat flow	W
G	Moisture flow	kg/s
a	Thermal diffusivity	m ² /s
c	Heat capacity	J/(kg·K)
d _p	Penetration depth	m
i	Imaginary unit	
n	Air change rate	s ⁻¹
n	Counter	
t	Time	s
w	Moisture content	kg/m ³
x	Spot co-ordinate	m
α	Heat transfer coefficient	W/(m ² ·K)
λ	Heat conductivity	W/(m·K)
φ	Phase	
ρ	Density	kg/m ³
ω	Time factor	
^	Periodic case	

Indices:

0	Mean
0	Steady-state situation
1	Amplitude
e	Exterior
i	Interior
l	Light
p	Period of time
w	Wall
v	Ventilation
y	Period of one year
air	Air
bw	Brickwork
ins	Insulation
cc	Concrete
iw	Inner walls
ow	Outer wall
pp	Paper

References

Alkærstig, O.; Garff, J. and Lundbæk, M. (editors). 1986. *Bevaringshåndbogen (Preservation Handbook)*. In Danish. Christian Ejlers' forlag. København.

Ayerst, G. 1968. *Prevention of biodeterioration by control of environmental conditions*. Biodeterioration of materials. Microbiological and applied aspects. London.

Baynes-Cope, A.D. 1981. *Förvaring av böcker och dokument (Storage of Books and Documents)*. In Swedish. Konsthögskolans Institut för Materialkunskap.

Bergh, J.-E. and Foghelin, M. *Utvärdering av klimatmätningar på Skoklosters slott (Evaluation of temperature recordings at Skokloster Castle Museum)*. In Swedish. The Corrosion Institute and the Swedish National Museum, Fakta-samling 3 - 1989.

Birch & Krogboe A/S. 1980. *Neubau des Landesarchiv Schleswig-Holstein. Bauphysikalisches Gutachten (New Building of the Regional Archive of Schleswig-Holstein. Building Physical Guidelines)*. In German. Birch & Krogboe A/S, Ingenieur- und Planungsbüro. Hamburg.

Brown, J.P. *Hygrometric Measurements in Museums: Calibration, Accuracy and the Specification of Relative Humidity*. pp. 39-43 in Preventive Conservation. Practice, Theory and Research. (ed.: Ashok, R and Smith, P.) Preprints of the Contributions to the IIC Ottawa Congress, September 1994. IIC, London.

British Standards Institution. 1989. *British Standard Recommendations for Storage and Exhibition of Archival Documents*. BS 5454:1989.

Byggnadsstyrelsen. 1986. *Krav & Råd - C8 Arkivlokaler (Requirements and Advice - C8 Archive Storerooms)*. In Swedish. Stockholm.

Claesson, J. and Hagentoft, C.E. 1994 *Basic Building Physics - Mathematical Modelling* (Preliminary version). Lund University, Department of Building Physics, Lund.

Clavir, M. *Preserving Conceptual Integrity: Ethics and Theory in Preventive Conservation*. pp. 53-57 in *Preventive Conservation. Practice, Theory and Research*. (ed.: Ashok, R and Smith, P.) Preprints of the Contributions to the IIC Ottawa Congress, September 1994. IIC, London.

DMI, 1994. *Jordens klima - Guide til vejr og klima i 156 lande (Climate of the Earth - Guide for weather and climate in 156 countries)*. In Danish. DMI (Danmarks Meteorologiske Institut), Copenhagen.

DWD, 1996. *Climatic data from Schleswig Weather Station recorded by the German National Weather Service (Deutscher Wetterdienst) during the period April, 1994 to October, 1995*. Offenbach.

Erhardt, D. and Mecklenburg, M. *Relative Humidity Re-Examined*. pp 32-38 in *Preventive Conservation. Practice, Theory and Research*. (ed.: Ashok, R and Smith, P.) Preprints of the Contributions to the IIC Ottawa Congress, September 1994. IIC, London.

Grzywacz, C.M. and Tennent, N.H. *Pollution Monitoring in Storage and display Cabinets: Carbonyl Pollutant Levels in Relation to Artifact Detrioration*. pp 164-170 in *Preventive Conservation. Practice, Theory and Research*. (ed.: Ashok, R and Smith, P.) Preprints of the Contributions to the IIC Ottawa Congress, September 1994. IIC, London.

Hanseatisches Umweltbüro. *Messung der CO₂-Konzentration im Magazin des Landesarchiv Schleswig-Holstein. (Measurement report of the CO₂-concentrations in the storerooms at the Regional Archive of Schleswig-Holstein).*

Lübeck, January 1993.

Hearle, J.W.S. and Peters, R.H. (ed). *Moisture in Textiles*. The Textile Institute, 1960, London.

ISO, 1995. *Proposal to ISO-standard for Storage Requirements for Library and Archive Material*. ISO/TC40/SC10/CD 11799. May 1995.

MATCH. *PC-program for Moisture And Temperature Calculations for constructions of Hygroscopic Materials*. Bygge- og Miljøteknik ApS.

Michalski, S. *"Relative Humidity: A Discussion of Correct/Incorrect Values"*. Preprints of the 10th Triennial Meeting of ICOM Committee for Conservation. 624-629. Washington, 1993.

Neuhauser, H.P. and Schata, M. *Gesundheitsvorsorge in Archiven (Health care in Archives)* In German. *Der Archivar*, Jahrgang 47, 1994, H.1. 119-128.

Nevander, L.E. and Elmarsson, B. 1994. *FUKT Handbok - Praktik och teori. (The Moisture Handbook)* in Swedish. Svensk Byggtjänst, Stockholm.

Nielsen, A. *Bygningsmaterialers egenskaber - TR 274/92 (The Physical Properties of Building Materials)*. In Danish. Building Materials Laboratory, Technical University of Denmark, Lyngby.

Padfield & Jensen, 1990. *Low energy climate control in museum stores*. Preprints of the 9th Triennial Meeting of ICOM Committee for Conservation. Dresden, 1990.

Padfield, 1996. *Low energy climate control in museum stores - a postscript*. Proposed paper for the 11th Triennial Meeting of ICOM Committee for Conservation. Edinburgh, 1996.

Rangström, L.; Skeri, K. and Westin, E. *Skokloster Slott och samlinger (The Skokloster Castle and Collections)*. In Swedish. Uddevalla. 1980.

PC Globe "*Maps "N" Facts*" (CD-ROM). Brøderbund Software, Inc. 1994.

Riksarkivets förfatningssamling, 1994. (Regulations of The National Archives in Sweden). In Swedish. RA-FS 1994:6. Stockholm.

Snow, D.; Crichton, M.H.G.; Wright, N.C. *Mould deterioration of feeding-stuffs in relation to humidity of storage. Part I: The growth of moulds at low humidities*. The Annals of applied biology, No. 2, May 1944, 102-110. Cambridge University Press, London.

Thomson, G. 1978. *The Museum Environment*. Butterworths. London.

Stehkämper, H. 1971. *Der neubau des Historischen Archivs der Stadt Köln (The new building of the Historical Municipal Archive of Cologne)*. In German. Achivalische Zeitschrift 68. P: 99-116.

Stein, W.H. 1992. *Fragen der Anwendung des Kölner Modells im Archivbau (Questions on the use of the Cologne Principle in archive building)*. In German. Der Archivar 45. Jahrgang, Juli 1992, Heft 3.

Waller, R. *Conservation Risk Assessment: A Strategy for Managing Resources for Preventive Conservation*. pp. 12-16 in Preventive Conservation. Practice, Theory and Research. (ed.: Ashok, R and Smith, P.) Preprints of the Contributions to the IIC Ottawa Congress, September 1994. IIC, London.

Wilson, W.K. and Wessel, C.J. 1984. *Guidelines for Environmental Conditions in Archives and Libraries*. National Institute for Conservation. Washington D.C.

Appendix 1: Description of the System/Equipment used for Measurements at the Regional Archive of Schleswig-Holstein, Germany

The measuring equipment consists of a programmable datalogger recording data from five temperature and humidity sensors and one thermocouple. For more detailed information about the sensor locations see chapter 10.



The datalogger is the CR10 Measurement and Control Module from Campbell Scientific Ltd. The CR10 has, among other channels, 12 single-ended or 6 differential analogue inputs, with 13-bit resolution on selectable voltage ranges between ± 2.5 mV and ± 2.5 V. The resolution is between 0.33 μ V and 333 μ V for differential inputs and twice the resolution value for single-ended inputs. This is an acceptable quality for research purposes. It stores 29,900 data points in a internal circle memory.

The sensors are temperature and relative humidity transmitters from General Eastern. The temperature transmitter which is 12 V loop-powered converts temperature to a 4-20 mA current loop signal using a 100 Ω Platinum Resistance Temperature Detector, with a temperature accuracy better than ± 0.3 $^{\circ}$ C according to the certificate of calibration. The relative humidity transmitter is a bulk polymer element, which has a relative humidity depending resistance. The bulk polymer element which is 12 V loop-powered converts relative humidity to a 4-20 mA current loop signal. One high-accuracy resistance is placed in every measuring circuit and letting the datalogger detect the voltage drop over this resistance. The voltage drop will be varying depending on the relative humidity. The accuracy including hysteresis, linearity and repeatability of the relative humidity sensor is better than $\pm 2\%$ according to the certificate of calibration with a maximum drift of 1% per year. The temperature and humidity sensors placed in the room and in the archive box are calibrated four times during measuring period towards calibrated hand-held instruments (Vaisala HMP or TESTO 601). No derivations larger than the accuracy of the instruments where found.

The measuring system is remote controlled via modem. The datalogger is connected to the modem via a RS232 opto-isolated interface and data (ascii-format) are once a week transmitted from the datalogger to a PC, located at Birch & Krogboe in Copenhagen. The data are transferred from ascii-format into SPSS-format (SPSS: Statistical Package for Social Sciences), where data

are further processed and graphical presentations are made.

The whole datalogger system with power supplies and battery backup are assembled in a closed wall mounted case.

Appendix 2: Air Change Rate Measurement Report

Place: The Regional Archive of Schleswig-Holstein, Germany.
Storage room 2. Groundfloor.

Date: April 24, 1994.

Measuring
period: 24 hours.

Weather
conditions: Average temperature: 13.3°C.
Average relative humidity: 61%.
Sun: Cloudy.
Wind: Steady wind.

Volume: 1,560 m³

Method: Concentration Decay Method.

Tracer gas: Sulfurhexafluride (SF₆).

Equipment: Brüel & Kjær Multi-gas Monitor - Type 1302.
Brüel & Kjær Multipoint Sampler and Doser - Type 1303.
Lent by courtesy of the Thermal Insulation Laboratory at the
Technical University of Denmark

Result: From the the tracer gas concentration curve the air change rate

can be calculated to be 85 m³/h or 0,05 changes per hour. The accuracy of this kind of measurements can be expected to be better than 10%.

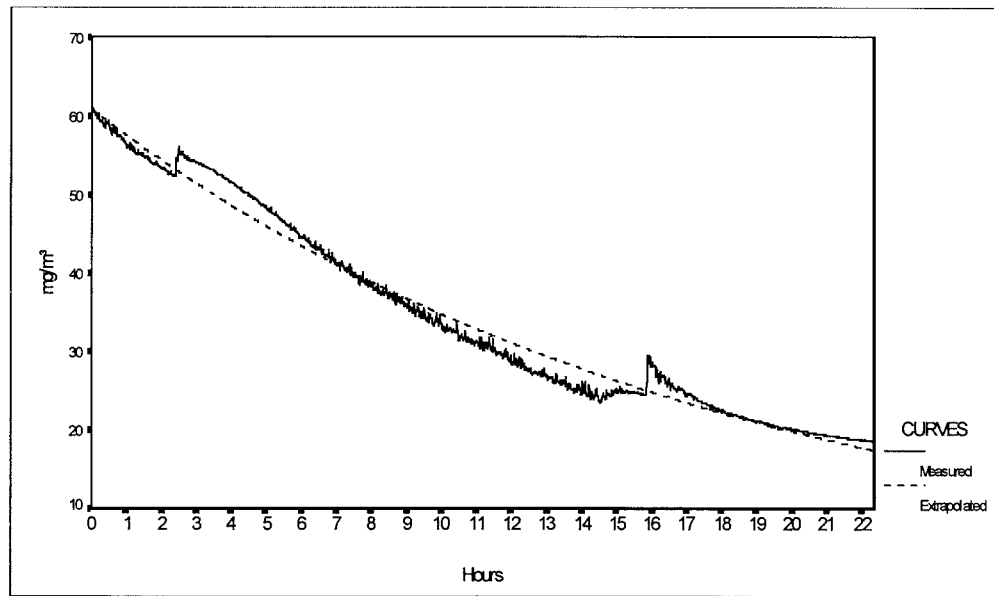

Recording of the tracer gas concentration in the storeroom during the investigation. The extrapolated curve is used for further calculations.

Appendix 3: Reduction of Network

This appendix is a going through the reductions of the periodic network, starting with the complete model shown below.

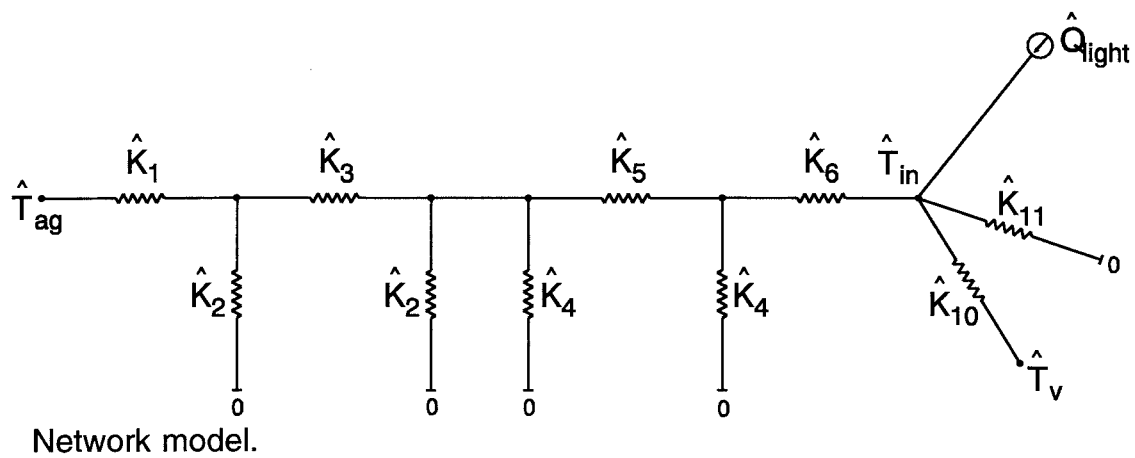

The conductances can be calculated by the following equations:

The outdoor surface resistance:

$$\hat{K}_1 = A\alpha_{ag} \tag{1}$$

The capacity of the first material layer:

$$\hat{K}_2 = \frac{\cosh[(1+i)\frac{L_{ins}}{d_p}] - 1}{\sinh[(1+i)\frac{L_{ins}}{d_p}]} \frac{A\lambda_{ins}(1+i)}{d_p} \quad (2)$$

The resistance of the first material layer:

$$\hat{K}_3 = \frac{1}{\sinh[(1+i)\frac{L_{ins}}{d_p}]} \frac{A\lambda_{ins}(1+i)}{d_p} \quad (3)$$

The capacity of the second material layer:

$$\hat{K}_4 = \frac{\cosh[(1+i)\frac{L_{brick}}{d_p}] - 1}{\sinh[(1+i)\frac{L_{brick}}{d_p}]} \frac{A\lambda_{brick}(1+i)}{d_p} \quad (4)$$

The resistance of the second material layer:

$$\hat{K}_5 = \frac{1}{\sinh[(1+i)\frac{L_{brick}}{d_p}]} \frac{A\lambda_{brick}(1+i)}{d_p} \quad (5)$$

The indoor surface resistance:

$$\hat{K}_6 = A\alpha_{in} \quad (6)$$

For the sake of clarity the network is split up into two sections. The first represents the conductances in the wall construction, the second represents the conductances related to the room.

Two conductances in parallel representing a capacity and a resistance can be combined into one conductance by simple addition and by multiplying a constant to the value of the node. This is illustrated below.

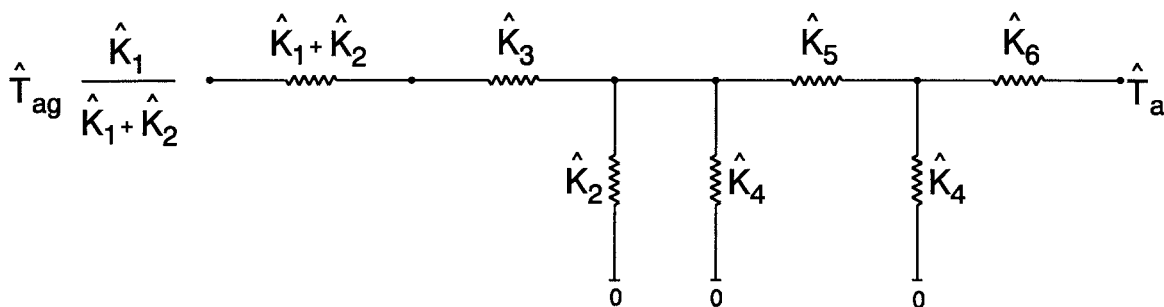

Network model with combination of two parallel conductances.

The wall section can be reduced by the following process:

Two conductances in series are combined by multiplication of the two conductances divided by their sum (equation (7)).

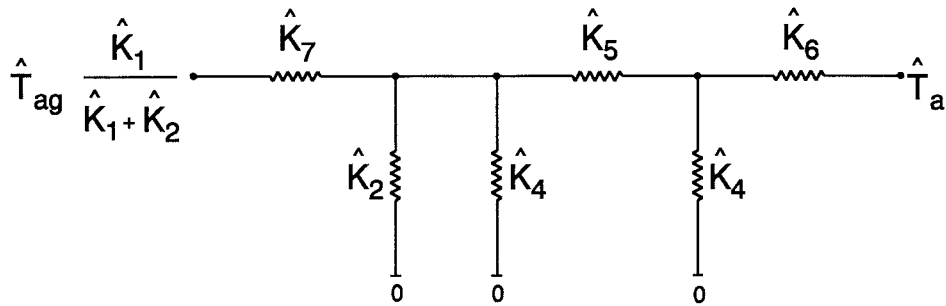

$$\hat{K}_7 = \frac{(\hat{K}_1 + \hat{K}_2)\hat{K}_3}{\hat{K}_1 + \hat{K}_2 + \hat{K}_3} \quad (7)$$

So the reduction proceed.

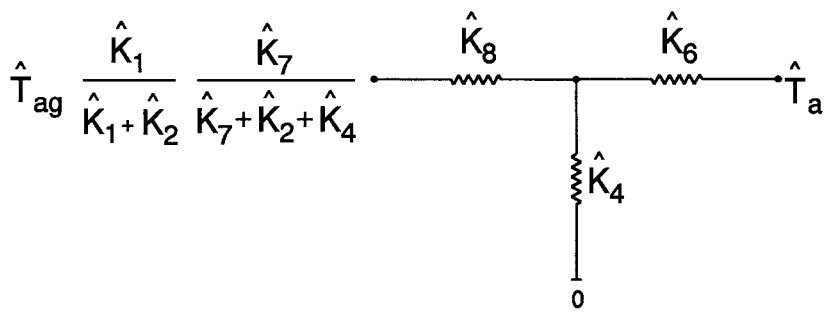
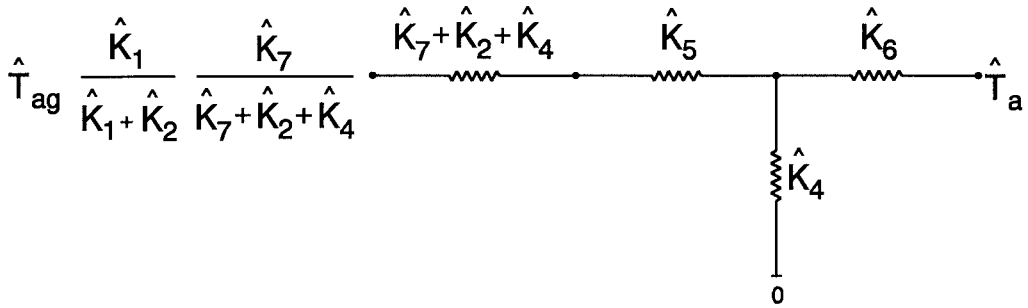

$$\hat{K}_8 = \frac{(\hat{K}_7 + \hat{K}_2 + \hat{K}_4)\hat{K}_5}{\hat{K}_7 + \hat{K}_2 + \hat{K}_4 + \hat{K}_5} \quad (8)$$

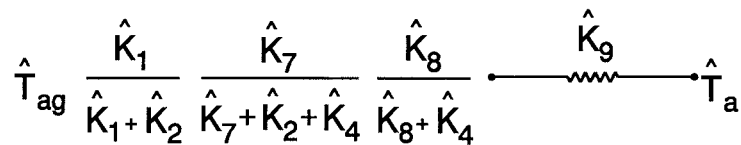

$$\hat{K}_9 = \frac{(\hat{K}_8 + \hat{K}_4)\hat{K}_6}{\hat{K}_8 + \hat{K}_4 + \hat{K}_6} \quad (9)$$

The two network sections are put together again and the partly reduced network is then:

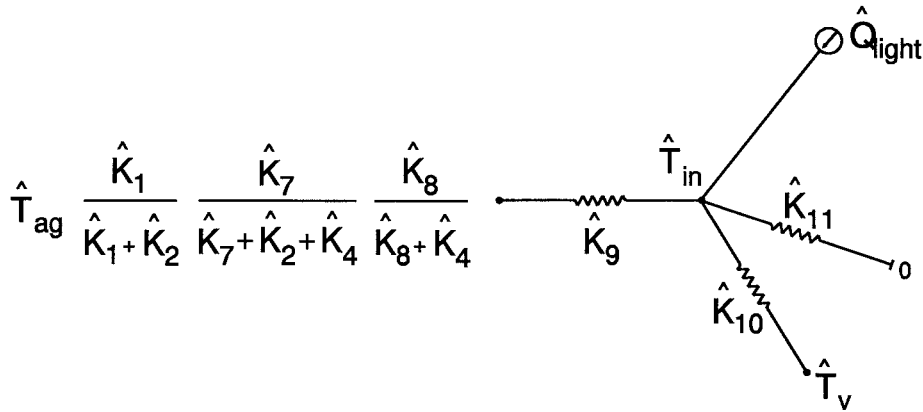

Partly reduced network.

The remaining conductances can be calculated by the following equations.

$$\hat{K}_{10} = i \frac{2\pi}{t_y} (\rho_{air} c_{air} V_{air} + \rho_{doc} c_{doc} V_{doc}) \quad (10)$$

$$\hat{T}_v = T_{v,1} e^{i\phi_v} \quad (11)$$

$$\hat{K}_{11} = i \frac{2\pi}{t_y} \dot{M}_v c_v V_{\text{air}} \quad (12)$$

$$\hat{T}_{\text{in}} = \hat{T}_{\text{ag}} \hat{F}_w \quad (13)$$

$$\hat{Q}_{\text{light}} = Q_{\text{light},1} e^{i\varphi_{\text{light}}} \quad (14)$$

The weighted factor in equation (15) is the factor between the outdoor temperature and the indoor temperature, when ventilation and internal heat production are taken into account.

$$\hat{F}_w = \frac{\hat{K}_1}{\hat{K}_1 + \hat{K}_2} \frac{\hat{K}_7}{\hat{K}_7 + \hat{K}_2 + \hat{K}_4} \frac{\hat{K}_8}{\hat{K}_8 + \hat{K}_4} \frac{\hat{K}_9}{\hat{K}_9 + \hat{K}_{10}} \frac{\hat{K}_9 + \hat{K}_{10}}{\hat{K}_9 + \hat{K}_{10} + \hat{K}_{11}} \quad (15)$$



ΖΕΦΥΡΟΣ