



# LUND UNIVERSITY

## DIGITAL ANALYSIS OF CARDIAC ACOUSTIC SIGNALS IN CHILDREN

El-Segaier, Milad

2007

[Link to publication](#)

*Citation for published version (APA):*

El-Segaier, M. (2007). *DIGITAL ANALYSIS OF CARDIAC ACOUSTIC SIGNALS IN CHILDREN*. [Doctoral Thesis (compilation), Paediatrics (Lund)]. Institutionen för kliniska vetenskaper, Lunds universitet.

*Total number of authors:*

1

### General rights

Unless other specific re-use rights are stated the following general rights apply:

Copyright and moral rights for the publications made accessible in the public portal are retained by the authors and/or other copyright owners and it is a condition of accessing publications that users recognise and abide by the legal requirements associated with these rights.

- Users may download and print one copy of any publication from the public portal for the purpose of private study or research.
- You may not further distribute the material or use it for any profit-making activity or commercial gain
- You may freely distribute the URL identifying the publication in the public portal

Read more about Creative commons licenses: <https://creativecommons.org/licenses/>

### Take down policy

If you believe that this document breaches copyright please contact us providing details, and we will remove access to the work immediately and investigate your claim.

LUND UNIVERSITY

PO Box 117  
221 00 Lund  
+46 46-222 00 00

Avdelning för Pediatrik, Sektion för barnkardiologi  
Universitetssjukhuset I Lund, Lunds Universitet

# **DIGITAL ANALYSIS OF CARDIAC ACOUSTIC SIGNALS IN CHILDREN**

**Milad El-Segaier**

Akademisk avhandling

Som med vederbörligt tillstånd av Medicinska Fakulteten,  
Lunds universitet, för avläggande av doktorsexamen I medicinsk  
vetenskap I ämnet barnkardiologi, offentligen kommer att försvaras  
fredagen den 20 april 2007, kl. 9:00 i föreläsningssalen, Gamla barnkliniken,  
Universitetssjukhuset i Lund, Barngatan 2, Lund

**Fakultetsopponent**

Bo Lundell med. dr. docent  
Institutionen för kvinnors och barns hälsa  
Astrid Lindgrens Barnsjukhus Q1:03  
Karolinska Universitetssjukhuset  
171 76 Stockholm

**Handledare,**

Professor Erkki Pesonen, Universitetssjukhuset I Lund,  
Avdelning för Pediatrik, Sektion för barnkardiologi,  
Lunds Universitet  
Lund

Organization LUND UNIVERSITY		Document name DOCTORAL DISSERTATION	
Division of Paediatric Cardiology Department of Paediatrics Lund University Hospital SE-22185 Lund, Sweden		Date of issue April 20, 2007	
		Sponsoring organization	
Author(s) Milad El-Seaier			
Title and subtitle DIGITAL ANALYSIS OF CARDIAC ACOUSTIC SIGNALS IN CHILDREN			
<p>Abstract</p> <p>Despite tremendous development in cardiac imaging, use of the stethoscope and cardiac auscultation remains the primary diagnostic tool in evaluation of cardiac pathology. With the advent of miniaturized and powerful technology for data acquisition, display and digital signal processing, the possibilities for detecting cardiac pathology by signal analysis have increased. The objective of this study was to develop a simple, cost-effective diagnostic tool for analysis of cardiac acoustic signals. Heart sounds and murmurs were recorded in 360 children with a single-channel device and in 15 children with a multiple-channel device. Time intervals between acoustic signals were measured. Short-time Fourier transform (STFT) analysis was used to present the acoustic signals to a digital algorithm for detection of heart sounds, define systole and diastole and analyse the spectrum of a cardiac murmur. A statistical model for distinguishing physiological murmurs from pathological findings was developed using logistic regression analysis. The receiver operating characteristic (ROC) curve was used to evaluate the discriminating ability of the developed model. The sensitivities and specificities of the model were calculated at different cut-off points. Signal deconvolution using blind source separation (BSS) analysis was performed for separation of signals from different sources.</p> <p>The first and second heart sounds (S1 and S2) were detected with high accuracy (100% for the S1 and 97% for the S2) independently of heart rates and presence of a murmur. The systole and diastole were defined, but only systolic murmur was analysed in this work. The developed statistical model showed excellent prediction ability (area under the curve, AUC = 0.995) in distinguishing a physiological murmur from a pathological one with high sensitivity and specificity (98%). In further analyses deconvolution of the signals was successfully performed using blind separation analysis. This yielded two spatially independent sources, heart sounds (S1 and S2) in one component, and a murmur in another.</p> <p>The study supports the view that a cost-effective diagnostic device would be useful in primary health care. It would diminish the need for referring children with cardiac murmur to cardiac specialists and the load on the health care system. Likewise, it would help to minimize the psychological stress experienced by the children and their parents at an early stage of the medical care.</p>			
Key words: Cardiac acoustic signals, time interval measurements, short-time Fourier transform, heart sound detection, logistic regression, receiver operating characteristic curve, signal deconvolution.			
Classification system and/or index terms (if any):			
Supplementary bibliographical information:		Language English	
ISSN and key title: 1652-8220		ISBN 978-91-85559-54-1	
Recipient's notes		Number of pages 135	Price
		Security classification	

Distribution by (name and address)

I, the undersigned, being the copyright owner of the abstract of the above-mentioned dissertation, hereby grant to all reference sources permission to publish and disseminate the abstract of the above-mentioned dissertation.

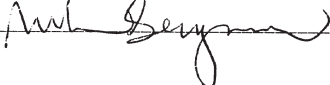
Signature 

Date March 15, 2007

# **DIGITAL ANALYSIS OF CARDIAC ACOUSTIC SIGNALS IN CHILDREN**

Milad El-Segaier  
Division of Paediatric Cardiology  
Department of Paediatrics  
Lund University  
Lund, Sweden  
2007



﴿ بِسْمِ اللّٰهِ الرَّحْمٰنِ الرَّحِیْمِ ﴾

وَمِنَ النَّاسِ وَالدَّوَابِّ وَأَلْأَنْعَامِ

مُخْتَلِفٌ أَلْوَانُهُ كَذٰلِكَ ۗ إِنَّمَا يَخْشَى اللّٰهَ مِنْ عِبَادِهِ الْعُلَمَاءُ ۗ إِنَّ اللّٰهَ

عَزِيزٌ غَفُورٌ

And likewise of men and Ad-Dawabb (moving (living) creating, beasts), and cattle are of various colours. It is only those who have knowledge among His salves that fear Allah. Verily, Allah is All-Mighty, Oft-Forgiving.  
(Holy Quran-Surat Fatir, Aya 28)

#### **DEDICATED TO**

**My** parents who TAUGHT me ALL,

**My** brothers and sisters who SUPPORTED me,

**You**, my wife and children, who PROVIDED me with

LOVE and HAPPINESS... in my life



## CONTENTS

<b>LIST OF PAPERS</b> .....	11
<b>ABBREVIATIONS</b> .....	13
<b>SUMMARY</b> .....	15
<b>INTRODUCTION</b> .....	17
A. Cardiac auscultation .....	17
Cardiac auscultation in clinical practice .....	18
Limitations of auscultation .....	18
B. Cardiac sounds .....	19
First heart sound .....	19
Second heart sound .....	19
C. Cardiac murmurs .....	22
Classification of cardiac murmurs .....	23
Systolic murmurs .....	23
Diastolic murmurs .....	24
Continuous murmurs .....	24
D. Time interval measurements.....	25
E. Recent advances in signal processing.....	26
<b>AIMS OF THE PRESENT STUDY</b> .....	29
<b>MATERIALS AND METHODS</b> .....	31
A. Patients .....	31
Study groups .....	31
B. Apparatus and data acquisition .....	33
C. Time interval measurements .....	35
D. Automatic detection of heart sounds .....	37
E. Spectral analysis of systolic murmurs .....	37
F. Deconvolution of the signals .....	39
G. Statistical analyses .....	39
Logistic regression analysis and model design .....	39
Receiver operating characteristic curve .....	40
<b>RESULTS AND DISCUSSION</b> .....	43
A. Study I: Computer detection of cardiac sounds in children .....	43
B. Study II: Detection of cardiac pathology .....	45
C. Study III: Diagnosis of atrial septal defect .....	46





D. Designing the statistical model .....	47
E. Overlap between signals and artefact filtering .....	48
F. Study IV: Blind signal separation .....	49
G. Study V: First frequency peak .....	49
<b>CONCLUSION AND FINAL REMARK .....</b>	<b>51</b>
<b>LIMITATION OF THE STUDY .....</b>	<b>53</b>
<b>ACKNOWLEDGEMENTS .....</b>	<b>55</b>
<b>REFERENCES .....</b>	<b>57</b>
<b>PAPERS I-V .....</b>	<b>64</b>



**LIST OF PAPERS**

This thesis is based on the following papers, which are referred to in the text by their Roman numerals:

- I. El-Segaier M, Lilja O, Lukkarinen S, Sörnmo L, Sepponen R, and Pesonen E.  
Computer-based detection and analysis of heart sound and murmur.  
Annals of Biomedical Engineering, 2005; 33(7):937–942
- II. El-Segaier M, Pesonen E, Lukkarinen S, Peters K, Sörnmo L, and Sepponen R.  
Detection of cardiac pathology: time intervals and spectral analysis.  
(Submitted to Acta Paediatrica)
- III. El-Segaier M, Pesonen E, Lukkarinen S, Peters K, Ingmansson J, Sörnmo L, and Sepponen R.  
Atrial septal defect: a diagnostic approach.  
Medical & Biological Engineering & Computing, 2006; 44:739–745
- IV. Pietilä A, El-Segaier M, Vigário R, and Pesonen E.  
Blind source separation of cardiac murmur from heart recordings.  
Lecture Note in Computer Science, electronic edition, 2006; 3889:470–477
- V. El-Segaier M, Lukkarinen S, Peters K, Ingemansson J, and Pesonen E.  
First frequency peak in separation of innocent from organic murmurs.  
(Manuscript)



**ABBREVIATIONS**

$A_2$	aortic component of the second heart sound ( $S_2$ )
AI	aortic insufficiency
AR	autoregressive
AS	aortic stenosis
ASD	atrial septal defect
AUC	area under the curve
BMI	body mass index
bpm	beats per minute
BSS	blind source separation
CI	confidence interval
dB	decibel
$\Delta S_2$ (delta $S_2$ )	respiratory variation of the splitting of the second heart sound ( $S_2$ )
DSS	denoising source separation
ECG	electrocardiography
FFT	fast Fourier transform
Fimax	frequency of the murmur at the point of maximum intensity in the spectrum
Fm	mean frequency of the murmur
ICA	independent component analysis
I <sub>max</sub>	maximum intensity of systolic murmur
MR	mitral regurgitation
ms	millisecond
M <sub>Sp</sub>	mean spectral power
$P_2$	pulmonary component of the second heart sound ( $S_2$ )
PDA	persitent ductus arteriosus
PM	punctum maximum
PS	pulmonary stenosis
Q <sub>p</sub> :Q <sub>s</sub>	pulmonary to systemic flow ratio

ROC	receiver operating characteristic
S <sub>1</sub>	first heart sound
S <sub>2</sub>	second heart sound
SD	standard deviation
SDT <sub>imax</sub>	standard deviation of the interval from the end of the S <sub>1</sub> to the maximum intensity of the murmur
SSA	singular spectrum analysis
S <sub>1</sub> SM	interval between the end of the S <sub>1</sub> and the beginning of the systolic murmur
STFT	short-time Fourier transform
T <sub>imax</sub>	interval from the end of the S <sub>1</sub> to the maximum intensity of the murmur
VSD	ventricular septal defect

**DIGITAL ANALYSIS OF CARDIAC ACOUSTIC SIGNALS IN CHILDREN**

Milad El-Segaier, MD

Division of Paediatric Cardiology, Department of Paediatrics, Lund University Hospital, Lund, Sweden

**SUMMARY**

Despite tremendous development in cardiac imaging, use of the stethoscope and cardiac auscultation remains the primary diagnostic tool in evaluation of cardiac pathology. With the advent of miniaturized and powerful technology for data acquisition, display and digital signal processing, the possibilities for detecting cardiac pathology by signal analysis have increased. The objective of this study was to develop a simple, cost-effective diagnostic tool for analysis of cardiac acoustic signals. Heart sounds and murmurs were recorded in 360 children with a single-channel device and in 15 children with a multiple-channel device. Time intervals between acoustic signals were measured. Short-time Fourier transform (STFT) analysis was used to present the acoustic signals to a digital algorithm for detection of heart sounds, define systole and diastole and analyse the spectrum of a cardiac murmur. A statistical model for distinguishing physiological murmurs from pathological findings was developed using logistic regression analysis. The receiver operating characteristic (ROC) curve was used to evaluate the discriminating ability of the developed model. The sensitivities and specificities of the model were calculated at different cut-off points. Signal deconvolution using blind source separation (BSS) analysis was performed for separation of signals from different sources.

The first and second heart sounds ( $S_1$  and  $S_2$ ) were detected with high accuracy (100% for the  $S_1$  and 97% for the  $S_2$ ) independently of heart rates and presence of a murmur. The systole and diastole were defined, but only systolic murmur was analysed in this work. The developed statistical model showed excellent prediction ability (area under the curve, AUC = 0.995) in distinguishing a physiological murmur from a pathological one with high sensitivity and specificity (98%). In further analyses deconvolution of the signals was successfully performed using blind separation analysis. This yielded two spatially independent sources, heart sounds ( $S_1$  and  $S_2$ ) in one component, and a murmur in another.



The study supports the view that a cost-effective diagnostic device would be useful in primary health care. It would diminish the need for referring children with cardiac murmur to cardiac specialists and the load on the health care system. Likewise, it would help to minimize the psychological stress experienced by the children and their parents at an early stage of the medical care.

**Key words:** cardiac acoustic signals, time interval measurements, short-time Fourier transform, heart sound detection, logistic regression, receiver operating characteristic curve, signal deconvolution.

## INTRODUCTION

### A. Cardiac auscultation

Before the 19th century, physicians could listen to the heart only by applying their ear directly to the chest. This “immediate auscultation” had social and technical limitations, which resulted in its disfavour. With the invention of the stethoscope by Laennec in 1816, “mediate auscultation” became possible, introducing an exciting and practical new method of bedside examination. Over the past two centuries, many illustrious physicians have contributed to the understanding of cardiac auscultation by providing an explanation for the sounds and noises that are heard in the normal or diseased heart. Auscultation remains a low-cost and sophisticated method that intimately connects the physician to the patient and transfers that all-important clinical information for diagnosis of heart diseases. When used with skill, it may allow the physician to correctly determine whether more expensive testing is indicated. The stethoscope deserves our continued respect and more attention as an indispensable aid for evaluation of our patients.

Sound waves monitored from the surface of the body with the acoustic stethoscope are an important source of clinical information [1]. Together with the bedside examination, not only is the use of the stethoscope cost-effective but it also cannot be totally replaced by alternative technological methods [2]. Even though the characteristics of acoustic findings are based on well-established physiological principles [3, 4], their interpretation depends on the experience and skill of the examiner. In experienced hands misclassifying a pathological murmur as an innocent one is extremely rare but for an inexperienced health care provider or even for a paediatrician, this diagnosis may be difficult [4-10]. Further simple diagnostic tests, electrocardiography (ECG) and chest radiography are of limited help in the discrimination between organic heart disease and normality in asymptomatic children with cardiac murmur [5, 9-15].

The stethoscope cannot store and play back sounds, and cannot offer a visual display [16, 17]. Electronic stethoscopes were invented many years ago, but they have provided little, or no, improvement over their mechanical predecessors [18]. The problem is often a disturbing background noise. In addition, these devices often lack the means to interface with a computer that could play back the sound without

distortion. The display of the sound signals for visual reference, convenient transmission of the signals to a remote site, and documentation for later recall would be important for effective analysis [19]. In a study comparing the acoustic stethoscope with the electronic stethoscope it was shown that a new, electronic stethoscope needs to be designed based on the best characteristics of both the acoustic and the electronic stethoscope [20].

### **Cardiac auscultation in clinical practice**

The prevalence of cardiac murmur is 50–80% [4-7, 21-23]. However, only 1% of children have heart disease [24-26]. The main problem is to decide whether the murmur is benign or associated with structural cardiac disease. An increasing number of referrals to specialists suggest that doctors' auscultation skills are declining [27-37].

Perceptions of parents concerning the diagnosis of cardiac murmur in their child vary considerably. Regardless of the normal result of diagnostic tests and the assurance by a paediatric cardiologist that their child does not have heart disease, a significant number (10%) of parents continue to believe that their child has a heart problem and many impose restrictions and emotional distress on their children [38-48].

Economically the health care system is burdened from the referral of children with physiological murmur due to uncertainty in the primary diagnosis of cardiac pathology [21, 42, 48, 49]. In some cases it is difficult not to refer an asymptomatic child, even with clear-cut innocent murmurs, when parents need reassurance. Parental expectations, based on the media and the Internet, are often such that only an echocardiogram will provide them with sufficient reassurance of normality. Increasing awareness of costs for this service exerts pressure to increase diagnostic accuracy by primary care paediatricians [50]. Therefore, a simple, objective primary diagnostic method is increasingly called for.

### **Limitations of auscultation**

The human ear has several physical limitations. The sensitivity of the ear with regard to frequencies follows a logarithmic scale. The ear hears frequency changes better than it detects changes in intensity. Sounds with higher frequencies are perceived as

being louder than sounds with lower frequencies of the same intensity. Therefore changes in frequency may be interpreted as changes in intensity. In the presence of high-frequency sounds, the ear may be unable to detect a low-frequency sound immediately following a high-frequency one [51]. Low and high-frequency murmurs reveal separate diagnostic information, which must be heard and analysed separately [52-54]. They contain information which cannot be analysed by the human ear [55]. Furthermore, the quality of the acoustic information from the heart depends on the quality of the stethoscope [17]. The received signals are not perceived with high fidelity [16, 17].

## **B. Cardiac sounds**

### **First heart sound**

The first heart sound ( $S_1$ ) has two high-frequency components that occur with closure of the mitral and tricuspid valves. Controversies exist about the genesis of the  $S_1$ . The  $S_1$  appears synchronously with mitral and tricuspid valve closures. It occurs before aortic ejection, and is not caused by muscle contraction [56]. The sounds are not produced by coaptation of the valve leaflets but by stretching of the valves and recoil of blood against the closed valves and back toward the ventricles (i.e. by a rapid deceleration of blood flow). The vibrations, some of which are audible, occur throughout all structures; the valves, the myocardium, and the blood within the ventricle. This complex of structures has been labelled the "cardiohemic system" because the structures tend to function as a unit, each dependent on the others. In normal subjects the mitral valve closes about 0.03 seconds before the tricuspid valve. Physicians using the acoustic stethoscope cannot discriminate between components which are <0.03 seconds apart. Therefore, valve closures that occur close together may sound as if they are single rather than split events [57].

### **Second heart sound**

Evidence for valvular origin of the second heart sound ( $S_2$ ) was first presented by James Hope (1801–1841) in 1829 (see Hanna & Silverman [58]). Closure of the aortic and pulmonic valves produces the aortic ( $A_2$ ) and pulmonary ( $P_2$ ) components of the  $S_2$ . The sounds result from rapid vibrations in the valves rather than from coaptation of the leaflets [59]. The intensity of the sound is related to the rate of change of the pressure gradient across the valve, but valve flexibility, valve mass,

valve diameter, density and viscosity of blood, frequency of valve vibrations, the coefficient of sound absorption of the ventricular walls, and geometry of the ventricle also influence its intensity [60]. Moreover, the phase of respiration and body habitus have an impact on the intensity of the  $S_2$  [61].

#### Splitting of the second heart sound and respiratory variation

The splitting of the  $S_2$  was first described by Jean-Baptiste Bouillaud (1796–1881) in the late 1820s [58]. Normally aortic valve closure precedes pulmonic valve closure, creating a double, or split,  $S_2$ . The  $A_2$ – $P_2$  interval is wider during inspiration than during expiration [57, 62]. During right ventricular systole the time from tricuspid valve closure to pulmonic valve closure includes three major intervals: isometric contraction, the ejection period, and the hangout interval.

The right ventricular pressure declines faster after maximal contraction of the ventricles compared with the pressure in the pulmonary artery. There is an interval separating the right ventricular pressure from the pulmonary artery pressure at the level of the dicrotic notch, and this is called the “hangout interval” (Figure 1). It is a measure of the impedance of the pulmonary vasculature. The inertia of blood leaving the right ventricle keeps the pulmonic valve open longer when the vascular resistance is low and consequently the hangout interval is longer. The duration of the interval is inversely related to the impedance of the pulmonary arterial system. On inspiration, when pulmonary vascular impedance drops, the hangout interval is prolonged, the pulmonic closure sound is delayed and the split between components is widened. On expiration the reverse occurs. The pulmonary closure sound occurs earlier, and the split is narrowed [62].

Normal respiration influences the volume of venous return to both sides of the heart; the right and left ventricular stroke volume therefore varies with respiration. On inspiration the stroke volume increases in the right ventricle but decreases in the left ventricle. The reverse occurs on expiration. The larger right ventricular stroke volume on inspiration prolongs right ventricular ejection and delays pulmonic valve closure. In the left ventricle the opposite occurs on inspiration, shortening left ventricular systole and allowing the aortic valve to be closed earlier. About half of the increase in inspiratory splitting is estimated to be due to the change in pulmonary vascular

impedance, while about one-fourth is due to an increased right ventricular stroke volume and about one-fourth is due to a decreased left ventricular stroke volume [62].

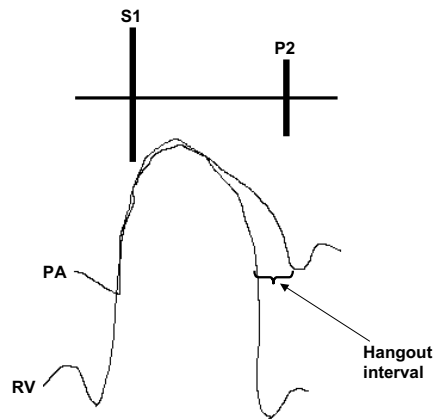

**Figure 1:** Pulmonary artery hangout. PA = pulmonary artery; RV = right ventricle;  $S_1$  = first heart sound;  $P_2$  = pulmonary component of the second heart sound ( $S_2$ ).

Splitting is an important criterion in evaluation of a grade 1–2/6 pulmonic ejection murmur in non-cyanotic and in the clinically asymptomatic child. The usual differential diagnosis is either an innocent pulmonic ejection murmur or an atrial septal defect (ASD). Wide splitting of the  $S_2$  on both inspiration and expiration is found in patients with ASD because of low pulmonary vascular resistance and a large left-to-right shunt [63, 64]. Normal  $S_2$  splitting virtually excludes the diagnosis of ASD [57, 65]. In ASD the wide fixed splitting is in part due to the highly compliant pulmonary artery and a wide hangout interval; after successful surgical or device closure, wide splitting often persists, presumably because of the persistence of altered, low pulmonary vascular impedance [59, 64, 66]. Right bundle branch block seen in ECG causes a wide but not fixed splitting of the  $S_2$  and must be excluded as a cause of pathological splitting.

### C. Cardiac murmurs

A systolic murmur is often heard on routine physical examination in a healthy child. It represents the most common reason for referral to a paediatric cardiologist [6]. The cardiac murmur should be evaluated with regard to (1) location; (2) timing; (3) intensity; (4) radiation; (5) quality; (6) frequency; (7) configuration; (8) duration; and (9) response to interventions [67].

- 1- Location: the location on the chest walls where the murmur is loudest (point of maximal intensity, punctum maximum (PM)) must be determined.
- 2- Timing: it must be decided whether the murmur is a systolic or a diastolic one.
- 3- Intensity or loudness: murmurs can be graded on a scale of I–VI. Defining the loudness of a murmur is in part subjective, but if a thrill can be palpated the grade is IV or more. In clinical practice the grading usually works well between different observers. The grades are presented as follows:
  - I: heard only with intense concentration
  - II: faint, but immediately audible
  - III: loud murmur without a palpable thrill
  - IV: loud murmur associated with a thrill (a palpable vibration on the chest wall)
  - V: very loud; thrill present and audible with only the edge of the stethoscope touching the chest wall
  - VI: audible without contact of the stethoscope with the chest wall
- 4- Radiation: the murmurs spread in a predictable direction from their point of maximal intensity, depending on the anatomic structure involved and the direction of blood flow.
- 5- Quality: the presence of harmonics and overtones determines the quality of the murmurs. Terms such as “harsh”, “coarse” and “blowing” can add meaning to the description of the murmur but generally this is of most value to the individual observer and is hard to accurately convey to others.
- 6- Frequency: this term refers to a rough estimate of the dominant sound range, i.e. low, middle or high.
- 7- Configuration: the dynamic shape of the murmur is determined by the variation in intensity of the murmur. A murmur may build up (crescendo) or decrease

from a loud onset (decrescendo), rise and fall (crescendo–decrescendo) or remain relatively constant (plateau).

- 8- Duration: this is a definition of how much of systole or diastole is occupied by the murmur. It is important to note the time of onset and length of the murmur during systole or diastole.
- 9- Response to interventions: a change in the patient's body position, the Valsalva manoeuvre and sustained handgrip exercise can be used to change the characteristics of the murmur.

### **Classification of cardiac murmurs**

Cardiac murmurs are classified into systolic, diastolic and continuous murmurs.

#### **Systolic murmurs**

Systolic murmurs begin with the  $S_1$  and end before the  $S_2$ . They may be subclassified as (1) holosystolic murmurs; (2) ejection murmurs; (3) early systolic murmurs; and (4) mid- to late systolic murmurs.

- 1- Holosystolic murmurs, beginning abruptly with the  $S_1$  and continuing at about the same intensity until the  $S_2$ , occur when there is a regurgitant atrioventricular valve (tricuspid or mitral), or in association with the majority of ventricular septal defects (VSDs).
- 2- Ejection murmurs are crescendo–decrescendo murmurs, also called “diamond-shaped murmurs”, which may arise from narrow semilunar valves or outflow tracts. The rising and falling nature of these murmurs reflects the periods of rising and lowering ventricular ejection rate during systole.  
Innocent murmurs are almost exclusively ejection-type murmurs. They are generally soft, are never associated with a palpable thrill, and are subject to considerable variation with change in body position.
- 3- Early systolic murmurs start abruptly with the  $S_1$  but taper and disappear before the  $S_2$  and are exclusively associated with small muscular VSDs.



- 4- Mid- to late systolic murmurs begin midway through systole and are often associated with mid-systolic clicks and insufficiency of the mitral valve.

### **Diastolic murmurs**

Diastole, the period between closure of the semilunar valves and subsequent closure of the atrioventricular valves, is normally silent because of mild turbulence associated with low-pressure flow through relatively large valve orifices. Regurgitation of the semilunar valves, stenosis of atrioventricular valves or increase flow across an atrioventricular valve can all cause turbulence and may produce diastolic heart murmurs. Early diastolic murmurs are decrescendo in nature and arise from either aortic or pulmonary valve insufficiency (regurgitation). Mid-diastolic murmurs are diamond-shaped and occur because of either increased flow across normal valves or normal flow across an obstructed or stenotic atrioventricular valve. Late diastolic or crescendo murmurs are created by stenotic or narrowed atrioventricular valves and occur in association with atrial contraction.

### **Continuous murmurs**

Continuous flow through vessels outside the heart distal to the semilunar valves can cause turbulent flow throughout the cardiac cycle. The resulting murmurs extend over the S<sub>2</sub>. Continuous murmurs can be heard for a part of or the whole of diastole. Continuous murmurs are generally pathologic. The most typical example is the murmur caused by the persistent ductus arteriosus (PDA). The pressure difference between the aorta and the pulmonary artery exists throughout the whole cardiac cycle. The rapid flow through the relatively small orifice of the PDA initiates the turbulence and murmur.

The venous hum due to the flow in the internal jugular vein at the level of crossing behind the clavicle is a physiological murmur. It is not heard if the patient is examined in lying position. Figure 2 presents the main types of murmurs.

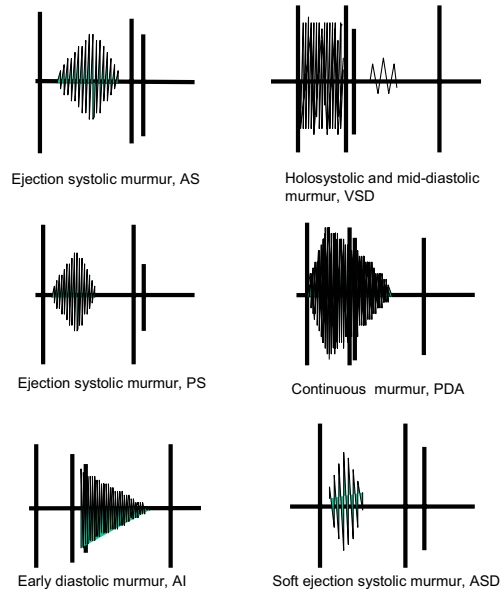

**Figure 2:** Different types of murmurs, with the main diagnostic cause given. AS = aortic stenosis; PS = pulmonary stenosis; VSD = ventricular septal defect; PDA = persistent ductus arteriosus; AI = aortic insufficiency; ASD = atrial septal defect. Reproduced with permission from student literature.

#### D. Time interval measurements

Determining the interval between the end of the  $S_1$  and the beginning of the systolic murmur is important. The majority of systolic pathological murmurs start abruptly with the  $S_1$ . Physiological murmur starts late in systole, which leads to an interval between its start and the end of the  $S_1$ . The measurement of this interval can be used to distinguish physiological murmurs from pathological ones. Time interval analyses ( $S_2$  duration and its variation with respiration) are mandatory for diagnosis of secundum ASD. The referral of children with an ASD for treatment is often significantly delayed because of lack of murmur and symptoms [63, 68]. Late diagnosis and management of significant defects may lead to impaired exercise tolerance, increased incidence of

pneumonia, cardiac arrhythmia later in life and, in some cases, pulmonary hypertension and shortened life expectancy [69, 70]. The early detection and assessment by the primary care physician necessitates the measurement of the  $S_2$  interval. The diagnosis is based on a wide and fixed splitting of the  $S_2$ . Respiratory variation of the  $S_2$  less than 20 ms suggests diagnosis of ASD [62].

### **E. Recent advances in signal processing**

Spectral analysis, especially presentation of the dominant frequency, is a technique which is much more cost-effective than echocardiography and magnetic resonance imaging [71-73]. With the advent of miniaturized and powerful technology for data acquisition, display and digital signal processing, the possibilities for detecting cardiac pathology by signal analysis have increased. Permanent records permit objective comparisons of the acoustic findings [74-76]. Many advanced methods for signal processing and analysis (e.g. sound spectral averaging techniques, artificial neural networks, time-frequency analysis and wavelet analysis) have been reported to be effective for presentation and analysis of cardiac acoustic signals [77-79]. Using electronic mail, it is possible to transmit the records to remote sites for further, sophisticated analysis and conclusions [80-82].

Automated analysis of cardiac auscultation and interpretation of data is a sensitive and specific diagnostic method. It is useful as a diagnostic aid to support clinical decision making [83, 84]. The technical device should have the ability to register good sound quality, give a clear visual display, be able to play back the signals, establish a database for signals, and store and transmit the signals to a distant site.

The cardiac acoustic signals, recorded at the surface of the chest, are convoluted because they are mixed with respiratory sounds and noise from the surroundings. Moreover, such signals overlap each other. The ability to time and separate different components of the heart cycle is therefore essential.

Signal deconvolution and blind source separation (BSS) techniques are methods for improving the signal-to-noise ratio [85, 86]. These methods necessitate simultaneous multiple-channel recordings to obtain an understanding of the signal mixtures of various origins [87].

The first frequency peak is powerful as a separating variable between cardiac pathology and normal findings [78]. It can be obtained from autoregressive (AR) models [88]. The spectral power ratio (i.e. the spectral power of the signal components >200 Hz, related to the total spectral power of the signal) can be a powerful variable in estimation of the murmur types. In the upper frequencies, pathological murmurs contain higher spectral power than do physiological murmurs. The power ratio can be obtained from the power spectrum which is obtained from fast Fourier transform (FFT) [88, 89].



**AIMS OF THE PRESENT STUDY**

The main aim of this thesis work was to develop a simple, secure, objective and cost-effective tool for diagnosis of non-cyanotic congenital heart disease by the primary care physician. Aims of the separate studies are given below:

- **Study I:** To configure an algorithm for automatic detection of the  $S_1$  and  $S_2$ , define the systolic and diastolic parts of the cardiac cycle, and characterize the murmur through spectral analysis.
- **Study II:** To distinguish physiological murmurs from those caused by haemodynamically significant heart defects.
- **Study III:** To design a diagnostic model for recognizing patients with ASD.
- **Study IV:** To separate cardiac murmur from heart sounds and to minimize the effects of signal overlapping and noise artefacts on the final analysis.
- **Study V:** To further improve the prediction power of the statistical model.



## MATERIALS AND METHODS

### A. Patients

Patients with a cardiac murmur who visited the outpatient paediatric cardiology clinic at Lund University Hospital between September 1998 and December 2003 were considered as potential candidates for heart sound recording. Ethical approval was given by the Ethics Committee, Faculty of Medicine, at Lund University (No. LU 502-97). Cardiac sound recordings were performed if the child had a cardiac murmur, but was not cyanotic; if sufficient time and technical support were available; and if consent for participation had been obtained from the children and/or their parents.

Approximately 23,000 patients visited our outpatient clinic during this period and 380 children with cardiac murmur aged between 1 month and 17 years (median age 5.5 years) were examined with a digital heart sound recorder. The first 365 children were examined with a digital recorder, which has a single channel for sound recording. Records from 15 children were registered with a multiple-channel device for blind separation analysis. To make or confirm the diagnosis, the patients were examined by echocardiography using either an Acuson Sequoia™ C512 or an Acuson 128 XP echocardiography system (Acuson Mountain View, California, USA). The child was considered to have a physiological murmur if the echocardiography revealed no anatomical or functional pathology.

### Study groups

- **Study I:** A detection algorithm was developed based on sound files recorded from 300 children with cardiac murmur.
- **Study II:** Sound records from 257 children (69 with physiological murmur and 188 with pathological murmur) were included. The diagnosis and severity of cardiac pathology were assessed by echocardiography. Twenty-four records (nine from the physiological murmur group and 15 from the pathological murmur group) were excluded from further analysis because of low heart sound signal intensity, high-frequency noises or irregularity in the registration.
- **Study III:** The 60 high-quality recordings with physiological murmur and 61 recordings of patients with ASD were used to design a diagnostic statistical model that distinguishes ASD patients from healthy ones.



- **Study IV:** Heart sounds and murmurs in 15 patients (aged 3–17 years) with pathological murmur were registered. For the blind source separation analysis, we used sound signals registered by a multiple-channel sound recorder. In six recordings the signals were weak and judged as unsuitable for the analysis. Nine recordings, 45–50 seconds long, were used for creating the analysis framework for deconvolution of the signals.
- **Study V:** Recordings from 60 subjects with physiological murmur and a random sample of 60 recordings of pathological murmur were included in the analysis of the signal regarding the first frequency peak and power ratio.

To find clinically significant cardiac pathology, the severity of cardiac pathology was evaluated in **Study II**. The patient population was divided into two groups according to severity of the pathology. The group with significant pathology included –

- 1 patients with a semilunar valve (aortic and pulmonary) stenosis and a maximum Doppler gradient  $\geq 30$  mmHg;
- 2 patients with VSD, PDA or mitral regurgitation (MR) who had signs of significant shunt or regurgitation in the form of left atrium and left ventricle volume overload in the echocardiogram, or had increased pulmonary vascular markings and cardiomegaly in the chest X-rays, or had all of these findings; and
- 3 patients with ASD who had right ventricle volume overload in the echocardiogram or a pulmonary to systemic flow ratio ( $Q_p:Q_s$ )  $>1.5:1$  (according to Fick's principle) or both.

The group with mild cardiac pathology included –

- 1 patients with a semilunar valve stenosis and a maximum Doppler gradient  $<30$  mmHg;
- 2 patients with small apical and muscular VSD, small PDA with a normal size left atrium and left ventricle in the echocardiogram, and normal pulmonary vascular markings without cardiomegaly in the chest X-ray;
- 3 patients with ASD without right ventricle volume overload in the echocardiogram, or  $Q_p:Q_s \leq 1.5:1$ .

The numbers of patients in the groups, according to diagnosis and the severity of their cardiac pathology, are presented in Table 1 below.

**Table 1. Number of patients included in Study II, by diagnosis and severity of cardiac pathology.**

Diagnosis	Degree of severity of the pathology	
	Significant	Mild
Semilunar valve stenosis		
AS (N = 40)	28	12
PS (N = 11)	8	3
Shunt lesions		
VSD (N = 45)	30	15
ASD (N = 53)	34	19
PDA (N = 19)	17	2
MR (N = 5)	5	0
<b>Total</b>	<b>122</b>	<b>51</b>
Physiological murmur		60

AS = aortic stenosis; PS = pulmonary stenosis; VSD = ventricular septal defect; ASD = atrial septal defect; PDA = persistent ductus arteriosus; MR = mitral regurgitation.

## B. Apparatus and data acquisition

Our apparatus for recording heart sounds (Figure 3) consisted of –

- an electric microphone, Welleman MCE-2000, frequency range 20–20,000 Hz, self-noise level <34 decibel (dB), signal-to-noise ratio >58 dB, sensitivity  $-44 \pm 4$  dB, within a cylindrically shaped polyvinyl chloride (PVC) cup. The cup for the microphone had an outer diameter of 20 mm, inner diameter of 10 mm, inner depth of 7 mm and a flat frequency response of 1 Hz–2 kHz [90];
- a sound amplifier amplifying the sound signals by 40 dB;
- a National Instruments-DAQ PCI-MIO-16XE-10 data acquisition card and multi-channel distributor box;
- a personal computer with Microsoft Windows 2000 operating system; and
- a monitor for electrocardiography and respiration monitoring.

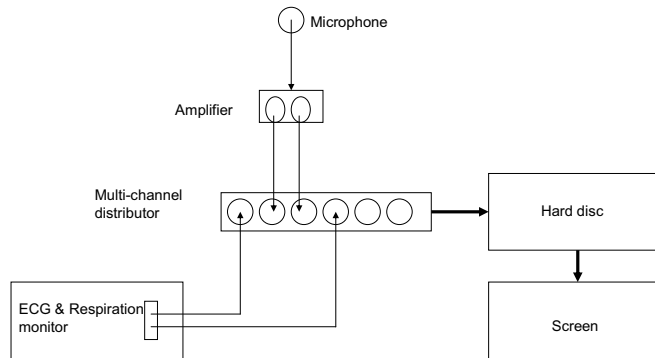

**Figure 3:** Schematic diagram to the apparatus.

The examination room did not have special sound insulation. The heart sounds and murmurs were recorded using four auscultation points on the precordium. The heart sound signals passed through the sound amplifier. The electrocardiography and respiration signals passed to the monitor as analogy signals. The three types of signals were transmitted to the multiple-channel sound distributor and then to the PC.

The sound recording transducer was fixed firmly to the chest wall using a skin-friendly, double-sided adhesive tape. With the patient in the supine position, cardiac sounds were recorded in a rotation manner at left parasternal intercostal spaces 2, 3 and 4, and at the apex. To encourage cooperation, the young toddlers (10 months to 3 years of age) were examined in their parents' arms, sometimes while their attention was diverted with a silent moving toy. No sedation was used. The signal was amplified by 40 dB in order to compensate for signal intensity attenuation due to the acoustic properties of the chest wall, such as subcutaneous fat. The amplified signals were digitized using a National Instruments-DAQ PCI-MIO-16XE-10 card (National Instruments Corporation, Austin, USA) with 16-bit resolution and 11.025 kHz

sampling frequency. This was considered sufficient to cover the dynamic range of the heart sounds and murmurs and to enable easy playback in multimedia systems [16, 91]. The signal was band-pass filtered by an analog electric filter consisting of a high-pass filter, corner frequency 40 Hz, 6 dB/octave, and a low-pass second-order filter, corner frequency 1,500 Hz, 12 dB/octave. The ECG and respiration signals were registered simultaneously. Finally, the sound signals were viewed to assess the adequacy of registration in terms of noises and irregularity between the acoustic signal and the ECG.

Figure 4 shows examples of recorded signals. Diagnoses in these examples are physiological murmur (left panel) and aortic stenosis (AS) (right panel).

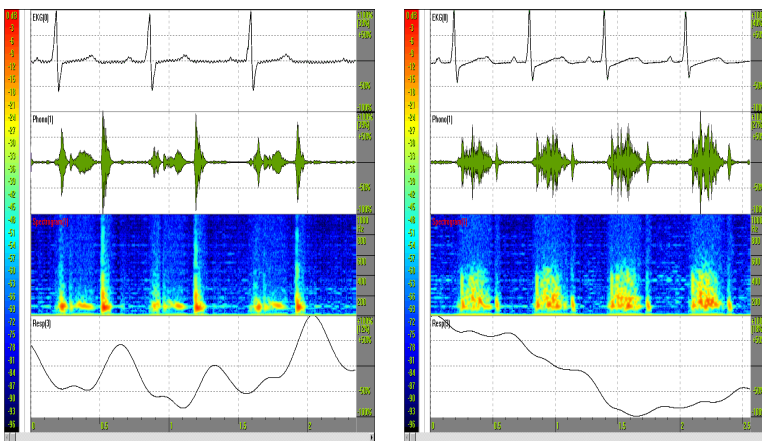

**Figure 4:** Recorded signals in patients with aortic stenosis (AS) (left) and ventricular septal defect (VSD) (right).

### C. Time interval measurements

The first ( $S_1$ ) and second ( $S_2$ ) heart sounds were visually determined as the first signal peaks from baseline after the QRS complex and the T-wave in the ECG, respectively. The interval from the end of the  $S_1$  to the beginning of the systolic murmur ( $S_1SM$ ) and the interval between the  $A_2$  and  $P_2$  in  $S_2$  were measured

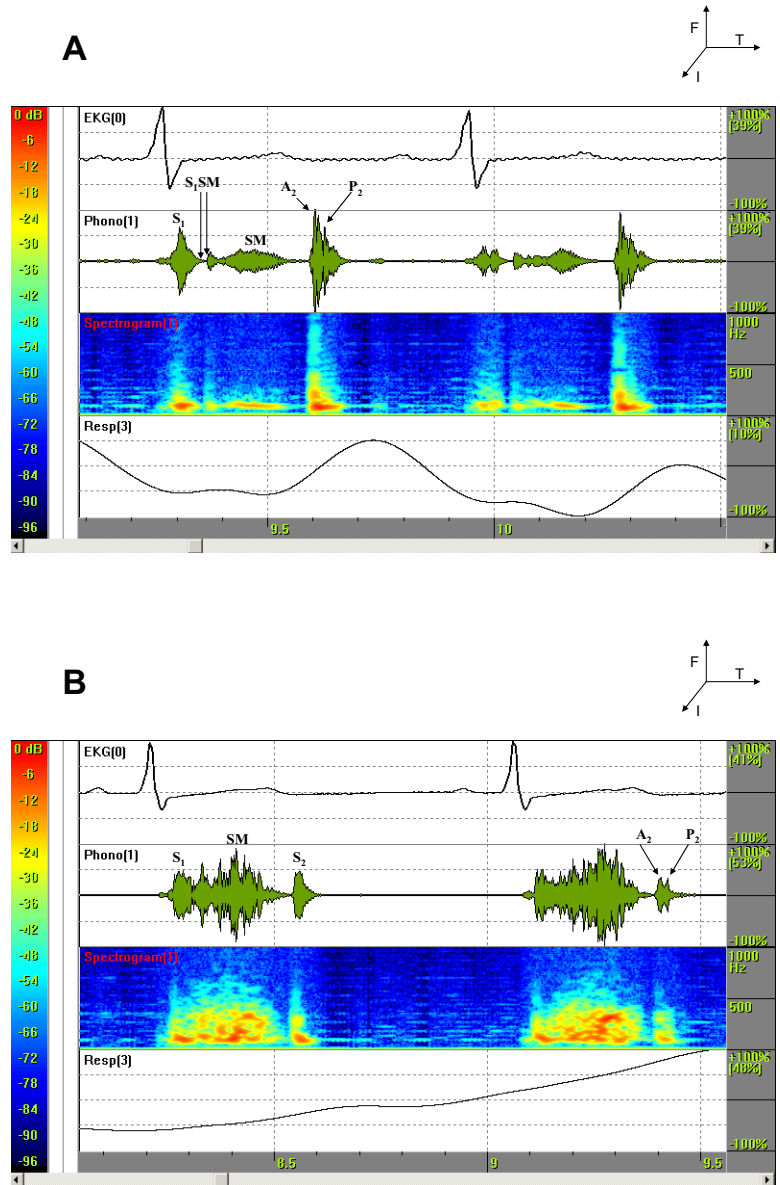

**Figure 5 A and B:** Time interval measurements. Upper panel in the records shows waveform displays and lower ones spectral displays. A: physiological murmur and B: aortic stenosis. S<sub>1</sub>SM = Intervals between S<sub>1</sub> and the beginning of the murmur. A<sub>2</sub> = aortic and P<sub>2</sub> = pulmonic components of second heart sound. SM = Systolic murmur. The three dimensional arrows show the axes of spectral domains, F = frequency, T = time and I = intensity. ECG and respiratory signals are also shown.

manually in five cardiac cycles at the maximum of inspiration and in another five cycles at the maximum of expiration. The longest  $S_2$  duration during inspiration and the shortest  $S_2$  duration during expiration were chosen for calculation of respiratory variation of the splitting of the  $S_2$  ( $\Delta S_2$ ). The software for spectral analysis (developed at our laboratory) was used to measure the interval from the end of the  $S_1$  to the maximum intensity point in the spectrum ( $T_{\text{imax}}$ ). Time interval measurements are presented in Figure 5 A and B.

#### **D. Automatic detection of heart sounds**

Software was developed for automatic detection of heart sounds and analysis of cardiac murmurs. The ECG signals were high-pass-filtered in order to remove baseline wander, and used as a reference for heart sound detection. The R-waves in the ECG signal were detected using an envelope-based detection algorithm [92]. The time intervals between R-wave peaks (R-R) and between R-waves and the peaks of T-waves (R-T) were measured. The R-R and R-T intervals were used as a reference for heart sound detection. The detection algorithm excludes R-R intervals with a length variation greater than  $\pm 60\%$  of the preceding interval, because this kind of variation must indicate an external disturbance in the registration process. Sound signals, band-pass-filtered with cut-off frequencies of 40 Hz and 1,100 Hz, were processed using the short-time Fourier transform (STFT). Detection of the  $S_1$  and  $S_2$  was based on the time function describing the total spectral power in the interval 40–100 Hz [54, 55]. The signal with the largest spectral power, within the interval 0.05–0.2 R-R, was selected as the  $S_1$ , provided that the selected signal corresponded to a well-defined peak in the time function. The peak was considered well defined if the intensities of the surrounding signals, within an interval of 0.05 R-R, were  $<10\%$  of the intensity of the peak. Detection of the  $S_2$  was performed by the same approach while R-waves and the peak of T-waves were used as references within the interval from 1.2 R-T to 0.6 R-R.

#### **E. Spectral analysis of systolic murmurs**

Sound signals were band-pass-filtered using a fourth-order Butterworth filter (cut-off frequencies 40 Hz and 1,100 Hz) and processed using STFT. In the STFT analysis we made use of a 128 ms window to achieve a reasonable compromise in time-frequency resolution on the heartbeat cycle. For the automatic spectral analysis of

systolic murmur, the first 20% from the beginning of systole and the last 30% were rejected to avoid overlap between the heart sounds ( $S_1$  and  $S_2$ ) and murmurs. To minimize the influence of high-frequency artefacts (crying, motion artefacts, breathing and room noise) the mean intensity in the spectrum above and below 300 Hz was measured. The cardiac cycle was excluded by the analysis algorithm if the mean intensity in the upper frequency region was higher than in the lower frequency region.

The systolic segment was analysed automatically at all four recording points with regard to its mean spectral power (MSp; mean sound intensity, in dB), the maximum intensity of systolic murmur ( $I_{max}$ ), the mean frequency over the entire segment of the murmur ( $F_m$ ; the mean of the frequencies measured per unit of time) and the frequency of the murmur at the point of maximum intensity in the spectrum ( $F_{imax}$ ).

The auscultation point at which the murmur had its highest intensity (PM) was determined for each patient. Frequencies in physiological murmurs are mostly <250 Hz. Therefore the intensity of the systolic murmur was measured for frequencies  $\geq 250$  Hz until the relative energy dropped below 0.01 dB. In order to standardize the variability in intensity due to conduction of the sounds through various tissues with different thickness, the intensity of the murmur was normalized using the intensity of the  $S_1$  as a standard unit. The ratio of the murmur's intensity to the intensity of the  $S_1$  ( $I_{max}/S_1$  intensity) was calculated. This was considered an appropriate standard because the patient population was uniform with respect to heart failure, which would weaken the cardiac contractility and therefore the closing intensity of atrioventricular valves. The intensity of the  $S_1$  was measured within an interval of 0.05 R-R around its peak.

The first frequency peak was calculated using the autoregressive (AR) model. The sound files were viewed and the best six consecutive cardiac cycles were randomly selected. Signals were sampled with 11,025 Hz sampling frequency. The digital signal was filtered with an 8th degree of a 2nd type digital Chebychev low-pass filter with a cut-off frequency of 1,500 Hz. Consequently it was filtered with a 2nd degree digital Butterworth high-pass filter with a cut-off frequency of 50 Hz. The signal was normalized by applying the absolute maximum value to the signal as scaling factor. To estimate the first frequency peak we used the Burg method to fit a 4th-order AR

model to the input signal [88]. The spectral power ratio was defined as the ratio of the spectral power of the signal components  $>200$  Hz to the total spectral power of the signal. The ratio was obtained from the power of spectral density of the filtered and normalized signal. The power spectral density was calculated using Welch's method of 2048-point FFT with hamming windowing function and overlap of 1,024 data points [88, 89]. The power ratio was given in dB. All measured data were collected for statistical analysis.

### **F. Deconvolution of the signals**

The recorded signals made up a convoluted sample. Blind source separation of the cardiac signal was performed. This approach combines singular spectrum analysis (SSA) with independent component analysis (ICA) and denoising source separation (DSS). The SSA and ICA approaches take into account the convolutive nature of the recorded cardiac sounds and the intrinsic statistical characteristics of these signals. The whole approach produces a good set of filtering templates for the DSS algorithmic framework, which is able to isolate murmurs from the main cardiac sounds ( $S_1$  and  $S_2$ ) even in the presence of overlap between signals, and filtrates the artefacts produced by external noises.

### **G. Statistical analyses**

#### **Logistic regression analysis and model design**

To build a model we performed a stepwise logistic regression analysis using the SAS software package, version 6.12 (SAS Institute, Cary, NC, USA). The dependent variables were either cardiac pathology or a normal finding. The independent variables were those derived from signal processing of the murmur and time interval measurements. The standard deviation (SD) of each variable for each patient was calculated from the four auscultation points. These SDs, as well as the patient's sex, age, weight, height, body mass index (BMI) and proportional heart volume, were included as independent variables to predict cardiac pathology. In some patients (those with ASD) the systolic murmur started late, similar to physiological murmur. Therefore, the  $S_1SM$  and  $\Delta S_2$  were combined into one independent variable, a "designed" variable. In this variable the  $S_1SM$  was used as a separate independent variable if its value was 0 (the systolic murmur started at the  $S_1$ ), while if its value was  $>0$  we used  $\Delta S_2$  instead. Alpha to enter and alpha to remove were both set to 0.05.



The fitted model suggested by the stepwise procedure was then examined for adequacy.  $p$ -values  $>0.05$  in the Pearson, deviance and Hosmer-Lemeshow goodness-of-fit tests were required for the fitted model to be considered adequate [93, 94]. Goodness-of-fit tests were performed using the Minitab software package, version 13.2 (Minitab Ltd, Coventry, UK).

The stepwise procedure can exclude variables that may be theoretically relevant, due to multi-collinearity. A model with no multi-collinearity was preferred over a model with multi-collinearity. If the pairwise correlation among independent variables was significant ( $p < 0.05$ ), multi-collinearity was inferred. However, multi-collinearity can exist even without significant pairwise correlation. To ensure that multi-collinearity was not present, a manual addition and deletion of variables was performed to establish the effect on the regression coefficients. Multi-collinearity was inferred in cases where these coefficients were significantly altered after this procedure [95].

The percentages of concordant, discordant and tie pairs were calculated as a measure of association between the observed and the predicted response. A pair (one patient with cardiac pathology and one with a normal finding) was considered concordant if the fitted value for the patient with cardiac pathology was higher than the fitted value for the patient with a normal finding. A pair was considered discordant if the opposite was true while a pair was considered a tie pair if the two fitted values were equal.

Graphical and visual analysis was performed to evaluate the possible outliers in the model; delta chi-square was plotted versus the fitted values and the leverage values. Delta chi-square values  $>3.84$  were considered as a sign of bad fit of the model [94].

### **Receiver operating characteristic curve**

A receiver operating characteristic (ROC) curve was plotted using SPSS, version 11.0.1 (SPSS Inc, Chicago, IL, USA), to graphically show the prediction power of the model. The area under the curve (AUC) was measured by the non-parametric method, and the 95% confidence interval (CI) was calculated. It measures discrimination, or the ability to correctly classify patients. "Area under the curve" is

defined as the number of concordant pairs plus half the number of tied pairs, divided by all the pairs (the number of pairs equals the number of children with cardiac pathology multiplied by the number of children with a normal finding). An AUC of 0.5 as represented by the 45° line in the ROC curve indicates that the model's ability to correctly classify patients is random. An AUC of 0.7–0.8 is considered fair, while an AUC of 0.8–0.9 is considered good, and a value exceeding 0.9 is considered excellent [96, 97].

It has been stated in the literature that an experienced paediatric cardiologist has a 95% sensitivity in distinguishing a physiological murmur from a pathological one [6]. For prediction purposes and to minimize the risk of missing patients with cardiac pathology, a sensitivity of around 95% at the expense of a lower specificity was set as a goal in this work. To find the best threshold for classifying patients with cardiac pathology, various cut-off points (ranging from 0.01 to 0.99 in steps of 0.01) were tested to calculate sensitivity and specificity. A patient was considered to have cardiac pathology if the fitted value was greater than the cut-off point. The cut-off point that maximized specificity and had a sensitivity of around 95% was then chosen as the threshold for prediction purposes.



## RESULTS AND DISCUSSION

### A. Study I: Computer detection of cardiac sounds in children

An algorithm was developed for automatic detection of heart sounds, definition of systole and diastole and analysis of systolic murmur. The  $S_1$  was detected in 100% of records in reference to the R-wave, within the interval  $0.05 R-R-0.2 R-R$ . The  $S_2$  was detected in 97% of records in reference to the R-wave and T-wave, within the interval  $0.6 R-R-1.2 R-T$ . The steps for improving the algorithm for detection of the  $S_2$  are illustrated in Figure 6. The definitions of systole and diastole were attained. Spectral analysis of the systolic murmur was performed.

For computer analysis of the cardiac acoustic signals, the timing and separations of different components of the cardiac cycle are crucial for confirming or excluding cardiac pathology. Based on finding local maximum peaks the linear prediction analysis has been reported to be effective in detection of heart sounds even in cases where the  $S_2$  is buried in the cardiac murmur [98]. In an another study, an algorithm was developed to detect heart sounds, using only R-waves of the ECG signal as a reference [99]. However, variations in the position of the  $S_2$  within the R-R interval due to different heart rate were not emphasized in that algorithm. In paediatric patients with congenital heart disease, heart rate is affected by age or incipient heart failure. With an increase in heart rate the length of diastole decreases more significantly than does that of systole (Figure 7). At higher heart rates the  $S_2$  is therefore located relatively later within the heart cycle.

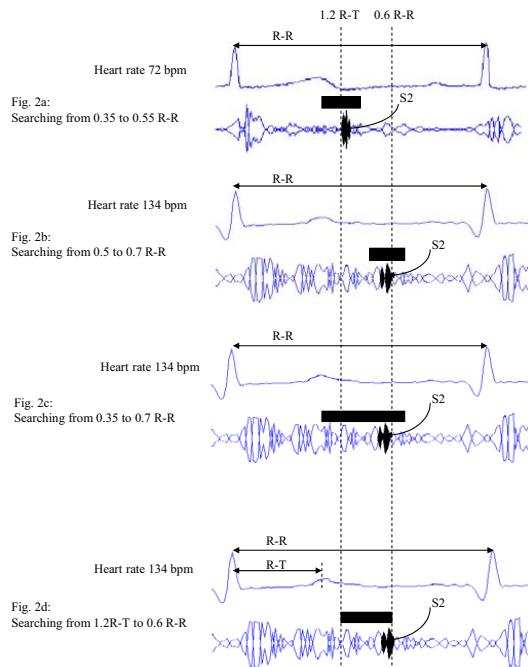

**Figure 6:** Detection algorithms for the second heart sound ( $S_2$ ). Dark rectangles indicate the searching intervals. The two dotted vertical lines indicate the final detection interval. **6a:** Detection of the  $S_2$  in association with normal heart rate in the interval between 0.35 R-R and 0.55 R-R. At a high heart rate the  $S_2$  occurs after this interval. **6b:** Detection of the  $S_2$  in association with a high heart rate and intense systolic murmur, in the interval between 0.5 R-R and 0.7 R-R. The searching interval does not cover the  $S_2$  at a normal heart rate, as seen in Figure 6a. **6c:** The searching interval 0.35–0.7 R-R covers the  $S_2$  both at normal and at a high heart rate but increases the risk of false detection (see text) if a long and intense murmur is present. **6d:** The searching interval 1.2 R-T–0.6 R-R covers the  $S_2$  at both normal and high heart rate. The detection rate is 97% even if a long and intense murmur is present. R-R = interval between R-waves in electrocardiography (ECG); R-T = interval between R and T-waves; bpm = beats per minute.

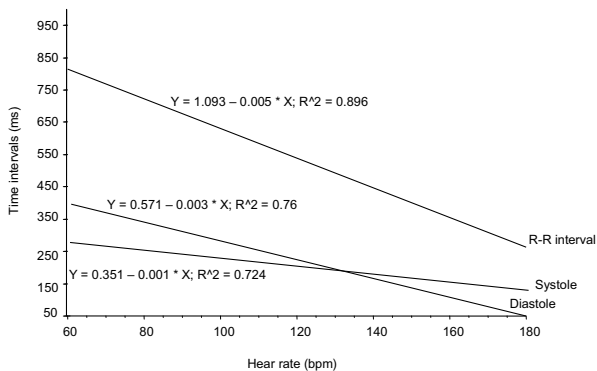

**Figure 7:** Correlation between heart rate and the length of systole, diastole and the R-R interval. ms = millisecond; bpm = beats per minute.

**B. Study II: Detection of cardiac pathology**

The intervals and variables resulted from spectral analysis were used to classify the cardiac murmurs as physiological or pathological ones. Stepwise logistic regression analysis was used for classification of the murmurs. The significant variables were the designed variable ( $S_1Ms$  or  $\Delta S_2$ ),  $I_{max}$ , and standard deviation (SD) of the interval from the end of the  $S_1$  to the maximum intensity of the murmur ( $SDT_{imax}$ ). The best combination of sensitivity and specificity was calculated from the ROC curve at different cut-off points (Figure 8, left panel). A sensitivity of 95% and a corresponding specificity of 72% were achieved at cut-off point 0.45. The ROC curve was also used to test the prediction ability of the model in classifying the cardiac murmurs. The area under the ROC curve was 0.95, which indicates excellent prediction ability (Figure 8, right panel).

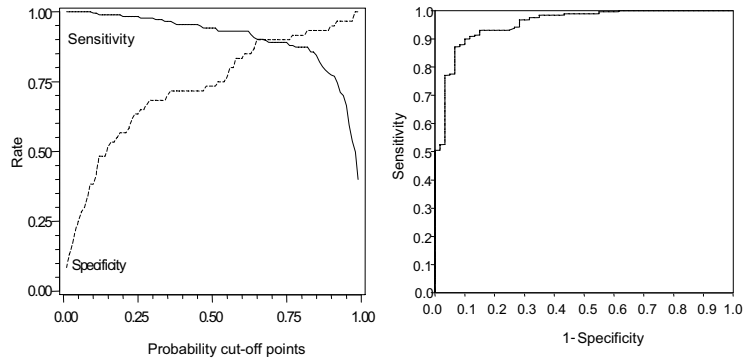

**Figure 8:** Sensitivity and specificity at different probability cut-off points (left). Receiver operating characteristic (ROC) curve (right). The area under the curve (AUC) = 0.95.

The haemodynamically significant cardiac defects were correctly classified. Those misclassified as physiological (involving eight patients) were five small ASDs, a trivial PDA, a small apical muscular VSD, and mild PS. These misclassifications presented no risk of developing congestive heart failure. However, mild defects may predispose to infective endocarditis even if ASD and a small PDA do not pose any risk [100, 101]. Misclassification of haemodynamically mild cardiac defects was mainly due to the elimination of the early part of systolic murmur by the model. Therefore further development of the model is needed. **Study IV** was designed to deal with and correct this deficiency.

### C. Study III: Diagnosis of atrial septal defect

The majority of (five out of eight) misclassifications in **Study II** were cases of ASD. **Study III** was designed to distinguish signals caused by ASD from physiological murmur. The recorded signals were analysed and the intervals were measured in the same manner as in **Study II**. The significant distinguishing variables were the designed variable ( $S_1Ms$  or  $\Delta S_2$ ) and the Fimax. The sensitivity of the model was 94% and a specificity of 71% was achieved at cut-off point 0.27 (Figure 9, left panel).

The area under the ROC curve was 0.922, indicating very good fit of the model. The 95% CI was 0.872–0.971 (Figure 9, right panel). The diagnosis of ASD is mainly dependent on the duration of the  $S_2$  and its variation with respiration, which is included in the designed variable.

A systolic murmur is present in only 60% of patients with ASD and is physiological in character. It is caused by an overflow of the large stroke volume ejected from the right ventricle. It is therefore essential to include interval analyses for diagnosis of ASD.

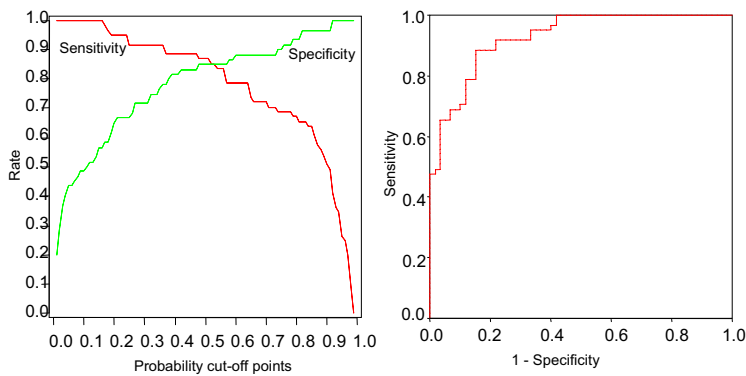

**Figure 9:** Sensitivity and specificity at different cut-off points (left). Receiver-operating characteristic (ROC) curve (right). The area under the curve (AUC) = 0.922.

#### D. Designing the statistical model

Various statistical methods can be applied to classify data. In **studies II** and **III** binary stepwise logistic regression analysis was used to design the statistical model. One of our main requirements was that the model must predict the probability of class membership. Models that do not give probability (i.e. support vector machines) were therefore not considered. Logistic regression, k-nearest neighbour and decision trees are examples of methods that could be applied.



In k-nearest neighbour the probability for a given observation is calculated as the ratio of members of class  $y$  among the  $k$ -nearest neighbours of the given observation. The value that  $k$  takes can greatly affect the result. An additional difficulty with k-nearest neighbour arises when many variables are included. If the relative importance of variables is not weighted, then data from irrelevant variables have an equal impact to data from an important variable [102]. Since no prior knowledge existed about which variables to include or how different weights should be created, this method was not applied. However, this approach could be considered in future analysis when more is known about which variables should be included for prediction of patients with cardiac pathology.

The decision tree is built up of nodes, whose main node is the dependent variable. Data are split into groups with the goal of maximizing the separation of the data. Some prior knowledge regarding best and second best variables to be included in the tree is necessary before this method can be applied. In addition, when working with continuous variables, a method for how to split them into groups is needed to obtain the nodes. Since this was an explorative study, we did not have any prior knowledge of which variables to include or how the independent variables should be split, and consequently chose not to apply this method [103].

The reason for selecting the logistic regression model was that it gave us not only a probability of class membership but also the chance to study the impact of different variables through its coefficients. The stepwise procedure is also convenient when it comes to choosing variables for inclusion in an explorative study.

#### **E. Overlap between signals and artefact filtering**

In **studies I–III** the overlap between heart sounds and systolic murmur was considered a limitation. This was solved by elimination of the early and late parts of systole. However, this may lead to missing small muscular VSDs and mild semilunar valve stenoses, which generate an early, short systolic murmur.

Infants and preschool children (the commonest age with physiological cardiac murmur) may not be cooperative during sound recordings. Artefacts such as crying, motion artefacts, breathing and room noise in the recorded signal are generated and

affect the original heart sound and murmur signal. The final results of the signal analyses may consequently be incorrect. These artefacts contain sounds with higher intensities in the upper frequency area compared with the heart sounds and murmurs, and overlap with the cardiac signals. To solve these difficulties and minimize their effect the mean intensity in the spectrum above and below 300 Hz was measured. The cardiac cycle was excluded if the mean intensity in the upper frequency region was higher than that in the lower frequency region. This solution gave significant improvements in the performance of our algorithm; however, further development was needed.

#### **F. Study IV: Blind signal separation**

In this study we aimed to solve the problem of overlapping of heart sounds and murmurs and effects of artefact on the final analysis, which was a limitation of **studies I–III**. We included the whole systolic murmur in the analysis. Using SSA, ICA and DSS, we addressed the problem by applying blind separation of convolutive mixtures of the signal [86, 104-107]. The cardiac sounds and murmur could be deconvoluted, visualized and analysed [108-112].

The overlap between heart sounds and murmur in **studies I and II** was avoided by elimination of the first 20% and the last 30% of systole. This solution was considered suboptimal because there is a risk of missing some of the cardiac pathology. Moreover, the artefacts from room noise and babies crying and movements further hampered the final analysis. The blind separation analysis addressed the problem of the convolutive nature of the samples. It yielded two spatially independent sources, heart sounds ( $S_1$  and  $S_2$ ) in one component and a murmur as raw, pure and whole signals in another. The results will have a strong impact on the final analysis of cardiac acoustic signals for the diagnosis of cardiac pathology. Further work including this analysis is in progress.

#### **G. Study V: First frequency peak**

In **Study II** we were able to distinguish the haemodynamically significant cardiac defects but the specificity was poor (71%). There was a need for further improvement of the prediction power of the statistical model. The first frequency peak was measured and added to the logistic regression analysis. This led to achievement of

sensitivity and specificity of 98% at probability cut-off point 0.35–0.63 (Figure 10, left panel). The area under the ROC curve was 0.995, indicating a perfect fit of the model for a correct murmur classification (Figure 10, right panel). The 95% CI for the AUC was 0.986–1.003.

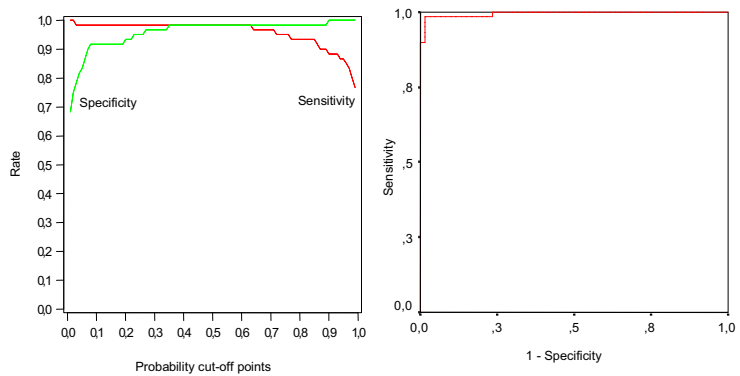

**Figure 10:** Sensitivity and specificity at different probability cut-off points (left). Receiver operating characteristic (ROC) curve (right). The area under the curve (AUC) = 0.995.

The first frequency peak depends on the spectral property of the cardiac acoustic signal. It was higher in the pathological murmurs than in the physiological ones. It has elsewhere been reported to be a strong discriminating variable between physiological and pathological cardiac murmurs [78].

## CONCLUSION AND FINAL REMARK

Although mounting evidence suggests that auscultation of the heart is a sensitive and specific method, little attention has been paid to development of this method during the last three decades. Likewise, despite the growing body of data that emphasize the significance of advanced computing techniques in signal processing and analysis, this aspect has as yet been insufficiently involved in analysis of acoustic signals from the heart for clinical evaluation of cardiac murmurs. The studies presented herein are among the first involving clinical data, computerized data acquisition and acoustic signal analysis, and concerned with developing a statistical model for diagnosis of cardiac disease. Nevertheless, it is conceivable that other signal analysis methods such as artificial neural network models may have good diagnostic power in evaluation of cardiac murmur. Combining STFT for signal analysis with time interval measurements and logistic regression analysis to design a diagnostic statistical model seems to be an appropriate method for characterizing cardiac acoustic signals. The analytical potential is powerful and can be used for primary diagnosis of cardiac disease.

Detection of cardiac sounds and definition of systole and diastole are the first steps towards automating the analysis of cardiac acoustic signals. Many earlier studies have been performed along these lines but until now all have been done in adults. The automatic detection of the  $S_2$  is a very complex process. Our **studies I** and **IV** provide a solution for automatic cardiac sound detection in children. Although the algorithm has not yet been tested blindly, its detection power presented in the study is promising.

**Study IV** is one of the first studies to emphasize the power of deconvolution of cardiac acoustic signals. It provides new mechanistic insights into signal processing and analysis. The blind separation analysis can separate signals and present them in raw, pure and free forms for further analysis even with overlap between heart sounds and murmurs.

The data analysis is useful for optimizing current clinical teaching and training in cardiac auscultation. Prospective clinical studies are important in that they can validate or refute the validity and importance of the described method in evaluation of

cardiac disease. Minimizing the psychological anxiety of the children and their parents when a cardiac murmur is accidentally found is essential.

What makes a heart murmur innocent or guilty? The answer to this question includes the characteristics of the murmur in the context of the patient's total cardiovascular examination, which is an important part of the evaluation of patients. Digital analysis of cardiac acoustic signals may prove valuable in decreasing the insecurity felt by parents and their children, as well as by doctors. It may also decrease the costs of the health care provided. Further developmental work on multiple-channel recordings is in progress.

### LIMITATION OF THE STUDY

In the present thesis the analysis of diastolic murmur has not been included. All diastolic murmurs except venous hum are pathological. The present thesis has focused solely on classifying the systolic murmur and on distinguishing physiological from pathological murmurs.

Systolic clicks are present in children with semilunar valve stenoses. Addition of their analysis to the diagnostic model still needs to be tested.

In this thesis work we did not attempt to classify cardiac defects according to the diagnosis and grades of severity. These steps need further study and assessment before the described method can be put to diagnostic use.

A diagnostic device for automatic diagnosis of cardiac acoustic signals needs to be implemented. Below follows a suggestion for a complete diagnostic algorithm for a child with a cardiac murmur, using acoustic signal analysis. It is presented in the two parts (1 and 2) of Figure 11 below.

#### Part 1

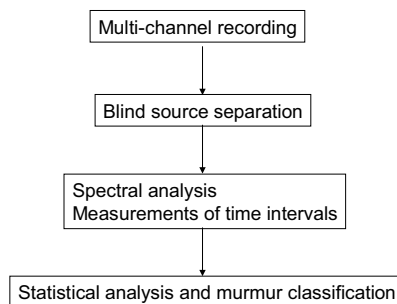

Part 2

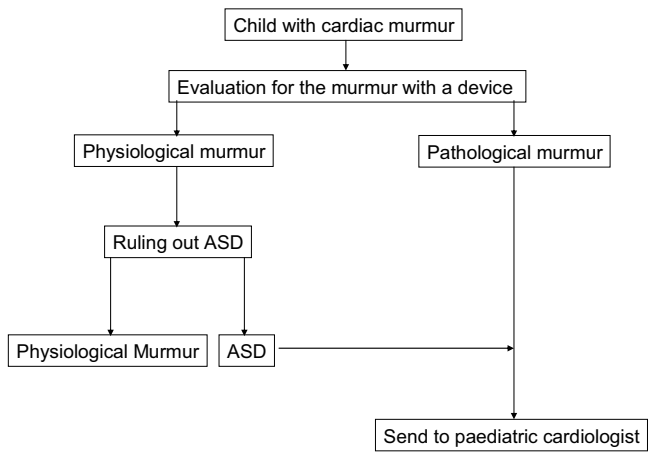

**Figure 11:** Diagnostic algorithm for classifying cardiac murmurs in children, using acoustic signal analysis. ASD = atrial septal defect.

## ACKNOWLEDGEMENTS

I wish to express my sincere gratitude to all those who have contributed to my education and these studies. Many thanks go to all my collaborators, colleagues and friends at the Department of Paediatrics, Lund and Malmö University Hospitals, and especially to –

**Erkki Pesonen**, professor, my supervisor and tutor, for giving me the opportunity and inspiring me to do research, making me believe that we have methods, the possibility and the resources to carry out this project, and for his enthusiasm and patience.

**Göran Wettrell**, associated professor, my clinical supervisor, for giving me excellent and constructive guidance and training in clinical paediatric cardiology.

**Gudrun Björkhem**, associated professor, and **Nils-Rune Lundström**, professor emeritus, for their extraordinary support and encouragement in both my research and clinical work.

**Katarina Hanséus**, Chief Consultant of the Paediatric Cardiology Department, at Lund University Hospital, for her kindness and willingness to help me get free time in which to carry out my research.

**Leif Sörnmo**, professor, and **Ola Lilja**, civil engineer, both at Lund Technical High School, Lund University, for sharing their extensive knowledge, for their advice in the field of signal processing and for their valuable expertise and discussion regarding how to perform and describe the signal analysis methods.

**Rimo Sepponen**, professor, and **Sakari Lukkarinen**, **Ricardo Nuno Vigário** and **Astrid Pietila**, civil engineers at Helsinki University of Technology, for their help, for contributing their ideas and for engaging in many a fruitful discussion through all the years and during my frequent stays in Helsinki.

**Kristoffer Peters** and **Johan Ingemansson**, statisticians, for being such pleasant mates and for designing and expertly performing the statistical analyses in all described studies.



**Laura O’Sullivan-Darsy**, **Annica Maxedius**, research nurses, and **Britt-Marie Nilsson-Brandt**, secretary, for their endless help in putting me in contact with the patients and their parents, for their positive attitude and kind support through all the years and for encouraging me to continue my doctoral project.

Likewise, my thanks go to **Solweig Harling**, **Thomas Higgins**, **Elhadi Aburawi**, **Eva Fernlund**, **Petru Liuba**, **Peter Munkhammar**, **Rolf Benhagen** and all members of staff at the Department of Paediatric Cardiology, at Lund University Hospital, for making my everyday work interesting and worthwhile.

Last but not the least, to my wife **Awatif** and children **Zakaria**, **Osama**, and **Afnan**, for your unrestricted love, support, tolerance and faith in me, no matter what, when or how. This work and all others in my life are dedicated to you.

### **Grants**

These studies were supported by generous grants from the Swedish Heart-Lung Foundation and Lund University Hospital.

**REFERENCES**

1. Webster, R., *The stethoscope as a diagnostic tool*. Aust Fam Physician, 1976. **5**(1): p. 16-31.
2. Patton, C. and E. Hey, *How effectively can clinical examination pick up congenital heart disease at birth?* Arch Dis Child Fetal Neonatal Ed, 2006. **91**(4): p. F263-7.
3. Rajakumar, K., et al., *Comparative study of clinical evaluation of heart murmurs by general pediatricians and pediatric cardiologists*. Clin Pediatr (Phila), 1999. **38**(9): p. 511-8.
4. McCrindle, B.W., et al., *Cardinal clinical signs in the differentiation of heart murmurs in children*. Arch Pediatr Adolesc Med, 1996. **150**(2): p. 169-74.
5. Newburger, J.W., et al., *Noninvasive tests in the initial evaluation of heart murmurs in children*. N Engl J Med, 1983. **308**(2): p. 61-4.
6. Smythe, J.F., et al., *Initial evaluation of heart murmurs: are laboratory tests necessary?* Pediatrics, 1990. **86**(4): p. 497-500.
7. Geva, T., J. Hegesh, and M. Frand, *Reappraisal of the approach to the child with heart murmurs: is echocardiography mandatory?* Int J Cardiol, 1988. **19**(1): p. 107-13.
8. Advani, N., S. Menahem, and J.L. Wilkinson, *The diagnosis of innocent murmurs in childhood*. Cardiol Young, 2000. **10**(4): p. 340-2.
9. Temmerman, A.M., E.L. Mooyaart, and P.P. Taverne, *The value of the routine chest roentgenogram in the cardiological evaluation of infants and children. A prospective study*. Eur J Pediatr, 1991. **150**(9): p. 623-6.
10. Hansen, L.K., N.H. Birkebaek, and H. Oxhoj, *[Pediatric evaluation of children with heart murmurs]*. Ugeskr Laeger, 1995. **157**(42): p. 5862-3.
11. Birkebaek, N.H., L.K. Hansen, and H. Oxhoj, *Diagnostic value of chest radiography and electrocardiography in the evaluation of asymptomatic children with a cardiac murmur*. Acta Paediatr, 1995. **84**(12): p. 1379-81.
12. Amaral, F.T., J.A. Granzotti, and M.A. Nunes, *[Management of children with heart murmurs. Diagnostic importance of noninvasive complementary tests]*. Arq Bras Cardiol, 1995. **64**(3): p. 195-9.
13. Macleod, C., *Evaluating cardiac murmurs; are diagnostic tests helpful?* Ir Med J, 2001. **94**(5): p. 154-5.
14. Lembo, N.J., et al., *Bedside diagnosis of systolic murmurs*. N Engl J Med, 1988. **318**(24): p. 1572-8.

15. Swenson, J.M., et al., *Are chest radiographs and electrocardiograms still valuable in evaluating new pediatric patients with heart murmurs or chest pain?* *Pediatrics*, 1997. **99**(1): p. 1-3.
16. Abella, M., J. Formolo, and D.G. Penney, *Comparison of the acoustic properties of six popular stethoscopes*. *J Acoust Soc Am*, 1992. **91**(4 Pt 1): p. 2224-8.
17. Kindig, J.R., et al., *Acoustical performance of the stethoscope: a comparative analysis*. *Am Heart J*, 1982. **104**(2 Pt 1): p. 269-75.
18. Hoyte, H., T. Jensen, and K. Gjesdal, *Cardiac auscultation training of medical students: a comparison of electronic sensor-based and acoustic stethoscopes*. *BMC Med Educ*, 2005. **5**(1): p. 14.
19. Tavel, M.E., *Cardiac auscultation: a glorious past--and it does have a future!* *Circulation*, 2006. **113**(9): p. 1255-9.
20. Grenier, M.C., et al., *Clinical comparison of acoustic and electronic stethoscopes and design of a new electronic stethoscope*. *Am J Cardiol*, 1998. **81**(5): p. 653-6.
21. Danford, D.A., A. Nasir, and C. Gumbiner, *Cost assessment of the evaluation of heart murmurs in children*. *Pediatrics*, 1993. **91**(2): p. 365-8.
22. Fogel, D., *The innocent heart murmur in children: a clinical study of its incidence and characteristics*. *Am Heart J*, 1960. **59**: p. 844-855.
23. Rosenthal, A., *How to distinguish between innocent and pathologic murmurs in childhood*. *Pediatr Clin North Am*, 1984. **31**(6): p. 1229-40.
24. Henikoff, L.M., W.A. Stevens, Jr., and L.W. Perry, *Detection of heart disease in children, 1919-1967*. *Circulation*, 1968. **38**(2): p. 375-85.
25. Ferencz, C., et al., *Congenital heart disease: prevalence at livebirth. The Baltimore-Washington Infant Study*. *Am J Epidemiol*, 1985. **121**(1): p. 31-6.
26. Hurrell, D.G., J.W. Bachman, and R.H. Feldt, *How to evaluate murmurs in children*. *Postgrad Med*, 1989. **86**(2): p. 239-41, 243.
27. Gaskin, P.R., et al., *Clinical auscultation skills in pediatric residents*. *Pediatrics*, 2000. **105**(6): p. 1184-7.
28. Ishmail, A.A., et al., *Interobserver agreement by auscultation in the presence of a third heart sound in patients with congestive heart failure*. *Chest*, 1987. **91**(6): p. 870-3.
29. Jordan, M.D., et al., *Audibility of the fourth heart sound. Relationship to presence of disease and examiner experience*. *Arch Intern Med*, 1987. **147**(4): p. 721-6.

30. Mangione, S. and L.Z. Nieman, *Cardiac auscultatory skills of internal medicine and family practice trainees. A comparison of diagnostic proficiency.* *Jama*, 1997. **278**(9): p. 717-22.
31. Lam, M.Z., et al., *Factors influencing cardiac auscultation proficiency in physician trainees.* *Singapore Med J*, 2005. **46**(1): p. 11-4.
32. Noonan, J., *Innocent murmur and the pediatrician.* *Clin Pediatr (Phila)*, 1999. **38**(9): p. 519-20.
33. Daniels, O., *Outpatient referrals to tertiary paediatric cardiac centres.* *Cardiol Young*, 2005. **15**(4): p. 439; author reply 439.
34. Murugan, S.J., et al., *New outpatient referrals to a tertiary paediatric cardiac centre: evidence of increasing workload and evolving patterns of referral.* *Cardiol Young*, 2005. **15**(1): p. 43-6.
35. St Clair, E.W., et al., *Assessing housestaff diagnostic skills using a cardiology patient simulator.* *Ann Intern Med*, 1992. **117**(9): p. 751-6.
36. Tavel, M.E., *Cardiac auscultation. A glorious past--but does it have a future?* *Circulation*, 1996. **93**(6): p. 1250-3.
37. McNamara, D.G., *Value and limitations of auscultation in the management of congenital heart disease.* *Pediatr Clin North Am*, 1990. **37**(1): p. 93-113.
38. McCrindle, B.W., et al., *An evaluation of parental concerns and misperceptions about heart murmurs.* *Clin Pediatr (Phila)*, 1995. **34**(1): p. 25-31.
39. Geggel, R.L., et al., *Parental anxiety associated with referral of a child to a pediatric cardiologist for evaluation of a Still's murmur.* *J Pediatr*, 2002. **140**(6): p. 747-52.
40. Advani, N., S. Menahem, and J.L. Wilkinson, *Innocent murmurs: the perception of the parents versus that of the child.* *Cardiol Young*, 2002. **12**(6): p. 587-8.
41. Giuffre, R.M., et al., *Opening Pandora's box: parental anxiety and the assessment of childhood murmurs.* *Can J Cardiol*, 2002. **18**(4): p. 406-14.
42. Van Oort, A., et al., *The vibratory innocent heart murmur in schoolchildren: a case-control Doppler echocardiographic study.* *Pediatr Cardiol*, 1994. **15**(6): p. 275-81.
43. McLaren, M.J., et al., *Innocent murmurs and third heart sounds in Black schoolchildren.* *Br Heart J*, 1980. **43**(1): p. 67-73.
44. Bergman, A.B. and S.J. Stamm, *The morbidity of cardiac nondisease in schoolchildren.* *N Engl J Med*, 1967. **276**(18): p. 1008-13.
45. McDonald, I.G., et al., *Opening Pandora's box: the unpredictability of reassurance by a normal test result.* *Bmj*, 1996. **313**(7053): p. 329-32.

46. Coleman, E.N. and W.B. Doig, *Diagnostic problems with innocent murmurs in children*. Lancet, 1970. **2**(7666): p. 228-32.
47. Scanlon, J.W., *Do parents need to know more about innocent murmurs? Experiences with an instructional fact sheet*. Clin Pediatr (Phila), 1971. **10**(1): p. 23-6.
48. Young, P.C., *The morbidity of cardiac nondisease revisited. Is there lingering concern associated with an innocent murmur?* Am J Dis Child, 1993. **147**(9): p. 975-7.
49. Danford, D.A., *Cost-effectiveness of echocardiography for evaluation of children with murmurs*. Echocardiography, 1995. **12**(2): p. 153-62.
50. Haney, I., et al., *Accuracy of clinical assessment of heart murmurs by office based (general practice) paediatricians*. Arch Dis Child, 1999. **81**(5): p. 409-12.
51. Maurice B. Rappaport, E.E., Haward B. Sprague M. D., *The Acoustic Stethoscope and the Electrical Amplifying Stethoscope and Stethograph*. Am Heart J, 1940. **21**(3): p. 257-318.
52. Pelech, A.N., *The cardiac murmur. When to refer?* Pediatr Clin North Am, 1998. **45**(1): p. 107-22.
53. Van Oort, A., et al., *The vibratory innocent heart murmur in schoolchildren: difference in auscultatory findings between school medical officers and a pediatric cardiologist*. Pediatr Cardiol, 1994. **15**(6): p. 282-7.
54. Selig, M.B., *Stethoscopic and phonoaudio devices: historical and future perspectives*. Am Heart J, 1993. **126**(1): p. 262-8.
55. Rangayyan, R.M. and R.J. Lehner, *Phonocardiogram signal analysis: a review*. Crit Rev Biomed Eng, 1987. **15**(3): p. 211-36.
56. Craige, E., *On the genesis of heart sounds. Contributions made by echocardiographic studies*. Circulation, 1976. **53**(2): p. 207-9.
57. Ronan, J.A., Jr., *Cardiac auscultation: the first and second heart sounds*. Heart Dis Stroke, 1992. **1**(3): p. 113-6.
58. Hanna, I.R. and M.E. Silverman, *A history of cardiac auscultation and some of its contributors*. Am J Cardiol, 2002. **90**(3): p. 259-67.
59. Luisada, A.A., et al., *Changing views on the mechanism of the first and second heart sounds*. Am Heart J, 1974. **88**(4): p. 503-14.
60. Stein, P.D. and H. Sabbah, *Intensity of the second heart sound. Relation of physical, physiological and anatomic factors to auscultatory evaluation*. Henry Ford Hosp Med J, 1980. **28**(4): p. 205-9.

61. Ishikawa, K. and T. Tamura, *Study of respiratory influence on the intensity of heart sound in normal subjects*. *Angiology*, 1979. **30**(11): p. 750-5.
62. Shaver, J.A. and J.D. O'Toole, *The second heart sound: newer concepts. Part I. Normal and wide physiological splitting*. *Mod Concepts Cardiovasc Dis*, 1977. **46**(2): p. 7-12.
63. O'Toole, J.D., et al., *The mechanism of splitting of the second heart sound in atrial septal defect*. *Circulation*, 1977. **56**(6): p. 1047-53.
64. Adolph, R., *Second Heart Sound: The role of altered electromechanical events, in Physiologic Principles of Heart sounds and Murmur*. Dallas, American Heart Association, 1975. **Monograph No. 46**: p. 45-57.
65. Curtiss, E.I., R.G. Matthews, and J.A. Shaver, *Mechanism of normal splitting of the second heart sound*. *Circulation*, 1975. **51**(1): p. 157-64.
66. Abrams, J., *Current concepts of the genesis of heart sounds. I. First and second sounds*. *Jama*, 1978. **239**(26): p. 2787-9.
67. Gessner, I.H., *What makes a heart murmur innocent?* *Pediatr Ann*, 1997. **26**(2): p. 82-4, 87-8, 90-1.
68. Stefani, T. and D. Otto, *How classical are the clinical features of the "ostium secundum" atrial septal defect*. *Cardiol Young*, 1997. **7**: p. 294-301.
69. Campbell, M., *Natural history of atrial septal defect*. *Br Heart J*, 1970. **32**: p. 820-826.
70. Engelfriet, P.M., et al., *Pulmonary arterial hypertension in adults born with a heart septal defect*. *Heart*, 2006.
71. Nygaard, H., et al., *Assessing the severity of aortic valve stenosis by spectral analysis of cardiac murmurs (spectral vibrocardiography). Part I: Technical aspects*. *J Heart Valve Dis*, 1993. **2**(4): p. 454-67.
72. Nygaard, H., et al., *Assessing the severity of aortic valve stenosis by spectral analysis of cardiac murmurs (spectral vibrocardiography). Part II: Clinical aspects*. *J Heart Valve Dis*, 1993. **2**(4): p. 468-75.
73. Donnerstein, R.L., *Continuous spectral analysis of heart murmurs for evaluating stenotic cardiac lesions*. *Am J Cardiol*, 1989. **64**(10): p. 625-30.
74. Tavel, M.E., D.D. Brown, and D. Shander, *Enhanced auscultation with a new graphic display system*. *Arch Intern Med*, 1994. **154**(8): p. 893-8.
75. Wood, J.C., A.J. Buda, and D.T. Barry, *Time-frequency transforms: a new approach to first heart sound frequency dynamics*. *IEEE Trans Biomed Eng*, 1992. **39**(7): p. 730-40.

76. Wood, J.C. and D.T. Barry, *Quantification of first heart sound frequency dynamics across the human chest wall*. Med Biol Eng Comput, 1994. **32**(4 Suppl): p. S71-8.
77. DeGross, C.G., et al., *Artificial neural network-based method of screening heart murmurs in children*. Circulation, 2001. **103**(22): p. 2711-6.
78. Tavel, M.E. and H. Katz, *Usefulness of a new sound spectral averaging technique to distinguish an innocent systolic murmur from that of aortic stenosis*. Am J Cardiol, 2005. **95**(7): p. 902-4.
79. Bulgryn, J.R., et al., *Comparison of short-time Fourier, wavelet and time-domain analyses of intracardiac sounds*. Biomed Sci Instrum, 1993. **29**: p. 465-72.
80. Dahl, L.B., et al., *Heart murmurs recorded by a sensor based electronic stethoscope and e-mailed for remote assessment*. Arch Dis Child, 2002. **87**(4): p. 297-301; discussion 297-301.
81. Johanson, M., M. Gustafsson, and L.A. Johansson, *A remote auscultation tool for advanced home health-care*. J Telemed Telecare, 2002. **8 Suppl 2**: p. 45-7.
82. Kofos, D., et al., *Telemedicine in pediatric transport: a feasibility study*. Pediatrics, 1998. **102**(5): p. E58.
83. Thompson, W.R., et al., *Automated cardiac auscultation for detection of pathologic heart murmurs*. Pediatr Cardiol, 2001. **22**(5): p. 373-9.
84. Balster, D.A., et al., *Digital acoustic analysis of precordial innocent versus ventricular septal defect murmurs in children*. Am J Cardiol, 1997. **79**(11): p. 1552-5.
85. Caron, J.N., *Blind deconvolution of audio-frequency signals using the self-deconvolving data restoration algorithm*. J Acoust Soc Am, 2004. **116**(1): p. 373-8.
86. Koivunen, V., M. Enescu, and E. Oja, *Adaptive algorithm for blind separation from noisy time-varying mixtures*. Neural Comput, 2001. **13**(10): p. 2339-57.
87. Lockwood, M.E., et al., *Performance of time- and frequency-domain binaural beamformers based on recorded signals from real rooms*. J Acoust Soc Am, 2004. **115**(1): p. 379-91.
88. The MathWorks, I., *Signal Processing Toolbox, User's Guide, Version 6*. 2006, The MathWorks, Inc.
89. DeFatta, D., J. Lucas, and W. Hodgkiss, *Digital Signal Processing: A System Design Approach*. 1988, New York: John Wiley & Sons.
90. Lukkarinen, S., et al., *A New Phonocardiographic Recording System*. Computer in Cardiology, 1997. **24**: p. 117-120.
91. Littmann, D., *An approach to the ideal stethoscope*. Jama, 1961. **178**: p. 504-5.

92. Nygard, M. and L. Sornmo, *Delineation of the QRS complex using the envelope of the e.c.g.* Med Biol Eng Comput, 1983. **Sep;21(5)**: p. 538-47.
93. Pearson, E.S., *Studies in the History of Probability and Statistics. Xiv. Some Incidents in the Early History of Biometry and Statistics, 1890-94.* Biometrika, 1965. **52**: p. 3-18.
94. Hosmer, D.W. and S. Lemeshow, *Applied Logistic Regression.* Wiley, New York, 1989. **3ed edn.**
95. Kmenta, J., *Elements of Econometrics.* New York McGraw-Hill, 1986: p. 434.
96. Lasko, T.A., et al., *The use of receiver operating characteristic curves in biomedical informatics.* J Biomed Inform, 2005. **38(5)**: p. 404-15.
97. Gönen, M., *Receiver Operating Characteristic (ROC) Curves.* Proceedings of the 31st Annual SAS(R) Users Group International Conference. Cary, NC. SAS Institute Inc., 2006: p. 210-31.
98. Iwata, A., et al., *Algorithm for detecting the first and the second heart sounds by spectral tracking.* Med Biol Eng Comput, 1980. **18(1)**: p. 19-26.
99. Baranek, H.L., et al., *Automatic detection of sounds and murmurs in patients with Ionescu-Shiley aortic bioprostheses.* Med Biol Eng Comput, 1989. **27(5)**: p. 449-55.
100. Thilen, U., *Infective Endocarditis in Adults with Congenital Heart Disease.* Curr Infect Dis Rep, 2003. **5(4)**: p. 300-306.
101. Hoen, B., *Epidemiology and antibiotic treatment of infective endocarditis: an update.* Heart, 2006. **92(11)**: p. 1694-700.
102. Dreiseitl, S. and L. Ohno-Machado, *Logistic regression and artificial neural network classification models: a methodology review.* J Biomed Inform, 2002. **35(5-6)**: p. 352-9.
103. Breiman, L., *Classification and regression trees.* Belmont, CA: Wadsworth, 1984.
104. Barbati, G., et al., *Optimization of an independent component analysis approach for artifact identification and removal in magnetoencephalographic signals.* Clin Neurophysiol, 2004. **115(5)**: p. 1220-32.
105. Zarzoso, V. and A.K. Nandi, *Noninvasive fetal electrocardiogram extraction: blind separation versus adaptive noise cancellation.* IEEE Trans Biomed Eng, 2001. **48(1)**: p. 12-8.
106. Boscolo, R., H. Pan, and V.P. Roychowdhury, *Independent component analysis based on nonparametric density estimation.* IEEE Trans Neural Netw, 2004. **15(1)**: p. 55-65.



107. Jancovic, P. and J. Ming, *A probabilistic union model with automatic order selection for noisy speech recognition*. J Acoust Soc Am, 2001. **110**(3 Pt 1): p. 1641-8.
108. Wubbeler, G., et al., *Independent component analysis of noninvasively recorded cortical magnetic DC-fields in humans*. IEEE Trans Biomed Eng, 2000. **47**(5): p. 594-9.
109. Maeda, S., et al., *Separation of signal and noise from in vivo optical recording in Guinea pigs using independent component analysis*. Neurosci Lett, 2001. **302**(2-3): p. 137-40.
110. Pietilä, A., et al., *Blind Source Separation of Cardiac Murmurs from Heart Recordings*. Lecture Notes in Computer Science, 2006. **3889 / 2006**: p. 470 - 477.
111. Schiessl, I., et al., *Blind signal separation from optical imaging recordings with extended spatial decorrelation*. IEEE Trans Biomed Eng, 2000. **47**(5): p. 573-7.
112. Stetter, M., et al., *Principal component analysis and blind separation of sources for optical imaging of intrinsic signals*. Neuroimage, 2000. **11**(5 Pt 1): p. 482-90.