



LUND UNIVERSITY

Development of Methods for Measuring Protein C Inhibitor and Antithrombin: Use of Monoclonal Antibodies against the Reactive Center Loop-Inserted Forms of the Serpins

Kjellberg, Margareta

2007

[Link to publication](#)

Citation for published version (APA):

Kjellberg, M. (2007). *Development of Methods for Measuring Protein C Inhibitor and Antithrombin: Use of Monoclonal Antibodies against the Reactive Center Loop-Inserted Forms of the Serpins*. [Doctoral Thesis (compilation), Clinical Chemistry, Malmö]. Department of Laboratory Medicine, Lund University.

Total number of authors:

1

General rights

Unless other specific re-use rights are stated the following general rights apply:

Copyright and moral rights for the publications made accessible in the public portal are retained by the authors and/or other copyright owners and it is a condition of accessing publications that users recognise and abide by the legal requirements associated with these rights.

- Users may download and print one copy of any publication from the public portal for the purpose of private study or research.
- You may not further distribute the material or use it for any profit-making activity or commercial gain
- You may freely distribute the URL identifying the publication in the public portal

Read more about Creative commons licenses: <https://creativecommons.org/licenses/>

Take down policy

If you believe that this document breaches copyright please contact us providing details, and we will remove access to the work immediately and investigate your claim.

LUND UNIVERSITY

PO Box 117
221 00 Lund
+46 46-222 00 00

**Development of Methods for Measuring Protein C
Inhibitor and Antithrombin: Use of Monoclonal
Antibodies against the Reactive Center Loop-Inserted
Forms of the Serpins**

Doctoral Thesis

Margareta Kjellberg

LUND UNIVERSITY
Faculty of Medicine

Department of Laboratory Medicine, Division of Clinical Chemistry, Lund
University, University Hospital Malmö, Sweden

2007

© Margareta Kjellberg 2007

ISSN 1652-8220

ISBN 978-91-85559-27-5

Lund University, Faculty of Medicine Doctoral Dissertation Series 2007:49

Development of Methods for Measuring Protein C Inhibitor and Antithrombin: Use of Monoclonal Antibodies against the Reactive Center Loop-Inserted Forms of the Serpins

by
Margareta Kjellberg

Institutionen för laboriemedicin, avdelningen för klinisk kemi,
Universitetssjukhuset MAS, Malmö
Lunds Universitet

Akademisk avhandling

som med vederbörligt tillstånd av Medicinska fakulteten vid Lunds Universitet för
avläggande av doktorsexamen i medicinsk vetenskap kommer att offentligen
försvaras i Jubileumsaulan, Medicinskt Forskningscentrum, ingång 59,
Universitetssjukhuset MAS, Malmö, fredagen den 30 mars 2007, kl 13.15

Fakultetsopponent är professor Agneta Siegbahn, Uppsala Universitet

Contents

List of papers	7
Abbreviations	8
Introduction	9
Background	9
Main principles of immunoassay techniques.....	9
General structure of proteins	11
Serine protease inhibitors	12
Structure.....	12
Function	14
Regulation by heparin	17
Clearance of serpins and serpin-protease complexes.....	19
Antithrombin	19
Protein C inhibitor	20
Hemostasis	20
Primary hemostasis.....	21
Blood coagulation.....	21
Fibrinolysis	25
Regulation of coagulation.....	25
Anticoagulation mediated by activated protein C	26
The present studies	28
Characterization of an antibody against cleaved PCI.....	28
Development of an immunoassay for measurement of APC-PCI complex	29
Crystallization and exploration of the structure of cleaved PCI	32
Characterization of an antibody against cleaved and latent AT and development of an immunoassay for measuring cleaved AT	35
Characterization of an antibody against latent AT and development of an immunoassay for measurement of latent AT.....	36

Summary.....	39
Populärvetenskaplig sammanfattning.....	41
Tack	43
References	44
Appendix, Papers I–V	

List of papers

This thesis is based on studies reported in the following papers, which are referred to in the text by their Roman numerals:

- I. Strandberg, K., Kjellberg, M., Erb, E.-M., Persson, U., Mosher, D., Villoutreix, B. O., Stenflo, J. Activated protein C-protein C inhibitor complex formation: Characterization of a neopeptide provides evidence for extensive insertion of the reactive center loop. *Biochemistry* 2000; 39: 15713–15720.
- II. Strandberg, K.* Kjellberg, M.* Knebel, R., Lilja, H., Stenflo, J. A sensitive immunochemical assay for measuring the concentration of the activated protein C-protein C inhibitor complex in plasma: Use of a catcher antibody specific for the complexed/cleaved form of the inhibitor. *Thromb Haemost* 2001; 86: 604–610.
*Both authors contributed equally to this work.
- III. Huntington, J. A., Kjellberg M., Stenflo, J. Crystal structure of protein C inhibitor provides insights into hormone binding and heparin activation. *Structure* 2003; 11: 205–215.
- IV. Kjellberg, M., Ikonomidou, T., Stenflo, J. The cleaved and latent forms of antithrombin are normal constituents of blood plasma: a quantitative method to measure cleaved antithrombin. *J Thromb Haemost* 2005; 4: 168–176.
- V. Kjellberg, M., Rimac, R., Stenflo, J. An immunochemical method for quantitative determination of latent antithrombin, the reactive center loop-inserted uncleaved form of antithrombin. *J Thromb Haemost* 2006; 5: 127–132.

The papers are reproduced with the kind permission of the copyright holders: Blackwell Publishing Company, Elsevier, Schattauer GmbH, and the American Chemical Society.

Abbreviations

α_1 -AT	α_1 -antitrypsin
ADP	adenosin diphosphate
APC	activated protein C
AT	antithrombin
β -NTA	2-naphtoyltrifluoroacetone
DELFLIA	dissociation enhanced lanthanide fluorescence assay
DTTA	diethylenetriaminetetraacetic acid
DVT	deep venous thrombosis
EPCR	endothelial cell protein C receptor
FITC	fluoroisothiocyanate
FV, FX, etc.	non-activated form of factor V, factor X, etc.
FVa, FXa, etc.	activated form of factor V, factor X, etc.
GAG	glycosaminoglycan
HAT	hypoxantine-aminopterin-thymidine
HCII	heparin cofactor II
HGPRT	hypoxanthine-guanine phosphoribosyl transferase
HMWK	high-molecular-weight kininogen
LRP	low-density lipoprotein receptor-related protein
PAGE	polyacrylamide gel electrophoresis
PAI-1	plasminogen activator inhibitor type I
PAI-2	plasminogen activator inhibitor type 2
PCI	protein C inhibitor
PiZ	mutated variant of α_1 -antitrypsin
RCL	reactive center loop
SDS	sodium dodecyl sulphate
SEC	serpin-protease complex
Serpin	serine protease inhibitor
SFM	soluble fibrin monomer
TAFI	thrombin-activatable fibrinolysis inhibitor
TAT	thrombin antithrombin complex
TF	tissue factor
TFPI	tissue factor pathway inhibitor
TM	thrombomodulin
t-PA	tissue-type plasminogen activator
u-PA	urokinase-type plasminogen activator
vWf	von Willebrand factor

Introduction

I began this research in 1993, and the initial objective was to develop immunological methods for measuring activated protein C (APC) and its inhibitors, protein C inhibitor (PCI) and α_1 -antitrypsin (α_1 -AT) in human blood plasma. The purpose of the work was to provide sensitive markers of the activation of blood coagulation that could be used as clinical diagnostic tools. A monoclonal antibody specific for cleaved PCI was produced, and development of an APC-PCI assay was completed in 1999. As the antibody proved to have outstanding specificity and affinity for cleaved PCI, we found it important to precisely locate the epitope and therefore crystallization experiments were started. Finally, the focus changed to production and characterization of monoclonal antibodies directed against two modified forms of antithrombin (AT).

Background

Main principles of immunoassay techniques

Immunological techniques are based on the use of specific antibodies directed against the analyte to be measured. In the 1960s, sensitive immunoassays were developed to measure hormones primarily in blood plasma, which markedly improved the strategies used in clinical investigations in the field of endocrinology. Most of these assays were competitive methods based on the use of radioisotopes as labels. The main advantages of the techniques were the very high sensitivity and precision they offered, and the chief disadvantages were that they required hazardous radioactive reagents. Moreover the labeled compounds had a short shelf, which resulted in substantial methodological variations. Therefore, new reagents for detection were developed, and enzymes were the first labels to replace radioisotopes. The final step in these assays is an enzyme-catalyzed substrate reaction with a high turn-over, measured as absorbance, fluorescence, or luminescence, and it is this step that ensures the substantial sensitivity of the methods [1,2]. The weakness of these assays lies in the fact that the enzyme is a large molecule, and it can be denatured. In addition, conventional fluorescent labels like fluorescein isothiocyanate (FITC) give a high background reading that decreases the sensitivity of the assay. However, that problem can be diminished by using long fluorescent lanthanides, such as Eu^{3+} , Sm^{3+} and Tb^{3+} , as is done in time-resolved fluorometric assay, a method in which the fluorescence intensity is measured after a certain time delay (Figure 1) [3,4]. Thus the initial, short-lived, background is removed. In dissociation enhanced lanthanide fluorescence immunoassays (DELFIAs), the lanthanide is coupled to N¹-isothiocyanatobenzyl modified diethylenetriaminetetraacetic acid (DTTA), which is a chelate with bifunctional

properties: it binds the lanthanide ion and it interacts covalently with amino groups on the target molecule (e.g., an antibody). DELFIA Enhancement Solution is added before detection in the final step, which releases the lanthanide ion from the first chelate and binds it to another, usually 2-naphthoyltrifluoroacetone (β -NTA) (for detection of Eu^{3+}), and that in turn improves the excitation level [5].

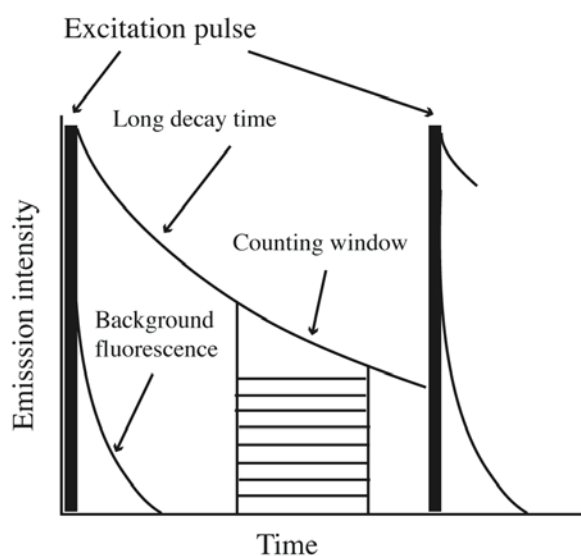

Figure 1. The principle of time-resolved fluorometry. Background interference is abolished by the delayed counting, which is enabled by use of long-lasting fluorescent lanthanides.

The antibodies that were first used in immunoassays were polyclonal and in most cases raised in rabbits. IgG fractions were obtained by affinity chromatography on Sepharose-coupled protein A and about 90% of the antibodies in such fractions are non-specific, which often results in a high background and therefore low sensitivity of the immunoassay. Also at that time there were limited access to pure antigen-specific antibodies, and they could be obtained only when

there was an abundance of the antigen of interest to use for Sepharose coupling. In the 1970s, the use of monoclonal antibodies emerged in parallel with the technique employed to produce immortal cell clones [6]. Production of such clones involves fusion between short-lived B-lymphocytes from an immunized mouse and cells from an immortal mouse B-cell tumor line (myeloma cells). Normal cells can synthesize DNA in two different ways: along the *de novo* pathway, nucleic acids are constructed from purine and pyrimidine bases, deoxyribose, and phosphate; in the *salvage* pathway, comparable nucleotides are converted into the correct nucleic acid with the help of hypoxanthine-guanine phosphoribosyl transferase (HGPRT). In short, to create clones a tumor cell-line is selected that is deficient in HGPRT and in addition is unable to secrete immunoglobulins. The *de novo* pathway can be blocked with aminopterin and the salvage pathway can be promoted by adding of hypoxanthine and thymidine, and thus only fusions between myeloma cells and spleen cells can survive in HAT (hypoxanthine-aminopterin-thymidine)-medium. Spleen cells from immunized mice are fused with myeloma cells in polyethylene glycol. The fused (hybridoma) cells are distributed in microwell plates and are selected by exposure to HAT-medium. Single-cell clones are obtained by limiting dilution at ≤ 0.5 cell/well. Cell clones are tested for binding to a specific antigen or part of an antigen. Immortal hybridoma cell clones offer an excellent source of monoclonal antibodies, but in some cases they are subject to mutations, chiefly in the myeloma fusion partner, which may result in loss of affinity for the antigen [7,8].

General structure of proteins

Proteins are macromolecules that play a vast number of different roles in biochemical reactions. The function of every protein depends on its three-dimensional structure, which is determined by the amino acid sequence of the polypeptide chain. That sequence makes up what is called the *primary structure*, which is the first of four levels in a hierarchical building process. The *secondary structure* consists of elements such as α -helices and β -sheets, which are formed through interactions between the amino acids, primarily in the polypeptide chain. The *tertiary structure* is attained with the final globular folding of the protein. During this stage secondary structural elements are packed and arranged in relation to each other as a result of associations between amino acids, which are to some extent forced by the environment of the protein. Proteins that have more than one polypeptide chain form a *quaternary structure* that arises due to interlocking of the chains, most often through noncovalent bonds.

Serine protease inhibitors

Serine protease inhibitors (serpins) constitute a family of homologous proteins. The similarity between the members of this group was first reported for α_1 -AT, AT and ovalbumin [9]. The name of the family was coined by Carrell and Travis and refers to the ability to block the effects of serine proteases, even though some serpins inhibit cysteine proteases and some are not inhibitory at all [10,11]. Today, more than 500 serpins have been described in different species, and they have a highly conserved secondary structure in common. Most of the human serpins that have been characterized are plasma proteins involved in regulation of extracellular proteolysis during coagulation, fibrinolysis, and inflammation. However, research has also revealed intracellular serpins, such as maspin in normal mammary epithelial cells and plasminogen activator inhibitor 2 (PAI-2) in keratinocytes and retinoblastoma cells [12–14].

Structure

The characteristic structure of a native serpin consists of a core domain with three β -sheets (A–C), about nine α -helices (A–I), and an exposed reactive center loop (RCL) that is usually 17 residues long and contains the protease recognition site (P1–P1') (Figure 2A) [15–17]. The amino acids are successively labeled P1, P2, P3, etc. on the amino-terminal side of the cleavage site, and they are designated P1', P2', P3', etc. on the carboxy-terminal side [18]. The largest sheet, β -sheet A, contains five strands: the two central strands are parallel and the other three are antiparallel. All α -helices are placed on the same side of the protein, with the exception of helix F, which is believed to be important for the stability of β -sheet A [19]. The native (also called stressed) conformation is very unstable and unfolds at about 60 °C [20].

When the exposed RCL at or near the P1–P1'-bond is cleaved by a protease, the large central β -sheet A is opened, and that allows the RCL to be inserted as the fourth strand in the five-stranded sheet and thereby renders the sheet entirely antiparallel (Figure 2B) [21]. Such RCL insertion results not only in the significant structural change from exposed to buried RCL, which is accompanied by an approximately 70 Å shift in the reactive site, but it also leads to smaller alterations in underlying helices [22]. The cleaved (also called relaxed) RCL-inserted serpin is highly stable up to at least 120 °C or 6 M guanidine-HCl [23,24]. Studies have shown that insertion of a synthetic N-acetylated RCL peptide into β -sheet A of a native inhibitory serpin causes the protein to exhibit the same stability as the cleaved form, as indicated by the fact that it will not unfold in 6 M guanidine-HCl or at 60 °C. At the same time, the serpin is converted from an inhibitor to a substrate, and thus it will be cleaved and released by its cognate protease [25–27].

RCL insertion into β -sheet A can also occur spontaneously, without previous cleavage of the reactive P1–P1'–bond. The conversion of the protein to this latent state involves the first strand of β -sheet C, which is removed from the sheet (Figure 2C). The latent form of a serpin was first found in a structure of plasminogen activator inhibitor 1 (PAI-1) and later also in a dimer consisting of latent and native AT [17,28]. A few years later the latent form of α_1 -AT was produced in vitro, and latent α_1 -antichymotrypsin was subsequently detected in blood plasma and bronchoalveolar lavage fluid [29,30]. Serpins that are in a latent state have lost their ability to inhibit proteases, they are more thermostable than their native counterparts, and their RCL is inaccessible to proteolytic cleavage by cognate proteases [31,32]. The latent form of PAI-1 is the only inhibitory serpin known to be able to convert back to the native state by denaturing and refolding [33]. In blood, PAI-1 is protected from transition to the latent form when it is bound to vitronectin [34,35].

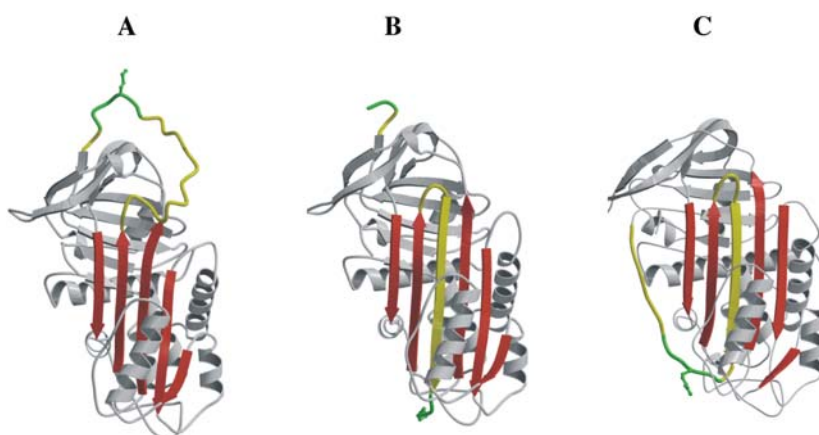

Figure 2. Structures of native (A), cleaved (B), and latent (C) α_1 -AT. Color coding: RCL, yellow: reactive center region, green: β -sheet A, red. (The ribbon diagrams were kindly provided by Dr. James Huntington.)

The conformational lability of the serpins is essential for the inhibitory activity of these proteins, but that characteristic also has an undesired effect in that the proteins tend to undergo polymerization or to form dimers, which entails insertion of the RCL of one molecule into a β -sheet of another. This has been demonstrated *in vitro* by heating at about 60 °C, followed by molecular weight analysis of the products [36]. Such polymerization can also take place *in vivo*, especially if the serpin contains a mutation that influences the stability of the native molecule. This can be seen in the PiZ variant of α_1 -AT (Glu342Lys), which accumulates in the liver and lung and another example is neuroserpin, which is mutated at Ser53Pro or Ser56Arg and shows an increased tendency towards polymer deposition within the cerebral cortex [37–39]. It has been suggested that the formation of a dimer between native and latent AT can increase the risk of thrombotic events, because it inactivates the native component (Figure 3) [40].

Function

Serpins attach proteases by exposing a “bait” residue, designated P1, which is located on the amino-terminal side of the scissile bond of the RCL. In contrast to other protease inhibitors, the serpins capture their cognate proteases by a suicide mechanism, wherein the inhibitor undergoes a dramatic structural change that results in covalent entrapment of the protease.

The inhibition can be described as a process comprising several steps, in the last of which either the protease becomes trapped in an essentially irreversible complex (the inhibiting pathway) or the inhibitor is cleaved and the protease released (the substrate pathway) (Figure 4) [41]. The initial contact between inhibitor and protease leads to formation of a reversible non-covalent Michaelis-like complex, in which the inhibitor is not yet cleaved. The next step involves cleavage of the inhibitor with concomitant formation of a covalent acyl ester intermediate between the active site of the protease and the carboxyl of the P1 residue of the RCL. At this point, the RCL can begin to insert into β -sheet A. The rate of insertion determines whether the final product of the total reaction will be a covalent serpin-protease complex or a free cleaved inhibitor and a free active protease.

At neutral pH and physiological ion strength, about 7% of the inhibitory reactions yields a cleaved inhibitor and a liberated protease [42,43]. Varying the pH, temperature and ionic strength can change the relative rate of RCL insertion and thereby also alter the proportions of the final products of the inhibitory reaction. A reduction in temperature often decreases the rate of RCL insertion and thereby directs the reaction towards the substrate pathway [44,45]. Lowering the pH from 8 to 6 favors the inhibitory reaction between α_1 -antichymotrypsin and

chymase, whereas it has the opposite effect on PAI-1-induced inhibition of urokinase-type plasminogen activator (u-PA) [32,46].

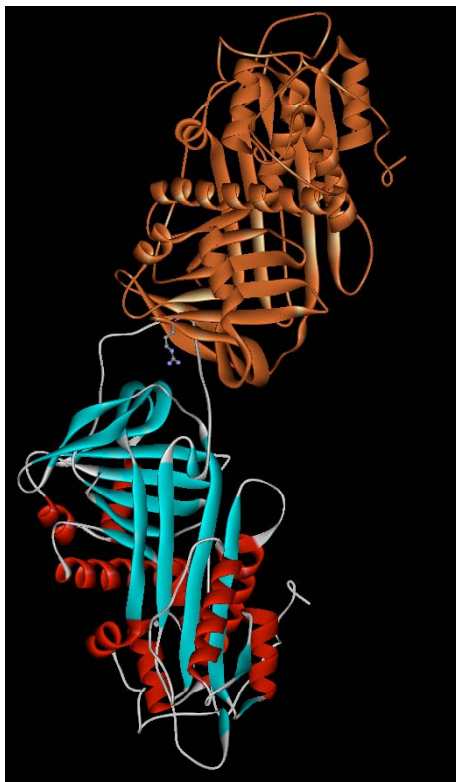

Figure 3. Dimer between native (blue, red) and latent (brown) AT.
(The ribbon diagram was kindly provided by Dr. Li Wei.)

The importance of residue P14 for loop insertion has been examined in detail in PAI-1: in short, it was found that replacing the threonine in position P14 with sixteen different amino acids promoted the substrate pathway by decreasing the rate of RCL insertion [47]. The significance of the length of the RCL has been elucidated by varying the span of the loop in α_1 -AT (Pittsburgh), which showed that shortening or elongation by more than two residues turned the inhibitor into a substrate [48].

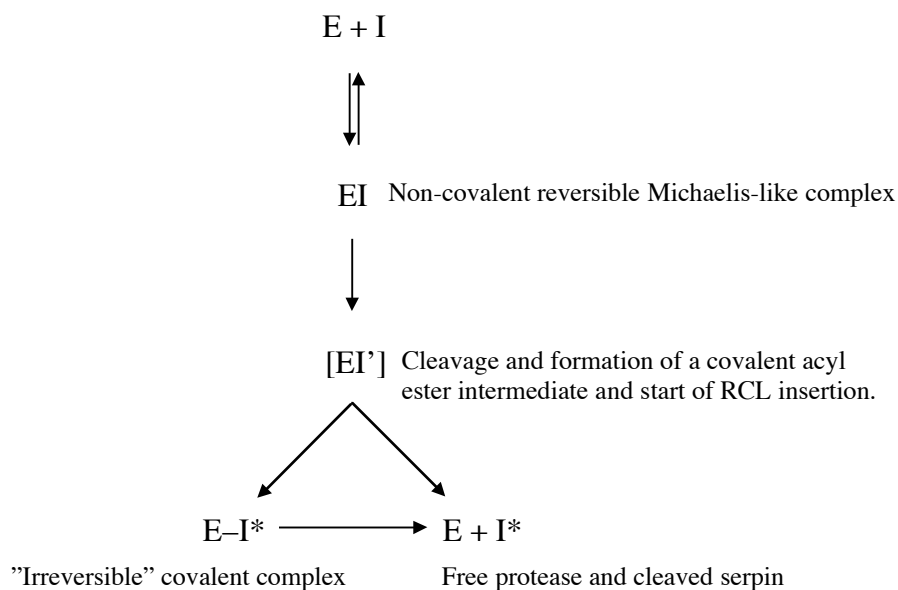

Figure 4. The mechanism of the inhibition of proteases (*E*) by serpins (*I*). In the first step, a reversible non-covalent Michaelis-like complex is formed (*EI*). In the second step, the protease cleaves the inhibitor at *P1*, which results in a covalent acyl ester intermediate [*EI'*]. RCL insertion starts at this stage, and the rate of insertion determines whether the final product will be a covalent complex with trapped, distorted protease *E-I** or a free protease and cleaved serpin *E+I**.

The inhibitory pathway ends with an essentially irreversible covalent complex formed between a cleaved serpin and a protease. Determination of the crystal structure of the complex between bovine trypsin and recombinant α_1 -AT confirmed earlier results indicating complete loop insertion and translocation of the protease by 71 Å, and it also revealed that the active site of the trapped protease was disrupted in (Figure 5) [49,50]. Accordingly, the protease is not only inactivated, but it also seems to be more vulnerable to proteolysis catalyzed by free proteases [51,52]. The final acylester complex dissociates gradually into cleaved serpin and free active protease, with a half-life ranging from days to months [53,54]. This dissociation can be enhanced by elevated pH, regardless of whether the catalytic triad of the enzyme is ruptured [55]. Furthermore, calcium ions can restore the activity of the protease and thereby increase the rate of dissociation of the complex [56].

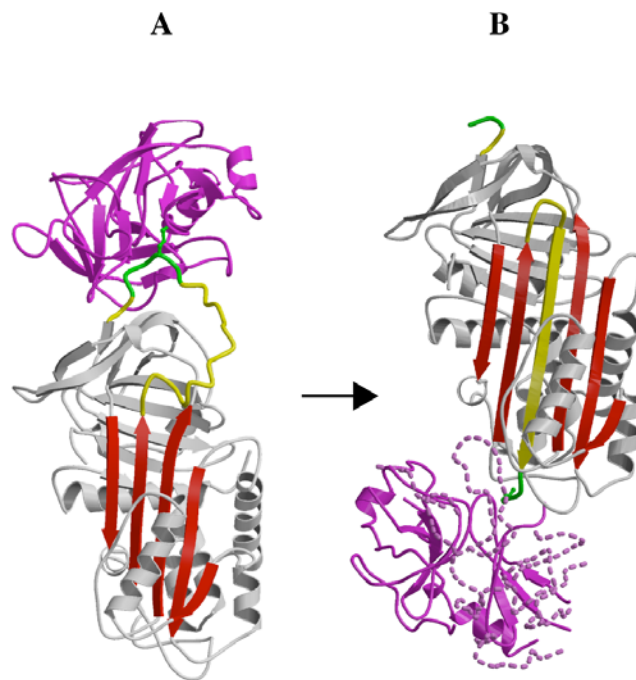

Figure 5. *The mechanism of protease inactivation by serpins. A.* A serpin (β -sheet A, red; RCL, yellow; reactive center, green) and its cognate protease (magenta) in the Michaelis-like reversible complex. **B.** The covalent acyl-enzyme intermediate with full insertion of the RCL into β -sheet A and the protease translocated to the opposite side of the serpin. (The models were kindly provided by Dr. James Huntington.)

Regulation by heparin

Some of the serpins that are found in plasma and are involved in regulation of coagulation are rather poor inhibitors, unless they are activated by heparin (or some other glycosaminoglycan, GAG). There are two ways in which such stimulation can occur: heparin can act as a bridge between inhibitor and protease by binding to both, or it can induce a conformational change in the inhibitor, which thereby becomes more reactive towards the protease.

The heparin-binding sites in AT involve basic residues within helices D and A, which bind to a distinct pentasaccharide sequence in heparin with the highest affinity among the serpins [57–60]. In native AT, two residues of the RCL, P15 and P14, are inserted in β -sheet A [17]. When AT is activated by heparin, these

residues are expelled from the β -sheet, which increases the flexibility of the RCL (Figure 6) [60]. Inhibition of thrombin by AT depends not only on this allosteric activation of AT, but also on the heparin-effected bridging between protease and inhibitor, which requires a length of at least eighteen saccharides [61,62]. Inhibition of FXa by AT has been said to involve only the allosteric mechanism, and therefore shorter heparin chains (pentasaccharides) are sufficient to activate the serpin. However, recent studies have shown that the heparin-induced inhibition of FXa by AT is further enhanced in the presence of Ca^{2+} , which neutralizes the negatively charged surface of FXa that otherwise repels heparin [63,64].

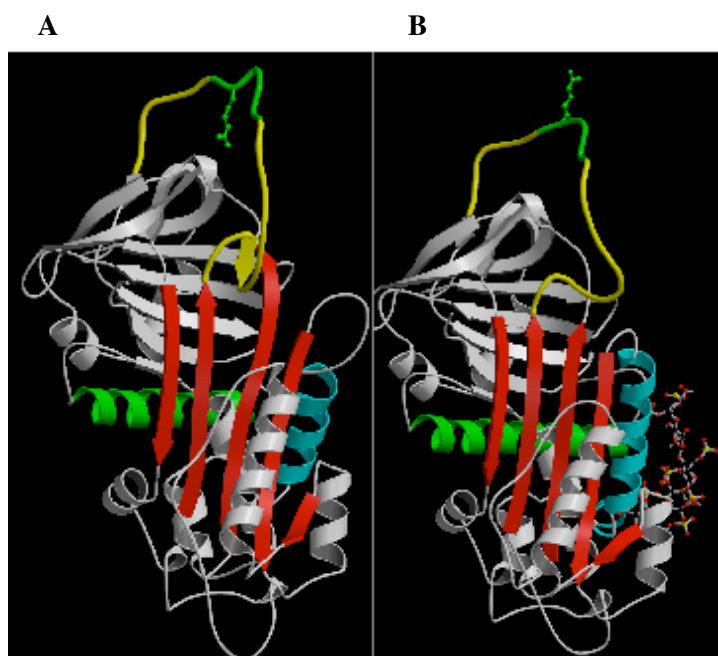

Figure 6. Structural changes in AT induced by activation of heparin. **A.** Native AT with two residues of the RCL (yellow) inserted into β -sheet A (red). **B.** Binding of heparin leads to expulsion of the RCL and elongation of α -helix D (blue).
(The ribbon diagrams were kindly provided by Dr. Li Wei.)

The heparin-binding sites in PCI comprise basic residues, primarily in helix H [65]. In contrast to AT, there is no evidence that heparin induces conformational activation of PCI. Instead experiments have indicated that PCI is stimulated when it becomes part of a ternary complex in which heparin serves as the link between the protease and the serpin [66,67].

Heparin cofactor II (HCII) is another serpin that inhibits thrombin, and it is activated by heparin in a somewhat different way. Heparin binds strongly to basic residues in helix D in HCII and thereby competitively releases the acidic amino-terminal part of the molecule from helix D, which makes the amino-terminal region available for interaction with positively charged residues in thrombin. HCII and thrombin can also be joined in a heparin-bridged complex [68,69].

Clearance of serpins and serpin-protease complexes

The rate of elimination of serpins and serpin-protease complexes (SECs) has been described in different species and determined to be 10–50 times faster for the complexes than for unbound molecules, regardless of which configuration of the free inhibitor is considered (i.e., native, cleaved, or latent) [70–73]. Competitive clearance studies in HepG2 cells and mice have indicated that free and complexed serpins are cleared from the circulation by different systems, and that there is a common receptor for several SECs [74,75]. In the decade that followed those findings, the receptor was identified as the low-density lipoprotein receptor-related protein (LRP) [76–80].

Inasmuch as the clearance of a number of SECs involved the same receptor, it was also suggested that these complexes possess a common epitope, which was indeed found in the carboxy-terminal cleavage peptide with a highly conserved sequence [81,82]. Mutations in this region of HCII were subsequently found to have no effect on clearance of HCII-protease complexes, which seems to refute the earlier results [83].

Antithrombin

AT is synthesized in the liver and circulates in the blood at a concentration of about 150 mg/L [84]. It is a single-chain glycoprotein with a molecular weight of 58 kDa. There are two forms of AT in blood: α -AT, which is fully glycosylated at all four glycosylation sites and is the major form in that it accounts for 90% of the total amount of AT in plasma; and the minor form β -AT, which lacks the carbohydrate chain at one site (Asn135) [85,86]. The β -form is bound more strongly to heparin than the α -form is, and hence it has been proposed that β -AT is preferentially localized to heparan sulfate on the surface of endothelial cells in the capillaries [87]. Physiologically, AT is the most important inhibitor of thrombin and activated factor X (FXa) (Figure 7). This is illustrated by the fact that individuals with AT

deficiency are predisposed to thrombotic events [88–90]. Besides being involved in regulating coagulation, AT has been shown to have anti-inflammatory properties. It has been observed that treatment with AT reduced the interaction between leukocytes and endothelial cells in endotoxaemic animals, but the effect was abolished when heparin was co-administrated with AT [91,92]. In contrast to that finding, other investigators have reported that elastase-cleaved α_1 -AT and α_1 -antichymotrypsin cleaved by exposure to a bacterial metalloprotease exhibit neutrophil chemotactic properties [93,94]. Latent and cleaved AT can inhibit angiogenesis by suppressing the proangiogenic proteoglycan perlecan in endothelial cells [95]. The antiangiogenic forms of AT can be produced by tumor cells, as indicated by a study showing that cleaved and latent AT are generated from native AT in a human pancreatic cell line [96].

Protein C inhibitor

PCI is a glycoprotein with three glycosylation sites and a molecular weight of 57 kDa [97]. It is produced not only in the liver, but also in the kidneys, reproductive organs, megakaryocytes, and keratinocytes [98–101]. PCI circulates in plasma at a concentration of about 5 mg/L, whereas the levels are 40-fold and 10-fold higher in seminal plasma and urine, respectively [99,102]. The specificity of PCI is rather broad in that it is known to inhibit APC, thrombin, urokinase (uPA), prostate-specific antigen, acrosin, and plasma kallikrein: the binding to acrosin is the strongest of these interactions, and it occurs in the presence of heparin. In addition to the procoagulant role of PCI as the major inhibitor of APC, it seems that thrombin in complex with thrombomodulin (TM) is more potently inhibited by PCI than by AT [103]. PCI is also involved in regulating the activity of acrosin on sperm cells, and it has been reported that male mice deficient in the inhibitor are infertile [104,105].

Hemostasis

The maintenance of life depends on both the fluidity and the clotting of blood, because the former is a prerequisite for the transport of oxygen and nutrition to body tissues, and the latter is necessary to avoid loss of blood upon rupture of a vessel. In intact vessels, membrane-bound molecules on the endothelial cells prevent clotting of blood by interacting with circulating anticoagulant factors. Protection of the fluidity of the blood on one hand and the intact circulatory system on the other is balanced by what is known as hemostasis. That process involves a network of endothelial cells, platelets, and soluble pro- and anticoagulant proteins, and it comprises primary hemostasis, blood coagulation, anticoagulation, and fibrinolysis. Primary hemostasis is initiated by vessel damage and continues up to

the formation of a temporary clot of activated platelets. By convention, blood coagulation includes two parallel systems called the *intrinsic* and the *extrinsic* pathways, which entail cascade-like activation of proenzymes and converge into a shared pathway that leads to activation of prothrombin and subsequent degradation of fibrinogen and formation of fibrin. Anticoagulation involves the inhibition or degradation of procoagulant factors by soluble proteins. In the fibrinolytic system, enzymes are activated to break down insoluble fibrin after events such as regeneration of new tissue.

Primary hemostasis

Under normal conditions platelets circulate in the blood in an unactivated state. However, upon vascular injury, subendothelial collagen is exposed, and the platelets adhere to that matrix and become activated. In this initial anchoring, von Willebrand factor (vWf) serves as a link by binding to both collagen and specific receptors on the platelets [106]. The activation involves platelet aggregation, release of the contents of dense bodies and α -granules, and exposure of negatively charged phospholipid surfaces. The dense bodies contain substances such as serotonin, adenosin diphosphate (ADP), and calcium ions, and the α -granules are storage bins for several proteins including vWf, fibrinogen, and factor V (FV). Platelet aggregation requires fibrinogen, ADP, and thromboxane A_2 . The exposure of a negatively charged phospholipid surface is crucial for coagulation of the blood, because it acts as a platform for stimulation of the proteins that are involved in that process, which ultimately leads to the formation of a secure fibrin network [107]. The activation of platelets also requires small amounts of thrombin that has been activated by a complex comprising the activated cofactor FV (FVa) and FXa.

Blood coagulation

The classical model of blood coagulation consists of as mentioned above, a chain of cascade-like activations of proenzymes that occur in two parallel, and to some extent interacting, systems referred to as the *intrinsic* and *extrinsic* pathways. These two sequences of reactions converge in a common pathway that involves activation of factor IX (FIX) and FX to FIXa and FXa, and terminates with the generation of thrombin and subsequent formation of fibrin (Figure 7) [108,109]. The *extrinsic* pathway is considered to play the most important role in coagulation *in vivo* [110].

The *intrinsic* pathway is initiated when factor XII (FXII) interacts with factor XI (FXI), plasma prekallikrein, and high-molecular-weight kininogen (HMWK). HMWK and HMWK-activated prekallikrein transform FXII to FXIIa

and that event converts FXI to FXIa. FXIa can then stimulate FIX to give FIXa, which in turn binds to its cofactor, activated factor FVIII (FVIIIa), on negatively charged phospholipid surfaces. This macromolecular formation is called the tenase complex, and its task is to activate FX in the presence of calcium ions.

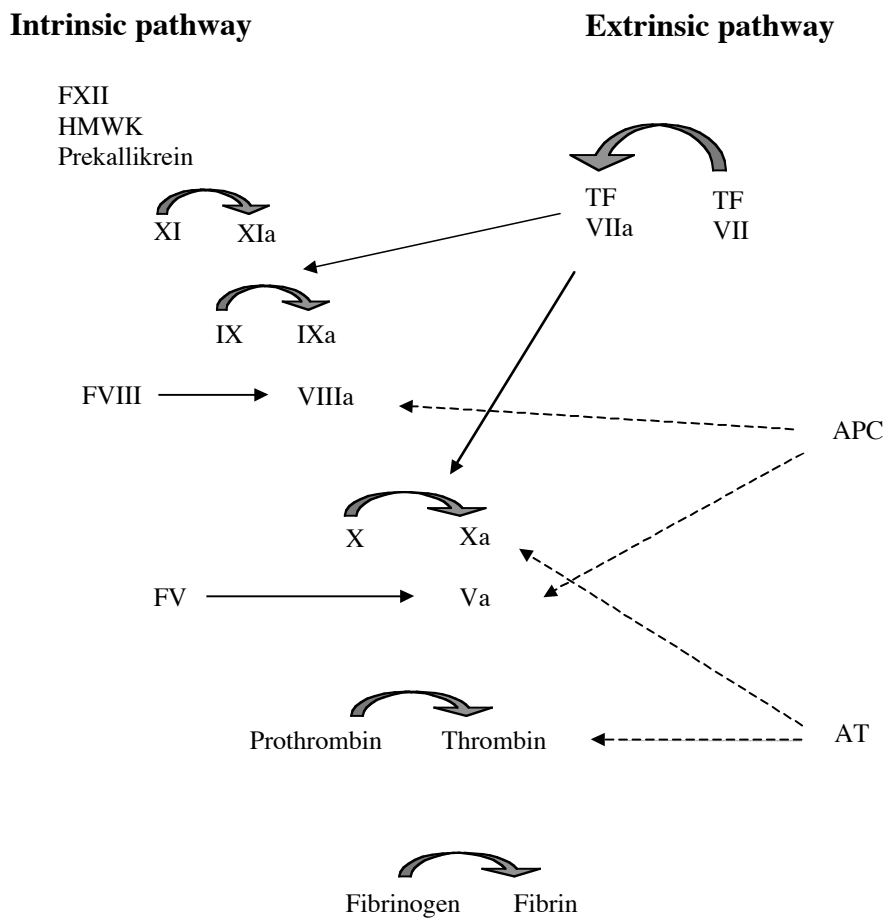

Figure 7. Cascade model of blood coagulation. Dashed arrows denote inhibition by APC and AT.

The *extrinsic* pathway is initiated by tissue factor (TF), which is an integral membrane protein that is exposed intravascularly, either as a result of endothelial rupture or through effects of stimulated monocytes. TF interacts with activated factor VII (FVIIa), which circulates in plasma in trace amounts (<1%) [111]. Factors IX and X are only weakly activated by FVIIa, whereas they are strongly stimulated by FVIIa in complex with TF. Non-activated FVII also binds to tissue factor, and it is converted to the active form by FVIIa or by enzymes released from damaged cells [112]. The TF–FVIIa complex can activate both FIX and FX [113]. By molecular rearrangements on the phospholipid surface, FXa can interact with its cofactor FVa to form the prothrombinase complex, which activates prothrombin to thrombin. Thrombin then cleaves fibrinogen to fibrin.

The proteins in the tenase and prothrombinase complexes, as well as the substrates of those complexes bind to the negatively charged phospholipid surface through their γ -carboxylated amino-terminal glutamic acid residues, the carboxylation of which requires the presence vitamin K [114]. In addition to being able to degrade fibrinogen to fibrin, thrombin also is responsible for the feed-back amplification of the blood coagulation in that it activates FV, FVIII and the intrinsic factor XI [115–118].

Considering the intrinsic pathway, the cascade model of blood coagulation does not satisfactorily explain why bleeding disorders are not caused by deficiencies in FXII, HMWK or prekallikrein, whereas they are induced by insufficient levels of FVIII and FIX. Furthermore, the model does not plausibly clarify why FVIIa is able to restore deficiencies in FVIII and FIX [119,120]. Thus a new model of blood coagulation has been suggested, which is based on the importance of localization to proper cell surfaces and proposes that coagulation occurs in three distinct but overlapping stages designated *initiation*, *amplification*, and *propagation* (Figure 8) [121].

The *initiation* phase of the novel model takes place on TF-presenting cells, where assembly of the FVIIa–TF complex occurs even in the absence of tissue rupture. FVIIa–TF can activate small amounts of FIX and FX, which infiltrate tissues and become associated with TF-bearing cells [122]. Soluble FIXa is poorly inactivated by AT, and it can bind to stimulated platelet membranes, where it interacts with its cofactor FVIIIa to form the tenase complex, which in turn activates FX. FXa or other proteases activate FV on the tissue cell [123]. FXa that dissociates from the TF-presenting cell is inactivated by tissue factor pathway inhibitor (TFPI) or by AT. These low-level procoagulant activities are probably normal events, and they explain the presence of small peptides, liberated from activated FIX and FX, in blood plasma of healthy individuals, [124,125]. The basal coagulation continues to the amplification phase, only when activated platelets are present due to vessel rupture.

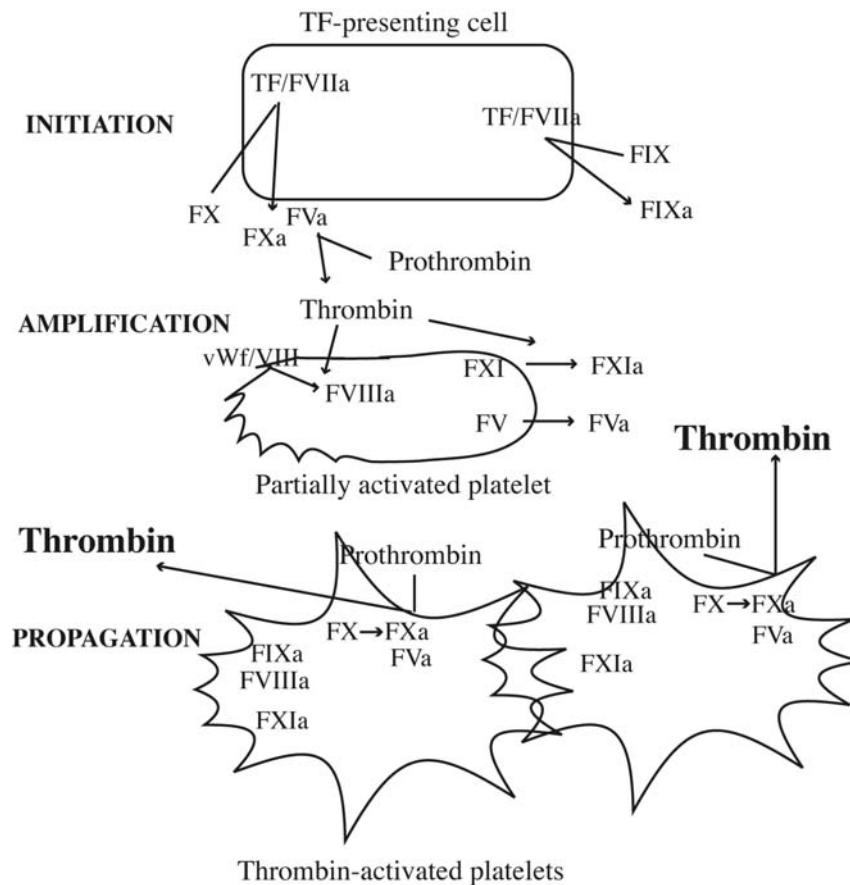

Figure 8. Cell-based model of blood coagulation. *INITIATION* stands for basic coagulation. Damage to a vessel induces adherence of platelets and *AMPLIFICATION* starts when thrombin binds to specific receptors on the platelets and activates factors V, VIII, and XI. *PROPAGATION* takes place on the surface of activated platelets. *FIXa* from TF-presenting cells or bound to platelets interacts with *FVIIIa* and thereby yields more *FXa*. *FXa* joins with *FVa* and that complex activates more prothrombin. Thus a sufficient amount of thrombin is generated to form the fibrin clot.

In the *amplification* phase trace amounts of thrombin (generated by FXa during the initiation phase), can bind to specific platelet receptors, which not only enhances adhesion and activation of platelets, but also stimulates the cofactors FV and FVIII that are bound to the platelet surface [126–128]. This starts the *propagation* phase, wherein the tenase and prothrombinase complexes are organized partly because of the high-affinity binding sites for FIX, FX, and FXI offered by the negatively charged platelet surface [129,130]. In this way, sufficient amounts of thrombin are generated, to create the fibrin clot, which is then stabilized by thrombin-activated FXIII.

Fibrinolysis

The fibrin clot is only a temporary plug that is dissolved as part of the healing process. It is degraded to soluble fibrin degradation products by the fibrinolytic system, the main component of which is plasminogen [131]. Plasminogen circulates as a proenzyme in plasma and it can be converted to the active form called plasmin mainly by tissue-type plasminogen activator (t-PA), which is produced by endothelial cells. In circulating plasma, the affinity of t-PA for plasminogen is too low to play a significant role in fibrinolysis, whereas plasminogen is efficiently cleaved to the proteolytically active plasmin on the fibrin surface [132]. Fibrinolysis is decreased either by inhibition of plasmin by α_2 -antiplasmin or by PAI-induced inactivation of t-PA. Free plasmin binds with high affinity to α_2 -antiplasmin circulating in plasma, which results in formation of an irreversible complex, but plasmin bound to the fibrin surface has the binding sites for α_2 -antiplasmin concealed and is therefore not accessible to the rapid inhibition by this inhibitor [133]. PAI-1 is secreted from endothelial cells and inhibits t-PA by forming 1:1 complexes [134]. Finally, it has been shown that thrombin bound to TM stimulates thrombin-activatable fibrinolysis inhibitor (TAFI), which is a plasma protein that inhibits fibrinolysis by preventing binding of plasminogen or t-PA to fibrin [135].

Regulation of coagulation

Blood coagulation is strictly regulated to prevent the formation of clots in places other than site of injury, and it is to a great extent governed by intact endothelial cells. Two of the regulatory mechanisms operated by these cells involve serpins, and one of those mechanisms entails cell surface exposure of heparin-like substances that are necessary for AT-mediated inhibition of FXa and thrombin [136,137]. In contrast to the blocking of thrombin brought about by AT, such inhibition induced by HCII is apparently not effected by endothelial cells, whereas it is influenced by dermatan sulfate exposed on fibroblasts and by heparan sulfate

displayed on smooth muscle cells [138,139]. Therefore it has been proposed that HCII plays a more important role as a thrombin inhibitor in connective tissue and especially in placenta, a tissue that is rich in dermatan sulfate [140]. The other regulatory impact that endothelial cells exert on coagulation involves production of the integral membrane protein TM, which has high affinity for binding thrombin [141,142]. Upon interaction with TM thrombin loses its procoagulant qualities and instead becomes a potent activator of the anticoagulant serine protease protein C (Figure 9) [143–145]. The activation of protein C by TM-bound thrombin is facilitated when protein C is connected to the endothelial cell protein C receptor (EPCR), which is present mainly on endothelial cells in larger vessels [146,147]. Soluble EPCR has been found to bind APC and thereby prevent it from interacting with phospholipids, and consequently downgrade the inactivation of FVa [148]. It has also been reported that inflammatory cytokines increase the loss of the membrane-bound TM from the endothelial cells, and causes reduced generation of APC [149].

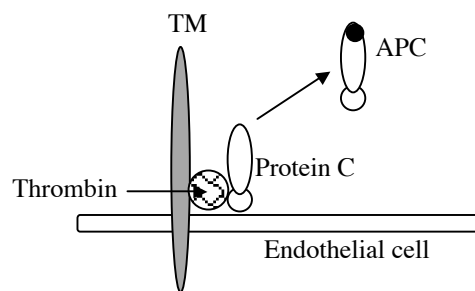

Figure 9. Activation of protein C by the thrombin-TM complex.

Anticoagulation mediated by activated protein C

Protein C circulates as a zymogen in plasma at a concentration of about 4 mg/L [150–152]. Approximately 85% of the protein C exists in a disulfide-linked two-chain form that is the result of cleavage in the Golgi apparatus before extracellular export, and the remaining 15% is a single-chain form [153]. Protein C is a vitamin-K-dependent molecule that contains nine Gla-residues that are essential for the

Ca²⁺-dependent binding to negatively charged phospholipids [154]. APC catalyzes the degradation of membrane-bound FVa and FVIIIa, and the activity of APC is induced in a synergistic manner by two cofactors, protein S and FV (Figure 10) [155–158]. The vitamin-K-dependent protein S circulates in plasma at a concentration of around 25 mg/L, about 40% of which is in a free form and the rest is linked to the complement regulating protein C4b-binding protein [159,160]. Only free protein S can act as a cofactor for APC [161]. FV bound to a phospholipid surface can be cleaved by APC, which converts FV into an anticoagulant protein by acting together with protein S to enhance the APC-induced degradation of FVIIIa [162]. It has been observed that a mutation at R506Q in FV renders that protein resistant to degradation by APC, and is the most common genetic risk factor for thrombosis [163–165]. The protease activity of APC can be inhibited by PCI, α_1 -AT, and α_2 -macroglobulin [166–168]. Homozygous deficiency of protein C or protein S results in severe thrombotic complications, which confirms the value of this anticoagulation system [169]. APC also has effects on cells that are involved in the inflammatory system, such as monocytes, neutrophils, and endothelial cells, which is demonstrated by the finding that administration of APC improves the survival of patients with severe sepsis [170–172].

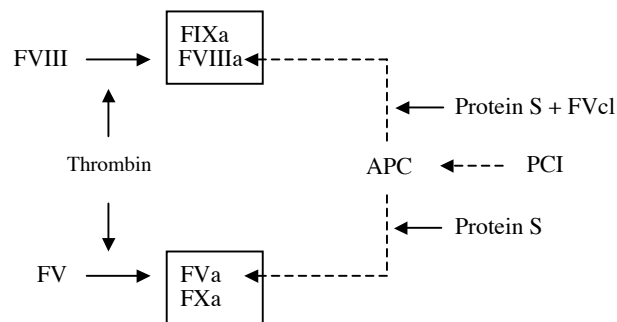

Figure 10. The protein C anticoagulant pathway. Activated protein C inhibits the functions of FVIIIa and FVa mediated by limited proteolysis. Protein S stimulates the activity of APC. Protein S acts together with APC-cleaved FV (FVcl) to induce APC to degrade FVIIIa. PCI forms complex with, and thereby inhibits APC. Dashed arrows denote inhibition.

The present studies

Characterization of an antibody against PCI (Paper I)

In plasma concentrations of protein C and native PCI are about 4 mg/L, whereas the levels of APC and APC-PCI complex are only about 1 $\mu\text{g/L}$ and 0.1 $\mu\text{g/L}$, respectively. Thus it is obvious that a catcher antibody that is not specific for either APC or the cleaved form of PCI must be highly saturated with protein C or native PCI. An assay that measures plasma concentrations of free APC or APC in complex with PCI might be a sensitive tool for detecting coagulation disorders at an early stage. Methods applied thus far to analyze APC in plasma use immobilized monoclonal catcher antibodies that recognize both APC and the zymogen protein C. The amount of APC that has bound to the antibody is then measured by the use of a specific chromogenic substrate for APC and the results show that the techniques have weaknesses such as long incubation times, low signals, or non-linear dose-response curves [173–176]. Determination of APC-PCI complexes has been achieved using immunoassays based on catcher antibodies against protein C or PCI [177,178]. In one of the methods native PCI is excluded by precipitation with barium citrate before the start of the antibody reaction, and that improves the sensitivity of the assay, but it is a time consuming procedure and unsuitable for automation. Moreover these immunoassays are not sensitive enough to measure APC-PCI complex in healthy individuals.

Accordingly with the aim of developing a more sensitive technique, we produced monoclonal antibodies by immunizing mice with cleaved PCI. Antibodies from different cell-lines were tested for binding to ^{125}I -labeled APC-PCI complex, cleaved PCI, and native PCI. Clones that preferentially bound ^{125}I -labeled APC-PCI and cleaved PCI were recloned twice. Large-scale production of the antibodies was performed in a Technomouse apparatus, and one of the antibodies (M36) was selected and further characterized.

The specificity of M36 was demonstrated on an Affi-Gel 10 column containing immobilized M36 antibody. APC-PCI complex, cleaved PCI, and native PCI were injected and fractions were tested in an immunoassay for binding to a monoclonal antibody M52, which recognizes all forms of PCI. A Eu^{3+} -labeled antibody, M11-5 against PCI or HPC4 against protein C, was employed as reporter molecule. The results showed that both the APC-PCI complex and cleaved PCI bound to the column and were detected by the immunoassay. Native PCI did not bind to the column, but it was confirmed to be PCI by the immunoassay.

The affinity of M36 was determined by surface plasmon resonance analysis by the use of a Biacore biosensor. Biotinylated M36 was immobilized on streptavidin-coated sensor chips, and APC-PCI complex and cleaved and native PCI were injected at several concentrations. The affinity was assessed using the software program Biaevaluation 3.0. The K_D values for APC-PCI complex and

cleaved PCI were determined to be 8.5×10^{-11} and 2.9×10^{-11} M, respectively, whereas the affinity for native PCI was too low to be measured.

Insertion of a synthetic N-acetylated RCL peptide into native PCI exposed the epitope for M36. This was demonstrated by performing a DELFIA using biotinylated M36 as catcher and Eu^{3+} -labeled M11-5 as detector, the latter of which is directed against all forms of PCI. The transformation to the relaxed form was confirmed by tryptophan fluorescence measurements and by an inhibitory test that determined the amidolytic activity of APC after incubation with the RCL-inserted PCI. The lost ability to complex with APC was also shown by SDS-PAGE and in a DELFIA using M36 as catcher antibody and Eu^{3+} -labeled HPC4 as the reporter molecule.

To locate the epitope of M36, native PCI with an inserted RCL peptide mutated at ArgP13Thr, AlaP9Ile, or ThrP6Ala was examined for binding to the antibody by performing a DELFIA using M36 as catcher antibody and Eu^{3+} -labeled M11-5 as detector. Full incorporation of the mutated RCLs into native PCI was confirmed by tryptophan fluorescence analysis. Binding of M36 to the PCI with inserted ArgP13Thr-RCL and the PCI containing AlaP9Ile-RCL was reduced by 80% and 20%, respectively, compared to PCI with the wild-type RCL. These results suggest that the epitope of M36 is located around P13–P9. It is highly likely that one or both of the adjacent strands of β -sheet A are parts of the epitope, since M36, was found to depend on conformation, as indicated by weak reaction in SDS-PAGE and subsequent Western blotting.

Development of an immunoassay for measurement of APC-PCI complex (Paper II)

In this investigation we focused on optimization of the DELFIA that was applied to some extent in our previous study (Paper I), in which biotinylated M36 was used as a catcher antibody and Eu^{3+} -labeled HPC4 directed against protein C was included as reporter antibody (Figure 11). To prohibit further complex formation between APC and PCI in the plasma samples, benzamidine, an inhibitor of serine proteases, was added to the citrate-containing tubes used to collect blood from healthy individuals and patients. In the absence of benzamidine the concentration of the complex increased by about 60% within 3 h at room temperature.

Dose-response curves for the APC-PCI complex in buffer and plasma were linear, and native PCI in plasma interfered only negligibly with the binding of APC-PCI to M36 (Figure 12). The analytical recovery was 98–136% at $0.2 \mu\text{g/L}$ and 92–117% at $0.78 \mu\text{g/L}$, with intra- and inter-assay imprecision of 6.3% at $1.0 \mu\text{g/L}$ and 8.1% at $0.68 \mu\text{g/L}$, respectively. The analytical detection limit, defined as the medium value +3SD of repeated measurements of a sample lacking the analyte, was calculated to $0.06 \mu\text{g/L}$ based on 11 measurements of complex-depleted and

free-PCI-depleted plasma. The reference interval of levels of APC-PCI complex in 198 healthy individuals was 0.16–0.54 $\mu\text{g/L}$ with a mean of 0.30 $\mu\text{g/L}$. In warfarin-treated patients, the mean was 0.09 $\mu\text{g/L}$. The concentrations of some of the samples were below the detection limit, and therefore only the upper value of a 95% reference interval (i.e., 0.26 $\mu\text{g/L}$) was given. The lower values for these patients were consistent with a reduced activation of protein C, caused by a decrease in thrombin generation due to the warfarin treatment.

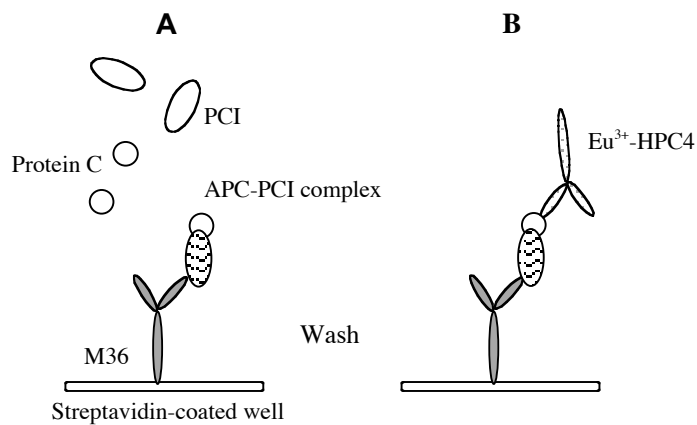

Figure 11. Principle of the APC-PCI assay. **A.** PCI in complex with APC binds to biotinylated M36 in streptavidin-coated wells. **B.** After a washingstep, Eu^{3+} -labeled HPC4 is added, and the amount bound to APC is measured

PCI levels were measured by an assay employing M52 as catcher antibody and Eu^{3+} -labeled M11-5 as detector. An assay for measuring protein C used the monoclonal antibody HPC10 as catcher and Eu^{3+} -labeled HPC4 as detector. In healthy individuals, the means of the distributions of PCI and protein C were 4.9 and 2.8 mg/L, respectively. No correlation was found between APC-PCI and either PCI or protein C.

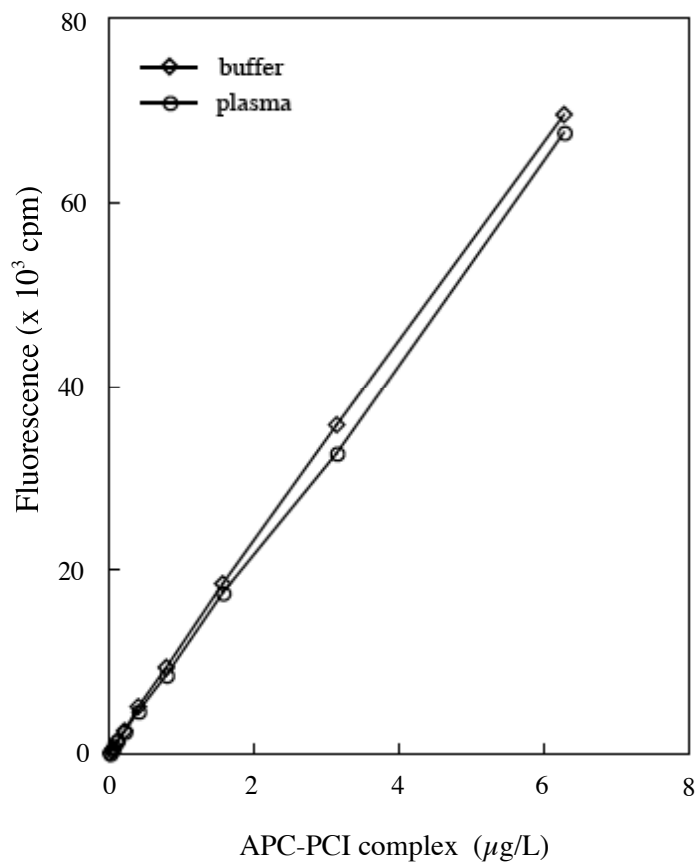

Figure 12. Dose-response curves of APC-PCI complex in Assaybuffer and Stabilyte plasma.

Hip surgery involves substantial bone destruction, which is accompanied by high plasma levels of TF, fibrinopeptide A, and thrombin-AT (TAT) complex [179]. In this pilot study, comprising 5 patients undergoing hip replacement surgery, we

compared variations in the levels of APC-PCI with concentrations of PCI, TAT, D-dimers, and F1+2. The results showed that concentrations of APC-PCI were increased 4 h after surgery and declined successively to normal values after 24 h. In contrast, levels of PCI dropped during the same time frame and were still not normalized after seven days. The pattern of change in the levels of TAT and D-dimers was similar to that observed for APC-PCI, but the amplitude of the increase in TAT was considerably higher.

After this Paper II was published, other researchers performed investigations to evaluate the APC-PCI assay as a diagnostic tool for disorders involving the coagulation system. The first clinical study comprised 123 patients with suspected deep vein thrombosis (DVT) [180]. The diagnosis was confirmed by phlebography, and the levels of APC-PCI, in association with D-dimer, TAT, F1+2, and soluble fibrin monomer (SFM), were evaluated by receiver operating characteristic (ROC) analysis. It was found that APC-PCI had a discriminatory potential similar to that of D-dimer. The second investigation included 76 consecutive patients who presented with suspected myocardial infarction [181]. Levels of APC-PCI were not correlated with CKMB or troponin I on arrival, but they later correlated best with CKMB. In another study of 356 patients consecutively admitted for chest pain, it was observed that the concentration of APC-PCI was elevated in the early stage of myocardial infarction, whereas troponin I was still remained at a normal level [182]. Moreover, very high levels of APC-PCI have been measured in patients with aortic aneurysm [183]. In addition, a study of patients that underwent different types of aortic surgery suggested that analysis of APC-PCI could predict the severity and outcome of the disease [184].

Crystallization and exploration of the structure of cleaved PCI (Paper III)

The specificity and high affinity of M36 for cleaved PCI indicated that work was needed to more precisely localize the epitope. As a first step towards crystallization of the complex between cleaved inhibitor and the fab fragments of M36, crystals of cleaved PCI were grown. Good diffracting crystals were obtained using 5 mg/ml PCI in hanging drops of 17% PEG 3350, 3% isopropanol, and 170 mM NaF. The resolution of the diffraction was 2.4 Å. The structure of PCI was solved by molecular replacement, employing the structure of α_1 -AT as a search model. The experiments involving the binding of retinoic acid to cleaved PCI were conducted with the program DockVision.

The crystal structure of cleaved PCI revealed that it is almost identical to the cleaved form of α_1 -AT, except a two turn shorter helix A and a truncation of three amino acids in the β -turn between strands 4 and 5 in β -sheet B. Also, helix H has a new position, which is probably due to the shortening of helix A (Figure 13). The

shorter helix A exposes a hydrophobic pocket that might bind non-polar substances, and indeed docking experiments indicated that it is a possible binding site for retinoic acid, a compound that has been shown to bind to PCI in biochemical studies [185]. The N-terminal sequence of PCI, which precedes and includes helix A is similar to the corresponding region in corticosteroid-binding globulin and thyroxine-binding globulin, which indicates that the short helix A is necessary for binding hydrophobic hormones (Figure 13).

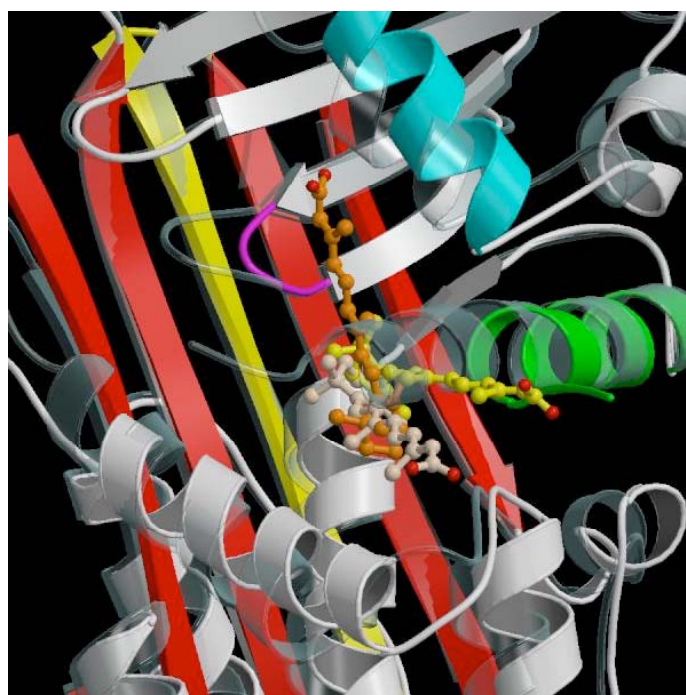

Figure 13. Close-up of the center of cleaved PCI, showing β -sheet A (red) with inserted RCL (yellow), the short α -helix A (green), helix H (blue), and with three docked retinoic acids (white, yellow, and orange).

It has been suggested that the heparin binding sites in PCI consist of basic residues that are present mainly in helix H, but additional plausible sites for interaction with heparin can be seen in the crystal structure of cleaved PCI [65]. This is to some extent supported by the observation that prevention of glycosylation at N230, near the proposed heparin-binding region, increases the ability of PCI to inhibit thrombin and kallikrein, which shows that the glycosylated

area is close to the protease-binding site [186]. Support of potential sites for association with heparin in APC is provided by results of mutagenic studies showing that heparin-binding APC variants, in which positively charged residues had been replaced by neutral or negatively charged residues, were inhibited more slowly by PCI, compared to wild-type APC in the presence of heparin [67,187,188]. The finding that basic residues are close to those involved in the interaction of the proteins suggests, that APC and PCI first bind to the same heparin at different sites and then move towards each other to achieve complex formation (Figure 14). After this paper III was published, we crystallized the complex between cleaved PCI and the Fab-fragment of antibody M36, but the crystals did not diffract sufficiently, and we are now optimizing the conditions with the intention of obtaining high-resolution crystals.

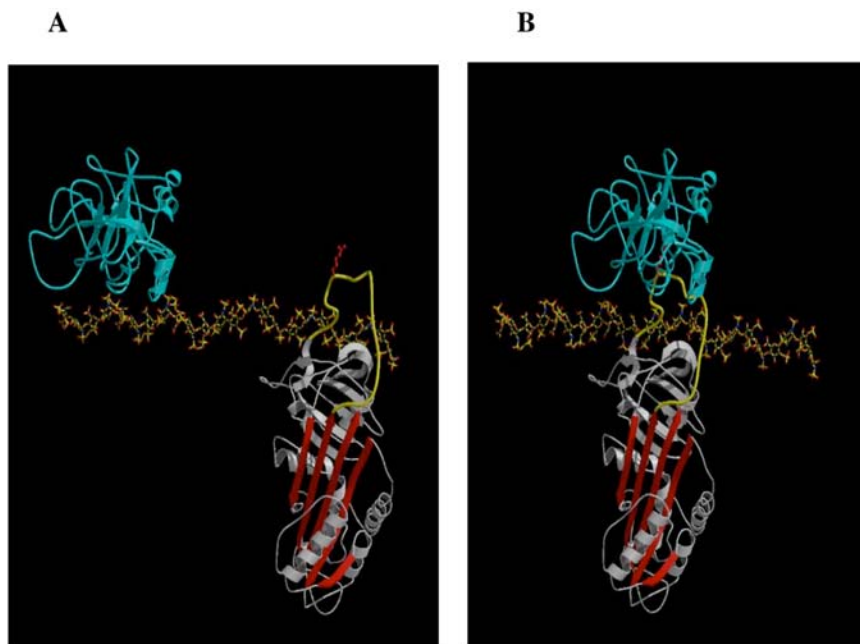

Figure 14. Proposed heparin-activating mechanism of PCI involving inhibition of APC. Both proteins bind unspecifically to different sites in heparin and move towards each other (A), which leads to complex formation (B).

Characterization of an antibody against cleaved and latent AT and development of an immunoassay for measuring cleaved AT (Paper IV)

Research has shown that both cleaved and latent AT inhibit angiogenesis, and also that latent AT is formed spontaneously through transition of native AT, particularly when that form contains mutations in β -sheet C [189–191]. There are also a number of mutations in AT that can have an impact on heparin binding or the rate of RCL-insertion, which can result in an impaired inhibition of the protease. Therefore, we considered that it might be of interest to measure not only native AT, but also cleaved and latent AT.

We immunized mice with TAT and used biotinylated FXa-AT complexes formed in plasma to screen the different cell clones. Thus there was a molar excess of native AT in the screening system and clones recognizing native AT were not detected. Two monoclonal antibodies were selected, one of which, M9, was characterized in various ways. Mixtures of native and cleaved AT, and native and latent AT were chromatographed on a heparin Sepharose column, and the eluate was analyzed for its ability to inhibit thrombin and for binding to M9. In a DELFIA, cleaved and latent AT that eluted at about 0.4 M NaCl, did not inhibit thrombin but they did bind to M9, whereas native AT, eluted at about 0.9 M NaCl did not bind to M9 but did inhibit thrombin.

Cleaved, native, native incubated, native RCL-inserted, and latent AT, as well as TAT complex competed with Eu^{3+} -labeled cleaved AT for binding to M9. In contrast to native AT, cleaved and latent AT fully replaced Eu^{3+} -labeled cleaved AT in the competition for M9. To ascertain whether insertion of a synthetic RCL peptide could expose the epitope of M9, we incubated native AT at 37 °C with a 100-fold molar excess of the synthetic peptide, or without the synthetic RCL as a control. The RCL-inserted AT and the control competed equally and to a minor extent with Eu^{3+} -labeled cleaved AT, no doubt due to a transition to the latent state induced by incubation at 37 °C rather than as a result of exposure of the epitope caused by RCL-insertion. M9 showed affinities of 3.07×10^{-9} and 2.27×10^{-9} M for latent and cleaved AT, respectively.

We used a Sepharose column conjugated with M9 to isolate latent and cleaved AT from plasma. Both the flow-through and the bound fraction reacted with a polyclonal antibody against AT, but, as expected, only the bound material reacted with M9 in a DELFIA. Sequence analysis showed that about 75% of the eluted AT was latent and about 25% was cleaved.

To be able to devise an immunoassay for cleaved AT using M9 as catcher, it is imperative that the reporter antibody does not recognize the latent form of AT. We found that the previously characterized M27 antibody had a 200-fold lower affinity for latent AT than for cleaved and native AT, and hence it was useful as a Eu^{3+} -labeled detector in our assay [192]. Increasing concentrations of cleaved AT

in buffer, in cleaved/latent AT-deficient plasma, and in cleaved AT-deficient plasma gave linear and identical curves within experimental errors. The analytical recovery was 91–97% at 1 mg/L cleaved AT and 94–96% at 2 mg/L. The intra- and inter-assay variations were calculated based on a sample containing 1.7 mg/L cleaved AT and were found to be 4.7% (10 measurements) and 6.2% (14 measurements), respectively. The detection limit was calculated as a mean value +3SD of five samples of cleaved AT-deficient plasma diluted 1:200, which gave a value of 0.05 mg/L. The frequency distribution of cleaved AT in 110 healthy subjects (75 females and 35 males) was positively skewed, with a median of 1.3 mg/L (range: 1.0–1.9 mg/L). Two other immunoassays for measurement of cleaved AT have been reported that employ antibodies, which are directed to all forms of AT. To eliminate the native form of the inhibitor both methods include a denaturing step that is achieved either by heating or by treating the samples with SDS, which means that latent AT must interfere with the measurements. [193,194].

We found that both TAT and cleaved AT were generated in heparinized plasma incubated at room temperature, but such production did not occur in citrated plasma. Those observations demonstrate the importance of using a correct method of blood collection, and they also confirm the heparin-induced AT-effected inhibition of thrombin. The presence of heparin provides access to the substrate pathway, and that increases the formation of free cleaved AT to about 30%, which can be compared with a rate of about 7% in the absence of heparin [42,43]. Formation of the TAT complex *in vivo* takes place under heparinized conditions, which raises the question of whether cleaved AT present in plasma is the result of unsuccessful complex formation between AT and thrombin [195]. Calculations using a half-life of 54 min for TAT complex and 64 h for cleaved AT, and assuming a first-order rate of elimination and steady-state conditions for both, as well as equal distribution volumes, indicated that 0.6 pM TAT complex and 12.1 pM cleaved AT were formed per minute *in vivo*. Thus more cleaved AT is generated than can be explained by TAT formation, as compared to the experiments *in vitro*. Other sources seem to be involved in the generation of cleaved AT, which is supported by the lack of correlation between cleaved AT and TAT complex in patients with DVT.

Characterization of an antibody against latent AT and development of an immunoassay for measurement latent AT (Paper V)

Mice were immunized with latent AT, and a screening procedure based on the use of biotinylated latent AT in the presence of an excess of cleaved AT was used to select cell clones specific for the latent form of AT. The monoclonal antibody 8C8 was selected and further characterized. A competition assay was performed, in

which latent, cleaved and thrombin-complexed AT competed with Eu^{3+} -labeled latent AT for binding to 8C8, and the results showed that latent AT bound to 8C8 more strongly than native and cleaved AT did. That observation was verified by measurements performed on a Biacore 2000 instrument, which gave K_D values of 0.92×10^{-9} , 5.69×10^{-7} , and 5.65×10^{-6} M for binding to latent, native and cleaved AT, respectively.

A DELFIA for measuring latent AT was constructed using biotinylated M9 (characterization reported in Paper IV) as catcher and Eu^{3+} -labeled 8C8 as detector antibody. Dose-response curves for the analyte in buffer and in plasma deficient in latent and cleaved AT were linear and identical within experimental error. A standard curve that consisted of latent AT diluted in a plasma sample was found to be parallel to those curves (up to about 8 mg/L). The analytical recovery was 100–111% at 4 mg/L and 98–100% at 8 mg/L. The intra- and inter assay variations were determined by analysis of a normal sample and were found to be 4.5% (24 measurements) and 5.2% (38 measurements), respectively. The detection limit was calculated to 0.19 mg/L (mean +3SD) based on six measurements performed on a sample deficient in both cleaved and latent AT. The frequency distribution of the plasma concentration of latent AT in 114 healthy individuals (75 women, 37 men) had a mean of 4.8 mg/L and a median of 4.7 mg/L (range 3.2–7.1).

Commercial preparations of native AT have been found to contain considerable amounts of latent AT [196]. Accordingly, we examined the induction of latent AT at 23 °C and 37 °C in samples of purified native AT prepared in buffers with or without added citrate or heparin, and in citrated plasma and plasma containing heparin. At 37 °C, about 8% of native AT was transformed to the latent form within 48 h in a Tris buffer supplemented with citrate, whereas < 2% was converted to latent AT in heparin-containing buffer after the same amount of time. By comparison, the formation of latent AT within the same time frame was only 4% in citrated plasma and it was negligible in heparinized plasma. At 23 °C only minor conversion of native AT to the latent form was detected in the purified native AT preparations with or without added citrate. The mentioned results show that citrated tubes can be used to collect blood for the analysis of latent AT, and they also demonstrate the importance of careful preparation of commercial native AT to be used in the medical treatment of patients. The analysis of such preparations revealed that $\leq 10\%$ of the native AT was latent, which indicates that this problem has already been taken care of.

It has been confirmed that native AT can form a dimer with latent AT *in vitro*, and it has also been suggested that this dimer formation can occur *in vivo*, and thereby increase the risk of thrombotic events [17,40]. Inasmuch as we had access to monoclonal antibodies against both latent and native AT, we performed experiments to see if we could detect the dimers. To achieve that goal, we mixed equal concentrations of latent and native AT, and confirmed the presence of the

dimers by performing native PAGE. Two alternative DELFIAs were carried out to detect the dimers: both assays used Eu³⁺-labeled M27 as reporter antibody, whereas one used biotinylated 8C8 and another biotinylated M9 as catcher antibody. No dimer was detected, and hence it was necessary to examine the binding conditions between native and latent AT in greater detail. According to surface plasmon resonance, the affinity (K_D) of native AT for latent AT was 51 μ M, which is not consistent with stable dimer formation in blood. Therefore, the dimer seen in the crystal structure of native AT and revealed by PAGE can most likely be explained by very high concentrations in the experiments. Nonetheless, dimer formation may also occur *in vivo* in the capillaries, where it would be possible for AT to accumulate on the heparan-sulfate-covered endothelial cells.

Summary

The high-affinity monoclonal antibody M36 against PCI was produced and was characterized and found to discriminate between the cleaved and the native form of the inhibitor. The epitope of M36 appeared to be located close to the P13 residue of the RCL. Furthermore, the tryptophan fluorescence studies of native PCI in which a synthetic RCL-peptide had been inserted demonstrated that PCI is converted to a substrate and its structure is stabilized in a manner similar to AT and α_1 -AT.

A DELFIA method for measuring the APC-PCI complex was developed using M36 as a catcher antibody. Due to the high specificity and affinity of M36, the technique offers substantial sensitivity and thus it is sensitive enough to measure the APC-PCI complex in healthy individuals. APC-PCI levels were found to be lower in patients treated with warfarin. However, in patients, who underwent hip surgery the levels of APC-PCI were elevated four hours after operation and there were also increased concentrations of TAT and D-dimer, which indicates activation of the coagulation system.

Cleaved PCI was crystallized, and the X-ray structure revealed that helix A is shorter at the amino terminal end compared to the same helix in α_1 -AT, the protein that was used as a search model. Notably, PCI shares this feature with the non-inhibitory hormone-binding serpins CBG and TBG. The shortening of helix A opens up a hydrophobic pocket, in which retinoic acid was found to fit very well, agrees with the results of biochemical studies conducted by other investigators. In addition to helix H, another potential novel heparin-binding site was found on the surface and close to the APC interaction site. Based on this finding, a new model for heparin-induced inhibition of APC by PCI was suggested, which indicates that PCI and APC bind unspecifically to the same heparin molecule and then drift towards each other until they reach the same site to achieve complex formation.

The high-affinity monoclonal antibody M9 was produced against cleaved and latent AT. M9 has no measurable affinity for native AT. By applying blood plasma to an M9-conjugated Sepharose column and then subjecting the bound fraction to sequence analysis, the proportions of latent and cleaved AT could be estimated to 75% and 25%, respectively. A DELFIA method was developed using biotinylated M9 as catcher antibody. Another monoclonal antibody, M27, was found to be specific for native and cleaved AT and it was used as detector. The median level of cleaved AT in 114 healthy individuals was measured and was found to be 1.3 mg/L (range: 0.9–2.2 mg/L). No correlation was observed between concentrations of cleaved AT and TAT in patients with DVT and between cleaved AT and PK(INR) in warfarin-treated patients, which seems to indicate that there is some other source of the cleaved AT present in plasma.

The high affinity monoclonal antibody 8C8 was found to be specific for latent AT and the affinity for this antibody is 500-fold higher than for native AT and 5000-fold higher than for cleaved AT. A DELFIA method was developed with

biotinylated M9 as a catcher antibody and 8C8 as detector. The median level of latent AT was measured in 114 healthy individuals and was found to be 4.8 mg/L (range: 3.2-7.1 mg/L). More latent AT was generated at 37 °C in solutions of purified proteins than in samples of plasma containing citrate, whereas heparin inhibited the formation of latent AT. It was also found that the interaction between native and latent AT was weak ($K_D = 51 \mu\text{M}$), which indicates that stable dimers between the two forms of AT are not created in blood, except in the capillaries, where such dimer formation can occur due to the accumulation of AT.

Populärvetenskaplig sammanfattning

Antitrombin (AT) och protein C inhibitor (PCI) är serin proteas inhibitorer (serpiner) som cirkulerar i blodet. De hämmar enzymer genom en så kallad självmordsmekanism, varvid inhibitorn klyvs och enzymet fångas i ett irreversibelt komplex. Samtidigt sker i serpinen en drastisk strukturell förändring från *nativ* form till *kluven* form. En liknande omvandling, men till *latent* form, kan ske spontant utan föregående proteasklyvning. Genom att producera antikroppar, som är specifika för de olika formerna, kan metoder utvecklas för att bestämma koncentrationen av var och en, utan att övriga former interfererar.

PCI och AT är verksamma i regleringen av koagulationen. PCI hämmar aktivt protein C (APC), vilket är ett serinproteas som degraderar de aktiverade koagulationsfaktorerna Va och VIIIa. Koncentrationen av APC-PCI komplex i plasma ökar vid en aktivering av koagulationen. AT hämmar företrädesvis enzymerna trombin och aktiv koagulationsfaktor X (FXa). De inaktiva formerna kluvet och latent AT har visat sig hämma nybildandet av kärl hos tumörer. Vid vissa mutationer i AT har den nativa formen av AT en tendens att övergå till latent form. Då minskar den AT-kontrollerade hämningen av trombin och FXa, och risken för bildning av trombos ökar.

Genom att immunisera möss med kluvet PCI producerade vi en monoklonal antikropp M36, som inte reagerar med den nativa formen. Antikroppens bindningsställe kunde preciseras till den del i PCI som förändras mest då det klyvs i det reaktiva området. En metod utvecklades för att mäta koncentrationen av APC-PCI komplex i plasma. Principen för denna är att M36 fångar upp kluvet PCI i ett plasma prov. Därefter utnyttjas en annan antikropp för att detektera det protein C, som är i komplex med detta kluvna PCI. Medelvärdet för koncentrationen av komplexen hos friska individer beräknades till $0.30 \mu\text{g/L}$. Hos höftopererade patienter ökade nivåerna av APC-PCI upp till 4 timmar efter operationen, medan patienter behandlade med warfarin hade lägre värden.

Den exceptionellt höga bindningsstyrkan hos M36 för kluvet PCI gav anledning till att försöka definiera bindningsstället i PCI för denna antikropp mer exakt än i Paper I. Som ett led i detta kristalliserade vi kluvet PCI. Strukturen avslöjade att PCI liknar de hormonbindande serpinerna cortisonbindande globulin (CBG) och tyroxinbindande globulin (TBG). Resultat från datorstyrda försök att koppla retinolsyra till PCI visade utmärkt inbindning och därutöver presenterades en ny modell för heparinaktiverad komplexbildning mellan PCI och APC. Efter det att bestämningen av strukturen på kluvet PCI blev slutförd, påbörjade vi försök med att kristallisera komplexet mellan kluvet PCI och antikroppen M36. Kristaller uppnåddes men upplösningen var inte tillräcklig för att kunna definiera bindningsstället för M36 i PCI. Vi har påbörjat försök med att optimera betingelserna för kristallbildningen i avsikt att få fram kristaller med bättre kvalitet.

En monoklonal antikropp M9 producerades, genom att möss immuniserades med trombin-antitrombin (TAT) komplex. M9 har en hög affinitet för latent och kluvet AT, men reagerar inte med nativt AT. Vi utvecklade en metod för att mäta koncentrationen av kluvet AT: först fångar M9 upp latent och kluvet AT i ett plasmaproov. Därefter detekterar en annan antikropp, M27 (specifik för kluvet och nativt AT), hur mycket kluvet AT, som har bundits till M9. Medelnivån av kluvet AT hos friska individer uppskattades till 1.3 mg/L. Vid en jämförelse av nivåerna av TAT och kluvet AT hos patienter med djup ventrombos, kunde vi inte påvisa något samband mellan TAT och kluvet AT. En sådan korrelation kunde inte heller fastställas mellan PK (INR) och kluvet AT hos patienter som behandlades med warfarin. Resultaten talar för att det finns en annan faktor som bidrar till koncentrationen av kluvet AT i plasma.

Vi immuniserade möss med latent AT och fick fram en antikropp 8C8 med hög bindningsstyrka, som är specifik för denna form av AT. En metod konstruerades för att mäta koncentrationen av latent AT. Principen för denna är att antikroppen M9 först fångar upp latent och kluvet AT i ett plasmaproov, varefter 8C8 detekterar mängden latent AT som bundit till M9. Medelnivån av latent AT hos friska individer beräknades till 4.8 mg/L. Tidigare experiment har visat att nativt AT kan bilda komplex med latent AT inte bara *in vitro*, utan även *in vivo*. Därför försökte vi konstruera en metod för att mäta sådana komplex. Två metoder med olika antikropps-kombinationer utfördes: i båda metoderna användes M27 i steg två som detektor, medan M9 utnyttjades som första antikropp i den ena och 8C8 i den andra. Då vi inte lyckades detektera några komplex, beräknade vi bindningskonstanten mellan nativt och latent AT till 51 μM . Detta värde talar för att det inte bildas stabila komplex mellan dessa båda komponenter i blodet.

En Stor Kram till Alla
– ingen nämnd och ingen glömd –
för att Ni
har tröstat och uppmuntrat mig när det har behövts,
och delat min glädje när experimenten har gått bra!

Ett Stort Tack
för att jag har fått möjlighet
att bedriva intressant forskning
som har lett fram till denna avhandling!

Utan Ert stöd i många år hade jag inte lyckats!

References

1. Gosling, J.P. A decade of development in immunoassay methodology. *Clin Chem*, 1990. **36**(8 Pt 1): p. 1408-27.
2. Barnard, G.J., and Collins W.D. The development of luminescence immunoassays. *Med Lab Sci*, 1987. **44**(3): p. 249-66.
3. Soini, E., and Hemmilä I. Fluoroimmunoassay: present status and key problems. *Clin Chem*, 1979. **25**(3): p. 353-61.
4. Hemmilä, I., Ståhlberg T., and Mottram P. Bioanalytical applications of labelling technologies. 1994: Wallac, EG&G.
5. Hemmilä, I., Dakubu, S., Mukkula, V-M., Siitari, H., and Lövgren, T. Europium as a label in time-resolved immunofluorometric assays. *Anal Biochem*, 1984. **137**: p. 335-43.
6. Kohler, G., and Milstein C. Continuous cultures of fused cells secreting antibody of predefined specificity. *Nature*, 1975. **256**(5517): p. 495-7.
7. Strohal, R., Kroemer, G., Wick, G., and Kofler, R. Complete variable region sequence of a nonfunctionally rearranged kappa light chain transcribed in the nonsecretor P3-X63-Ag8.653 myeloma cell line. *Nucleic Acids Res*, 1987. **15**(6): p. 2771.
8. Krebber, A., Bornhauser, S., Burmester, J., Honegger, A., Willuda, J., Bosshard, H.R., and Pluckthun, A. Reliable cloning of functional antibody variable domains from hybridomas and spleen cell repertoires employing a reengineered phage display system. *J Immunol Methods*, 1997. **201**(1): p. 35-55.
9. Hunt, L.T., and Dayhoff M.O. A surprising new protein superfamily containing ovalbumin, antithrombin-III, and alpha 1-proteinase inhibitor. *Biochem Biophys Res Commun*, 1980. **95**(2): p. 864-71.
10. Carrell, R.W., and Travis, J. α 1-Antitrypsin and the serpins. Variation and countervariation. *Trends in Biological Science*, 1985. **10**: p. 20-24.
11. Takeda, A., Yamamoto, T., Nakamura, Y., Takahashi, T., and Hibino, T. Squamous cell carcinoma antigen is a potent inhibitor of cysteine proteinase cathepsin L. *FEBS Lett*, 1995. **359**(1): p. 78-80.
12. Lian, X., and Yang, T. Plasminogen activator inhibitor 2: expression and role in differentiation of epidermal keratinocyte. *Biol Cell*, 2004. **96**(2): p. 109-16.
13. Darnell, G.A., Antalis, T.M., Johnstone, R.W., Stringer, B.W., Ogbourne, S.M., Harrich, D., and Suhrbier, A. Inhibition of retinoblastoma protein degradation by interaction with the serpin plasminogen activator inhibitor 2 via a novel consensus motif. *Mol Cell Biol*, 2003. **23**(18): p. 6520-32.
14. Zou, Z., Anisowics, A., Hendrix, M.J., Thor, A., Neveu, M., Sheng, S., Rafidi, K., Seftor, E., and Sager, R. Maspin, a serpin with tumor-suppressing activity in human mammary epithelial cells. *Science*, 1994. **263**(5146): p. 526-9.

15. Stein, P.E., Leslie, A.G., Finch, J.T., Turnell, W.G., McLaughlin, P.J., and Carrell, R.W. Crystal structure of ovalbumin as a model for the reactive centre of serpins. *Nature*, 1990. **347**(6288): p. 99-102.
16. Schreuder H.A., de Boer, B., Dijkema, R., Mulders, J., Theunissen, H.J.M., Grootenhuis, P.D.J., and Hol, W.G.J. The intact and cleaved human antithrombin III complex as a model for serin-proteinase interactions. *Nature struct Biol*, 1994. **1**: p. 48-54.
17. Carrell, R.W., Stein, P.E., Fermi, G., and Wardell, M.R. Biological implications of a 3 A structure of dimeric antithrombin. *Structure*, 1994. **2**(4): p. 257-70.
18. Schechter, I., and Berger, A. On the size of the active site in proteases. I. Papain. *Biochem Biophys Res Commun*, 1967. **27**(2): p. 157-62.
19. Yamasaki, M., Arii, Y., Mikami, B., and Hirose, M. Loop-inserted and thermostabilized structure of P1-P1' cleaved ovalbumin mutant R339T. *J Mol Biol*, 2002. **315**(2): p. 113-20.
20. Busby, T.F., Atha, D.H., and Ingham, K.C. Thermal denaturation of antithrombin III. Stabilization by heparin and lyotropic anions. *J Biol Chem*, 1981. **256**(23): p. 12140-7.
21. Loebermann, H., Tokuoka, R., Deisenhofer, J., and Huber, R. Human α_1 -proteinase inhibitor. Crystal structure analysis of two crystal modifications, molecular model and preliminary analysis of the implications for function. *J Mol Biol*, 1984. **177**: p. 531-556.
22. Stein, P., and Chothia, C. Serpin tertiary structure transformation. *J Mol Biol*, 1991. **221**(2): p. 615-21.
23. Bruch, M., Weiss, V., and Engel, J. Plasma serine proteinase inhibitors (Serpins) exhibit major conformational changes and a large increase in conformational stability upon cleavage at their reactive sites. *J Biol Chem*, 1988. **263**(32): p. 16626-30.
24. Gettins, P., and Harten, B. Properties of thrombin- and elastase-modified human antithrombin III. *Biochemistry*, 1988. **27**(10): p. 3634-9.
25. Björk, I., Ylinenjarvi, K., Olson, S.T., and Bock, P.E. Conversion of Antithrombin from an Inhibitor of Thrombin to a Substrate with Reduced Heparin Affinity and Enhanced Conformational Stability by Binding of a Tetradecapeptide Corresponding to the P1 to P14 Region of the Putative Reactive Bond Loop of the Inhibitor. *J Biol Chem*, 1992. **267**: p. 1976-1982.
26. Bjork, I., Nordling, K., Larsson, I., and Olson, S.T. Kinetic characterization of the substrate reaction between a complex of antithrombin with a synthetic reactive-bond loop tetradecapeptide and four target proteinases of the inhibitor. *J Biol Chem*, 1992. **267**(27): p. 19047-50.
27. Schulze, A.J., Frohnert, P.W., Engh, R.A., and Huber, R. Evidence for the extent of insertion of the active site loop of intact α_1 -proteinase inhibitor in b-sheet A. *Biochemistry*, 1992. **31**: p. 7560-7565.
28. Mottonen, J., Strand, A., Symersky, J., Sweet, R.M., Danley, D.E., Geoghegan, K.F., Gerard, R.D., and Goldsmith, E.J. Structural basis of

- latency in plasminogen activator inhibitor-1. *Nature*, 1992. **355**(6357): p. 270-3.
29. Lomas, D.A., Elliott, P.R., Chang, W-S.W., Wardell, M.R., and Carrell, R. W. Preparation and characterisation of latent α_1 -antitrypsin. *J Biol Chem*, 1995a. **270**: p. 5282-5288.
 30. Chang, W-S.W., and Lomas, D.A. Latent α_1 -Antichymotrypsin. *J Biol Chem*, 1998. **273**: p. 3695-3701.
 31. Wardell, M.R., Chang, W-S.W., Bruce, D., Skinner, R., Lesk, A.M., and Carrell, R.W. Preparative induction and characterization of L-Antithrombin: A structural homologue of latent plasminogen activator inhibitor-1. *Biochemistry*, 1997. **36**: p. 13133-13142.
 32. Lawrence, D.A., Olson, S.T., Palaniappan, S., and Ginsburg, D. Serpin reactive-center loop mobility is required for inhibitor function but not for enzyme recognition. *J Biol Chem*, 1994. **269**: p. 27657-27662.
 33. Hekman, C.M., and Loskutoff, D.J. Endothelial cells produce a latent inhibitor of plasminogen activators that can be activated by denaturants. *J Biol Chem*, 1985. **260**: p. 11581-11587.
 34. Wiman, B., Almquist, A., Sigurdardottir, O., and Lindahl, T. Plasminogen activator inhibitor 1 (PAI) is bound to vitronectin in plasma. *FEBS Lett*, 1988. **242**(1): p. 125-8.
 35. Andreasen, P.A., Georg, B., Lund, L.R., Riccio, A., and Stacey, S.N. Plasminogen activator inhibitors: hormonally regulated serpins. *Mol Cell Endocrinol*, 1990. **68**(1): p. 1-19.
 36. Patston, P.A., Hauert, J., Michaud, M., and Schapira, M. Formation and properties of C1-inhibitor polymers. *FEBS Lett*, 1995. **368**(3): p. 401-4.
 37. Lomas, D.A., Evans, D.L., Finch, J.T., and Carrell, R.W. The mechanism of Z alpha 1-antitrypsin accumulation in the liver. *Nature*, 1992. **357**(6379): p. 605-7.
 38. Elliott, P.R., Bilton, D., and Lomas, D.A. Lung polymers in Z alpha1-antitrypsin deficiency-related emphysema. *Am J Respir Cell Mol Biol*, 1998. **18**(5): p. 670-4.
 39. Davis, R.L., Shrimpton, A.E., Holohan, P.D., Bradshaw, C., Feiglin, D., Collins, G.H., Sonderegger, P., Kinter, J., Becker, L.M., Lacbawan, F., Krasnewich, D., Muenke, M., Lawrence, D.A., Yerby, M.S., Shaw, C.M., Gooptu, B., Elliott, P.R., Finch, J.T., Carrell, R.W., and Lomas, D.A. Familial dementia caused by polymerization of mutant neuroserpin. *Nature*, 1999. **401**(6751): p. 376-9.
 40. Zhou, A., Huntington, J.A., and Carrell, R.W. Formation of the Antithrombin Heterodimer In Vivo and the Onset of Thrombosis. *Blood*, 1999. **94**: p. 3388-3396.
 41. Gettins, P.G.W., Serpin Structure, Mechanism, and Function. *Chem Rev*, 2002. **102**: p. 4751-4803.
 42. Björk, I., and Fish, W.W. Production in Vitro and properties of a modified form of bovine antithrombin, cleaved at the active site by thrombin. *J Biol Chem*, 1982. **257**: p. 9487-9493.

43. Olson, S.T. Heparin and ionic strength-dependent conversion of antithrombin III from an inhibitor to a substrate of α -thrombin. *J Biol Chem*, 1985. **260**: p. 10153-10160.
44. Patston, P.A., Gettins, P., Beechem, J., and Schapira, M. Mechanism of serpin action: evidence that C1 inhibitor functions as a suicide substrate. *Biochemistry*, 1991. **30**(36): p. 8876-82.
45. Komiyama, T., Gron, H., Pemberton, P.A., and Salvesen, G.S. Interaction of subtilisins with serpins. *Protein Sci*, 1996. **5**(5): p. 874-82.
46. Schechter, N.M., Sprows, J.L., Schoenberger, O.L., Lazarus, G.S., Cooperman, B.S., and Rubin, H. Reaction of human skin chymotrypsin-like proteinase chymase with plasma proteinase inhibitors. *J Biol Chem*, 1989. **264**(35): p. 21308-15.
47. Lawrence, D.A., Olson, S.T., Muhammad S., Day, D.E., Kvassman, J-O., Ginsburg, D., and Shore, J.D. Partitioning of serpin-proteinase reactions between stable inhibition and substrate cleavage is regulated by the rate of serpin reactive center loop insertion into β -sheet A. *J Biol Chem*, 2000. **275**: p. 5839-5844.
48. Zhou, A., Carrell, R.W., and Huntington, J.A. The serpin inhibitory mechanism is critically dependent on the length of the reactive center loop. *J Biol Chem*, 2001. **276**(29): p. 27541-7.
49. Fa, M., Bergström, F., Hägglöf, P., Wilczynska, M., Johansson, L.B., and Ny, T. The structure of a serpin-protease complex revealed by intramolecular distance measurements using donor-donor energy migration and mapping of interaction sites. *Structure Fold Des*, 2000. **8**(4): p. 397-405.
50. Huntington, J.A., Read, R., and Carrell, R.W. Structure of a serpin-protease complex shows inhibition by deformation. *Nature*, 2000. **407**: p. 923-6.
51. Kaslik, G., Patthy, A., Balint, M., and Graf, L. Trypsin complexed with α 1-proteinase inhibitor has an increased structural flexibility. *FEBS Lett*, 1995. **370**(3): p. 179-83.
52. Egelund, R., Petersen, T.E., and Andreasen, P.A. A serpin-induced extensive proteolytic susceptibility of urokinase-type plasminogen activator implicates distortion of the proteinase substrate-binding pocket and oxyanion hole in the serpin inhibitory mechanism. *Eur J Biochem*, 2001. **268**(3): p. 673-85.
53. Danielsson, A. and Björk, I. Properties of antithrombin-thrombin complex formed in the presence and in the absence of heparin. *Biochem J*, 1983. **213**(2): p. 345-53.
54. Plotnick, M.I., Schechter, N.M., Wang, Z.M., Liu, X., and Rubin, H. Role of the P6-P3' region of the serpin reactive loop in the formation and breakdown of the inhibitory complex. *Biochemistry*, 1997. **36**(47): p. 14601-8.
55. Plotnick, M.I., Samakur, M., Wang, Z.M., Liu, X., Rubin, H., Schechter, N.M., and Selwood, T. Heterogeneity in serpin-protease complexes as

- demonstrated by differences in the mechanism of complex breakdown. *Biochemistry*, 2002. **41**(1): p. 334-42.
56. Calugaru, S.V., Swanson, R., and Olson, S.T. The pH dependence of serpin-proteinase complex dissociation reveals a mechanism of complex stabilization involving inactive and active conformational states of the proteinase which are perturbable by calcium. *J Biol Chem*, 2001. **276**(35): p. 32446-55.
 57. Lindahl, U., Bäckström, G., Thunberg, L., and Leder, I.G. Evidence for a 3-O-sulfated D-glucosamine residue in the antithrombin-binding sequence of heparin. *Proc Natl Acad Sci U S A*, 1980. **77**(11): p. 6551-5.
 58. Lindahl, U., Thunberg, L., Bäckström, G., and Riesenfeld, J. The antithrombin-binding sequence of heparin. *Biochem Soc Trans*, 1981. **9**(6): p. 499-51.
 59. Casu, B., Oreste, P., Torri, G., Zoppetti, G., Choay, J., Lormeau, J.C., Petitou, M., and Sinay, P. The structure of heparin oligosaccharide fragments with high anti-(factor Xa) activity containing the minimal antithrombin III-binding sequence. Chemical and ¹³C nuclear-magnetic-resonance studies. *Biochem J*, 1981. **197**(3): p. 599-609.
 60. Jin, L., Abrahams, J.P., Skinner, R., Petitou, M., Pike, R.N., and Carrell, R.W. The anticoagulant activation of antithrombin by heparin. *Proc Natl Acad Sci U S A*, 1997. **94**: p. 14683-14688.
 61. Bray, B., Lane, D.A., Freyssinet, J.M., Pejler, G., and Lindahl, U. Antithrombin activities of heparin. Effect of saccharide chain length on thrombin inhibition by heparin cofactor II and by antithrombin. *Biochem J*, 1989. **262**(1): p. 225-32.
 62. Wei, L, Johnson, D.J.D., Esmon, C., and Huntington, J.A. Structure of the antithrombin-thrombin-heparin ternary complex reveals the antithrombotic mechanism of heparin. *Nature structural & molecular biology*, 2004. **11**: p. 857-862.
 63. Rezaie, A.R. Calcium enhances heparin catalysis of the antithrombin-factor Xa reaction by a template mechanism. Evidence that calcium alleviates Gla domain antagonism of heparin binding to factor Xa. *J Biol Chem*, 1998. **273**(27): p. 16824-7.
 64. Rezaie, A.R., and Olson, S.T. Calcium enhances heparin catalysis of the antithrombin-factor Xa reaction by promoting the assembly of an intermediate heparin-antithrombin-factor Xa bridging complex. Demonstration by rapid kinetics studies. *Biochemistry*, 2000. **39**(39): p. 12083-90.
 65. Shirk, R.A., Elisen, M.G., Meijers, J.C., and Church, F.C. Role of the H helix in heparin binding to protein C inhibitor. *J Biol Chem*, 1994. **269**(46): p. 28690-5.
 66. Pratt, C.W., and Church, F.C. Heparin binding to protein C inhibitor. *J Biol Chem*, 1992. **267**(13): p. 8789-94.
 67. Friedrich, U., Blom, A.M., Dahlbäck, B., and Villoutreix, B.O. Structural and energetic characteristics of the heparin-binding site in antithrombotic protein C. *J Biol Chem*, 2001. **276**(26): p. 24122-8.

68. Van Deerlin, V.M., and Tollefsen, D.M. The N-terminal acidic domain of heparin cofactor II mediates the inhibition of alpha-thrombin in the presence of glycosaminoglycans. *J Biol Chem*, 1991. **266**(30): p. 20223-31.
69. Baglin, T.P., Carrell, R.W., Church, F.C., Esmon, C.T., and Huntington, J.A. Crystal structures of native and thrombin-complexed heparin cofactor II reveal a multistep allosteric mechanism. *Proc Natl Acad Sci U S A*, 2002. **99**(17): p. 11079-84.
70. Ohlsson, K., and Laurell, C.B. The disappearance of enzyme-inhibitor complexes from the circulation of man. *Clin Sci Mol Med*, 1976. **51**(1): p. 87-92.
71. Fuchs, H.E., Shifman, M.A., and Pizzo, S.V. In vivo catabolism of alpha 1-proteinase inhibitor-trypsin, antithrombin III-thrombin and alpha 2-macroglobulin-methylamine. *Biochim Biophys Acta*, 1982. **716**(2): p. 151-7.
72. Mast, A.E., Enghild, J.J., Pizzo, S.V., and Salvesen, G. Analysis of the plasma elimination kinetics and conformational stabilities of native, proteinase-complexed, and reactive site cleaved serpins: comparison of alpha 1-proteinase inhibitor, alpha 1-antichymotrypsin, antithrombin III, alpha 2-antiplasmin, angiotensinogen, and ovalbumin. *Biochemistry*, 1991. **30**(6): p. 1723-30.
73. Mushunje, A., Evans, G., Brennan, S.O., Carrell, R.W., and Zhou, A. Latent antithrombin and its detection, formation and turnover in the circulation. *J Thromb Haemost*, 2004. **2**: p. 2170-2177.
74. Pizzo, S.V., Mast, A.E., Feldman, S.R., and Salvesen, G. In vivo catabolism of alpha 1-antichymotrypsin is mediated by the Serpin receptor which binds alpha 1-proteinase inhibitor, antithrombin III and heparin cofactor II. *Biochim Biophys Acta*, 1988. **967**(2): p. 158-62.
75. Pratt, C.W., Church, F.C., and Pizzo, S.V. In vivo catabolism of heparin cofactor II and its complex with thrombin: evidence for a common receptor-mediated clearance pathway for three serine proteinase inhibitors. *Arch Biochem Biophys*, 1988. **262**(1): p. 111-7.
76. Kristensen, T., Moestrup, S.K., Gliemann, J., Bendtsen, L., Sand, O., and Sottrup-Jensen, L. Evidence that the newly cloned low-density-lipoprotein receptor related protein (LRP) is the alpha 2-macroglobulin receptor. *FEBS Lett*, 1990. **276**(1-2): p. 151-5.
77. Nykjaer, A., Petersen, C.M., Möller, B., Jensen, P.H., Moestrup, S.K., Holtet, T.L., Etzerodt, M., Thogersen, H.C., Munch, M., and Andreasen, P.A. Purified alpha 2-macroglobulin receptor/LDL receptor-related protein binds urokinase.plasminogen activator inhibitor type-1 complex. Evidence that the alpha 2-macroglobulin receptor mediates cellular degradation of urokinase receptor-bound complexes. *J Biol Chem*, 1992. **267**(21): p. 14543-6.
78. Poller, W., Willnow, T.E., Hilpert, J., and Herz, J. Differential recognition of alpha 1-antitrypsin-elastase and alpha 1-antichymotrypsin-cathepsin G complexes by the low density lipoprotein receptor-related protein. *J Biol Chem*, 1995. **270**(6): p. 2841-5.

79. Kounnas, M.Z., Church, F.C., Argraves, W.S., and Strickland, D.K. Cellular internalization and degradation of antithrombin III-thrombin, heparin cofactor II-thrombin, and alpha 1-antitrypsin-trypsin complexes is mediated by the low density lipoprotein receptor-related protein. *J Biol Chem*, 1996. **271**(11): p. 6523-9.
80. Storm, D., Herz, J., Trinder, P., and Loos, M. C1 inhibitor-C1s complexes are internalized and degraded by the low density lipoprotein receptor-related protein. *J Biol Chem*, 1997. **272**(49): p. 31043-50.
81. Perlmutter, D.H., Glover, G.I., Rivetna, M., Schasteen, C.S., and Fallon, R.J. Identification of a serpin-enzyme complex receptor on human hepatoma cells and human monocytes. *Proc Natl Acad Sci U S A*, 1990. **87**(10): p. 3753-7.
82. Joslin, G., Fallon, R.J., Bullock, J., Adams, S.P., and Perlmutter, D.H. The SEC receptor recognizes a pentapeptide neodomain of alpha 1-antitrypsin-protease complexes. *J Biol Chem*, 1991. **266**(17): p. 11282-8.
83. Maekawa, H., and Tollefsen, D.M. Role of the proposed serpin-enzyme complex receptor recognition site in binding and internalization of thrombin-heparin cofactor II complexes by hepatocytes. *J Biol Chem*, 1996. **271**(31): p. 18604-9.
84. Conard, J., Brosstad, F., Lie Larsen, M., Samama, M., and Abildgaard, U. Molar antithrombin concentration in normal human plasma. *Haemostasis*, 1983. **13**(6): p. 363-8.
85. Peterson, C.B., and Blackburn, M.N. Isolation and characterization of an antithrombin III variant with reduced carbohydrate content and enhanced heparin binding. *J Biol Chem*, 1985. **260**(1): p. 610-5.
86. Turk, B., Brieditis, I., Bock, S.C., Olson, S.T., and Björk, I. The oligosaccharide side chain on Asn-135 of alpha-antithrombin, absent in beta-antithrombin, decreases the heparin affinity of the inhibitor by affecting the heparin-induced conformational change. *Biochemistry*, 1997. **36**(22): p. 6682-91.
87. Frebelius, S., Isaksson, S., and Swedenborg, J. Thrombin inhibition by antithrombin III on the subendothelium is explained by the isoform AT beta. *Arterioscler Thromb Vasc Biol*, 1996. **16**(10): p. 1292-7.
88. Egeberg, O. Inherited Antithrombin Deficiency Causing Thrombophilia. *Thromb Diath Haemorrh*, 1965. **13**: p. 516-30.
89. Lane, D.A., Ireland, H., Olds, R.J., Thein, S.L., Perry, D.J., and Aiach, M. Antithrombin III: a database of mutations. *Thromb Haemost*, 1991. **66**(6): p. 657-61.
90. Kojima, T. Targeted gene disruption of natural anticoagulant proteins in mice. *Int J Hematol*, 2002. **76 Suppl 2**: p. 36-9.
91. Hoffmann, J.N., Vollmar, B., Inthorn, D., Schildberg, F.W., and Menger, M.D. Antithrombin reduces leukocyte adhesion during chronic endotoxemia by modulation of the cyclooxygenase pathway. *Am J Physiol Cell Physiol*, 2000. **279**(1): p. C98-C107.
92. Hoffmann, J.N., Vollmar, B., Laschke, M.W., Inthorn, D., Kaneider, N.C., Dünzendorfer, S., Wiedermann, C.J., Romisch, J., Schildberg, F.W., and

- Menger, M.D. Adverse effect of heparin on antithrombin action during endotoxemia: microhemodynamic and cellular mechanisms. *Thromb Haemost*, 2002. **88**(2): p. 242-52.
93. Potempa, J., Fedak, D., Dubin, A., Mast, A., and Travis, J. Proteolytic inactivation of alpha-1-anti-chymotrypsin. Sites of cleavage and generation of chemotactic activity. *J Biol Chem*, 1991. **266**(32): p. 21482-7.
 94. Banda, M.J., Rice, A.G., Griffin, G.L., and Senoir, R. M. Alpha 1-proteinase inhibitor is a neutrophil chemoattractant after proteolytic inactivation by macrophage elastase. *J Biol Chem*, 1988. **263**(9): p. 4481-4.
 95. Zhang, W., Chuang, Y.J., Swanson, R., Li, J., Seo, K., Leung, L., Lau, L.F., and Olsen, S.T. Antiangiogenic antithrombin down-regulates the expression of the proangiogenic heparan sulfate proteoglycan, perlecan, in endothelial cells. *Blood*, 2004. **103**(4): p. 1185-91.
 96. Kisker, O., Onizuka, S., Banyard, J., Komiyama, T., Becker, C.M., Achilles, E.G., Barnes, C.M., O'Reilly, M.S., Folkman, J., and Pirie-Shepherd, S.R. Generation of multiple angiogenesis inhibitors by human pancreatic cancer. *Cancer Res*, 2001. **61**(19): p. 7298-304.
 97. Suzuki, K., Nishioka, J., and Hashimoto, S. Protein C inhibitor. Purification from human plasma and characterization. *J Biol Chem*, 1983. **258**: p. 163-8.
 98. Radtke, K.P., Fernandez, J.A., Greengard, J.S., Tang, W.W., Wilson, C.B., Loskutoff, D.J., Scharrer, I., and Griffin, J.H. Protein C inhibitor is expressed in tubular cells of human kidney. *J Clin Invest*, 1994. **94**(5): p. 2117-24.
 99. Laurell, M., Christensson, A., Abrahamsson, P.A., Stenflo, J., and Lilja, H. Protein C inhibitor in human body fluids. Seminal plasma is rich in inhibitor antigen deriving from cells throughout the male reproductive system. *J Clin Invest*, 1992. **89**(4): p. 1094-101.
 100. Prendes, M.J., Bielek, E., Zechmeister-Machhart, M., Vanyek-Zavadil, E., Carroll, V.A., Breuss, J., Binder, B.R. and Geiger, M. Synthesis and ultrastructural localization of protein C inhibitor in human platelets and megakaryocytes. *Blood*, 1999. **94**(4): p. 1300-12.
 101. Krebs, M., Uhrin, P., Vales, A., Prendes-Garcia, M.J., Wojta, J., Geiger, M., and Binder, B.R. Protein C inhibitor is expressed in keratinocytes of human skin. *J Invest Dermatol*, 1999. **113**(1): p. 32-7.
 102. España, F., Gilabert, J., Estelles, A., Romeu, A., Aznar, J., and Cabo, A. Functionally active protein C inhibitor/plasminogen activator inhibitor-3 (PCI/PAI-3) is secreted in seminal vesicles, occurs at high concentrations in human seminal plasma and complexes with prostate-specific antigen. *Thromb Res*, 1991. **64**(3): p. 309-20.
 103. Rezaie, A.R., Cooper, S.T., Church, F.C., and Esmon, C.T. Protein C Inhibitor is a Potent Inhibitor of the Thrombin-Thrombomodulin Complex. *J Biol Chem*, 1995. **270**(43 October 27): p. 25336-25339.
 104. Elisen, M.G., van Kooji, R.J., Nolte, M.A., Marquart, J.A., Lock, T.M., Bouma, B.N., and Meijers, J.C. Protein C inhibitor may modulate human sperm-oocyte interactions. *Biol Reprod*, 1998. **58**(3): p. 670-7.

105. Uhrin, P., Dewerchin, M., Hilpert, M., Chrenek, P., Schofer, C., Zechmeister-Marchhart, M., Kronke, G., Vales, A., Carmeliet, P., Binder, B.R., and Geiger, M. Disruption of the protein C inhibitor gene results in impaired spermatogenesis and male infertility. *J Clin Invest*, 2000. **106**(12): p. 1531-9.
106. Majerus, P.W. Platelets, in *The molecular basis of blood diseases*, G. Stamatoyannopoulos, Majerus, P. W., Perlmutter, R. M., Varmus, H., Editor. 2001, W. B. Saunders: Philadelphia. p. 764-780.
107. Heemskerk, J.W., Bevers, E.M., and Lindhout, T. Platelet activation and blood coagulation. *Thromb Haemost*, 2002. **88**(2): p. 186-93.
108. Macfarlane, R.G. An Enzyme Cascade in the Blood Clotting Mechanism, and Its Function as a Biochemical Amplifier. *Nature*, 1964. **202**: p. 498-9.
109. Davie, E.W., and Ratnoff, O.D. Waterfall Sequence for Intrinsic Blood Clotting. *Science*, 1964. **145**: p. 1310-2.
110. Rapaport, S.I., and Rao, L.V. The tissue factor pathway: how it has become a "prima ballerina". *Thromb Haemost*, 1995. **74**(1): p. 7-17.
111. Morrissey, J.H. Tissue factor modulation of factor VIIa activity: use in measuring trace levels of factor VIIa in plasma. *Thromb Haemost*, 1995. **74**(1): p. 185-8.
112. Morrissey, J.H., Neuenschwander, P.F., Huang, Q., McCallum, C.D., Su, B., and Johnson, A.E. Factor VIIa-tissue factor: functional importance of protein-membrane interactions. *Thromb Haemost*, 1997. **78**(1): p. 112-6.
113. Osterud, B., and Rapaport, S.I. Activation of factor IX by the reaction product of tissue factor and factor VII: additional pathway for initiating blood coagulation. *Proc Natl Acad Sci U S A*, 1977. **74**(12): p. 5260-4.
114. Suttie, J.W., Vitamin K-dependent carboxylase. *Annu Rev Biochem*, 1985. **54**: p. 459-77.
115. Rosing, J., and Tans, G. Coagulation factor V: an old star shines again. *Thromb Haemost*, 1997. **78**(1): p. 427-33.
116. Regan, L.M., and Fay, P.J. Cleavage of factor VIII light chain is required for maximal generation of factor VIIIa activity. *J Biol Chem*, 1995. **270**(15): p. 8546-52.
117. Naito, K., and Fujikawa, K. Activation of human blood coagulation factor XI independent of factor XII. Factor XI is activated by thrombin and factor XIa in the presence of negatively charged surfaces. *J Biol Chem*, 1991. **266**(12): p. 7353-8.
118. Gailani, D., and Broze Jr, G.J. Factor XI activation by thrombin and factor XIa. *Semin Thromb Hemost*, 1993. **19**(4): p. 396-404.
119. Hoffman, M., Monroe, D.M. 3rd, and Roberts, H.R. Activated factor VII activates factors IX and X on the surface of activated platelets: thoughts on the mechanism of action of high-dose activated factor VII. *Blood Coagul Fibrinolysis*, 1998. **9 Suppl 1**: p. S61-5.
120. Monroe, D.M., Hoffmann, M., Oliver, J.A., and Roberts, H.R. Platelet activity of high-dose factor VIIa is independent of tissue factor. *Br J Haematol*, 1997. **99**(3): p. 542-7.

121. Hoffman, M., and Monroe, D.M. A cell-based model of hemostasis. *Thromb Haemost*, 2001. **85**(6): p. 958-65.
122. Le, D.T., Borgs, P., Toneff, T.W., Witte, M.H., and Rapaport, S.I. Hemostatic factors in rabbit limb lymph: relationship to mechanisms regulating extravascular coagulation. *Am J Physiol*, 1998. **274**(3 Pt 2): p. H769-76.
123. Allen, D.H., and Tracy, P.B. Human coagulation factor V is activated to the functional cofactor by elastase and cathepsin G expressed at the monocyte surface. *J Biol Chem*, 1995. **270**(3): p. 1408-15.
124. Bauer, K.A., Kass, B.L., ten Cate, H., Bednarek, M.A., Hawiger, J.J., and Rosenberg, R.D. Detection of factor X activation in humans. *Blood*, 1989. **74**(6): p. 2007-15.
125. Bauer, K.A., Kass, B.L., ten Cate, H., Hawiger, J.J., and Rosenberg, R.D. Factor IX is activated in vivo by the tissue factor mechanism. *Blood*, 1990. **76**(4): p. 731-6.
126. Hung, D.T., Vu, T.K., Wheaton, V.I., Ishii, K., and Coughlin, S.R. Cloned platelet thrombin receptor is necessary for thrombin-induced platelet activation. *J Clin Invest*, 1992. **89**(4): p. 1350-3.
127. Monkovic, D.D., and Tracy, P.B. Functional characterization of human platelet-released factor V and its activation by factor Xa and thrombin. *J Biol Chem*, 1990. **265**(28): p. 17132-40.
128. Hultin, M.B. Modulation of thrombin-mediated activation of factor VIII:C by calcium ions, phospholipid, and platelets. *Blood*, 1985. **66**(1): p. 53-8.
129. Ahmad, S.S., Rawala-Sheikh, R., and Walsh, P.N. Platelet receptor occupancy with factor IXa promotes factor X activation. *J Biol Chem*, 1989. **264**(33): p. 20012-6.
130. Greengard, J.S., Heeb, M.J., Ersdal, E., Walsh, P.N., and Griffin, J.H. Binding of coagulation factor XI to washed human platelets. *Biochemistry*, 1986. **25**(13): p. 3884-90.
131. Collen, D., and Lijnen, H.R. Basic and clinical aspects of fibrinolysis and thrombolysis. *Blood*, 1991. **78**(12): p. 3114-24.
132. Hoylaerts, M., Rijken, D.C., Lijnen, H.R., and Collen, D. Kinetics of the activation of plasminogen by human tissue plasminogen activator. Role of fibrin. *J Biol Chem*, 1982. **257**(6): p. 2912-9.
133. Wiman, B., and Collen, D. On the kinetics of the reaction between human antiplasmin and plasmin. *Eur J Biochem*, 1978. **84**(2): p. 573-8.
134. Thorsen, S., Philips, M., Selmer, J., Lecander, I., and Åstedt, B. Kinetics of inhibition of tissue-type and urokinase-type plasminogen activator by plasminogen-activator inhibitor type 1 and type 2. *Eur J Biochem*, 1988. **175**(1): p. 33-9.
135. Nesheim, M., Wang, W., Boffa, M., Nagashima, M., Morser, J., and Bajzar, L. Thrombin, thrombomodulin and TAFI in the molecular link between coagulation and fibrinolysis. *Thromb Haemost*, 1997. **78**(1): p. 386-91.
136. Bourin, M.C., and Lindahl, U. Glycosaminoglycans and the regulation of blood coagulation. *Biochem J*, 1993. **289** (Pt 2): p. 313-30.

137. Bauer, K.A., and Rosenberg, R.D. Role of antithrombin III as a regulator of in vivo coagulation. *Semin Hematol*, 1991. **28**(1): p. 10-8.
138. McGuire, E.A., and Tollefsen, D.M. Activation of heparin cofactor II by fibroblasts and vascular smooth muscle cells. *J Biol Chem*, 1987. **262**(1): p. 169-75.
139. Shirk, R.A., Church, F.C., and Wagner, W.D. Arterial smooth muscle cell heparan sulfate proteoglycans accelerate thrombin inhibition by heparin cofactor II. *Arterioscler Thromb Vasc Biol*, 1996. **16**(9): p. 1138-46.
140. Andrew, M., Mitchell, L., Berry, L., Paes, B., Delorme, M., Ofosu, F., Burrows, R., and Khambalia, B. An anticoagulant dermatan sulfate proteoglycan circulates in the pregnant woman and her fetus. *J Clin Invest*, 1992. **89**(1): p. 321-6.
141. Dittman, W.A., and Majerus, P.W. Structure and function of thrombomodulin: a natural anticoagulant. *Blood*, 1990. **75**(2): p. 329-36.
142. Maruyama, I., Bell, C.E., and Majerus, P.W. Thrombomodulin is found on endothelium of arteries, veins, capillaries, and lymphatics, and on syncytiotrophoblast of human placenta. *J Cell Biol*, 1985. **101**(2): p. 363-71.
143. Esmon, C.T., and Owen, W.G. Identification of an endothelial cell cofactor for thrombin-catalyzed activation of protein C. *Proc Natl Acad Sci U S A*, 1981. **78**(4): p. 2249-52.
144. Owen, W.G., and Esmon, C.T. Functional properties of an endothelial cell cofactor for thrombin-catalyzed activation of protein C. *J Biol Chem*, 1981. **256**(11): p. 5532-5.
145. Esmon, C.T., Esmon, N.L., and Harris, K.W. Complex formation between thrombin and thrombomodulin inhibits both thrombin-catalyzed fibrin formation and factor V activation. *J Biol Chem*, 1982. **257**(14): p. 7944-7.
146. Laszik, Z., Mitro, A., Taylor Jr, F.B., Ferrell, G., and Esmon, C.T. Human protein C receptor is present primarily on endothelium of large blood vessels: implications for the control of the protein C pathway. *Circulation*, 1997. **96**(10): p. 3633-40.
147. Stearns-Kurosawa, D.J., Kurosawa, S., Mollica, J.S., Ferrell, G.L., and Esmon, C.T. The endothelial cell protein C receptor augments protein C activation by the thrombin-thrombomodulin complex. *Proc Natl Acad Sci U S A*, 1996. **93**(19): p. 10212-6.
148. Kurosawa, S., Stearns-Kurosawa, D.J., Hidari, N., and Esmon, C.T. Identification of functional endothelial protein C receptor in human plasma. *J Clin Invest*, 1997. **100**(2): p. 411-8.
149. Boehme, M.W., Deng, Y., Raeth, U., Bierhaus, A., Ziegler, R., Stremmel, W., and Nawroth, P.P. Release of thrombomodulin from endothelial cells by concerted action of TNF-alpha and neutrophils: in vivo and in vitro studies. *Immunology*, 1996. **87**(1): p. 134-40.
150. Stenflo, J. A new vitamin K-dependent protein. Purification from bovine plasma and preliminary characterization. *J Biol Chem*, 1976. **251**(2): p. 355-63.

151. Esmon, C.T., Stenflo, J., and Suttie, J.W. A new vitamin K-dependent protein. A phospholipid-binding zymogen of a serine esterase. *J Biol Chem*, 1976. **251**(10): p. 3052-6.
152. Kisiel, W. Human plasma protein C: isolation, characterization, and mechanism of activation by alpha-thrombin. *J Clin Invest*, 1979. **64**(3): p. 761-9.
153. Miletich, J.P., Leykam, J.F., and Broze Jr, G.J. Detection of a single chain protein C in plasma. *Blood (suppl. 1)*, 1983. **62**: p. 306a.
154. Sunnerhagen, M., Forsen, S., Hoffren, A.M., Drakenberg, T., Teleman, O., and Stenflo, J. Structure of the Ca(2+)-free Gla domain sheds light on membrane binding of blood coagulation proteins. *Nat Struct Biol*, 1995. **2**(6): p. 504-9.
155. Walker, F.J., Sexton, P.W., and Esmon, C.T. The inhibition of blood coagulation by activated Protein C through the selective inactivation of activated Factor V. *Biochim Biophys Acta*, 1979. **571**(2): p. 333-42.
156. Fulcher, C.A., Gardiner, J.E., Griffin, J.H., and Zimmerman, T.S. Proteolytic inactivation of human factor VIII procoagulant protein by activated human protein C and its analogy with factor V. *Blood*, 1984. **63**(2): p. 486-9.
157. Dahlbäck, B. Protein S and C4b-binding protein: components involved in the regulation of the protein C anticoagulant system. *Thromb Haemost*, 1991. **66**(1): p. 49-61.
158. Shen, L., and Dahlbäck, B. Factor V and protein S as synergistic cofactors to activated protein C in degradation of factor VIIIa. *J Biol Chem*, 1994. **269**(29): p. 18735-8.
159. DiScipio, R.G., and Davie, E.W. Characterization of protein S, a gamma-carboxyglutamic acid containing protein from bovine and human plasma. *Biochemistry*, 1979. **18**(5): p. 899-904.
160. Dahlback, B., and Stenflo, J. High molecular weight complex in human plasma between vitamin K-dependent protein S and complement component C4b-binding protein. *Proc Natl Acad Sci U S A*, 1981. **78**(4): p. 2512-6.
161. Dahlbäck, B. Inhibition of protein Ca cofactor function of human and bovine protein S by C4b-binding protein. *J Biol Chem*, 1986. **261**(26): p. 12022-7.
162. Thorelli, E., Kaufman, R.J., and Dahlbäck, B. Cleavage of factor V at Arg 506 by activated protein C and the expression of anticoagulant activity of factor V. *Blood*, 1999. **93**(8): p. 2552-8.
163. Dahlbäck, B., and Hildebrand, B. Inherited resistance to activated protein C is corrected by anticoagulant cofactor activity found to be a property of factor V. *Proc Natl Acad Sci U S A*, 1994. **91**(4): p. 1396-400.
164. Rees, D.C., Cox, M., and Clegg, J.B. World distribution of factor V Leiden. *Lancet*, 1995. **346**(8983): p. 1133-4.
165. Zöller, B., Norlund, L., Leksell, H., Nilsson, J.E., von Schenk, H., Rosén, U., Jepsson, J.O., and Dahlbäck, B. High prevalence of the FVR506Q

- mutation causing APC resistance in a region of southern Sweden with a high incidence of venous thrombosis. *Thromb Res*, 1996. **83**(6): p. 475-7.
166. Suzuki, K., Deyashiki, Y., Nishioka, J., and Toma, K. Protein C inhibitor: structure and function. *Thromb Haemost*, 1989. **61**(3): p. 337-42.
 167. Heeb, M.J., and Griffin, J.H. Physiologic inhibition of human activated protein C by alpha 1-antitrypsin. *J Biol Chem*, 1988. **263**(24): p. 11613-6.
 168. Hoogendoorn, H., Toh, C.H., Nesheim, M.E., and Giles, A.R. Alpha 2-macroglobulin binds and inhibits activated protein C. *Blood*, 1991. **78**(9): p. 2283-90.
 169. Marlar, R.A., and Neumann, A. Neonatal purpura fulminans due to homozygous protein C or protein S deficiencies. *Semin Thromb Hemost*, 1990. **16**(4): p. 299-309.
 170. Bernard, G.R., Vincent, J.L., Laterre, P.F., LaRosa, S.P., Dhainaut, J.F., Lopez-Rodriguez, A., Steingrub, J.S., Garber, G.E., Helterbrand, J.D., Ely, E.W., and Fisher Jr, C.J. Efficacy and safety of recombinant human activated protein C for severe sepsis. *N Engl J Med*, 2001. **344**(10): p. 699-709.
 171. Grey, S.T., Tsuchida, A., Hau, H., Orthner, C.L., Salem, H.H., and Hancock, W.W. Selective inhibitory effects of the anticoagulant activated protein C on the responses of human mononuclear phagocytes to LPS, IFN-gamma, or phorbol ester. *J Immunol*, 1994. **153**(8): p. 3664-72.
 172. Nick, J.A., Coldren, C.D., Geraci, M.W., Poch, K.R., Fouty, B.W., O'Brien, J., Gruber, M., Zarini, S., Murphy, R.C., Kuhn, K., Richter, D., Kast, K.R., and Abraham, E. Recombinant human activated protein C reduces human endotoxin-induced pulmonary inflammation via inhibition of neutrophil chemotaxis. *Blood*, 2004. **104**(13): p. 3878-85.
 173. Gruber, A., and Griffin, J.H. Direct detection of activated protein C in blood from human subjects. *Blood*, 1992. **79**(9): p. 2340-8.
 174. Orthner, C.L., Kolen, B., and Drohan, W.N. A sensitive and facile assay for the measurement of activated protein C activity levels in vivo. *Thromb Haemost*, 1993. **69**(5): p. 441-7.
 175. Espana, F., Zuazu, I., Vicente, V., Estelles, A., Marco, P., and Aznar, J. Quantification of circulating activated protein C in human plasma by immunoassays--enzyme levels are proportional to total protein C levels. *Thromb Haemost*, 1996. **75**(1): p. 56-61.
 176. Liaw, P.C., Ferrell, G., and Esmon, C.T. A monoclonal antibody against activated protein C allows rapid detection of activated protein C in plasma and reveals a calcium ion dependent epitope involved in factor Va inactivation. *J Thromb Haemost*, 2003. **1**(4): p. 662-70.
 177. Espana, F., and Griffin, J.H. Determination of functional and antigenic protein C inhibitor and its complexes with activated protein C in plasma by ELISA's. *Thromb Res*, 1989. **55**(6): p. 671-82.
 178. Minamikawa, K., Wada, H., Wakita, Y., Ohiwa, M., Tanigawa, M., Deguchi, K., Hiraoka, N., Huzoika, H., Nishioka, J., and Hayashi, T. Increased activated protein C-protein C inhibitor complex levels in patients with pulmonary embolism. *Thromb Haemost*, 1994. **71**(2): p. 192-4.

179. Giercksky, K.E., Björklid, E., Prydz, H., and Renck, H. Circulating tissue thromboplastin during hip surgery. *Eur Surg Res*, 1979. **11**(4): p. 296-300.
180. Strandberg, K., Astermark, J., Björgell, O., Becker, C., Nilsson, P.E., and Stenflo, J. Complexes between activated protein C and protein C inhibitor measured with a new method: comparison of performance with other markers of hypercoagulability in the diagnosis of deep vein thrombosis. *Thromb Haemost*, 2001. **86**: p. 1400-8.
181. Strandberg, K., Bhiladvala, P., Holm, J., and Stenflo, J. A new method to measure plasma levels of activated protein C in complex with protein C inhibitor in patients with acute coronary syndromes. *Blood Coagulation and Fibrinolysis*, 2001. **12**: p. 503-510.
182. Bhiladvala, P., Strandberg, K., Stenflo, J., and Holm, J. Early identification of acute myocardial infarction by activated protein C--protein C inhibitor complex. *Thromb Res*, 2006. **118**(2): p. 213-9.
183. Kolbel, T., Strandberg, K., Mattiasson, I., Stenflo, J., and Lindblad, B. Activated protein C-protein C inhibitor complex: a new biological marker for aortic aneurysms. *J Vasc Surg*, 2006. **43**(5): p. 935-9.
184. Nilsson, G., Strandberg, K., Astermark, J., Vernersson, E., Stenflo, J., and Berntorp, E. The APC-PCI complex concentration predicts outcome of aortic surgery. *Thromb Res*, 2006.
185. Jerabek, I., Zechmeister-Machhart, M., Binder, B.R., and Geiger, M. Binding of retinoic acid by the inhibitory serpin protein C inhibitor. *Eur J Biochem*, 2001. **268**(22): p. 5989-96.
186. Fujita, M., Izutani, W., Takahashi, K., Nishizawa, K., Shirono, H., and Koga, J. Role of each Asn-linked glycan in the anticoagulant activity of human protein C inhibitor. *Thromb Res*, 2002. **105**(1): p. 95-102.
187. Shen, L., Villoutreix, B.O., and Dahlbäck, B. Involvement of Lys 62(217) and Lys 63(218) of human anticoagulant protein C in heparin stimulation of inhibition by the protein C inhibitor. *Thromb Haemost*, 1999. **82**(1): p. 72-9.
188. Yang, L., Manithody, C., and Rezaie, A.R. Contribution of basic residues of the 70-80-loop to heparin binding and anticoagulant function of activated protein C. *Biochemistry*, 2002. **41**(19): p. 6149-57.
189. O'Reilly, M.S., Pirie-Shepherd, S., Lane, W.S., Folkman, J., Antiangiogenic activity of the cleaved conformation of the serpin antithrombin. *Science*, 1999. **285**: p. 1926-1928.
190. Larsson, H., Sjöblom, T., Dixelius, J., Ostman, A., Ylinenjärvi, K., Björk, I., and Calesson-Welsh, L. Antiangiogenic effects of latent antithrombin through perturbed cell-matrix interactions and apoptosis of endothelial cells. *Cancer Res*, 2000. **60**(23): p. 6723-9.
191. Beauchamp, N.J., Pike, R.N., Daly, M., Butler, L., Makris, M., Dafforn, T.R., Zhou, A., Fitton, H.L., Preston, F.E., Peake, I.R. and Carrell, R.W. Antithrombins Wibble and Wobble (T85M/K): archetypal conformational diseases with in vivo latent-transition, thrombosis, and heparin activation. *Blood*, 1998. **92**(8): p. 2696-706.

192. Long, G.L., Kjellberg, M., Villoutreix, B.O., and Stenflo, J. Probing plasma clearance of the thrombin-antithrombin complex with a monoclonal antibody against the putative serpin-enzyme complex receptor-binding site. *Eur J Biochem*, 2003. **270**: p. 4059-4069.
193. Esmon, P.C., and Yee, E. Ezyme-linked immunosorbent assay for proteolytically inactivated antithrombin-III: Use of sodium dodecyl sulfate to eliminate signal due to intact antithrombin-III. *Analytical Biochemistry*, 1992. **202**: p. 344-347.
194. Lindo, V.S., Kakkar, V.V., and Melissari, E. Cleaved antithrombin (ATc): a new marker for thrombin generation and activation of the coagulation system. *Br J Haematol*, 1995. **89**: p. 157-162.
195. Marcum, J.A., McKenney, J.B., and Rosenberg, R.D. Acceleration of thrombin-antithrombin complex formation in rat hindquarters via heparinlike molecules bound to the endothelium. *J Clin Invest*, 1984. **74**: p. 341-350.
196. Chang, W-S.W., and Harper, P.L. Commercial antithrombin concentrate contains inactive L-forms of antithrombin. *Thromb Haemost*, 1997. **77**: p. 323-328.