



LUND UNIVERSITY

Urban Design and Outdoor Thermal Comfort in Warm Climates. Studies in Fez and Colombo

Johansson, Erik

2006

[Link to publication](#)

Citation for published version (APA):

Johansson, E. (2006). *Urban Design and Outdoor Thermal Comfort in Warm Climates. Studies in Fez and Colombo*. [Doctoral Thesis (compilation), Housing Development and Management]. Housing development & management.

Total number of authors:

1

General rights

Unless other specific re-use rights are stated the following general rights apply:

Copyright and moral rights for the publications made accessible in the public portal are retained by the authors and/or other copyright owners and it is a condition of accessing publications that users recognise and abide by the legal requirements associated with these rights.

- Users may download and print one copy of any publication from the public portal for the purpose of private study or research.
- You may not further distribute the material or use it for any profit-making activity or commercial gain
- You may freely distribute the URL identifying the publication in the public portal

Read more about Creative commons licenses: <https://creativecommons.org/licenses/>

Take down policy

If you believe that this document breaches copyright please contact us providing details, and we will remove access to the work immediately and investigate your claim.

LUND UNIVERSITY

PO Box 117
221 00 Lund
+46 46-222 00 00

Urban Design and Outdoor Thermal Comfort in Warm Climates

Studies in Fez and Colombo

Keywords

Arid zones	Humid tropics	Tropical areas
Built environment	Land-use	Urban climate
Climate	Microclimates	Urban design
Climatic design	Morocco	Urban planning
Colombo	Planning regulations	
Developing countries	Sri Lanka	
Fez	Thermal comfort	

Erik Johansson
Urban Design and Outdoor Thermal Comfort in Warm Climates.
Studies in Fez and Colombo

Thesis 3
ISBN 91-87866-27-7
ISSN 1652-7666

Layout, Jan-Anders Mattsson
Illustrations, Mattias Rückert
Photos, Erik Johansson, Karin Grundström
Printed in Sweden by Grahns Tryckeri AB, Lund, 2006

This Thesis can be ordered from
Housing Development & Management

Lund University
Box 118
SE-221 00 Lund
Sweden

Telephone +46 64 222 97 61
Telefax +46 46 222 81 81
E-mail hdm@lth.se
Homepage <http://www.hdm.lth.se>

Urban Design and Outdoor Thermal Comfort in Warm Climates

Studies in Fez and Colombo

Table of Contents

Acknowledgements	7
1 Introduction	11
1.1 Background	11
1.2 Problem statement	11
1.3 Aim of the thesis	13
1.4 Scope and limitations	13
1.5 Structure of the thesis	14
2 Cities studied	17
2.1 Choice of cities	17
2.2 Fez	19
2.3 Colombo	28
3 Concepts	37
3.1 The climate of the urban canopy layer	37
3.2 Outdoor thermal comfort	46
4 Literature review	53
4.1 Microclimate in tropical cities	53
4.2 Outdoor thermal comfort in tropical cities	55
4.3 Models and tools predicting urban microclimate	58
4.4 Urban design guidelines for tropical climates	62
4.5 Consideration of climate aspects in urban planning and design	65
4.6 Conclusions	67
5 Methodology	69
5.1 Experimental methods	70
5.2 Simulation methods	76
5.3 Qualitative methods	81
6 Results	85
6.1 Microclimate measurements	85
6.2 Calculated outdoor thermal comfort	91
6.3 Simulations of microclimate and outdoor thermal comfort	94
6.4 Consideration of climate in the urban planning and design processes	103

7	Discussion and conclusions	113
7.1	Influence of urban design on outdoor thermal comfort	113
7.2	The consideration of climate in urban planning and design	119
7.3	How to improve thermal comfort at street level	120
7.4	Future studies	123
	References	125
	Appendices	131
	Appendix 1 Glossary of terms and definitions	131
	Appendix 2 Material properties	135
	Appendix 3 The interview guide	137
Paper I	Influence of urban geometry on outdoor thermal comfort in a hot dry climate: A study in Fez, Morocco	139
Paper II	Influence of urban morphology and sea breeze on hot humid microclimate: the case of Colombo, Sri Lanka	161
Paper III	The influence of urban design on outdoor thermal comfort in the hot, humid city of Colombo, Sri Lanka	183
Paper IV	Simulations of urban microclimate and outdoor thermal comfort in the hot dry city of Fez and in the hot humid city of Colombo	209

Acknowledgements

I would like to thank everyone who has encouraged and supported me during the years I have spent working on this thesis.

First of all, I am particularly thankful to my tutors, who contributed to this work in different ways. Jan Söderberg, my main supervisor, continuously stressed the importance of a multi-disciplinary research approach. Hans Rosenlund gave very valuable advice throughout the work, especially on aspects regarding climate and thermal comfort. Johnny Åstrand encouraged me to apply for this project, broadened my perspectives and introduced me to the urban planning process in developing countries.

I am also grateful to many others who contributed at different stages of the research:

- My colleagues at HDM for providing a creative working environment and for their encouragement and support throughout the work, especially Karin Grundström and Janis Kursis for their cooperation during the field study in Fez.
- The staff of the National Laboratory for Tests and Studies (LPEE), Morocco, for their professional assistance during the measurement campaigns in Fez. Special thanks to Mohamed Mraissi for his contribution in planning and carrying out the measurements in Fez, for arranging contacts with the urban planning authorities and for providing essential information on Fez and Morocco.
- Rohinton Emmanuel of the Dept. of Architecture, University of Moratuwa, Sri Lanka, for organizing and participating in the field measurement campaign and arranging contacts with professionals in the public and private sectors for the interviews in Colombo. His knowledge and experience in the field of urban climate in the tropics, as well as on the city of Colombo, provided invaluable input to this work.
- Birgitta Ericson and Britt-Marie Johansson of the dept. of Sociology, Lund University, for their help in designing the interview guides used in Colombo.
- Those residents of Fez and Colombo who allowed their buildings and homes to be used for the installation of measurement stations.
- Fazia Ali-Toudert for her advice on the ENVI-met simulations and her willingness to exchange experience on thermal comfort in hot dry climates.
- Ingegärd Eliasson of the Urban Climate Group, Göteborg University, for her valuable critique at a mid-term seminar and general advice on urban climate issues.
- Christer Bengs of the department of Urban and Rural Development at the Swedish University of Agricultural Sciences, for sug-

gesting important improvements to the draft manuscript of this thesis at a final seminar.

Special thanks to Bryan Mosey for his excellent work in editing the English, Mattias Rückert for such attractive line drawings and Jan-Anders Mattsson for his professional work with the layout of this thesis.

Last, but not least, I want to thank my family. I am most grateful to my wife Cintia, who also helped me understand complicated meteorological phenomena, my son Erik and my parents Eva and Lennart for their encouragement, support and patience during difficult phases of this work.

The financial support provided by the Swedish International Development Cooperation Agency (Sida) is gratefully acknowledged.

Abbreviations

ADER-Fès	Agence de Dédensification et de Réhabilitation de la médina de Fès
ASHRAE	American Society of Heating, Refrigerating and Air-conditioning Engineers
AUSF	Agence Urbaine et de Sauvegarde de Fès
CMC	Colombo Municipal Council
CMR	Colombo Metropolitan Region
ET*	New effective temperature
FAR	Floor area ratio
H	Height of buildings
LST	Local standard time
MRT	Mean radiant temperature
PET	Physiologically equivalent temperature
PMV	Predicted mean vote
RH	Relative humidity
SET*	New standard effective temperature
SVF	Sky view factor
UCL	Urban canopy layer
UDA	Urban Development Authority (Sri Lanka)
UHI	Urban heat island
UME	Urban moisture excess
VP	Vapour pressure
W	Distance between buildings in a street canyon

1 Introduction

1.1 Background

In 2000, the proportion of the world's population living in the tropical climate zone was estimated at about 40% (Landsberg 1984, OTS 2006). Most tropical countries are developing countries and most are experiencing rapid urbanization. During the period from 1990 to 2020, the urban population in the developing world is expected to increase by about 25–45%, except in Latin America and the Caribbean where the urban population already exceeds 70%. By 2020, the urban population is expected to be greater than the rural population in all parts of the world except sub-Saharan Africa and South Asia (World Bank 2002). Rapid urbanization in developing countries is often regarded as negative, causing poor housing conditions, poverty, environmental problems, ill-health, etc. However, despite the problems brought by urbanization, urban areas are important in a national perspective, since they experience a high level of economic growth (Tannerfeldt and Ljung 2006).

Urban areas act as climate modifiers. Climate elements, such as solar radiation, air temperature, humidity and wind are affected by the urban fabric. Nocturnal urban-rural temperature differences of 6°C or more are common in the centres of major cities (Oke 1987). This indicates that the average diurnal temperature rise due to urbanization may be greater than the estimated 1–3.5°C rise in temperature due to global climate change over the next 100 years (IPCC 2001).

The urban climate in temperate regions has been studied extensively, mainly in mid-latitude cities in developed countries. Fewer studies have been conducted in low-latitude, tropical climates (Arnfield 2003). Most tropical studies have dealt with urban-rural differences and fewer with microclimate variations within cities. Moreover, few studies have considered intra-urban microclimate differences in relation to urban design (Ali-Toudert 2006).

This study focuses on the influence of urban design on street-level thermal comfort. It has been carried out in two climate types common in many developing countries: hot dry and hot humid. The two cities chosen to represent these climate types are Fez in Morocco (hot dry) and Colombo in Sri Lanka (hot humid).

1.2 Problem statement

Poor outdoor thermal comfort and its consequences

In hot climates, urban warming will lead to decreased thermal comfort in urban areas. This has a negative effect on people's well-being and can have serious consequences for health; it is well known that

the frequency of heat stroke and heart-disease increases with increased heat stress¹. It is also a known fact that efficiency in the performance of both mental and physical tasks diminishes at uncomfortably high temperatures (McIntyre 1980).

However, the lack of outdoor thermal comfort has gained little attention in developing countries. Although people adapt to difficult climate conditions, this is likely to be a hidden problem, especially for the urban poor, who spend much of their time outdoors (see e.g. Correa 1989) and whose buildings are poorly adapted to the climate and thereby sensitive to urban warming.

The lack of outdoor thermal comfort is also likely to have negative social and economic consequences. If the climate is too unpleasant, people will tend to spend time outdoors only when necessary, that is, in performing essential tasks, such as travelling to work, shopping, etc. Optional and social activities – such as taking a walk, meeting people in public spaces, children's play, and so forth – will diminish (Gehl 2001, Baker et al. 2002, Givoni 2003 et al.). As a consequence, there is also a risk that outdoor commercial activities – such as cafés and restaurants, street and open-air markets, cultural events, etc. – will suffer.

Poor urban microclimatic conditions will also, indirectly, lead to deteriorating indoor comfort. This will have a negative impact on performance and health, and will also lead to increased use of air conditioning, subsequently resulting in higher energy costs for urban dwellers.

The consequences of greater energy use include increased air pollution through the consumption of fossil fuels and higher pressure on the energy supply, which may cause frequent power outages. In warm countries, there is also a risk that a feedback loop will arise: air conditioning units cool the interior of buildings but emit sensible heat to the exterior, further worsening outdoor conditions and creating a vicious circle (de Schiller and Evans 1998, Baker et al. 2002).

Lack of climate-conscious urban planning and design

Although urban areas can be designed to offer a favourable microclimate, possibly more pleasant than that of surrounding rural areas (Givoni 2003), the opposite is normally the case. A major reason for urban areas often becoming unnecessarily uncomfortable is that urban microclimate and outdoor thermal comfort are generally ascribed little importance in urban planning and design processes (Evans and de Schiller 1996, Eliasson 2000). Aynsley and Gulson (1999) interpret the lack of climate consciousness in urban planning and design as follows: "*Urban climate is often a largely unplanned outcome of the interaction of a number of urban planning activities [...], an outcome for which no authority and no profession takes responsibility*". Studies have shown that knowledge about climate issues among planners and urban designers is often missing and that there is a lack of suitable design tools for urban planners and designers (Eliasson 2000, Givoni 2003 et al.).

1 A heat wave in Europe in 2003 is believed to have caused the death of some 35,000 people (WHO 2005).

In developing countries, rapid urbanization often implies the uncontrolled growth of cities through the formation of substantial informal settlements. In these settlements, climate aspects are often disregarded.

One of the reasons that planned settlements also become uncomfortable is that regulations determining urban design are often inspired by planning ideals from temperate climates and consequently poorly suited to local conditions (see e.g. Al-Hemaidi 2001 and Baker et al. 2002).

1.3 Aim of the thesis

There is a need to find ways of improving thermal comfort conditions in tropical urban areas and of increasing the awareness of climate considerations among urban planners and designers in these cities.

The main aim of this thesis is to deepen the knowledge about the relationship between urban design, microclimate and outdoor thermal comfort in hot dry and hot humid climates through studies conducted in the cities of Fez and Colombo. The aim is also to highlight the impact of urban planning on the urban microclimate.

To achieve these research objectives, the following questions must be answered:

- How do microclimate and outdoor thermal comfort vary temporally and spatially?
- Which are the main design parameters influencing the urban microclimate and outdoor thermal comfort?
- To what extent are climate and thermal comfort issues considered in the urban planning and design processes?
- Do existing urban regulations favour or hinder climate-conscious urban design?
- How can new urban areas be designed to improve the microclimate and thermal comfort at street level?

The results of this study could provide a foundation for the development of guidelines and recommendations for climate-conscious urban design in Fez and Colombo, as well as in other cities with similar climates.

1.4 Scope and limitations

The research presented in this study concentrates on how urban design affects the microclimate and outdoor thermal comfort. The study is limited to the microclimate at street level, i.e. the *urban canopy layer*, roughly the space between the ground and the roof tops.

The study is limited to two cities, one in a hot dry climate and the other in a hot humid climate. The intention has not been to compare the two cities. Although some of the findings are general, the conclusions of the study are not necessarily valid throughout the hot dry and hot humid climate groups, since there are climate variations

within each of these and considerable variations between different cities in terms of size, planning principles, proximity to the sea, topography, etc.

The main focus is on residential and mixed-use areas and, to a lesser extent, on other land use areas. The study concentrates on urban design and the detailed planning level rather than on comprehensive planning aspects, such as the location of urban areas within a city. The study is limited to street design and does not include public spaces such as squares and parks. Vegetation is studied only for shading purposes.

The cities studied contain both “traditional” and “modern” urban forms. These differ not only physically but also relate to differences in culture and lifestyle. Here, however, urban form is dealt with strictly in regard to its geometrical features.

Thermal comfort is estimated by calculating a comfort index based on environmental parameters that are either measured, calculated or simulated. The study does not include field studies on subjective thermal comfort as perceived by pedestrians.

The amount of air pollution is affected by urban geometry. However, air pollution and its consequences on health are not treated here. Moreover, the effect of air pollution on thermal conditions in cities has proven to be small, at least in moderately polluted cities, such as those included in this study.

The effect of anthropogenic heat is not considered in this study as its effect on the urban climate has been found to be negligible in most cases. Energy use in buildings is not treated, mainly to limit the study but also because the use of space conditioning is, to date, limited in both of the cities studied. Although indirectly affected by the urban climate, indoor thermal comfort is not treated.

1.5 Structure of the thesis

This thesis consists of a summary and four annexed journal papers. The thesis summary is mainly based on the papers but also includes the results of a study of urban regulations and the consideration of climate aspects in urban planning and design.

Chapter 2 provides background on the two cities, Fez and Colombo, and on urban design regulations in each city. Chapter 3 defines general concepts regarding the characteristics of the urban climate as well as outdoor thermal comfort. Chapter 4 is a review of literature relevant to urban climate, outdoor thermal comfort and climate-conscious urban design in tropical climates. Chapter 5 presents the different research methodologies and techniques applied in this study. Chapter 6 contains the results of microclimate measurements and simulations, calculations of thermal comfort, as well as the role climate aspects play in the urban planning process. The interpretations and implications of the results are discussed in Chapter 7.

The thesis includes the following papers:

- I Johansson, E.: Influence of urban geometry on outdoor thermal comfort in a hot dry climate: A study in Fez, Morocco. *Building and Environment*, 2006, vol. 41, no. 10, pp. 1326–1338.

This paper deals with microclimate measurements and the calculation and analysis of outdoor thermal comfort conditions in the city of Fez during the winter and summer seasons.

- II Emmanuel, R., and Johansson, E.: Influence of urban morphology and sea breeze on hot humid microclimate: the case of Colombo, Sri Lanka. *Climate Research*, 2006, vol. 30, no. 3, pp. 189–200.

This paper deals with microclimate measurements and the analysis of the effect of urban design and sea breeze on microclimate in the city of Colombo during the inter-monsoon period in April–May.

- III Johansson, E., and Emmanuel, R.: The influence of urban design on outdoor thermal comfort in the hot, humid city of Colombo, Sri Lanka. *International Journal of Biometeorology*(in press).

This paper treats the calculations of outdoor thermal comfort in the city of Colombo based on the measurements presented in paper II. The role of urban design and sea breeze on outdoor thermal comfort is analyzed.

- IV Johansson, E.: Simulations of urban microclimate and outdoor thermal comfort in the hot dry city of Fez and in the hot humid city of Colombo. *Manuscript*.

This paper presents simulations of microclimate and outdoor thermal comfort in the cities of Fez and Colombo and includes proposals for optimized design solutions for different seasons.

In papers II and III, the implementation of the study, analysis of results and composition were conducted in cooperation between the authors.

Articles published or in press have been reproduced with the kind permission of the respective journals.

2 Cities studied

This Chapter explains why the cities of Fez and Colombo were chosen for this study and provides background information on the two cities regarding their historic development and current urban structure as well as a brief overview of the urban planning process and a more detailed description of the urban design regulations in force. *A glossary of terms and definitions is given in Appendix 1.*

2.1 Choice of cities

The cities were selected as a result of both deliberate choice and practical considerations. The aim was to find two cities in developing countries located in different climate zones. Another requirement was the population size of the cities. Very large cities such as mega-cities may have high levels of anthropogenic heat influencing the urban climate. Conversely, cities that are too small may present a limited variation in urban design and therefore limited intra-urban microclimatic differences. The choice was, however, also a result of local contacts and on-going research cooperation¹ which facilitated the implementation of the study.

The cities chosen for this study, Fez in Morocco and Colombo in Sri Lanka, represent two types of climate typical of many urban areas in developing countries. Fez is situated in the hot, dry climate of North Africa, whereas Colombo belongs to the hot, humid climate of South Asia (Fig. 2.1). The intention has not been to compare the two cities, rather, they were chosen to represent two climate types in which a large part of the developing world's population lives.

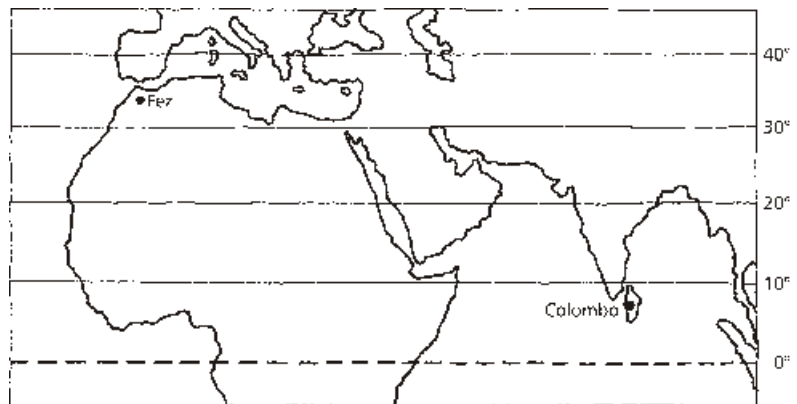

Fig. 2.1 The locations of Fez and Colombo.

¹ The institutes cooperating in this study were the Moroccan Laboratoire Public d'Essais et d'Etudes (LPEE) and the Sri Lankan Department of Architecture, University of Moratuwa.

Hot dry climates are found at latitudes between approximately 15° and 35° north and south of the equator (Koenigsberger et al. 1974, Evans 1980). They are characterised by distinct seasons: a long hot and dry season and a shorter wet or cool season. The dry season is characterised by high daytime temperatures, low humidity and sparse precipitation. Mean daytime maximum temperatures vary between about 32°C and 45°C depending on the region. Vapour pressure varies between 7.5 and 15 hPa. As a result of low humidity and clear skies, solar radiation is intense and nocturnal cooling high, resulting in large diurnal temperature fluctuations, often exceeding 15°C. Some hot dry regions have mild winters with a short wet season, while others, such as Fez, have a cold season with higher precipitation and temperatures near the freezing point at night (Fig. 2.2a). Hot dry climates are typically found in North Africa, the Middle East, parts of Central Asia, central Australia and in parts of North and South America.

Hot humid climates are found between latitudes approximately 20° north and south of the equator (Koenigsberger et al. 1974, de Schiller and Evans 1998). In the region close to the equator, where Colombo is situated, annual temperature variations are small (Fig. 2.2b). Further from the equator, towards the sub-tropical zone, hot humid conditions may be found during the summer season. The hot humid climate is characterised by high average temperature and humidity. Mean daytime maximum temperatures vary between 27 and 32°C depending on the region. Vapour pressure varies between 17.5 and 30 hPa. Precipitation is high, but often varies between wetter and dryer seasons as a result of the monsoon winds. Due to high humidity and relatively high cloud cover, both daytime solar radiation and nocturnal cooling are reduced, resulting in low diurnal temperature ranges, often below 10°C. Since the hot humid tropics lie within

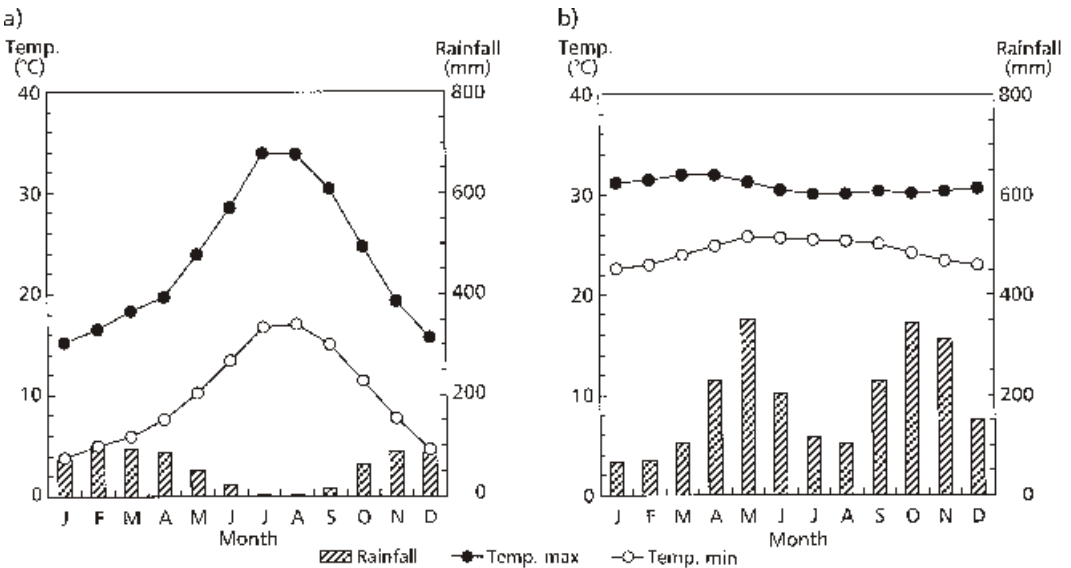

Fig. 2.2 Mean maximum and minimum temperatures as well as rainfall in (a) Fez (based on data from Fez airport at 33°58'N, 4°59'W, altitude 571 m) and (b) Colombo (based on data from Colombo city meteorological station at 6°54'N, 79°52'E, altitude 7 m).

the Inter-Tropical Convergence Zone, wind speeds are normally low. Hot humid climates are typically found in Western and Central Africa, South and South-East Asia, Northern Australia, the Caribbean, Central America and the northern part of South America.

2.2 Fez

The city of Fez (34.0°N, 5.0°W) is located in the interior of Morocco in a valley at an altitude of about 400 m between the Rif mountains to the north and the Atlas mountains to the south. Intra-urban altitude differences are well above 100 m. Fez has distinct seasonal variations with hot, dry summers and fairly cold and wet winters (Fig. 2.2a). Diurnal temperature fluctuations are large, especially in the summer. Due to the limited amount of rainfall, the city has little green cover, few green areas, and is surrounded by sparse vegetation. See also Paper I.

Morocco (2006 estimates)	
Population	31.5 million
Population density	70 inhab./km ²
Annual growth rate	1.48%
Urban population	18.5 million (59%)
Urban growth rate	2.7%
Major cities	Casablanca (3.2 million) Rabat-Salé (1.6 million) Fez (1.0 million) Marrakech (0.9 million)

Sources: UN (2006), World Gazetteer (2006).

Historic development

The city of Fez was founded following Arab conquests in North Africa. The first settlers arrived in the 8th century and the city was established in the following century. When the Marinids arrived in the late 13th century, they extended the city and made Fez the capital of Morocco. In the 15th century, Fez had become a commercial and cultural centre and had relations with Europe, Sub-Saharan Africa and the Middle East (Ichter 1979). The city was built according to Arab-Islamic urban design principles with courtyard houses and narrow, winding alleyways (Figs. 2.3a and 2.4a). Fez remained the cultural, economic and spiritual centre of Morocco until 1912 when most of present-day Morocco became a French protectorate. The city, which had been the largest in Morocco, then lost much of its economic importance, since the French chose Rabat as the capital of the protectorate.

In the 1920s the New city (*Dar Debibagh* or *Ville nouvelle*) was founded on a plateau southwest of the walled Medina (Fig. 2.9). The new city was built in a “colonial” style² and exclusively housed Europeans. Its main streets consisted of wide avenues in a regular grid

2 The plan was conceived by the French urban planner Henri Prost, who planned several colonial cities in Morocco during the first decade of the protectorate.



Fig. 2.3 (a) A street in the Medina and (b) an avenue in the colonial part of the new city.

pattern (Fig. 2.3b). The local population continued to live in the Medina (the old city), which was left fairly intact by the French (Vacher 1991). Towards the end of the period of the French protectorate, the Ain Kaddous³ district was planned on the hillside northwest of the Medina (Fig. 2.9). This district, which was built to release the population pressure on the Medina, consisted largely of “modern” residential blocks and became a dormitory city for low and middle-income groups (Bianca 2000). However, some parts of Ain Kaddous were built with “neo-traditional” multi-family courtyard houses intended for low-income residents.

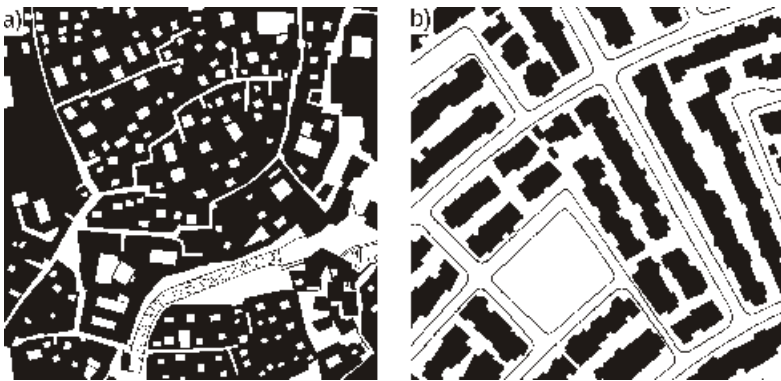

Fig. 2.4 Footprint area of buildings and road network in (a) the core of the historical Medina (Seffarine district) and (b) a residential suburb in the new city (Adarissa district). Map size: 200 m × 200 m.

Morocco’s population grew rapidly towards the end of the colonial period and this growth accelerated during the initial decades following Morocco’s independence in 1956 (Abu-Lughod 1980). This resulted in rapid urbanisation, which has continued to the present day (Fig. 2.5). The planned extensions of the city were primarily to the

3 The district was planned by Michel Ecochard, who was the chief planner in Morocco at the end of the protectorate (1945–53).

south and southwest, as a continuation of the colonial city, and to the north (Ain Kaddous). The former consisted primarily of European style construction in the form of low-density residential areas (Figs. 2.4 and 2.6), while the latter consisted of low and middle-income settlements (Fig. 2.7a). The growth rate reached its peak during the 1980s and resulted in an increase in informal settlements, which grew up to the east and southeast of the Medina, in parts of Ain Kaddous and around the new city. The informal sector includes illegal, spontaneous settlements, illegally extended buildings, rural building types and shanty towns (Ichter 1979) (Fig. 2.7b).

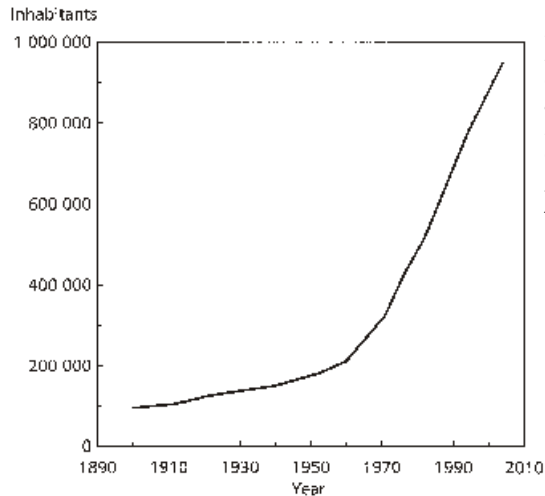

Fig. 2.5 Population growth in the city of Fez between 1900 and 2004. During this period, the city's area increased substantially.

Sources: Bouayad (1979), Abu-Lughod (1980), Laborie (1990), HCP (2004).

Fez and other major Moroccan cities faced increasing housing shortage problems due to rapid urbanisation in the 1980s and 1990s. To improve the situation, the national 200,000 Dwellings Programme was initiated in the mid-1990s. Moreover, the urban codes, many of which dated back to the protectorate, were revised slightly.

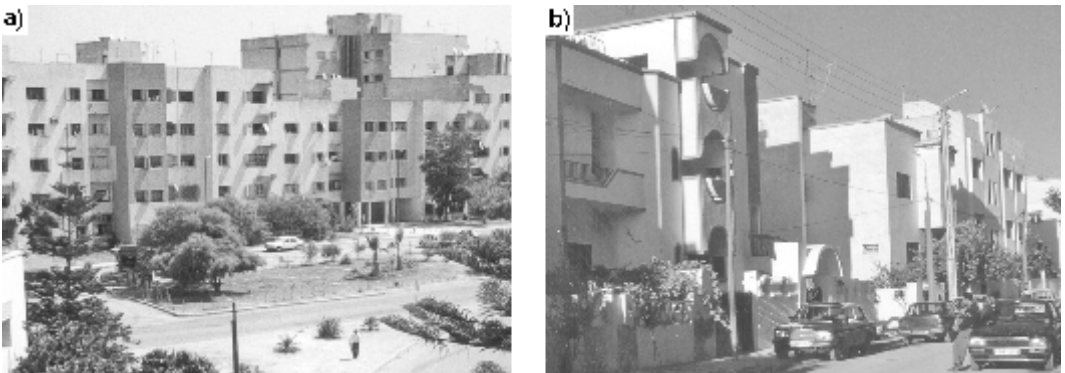

Fig. 2.6 Residential buildings in the Adarissa district on the southern outskirts of the new city. (a) Apartment buildings and (b) terraced houses.

Current situation

Annual urban growth in Fez, between the censuses of 1994 and 2004, was 2.1% and, despite local and national efforts to increase low-income housing production, the city has not managed to provide adequate housing for the increasing number of low-income residents. The consequences have been overcrowding in the old Medina, mainly involving rural migrants, and the creation of a number of informal low-income settlements, often situated on rough terrain. In 2000, an estimated 17% of the population⁴ was living in the informal sector, either in illegal settlements or in shanty towns.

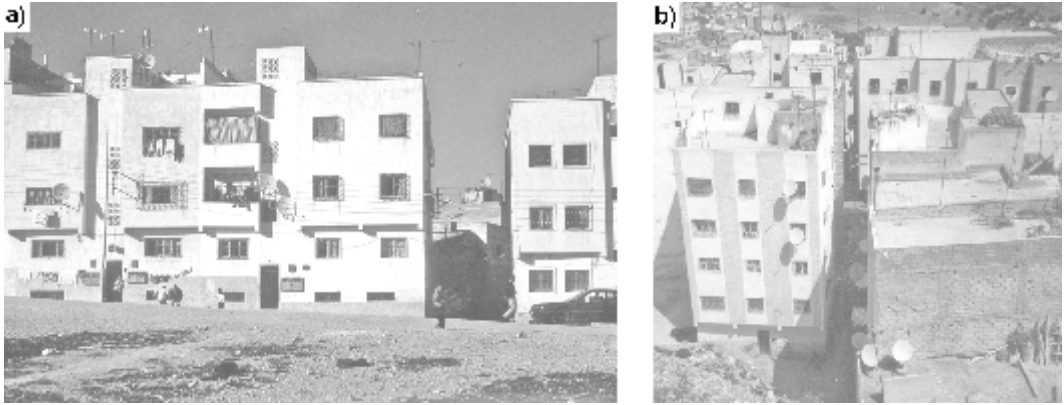

Fig. 2.7 Low-income settlements in Ain Kaddous: (a) neo-traditional courtyard houses (Hay Benzakour district) and (b) an illegal settlement (Hay Hassani district).

Another problem in Fez is the uneven distribution of the population. Low-income residents in parts of the Medina and the informal sector live in very high population densities, which stand in stark contrast to the much lower densities of the formal sector found in the new city. In the late 1970s, the Medina is believed to have had an average population density of nearly 1,000 inhab./ha, whereas the densities of Ain Kaddous and the new city were 350 and 55 inhab./ha respectively (Bouayad 1979, Ichter 1979)⁵.

The failure to provide housing for the urban poor has been a major concern among the national authorities in recent years (Tahiri 1999, MHU 2005). In an attempt to review current urban regulations and reduce all forms of unsanitary housing, a new law aimed at guaranteeing sufficient low-income housing and simplifying building permit procedures was proposed in 2004 (MHU 2006). A complete revision of urban regulations that is to result in a national Urban Planning Code (*Code de l'Urbanisme*) is currently under preparation.

The recent debate has also involved the type of low-income housing established nationally by the decree of 1964, which is still in

4 This figure, which does not include the people living in overcrowded parts of the Medina, is based on population data by Observatoire de l'Habitat (2001) and CERED (2004).

5 However, since the 1981 declaration of the old Medina of Fez as a World Heritage site, one aim has been to reduce its population density and the current density is estimated at 550 inhab./ha. (Carfree.com 2006)

force. This type of housing consists of the neo-traditional courtyard houses, mentioned previously, laid out on a regular grid plan⁶. In recent years, this has been criticised for causing low population density (Tahiri 1999) and for its lack of cultural adaptation – the size and distribution of the rooms being inappropriate and the courtyard not being located at the centre of each housing unit as in traditional housing (Pinson 1994). An on-going study (MHU 2005) aims to revise the regulations for low-income housing in order to increase density and reduce costs.

Urban design regulations

Morocco is divided into regions, each of which is divided into provinces and prefectures. Each province/prefecture is divided into rural and urban communes (the latter sometimes called municipalities). The city of Fez belongs to the Fez-Boulemane region, which has 1.6 million inhabitants and covers 20,000 km² (Fig. 2.8). This region is subdivided into three provinces and the Prefecture of Fez, which, in turn, consists of two municipalities and three rural communes.

In Morocco, regional and urban planning is governed by “urban agencies” (*agences urbains*), which serve under the Ministry of Regional and Urban Planning, Housing and Environment⁷. Each of the regions in Morocco has one or more urban agencies. The city of Fez



Fig. 2.8 Northern Morocco and the region of Fez-Boulemane.

- 6 This type of housing was originally introduced at the end of the protectorate by Michel Ecochard, the chief planner in Casablanca at the time, on an 8 m by 8 m grid known as la trame Ecochard.
- 7 MinistPre de l'aménagement du territoire, de l'urbanisme, de l'habitat et de l'environnement.

is covered by the Agency of Urban Planning and Preservation of Fez⁸ (AUSF), which was founded in 1991. AUSF is responsible for the coordination of all planning issues for the entire region of Fez-Boulemane. AUSF's mission comprises urban planning (including the establishment and implementation of the master plan, as well as the establishment of urban regulations), urban management and technical assistance to the rural and urban communes/municipalities within the region regarding urban planning issues (AUSF 2006).

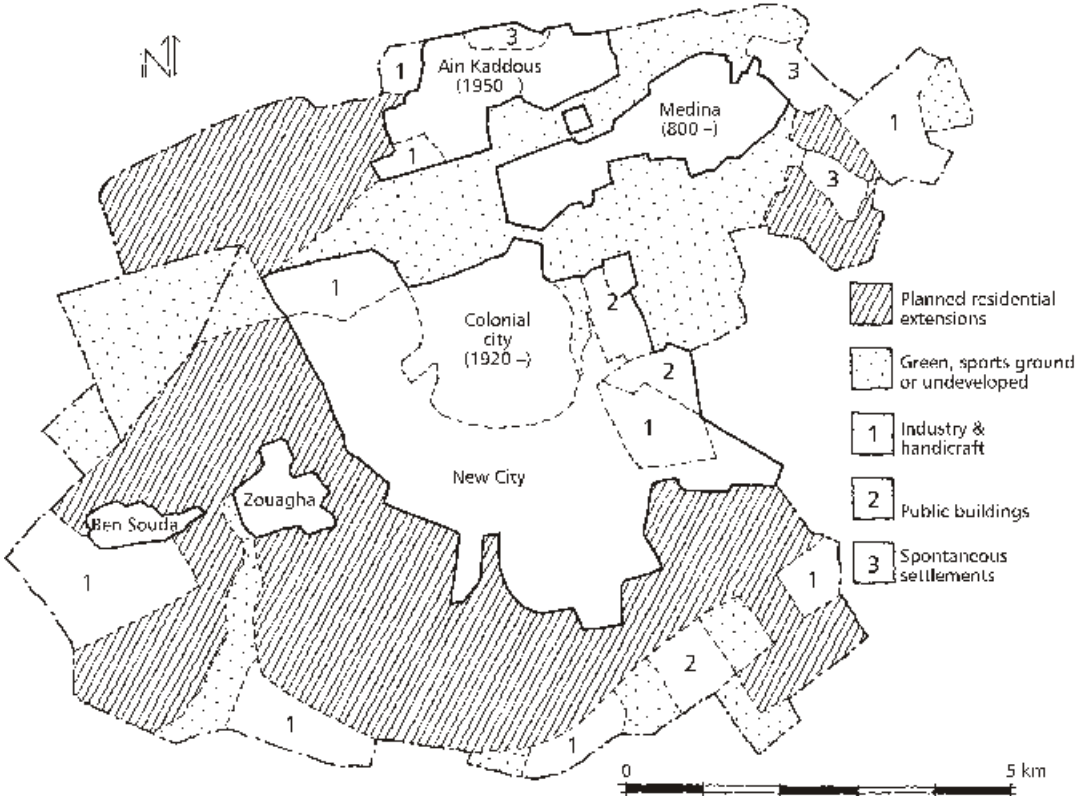

Fig. 2.9 The city of Fez and its three main parts: the old city (the Medina), the new city and Ain Kaddous. The planned extensions according to the current master plan of 1991 are also shown.

Source: The master plan of Fez, Agence Urbaine et de Sauvegarde de Fès.

Urban planning in Fez is governed by two regulatory documents. At a comprehensive level, urban areas are covered by a master plan (*Schéma Directeur d'Aménagement Urbain*), comprising land-use and zoning maps, as well as a written report explaining the aims of the plan and describing how to implement it. At a detailed level, land use plans (*Plan d'Aménagement*) cover a whole or part of a municipality or an urban centre. The master plan, which is valid for a maximum of 25 years, determines, among other things, new zones of urbanisation, the dates when developments are planned to start, the location of different land-use zones and planned population densities within residential zones. The current master plan, which origi-

⁸ Agence Urbaine et de Sauvegarde de Fès.

nates from 1980 but was revised in 1991, is shown in Fig. 2.9. Its goals include the provision of 150 hectares of new urban land per year, half of which is reserved for housing. The urban extensions are planned both as an extension of the city to the west, southwest and south as shown in Fig. 2.9 and as the development of urban centres outside the main urban area (AUSF 2006).

Land-use plans are valid for ten years, with the exception of zoning regulations which may be valid longer. These plans define different land-use zones (residential, industrial, etc), the road network, green areas, preservation of historical monuments, etc. and contain specific rules pertaining to urban form.

Urban zones

The land-use plans for Fez divide the municipal area into zones of different types of development. The existing urban zones are shown in Table 2.1. Many of the zones are divided into sub-zones, as can be seen in Table 2.2 and Table 2.3. Basically, these urban zones can be found throughout the city, except zone M, which is unique to the old city. However, zones A and B are mainly found in the city centre, i.e. basically the colonial part of the new city. To the west, southwest and south of the city centre the residential zones C, D and E are dominant.

Table 2.1 Urban zones and development types in Fez (AUSF 1988, 2006).

<i>Zone</i>	<i>Land use</i>	<i>Description</i>
A	Mixed	Attached apartment buildings for residential use, business, offices, public administration and hotels (city centre)
B	Mixed	Attached apartment buildings for residential use, business, offices, handicraft, public administration and hotels
C	Residential	Detached apartment buildings for residential use, but also commercial activities, offices and hotels
D	Residential	Detached, semi-detached and terraced houses ("villas") intended mainly for residential use
E	Residential	Neo-traditional courtyard buildings on small plots for low-income residents
In	Commercial	Buildings for industrial, commercial, handicraft and office use
S	Special	Residential or non-residential buildings subject to special conditions
M	Old city (mixed)	Mainly traditional courtyard houses, intended for a variety of activities

Regulation of urban form

The urban codes dealing with urban form constitutes parts of the land-use plans. The city of Fez has two regulations that are in force: the "General Regulations for the Land Use Plan of the Wilaya of Fez⁹" (AUSF 1988) and the "Regulations for the Land Use Plan of the Walled Medina of Fez" (AUSF and ADER-Fès 1999). The former of

9 Wilaya means administrative region. The former Wilaya of Fez did not include the Province of Boulemane, but this province is now also covered by the regulation.

these documents concerns all urban areas except the historical Medina; it has been subjected to some minor revisions lately (AUSF 2006). The latter regulation concerns the historic old city (the Medina). In addition to these codes, the old by-law “Regulation of Road Network and Building” (Ville de Fès 1969) is still in force.

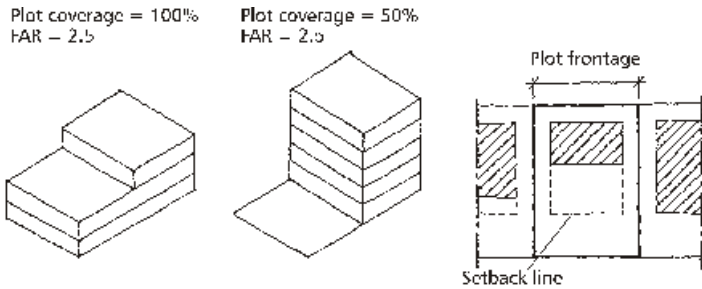

Fig. 2.10 Illustration of plot coverage, FAR, plot frontage and setbacks.

In Fez, the new city has the greatest variety of building types comprising street-aligned attached apartment buildings (zones A and B), detached apartment buildings (C), detached low-rise houses (D) and neo-traditional courtyard houses for low-income residents (E). The rules governing the number of storeys, building heights, distances between buildings, plot coverage, floor area ratio (FAR)¹⁰, setbacks, etc. are shown in Table 2.2. Plot coverage, FAR, plot frontage and setbacks are illustrated in Fig. 2.10.

As can be seen in Table 2.2, maximum building height is related to street width. The maximum FAR varies between only 0.2, for the largest detached houses (*villas*) in zone D5, up to 2.4 for four-storey attached apartment buildings in zone B3 (for buildings of more than four storeys, there are no FAR limitations). There are extensive variations in minimum plot sizes: from 60 m² for low-income housing (zone E) to 4,000 m² for the most luxurious category of detached houses (zone D5). Similarly, plot coverage varies between only 10% for detached houses (zone D5) to 80% for low-income housing (zone E1). There are no setback rules for apartment buildings in the city centre and low-income courtyard houses. However, detached apartment buildings and low-rise buildings have minimum front, back and side setbacks. For street-aligned buildings (zones A, B and E), projected upper floors are permitted above a height of 2.2 m (Ville de Fès 1969).

In the Medina (zone M), new construction is rare and mainly takes the form of infill buildings in existing built-up areas. Consequently, regulations differ completely from those applied in the new city. The Medina has basically three types of buildings: old historical buildings – residential, commercial and public – (zone M1), more recently constructed neo-traditional buildings (M2) and modern residential blocks (M3). There are also neo-traditional courtyard houses for low-income residents (E2) and a zone of modern commercial and industrial buildings (IM). See Table 2.3.

¹⁰ FAR is calculated as the total floor area of a building divided by the total area of the plot (Acioly and Davidson 1996).

Table 2.2 The regulations pertaining to urban form in the city of Fez (not including industrial buildings and buildings in the historical Medina).
 FAR = floor area ratio, H = building height, W = distance between buildings.

Zone	Type of building	Type of use	Plot size (m ²)	Min. plot frontage (m)	Max. FAR	Max. plot coverage (%)	Max. no. of floors	Max. H (m) ^a	Minimum setbacks		
									front (m)	rear (m)	side (m)
A1	Apartment building	Residential/commercial	no limit	no limit	no limit	no limit	7 ^b	24 or 1.5 W	—	0.5 H or 4	—
B1	Apartment building	Residential/commercial	250	10	no limit	no limit	6 ^b	21 or 1.2 W ^c	—	0.5 H or 4	—
B2	Apartment building	Residential/commercial	250	10	no limit	no limit	5 ^b	17.5 or 1.2 W ^c	—	0.5 H or 4	—
B3	Apartment building	Residential/commercial	200	10	2.4 ^d	70	4 ^b	14.5 or W	—	0.5 H or 4	—
B4	Apartment building	Residential/commercial	200	10	2.0	70	3 ^b	11 or W	—	0.5 H or 4	—
B5	Apartment building	Residential/commercial	120	8	1.6	60	3 ^b	11 or W	—	0.5 H or 4	—
C1	Apartment building	Residential, hotel Office	5000 2000	50 40	1.4	30	5 ^b	17.5 or W	5	0.5 H or 6	0.5 H or 6
C2	Apartment building	Residential, hotel Office	5000 2000	50 40	1.2	35	4 ^b	14.5 or W	5	0.5 H or 6	0.5 H or 6
C3	Apartment building	Residential, hotel Office	5000 2000	50 40	1.0	40	3 ^b	11 or W	5	0.5 H or 6	0.5 H or 6
D1	Terraced houses	Residential	200	10	1.0	50	2	8	5	4	—
	Semi-detached h.		300	15	0.8	40	2	8	5	4	4
D2	Detached houses	Residential	400–999	20	0.6	30	2	8	5	4	4
D3	Detached houses	Residential	1000–1999	25	0.5	25	2	8	5	6	6
D4	Detached houses	Residential	2000–3999	25	0.3	15	2	8	8	8	8
D5	Detached houses	Residential	4000	50	0.2	10	2	8	8	8	8
E1	One-family courtyard	Residential	60	6	1.6	80	2	8	—	— ^e	—
E2	Multi-family courtyard	Residential	80	8	2.2	75	3	11	—	— ^f	—

a Parapets for trafficable flat roofs of a maximum of 1.2 m are permitted above this height.

b Additional storeys are permitted, provided a light angle of 45° towards the street is maintained and the maximum building height (H) is respected.

c If W = 15 m.

d For apartments buildings of < 100 m² there is no FAR limit.

e Min. courtyard size = 12 m², min. courtyard width = 3 m.

f Min. courtyard size = 20 m², min. courtyard width = 4 m.

Table 2.3 gives maximum building heights for the old city, although actual height may not exceed that of existing, adjacent buildings. Only in zone E2 is maximum FAR limited, at 2.2. Plot coverage for all zones is maximised to 75% (guaranteeing that the courtyard occupies at least 25% of the plot). There are no setback rules; on the contrary buildings should be street-aligned and attached on all other sides.

Table 2.3 Regulations pertaining to urban form in the historical Medina of Fez (not including industrial buildings). FAR = floor area ratio, H = building height, W = distance between buildings.

Zone	Plot size (m ²)	Min. plot frontage (m)	Max. FAR	Max. plot coverage (%)	Max. no. of floors	Max. H (m)	Min. W (m)	Minimum courtyard size	courtyard width (m)
M1	< 100	—	—	75	3	14 ^a	—	25%	3
	100	—	—	75	3	13 ^a	—	25%	5
M2	< 100	—	—	75	2	9	—	25%	3
	100	—	—	75	2	9	—	25%	5
M3	< 100	—	—	75	3	12.2 ^b	H	20 m ²	4
E2	80	8	2.2	75	3	12.2 ^b	H	20 m ²	4

a Building height should, however, not exceed that of adjacent buildings.
 b Including the parapet wall. Not including the parapet, the max. height is 11 m.

Areas studied

In this study, urban microclimate and outdoor thermal comfort were studied in detail in one neighbourhood belonging to zone D1 (semi-detached and terraced houses) in the new city and in one neighbourhood with buildings of type M1 in the historical Medina. The positions of the measurement sites are shown in Fig. 5.1. An analysis of the consequences of urban regulations on outdoor thermal comfort is given in Section 6.4.

2.3 Colombo

The city of Colombo (6.9°N, 79.9°E) is located on Sri Lanka’s west coast. It has a flat terrain with the lowest areas (some being marshland) lying just below sea level and the highest points at 18 m above sea level (van Horen 2002). The climate is constantly hot and humid with a few rainy seasons. The combination of high temperature and humidity results in considerable heat stress, especially during the daytime. Due to abundant rainfall, Colombo is to a large extent a very green city and is surrounded by marshlands, paddy fields and rubber estates. See also Papers II and III.

Sri Lanka (2006 estimates)	
Population	20.7 million
Population density	316 inhab./km ²
Annual growth rate	0.88%
Urban population	4.4 million (21%)
Urban growth rate	0.8%
Major cities	Colombo* (0.6 million) Dehiwala-Mt. Lavinia (0.2 million) Moratuwa (0.2 million) Jaffna (0.2 million)
*Colombo Municipal Council	
Sources: UN (2006), World Gazetteer (2006).	

Historic development

Colombo is believed to have first been settled in the 8th century in what is now the Pettah district. Due to its harbour, the city grew to become an important commercial centre in the 13th century (UDA 1999a). In the early 16th century, Colombo came under colonial rule, beginning with the Portuguese, followed by the Dutch and ending with 150 years of British rule, which ended in 1948¹¹. It was in 1815, during the British colonial period, that Colombo became the capital city and began to expand to the north, east and south. The British introduced a legal and regulatory system that, to a large extent, is still in use (van Horen 2002).

The oldest parts of the city are the old commercial quarters (Pettah) and the old colonial city centre (Fort). The former is characterised by street-aligned, medium rise buildings of 3–4 storeys and narrow streets (Figs. 2.11a and 2.12a). The latter has street-aligned colonial buildings laid out in a grid with fairly wide streets (Fig. 2.12b). The three to four-storey buildings have high ground floors with pedestrian arcades (Fig. 2.11b). The areas that were developed outside the historic core became very different from the centre. Colombo's first city plan was adopted in 1921 with the aim of creating a garden city¹². The plan was never fully implemented, but included the Cinnamon Gardens, today a low density, high-income neighbourhood characterised by a high level of greenery and its tree-lined streets (UDA 1999a). At the end of the colonial period, the "Abercrombie Plan"¹³ was developed with the aim of decentralising the economic activities of the city by creating satellite towns around the

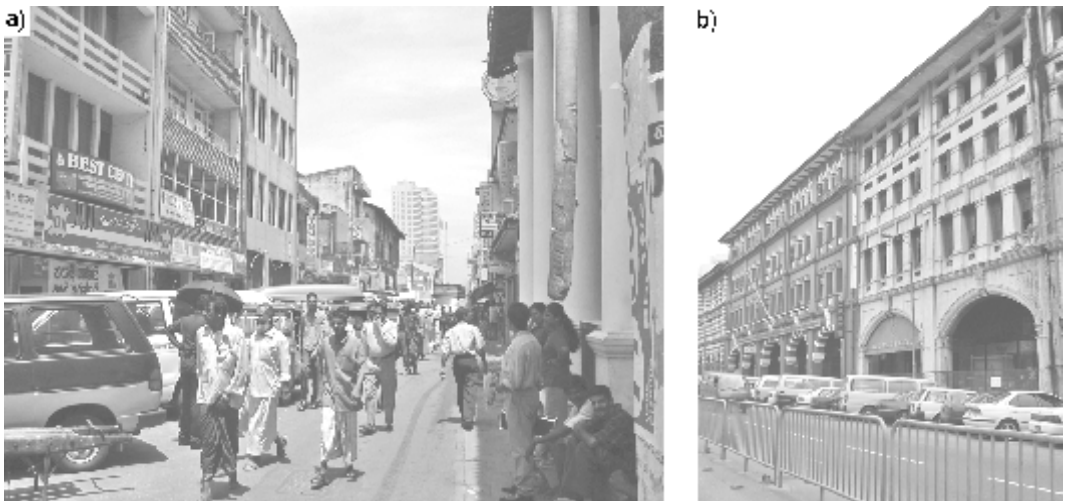

Fig. 2.11 (a) Street in the old commercial quarters of Pettah and (b) colonial buildings in Fort.

- 11 Whereas the Portuguese and Dutch only had control of the major coastal cities, the British colonised the entire island of Ceylon in 1815.
- 12 The plan was prepared by the British urban planner Sir Patrick Geddes.
- 13 Prepared by the British urban planner Sir Patrick Abercrombie, who formulated the Greater London Plan of 1945.

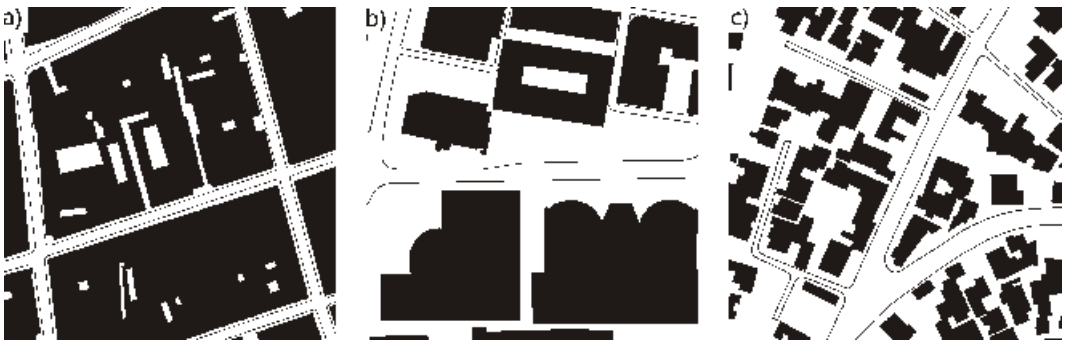

Fig. 2.12 Footprint area of buildings and road network in (a) the old commercial quarters (Pettah), (b) the central business district (Fort) and (c) a residential suburb (Nugegoda). Map size: 200 m × 200 m.

city of Colombo. However, only a few of the satellite towns planned were actually built (UDA 1999a).

After Sri Lanka's independence in 1948, Colombo continued to grow and reinforce its position as the country's major urban area. Economic growth was accompanied by rapid urbanisation (Fig. 2.15). Due to the natural limits to the west (the Indian Ocean) and the east (extensive marshlands), the urban area grew primarily in a north-south direction along the national highways. The urban fabric of Colombo has, to a large extent, been characterised by low-rise (single to four-storey) buildings, wide streets and high amount of green cover (Figs. 2.12c and 2.13). In the 1960s and 1970s, problems of urban sprawl had become severe. A master plan for Colombo was completed in 1978 with the aim of achieving a more balanced spatial development, although this was never successfully implemented (van Horen 2002). However, the master plan did lead to the establishment of the Urban Development Authority (UDA), which remained the main national planning authority until the creation of the National Physical Planning Department in 2003¹⁴.

Economic reforms at the end of the 1970s led, among other things, to a shift in housing policy. The Colombo Development Plan was produced by the UDA in 1985 and included zoning and building regulations for the city. The plan also proposed the transformation of the state to an “enabler” rather than a “provider” of housing. This new strategy was used in the Million Houses Programme (1984–1989) and the 1.5 Million Houses Programme (1990–1994) (van Horen 2002). The new strategy also included the shift from rigid master planning to a more performance-based strategy. This is reflected both in the Colombo Metropolitan Region Structural Plan of 1998 and in the City of Colombo Development Plan (UDA 1999a). The former takes into account the entire Colombo Metropolitan Region, which had 5.3 million inhabitants in 2001 (Fig. 2.14).

Increased foreign investment since the end of the 1970s has led to the transformation of the southern part of the colonial Fort area into a central business district with the construction of high-rise buildings such as the twin towers of the World Trade Centre (van Horen 2002).

¹⁴ This department will deal with planning on a broader, national scale.



Fig. 2.13 (a) The coastal Galle Road, the main north-south transport axis and (b) a street in the residential suburb Nugegoda.

Current situation

Many of the problems in Colombo are related to urban growth (Fig. 2.15) and the high number of informal settlements. Although urbanisation in Sri Lanka is low compared to many other Asian countries¹⁵, the city of Colombo and its suburbs, where most urbanisation has taken place, have not managed to provide housing for the urban poor. In recent decades, annual urban growth of the Colombo Municipal Council has been only 0.4% (between 1981 and 2001), although during this period, the neighbouring urban areas have also grown, leading to a much larger urbanised region. The area defined by UDA as the Colombo Core Area (Fig. 2.14) had a population of about 1.1 million inhabitants in 2001.

A major concern for the authorities is that the city's growth mainly involves horizontal expansion with low-rise housing, causing several problems (UDA 1999a). This makes it more expensive to provide infrastructure and urban services, such as water supply, sewerage and drainage. Moreover, land suitable for building is insufficient (encroachment into ecologically sensitive marshlands and flood-prone lowlands is causing a number of environmental problems). However, according to the UDA (1999a), available, developable land is under-utilised – and inappropriately distributed. More than half of the city's population is estimated to live in densely populated slums¹⁶ and shanty towns, often located on marginal land occupying only 11% of the area of the Colombo Municipal Council.

In 1997, population densities within the Colombo Municipal Council varied between below 100 persons/ha in high-income areas to 300–400 in a few high-density areas. A survey of floor-space distribution in Colombo revealed that the average plot coverage was around 43% and the average floor area ratio (FAR) was less than one. This is evidence of a dispersed city with poor land-use efficiency (UDA 1999a).

15 According to official statistics the urban population is around 20%, but according to Mendis (2003) a more realistic figure is around 30%.

16 Here, “slum” refers to old tenements in very poor condition and lacking basic sanitary facilities.

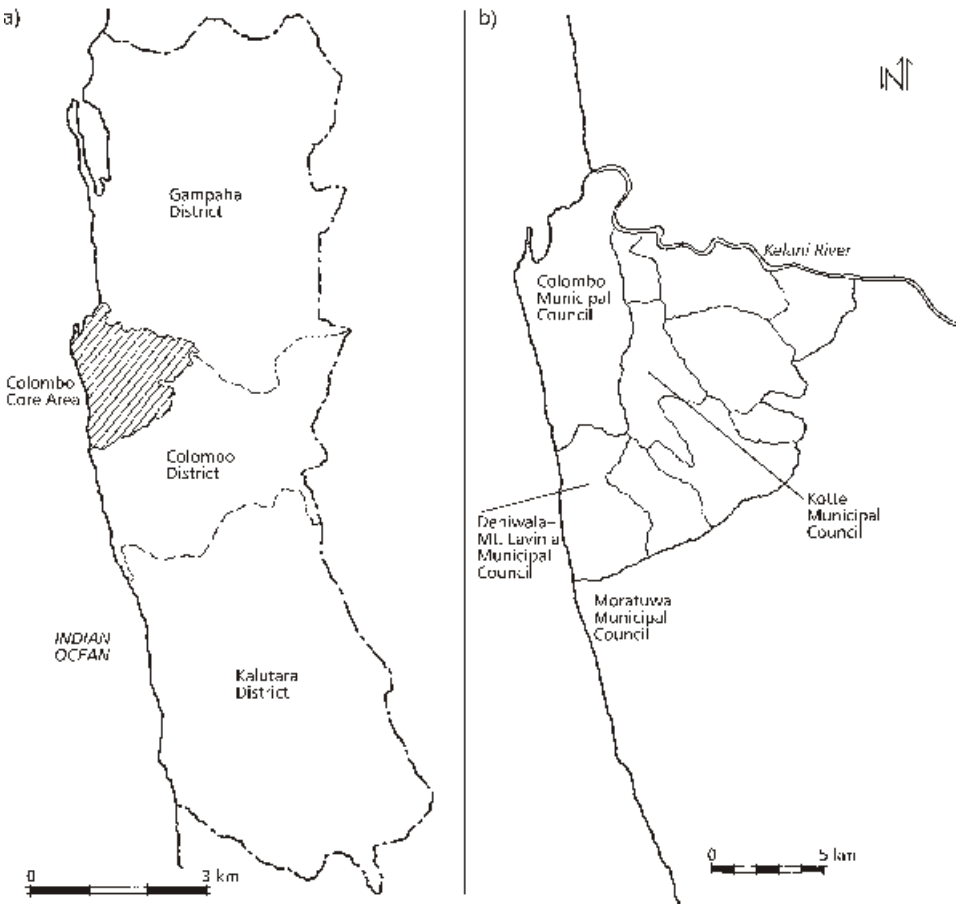

Fig. 2.14 (a) Colombo Metropolitan Region (Western Province) and its three districts. (b) Colombo Core Area consisting of the Colombo Municipal Council and neighbouring urban councils.

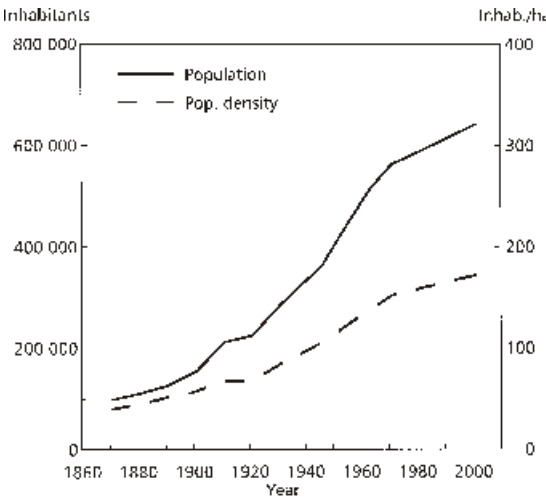

Fig. 2.15 Population growth and density of the Colombo Municipal Council (CMC) between 1861 and 2001. During this period the area of the municipality increased from about 2500 ha to 3700 ha. Source: UDA (1999a), Dept. of Census and Statistics (2005).

The objective of the recently issued Colombo Development Plan (UDA 1999a, b) is to reduce the expansion of slums and shanty towns and to provide housing for an increasing urban population without increasing the area designated for residential buildings. The plan is to increase population densities by radically increasing the number of floors permitted in buildings (thus increasing FAR) in some areas (see Table 2.4 and Fig. 2.17). The plan also includes a vision related to outdoor thermal comfort: the “establishment of tree-lined boulevards and malls for comfortable walking and visual comfort”.

The tendency towards high-rise, high-density settlements is illustrated by a recent programme to relocate slum and shanty town residents to high-rise apartment buildings. The programme, called Compact Townships, is financed by selling prime land occupied by illegal settlements. However, of six relocation projects planned, only one has been implemented (Fig. 2.16).

The recent increasing number of high-rise buildings has been criticised, both for leading to abrupt social changes and for destroying the character of Colombo as a low-rise garden city (see e.g. Wijewardena 2005).

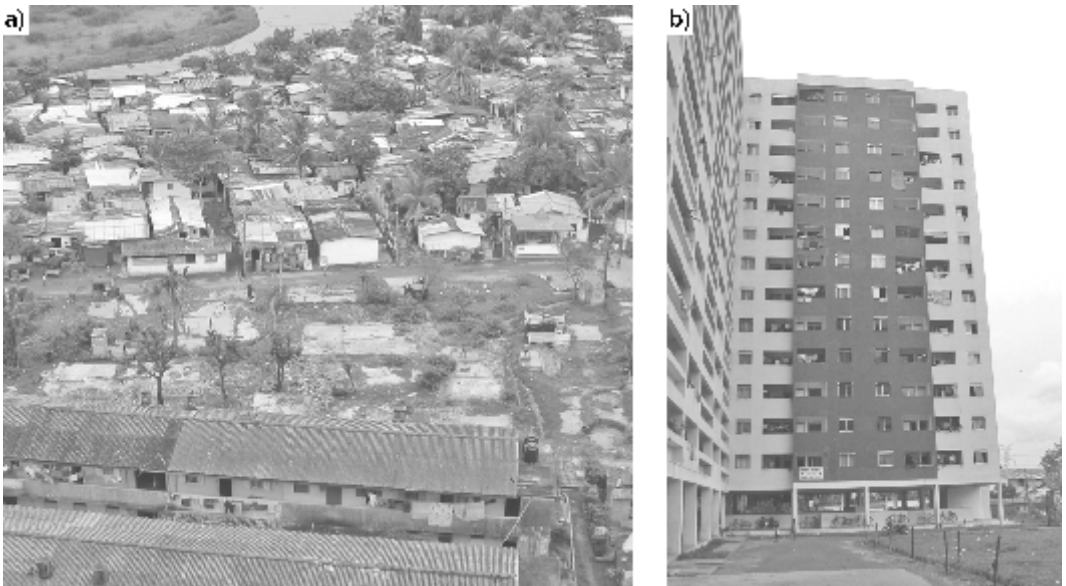

Fig. 2.16(a) Illegal shanty town (above) and slum tenements (below).
(b) High-rise residential building for relocated slum and shanty town residents (the Sahaspura project).

Urban design regulations

Sri Lanka is divided into provinces, each of which is subdivided into districts. In turn, the districts are divided into municipal and urban councils, as well as Pradeshiya Sabhas (van Horen 2002). The municipal councils govern larger urban areas (with a population typically above 30,000 inhabitants) whereas urban councils have smaller populations. Pradeshiya Sabhas are administrative units in smaller

towns in predominantly rural areas. Colombo is situated in the Western Province, also called the Colombo Metropolitan Region, which comprises three districts (Fig. 2.14a).

In Sri Lanka, urban planning is governed by the Urban Development Authority (UDA). This authority is responsible for every urban area in the country which it has declared as being under its jurisdiction (van Horen 2002). The UDA elaborates both comprehensive and detailed urban plans.

In Colombo, the City of Colombo Development Plan (UDA 1999a, b) deals with urban regulations within the Colombo Municipal Council (Fig. 2.14b). Volume I of this document (UDA 1999a) deals with land-use zoning whereas Volume II (UDA 1999b) contains rules related to construction including specific rules regarding urban form. Additionally, some especially important areas within the city of Colombo will be covered by so-called development guide plans which give detailed guidance on environmental characteristics, urban form and architectural design. Outside the borders of the municipal council, the Housing and Town Improvement Ordinance (Gov. of Sri Lanka 1980) stipulates construction-related regulations including specific rules regarding urban form.

Land-use zones

The land-use zones that apply to the city of Colombo are described in Table 2.4 and shown in Fig. 2.17. The current land-use zones suggest considerably higher densities than those existing today. This particularly concerns the Concentrated development zone, where buildings should be *at least* ten storeys high and the Primary residential zone, where building heights up to ten storeys are permitted. The former include Fort and Pettah as well as the area just south of Fort. The latter is found along the coast south of Fort. The Special primary residential zone is found in Cinnamon Gardens, a traditional high income area.

Table 2.4 The land-use zones in Colombo (UDA 1999a)

Zone	Land use	Description
1	Special primary residential	Mainly residential, max. three storeys
2	Primary residential	Max. ten storeys
3	Commercial	Non-polluting, light industries
4	Mixed development	Mix of residential and commercial
5	Concentrated development	High density zone, min. ten storeys
6	Port-related activity	
7	Recreational	Recreation and residential
8	Environmental conservation	Preserved nature, limited recreation

Regulation of urban form

Current regulations governing the number of storeys, building height, distances between buildings, plot coverage, floor area ratio (FAR)¹⁷ and setbacks are shown in Table 2.5. (Plot coverage, FAR, plot frontage and setbacks are illustrated in Fig. 2.10.)

17 FAR is calculated as the total floor area of a building, divided by the total area of the plot.

Fig. 2.17
 The land-use zones for
 the Colombo Municipal
 Council as proposed by
 the UDA (1999a).
 (The numbers refer to
 the land-use zones in
 Table 2.4)

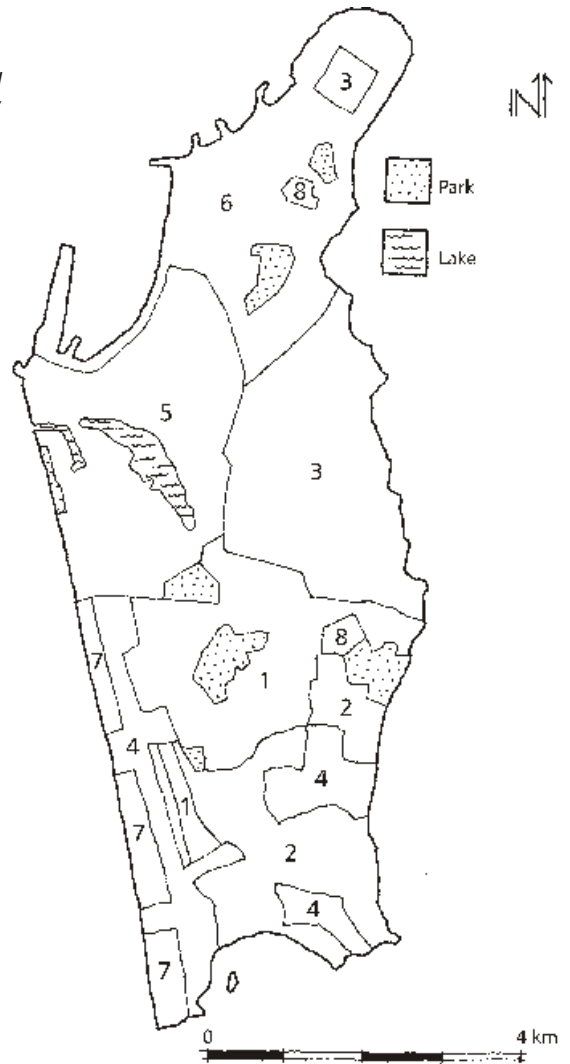

As can be seen in Table 2.5, the maximum FAR is 1.5 for the smallest low-rise buildings and increases up to 8 for middle-rise buildings (and even higher for high-rise buildings). The maximum plot coverage is almost independent of plot size and building type. For buildings up to eight storeys, it is 65% for residential buildings and as high as 80% for non-residential purposes. For these categories, there are setback rules for the front and the rear of the buildings, but not for the sides. However, buildings higher than eight storeys are subject to setback requirements on all four sides. The minimum street width and setbacks increase with the height of the buildings. Up to six storeys, the front setback is only 1 m. However, this distance may be greater if a street line indicates possible future widening of the street.

Roof overhangs or any type of shading devices on the façade of a building are permitted to project up to 1.0 m beyond the building line. Footways under projecting verandas or the like, along the front

Table 2.5 The regulations pertaining to urban form in the city of Colombo.
 FAR = floor area ratio, H = building height.

Class of building	Type of use	Plot size (m ²)	Min. plot frontage (m)	Max. plot coverage		Max. no. of floors	Max. H (m)	Min. road width (m)	Minimum setbacks (m)		
				Max. FAR	(%)				front	rear	side
Low rise A	Residential	150–249	6	1.50	65	2	7.5	3	1 ^a	2.3	—
	Non-residential			1.50	80						
Low rise B	Residential	150–249	6	2.00	65	3	11.25	6	1 ^a	3.0	—
	Non-residential			2.25	80						
Intermediate rise A	Residential	250–399	8	3.00	65	5	18.75	6	1 ^a	3.5	—
	Non-residential			3.75	80						
Intermediate rise B	Residential	400–749	10	3.75	65	6	22.5	9	1 ^a	4.5	—
	Non-residential			4.50	80						
Intermediate rise C	Residential	750–999	15	5.00	65	8	30	9	2	5.0	—
	Non-residential			6.00	80						
Middle rise	Residential	1000–1999	30	7.50	65	12	45	12	3	6.5	6.5
	Non-residential			8.00	70						
High rise		2000	40	— ^b	50	13	46	12	3	10.0	10.0

a If there are no building lines.
 b To be issued by the authority.

of the building, are only permitted if they are located within the building lot.

The building types shown in Table 2.5 do not include the buildings found in the historic core of the central Fort area. According to the proposed development guide plan for Fort (UDA 1999a), new or renovated buildings should be of the same type as existing ones, entailing, for example, that setbacks are not stipulated, although colonnades must be provided along all vehicular and pedestrian roads.

Areas studied

In this study, urban microclimate and outdoor thermal comfort was studied in detail in three neighbourhoods within the Colombo Municipal Council (zones 4 and 5) and in two neighbourhoods outside the municipal council. The position of the measurement sites are shown in Fig. 5.1. An analysis of the consequences of the urban regulations on outdoor thermal comfort is given in Section 6.4.

3 Concepts

This chapter describes the state-of-the-art regarding two concepts central to this study. The first section considers the influence of the built environment on the microclimate within the urban canopy layer. The second section deals with outdoor thermal comfort, including both theoretically derived comfort indices and aspects of climatic adaptation. *A glossary of terms and definitions is given in Appendix 1.*

3.1 The climate of the urban canopy layer

Urban climate on different scales

When countryside air flows over a city, different horizontal layers of air are formed, each of which develops its own climate (Fig. 3.1). According to Oke (2004), three climate scales apply in urban areas: the micro, local and meso scales (Fig. 3.1). The horizontal and vertical extensions of these scales are shown in Table 3.1. The micro-scale includes buildings, streets, squares, gardens, trees, etc. The local scale represents urban neighbourhoods, whereas the meso-scale represents an entire city.

Table 3.1 Horizontal and vertical scales of urban atmosphere (after Oke 2004).

Scale	Urban level	Horizontal distance	Vertical layer
Micro	Street canyons, squares, gardens	< 200–300 m	Roughness sub-layer
Local	Neighbourhood	100 m – 10 km	Inertial sub-layer
Meso	City	> 10 km	Mixing layer

Vertically, the micro-scale falls within the roughness sub-layer, the height of which depends on building density and atmospheric stability (Roth 2000). It has been found to vary between about 1.5 and 4 times the average height of the buildings (Oke 2004). Above this height, micro-climate effects from the buildings and objects below are phased out. The area between the ground and the rooftops is called the *urban canopy layer*. This layer, which constitutes the lower part of the roughness sub-layer, comprises buildings and the areas around them, such as gardens, streets, squares and parks.

This thesis focuses on the climate in the urban canopy layer (UCL), that is, the climate between the buildings (Fig. 3.1c). Within this layer, the microclimate is site-specific and varies greatly within short distances (Arnfield 2003, Oke 2004).

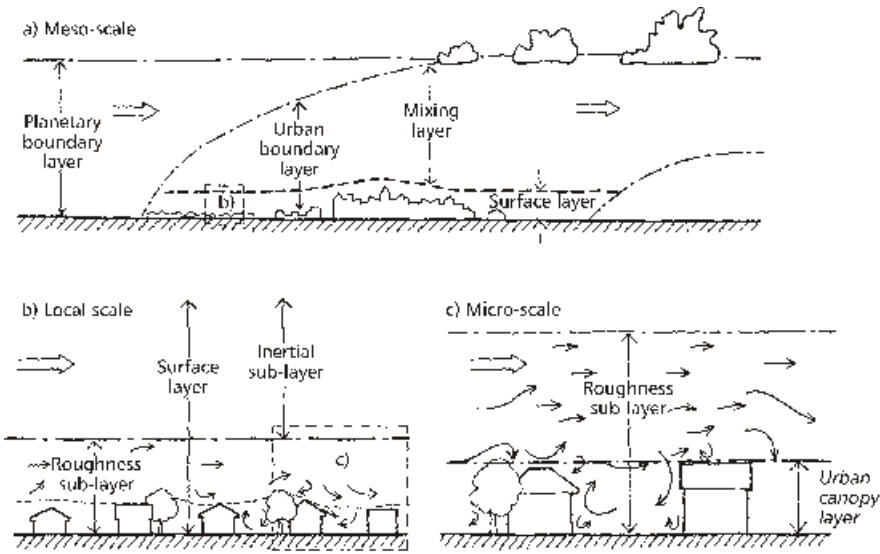

Fig. 3.1 Climatic scales in urban areas: meso, local and micro-scale (modified from Oke 2004).

Features of the built environment

Built-up areas influence the absorption and reflection of solar radiation, the ability to store heat, the absorption and emittance of long-wave radiation, winds and evapotranspiration. The built environment is also characterised by human activities affecting the climate, such as the heating and cooling of buildings, motor traffic and industrial production. These activities release heat and moisture but also pollute the air, which affects incoming and outgoing radiation.

Urban geometry and properties of surface materials

It is generally agreed that the geometric form of the urban canopy layer greatly influences the urban climate (Arnfield 2003). A common element within the canopy layer, particularly in city centres, is a street flanked on both sides by rows of buildings. This simplified element of the urban environment, referred to as the urban street canyon (Fig. 3.3), is determined geometrically by the ratio between the height of the façades and the width of the street (H/W ratio). For asymmetric canyons with varying building heights, the H/W ratio is calculated using the average building height.

The thermal properties of surface materials also greatly influence the urban climate (Arnfield 2003). The reflectivity, or albedo, of surfaces, determining the amount of absorbed short-wave radiation, depends mainly on the colour of the surface and varies greatly in urban areas: between about 0.3 for light colours up to about 0.9 for dark colours. Conversely, the ability to emit and absorb heat (long-wave radiation) is very similar for rural and urban surface materials whose emissivities lie around 0.9 (one exception being shiny metallic surfaces, which have considerably lower values).

Thermal admittance μ is identified by Oke (1987) as the key parameter in determining how much of the radiation absorbed at the surface will be stored in the sub-surface; the higher the thermal ad-

mittance, the more heat will be stored in the material while less energy will be released as sensible heat. Thermal admittance, sometimes called the heat penetration coefficient (McIntyre 1980), is calculated as:

$$\mu = \sqrt{\frac{k}{C}} \quad (3.1)$$

where k represents thermal conductivity and C the thermal capacity of the material. Fig. 3.2 shows how thermal admittance increases with the density of building materials and moisture content of soils.

Fig. 3.2
The relation between thermal admittance μ and density of building materials and soils. For soils, lower values are for dry soils and the higher values for saturated conditions.

Sources: Evans (1980), Oke (1987) and Szokolay (2002).

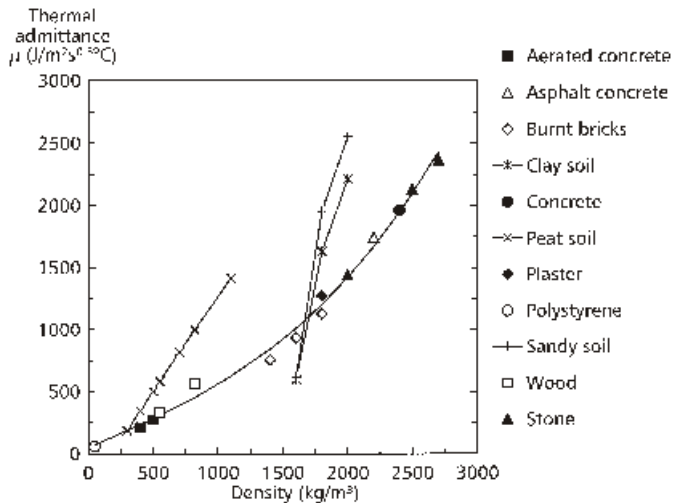

In Fig. 3.2, it can be seen that dry soils have lower thermal admittance than typical urban surfaces, such as concrete, asphalt and stone. However, the values for moist soils are similar to, or even higher than, those of urban materials. However, due to the irregular urban geometry, the active surface, i.e. the surface exposed to the air, is considerably larger in urban areas than in rural areas (Oke et al. 1999).

Thermal and surface properties for some common urban and rural materials are shown in Appendix 2.

Anthropogenic heat

To a greater or lesser extent, all cities release heat from space heating, air conditioning, motor traffic and other domestic and industrial activities that require energy. According to Oke (1982), typical values for anthropogenic heat in temperate climates vary between 5 W/m² in residential suburbs and 50 W/m² in the centres of large cities. These values are low compared to the radiation energy flux in urban areas (Fig. 3.6).

Air pollution

Air pollution from motor vehicles and industrial activities adds to the aerosols in the air. Consequently, incoming solar radiation is attenuated and its diffuse component increased. For most cities, the reduction of global solar radiation is normally below 10%, but may exceed 20% in highly polluted cities (Oke 1988b, Arnfield 2003). Another ef-

fect of pollution is that a larger part of the outgoing long-wave radiation will be absorbed by the atmosphere and re-emitted towards the ground (Oke 1987).

Green areas and vegetation

In urban areas, bare and vegetated soils are largely replaced by hard, often waterproof, surfaces. Consequently, much of the ground’s ability to release energy through evaporation and transpiration is lost. However, green areas within cities act similarly to rural areas and are normally cooler than built-up areas, especially by night. Irrigated green areas can be considerably cooler than their surroundings, even during daytime, especially in semi-arid and arid areas.

Single trees and small clusters of trees can be effective in providing shade. The shading of solar radiation – including direct, diffuse and reflected radiation (from the walls and the street) – will keep urban surfaces cooler, in turn, decreasing air temperature.

Influence of the built environment on urban climate

Short and long-wave radiation

The amount of absorbed solar radiation in an urban area depends both on the reflectivities of the urban surfaces and on the canyon geometry. The absorbed short-wave radiation K^* at a single surface is calculated as (Oke 1987):

$$K^* = K - K_r = (S + D) - \rho(S + D) = (1 - \rho)(S + D) \tag{3.2}$$

where K is the incoming global radiation, K_r is the reflected radiation, S and D are the direct-beam and diffuse radiation components, respectively, and ρ is the reflectivity of short-wave radiation.

The direct-beam irradiation S on a surface depends on its orientation and on the azimuth and altitude angles of the sun. The amount of diffuse irradiation D received at street level depends on the sky view factor (SVF), which expresses the portion of the sky seen from the street as illustrated in Fig. 3.3. D decreases with decreasing sky view factor.

Whereas there is often little difference in reflectivity between urban and rural surfaces (Appendix 2), the *overall reflectivity* of the urban fabric is generally lower than for rural surfaces. This is because the irregular urban surface tends to trap solar radiation. Due to multiple reflections within the canyons, the amount reflected back to the

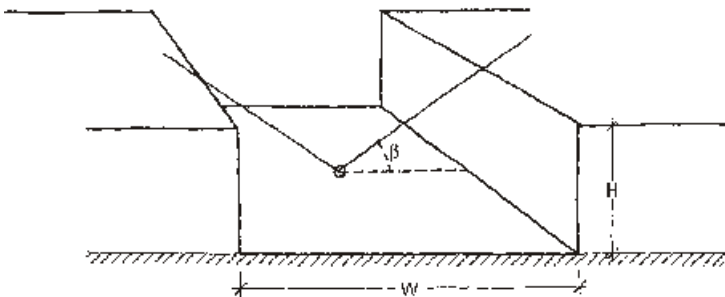

Fig. 3.3 Sky view factor of an urban street canyon. At the middle of the street of an infinitely long canyon, $SVF = \cos^2 \beta$.

atmosphere is small. Steemers et al. (1998) studied the reflectivity of the entire urban fabrics of some European cities, both through scale modelling and simulations using the tool Radiance, and found that, compared to a flat surface of the same colour, the decrease in reflectivity of urban fabrics can be as great as 40%. Using numerical simulations with a model that takes multiple reflections into account, Arnfield (1990a) could show that the overall reflectivity of global solar radiation ($S + D$) for an urban canyon typically varies between 0.06 and 0.15 (Arnfield 1990a). Reflectivity decreases approaching the equator and with an increasing H/W ratio.

The net long-wave radiation L^* at an urban surface is calculated as (Oke 1987):

$$L^* = L_{\text{in}} - L_{\text{out}} \quad (3.3)$$

where L_{in} is the incoming long-wave radiation from the sky and L_{out} is the emitted long-wave radiation from the surface. The outgoing long-wave radiation L_{out} is always greater than the atmospheric counter-radiation L_{atm} and therefore L^* is negative.

The magnitude of the incoming long-wave radiation from the sky L_{in} depends on the air temperature and atmospheric emissivity. The latter depends, in turn, on the humidity, the cloud cover and the type of clouds (Arnfield 1990b, Oke et al. 1991). L_{in} is fairly constant throughout the day and typically varies between about 300 W/m² for clear skies to about 400 W/m² for skies with high humidity and cloud cover (Oke et al. 1991, Jonsson et al. 2005). As with diffuse radiation, the amount of incoming long-wave radiation from the sky reaching street level decreases with decreasing SVF.

The outgoing radiation from an urban canyon is complex. Apart from radiative exchange with the sky, the canyon surfaces will also exchange radiation with each other. For a single surface, the emitted long-wave radiation can be expressed as (Oke 1987):

$$L_{\text{out}} = \epsilon T_s^4 \quad (3.4)$$

where ϵ is the emissivity for long-wave radiation at the surface (see Appendix 2), σ is the Stefan-Boltzmann constant = 5.67 · 10⁻⁸ W/m²K⁴ and T_s is the temperature of the surface (in degrees Kelvin). Similarly to incoming long-wave radiation, the outgoing long-wave radiation from a canyon is linked to the SVF; the lower the SVF, the lower the L_{out} from the canyon. Consequently L^* diminishes with lower SVF (higher H/W ratio).

Air temperature

The best known characteristic of the urban climate is that cities are warmer than their rural surroundings. The urban *heat island*, which is primarily a nocturnal phenomenon, has been studied extensively throughout the 20th century (see e.g. Landsberg 1981, Oke 1982, Arnfield 2003). During the daytime, urban-rural temperature differences are normally smaller and, as a consequence of the nocturnal heat island, the diurnal temperature range is less in urban areas than in rural areas.

Field studies in numerous cities, mainly in temperate climates, have shown that the magnitude of nocturnal heat islands increases

with increasing H/W ratio (reduced SVF) of street canyons (see e.g. Oke 1982). The link between the nocturnal heat island and canyon geometry has been confirmed by Arnfield (1990b) and Oke et al. (1991) through the simulation of canyon surface temperatures. These studies also demonstrated that the size of the heat island increases with increasing urban-rural differences in thermal admittance. By day, the urban canyon is a good absorber of solar energy and, because of the relatively high thermal capacity of urban surface materials, this energy is stored in the fabric and not released until after sunset (Nakamura and Oke 1988). The size of the urban heat island decreases with increasing emissivity from the sky (e.g. due to increased cloud cover) and with increased wind speed (Oke 1982). Consequently, the largest urban-rural temperature differences occur during calm and cloudless nights.

By day, both heat and *cool* islands can be found. Daytime heat islands are normally believed to be caused by anthropogenic heat, whereas cool islands are attributed to the shade cast by buildings (Oke 1982).

An extensive study of summertime air temperature distribution in an urban canyon with H/W = 1 in Kyoto (35°N), Japan, revealed that the air temperature within the canyon was uniform except for within about 1m from the canyon's surfaces (Nakamura and Oke 1988). This is because the air mixes well due to natural and forced convection.

The impact of anthropogenic heat on air temperature is often small and seldom a major cause of urban warming, except in some cities where extensive space heating or cooling is common and buildings are poorly insulated (Oke et al. 1991, Arnfield 2003).

Air pollution reduces both net incoming short-wave radiation K^* and net outgoing long-wave radiation L^* and consequently the net effect on the radiation budget ($K^* + L^*$) is small. This explains why air pollution has a surprisingly limited effect on air temperature (Oke 1987, Arnfield 2003).

Green areas and vegetation can have a significant impact on air temperature. Larger parks are cooler than built-up areas. Temperature differences of 1–2°C are common (Oke 1989) but can reach as much as 5°C (Spronken-Smith and Oke 1998, Upmanis et al. 1998). The major reasons for parks being cooler by night include more efficient cooling of the ground through net outgoing long-wave radiation due to higher SVF and less heat storage in surfaces compared to street canyons.

In arid regions, irrigated green areas may be considerably cooler than built-up areas due to the so-called oasis effect (Oke 1987). If there is an excess of water, evaporation from vegetation and moist soil becomes so strong that energy is taken from the air, causing it to cool. However, if irrigation ceases, the effect will eventually disappear.

For single trees and small clusters of trees, the effect of evaporation on air temperature is marginal; Oke (1989) estimates this to be lower than 0.5°C. However, due to shading of the ground, air temperatures may be reduced. Shashua-Bar and Hoffman (2000) found 2–4°C cooler air temperatures in tree-lined streets in Tel Aviv, Israel.

They also found that during the night, the trees blocked the outgoing long-wave radiation from the canyon surfaces and nocturnal cooling was therefore reduced. Consequently, the trees helped create a more conservative climate with cooler days and warmer nights.

Humidity

In general, urban-rural humidity differences are small. However, there is a tendency for cities to be slightly more humid by night and dryer by day than their rural surroundings (Oke 1987). This phenomenon is often called urban moisture excess (Holmer and Eliasson 1999, Mayer et al. 2003). The fact that cities are, in general, more humid by night is believed to enhance the heat island effect slightly, since the incoming long-wave radiation L_{\downarrow} above cities increases compared to the surrounding rural areas (Oke et al. 1991).

Wind

The complex geometrical forms of urban areas, comprising buildings with sharp edges, strongly affect regional winds blowing through and over a city. Measurements and wind tunnel tests have shown that regional horizontal wind speed is reduced to 25–50% (Glaumann and Westerberg 1988, Bosselmann et al. 1995). However, the wind pattern is highly irregular and characterised by a high level of gustiness. Locally, wind speeds in urban areas can exceed those of the rural surroundings, especially in the presence of high-rise buildings (Oke 1987, Bosselmann et al. 1995).

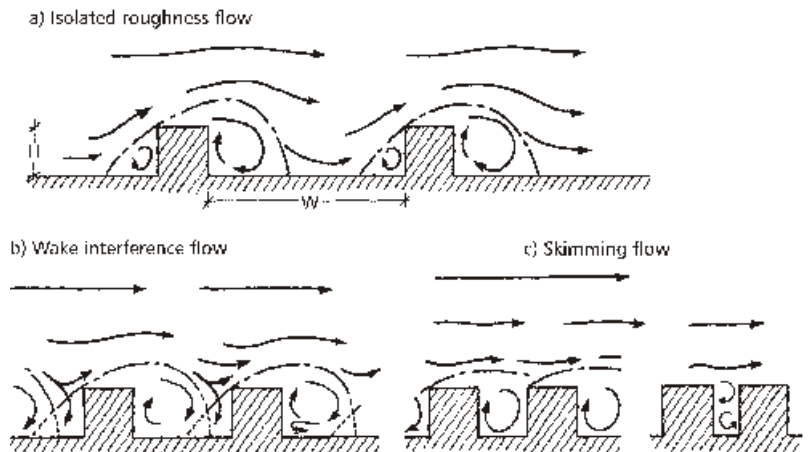

Fig. 3.4 Air flow in street canyons with different H/W ratios (Modified after Oke 1987 and Santamouris 2001). The closer the buildings, the more the air flow tends to skim over them.

Because of the variation in the size and shape of buildings and the distances between them, air movements in urban areas become extremely complex and it is very difficult to calculate or estimate properties such as direction, speed and gustiness. However, using wind tunnel tests and field measurements, some basic wind phenomena have been observed and are summarised by Oke (1987, 1988a). For several parallel and symmetrical urban canyons, the wind flow perpendicular to the long-axis of the canyon will depend on the H/W ra-

tio according to Fig. 3.4. For $H/W < 0.3$, a low pressure zone is formed behind the buildings on the leeward side with a circulatory vortex flow. At these low H/W ratios, most of the wind flow enters the canyon. As distances between the rows of buildings decrease, the vortex flow will be reinforced because of downward deflection by the next building. For $H/W > 0.65$, a stable circulatory vortex develops within the canyon and the coupling with the air above the canyon becomes weaker, causing most of the flow to skim over the buildings. In deep canyons, a secondary vortex is common, located beneath the first and rotating in the opposite direction (Fig. 3.4c). The coupling between the canyon and the air above it thereby decreases with increasing H/W ratio. In deep canyons, this results in the canyon air becoming isolated from the air above.

The wind patterns may be more complex for irregular urban forms and for wind directions other than perpendicular. For wind flows parallel to an urban canyon, wind speeds may be increased due to channelling (Oke 1987).

The energy balance of an urban canyon

In recent decades, urban climate research has, to a great extent, focused on the energy balance of urban areas (Arnfield 2003). This balance includes all the energy processes involved in the formation of the urban climate and illustrates the diurnal variation of different energy fluxes and how they relate to each other. The basic idea is that the input from radiation and anthropogenic heat has to be balanced with the release of sensible and latent heat. However, there is also heat entering and leaving the canyon through the horizontal transport of air (advection) and heat that is stored in the urban surfaces.

For a volume consisting of a street canyon (Fig. 3.5), or a larger urban area, the energy balance is normally expressed as (Oke 1987, Arnfield 2003):

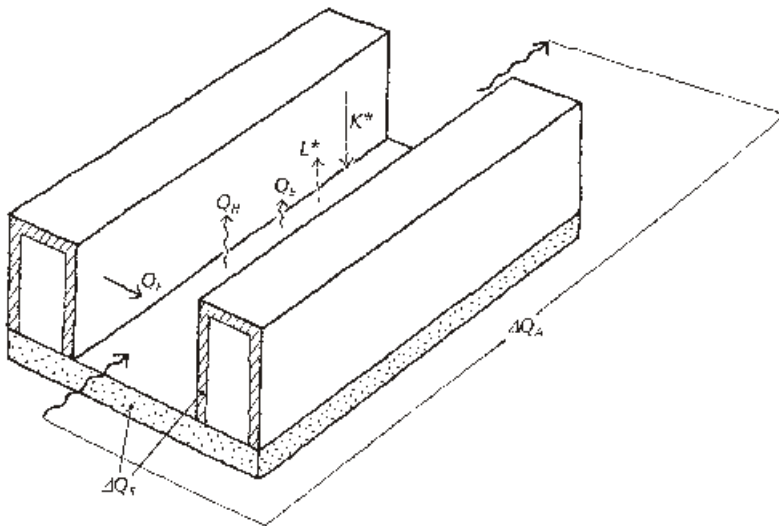

Fig. 3.5 The street canyon volume active in the energy balance in equation 3.5. The boundaries of the volume consist of the canyon top, the inner surface of the canyon walls and the lower limit of the active soil.

$$(K^* + L^*) + Q_F = Q_H + Q_E + Q_S + Q_A \tag{3.5}$$

where K^* and L^* are net incoming short and long-wave radiation respectively, Q_F is anthropogenic heat, Q_H is sensible heat, Q_E is latent heat, Q_S represents net heat storage and Q_A is the net advection through the sides of the volume. All fluxes are in W/m^2 .

The net radiation¹, K^*+L^* , is positive during the day because the absorbed solar radiation is greater than the net outgoing long-wave radiation (Fig. 3.6). At night, however, when there is no solar radiation ($K^* = 0$), net radiation consists entirely of net outgoing long-wave radiation (L^*) and is therefore negative. As mentioned above, anthropogenic heat Q_F is normally small compared to the radiation input.

The sensible heat Q_H released (or absorbed) depends on the turbulence of the atmosphere and the temperature gradient between the surface and the air. The Q_H released from a surface can be calculated as (Arnfield and Grimmond 1998):

$$Q_H = h(T_s - T_a) \tag{3.6}$$

where h is the overall heat transfer coefficient from radiation and convection, T_s is the surface temperature and T_a is the air temperature. From equation 3.6, it can be seen that Q_H increases with increased convection and increased air-surface temperature difference. Consequently, Q_H is high during the day when both surface temperature and natural convection are high, particularly on sunny days (Fig. 3.6).

Similarly to Q_H , latent heat Q_E is dependent on air turbulence (the more turbulent, the higher Q_E) and the humidity gradient (the greater the difference in humidity between the surface and the air, the higher the Q_E). Consequently, Q_E will be great when surfaces are moist and when the surrounding air is dry. If the release of latent heat Q_E increases due to evaporation, the sensible heat Q_H will diminish (at extreme evaporation rates, Q_H may become negative and the air cools, causing the “oasis effect” mentioned above).

Fig. 3.6
 The energy balance according to equation 3.5 for an urban canyon in Vancouver, Canada. K^*+L^* = net short and long-wave radiation, Q_H = sensible heat, Q_E = latent heat and Q_S = heat storage. The anthropogenic heat Q_F and advection Q_A were not measured and are included in the other heat fluxes. They are, however, assumed to be small. (Modified after Oke 1987).

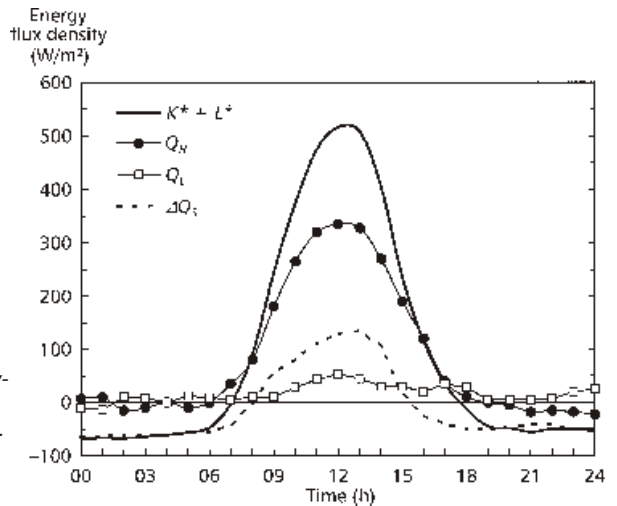

1 The all-wave net radiation K^*+L^* is often denoted Q^* .

The heat storage component Q_S comprises heat stored in urban surfaces, both in façades and in the ground down to the depth at which each surface is active. Its magnitude depends on the heat capacity and thermal admittance of the canyon surfaces (see Appendix 2). As can be seen in Fig. 3.6, Q_S is mainly positive during the day (heat is stored in the urban surfaces) and negative during the night (heat is released from urban surfaces).

The advective component Q_A , which consists of horizontal air movements between urban and rural sites, or between different urban sites, depends on the wind speed and how permeable the urban area is to air movements. However, for urban sites surrounded by areas of similar urban form and land use, Q_A can often be neglected, assuming no net horizontal energy exchange, especially if wind speeds are low (Oke 1987, Oke 1988b).

In Fig. 3.6, it can be seen that net daytime radiation (K^*+L^*) results primarily in sensible heat Q_H and heat storage Q_S . The canyon in question had a gravelled road, resulting in a small amount of latent heat Q_E (for impervious surfaces, Q_E is normally negligible). Moreover, it can be seen that during the night, the net outgoing long-wave radiation L^* (negative) equals the release of heat from the surfaces (Q_S is also negative).

In this study, the energy balance of the urban canyon (equation 3.5) was used to identify strategies to improve the microclimate, see Section 5.2 and Paper IV.

3.2 Outdoor thermal comfort

According to ASHRAE, thermal comfort is defined as the “condition of mind that expresses satisfaction with the thermal environment” (ASHRAE 1997). Another definition is the absence of thermal discomfort, that is to say, that an individual feels neither too warm nor too cold (McIntyre 1980). The temperature of this state is referred to as the *neutral temperature*. However, thermal sensation is subjective, meaning that not all people will experience comfort in the same thermal environment. For indoor conditions, comfort zones are typically implemented to satisfy 80% of people (Fountain and Huizenga 1994). The comfort zone is often expressed as a temperature range around the neutral temperature.

Outdoors, the thermal comfort range is wider than indoors, spanning from thermal comfort to a stressful environment (Spagnolo and de Dear 2003, Emmanuel 2005a). Moreover, outdoor conditions show large temporal and spatial variations and the thermal balance of the body is seldom in steady state as it is in controlled indoor environments. In warm climates, which are the focus of this study, it is well known that mental and physical performance deteriorates at high temperatures and that heat stress may lead to heat-related illness (McIntyre 1980).

The heat balance of the human body

A good way to illustrate all of the variables that influence thermal comfort, and how these inter-relate, is to study the energy balance of

the human body. Many of the most common thermal indices for indoor conditions are based on this heat balance (McIntyre 1980).

The input in the heat balance is the metabolic heat production of the body and the output is the sum of heat losses through *sensible heat flow* from the skin, *evaporation* from the skin and *respiration*. The heat balance can be expressed as (see e.g. McIntyre 1980, ASHRAE 1997, Höppe 1999):

$$M = (R + C) + (E_{dif} + E_{sw}) + (C_{res} + E_{res}) \quad (3.7)$$

where M is the internal heat production of the human body, R and C are the radiation and convection heat losses from the outer surface of the clothed body (or exposed skin) respectively, E_{dif} is heat loss by evaporation of moisture diffused through the skin, E_{sw} is heat loss through the evaporation of sweat and C_{res} and E_{res} are the convective and evaporative heat losses through respiration respectively.

From a thermo-regulatory perspective, equation 3.7 represents the requirement for thermal comfort, i.e. heat production must equal heat losses (McIntyre 1980, Höppe 2002). If the body is not in thermal balance its temperature will change and eventually become uncomfortable. However, the heat balance can be maintained by physiological mechanisms, e.g. sweating, even if the body is not thermally comfortable. Therefore, an additional requirement for the state of thermal comfort is that mean skin temperature and the rate of sweating should maintain appropriate levels (McIntyre 1980, Höppe 2002).

In this study, the energy balance of the human body (equation 3.7) was used to identify strategies to improve the microclimate, see Section 5.2 and Paper IV.

Variables influencing thermal comfort

There are four environmental variables affecting the thermal comfort of the human body: air temperature, mean radiant temperature, air humidity and air speed. Additionally, two personal variables influence thermal comfort: clothing and the level of activity. However, other personal factors related to adaptation and acclimatisation have proven to affect thermal sensation and are discussed below.

Air temperature

The air temperature, defined as the dry-bulb temperature in the shade, is one of the most important climatic factors influencing thermal comfort. Both the body's convective heat loss C and its dry respiration heat loss C_{res} decrease with increasing air temperature. If the air temperature exceeds the surface temperature of the clothed body, or of the exposed skin, which is around 34°C, C is negative and there will be convective heat gain.

Radiation

The absorption of solar radiation and the exchange of long-wave radiation strongly affect the state of thermal comfort of the human body. For indoor conditions, the concept of mean radiant temperature (MRT) was developed. This is defined as "the uniform temperature of an imaginary enclosure in which radiant heat transfer from the human body equals the radiant heat transfer in the actual non-

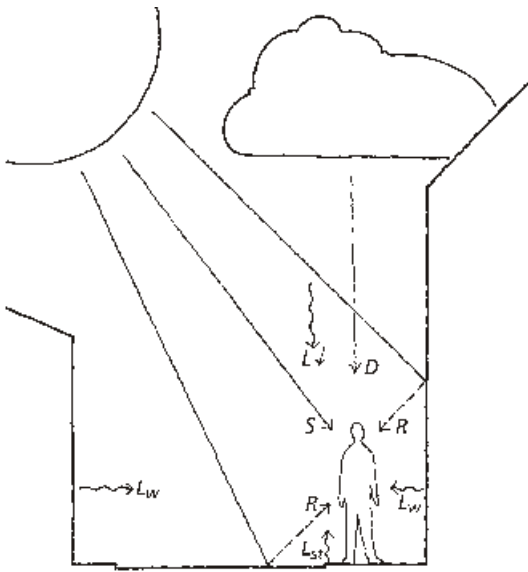

Fig. 3.7
A person in a street canyon exposed to direct (S), diffuse (D) and reflected (R) short-wave radiation as well as long-wave radiation from the sky (L_s) and the urban surfaces (L_g and L_{sv}).

uniform enclosure” (ASHRAE 1997). Indoors, where short-wave radiation is normally absent, the body exchanges long-wave radiation with the six room surfaces and the MRT can be calculated by weighting the influence of the temperatures of each surface (see e.g. McIntyre 1980, ASHRAE 1997). Outdoors it is much more complicated to determine MRT because of the extensive variation in radiation from different sources (Fig. 3.7). The human body may receive solar radiation as direct and diffuse, as well as reflected radiation from building façades and the ground. Moreover, the body exchanges long-wave radiation with the sky, with urban surfaces and with objects such as trees. The magnitude of the radiation from the different sources varies greatly in space and time. The most accurate way to determine outdoor MRT is by measuring the short and long-wave radiation from different directions and then calculating MRT (see e.g. VDI 1998, Spagnolo and de Dear 2003, Ali-Toudert et al. 2005). However, MRT can also be measured using a globe thermometer (see e.g. Nikolopoulou et al. 2001) or can be estimated through calculations (Matzarakis 2000, Ali-Toudert and Mayer 2006).

The radiant heat loss R of the human body decreases with increasing MRT. When MRT is higher than the temperature of the outer surface of the clothed body (or exposed skin), there is a radiative heat gain. Otherwise, R is positive and there is a radiative heat loss.

Air humidity

A change in the humidity of the atmosphere affects thermal sensation in that a person feels warmer, sweeter and less comfortable (McIntyre 1980). Especially under warm conditions, when both convective C and radiative R heat losses are small, sweat evaporation E_{sw} is an important mechanism in maintaining comfort. When the liquid sweat on the skin surface evaporates, latent heat is extracted from the body and a cooling effect is produced.

The humidity of the air influences both evaporative (E_{dif} and E_{sw}) and respiratory (E_{res}) heat losses. As humidity increases, evaporative losses will decrease. However, according to Givoni (1998) humidity does not influence thermal sensation below a critical level. This is because, although the evaporative capacity of the air diminishes with increasing humidity, the body compensates for this by spreading the sweat over a larger area of skin, thus maintaining the required evaporation rate. The same author claims, however, that above a certain critical level of humidity, part of the latent heat of vaporisation is taken from the ambient air instead of from the skin. This will lead to more sweat production and thus increased discomfort due to the feeling of excessive skin wetness². For subjects with sedentary activity, Givoni (1998) has defined this limit to 80% relative humidity for temperatures up to 25°C, corresponding to a vapour pressure of about 25 hPa.

Air speed

Air speed is a major factor affecting the state of thermal comfort. Outdoors, winds change speed and direction rapidly and a high degree of turbulence makes the wind speed feel higher than the measured mean value (Glaumann and Westerberg 1988, Bosselmann et al. 1995).

Both the convective heat loss C and the evaporation of sweat E_{sw} increase with increasing air speed because both the convective and evaporative heat transfer coefficients increase in magnitude (the insulating boundary layer around the body becomes smaller). Strong air movement is thus a disadvantage in cold climates, but a clear advantage in hot climates.

Personal factors

Metabolic heat M depends on the level of activity, which tends to vary more outdoors than indoors, typically from sitting to fast walking. Outdoors, people dress according to seasonal climate variations. Increased clothing insulation leads to a lower temperature difference between the outer surface of the clothed body and the ambient air temperature. Consequently, the convective C and radiative R heat losses decrease with increasing clothing insulation.

People adapt physically to an environment by adjusting how they dress and move, e.g. slow walking in hot climates, and by avoiding exposure to extreme climate situations etc. (Nikolopoulou and Steemers 2003).

Psychological factors also influence thermal comfort. These factors have gained more attention in recent years because discrepancies have been found between predictions using thermal indices and subjective thermal sensation. These discrepancies have been found both indoors and outdoors and give evidence to the fact that people adapt to their thermal environment (Brager and de Dear 1998, Emmanuel 2005a). However, psychological factors are likely to be greater outdoors where the environment is much more complex and dynamic (Nikolopoulou and Steemers 2003).

² Skin wetness is the ratio between the actual and maximum evaporative loss at the skin surface. At maximum loss, the whole skin surface is wet.

In the hot humid climate of Bangkok (14°N), Thailand, Busch (1992) found that people spending most of their time in naturally ventilated (passive) buildings tended to accept higher indoor temperatures than those spending most of their time in air conditioned buildings. He attributed the results to this difference in “background” experience: people accustomed to cool, air conditioned environments expected, and preferred, it to be colder, whereas people who spent most of their time in warm, non-air conditioned environments expected it to be warm. In the warm-temperate climate of Sydney (34°S), Australia, Spagnolo and de Dear (2003) found that the comfort zone was wider outdoors than indoors. Their explanation is that people’s expectations are different outdoors because the thermal environment varies much more in time and space and there is no way people can control it.

Another factor that has proven to influence thermal sensation is thermal history, i.e. the climate a person has recently been exposed to (Spagnolo and de Dear 2003, Thorsson et al. 2004). E.g. a person who has been exposed to extreme heat for a long time and moves to a shady location will experience a different thermal sensation than someone who has spent a long period of time in the shady environment.

Thermal comfort indices

A thermal comfort index combines two or more variables into one single index. A great number of indices trying to predict the state of thermal comfort, mainly for indoor applications but also for the outdoors, have been developed (McIntyre 1980, Emmanuel 2005a).

Special outdoor thermal indices

Some thermal comfort indices have been specially developed for the outdoors. Some indices, such as the Index of Thermal Stress (ITS) (McIntyre 1980, Givoni 1998) and the Wet-Bulb Globe Temperature index (WBGT) (McIntyre 1980, Emmanuel 1997 and 2005a), have mainly been developed for extremely warm outdoor conditions, such as hot work places and military activities. Consequently, they can be classified as heat stress indices rather than comfort indices (McIntyre 1980). Another index widely used in outdoor applications is the temperature-humidity index (THI), which combines air temperature and relative humidity (McIntyre 1980, Bitan and Potchter 1995, Emmanuel 1997, Deosthali 2000, Emmanuel 2005b). However, this index has the disadvantage of considering neither radiation nor air speed.

There also exist empirically derived multivariable regression models, which calculate thermal sensation based on measured air temperature, solar radiation, humidity and wind speed (see e.g. Givoni et al. 2003, Nikolopoulou et al. 2003). Regression coefficients are derived from subjective comfort votes given by individuals. These models have proven to accurately predict thermal comfort but have the disadvantage of being restricted to the type of environment and climate in which the study took place.

Thermal comfort indices based on the heat balance

The most commonly used thermal comfort indices for indoor applications are based on the heat balance of the human body, e.g. the new effective temperature (ET*), the standard effective temperature (SET*), the predicted mean vote (PMV) and the physiologically equivalent temperature (PET). These indices have in common that they take into account all environmental variables influencing thermal comfort.

Both ET* and SET*, which are expressed in °C, are calculated with the same two-node model, where the heat balance between the environment and a cylinder is calculated in an iterative process until equilibrium is reached, normally after one hour (Fountain and Huizenga 1994). The difference between them is that SET* also incorporates the level of activity and clothing insulation. A special feature of ET* and SET* is that in cold environments, thermal comfort is related to skin temperature (which is a good predictor of thermal sensation) whereas in warm environments it is determined by the skin wetness. The reason is that skin temperature changes are small in warm environments where sweating occurs (Fountain and Huizenga 1994). ET* and SET* have been validated by extensive climate chamber studies establishing the comfort zones (Fountain and Huizenga 1994). Recently, Pickup and de Dear (2000) adapted SET* to outdoor conditions, calling the index OUT_SET*, by developing a model to calculate MRT in the complex outdoor environment.

PMV, which is the most widely used thermal comfort index, has proven to provide reliable results for thermal environments close to thermal comfort. Like SET*, the PMV index includes the level of activity and clothing insulation. A limitation with PMV is that the heat balance includes assumptions that are valid only for low to moderate levels of activity and light indoor clothing (Fountain and Huizenga 1994, de Dear and Pickup 2000). It does not, e.g., take the vapour resistance of clothing into account, which means that the index overestimates the ability of sweat to evaporate from the clothed body. Moreover, when humidity is high, PMV does not account for a reduction in sweating. The thermal sensation in hot humid environments will thus be worse than the PMV index predicts. PMV was recently extended to better predict indoor comfort in naturally ventilated buildings in warm climates by including an expectancy factor (Fanger and Toftum 2002).

PET, which is expressed in °C, is based on a combination of the heat balance model MEMI (Höppe 1993) and a parts of the two-node model used for ET* and SET* (Höppe 1999). It is defined as “the physiologically equivalent air temperature at any given place (outdoors or indoors) and is equivalent to the air temperature at which, in a typical indoor setting, the heat balance of a human body is maintained with core and skin temperatures equal to those under the conditions being assessed” (Höppe 1999). The conditions of the indoor reference climate entail air temperature equal to MRT, wind speed of 0.1 m/s (“still” air) and vapour pressure of 12 hPa. For a sedentary person wearing typical indoor clothing, thermal comfort is defined as PET values between 18 and 23°C (Matzarakis et al. 1999). PET differs from e.g. the PMV model in that it uses real values for

skin temperature and sweat evaporation. The latter is a function of both mean skin temperature and the core temperature of the body (Mayer and Höppe 1987). Calculations of heat flux from the core to the skin and to the outer surface of the clothing are similar to ET^* and SET^* (VDI 1998).

There are several limitations with the thermal indices described above. A common feature is that they often fail to correctly predict the thermal sensation in environments outside the comfort zone or under dynamically changing conditions (Fountain and Huizenga 1994). According to Oseland and Humphreys (1994) one reason for this is that subjective thermal sensation can be quite different from the physiological state of the body, especially if climatic conditions are not steady or if there are abrupt changes in activity and clothing. Another problem is that none of the indices have been properly validated for the outdoors.

Although the applicability of the indices described above is limited, they have several advantages. For example, they take all environmental variables into account and consequently provide a comprehensive picture of the thermal environment. Moreover, they are universal, which makes it possible to compare results from different thermal environments.

In this study, activity and clothing have not been considered, thus excluding the SET^* and PMV indices. Instead PET was chosen. It was preferred to ET^* , since it has been more commonly applied in outdoor environments.

4 Literature review

This chapter contains a literature review of topics central to this thesis. The first two sections deal with the urban microclimate and outdoor thermal comfort respectively. Contrary to the general overview in Chapter 3, the emphasis here is on cities in hot dry and hot humid climates. The third section presents models and tools to predict the urban microclimate and the fourth section treats urban design guidelines for tropical climates. Section five is a review of the consideration of climate aspects in urban planning and design.

4.1 Microclimate in tropical cities

Most studies in tropical cities have dealt with urban-rural differences, but there are also a few studies on intra-urban microclimate variation.

Urban-rural differences

Air temperature

Jonsson and Lindqvist (2005) reviewed 13 studies and conducted two in tropical, predominantly hot humid, climates. Nocturnal heat islands typically varied by between 2 and 5°C. In general, heat islands in the cities studied were of smaller magnitudes than those found in temperate climates. Moreover, almost all studies show that nocturnal urban heat islands are at their largest during the dry season. Jonsson and Lindqvist (2005) explain the smaller urban-rural temperature differences as being attributable to more humid rural surroundings and higher sky emissivity. There are few studies from hot dry cities, although the summertime nocturnal heat island in Phoenix (33°N), Arizona (USA), is around 6°C, which is similar to temperate climates (Baker et al. 2002). However, Nasrallah et al. (1990) found a heat island of only 2°C in the hot dry maritime climate of Kuwait City. They explain this low value as being attributable to the moderating effect of the Persian Gulf.

Daytime conditions have gained far less attention than nocturnal heat islands, although the former are more important from a human comfort point of view. In their comparison of tropical urban heat island studies, Jonsson and Lindqvist (2005) report mainly daytime heat islands and very few cool islands. Jáuregui (1997) found fairly high daytime heat islands in the tropical highland city of Mexico City (19°N): 2.5°C in the wet season and 4–5°C in the dry season. He attributes the latter to the higher absorption of solar radiation by urban surfaces compared to surfaces in rural areas. Jonsson and Lindqvist (2005) found small but frequent cool islands in Ouagadougou (12°N), Burkina Faso, especially during the wet season, and attribute these

to evaporative cooling in the city (the rural station was dryer). They also found cool islands in Dar es Salaam (7°S), Tanzania, but these were smaller and less frequent and are believed to be a result of the sea breeze (the rural station was situated inland from the city).

Humidity

There are few studies on urban-rural humidity differences. In Mexico City, Jáuregui and Tejeda (1997) found that the specific humidity in urban areas reached its peak in the evening and remained high throughout the night. A few hours after sunrise, humidity began to fall, reaching its minimum in the afternoon. This tendency was also found by Adebayo (1991), although he studied only daytime variations. Conversely, Ali-Toudert et al. (2005) found that the vapour pressure in the hot dry desert city of Beni-Isguen (32°N), Algeria, was higher by day than by night. They suggest that a possible explanation for this may be the use of water in the kitchens, which are situated close to the streets.

Air temperature variations within urban areas

Field studies

A few authors have studied the effect of urban geometry on daytime maximum temperatures in hot dry climates. In the hot dry summer of Seville (37°N), Spain, Coronel and Alvarez (2001) compared deep canyons in the city centre with the above-roof temperature outside the city centre. By night, they found that the streets were warmer by 2–3°C, while during daytime, the deep street canyons were 4–8°C cooler. In the hot dry desert city of El-Oued (33°N), Algeria, Bourbia and Awbi (2004) compared the temperature differences between one traditional and one contemporary neighbourhood. For the summer period, they found that the streets in the traditional neighbourhood (H/W 1.5–2) were slightly warmer by night and 5–6°C cooler by day than the streets in the contemporary neighbourhood (H/W 0.5–0.6). In their study of the microclimate in the hot dry desert village of Beni-Isguen (32°N), Algeria, Ali-Toudert et al. (2005) also found that the daytime maximum temperature decreased with increasing H/W ratio, although the variation was rather small (2–2.5°C), despite extensive variation in average H/W ratios from 0.1 to 6. One possible explanation suggested by the authors is that the deepest canyon (H/W = 6) was situated close to the city boundary and was thus affected by the much warmer climate outside.

In the hot humid summer climate of Dhaka (24°N), Bangladesh, Ahmed (1994) found that daytime temperatures had a tendency to decrease with increasing H/W ratio. He found the average decrease to be 4.5°C when the H/W ratio increased from 0.3 to 2.8. Similarly, the importance of shade for air temperature was investigated by Nichol (1996) in hot humid Singapore (1°N). She found significant differences between shaded and open places - where the ground was shaded by either high-rise buildings or shade trees, the average daytime air temperature was 1.5–2°C lower than for non-shaded ground of concrete or grass.

In their canyon study in a hot dry desert climate, Pearlmutter et al. (1999) examined the influence of orientation on the canyon air temperature. They found that, by day the north-west oriented street was slightly ($<1^{\circ}\text{C}$) cooler than the east-west oriented street. By night there was no difference between the canyons. In a similar climate, Bourbia and Awbi (2004) also found that during daytime the north-west oriented streets were $1\text{--}2^{\circ}\text{C}$ cooler than the east-west oriented streets.

Computer simulations

Ali-Toudert and Mayer (2005, 2006) simulated the microclimate of the desert city of Beni-Isguen (32°N), Algeria using the computer programme ENVI-met (Bruse 2006). They found that during hot dry summer conditions, the temperature decreased by about 3°C when the H/W ratio increased from 0.5 to 4 and that north-south streets were slightly cooler than those oriented east-west. Their investigations were restricted to the summer season. Swaid et al. (2003) simulated air temperatures for Tel Aviv (32°N), Israel, using the CTTC model (Swaid and Hoffman 1990) and also found lower air temperatures for north-south than east-west streets.

Concluding remarks

Most studies show that nocturnal heat islands are generally smaller in tropical cities than in mid-latitude cities, particularly during the wet season. A likely reason is that wet soils in rural surroundings have similar thermal admittance (see Fig. 3.2) as urban surface materials (see e.g. Oke et al. 1991). By day, the urban areas may be warmer or cooler than their surroundings. The results on humidity are somewhat contradictory, but it appears that cities are moister by night than their rural surroundings.

A majority of the field studies on intra-urban variations show that the urban geometry has a significant influence on air temperature and that daytime maximum temperatures tend to decrease with increasing H/W ratios. However, the effect of street orientation on air temperature has proven limited. However, field studies in hot dry climates have been restricted to the warm season and only a few studies have been conducted in hot humid climates. The few existing simulation studies confirm the link between urban geometry and air temperature. The simulations have not included the effect of parameters such as surface reflectivity and the thermal mass of canyon surfaces.

4.2 Outdoor thermal comfort in tropical cities

Of existing investigations on outdoor thermal comfort in hot dry and hot humid climates, two types can be discerned: those only comprising theoretical calculations of thermal comfort (based on measurements or simulations of climatic parameters) and those consisting of field campaigns combining climate measurements (often combined

with index calculations) and questionnaire surveys on subjective thermal sensation.

Calculated thermal comfort

Pearlmutter et al. (1999) compared the energy exchange of a cylinder representing the human body within and above an urban canyon with $H/W = 1$ in the hot dry Negev Highlands (31°N), Israel. Later Pearlmutter et al. (2005) used the same approach in a physical scale model placed in the open air with H/W ratios of 0.33, 0.66, 1.0 and 2.0. In the summer, they found that daytime energy gain diminished with increasing H/W ratio. Moreover, they concluded that street orientation is important: north-south oriented streets were significantly more comfortable due to more efficient shading of direct-beam radiation. Only results from the summer period were presented and none of the conventional comfort indices were calculated, which makes it difficult to compare the results with other studies.

Swaid et al. (1993) used the CTTC model (Swaid and Hoffman 1990) to simulate the relationship between street design and thermal comfort, expressed as the Index of Thermal Stress, in the warm Mediterranean summer climate of Tel-Aviv (32°N), Israel. They found that the thermal comfort was better for $H/W = 0.5$ than $H/W = 1$ as well as in north-south compared to east-west streets.

Ali-Toudert et al. (2005) and Ali-Toudert and Mayer (2005, 2006) studied the relationship between street design and thermal comfort in the old desert city of Beni-Isguen (32°N), Algeria, by both measuring and simulating the microclimate. Extensive field measurements (Ali-Toudert et al. 2005) included eight streets and squares with different H/W ratios and orientations. The physiologically equivalent temperature (PET) was calculated after measuring all necessary environmental variables. PET was found to vary considerably, mainly as a result of extensive variations in mean radiant temperature (MRT). Both the MRT and the PET were found to decrease with increasing H/W ratio. In the afternoon, PET values were around 55°C for the open square ($H/W = 0.1$) and the shallow canyon ($H/W = 1$) and around 40°C for the deeper canyons (H/W between 4 and 6), which provided shade. At around noon, not even the deep canyons could provide shade and values were high for all sites. However, the deeper canyons were found to have the advantage of shortening the duration of high PET values. An interesting finding was that the long-wave radiation absorbed by pedestrians exceeded the short-wave absorption and the authors stress the importance of shading the walls in order to reduce surface temperatures. The simulations (Ali-Toudert and Mayer 2005 and 2006) using ENVI-met (Bruse 2006) confirmed the measurements as regards the relationship between PET and H/W ratio. They pointed out that MRT decreases much more than the air temperature as the H/W ratio increases. Additionally, they found north-south streets to be more comfortable than east-west streets and that PET was lower under colonnades and shade trees than in non-shaded parts of the urban canyon. Finally, they suggested that streets be oriented northeast-southwest or northwest-southeast to achieve a favourable compromise between summer comfort and solar access in the winter.

Questionnaire surveys of thermal sensation

In his summertime field study in hot humid Dhaka (24°N), Bangladesh, Ahmed (2003) recorded subjective thermal sensation votes and measured environmental variables. He found comfortable conditions at considerably higher temperatures and levels of relative humidity than normally accepted indoors in temperate climates. The reported comfort zone is 27.5–32.5°C, where, however, the upper limit decreases for relative humidity levels exceeding 75%. Moreover, he concluded that semi-enclosed spaces, where air movement is restricted but where shade is provided, were sometimes perceived as comfortable during the hottest period of the day. This is contradictory to the common belief that the most important design strategy in the hot, humid tropics is to provide air movement.

Ahmed (2003) also found evidence of the influence of psychological factors, such as adaptation, expectations and thermal history (see Section 3.2). For example, he found that both the temperature and relative humidity perceived as comfortable were higher after a longer stay in the same place and that office workers accustomed to a relatively cool indoor environment, perceived the outdoor environment as warmer than street traders did, who spent the whole day outdoors. However, Ahmed did not calculate a comfort index, which makes it difficult to compare the results with other studies.

Both Spagnolo and de Dear (2003) and Nikolopoulou et al. (2003) compared objective microclimatic measurements (and calculation of thermal indices) with the subjective thermal sensation votes of a large number of subjects in the warm-temperate climates of Sydney, Australia (34°S) and Athens, Greece (38°N) respectively. They found a discrepancy between the measured and calculated thermal comfort and subjective thermal sensation. In general, people accepted a wider range of thermal conditions than indoors. Both studies point out the importance of physical adaptation to the outdoor thermal environment, which includes seasonal variation in clothing, changes in metabolic heat through the consumption of cool drinks and changes in posture and position. Psychological factors, such as expectations and thermal history also explain the discrepancies. For example, when outdoors, people expect more climatic variation than indoors, and this may increase their tolerance.

Concluding remarks

The studies reviewed show that calculated heat stress diminishes with increasing H/W ratios, at least for H/W above about 1, and that the heat stress is lower for north-south oriented streets than east-west streets. However, the studies have mainly dealt with the summer season in hot dry and warm-temperate climates and no studies of this kind have been conducted in hot humid climates.

As regards subjectively perceived thermal comfort, the studies indicate a poor correlation with calculated thermal comfort indices. The studies conclude that the comfort range is wider outdoors than indoors. One of the field studies reviewed also indicates that shade may be sufficient to achieve acceptable thermal comfort in hot humid climates.

4.3 Models and tools predicting urban microclimate

This section is mainly on numerical computer models that predict microclimatic parameters, but some other models and tools are treated briefly.

Numerical models

A large number of numerical models predicting different urban climate variables have been developed. In the choice of models and tools for this review, the emphasis has been on those predicting micro-climate variables such as temperature, humidity, radiation and wind speed within the urban canopy layer. However, pure wind simulation models based on advanced computational fluid dynamics (CFD) have not been reviewed although they are accurate and useful tools (see e.g. Tablada de la Torre 2006). The reason is that most CFD programmes are complex and require a high level of expertise. Local and meso-scale models dealing with entire urban areas and cities have not been considered.

ENVI-met

ENVI-met is a computer programme that predicts microclimate in urban areas (Bruse 2006). It is based on a three-dimensional CFD and energy balance model and is described in detail by Bruse (1999). A comprehensive summary of the model is also provided by Ali-Toudert (2005). See also Paper IV.

The model takes into account the physical processes between the atmosphere, ground, buildings and vegetation and simulates the climate within a defined urban area with a high spatial and temporal resolution, enabling a detailed study of microclimatic variations. The horizontal model size is typically from 100 m × 100 m to 1000 m × 1000 m with grid cell sizes of 0.5–5 m. The fact that the programme requires limited input data and that the modelling of the urban area is simple, makes it user friendly.

The input data consist of the physical properties of the urban area of study and limited geographical and meteorological data. The required input data for the buildings are dimensions, reflectivity, U-value and indoor temperature. Reflectivity and U-value are the same for all walls and roofs and the indoor temperature is constant and the same for all buildings. The model uses detailed data on soils, including thermal and moisture properties. Both the evapotranspiration and shading from vegetation is taken into account.

The required geographical and meteorological input data are longitude and latitude, initial temperature and specific humidity of the atmosphere at 2500 m (upper model boundary), relative humidity at 2 m height, wind speed and direction at 10 m height, and cloud cover. The model provides a large amount of output data including wind speed, air temperature, humidity and MRT.

Despite being highly comprehensive, the ENVI-met model has a few shortcomings. A major limitation is that it does not take into account the thermal mass of building envelopes (thermal capacity is

only included for the ground). This is a significant drawback as the heat storage of façades exposed to solar radiation is not taken into account. Another limitation is the fact that the indoor temperature of buildings has to be constant during the simulation period, which is not realistic for naturally ventilated buildings. Both of the shortcomings mentioned will affect the surface temperatures of façades and, consequently, mean radiant temperature and air temperature.

ENVI-met can be classified as a tool intended for research purposes, rather than for design applications, since it requires detailed knowledge of urban climatology to be used properly. It has been successfully applied to a number of urban areas in a wide range of climates (see e.g. Lahme and Bruse 2004, Ali-Toudert 2005, Ali-Toudert and Mayer 2005, 2006, Jansson 2006 and Yu and Hien 2006). However, both Ali-Toudert (2005), who simulated the hot dry climate of Ghardaia (32°N), and Jansson (2006), who simulated the temperate climate of Stockholm (59°N), found that the programme underestimated diurnal temperature variations.

CTTC

The Cluster Thermal Time Constant (CTTC) model was developed by Swaid and Hoffman (1990) and calculates diurnal air temperature variation in an urban street canyon. The model uses the daily mean temperature, to which it adds a temperature increase due to solar radiation and subtracts a temperature reduction due to the net outgoing long-wave radiation. The solar addition term is based on the assumption that only the portion of the street heated by direct solar radiation heats up the air in the canyon. The solar term includes the empirical CTTC term, whose magnitude depends on the urban geometry. Although the model is simple, simulated results have agreed well with field measurements from the summer in Jerusalem (32°N) (Swaid and Hoffman 1990). However, according to Swaid and Hoffman (1990), the model is restricted to clear weather conditions and the summer season.

Elnahas and Williamson (1997) proposed further development of the CTTC model. Their modified model takes into account both diffuse and reflected solar radiation and uses hourly, rather than daily mean, values of the nearest weather station. This modified CTTC model, which also incorporates cloud cover and anthropogenic heat, has shown a good correlation with results measured in Sydney (34°S), Australia.

Later Shashua-Bar and Hoffman (2002) developed the Green CTTC model, which is a further development of the original CTTC model by Swaid and Hoffman (1990). The Green CTTC includes the effect of shade trees on canyon air temperature.

A major disadvantage with the original (Swaid and Hoffman 1990) and Green (Shashua-Bar and Hoffman 2002) CTTC models is that they are restricted to the summer season. The modified CTTC model by Elnahas and Williamson (Elnahas and Williamson 1997, Erell and Williamson 2006) may have wider applicability. However, another limitation with these models is that they are geometrically restricted to ordinary street canyons and only provide one parameter, the air temperature, as their output. Moreover, none of the models have, to

the author's knowledge, been validated for climates other than those for which they were developed.

Other urban canopy layer models

A number of numerical models have been developed for the urban canopy layer based on the energy balance of urban surfaces and taking into account the thermal mass of buildings. These include, for example, the models of Mills (1997b) and Kusaka and Kimura (2004). A key disadvantage with these models is that they do not exist as user-friendly computer programmes and thus require a certain level of computational skill. Moreover, similarly to CTTC they provide few output variables and the modelling of the urban environment is very unrefined (either identical building dimensions and spacing or only a single canyon).

Models predicting solar radiation and surface temperatures

The RayMan computer programme (Matzarakis 2000, Matzarakis et al. 2000) is a tool for the calculation of MRT and thermal indices such as PET, PMV and SET*. To calculate MRT, the programme requires building geometry (length, width and height), information about trees (type, height, width of canopy), global solar radiation and cloud cover. The calculation procedure is described in detail in Papers I and III. RayMan's principal shortcoming is the uncertainty that exists regarding how it calculates surface temperatures. The programme does not require thermal properties, such as the thermal capacity and conductivity of the surfaces, and it is not possible to set different reflectivities for the street and walls. Nevertheless, it is reported that MRTs calculated using the programme have shown a good correlation with values measured in certain urban environments (Matzarakis et al. 2000).

The Solène computer programme simulates, among other things, short and long-wave radiation, as well as solar access and shade in urban spaces (CERMA 2006). It requires detailed geometrical information of the built environment, as well as material and surface properties. It calculates surface temperatures, making it possible to estimate MRT in urban environments.

TownScope (Teller and Azar 2001, Azar 2006) is a computer programme that, among other things, calculates solar access and shade in urban areas and on buildings. TownScope can also calculate thermal comfort expressed as the PMV index, although the accuracy could be questioned since meteorological input data is based on monthly mean values.

Other models and tools

Scale models

An alternative to field studies and computer simulations is to establish small-scale physical models. Scale models of this kind can be used to determine the effects of one or more variables on the urban climate. The best-known scale model regarding urban climate is the wind tunnel. Other scale models have investigated phenomena such as the nocturnal cooling of urban surfaces (Oke 1981), the relation-

ship between urban geometry and indoor temperatures (Mills 1997a) and the solar absorption of different urban fabrics (Steemers et al. 1998). Some recent scale modelling, such as Kanda et al. (2005), Pearlmutter et al. (2005) and Pearlmutter et al. (2006), comprises comprehensive long-term measurements of several variables in models of built-up areas in the open air.

The main shortcoming of scale modelling is that it requires resources in space and time (the models are complicated to build up). Moreover, they often become expensive, which may explain why e.g. wind tunnel tests have rarely been performed in urban development. Consequently, physical scale modelling is generally more suitable for research than as a design tool.

Climatic maps

Climatic maps are graphical tools intended to help planners and urban designers. They exist in many different forms and scales, from regional to detailed planning levels (Lindqvist and Mattsson 1989, Katzschner 2000). At regional and land-use planning levels they provide climate information, helping determine where to build new urban areas. Maps aimed at the detailed planning level, i.e. the neighbourhood scale (scales 1: 5 000 or 1:1 000), typically show air flows around buildings, areas exposed to strong winds, thermally uncomfortable areas, duration of sunshine, heat islands, etc. (Lindqvist and Mattsson 1989, Katzschner 2000). Recently, thermal comfort maps of different scales (city, neighbourhood or public space) have been developed (Svensson et al. 2003, Katzschner et al. 2004). In these maps, a thermal index is calculated, making it possible to see which areas are more comfortable than others.

One shortcoming of climatic maps is that they seldom give detailed advice to planners. Their use requires some experience regarding climate issues and how climate data can be transformed into urban design principles.

Concluding remarks

There are few user-friendly computer programmes and tools that can predict the influence of urban design on the urban microclimate with good precision. Existing programmes tend to be either too complicated or their output is too limited. In this study, ENVI-met was considered the most appropriate tool for the simulation part of the study (see Section 5.2 and Paper IV). Despite certain shortcomings, it is one of the few numerical models in which a detailed modelling of the urban environment is possible and which provides detailed microclimatic output. RayMan was used to calculate MRT in this study (see Section 5.1 and Papers I and III) in spite of the possible inaccuracy in determining surface temperatures.

4.4 Urban design guidelines for tropical climates

Several studies include guidelines for climate-conscious urban design, both for hot dry and hot humid climates (e.g. Givoni 1992, Swaid 1992, Emmanuel 1993, Golany 1996, de Schiller and Evans 1998, Givoni 1998, Aynsley and Gulson 1999, Emmanuel 2005a). These guidelines cover a wide range of aspects, such as street orientation, urban form, shade in public spaces, surface material properties and building types. Many of the guidelines also cover aspects such as the choice of location and the use of green areas, although these are not treated here.

Guidelines for hot dry climates

The urban design guidelines for hot dry, and similar, climates that have been studied are included in Givoni (1992 and 1998), Swaid (1992), Golany (1996) and Grundström et al. (2003). As regards street orientation, the suggestions by Golany (1996) are in-line with solutions traditionally found in desert cities. He suggests narrow, winding, zigzagging alleys in order to create maximum mutual shading by buildings and claims that deep canyons of this type provide both solar protection during the day and remain warm during the night. Moreover, he claims that this street pattern provides good protection against warm and cold winds. Givoni (1998) argues that the orientation of streets is primarily related to access to, and protection from, the sun, whereas ventilation is of secondary importance in hot dry climates, since it is mainly needed at night. In contrast to Golany (1996), his opinion is that street orientation should encourage solar heating of buildings in winter and protect against solar radiation in summer. His solution to these virtually incompatible requirements is wide, east-west oriented streets (0.5 H/W 0.7) and narrow, north-south oriented streets (3 H/W 5). Similarly, Grundström et al. (2003) propose a blend of H/W ratios of 2, 1 and 0.7, where the lower H/W ratios are intended for east-west oriented streets.

As regards urban form, Golany (1996) suggests a compact urban form. He proposes that buildings be varied in height in order to maximize shade and suggests that public open spaces should be small, dispersed and well protected. According to Givoni (1998), an urban form should be chosen that both maximizes the shading of pedestrians and assures sufficient ventilation. Givoni (1992) argues that attached houses, such as terraced houses, are better than detached houses, since they have fewer walls exposed to the sun.

The above-mentioned guidelines emphasize the need for shade in urban public spaces, such as sidewalks and squares. According to Golany (1996), much of the shade is achieved by high H/W ratios. Givoni (1998), on the other hand, suggests shading of sidewalks by building details such as overhanging roofs, horizontal shading devices above the sidewalks or colonnades under projecting upper floors. A more unconventional approach is given by Swaid (1992), suggesting adjustable shading screens at roof level in the form of vertical screens (to increase building heights), overhangs and louvers.

These screens are intended to be used by day to increase shade and to be removed at night in order to increase the SVF to stimulate nocturnal cooling. Both Golany (1996) and Givoni (1998) promote shade trees, which also help cool the air through evapotranspiration, although the latter points out that planted areas require irrigation and may be expensive to maintain in hot dry climates.

Givoni (1998) stresses the importance of keeping surface temperatures low to reduce the energy absorbed by the urban fabric. This can be achieved through shading by buildings and by using vegetation, but also through high surface reflectivity. He argues that roofs in particular should use light colours.

Guidelines for hot humid climates

The urban design guidelines for hot humid climates that have been studied are included in Givoni (1992 and 1998), Emmanuel (1993 and 2005), de Schiller and Evans (1998) and Ainsley and Gulson (1999). As regards street orientation, Givoni (1992) emphasizes that this is of importance in densely developed rather than sparsely built areas. He argues that the optimum orientation of wide avenues is at an angle of 30–60° to the prevailing wind direction to enable the wind not only to penetrate into the city but also to provide cross-ventilation of individual buildings.

The guidelines studied agree that streets with long rows of closely spaced buildings perpendicular to the wind directions should be avoided as they may block the wind for entire urban areas. This is particularly important in coastal areas where the afternoon sea breeze can improve comfort conditions considerably. Consequently, urban spaces should, if possible, be aligned in the direction of the breeze. Aynsley and Gulson (1999) recommend that coastal urban spaces have a width at least four times the height of surrounding buildings. Moreover, they emphasize that required shading vegetation and shading devices should be located and designed to minimize resistance to breeze penetration.

As regards urban form, Givoni (1992) points out that compact urban areas have poor ventilation and high nocturnal heat islands. The authors agree that the best urban configuration in a hot humid climate includes dispersed high, slender buildings, preferably tower blocks or with the short end perpendicular to the wind direction. Aynsley and Gulson (1999) recommend that such towers, which could rise above a layer of two to three-storey buildings, should be spaced at least six tower widths apart. This urban form is also the most adequate for building ventilation and enables higher population densities. Givoni (1992), however, points out that such buildings are expensive to construct, operate and maintain.

For high-rise buildings, de Schiller and Evans (1998) recommend variations in height, irregular spacing and open passages at ground level in order to encourage the channelling of breezes, helping direct them to the pedestrian level. They propose a similar strategy for medium-rise buildings including variations in building height, form and spacing between buildings. For low-rise (one to two-storey) buildings de Schiller and Evans (1998) suggest courtyard buildings,

whereas Givoni (1998) suggests detached houses. The former gives examples of how to group and design buildings to promote air movements for high, medium and low-rise construction.

The above-mentioned guidelines emphasize the need for shade in urban spaces, which can be achieved through shade trees, shading devices such as canvas screens, as well as colonnades for protection from the sun and rain. It is pointed out that shade trees should be tall with wide canopies, allowing them to provide protection against direct solar radiation at high solar elevations while permitting air movement at pedestrian level. Emmanuel (2005a), however, points out that finding space for trees in dense city centres may be problematic and that tree maintenance is often lacking. Contrary to the general concept of the majority of the guidelines that hot humid climates require a dispersed urban form, Emmanuel (1993) suggests more closely spaced buildings to enable shading. He proposes a method called “shadow umbrella”, which seeks to determine adequate building heights for shading purposes (Emmanuel 1993 and 2005a).

The guidelines studied point out the importance of shading the ground to keep surface temperatures low. To achieve this, they suggest using shading devices and vegetation. De Schiller and Evans (1998) also propose using colours that are as light as possible for façades and roofs to reduce solar absorption in urban surfaces. Emmanuel (2005a), however, points out the difficulty of keeping surfaces light in urban areas due to dirt and pollution. Moreover, he points out the risk of glare if excessively light surfaces are used.

Concluding remarks

To some extent, the existing guidelines are vague, since, with few exceptions, they do not define or quantify design aspects such as the space between buildings, building heights, H/W ratios, etc. In part, this probably is due to the fact that these guidelines are general for a larger region. De Schiller and Evans (1998) point out that their guidelines must be adjusted to local climatic factors and to other local conditions, such as topography, existing urban form and building traditions. However, the “vagueness” of the guidelines may also be a result of lack of research on the actual effects of urban design on the microclimate.

For hot humid climates, the majority of the guidelines reviewed argue for an open, dispersed city plan. This conflicts with the need in many tropical countries to increase population densities in cities.

4.5 Consideration of climate aspects in urban planning and design

This section reviews studies on the consideration of microclimate and outdoor thermal comfort in urban planning and design.

Good and bad examples of climate-conscious urban design

Examples of climate-conscious urban planning and design in developing countries in tropical climates are scarce. However, Evans and de Schiller (1990/91, 1996) report a few cases where microclimate aspects have been successfully implemented in urban design in Argentina. A project for the planned new Capital City included an urban design that provided wind protection and allowed for solar access, although this project was postponed. Moreover, the planning code of a municipality in the Buenos Aires (34°S) region was revised to allow tower blocks instead of a continuous street frontage along River Plate (Rio de la Plata) to encourage the sea breeze to enter the urban area.

Al-Hemaidi (2001) reports from a residential area in the hot dry city of Riyadh (25°N), Saudi Arabia, where climate-conscious design principles were successfully implemented. This was achieved by using a compact urban design with courtyard buildings without setbacks, oriented to maximize shade and wind exposure. Eben Saleh (2001) also reports from some recent, more compact residential areas in Saudi Arabia where a favourable microclimate was one of the priorities, although there is no information on the level of success of the concept.

However, many studies from warm countries report that climate issues are generally *not* considered in contemporary urban design. Both Al-Hemaidi (2001) and Eben Saleh (2001) report that current urban design in Saudi Arabia has led to an undesirable microclimate around buildings. They explain this with the prescription of an extremely dispersed urban design where the provision of shade is totally lacking. The current urban form is characterized by gridiron plans with wide streets where the detached, low rise “villa” is the most common type of house. Baker et al. (2002) report from a similar experience in hot dry Phoenix (33°N), in Arizona (USA): wide streets, dispersed low-rise buildings and oversized parking lots have contributed to urban warming. Bouchair and Dupagne (2003) found a similar situation in the Mzab valley (32°N), Algeria, where contemporary urban design lacks the microclimatic qualities of the traditional cities in the region.

Constraints for climate-conscious urban design

Urban planning is a complex field where different aspects have to be considered, including land-use, infrastructure, public transport, aesthetics, etc. Moreover, economy and politics strongly affect the plan-

ning process, which may have the effect that important urban design aspects are overlooked (Owens 1986, Evans and de Schiller 1996, Eliasson 2000). The microclimate is thus only one aspect in a planning process characterised by a multitude of often conflicting interests.

Several constraints that can explain the limited use of climate in urban planning have been identified. Both Evans and de Schiller (1996), in their study in Argentina, and Eliasson (2000), in her study in Sweden, found that necessary climatic investigations are often lacking in town planning projects due to budget and time constraints. Evans and de Schiller (1996) pointed out the lack of communication between climatologists and planners as a problem. Reports from climate consultants often describe only local climatic phenomena without giving any concrete advice to planners and architects on how to design the particular area.

Eliasson (2000) found evidence that climate had low priority in the planning process. Issues such as traffic safety and building design were considered more important. Moreover, she identified the lack of knowledge on urban climate as a major constraint, hampering planners' arguments in disputes on conflicting interests. She also found that the use of tools for climate-conscious urban design was limited.

Urban codes are often mentioned as a constraint for climate-conscious urban design. Severe problems caused by inappropriate building codes have been reported from hot dry climates. Al-Hemaidi (2001) and Eben Saleh (2001) both blame the poor outdoor comfort conditions in Saudi Arabian cities on Western-inspired planning codes. Baker et al. (2002) report a similar experience from Phoenix, Arizona, where current planning codes follow principles developed in cold climates and lacking requirements for shading.

Many of the world's urban codes have their roots in Western planning ideals from the first half of the 20th century. These planning principles, which were a reaction to the extremely poor sanitary conditions that existed in many Western cities during the 19th century and beginning of the 20th century (Pinson 1994, Bosselmann et al. 1995, Hall 2002), sought to guarantee "sunlight, fresh air and greenery" around buildings for health reasons. Distances between buildings were, for example, designed to allow for a sufficient number of hours of solar exposure per year (Pinson 1994).

Ways to incorporate climate issues in planning and urban design

Several studies discuss how climate issues can be better incorporated in the planning process. Evans and de Schiller (1996) urge the development of easily understood guidelines and design recommendations including the graphic presentation of urban design aspects. They claim that planners need guidance on factors such as building densities, maximum building heights and building forms.

Bitan and Potchter (1995), Evans and de Schiller (1996) and Eliasson (2000) all stress planners' need for guidance early in the planning process and the fact that climatic issues should be incorporated

throughout the process. They point out the importance of establishing a dialogue between climatologists, planners, architects and others involved in urban development. Eliasson (2000) claims that if climate aspects are brought in late in the process, planners and architects tend to be unwilling to change their designs. Similarly, de Schiller and Evans (1998) emphasize that incorrect decisions at the town planning level are normally impossible to correct at a later stage. Ainsley and Gulson (1999) argue that outdoor thermal comfort should be a routine aspect of urban development and that climatic aspects should be included in urban codes at different planning levels.

Concluding remarks

The studies reviewed show that climate is rarely considered in urban planning and design and also indicate that codes and regulations are poorly adapted to local climatic conditions, often acting as obstacles to climate-conscious urban design. However, there are few studies from hot dry and, particularly, hot humid climates. Most of the studies stress the importance of increasing knowledge on climate aspects among urban planners and designers and of increasing cooperation between planners and urban climatologists during the entire planning process.

4.6 Conclusions

The main conclusions from this literature review are:

- Urban design has proved to have a considerable impact on urban microclimate in hot dry and hot humid climates. Outdoor thermal comfort generally improves with increasing H/W ratios in urban canyons due to increased shade.
- There are few user-friendly computer programmes aimed at predicting urban microclimate that provide both reliable results and detailed output.
- Urban design guidelines in hot dry and hot humid climates are often general in character and not always based on research. They need to be improved through specific guidance on design parameters, such as H/W ratio, orientation, surface properties and the spacing of buildings.
- Climate aspects are rarely considered in urban planning and design and urban codes are often poorly adapted to local climate conditions and may therefore hinder climate-conscious urban design.

However, although these topics have gained increased attention in tropical climates in recent years, the number of studies remains small, especially concerning hot humid climates and the cold season in hot dry climates.

This study seeks to bridge some of the gaps mentioned above by deepening the knowledge on how urban design influences the urban microclimate and outdoor thermal comfort through studies in the hot dry city of Fez, including both summer and winter conditions,

and in the hot humid city of Colombo. The study tries to link measurements and simulations of the urban microclimate with an investigation of the role of climate aspects in the urban planning and design processes and an analysis of the effects of existing urban regulations on urban microclimate. The methods, results and discussion are presented in the following chapters.

5 Methodology

The research in this study is multidisciplinary in character. Its main objective is to understand how the physical characteristics of the built environment influence microclimate and thermal comfort in urban areas. However, the study also examines how climate-related issues are considered in the urban design and planning processes.

To provide responses to the research questions presented in Section 1.3, it was necessary for the design of the research process to combine various research methodologies. The overall design could be classified as experimental, although it includes a combination of the following *research methodologies*¹ (Groat and Wang 2002):

- Experiment
- Simulation
- Qualitative study.

In the combined approach of this thesis, the quantitative (experiment and simulation) methodologies dominate over the qualitative methodology. Within each methodology, different methods, or techniques, have been used.

The aim of the *experimental* part of this study was to map variations in microclimate and outdoor thermal comfort within each city. This entailed field measurements in areas with significantly different characteristics, including variations in urban geometry, ground cover and distance to the sea.

However, microclimate variation in cities is large and covering all differences would require extensive measurements. These would also be restricted to existing conditions in each city. The aim of the *numerical simulations* was to cover a wider range of urban design. Moreover, by using a simulation methodology, it is possible to isolate independent variables in order to determine their respective impact. It may also be possible to predict the effects of new urban design options on the microclimate and to optimize the design from a microclimate and thermal comfort perspective.

The possibility of implementing such design principles will, however, depend on current planning and design practices, awareness among professionals, design limits stipulated by urban codes and so forth. The aim of the *qualitative* part of the research was to obtain basic knowledge of the urban planning and design processes, including the role of climate and thermal comfort aspects.

The three methodologies were combined in different ways in order to obtain more reliable research results. For example, the physical and atmospheric processes governing urban climate are complex. This makes them difficult to simulate and the accuracy of existing models is sometimes questioned. Consequently, the experimental study was important in validating and calibrating the results of the

¹ The term used by Groat and Wang (2002) is “research strategies”.

simulation study. The qualitative study was used to ascertain whether the optimum designs obtained from the simulation study complied with current regulations and current urban design practices. The mixed methodology also helped in identifying the strengths and weaknesses of existing urban codes with regard to climate-conscious urban design.

5.1 Experimental methods

The experimental part of the study, which is described in detail in Papers I, II and III, comprised measurements of climate variables in urban environments and estimations of outdoor thermal comfort. With a few exceptions, the measurements were performed within the urban canopy layer, see Fig. 3.1c.

The periods during which the experimental studies were conducted were timed to cover the seasons with the worst thermal stress. In the case of Fez, which experiences distinct climate seasons, both the hot dry summer and the cold winter periods were covered (see Fig. 2.2a). For Colombo, where annual climate variations are small, the climate measurements were conducted during the most thermally uncomfortable period, which is the inter-monsoon period in April–May (see Fig. 2.2b).

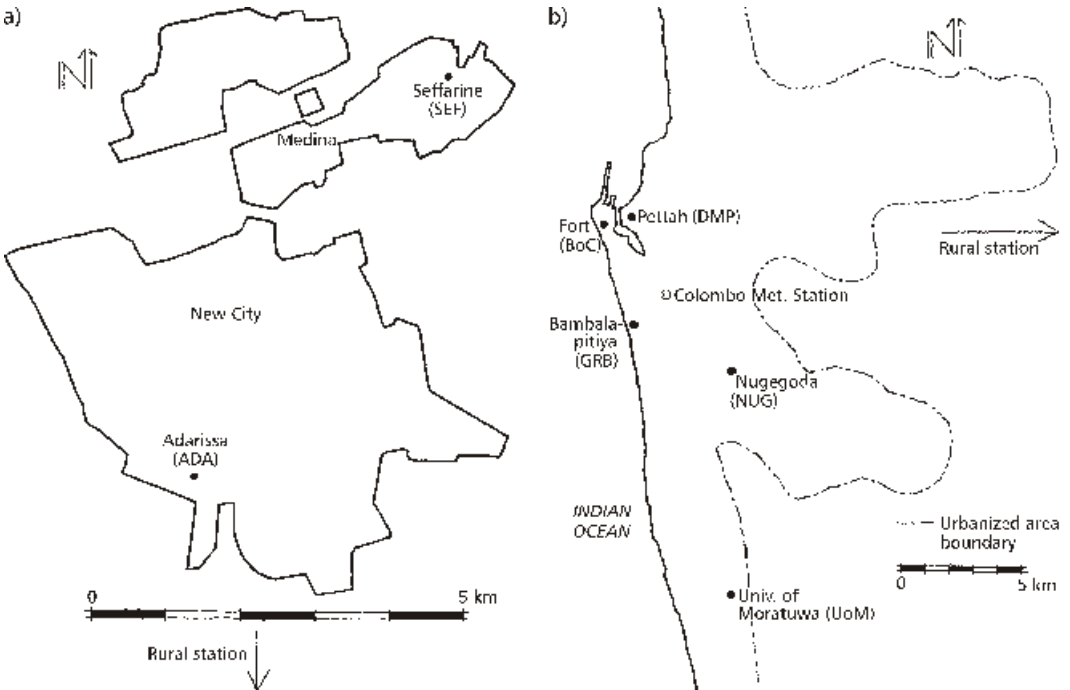

Fig. 5.1 The location of the measurement sites in (a) Fez and (b) Colombo.

Climate measurements in urban street canyons

Measurement sites

The testing environment consisted of a set of urban street canyons – two in Fez and five in Colombo. The location of the measurement sites within each city is shown in Fig. 5.1. These urban sites were compared with a rural station outside each city. In Fez, the climate at the official weather station², situated at Saïs Airport, about 15 km south of the city centre, was considered representative of rural conditions. In Colombo, measurements were taken in a rural area near Avisawella, some 30 km east of Colombo city centre.

The canyons were chosen to be representative of their respective neighbourhoods. The two canyons in Fez were completely different in terms of urban geometry (H/W ratio) and the amount of the ground covered by buildings. In Colombo, the differences in geometry between the five urban sites were significant, although not as great as in Fez. However, other parameters varied, such as the amount and type of vegetation, the type of ground cover and the proximity to the sea. The sites investigated in Fez are shown in Fig. 5.2 and described in detail in Paper I. The Colombo sites are shown in Fig. 5.3 and described in detail in Papers II and III. The characteristics of the urban canyons studied are shown in Table 5.1.

The thermal characteristics of the urban surfaces were similar for all sites in the two cities, comprising mainly dense materials, such as asphalt, concrete, brick and plaster. The predominantly impervious ground cover of the urban sites contrasted with the permeable soils in the rural surroundings. Whereas motor traffic was very limited at the two sites in Fez, it was intensive at some of the Colombo sites. However, since the impact of motor vehicles on the urban climate has proven to be very limited – except regarding air quality – it was not considered in this study. Similarly, anthropogenic heat was assumed to have an insignificant impact on the microclimate, since the heating and cooling of buildings and other heat-generating activities are limited in both cities.

Variables measured

- The variables measured were:
- Air temperature
- Surface temperatures
- Relative humidity
- Wind speed.

At each urban site, the temperature and humidity of the air was measured continuously with miniature data loggers, which were shielded against radiation. The loggers were placed at least 3 m above ground, because of pedestrian traffic and the risk of theft, and at least 1 m from the nearest façade. The measurements are assumed to be representative of the conditions at the pedestrian level, since temperature and humidity variations within urban canyons

2 Run by the Direction de la Météorologie Nationale, Morocco.

have proven to be small except near urban surfaces (Oke 2004). The complementary, instantaneous measurements of air temperature and humidity were taken at a height of about 2 m. In Fez, surface temperatures were measured both continuously and instantaneously, whereas in Colombo, only instantaneous measurements were taken. Wind speed was only measured instantaneously and on a limited number of occasions.

The parameters measured during each campaign are shown in Table 5.2 and the positions of the measurement probes are shown in Figs. 5.2 and 5.3. The type of equipment, as well as plans of the measurement sites, including the positions of the measurement probes, are presented in Paper I (for Fez) and Papers II and III (for Colombo).

Adarissa (ADA)

- Air temperature & humidity (continuous)
- Air temperature & humidity (instantaneous)
- Air temperature (continuous)
- ▲ Surface temperature (continuous)
- △ Surface temperature (instantaneous)

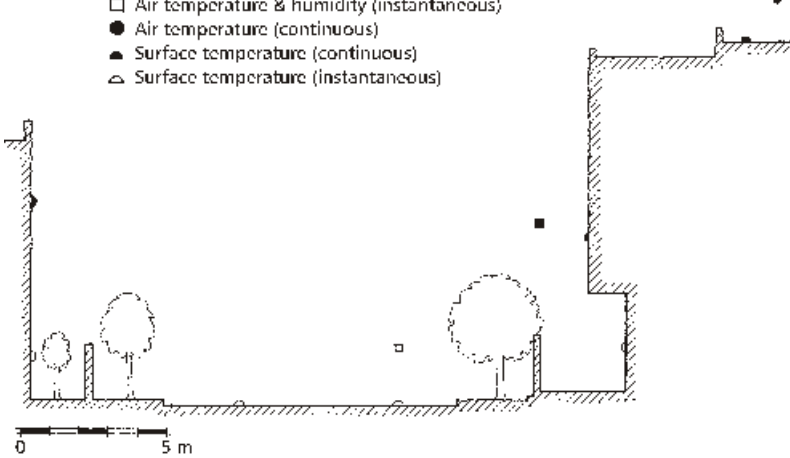

Seflarine (SEF)

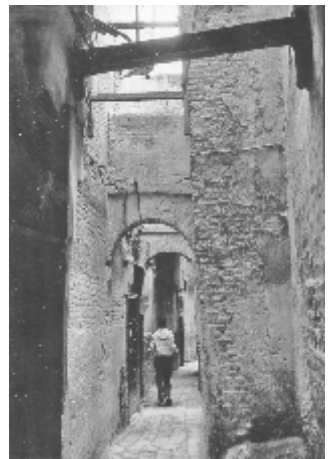
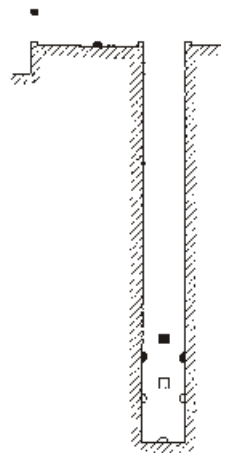

Fig. 5.2 The canyons studied in Fez and the positioning of the measurement probes.

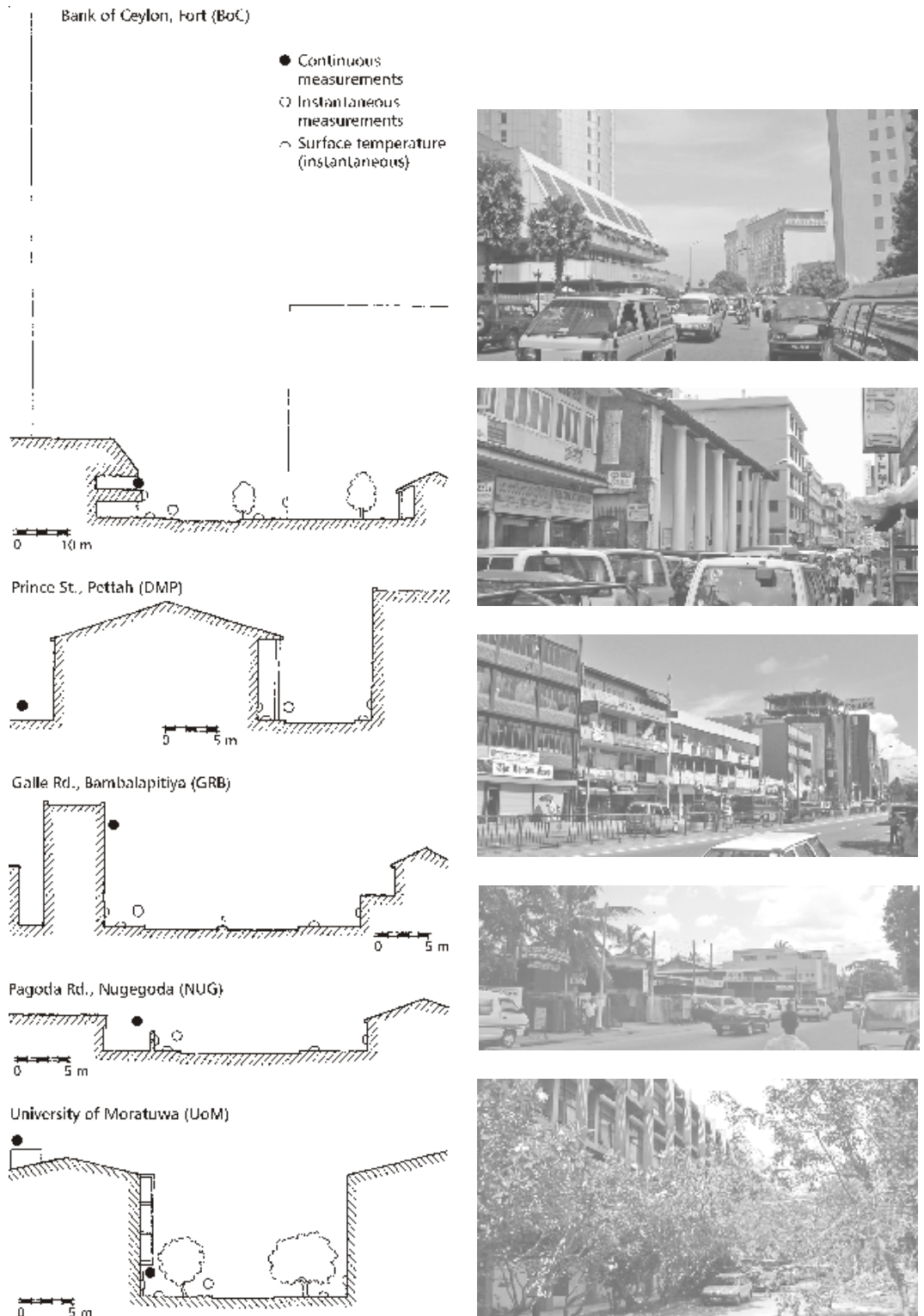

Fig. 5.3 The canyons studied in Colombo and the positioning of the measurement probes.

Table 5.1 The characteristics of the urban canyons studied and their immediate surroundings. The ground cover was estimated for a radius of 200 m around each site.

Site	Key	General description	Land-use	Buildings	H/W	Dist. to sea (km)	Altitude (m)	Built-up	Roads, paving	Green
<i>Fez</i>										
Adarissa, new city	ADA	Low-density suburb south of the city centre. Some small street trees.	Residential	Medium-rise (2–3 storeys)	0.6	150	420	30	55	15
Seffarine, old city (the Medina)	SEF	Very compact neighbourhood in the heart of the old city. Deep canyons, devoid of vegetation.	Residential (mixed)	Medium-rise (3–4 storeys)	9.6	150	280	80	20	0
<i>Colombo</i>										
Bank of Ceylon, Fort	BoC	City centre location (the central business district). Close to sea-shore, some trees.	Commercial/office	High-rise, some very high towers	0.8	0.2	5	40	55	5
Prince Street, Pettah	DMP	High density city centre location, the old commercial quarters, just east of Fort. Away from the shore, almost devoid of vegetation.	Commercial/residential	Medium-rise (3–4 storeys)	1.2	0.5	5	60	40	0
Galle Road, Bambalapatiya	GRB	Commercial sector south of Fort, some trees. Close to sea shore, but buildings act as a barrier to sea breeze.	Commercial/office residential	Low to medium rise (3–4 storeys)	0.3	0.3	5	35	55	10
Pagoda Road, Nugegoda	NUG	Mixed-residential sector south-east of the city centre. Few street trees, but green gardens. Away from the sea.	Residential	Low rise	0.1	4	10	30	50	20
University of Moratuwa	UoM	Low-density, suburban location south of the city. High amount of green cover. Away from the sea.	Institutional	Medium rise	0.5	3	5	20	20	60

Table 5.2 The climate parameters measured during the measurement campaigns for the canyon studies. (T_a = air temperature, T_s = surface temperature, RH = relative humidity, W = wind speed).

City	No. of sites	Continuous	Instantaneous	Time period
Fez	2	T_a, T_s, RH		Feb. 2000–Aug. 2001
			T_a, T_s, RH, W	2–6 Feb. and 26–30 June 2000
Colombo	5	T_a, RH		30 April–12 May 2003
			T_a, T_s, RH, W	30 April–8 May 2003

The Fez study also included above-canyon measurements of air and surface temperatures. Moreover, additional instantaneous measurements were taken in canyons with varying H/W ratios and orientation within the two neighbourhoods studied during one summer and one winter week in 1998 (Rosenlund et al. 2000). In Colombo,

temperature, humidity and global radiation above roof level were measured at the University of Moratuwa (UoM) site.

Definition of seasons and types of days

For the long-term measurements in Fez, the summer period was defined as the period from the end of May to mid-September 2000. During this 3.5-month period, the mean daily maximum temperature was above 30°C except for a few days. The winter period was defined as the three months with the lowest mean daily temperature: February and December 2000 and January 2001.

The two-week measurement period in Colombo in 2003 included a variety of weather conditions ranging from fairly clear days to overcast days, sometimes with rainfall. The measurement data were divided into clear, partly cloudy and overcast days and nights. In this study, the definition of “clear” was cloud cover of <5 octas, “partly cloudy” 5–7 octas and “overcast” >7 octas. For daytime conditions, these groups corresponded to the following daily global solar radiation ranges: >5000 Wh/m², 2000–5000 Wh/m² and < 2000 Wh/m² respectively.

Calculation of outdoor thermal comfort

Outdoor thermal comfort was estimated through theoretical calculations. The Physiologically Equivalent Temperature (PET) index, which takes all environmental factors influencing thermal comfort into account and is expressed in °C, was chosen for this study. The index is described in Section 3.2. The calculation of PET requires data on air temperature, vapour pressure, wind speed and mean radiant temperature (MRT). All of the necessary climatic variables were measured except certain radiation fluxes needed to calculate MRT. Vapour pressure was derived from air temperature and relative humidity.

For all canyons except the deep canyon in Fez (see Paper I), MRT was calculated using the RayMan 1.2 computer programme (Matzarakis 2000), which is described briefly in Section 4.3. The input data needed are global solar radiation (at pedestrian level), cloud cover and the urban geometry of the site.

In calculating global radiation at pedestrian level, it was necessary to take shading from buildings into account. For Fez, where no measurements of solar radiation were taken, global radiation was assumed to be equal to average values based on the period 1960–90 obtained using the Meteonorm software (Meteotest 1999). For Colombo, the unobstructed global radiation measured at the official weather station³, situated centrally in the Cinnamon Gardens, was used (see Fig. 5.1). After dividing the global radiation into its direct S and diffuse D components, the global radiation at pedestrian level K_{street} was estimated as:

$$K_{street} = S + SVF D \quad (5.1)$$

where the sky view factor (SVF) is calculated at pedestrian level (1.1 m). This is a simplification, since reflected radiation from the

3 Operated by the Department of Meteorology, Sri Lanka

façades is not considered. However, such reflection is assumed to be limited compared to other radiation fluxes.

Each site was geometrically modelled in RayMan, including the size and position of buildings and trees. The reflected short-wave radiation from the street and the incoming long-wave radiation from the sky and urban surfaces was calculated using RayMan. The programme then calculates MRT according to VDI (1998), see Papers I and III.

Finally, PET was calculated using the RayMan software. However, the thermal comfort zone for PET in hot dry and hot humid climates has not been defined. In this study, the upper discomfort limit proposed by Ahmed (2003) for the summer in Dhaka, Bangladesh, see Section 4.2, which roughly corresponds to $PET = 33^{\circ}\text{C}$ (see Paper III), has been included as a reference for Colombo and the summer in Fez. The lower discomfort limit suggested for temperate climates – $PET = 18^{\circ}\text{C}$ (Matzarakis et al. 1999) – has been included as a reference for the winter in Fez. It should be noted, however, that this limit concerns a seated individual wearing typical indoor clothing (see Section 3.2).

5.2 Simulation methods

The simulation part of the study included computer simulations of the urban microclimate and calculation of thermal comfort.

Choice of model and calibration

Among the numerical models reviewed in Section 4.3, ENVI-met, version 3.0 was judged to be the most suitable for the simulation study. The programme is described briefly in Section 4.3 and in Paper IV.

One measurement site in each city was modelled in ENVI-met and the simulated microclimate was compared with the measured results. As a result of the deviation between measured and simulated results, input data, such as initial temperature, the humidity of the air and soil, as well as the thermal properties of the ground were adjusted. The magnitude of the solar radiation was also adjusted to agree better with the values measured.

The diurnal temperature variations were found to be underestimated by the programme for both the Fez and Colombo simulations. However, by lowering the wind speed in the Fez simulations from 2 m/s to 0.6 m/s, more realistic temperature fluctuations could be obtained (the reason being that the programme uses a different turbulence model at such low wind speeds). This manoeuvre did not work for the Colombo case. However, in Colombo, the diurnal variations are less and, consequently, the difference between simulated and measured variations was also less.

As mentioned in Section 4.2, ENVI-met 3.0 does not take into account the thermal capacity of the building envelopes. This was compensated for by increasing the thermal admittance (see Section 3.1) of the street. The effect of increased building density was included

by increasing the thermal admittance of the ground with increasing H/W ratio.

The calibration for the Fez and Colombo cases is described in detail in Paper IV.

Parametric modelling

Model area and typified street canyons

The testing environment in the simulation part of this study was a street canyon (Fig. 5.4). The height of the buildings was kept constant at 12 m whereas the width of the canyon varied. In order to avoid influences from the ends of the canyon, the canyon was long, with a constant length-to-width ratio of 15, and with the wind always perpendicular to the long-axis of the canyon. The two buildings were enclosed by a wall of the same height as the buildings (12 m) in order to reduce the effect of advection from the surrounding “rural” area. The distance between the buildings and the wall was set equal to the width of the street (W). The reason for choosing a small model area was to limit the number of grids in order to restrict computation time. The area in Fig. 5.4a is to be seen as a part of a larger homogeneous area.

For each of the cities, a base case was created comprising a simplified urban canyon with typical geometric characteristics (H/W ratio), material properties, façade colours and ground elements. The input data of the base cases, which had no vegetation or shading devices, are shown in Table 5.3.

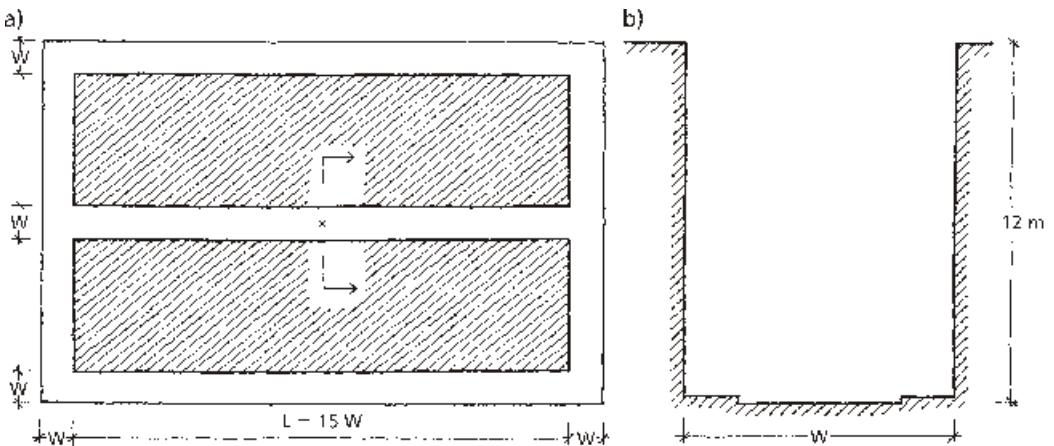

Fig. 5.4 (a) Model area and (b) the street canyon of the base case.

Table 5.3 Input data for the base cases in Fez and Colombo.

	Fez summer	Fez winter	Colombo
Building height, H (m)	12	12	12
Street width, W (m)	6	6	9
H/W ratio	2	2	1.3
Indoor temperature (°C)	26	20	26
U-value, walls (W/m ² °C)	1.5	1.5	1.5
U-value, roof (W/m ² °C)	1.5	1.5	1.5
Reflectivity, façades	0.3	0.3	0.4
Reflectivity, roofs	0.4	0.4	0.4
Reflectivity, street	0.3	0.3	0.3
Thermal admittance ^a μ, street (J/m ² s ^{0.5} °C)	4100	4100	3500

a Including the thermal admittance of the lower parts of the walls, see Paper IV.

Strategies for parametric modelling

The energy balance of a street canyon (see Fig. 3.6 and equation 3.5) was used to identify strategies to improve the microclimate of the urban canyons modelled for each city. If advection and anthropogenic heat are neglected, which is reasonable if the area studied is assumed to be sufficiently large and if buildings are neither heated nor cooled, sensible heat Q_H can be expressed as:

$$Q_H = K^* + L^* - Q_E - Q_S \tag{5.2}$$

where K^* is the absorbed solar radiation, L^* is the net outgoing long-wave radiation, Q_E is the latent heat from evapotranspiration and Q_S is the net heat storage in the canyon surfaces.

In a warm climate, such as that of Colombo and of the summer in Fez, the strategy to improve the microclimate would be to minimize sensible heat Q_H . In the daytime, the strategies will thus include:

- Decreasing absorbed solar radiation $K^* = K - K'$. This can be achieved through increased shade (to reduce the incoming solar radiation K), either by increasing the H/W ratio or by using shading devices or shade trees. By using light colours, reflected radiation K' can be increased. It should be noted that a decline in K^* through additional shade will automatically reduce cooling through long-wave radiation L^* . However, since K^* is dominant over L^* during the daytime, the main strategy is to lower K^* .
- Increasing latent heat Q_E . This can be achieved by using permeable surfaces and vegetation to increase evaporation and transpiration. The increase in Q_E is particularly efficient in hot dry climates where evaporation is strong. However, as rainfall is scarce, abundant irrigation is necessary.
- Increasing heat storage Q_S . This can be achieved by using heavy materials with high thermal admittance in façades and ground elements. It should be noted that a high daytime Q_S may be negative in a climate with warm nights, such as that of Colombo, since the heat stored in urban surfaces during the day will be released after sunset.

The strategies for a cold climate, such as the winter period in Fez, would be the reverse of those proposed above, that is, to maximize Q_H . Consequently, it is necessary to identify a compromise between summer and winter requirements.

Similarly, the heat balance of the human body (equation 3.7) can be used to identify strategies to improve thermal comfort in different climates. In warm conditions, the heat loss through the evaporation of moisture diffused through the skin E_{dif} , as well as convective C_{res} and evaporative E_{res} heat loss through respiration are normally small compared to the other heat fluxes in the heat balance equation (see e.g. Höppe 1999). Consequently, the energy balance is maintained primarily through a balance between metabolic heat production M , convective and radiant heat losses ($C+R$) and the loss of heat through the evaporation of sweat E_{sw} . However, the latter may also be restricted in hot humid conditions, such as in Colombo, due to the high levels of humidity. Moreover, in warm climates, the sensible heat loss ($C+R$) is small and R can often be negative (radiative heat gain). It is therefore very important to maximize radiative and convective heat losses. Under warm conditions, the strategies to improve comfort conditions include:

- Increasing radiant heat loss (or minimising heat gain) R . This is achieved by lowering MRT, mainly through the provision of shade. Shade is needed both to minimize exposure to solar radiation and to lower surface temperatures. Surface temperatures can also be lowered through the use of lighter colours.
- Increasing convective heat loss C . This is achieved by increasing air movements.

In a cold climate, such as during the winter in Fez, the strategy would be precisely the opposite.

Parametric study

The simulations were performed as a parametric study in which different parameter characteristics of the urban canyons were subjected to adjustment. Only one parameter was changed at a time in order to determine the relative influence of each. The effect of the following design parameters on microclimate and thermal comfort were studied:

- H/W ratio
- Street orientation
- Reflectivities (colours) of ground and façades
- Thermal properties of ground materials
- Colonnades for shading of pedestrians
- Shading trees
- Wind corridors perpendicular to the street (Colombo).

The design parameters studied are shown in Table 5.4. The H/W ratios were chosen to reflect the measurement sites and the ratios commonly found in each city. Street orientation for all simulations was east-west. However, the north-south orientation was also studied for each H/W ratio. Reflectivity values represent realistic ranges, varying from dark to light façades, as well as from dark to medium-

dark streets. As regards the effect of thermal mass, the lower thermal admittance value corresponds to light materials in the form of wooden façades and ground in the form of a light dry soil. The higher value corresponds to façades and ground of high density stone. The thermal admittance of the street has been enhanced by adding the thermal admittance of the lower parts of the façades, see Paper IV.

Table 5.4 The simulation cases for Fez and Colombo.

	Base case				
H/W ratio ^a , Fez	0.5	1.0	2	4	8
Colombo	0.12	0.6	1.3	2	4
Reflectivity, façades		0.2	0.4 ^b	0.6	0.8
ground	0.1	0.2	0.3	0.4	
Thermal adm., street (J/m ² s ^{0.5} °C)	600	2500	4100	6500	
Colonnades			No	Yes	
Shading trees			No	Yes	
Wind corridors			No	Yes	

a Both east-west and north-south orientations were tested.
 b The reflectivity of the façades was 0.3 in the base case for Fez.

The effect of colonnades was simulated according to Fig. 5.5. In both Fez and Colombo east-west oriented street with colonnades on both sides of the street was used. The effect of shading trees was simulated by placing a continuous row of trees along one of the façades in the base case, see Fig. 5.6.

As a final step, all of the changes found to improve the microclimate and thermal comfort at street level were combined to form a “best case” scenario. In the case of Fez, solutions were sought that could improve thermal conditions for both the summer and winter seasons.

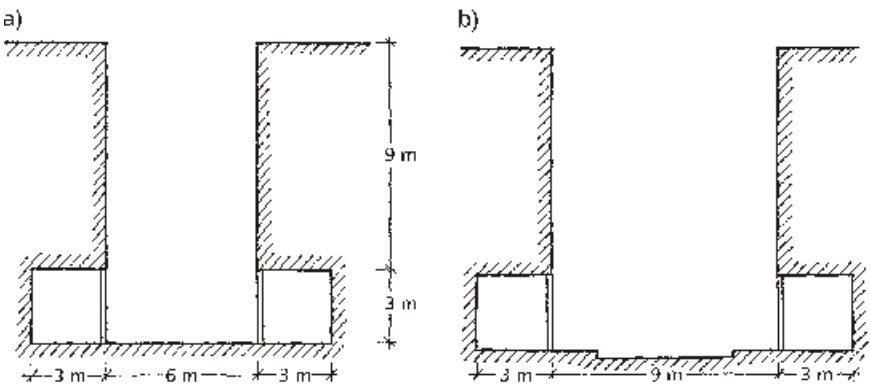

Fig. 5.5 The simulation cases for the colonnades. East-west oriented streets with colonnades on both sides of the street. (a) Fez, (b) Colombo.

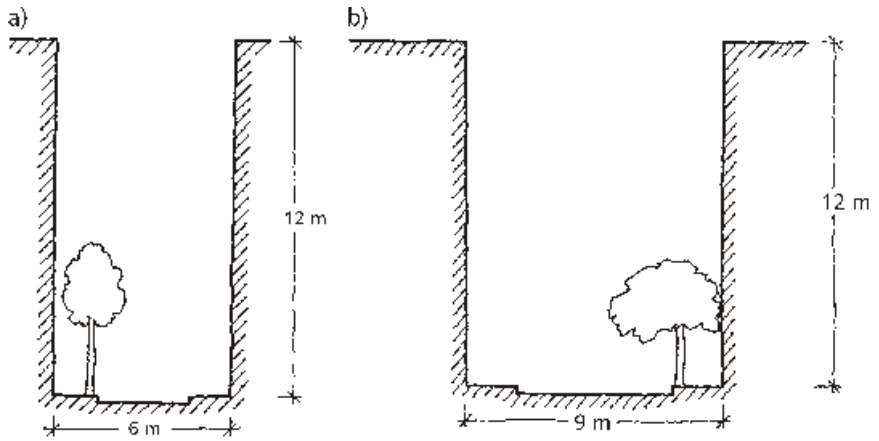

Fig. 5.6 The simulation cases for shading trees: (a) Fez, (b) Colombo.

Simulation of microclimate and calculation of thermal comfort

The simulations normally started at around sunrise and ran for at least 12 hours. The time step varied between two and ten seconds. The lower value was for high solar altitudes and the higher value for low solar altitudes and night time.

The Fez simulations were made for 15 January and 15 July. For these days, the solar radiation was adjusted to represent average conditions for the winter and summer periods respectively. The Colombo simulations were made for 3 May 2003, which was a “clear” day and representative of the most uncomfortable weather conditions (see Paper II). The PET index was calculated (see Section 5.1) on the basis of simulated hourly values for air temperature and MRT, as well as measured values for vapour pressure and wind speed as explained in Paper IV. The detailed output of the ENVI-met model, which gives the spatial variation of the climate parameters within the canyon volume, makes it possible to calculate how the PET index varies within the canyon (e.g. the difference in PET between areas in shade and areas exposed to solar radiation).

5.3 Qualitative methods

The qualitative study comprised an analysis of existing regulations related to urban design, as well as interviews with professionals involved in the urban planning and design processes.

Analysis of urban regulations

The documents studied consisted of regulations on urban design aspects, such as building heights, spacing between buildings and the portion of the ground permitted to be occupied by buildings. A list of the documents studied in Fez and Colombo is shown in Table 5.5. These documents have also been referred to in Chapter 2.

Table 5.5 The urban regulations studied in Fez and Colombo.

Document	Year	Type of regulations
<i>Fez</i>		
Land-use plan for the Wilaya of Fez (AUSF 1988)	1988	Zoning and building regulations
Land-use regulation of the walled medina of Fez (AUSF and ADER-Fès 1999)	1999	Building regulations
By-law concerning general regulations of road network and building (Ville de Fès 1969).	1969	Planning and building regulations
By-law concerning general regulations of road network and building (Ville de Casablanca 1952)	1952	Planning and building regulations
<i>Colombo</i>		
City of Colombo Development Plan. Volume I (UDA 1999a)	1999	Zoning regulations
City of Colombo Development Plan. Volume II (UDA 1999b)	1999	Planning and building regulations
Housing and Town Improvement Ordinance (Government of Sri Lanka 1980)	1980	Planning and building regulations

The main aim of the analysis of the urban codes was to find out which rules apply in each of the two cities studied. This included the following information:

- Zone types (residential, commercial, industrial, etc.)
- Building types in each zone (attached, semi-detached, detached, block, etc.)
- Maximum building heights
- Minimum street widths
- Maximum plot coverage
- Minimum setbacks
- Maximum floor area ratio (FAR).

The urban design regulations were translated into maximum H/W ratios for both the street and the backyards/courtyards. The urban regulations were analyzed to ascertain whether they facilitate or hinder climate-conscious urban design.

Interviews with people involved in urban planning and design processes

Interviews were held with urban planners, urban designers, urban developers and architects. The main aim of the interviews was to obtain information regarding the extent to which climate and thermal comfort aspects are considered in current urban planning and design. Another aim was to obtain general knowledge regarding the planning process in each city, which is important in being able to propose appropriate planning and design guidelines.

Informants were selected to represent professionals involved at different levels of the urban planning and design processes and included representatives of both the private and the public sectors. They consisted of senior officials at planning authorities, university teachers, private consultants in urban and architectural design and public and private urban developers.

In Fez, informants were selected through contacts with urban authorities in both Fez and Casablanca (Kursis 2001). The interviews and meetings with the informants were conducted as part of a cooperative project with the Laboratoire Public d'Essais et d'Etudes (Grundström et al. 2003). In Colombo, the key informants were selected in cooperation with the Department of Architecture at the University of Moratuwa. The number of informants representing different levels of planning and organization are shown in Table 5.6.

Table 5.6 Number of informants representing different levels of urban planning and design, as well as different organizations.

	Feza	Colombo
<i>Public authorities</i>		
National planning		1
Comprehensive planning	1	1
Detailed planning	2	
Landscape planning		1
<i>Private consultants</i>		
Detailed planning/urban design		2
Architectural design	2	1
<i>Urban developers</i>		
Public urban developer	1	2
Private urban developer		1
<i>Universities</i>		
Town and country planning		1
Total	6	10

a Including one informant from Casablanca.

The interviews in Fez were performed during the period 1998–2000 and in Colombo in May 2003.

In Fez, the interviews were not structured and instead took the form of group discussions and personal meetings. In Colombo, semi-structured interviews (Widerberg 2002) were conducted. The aim of the interviews was to obtain information on the extent to which climate aspects are considered in urban planning and design, the information and tools used, the role of the urban codes, constraints for climate-conscious urban design, as well as the interest in and demand for climate-conscious urban design. The interview guide is shown in Appendix 3.

The analysis consisted of grouping the output from the interviews into themes from which conclusions could be drawn.

6 Results

The first two sections of this chapter present measurements and the results of calculations of outdoor thermal comfort. The third section shows results from simulations of the urban microclimate and thermal comfort. The final section deals with the results of the study on the consideration of climate in the urban planning and design processes in the cities of Fez and Colombo.

6.1 Microclimate measurements

This section summarises the results of the climate measurements in Fez and Colombo. The results are presented in detail in Papers I and II.

Microclimate in Fez

The results presented here derive mainly from long-term measurements in the “deep” and “shallow” urban canyons shown in Fig. 5.2 and described in Table 5.1. However, results from short-term measurements in the compact neighbourhood of Seffarine (in the ancient Medina) and in the dispersed, new suburb of Adarissa are also presented. The measurement campaigns are described in Section 5.1.

Seasonal urban–rural air temperature variations

The average temperature variations for the summer and winter periods defined in Section 5.1 are shown in Figs. 6.1a and 6.2 alongside the rural temperatures (Fez airport). The deep street canyon at the Seffarine (SEF) site had lower maximum temperatures than both the shallow canyon at the Adarissa (ADA) site and the rural site, both during the summer and winter. Conversely, daytime temperatures in the shallow canyon were similar to those of the rural site, being a few °C warmer in the summer period and about 1°C cooler in the winter period. During the night, both canyons displayed typical heat islands, whose intensity was greater in the deep canyon.

Intra–urban air temperature variations

In Figs. 6.1 and 6.2, it can be seen that the afternoon difference between the canyons was especially pronounced during summer. During the warm season, the difference in mean maximum daytime temperatures between the two canyons was 6°C, although the difference was even greater on hot, sunny days (Fig. 6.1b). During the winter period, the maximum difference between the canyons was only 3°C.

From the short-term, instantaneous measurements at five locations in each neighbourhood (see Paper I), it was found that the

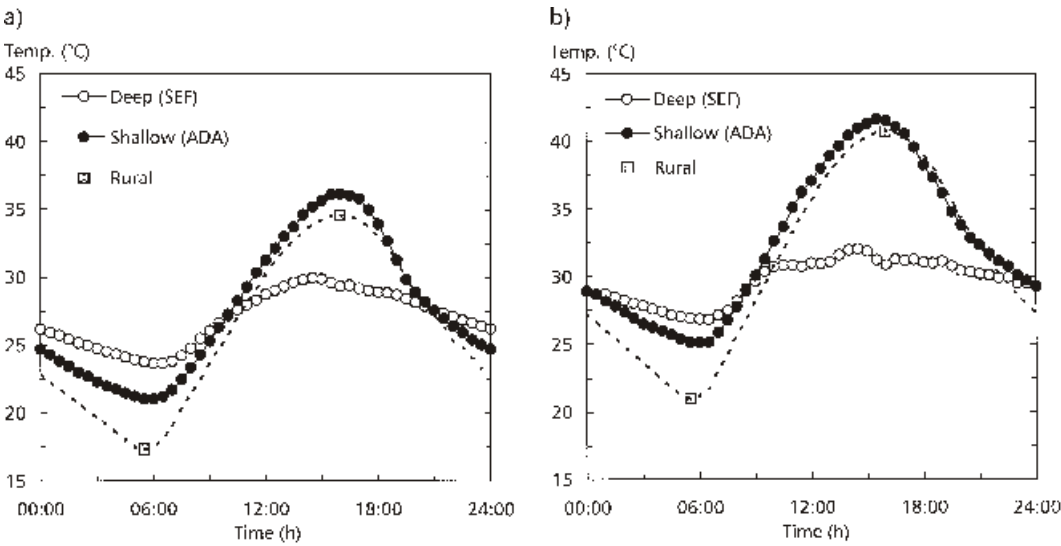

Fig. 6.1 Average temperatures for the canyons in Fez: (a) for the whole summer period and (b) for the 15 warmest days of the summer. (For site keys, see Table 5.1.).

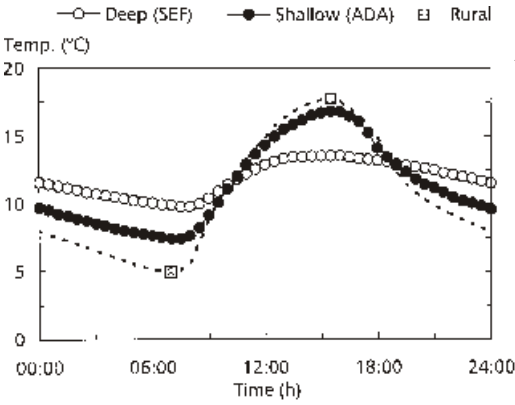

Fig. 6.2 Average temperatures for the canyons in Fez during the winter period. (For site keys, see Table 5.1.).

maximum air temperature tended to decrease with increasing H/W ratio. Consequently, in the compact neighbourhood in the Medina, a difference as great as 10°C was found between dense residential areas and the more open bazaar area, only 100–150 m away. In the suburban, dispersed neighbourhood, where all streets have a similar H/W ratio, the temperature differences were insignificant.

The short-term measurements did not reflect any significant influence from street orientation on air temperature in either neighbourhood.

Surface temperatures

While the surface temperatures of the façades of the deep canyon at the SEF site were stable, due to almost complete shade and low SVF, the shallow canyon at the ADA site showed extensive variation in surface temperatures depending on orientation, surface colour and height above ground. During the summer period, the maximum and minimum surface temperatures of the deep canyon façades

were 28°C and 24°C respectively, and the street showed similar temperatures. In the shallow canyon, on the other hand, the temperatures of the light-coloured façades varied between 21 and 40°C, whereas the dark-grey street surface was the warmest with temperatures reaching 50°C. During the winter, the tendency was similar, although temperature fluctuations were smaller. Façade temperatures varied between 11 and 14°C in the deep canyon and between 7 and 23°C in the shallow canyon. However, lower portions of façades in the shallow canyon displayed lower maximum and higher minimum surface temperatures due to vegetation providing solar shading by day and preventing radiative cooling by night (see Fig. 5.2).

Humidity

Relative humidity was highly stable in the deep canyon at the SEF site but showed large diurnal variation in the shallow canyon at the ADA site, both in summer and winter (Fig. 6.3). Although relative humidity was higher during the winter period, the humidity in the air – expressed as vapour pressure – was lower (Fig. 6.3). Both in summer and winter, the deep canyon displayed higher vapour pressure than the shallow canyon, a difference that was particularly pronounced on summer afternoons.

Wind speed

The wind speed, which was measured instantaneously on three occasions per day, varied greatly from day to day and according to the time of the day. Wind speeds were lower and more stable in the deep canyon. The average wind speed in the deep canyon was 0.4 m/s during both the summer and winter measurement periods. The

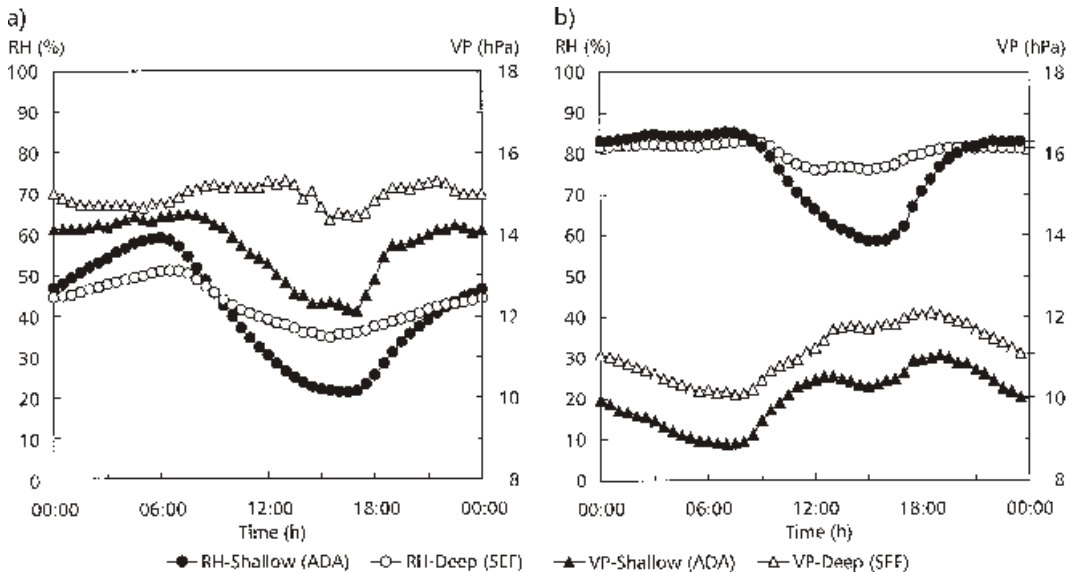

Fig. 6.3 Average relative humidity (RH) and vapour pressure (VP) in the canyons in Fez during (a) the summer period and (b) the winter period. (For site keys, see Table 5.1.).

shallow canyon had an average wind speed of 0.7 m/s in summer and 0.8 m/s in winter.

Microclimate in Colombo

The results presented here derive from the measurements in the urban canyons shown in Fig. 5.3 and described in Table 5.1. The measurement campaign is described in Section 5.1.

Urban-rural air temperature variations

The urban-rural air temperature differences during the measurement period were significant. Under clear conditions, differences were greater by day than by night. Fig. 6.4 shows the urban sites alongside the rural site on clear and partly cloudy days. On clear days, most of the urban sites were cooler (up to 4°C) than the rural station, whereas on partly cloudy days, the urban sites displayed maximum temperatures similar to those of the rural site (within ± 1.5°C). During clear and partly cloudy nights, a small, but distinct, heat island of about 3°C was able to develop (Fig. 6.6). There was a tendency for the heat island effect to diminish with increased cloud cover.

Intra-urban air temperature variations

The intra-urban differences were far greater by day than by night, especially on clear, days, but also on partly cloudy, days (Figs. 6.4 and 6.6). On clear days, the intra-urban difference reached 7°C. On overcast days, temperature differences between the fixed stations were negligible, which was to be expected since solar radiation is limited and the sea breeze weak.

Sites with higher H/W ratios, such as the Bank of Ceylon (BoC) and the University of Moratuwa (UoM) canyons, were significantly cooler than the shallow Nugegoda (NUG) canyon. The tendency for the maximum temperatures (here defined as the temperature at 14:00 h) to decrease with increasing H/W ratio on clear days is shown in Fig. 6.5. Although less pronounced, the same trend was also observed on partly cloudy days. During the night, there were small differences between the urban sites (Fig. 6.6). The relationship

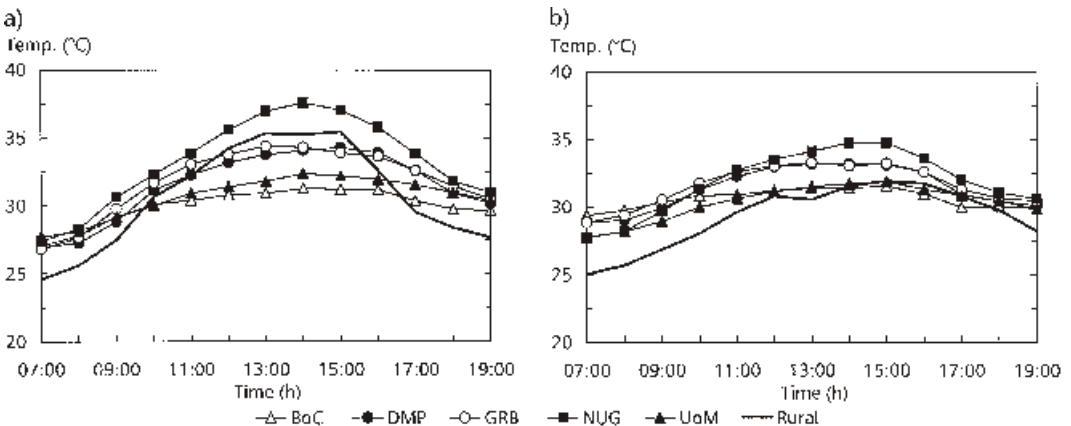
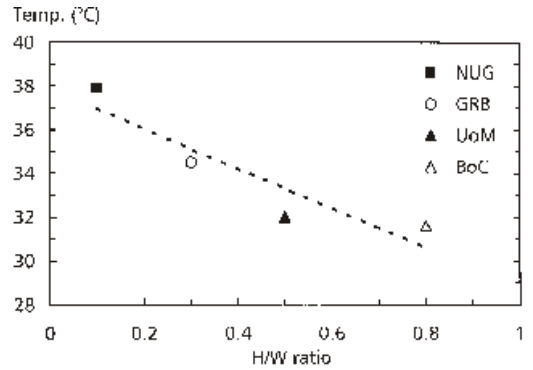

Fig. 6.4 Average temperatures for the canyons in Colombo on (a) clear days and (b) partly cloudy days. (For site keys, see Table 5.1).

Fig. 6.5
The relationship between maximum daytime temperatures (at 14:00 h) and the H/W ratio in Colombo on clear days. (For site keys, see Table 5.1).



between H/W ratio and nocturnal heat islands was weak but towards the end of the night, just before sunrise (at 06:00 h), the tendency of increasing heat islands with increasing H/W ratio could be discerned.

The clearest evidence of the sea breeze effect can be seen by comparing the BoC site with the sites at Galle Road (GRB) and Pettah (DMP), see Fig. 6.4. All three sites are located roughly equidistant from the sea. Nonetheless, GRB and DMP are much warmer. The sea breeze is prevented from reaching these sites because they

Fig. 6.6
Average temperatures of the Colombo sites during clear nights. (For site keys, see Table 5.1).

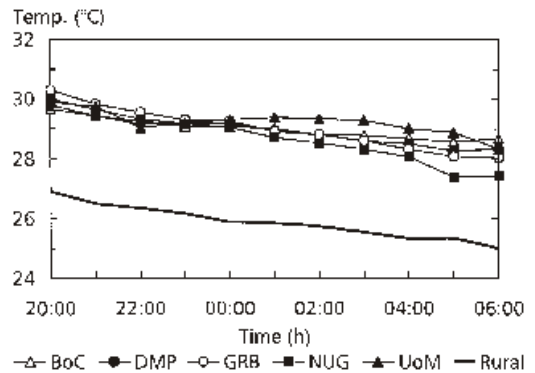

are blocked by a continuous frontage of medium-rise buildings acting as a wind barrier. The sea breeze is also a factor contributing to the difference between the cool BoC site and the warm NUG site, which is about 4 km inland and not affected by the sea breeze.

The thermal properties of surface materials may also have contributed to the intra-urban temperature differences. For example, the only site where permeable ground existed (the gravelled road at the UoM site) was among the coolest by day. At the GRB and NUG sites, the maximum heat island was observed just after sunset. This may be attributed to the dense and dark surface materials, which absorb and store large amounts of heat during the day and release it after sunset. The phenomenon was particularly noticeable on nights following clear days with high solar radiation.

Surface temperatures

The surface temperatures of façades, sidewalks and streets varied considerably depending on orientation and surface colour. Under

clearer conditions, horizontal surfaces, such as concrete paving and asphalt, which are fairly dark (i.e., having low reflectivity), displayed temperatures of between 50 and 60°C in the early afternoon. The temperature difference between sunlit and shaded areas located close to one another was between 10 and 20°C.

In general, façades were cooler than horizontal surfaces, especially around noon when differences reached 10–20°C. The reason was mainly because the angle of incidence was smaller, resulting in lower flux density of solar radiation. However, it should also be noted that some façades were of lighter colours than the streets and sidewalks. Nonetheless, under sunny conditions, façades were 5–15°C warmer than the surrounding air.

Humidity

The relative humidity varied between sites, but was, on average, around 75% during the daytime and around 90% at night. On clear days, however, the relative humidity dropped to 55% at the warmest sites (Fig. 6.7a). At the urban sites, vapour pressure at night was found to be slightly higher than at the rural site (Fig. 6.7b). During the day, however, vapour pressure was much lower in the urban areas. The observed positive nocturnal urban-rural vapour pressure difference agrees well with other studies which also found urban areas to have a moisture excess by night (Jáuregui & Tejeda 1997, Holmer & Eliasson 1999, Mayer et al. 2003).

Wind speed

Wind data reported from the official weather stations showed low wind speeds – averaging less than 2 m/s at the city station. The limited number of instantaneous measurements in the chosen street

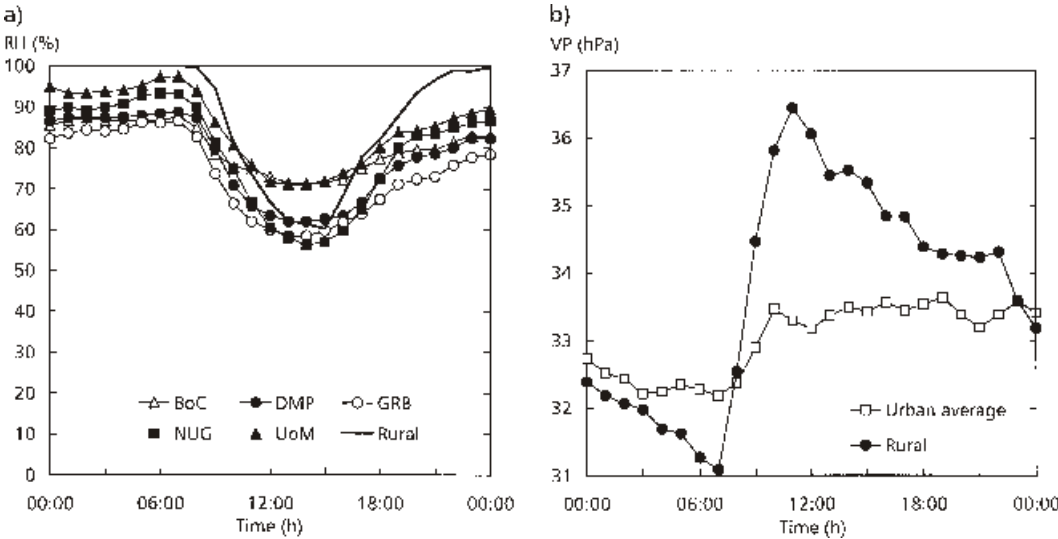

Fig. 6.7 (a) Average relative humidity (RH) for clear days in Colombo. (b) Average vapour pressure (VP) at the urban sites on clear and partly cloudy days compared with the rural site. (For site keys, see Table 5.1).

canyons indicated that wind speeds are higher in shallow canyons (NUG, GRB) and at the site open to the sea (BoC) than in the deeper canyons (DMP, UoM).

6.2 Calculated outdoor thermal comfort

This section provides results from calculations of thermal comfort expressed as the physiologically equivalent temperature (PET). The calculations, as well as the estimation of discomfort limits, are described in Section 5.1. The results are presented in detail in Papers I and III.

Outdoor thermal comfort in Fez

The calculated PET for the summer and winter periods defined in Section 5.1 are shown in Fig. 6.8 for a person standing in the middle of the street. In summer, the PET values in the deep canyon at the SEF site were very stable within a range of 23 to 28°C (the peak at 14:00 h is a result of the solar beam, which reached down to the street for a short period) and well below the assumed discomfort level of PET = 33°C. In contrast, the shallow canyon at the ADA site had PET values that were extremely high, exceeding the assumed discomfort threshold between 10:00 h and 18:00 h and reaching almost 50°C in the early afternoon. In winter, the deep canyon had low PET values, both by day and night, whereas the shallow canyon had very low values during the night but reached “comfortable” PET levels in the early afternoon. It should be noted, however, that the discomfort level concerns a sedentary person wearing indoor clothing. The level of discomfort will be considerably lower for a person wearing more clothing and/or being involved in a higher level of activity.

The large differences in PET between the canyons are mainly attributable to air temperature variations (see Figs. 6.1 and 6.2) and

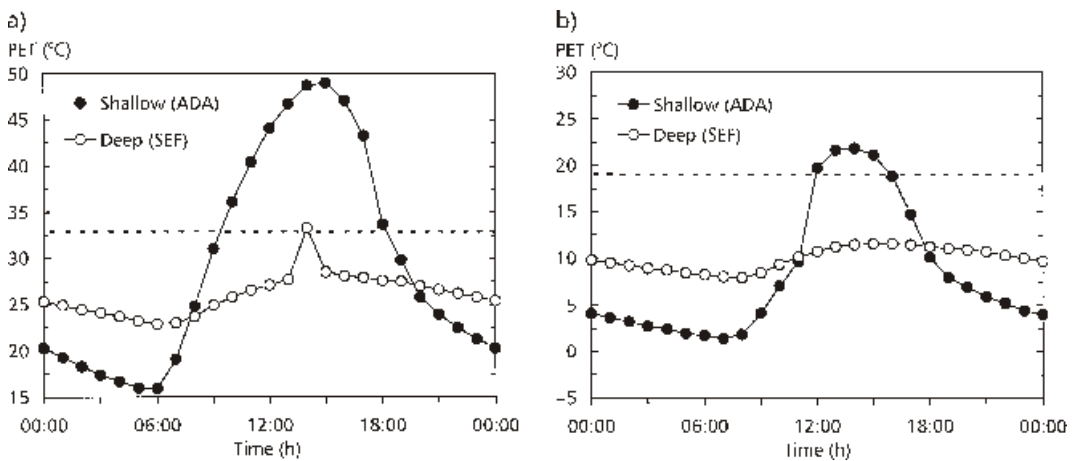

Fig. 6.8 Calculated PET in the middle of the street for Fez during (a) the summer period and (b) the winter period. The assumed upper (summer) and lower (winter) comfort limits are included as a reference (dashed lines). (For site keys, see Table 5.1).

mean radiant temperature (MRT). The latter is strongly linked to the H/W ratio. In the deep canyon, where people find themselves in almost constant shade during the day, with very little exposure to the cold sky vault, MRT varied between 25 and 28°C (except at 14:00 h, see Fig. 6.8a) in summer and between 11 and 13°C in winter. Conversely, there were extensive diurnal swings in MRT in the shallow canyon, where both incoming solar and outgoing long-wave radiation are strong, affecting not only people in the street but also the temperature of the canyon surfaces (see Section 6.1). During the summer period, diurnal MRT values varied between 16 and 63°C and, during the winter period, between 2 and 38°C.

The H/W ratio also influences the wind speed, but the difference between the canyons turned out to be rather small despite the extensive geometrical difference. The calculated PET values in Fig. 6.8 are based on the assumption that the wind speeds have constant values of 0.4 and 0.8 m/s in the deep and shallow canyons respectively (see Section 6.1).

Outdoor thermal comfort in Colombo

The calculated PET values for a clear day are shown in Fig. 6.9. In the calculations, the wind speeds from this day (3 May) have been assumed to be constant throughout the day, although measurements were taken on only a single occasion at each site (and not simultaneously). Fig. 6.9a shows PET for a person exposed to solar radiation (i.e. choosing to walk on the sunny side of the street). At all sites, values are above the assumed upper comfort zone limit between 11:00 h and 17:00 h. In the early afternoon, they far exceed this threshold, reaching 40-50°C. Fig. 6.9b shows the calculated PET values for someone choosing the shady part of the street (when shade exists). At several sites, this improves thermal comfort conditions considerably.

The main reason for extremely high daytime PET is the exposure to direct solar radiation. Intense solar radiation also results in temperatures of sunlit canyon surfaces being considerably higher than those of the surrounding air during clear and partly cloudy days. The sum of these two effects leads to high MRT, reaching values above 60°C in the early afternoon during clear weather conditions. MRT is linked to the H/W ratios of the urban canyons, but also to the position of the person within the canyon, i.e. whether exposed to the sun or in the shade. At most of the sites, the effect of shade on clear days can be seen as a sharp fall in PET (Fig. 6.9b). At the DMP and GRB sites, for example, PET drops by more than 10°C when shade is available. The effect is especially noticeable at the UoM site, where horizontal shading devices along the northern façade facilitate shade throughout the day. However, note that, around noon, none of the other sites provide sufficient shade because of the high solar altitude. At the NUG site, where the availability of shade is negligible, conditions are very poor throughout the day. Here, shade is available only in the early morning and late afternoon.

In a hot humid climate where weather conditions vary greatly, the magnitude of MRT is strongly related to sky conditions. Fig. 6.10

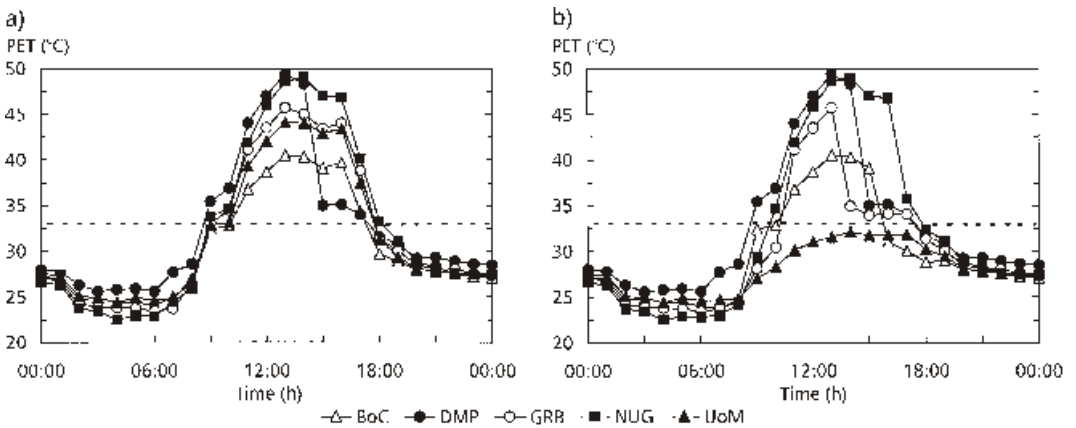
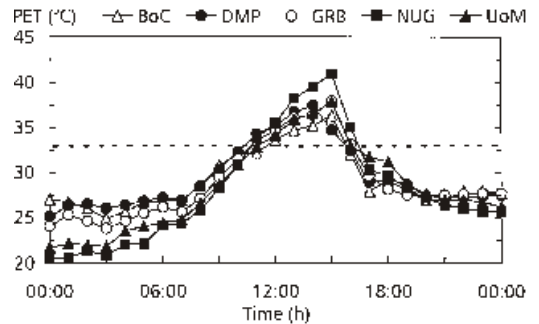

Fig. 6.9 Calculated PET on a clear day in Colombo (3 May 2003) for a person (a) exposed to solar radiation and (b) in shade, where available. The assumed upper comfort limit is included as a reference (dashed lines). (For site keys, see Table 5.1.).

Fig. 6.10 Calculated PET on a partly cloudy day (7 May 2003) for a person exposed to solar radiation. The assumed upper comfort limit is included as a reference (dashed lines). (For site keys, see Table 5.1.).



shows PET on partly cloudy days for someone exposed to the sun. On this day (7 May), only a few wind speed measurements were taken, but the relative difference between the sites was assumed to be the same as on 3 May. For the partly cloudy day, the differences in PET between the sites were smaller than under clear sky conditions (Fig. 6.9a). However, although the solar radiation was considerably less, the PET values were above the assumed discomfort threshold between 11:00 and 16:00 h. Consequently, shading will also have a positive effect during partly cloudy days. When the sky was completely overcast, and solar radiation weak, PET did not exceed the discomfort level and intra-urban variations were negligible, although areas with higher wind speeds tended to be more comfortable.

The sea breeze has a moderating effect on PET in that it lowers the air temperature. The effect of the sea breeze can be seen by comparing the BoC site, which is open to the sea breeze, with the GRB and DMP sites. The latter sites are also situated close to the sea, although the breeze is blocked by uninterrupted street frontages, resulting in poorer thermal comfort. The effect of wind speed can also be discerned in the PET results. For example, the compact urban form of the DMP site, with the highest H/W ratio, reduces wind speed, resulting in high PET values.

At night, PET is fairly low (Figs. 6.9 and 6.10). The lowest values were observed in the shallower canyons, which have the highest wind speeds and the highest levels of radiative cooling.

6.3 Simulations of microclimate and outdoor thermal comfort

This section presents the results from microclimate simulations using the ENVI-met software and subsequent calculations of thermal comfort. Only daytime conditions are considered. The results are described in detail in Paper IV.

Results from the parametric study

Once the model had been calibrated against the measurements (see Paper IV), the effect of the different design parameters described in Section 5.2 was studied. The area modelled and the street canyons studied are shown in Figs. 5.4–5.6. The results are presented as calculated PET, although the effects of H/W ratio and street orientation on air temperature are also presented.

Parametric study of Fez

Effect of H/W ratio and orientation

The relationships between the maximum daytime air temperature (defined as the temperature at 14:00 h) and the H/W ratio for both the summer and winter in Fez are shown in Fig. 6.11. For both seasons, the trend is for air temperature to decrease with increasing H/W ratio. In summer, daytime air temperature was found to peak for H/W ratios of about 1, see Fig. 6.11a. A sharp decrease in air temperature was found for H/W ratios of ≥ 2 in summer and for H/W ratios of ≥ 1 in winter.

In the summer case, the daytime temperature was found to be lower in canyons with a north-south orientation. This is because east-west oriented streets receive solar radiation during a longer period of the day. In the winter case, the east-west streets showed lower air temperatures than the north-south streets, although the difference was only about 1°C. For both seasons, the impact of street orientation is negligible for H/W ratios of ≥ 2 .

Daytime PET values, calculated as average PET at pedestrian level (at 1.5 m height), for the Fez canyons are shown in Fig. 6.12 (summer) and Fig. 6.13 (winter). The assumed upper and lower comfort limits (see Section 5.1) are included for reference. During both seasons, and for both east-west and north-south oriented streets, the trend is for PET values and the duration of high PET values to decrease with increasing H/W ratios. However, for the same H/W ratio, north-south oriented streets are more comfortable than east-west oriented streets, during *both* summer and winter. The difference is most pronounced for H/W ratios of below about 4 since for higher H/W ratios the amount of solar radiation that reaches the street is small, regardless of orientation.

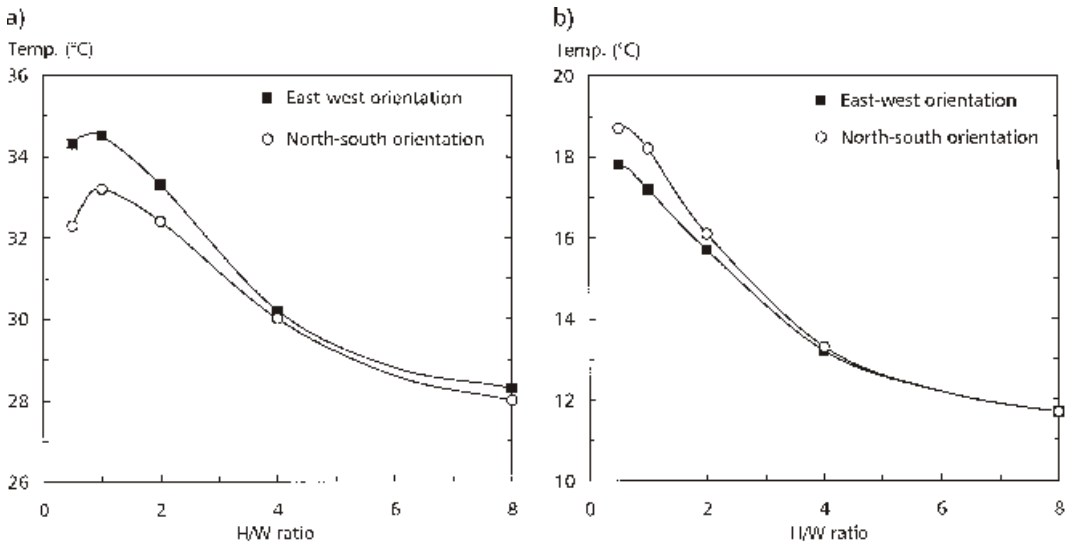

Fig. 6.11 Maximum daytime air temperature (at 14:00 h) as a function of H/W ratio in Fez for (a) the summer (15 July) and (b) the winter (15 January).

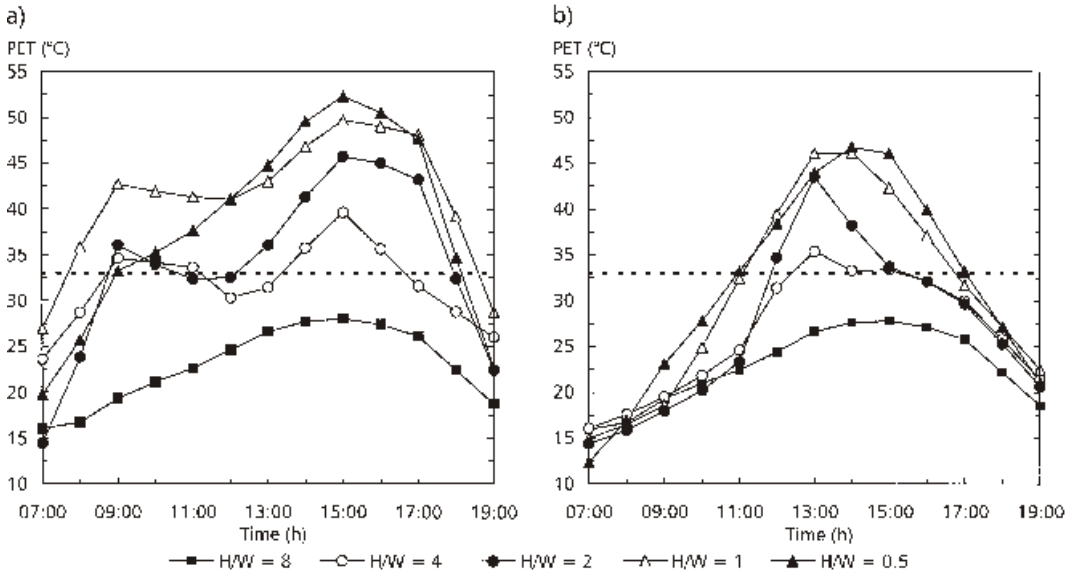

Fig. 6.12 PET at pedestrian level (average for the entire canyon width at 1.5 m height) for the different H/W ratios for the summer in Fez (15 July). (a) East-west oriented streets and (b) north-south oriented streets. The assumed upper comfort limit (dashed line) is included as a reference.

The peaks at 09:00 h and 15:00 h in the east-west canyon in summer are due to the fact that the sun is positioned due-east and due-west respectively at these times and, consequently, the entire canyon is exposed to solar radiation.

It should be noted that Figs. 6.12 and 6.13 show average values for the whole canyon width. In east-west oriented streets, for example, PET values on the northern side of the street will reach magnitudes

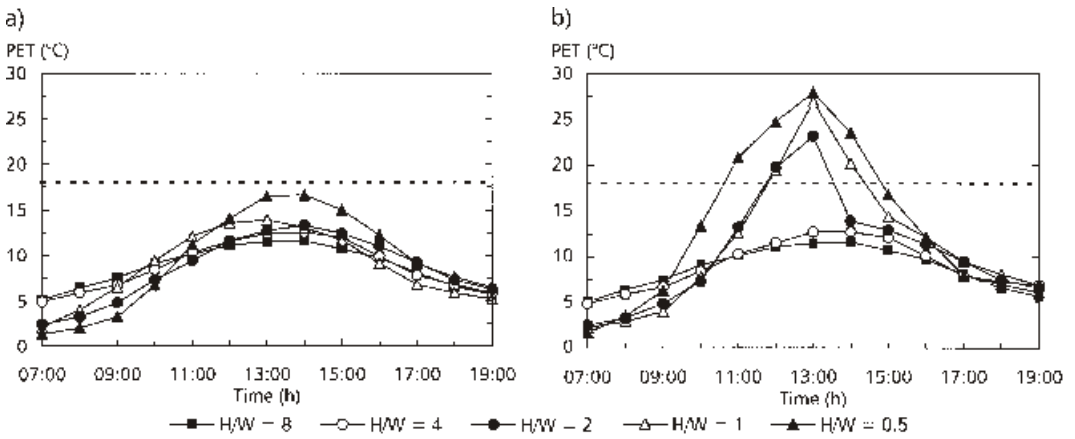

Fig. 6.13 PET at pedestrian level (average for the entire canyon width at 1.5 m height) for the different H/W ratios for the winter in Fez (15 January). (a) East-west oriented streets and (b) north-south oriented streets. The assumed lower comfort limit (dashed line) is included as a reference.

above 20°C during hours of solar exposure in the winter (see, e.g. Fig. 6.18b).

Effect of surface reflectivity

Surface reflectivity proved to have a minor effect on PET at street level. The difference in maximum PET between the cases with the highest and lowest reflectivity was 5°C in summer and 2°C in winter. However, what was unexpected was that the MRT (and consequently PET) *increases* with increasing reflectivity. This suggests that, in these simulations, the effect on MRT of increased reflection was greater than the effect of lower surface temperatures. This may be due to the fact that ENVI-met 3.0 does not take the thermal mass of the façades into account by. That is to say, the façades are unable to store the absorbed solar radiation. This has the effect that afternoon temperatures will be underestimated, particularly for dark surfaces.

Effect of thermal mass

PET tended to decrease with increasing thermal admittance μ of the street surface. This was expected, since the increased heat penetration into the substrate will lead to lower surface temperatures in the daytime (and consequently lower MRTs), as well as less sensible heat. However, the effect was greater for the summer case than for the winter case. In summer, the difference in maximum PET between the lowest and highest μ was about 8°C. In the winter, the difference was only 2°C. This is because less solar radiation reaches the street level in the winter.

Effect of shading at street level

The effect of shading by colonnades and a row of trees on maximum PET for the summer is shown in Fig. 6.14. It is clear that overhead shading significantly improves thermal comfort conditions. Beneath the colonnade, PET is about 18°C lower than in the centre of the canyon and just below to the assumed discomfort threshold (Fig. 6.14a). The row of trees is a little less efficient than a colonnade since the

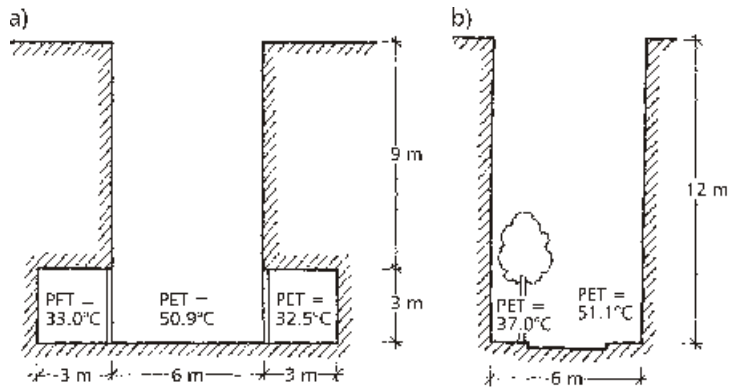

Fig. 6.14 Effect of shade on maximum PET (at 15:00 h) for the summer in Fez (15 July): (a) east-west street with colonnades on both sides, (b) east-west street with a row of trees along one of the façades.

tree canopies have some transparency. Beneath the trees, PET is about 14°C lower than in the centre of the canyon, but clearly above the assumed discomfort limit (Fig. 6.14b).

Parametric study of Colombo

Effect of H/W ratio and orientation

Contrary to the case of Fez, and contrary to measurement results, the simulated air temperatures varied only marginally between the Colombo cases. The simulated maximum daytime temperatures were about 32°C for all sites. The differences between different H/W ratios and street orientations were less than 0.5°C. This is probably due to the turbulence model used by ENVI-met, which differed from that used in the Fez simulations because of lower wind speeds, see Section 5.2. See also Paper IV.

Daytime PET (average value at a height of 1.5 m) for the Colombo canyons on a clear day is shown in Fig. 6.15. The assumed upper comfort limit (see Section 5.1) is included as a reference. As with the Fez summer case, the trend is for both PET values and the duration of uncomfortably high PET values to decrease with increasing H/W ratio. For very low H/W ratios (below 0.6), the influence of street orientation is marginal, but as the H/W ratio decreases, north-south oriented streets are more comfortable than east-west oriented streets. The former have lower maximum values and the duration of uncomfortable PET values is shorter than for the latter. To achieve a noticeable improvement in outdoor thermal comfort, east-west streets would need to be very deep, at least $H/W = 4$. For north-south oriented streets, a noticeable effect is seen for H/W ratios as low as about 2.

Effect of surface reflectivity

Surface reflectivity proved to have a minor effect on simulated maximum daytime PET at street level. As in the case of Fez, there is an unexpected tendency for PET values to *increase* with increasing reflectivity (see the comment on the Fez results above). For the Co-

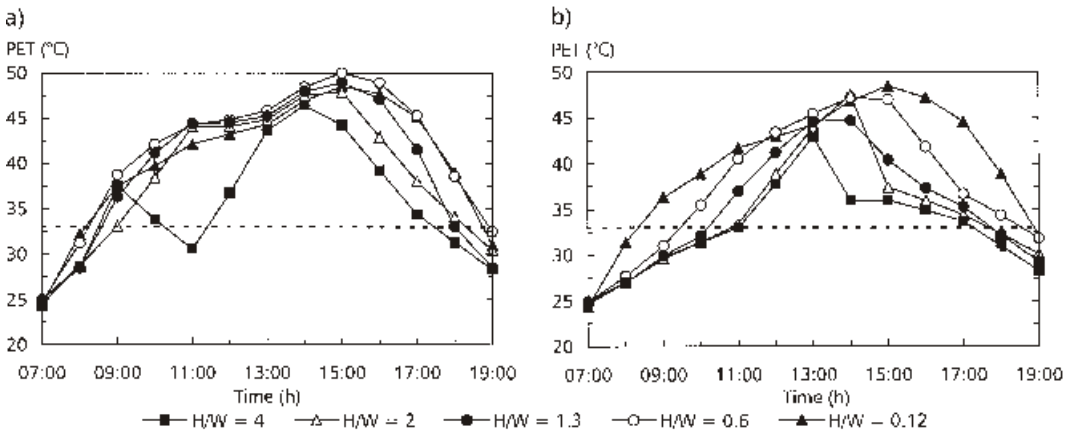

Fig. 6.15 PET at pedestrian level (average for the entire canyon width at a height of 1.5 m) for different H/W ratios on a clear day in Colombo (3 May). (a) East-west oriented streets and (b) north-south oriented streets. The assumed upper comfort limit (dashed line) is included as a reference.

lombo case, the difference in PET between the darkest and lightest alternative was 2°C.

Effect of thermal mass

As in the case of Fez, PET tended to decrease with increasing thermal admittance \bar{i} of the street. However, the difference in maximum daytime PET was only 5°C between the lowest and highest \bar{i} value.

Effect of shading at street level

The effect of shading by colonnades and rows of shading trees on maximum PET is shown in Fig. 6.16. Maximum PET was about 10°C lower under the colonnades than in the centre of the canyon. Nonetheless, the simulated values are still higher than the assumed discomfort threshold. The trees are a little less efficient than a colonnade, since tree canopies provide some transparency and their ability to reduce PET was limited to about 7°C.

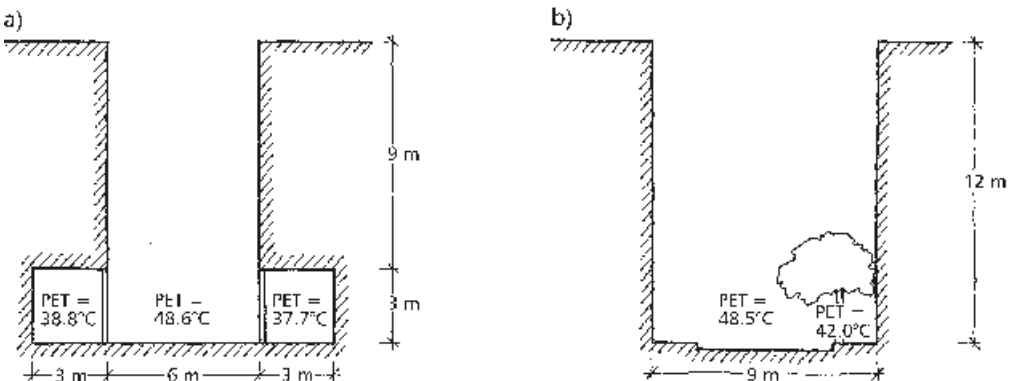

Fig. 6.16 Effect of shade on maximum PET (at 15:00 h) in Colombo (3 May). (a) East-west street with colonnades on both sides, (b) east-west street with a row of trees along one of the façades.

Effect of wind corridors

Although simulated wind speeds were unrealistically low, the opening up spaces perpendicular to the street canyon of the base case clearly led to increased wind speeds at pedestrian level. The simulated wind speed in the street more than doubled and at intersections, the wind speed was about twice of that in the canyon.

Optimised street design

The results of the parametric study showed that the H/W ratio, street orientation and provision of horizontal shading had the greatest influence on thermal comfort at street level. It was also shown that heavy building materials are favourable in a warm climate, whereas the influence of material properties proved to be negligible during the cold season in Fez. Since the ground surface and building materials most commonly used in both Fez and Colombo, such as asphalt, concrete, burnt clay bricks, concrete blocks and plaster, are already of medium to high density (see Fig. 3.2), the thermal admittance values used in the base cases were kept. Similarly, the reflectivity values of façades and the ground were not changed, since these proved to have an insignificant impact on thermal comfort in the simulations.

Optimised design for Fez

The fact that Fez has one warm and one cold season makes it difficult to optimise the design. What is a design advantage in the summer is normally a disadvantage in the winter. One way to overcome this problem is to combine streets that are comfortable in the summer with streets that show favourable winter characteristics.

The results from the parametric study showed that a street with favourable summer characteristics should have a high H/W ratio. However, the appropriate H/W ratio will depend on street orientation. North-south oriented streets should preferably have $H/W = 2$. East-west streets, on the other hand, need to be deeper ($H/W = 4$), to provide adequate shade in the summer. For lower H/W ratios than those suggested above, streets should be provided with some type of horizontal shading such as projecting first floors, colonnades, shading trees or other devices to provide shade around midday in summer.

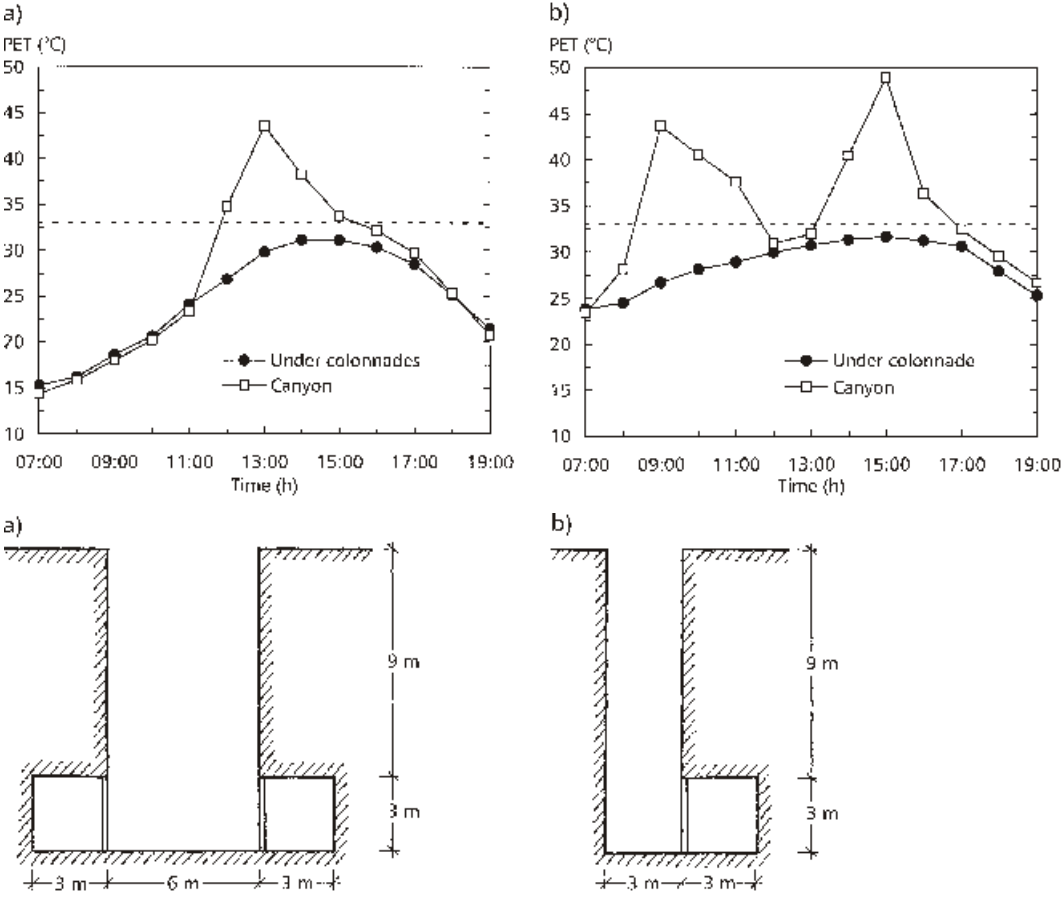

Fig. 6.17 Optimum design of street canyons for the summer in Fez. (a) North-south street of $H/W = 2$ with colonnades on both sides, (b) east-west street of $H/W = 4$ with a colonnade on the northern side. The graphs show the daytime PET variation for 15 July and include the assumed upper comfort limit (dashed line).

To achieve comfortable conditions in winter, east-west streets should have a H/W ratio sufficiently low to allow direct solar radiation to reach pedestrian level. If the H/W ratio is less than 0.7 and there is a colonnade on the northern side, solar access can be provided on that side of the street for a large part of the day during the winter months. Moreover, the colonnade will provide shade in summer. However, such streets should also preferably have some form of overhead shading, such as trees, on the southern side to improve the shade in summer. North-south oriented streets require a H/W ratio of ≥ 2 to provide some comfort in winter.

The various design considerations were combined to form “best cases”, presented as the street designs shown in Fig. 6.17 (summer) and Fig. 6.18 (winter). The daytime variation in PET for these canyons is also shown in the figures. North-south streets with $H/W = 2$ have been selected for both seasons since they constitute a compromise between summer and winter comfort. Colonnades have been added on both sides of the street to provide necessary shade in sum-

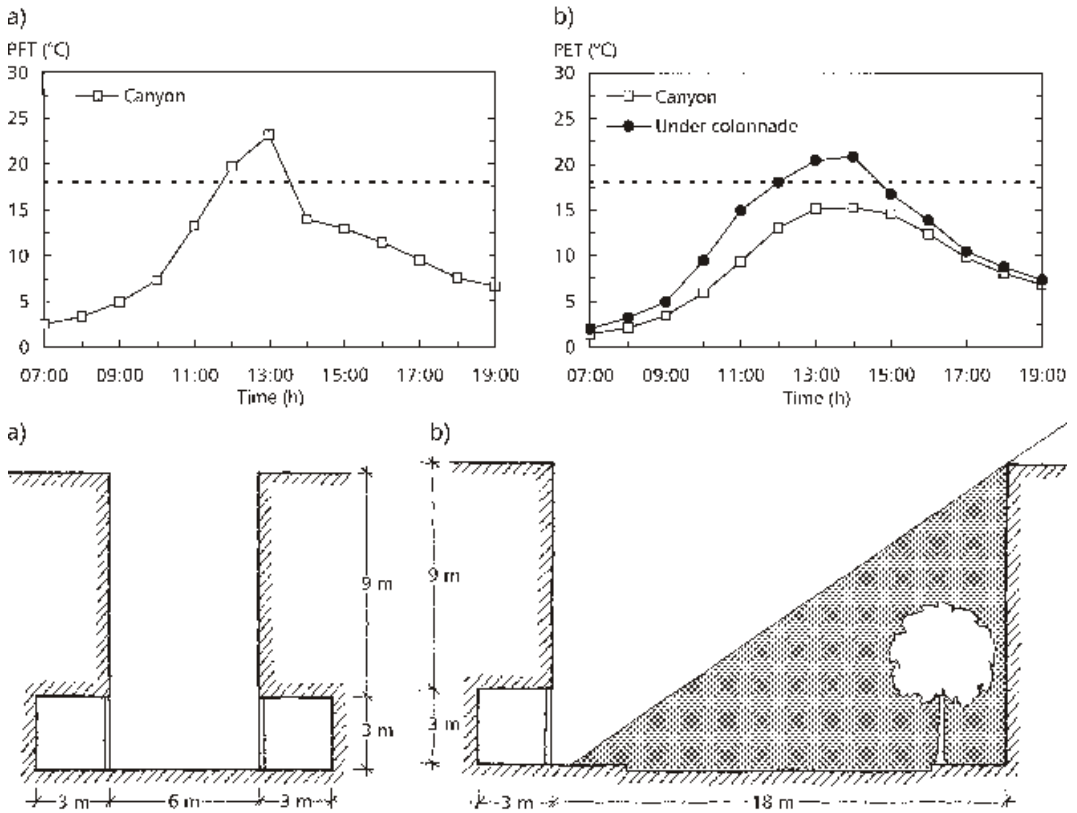

Fig. 6.18 Optimum design of street canyons for the winter in Fez. (a) North-south street of $H/W = 2$ with colonnades on both sides, (b) east-west street of $H/W = 0.67$ with a colonnade on the northern side and a row of shading trees on the southern side (showing the solar exposure at around noon). The graphs show the daytime PET variation for 15 January and include the assumed lower comfort limit (dashed line).

mer during times of solar exposure. In winter, the north-south canyon of $H/W = 2$ reached “comfortable” levels around noon. The shallower east-west canyon of $H/W = 0.67$, which has a colonnade on the northern side, can provide “comfortable” conditions for a larger part of the day (between about 11:00 h and 15:00 h). This period will be slightly shorter in December but longer in February.

Optimised design for Colombo

As in the case of Fez, the parametric study showed that streets should have high H/W ratios to improve thermal comfort conditions. However, to achieve improved comfort conditions for street canyons oriented east-west, the most problematic orientation, H/W ratios would have to be as high as 4. North-south oriented streets should have H/W ratios of at least 2. Regardless of H/W ratio and orientation, streets in Colombo require horizontal shading – through projecting first floors, colonnades, shading trees or other horizontal shading devices – to improve comfortable conditions between about 11:00 h and 16:00 h.

In Colombo, it is also important to facilitate air flow. Consequently, long, uninterrupted street frontages are disadvantageous, since they block the wind. One way of providing shade and air movement is to use detached, rather high blocks, which would provide shade at street level and allow the wind to be channelled between the buildings. Buildings could also be varied in height and raised on columns to increase air movement at pedestrian level. Since the sea-breeze in Colombo comes from the west, a good strategy would be to allow fairly wide east-west oriented streets near the coast to maximise the penetration of the sea breeze.

Examples of optimum design for street canyons are shown in Fig. 6.19 (north-south orientation) and Fig. 6.20 (east-west orientation), including daytime PET variation for these canyons. It can be seen that a north-west oriented street with $H/W = 2$ and colonnades causes only slight discomfort during the hottest hours (12:00 h – 16:00 h). The case is very similar for the east-west oriented street of $H/W = 4$. The shallow east-west canyon (Fig. 6.20b) is assumed to be near the coast and therefore the wind speed was increased by 100% compared to the base case. Still the canyon is extremely uncomfortable. However, under the colonnades the comfort is much better, although it is above the assumed discomfort level between 12:00 h and 17:00 h.

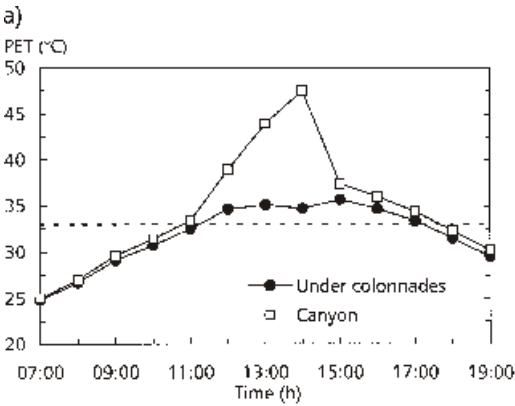
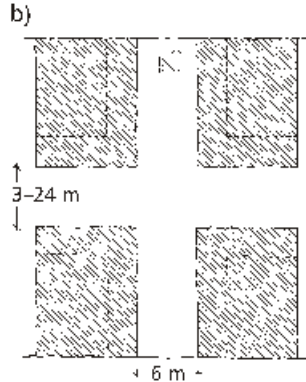
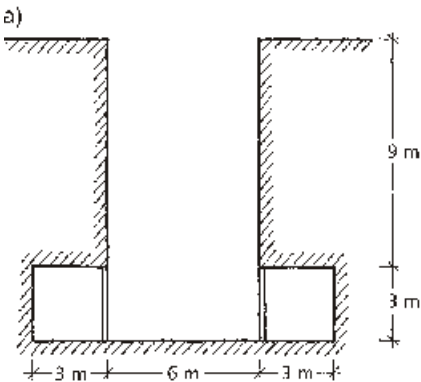

Fig. 6.19
 Optimum design for a north-south oriented street in Colombo.
 (a) Section of a canyon of $H/W = 2$ with colonnades on both sides. The graph shows the daytime PET variation for 3 May and include the assumed upper comfort limit (dashed line).
 (b) Plan showing detached blocks allowing the westerly sea breeze to enter the street.



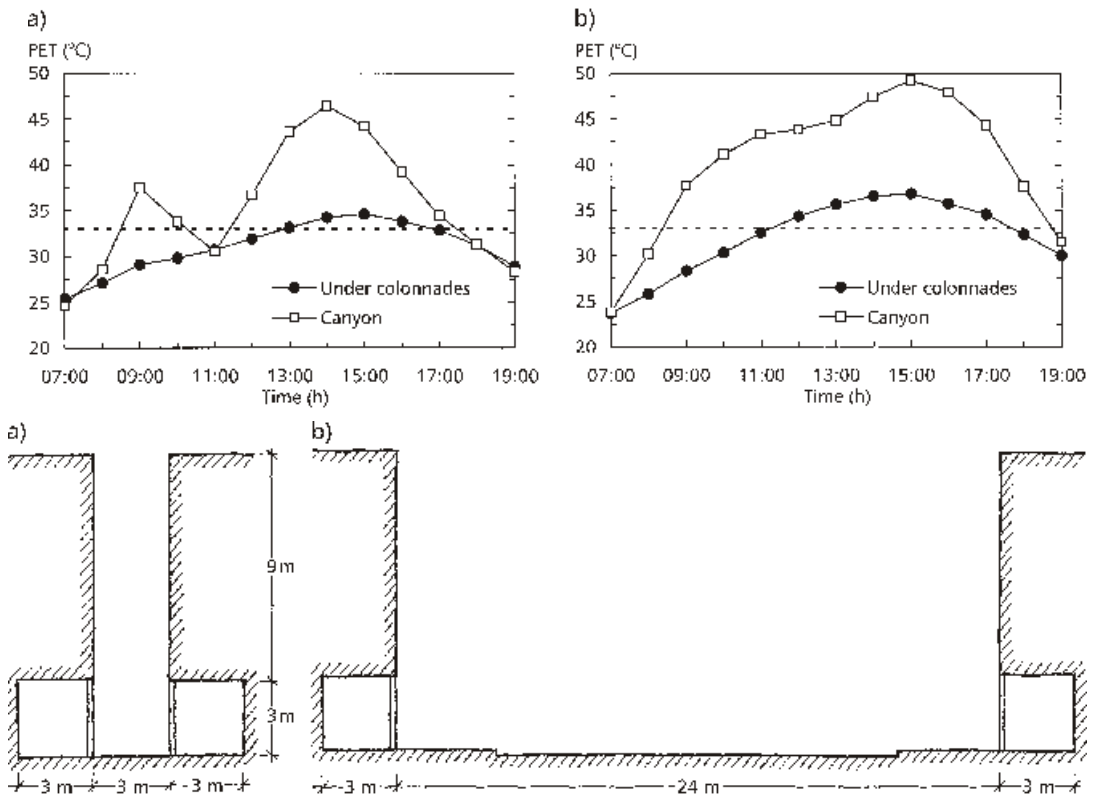

Fig. 6.20 Optimum design of east-west oriented streets in Colombo.

(a) Section of a canyon of $H/W = 4$ with colonnades on one side.

(b) A shallower canyon of $H/W = 0.5$, with a colonnade on both

sides, designed to allow the westerly sea breeze to penetrate the city.

The graphs show the daytime PET variation for 3 May and include the assumed upper comfort limit (dashed line).

6.4 Consideration of climate in the urban planning and design processes

This section presents the findings regarding the extent to which current urban planning and design practices in Fez and Colombo take climate aspects into account.

Influence of urban codes on microclimate and outdoor thermal comfort

The urban codes of the two cities have in common that they date back to the colonial period when Western planning ideals were introduced. Although some adjustments to the urban regulations in both Fez and Colombo have been made over the years since their introduction, the principles have remained the same.

Urban codes in Fez

H/W ratio, plot coverage and floor area ratio (FAR)

The regulations for the new city, which are described in Table 2.2, result in the urban geometry, expressed in terms of height-to-width (H/W) ratios, shown in Fig. 6.21. This figure shows the H/W ratios both for street canyons and back yards (courtyards), see Fig. 6.22. Streets have been assumed to be 10 and 4 m wide respectively for zones D and E¹.

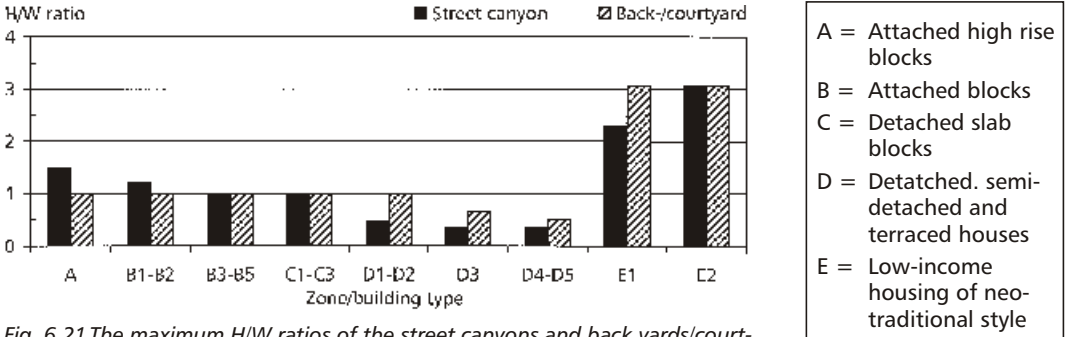

Fig. 6.21 The maximum H/W ratios of the street canyons and back yards/courtyards for different housing types in the new city of Fez. (Calculated from AUSF (1988), assuming street widths of 10 and 4 m respectively for zones D and E).

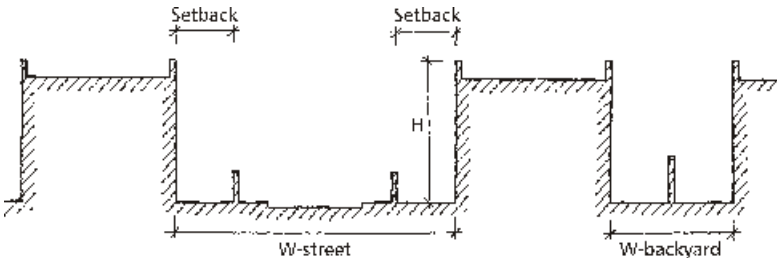

Fig. 6.22 Section defining the height and width of street canyons and back yards (courtyards).

In the historical Medina, the regulations described in Table 2.3 lead to the H/W ratios shown in Fig. 6.23.

It should be noted that the H/W ratios in Fig. 6.21 assume an average storey height of about 3.5 m. Were minimum storey height (about 3 m including the floor structure²) to be used, H/W ratios would be lower. It could also be the case that H/W ratios should be lower due to limitations of plot coverage and floor area ratio (FAR), see Table 2.2. Moreover, it should be noted that road widths in zone

1 The national decree of 1964 provides for street widths of 8 m for zone E1 and 12 m for zone E2. The code for Fez (AUSF 1988), on the other hand, does not prescribe any minimum street widths. However, it does state that where street width is less than 4 m in zone E2, the top storey must have a setback equivalent to at least half of the height of the building.
 2 The minimum height, measured between the floor and the ceiling, is 2.8 m for living spaces and 4 m for ground floor shops (VF 1969).

Fig. 6.23
The maximum H/W ratios of street canyons and courtyards for different housing types in the historical Medina of Fez. (Calculated from AUSF and ADER-Fèz (1999), assuming street widths of 1.5, 2, 2.5 and 4 m respectively for zones M1, M2, M3 and E2).

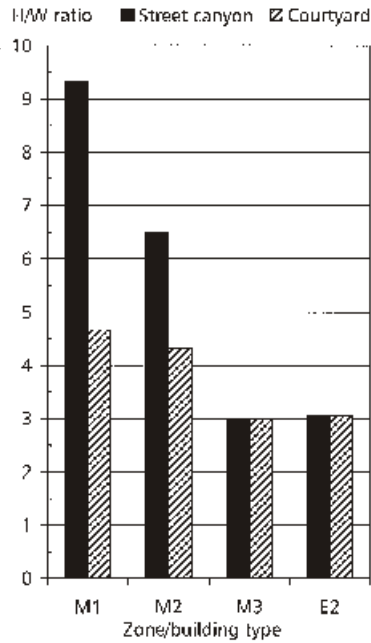

M1 =
Traditional courtyard houses
M2 =
Neo-traditional courtyard houses
M3 =
Modern residential blocks
E2 =
Low-income housing of neo-traditional style

E are often greater than assumed here, with narrow roads generally comprising pedestrian alleyways within blocks.

Consequently, with the exception of the old Medina, certain low-income areas, and some non-regulatory, spontaneous development areas, maximum permitted H/W ratios are low. In most of the city, zones B–D apply, and normal H/W ratios are therefore 0.3–1.2. Moreover, plot coverage is low, especially for detached slab blocks (zone C) and low-rise houses (zone D) where maximum plot coverage varies between 10 and 50%. If the wide roads are taken into account, the portion of the ground covered by buildings is even lower. Consequently, current urban codes prescribe a highly dispersed urban form.

Furthermore, the density of development, expressed as FAR, is low in Fez. Maximum FAR values in the new city vary between 0.2 for detached houses (villas) to about 2.7 for the densest city centre areas³. These low FAR values lead to low population density and highly inefficient land-use. Even the FAR values of the traditional buildings in the historic Medina are fairly low, at around 2.2, due to high ceilings and the limited number of storeys. The low FAR values of the formal areas stand in stark contrast to the high FAR values found in informal settlements.

In Fez, the urban codes for the modern part of the city prescribe an urban form that is the very opposite of that found in traditional architecture. While the contemporary urban form guarantees solar exposure of the street and façades, the traditional, residential areas of the Medina have narrow alleyways without setbacks and buildings often have projected upper floors and shading devices, resulting in almost complete shade at pedestrian level.

3 The figure is an estimation based on data from Table 2.2 (there is no FAR requirement for zone A).

Consequences for microclimate and outdoor thermal comfort

In Fez, the intention of the current urban codes is to guarantee daylight for buildings. This has resulted in a dispersed urban form with low to extremely low H/W ratios. This may be relevant for the winter period when solar elevations are low and passive heating of buildings is desired. However, during the long, warm summer, when there is a need for solar protection, the shade provided by buildings is extremely limited. Moreover, there are no requirements on shading of pedestrians with, for example, shading devices, colonnades, projecting upper floors or shade trees. For the warm season, this results in a very poor microclimate at street level, used by pedestrians conducting their daily activities. It also results in the warming of buildings and thus poor indoor climate or increased need for cooling. The worst conditions are found in areas designated for low-rise houses where plots are very large and plot coverage low. Apart from poor microclimatic conditions in the summer, land-use in these areas is highly inefficient, with a disproportionately large amount of ground occupied by streets, sidewalks and front yards.

The lack of climate concern can also be seen in the fact that basically the same regulation of urban form is exercised throughout the country despite extensive climatic variations. This is also true of the type of low-income housing used nationwide since 1964. This is currently under review (MHU 2005), with the preliminary result that roads 2 m narrower will be permitted, as well as the construction of up to five storeys (rather than three). However, these modifications, aimed at increasing the efficiency of land-use, are minor, and result in H/W ratios of 1.3–1.6. This is lower than current practice in Fez and will have negligible effects on the urban microclimate.

Urban codes in Colombo

Compared to the old code (Government of Sri Lanka 1980), which is still in force outside the Colombo Municipal Council and which prescribes a maximum H/W of 2.0, the current code allows slightly higher H/W ratios. Plot coverage prescriptions are almost identical; 65% for residential construction and 80% for non-residential, except for high-rise buildings, for which maximum plot coverage is restricted to 50%. A feature of the new code is also the prescription of side setbacks on middle and high-rise buildings, i.e. buildings of more than eight storeys.

H/W ratio, plot coverage and floor area ratio (FAR)

The regulations in force (UDA 1999b), which are described in Table 2.5, result in the H/W ratios shown in Fig. 6.24. This figure shows the H/W ratio for both the street canyon and the back yard, see Fig. 6.22.

It should be noted that the H/W ratios in Fig. 6.24 are based on an average storey height of 3.75 m. At a normal storey height of 3 m, including the floor structure⁴, H/W ratios would be lower, since the maximum number of storeys must be respected. It should also be noted that it may be necessary for H/W ratios to be lower due to limitations of plot coverage and FAR. This is particularly likely for resi-

4 The minimum height, measured between the floor and the ceiling, is 2.8 m for living spaces and 3 m for ground floor shops (UDA 1999b).

Low-rise =
Detached or
terraced houses,
max. 3 storeys
Intermediate-rise =
Detached or
attached blocks,
max. 8 storeys
Middle-rise =
Detached blocks,
max. 12 storeys
High rise =
Detached blocks,
above 12 storeys

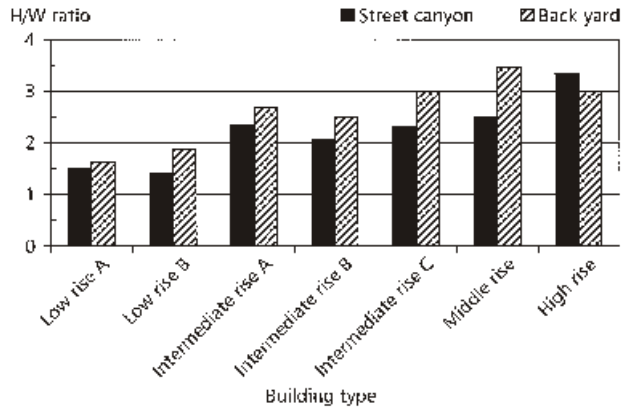

Fig. 6.24 The maximum H/W ratios of the street canyons and back yards permitted for different building types in Colombo. (Calculated from UDA (1999b). There is no maximum height limit for high-rise buildings. Here, the height has been assumed to be 60 m).

dential buildings, which have lower maximum plot coverage and FAR than commercial buildings.

Both the new and old codes place strict limits on projecting architectural details, such as shading devices on the street façade. Consequently, the shading of pedestrians on the street is not encouraged.

In addition to the stipulated street widths and setbacks, the authorities have often prescribed a so-called street line, or street reservation, indicating the future width of the road. No part of the building is allowed to project beyond this line. Therefore, the maximum allowed H/W ratios are likely to be considerably lower than the maximum values shown in Fig. 6.24.

As mentioned in Section 2.3, average FAR for existing buildings in Colombo is less than 1 (UDA 1999a). The new code proposes considerably higher maximum FAR values, varying from 1.5–2.25 for low-rise buildings, to as much as 8 for middle-rise buildings (and even higher for high-rise buildings). Consequently, the new codes allow for a considerable increase in population density.

Consequences for microclimate and outdoor thermal comfort

In Colombo, the intention of the current urban codes is to guarantee solar exposure of the buildings and ventilation around them. This has resulted in a dispersed urban form with low H/W ratios. Consequently, the shade provided by buildings is highly limited and results in very poor microclimate at street level where pedestrians conduct their daily activities. It also leads to the warming of buildings and thus poor indoor climate or increased need for cooling. Although slightly higher H/W ratios are permitted by the latest code (UDA 1999b), these are still too low to provide efficient shade. Moreover, there are no requirements for the shading of pedestrians with, for example, shading devices, colonnades or shade trees. On the contrary, the use of shading devices on façades is restricted.

On the other hand, maximum permitted plot coverage, 65% for residential buildings and 80% for non-residential, is quite high and for buildings up to 8 storeys there are no requirements for setbacks at the sides. Consequently, the construction of terraced houses and attached residential blocks is encouraged, decreasing the ventilation around the buildings.

The consideration of climate aspects in urban planning and design

The aim of the interviews was to ascertain the extent to which climate is considered in urban planning and design, what are the constraints preventing the consideration of climate issues, what is the role of the urban codes, and in what way could climate aspects be included in the planning and design processes? The findings have been grouped according to these questions.

Interviews in Fez

Consideration of climate issues

According to the interviewees, climate issues are not explicitly considered in urban planning and design. There are very few projects where architects have considered climate aspects in the design of buildings or urban neighbourhoods. On the other hand, environmental issues are being ascribed an increasingly high priority.

Reasons why climate is not considered

One reason why climate is not considered, mentioned by several respondents, was that much of today's construction consists of low-income housing. A major problem in these areas has been high population density and many town planners are concerned about hygiene conditions. Therefore, in order to prevent the health problems caused by overcrowding, low-density settlements with wide roads are being built. Many interviewees also pointed out that in low income areas, the main aim is to keep costs at a minimum. Consequently, it is very difficult to introduce any measures that would increase costs, such as improving comfort conditions.

Another obstacle mentioned by a few respondents was that various security regulations must be adhered to. For example, the fire brigade requires sufficiently broad streets and space is also needed for infrastructure services such as sewerage and electricity.

One informant mentioned the problem of conflicting interests where the client and architect are often more concerned with the individual building than with urban design. He also claimed that there has been a trend in recent decades to build isolated, spectacular buildings rather than considering uniform urban design.

The interviews gave no evidence of any explicit interest in, or demand for, climate-conscious urban design. None of the informants had any specific education in climate-conscious urban design and the access to tools is likely to be limited.

The role of urban codes

The general opinion of the planners interviewed was that current regulations are suitable and well-founded, including the Casablanca by-law from 1952, which provided the basis for urban codes in other cities. The urban regulations in Fez are normally followed strictly. However, a few informants claimed that this is not always the case; non-regulatory developments exist in low-income areas, as well as in medium and high-income neighbourhoods. In low-income areas, illegal storey additions and building extensions into courtyards are common. In medium and high-income areas, exceptions from the urban codes are possible, especially if the architect and urban designer are able to argue for another urban design.

Several respondents did not view the current urban codes as an obstacle for climate-conscious urban design or “bioclimatic” architecture. One respondent argued that although he did not see the current code as an obstacle, he had to admit that the current codes did not, on the other hand, favour climate-conscious urban design. For example, dense “medina type” developments are not possible. A few informants pointed out that current codes were imported from France and are not really suited to the Moroccan context.

Ways to include climate issues

Several informants argued that better knowledge on climate aspects is needed among urban designers and planners. One respondent claimed that current codes and regulations would not hinder knowledgeable designers from achieving a favourable urban environment. Furthermore, he argued that the role of the authorities is to interpret the text of the codes in relation to each situation. Thus, he continued, the urban designer (or developer) is able to achieve an individually unique neighbourhood if he can convince the authorities. Another interviewee claimed that the authorities can establish special codes for individual housing areas.

One informant argued that more research is needed about climate-conscious planning and design.

Interviews in Colombo

Consideration of climate issues

A majority of the informants claimed that they considered climate issues in urban planning and design. Although the extent to which climate was considered varied between the respondents, the general impression was that climate issues are not thoroughly studied and have low priority.

At the comprehensive planning level, for example when choosing the site, climate data, such as temperature and rainfall are often gathered. However, several respondents pointed out that this data is not analyzed and the link to design is missing. At the detailed planning level, a few interviewees said they considered the microclimate around the buildings whereas some thought climate issues were considered by applying the urban codes, which “give priority to light and ventilation”. Several respondents said climate issues were considered unintentionally or “in the back of our heads” deriving from extensive experience of living in the climate and knowledge of tradi-

tional solutions. The most common level where climate issues are considered seems to be architectural design.

Many of the informants recognised that high temperatures affect people's working efficiency and that thermal comfort is important for good performance.

Most of the respondents also expressed a personal interest in climate and thermal comfort issues. This interest was especially great among urban planners, urban designers and architects but was weaker among builders and developers.

Reasons why climate is not considered

Several reasons were identified as to why climate issues are considered only to a very limited extent in urban planning and design.

Many respondents pointed out the lack of knowledge and training, both among professionals and the public. One respondent said that there is a lack of skilled people and that the practice is lacking. Most informants also pointed out the lack of tools and lack of access to existing tools as a barrier.

Most informants have no education whatsoever in urban climate and outdoor thermal comfort. A few informants, though, had a degree in urban design, or the like, from abroad. Educational programmes also covered climate issues, albeit only for temperate climates. Respondents with an architectural background had, however, a general education in climatic building design and indoor thermal comfort.

The utilisation of tools for climate-conscious planning and design appears to be very limited. One respondent mentioned climate atlases that show, for example, rainfall, and maps of disaster-prone areas. A few respondents said they used climate data such as temperature, humidity and rain. No respondent had used, or even heard of, specific tools for climate-conscious urban design, such as climate maps, graphic or computer-based tools for the calculation of shade, radiant temperature, etc.

In general, there seems to be a lack of information, both regarding climatic data and guidelines. Many said that they had no access to data and one respondent pointed out that climate data should not only be accessible, but must be analysed and interpreted in order that it be possible to understand how to use it. One respondent indicated that it takes too much time to gather the necessary information, review it and make assumptions. Moreover, he continued, it is difficult to know what information to look for when you are not familiar with the field. Another interviewee pointed out that there is a lack of knowledge on how to interpret available data.

A major barrier involves conflicting interests and other priorities in the planning and design process. A few informants pointed out that thermal comfort is subjective and difficult to measure. Consequently, other problems, which are considered more important or urgent, are likely to be assigned priority. Several interviewees said that the main problems in urban planning include sanitation, environmental issues, such as solid waste and wastewater disposal, and infrastructure. Other informants mentioned environmental problems, such as

air pollution and dust, which are direct health problems, and the protection of wetlands and bodies of water.

The role of the urban codes

According to the informants, the urban and building regulations are normally followed strictly. One important reason for this is that unless the building conforms to the regulations, the owner will not receive the certificate required for infrastructure connections. However, several informants said that extensions are commonly built after the certificate has been received. One informant pointed out that exceptions from the rules can occur in larger projects involving influential architects and clients.

The opinion of the majority of the informants was that the recently revised urban and building regulations are good. One informant thought it was good that side setbacks and lower plot coverage had been introduced for middle and high-rise buildings. However, there was also some criticism. One informant indicated the lack of prescriptive guidelines for shading, while another felt the codes constituted an obstacle due to their lack of flexibility. Another criticism was that the codes did not prescribe trees along roadsides.

Ways to include climate issues

All informants had ideas on how to include climate issues in planning and urban design. The suggestions concerned the planning process, the role of urban codes and guidelines and education.

One informant said that it should be possible to include climate issues in the planning process without difficulty, because there is an interest – it is just a matter of “expanding the scope”. Regarding which planning levels should include climate aspects, opinion was inconsistent. Most informants, however, suggested that issues of climate and thermal comfort should be included at all levels of planning and design, from comprehensive to detailed level.

A majority of the informants expressed the view that the most efficient way to involve climate issues would be to include them in zoning, planning and building regulations. The main reason stated was that the codes are generally respected and that the consideration of climate aspects will therefore become praxis. One informant pointed out that if requirements are built into the planning regulations, people will begin to consider these issues already at the building permit stage. Many also suggested developing planning and design guidelines.

The suggested content of codes or guidelines included prescriptive guidelines on the minimum percentage of green areas, green belts and bodies of water, the minimum amount of open space, requirements on shade trees, increased minimum plot sizes (to allow for more ventilation) and requirements on the reflectivity of paving materials (to avoid heat absorption).

A general opinion was that education is important in increasing knowledge among professionals in the field. One informant suggested that climate issues should be included in the university education of urban planners. One informant said, on the other hand, that education should be provided, not only via universities, but also at other organisations involved in planning, urban design and housing.

He added that a stronger link between the universities and public institutions is necessary to enable the exchange of information and knowledge. One informant stressed the importance of generating awareness, both among professionals and the public, for example through newspaper articles.

Several respondents also pointed out that public demand for climate-conscious design may develop, at least among the middle and high-income population. One respondent argued that rising living standards will create a demand in the future - there is already a demand for a better environment. Some respondents, however, did not feel there was any demand, particularly from low-income residents who have other priorities and are not aware of the problem or of the possible benefits of climate-conscious design.

7 Discussion and conclusions

This chapter discusses the results of the previous chapter and their implications for climate-conscious urban design in hot climates, exemplified by the cities of Fez and Colombo. The first section deals with the influence of different design parameters on the microclimate and outdoor thermal comfort. In the second section, the consideration of climate aspects in urban planning and design is discussed. The third section contains conclusions regarding how to design urban areas to achieve outdoor thermal comfort. The final section contains suggestions for future studies.

7.1 Influence of urban design on outdoor thermal comfort

Urban-rural differences

In both Fez and Colombo, urban-rural temperature differences were found to be significant, both by day and by night. Whereas the urban canyons studied in both cities were warmer than the rural sites by night, some sites were warmer and others cooler by day. The urban-rural temperature differences are linked to urban geometry, which indicates the importance of urban design in providing comfortable urban environments.

By day, the sites with shallower street canyons were, in general, warmer than the rural sites due to their high absorption of solar radiation. Deeper canyons, however, tended to be cooler than the rural sites due to the protection they afforded against solar radiation. In the case of Colombo, the reason for the cool islands is likely to be a combination of shade from buildings and cooling by the sea breeze. Similar urban-rural daytime differences have been observed by e.g. Bourbia and Awbi (2004) in a hot dry climate and by e.g. Nichol (1996) and Jonsson (2005) in hot humid climates.

In Fez, the “deep” canyon (SEF) had the strongest nocturnal heat island. This was to be expected given the far greater height-to-width (H/W) ratio (lower sky view factor) than in the “shallow” canyon (ADA). The observed seasonal variation, with stronger heat islands in the summer than in the winter, agrees well with studies conducted in mid-latitude cities (Arnfield 2003). This is probably because the higher amount of rainfall in the winter period leads to higher soil moisture at the rural site, as well as more clouds and consequently higher sky emissivity (see e.g. Oke et al. 1991).

The nocturnal heat island found in Colombo is weaker than those commonly observed in temperate climates. This is most probably linked to the high amount of rainfall, resulting in high soil moisture levels at the rural site, as well as the high humidity in the air and high degree of cloud development, causing high sky emissivity (see e.g. Oke et al. 1991). The results agree well with those from other hot-humid coastal cities, such as Singapore (2°N) (Tso 1996) and Dar es Salaam (7°S) (Jonsson 2005).

Microclimate and outdoor thermal comfort in Fez

Effect of H/W ratio

In Fez, it was shown that the H/W ratio influenced all of the environmental parameters measured, particularly air temperature and MRT.

The fact that the maximum air temperature was found to decrease with increasing H/W ratio agrees with other studies in similar climates (Coronel and Alvarez 2001, Bourbia and Awbi 2004 and Ali-Toudert et al. 2005). However, none of these studies examined canyons as deep as those included in this study and they did not find intra-urban differences as large as those found here, where the deep canyon (H/W = 10) in the compact neighbourhood (site SEF) was up to 10°C cooler than the shallow canyon (H/W = 0.6) in the dispersed neighbourhood (site ADA) on the warmest summer days.

The reason for the large daytime cool island in the deep canyon is its high H/W ratio. By day, the lower part of the canyon is in complete shade and, consequently, the air is not warmed. Moreover, in contrast with the shallow canyon, which is penetrated by the air from above, the deep canyon is, to a large extent, isolated from the warm air above that skims over it (Fig. 3.4). The reason for the intra-urban differences being smaller during the winter is probably the fact that diurnal temperature swings are smaller in the winter due to less intensive solar radiation, because of lower solar altitudes, and because of the greater amount of overcast and rainy weather.

The simulated maximum daytime air temperatures (Fig. 6.11) agree well with the results of the field measurements in the shallow and deep canyons in Fez, especially in the summer (Figs. 6.1a and 6.2). The simulations indicated that the cooling effect on the air temperature tended to be especially big for canyons with H/W ratios of around 2 and above in summer and for H/W = 1 and above in winter.

The parameter that was most affected by the H/W ratio, apart from the air temperature, was MRT at pedestrian level. The canyon geometry influences both the exposure to solar radiation and pedestrians' radiative heat exchange, as well as surface temperatures. The difference in surface temperatures between the deep and shallow canyons in Fez proved to be huge, both during summer and winter. The pattern agrees well with differences between deep and shallow canyons found by Ali-Toudert et al. (2005) in hot dry Beni-Isguen (32°N), although their study included only summer conditions.

The higher vapour pressure in the deep canyon compared with the shallow one is probably attributable to moisture in the deep canyon not being dispersed through ventilation, due to the stable conditions there. In the shallow canyon, on the other hand, good ventilation is provided by the wind that enters and natural convection is high (see e.g. Mayer et al. 2003). It should be noted that, throughout the year, vapour pressure in both of the canyons studied in Fez is well below the critical level of approximately 25 hPa suggested by Givoni (1998), see Section 3.2. Consequently, humidity is not likely to significantly affect thermal sensation.

The tendency for daytime PET, based on measurements, to decrease with increasing H/W ratio was observed for both the summer and winter seasons. The summer results agree well with the findings of Ali-Toudert et al. (2005) in Beni-Isguen, Algeria. However, in general, their field study evidenced less intra-urban variation and higher PET values than were observed in the summer in Fez. This is explained by lower variation in H/W ratio and higher air temperatures in their case.

Thermal comfort, based on measurements, showed extensive differences in PET variation between the deep and the shallow canyons, both in summer and winter. It should be noted that, in reality, a person in the shallow canyon has the option of moving between sunny and shady locations. However, this is only really possible during the cold season. In the summer, when the solar elevation is high, it is almost impossible to find shade, partly because pavements are situated 4 m from the façades because of setback regulations. In the winter season, discomfort in the deep canyon could, to some extent, be compensated for by heavier clothing, although the total lack of solar access at pedestrian level contributes to discomfort.

The magnitudes of the simulated PET values (Figs. 6.12 and 6.13) agree fairly well with the measurement-based results (Fig. 6.8). The simulations, in which a greater variety of H/W ratios were studied than in the measurements, confirmed the trend for PET to decrease with increasing H/W ratio, both in summer and winter. The summer results agree well with the findings of Ali-Toudert and Mayer (2006) in a similar climate.

Effect of street orientation

Whereas other field studies have found north-south streets to be significantly cooler than east-west streets, e.g. Bourbia and Awbi (2004) and Pearlmutter et al. (1999), street orientation was found to have an insignificant impact on air temperature. This is due to the fact that predominantly deep and shallow canyons were studied in Fez. In the compact neighbourhood, alleys are so narrow and winding that solar radiation seldom penetrates, irrespective of street orientation. In the dispersed neighbourhood, on the other hand, the streets are so wide that temperature differences between them will probably be levelled out by horizontal air movements (micro-advection, see e.g. Eliasson 1996).

The simulated effect of orientation on air temperature was found to be fairly small, less than 2°C for the summer and less than 1°C for the winter (Fig. 6.11), and negligible for H/W ratios above 2. The fact

that north-south oriented streets were cooler than the east-west oriented streets in the summer agrees well with the simulations by Ali-Toudert and Mayer (2006) for a similar climate, although they found a maximum difference for $H/W = 2$. In this study, in contrast with the summer case, north-south streets were found to be slightly warmer than east-west streets. However, in reality, the difference in air temperature will be less because of the influence of street intersections and the mixing of air between streets of different orientation as discussed above.

Even if the effect of street orientation on air temperature may be limited, the effect on MRT tended to be significant, as reflected by the PET index. The fact that north-south oriented streets give lower PET than east-west oriented streets of the same H/W ratio agrees well with the findings of Ali-Toudert and Mayer (2006). Similarly, Pearlmutter et al. (2005) found the radiative heat gain of a body in the centre of the canyon to be lower in north-south streets than in east-west streets. The difference in PET is most pronounced for H/W ratios of less than about 4, since for higher H/W ratios, the amount of solar radiation reaching the street is small, regardless of orientation.

Effect of shading by colonnades and trees

The simulations showed that shading by colonnades and trees was very efficient in lowering PET. This trend agrees well with the findings of Ali-Toudert and Mayer (2005, 2006). Shading is especially efficient in the summer climate of Fez, since solar radiation is dominated by the direct component. As expected, colonnades are more efficient than shading trees, since the latter have some transparency.

Effect of surface reflectivity and thermal mass

The simulated effect of the reflectivity and thermal mass of surfaces proved to be surprisingly small. This is not in agreement with several guidelines proposing light surface colours to keep surface temperatures low during the warm season (see Section 4.4). Even though highly reflective materials are likely to have a positive effect on thermal comfort, it can be difficult to maintain light colours due to dust in hot dry climates and colours that are too bright may cause problems of glare.

It should be noted that the effect of both the surface reflectivity and thermal properties of surface materials might have been more significant if a simulation programme had been used that took the thermal mass of buildings into account. However, no such programme is available that also is user-friendly.

Microclimate and outdoor thermal comfort in Colombo

Effect of H/W ratio

As in the case of Fez, it was shown that the H/W ratio influenced all of the environmental parameters measured. The measurements in Colombo evidenced the significant impact of urban geometry on daytime air temperatures. The fact that the maximum daytime temperature tended to decrease with increasing H/W ratio was also

found by Ahmed (1994) in the hot humid summer in Dhaka (24°N). This tendency has also been found in many hot dry climates, such as in the case of Fez discussed above.

The negligible differences in air temperature between canyons of different H/W ratios found in the Colombo simulations are likely to be linked to the simulation programme, see Section 5.2 and Paper IV.

As in the case of Fez, the H/W ratio had a great effect on surface temperatures and on MRT at pedestrian level. Canyon geometry influences both exposure to solar radiation and pedestrians' radiative heat exchange, as well as surface temperatures. The huge difference in surface temperatures between sunlit and shaded areas agrees well with the findings of Nichol (1996) in Singapore.

The reason why no link could be found between urban geometry and the level of humidity, as was the case of Fez, is probably that the H/W ratios between the Colombo canyons vary less. Other factors also have a significant impact, such as the amount of vegetation, the permeability of the ground and the proximity to the sea. Although the average vapour pressure for the urban sites was lower than that of the rural station by day, it by far exceeded the critical level of approximately 25 hPa suggested by Givoni (1998), see Section 3.2. Humidity is thus likely to have a significant negative impact on thermal comfort, since the evaporative cooling potential of the human body decreases at such high levels of humidity.

The measurement-based PET calculations show the importance of shading by buildings for the improvement of daytime thermal comfort. Higher H/W ratios can, thus, provide more comfortable conditions than low H/W ratios. For the canyons with higher H/W ratios, such as the Pettah (DMP) and Bank of Ceylon (BoC) sites, shade was available in the early morning and late afternoon. However, the highest H/W ratio was only 1.2 (at the DMP site) and, in all of the canyons investigated, the possibility of finding shade from buildings was limited on both sides of the street, particularly between about 11:00 h and 15:00 h when the solar elevation is high. For some streets, the period with no possibilities for shade was even longer, since pavements are located some meters from the façades due to setback regulations.

The simulated PET values (Fig. 6.15) agree fairly well with the measurement-based results for a "clear" day (Fig. 6.9) and confirm the relationship with canyon geometry. From the simulations, which considered a greater variation in canyon geometry than the measurements, there was a clear trend for decreasing PET with increasing H/W ratio. The results agree well with some studies in hot dry climates, as discussed above for the case of Fez.

Effect of street orientation

The simulated effect of street orientation on PET was significant, showing that both maximum PET and the duration of uncomfortably high PET values are lower for north-south oriented streets. For such streets, shade is provided by the buildings both in the morning and the afternoon provided the H/W ratio is sufficiently high. East-west oriented streets are far more problematic. However, there will be

shade on the south side of the street during the period October–March provided buildings on this side of the street are sufficiently tall. During the remainder of the year, the sun is at its zenith, or slightly to the north, making it difficult to achieve shade without some kind of overhead shading.

Effect of the sea breeze

The measurements showed clear evidence that the sea breeze has a positive effect, due to its lower air temperature and higher wind speeds, which have a cooling effect during in the afternoon. This is clearly illustrated by the difference between the Bank of Ceylon (BoC) site in Fort and the Galle Road (GRB) site in Bambalapitiya. Although both are close to the sea, the former, which is open to the sea, is more comfortable due to the sea breeze, whereas the latter has a continuous frontage of medium-rise buildings along its western side effectively blocking the sea breeze.

The findings agree well with those of Jonsson (2005) in hot humid Dar es Salaam, Tanzania, where the sea breeze was found to create a daytime cool island during the inter-monsoon period. The effect of sea breeze on urban climate was also noted by Saaroni et al. (2000) in Tel-Aviv, Israel, where areas close to the sea, or where the sea breeze was allowed to penetrate by the urban morphology, were cooler than other parts of the city.

Effect of shading by colonnades and trees

Overhead shading can improve comfort conditions considerably, as is clearly illustrated by the calculated PET for the street at the University of Moratuwa (UoM) site, where overhead shading existed on one side of the street. The simulations also show that shade from either colonnades or trees gives considerably lower PET values, resulting in comfortable or only slightly uncomfortable conditions according to the assumed comfort limits. These findings agree with Ahmed (2003), who found that well shaded urban spaces often were considered comfortable in the hot humid summer climate of Dhaka, Bangladesh. As noted in the Fez case, colonnades provide more efficient shading than trees, since the latter have a certain degree of transparency.

Simulated PET values under colonnades and trees are slightly higher in the Colombo case than in the Fez summer case, although global radiation in Colombo is lower (see Paper IV). This is due to the higher amount of diffuse radiation in Colombo.

Effect of surface reflectivity and thermal mass

The simulated effect of the reflectivity and thermal mass of surfaces proved to have a limited influence on thermal comfort. However, even if lighter colours could improve comfort conditions, as suggested by many guidelines, maintaining light colours could prove difficult, due to dust and air pollution. Although there is a slight tendency for PET to decrease with increasing thermal admittance, it is not realistic to introduce heavier building materials, since those that exist are already of medium to high density.

As noted for the Fez case, the effects of both surface reflectivity and thermal properties might have been more significant if a simula-

tion programme had been used that takes the thermal mass of buildings into account.

7.2 The consideration of climate in urban planning and design

The role of urban codes

Urban codes have a major impact on urban design in both Fez and Colombo, since they include strict regulations on building heights, street widths, plot coverage, etc. The codes are respected and tend to be followed strictly in formal construction in both cities. However, in Fez, and Morocco in general, urban codes are largely inappropriate from a climate point of view. Instead of promoting shade, which is crucial in warm climates with intense solar radiation, the codes stipulate large distances between buildings. Similarly “inappropriate” codes have been reported from other warm climates (e.g. Al-Hemaidi 2001, Baker 2002).

However, due to rapid urbanisation in both Morocco and Sri Lanka, there is an ongoing debate regarding approaches to increasing the population density through the revision of the urban codes. Hence, the latest code for Colombo (UDA 1999a, b) promotes high-rise buildings and allows maximum floor area ratio (FAR) values of 8 and above. In Morocco, low-income dwellings will be permitted to have more storeys (MHU 2005). However, although the ongoing changes are in the right direction in both countries, they will not improve outdoor thermal comfort conditions significantly as they will only result in minor increases in maximum H/W ratios.

Consideration of climate aspects in urban design

The interviews with urban planners conducted in this study revealed that the consideration of climate in urban planning and design is limited both in Fez and Colombo. Climate is not considered explicitly but is, instead, included in other aspects, such as environmental issues. Eliasson (2000) came to a similar conclusion after interviewing Swedish urban planners.

Constraints for climate-conscious urban design

There are a number of constraints explaining why climate issues are not considered in urban design. One important constraint is the lack of knowledge about climate issues among urban planners and designers. Apart from limiting opportunities for climate-conscious urban design, this lack of knowledge is likely to make it more difficult for urban planners to argue for climate aspects when conflicts of interest occur, as suggested by Eliasson (2000). There was no evidence that consultant expertise, such as that offered by meteorologists or climatologists, was used. Another major problem is the lack of user-friendly tools to predict the effect of urban design on the microclimate. The use of tools was limited to climate data from climate

Atlases. The findings of this study agree quite well with those of Eliasson (2000), except that the Swedish planners had access to somewhat more tools and occasionally employed the services of climate consultants.

Ways to incorporate climate issues in urban design

Several respondents suggested ways to better incorporate climate issues in the urban planning and design processes. A common proposal was to include climate aspects in zoning and building regulations. This approach is supported by Aynsley and Gulson (1999), who argue that climate aspects should be a legislated planning requirement. There were also suggestions for the development of planning and design guidelines. The latter suggestion agrees with the conclusions of Evans and de Schiller (1996) in Argentina.

Undoubtedly, urban codes play an important role in the provision of climate-conscious urban design. However, governing climate-sensitive urban design solely through codes only is not feasible. For example, a variety of different street designs may be needed to provide comfort. Consequently, it is necessary for planners and urban designers to be knowledgeable about urban climate while also cooperating with climatologists. The interviewees were also of the opinion that education is important, especially for professionals within the fields of urban planning and design. Moreover, public awareness was considered important.

7.3 How to improve thermal comfort at street level

Presented below are proposals for climate-conscious street designs for Fez and Colombo. These are mainly based on the simulation study, but also take measurement results and current urban design practices into account. It should be noted that no comfort zone for PET in hot dry and hot humid climates has been established. The discomfort limits assumed in this study are therefore uncertain. This particularly concerns the lower discomfort level in Fez during the winter, which is based on indoor clothing and activity and which, in reality, is therefore likely to be lower than that shown here.

Recommendations for hot dry climates

The studied city of Fez is used here to represent a hot dry climate. With the exception of its ancient Medina, Fez is, in general, a dispersed, low-rise city. The simulations showed that canyons with high H/W ratios, where buildings provide shade, represent an advantage under summer conditions. On the other hand, for the winter season, a dispersed urban form, with streets with low H/W ratios, is preferable. However, since the summer season is longer than the winter season and since it is more difficult to adapt behaviour and clothing to warm conditions, the majority of streets should be designed for good summer comfort. This would require new urban areas being

far more compact than today's to improve microclimatic conditions during the warm season.

Higher H/W ratios could be achieved either by making the streets narrower, which could be suitable for pedestrian streets, or by making the buildings higher, which is more suitable for streets intended for motor traffic. However, an increase in H/W will lead to higher nocturnal temperatures, which may decrease the possibility of cooling by night ventilation. Moreover, as streets become narrower, problems of privacy increase, with neighbours being able to see into dwellings from across the street. Furthermore, very deep canyons would be unfavourable from the perspective of the dispersion of pollution from motor traffic. Therefore, extremely deep canyons are not recommended.

The simulation study suggested that H/W ratios for east-west oriented streets should be as high as 4 to provide comfort in the summer (Fig. 6.17b). For north-south oriented streets, which turned out to be less problematic in terms of thermal comfort, a H/W ratio of about 2 provided acceptable conditions both in summer and winter (Figs. 6.17a and 6.18a). To provide thermal comfort on a neighbourhood level also in winter, at least some streets, preferably oriented east-west, should be wider to allow for solar access. The canyon of H/W = 0.67 with a colonnade on its northern side and trees planted along the southern side (Fig. 6.18b) provided sufficient solar access under the colonnade in winter, while providing sufficient shade under the same colonnade and under the shading trees on the southern side in summer. The proposed H/W ratio of 4 for east-west oriented streets is higher than that proposed by e.g. Givoni (1998) and Grundström et al. (2003). However, the suggested canyon of H/W = 0.67, intended to permit solar access, is in line with the proposals of these studies. The H/W ratio of 2 that this study proposes for north-south oriented streets is lower than that proposed by Givoni (1998), who suggested H/W ratios between 3 and 5.

It is recommended that buildings have no front setbacks, in order to increase the possibilities of shade for pedestrians. Moreover, overhead shading should be provided in the form of projected upper floors, colonnades, shading trees or other devices to improve thermal comfort for pedestrians. Deciduous trees are suitable since they provide shade in summer and allow solar access in winter.

Open public spaces should preferably be small, but sufficiently large to allow solar access in winter. They should be provided with overhead shading to improve comfort in summer.

Most of the proposed street designs are not possible to achieve given current urban regulations in Fez, particularly not in low-rise residential areas where plots are often large with required setbacks. Consequently, it would be necessary to change the codes to permit higher H/W ratios for streets than is currently the case. Moreover, plot coverage should be increased and there should be no front setbacks. There should be fewer zones for detached villas and plots should be smaller. Such a shift, to a more compact urban design, would lead to higher building and population densities and thus a more efficient land-use, which is in line with the aims of the national authorities. The codes should also promote projecting upper floors

and colonnades, which provide shade at street level. Similarly, horizontal shading devices and shading trees should be encouraged.

Recommendations for hot humid climates

The studied city of Colombo, which is used here to represent a hot humid climate, is, in general, a dispersed, low-rise city. The simulations showed that canyons with high H/W ratios, where shade is provided by buildings, would be desirable to improve microclimatic conditions. This could be achieved either by making the streets narrower, which could be suitable for pedestrian streets, or by making the buildings higher, which is more suitable for streets intended for motor traffic. However, excessively high H/W ratios are likely to increase the nocturnal heat island, which would be negative in Colombo where nocturnal temperatures are high. Moreover, this would restrict air flow and would be unfavourable from the perspective of the dispersion of pollution from motor traffic. Therefore, extremely deep canyons are not recommended.

The simulation study suggests that H/W ratios for east-west streets should be as high as 4 to provide comfort in the summer (Fig. 6.20a). For north-south streets, which proved less problematic in terms of thermal comfort, a H/W ratio of about 2 provides acceptable conditions (Fig. 6.19). In Colombo, spacing between buildings is preferable to permit air flow. This is especially important for the coastal strip to allow the westerly sea breeze to penetrate the city. Consequently, some east-west oriented streets in coastal areas could have H/W ratios as low as about 0.5 (Fig. 6.20b). The H/W ratios proposed in this study are considerably higher than those normally suggested for hot humid climates (see Section 4.4).

Detached tower blocks are well adapted to the hot, humid climate, since they provide a large amount of shade while allowing the wind through and, in fact, stimulating air flow. A blend of high-rise towers and lower buildings, as suggested by de Schiller and Evans (1998) and Aynsley and Gulson (1999), and the use of buildings raised on columns would probably promote even greater air flow. It should be noted, however, that wind speeds in Colombo are, in general, low and the possibilities are therefore limited. However, the possibilities of enhancing air flow require further investigation, as suggested in Section 7.4.

It is recommended that buildings have no front setbacks, in order to increase opportunities to provide shade for pedestrians at street level. However, side setbacks are recommended to increase air movements around buildings and in the streets. Moreover, overhead shading should be provided in the form of projected upper floors, colonnades, shading trees or other devices to improve thermal comfort for pedestrians. Similarly, open public spaces should be provided with overhead shading to improve comfort.

H/W ratios above about 2, as suggested above, are currently not permitted in Colombo and, consequently, urban codes need to be changed. Such a change would lead to higher building and population densities, which is in line with the aims of the national authorities. Instead of front setbacks, codes should stipulate side setbacks

to increase air flow. Projecting upper floors and colonnades, which provide shade at street level, should be promoted and horizontal shading devices and shading trees should be encouraged.

7.4 Future studies

In this study, thermal comfort was calculated theoretically and comfort limits were estimated on the basis of other studies. Moreover, the effects of climate adaptation were not considered. Therefore, there is a great need to conduct field surveys in hot dry and hot humid climates in order to determine actual comfort zones. Such field surveys should include simultaneous microclimate measurements at street level and subjective comfort votes by pedestrians.

Detailed, climate-conscious urban design guidelines and regulations need to be developed for Fez and Colombo. These should include requirements and recommendations regarding street widths, building heights, the spacing of buildings, street orientation, desirable building forms, plot coverage, shading devices, shading trees, surface materials and façade colours. However, since this study was restricted to east-west and north-south oriented streets, the performance of other street orientations needs to be investigated for the two cities.

This study showed the importance of overhead shading in warm climates. Future studies should include *in situ* measurements to develop more detailed knowledge on the effect of shading devices and shading trees.

Wind speeds need to be promoted in hot humid climates, especially where wind speeds are low. The design of urban areas to promote air flow needs to be studied thoroughly, for example by using detailed CFD modelling.

In future studies, it would be interesting to investigate the effect of urban design on thermal comfort and energy use in buildings. Such studies should include the link between architectural and urban design.

Due to the complexity of the urban environment, simulation models are important in understanding how it affects urban climate and to predict the effects of different urban designs. While highly comprehensive and providing detailed output, the simulation programme used in this study, ENVI-met, does not consider the thermal mass of buildings. Future microclimate simulations should preferably use models that take this parameter into account.

In order to increase opportunities for urban designers to *design* comfortable outdoor environments, there is a need to develop user-friendly design tools. Such development should preferably be conducted in cooperation between urban climatologists and urban designers.

References

- Abu-Loghud, J.
1980 *Rabat: Urban Apartheid in Morocco*. Princeton: Princeton University Press.
- Acioly Jr., C., and F. Davidson
1996 *Density in Urban Development*, Building issues 8(3), LCHS, Lund University.
- Adebayo, Y.R.
1991 "Day-time effects of urbanization on relative humidity and vapour pressure in a tropical city", *Theoretical and Applied Climatology* 43: 17–30.
- Ahmed, K.S.
1994 "A comparative analysis of the outdoor thermal environment of the urban vernacular and the contemporary development: case studies in Dhaka". In: Etzion, Y. et al. (eds.), *Proc. 11th International PLEA Conference*, Dead Sea 3–8 July. Ben-Gurion Univ of the Negev, Sede-Boker, p. 341–348.
- 2003 "Comfort in urban spaces: defining the boundaries of outdoor thermal comfort for the tropical urban environments", *Energy and Buildings* 35: 103–110.
- Al-Hemaidi, W.K.
2001 "The metamorphosis of the urban fabric in an Arab-Muslim city: Riyadh, Saudi Arabia", *Journal of Housing and the Built Environment* 16: 179–201.
- Ali-Toudert, F.
2005 *Dependence of Outdoor Thermal Comfort on Street Design in Hot and Dry Climate*, PhD Thesis. Berichte des Meteorologischen Institutes der Universität Freiburg, No. 15, University of Freiburg, Germany.
- Ali-Toudert, F., M. Djenane, R. Bensalem and H. Mayer
2005 "Outdoor thermal comfort in the old desert city of Beni-Isguen, Algeria", *Climate Research* 28: 243–256.
- Ali-Toudert, F., and H. Mayer
2005 "Thermal comfort in urban streets with trees under hot summer conditions", In: Raydan, D.K., and H.H. Melki (eds.), *Proc. 22nd International PLEA Conference*, Notre Dame University, Lebanon, 13–16 November, p. 699–704.
- 2006 "Numerical study on the effects of aspect ratio and orientation of an urban street canyon on outdoor thermal comfort in hot and dry climate", *Building and Environment* 41: 94–108.
- Arnfield, A.J.
1990a "Street design and urban canyon solar access", *Energy and Buildings* 14: 117–131.
1990b "Canyon geometry, the urban fabric and nocturnal cooling: a simulation approach", *Physical Geography* 11: 220–239.
2003 "Two decades of urban climate research: a review of turbulence, exchanges of energy and water, and the urban heat island", *International Journal of Climatology* 23: 1–26.
- Arnfield, A.J., and C.S.B. Grimmond
1998 "An urban canyon energy budget model and its application to urban storage heat flux modeling", *Energy and Buildings* 27(1): 61–68.
- ASHRAE
1997 *1997 ASHRAE Handbook: Fundamentals (SI Edition)*, Atlanta: American Society of Heating, Refrigerating and Air-Conditioning Engineers.
- AUSF
1988 *Plans d'aménagement de la Wilaya de Fès: règlement général*. Fez: Agence Urbaine et de Sauvegarde de Fès (AUSF).
2006 *Le règlement d'aménagement*. Fez: Agence Urbaine et de Sauvegarde de Fès (AUSF). <http://www.ausf.org.ma>
- AUSF and ADER-Fès
1999 *Plan d'aménagement Médina de Fès intra muros*. Fez: Agence Urbaine et de Sauvegarde de Fès (AUSF) and Agence de Dédensification et de Réhabilitation de la médina de Fès (ADER-Fès).
- Aynsley, R., and L. Gulson
1999 "Microclimate and urban planning in the humid tropics", paper presented at *RAPI 27th National Congress*, 19–22 September, Northern Territory Dept. of Lands, Planning and Environment, Darwin (Australia).
- Azar, S.
2006 *TownScope III* website. <http://www.townscope.com>

- Baker, L.A., A.J. Brazel, N. Selover, C. Martin, N. McIntyre, F.R. Steiner, A. Nelson and L. Musacchio
2002 "Urbanization and warming of Phoenix (Arizona, USA): impacts, feedbacks and mitigation", *Urban Ecosystems* 6: 183–203.
- Bianca, S.
2000 *Urban Form in the Arab World: Past and Present*. London: Thames & Hudson
- Bitan, A., and O. Potchter
1995 "Theory and methodology of climatic planning and its application to the new city of Bet-Shemesh", *Town Planning Review* 66(1): 61–81.
- Bosselmann, P., E. Arens, K. Dunker and R. Wright
1995 "Urban form and climate. Case study, Toronto", *Journal of the American Planning Association* 61(2): 226–239.
- Bouayad, L.
1979 *La sauvegarde de la médina de Fès/The preservation of the medina in Fez*. UNESCO-ICOMOS Documentation Centre, Monumentum vol. 18–19. <http://www.international.icomos.org/monumentum/vol18-19/>
- Bouchair, A., and A. Dupagne
2003 "Building traditions of Mzab facing the challenges of re-shaping of its built form and society", *Building and Environment* 38: 1345–1364.
- Bourbia, F., and H.B. Awbi
2004 "Building cluster and shading in urban canyon for hot dry climate. Part 1: Air and surface temperature measurements", *Renewable Energy* 29: 249–262.
- Brager, G.S., and R.J. de Dear
1998 "Thermal adaptation in the built environment: a literature review", *Energy and Buildings* 27: 83–96.
- Bruse, M.
1999 *Die Auswirkungen kleinskaliger Umweltgestaltung auf das Mikroklima. Entwicklung des prognostischen numerischen Modells ENVI-met zur Simulation der Wind-, Temperatur-, und Feuchtverteilung in städtischen Strukturen*. PhD Thesis. Bochum: University of Bochum.
- 2006 *ENVI-met website*. <http://www.envi-met.com>
- Busch, J.F.
1992 "A tale of two populations: thermal comfort in air-conditioned and naturally ventilated offices in Thailand". *Energy and Buildings* 18: 235–249.
- CERED
2004 *Evolution des ménages et des logements et stratégies résidentielles*. Cahier de recherche no. 16. Rabat: Centre d'Etudes et de Recherches Démographiques (CERED), Haut Commissariat au Plan.
- CERMA
2006 *Solène – software for simulating of sunshine, lighting and thermal radiation*. <http://www.cerma.archi.fr/CERMA/Expertise/solene>.
- Coronel, J.F., and S. Álvarez
2001 "Experimental work and analysis of confined urban spaces", *Solar Energy* 70(3): 263–273.
- Correa, C.
1989 *The New Landscape: Urbanization in the Third World*. London: Butterworth Architecture.
- de Dear, R.J., and J. Pickup
2000 "An outdoor thermal environment index (OUT_SET*) – Part II – Applications, In: de Dear, R.J. et al. (eds.), *Biometeorology and Urban Climatology at the Turn of the Millennium*. Sydney: World Meteorological Organization, p. 285–290.
- Dept. of Census and Statistics
2005 *Statistical Abstract 2005*. <http://www.statistics.gov.lk/abstr/index.htm>
- de Schiller, S., and J.M. Evans
1998 "Sustainable urban developments: design guidelines for warm humid cities", *Urban Design International* 3(4): 165–184.
- Eben Saleh, M.A.
2001 "The evolution of planning and urban theory from the perspective of vernacular design: MOMRA initiatives in improving Saudi Arabian neighbourhoods", *Land Use Policy* 18: 179–190.
- Eliasson, I.
1996 "Urban nocturnal temperatures, street geometry and land use", *Atmospheric Environment* 30(3): 379–392.
- 2000 "The use of climate knowledge in urban planning", *Landscape and Urban Planning* 48: 31–44.
- Elnahas, M.M., and T.J. Williamson
1997 "An improvement of the CTTC model for predicting urban air temperatures", *Energy and Buildings* 25: 41–49.
- Emmanuel, R.
1993 "A hypothetical "shadow umbrella" for thermal comfort enhancement in the equatorial urban outdoors", *Architectural Science Review* 36: 173–184.
- 1997 *Summertime heat island effects of urban design parameters*. PhD Thesis, University of Michigan, Ann Arbor.
- 2005a *An urban approach to climate-sensitive design: strategies for the tropics*. Spon Press, London.
- 2005b "Thermal comfort implications of urbanization in a warm-humid city: the Colombo Metropolitan Region (CMR), Sri Lanka", *Building and Environment* 40: 1591–1601.

- Erell, E., and T. Williamson
2006 "Comments on the correct specification of the analytical CTTC model for predicting the urban canopy layer temperature", *Energy and Buildings* 38: 1015–1021.
- Evans, J.M.
1980 *Housing, Climate and Comfort*. London: The Architectural Press.
- Evans, J.M., and S. de Schiller
1990/91 "Climate and urban planning: the example of the planning code for Vicente Lopez, Buenos Aires", *Energy and Buildings* 15/16: 35–41.
- 1996 "Application of microclimate studies in town planning: a new capital city, an existing urban district and urban river front development", *Atmospheric Environment* 30(3): 361–364.
- Fanger, P.O., and J. Toftum
2002 "Extension of the PMV model to non-air-conditioned buildings in warm climates", *Energy and Buildings* 34: 533–536.
- Fountain, M.E., and C. Huizenga
1994 *Using the ASHRAE thermal comfort tool*. An ASHRAE Special Publication, ASHRAE, Atlanta.
- Gehl, J.
2001 *Life Between Buildings – Using Public Space*, Copenhagen: The Danish Architectural Press.
- Givoni, B.
1992 "Climatic aspects of urban design in tropical regions", *Atmospheric Environment* 26B(3): 397–406.
- 1998 *Climate considerations in building and urban design*. New York: Van Nostrand Reinhold.
- Givoni, B., M. Noguchi, H. Saaroni, O. Potchter, Y. Yaacov, N. Feller and S. Becker
2003 "Outdoor comfort research issues", *Energy and Buildings* 35: 77–86.
- Glaumann, M., and U. Westerberg
1988 *Klimatplanering – Vind*. Stockholm: Svensk Byggtjänst.
- Golany, G.
1996 "Urban design morphology and thermal performance", *Atmospheric Environment* 30(3): 455–465.
- Government of Sri Lanka
1980 *Housing and Town Improvement Ordinance*. In: Legislative Enactments of the Democratic Socialist Republic of Sri Lanka, volume XIX.
- Groat, L., and D. Wang
2002 *Architectural Research Methods*. New York: John Wiley & Sons.
- Grundström, K., E. Johansson, M. Mraissi and D. Ouahrani
2003 *Climat & Urbanisme – La relation entre le confort thermique et la forme du cadre bâti*, Report 8. Lund: Housing Development & Management.
- Hall, P.
2002 *Cities of Tomorrow*. Oxford: Blackwell.
- HCP
2004 *Recensement Général de la Population et de l'Habitat*. Rabat: Haut Commissariat au Plan. (HCP) http://www.recensement.hcp.ma/rubrique.php?id_rubrique=33
- Holmer, B., and I. Eliasson
1999 "Urban-rural vapour pressure differences and their role in the development of urban heat islands", *International Journal of Climatology* 19: 989–1009.
- Höppe, P.
1993 "Indoor Climate", *Experientia* 49: 775–779.
- 1999 "The physiological equivalent temperature – a universal index for the biometeorological assessment of the thermal environment", *International Journal of Biometeorology* 43: 71–75.
- 2002 "Different aspects of assessing indoor and outdoor thermal comfort", *Energy and Buildings* 34: 661–665.
- Ichter, J.-P.
1979 "Le schéma d'aménagement de Fès", *Urbanisme* 48 (173/174): 66–72.
- IPCC
2001 *Climate Change 2001: Impacts, Adaptation, and Vulnerability*. Cambridge: Cambridge University Press.
- Jansson, C.
2006 *Urban microclimate and surface hydro-meteorological processes*. PhD Thesis. Stockholm: Royal Institute of Technology.
- Jáuregui, E.
1997 "Heat island development in Mexico City", *Atmospheric Environment* 31: 3821–3831.
- Jáuregui, E., and A. Tejada
1997 "Urban-rural humidity contrast in Mexico City", *International Journal of Climatology* 17: 187–196.
- Jonsson, P.
2005 *Urban climate and air quality in tropical cities*. PhD Thesis, Earth Sciences Centre, Göteborg University, Göteborg.
- Jonsson, P., and S. Lindqvist
2005 "Differences in urban heat island development between a coastal and an inland city in Africa", Submitted to *International Journal of Climatology*.
- Jonsson, P., I. Eliasson, B. Holmer and C.S.B. Grimmond
2005 "Longwave incoming radiation in the tropics – results from field work in three African cities", Submitted to *Theoretical and Applied Climatology*.

- Kanda, M., R. Moriwaki and Y. Kimoto
2005 "Temperature profiles within and above an urban canopy", *Boundary-Layer Meteorology* 115: 499–506.
- Katzschner, L.
2000 "Urban climate maps – a tool for calculations of thermal conditions in outdoor spaces". In Steemers, K. and S. Yannas (eds.): *Architecture City Environment – proc. 17th International PLEA Conference*, Cambridge (UK), 3–5 July, p. 453–458. London: James & James Ltd.
- Katzschner, L., U. Bosch and M. Roettgen
2004 "Thermal comfort mapping and zoning". In: Nikolopoulou, M. (ed.): *Designing Open Spaces in the Urban Environment: a Bioclimatic Approach*, Centre for Renewable Energy Sources (CRES), Athens.
- Koenigsberger, O.H., T.G. Ingersoll, A. Mayhew and S.V. Szokolay
1974 *Manual of Tropical Housing and Building*. Part 1: Climatic Design. London: Longman.
- Kursis, J.
2001 *Normes d'urbanisme et d'habitat à Fès: une étude tenant en compte du climat urbain*. Housing Development & Management, Lund University, and Laboratoire Public d'Essais et d'Etudes, Morocco. Lund: Housing Development & Management.
- Kusaka, H., and F. Kimura
2004 "Thermal effects of urban canyon structure on the nocturnal heat island: numerical experiment using a mesoscale model coupled with an urban canopy model". *Journal of Applied Meteorology* 43: 1899–1910.
- Laborie, J.-P. (ed.)
1990 *Atlas de la médina de Fès*. Toulouse: Presses Universitaires du Mirail.
- Lahme, E., and M. Bruse
2005 "Microclimatic effects of a small urban park in a densely built up area: measurements and model simulations". In: Klysiak, K., et al. (eds.), *5th International Conference on Urban Climate*, Vol. 2: 273–276, Dept. of Meteorology and Climatology, University of Lodz, Poland.
- Landsberg, H.E.
1981 *The urban climate*, vol. 28, International Geophysics Series. New York: Academic Press.
- 1984 "Problems of design for cities in the tropics". In: Oke, T.R. (ed.): *Urban climatology and its applications with special regard to tropical areas*. WMO Report no. 652. Geneva: World Meteorological Organization (WMO).
- Lindqvist, S., and J.O. Mattsson
1989 "Planning, topography and climate; topoclimatic maps for different planning levels: some Swedish examples", *Building Research and Practice* 5: 299–304.
- Matzarakis, A.
2000 "Estimation and calculation of the mean radiant temperature within urban structures". *Manual to RayMan*, University of Freiburg, Germany.
- Matzarakis, A., H. Mayer and M.G. Iziomon
1999 "Applications of a universal thermal index: physiological equivalent temperature", *International Journal of Biometeorology* 43: 76–84.
- Matzarakis, A., F. Rutz and H. Mayer
2000 "Estimation and calculation of the mean radiant temperature within urban structures". In: de Dear, R.J. et al. (eds.), *Biometeorology and Urban Climatology at the Turn of the Millennium*. Sydney: World Meteorological Organization, p. 273–278.
- Mayer, H., and P. Höppe
1997 "Thermal comfort of Man in Different Urban Environments", *Theoretical and Applied Climatology* 38: 43–49.
- Mayer, H., A. Matzarakis and M.G. Iziomon
2003 "Spatio-temporal variability of moisture conditions within the urban canopy layer", *Theoretical and Applied Climatology* 76: 165–179.
- McIntyre, D.A.
1980 *Indoor Climate*. London: Applied Science Publishers.
- Mendis, W.
2003 Personal communication.
- Meteotest
1999 *METEONORM 4.0*. Bern: Meteotest.
- MHU
2005 *La définition des normes pour l'habitat social*. Rabat: Ministère de l'Habitat et de l'Urbanisme. (MHU) http://www.seh.gov.ma/Habitat%20Insalubre/Etudes/etude_norme.htm
- 2006 *Projet de loi no. 04-04 édictant diverses dispositions en matière d'habitat et d'urbanisme*, Ministère délégué chargé de l'Habitat et de l'Urbanisme. <http://www.mhu.gov.ma/NR/exeres>
- Mills, G.
1997a "Building density and interior building temperatures: a physical modeling experiment", *Physical Geography* 18(3): 195–214.
- 1997b "An urban canopy-layer climate model", *Theoretical and Applied Climatology* 57: 229–244.
- Nakamura, Y., and T.R. Oke
1988 "Wind, temperature and stability conditions in an east-west oriented urban canyon", *Atmospheric Environment* 22(12): 2691–2700.
- Nasrallah, H.A., A.J. Brazel and R.C. Balling
1990 "Analysis of the Kuwait City urban heat island", *International Journal of Climatology* 10: 401–405.

- Nichol, J.E.
1996 "High-resolution surface temperature patterns related to urban morphology in a Tropical city: a satellite-based study", *Journal of Applied Meteorology* 35: 135–146.
- Nikolopoulou, M., S. Lykoudis and M. Kikira
2003 "Thermal comfort in outdoor spaces: field studies in Greece", In: Klysiak, K., et al.(eds.), *5th International Conference on Urban Climate*, Vol. 2: 91–94, Dept. of Meteorology and Climatology, University of Lodz, Poland.
- Nikolopoulou, M., and K. Steemers
2003 "Thermal comfort and psychological adaptation as a guide for designing urban spaces", *Energy and Buildings* 35: 95–101.
- Observatoire de l'Habitat
2001 *L'évaluation du volume de l'habitat insalubre en 2000*. Rabat: Observatoire de l'Habitat, Direction de la Promotion Immobilière, Ministère de l'Aménagement du Territoire, de l'Environnement, de l'Urbanisme et de l'Habitat.
- Oke, T.R.
1981 "Canyon geometry and the nocturnal urban heat island: comparison of scale model and field observations", *International Journal of Climatology* 1: 237–254.
- Oke, T.R.
1982 "The energetic basis of the urban heat island", *Quart. Journal of Royal Meteorological Society* 108: 1–24.
1987 *Boundary Layer Climates*. 2nd edition London, New York: Routledge.
1988a "Street design and urban canopy layer climate", *Energy and Buildings* 11: 103–113.
1988b "The urban energy balance", *Progress in Physical Geography* 12: 471–508.
1989 "The micrometeorology of the urban forest", *Philosophical Transactions of the Royal Society of London, Series B* 324: 335–349.
2004 *Initial guidance to obtain representative meteorological observations at urban sites*, World Meteorological Organization (WMO), Geneva.
- Oke, T.R., G.T. Johnson, D.G. Steyn, I.D. Watson
1991 "Simulation of surface urban heat islands under 'ideal' conditions at night. Part 2: diagnosis of causation", *Boundary-Layer Meteorology* 56:339–358.
- Oke, T.R., R.A. Spronken-Smith and C.S.B. Grimmond
1999 "Energy balance of central Mexico City during the dry season", *Atmospheric Environment* 33: 3919–3930.
- Oseland, N.A., and M.A. Humphries
1994 *Trends in thermal comfort research*, BR 266, Building Research Establishment, Watford.
- Owens, S.
1986 *Energy, Planning and Urban Form*, Pion, London.
- Pearlmutter, D., A. Bitan and P. Berliner
1999 "Microclimatic analysis of 'compact' urban canyons in an arid zone", *Atmospheric Environment* 33(24–25): 4143–4150.
- Pearlmutter, D., P. Berliner and E. Shaviv
2005 "Evaluation of urban surface energy fluxes using an open-air scale model", *Journal of Applied Meteorology* 44: 532–545.
2006 "Physical modeling of pedestrian energy exchange within the urban canopy", *Building and Environment* 41: 783–795.
- Pickup, J., and R.J. de Dear
2000 "An outdoor thermal comfort index (OUT_SET*) – Part I – The model and its assumptions", In: de Dear, R.J. et al. (eds.), *Biometeorology and Urban Climatology at the Turn of the Millennium*. Sydney: World Meteorological Organization, p. 279–283.
- Pinson, D.
1994 "Insalubrité et renouvellement du cadre bâti: de l'approche hygiéniste à l'approche écologique", *Habitat Insalubre et Stratégies d'Intervention*, International seminar, Meknès 24–26 May 1994. Rabat: Agence National de lutte contre l'Habitat Insalubre (ANHI)
- Rosenlund, H., E. Johansson, K. Grundström, M. El Kortbi and M. Mraissi
2000 "Urban micro-climate in the city of Fez, Morocco". In Steemers, K. and S. Yannas (eds.): *Architecture City Environment – proc. 17th International PLEA Conference*, 3–5 July, Cambridge, UK. London: James & James Ltd, p. 453–458.
- Roth, M.
2000 "Review of atmospheric turbulence over cities", *Quarterly Journal of the Royal Meteorological Society* 126: 941–990.
- Saaroni H., E. Ben-Dor, A. Bitan and O. Potchter
2000 "Spatial distribution and microscale characteristics of the urban heat island in Tel-Aviv, Israel", *Landscape and Urban Planning* 48: 1–18.
- Santamouris, M.
2001 *Energy and Climate in the Urban Built Environment*. London: James & James.
- Shashua-Bar, L., and M.E. Hoffman
2000 "Vegetation as a climate component in the design of an urban street", *Energy and Buildings* 31: 223–238.
2002 The green CTC model for predicting the air temperature in small urban wooded sites, *Building and Environment* 37: 1279–1288.
- Spagnolo, J.C., and R.J. de Dear
2003 "A field study of thermal comfort in outdoor and semi-outdoor environments in subtropi-

- cal Sydney Australia”, *Building and Environment* 38: 721–738.
- Spronken-Smith, R.A., and T.R. Oke
1998 “The thermal regime of urban parks in two cities with different summer climates”, *Int. Journal of Remote Sensing* 19(11): 2085–2104.
- Stemmers, K., N. Baker, D. Crowther, J. Dubiel and M. Nikolopoulou
1998 “Radiation absorption and urban texture”, *Building Research & Information* 26(2): 103–112.
- Svensson, M.K., S. Thorsson and S. Lindqvist
2003 “A geographical information system model for creating bioclimatic maps – examples from a high, mid-latitude city”, *International Journal of Biometeorology* 47: 102–112.
- Swaid, H.
1992 “Intelligent urban forms (IUF) – A new climate-concerned, urban planning strategy”, *Theoretical and Applied Climatology* 46: 179–191.
- Swaid, H., and M.E. Hoffman
1990 “Prediction of urban air temperature variations using the analytical CTTC model”, *Energy and Buildings* 14: 313–324.
- Swaid, H., M. Bar-El and M.E. Hoffmann
1993 “A bioclimatic design methodology for urban outdoor spaces”, *Theoretical and Applied Climatology* 48: 49–61.
- Szokolay, S.V.
2004 *Introduction to Architectural Science – the basis of sustainable design*. Oxford: Architectural Press.
- Tablada de la Torre, A.
2006 *Shape of new residential buildings in the historical centre of old Havana to favour natural ventilation and thermal comfort*. PhD Thesis, Post-Graduate Centre Human Settlements, Catholic University of Leuven, Leuven
- Tahiri, M.C.
1999 “Norme d’urbanisme et habitat social”. *Le Matin du Sahara et du Maghreb*, 10 May 1999.
- Tannerfeldt, G., and P. Ljung
2006 *More Urban – Less Poor. Fighting poverty in an urban world*. London: Earthscan.
- Teller, J., and S. Azar
2001 “TOWNSCOPE II – A computer system to support solar access decision-making”, *Solar Energy* 70(3): 187–200.
- Tso, C.P.
1996 “A survey of urban heat island studies in two tropical cities”, *Atmospheric Environment* 30: 507–519.
- UDA
1999a *City of Colombo Development Plan. Volume I*. Colombo: Urban Development Authority
- (UDA), Ministry of Urban Development, Housing and Construction.
- 1999b *City of Colombo Development Plan. Volume II: Planning and Building Regulations*. Colombo: Urban Development Authority (UDA), Ministry of Urban Development, Housing and Construction.
- UN
2006 *World Population Prospects : The 2004 Revision Population Database*. <http://esa.un.org/unpp/>
- Upmanis, H., I. Eliasson and S. Lindqvist
1998 “The influence of green areas on nocturnal temperatures in a high latitude city (Göteborg, Sweden)”, *International Journal of Climatology* 18: 681–700.
- Vacher, H.
1991 “Bevaring i Fez”. *Arkitekten* 93: 138–145.
- van Horen, B.
2002 “City profile: Colombo”. *Cities* 19(3): 217–227.
- VDI
1998 *Environmental meteorology – Methods for the human biometeorological evaluation of climate and air quality for the urban and regional planning at regional level. Part I: Climate*. VDI 3787 Part 2, VDI/DIN Handbuch Reinhaltung der Luft, Band 1b. Berlin: Beuth Verlag.
- Ville de Casablanca
1952 *Arrêté Municipal Permanent portant règlement général de voirie et de construction*. Casablanca: Ville de Casablanca.
- Ville de Fès
1969 *Arrêté Municipal portant Règlement de Voirie et de Construction pour la ville de Fès*. Fez: Ville de Fès.
- Widerberg, K.
2002 *Kvalitativ forskning i praktiken*. Lund: Studentlitteratur.
- Wijewardena, D.H.
2005 “Colombo – once a garden city turning into a concrete jungle”, *Daily News*, 2 June. <http://www.dailynews.lk/2005/06/02/fea06.htm>
- WHO
2005 *Fact sheet EURO/15/05*. Copenhagen: World Health Organization.
- World Bank
2000 *Cities in Transition: World Bank Urban and Local Government Strategy*. Washington: The World Bank.
- World Gazetteer
2006 *Population of cities and towns of the world*. <http://www.world-gazetteer.com>
- Yu, C., and W.N. Hien
2006 “Thermal benefits of city parks”, *Energy and Buildings* 38: 105–120.

Glossary of terms and definitions

Advection	Horizontal air movements
Albedo	Reflectivity
Anthropogenic heat	Heat release from human activities.
Atmospheric stability	The atmosphere is said to be <i>unstable</i> when the air temperature decreases with height (typical for sunny days when solar radiation induces natural convection), <i>stable</i> when the air temperature increases with height (typical for calm nights) and <i>neutral</i> when there is no temperature gradient.
Density (building)	Amount of the ground occupied by buildings.
Density (residential)	No. of persons per unit of land (or no. of housing units per unit of land).
Dry bulb temperature	The air temperature of a dry thermometer.
Emmissivity	The ratio of energy emitted from a surface compared to a black body.
Evapotranspiration	Loss of water to the air due to combined evaporation and transpiration.
Floor area ratio (FAR)	The ratio between the total gross area of all floors of a building and the plot area
Forced convection	Air motion caused by wind.
Global radiation	The sum of direct and diffuse solar radiation.
Globe thermometer	A thermometer enclosed in a black painted globe used to measure the mean radiant temperature.
Impervious surface	A surface through which water cannot penetrate.
Land-use	The activity land is used for.
Latent heat	The heat required to change the state of water, e.g. from liquid to vapour, without change of temperature.
Long-wave radiation	“Low temperature” radiation, e.g. heat radiation from building surfaces.

Master plan	Document describing, in words and with maps, an overall development concept including both present land-uses as well as future land development.
Mean radiant temperature (MRT)	The temperature of an imaginary enclosure with which the human body would exchange the same radiation as with the actual environment.
Medina	Here used in the context “old”, historic city.
Natural (free) convection	Vertical air motion due to density differences.
Octa	Unit that expresses the portion of the sky covered with clouds (equal to one-eighth of the sky vault).
Physiologically equivalent temperature	The air temperature in a typical indoor setting at which the heat balance of the human body is maintained with core and skin temperatures equal to those of the actual environment
Plot coverage	The amount of a plot covered by buildings.
Sensible heat	Heat energy that can be sensed, i.e. measured by a thermometer.
Setback	A required distance from the plot border to the building occupying the plot.
Shanty town	Informal settlement with “non-permanent” buildings, often lacking land ownership.
Short-wave radiation	“High temperature” radiation emitted by the sun.
Sky view factor (SVF)	The portion of the sky that can be seen from a point on a surface.
Slum area	Area of permanent buildings in very poor condition and lacking basic sanitary facilities.
Solar altitude	The vertical angle between the sun’s position and the horizon.
Solar azimuth	The horizontal angle of the sun in relation to north.
Spontaneous settlement	Unplanned, non-regularized, and often illegal, human settlement.
Thermal admittance	The ability of a surface to take up or release heat (also called the heat penetration coefficient).
Turbulence	A state of the air in which air speed and direction vary randomly.

Urban canopy layer	The atmospheric layer between the ground and the roof tops
Urban street canyon	The space delimited by the street and the façades of the buildings along the street
Urban design	Part of urban planning that focuses on the design of places, i.e. buildings and the three-dimensional space between them. It is often defined as an intermediate scale between architecture and urban planning.
Urban fabric	The physical structure of an urban area.
Urban form	The physical form of an urban area consisting of street patterns, building sizes and shapes, architecture, and density.
Urban growth	The increase in urban population.
Urbanization	The growth of the proportion of urban population in a country.
Urban heat island	Urban areas being warmer than the surrounding rural areas. Primarily a nocturnal phenomenon.
Urban sprawl	Horizontal growth of a city through low-density developments.
U-value	The amount of heat per unit area that passes through a building element.
Vapour pressure	The partial pressure of the air due to water vapour.
Wilaya	Here: administrative region (Morocco).

Material properties

Table A 1 Short-wave reflectivity (albedo) and long-wave emissivity (and absorptivity) of typical rural and urban surface materials (Evans 1980, Oke 1987).

<i>Surface</i>	<i>Short-wave reflectivity</i>	<i>Long-wave emissivity and absorptivity</i>
Dark, wet soil	0.05	0.98
Light, dry soil	0.40	0.90
Long grass	0.16	0.90
Short grass	0.26	0.95
Asphalt	0.05–0.20	0.95
Concrete	0.10–0.35	0.90
Brick	0.20–0.40	0.90–0.92
White paint	0.50–0.90	0.85–0.95
Red, brown and green paint	0.20–0.35	0.85–0.95

Table A 2 Typical values of volumetric heat capacity, thermal conductivity and thermal admittance of typical rural and urban materials.

<i>Material</i>	<i>Heat capacity (kJ/m³°C)</i>	<i>Thermal conductivity (W/m°C)</i>	<i>Thermal admittance* (J/m²s^{0.5}°C)</i>
Sandy soil, dry	1300	0.30	600
Sandy soil, saturated	3000	2.2	2600
Clay soil, dry	1400	0.25	600
Clay soil, saturated	3100	1.6	2200
Asphalt	1900	0.80	1200
Brick	1400	0.70	1100
Concrete	2100	1.5	1800
Natural stone	2300	2	2100
Softwood	1400	0.14	400

* Sometimes called heat penetration coefficient or thermal effusivity.

Sources: Evans 1980, Oke 1987, Oke 1988b.

The interview guide

1 Background questions

- Name, profession, age and sex.
- Current department and position.
- Time working in the current position. Previous career within the same organization.
- Academic education and professional career.

2 Duties/tasks

- What are your current tasks/responsibilities?
- What is your role in urban planning/at what level of planning are you involved?
- What planning issues do you give the highest priorities – traffic, infrastructure, housing, aesthetics, etc?
- What are the main constraints in your planning work – economy, time, policy, etc?
- What are the current building densities for residential housing? Within which limits is it allowed to vary? Is the trend that the density is increasing/decreasing?

3 Urban planning/design and climate

- Do you have an interests in questions related to climate adaptation and thermal comfort? Do you think it would be beneficial to include climate and comfort aspects in urban design?
- At which level(s) of the planning process is climatic issues considered?
- How much time do you spend on discussing climatic aspects in planning? Would you like to dedicate more/less time for these issues?
- Have you had any education (university, internal, post graduate, etc) regarding the link between urban design and urban micro-climate?
- Which tools – e.g. climatic maps, statistical weather data, computer softwares – are available to predict the effect of urban planning/design on the micro-climate? Where do you find these tools/information?

- If the answers of questions 12–14 are no:
 - Why are climatic issues not considered?
 - What are the obstacles/constraints – lack knowledge, lack of tools, lack of climate data, etc?
- If you knew that you could improve the micro-climate in urban environments through urban design, would you be interested to incorporate these aspects in the planning process?
- Are clients/developers or the public demanding climate-conscious design?
- In your opinion, how could climate aspects be incorporated in urban development in the future?