



LUND UNIVERSITY

Heterogeneity in the apprehension of adaptation and justice

Bierschenk, Bernhard; Bierschenk, Inger

2004

[Link to publication](#)

Citation for published version (APA):

Bierschenk, B., & Bierschenk, I. (2004). *Heterogeneity in the apprehension of adaptation and justice*. (Kognitionsvetenskaplig forskning / Cognitive Science Research; Vol. 91). Copenhagen University & Lund University. <http://archive.org/details/studiesinconsciousness>

Total number of authors:

2

General rights

Unless other specific re-use rights are stated the following general rights apply:

Copyright and moral rights for the publications made accessible in the public portal are retained by the authors and/or other copyright owners and it is a condition of accessing publications that users recognise and abide by the legal requirements associated with these rights.

- Users may download and print one copy of any publication from the public portal for the purpose of private study or research.
- You may not further distribute the material or use it for any profit-making activity or commercial gain
- You may freely distribute the URL identifying the publication in the public portal

Read more about Creative commons licenses: <https://creativecommons.org/licenses/>

Take down policy

If you believe that this document breaches copyright please contact us providing details, and we will remove access to the work immediately and investigate your claim.

LUND UNIVERSITY

PO Box 117
221 00 Lund
+46 46-222 00 00

**Heterogeneity in the Apprehension of
Adaption and Justice**

**Bernhard Bierschenk
Inger Bierschenk**

2004

No. 91



Copenhagen University
Denmark



Lund University
Sweden

**KOGNITIONSVETENSKAPLIG
FORSKNING**

Cognitive Science Research

**Heterogeneity in the Apprehension of
Adaption and Justice**

**Bernhard Bierschenk
Inger Bierschenk**

2004

No. 91

Cognitive Science Research
Lund University
University of Copenhagen

Editorial board

Bernhard Bierschenk (editor), Lund University
Inger Bierschenk (co-editor), University of Copenhagen
Ole Elstrup Rasmussen, University of Copenhagen
Helge Helmersson (adm. editor), Lund University
Jørgen Aage Jensen, Danish University of Education

Cognitive Science Research

Copenhagen Competence
Research Center
University of Copenhagen
Njalsgade 88
DK-2300 Copenhagen S
Denmark

Adm. editor

Helge Helmersson
Dep. of Business Adm.
Lund University
P.O. Box 7080
S-220 07 Lund
Sweden

Abstract

The present report is about the fourth experiment in a series of five. This series concerns a longitudinal study of changing shapes of mind. Based on the assumption that mind is an emergent property of the processes that produce natural language expressions, mental development is discoverable through the Agent-action-Objective (AaO) mechanisms forming language spaces. These are approachable with Perspective Text Analysis (PTA). The present study is focussing on the way in which the evolutionary process of text production portrays the system of thought that holds that human fitness can be explained on the basis of progressive adaptation. In what way this idea has been apprehended from Strindberg's drama play (Miss Julie) and to what degree it has been embodied into the students' discourse, has been studied in the natural context of an educational program. The mediated structures show a clear-cut result. It is the individual perspective that has emerged out of the verbal flow. In one perspective appears the social aspect of the play, while the naturalistic aspect is dominating the other. This result confirms previously made observations: The social aspect pertains to a descriptive dimension. The extraction of the naturalistic aspect has been shown to be dependent on a reflective dimension. Finally, this individual ability to apprehend one or the other form of structural information confirms that the individual attunes his perceptions in agreement with the predetermined order of an analytic or a synthetic mind.

The primary postulate, which is governing the research approaches in the behavioural sciences, appears to be that the application of the problem solving paradigms of the physical sciences to behavioural problems would produce proper solutions. But the development of tests and measurements has not been able to contribute to proper adjustment and evaluative justice. The underlying assumptions seem to confound the scientific study of human fitness with the understanding of the physical science paradigms, which assert that nature's objectivity is the cornerstone in any scientific study.

Short Background

In physics and chemistry studies are carried out with the purpose to explain "spacetime" structures on the basis of light emission and processes that generate hydro-dynamical convections. At the interface between this kind of studies and biology is the scientific focus oriented towards the evolutionary development of organic molecules. These studies are designed to gain insight into the working of those processes that generate biological information in a pre-biotic world. But in the transition from the physiological to the ecological level are biological phenomena investigated that constitute the basis for the bio-kinetic study of onto- as well as phylogeny. The establishment of a link between biological information and behaviour has been crucial for this approach. However, methodological shortcomings and uncritical acceptance of seemingly objective physiological measurements have, thus far, led to its weakness. At present, there are no signs of a critical discussion of the "illusions" communicated with the application of psychophysical methods as "blinds" to lacking precision in measurement and objectivity in approach (Fiedler, 2003).

The reductive approach. The scientific laboratory is the classical site for the production of new knowledge, and the uncertainty, related to it is believed to be reducible through science. Thus far, knowledge, derived from laboratory experiments, has been conceived to be independent of its context of production. With reference to linear problems, it means that the proper design has free parameters, which implies that the resulting knowledge can be fiddled into the context of choice. Thus, only the connectivity of the applied design is accepted as proper foundation for the construction of a general solution and consequently a universal knowledge base, which everyone can access through scientific journals. Further context independent processing of natural language expressions in modelling and simulation is carried out on the assumption that text can be broken into pieces, which can provide the elements for model construction. Conceptualised as universally valid labels of links and boxes, this approach has been treated as if it had a problem-solution capacity. Thus, it is assumed that primitives carry commonly valid properties, which may be framed deductively into a logically sound design. Together with the absence of a method that can account for singularity and meaning, the reductive approach has contributed to the fact that all measuring devices have been restricted to the establishment of bulk averages and their relationship to constructs, definitions and other frames of reference, which however are obscuring insight into intermittent phase transitions and the development of corresponding thermodynamic trajectories.

The non-reductive approach. The production of knowledge within the context of a planned application implies an entirely new approach, namely embedding. This means that the complexity of natural systems and their non-linear dynamics is producing the intrinsic coordinates that generate the structures. What sets the non-reductive approach apart from working with interconnectivity and artificially constructed classes, as well as their arrangement into models is its concentration on rotational dynamics and on the "geometric" foundation of individual behaviour. This condition will make it possible to demonstrate dynamical behaviour through the discovered AaO mechanism and to extract orientation and

direction in the identified movement patterns. The goal is to produce multiply stable trajectories, which are adapted to the particular task. Therefore, the development of a theory, a method of analysis and the representation of fitness measures require that the specificity and uniqueness of the individual can be made the foundation of research. The establishment of the dynamic basis for self-organisation and self-reference by means of text production together with the development of an algorithm for automatic processing has resulted in the VERTEX version of "Perspective Text Analysis". The method has the capacity to extract specificity and to provide its invariant formulation. In particular, it is this dynamic behaviour in the [AaO] units that will provide the basis for a thermodynamic description of what is implied by a theory or enclosed through the links of a particular model.

Method

In agreement with the previously described experiments, the approach to be presented in the following connects to current trends and developments in the study of complex systems (Winfrey, 1980; Mainzer, 1999), rotational dynamics (Hestenes, 1993), and self-organisation (Kelso, 1995; Kugler & Turvey, 1987), however with special emphasis on non-linear language mechanics (I. Bierschenk, 1999) as key to structural invariance (B. Bierschenk, 2001). In short, the design for the study of shapes of mind as they are embodied textually and describable thermodynamically, has been made operational with the purpose to investigate students' consciousness in relation to progressively more complex prose narratives. Their implied cumulative succession was initiated with an Icelandic prose narrative of the 13th century, recounting historical and legendary events (Bierschenk & Bierschenk, 2003a). The next following stage was investigated with a long narrative about a Renaissance novel. This is frequently called a problem-novel and is concerned with the formation of evil-mindedness (Bierschenk & Bierschenk, 2003b). At the third stage, a satiric novel did constitute the progression toward the contrasting formation of rationalism and empiricism (Bierschenk & Bierschenk, 2003c). At the present (fourth) stage, the focus of the study is directed toward the investigation of students' apprehension of naturalism as it is presented in the form of the drama play "Miss Julie" by August Strindberg.

A first measure in the establishment of its textual pattern dynamics is the manifestation of "curling strings". Their successful identification builds on the presence of verbs. Their presence is establishing the ways in which the A's and O's contribute to the development of a language space. Hence, the a-component of the AaO mechanism is determining the specific bonding relations, which the participating verbs have produced. But, the production of a language space and its effect on developing time morphologies becomes accessible only if a complete textual surface can be produced. Such a surface requires that the dummies (\emptyset) can be supplemented with text segments, i.e., sewed up. This operation can only be performed under the condition that there is either a thread or a string with which the mechanism can work (B. Bierschenk, 2001). Therefore, their production and use must necessarily refer to intentionality as well as orientation. This means at the same time that dimensionality is inherent within the string itself. Further, it becomes identifiable and differentiable in the moment when a grapheme is produced. Hence observing the production of natural language expressions in a meaningful environment is hardly possible without an intention and orientation. It follows that a grapheme is a suitable marker of an identifiable string. Any string may be associated with some of the components (A, O) and give expression to the variability within each component. On the other hand, without a verb no entanglement can be observed and no channels can be formed. Their difference in variability may refer to the complexity of the strings on one hand and to the curling of the strings on the other. Both properties are expressions of distance in place and time.

Based on the assumption that rotations are determining dynamical movements in a language space, the "string" concept is applied to the study of abstract spaces as they result from natural language production. Applying the space concept to the study of rotational dynamics of natural language expressions, however, requires a successful manifestation of the validity of the "string" hypothesis, which among others, has been proposed by Greene (1999). Furthermore, to catch the fundamental implications of this hypothesis in the present context, it is expected that corresponding movements can be observed at the textual level. Finally, the functional geometry, proposed by Hestenes (1993) will be used as basis for the observation of string movements and the description of their pattern dynamics.

The meaningfulness of the space hypothesis relates simultaneously to the fact that the proposed approach must provide a means for measuring, which requires experimental testing of its value. From the validation point of view of the intended fourth experiment, it implies that any produced text is suitable for processing, provided that it contains cues to its capacity of stretching and straining and of winding and curling. However, during the process of text production, the individual producer is providing his or her "own unique physical context", which is introducing heterogeneity as a new constraining factor.

Heterogeneity

An important presupposition is that heterogeneity comes into existence through the individual's way of putting his own perspective into his writing about Strindberg's drama. By necessity heterogeneity is expected to produce selective changes in response to the requirement of language-specific adjustments during text production. To be sure, individuals with completely uncorrelated intentional behaviour would constitute a condition that brings the concept of intention under rigorous experimental control.

To build explicitly on the text producer's intention as governor of a textual organisation would imply the discovery of the "laws" of heterochrony. Moreover, to get a deeper understanding of the process of intentional adjustment and how this process is influencing the heterochrony of a particular text production will be studied with reference to Strindberg's play. However, that heterogeneous individuals with completely uncorrelated behaviour would constitute a community is unreasonable to expect, but nonetheless a useful assumption in the conceptualisation of social structures. Traditionally, those structures have been comprehended as forms of togetherness and social processes have simply been equated with social behaviour. Moreover, in the absence of a reliable method that would account for "singularity" as well as the development of "meaning", the individual is taken as point of departure for the explanation of society. This is obvious in Strindberg's drama. However the heterogeneity of the formed social conditions of individual life is too complex in order to be treated with the classical assumption of "homoscedasticity" (Rozeboom, 1966, p. 86). The orientation on conventional methods would require extensive rule-writing and statistical calculation. Thus, when social conditions are taken for the definition of individual life, heterogeneity undermines the needed reciprocity between heterogeneity and heterochrony. All that could be achieved are measures of social behaviour that has been forced into compiled classes of social indicators, sometimes called criteria or values. However, these indicators can support neither needed flexibility nor the needs for evaluating individual life.

At least since Darwin, the commonly accepted position is that heterogeneity is the result of natural selection and consequently a fundamental property of life. But understanding the mechanisms of natural selection implies at once an understanding of the laws of heterochrony. Expressed in modern terms, one of the major obstacles of the attainment of the sustainable conditions of life appears at the edge of nature and society, that is, in a naturalistic understanding of the critical factors of influence.

At the time of the occurrence of "Naturalism" the search for and identification of the decisive factors was manifested in Strindberg's drama "Fröken Julie" ("Miss Julie"). His conceptual model was based on Charles Darwin's ideas concerning the individual's adaptation to its environment through natural selection. Strindberg tried to make conscious Darwin's influence on the perspectivization of natural development, which implied an understanding of the nature of the environment in which the individual organism lives and with which it interacts. In determining in what sense the modifications in one individual are more successful than the modifications in another, competition between individuals appeared as the single and most critical factor of influence. Furthermore, competition between individuals has been identified with comparable trends of adaptation to social environments.

Heterochrony

What causes the genetic modifications between individuals that give one of them a slight advantage over the others in a community appears to be dependent on the heterochronic relationship. Its literal meaning implies a relationship that is dependent on timing. The concept of "changing time" was introduced in order to account for changes that occur during the development of the individual, but Herbert Spencer included "changes that occur during the transformation of one species into another" (McNamara, 1997, p. 12). Hence, when language is conceived of as a biological expression, heterochrony plays an important role in the study of Strindberg's drama, since acting on the timing of the different parts of the produced text is fundamental, but generally neglected aspect of textual evolution. Conceived of as the foundation of a circular dependency between structure and process or between system and system specific processes, heterochronic changes are always the result of a successful differentiation between system and environment. The structure of the drama is assumed to emerge naturally from the non-linear processes of string dynamics and from the working of heterochronic relationships, which form the basis in the development of text. However, these are covered by the textual surface layout but are approachable by means of "Perspective Text Analysis" (PTA). It is an effective tool for the manifestation of the heterochrony of Strindberg's drama in the form of time morphologies.

Text, conceived of as a system that is self-referential (i.e. contains its own description), becomes structured through its own internal driving forces. Thus the formation of textual patterns is the result of self-organising processes. But self-reference as information synthesising mechanism implies the coupling of language structure and system dynamics. PTA is the method, which can perform the coupling. It has the demonstrated capacity to extract uniqueness and consequently guarantees the abstraction of the quality in a particular style of approach. Based on the AaO axiom, the discovered mechanism shows that the circular coupling of textual agents (A) with textual objectives (O) is the characteristic property. Through individual variations in the growth of the components as well as their variations in nesting, it is possible to demonstrate that structural stability and textual morphogenesis is generating corresponding informational invariants.

Participants

The study was carried out during the academic year 2003/04. 30 students from a gymnasium at the city of Lund in Sweden did participate. They were enrolled in the social science program at their third and last year. At that time, the students were between 18 and 19 years of age. However, in focus of the present study are the two students, who participated in the previous experiments of this series. These students were selected according to the design and procedure, which have been described in Bierschenk and Bierschenk (2003a, pp. 6-9). But the instructional program, which preceded the present investigation, has been described in Bierschenk and Bierschenk (2003c).

Materials

“Fröken Julie” of August Strindberg is a drama typical of his time, i.e., the late 19th century. The drama reflects the naturalistic period and was produced in the year 1888. After an introductory course, which introduced the ideas of the new society, the drama was made the compulsory reading assignment for the whole class. Thus, at the third year study course, the drama was selected in order to serve as “test” materials. A more detailed description of the teaching period, which preceded this reading assignment, is given under the heading “Design and Procedure”.

“Fröken Julie” is a drama of fate in modern guise. The scene is the kitchen of a Swedish Country-House at a midsummer night. The master of the house is on an outward journey and the servants feel more relaxed than usually. The female cook is Kristin, the women, who knows her place, but is aware of the possibility to reach a step higher on the social ladder. The means appear to her in the form of a relationship with Jean, who is the servant of the lord. He has been born to agricultural labourer receiving allowance in kind of agricultural products. But he has energy and he is working for making his way upward, since he has the verbal capacity that is required for upward mobility. When Julie, the daughter of the lord, according to his taste, is offering herself, perhaps because of the midsummer night’s drunkenness of scent, Kristin is calling this monthly craziness. Jean is taking his chance and eager for conquest, because it would provide him with the opportunity to another life. The promise given to Kristin is easily broken. On the other hand, Julie herself is playing with Jean and seems to prevent herself from the understanding that she is playing with fire, before the catastrophe has happened. Now, Jean is changing his behaviour from admiring and flattering to being full of disdain. After all she has not been better and more respectable than all others. On the contrary, she aroused more disdain because she lowered herself down to his level. Kristin is earth-bound and does not become jealous, but she is mostly disappointed concerning Julie’s behaviour, which caused the loss of an illusion about better folk’s better manners and higher moral standing. She herself thinks about going to the church on day of midsummer, something that Julie does not consider of any comfort for her own part. After all she is not a believer. Julie can only commiserate her vanished moral and therefore, she is full of regret and anxiety over her wasted life. But Jean has nothing to loose because of his escapade, meanwhile Julie has pledged her honour. The verbal play between them is performed meanwhile Kristin has fallen into sleep. The acting concerns their possibility to escape together to Switzerland and to begin a new life. When Julie wants to take the cage with her, Jean is showing his fearlessness and brutality in that he is breaking the neck of the bird. Jean has with this action destroyed a part of Julie’s personality. However, when the lord comes home, which is signalled through his voice, coming from a speech channel, Jean retreats to his habitual Ego. He is again the subjugated servant, who wants nothing more than to make the happening undone so that his carrier can continue unaffected. He commands Julie to take a razor and to do what she has to do in order to rescue herself from the consequences.

As illustrated with this sketch of Strindberg’s dramatic course of events, he has been able to built into the play the modern ideas of his time, such as the ideas of social Darwinism of Spencer. Thoughts concerning inheritance and the influence of the environment on the evolution of species have been incorporated with the power of survival of the strongest member. Here, the strongest member in the play is simply the underdog Jean, which is

modelled as someone, who determinates the species. Julie is, due to her degenerated family and genealogy, on the declining line despite her socially higher standing. What is at stake is partly a fight between the classes, partly a fight between the male and female. The latter becomes obvious in the question put forward by Jean, namely if it isn't the case that Julie has seduced him and not the other way around, which nature would have required?

Schopenhauer's idea concerning the dilemma of the "free will" would also fit as an answer to this question since the idea of that time about the "Übermensch" is surfacing. Besides this note, one should keep in mind that Strindberg during some periods of time has admired Nietzsche and was in correspondence with him. Furthermore, Strindberg has been of the opinion that he has produced a narrative, which reflects the psychological course of events through a dialogue. Its naturalness has been preserved with the means of incomplete rhythms and broken lines of thought. The writers of naturalism have been eager to mimic human behaviour and to expose its worst parts without any mercy. These are the means with which the erotic play communicates to the audience that it is looking at something that is a clear naturalistic provocation.

What can be expected of the two students after having read the drama? The student, who has advanced in the study of literature and understanding of the development of ideas, may be expected to focus on Julie and Jean's background. Thus, the heritage she is carrying with her and which is pressing upon her as well as the heritage that he has the power to get away from in his new milieu are the important factors to be picked up from the reading. Furthermore, the importance of demoralisation should show up and come into perspective. The same applies to the implied scene of a sexual intercourse and the associated reasoning about the differences in the characters before and after the occurrence of the event. A superficial reading, on the other hand, is expected to take into account the fights based on class and sex differences at the action level and possibly also Kristin's role of the "voice of ordinary people".

Design and Procedure

The preceding course program concerned the second year of study. During this year, a change was initiated between the literary and the communicative part of the program. The latter part was carried out between the week (41) and week (2). With the beginning of week (3), a short section on the history of the Swedish language was included in the program. Furthermore, a minor part of the course was also oriented towards reading text samples of 18th century literature. The study program did consist of interchangeable lessons and three times the preparation of homework. This part of the program was finalised with a test concerning Voltaire's *Candide* (Bierschenk & Bierschenk, 2003c). It may be important to note that the two students of the study were absent at the time when the results of the exam were handed back to the class. Hence both missed the opportunity to hear the teacher's explanatory comments to the ideational content of the third question.

The communicative part of the program was restarted at week (11) and continued until the end of the spring term (in the beginning of June). This part of the course was initiated with a theoretical study of writing style and text samples. The emphasis was on the cultural aspects of the samples and was connecting to the previous study of text on facts. The students were asked to compare popular science text with the text of journalists reproduced in newspapers as well as literary text chapters taken from novels. All samples did treat the same theme, namely "nature and culture", which was expected to facilitate the comparison. During the weeks (12-13) the lessons were worked through orally. Thereafter, the students had the task to write an article with a personal style about some cultural happening, which they had visited during school time or during their leisure time. Their other assignment was to write a text containing facts, which was a major report.

After a week of an introductory theoretical overview, the work with the report continued through the weeks (17-21). Writing a report was initiated with the choice of a subject and a preliminary formulation of the problem to be approached. A minor empirical study, using verbal statements on some opinions made up the context for the account in the form of a report. The preparatory work did also include information search, evaluation of information as well as citation and reference techniques. Part of this assignment was the task to produce a correct list of references. Free choice of the subject according to some personal principle together with the possibility to get some training in writing a report have been aimed at a distraction from the literary time line. The last week was used for a summary of the content of the course. The students were asked to prepare a folder, which would inform the next generation of students about the course.

The last year of study was introduced with a section on romance, which initiated the study of the 19th century's literature. During the first two weeks (34-35) of the autumn term representative poems of some well-known romanticists (Heine, Keats, Tegnér and Stagnelius) were read as well as excerpts from Goethe's letter novel "Die Leiden des jungen Werthers". As an exercise during lesson hours, analyses were made against the background provided by concepts like new Platonism, animation, cult of genius, folk inspire and escapism/historicism.

Next in the program were a focus on the concepts of realism and naturalism. According to the planning, this period of study would be finalised with the compulsory reading of "Fröken Julie". Therefore, the study of the text samples was concentrated to those samples that were expected to support the understanding of the stream of ideas of that time, especially the differences between romance on one hand and realism and naturalism on the other. In addition, all students had to read excerpts of Honoré, de Balzac and Fjodor Dostojevskij. These writers' work made up the basis for a discussion of social and psychological realism. However, Émile Zola and Victoria Benedictsson provided the ground for a demonstration of the particular characteristics of naturalism. Especially the latter was expected to be of help in the individual study of Strindberg's drama. The preparation also contained some other materials for discussion during lesson hours. The drama was distributed during the week (37). The account of the students was required in the form of an exam, which occurred in the writing room during the week (39). It should also be mentioned that the edition for use in schools contains a Foreword of Strindberg himself, where he delineates the background in the form of ideas and explains his aims. Further, there, he makes explicit what kind of motifs he has attributed to the actors. The students did not get this version, but were provided with stencil copies without the Foreword. This was a precaution in order to prevent a response, which contained Strindberg's explanations.

The exam contained three concise and descriptive questions as well as one analytic question and one resonating question:

1. In what kind of milieu does the course of actions develop?
2. How is that influencing the people? (Belongs to question 1)
3. Who is Julie and who is Jean?
4. Give an example, which shows how Strindberg is using symbols. Explain also its meaning.
5. "Fröken Julie" is a good example of the way in which the current of the time has been transformed into literature. What do you think Strindberg was trying to say with his drama? Discuss and give examples.

After having collected the response to the exam, it is in the first place question five, which will be treated further.

Results

The analysis will be focused on the way in which the evolutionary process of text production portrays the act of unrolling or unfolding the natural time frame and the apparent processes that have been dramatised. The major concern, reflected through the play, seems to have been to establish a connection between the course of development of the individual and the evolutionary development of the human species. Obviously, the "biogenetic Law" of Ernst Heinrich Haeckel (1843-1919), who was a German biologist and natural philosopher, appears to have had an impact on the formation of the drama. The other aspect of evolutionary development that can be noticed, relates to Herbert Spencer (1820-1903). He was an influential British philosopher of his time, who changed the meaning of the terminus "evolution" from progressive to adaptive. In this view, the individual's interaction with the external environment and social factors are influencing selection. Just how much of these two aspects has been picked up and is pertinent will be demonstrated with the following two text productions. The written responses have been assigned the labels (A4) for the analytic-descriptive style of approach and (B4) for the synthetic-reflective:

A4. Original Swedish Text Production

Det klassamhälle som visas tror jag Strindberg tyckte var fel. Samhället var på väg att förändras och medför att de första förändrarna, Julie och Jean, inte kunde bli lyckliga. Jag tror att Strindberg ville visa just hur fel den synen på människor var.

A4. Literal English Translation

The class society, which is displayed, I believe, Strindberg meant to be wrong. The society was on its way to change and this led to the result that the first pioneers, Julie and Jean, could not be happy. I believe that Strindberg wanted to show how wrong this opinion was about humans.

B4. Original Swedish Text Production

Kanske något om hur alla har en viss plats i samhället och att även om man drömmer sig bort i storslagna planer så behåller man den platsen. T. ex hur Julie går på hans ord om Como men det slutar ändå med att han är tvungen att stanna vilket även innefattar hennes död. # Kanske också försöker Strindberg påvisa hur det straffar sig att befatta sig med synder, som att förföra en enkel man etc., även om domen fälls över kvinnan. # Man ser ju också hur dåtidens kvinnoyn var, och att det är mannen som står över. # Eller så kanske är hans tanke inte alls som jag först tänker mig utan att det spelar ingen roll ur vilken klass du är född, det gör inte din personlighet. Jean är ju eller anser sig minst lika, om inte mer, sofistikerad än Julie.

B4. Literal English Translation

Perhaps something about how everyone has a certain given place in the society and even though one is dreaming oneself away by grandiose plans, though one keeps the place. For example, how Julie trusts in his word about Como, but it ends nevertheless with that he is forced to stay, which also includes her death. # Also, perhaps Strindberg tries to demonstrate how your sins will find you out, when you seduce a simple man etc, even though the sentence is passed over the woman. You also see how the past time opinion was about women and that it is the man, who is superior. # Or may be, his idea is not at all what I first think, but that it does not matter in which class you are born, that does not make your personality. Jean is you know or thinks he is at least as much, if not more sophisticated than Julie.

Unfolding of the Source Spaces

When the text of (A4) is compared with the text of (B4), it becomes obvious that the first one is typical of a hard and rigid writing style, while the other one constitutes the contrasting case. A soft and consequently more elastic writing style has produced a text of different complexity. How the evolution of their forms of complexity can account for both underlying stability and apparent heterogeneity in their appearances is the prominent aspect of the underlying hypothesis, namely that the structural relations, that are forming the basis for their space developments, are covered by their textual surface properties.

Plainly, the mechanisms responsible for dynamic change, flow and rhythm are producing "heterochronic" (i.e. evolutionary) differences, since the mechanisms are changing the relations between the structural properties. Basically, Haeckel defined "heterochrony" as a displacement in time, which means a dislocation in the evolutionary relationship within and between groups of variables. Hence the next step in the evolutionary analysis of text production must necessarily concern the examination of the resulting time morphologies, which requires an abstraction of their spaces.

The Sequencing Space of String Dynamics

String production rests on the realisation of kinetic energy through text production. Most of its production becomes evident through the interaction of two kinds of strings, which may appear either as "virtual" strings or as "material" strings. Hence, individual strings are the carriers of information. When a textual surface is altered, produced kinetic energy is forming the sequencing space of string dynamics. In manifesting the observed effects of string dynamics on a semantic-free patterning of the involved AaO-units, the introduction of novel strings and the production of particular expressions concern the relationship between individual strings and text. Thus, individual strings constitute the elements of text production, but they do not develop evolutionary. Individual strings cannot grow when they appear as grapheme but propagate when they appear as virtual, which means that they appear as placeholders.

The Production of a Concentration Space

In contrast, heterochronic changes appear through the formation of patterns of strings, i.e. composites. The latter are the result of an integration of strings and compounds. Thus, this kind of integration has generated the layered variables of the Figures 1 to 4. As demonstrated, the differentiability of textual segments is dependent on the intrinsic spacing and timing of a particular text. Moreover, the Figures show that the time-dependent layout of the produced variables for the purpose to process the intervals of relevance for a particular variable-interval relationship. As shown, the degree of elasticity provides the basis for an exact characterisation of the involved transitions. Resulting from the exact reproduction of the identified control parameters is the generation of a thermodynamic trajectory. This implies that the functional aspect of the coordinated displacements of textual segments in text (A4) can be identified with a dynamical system that is changing its path abruptly. The Figures 1 and 2 provide the means for an investigation into the morphological differences between "Orientation" on one hand and naturalised "Intention" on the other. Their separation makes it possible to account for the differences in their functional geometries.

When these geometries are compared with the abstracted spaces, shown in the Figure 3 and 4, observations on differences in their pattern dynamics can be described and used for the determination of the changing direction in their heterochronic developments. For example, the smoothness in textual movement coordination is dependent not only on one's ability to produce a discourse but also on the rotational variability, which is contributing to the proper adaptation of the discourse to the complexity of a particular task.

Figure 1.*Text A4. Analytic – Descriptive Approach to Miss Julie***Angular Articulation in the Unfolded Orientation Space**

Figure 2.

Text A4. Analytic – Descriptive Approach to Miss Julie

Angular Articulation in the Unfolded Intention Space

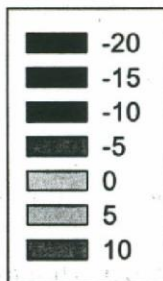
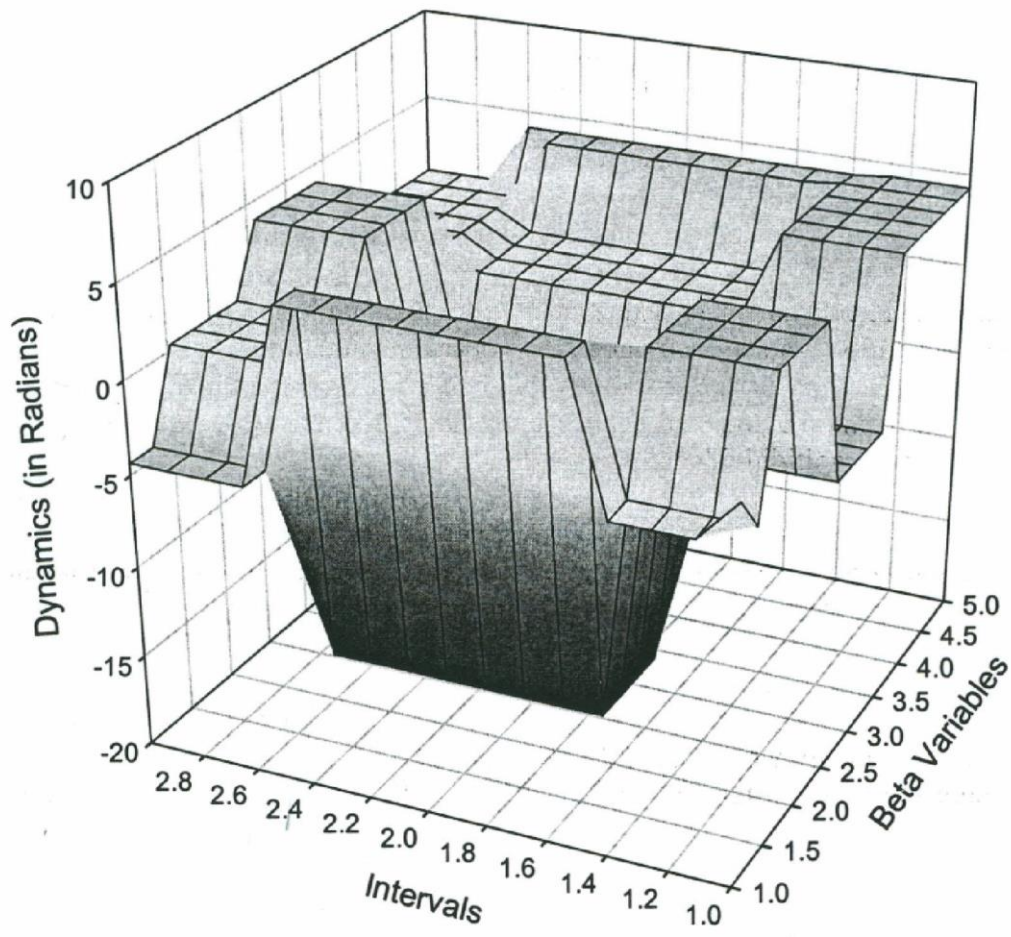
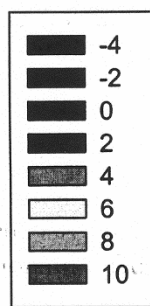
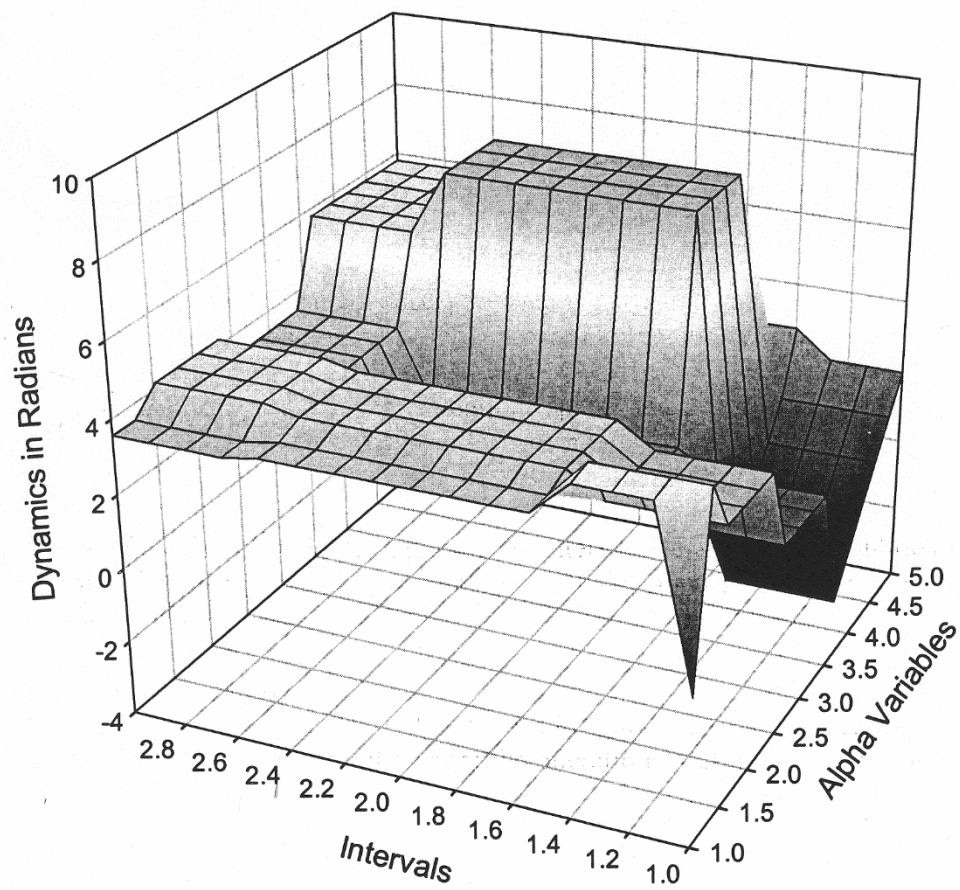

Figure 3.

Text B4. Synthetic – Reflective Approach to Miss Julie

Angular Articulation in the Unfolded Orientation Space

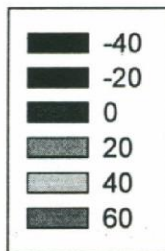
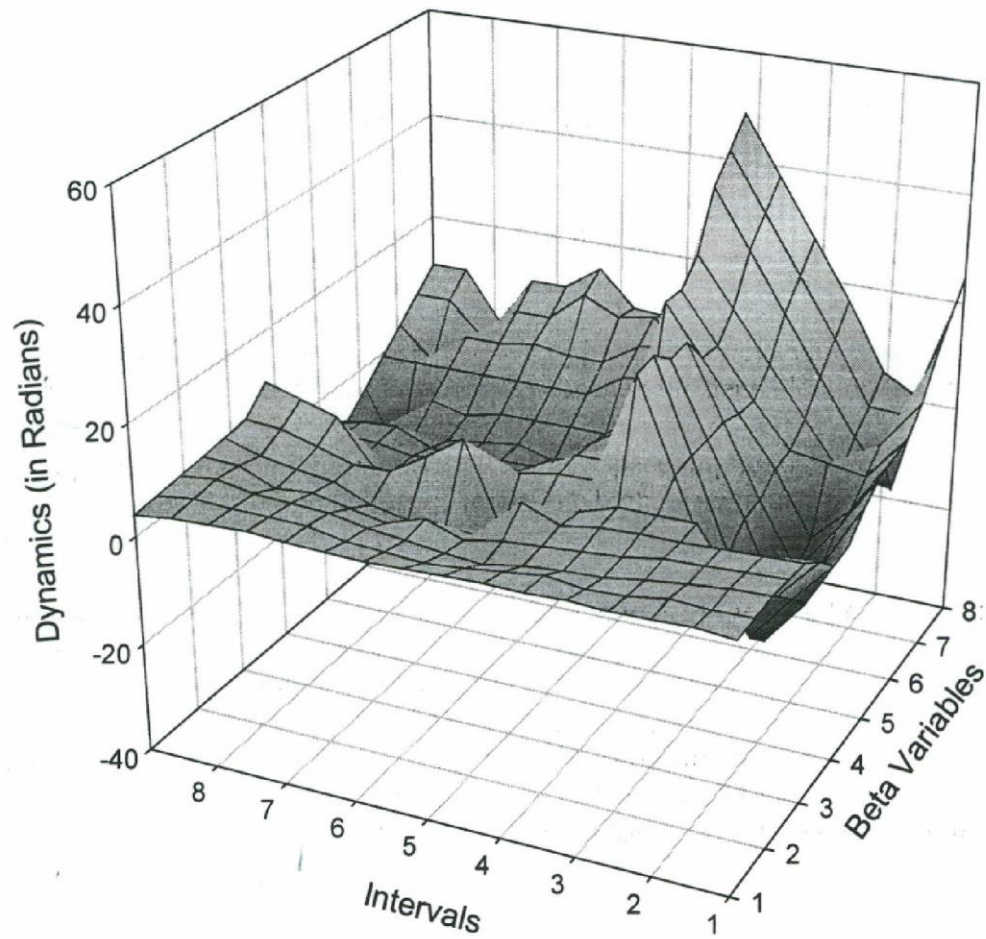
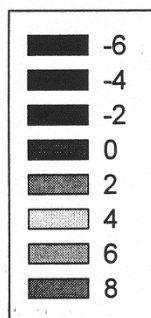
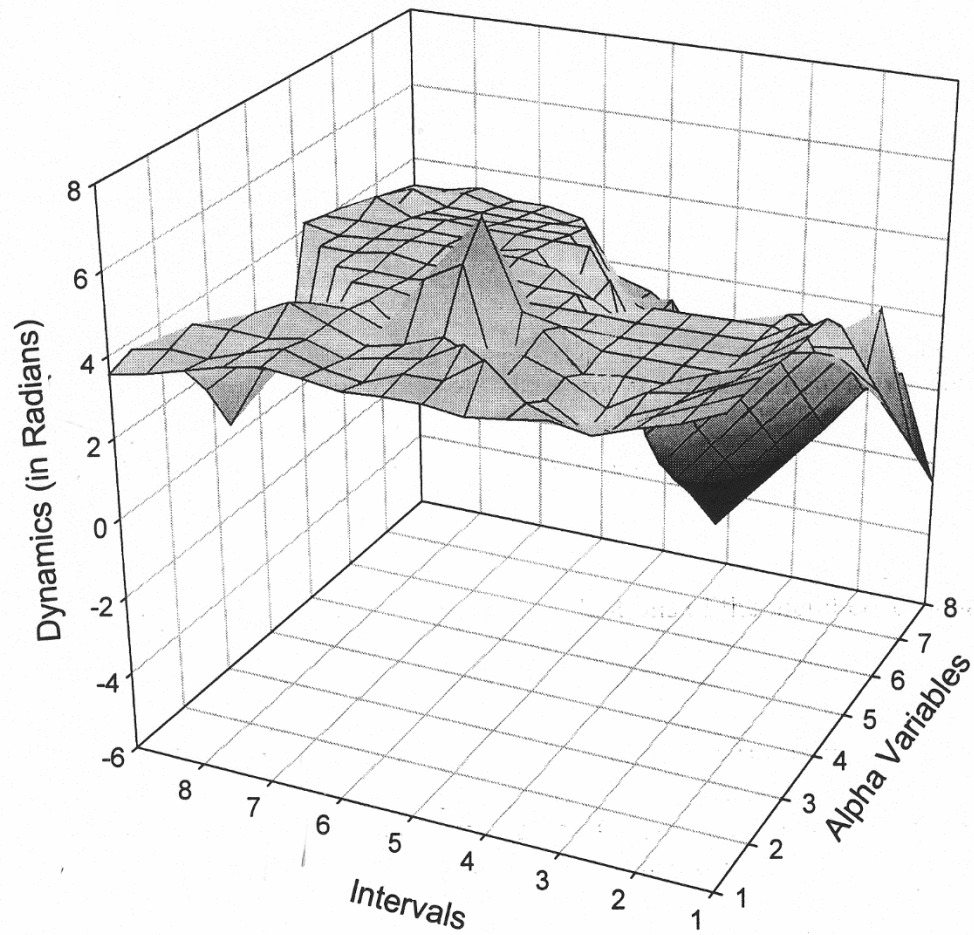

Figure 4.*Text B4. Synthetic – Reflective Approach to Miss Julie***Angular Articulation in the Unfolded Intention Space**

Evidently, the abstracted spaces show that the developed structures differ in their rotational dynamics as well as in their complexity. It follows that it has been possible to demonstrate that the kinetics of text production is based on the intrinsic measures. For example, the Intervals refer to the naturally occurring number of periods and fractions of periods. Furthermore, the Beta and Alpha variables are the outcome of text dynamics and entirely dependent on the number of textual objectives and agents, which the O- and the A-functions have produced. Finally, the Dynamics, as measured in Radians, gives expression to the speed and acceleration of the variables.

The most typical silhouette in the "Orientation" space of (A4) is demonstrating critical changes in all three intervals. The higher regions in the depicted landscape are an expression of the degree of "directness". However, this landscape demonstrates also certain degrees of "indirectness". This kind of change appears in the shadings of the second interval. Sharp changes in the rising and falling regions mark corresponding changes in speed and acceleration of the depicted process. Thus, the landscape of (A4) makes evident that the established distances are a measure of abrupt changing processes, which are driving the development of the gradient through the intervals.

The special character of the "Intention" space of (A4) appears in Figure 2. Preserved is the block-like character of the landscape. What is particular can be extracted easily, namely that the A-clock is running much faster compared to the O-clock. Differential functional requirements seem to have influenced the operations in subtle ways and changed the heterochronic development of the "Intention" space. The grove in the middle of the landscape is the result of a certain degree of local fading and global inhibition. In particular, the local fading in the first interval is generating the shadowing activity in the fourth Alpha-variable. In contrast, the plateau in the foreground and rising block in the background depict the top-most boundary of the fourth variable in the second interval. Hence, not only subtle differences at the terminals but also in the displacement of textual elements are shown to have profound effects on the acceleration of the clocks. However, what is more important is the observation that biological coordination mechanisms are at work, which are characterising the commonality of both landscapes.

As was demonstrated with the spaces of Figure 1 and 2, the introduction of the concept of an "abstract space" allows for the operational definition of the concepts of neighbourhood and distance in the context of natural language production. Both concepts have been shown to be of particular import in the demonstration of the heterochronic properties of language production. Moreover the observations on gradient dynamics and the evaluation of angular articulation as an expression of attitude change (in the mathematical sense of the word) can be evaluated on the basis of local conditions, which however may appear as global.

Thus far, it can be concluded that non-linear and consequently heterochronic phenomena are influencing locally defined pattern movements. In particular, the pattern dynamics, underlying the Figures 3 and 4, has produced landscapes that differ profoundly from the landscapes of the previously examined morphologies. The coupling between the A- and the O-kinematics that the biological mechanisms have to control in order to produce a comprehensive text has resulted in a space layout, which is very different in its dimensionality. Described in terms of a perfect 3D writing-style control, it can be concluded that the writing style of (B4) is very different when compared with (A4).

Different rotational states can influence the composition of a component in markedly different ways, as demonstrated in Figure 3. For example, in the process of entangling the states of the O-function, it is its particular range that is of import. Since the entangling is part of channelling functions, cyclic processing and stepwise production of layered composites has

resulted in a much higher degree of indirectness or acceleration in the variables. It follows that the deep in the first interval is the result of the acceleration in the fourth Beta-variable, while the deep in the second interval has been produced by the Beta-variables four to seven. Another acceleration can be observed in the seventh interval, where the Beta variables three, five and six are responsible for the sliding below sea level.

In contrast, the leaning rise in the background has resulted from various rotational speeds, mainly in the interval three, Beta-variable five and 6, and the first Beta-variable in the fourth interval. Hence the resulting landscape is explainable on the basis of a dynamical process, which develops with various rotational speeds and accelerations. Besides higher degrees of differentiation in the variables of the control parameters, the negatively curved (hyperbolic) shape demonstrates a landscape at a higher resolution, compared to the corresponding space of (A4).

In considering the "Intention" space of (B4), it is easily confirmed that this landscape is the result of individual rotations that exhibit differences in speed and acceleration, but these are not as striking as one might have expected. In comparison with (A4) the smoothness of the present landscape is the result of the overall layout, which is symmetrical. The higher degree of differentiation in the variables of the control parameters is mainly responsible for the order in the flow layers, caused by the slight differences in rotational distance. Both examples again make evident that heterochronic principles are at work.

Folding of the Source Spaces

While the unfolded morphologies provide for the unique shapes of the landscapes, the folding of these morphologies is dependent on the degree of their structural differentiation. A convenient device for visualising the convoluted configuration in folded spaces is to rule a mesh or grid on the rotation dynamics of the established variables. This operation implies that the grid can be used to represent the shape of the folded morphological structures, which opens a new perspective on the heterochrony of text and implies a discussion of the meaning of the emerging folds.

Heterochrony implies that the functional aspects of elasticity and the coordination of dislocated textual elements can be identified with a thermodynamic system under stress. That kind of stress, which appears at the terminal and is prolonging the discourse, can be captured with "shear", while the complementary stress, produced through displacement or dislocation, can be seized with "strain". At the present level of analysis, both functions help to identify the mountains and valleys of the folded landscapes, since they are forcing the fusion dynamics to generate the attractors, which are characteristic of the folds.

Since "wholeness" signifies text validity, the processing of the dynamically developing variables requires no other reference system. Furthermore, when text is considered as context, the productive cooperation between intention and orientation is in this process no longer the objective of physical conditions. Instead, it is the "metaphysical" determination of a natural language expression that comes into focus (Bierschenk & Bierschenk, 2002). Thereby, new constraining states are produced, which pass the limits of reality. As a consequence of transcending physical reality, abstract state spaces are evolving which have this metaphysical property.

Now, in demonstrating this effect, the states, carrying the produced variables, will be fused with the "Zipper" mechanism. Furthermore, it will be shown that the resulting fusion procedure has the capacity to keep track of the prescribed thermodynamic path. All that is needed is the assumption that intention as well as orientation is embedded in any natural language expression. Moreover, if the context of text production is conceived of as part of a resulting concentration of information, related attractor states may be viewed as basis for the

development of a trajectory that is characterised by termini that are producing themselves on the basis of the governing order parameter, i.e., lawful regularities.

To find out whether the meaning of a particular attractor configuration in the produced landscapes would make any difference, the five most profiling termini of each landscape have been reproduced and are shown at their proper position in the corresponding configuration. To begin with the resonance in the folded "Orientation" space of (A4), three regions have been identified on the basis of the significance of their singularities. By localising the two singularities at the top of the mountain in Figure 5, it can be concluded that the most explicit attractor relation has been manifested as the specification of a functional relationship, namely "*Correction by Adjustment*". Furthermore, an only partially adaptive relationship with the community means "*Failure*", since the behavioural function is not working effectively in the production of a proper relationship with the community.

Hence, the comprehended societal pressure towards complete agreement with current customs and rules or style is manifested in the singularity "*Conformity*". However, the significance of this aspect of internalised social control seems to be questioned implicitly, since two singularities have appeared below sea level. In fact, to find oneself within a socially determined enclosure appears as "*Confinement*". Thus, one who sees clearly that society is urging its members into the straight and narrow line of conformity may conceive this pressure as "*Lost Justice*". The latter means the lost opportunity to evaluate any individual's behavioural qualities. Obviously, "loss" has been made dependent on the implied kind of violation and injustice.

The resonance in the folded "Intention" space implies shifting directions and is effectively contributing to the formation of the highest mountain peak, which carries "Conformity". In its neighbourhood appears "Confinement" as the next highest but global singularity. To be forced into a particular position is confining and means that one is forced to regulate one's behaviour according to the evaluations of the members of a particular group or community.

This compulsory condition is amplified further through the other terminus in its neighbourhood, namely "*Rectification*". The latter means explicitly to convert one's behaviour with the purpose to improve one's conformity. But in the middle of the background appears "*Faithlessness*" as the singularity that has attracted the rebellious character, e.g. the lack of confidence or trust in the given values. Clearly, any force that restrains progressive societal changes appears to favour disloyalty and disobedience. Within the presented societal context, the "*Interrupted Course of Events*" implies that a complex chain of events cannot develop into equality between its members. Furthermore, interruption means also that society has missed its chance to transform into modernity. Since this singularity appears in the foothills at the right-hand side of Figure 6, it provides the anchorage.

The emphasis in the formulation of the main hypothesis of differences in sensibility of (A4) and (B4) has been put on the text producers ability to express their comprehension of the given play verbally. In approaching the conceiver-phenomenon, it is expected that the differences in the verbalisation of (B4) would organise themselves into different state attractors. The landscape, shown in the Figures 7 and 8 reveal obvious differences not only in their shapes, but also in the naming of their mountains and valleys. Since these differences are radical, especially when novelty and disparity is considered, it becomes apparent that a very high degree of transformational change must have been at work. It follows that the observed asymmetries are the result of a new kind of thermodynamic constraints.

As shown in Figure 7, the corresponding singularities have produced a selective change toward Darwin's theory. At the left-hand side appear "*Speciation*" and "*Natural Selection*" as dominating terms. Darwin recognised the role of variation among individuals.

Figure 5.

Text A4. Analytic – Descriptive Approach to Miss Julie

Resonance in the Folded Orientation Space

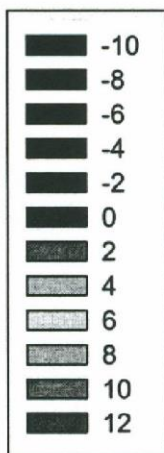
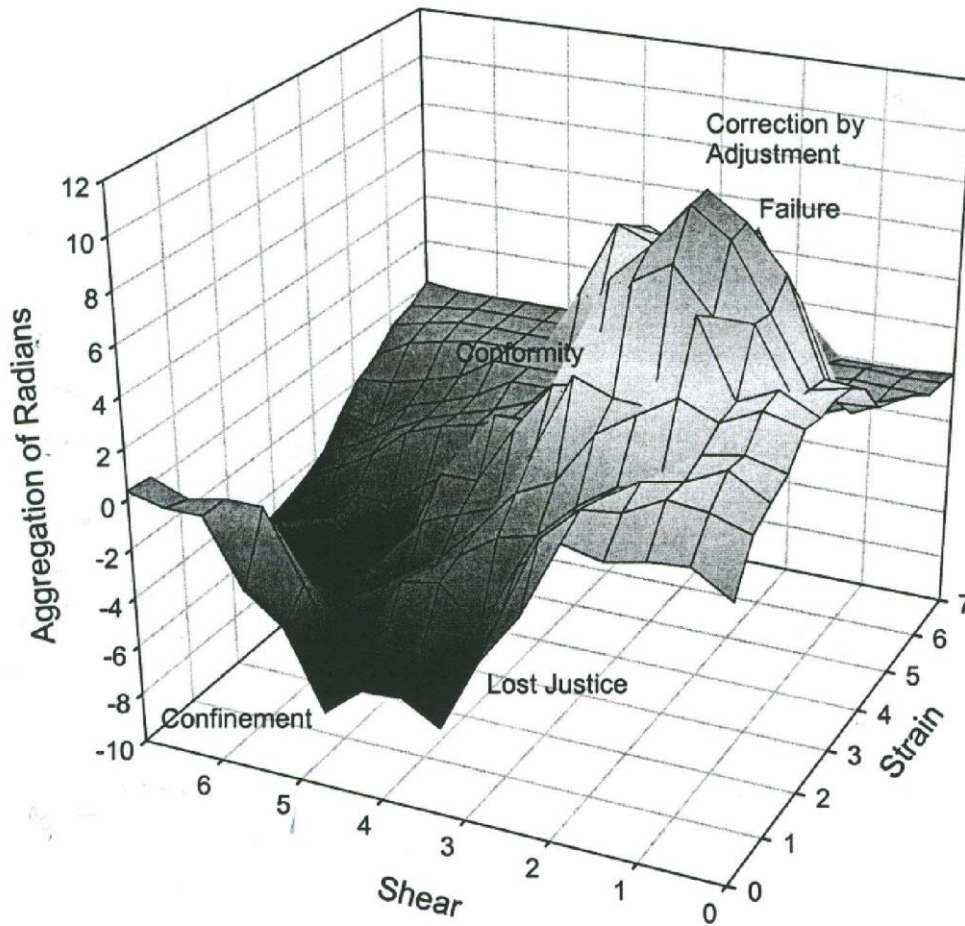
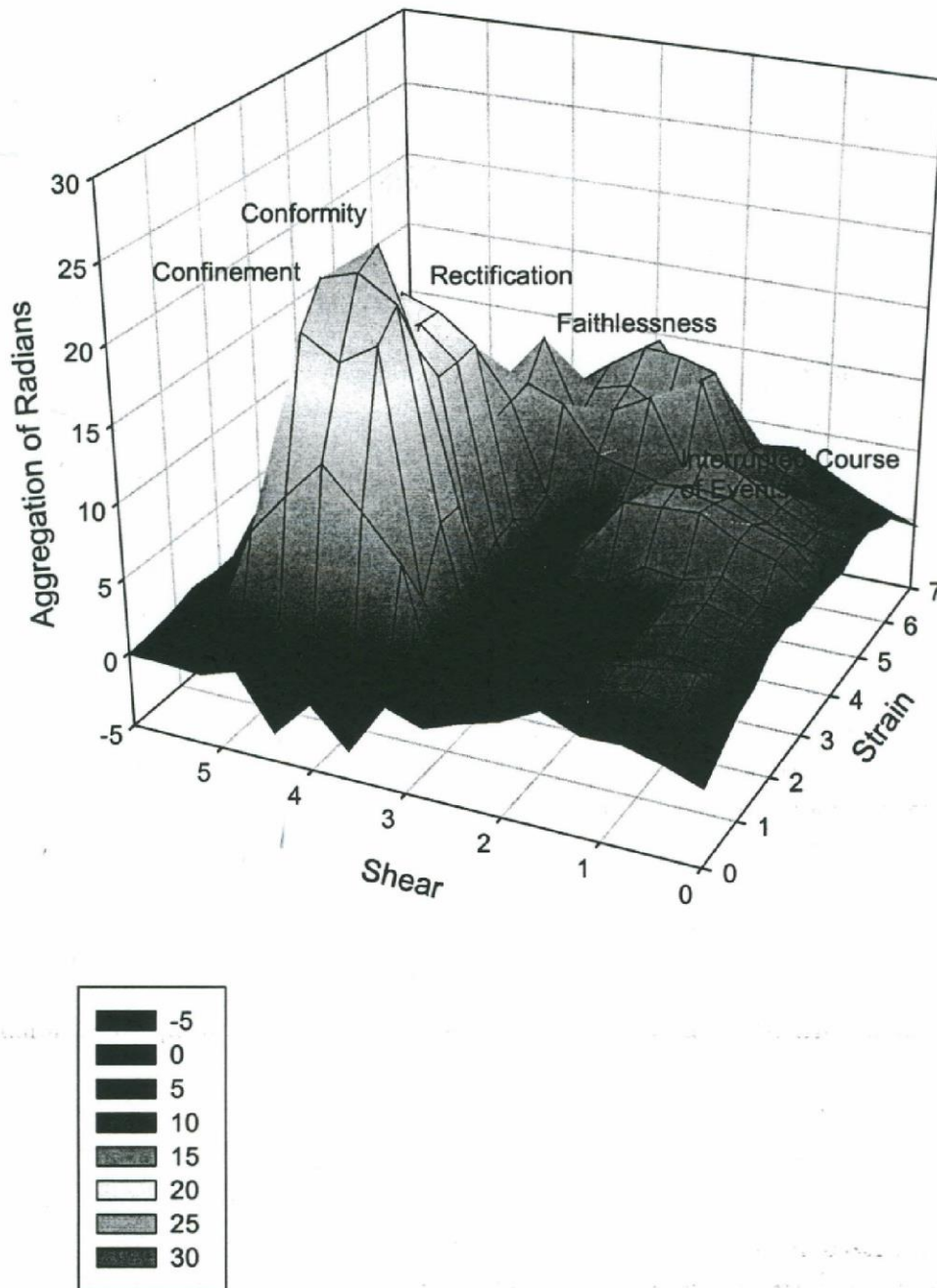

Figure 6.

Text A4. Analytic – Descriptive Approach to Miss Julie

Resonance in the Folded Intention Space



Synthetic – Reflective Approach to Miss Julie

Resonance in the Folded Orientation Space

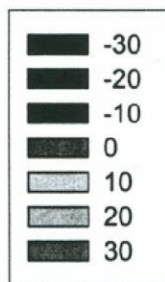
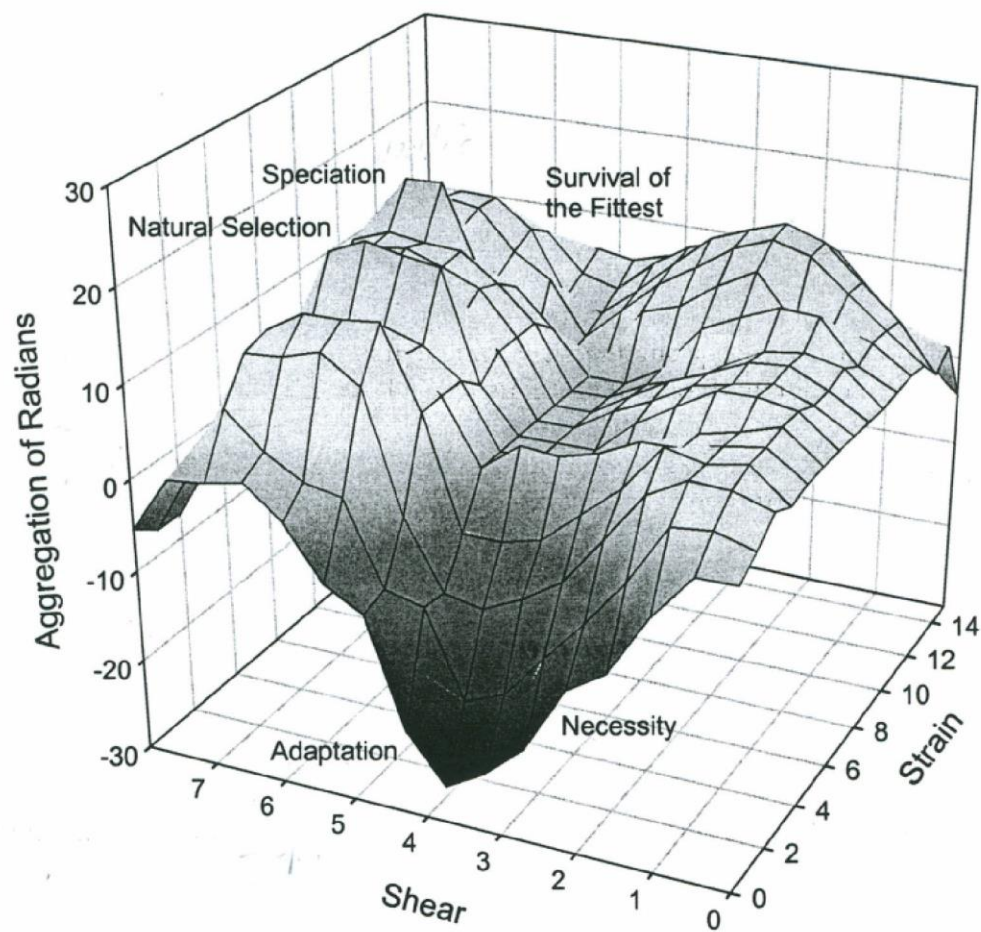
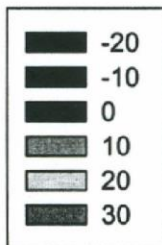
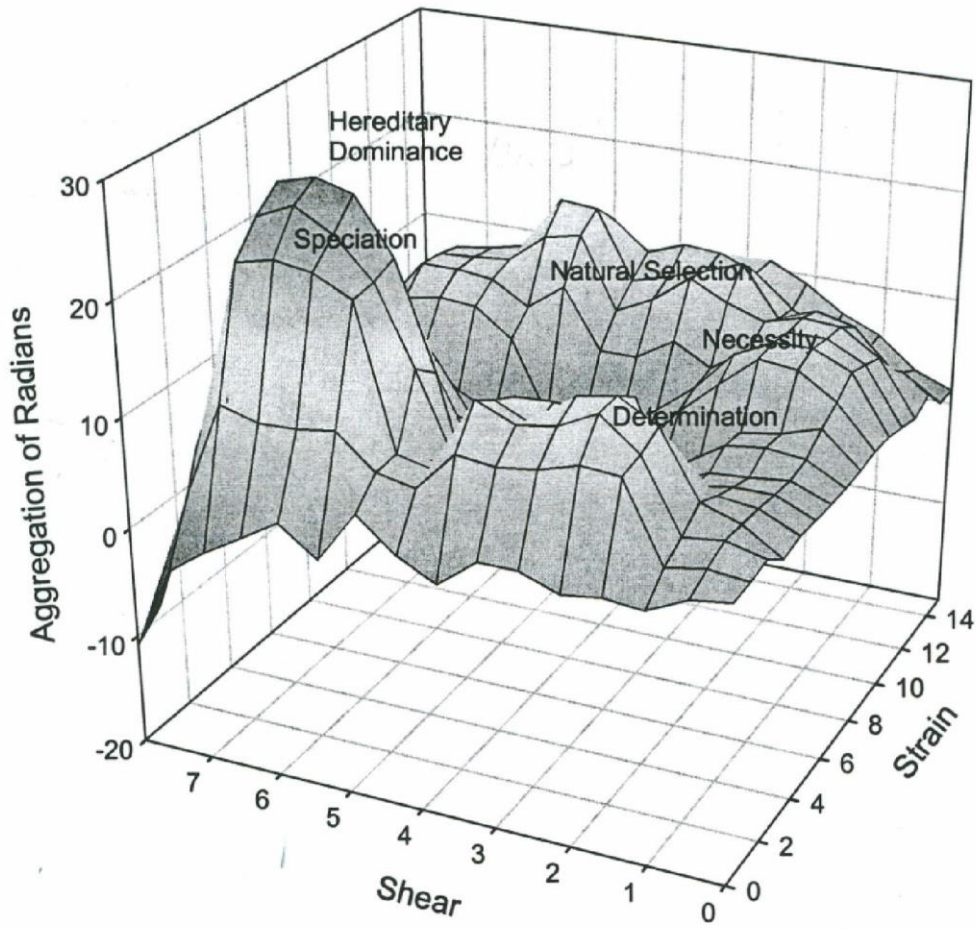

Figure 8.

Text B4. Synthetic – Reflective Approach to Miss Julie

Resonance in the Folded Intention Space



In providing the basis for the operations of natural selection, he contributed with the hypothesis that the life history of an individual is intertwined with the life history of the species.

The underlying assumption of Darwin's mechanism of natural selection is that "every organism" naturally displays slight variations from others of its kind. The individuals that survive and reproduce will be those whose natural variations adapt them better to their specific environments. Hence, "*Speciation*" appears to be based on evolutionary progression, which is producing those favourable variations that become selected. The selected traits will accumulate in subsequent generations. But how much evolutionary separation can be observed depends on the general capacity of the species to undergo evolutionary change, which is based on a deeply rooted distinctness. Hence, a successful response to environmental requirements may be seen to enhance the ability of the species to survive. However, over time, these traits become different and diverge. Without significant divergence there would be no diversity.

It follows that "*Natural Selection*" is closely linked to the elimination of those members of a population that are least adapted to the environmental requirements. The implied hypotheses concern (1) the effects of long-term selection, (2) the effects on environmental change, and (3) the effects of extinction. Explanations for adaptive success have been sought in terms of gene displacements or dislocations that yield higher fitness values. Accordingly, natural selection and the adaptability of an individual are in many ways dependent on inherited morphological traits.

However, with respect to the Darwinian principles of selection, the channelling of acceptable change meant to preserve only such variations as arise and are beneficial to the organism under its conditions of life. Consequently, below sea level appears the deeply implied problem of functional "*Adaptation*", which is one of changing a highly complex biological organisation to another without producing poorly adapted transitional morphologies. The nature of the existing biological systems appears to change behaviour under the influence of developmental constraints.

The other deep-seated terminus that has appeared below sea level is "*Necessity*". As it appears, it is the other intrinsic quality of natural law and dictates the minimum conditions. It follows that this attractor is constraining the circumstances, needed for the existence, effectiveness or success of the organism. In conclusion, Darwin conceived the inevitably driving force behind evolution as natural selection. But the operating factors, namely necessity and adaptation were formulated mainly as external causes. Internal factors that were responsible for the origin of individual variations were hardly considered before the discovery of the existence and importance of genes.

The final and consequently global singularity appears in the lacuna at the back of the landscape as "*Survival of the Fittest*". Accordingly, what appears as the very obvious and dominating factor, as Darwin sees it, is the competition between individuals. In terms of individual adaptation, it is the fittest, which is surviving. It follows that external factors, like competition and predation, are the constraints, i.e., the moulding and shaping forces in the battle of life. From the orientation point of view, fitness implies competition within a specific group or community that determines, which individuals survive.

The resonance in the folded space of Figure 8 reflects a dynamical fusion process, which has produced the conditions for novel changes in the constraining intention. The fusion dynamics, underlying the emergent termini, has obviously produced an overall symmetry. However, some important changes have appeared, since it can be concluded that the core of the configuration in Figure 8 is demonstrating that "*Hereditary Dominance*" is building up itself with functionalistic accuracy as the global singularity of the configuration.

Thus, the naming of the resulting attractor implies the production of a favourable genotypic outcome within the specified environment. To the extent that the behaviour of a particular individual can be taken as an account of the result of minimal modifications in its behavioural genetics, the observed outcome depicts hereditary dominant behaviour. This kind of behaviour appears to be highly resistant to environmental effects. It follows that one's ability to predominate others within a specified community, means that the particular individual affects or controls others behaviourally.

By way of contextual change, the nearby emerging terminus "*Speciation*" implies a short evolutionary forward move. Within the given configuration, it means structural as well as functional that a species-specific action pattern has emerged, which is highly independent of personal experiences. Thus, whether a particular individual of a given species is dominating depends on its genetic mechanisms. It follows that the type of produced behavioural outcomes may vary considerably from one individual to another, e.g., with respect to its strategic flexibility.

The reappearing termini "*Natural Selection*" and "*Necessity*" are now characterising directness in expression, which means that the latter is needed for the continuing existence and functioning of the species. Hence, both terms operate on the basis of an inherent property through which the individual gains access to fitness qualities. In emphasising "quality", the terminus "*Determination*" finally contributes with the specific attribution of values to the observed effects of innateness. Its appearance in this configuration underlines the perceived import of biological heritage in the formation of strategies of action as a reaction to available conditions. As a consequence, the intentional innateness of violence and inequality is the observed outcome. Since this invariant of intention is very difficult to change, hereditary determination appears as a most important factor for the production of individual differences, which includes violence as well as injustice.

Discussion

What makes the present approach to the relationship between the "heterogeneity" of text production and the "heterochrony" of produced text possible is the invariant formulation of the A-O kinematics of the involved A- and O-function. Besides the invariant formulation of these functions, the heterogeneity of a text is transcending intentional constraints and thereby establishing its heterochronic properties as boundary conditions. Thus, heterogeneity is in the present context defining the boundary conditions for textual self-organisation, which is producing the observed control constraints for the timing and spacing of a text.

A precondition for the successful working of both principles has been the embedding of text production into a natural learning environment. This condition has been shown to guarantee the production of a heterogeneous text material. Furthermore, the preserved diversity in comprehension has generated the heterochronic properties, which have been shown to be of import for the developed time morphologies. Expressed within the context provided by the particular student, it has been possible to demonstrate that the uniqueness of this context has been of fundamental import for the discovery of the social as well as the natural aspect of Strindberg's play.

The double aspect provides for alternative explanations. In essence, the experiment has shown that the study of structural sensibility is not only possible but must be based on something over and above linear language mechanics or various kinds of content analysis. Furthermore, the A-O kinematics has been shown to make structures knowable that by far surpass what can be known through phenomenological considerations and semantic interpretations. Therefore, it can be concluded that this experiment has contributed with a further demonstration concerning the impact of rotational dynamics on attitude change. The

greater the expansion and depth is in the unfolded spaces, the richer in folds are the emerging landscapes. The larger the increase is in the distances below sea level, the higher is the degree of "indirectness" in a particular verbalisation.

Based on the results of the two students, it can be concluded that the test material has been successful in simulating the two key notions of Strindberg's drama, namely natural selection on the one hand and conformity to social norms on the other. The result is in correspondence with the two different sensibilities of the students. In the analytic-descriptive mode, the student is concerned with the mechanism of social organisation. On the contrary, with a synthetic-reflective conduct, the student is attuned to those variables that are clearly encircling the main components of the theory of natural selection. In sum, the study shows, that a test material with a clear theoretical anchorage can be used to discover the disparity of the two minds.

References

- Bierschenk, B. (2001). Geometric foundation and quantification of the flow in a verbal expression. *Cognitive Science Research*, 81. (ERIC Document Reproduction Service, ED 459 193, TM 033 479)
- Bierschenk, B. (2002). Real time imaging of the rotation mechanism producing interview-based language spaces. *Cognitive Science Research*, No. 83. (ERIC Document Reproduction Service, No. ED 465 812, TM 034201)
- Bierschenk, B. (2003). Embodiment of consciousness. *Cognitive Science Research*, 89.
- Bierschenk, B., & Bierschenk, I. (2002). The AaO as building block in the coupling of text kinematics with the resonating structure of a metaphor. *Cognitive Science Research*, No. 85. (ERIC Document Reproduction Service, No. ED 472 170, TM 034 697)
- Bierschenk, B., & Bierschenk, I. (2003a). The manifestation of symmetry between the emergence of consciousness and the development of competence. *Cognitive Science Research*, No. 86. (ERIC Document Reproduction Service, No. ED472 156, TM 034 723)
- Bierschenk, B., & Bierschenk, I. (2003b). Individual Growth in competence. *Cognitive Science Research*, No. 87.
- Bierschenk, B., & Bierschenk, I. (2003c). Evolution of growth in the development of competence. *Cognitive Science Research*, No. 88.
- Bierschenk, I. (1999). The essence of text. *Cognitive Science Research*, 70. (ERIC Document Reproduction Service, No. ED 430 053, TM 029 798)
- Fiedler, K. (2003). Über Tests, physiologische Methoden und den Schein der Präzision [About tests, physiological methods, and spurious precision]. *Psychologische Rundschau*, 54(2), 112-115.
- Greene, B. (1999). *The elegant universe. Superstrings, hidden dimensions, and the quest for the ultimate theory*. New York: W. W. Norton & Company.
- Hestenes, D. (1993). *New foundations for classical mechanics*. Dordrecht: Kluwer Academic. (Original work published 1986)
- Kelso, J. A. S. (1995). *Dynamic patterns: The self-organisation of brain and behaviour*. Cambridge, MA: The MIT Press.
- Kugler, P. N. & Turvey, M. T. (1987). *Information, natural law, and the self-assembly of rhythmic movement*. Hillsdale, NJ: Erlbaum.
- Mainzer, K. (1999). *Komplexe Systeme und Nichtlineare Dynamik in Natur und Gesellschaft*. Heidelberg: Springer-Verlag.

- McNamara, K. J. (1997). *Shapes of time. The evolution of growth and development*. Baltimore: The Johns Hopkins University Press.
- Rozeboom, W. W. (1966). *Foundations of the theory of prediction*. Homewood, IL: The Dorsey Press.
- Winfree, A. T. (1980). *The geometry of biological time*. Berlin: Springer Verlag.

Accepted April 22, 2004

Authors' Note

Correspondence and requests for materials should be addressed to Bernhard F. Bierschenk, Department of Psychology at Lund University, Paradisgatan 5P, S-223 50 Lund, Sweden. E-mail bernhard.bierschenk@psychology.lu.se