



# LUND UNIVERSITY

## Model scale compartment fire tests with wall lining materials

Andersson, Berit

1988

[Link to publication](#)

*Citation for published version (APA):*

Andersson, B. (1988). *Model scale compartment fire tests with wall lining materials*. (LUTVDG/TVBB--3041--SE; Vol. 3041). Department of Fire Safety Engineering and Systems Safety, Lund University.

*Total number of authors:*

1

### General rights

Unless other specific re-use rights are stated the following general rights apply:

Copyright and moral rights for the publications made accessible in the public portal are retained by the authors and/or other copyright owners and it is a condition of accessing publications that users recognise and abide by the legal requirements associated with these rights.

- Users may download and print one copy of any publication from the public portal for the purpose of private study or research.
- You may not further distribute the material or use it for any profit-making activity or commercial gain
- You may freely distribute the URL identifying the publication in the public portal

Read more about Creative commons licenses: <https://creativecommons.org/licenses/>

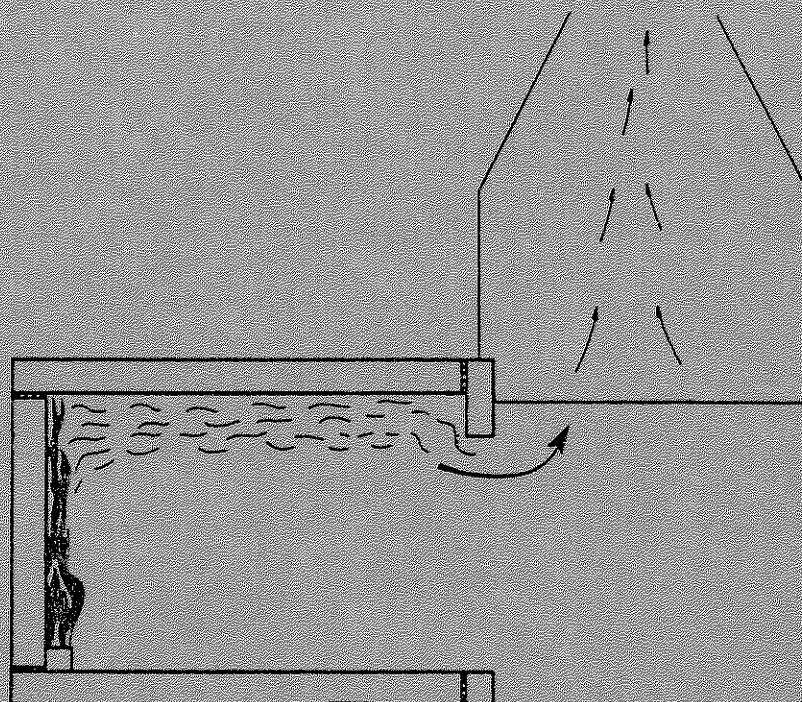
### Take down policy

If you believe that this document breaches copyright please contact us providing details, and we will remove access to the work immediately and investigate your claim.

LUND UNIVERSITY

PO Box 117  
221 00 Lund  
+46 46-222 00 00

LUND UNIVERSITY · SWEDEN  
INSTITUTE OF SCIENCE AND TECHNOLOGY  
DEPARTMENT OF FIRE SAFETY ENGINEERING  
REPORT LUTVDG/(TVBB - 3041)  
ISSN 0282 - 3756



---

BERIT ANDERSSON

# MODEL SCALE COMPARTMENT FIRE TESTS WITH WALL LINING MATERIALS

LUND 1988



## CONTENTS

- 1 Introduction
  
- 2 Testing Equipment
  - 2.1 Model Scale Compartment
  
  - 2.2 Instrumentation
    - 2.2.1 Temperature
    - 2.2.2 Total Heat Flux and Radiation
    - 2.2.3 Gas Analysis
    - 2.2.4 Rate of Heat Release
    - 2.2.5 Smoke Production
  
  - 2.3 Ignition Source
  
- 3 Tested Materials
  
- 4 Test Procedure
  - 4.1 Lining Material on three Walls and in the Ceiling
  
  - 4.2 Lining Material on three Walls

5 Results

5.1 Gas Temperature in the Fire Test Room

5.2 Surface Temperatures

5.3 Heat Flux and Radiation

5.4 Rate of Heat Release

5.5 Gas Analysis and Production of Combustion Gases

5.6 Smoke Production

5.7 Area Involved in Flaming Combustion

Appendix

A Gas Temperatures

B Surface Temperatures

C Heat Flux and Radiation

D Rate of Heat Release

E Gas Production

F Smoke Production

G Involved Area

H Observations

## Summary

Two series of tests with wall lining materials in an extensively equipped model scale room have been carried out. The dimensions of the room were 1.2 x 0.8 x 0.8 m<sup>3</sup>. In test series I the wall lining materials were mounted on three walls and in the ceiling. This test series comprised thirteen different materials. In test series II ten different materials were tested. They were mounted on the walls only.

The test compartment was instrumented for measurement of gas temperatures, surface temperatures, heat flux, rate of heat release and for analysis of oxygen, carbonmonoxide, carbon-dioxide and smoke. The ignition source was a propane gas diffusion burner. During the first 10 minutes the burner output was 11 kW. If no sustained burning in the material was achieved during this period the energy output was raised to 33 kW.

In the report all the collected data are summarized in tables, giving values at flashover and for combustion products production rates and total production. In appendices the time curves for the measured variables are given together with visual observations made during the tests.



## 1 INTRODUCTION

This report presents results from an experimental study within the project "Fire Hazard - Fire Growth in Compartments in the Early Stage of Development (Preflashover)". The project is carried out jointly by the Department of Fire Safety Engineering at the Lund Institute of Science and Technology and the Division of Fire Technology at the Swedish National Testing Institute.

The part of the project presented in this report comprise two test series in model scale with wall lining materials. In test series I the lining materials were mounted on three walls and in the ceiling. Thirteen different materials were tested in this test series. In test series II ten different materials were tested. They were mounted on three walls only. The criterion for choice of material for test series II was that the materials that caused flashover in test series I were tested also in this second configuration.

One of the goals for the whole project was to develop a test method for surface lining materials from which the behaviour of the tested material or product in a real fire can be predicted /1/. This goal has been achieved and the result is a fullscale room fire test for surface products. The test has also become a Nordtest method, NT Fire 025 /2/.

Testing materials and products in a full scale room is however expensive and requires a great deal of work when the material to be tested is mounted. The facts mentioned above were the main reasons for conducting tests in a model scale room. No comparisons between model scale and full scale tests will be presented in this report. Comparisons will be made and presented in other reports within the project.

## 2 TESTING EQUIPMENT

The experiments were carried out in an extensively equipped model scale room with a length of 1.2 m, a width of 0.8 m and a height of 0.8 m, figure 1. At the centre of one of the 0.8 m x 0.8 m walls there is a doorway 0.67 m high and originally 0.56 m wide. During the second test series this was changed to 0.46 m. The model compartment is a 1/3 scale model of the full scale compartment at the National Testing Institute in Borås.

The tested lining materials were mounted on three walls (the doorway wall excluded) and in the ceiling for test series I and only on the three walls for test series II. The tested materials were exposed to a propane gas burner acting as ignition source, figure 2. The burner was placed in the left-hand corner opposite the doorway wall in contact with the tested material. During the experiments measurements were made of gas temperatures, surface-temperatures, heat flux, smoke production, concentrations of oxygen ( $O_2$ ), carbonmonoxide (CO) and carbondioxide ( $CO_2$ ) and rate of heat release (RHR). The measurement of oxygen in the exhaust duct makes it possible to calculate the rate of heat released during the test.

All smoke and combustion gases coming out of the test compartment were collected in a hood just outside the room. The hood is connected to an exhaust duct and an evacuation system, figure 1.

Work is going on within ISO to standardize this type of full scale room test. A NORDTEST standard NT FIRE 025 developed within this project has been adopted /2/. In USA ASTM has published a similar proposal for standard /3/.





## 2.1 Model Scale Compartment

The model scale compartment is constructed of a special high temperature resistant concrete called "Viktor Korund" from Höganäs AB. Data for the concrete is given in table 1. The dimensions of the room are 1.2 x 0.8 x 0.8 m<sup>3</sup>. The room has one dooropening in one of the 0.8 m x 0.8 m sides. The doorway has a height of 0.67 m and a width of 0.56 m for test series I and 0.46 m for test series II. The design of the compartment is given in figure 1.

Table 1 Data for high temperature concrete "Viktor Korund"

---


$$k = 1.7 \text{ W/m} \cdot \text{K}$$

$$\rho = 2750 \text{ kg/m}^3$$

$$c = 1014 \text{ J/kg} \cdot \text{K}$$

$$k\rho c = 4740 \cdot 10^3 \text{ (W/(m}^2 \text{ K))}^2 \cdot \text{s}$$

## 2.2 Instrumentation

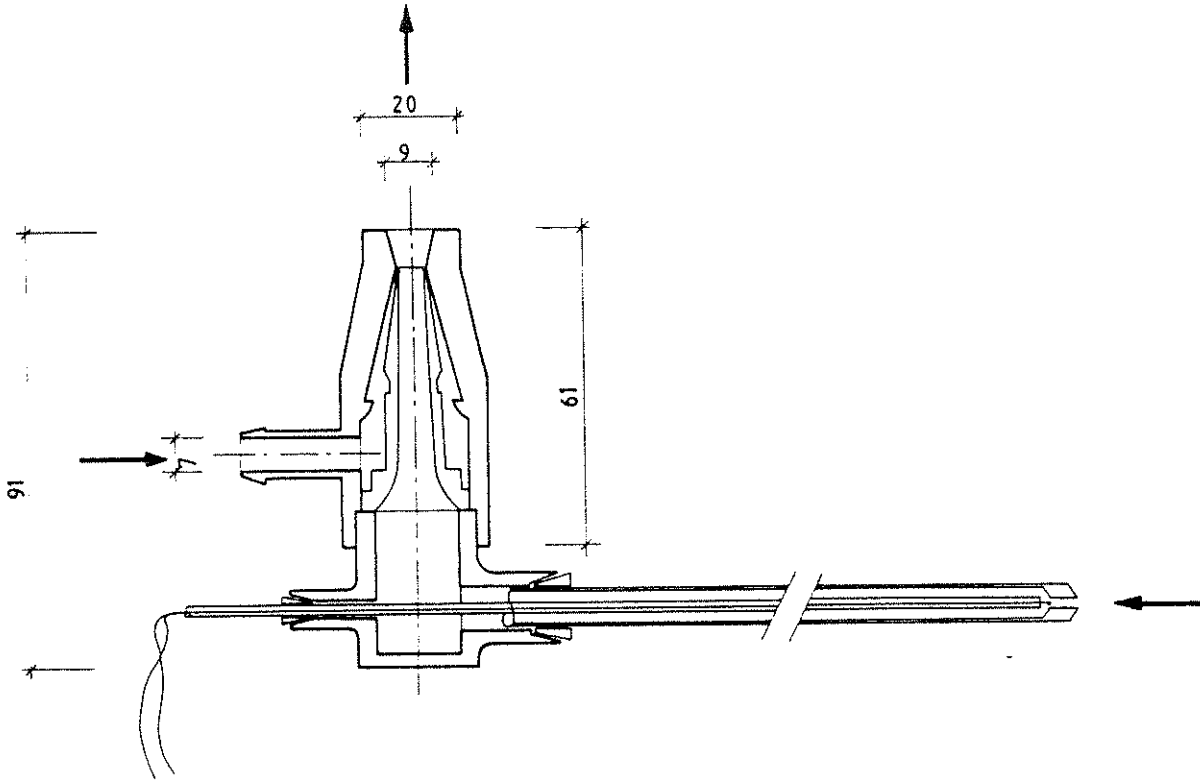
The test compartment was instrumented for measurement of gas temperatures, surface temperatures, heat flux, rate of heat release, smoke production and for analysis of the combustion products. All data were collected by a computer system. Sampling intervals were between 5 and 20 s. The chosen interval depending on the complexity of the measurements and the calculations performed during the experiment.

### 2.2.1 Temperature

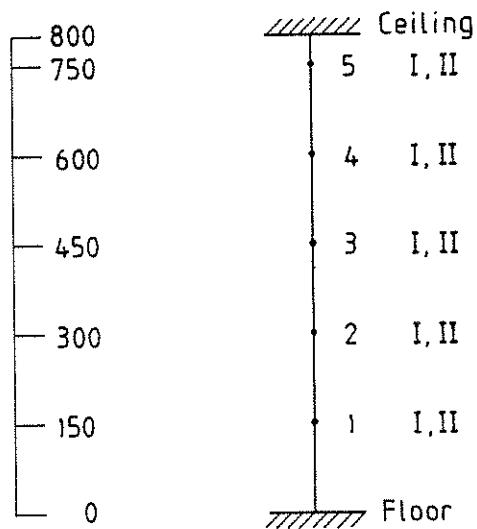
During test series I both gas temperatures and surface temperatures were measured. In the second test series only gas temperatures were measured. Gas temperatures were measured with thermocouples of Chromel Alumel with a wire diameter of 0.25 mm. In test series II suction pyrometers were used for measuring gastemperatures on a few locations. The principle for the suction pyrometer is given in figure 3. The thermocouples inside the suction pyrometers were identical to the bare thermocouples described above. Surface temperatures were also measured with Chromel Alumel thermocouples but with a wire diameter of 0.50 mm. The surface thermocouples were attached to the surface by covering them with approximately 1 cm<sup>2</sup> of thin, heat resistant glass fibre tape. An investigation, presented in /4/, shows that the method of attaching the thermocouple to the surface is not very critical to the measured surface temperature. The difference between the highest and the lowest temperature, for the methods used in /4/, is less than 50°C for surface temperatures up to about 400°C. Over 400°C flames impinge on the surface and the measurements are not relevant.

Gas temperatures were measured along a vertical profile inside the room, see figure 4. (channels 1I - 5I and 1II - 5II). The location of the profile in the room was changed between the two test series. The different locations are given in figure 5. In series II gas temperatures were also measured in the opening, channel 13II and at the centre of the room 50 and 100 mm below the ceiling, figure 6. Measurements on these locations were made with suction pyrometers (channels 11II - 13II). Thermocouples were used for reference in a few tests (channels 9II and 10II).

Surface temperatures were measured on the rear wall, in test series I, for positions see figure 7. (channels 6I - 9I) and in the ceiling, figure 8 (channels 10I and 11I).

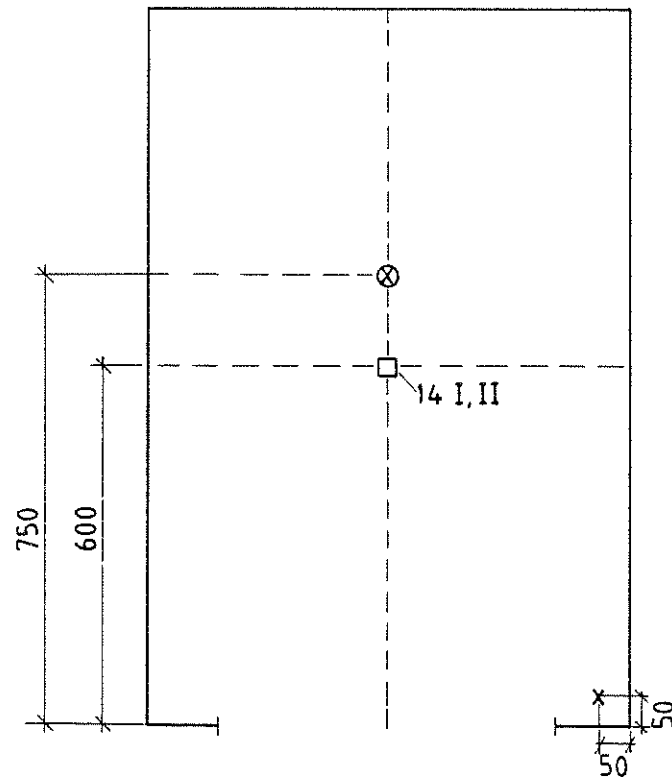


**Figure 3** The principle for the suction pyrometer.  
(Dimensions in mm.)



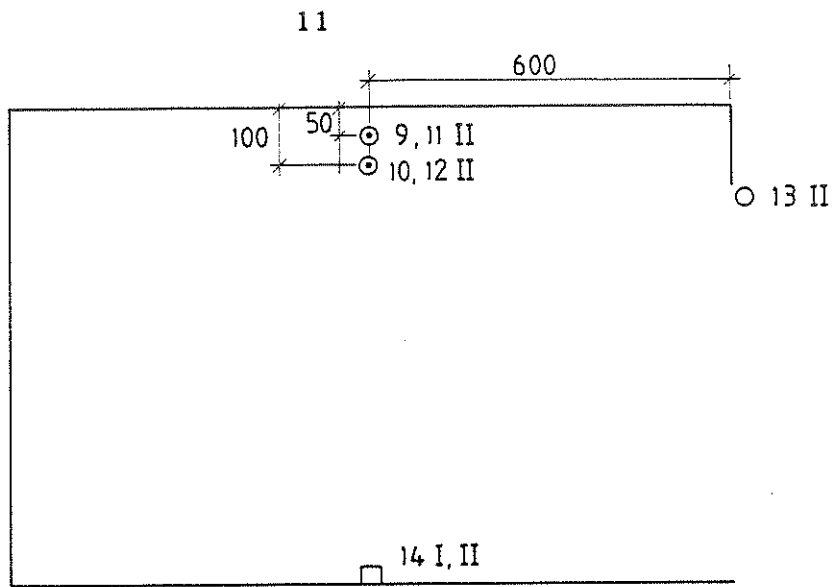
••thermocouple

**Figure 4** Vertical profile with thermocouples inside the test room. The numbers along the profile indicate the corresponding channel numbers for test series I and II respectively. (Dimensions in mm.)



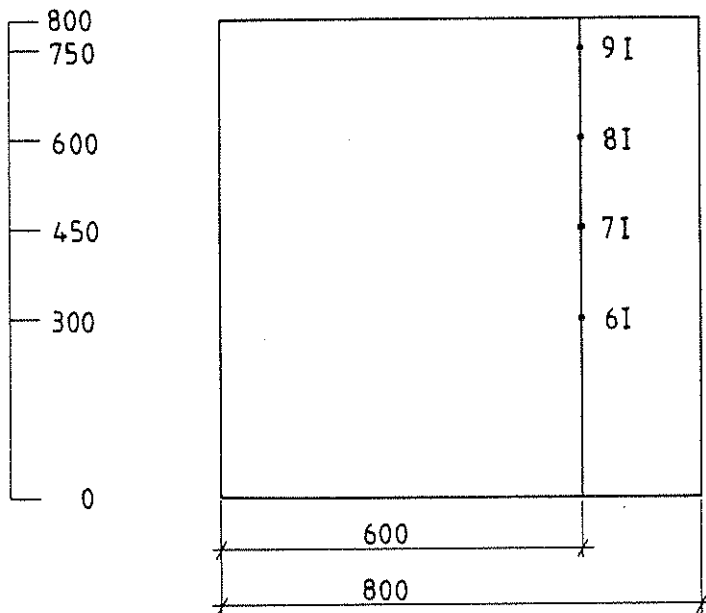
- total heat flux meter
- x location of vertical profile in test series I
- ⊗ location of vertical profile in test series II

**Figure 5** Locations for measurements in the floor inside the test room. The numbers indicate the corresponding channel numbers for test series I and II respectively. (Dimensions in mm.)



- thermocouple
- suction pyrometer
- ◻ total heat flux meter

Figure 6 Side view of the test room. Numbers indicate the corresponding channel numbers for test series I and II respectively. (Dimensions in mm.)



- thermocouple

Figure 7 Thermocouple positions on the rear wall. Numbers indicate the corresponding channel numbers for test series I. (Dimensions in mm.)

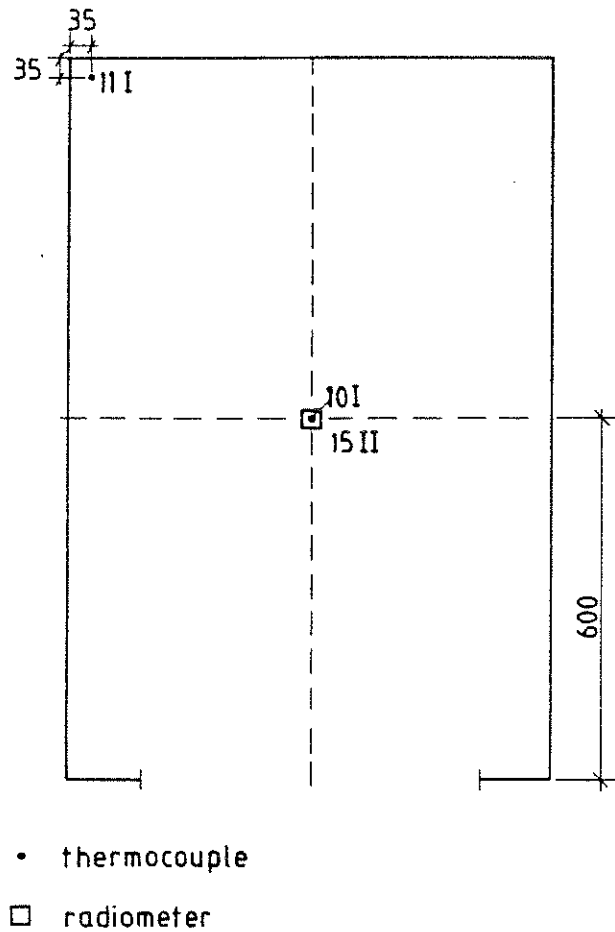


Figure 8 Locations for points of measurement in the ceiling of the test room. Numbers indicate the corresponding channel numbers for test series I and II respectively. (Dimensions in mm.)



### 2.2.2 Total Heat Flux and Radiation

During the tests measurements were made of total heat flux (radiation and convection) and of pure radiation. The total heat flux was measured with a Gardon-type instrument called Medtherm heat flux meter. For radiation measurements a Gunners radiometer /5/ was used.

In both test series total heat flux was measured in the middle of the floor (channels 14I and 14II). In test series II a measurement of radiation in the centre of the ceiling was added (channel 15II). The position of the measuring devices are given in figures 5 and 8.

### 2.2.3 Gas Analysis

The combustion gases were continuously analyzed for content of oxygen ( $O_2$ ), carbonmonoxide (CO) and carbondioxide ( $CO_2$ ). The gas sampling probe was mounted in the exhaust duct below the bidirectional probe and the smoke measuring system. The gas was pumped through a filtering system consisting of a cold trap with water and ice, a loosely packed glass-wool filter, a pleated capsule filter (3 $\mu$ m Gelman) and a silica gel filter. The filtering system is described in figure 9. For the  $O_2$ -analysis a Siemens Oxymat 2 (paramagnetic) was used and for CO and  $CO_2$  a Leybold-Heraeus Binos 1.2. (IR-analyser).

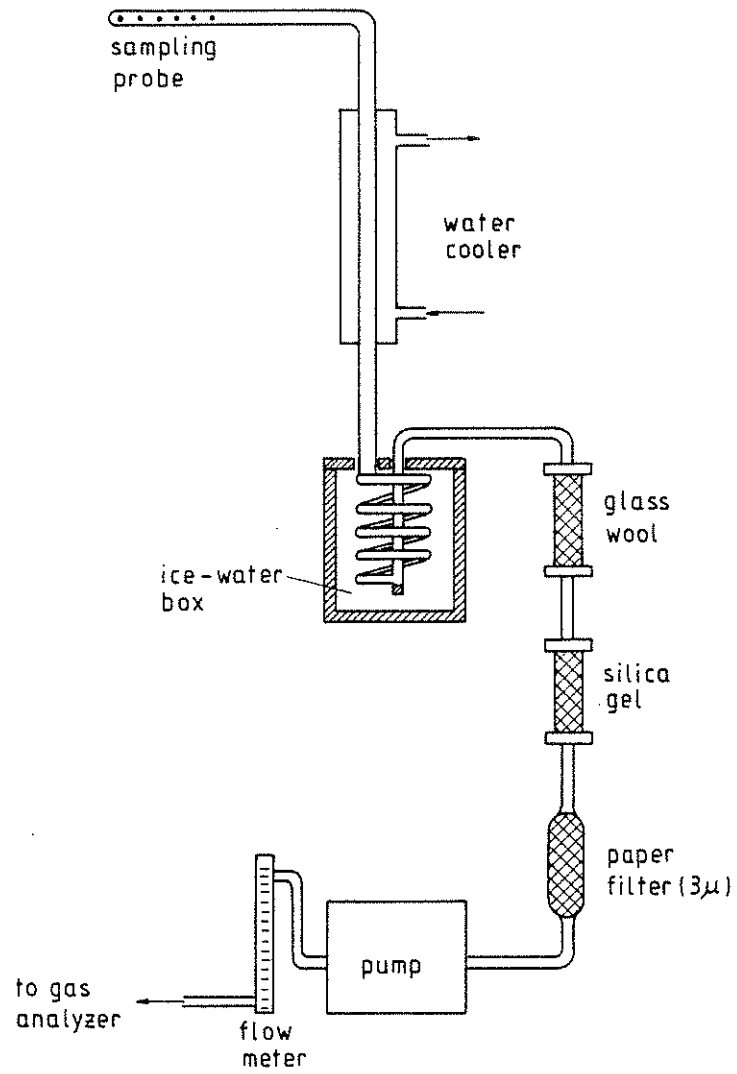


Figure 9 The layout of the filtering system connected to the equipment for continuous gas analysis.

#### 2.2.4 Rate of Heat Release

The rate of heat release (RHR), the amount of energy produced during the test, was determined by the technique of measuring oxygen consumption.

All smoke and hot gases leaving the test compartment were collected in a hood outside the model scale room and then via a duct exhausted to the atmosphere. The oxygen concentration and the mass flow rate were measured in the exhaust duct. The oxygen concentration was measured by a paramagnetic analyzer (Siemens Oxymat 2) with an accuracy of  $\pm 0.1$  vol% oxygen.

The massflow was determined by a pitot tube of the type bidirectional probe /6/ and thermocouple in the centre of the circular duct. The probe consists of a stainless steel cylinder having a massive wall in the centre, dividing it into two chambers. The pressure differential between the two chambers, created by the flow passing the probe, is used to calculate the volume flow. The velocity distribution across the duct is shown in figure 10. For the exhaust duct  $v/v_{\max} \approx 0.9$  which implies that the flow is truly turbulent in the regions of velocity used in this study. The flow is turbulent when  $v/v_{\max} > 0.5$  /7/. The method for calculating RHR from oxygen consumption and mass flow is presented in 5.4.

#### 2.2.5 Smoke Production

The smoke production was determined by measuring the absorptivity of the combustion gases in the exhaust duct, by a system consisting of a lamp, a lens system and a photocell. The lamp was a tungsten halogen lamp working at a colour temperature of  $2900 \pm 100$ K (Osram halo stars; 64410; 6V, 10W). The photocell had a spectral sensitivity according to the CIE photopic curve (United Detector Technology; PIN 10 AP). The distance between the lamp and the photocell was 0.15 m. The results and the method of calculation are presented in 5.6.

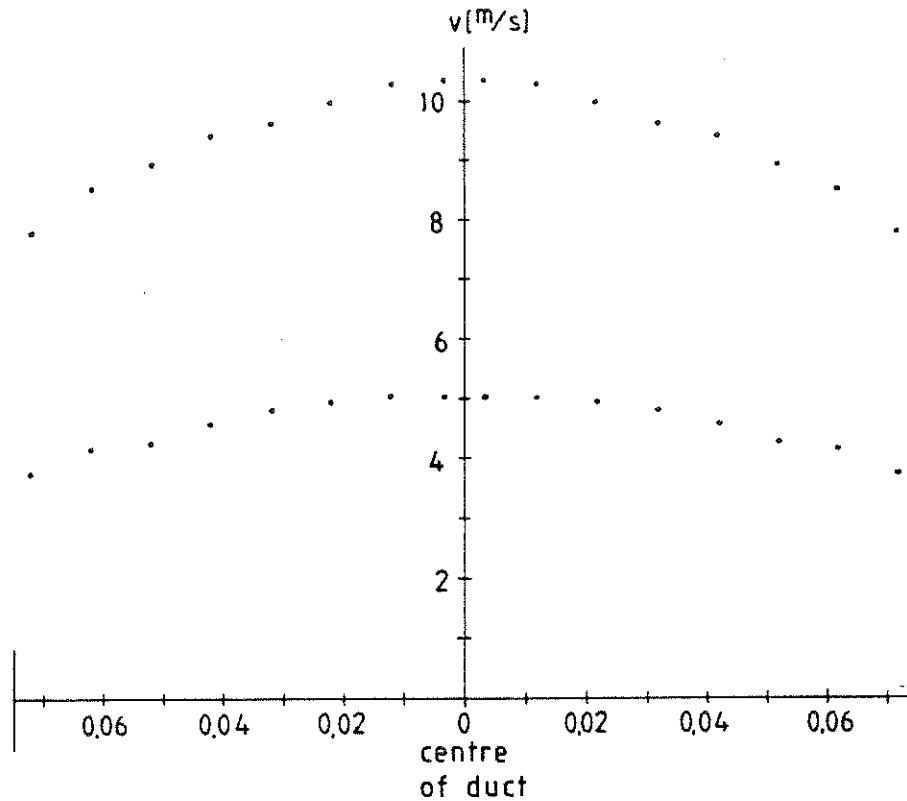


Figure 10 The velocity distribution across the exhaust duct (diameter = 0.15 m). The measurements were made at two different velocities,  $\sim 5$  m/s and  $\sim 10$  m/s. (Dimensions are in m.)

### 2.3 Ignition Source

The ignition source was a propane gas burner of diffusion type. The burner was a cube with a side of 0.07 m, see figure 2. The cube was filled with sand to achieve an even distribution of the gas. To facilitate a safe ignition the burner was equipped with a pilot flame. The burner was placed on the floor in the left-hand corner opposite the door. Contact between the burner walls and the tested wall material was ensured. The gasflow was measured with a variable area flowmeter.

Two levels of heat release rates were used. During the first 10 minutes the burner output was 11 kW. If no sustained burning in the material was achieved during this period the energy output was raised to 33 kW.

3 TESTED MATERIALS

Thirteen different materials (material 1 - 13 in table 2) were tested in test series I, in which the material was mounted on three walls and in the ceiling. Ten materials (material 1 - 3, 5, 7 - 9 and 11 - 13 in table 2) from test series I were also tested in a second test series in which the material was mounted on the walls only. The main criterion when choosing material for the second test series was that they had given flashover when tested with material both on the walls and in the ceiling.

The materials are presented in table 2. Prior to testing the materials were conditioned at 65% relative humidity and 20°C.

Table 2 Tested Materials

Material	Thickness (mm)	Density (kg/m <sup>3</sup> )	Weight (kg/m <sup>2</sup> )
1. Insulating fibreboard	13	250	3.25
2. Medium density fibreboard	12	600	7.2
3. Particle board	10	750	7.5
4. Gypsum plaster board	13	700	9.1
5. PVC wallcovering on gypsum plaster board	0.7 + 13 <sup>1</sup>	680 <sup>2</sup>	0.24 + 9.1 <sup>1</sup>
6. Paper wallcovering on gypsum plaster board	0.6 + 13 <sup>1</sup>	680 <sup>2</sup>	0.2 + 9.1 <sup>1</sup>
7. Textile wallcovering on gypsum plaster board	0.7 + 13 <sup>1</sup>	690 <sup>2</sup>	0.37 + 9.1 <sup>1</sup>
8. Textile wallcovering on mineral wool	0.7 + 42 <sup>1</sup>	180 <sup>2</sup>	0.37 + 7.5 <sup>1</sup>
9. Melamine faced particle board	1.2 + 13 <sup>1</sup>	810 <sup>2</sup>	11.5 <sup>3</sup>

10. Expanded polystyrene	50	20	1.0
11. Rigid polyurethane foam	30	30	0.9
12. Wood panel, spruce	11	530	5.8
13. Paper wallcovering on particle board	$0.6 + 10^1$	$730^2$	$0.2 + 7.5^1$

- 1) Surface material + substrate
- 2) Density of the entire product
- 3) Weight of the entire product

#### 4 TEST PROCEDURE

Two types of tests were conducted. They constitute two different test series. One series with lining material on three walls and in the ceiling and one series with lining material on three walls only.

##### 4.1 Lining Material on Three Walls and in the Ceiling

Thirteen different lining materials were tested in a model scale room. The materials are presented in table 2, and the tests are specified in table 3. In test series no I material was mounted on three walls (the wall with the door opening was not covered) and in the ceiling.

The materials were mounted with bolts through the material and the walls of the testing compartment. This was in order to keep the construction material inside the compartment as intact as possible throughout the test series.

A typical test was carried out as follows:

The conditioned wall lining material was mounted on the walls and in the ceiling.

The pilot flame was lit and the gas burner was placed in position (rear, left hand corner).

The gasvalve was opened and the flowmeter adjusted to give 11 kW out from the burner. Simultaneously the data collection was started.

The exhaust system was activated.

Photographs were taken every 30 s.



If sustained burning was not achieved within 10 minutes after ignition of the gas burner the gas flow was increased to give an output of 33 kW.

The test was continued either until all the material was consumed or until the fire was so intense that it was obvious that the exhaust system had problem to evacuate all the smoke. If the second situation arose the fire was extinguished using waterspray.

#### 4.2 Lining Material on Three Walls

The second test series (no II) comprised 11 tests with 10 different materials, material 1-3, 5, 7-9 and 11-13 in table 2. In this test series material was mounted on three walls. The materials are described in table 2 and specifications for the tests are given in table 4.

The materials were mounted in the same way as in test series I (described in paragraph 4.1). The tests were also conducted in the same way as in test series I.

As can be seen in table 4 two tests were run with material no 3, particle board. Test 3 had a dooropening which was 0.56 m wide and in test 4 the dooropening had a width of 0.46 m. The reason for this is that the model scale room is made as a 1/3 scale model of a full scale standard test room at the National testing institute in Borås and a correct scaling of the full scale room gives a doorwidth of 0.46 m. Unfortunately the model scale room has a doorwidth of 0.56 m and this is consequently a little too wide. Tests 3 and 4 were run to check the influence of the doorwidth on the test results. No significant difference could be found in the measured variable for these tests. Accordingly it was decided to have a doorwidth of 0.46 m throughout the test series. In test series I the doorwidth was constantly 0.56 m. The results from tests II:3 and II:4 indicates that this should cause no problem in comparing results from the test series I and II.

Table 3 Test conditions, series I

Material	Ignition source	Note
1. Insulating fibreboard	11 kW	
2. Medium density fibre-board	11 kW	Channels 1I, 2I, 3I, 4I 5I failed
3. Particle board	11 kW	
4. Gypsum plaster board	11 kW, increased to 33 kW after 10 min	
5. PVC wallcovering on gypsum plaster board	11 kW, increased to 33 kW after 10 min	
6. Paper wallcovering on gypsum plaster board	11 kW, increased to 33 kW after 10 min	
7. Textile wallcovering on gypsum plaster board	11 kW, increased to 33 kW after 10 min	Channels 1I, 2I, 3I, 4I 5I attached after 3.5 min
8. Textile wallcovering on mineral wool	11 kW	
9. Melamine faced particle board	11 kW, increased to 33 kW after 10 min	Channel 8I failed
10. Expanded polystyrene	11 kW, increased to 33 kW after 10 min	
11. Rigid polyurethane foam	11 kW	No measurements on channels 1I, 2I, 3I, 4I, 5I, 6I, 7I, 8I, 9I, 10I, 11I, 14I and of CO and CO <sub>2</sub> due to the short duration of the test
12. Wood panel, spruce	11 kW	Channel 8I failed
13. Paper wallcovering on particle board	11 kW	Channel 9I failed

Table 4 Test conditions, series II

Material	Ignition source	Note
1. Insulating fibre-board	11 kW	
2. Medium density fibreboard	11 kW	Channel 15II failed No measurement of CO, CO <sub>2</sub> and smoke
3. Particle board	11 kW	Doorwidth 0.56 m Channel 15II failed No measurement of CO, CO <sub>2</sub> and smoke
4. Particle board	11 kW	Doorwidth 0.46 m Channel 15II failed No measurement of CO, CO <sub>2</sub> and smoke
5. PVC wallcovering on gypsum plaster board	11 kW, increased to 33 kW after 10 min	Channel 15II failed
6. Textile wallcovering on gypsum plaster board	11 kW, increased to 33 kW after 10 min	Channel 15II failed
7. Textile wallcovering on mineral wool	11 kW	
8. Melamine faced particle board	11 kW, increased to 33 kW after 10 min	
9. Rigid polyurethane foam	11 kW	No measurement of the variables on channels 1II, 2II, 3II, 4II, 5II, 11II, 12II, 13II, 14II, 15II and of CO, CO <sub>2</sub> and smoke  due to the short duration of the test
10. Wood panel, spruce	11 kW	
11. Paper wallcovering on particle board	11 kW, increased to 33 kW after 15 min	

## 5 TEST RESULTS

During the test series a large amount of data was generated and collected. Some of the data has in addition been used in the calculation of new parameters.

In this section data are summarized in tables. Diagrams showing measured and calculated variables from each test are presented in appendicies.

### 5.1 Gas Temperature in the Fire Test Room

In appendix A all gas temperature data recorded during the tests are presented. This includes for test series I a vertical temperature profile inside the room, figure A1-11, as described in 2.2.1 and for test series II a similar vertical profile, the temperature in the upper part of the opening and the temperature inside the room just under the ceiling A12-A21. Included is also a comparison between temperatures measured with thermocouple and with suction pyrometer. It can be noted that the temperature of the hot upper gas layer in the room, when flames appear outside the room is approximately  $400^{\circ}\text{C}$  for test series I, (with material on walls and ceiling) and  $800^{\circ}\text{C}$  for test series II (with material on walls only).

During three tests in test series II measurements were made with both suction pyrometers and thermocouples on two locations in the hot upper layer inside the room. The results are presented in figure A22-A24. No big differences can be seen between the two measurement techniques at least not until the fire in the room is fully developed. In test series I no gas temperatures were registered during test 2 and 11. During test 2I the thermocouples failed. Test 11I was completed in less than 30 s so only a couple of scans were made. Accordingly there are no temperature measurements from test 11II which was completed in 60 s.

## 5.2 Surface Temperature

Appendix B contains diagrams presenting surface temperatures measured during test series I, figures B1-B12. Two types of surface temperatures were measured, wall temperatures and ceiling temperatures. During test 11I no surface temperatures were measured owing to the short duration of the test. The thermocouple on channel 8I failed during test 9I and 12I and during test 13I there was a failure in thermocouple 9I. The erroneous thermocouples all measured wall temperatures.

## 5.3 Heat Flux and Radiation

Appendix C shows the measured heat fluxes towards the floor for test series I, figures C1-C3 (all tests except test 11) and II, figures C4-C5 (all tests except test 11). Included is also radiation towards the ceiling measured during test series II, figure C6 (test 1, 8, 9, 12 and 13). The values at flashover are summarized in table 5 and table 6. With material on the walls and in the ceiling the heat flux towards the floor at flashover is between 10 and 14 kW/m<sup>2</sup>. When there is material on the walls only the heat flux towards the floor at flashover is higher, between 13 and 22 kW/m<sup>2</sup>.

Table 5 Heat flux towards the floor at flashover,  
series I

Material	Heat flux towards the floor [kW/m <sup>2</sup> ]
Insulating fibreboard	14
Medium density fibreboard	14
Particle board	11
PVC wallcovering on gypsum plaster board	12
Textile wallcovering on gypsum plaster board	11
Textile wallcovering on mineral wool	12
Melamine faced particle board	11
Expanded polystyrene	10
Wood panel, spruce	11
Paper wallcovering on particle board	11

Table 6 Heat flux towards the floor and radiation towards the ceiling, at flashover, series II

Material	Heat flux towards the floor [kW/m <sup>2</sup> ]	Radiation towards the ceiling [kW/m <sup>2</sup> ]
Insulating fibreboard	21	4.8
Medium density fibreboard	17	-
Particle board (0.56 m doorwidth)	13	-
Particle board (0.46 m doorwidth)	13	-
Textile wallcovering on mineral wool	16	5.5
Wood panel, spruce	16	3.1
Paper wallcovering on particle board	22	19.0



#### 5.4 Rate of Heat Release

The rate of heat release (RHR) is determined by the technique of measuring oxygen consumption. This technique is based on the fact that the energy released per unit oxygen consumed is close to a constant for complete combustion of most fuels of interest in compartment fires. This constant is  $17.2 \text{ MJ/m}^3$  oxygen consumed at  $25^\circ\text{C}$ , with an accuracy of 5% or better /8/.

All smoke and combustion gases emerging from the test compartment were collected in a hood just outside the room. The hood was connected to an exhaust duct, figure 1.

The oxygen concentration and the gas flow are measured in this exhaust duct. The gas flow was determined by a pitot tube of the type bi-directional probe /6/ and a thermocouple in the centre of the exhaust duct at a distance from the hood where the velocity profile is ensured to be fully developed. The oxygen concentration is measured in the exhaust duct by a paramagnetic analyzer (Siemens Oxymat 2). The volume flow at atmospheric pressure and ambient temperature (298K) is given by the expression (1):

$$\dot{V}_{298} = \frac{k_t}{k_p} \cdot \frac{A}{\rho_{298}} \left[ \frac{2\Delta p}{T_g} \frac{T_o}{\rho_o} \right]^{1/2} \quad [\text{m}^3/\text{s}] \quad (1)$$

where:

$k_t$  = ratio between the average velocity and the velocity in the centre of the duct = 0.9

$k_p$  = calibration constant for the bi-directional probe = 1.08

$A$  = cross section area of the exhaust duct =  $0.075^2 \cdot \pi$  [ $\text{m}^2$ ]

$\rho_{298}$  = density of air at 298K =  $1.1852$  [ $\text{kg/m}^3$ ]

$\Delta p$  = the pressure difference measured by the bi-directional probe in the duct [Pa]

$$T_o = 273.15 \text{ [K]}$$

$\rho_o$  = density of air at 273.15 K = 1.293 [kg/m<sup>3</sup>]

$T_g$  = gas temperature in the duct [K]

with all constants taken into account the expression becomes:

$$\dot{V}_{298} = 0.330 \left[ \frac{\Delta p}{T_g} \right]^{1/2} \quad [\text{m}^3/\text{s}] \quad (2)$$

When the RHR is calculated the production of carbondioxide (CO<sub>2</sub>) is taken into account but the production of carbonmonoxide (CO) and water is neglected. The CO<sub>2</sub>-production is taken care of by equation (3)

$$T = [O_2]_{I+1} / (100 - ([CO_2]_{I+1} - [CO_2]_1) / 10\ 000) \quad (3)$$

then the RHR can be calculated as

$$\text{RHR} = E \cdot \dot{V}_{298} / (10/[O_2]_1 + (1-T)/[O_2]_1 / 100 - T) \quad [\text{MW}] \quad (4)$$

where

$[O_2]_{I+1}$  = volume fraction of oxygen in the analyzer  
[vol%]

$[O_2]_1$  = volume fraction of oxygen in the incoming air  
[vol%]

$[CO_2]_{I+1}$  = volume fraction of carbondioxide in the analyzer  
[vol%]

$[CO_2]_1$  = volume fraction of carbondioxide in the incoming  
air [vol%]

E = heat release per volume of oxygen consumed = 17.2  
[MJ/m<sup>3</sup>]

The rate of heat release versus time is given in appendix D for all the tested materials, figures D1a-D7a. Included is also the total energy released during the experiments, figures D1b-D7b.

One significant event during the build up of a fully developed fire is the onset of flashover. Here the time to flashover is taken as the time when flames emerge out of the test compartment. These times to flashover are given in table 7 for test series I and in table 8 for test series II. In these tables are also given the values of RHR at the corresponding flashover times.

For the test situation in test series I a heat release of about 50 kW seems to be needed to give flashover. With material only on the walls a higher rate of heat release is needed. It is however difficult to find the correct level from the results presented in table 8.

Table 7 Heat release rates and times for flames out through the doorway, test series I

Material	Time to flames out the doorway (min:s)	Corresponding rate of heat release (kW)	Time to reach 50 kW
Insulating fibreboard	1:15	55	1:12
Medium density fibreboard	3:30	66	3:08
Particle board	3:50	48	3:51
Gypsum plaster board	-	-	-
PVC wallcovering on gypsum plaster board	10:20 <sup>1)</sup>	58	10:15
Paper wallcovering on gypsum plaster board	-	-	-
Textile wallcovering on gypsum plaster board	10:35 <sup>1)</sup>	49	10:40
Textile wallcovering on mineral wool	0:55	55	0:54
Melamine faced particle board	13:25 <sup>1)</sup>	48	12:10
Expanded polystyrene	10:40 <sup>1)</sup>	74	10:01
Rigid polyurethane foam	0:12	70	0:11
Wood panel, spruce	4:40	48	4:46
Paper wallcovering on particle board	3:40	50	3:40

1) The ignition source output was increased to 33 kW at 10 min

Table 8 Heat release rates and times for flames out through the doorway, test series II

Material	Time to flames out the doorway (min:s)	Corresponding rate of heat release (kW)
Insulating fibreboard	3:50	72
Medium density fibreboard	6:45	75
Particle board doorwidth 0.56 m	10:20 <sup>1)</sup>	58
Particle board doorwidth 0.46 m	10:15 <sup>1)</sup>	56
PVC wallcovering on gypsum plaster board	-	-
Textile wallcovering on gypsum plaster board	-	-
Textile wallcovering on mineral wool	1:43	88
Melamine faced particle board	-	-
Rigid polyurethane foam	0:30	72
Wood panel, spruce	9:45	126
Paper wallcovering on particle board	16:10 <sup>2)</sup>	155

1) The ignition source output was increased to 33 kW at 10 min

2) The ignition source output was increased to 33 kW at 15 min

### 5.5 Gas Analysis

During the tests carbonmonoxide (CO) and carbondioxide (CO<sub>2</sub>) were analysed continuously with an infrared spectrophotometer (BINOS 1.2).

The analyses were performed on samples taken in the exhaust duct close before the point where the volume flow rate was determined. Before entering the analyzer the gassample passed a train of coolers and filters. The layout of the sampling line is given in figure 9.

The volume flow in the duct was calculated according to the method described in 5.4 equation (1). With a known volume flow and a known gas concentration the rate of gas production can be calculated.

The production rate of CO is calculated according to equation (5):

$$\dot{V}_{CO} = \dot{V}_{298} \cdot [CO]/1000 \quad (5)$$

$\dot{V}_{CO}$  = production rate of CO at 298 K and 1 bar [l/s]

$\dot{V}_{298}$  = volume flow rate in the duct at 298 K and 1 bar  
[m<sup>3</sup>/s] (see 5.4)

[CO] = volume concentration of CO in the analyzer [ppm]

When calculating the production rate of CO<sub>2</sub> the startconcentration of CO<sub>2</sub> is taken into account.

$$\dot{V}_{CO_2} = \dot{V}_{298} ([CO_2] - [CO_2]_1)/1000 \quad (6)$$

$\dot{V}_{CO_2}$  = production rate of CO<sub>2</sub> at 298 K and 1 bar [l/s]

$[\text{CO}_2]$  = volume concentration of  $\text{CO}_2$  in the analyzer [ppm]

$[\text{CO}_2]_1$  = volume concentration of  $\text{CO}_2$  in the analyzer at the beginning of the experiment [ppm]

The total production of CO and  $\text{CO}_2$  was also calculated as the integrated values of the production rates.

In tables 9-12 the production rate, the total production and the production rate normalized versus the rate of heat release are given for all the tested materials. These values are all taken at flashover. In appendix E the time curves are given for CO and  $\text{CO}_2$  production, figures E1a-E14a, and for the total production of CO and  $\text{CO}_2$ , figures E1b-E14b.

The normalized CO production rate tends to lie between 10 and 15 l/MJ for test series I. Expanded polystyrene however gives an extremely low value of 3 l/MJ and wood panel gives 8 l/MJ. For test series II the results are too few to make any firm conclusions but the results are of the same order of magnitude as in test series I.

The normalized  $\text{CO}_2$  production rate tends to lie between 40 and 60 l/MJ for test series I. The few results that exist from test series II are more scattered and it is impossible to draw any conclusions.



Table 9      Analysis of carbonmonoxide, test series I.

Material	Production rate at flashover (1/s)	Total production up to flashover (1)	Production rate divided by heat release rate (1/MJ)
Insulating fibreboard	0.80	21	15
Medium density fibreboard	1.02	44	15
Particle board	0.74	38	15
Gypsum plaster board	--1)	--1)	--1)
PVC wallcovering on gypsum plaster board	0.7	15	12
Paperwallcovering on gypsum plaster board	--1)	--1)	--1)
Textile wallcovering on gypsum plaster board	0.51	15	10
Textile wallcovering on mineral wool	0.66	3	12
Melamine faced particle board	0.72	120	15
Expanded polystyrene	0.23	30	3
Rigid polyurethane foam	--2)	--2)	--2)
Wood panel, spruce	0.40	42	8
Paperwallcovering on particle board	0.49	26	10

notes: 1) Flashover was never achieved  
 2) Measurement of CO was not made

Table 10      Analysis of carbonmonoxide, test series II

Material	Production rate at flashover (l/s)	Total production up to flashover (l)	Production rate divided by heat release rate (l/MJ)
Insulating fibreboard	0.59	25	8
Medium density fibreboard	--2)	--2)	--2)
Particle board doorwidth 0.56 m	--2)	--2)	--2)
Particle board doorwidth 0.46 m	--2)	--2)	--2)
PVC wallcovering on gypsum plaster board	--1)	--1)	--1)
Textil wallcovering on gypsum plaster board	--1)	--1)	--1)
Textile wallcovering on mineral wool	0.86	25	10
Melamine faced particle board	--1)	--1)	--1)
Rigid polyurethane foam	--2)	--2)	--2)
Wood panel, spruce	0.78	49	6
Paper wallcovering on particle board	1.1	106	7

notes: 1) Flashover was never achieved  
 2) Measurement of CO was not made

Table 11      Analysis of carbondioxide, test series I

Material	Production rate at flashover (1/s)	Total production up to flashover (l)	Production rate divided by heat release rate (1/MJ)
Insulating fibreboard	3.2	80	60
Medium density fibreboard	4	240	60
Particle board	2.8	260	55
Gypsum plaster board	--1)	--1)	--1)
PVC wallcovering on gypsum plaster board	2.3	250	40
Paperwallcovering on gypsum plaster board	--1)	--1)	--1)
Textile wallcovering on gypsum plaster board	2.4	310	50
Textile wallcovering on mineral wool	2.6	35	50
Melamine faced particle board	2.4	65	45
Expanded polystyrene	3.3	62	45
Rigid polyurethane foam	--2)	--2)	--2)
Wood panel, spruce	2.6	360	55
Paper wallcovering on particle board	2.4	220	50

notes: 1) Flashover was never achieved

2) Measurement of CO<sub>2</sub> was not made

Table 12 Analysis of carbondioxide, test series II

Material	Production rate at flashover (1/s)	Total production up to flashover (1)	Production rate divided by heat release rate (1/MJ)
Insulating fibreboard	5.9	310	82
Medium density fibreboard	--2)	--2)	--2)
Particle board doorwidth 0.56 m	--2)	--2)	--2)
Particle board doorwidth 0.46 m	--2)	--2)	--2)
PVC wallcovering on gypsum plaster board	--1)	--1)	--1)
Textile wallcovering on gypsum plaster board	--1)	--1)	--1)
Textile wallcovering on mineral wool	5.9	130	67
Melamine faced particle board	--1)	--1)	--1)
Rigid polyurethane foam	--2)	--2)	--2)
Wood panel, spruce	2.8	460	22
Paper wallcovering on particle board	6.2	650	40

notes: 1) Flashover was never achieved  
 2) Measurement of CO<sub>2</sub> was not made

## 5.6 Smoke Production

The smoke production during the experiments was measured with a lamp-photocell system. This system is described in 2.2.5. The measurements were made in the exhaust duct just after the point where the volume flow rate was determined, see figure 1.

The lamp-photocell system measures the light obscuring effect of the smoke. This effect can be used to calculate the smoke production. The method presented by Rasbash /9/ where he introduces a quantity called obscura (ob) is used here when giving the results from the smoke measurements.

Firstly a calculation is made of the smoke intensity  $D_L$  in ob:

$$D_L = \frac{10}{L} \log \frac{I_o}{I} \quad (7)$$

$L$  = length of light path over which smoke is measured (m)

$I_o$  = intensity of light beam in absence of smoke

$I$  = intensity of light beam in presence of smoke

In our equipment the light path was 0.15 m.

The smoke production rate,  $D_{sp}$ , is calculated as:

$$D_{sp} = D_L \cdot \dot{V}_{298} \cdot (T_{duct} + 273.15)/298 \quad [\text{ob} \cdot \text{m}^3/\text{s}] \quad (7)$$

$\dot{V}_{298}$  = volume flow in the duct at atmospheric pressure and ambient temperature see section 5.4 equation (1), ( $\text{m}^3/\text{s}$ ).

$T_{duct}$  = gastemperature in the exhaust duct ( $^{\circ}\text{C}$ ).

The integrated value of the smoke production rate, called total smoke production,  $D_T$  can also be calculated. The unit of  $D_T$  becomes  $ob \cdot m^3$ .

In tables 13 and 14 the smoke production rate and the total smoke production up to flashover are presented for the tests in series I and II. A normalization of the smoke production rate to the heat release rate at the time of flashover is also presented. The complete time curves for smoke production rate and total smoke production are given in appendix F, figures Fla - F7b.

Table 13 Smoke production, test series I

Material	Production rate at flashover (ob · m <sup>3</sup> /s)	Total production up to flashover (ob · m <sup>3</sup> )	Production rate divided by heat release rate (ob · m <sup>3</sup> /MJ)
Insulating fibreboard	1.8	47	32.7
Medium density fibreboard	3.5	170	53.0
Particle board	4.2	200	82.4
Gypsum plaster board	--1)	--1)	--1)
PVC wallcovering on gypsum plaster board	5.0	210	100.0
Paper wallcovering on gypsum plaster board	--1)	--1)	--1)
Textile wallcovering on gypsum plaster board	1.9	50	40.4
Textile wallcovering on mineral wool	4.7	20	88.7
Melamine faced particle board	7.4	1200	160.9
Expanded polystyrene	3.0	1000	40.5
Rigid polyurethane foam	--2)	--2)	--2)
Wood panel, spruce	0.8	105	17.4
Paper wallcovering on particle board	2.9	120	61.7

notes: 1) Flashover was never achieved

2) Measurement of smoke production was not made

Table 14 Smoke production, test series II

Material	Production rate at flashover  (ob · m <sup>3</sup> /s)	Total production up to flashover  (ob · m <sup>3</sup> )	Production rate divided by heat release rate  (ob · m <sup>3</sup> /MJ)
Insulating fibreboard	0.9	32	13
Medium density fibreboard	--2)	--2)	--2)
Particle board doorwidth 0.56 m	--2)	--2)	--2)
Particle board doorwidth 0.46 m	--2)	--2)	--2)
PVC wallcovering on gypsum plaster board	--1)	--1)	--1)
Textile wallcovering on gypsum plaster board	--1)	--1)	--1)
Textile wallcovering on mineral wool	2.6	100	30
Melamine faced particle board	--1)	--1)	--1)
Rigid polyurethane foam	--2)	--2)	--2)
Wood panel, spruce	0.7	150	6
Paper wallcovering on particle board	3.9	200	25

notes: 1) Flashover was never achieved

2) Measurement of smoke production was not made



### 5.7 Area Involved in Flaming Combustion

During both testseries photographs were taken approximately every 30 s. The surfaces inside the testroom were marked every 0.1 m both horizontally and vertically. It was consequently possible to evaluate the area involved in flaming combustion, by studying these photographs. The photographs were studied carefully and the number of burning squares were calculated. This method cannot be exact as, especially for some materials, smoke obscures some of the squares and makes it difficult to see the border line between burning and non-burning material. The involved area as a function of time is presented in figures G1-G4 in appendix G.

### 5.8 Observations

Visual observations were made during the tests and notes were taken of what occurred. In appendix H the observations are presented as times to special events during the tests.

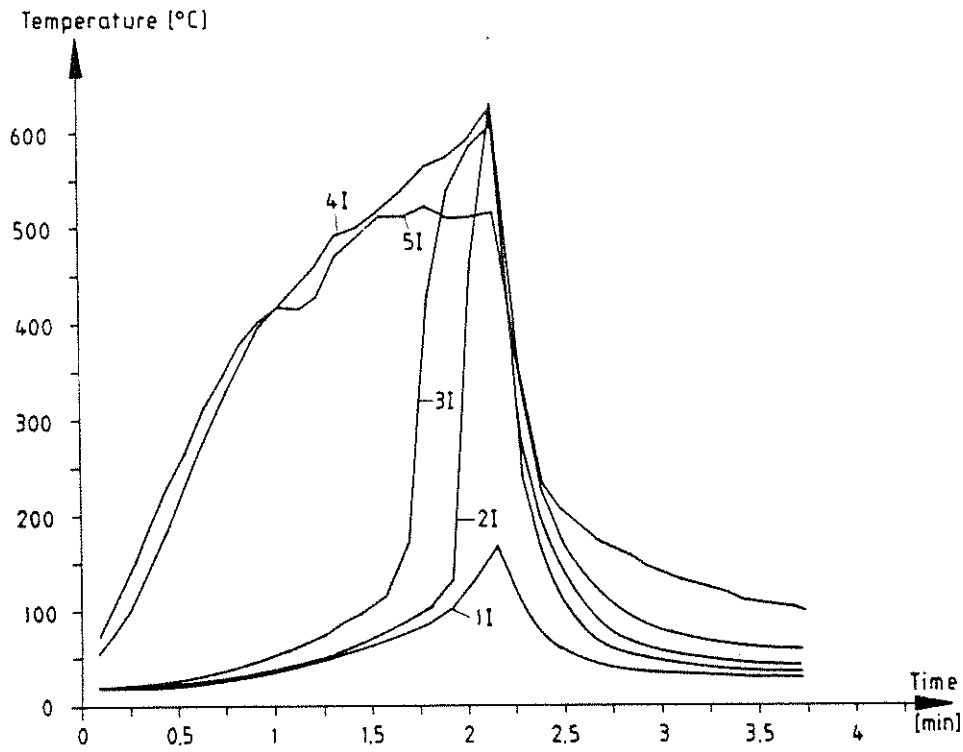
## REFERENCES

- 1/ Sundström, B., Room Fire Test in Full Scale for Surface Products, Technical Report SP-RAPP 1984:16, National Testing Institute, Borås, 1984
- 2/ Room Fire Test in full Scale for Surface Products, NORDTEST Fire Test Method, NT Fire 025.
- 3/ Proposed Method for Room Fire Test of Wall and Ceiling Materials and Assemblies, ASTM Annual Book of Standards, 1982
- 4/ Andersson, C. and Giacomelli, C., Ett modellrum i lågor, studie av strålning mot en yta, Examensarbete vid avdelningen för byggnadstekniskt brandskydd, 1985. (A Model Scale Compartment in Flames, a Study of Radiation towards a Surface, Master's Thesis at the Department of Fire Safety Engineering)
- 5/ Gunners, N.E., Methods of Measurement and Measuring Equipment for Fire Tests, National Swedish Institute for Materials Testing, Fire Engineering Laboratory 1967:1, 1967
- 6/ McCaffrey, B.J. and Heskestad, G., A Robust Bidirectional Low-Velocity Probe for Flame and Fire Application, Combustion and Flame, Vol 26, 125-127, 1976
- 7/ McCabe, W.L. and Smith, J.C., Unit Operations of Chemical Engineering, McGraw-Hill, Inc., New-York, 1967
- 8/ Hugget, C., Estimation of Rate of Heat Release by Means of Oxygen Consumption Measurements, Fire and Materials, Vol 4, No 2, 1980
- 9/ Rasbash, D.J. and Prat, B.T., Estimation of the Smoke Produced in Fires, Fire Safety Journal, Vol 2., 23-37, 1979/80

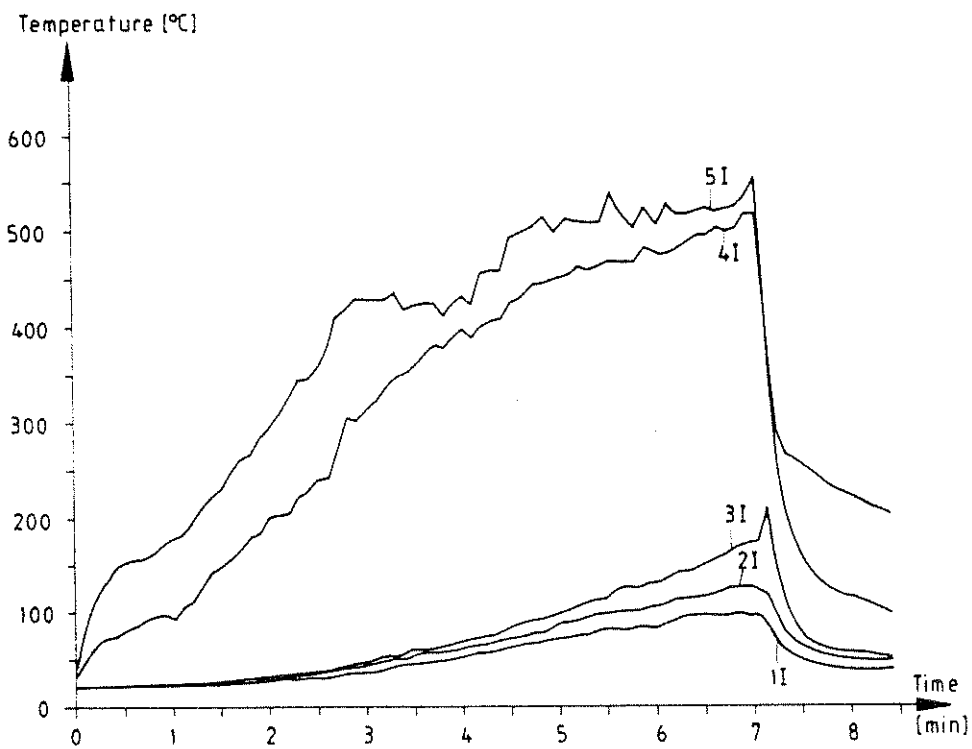
## APPENDICES

- A Gas Temperatures
- B Surface Temperatures
- C Heat Flux and Radiation
- D Rate of Heat Release
- E Gas Production
- F Smoke Production
- G Involved Area
- H Observations

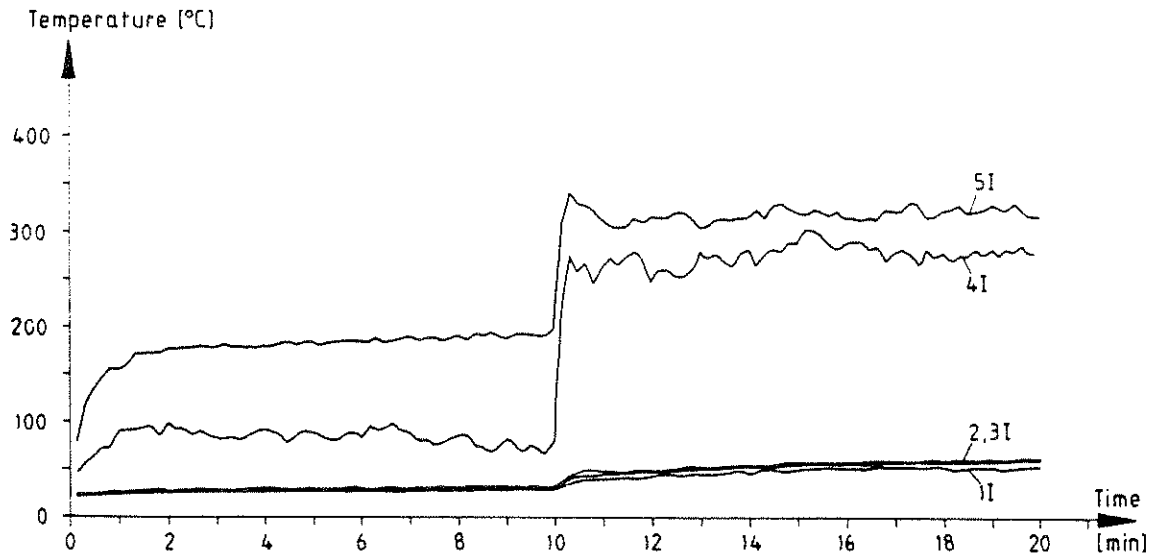
## Appendix A Gas temperatures



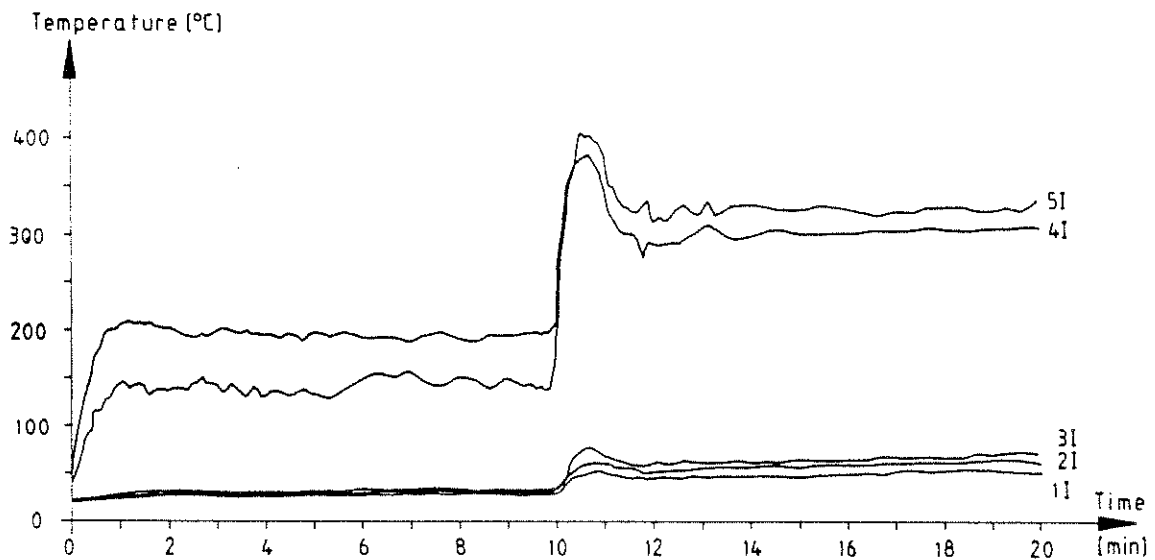
**Figure A1** Gas temperatures inside the test room during test I:1, insulating fibreboard. For positions of the thermocouples see figures 4 and 5.



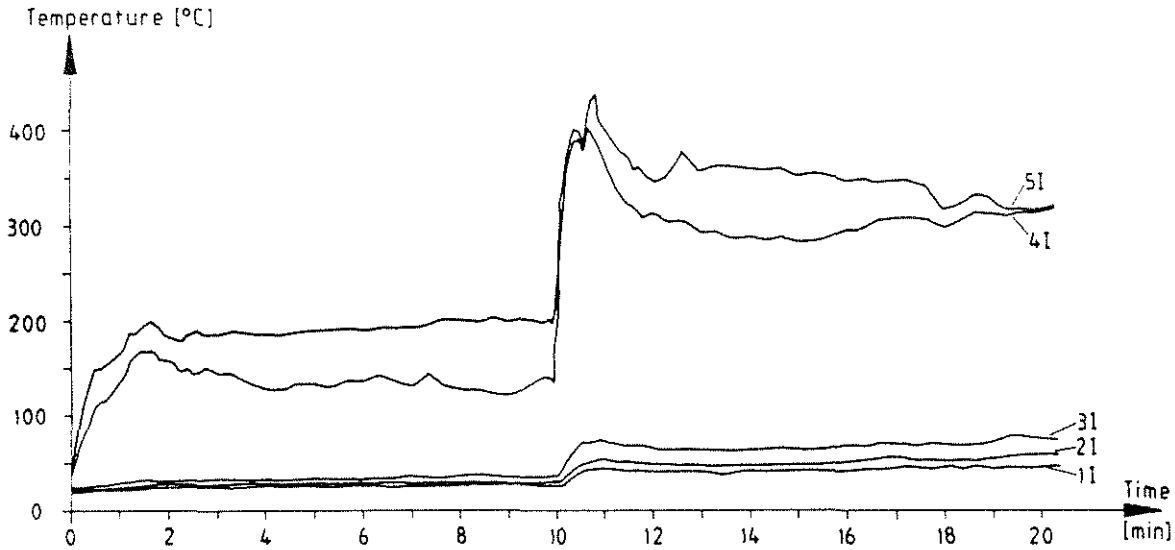
**Figure A2** Gas temperatures inside the test room during test I:3, particle board. For positions of the thermocouples see figures 4 and 5.



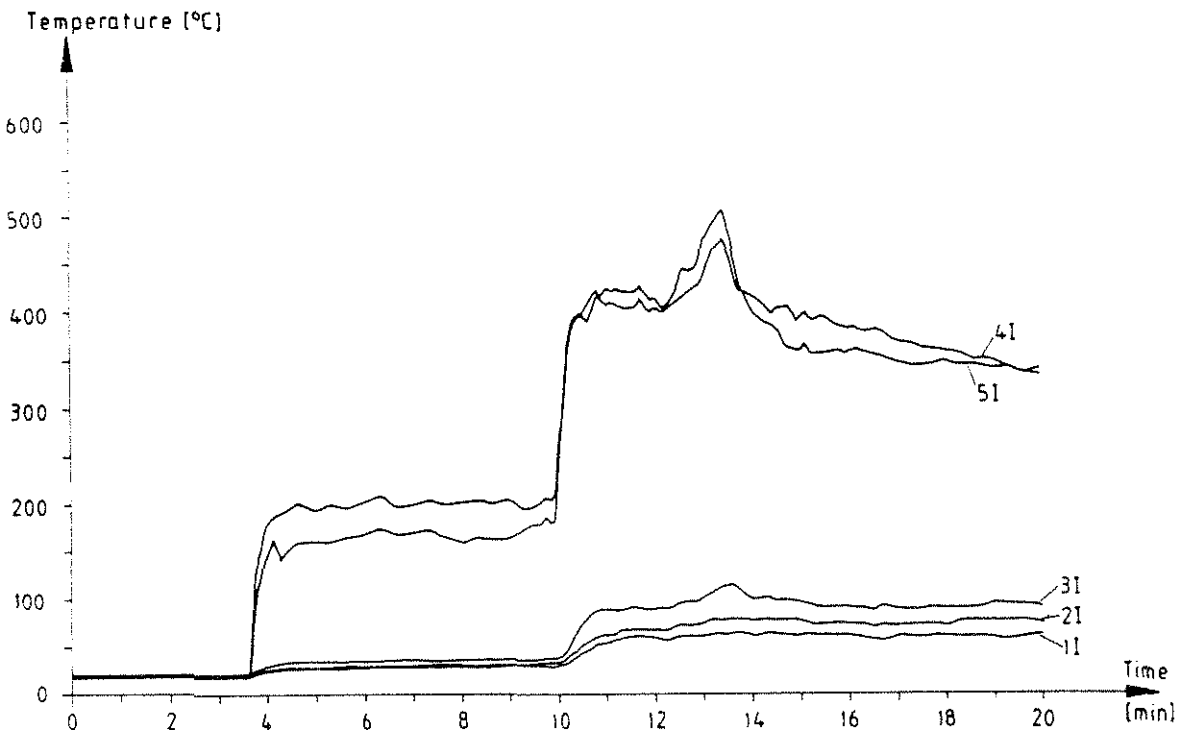
**Figure A3** Gas temperatures inside the test room during test I:4, gypsum plaster board. For positions of the thermocouples see figures 4 and 5.



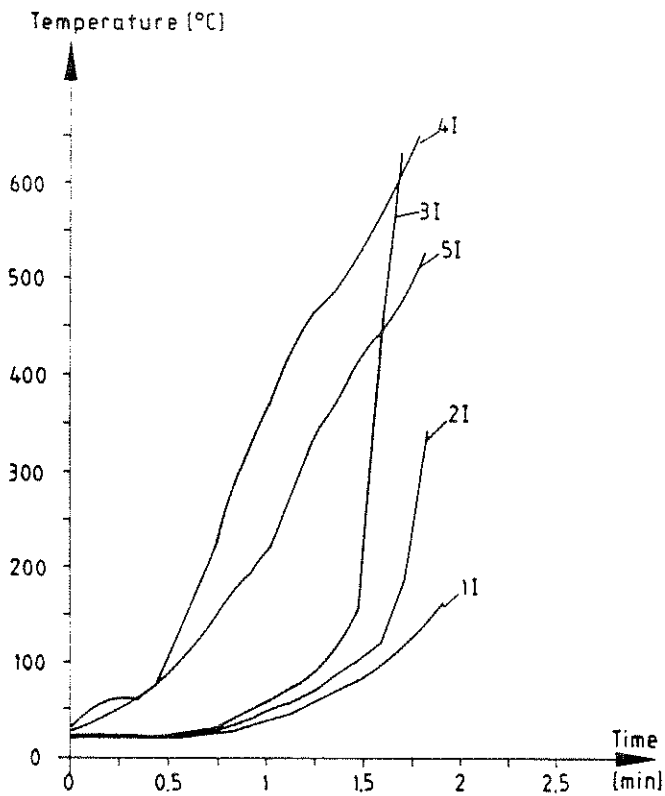
**Figure A4** Gas temperatures inside the test room during test I:5, PVC wallcovering on gypsum plaster board. For positions of the thermocouples see figures 4 and 5.



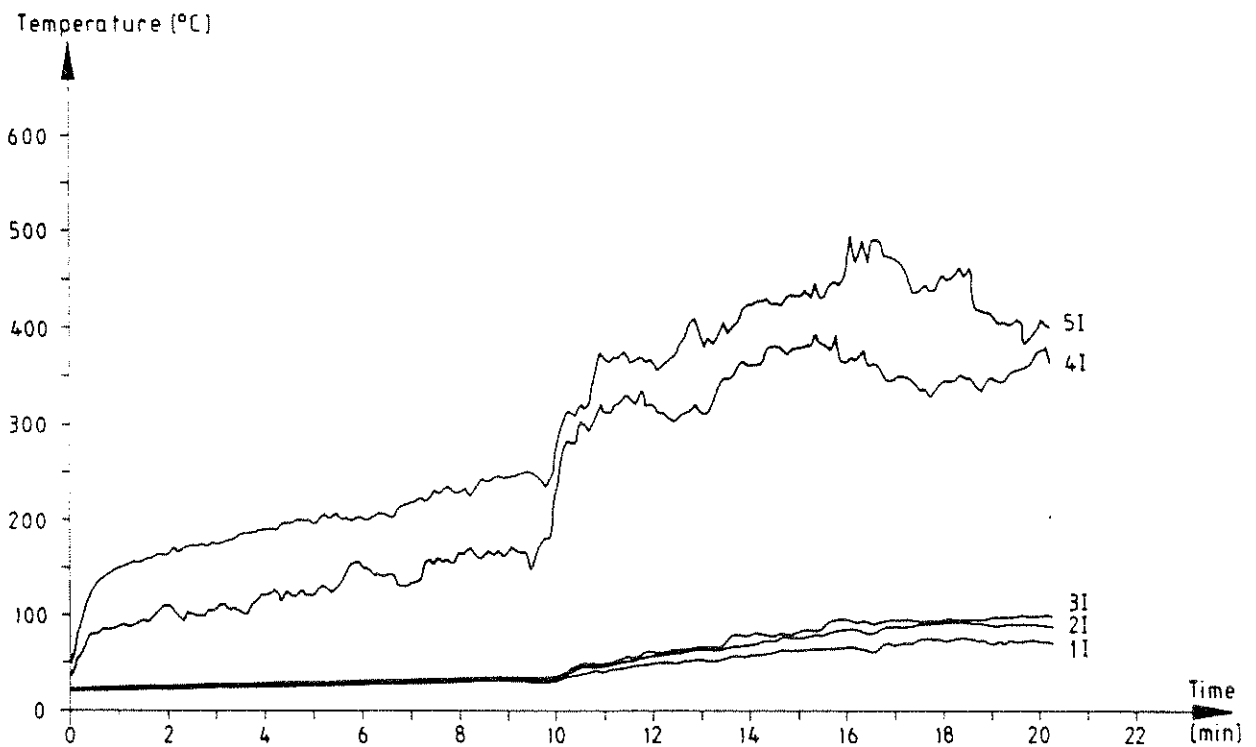
**Figure A5** Gas temperatures inside the test room during test I:6, paper wallcovering on gypsum plasterboard. For positions of the thermocouples see figures 4 and 5.



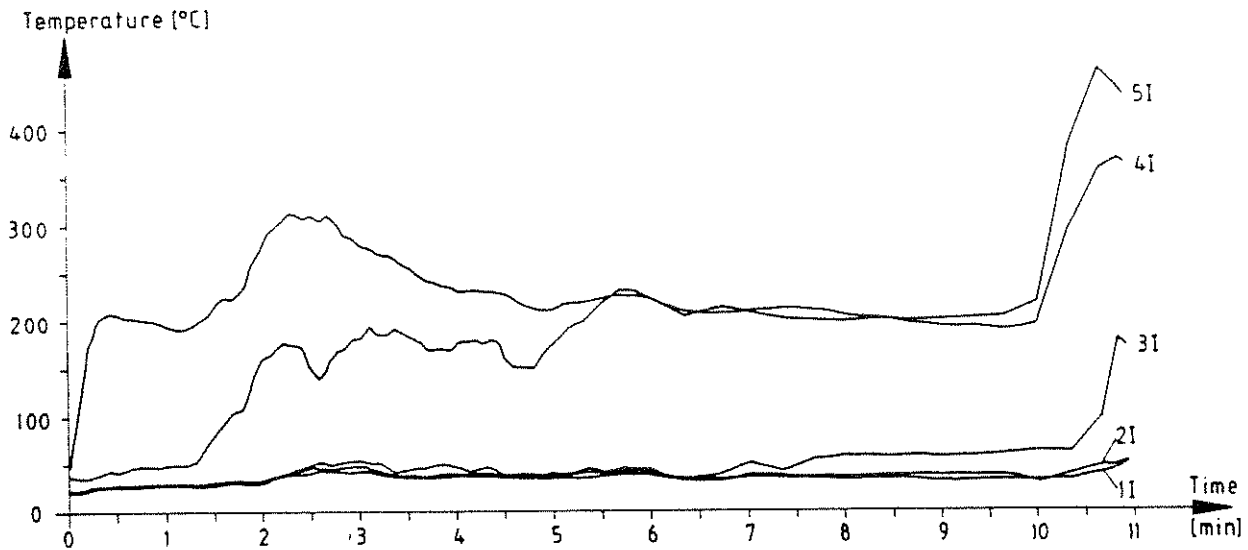
**Figure A6** Gas temperatures inside the test room during test I:7, textile wallcovering on gypsum plasterboard. For positions of the thermocouples see figures 4 and 5.



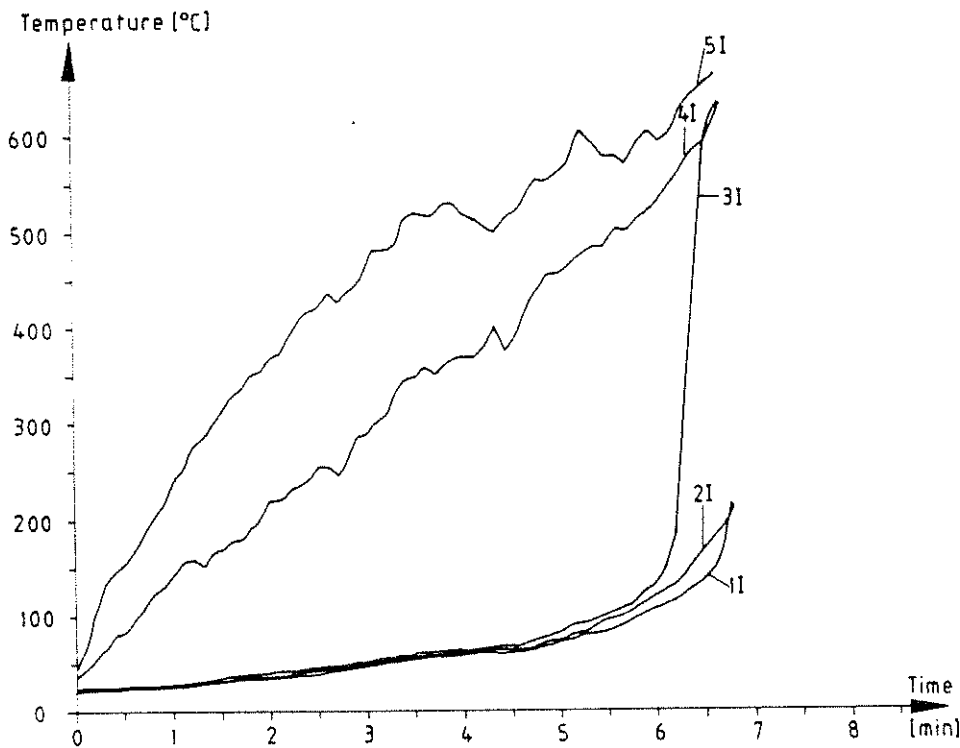
**Figure A7** Gas temperatures inside the test room during test I:8, textile wallcovering on mineral wool. For positions of the thermocouples see figures 4 and 5.



**Figure A8** Gas temperatures inside the test room during test I:9, melamine faced particle board. For positions of the thermocouples see figures 4 and 5.

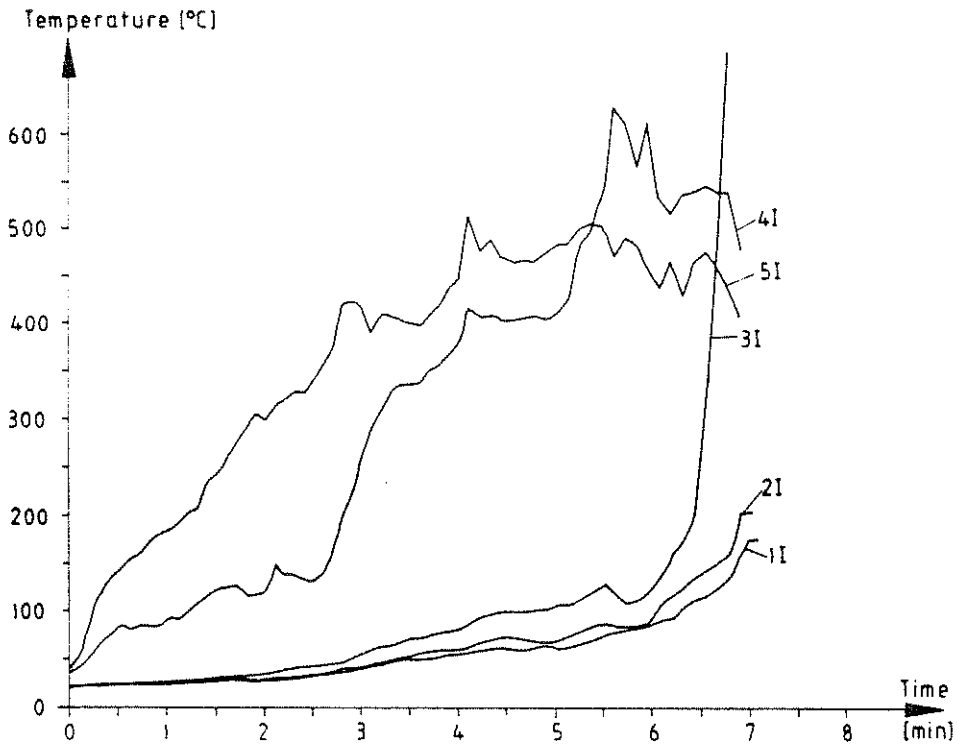


**Figure A9** Gas temperatures inside the test room during test I:10, expanded polystyrene. For positions of the thermocouples see figures 4 and 5.

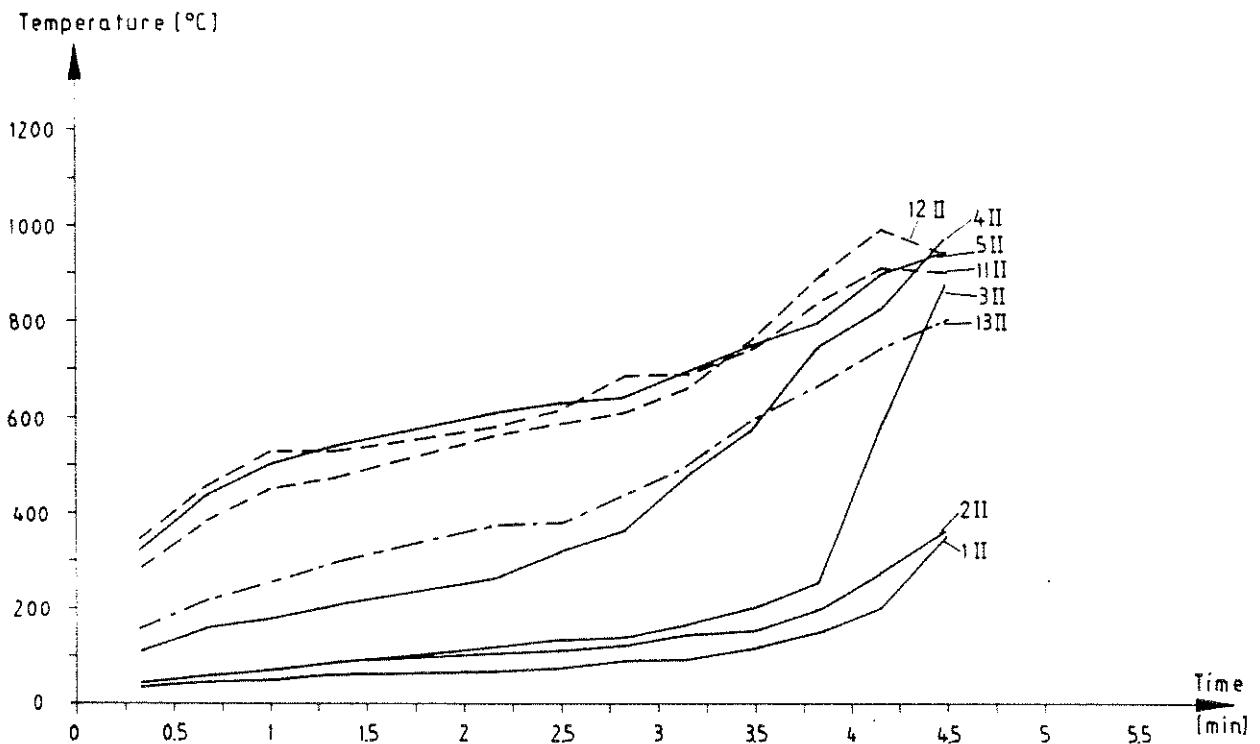


**Figure A10** Gas temperatures inside the test room during test I:12, wood panel, spruce. For positions of the thermocouples see figures 4 and 5.

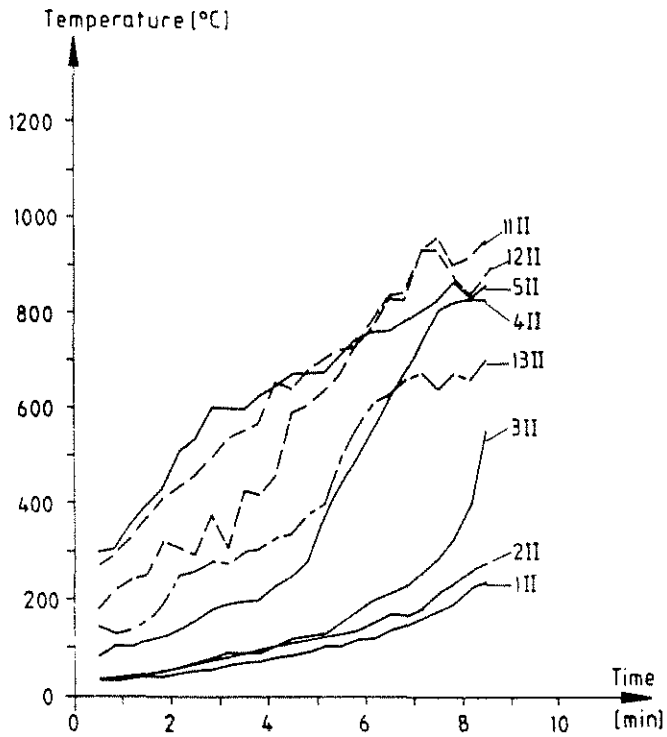




**Figure A11** Gas temperatures inside the test room during test I:13, paper wallcovering on particle board. For positions of the thermocouples see figures 4 and 5.



**Figure A12** Gas temperatures inside the test room during test II:1, insulating fibreboard. — vertical profile, ---- measurement with suction pyrometer inside the room, - - - measurement with suction pyrometer in the opening. For positions see figures 4 and 6.



**Figure A13** Gas temperatures inside the test room during test II:2, medium density fibreboard. — vertical profile, ---- measurement with suction pyrometer inside the room, - - - measurement with suction pyrometer in the opening. For positions see figures 4 and 6.

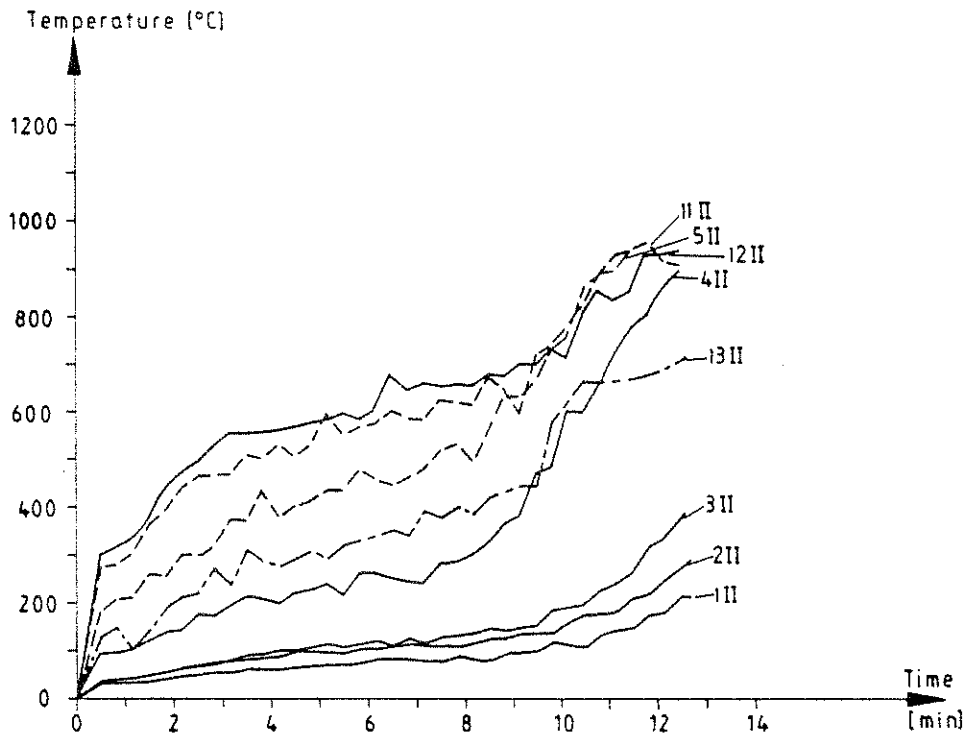
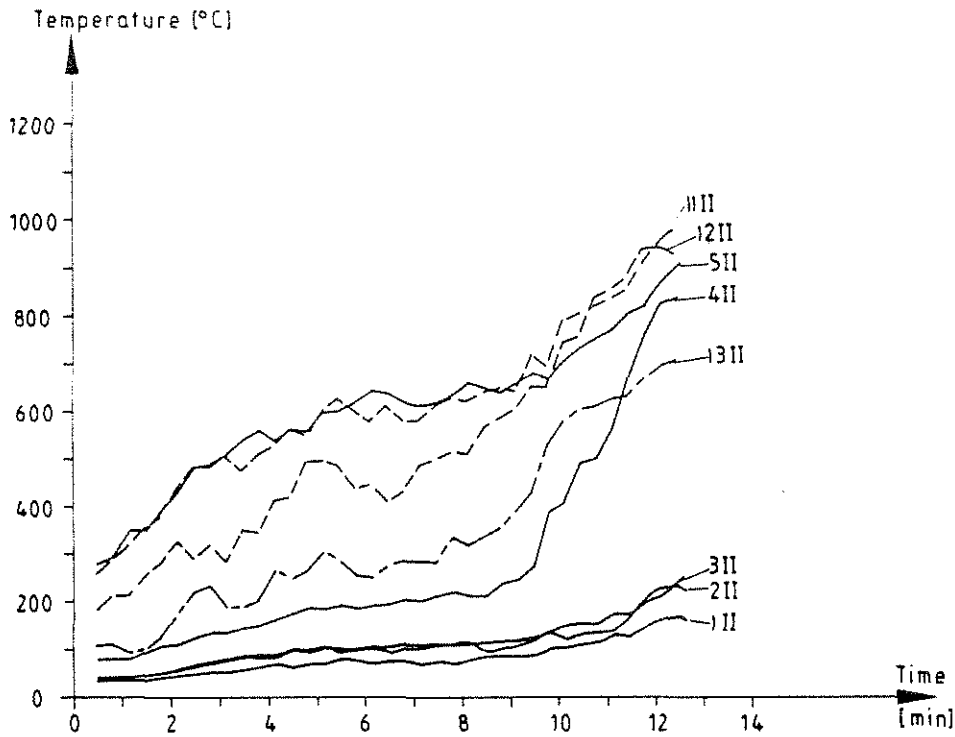
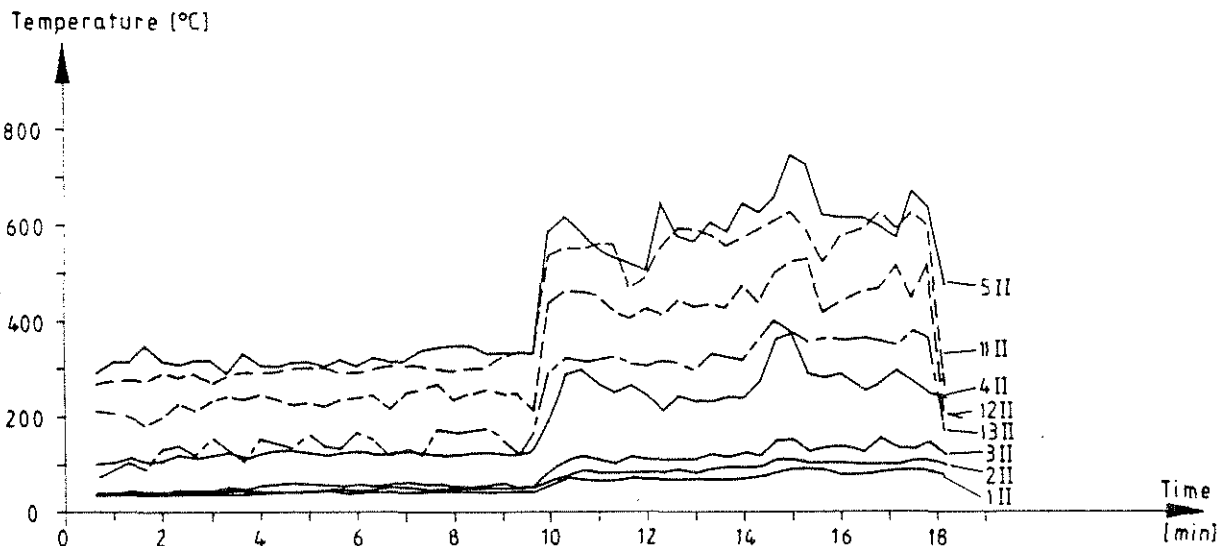


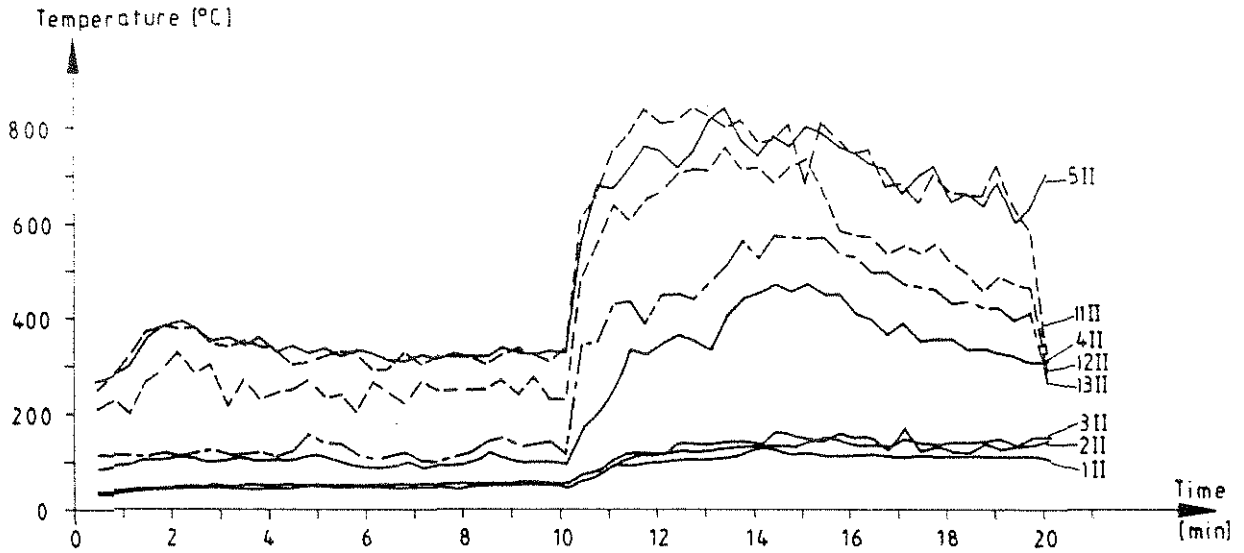
Figure A14 Gas temperatures inside the test room during test II:3, particle board (doorwidth 0.56 m) — vertical profile, ---- measurement with suction pyrometer inside the room, - - - measurement with suction pyrometer in the opening. For positions see figures 4 and 6.



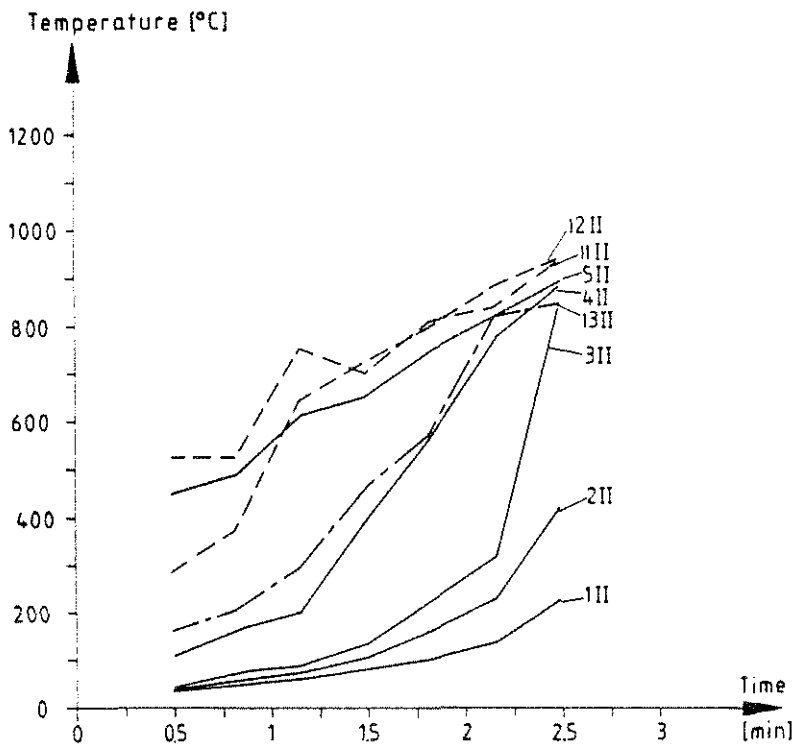
**Figure A15** Gas temperatures inside the test room during test II:4, particle board (doorwidth 0.46 m) — vertical profile, ---- measurement with suction pyrometer inside the room, - - - measurement with suction pyrometer in the opening. For positions see figures 4 and 6.



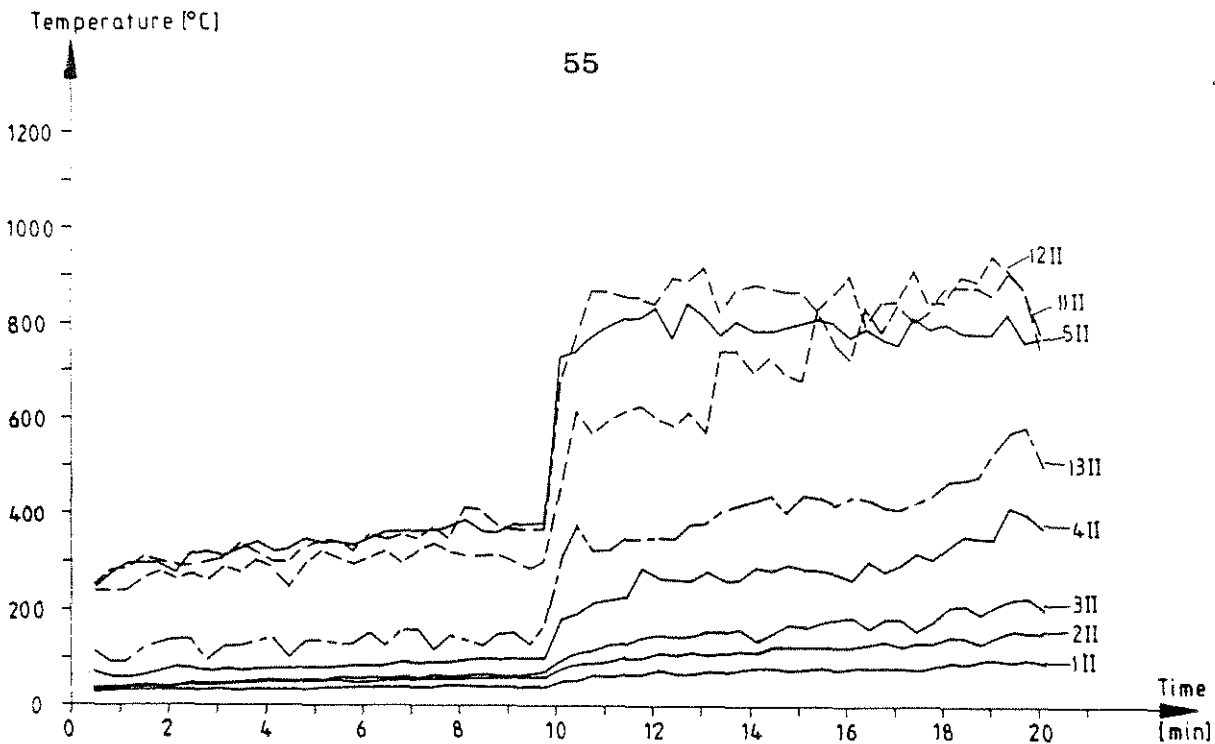
**Figure A16** Gas temperatures inside the test room during test II:5, PVC wallcovering on gypsum plaster board. — vertical profile, ---- measurement with suction pyrometer inside the room, - - - measurement with suction pyrometer in the opening. For positions see figures 4 and 6.



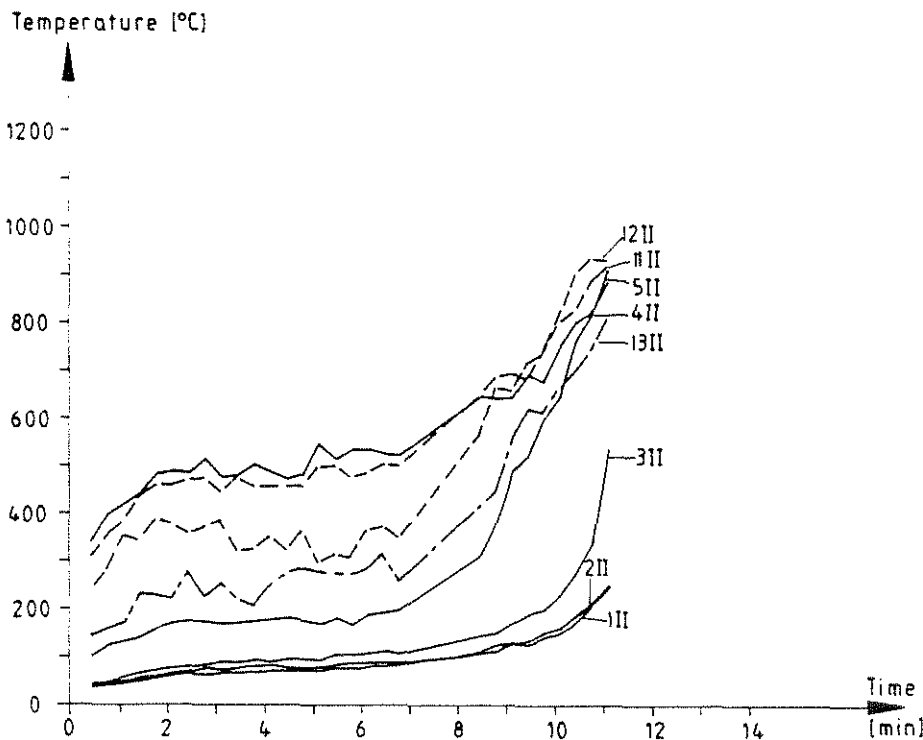
**Figure A17** Gas temperatures inside the test room during test II:6, textile wallcovering on gypsum plaster-board. — vertical profile, ---- measurement with suction pyrometer inside the room, - - - measurement with suction pyrometer in the opening. For positions see figures 4 and 6.



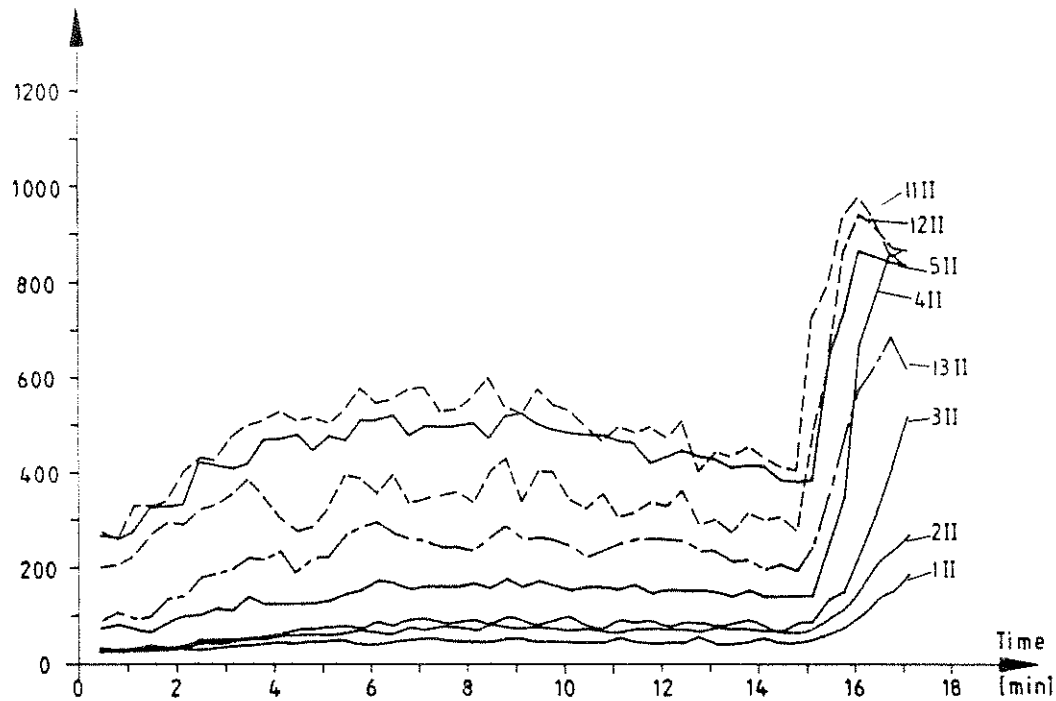
**Figure A18** Gas temperatures inside the test room during test II:7, textile wallcovering on mineral wool. — vertical profile, ---- measurement with suction pyrometer inside the room, - - - measurement with suction pyrometer in the opening. For positions see figures 4 and 6.



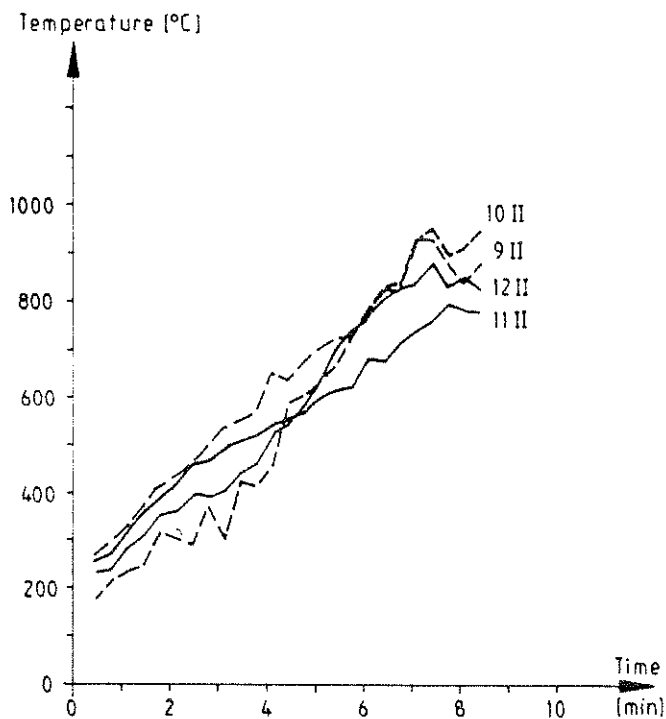
**Figure A19** Gas temperatures inside the test room during test II:8, melamine faced particle board. — vertical profile, ---- measurement with suction pyrometer inside the room, - - - measurement with suction pyrometer in the opening. For positions see figures 4 and 6.



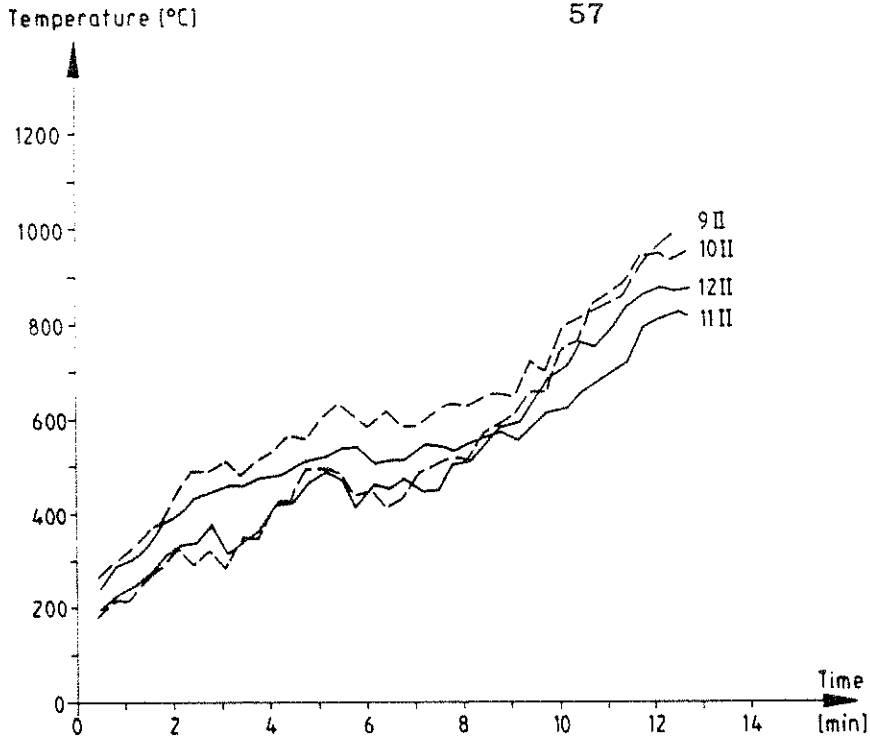
**Figure A20** Gas temperatures inside the test room during test II:10, wood panel, spruce. — vertical profile, ---- measurement with suction pyrometer inside the room, - - - measurement with suction pyrometer in the opening. For positions see figures 4 and 6.



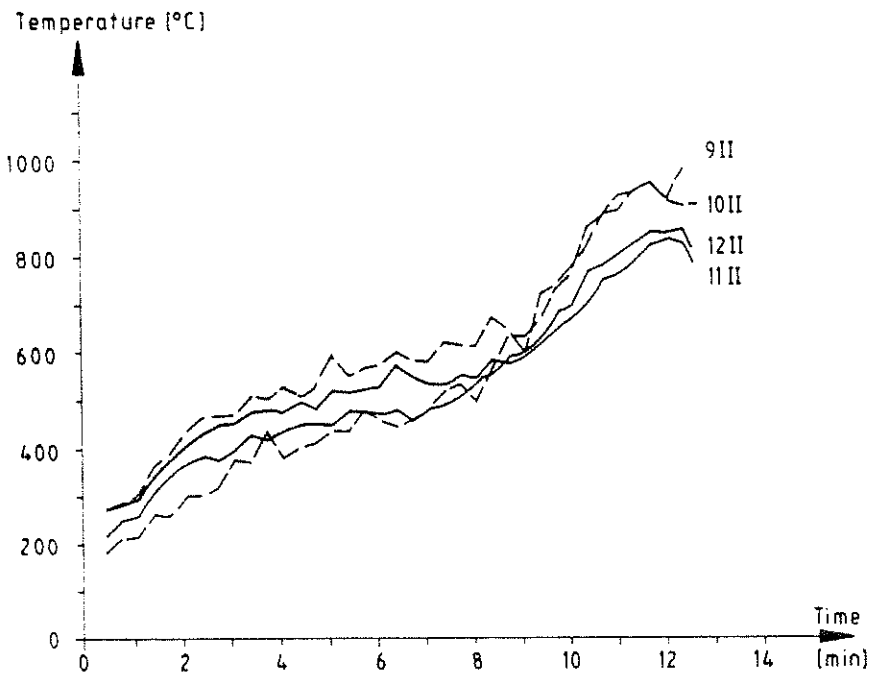
**Figure A21** Gas temperatures inside the test room during test I:11, paper wallcovering on particle board. — vertical profile, ---- measurement with suction pyrometer inside the room, - - - measurement with suction pyrometer in the opening. For positions see figures 4 and 6.



**Figure A22** Comparison between gas temperatures measured with thermocouple — and with suction pyrometer ----, inside the test room, for test II:2, medium density fibreboard. For positions see figure 6.



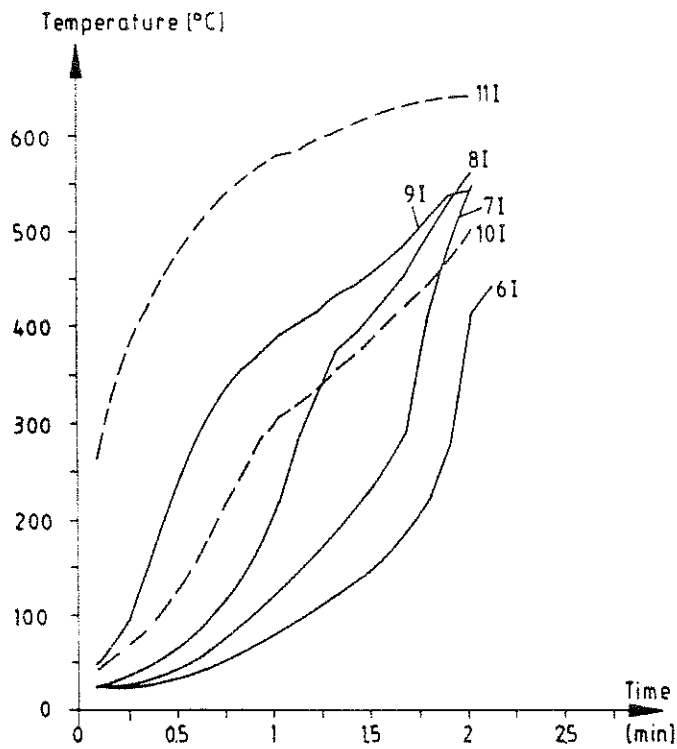
**Figure A23** Comparison between gas temperatures measured with thermocouple — and with suction pyrometer ----, inside the test room, for test II:3, particle board (doorwidth 0.56 m). For positions see figure 6.



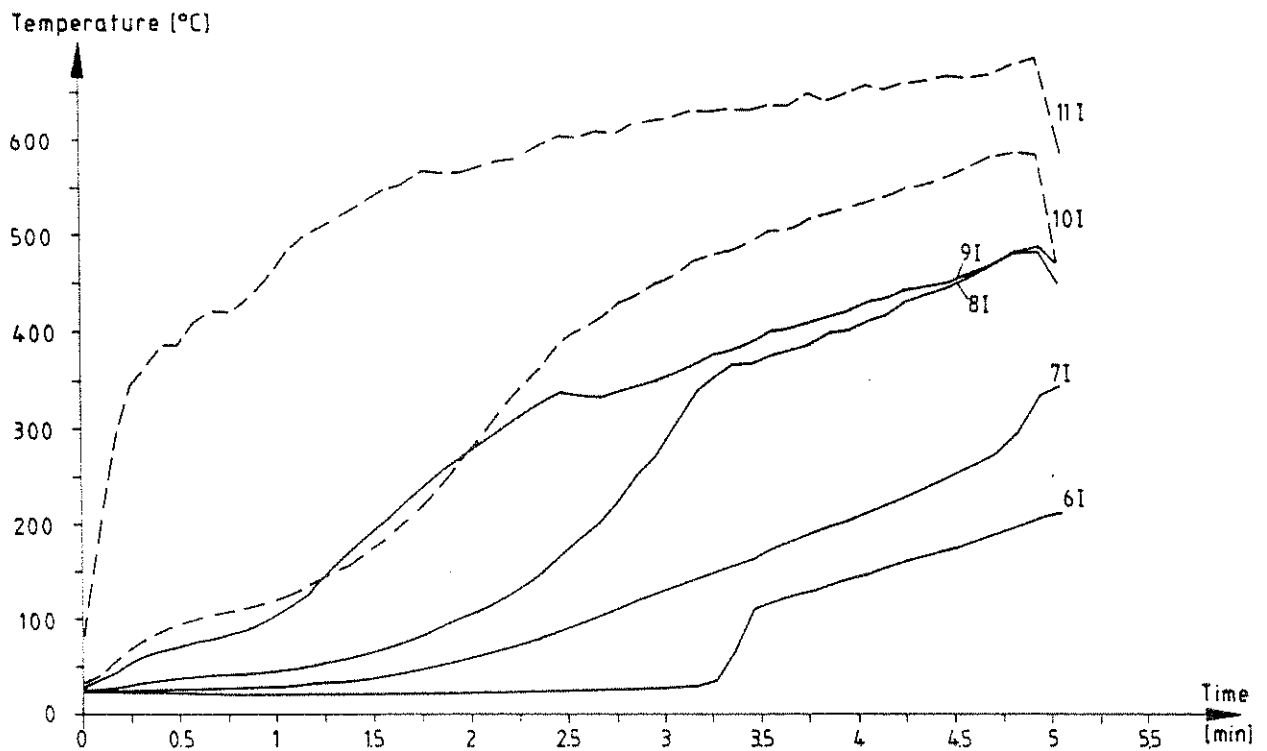
**Figure A24** Comparison between gas temperatures measured with thermocouple — and with suction pyrometer ----, inside the test room, for test II:4, particle board (doorwidth 0.46 m). For positions see figure 6.



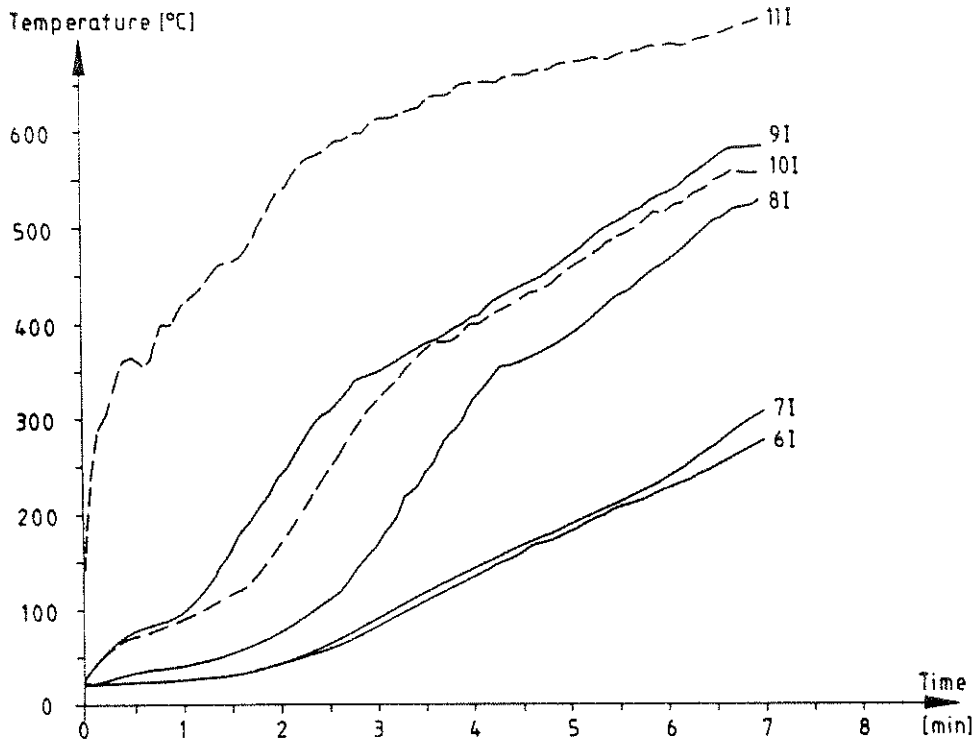
## Appendix B Surface Temperatures



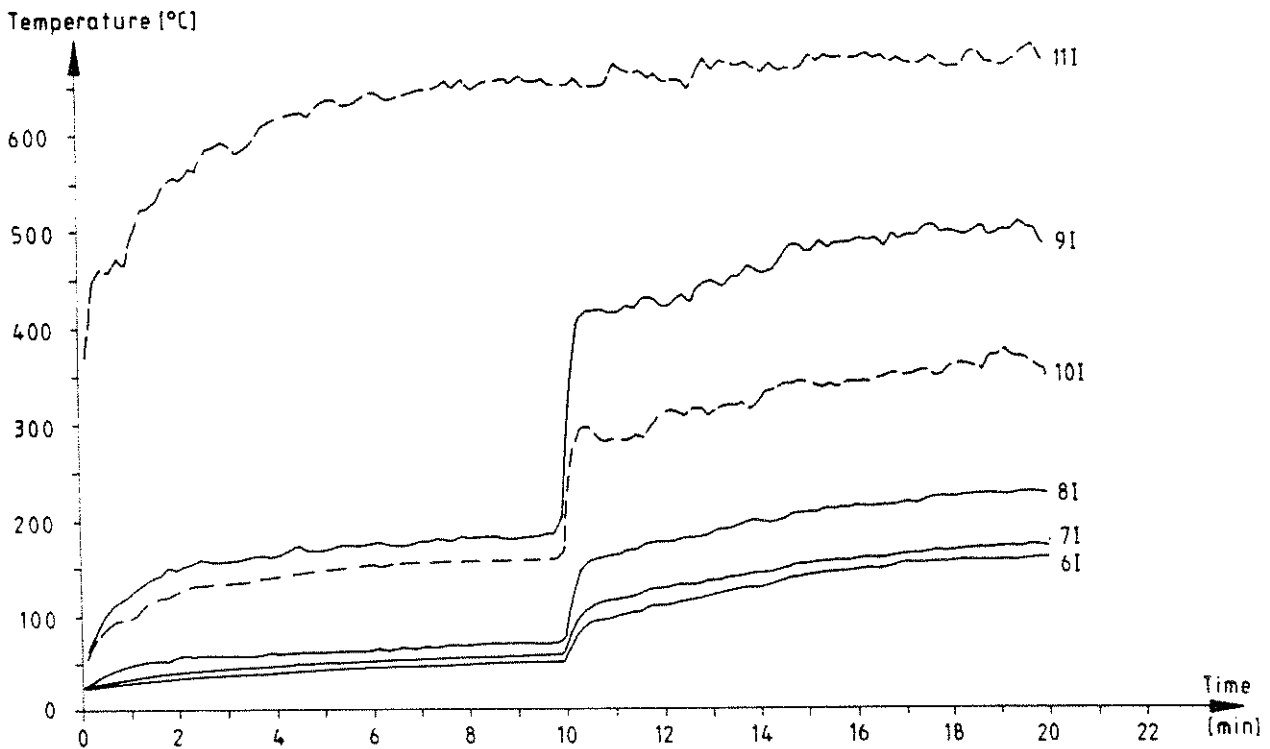
**Figure B1** Surface temperatures measured on the rear wall — and in the ceiling ----, for test I:1, insulating fibreboard. For positions see figures 7 and 8.



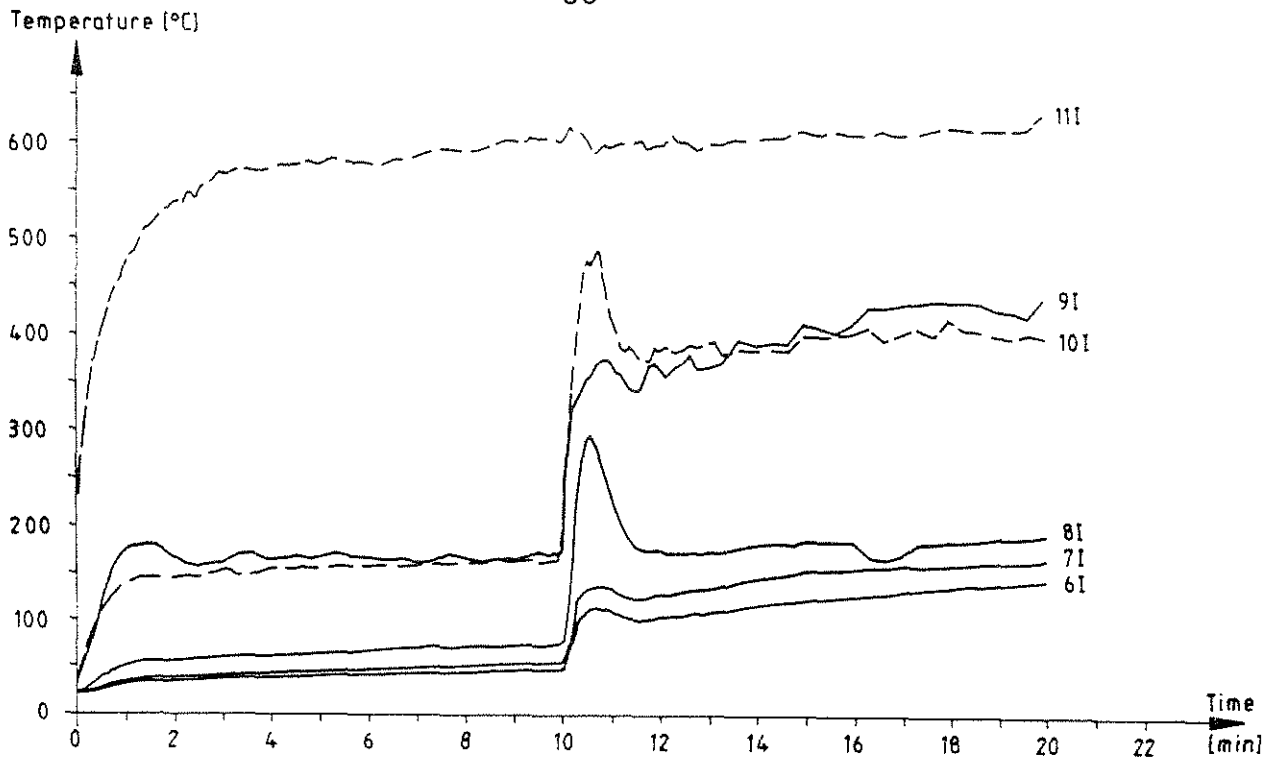
**Figure B2** Surface temperatures measured on the rear wall — and in the ceiling ----, for test I:2, medium density fibreboard. For positions see figures 7 and 8.



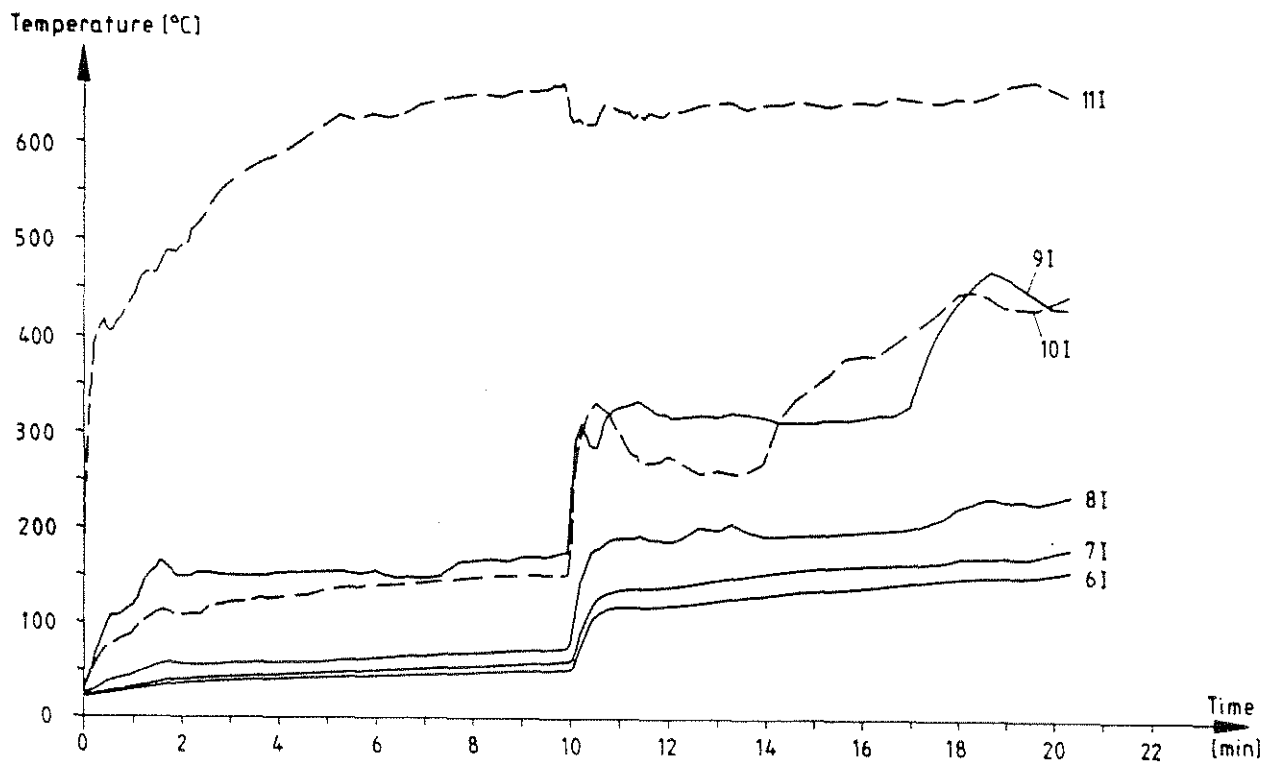
**Figure B3** Surface temperatures measured on the rear wall — and in the ceiling ----, for test I:3, particle board. For positions see figures 7 and 8.



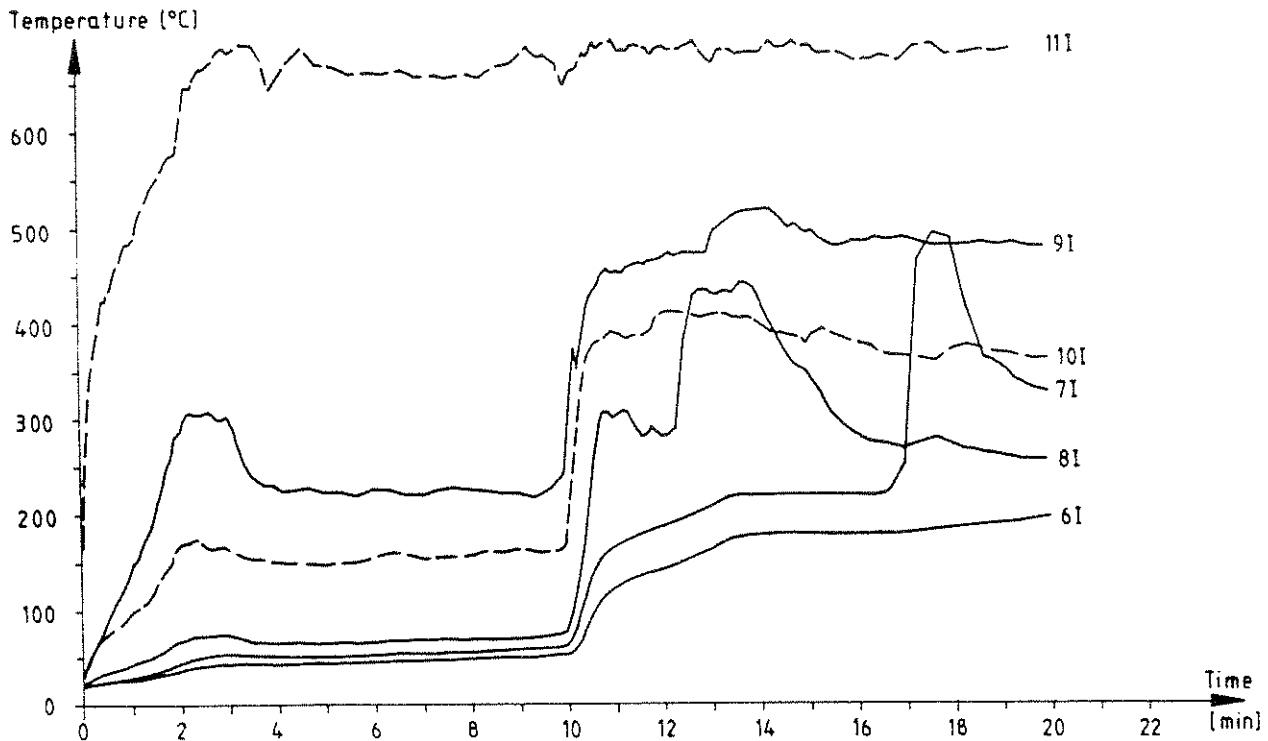
**Figure B4** Surface temperatures measured on the rear wall — and in the ceiling ----, for test I:4, gypsum plaster board. For positions see figures 7 and 8.



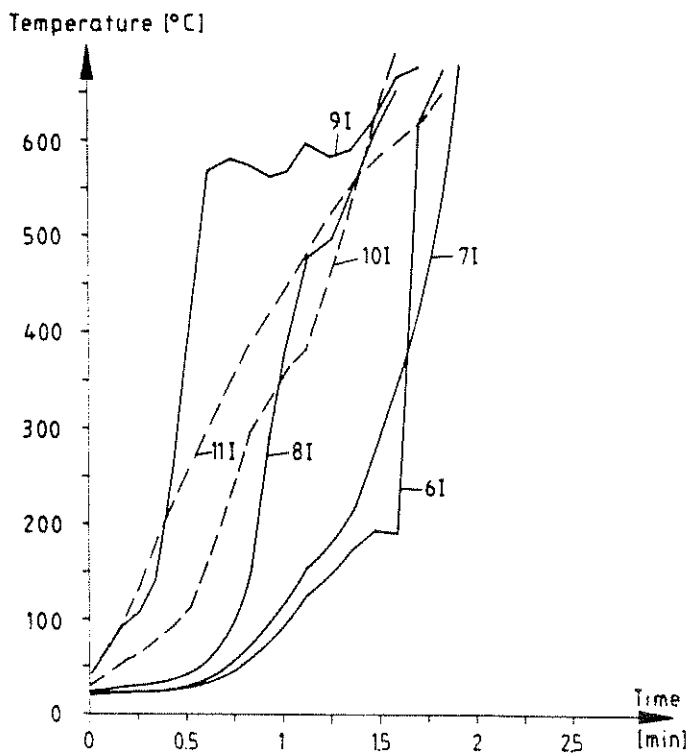
**Figure B5** Surface temperatures measured on the rear wall — and in the ceiling ----, for test I:5, PVC wallcovering on gypsum plaster board. For positions see figures 7 and 8.



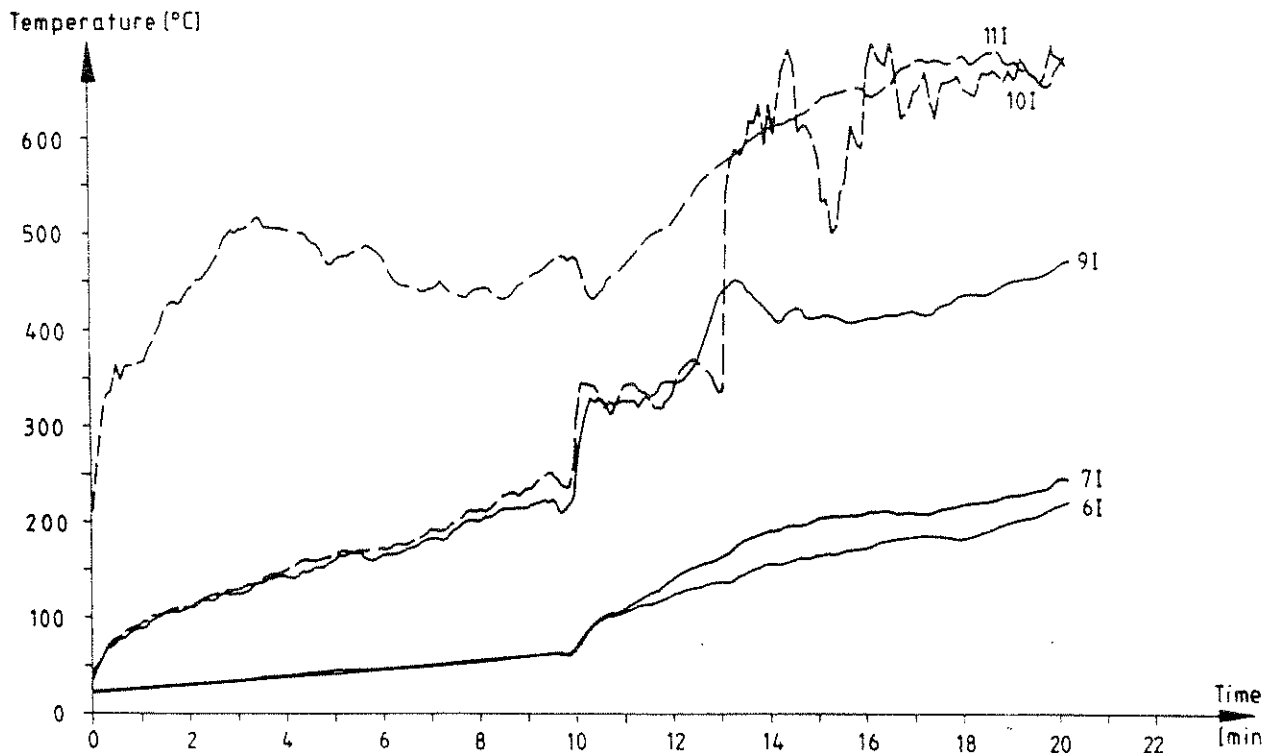
**Figure B6** Surface temperatures measured on the rear wall — and in the ceiling ----, for test I:6, paper wall covering on gypsum plaster board. For positions see figures 7 and 8.



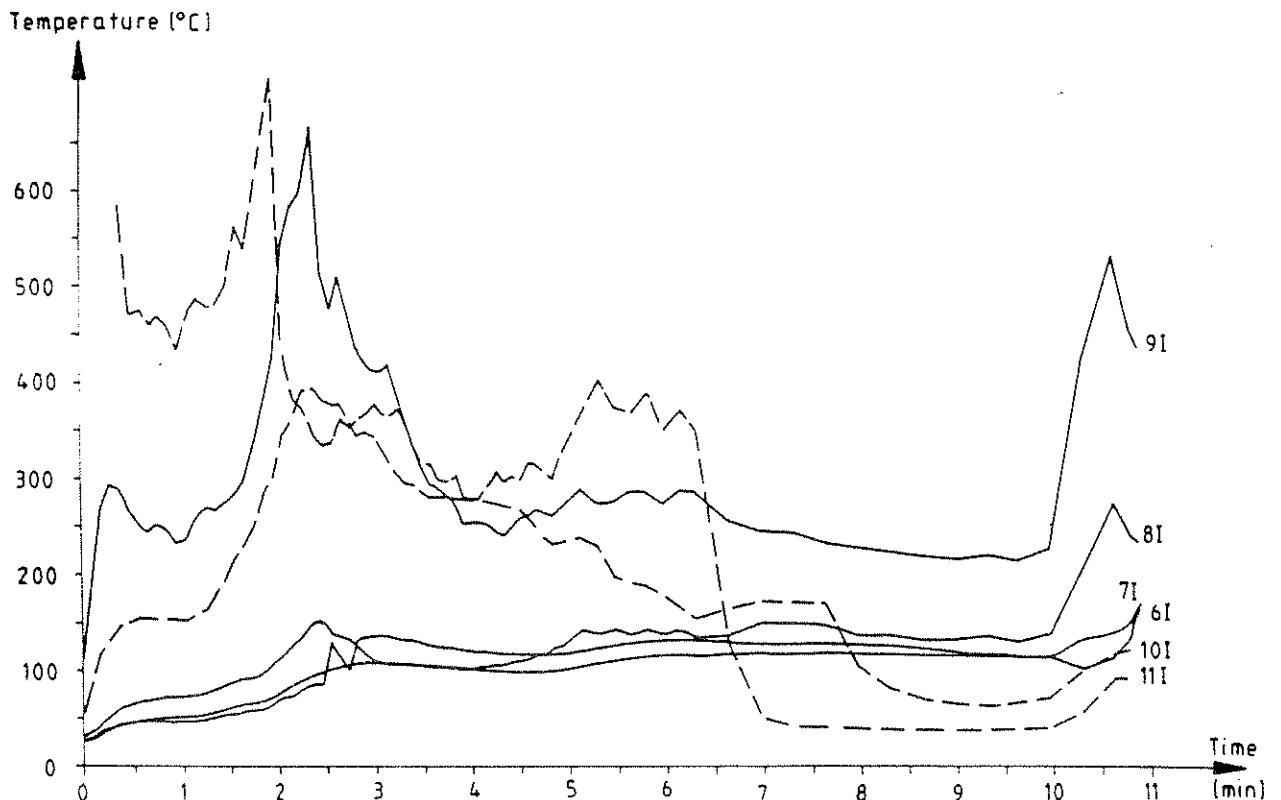
**Figure B7** Surface temperatures measured on the rear wall — and in the ceiling ----, for test I:7, textile wallcovering on gypsum plaster board. For positions see figures 7 and 8.



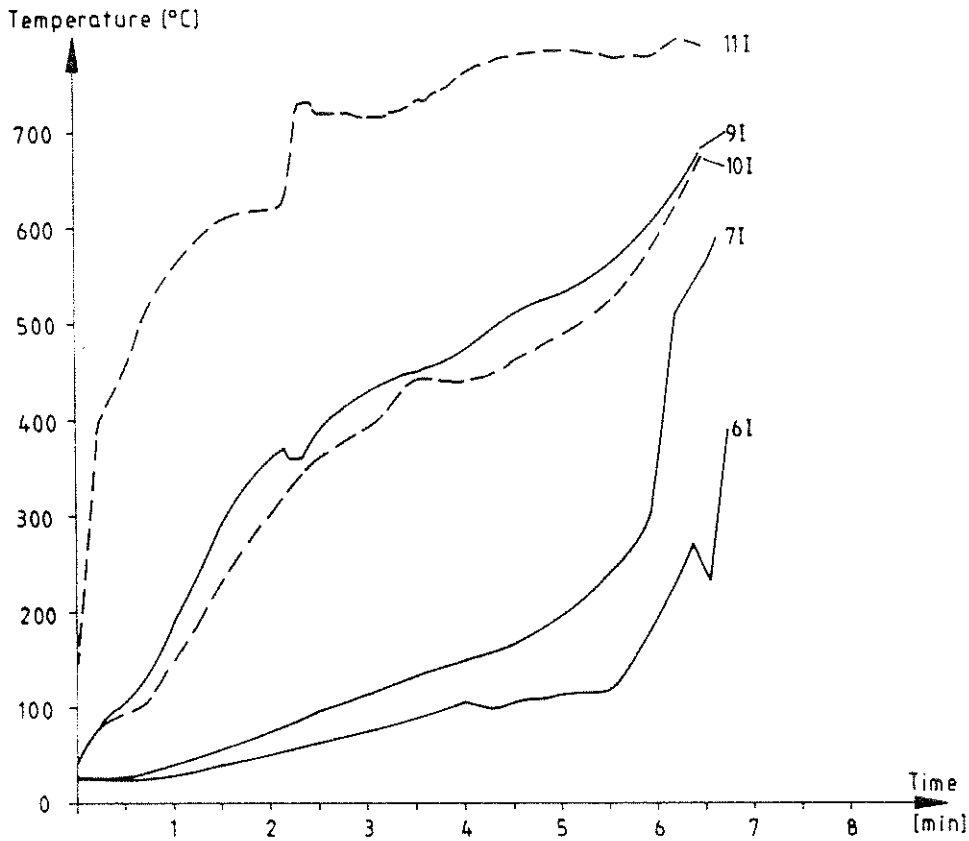
**Figure B8** Surface temperatures measured on the rear wall — and in the ceiling ----, for test I:8, textile wallcovering on mineral wool. For positions see figures 7 and 8.



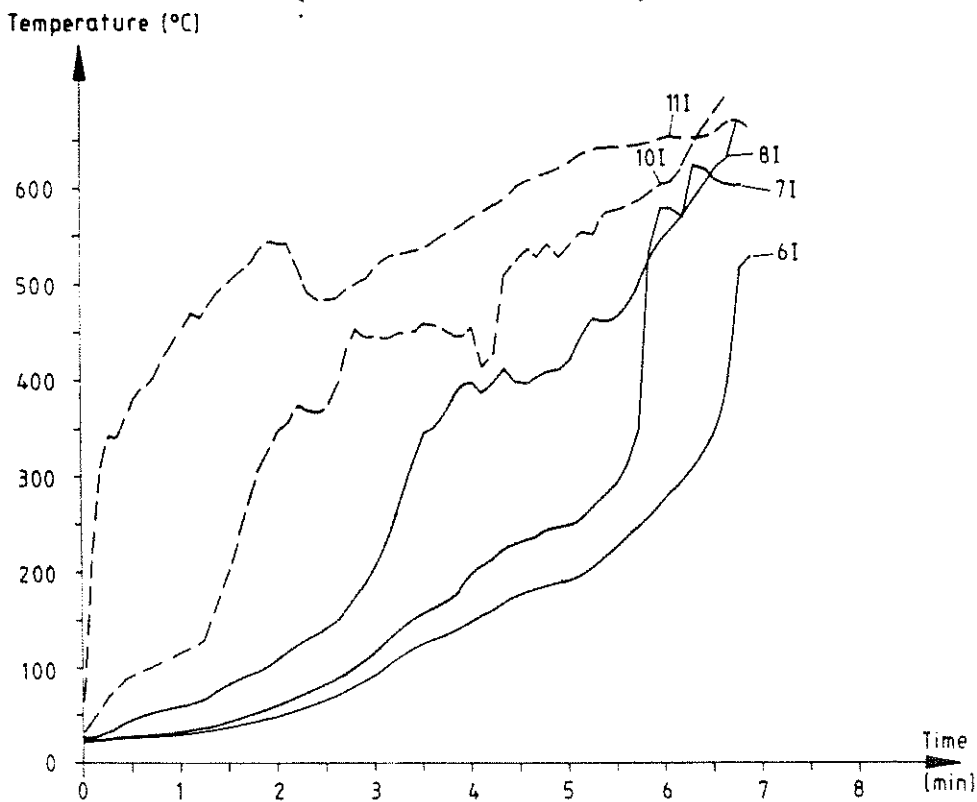
**Figure B9** Surface temperatures measured on the rear wall — and in the ceiling ----, for test I:9, melamine faced particle board. For positions see figures 7 and 8. (Channel 8I failed).



**Figure B10** Surface temperatures measured on the rear wall — and in the ceiling ----, for test I:10, expanded polystyrene. For positions see figures 7 and 8.



**Figure B11** Surface temperatures measured on the rear wall — and in the ceiling ----, for test I:12, wood panel (spruce). For positions see figures 7 and 8. (Channel 8I failed).



**Figure B12** Surface temperatures measured on the rear wall — and in the ceiling ---, for test I:13, paper wallcovering on particle board. For positions see figures 7 and 8. (Channel 9I failed).

## Appendix C

## Heat Flux

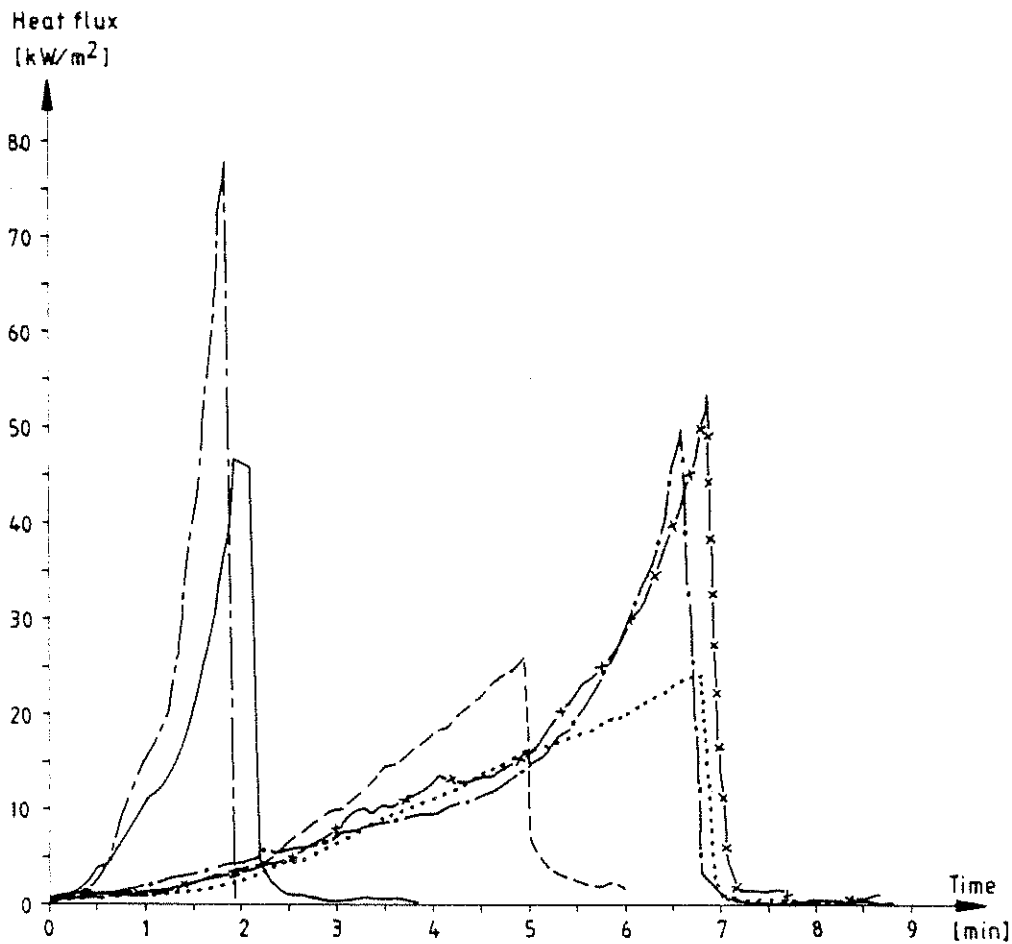
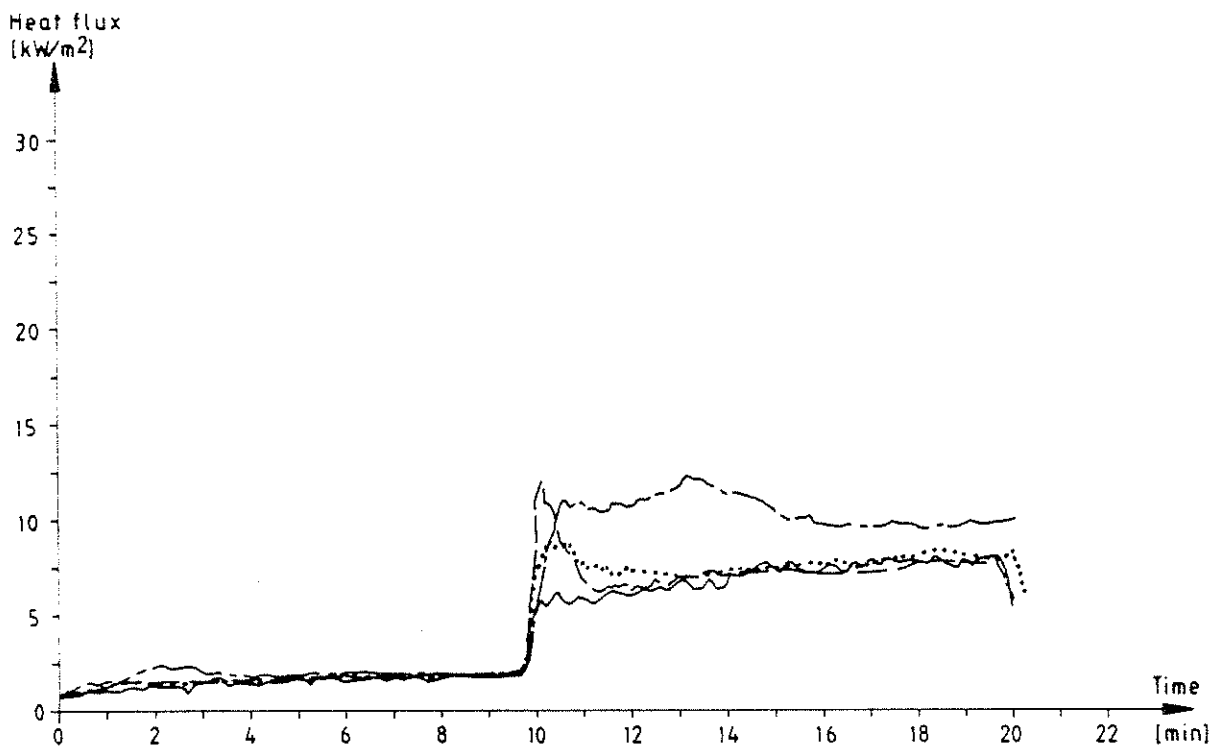


Figure C1 Total heat flux towards the centre of the floor for tests I:1 (insulating fibreboard) —, I:2 (medium density fibreboard) ----, I:3 (particle board) ····, I:8 (textile wallcovering on mineral wool) — — —, I:12 (wood panel, spruce) —·— and I:13 (paper wallcovering on particle board) —x—.



**Figure C2** Total heat flux towards the centre of the floor for tests I:4 (gypsum plaster board) —, I:5 (PVC wallcovering on gypsum plaster board) ----, I:6 (paper wallcovering on gypsum plaster board) ···· and I:7 (textile wallcovering on gypsum plaster board) — - —.



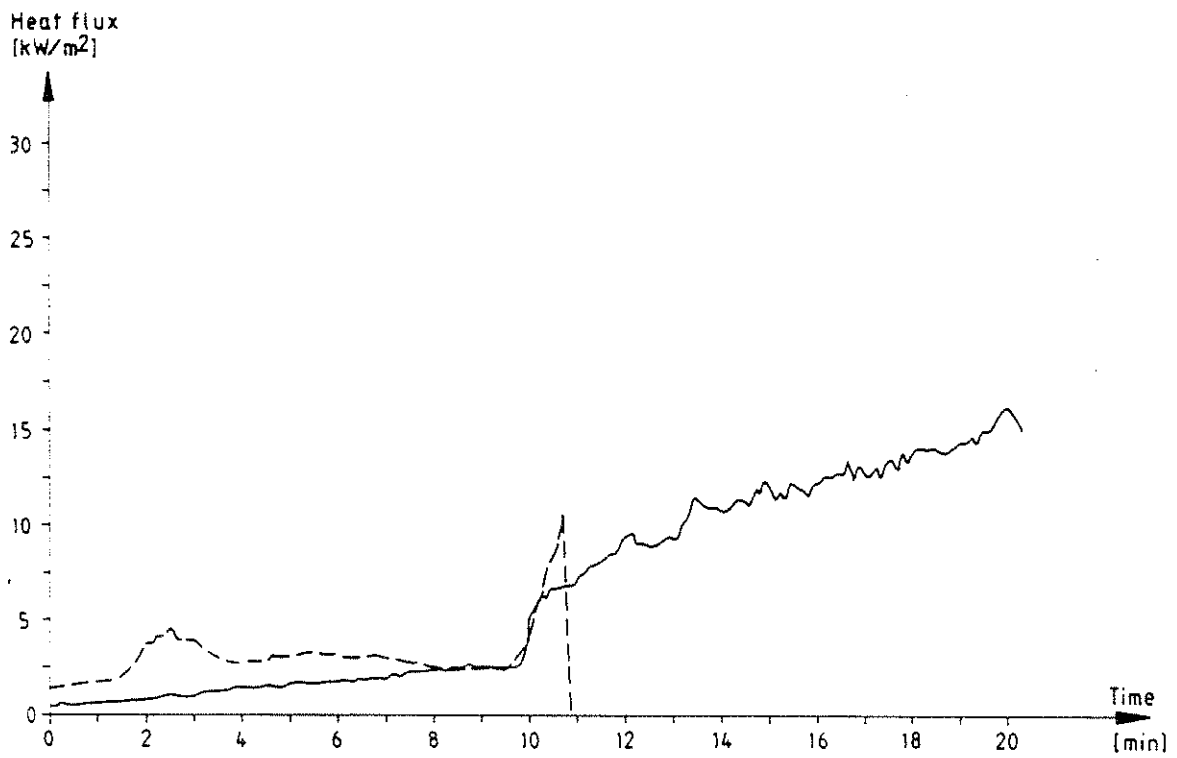
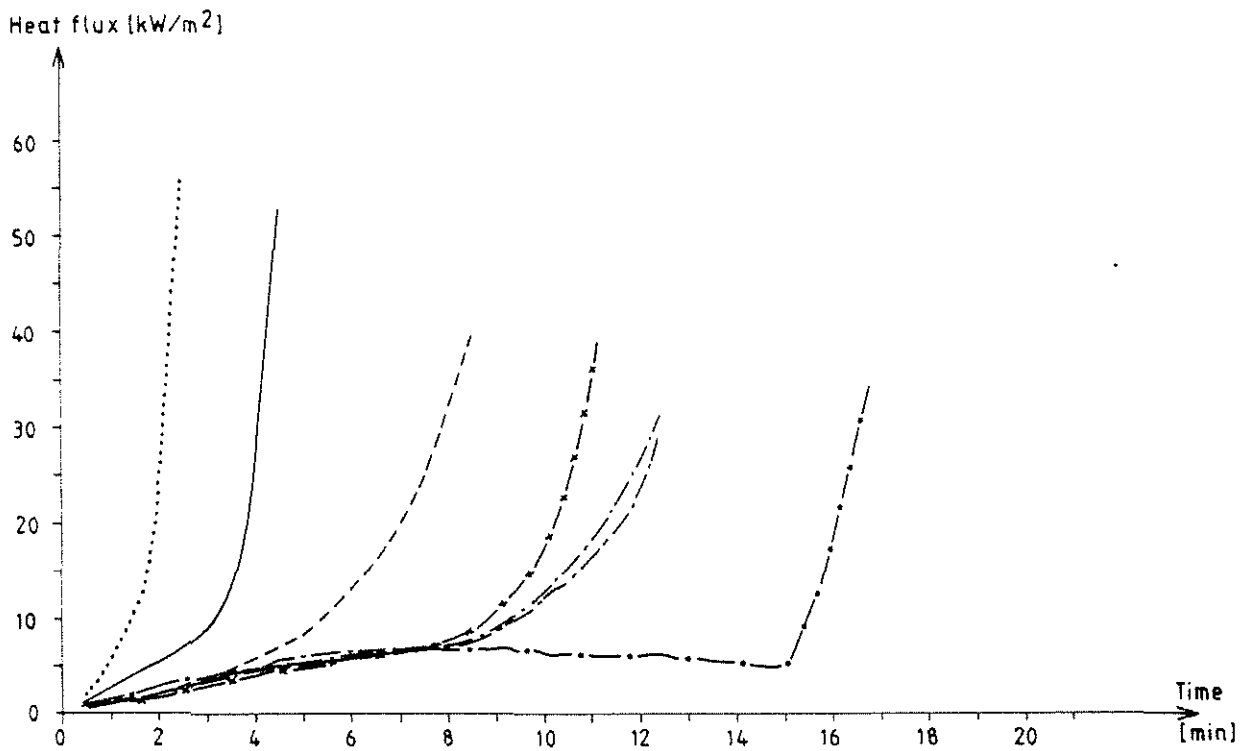
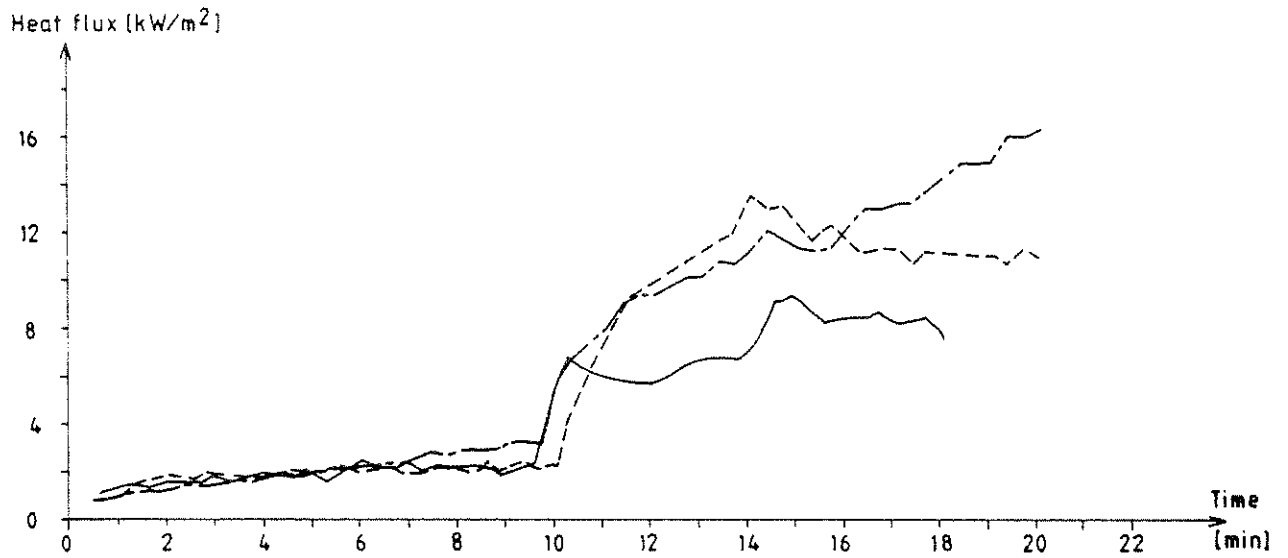


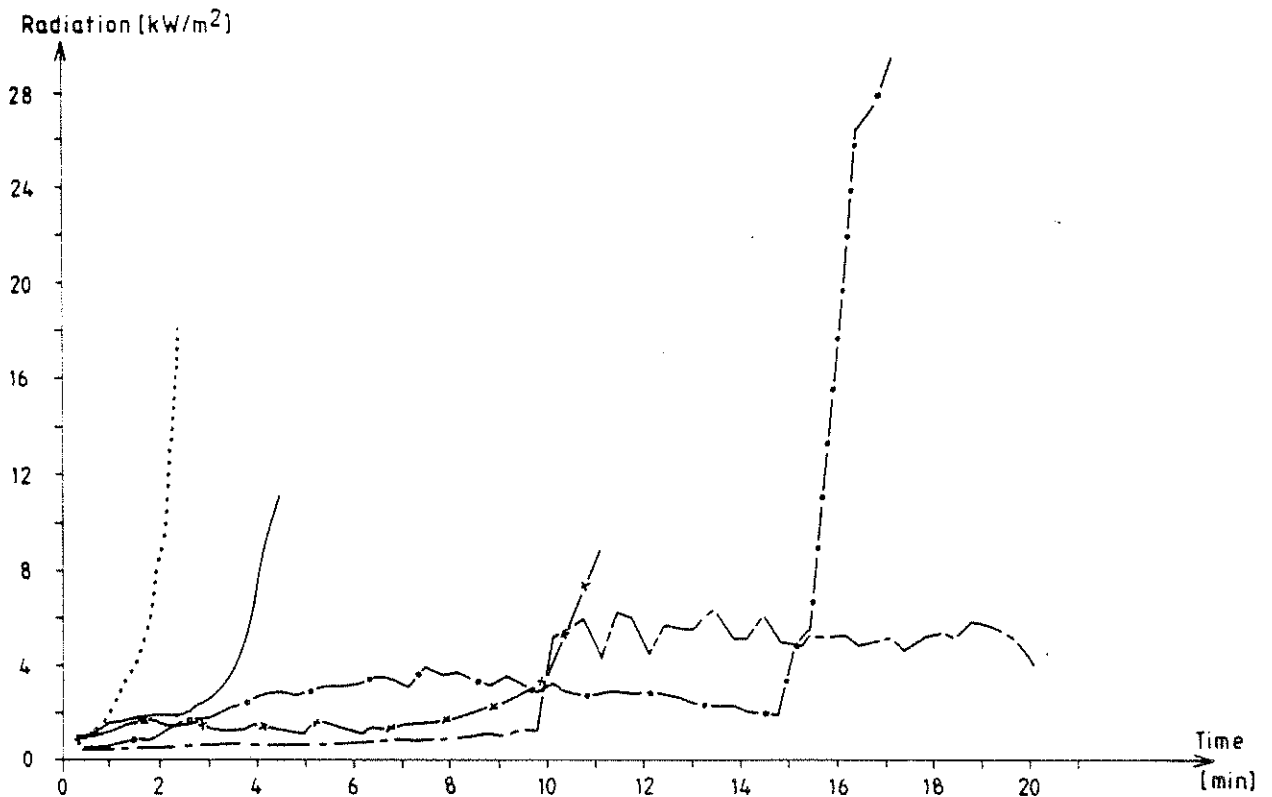
Figure C3 Total heat flux towards the centre of the floor for test I:9 (melamine faced particle board) — and I:10 (expanded polystyrene) ----.



**Figure C4** Total heat flux towards the centre of the floor for tests II:1 (insulating fibreboard) —, II:2 (medium density fibreboard) ----, II:3 (particle board, doorwidth = 0.56 m) - - -, II:4 (particle board, doorwidth = 0.46 m) — - —, II:7 (textile wallcovering on mineral wool) ····, II:10 (wood panel, spruce) —x— and II:11 (paper wallcovering on particle board) —·—.



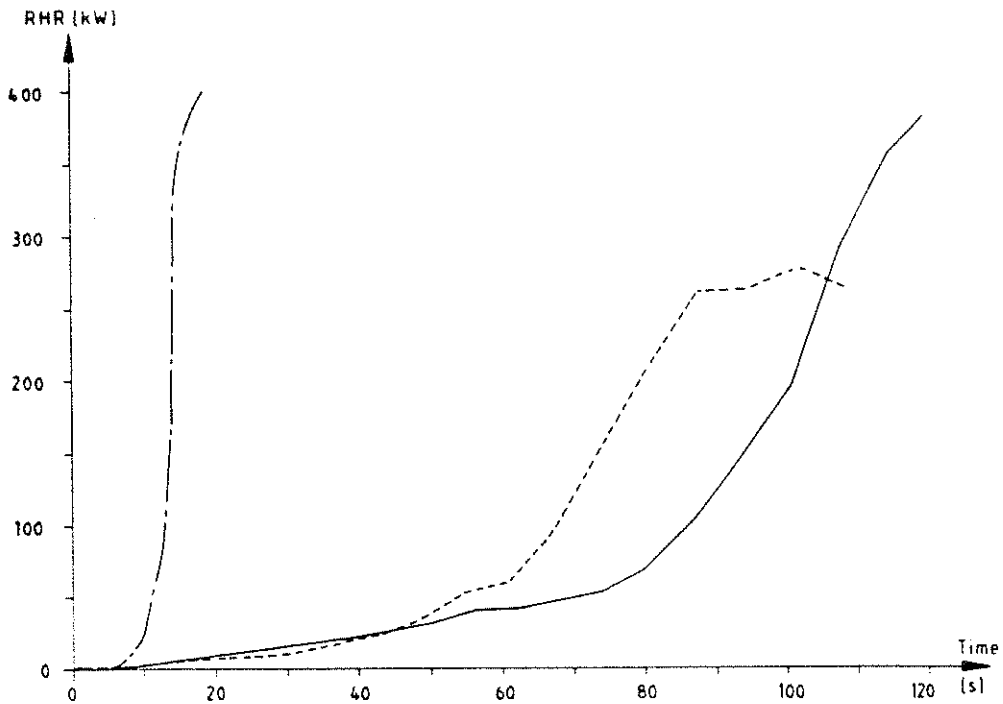
**Figure C5** Total heat flux towards the centre of the floor for tests II:5 (PVC wallcovering on gypsum plasterboard) —, II:6 (textile wallcovering on gypsum plaster board) ---- and II:8 (melamine faced particle board) — · —.



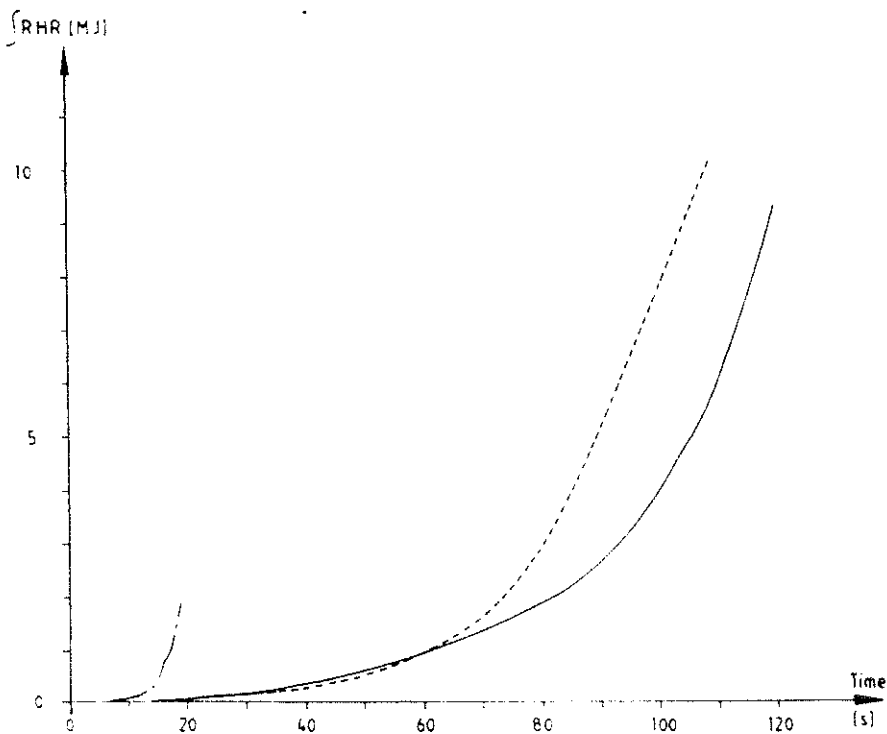
**Figure C6** Radiation towards the ceiling for tests II:1 (insulating fibreboard) —, II:7 (textile wallcovering on mineral wool) ····, II:8 (melamine faced particle board) - - -, II:10 (wood panel, spruce) —x— and II:11 (paper wallcovering on particle board) —·—.

## Appendix D

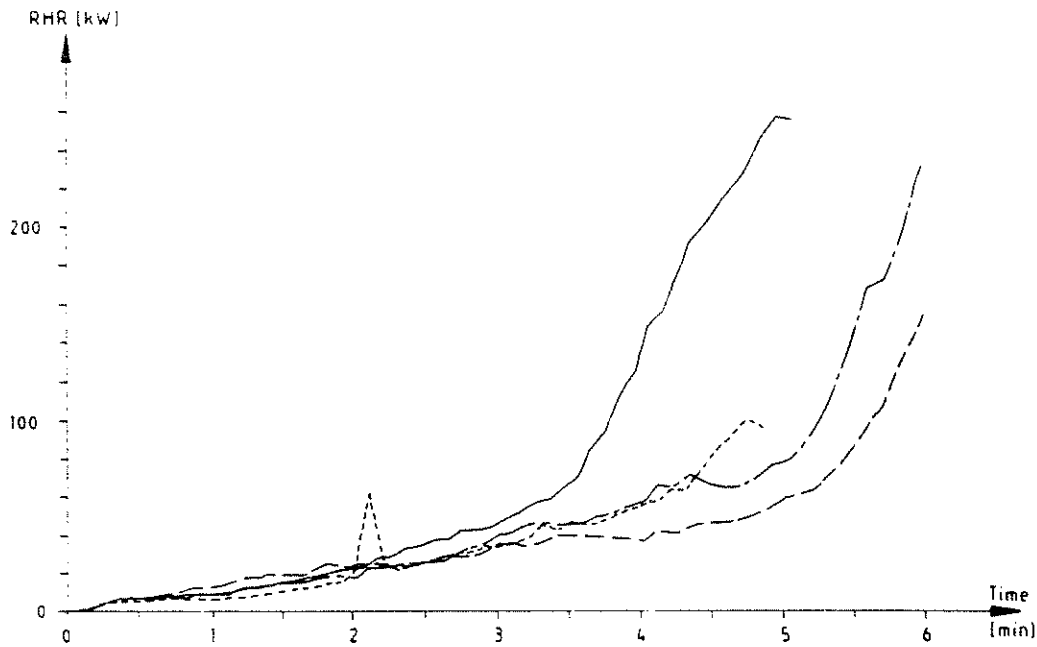
## RHR



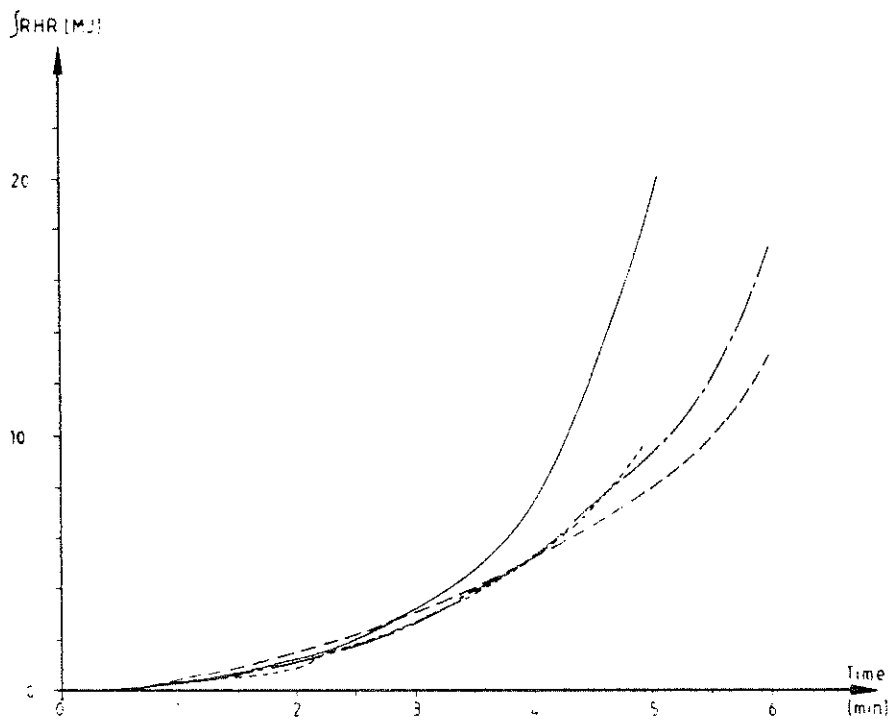
**Figure D1a** RHR curves for tests I:1 (insulating fibreboard) ———, I:8 (textil wallcovering on mineral wool) ———, and I:11 (rigid polyurethane foam) — - —.



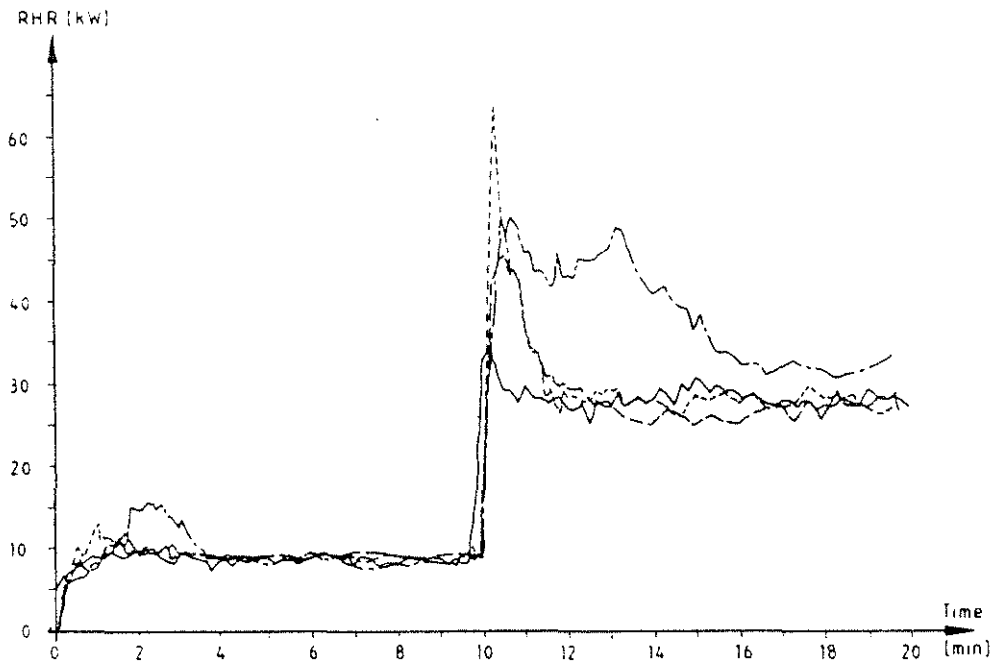
**Figure D1b** Total amount of heat released as a function of time for tests I:1 (insulating fibreboard) ———, I:8 (textile wallcovering on mineral wool) ——— and I:11 (rigid polyurethane foam) — - —.



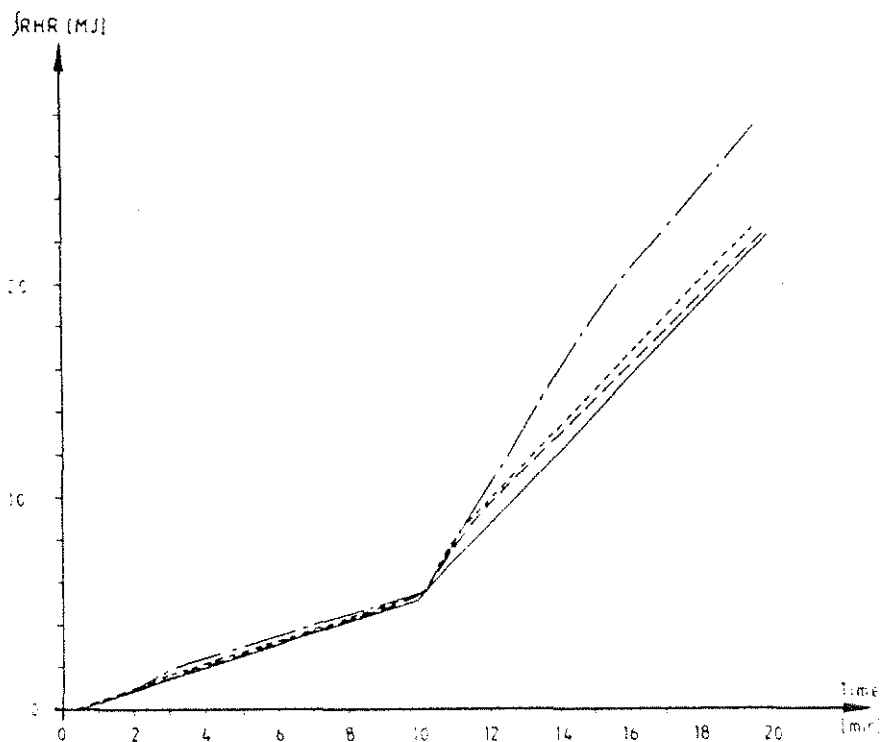
**Figure D2a** RHR curves for tests I:2 (medium density fibreboard) ———, I:3 (particle board) ----, I:12 (wood panel, spruce) — — — and I:13 (paper wallcovering on particle board) — - —.



**Figure D2b** Total amount of heat released as a function of time for tests I:2 (medium density fibreboard) ———, I:3 (particle board) ----, I:12 (wood panel, spruce) — — — and I:13 (paper wallcovering on particle board) — - —.



**Figure D3a** RHR curves for tests I:4 (gypsum plaster board) —, I:5 (PVC wallcovering on gypsum plaster board) ----, I:6 (paper wallcovering on gypsum plaster board) — — — and I:7 (textile wallcovering on gypsum plaster board) — - —.



**Figure D3b** Total amount of heat released as a function of time for tests I:4 (gypsum plaster board) —, I:5 (PVC wallcovering on gypsum plasterboard) ----, I:6 (paper wallcovering on gypsum plaster board) — — — and I:7 (textile wallcovering on gypsum plaster board) — - —.

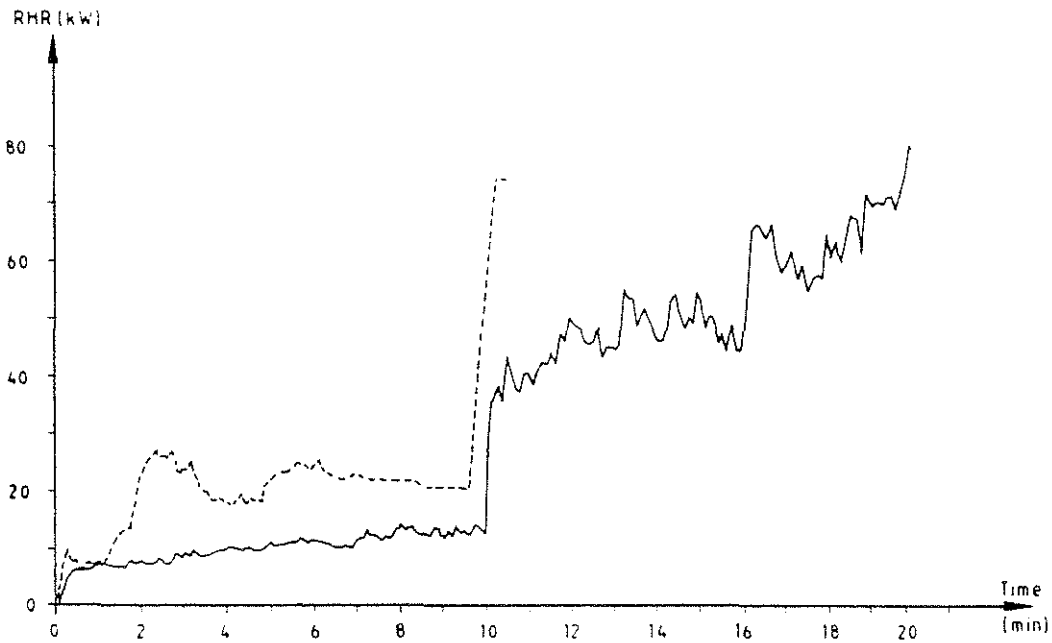


Figure D4a RHR curves for tests I:9 (melamine faced particle board) — and I:10 (expanded polystyrene) ----.

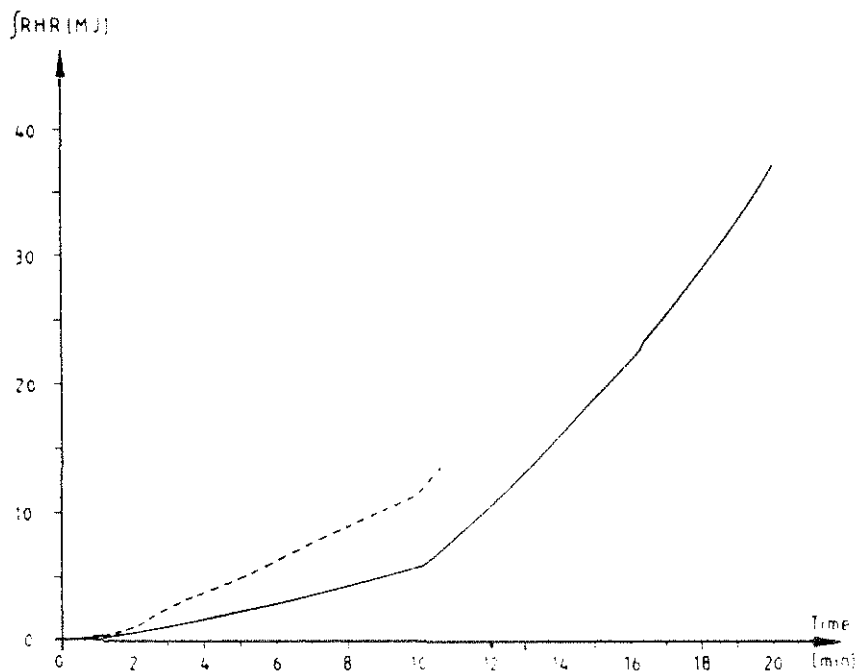
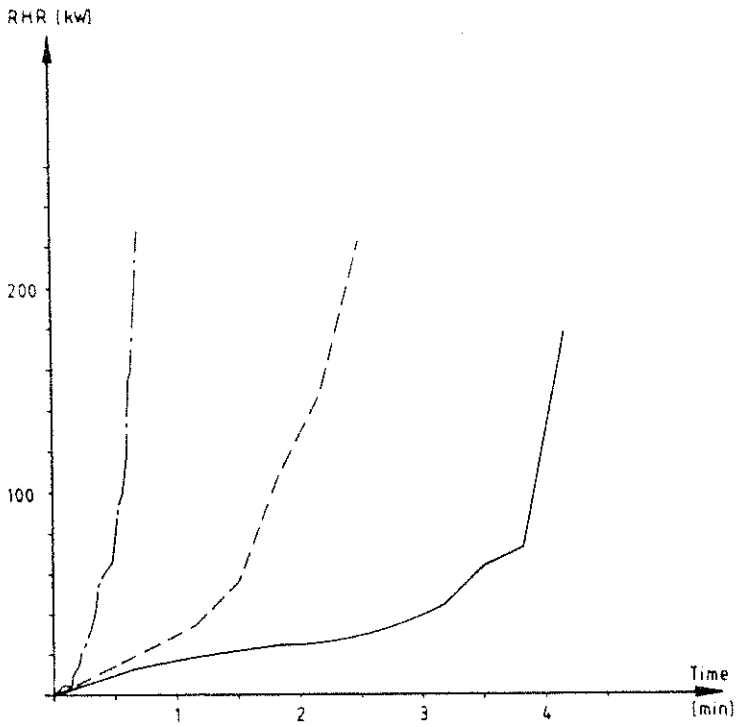
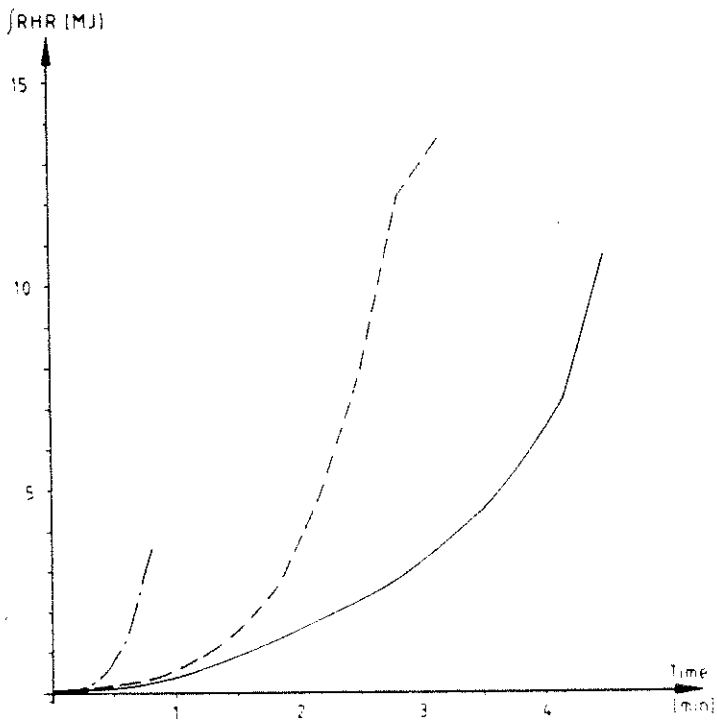


Figure D4b Total amount of heat released as a function of time for tests I:9 (melamine faced particle board) — and I:10 (expanded polystyrene) ----.

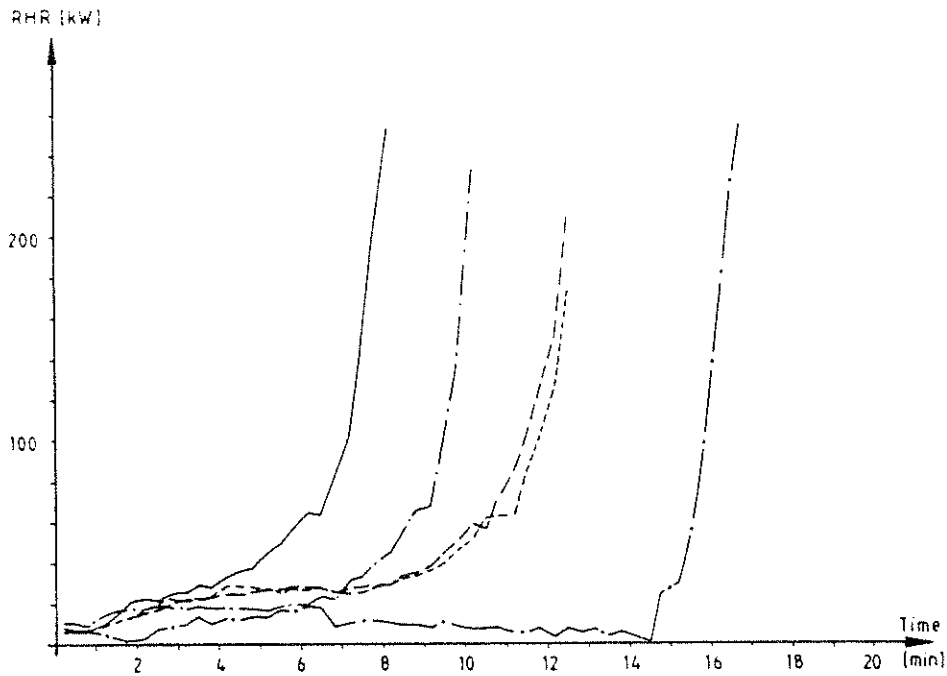


**Figure D5a** RHR curves for tests II:1 (insulating fibreboard) —, II:7 (textile wallcovering on mineral wool) ---- and II:9 (rigid polyurethane foam) - - -.

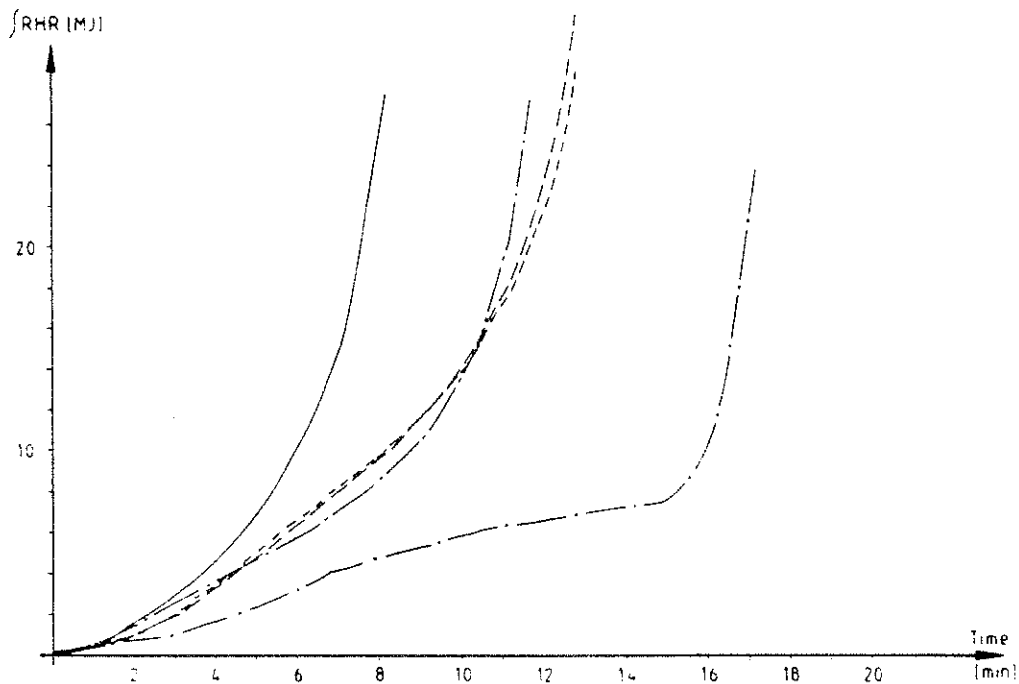


**Figure D5b** Total amount of heat released as a function of time for tests II:1 (insulating fibreboard) —, II:7 (textile wallcovering on mineral wool) ---- and II:9 (rigid polyurethane foam) - - -.

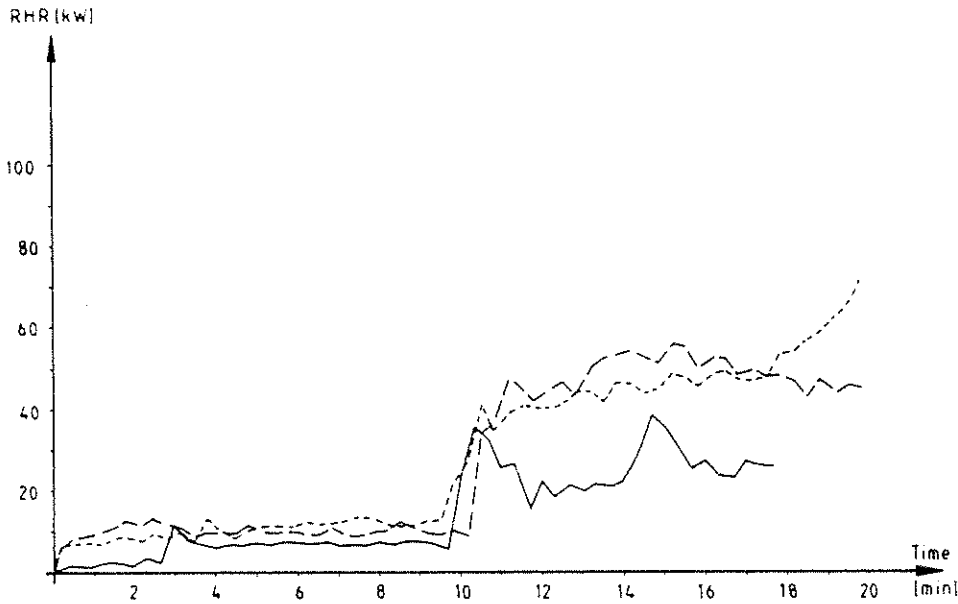




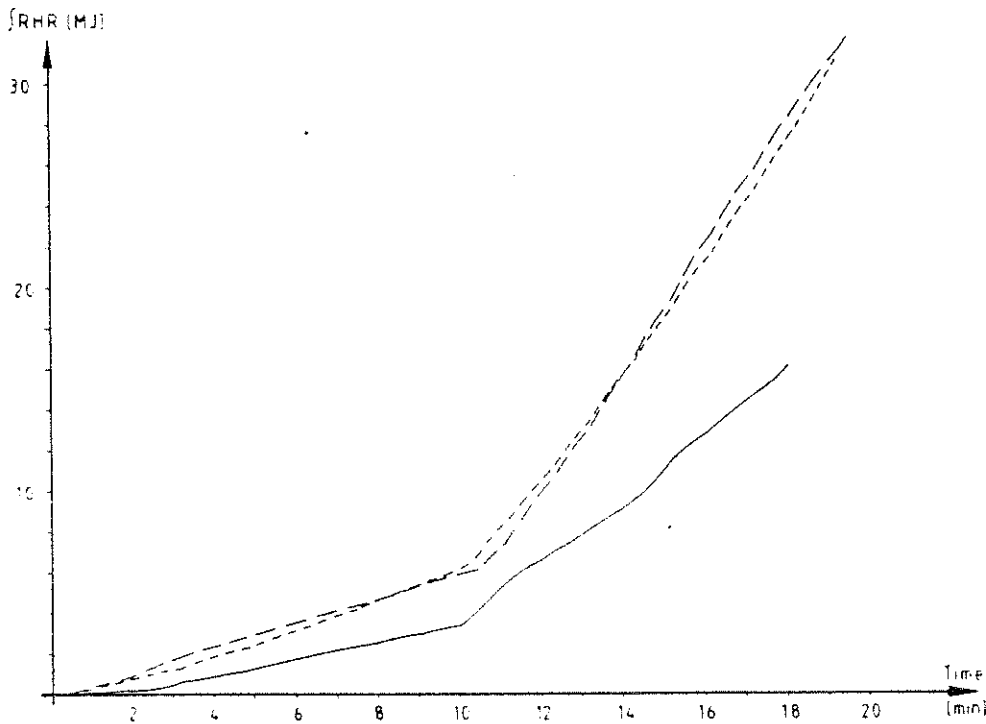
**Figure D6a** RHR curves for tests II:2 (medium density fibreboard) —, II:3 (particle board, doorwidth = 0.56 m) ----, II:4 (particle board, doorwidth = 0.46 m) — — —, II:10 (wood panel, spruce) - - - and II:11 (paper wallcovering on particle board) -.-.



**Figure D6b** Total amount of heat released as a function of time for tests II:2 (medium density fibreboard) —, II:3 (particle board, doorwidth = 0.56 m) ----, II:4 (particle board, doorwidth = 0.46 m) — — —, II:10 (wood panel, spruce) - - - and II:11 (paper wallcovering on particle board) -.-.



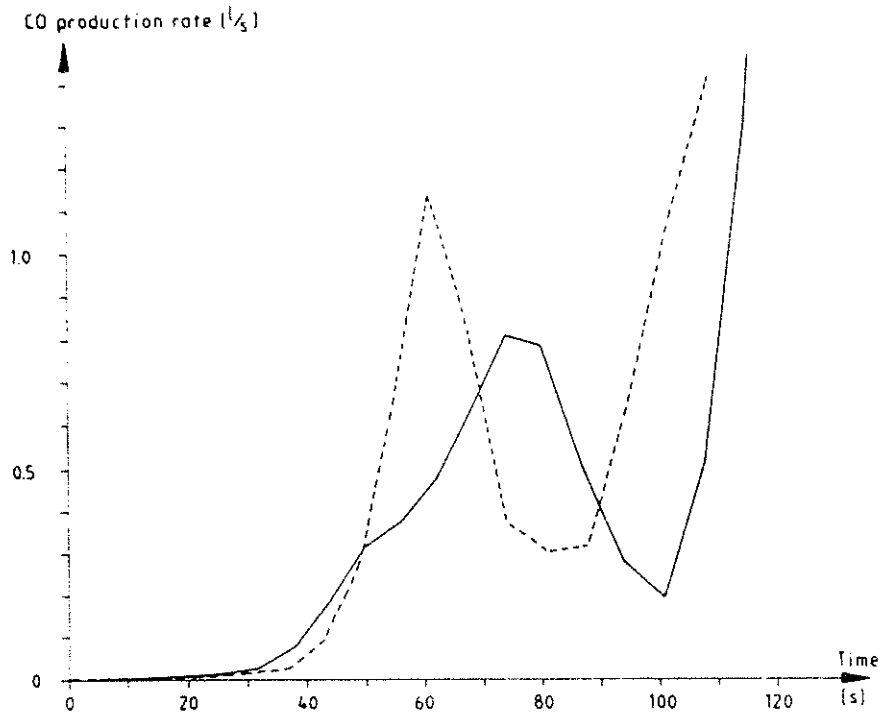
**Figure D7a** RHR curves for tests II:5 (PVC wallcovering on gypsum plaster board) —, II:6 (textile wallcovering on gypsum plaster board) — — — and II:8 (melamine faced particle board) - - - -.



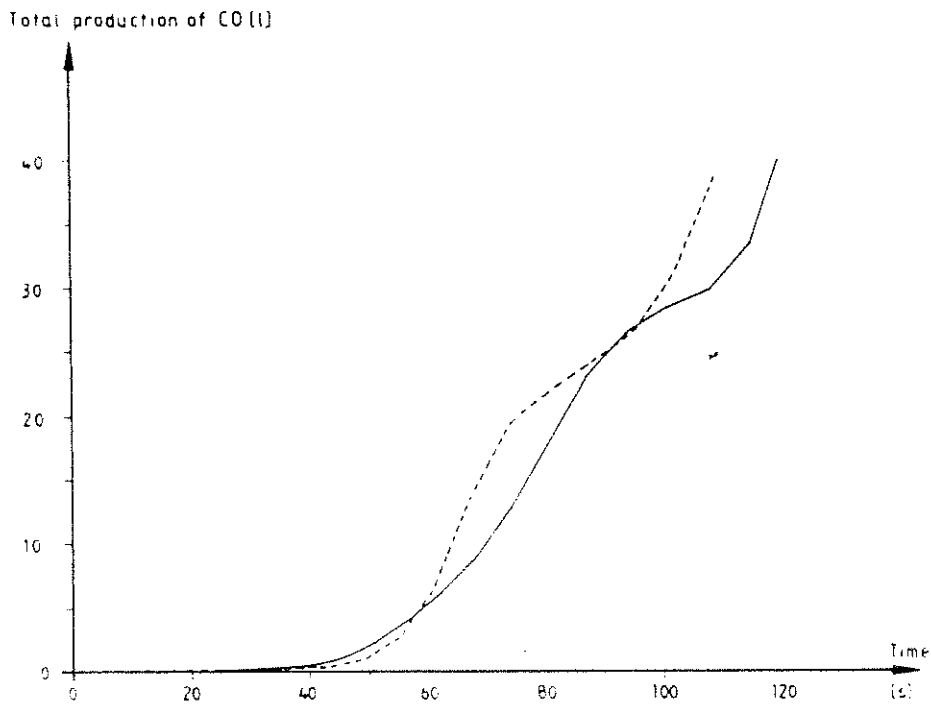
**Figure D7b** Total amount of heat released as a function of time for tests II:5 (PVC wallcovering on gypsum plaster board) —, II:6 (textile wallcovering on gypsum plasterboard) — — — and II:8 (melamine faced particle board) - - - -.

## Appendix E

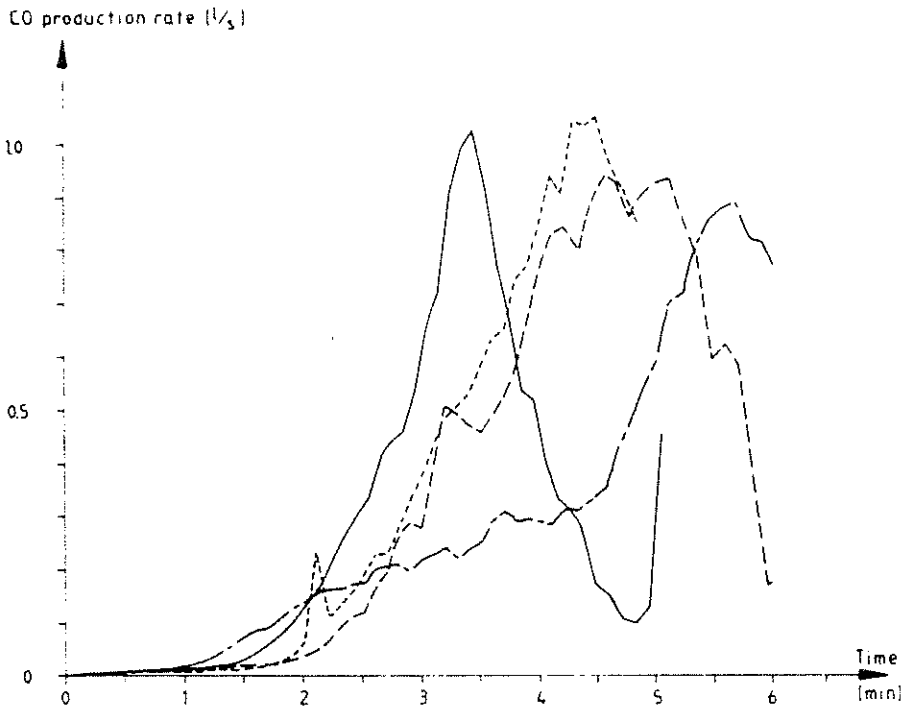
## Gas production



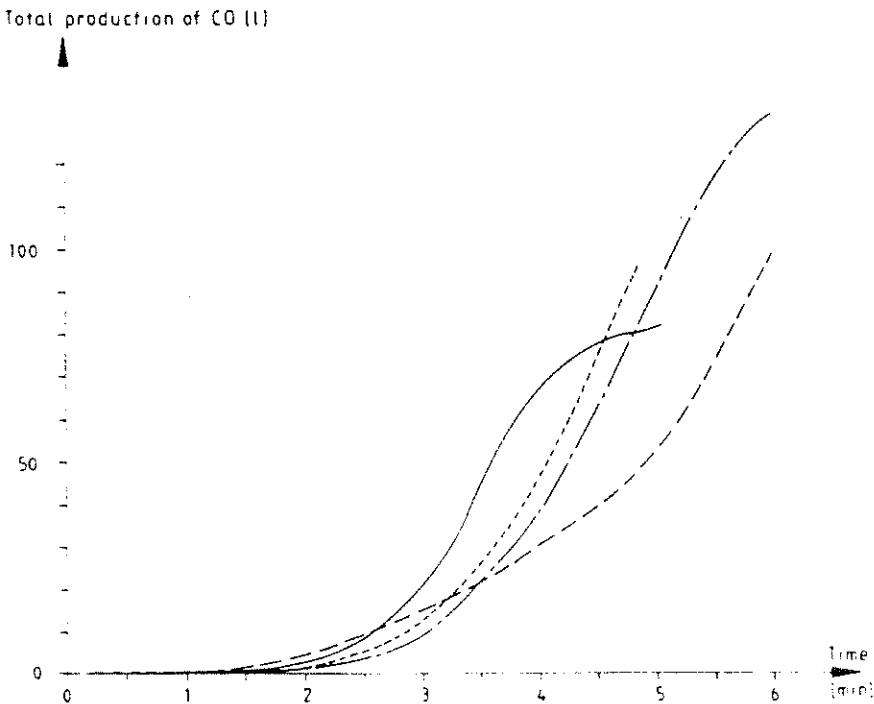
**Figure E1a** CO production rate for tests I:1 (insulating fibreboard) — and I:8 (textile wallcovering on mineral wool) ----.



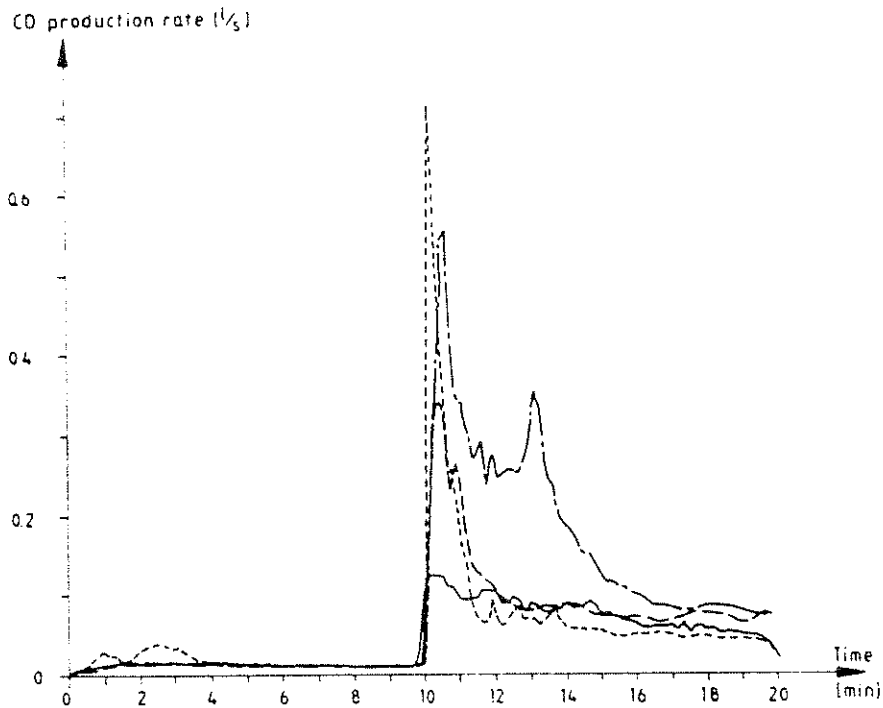
**Figure E1b** Total production of CO as a function of time for tests I:1 (insulating fibreboard) — and I:8 (textile wallcovering on mineral wool)----.



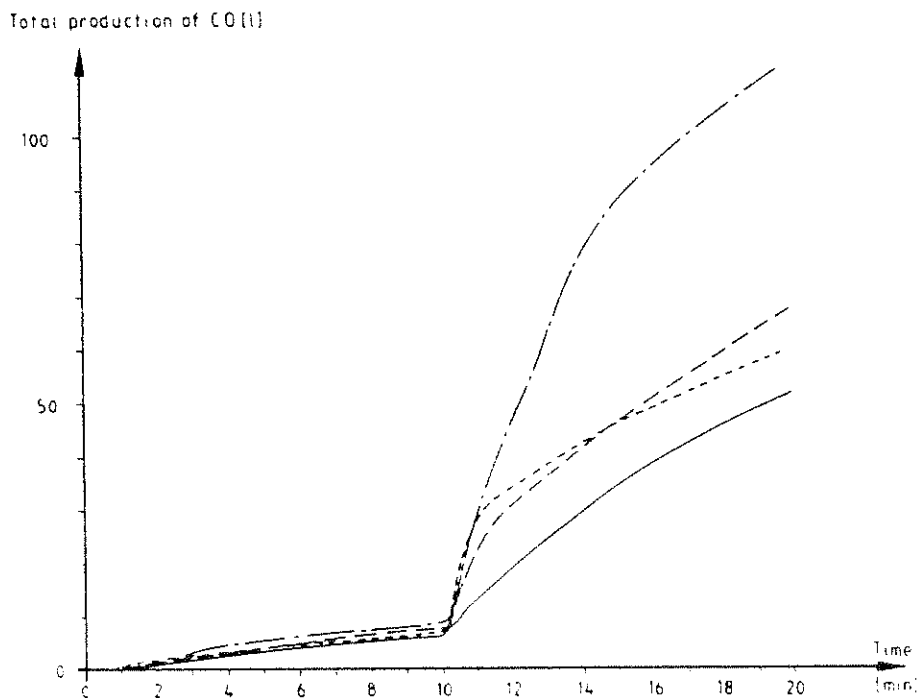
**Figure E2a** CO production rate for tests I:2 (medium density fibreboard) —, I:3 (particle board) ----, I:12 (wood panel, spruce) — — — and I:13 (paper wallcovering on particle board) — - —.



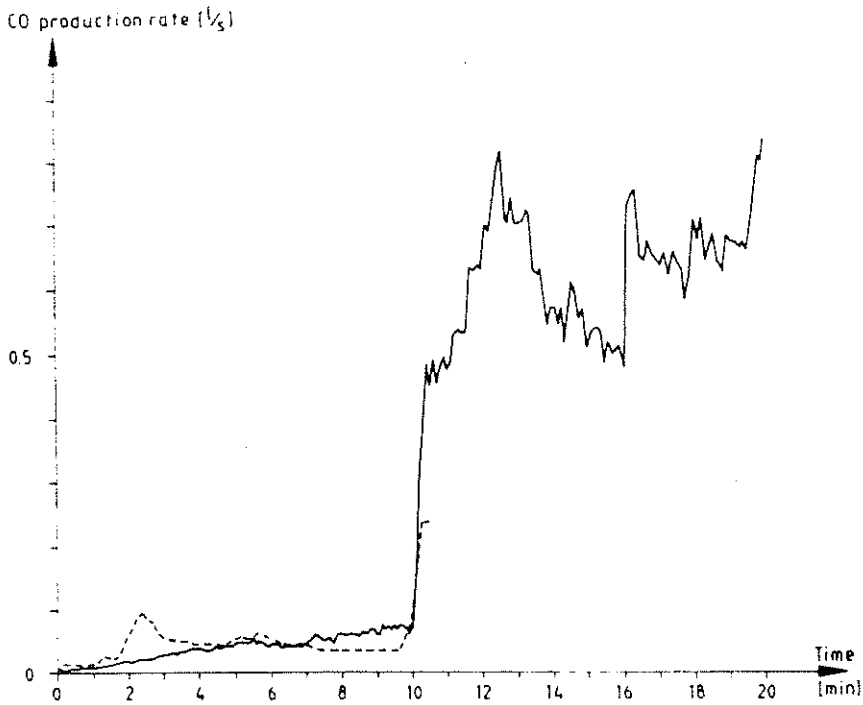
**Figure E2b** Total production of CO as a function of time for tests I:2 (medium density fibreboard) —, I:3 (particle board) ----, I:12 (wood panel, spruce) — — — and I:13 (paper wallcovering on particle board) — - —.



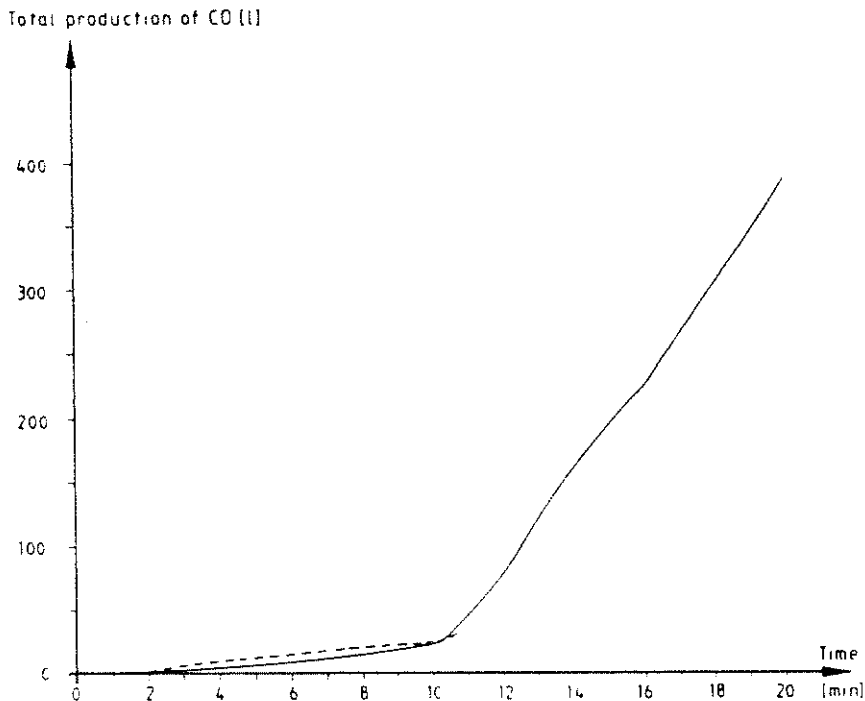
**Figure E3a** CO production rate for tests I:4 (gypsum plaster board) —, I:5 (PVC wallcovering on gypsum plaster board) ----, I:6 (paper wallcovering on gypsum plaster board) — — — and I:7 (textile wallcovering on gypsum plaster board) — - —.



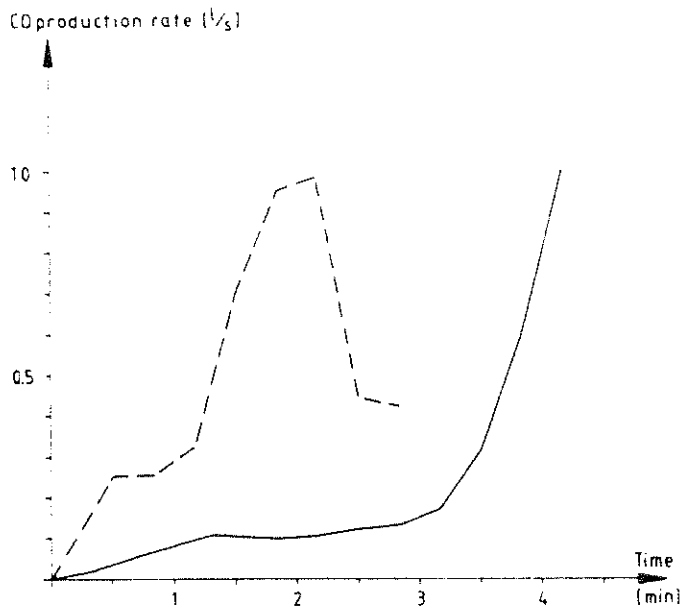
**Figure E3b** Total production of CO as a function of time for tests I:4 (gypsum plaster board) —, I:5 (PVC wallcovering on gypsum plaster board) ----, I:6 (paper wallcovering on gypsum plaster board) — — — and I:7 (textile wallcovering on gypsum plaster board) — - —.



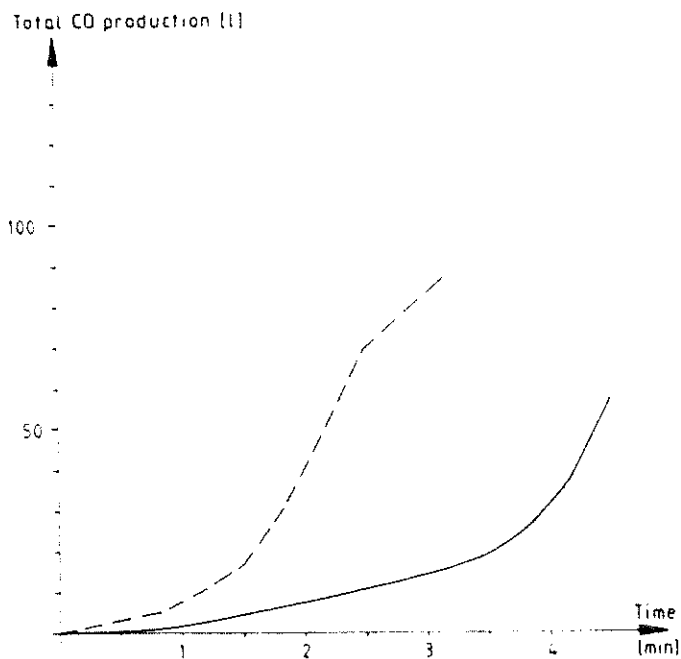
**Figure E4a** CO production rate for tests I:9 (melamine faced particle board) — and I:10 (expanded polystyrene) ----.



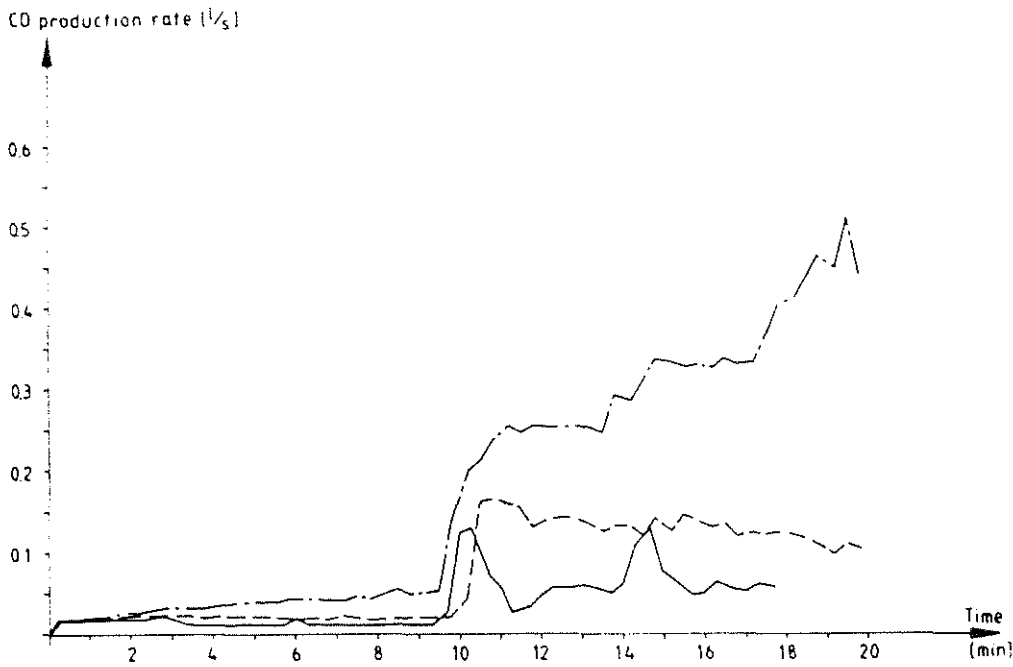
**Figure E4b** Total production of CO as a function of time for tests I:9 (melamine faced particle board) — and I:10 (expanded polystyrene) ----.



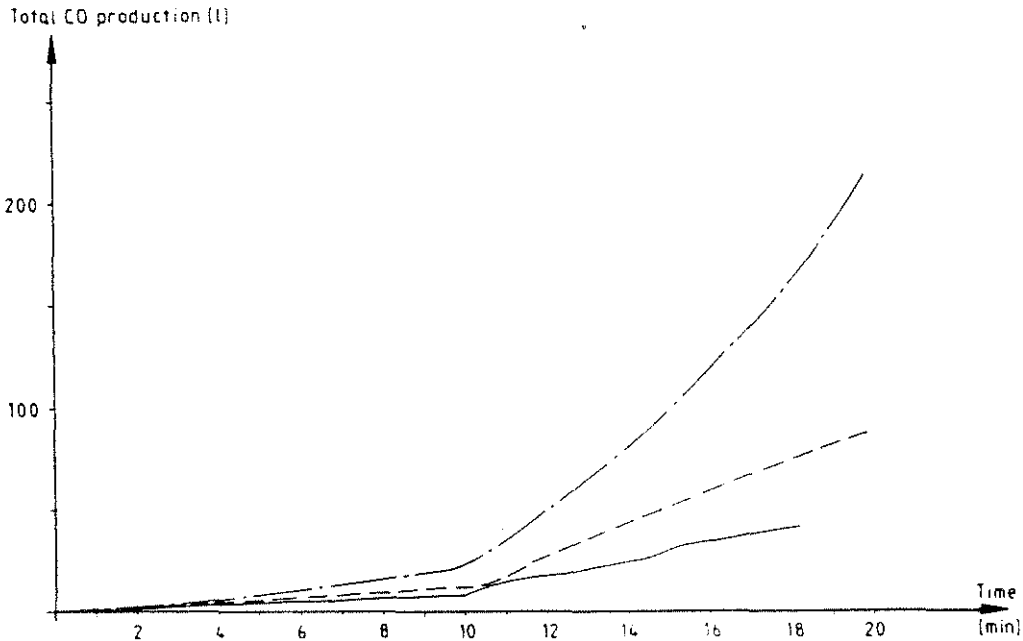
**Figure E5a** CO production rate for tests II:1 (insulating fibreboard) — and II:8 (textile wallcovering on mineral wool) ----.



**Figure E5b** Total production of CO as a function of time for tests II:1 (insulating fibreboard) — and II:8 (textile wallcovering in mineral wool) ----.

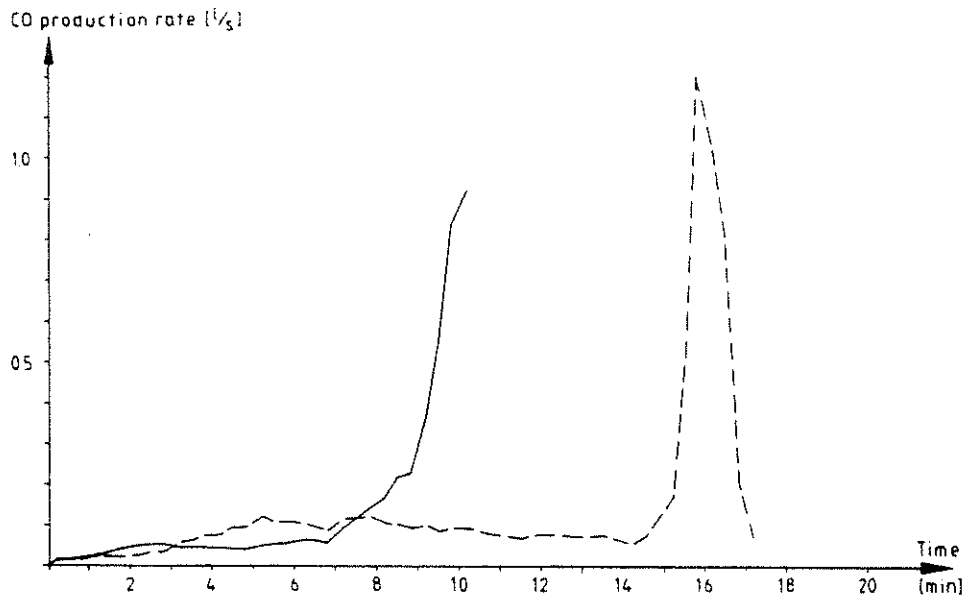


**Figure E6a** CO production rate for tests II:5 (PVC wallcovering on gypsum plaster board) —, II:6 (textile wallcovering on gypsum plaster board) ---- and II:8 (melamine faced particle board) - - -.

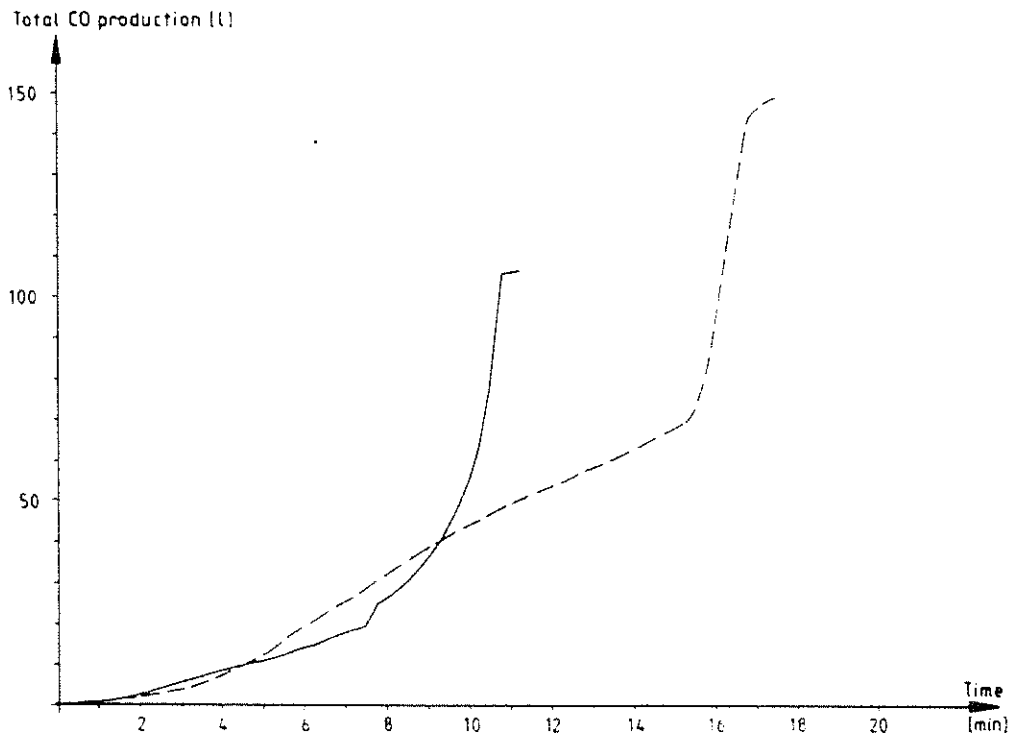


**Figure E6b** Total production of CO as a function of time for tests II:5 (PVC wallcovering on gypsum plaster board) —, II:6 (textile wallcovering on gypsum plaster board) ---- and II:8 (melamine faced particle board) - - -.

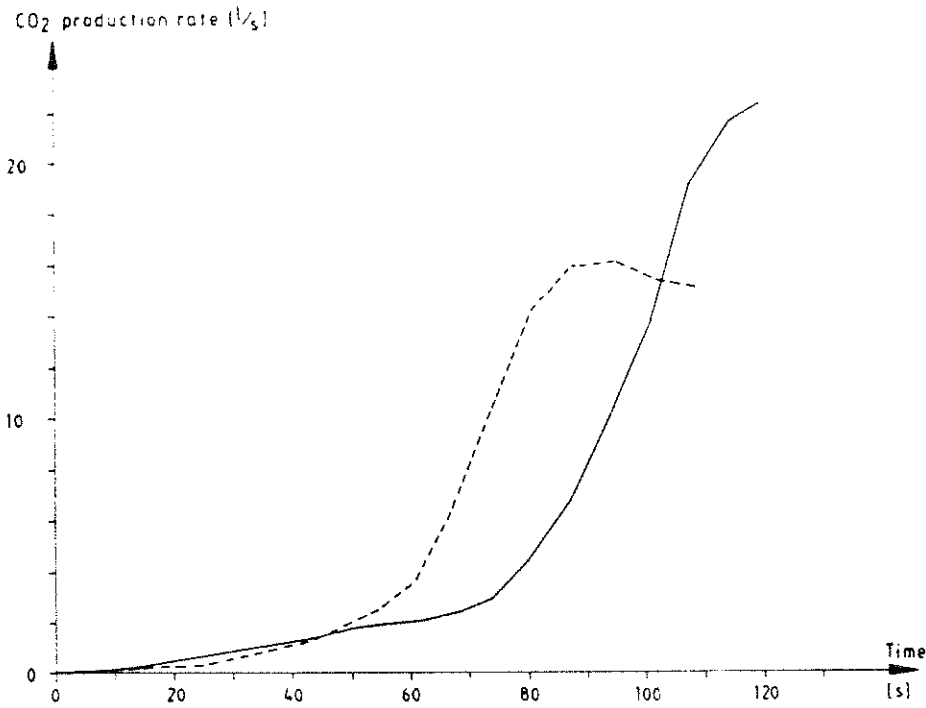




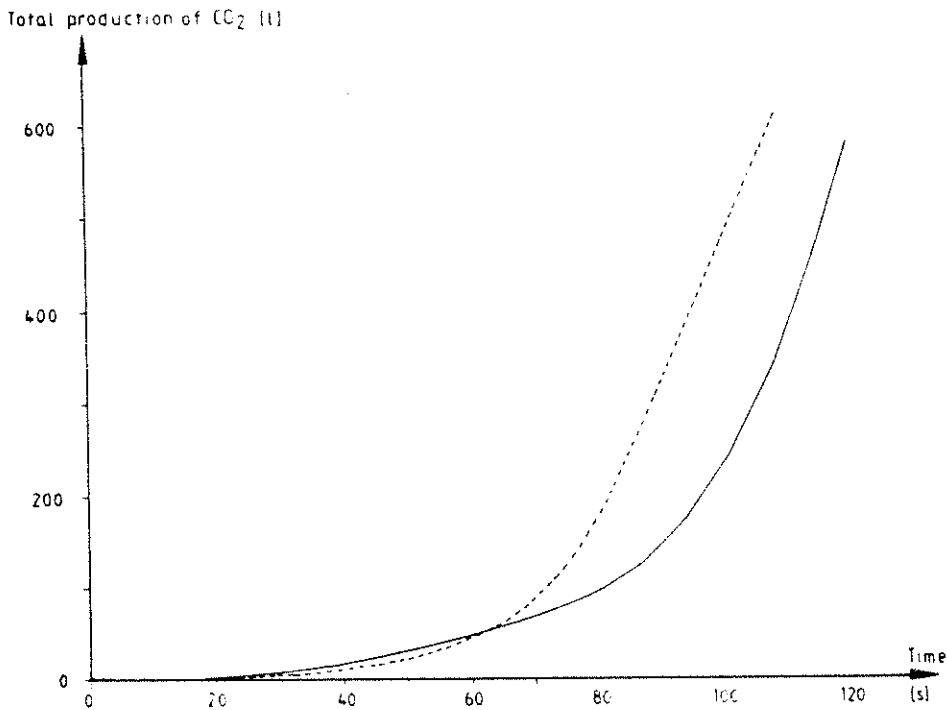
**Figure E7a** CO production rate for tests II:10 (wood panel, spruce) — and II:11 (paper wallcovering on particle board) ----.



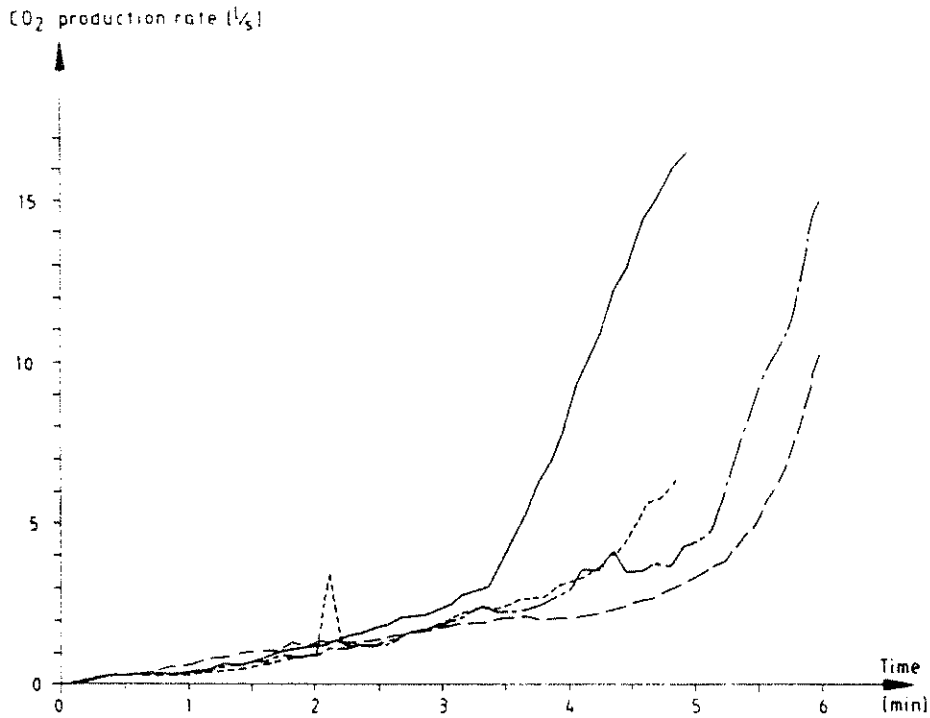
**Figure E7b** Total production of CO as a function of time for tests II:10 (wood panel, spruce) — and II:11 (paper wallcovering on particle board) ----.



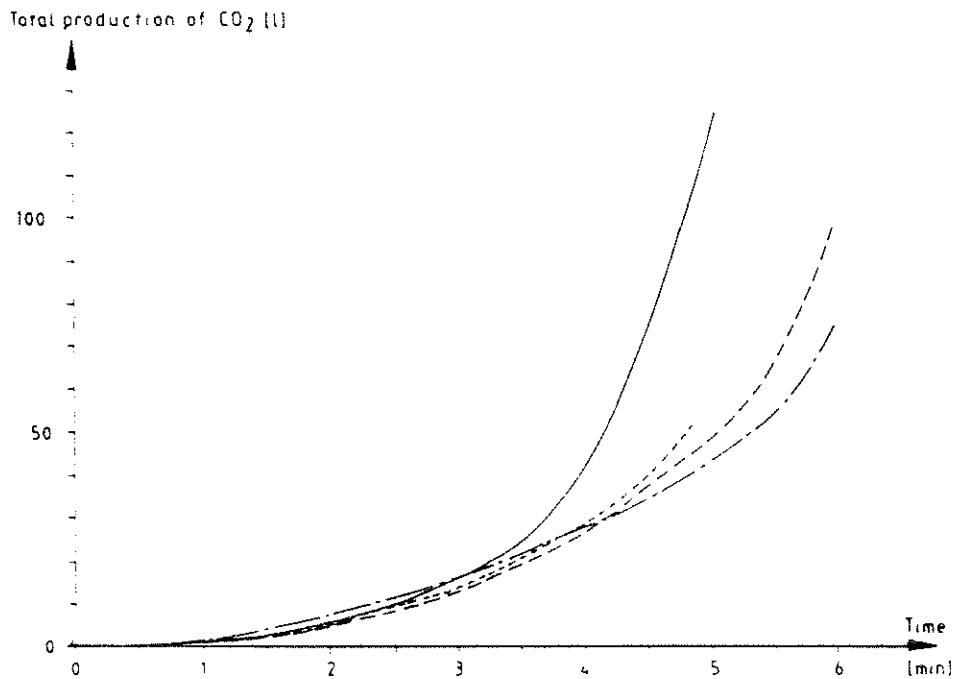
**Figure ESa** CO<sub>2</sub> production rate for tests I:1 (insulating fibreboard) — and I:8 (textile wallcovering on mineral wool) ----.



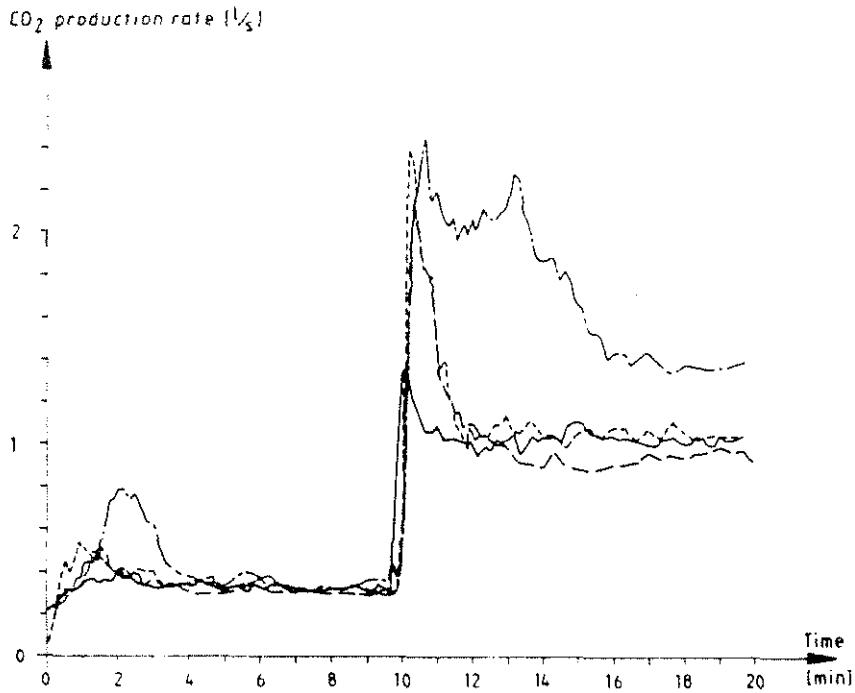
**Figure ESb** Total production of CO<sub>2</sub> as a function of time for tests I:1 (insulating fibreboard) — and I:8 (textile wallcovering on mineral wool) ----.



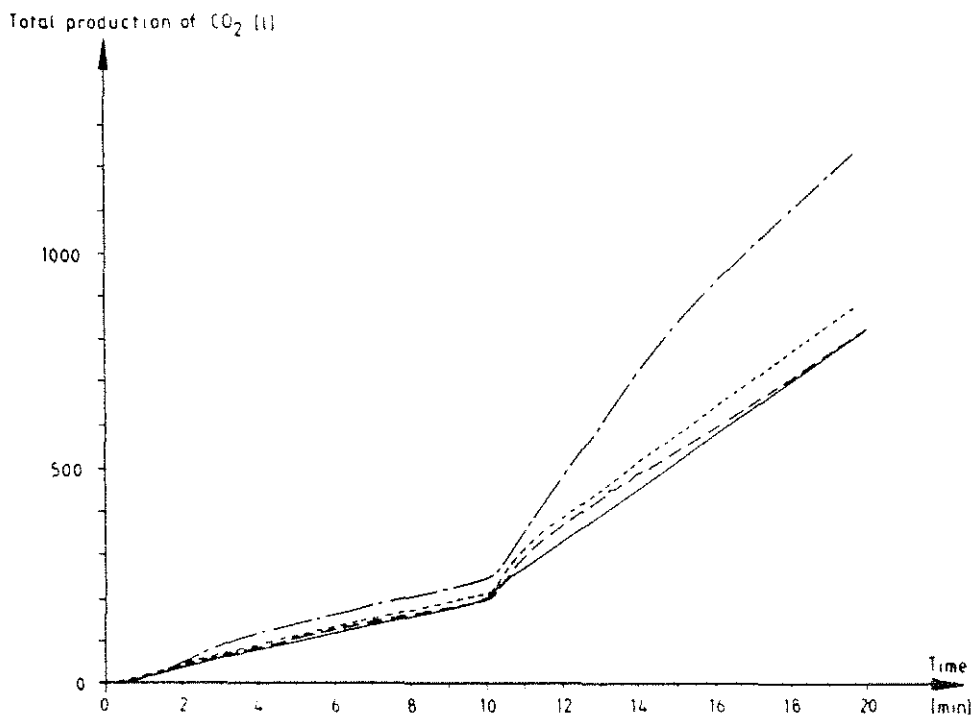
**Figure E9a** CO<sub>2</sub> production rate for tests I:2 (medium density fibreboard) —, I:3 (particle board) ----, I:12 (wood panel, spruce) — — — and I:13 (paper wallcovering on particle board) — - —.



**Figure E9b** Total production of CO<sub>2</sub> as a function of time for tests I:2 (medium density fibreboard) —, I:3 (particle board) ----, I:12 (wood panel, spruce) — — — and I:13 (paper wallcovering on particle board) — - —.



**Figure E10a** CO<sub>2</sub> production rate for tests I:4 (gypsum plaster board) —, I:5 (PVC wallcovering on gypsum plaster board) ----, I:6 (paper wallcovering on gypsum plaster board) — — — and I:7 (textile wallcovering on gypsum plaster board) — - —.



**Figure E10b** Total production of CO<sub>2</sub> as a function of time for tests I:4 (gypsum plaster board) —, I:5 (PVC wallcovering on gypsum plaster board) ----, I:6 (paper wallcovering on gypsum plaster board) — — — and I:7 (textile wallcovering on gypsum plaster board) — - —.

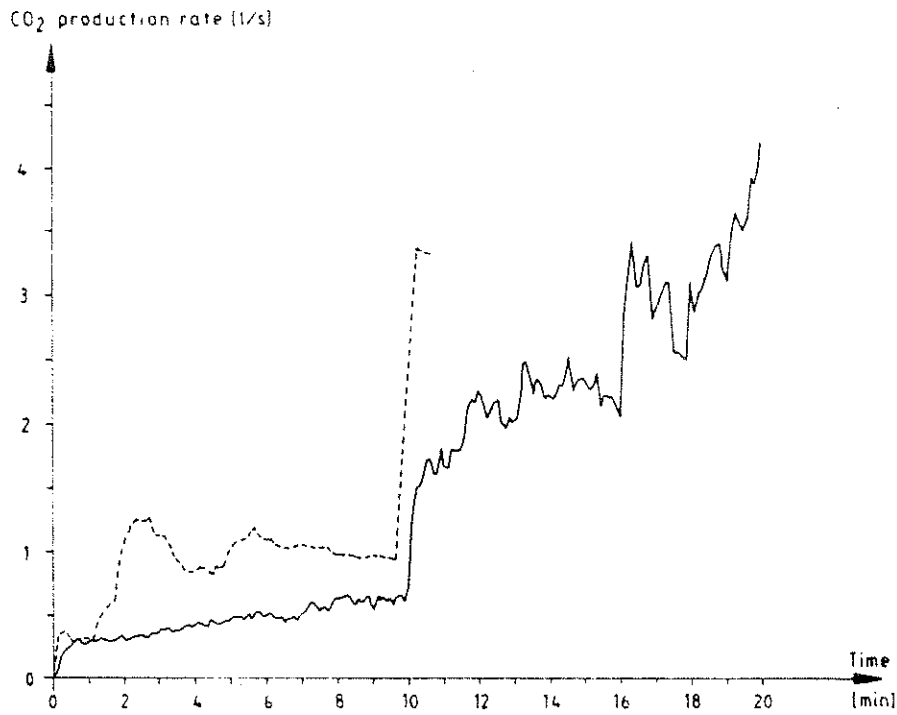


Figure E11a CO<sub>2</sub> production rate for tests I:9 (melamine faced particle board) — and I:10 (expanded polystyrene) ----.

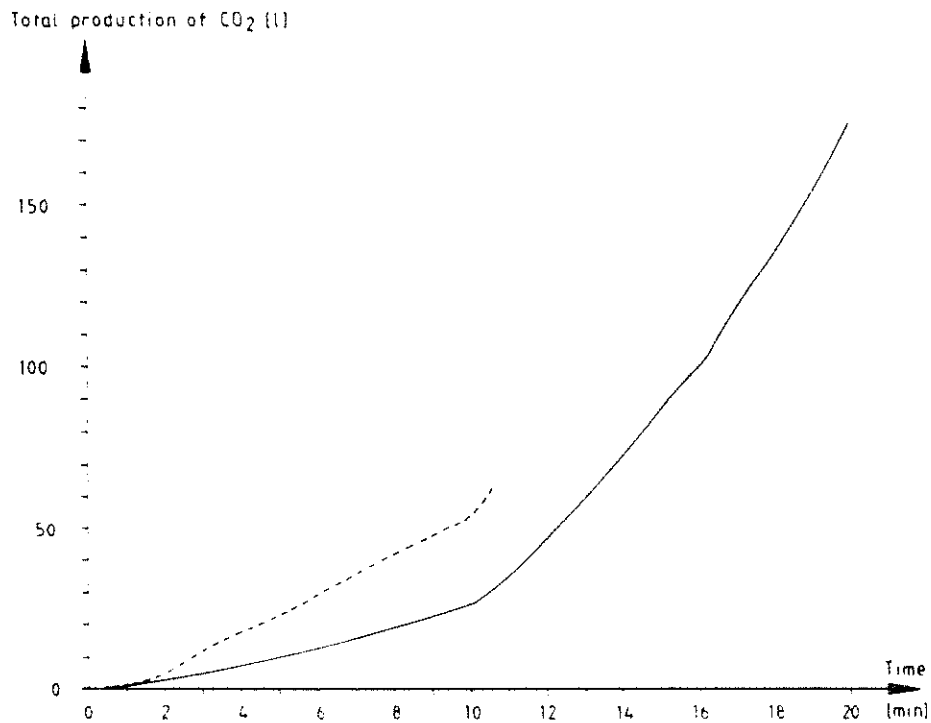
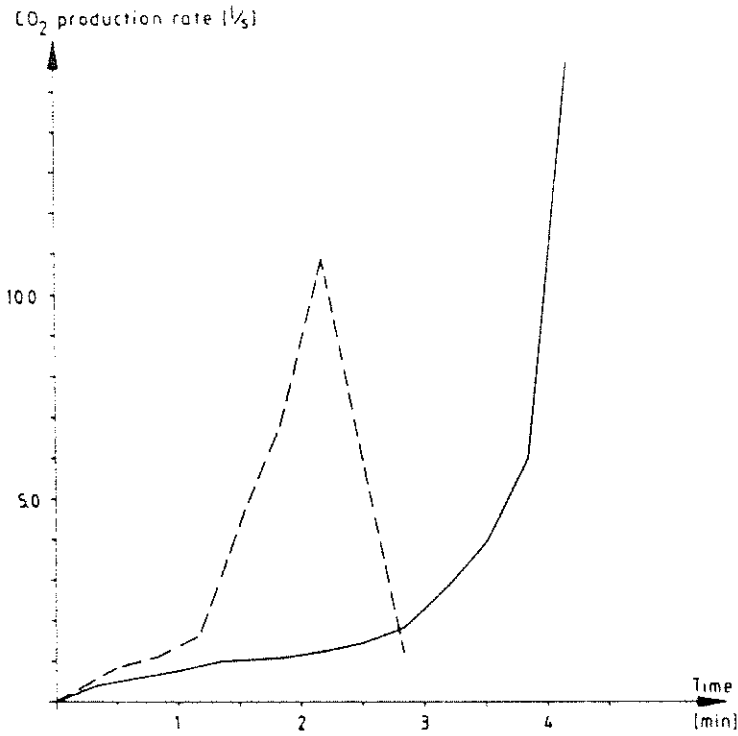
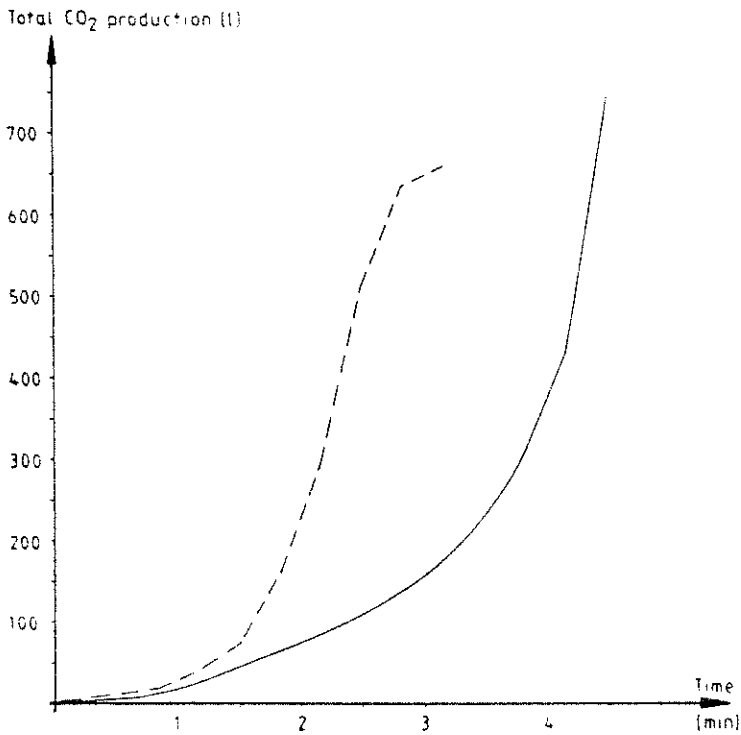


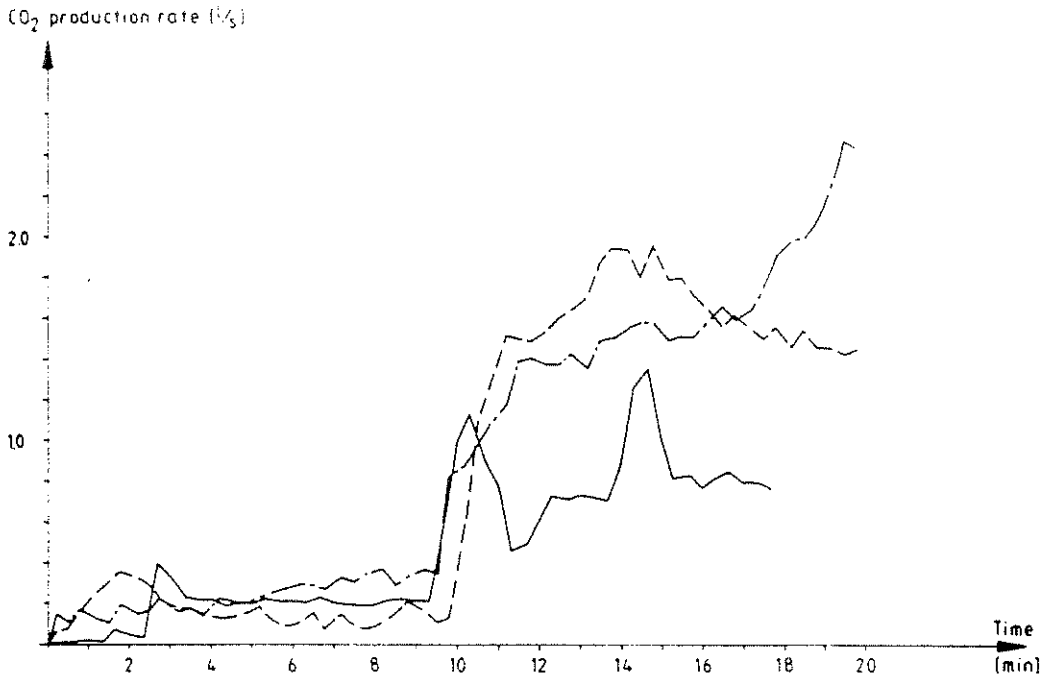
Figure E11b Total production of CO<sub>2</sub> as a function of time for tests I:9 (melamine faced particle board) — and I:10 (expanded polystyrene) ----.



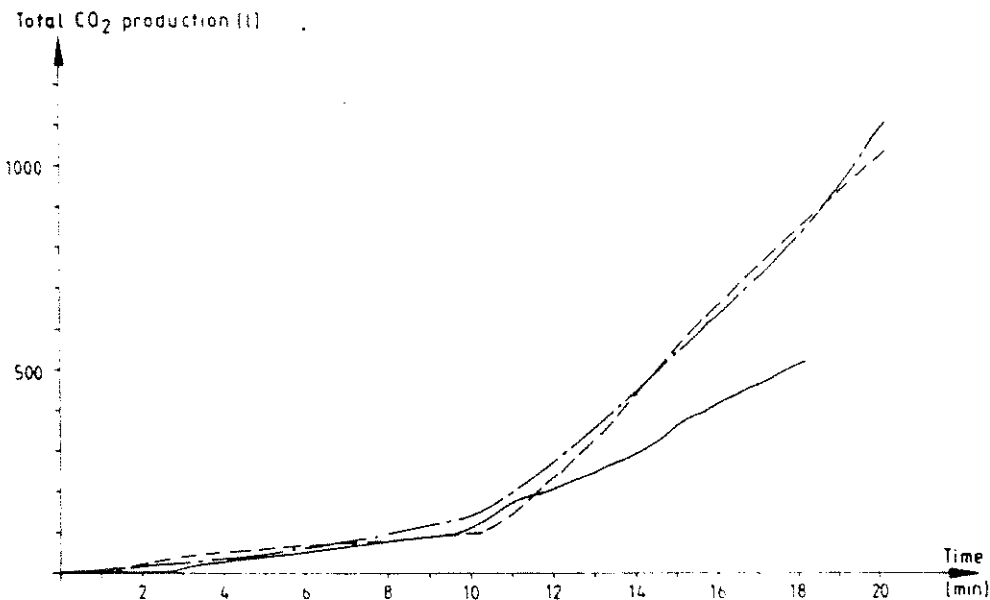
**Figure E12a** CO<sub>2</sub> production rate for tests II:1 (insulating fibreboard) — and II:7 (textile wallcovering on mineral wool) ----.



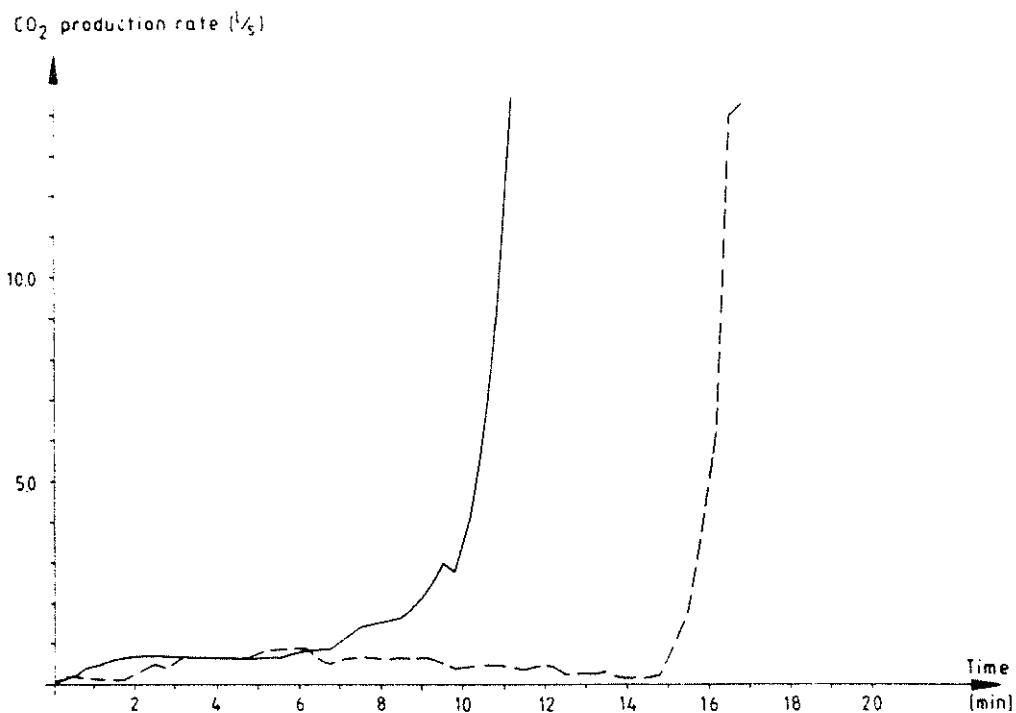
**Figure E12b** Total production of CO<sub>2</sub> as a function of time for tests II:1 (insulating fibreboard) — and II:7 (textile wallcovering on mineral wool) ----.



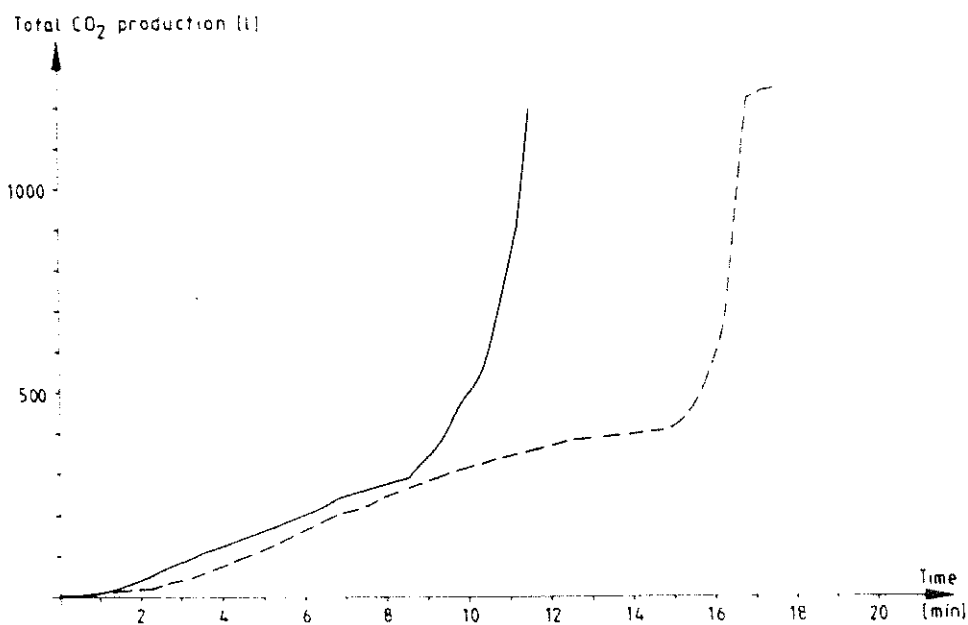
**Figure E13a** CO<sub>2</sub> production rate for tests II:5 (PVC wallcovering on gypsum plaster board) —, II:6 (textile wallcovering on gypsum plaster board) ---- and II:8 (melamine faced particle board) - - -.



**Figure E13b** Total production of CO<sub>2</sub> as a function of time for tests II:5 (PVC wallcovering on gypsum plaster board) —, II:6 (textile wallcovering on gypsum plaster board) ---- and II:8 (melamine faced particle board) - - -.



**Figure E14a** CO<sub>2</sub> production rate for tests II:10 (wood panel, spruce) — and II:11 (paper wallcovering on particle board) ----.



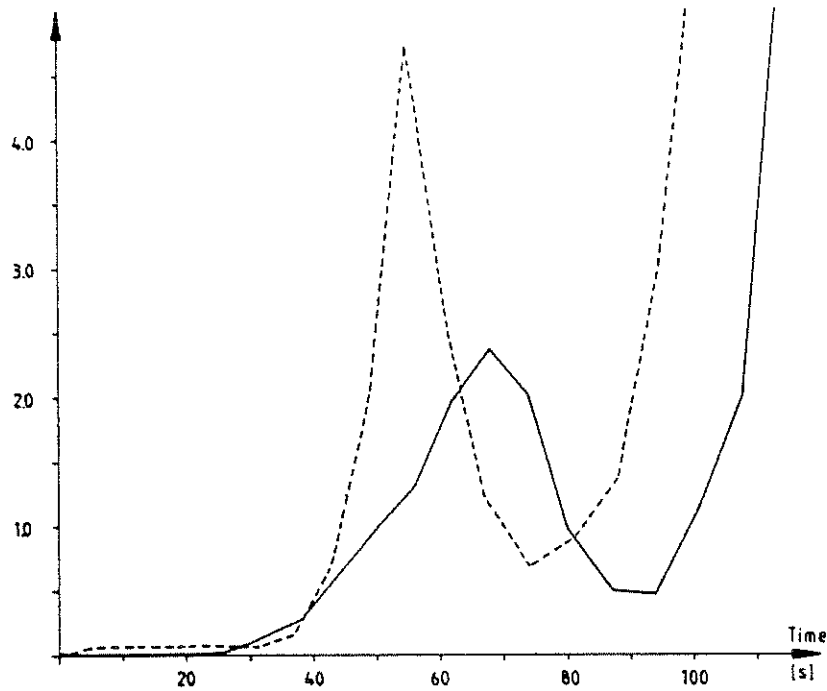
**Figure E14b** Total production of CO<sub>2</sub> as a function of time for tests II:10 (wood panel, spruce) — and II:11 (paper wallcovering on particle board) ----.



## Appendix F

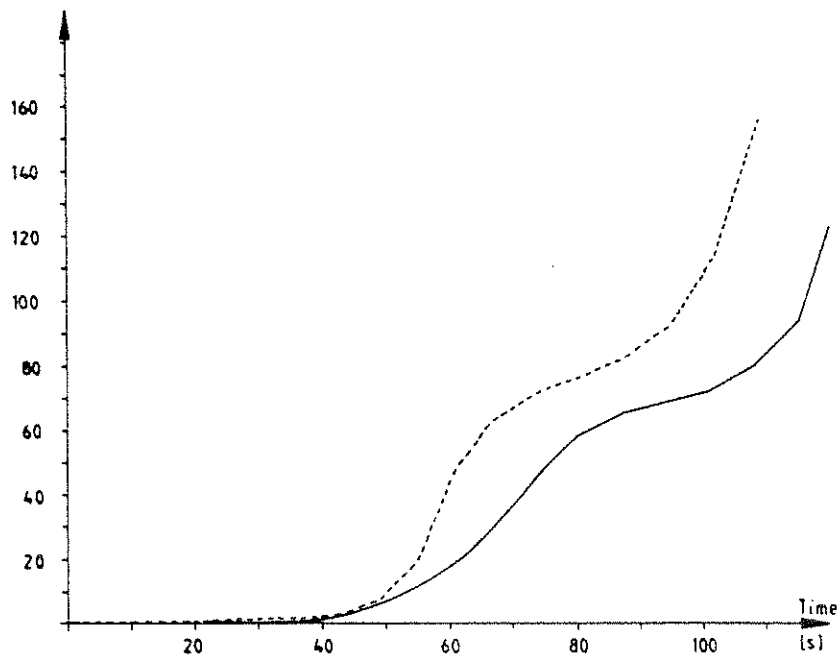
## Smoke production

Smoke production rate  
( $\text{ob m}^3/\text{s}$ )

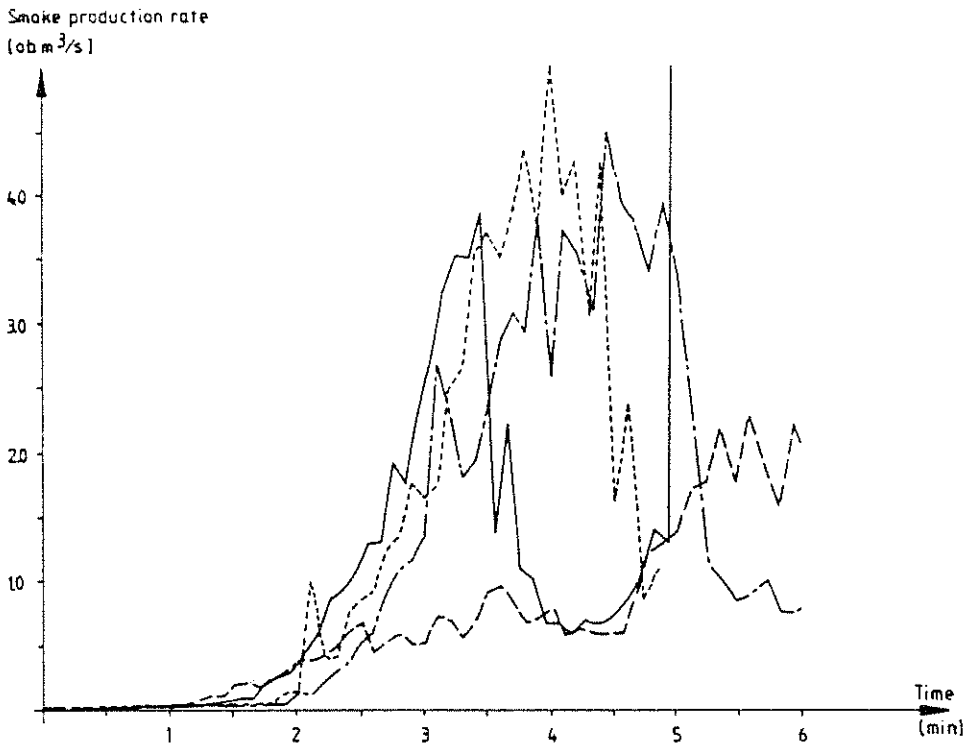


**Figure F1a** Smoke production rate for tests I:1 (insulating fibreboard) — and I:8 (textile wallcovering on mineral wool) ----.

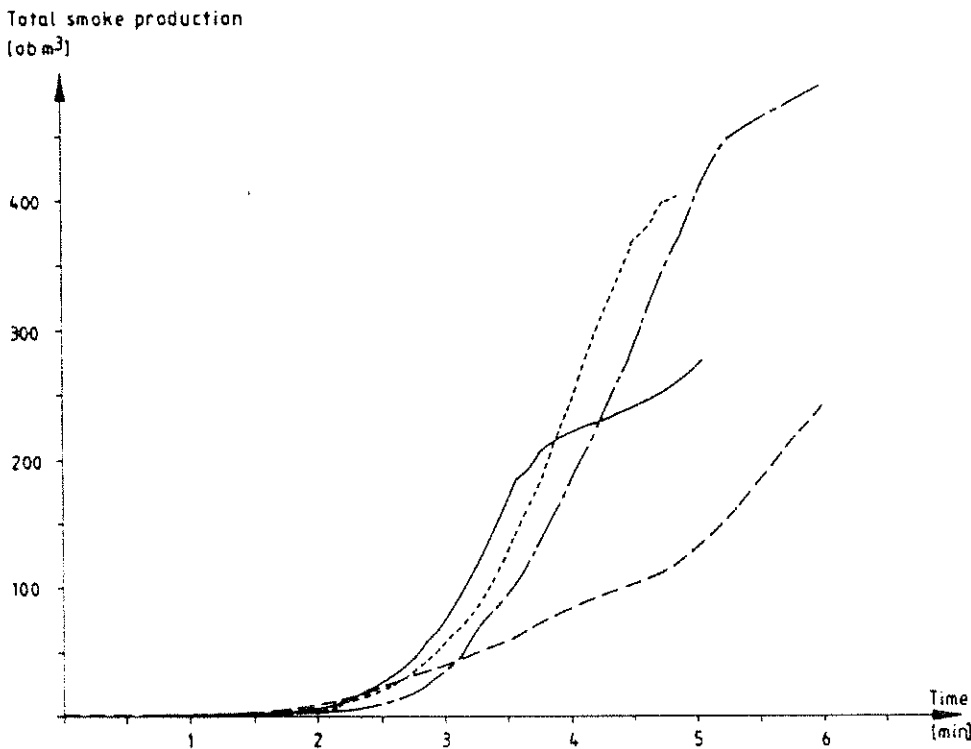
Total smoke production  
( $\text{ob m}^3$ )



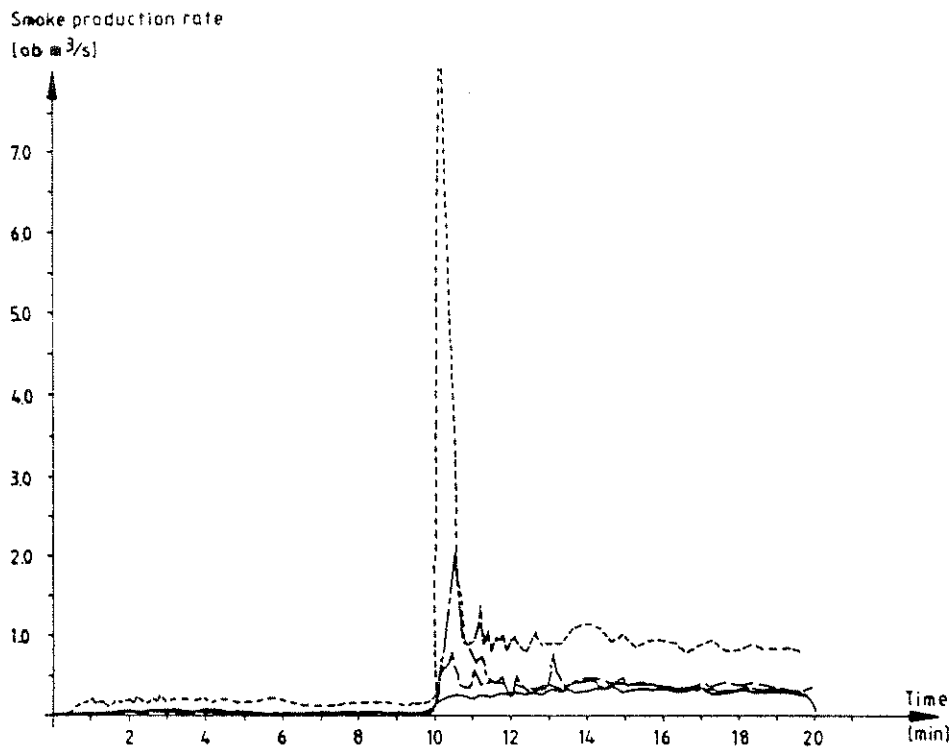
**Figure F1b** Total smoke production for tests I:1 (insulating fibreboard) — and I:8 (textile wallcovering on mineral wool) ----.



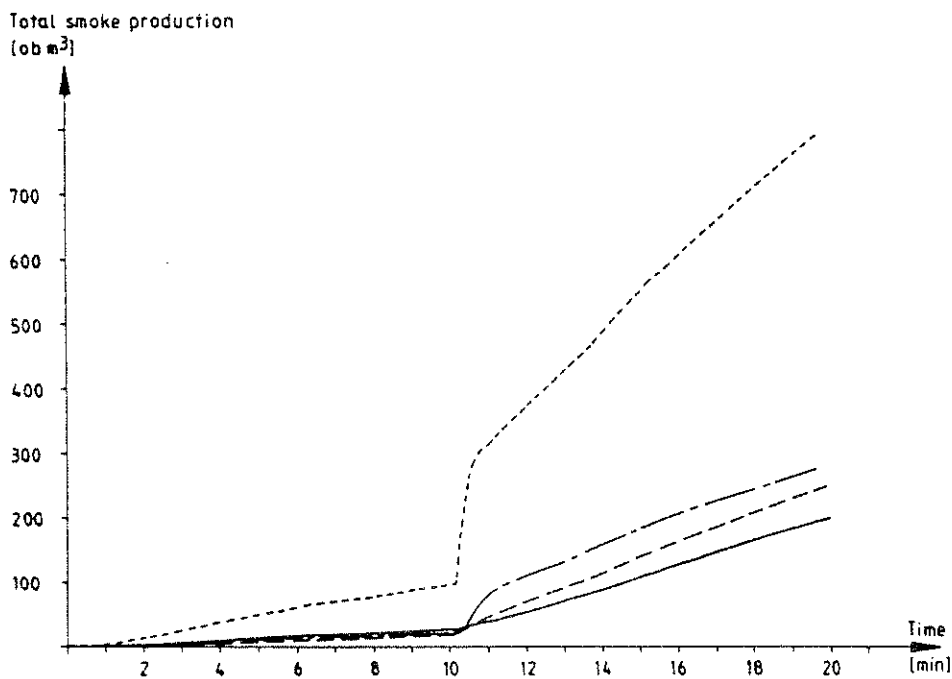
**Figure F2a** Smoke production rate for tests I:2 (medium density fibreboard) —, I:3 (particle board) ----, I:12 (wood panel, spruce) — — — and I:13 (paper wallcovering on particle board) — - —.



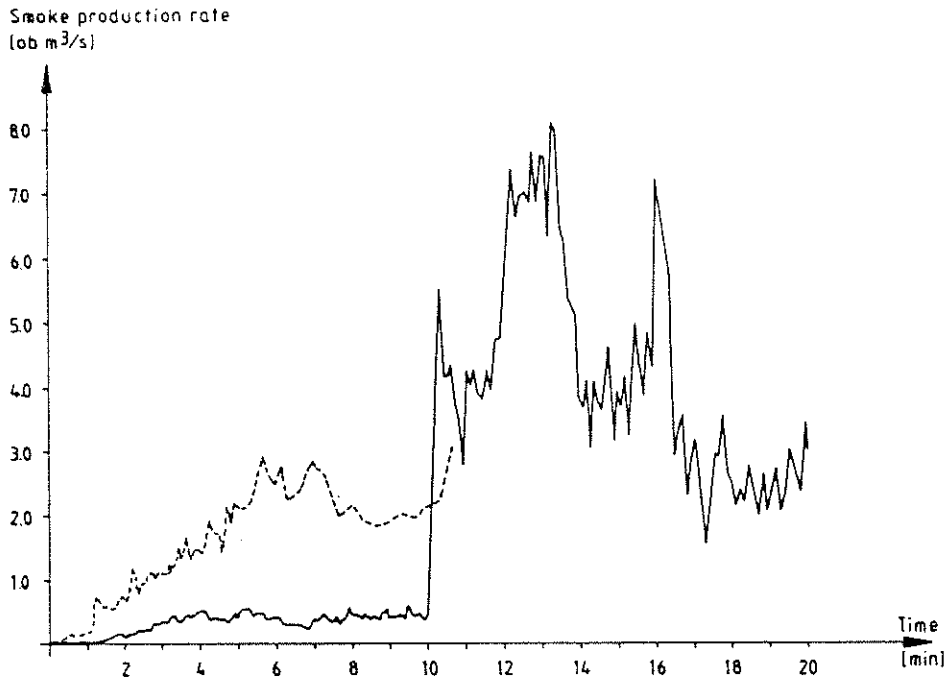
**Figure F2b** Total smoke production for tests I:2 (medium density fibreboard) —, I:3 (particle board) ----, I:12 (wood panel, spruce) — — — and I:13 (paper wallcovering on particle board) — - —.



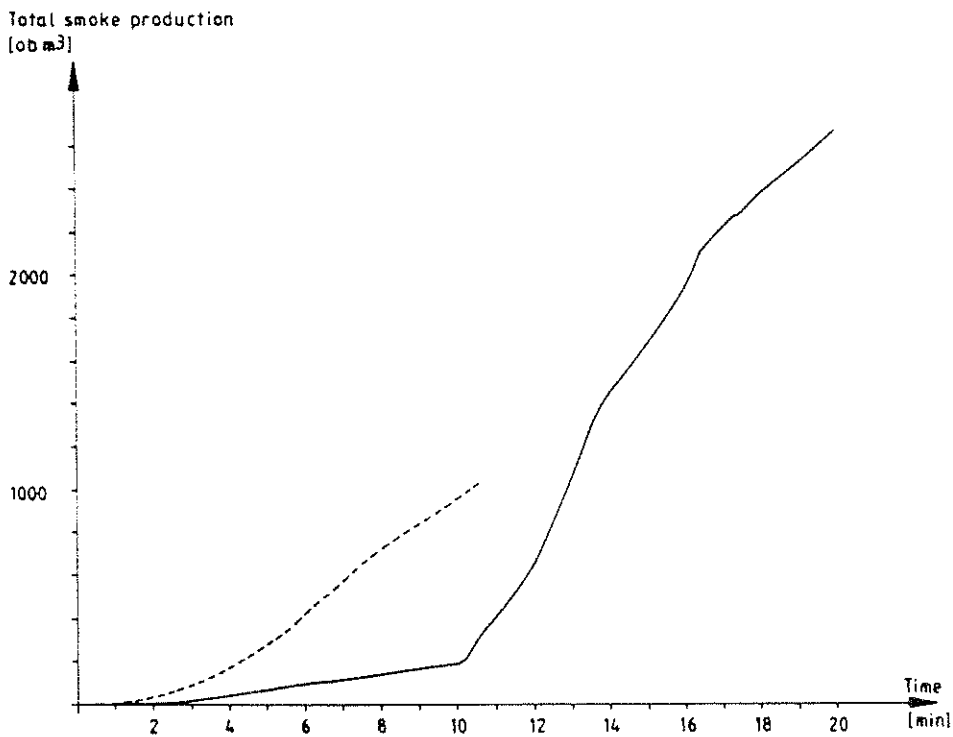
**Figure F3a** Smoke production rate for tests I:4 (gypsum plasterboard) —, I:5 (PVC wallcovering on gypsum plaster board) ----, I:6 (paper wallcovering on gypsum plaster board) — — — and I:7 (textile wallcovering on gypsum plaster board) — — — —.



**Figure F3b** Total smoke production for tests I:4 (gypsum plaster board) —, I:5 (PVC wallcovering on gypsum plaster board) ----, I:6 (paper wallcovering on gypsum plaster board) — — — and I:7 (textile wallcovering on gypsum plaster board) — — — —.



**Figure F4a** Smoke production rate for tests I:9 (melamine faced particle board) — and I:10 (expanded polystyrene) ----.



**Figure F4b** Total smoke production for tests I:9 (melamine faced particle board) — and I:10 (expanded polystyrene) ----.

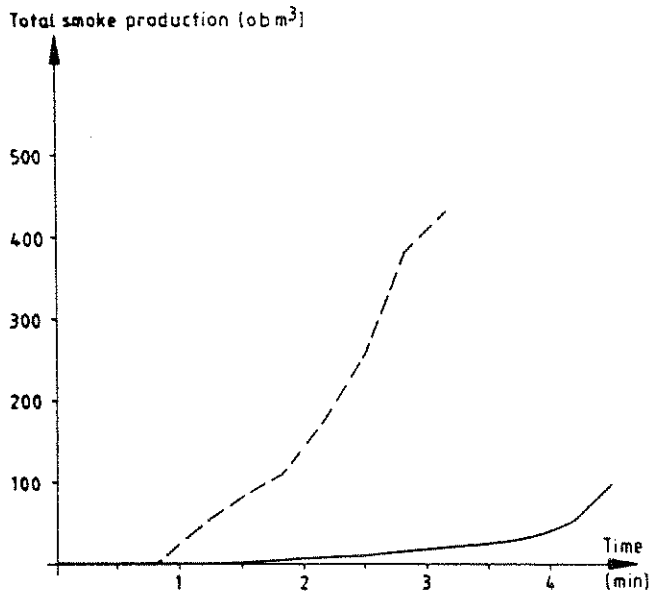


Figure F5a Smoke production rate for tests II:1 (insulating fibreboard) — and II:7 (textile wallcovering on mineral wool) ----.

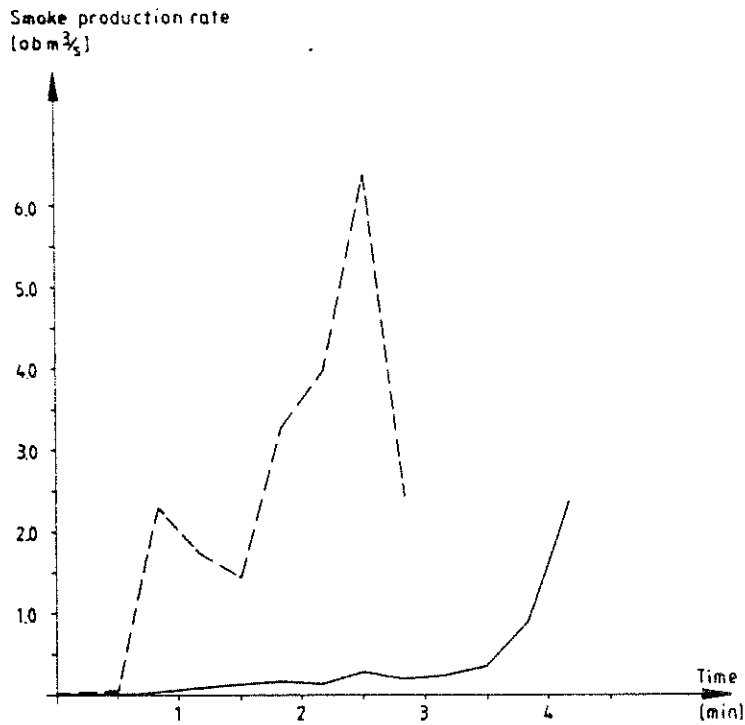
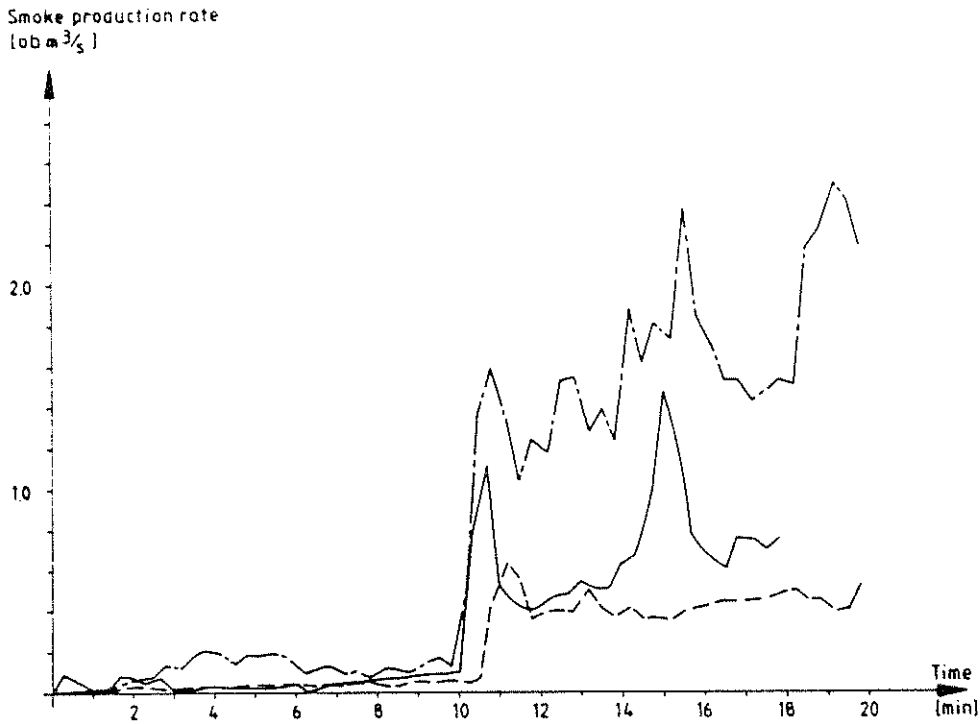
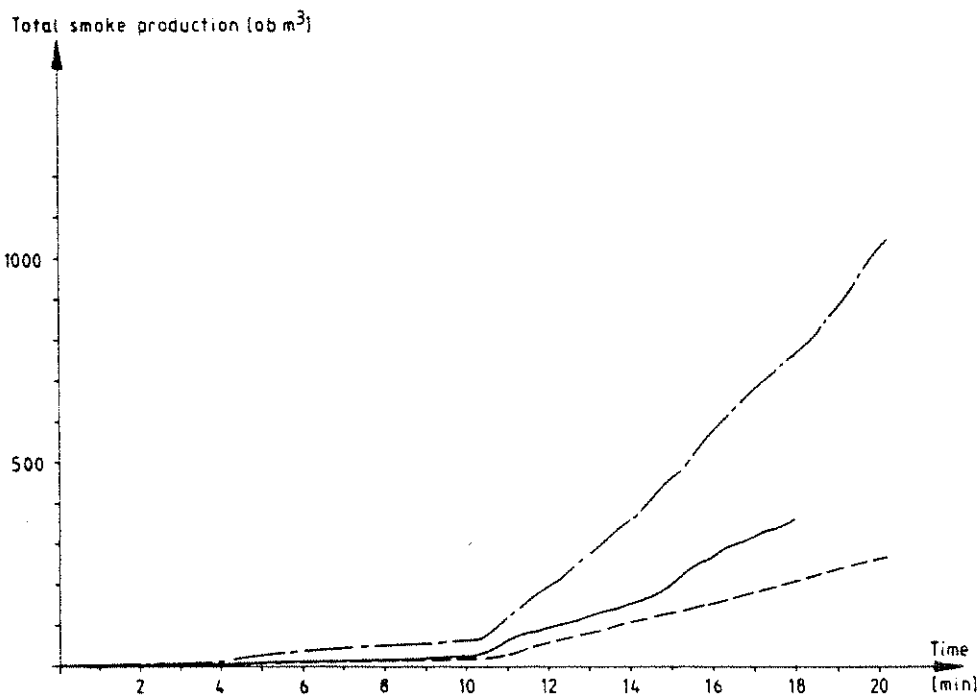


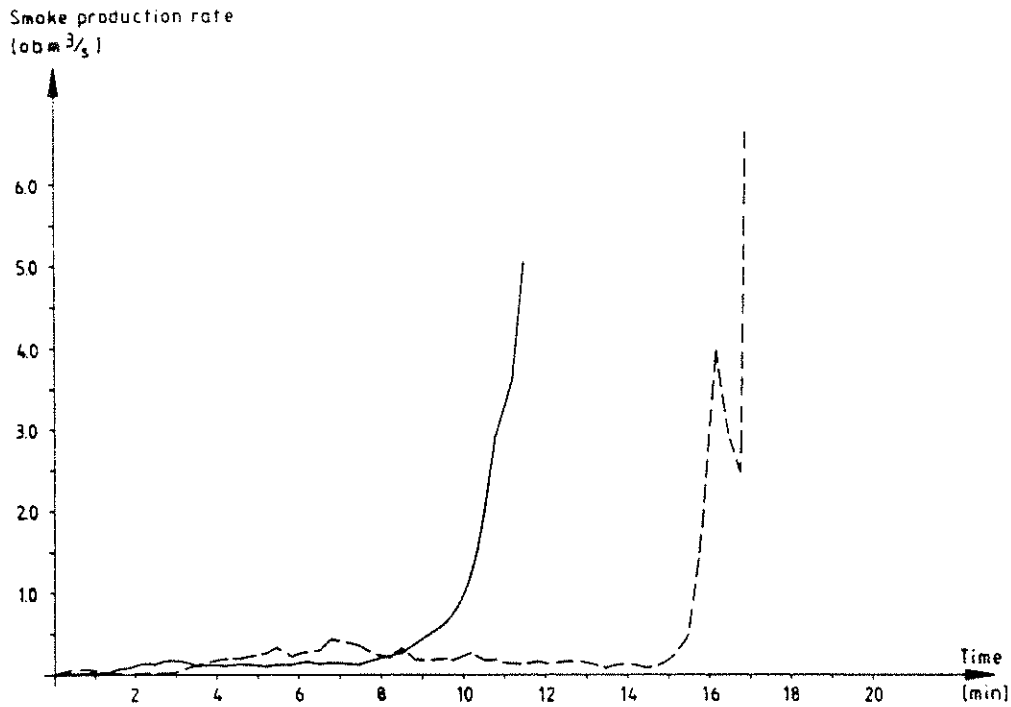
Figure F5b Total smoke production for tests II:1 (insulating fibreboard) — and II:7 (textile wallcovering on mineral wool) ----.



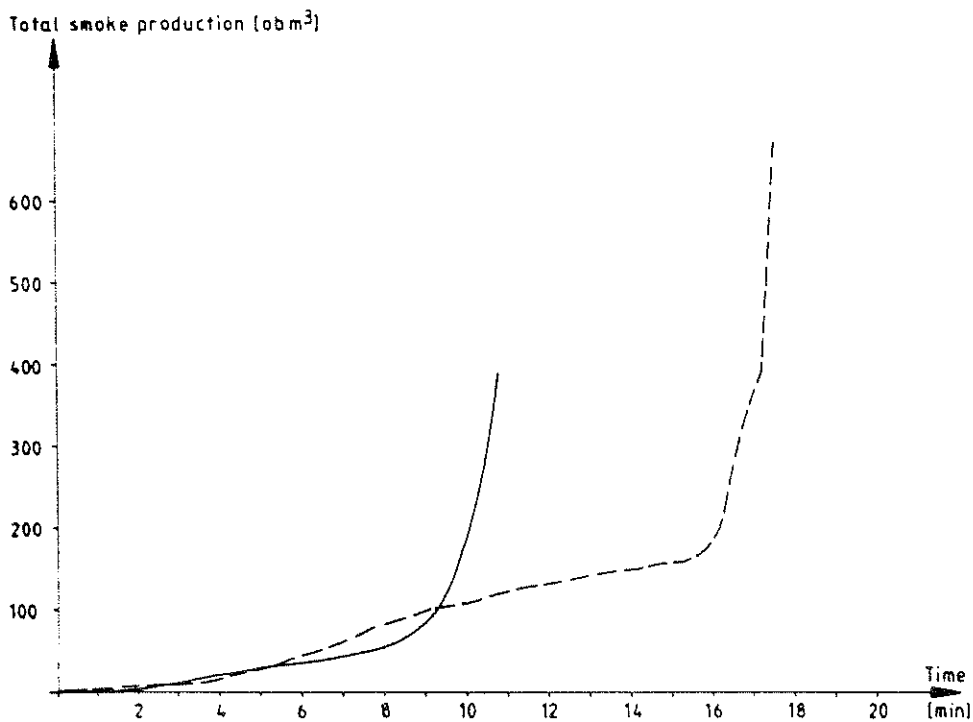
**Figure F6a** Smoke production rate for tests II:5 (PVC wall-covering on gypsum plaster board) —, II:6 (textile wallcovering on gypsum plaster board) ---- and II:8 (melamine faced particle board) - - -.



**Figure F6b** Total smoke production for tests II:5 (PVC wall-covering on gypsum plaster board) —, II:6 (textile wallcovering on gypsum plaster board) ---- and II:8 (melamine faced particle board) - - -.



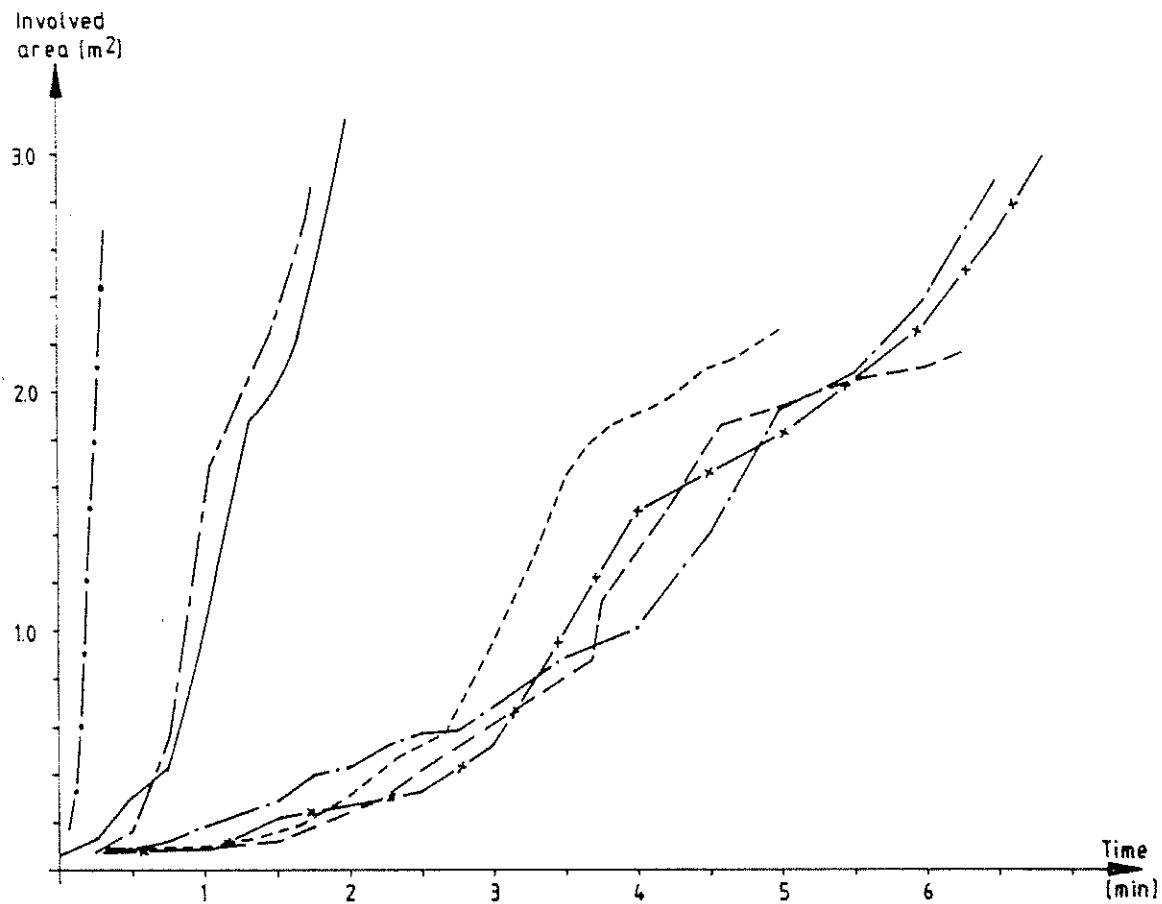
**Figure 7a** Smoke production rate for tests II:10 (wood panel, spruce) — and II:11 (paper wallcovering on particle board) ----.



**Figure 7b** Total smoke production for tests II:10 (wood panel, spruce) — and II:11 (paper wallcovering on particle board) ----.

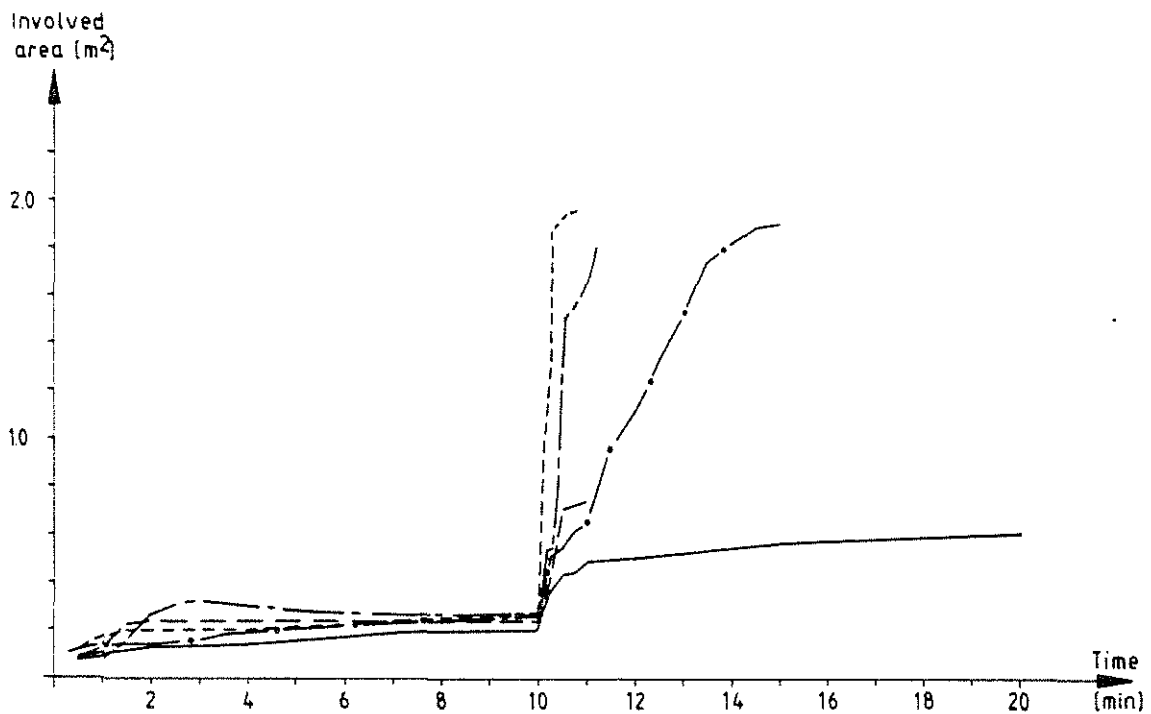
## Appendix G

## Involved area

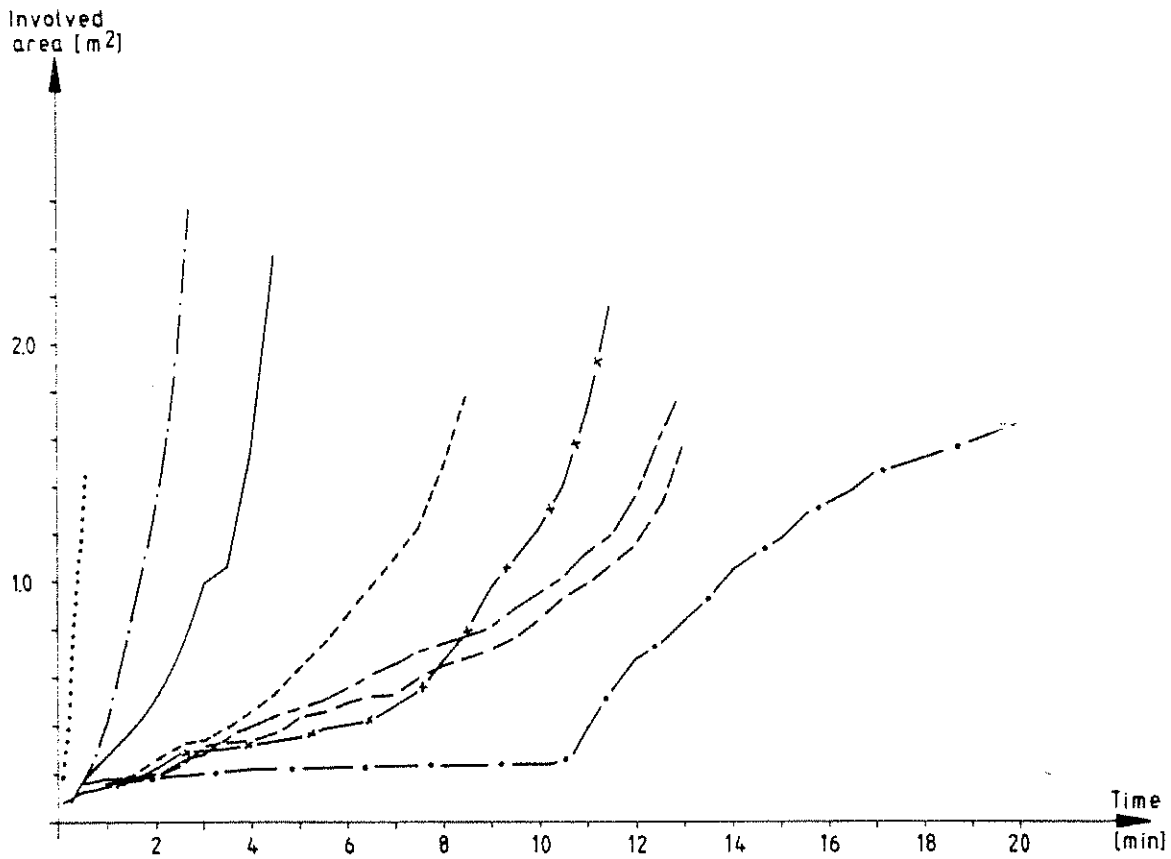


**Figure G1** Area involved in flaming combustion as a function of time for tests I:1 (insulating fibreboard) ———, I:2 (medium density fibreboard) ----, I:3 (particle board) — — —, I:8 (textile wallcovering on mineral wool) — - —, I:11 (rigid polyurethane foam) — o —, I:12 (wood panel, spruce) -·- and I:13 (paper wallcovering on particle board) —x—.

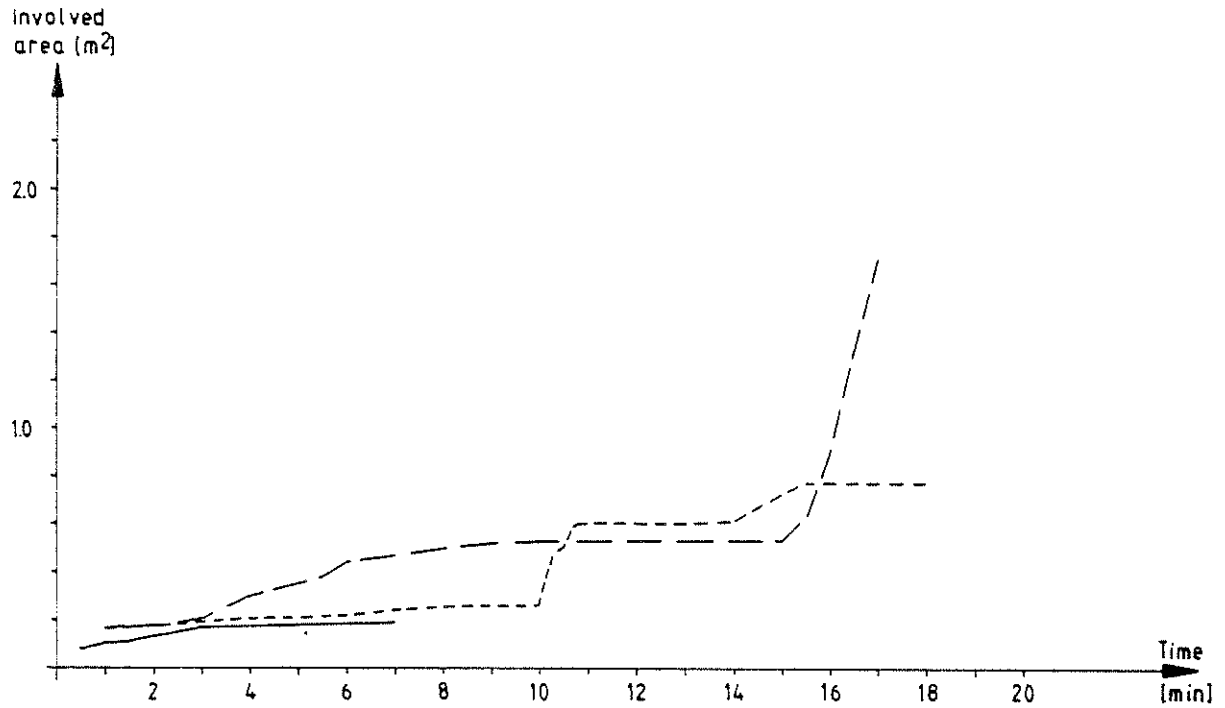




**Figure G2** Area involved in flaming combustion as a function of time for tests I:4 (gypsum plaster board) —, I:5 (PVC wallcovering on gypsum plaster board) ----, I:6 (paper wallcovering on gypsum plaster board) — — —, I:7 (textile wallcovering on gypsum plaster board) — - — and I:9 (melamine faced particle board) —o—.



**Figure G3** Area involved in flaming combustion as a function of time for tests II:1 (insulating fibreboard) —, II:2 (medium density fibreboard) ----, II:3 (particle board, doorwidth 0.56 m) — — —, II:4 (particle board, doorwidth 0.46 m) — - —, II:7 (textile wallcovering on mineral wool) — • —, II:9 (rigid polyurethane foam) ••••, II:10 (wood panel, spruce) — x — and II:11 (paper wallcovering on particle board) —o—.



**Figure G4** Area involved in flaming combustion as a function of time for tests II:5 (PVC wallcovering on gypsum plaster board ----, II:6 (textile wallcovering on gypsum plaster board) — — — and (gypsum plaster board ———).

Observations test I:1, insulating fibreboard

Time	Observation
0:00	Start
0:17	Ignition of the ceiling
0:45	Downward flame spread on the left hand wall and the rear wall
1:00	Half the ceiling area is involved
1:10	Downward flame spread on the right hand wall
1:15	Flames come out through the doorway
2:00	Extinction

Observations test I:2, medium density fibreboard

Time	Observation
0:00	Start
1:20	Ignition of the ceiling
2:40	Downward flame spread on the left hand wall and on the rear wall
3:00	Half the ceiling is involved
3:19	Downward flame spread on the right hand wall
3:30	Flames out through the doorway
5:00	Extinction

Observations test I:3, particle board

Time	Observation
0:00	Start
1:30	Ignition of the ceiling
3:41	Downward flame spread on the left hand wall and the rear wall
3:50	Flames out through the doorway
4:15	Downward flame spread on the right hand wall
6:20	Extinction

Observations test I:4. gypsum plaster board

Time	Observation
0:00	Start
2:00	Ignition of the ceiling
20:00	Extinction
	No downward flame spread on the left hand wall and the rear wall
	The right hand wall was never ignited
	One quarter of the ceiling was involved in the fire

Observations test I:5, PVC wallcovering on gypsum plaster board

Time	Observation
0:00	Start
0:30	Ignition of the ceiling
10:00	The output from the ignition source is increased to 33 kW
10:10	Downward flame spread on the left hand wall and the rear wall Half the ceiling is involved
10:16	Two thirds of the ceiling area is involved
10:20	Downward flame spread on the right hand wall The whole ceiling is involved Flames out through the doorway
10:45	No more combustible material left
20:00	Extinction



Observations test I:6, paper wallcovering on gypsum plaster board

Time	Observation
0:00	Start
1:30	Ignition of the ceiling
10:00	The output from the ignition source is increased to 33 kW
10:30	Downward flame spread on the left hand wall and the rear wall One quarter of the ceiling area is involved
11:30	The flame spread has stopped
20:00	Extinction The right hand wall was never ignited

Observations test I:7, textile wallcovering on gypsum plaster board

Time	Observation
0:00	Start
1:30	Ignition of the ceiling
10:00	The output from the ignition source is increased to 33 kW
10:09	Downward flame spread on the left hand wall and the rear wall
10:20	One quarter of the ceiling area is involved
10:27	Half the ceiling area is involved
10:30	Two thirds of the ceiling area is involved
10:35	The whole ceiling is involved Flames come out through the doorway
10:40	Downward flame spread on the right hand wall
11:20	The flame spread has stopped
20:00	Extinction

Observations test I:8, textile wallcovering on mineral wool

Time	Observation
0:00	Start
0:30	Ignition of the ceiling
0:45	One quarter of the ceiling area is involved Downward flame spread on the left hand wall and the rear wall
0:55	Flames out through the doorway
0:58	Downward flame spread on the right hand wall
1:50	Extinction

Observations test I:9, melamine faced particle board

Time	Observation
0:00	Start
3:00	Ignition of the ceiling The material cracks when it is heated and small pieces of the surface material falls off to the floor
10:00	The output from the ignition source is increased to 33 kW
10:45	Downward flame spread on the left hand wall and on the rear wall
11:30	Half the ceiling area is involved
12:30	Two thirds of the ceiling area is involved Downward flame spread on the right hand wall
13:25	Flames out through the doorway
20:00	Extinction

Observations test I:10, expanded polystyrene

Time	Observation
0:00	Start The material melts
1:30	A burning pool of melted material has formed on the floor
2:00	Ignition of the ceiling
2:31	Downward flame spread on the left hand wall and the rear wall
10:00	The output from the ignition source is increased to 33 kW
10:40	Flames out through the doorway but just for a few seconds The right hand wall is never properly ignited
11:30	Extinction

Observations test I:11, rigid polyurethane foam

Time	Observation
0:00	Start
0:07	Ignition of the ceiling
0:09	One quarter of the ceiling is involved Downward flame spread on the left hand wall and the rear wall
0:11	Two thirds of the ceiling is involved
0:12	Flames out through the doorway
0:13	Downward flame spread on the right hand wall
0:20	Extinction

Observations test I:12, wood panel (spruce)

Time	Observation
0:00	Start
0:45	Ignition of the ceiling
1:45	Downward flame spread on the left hand wall and the rear wall
2:30	One quarter of the ceiling is involved
3:30	Downward flame spread on the right hand wall
4:00	Half the ceiling is involved
4:30	Two thirds of the ceiling is involved
4:40	Flames out thorough the doorway
6.30	Extinction

Observations test I:13, paper wallcovering on particle board

Time	Observation
0:00	Start
1:30	Ignition of the ceiling
3:00	Downward flame spread on the left hand wall and the rear wall
3:30	Half the ceiling is involved
3:40	Flames out through the doorway
4:00	Downward flame spread on the right hand wall
6:50	Extinction



Observations test II:1, insulating fibreboard

Time	Observation
0:00	Start
1:32	Downward flame spread on the left hand wall and the rear wall
2:32	Ignition of the right hand wall
3:02	Downward flame spread on the right hand wall
3:50	Flames come out through the doorway
4:30	Extinction

Observations test II:2, medium density fibreboard

Time	Observation
0:00	Start
3:00	Downward flame spread on the left hand wall and the rear wall
3:30	Ignition of the right hand wall
5:30	Downward flame spread on the right hand wall
6:45	Flames come out through the doorway
8:30	Extinction

Observations test II:3, particle board (doorwidth 0.56 m)

Time	Observation
0:00	Start
4:00	Downward flame spread on the left hand wall and on the rear wall
7:31	Ignition of the right hand wall
9:00	Downward flame spread on the right hand wall
10:20	Flames come out through the doorway
13:00	Extinction

Observations test II:4, particle board (doorwidth 0.46 m)

Time	Observation
0:00	Start
3:00	Downward flame spread on the left hand wall and the rear wall
5:30	Ignition of the right hand wall
9:00	Downward flame spread on the right hand wall
10:15	Flames come out through the doorway
13:10	Extinction

Observations test II:5, PVC wallcovering on gypsum plaster board

Time	Observation
0:00	Start
10:00	The output from the ignition source is increased to 33 kW
10:10	Downward flame spread on the left hand wall and the rear wall
15:30	No more increase in the involved area
18:10	Extinction The right hand wall was never ignited

Observations test II:6, textile wallcovering on gypsum  
plaster board

Time	Observation
0:00	Start
4:00	Downward flame spread on the left hand wall and the rear wall
10:00	The output from the ignition source is increased to 33 kW
15:30	Ignition of the right hand wall
16:00	Downward flame spread on the right hand wall
20:00	Extinction

Observations test II:7, textile wallcovering on mineral wool

Time	Observation
0:00	Start
0:45	Downward flame spread on the left hand wall and the rear wall
1:15	Ignition of the right hand wall
1:30	Downward flame spread on the right hand wall
1:43	Flames come out through the doorway
3:10	Extinction

Observations test II:8, melamine faced particle board

Time	Observation
0:00	Start
10:00	The output of the ignition source is increased to 33 kW The material cracks when it is heated and small pieces of the surface material falls off to the floor
11:00	Downward flame spread on the left hand wall and the rear wall
12:00	Ignition of the right hand wall
14:00	Downward flame spread on the right hand wall
20:10	Extinction



Observations test II:9, rigid polyurethane foam

Time	Observation
0:00	Start
0:11	Downward flame spread on the left hand wall and the rear wall
0:19	Ignition of the right hand wall
0:23	Downward flame spread on the right hand wall
0:30	Flames come out through the doorway
0:60	Extinction

Observations test II:10, wood panel (spruce)

Time	Observation
0:00	Start
2:00	Downward flame spread on the left hand wall and the rear wall
7:30	Ignition of the right hand wall
8:30	Downward flame spread on the right hand wall
9:45	Flames come out through the doorway
11:40	Extinction

Observations test II:11, paper wallcovering on particle board

Time	Observation
0:00	Start
10:11	Downward flame spread on the left hand wall and the rear wall
11:30	Ignition of the right hand wall
13:30	Downward flame spread on the right hand wall
15:00	The output from the ignition source is increased to 33 kW
16:10	Flames come out through the doorway
17:50	Extinction



