



# LUND UNIVERSITY

## Safety Concept and Design for Fire Resistance of Steel Structures

Brozzetti, Jacques; Law, Margret; Pettersson, Ove; Witteveen, Jelle

1983

[Link to publication](#)

### *Citation for published version (APA):*

Brozzetti, J., Law, M., Pettersson, O., & Witteveen, J. (1983). *Safety Concept and Design for Fire Resistance of Steel Structures*. (LUTVDG/TVBB--3012--SE; Vol. 3012). Division of Building Fire Safety and Technology, Lund Institute of Technology.

*Total number of authors:*

4

### **General rights**

Unless other specific re-use rights are stated the following general rights apply:

Copyright and moral rights for the publications made accessible in the public portal are retained by the authors and/or other copyright owners and it is a condition of accessing publications that users recognise and abide by the legal requirements associated with these rights.

- Users may download and print one copy of any publication from the public portal for the purpose of private study or research.
- You may not further distribute the material or use it for any profit-making activity or commercial gain
- You may freely distribute the URL identifying the publication in the public portal

Read more about Creative commons licenses: <https://creativecommons.org/licenses/>

### **Take down policy**

If you believe that this document breaches copyright please contact us providing details, and we will remove access to the work immediately and investigate your claim.

LUND UNIVERSITY

PO Box 117  
221 00 Lund  
+46 46-222 00 00

LUND INSTITUTE OF TECHNOLOGY · LUND · SWEDEN  
DIVISION OF BUILDING FIRE SAFETY AND TECHNOLOGY  
REPORT LUTVDG/(TVBB - 3012 )

J. BROZZETTI - M. LAW - O. PETTERSSON -  
J. WITTEVEEN

SAFETY CONCEPT AND DESIGN FOR FIRE  
RESISTANCE OF STEEL STRUCTURES

FIRE PROTECTION OF STEEL STRUCTURES  
EXAMPLES OF APPLICATIONS

LUND 1983



ISSN 0377-7251

---

IABSE PERIODICA 1/1983  
PERIODICA AIPC  
IVBH PERIODICA

---

February 1983

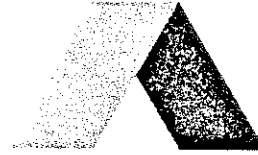

# IABSE SURVEYS

# S-22/83

REVUES AIPC  
IVBH BERICHTE

*Safety Concept and Design for  
Fire Resistance of Steel Structures*  
*J. Brozzetti, M. Law,  
O. Pettersson, J. Witteveen*

International Association for Bridge and Structural Engineering  
Association Internationale des Ponts et Charpentes  
Internationale Vereinigung für Brückenbau und Hochbau

IABSE  
AIPC  
IVBH

The Surveys are open for discussion until May 31, 1983.

La discussion de cette Revue est ouverte jusqu'au 31 mai 1983.

Diskussionsbeiträge zu diesem Bericht werden bis 31. Mai 1983 erbeten.

Editor - Publisher - Advertising  
Rédacteur - Editeur - Annonces  
Redaktion - Herausgeber - Inserate

**IABSE - AIPC - IVBH**

ETH-Hönggerberg  
CH-8093 Zürich, Switzerland

Tel.: 01/377 26 47  
Telex: 822 186 IABS CH  
Telegr.: IABSE, CH-8093 Zurich

Papers published under the sole responsibility of the author(s).

Les articles sont publiés sous la seule responsabilité de (des) l'auteur(s).

Die Artikel werden unter der alleinigen Verantwortung des oder der Autoren veröffentlicht.

## Safety Concept and Design for Fire Resistance of Steel Structures

Concept de sécurité et résistance au feu des structures en acier

Sicherheitskonzept und Berechnung des Feuerwiderstands von Stahlkonstruktionen

### Jacques BROZZETTI

Dir., Dép. Etudes  
CTICM  
Paris, France

### Margaret LAW

Technical Director  
Ove Arup and Partners  
London, Great Britain

### Ove PETTERSSON

Prof.  
Lund Inst. of Technology  
Lund, Sweden

### Jelle WITTEVEEN

Prof.  
TNO  
Delft, the Netherlands

### SUMMARY

This paper is aimed at describing the principles on which are based the current concepts of fire engineering design of steel structures. The first part deals with the design methods for fire safety through the definition of heat exposure and structural models. The second part reviews the state of art in structural fire calculation methods, according to different levels of assumption.

### RÉSUMÉ

Cet article se propose de décrire les principes sur lesquels se fonde la conception et le calcul de la résistance au feu des structures métalliques. Sa première partie est consacrée à la présentation de modèles concernant à la fois la description de l'incendie et la manière de prendre en compte le comportement de la structure. La deuxième partie passe en revue les différentes méthodes de calcul de la résistance au feu des structures en acier.

### ZUSAMMENFASSUNG

Der vorliegende Beitrag befasst sich mit den Prinzipien, die dem Sicherheitskonzept und der Berechnung des Feuerwiderstands von Stahlkonstruktionen zugrunde liegen. Der erste Teil beschreibt Modelle für den Brandverlauf und das Tragwerkverhalten. Der zweite Teil zeigt die verschiedenen Methoden zur Berechnung des Brandwiderstands von Stahlkonstruktionen.



## 1. INTRODUCTION

During the last two decades, remarkable progress has been made in understanding not only the parameters which influence the development of building fires but also the behaviour of fire exposed structural materials and structures. In particular, for steel structures this progress has resulted in the production of very detailed rules for the design and calculation of structural behaviour and load bearing capacity in fire.

Nevertheless, it must be admitted that up to now the greater part of the research effort in relation to the fire behaviour of steel structures has been confined to the two aspects mentioned above, although in recent years it has become obvious that, whatever progress may have been made in a better assessment of the rôle played by compartmentation and structural fire behaviour, the answer to the problem of the fire safety of building is an incomplete one.

It must be recalled that the fire safety of a building also depends on other preventive measures such as automatic fire detection and extinction systems, smoke control and extract systems, as well as the thorough analysis of the potential risks (fire load, oxygen supply, fire spread, fire exit...).

This paper reviews the most recent developments and new concepts in the field of fire resistance of steel structures and fire safety.

## 2. PRINCIPLES OF FIRE ENGINEERING

### 2.1. Objectives and analyses for fire safety in building

Fire safety objectives at large can be summarized as follows (1,2), :

- Reducing the risk of injury and death of people.
- Reducing the risk of damage and loss of the building, the contents and the environment.

Incorrect decisions regarding the level of fire protection are liable to have serious consequences :

- Too low a standard of fire safety may involve unacceptable risk for persons in the building as well as for fire fighting personnel and may lead to excessive monetary losses.
- Too high a standard of fire safety will entail unnecessary expense.

There is an evident need to develop principles and procedures which lead to optimal fire safety standards. Fire prevention measures and suppression in general serve both social and monetary interests simultaneously. The overall objective is an optimum return on investment in fire precautions in terms of lives and property saved. As far as monetary fire losses only are concerned, a cost benefit analysis balancing gains with losses should be made. In other cases, both monetary losses and social losses, such as injury and death by fire, have to be taken into account.

Ideally, a rational analysis for fire safety should comprise the following elements :

1. agreed levels of life and property safety,
2. quantitative methods assessing potential hazards,
3. quantitative methods assessing the effectiveness of protective measures and combinations to meet the required levels of safety for the identified potential hazards.

The present regulations for structural fire safety and the state of knowledge however, do not generally comply with the above conditions. Therefore, fire prevention measures for building and in particular the structural performance requirements are often a matter of controversy between authorities and designers. The three elements of a rational analysis are discussed briefly below :

#### Element 1.

The intended level of fire safety is usually not explicitly stated in building regulations and is not even known in all relevant aspects. A common feature of existing regulations is that requirements for the benefit of human lives and health are more strongly emphasized than those aiming at protection of property.

#### Element 2.

In assessing the potential hazards for structural safety, the authorities take into account not only the expected severity and duration of the fire, but also in a rather arbitrary way, factors such as the type of occupancy, the height, the situation of the building and the importance of the structure or structural element. The expected duration of the fire and the effect of the additional factors are "added" and expressed in one single parameter, i.e. the required fire resistance time (see § 2.3.).

#### Element 3.

A mixture of objectives for life and property safety and the arbitrary way in which the potential hazards for the structural safety are expressed in the required fire resistance time makes it difficult, if not impossible, to balance alternative protective measures to meet the same level of safety. The single parameter "required fire resistance time" puts the emphasis on structural fire protection and hampers an assessment of a reduction in structural fire protection when active measures such as early detection and sprinklers are employed.

During recent years a changing attitude to existing regulations and codes has become apparent, and attempts are being made to arrive at a more rational analysis for fire safety (see § 2.3.).

A related problem is the influence of insurance policies on fire safety in buildings (3).

Fire insurance companies have, through their grading and rating systems, an important influence on fire protection. The insurance industry affects decisions made about fire protection by private individuals and by private and public bodies. Consider, for example, the fire protection of a single building: in general, insurance companies require certain minimum prevention measures, otherwise the insurer will refuse to insure the building. When additional fire prevention measures are employed, such as sprinklers, detectors and compartmentation, the rating is reduced. Thus the owner of the building can decide whether or not to invest in preventive measures. Such an approach is the best that an individual can do to minimize total expenditure. The insurer however deals with large numbers of different risks. This is the reason why his criteria for assessing risks are global and simple and sometimes even inconsistent in particular aspects. Therefore insurance grading, based on fire losses at large, may be a poor indication for optimal fire protection for a particular building. Insurers show a general reluctance to bring their risk assessment, premiums, profit and loss accounts in detail into the open. Therefore no independent studies of the effect of insurance policies on fire protection are available.



## 2.2. Structural fire protection and alternative protective measures

Personal risk and structural damage can be prevented or limited by many measures which generally serve life and property safety simultaneously. If a limited budget is to be used, how should resources be allocated to provide the optimum level of fire protection? That is, how much effort should go into active measures such as early detection and sprinklers, and how much should go into passive measures provided by the building structure itself? Apart from some pilot studies, few data are available for defining the input and output of fire prevention measures in terms of costs and productivity.

In order to reduce injury and loss of life, the most effective protective measures are early detection, lay-out of escape routes and control of combustible materials. The risk of a large fire occurrence can be reduced by compartmentation, the use of automatic sprinkler systems and early detection.

One of the oldest and, where steel structures are concerned, the most restrictive fire prevention measures is an increase in the fire resistance of the structural members. It is important to appreciate that protection afforded by structural fire resistance alone does not generally ensure adequate reduction in material damage and personal risk. Indeed, experience shows that large fires often damage the building so badly that it has to be demolished regardless of whether the structure has collapsed or not. The investment in structural fire protection would be useless in that case. Examples are industrial fires where no sprinklers are available to avoid flash-over or partitions to limit the fire spread. Instead of an over designed fire resistance of the structural members the essential measures which should be considered for industrial buildings are:

- Sprinklers to avoid flash-over and fire growth.
- Partitions to limit the fire spread.
- Fire ventilation to reduce smoke and corrosion damage and to facilitate the fire fighting.

When, for reasons of life and property safety, sprinklers are installed, it can be argued that the fire resistance of structural elements can be reduced. Therefore methods should be developed to assess the reduction of structural fire protection when alternative protective measures are employed.

This matter becomes increasingly important because there is a growing use of automatic detection and extinguishing systems in industrial as well as in public buildings. Examples of the last category are the increasing number of large covered shopping developments and high rise buildings. The trend of increasing use of active fire prevention measures is connected with the improved standard of living and protection in the western countries.

Higher standards of life and property safety are demanded by public authorities as well as insurance companies. This change in approach to the design of fire safety can have an important implication. If fire safety is assured by other measures, it seems logical that reduction or even elimination of structural fire protection should be considered (see § 2.3.).

An important item is the cost of fire protection (3). The cost of structural fire protection for steel elements depends on several factors, such as the materials used for protection, the type of structure to be protected and the degree of fire resistance required. Also an important factor is that some protective measures fulfil additional functions as partitions or suspended ceilings. A rough estimate of the cost of fire protection for European non-industrial buildings in steel is given in the accompanying table. The cost of fire protection is expressed as a percentage of the cost of the steel structure, for different required fire resistance times. In order to see these figures in their correct proportion one should bear in mind that generally the cost of the steel structure only forms 5 to 10% of the total building costs.

Fire protection ( min )	Cost ( % )
30	10
60	20
90	25
120	30

It is also emphasized that the figures cannot be used as a guide when making preliminary estimates. Deviations of say 30% upwards as well downwards are possible.

It appears that the cost of protection increases appreciably with increased fire resistance.

However, studies as well as examples reveal that when the fire protection is integrated into the design from the beginning of the study of the project the cost of fire protection can be considerably reduced (4).

It is particularly useful to consider combining functions such as anti-corrosion or aesthetic finishes with fire protection, or combining fire protection with thermal insulation for energy conservation.

### 2.3 Design methods for structural fire safety

#### 2.3.1 Introduction

Internationally, the generally accepted method for the design of load bearing structural elements exposed to fire is based on a classification system, comprising two main components(5) :

1. A fire exposure according to ISO 834, with a required time of duration  $t_{fd}$ , stipulated in building regulations and codes for the structural application in question - usually expressed in multiples of 30 minutes.

2. A standard fire resistance test according to ISO 834 by which the fire resistance time  $t_{fr}$  of the structural element in question is determined experimentally - usually classified in multiples of 30 minutes.

The design implies a proof that the structural element has a fire resistance  $t_{fr}$ , which meets the required time of fire duration  $t_{fd}$ .

Although the classification system has been in use for over half a century, it has some serious weaknesses. These weaknesses apply to both components of the design procedure and can be summarized as follows :

1. The rise of temperature as a function of time according to ISO 834 and the fire duration are a rough approximation of the real gas-temperature time curve of a fully developed compartment fire.

The required time of fire duration is generally related, not only to the estimated fire exposure, but also to various safety considerations relevant for the building in question. This usually leads to a required time of fire duration, which is more severe than the actual fire exposure. The estimated fire exposure and the safety considerations are intermingled inextricably, which is a consequence of the fact that the building regulations do not provide any guidance as to the safety levels that they imply (2).

2. The specification of the fire resistance test according to ISO 834 is insufficient in several aspects, such as heat-flow characteristics of furnaces, material properties and imperfections of the specimen, temperature distribution along members and restraint conditions. Thus, repeated tests in the same furnace, not to mention different furnaces, may yield a considerable variation in results. The structural element to be tested is supposed to be modelled with respect to actual conditions expected in the structure. However, deviations from conditions in the actual structure are unavoidable because of the limited dimensions of the furnaces, idealized characteristics of the loading device and insufficiently defined support conditions during the test (6,7).

The deficiencies of the present classification system have certainly stimulated the development of rational methods of fire risk assessment and analytical modelling of thermal process as well as structural response, which potentially give the possibility of achieving solutions with greater economy and a defined and more uniform safety (8,9,10,11,12,13). Moreover, it is recognized that, following probabilistic design procedures in other fields of design for accidental events, structural fire engineering design should be probability based. In contrast to the present classification system, probabilistic design includes a methodology by which all relevant factors, such as safety considerations from both the human and economic point of view, probability of flash-over, uncertainties in fire exposure and structural response, the effect of fire brigade actions and sprinklers can be dealt with systematically (14,15).

### 2.3.2. Main elements for a structural fire engineering design

Generally a structural fire engineering design includes two main elements, corresponding to the components as described in the introduction.

1. A heat exposure model H, for the determination of the rise of temperature as a function of time.
2. A structural model S, for the determination of the heat transfer to and within the structure and the ultimate load bearing capacity of the structure. The structural model may be experimental or analytical.

The design implies a proof that the structure or structural member, under a defined load and subjected to the specified heat exposure, fulfils certain functional requirements, expressed by the limit states with respect to load bearing capacity, thermal insulation, fire integrity.

The available heat exposure models (H) and the structural models (S) can be characterized with respect to the type of thermal exposure and the type of structural system. The models are listed in sequence of improved schematic idealization, with a consequent increase in complexity of solution. For both types of model the listing starts with the components of the present deterministic classification system, discussed in paragraph 2.3.1. The improved models are probabilistic, including the explicit treatment of safety considerations and the effect of active protection measures, such as sprinklers (14,15).

The following probabilistic aspects are considered :

- intrinsic randomness of design parameters and properties.
- model uncertainties of the analytical models for the heat exposure and the structural response.
- assessment of frequency determined by the probability of flash-over, the effect of fire brigade actions, the reliability of detection systems and sprinklers.
- safety considerations from both the human and economic point of view such as the height, volume and occupancy of the buildings, the availability of escape routes and rescue facilities, as well as the consequences of reaching a limit state.

#### Heat exposure models



- (H<sub>1</sub>) A rise of temperature as a function of time according to ISO 834. The duration of the temperature rise is equal to the "required time of fire duration", expressed in building regulations and codes.
- (H<sub>2</sub>) A rise of temperature as a function of time according to ISO 834. The duration of the temperature is equal to the "equivalent time of fire exposure", a quantity which relates a non-standard or natural fire exposure to the standard temperature-time curve (see Chapter 3.2.3.).

(H<sub>3</sub>) A rise of temperature as a function of time characterized by an analytical determination of the gas temperature-time curve of a fully developed compartment fire.

Structural models

- (S<sub>1</sub>) The load bearing structure is composed of a series of single members with simplified restraint conditions such as beams and columns. The model can be either experimental - standard fire resistance test - or analytical.
- (S<sub>2</sub>) The load bearing structure is composed of a number of sub-assemblies, such as beam-column systems. Although the model can occasionally be experimental - standard fire resistance test - an analytical approach will be the norm.
- (S<sub>3</sub>) The load bearing structure, such as a building frame or a floor slab system is analysed as a whole. The model is only suitable for an analytical design.

A Classification System for Methods of Structural Fire Engineering Design

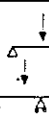
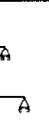
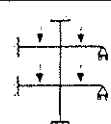
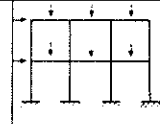
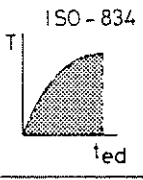
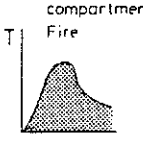
Structural Model \ Heat Exposure Model		S <sub>1</sub>	S <sub>2</sub>	S <sub>3</sub>
		Elements	Sub-assembly	Structures
H <sub>1</sub>	 <p>ISO-834 T t<sub>fd</sub></p>	   test or calculation (deterministic)	 calculation occasional test (deterministic)	 difference in schematization becomes too large
H <sub>2</sub>	 <p>ISO-834 T t<sub>ed</sub></p>	test or calculation (probabilistic)	calculation occasional test (probabilistic)	calculation (probabilistic) unpractical
H <sub>3</sub>	 <p>compartment Fire T</p>	calculation (probabilistic) occasional	calculation (probabilistic)	calculation (probabilistic) occasional and for research

t<sub>fd</sub> = required time of fire duration

t<sub>ed</sub> = design equivalent time of fire exposure

Figure 1 : Matrix of heat exposure and structural models in sequence of improved idealization.

### 2.3.3. Combinations of heat exposure and structural models

In the table of fig.1 the heat exposure models and structural models are combined in a matrix in sequence of improved idealization. In principle, each element in the matrix represents a particular design procedure. The matrix therefore can be considered as a classification system for methods of structural fire engineering design. It is evident that not all models can be used in all combinations and the rule should be to provide a sensible pairing at each level of advancement. In the text of figure 1 reference is made to these aspects. In principle, a differentiated fire engineering design offers problem-oriented choice for the combination of heat exposure model and structural model.

The final choice may also depend on national preferences, the simplicity of application and on the particular design situation (14,15) :

The design method  $H_1 - S_1$  and occasionally  $H_1 - S_2$  with experimental verification of the fire resistance, corresponds to the vast majority of national building codes (see § 2.3.1.). In many countries improved methods based on heat exposure models  $H_2$  and  $H_3$  (8,9,10,13) have occasionally been used, but, except in Sweden, they are not yet automatically accepted as methods which satisfy the requirements of the building regulations.

In contrast to the acceptance of improved heat exposure models, there is a growing acceptance of design methods  $H_1 - S_1$  and  $H_1 - S_2$  with an analytical verification of the fire resistance. In several countries these methods are now being used as an alternative to the standard fire resistance test. Recently the Fire Committee of the European Convention for Constructional Steelwork (ECCS) completed Recommendations providing a reference document for national codes of practice (11).

## 3. STATE OF THE ART IN STRUCTURAL FIRE CALCULATION METHODS

### 3.1 Limit state condition

Generally, the design criterion in a fire design requires that no limit state is reached during the fire exposure. Depending on the type of practical application, one, two or all of the following limit state conditions apply :

- limit state with respect to load bearing capacity.
- limit state with respect to insulation.
- limit state with respect to integrity.

For a load bearing structure, the design criterion implies that the minimum value of the load bearing capacity  $R(t)$  during the fire exposure shall meet the load effect on the structure  $S$ , i.e. :

$$\min \{ R(t) \} - S \geq 0 \quad [3.1]$$

The criterion must be fulfilled for all relevant types of failure - bending failure, shear failure, torsion failure, instability failure, etc...

For a separating structure, the design criterion with respect to insulation can be formulated analogously as :

$$T_{cr} - \max \{ T_s(t) \} \geq 0 \quad [3.2]$$

where

$T_{cr}$  = maximum temperature of the unexposed side of the separating structure, acceptable with respect to the requirement to prevent a fire spread from the fire compartment to an adjacent compartment, and

$T_s(t)$  = highest temperature on the unexposed side of the separating structure at time  $t$  of the relevant fire process.

For the requirement with respect to integrity, which can be decisive for some types of separating elements - for instance, doors - there is no analytically expressed design criterion available at present.

In the form given by Eqs. [3.1] and [3.2], the design criteria are directly adapted to structural fire design methods, based on the characteristics of the natural fire exposure - heat exposure model  $H_3$  according to fig.1. in fire design methods, based on a thermal exposure according to the standard temperature-time curve as specified in ISO 834 - heat exposure models  $H_1$  and  $H_2$  - the time to reach the decisive limit state defines the fire resistance of the structural element  $t_{fr}$  and, consequently, the design criterion is transferred to the alternative form:

$$t_{fr} - t_{fd} \geq 0 \quad [3.3]$$

where  $t_{fd}$  is the required fire resistance or time of fire duration, specified in the building codes and regulations.

The design criterion then applies to load bearing as well as separating structural elements.

3.2 Type of physical model and related fire exposure

3.2.1 Exposure according to standard temperature-time curve

As discussed in 2.3.1, virtually all countries use a fire engineering design procedure for structural elements based on classification and standard fire resistance test according to ISO 834 (with fixed heating conditions). In the design, the results of such fire resistance tests are compared directly with the requirements given by the building codes and regulations. Fig.2 illustrates this design procedure.

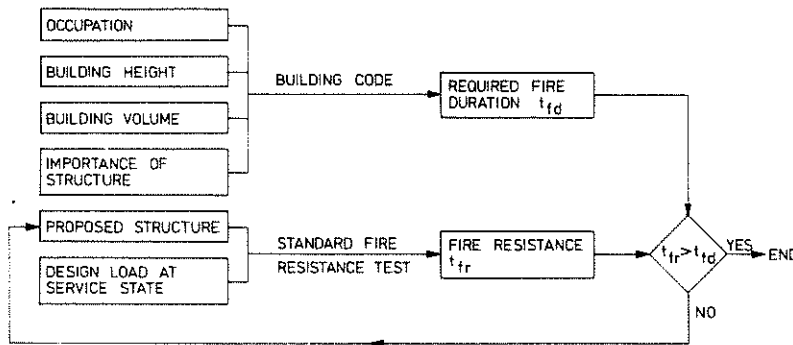

Figure 2 : Structural fire engineering design procedure used in most countries based on classification and results of standard fire resistance tests.

In the fire resistance test, the specimen is exposed in a furnace to a temperature rise, which is controlled so as to vary with time within specified limits according to the relationship (5) - heat exposure model  $H_1$

$$T - T_0 = 345 \log_{10} (8t + 1) \quad [3.4]$$

where

$t$  = time, in minutes,

$T$  = furnace temperature at time  $t$ , in  $^{\circ}\text{C}$  and

$T_0$  = furnace temperature at time  $t = 0$ , in  $^{\circ}\text{C}$ .

The important progress, made during the last ten years, in the development of computation methods for an analytical structural fire engineering design gives the opportunity for fire resistance to be determined by calculation for many practical applications. Consequently, more and more countries now permit a classification of load bearing structural elements with respect to fire to be formulated analytically, as an alternative to testing. This leads to a design procedure as shown in fig.3 (16).

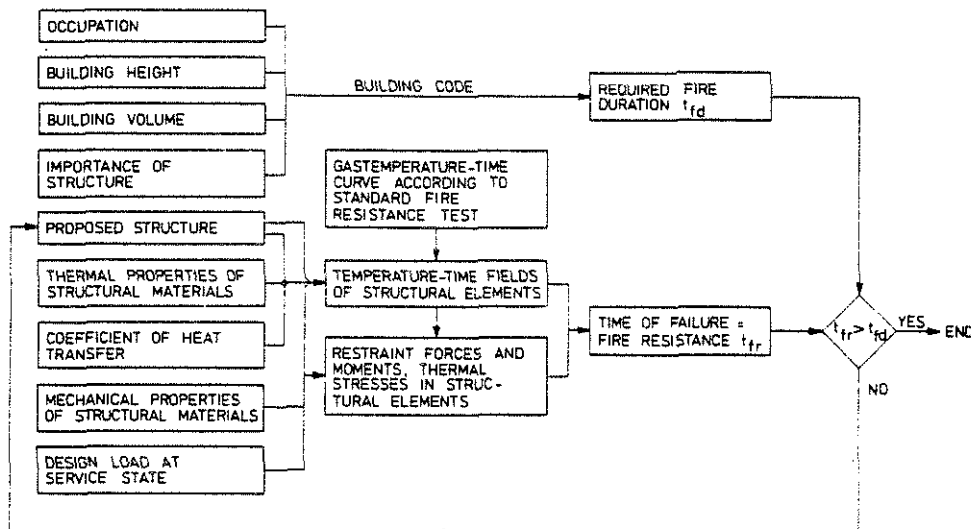

Fig. 3 : Analytical fire engineering design of load bearing structural elements, based on classification and thermal exposure according to the standard temperature-time curve, Eq. [3.4]

With the gas temperature-time curve according to Eq. [3.4] as thermal exposure, the temperature-time fields of the structural element can be calculated, using (a) the structural characteristics of the proposed structure, (b) the thermal properties of the structural materials, and (c) the coefficients of heat transfer for the various surfaces of the structure as further input data. Introducing (d) the mechanical properties of the structural materials, and (e) the load characteristics, the time variation of the restraint forces and moments, thermal stresses and load bearing capacity can then be determined. The time at which the load bearing capacity has decreased to the level of the design load at service state defines the time of failure or the fire resistance  $t_{fr}$ , and the design criterion to be satisfied is that  $t_{fr} \geq t_{fd}$  - cf. Eq. [3.3].



### 3.2.2 Natural fire exposure

In applying data on the fire resistance of structural elements in practice, it is important to consider that the standard fire resistance test - whether experimental or calculated - does not represent the real fire exposure in a building nor does it measure the behaviour of the structural element as a part of an assembly in a building. What the test or the corresponding calculations do is to grade structural elements and the building codes and regulations, then require different grades of element according to the circumstances.

These deficiencies have given rise to the development of analytical structural fire design methods, based on the characteristics of natural compartment fires and on well-defined functional requirements and performance criteria. Such analytical design methods have now reached a comparatively advanced level, especially as far as fire exposed steel structures are concerned. To aid the practical application, design diagrams and tables have been systematically produced and published, giving directly, on the one hand, the temperature of the fire exposed structure, and on the other, a transfer of this information to the corresponding load bearing capacity of the structure - cf. , for instance (8), (11), (17), (20), (23).

In general, the design methods fall into two groups with respect to the use of the basic data of the compartment fire. The methods of the first group are characterized by a design procedure, based directly on differentiated gas temperature-time curves of the complete process of a natural fire development - heat exposure model  $H_3$ . The characteristic of the methods of the second group is a design procedure with the varying properties of a natural fire development taken into account over an equivalent time of fire exposure, related to the heating according to the standard temperature-time curve - heat exposure model  $H_2$ .

The physical model for a structural fire engineering design, based on the heat exposure model  $H_3$ , is shown summarily in fig. 4, for a load bearing structure.

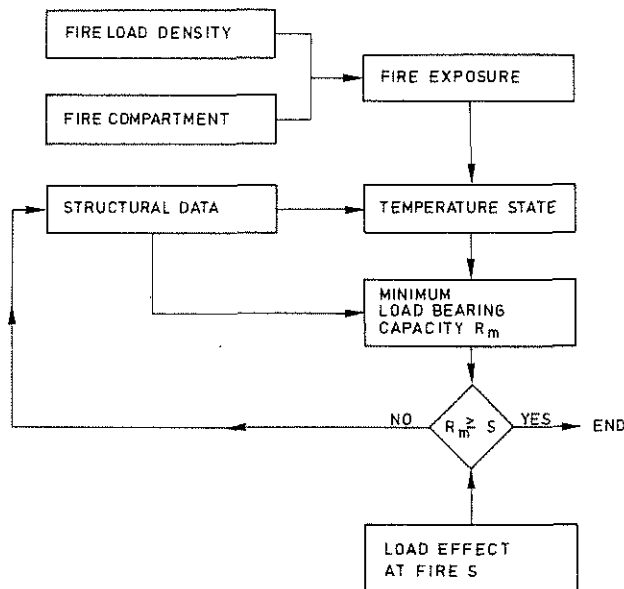
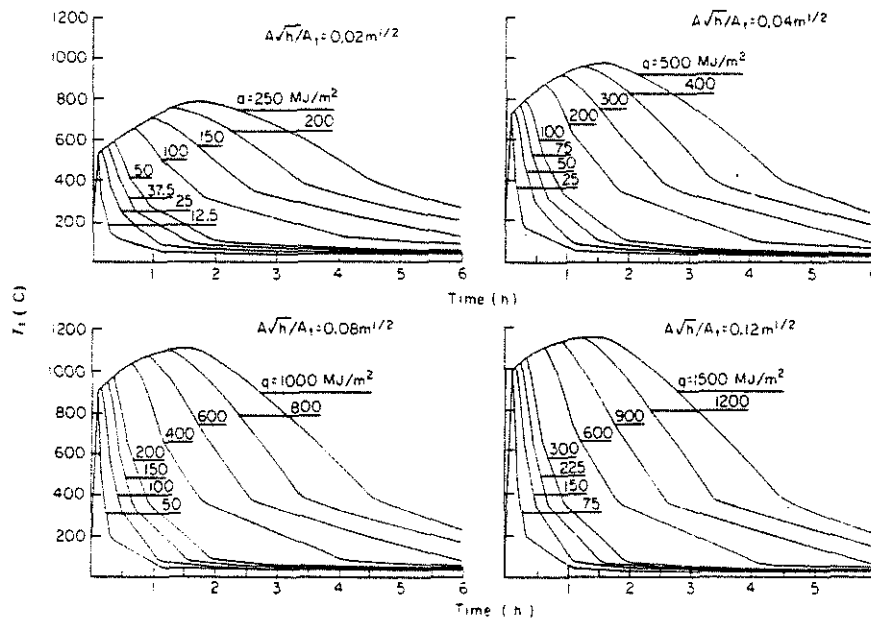

Figure 4 : Physical model for an analytical fire engineering design of load bearing structures, based directly on the characteristics of the natural compartment fire-heat exposure model  $H_3$ .

The design procedure starts by a determination of the fire exposure, given by, for instance, the gas temperature-time curve of the natural compartment fire. In the individual practical application, the fire exposure then can be obtained either by heat and mass balance calculations for the fire compartment cf., (8), (20), (24) to (30) or directly from a systematized design basis of the type exemplified by fig. 5 (8), (20), (25).

The combustion characteristics of the fire load and the geometrical, ventilation and thermal properties of the fire compartment are the important factors.



**Figure 5 :** Gas temperature-time curves for a complete, fully developed compartment fire with varying values for the fire load density  $q$  and the opening factor  $A\sqrt{h}/A_t$ .  $A$  is the total opening area of the fire compartment,  $h$  is a weighted mean value of the height of the openings based on their size, and  $A_t$  is the total internal surrounding area of the fire compartment, including openings. Fire compartment, type A (8), (20), (25).

The gas temperature-time curves  $T_g - t$  in fig.5 apply to a fire compartment with surrounding structures, made of a material with a thermal conductivity  $\lambda = 0.81 \text{ W}\cdot\text{m}^{-1}\cdot\text{°C}^{-1}$  and a heat capacity  $\rho C_p = 1.67 \text{ MJ}\cdot\text{m}^{-3}\cdot\text{°C}^{-1}$ , fire compartment type A. Such a surrounding material corresponds roughly to an average of brick, concrete, and aerated concrete. For fire compartments with surrounding structures, whose thermal properties deviate from compartment type A, the actual fire process can be transferred to a gas temperature-time curve for fire compartment type A by using an effective fire load density,  $q_f$ , and an effective opening factor  $(A\sqrt{h}/A_t)_f$ , calculated from the real fire load density  $q$  and the real opening factor  $A\sqrt{h}/A_t$  according to the formulae :

$$q_f = K_f q ; (A\sqrt{h}/A_t)_f = K_f A\sqrt{h}/A_t \quad [3.5]$$

In (8), (17), and (20), the coefficient  $K_f$  is given for seven types of fire compartments defined by their surrounding structures.

The fire load density  $q$  is given by the relationship :

$$q = \frac{1}{A_t} \sum \mu_v m_v H_v \quad [3.6]$$

where :

$m_v$  = total mass of combustible material  $v$  (kg)

$H_v$  = calorific value of combustible material  $v$   
(MJ.kg<sup>-1</sup>)

$\mu_v$  = a fraction between 0 and 1, giving the real degree of combustion for each individual component  $v$  of the fire load, and

$A_t$  = total interior area of the surfaces bounding the fire compartment, including all openings (m<sup>2</sup>).

In the opening factor of the fire compartment  $A \sqrt{h} / A_t$

$A$  = total area of door and window openings (m<sup>2</sup>), and

$h$  = mean value of the heights of the openings, weighted with respect to each individual opening area (m).

The gas temperature-time curves according to fig. 5 are applicable to fire compartments of a size representative of dwellings, ordinary offices, schools, hospitals, hotels, and libraries. For fire compartments with a very large volume for instance, industrial buildings and sport halls - the curves give an unsatisfactory description of the real fire exposure. At present, there is no validated design basis available for the determination of the fire exposure in compartments with a very large volume.

Returning to the physical model, as shown in fig. 4, in the next step, the fire exposure is transferred analytically to transient temperature fields in the exposed structure and then a determination is carried out of the time variation of the load bearing capacity  $R(t)$ .

A comparison between the minimum value  $R$  of the load bearing capacity  $R(t)$  during the relevant fire process and the load effect at fire  $S$  decides whether the structure can fulfil its required function or not during the fire exposure, as specified by the limit state condition according to Eq. [3.1].

For a separating structure, the physical model gives the transient temperature state, defining the maximum value,  $\max \{T_s(t)\}$ , of the highest temperature on the unexposed side of the structure during the relevant fire process. The corresponding limit state condition follows Eq. [3.2] with respect to the required function of insulation. The supplementary limit state condition regarding the integrity function has to be proved experimentally, when required, in either a fire resistance test or a simplified small scale test.

### 3.2.3. Equivalent time of fire exposure

The design scheme for a fire engineering design of a load bearing structural element, based on the heat exposure model  $H_2$ , is illustrated in fig. 6 (14). The design comprises a determination of the ultimate state of the structural element on one hand for a natural fire exposure, on the other hand for a thermal exposure according to the standard fire resistance test, ISO 834 - Eq. [3.4].

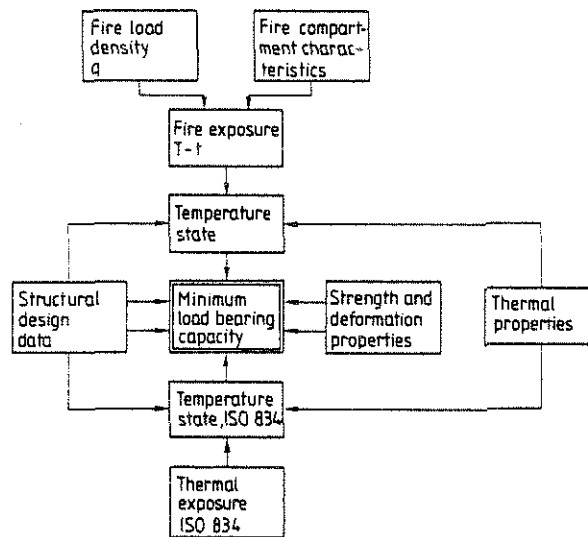

Figure 6 : Procedure for a determination of the equivalent time of fire exposure.

For the two types of exposure, the temperature state and the related load bearing capacity are determined for the structural element. Input information is data on the structural design and the thermal, strength and deformation properties of the structural materials. The minimum load bearing capacity of the structural element during the relevant natural compartment fire, put equal to the minimum load bearing capacity at the thermal exposure according to the standard fire resistance test, gives the equivalent time of fire exposure  $t_e$ . The minimum load bearing capacity may be defined by a critical value of a maximum deflection, or a maximum rate of deflection or a maximum temperature.

To be precise, the equivalent time of fire exposure  $t_e$  depends not only on the parameters influencing the natural compartment fire, but also on a number of structural parameters. For fire exposed steel structures, (8), (20), and (31) give a design basis which facilitates a practical approach to determining this form of the equivalent time of fire exposure.

More roughly,  $t_e$  can be described as dependent only on factors affecting the compartment fire according to the following approximate formula (31) :

$$t_e = 0.067 \frac{q_f}{(A\sqrt{h}/A_t)_f^{0.5}} \quad (\text{min}) \quad [3.7]$$

verified for application to unprotected and protected steel structures. In the formula,  $q_f$  is the effective fire load density per unit area of the surfaces bounding the fire compartment ( $\text{MJ}\cdot\text{m}^{-2}$ ) and  $(A\sqrt{h}/A_t)_f$  the effective opening factor of the fire compartment ( $\text{m}^{1/2}$ ), calculated according to Eqs. [3.5] and [3.6]. Written in this form, the formula enables the influence of varying thermal properties of the surrounding structures of the fire compartment to be taken into account.

The formula has the same limitations with respect to the size of fire compartment as stated in 3.2.2. for the gas temperature-time curves according to fig.5.



The design criterion in a fire engineering design based on the heat exposure model  $H_2$  is that the fire resistance of the structural element  $t_{fr}$  shall meet the required fire resistance, expressed as the equivalent time of fire exposure  $t_e$ , i.e. - cf. Eq. [3.3].

$$t_{fr} - t_e \geq 0 \quad [3.8]$$

The fire resistance  $t_{fr}$  then can be obtained either experimentally by standard fire resistance tests according to ISO 834 - or a corresponding national standard - or by calculation.

### 3.3. A probability based structural fire engineering design

The modern development of functionally well-defined, analytical structural fire design methods includes a probabilistic approach, based on either a system of partial safety coefficients or the safety index concept (9), (10), (14), (32), (33).

A probability based structural fire design should originate from validated models, describing the relevant physical processes and strictly specifying the connected uncertainties and reliability models. Only design methods, based on the heat exposure models  $H_2$  and  $H_3$ , fulfil these requirements from a conceptual point of view.

For the probabilistic model to be integrated with the physical model, various levels of ambition can be distinguished :

- an exact evaluation of the failure probability  $P(R < S)$  using multi-dimensional integration or Monte Carlo simulation,
- an approximate evaluation of the failure probability  $P(R < S)$  based on first order reliability methods (FORM), and
- a practical design format calculation, based on partial safety factors and taking into account characteristic values for action effects and response capacities.

For practical purposes, an exact evaluation of failure probability is not possible. Also, the FORM approximations are too cumbersome for everyday design and more simplified practical design formats have to be used.

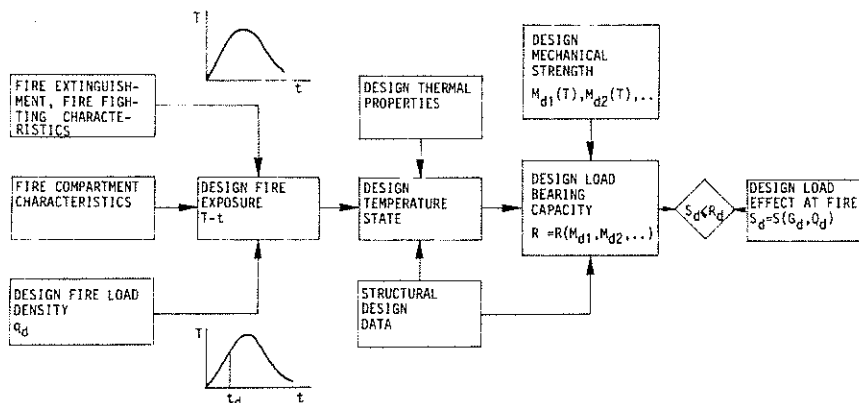

Figure 7: Procedure for a practical design format calculation of a load bearing structure, exposed to a natural compartment fire - heat exposure model  $H_3$ .

Fig. 7 summarises a practical design format calculation for a fire exposed load bearing structure, using the heat exposure model  $H_3$  (14), (32) to (34).

From the design fire load density  $q_d$  and the geometrical, ventilation and thermal characteristics of the fire compartment, the design fire exposure is determined, given as the gas temperature-time curve  $T-t$  of the fully developed compartment fire and obtained either from a systematized design basis or by heat and mass balance calculations.

Together with the structural design data, the design thermal properties and the design mechanical strength of the structural materials, the design fire exposure provides the design temperature state and the related design load bearing capacity  $R_d$  for the lowest value of the load bearing capacity during the relevant fire process.

A direct comparison between the design load effect at fire  $S_d$  finally establishes whether or not the structure can fulfil its required function on exposure to fire, i.e. the design format condition to be proved is

$$R_d - S_d \geq 0 \quad [3.9]$$

Depending on the type of practical application, the fulfilment of the condition has to be verified for either the complete fire process or a limited part of it  $t_d$ , determined by the time necessary for the fire to be extinguished under the most severe conditions or by the design evacuation time for the building.

The probabilistic influences are taken into account by specifying characteristic values and related partial safety factors for the fire load density, such structural design data as imperfections, the thermal properties, the mechanical strength and the loading. The partial safety factors are then derived by a probabilistic analysis, based on a first order reliability method (FORM), with the following effects and influences taken into consideration.

- the uncertainty in specifying the fire load density,
- the uncertainty in specifying the ventilation characteristics of the fire compartment and the thermal properties of the structures surrounding the fire compartment,
- the uncertainty of the analytical model for the determination of the compartment fire and its thermal exposure on the structure,
- the uncertainty in specifying the design data of the structure, dimensions, positions of reinforcement, imperfections, etc... ,
- the uncertainty in specifying the thermal and mechanical properties of the structural materials,
- the uncertainties of the analytical models for the calculation of the heat transfer to and within the structure and the ultimate load bearing capacity of the structure,
- the uncertainty in specifying the loads,
- the uncertainty of the model, describing the load effect on the structure,
- the probability of occurrence of a fully developed compartment fire,
- the efficiency of the fire brigade actions,
- the effect of an installed extinction system, and
- the consequences of a structural failure.

For a structural fire engineering design, based on the heat exposure model H<sub>2</sub>, the practical design format can be given in the following form (14) :

$$\frac{t_{fr}}{\gamma_f} \geq \gamma_{n1} \gamma_{n2} \gamma_e t_e \quad [3.10]$$

in which  $t_{fr}$  is the fire resistance of the structural element,  $t_e$  equivalent time of fire exposure according to Eq. [3.7], and  $\gamma_f$ ,  $\gamma_{n1}$ ,  $\gamma_{n2}$  and  $\gamma_e$  partial safety factors, taking into account all uncertainties in the design system.

The partial safety factor  $\gamma_g$  covers the uncertainties of the fire load density and the fire compartment characteristics, including the uncertainties of the analytical models for a determination of the fire exposure. The partial safety factor  $\gamma_f$  considers the uncertainties of the mechanical load and the thermal and mechanical material properties of the structural element, including the uncertainties of the analytical models for a determination of the load effect, the transient temperature state and the load bearing capacity if the fire resistance is evaluated analytically. The additional partial safety factors  $\gamma_{N1}$  and  $\gamma_{N2}$  include the effect of the probability of a fully developed compartment fire and the consequences of a structural failure. Then  $\gamma_{N2}$  is a partial safety factor due to average reliability requirements, and  $\gamma_{N1}$  is a correction factor due to deviations from average reliability requirements, correcting for instance, for the effect of a sprinkler system or the efficiency of the fire brigade actions.

#### 3.4. Temperature distribution in structural steel elements at fire exposure

For a fire exposed, uninsulated steel structure, the energy balance equation gives the following formula for a determination of the steel temperature-time curve  $T_s - t$  (fig. 8).

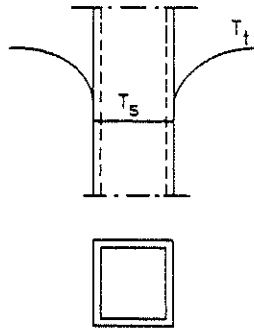

Figure 8 : Fire exposed, uninsulated steel structure.  
 $T_t$  = gas temperature within fire compartment,  $T_s$  = steel temperature at time t.

$$\Delta T_s = \frac{\alpha}{\rho_s C_{ps}} \frac{F_s}{V_s} (T_t - T_s) \Delta t \quad (^\circ\text{C}) \quad [3.11]$$

where

$\Delta T_s$  = change of steel temperature ( $^\circ\text{C}$ ) during time step  $\Delta t$ (s)

$\alpha$  = coefficient of heat transfer at fire exposed surface of structure ( $\text{W}\cdot\text{m}^{-2} \text{ } ^\circ\text{C}^{-1}$ ),

$\rho_s$  = density of steel material ( $7850 \text{ kg m}^{-3}$ ),

$C_{ps}$  = specific heat of steel material ( $\text{J}\cdot\text{kg}^{-1} \text{ } ^\circ\text{C}^{-1}$ ),

$F_s$  = fire exposed surface of steel structure per unit length (m)

$V_s$  = volume of steel structure per unit length ( $\text{m}^2$ ),

$T_t$  = gas temperature ( $^\circ\text{C}$ ) within fire compartment at time t (s).



Eq. [3.11] presupposes that the steel temperature  $T_s$  is uniformly distributed over the cross section of the structure at any time  $t$ .

The coefficient of heat transfer  $\alpha$  can be calculated from the approximate formula

$$\alpha = 23 + \frac{5.77 \varepsilon}{T_t - T_s} \left[ \left( \frac{T_t + 273}{100} \right)^4 - \left( \frac{T_s + 273}{100} \right)^4 \right] \quad (\text{W/m}^2 \cdot \text{°C}^{-1}) \quad [3.12]$$

giving an accuracy which is sufficient for ordinary practical purposes.

$\varepsilon$  is the resultant emissivity which for practical applications can be chosen according to the following table, giving values which are generally on the safe side.

1. Column, fire exposed on all sides	$\varepsilon = 0.7$
2. Column, outside a facade	$= 0.3$
3. Floor structure, composed of steel beams with a concrete slab on the lower flange of the beams	$= 0.5$
4. Steel beams with a floor slab on the upper flange of the beams	
a) Beams of I cross-section with width/height $\geq 0.5$	$= 0.5$
b) Beams of I cross-section with width/height $< 0.5$	$= 0.7$
c) Beams of box cross-section and trusses	$= 0.7$

In (8), (17), (20), more accurate values are given for  $\varepsilon$  in the case 4 of application.

For a given gas temperature-time curve  $T_g - t$ , the steel temperature  $T_s$  can be directly calculated from Eqs. [3.11] and [3.12] with allowance for the temperature dependence of  $C_{ps}$  and  $\alpha$ . Such computations have been carried out in a systematized way giving design tables as published in (11), (18), (19), (22), (23), for a thermal exposure according to the standard temperature-time curve and in (8), (17), (20), for a natural compartment fire exposure according to fig.5. The first set of tables give the steel temperature as a function of the time of exposure  $t$  for varying values of  $F_s/V_s$  ratio and the resultant emissivity  $\varepsilon$ . From the second set of tables, the maximum steel temperature  $T_{s,max}$  during a complete compartment fire can be determined directly as a function of  $\varepsilon$ , the effective fire load density  $q_f$ , the effective opening factor  $(A\sqrt{h}/A_t)_f$ , the  $F_s/V_s$  ratio and the resultant emissivity  $\varepsilon$ .

Similarly for a fire exposed insulated steel structure, a simplified energy balance equation gives the following formula for a direct determination of the steel temperature-time curve  $T_s - t$  (fig.9).

Figure 9 : Fire exposed, insulated steel structure

$T_t$  = gas temperature within the fire compartment

$T_s$  = steel temperature at time  $t$ .

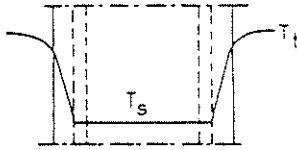

$$T_s = \frac{A_i}{(1/\alpha + d_i/\lambda_i) \rho_s C_{ps} V_s} (T_t - T_s) \Delta t \quad (^\circ\text{C}) \quad [3.13]$$

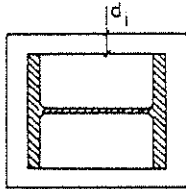

with the additional quantities

$A_i$  = internal enclosing surface area of insulation per unit length (m)

$d_i$  = thickness of insulation (m),

$\lambda_i$  = thermal conductivity of insulating material ( $\text{W}\cdot\text{m}^{-1}\cdot^\circ\text{C}^{-1}$ )

Eq. [3.13] presupposes that the steel temperature  $T_s$  is uniformly distributed over the cross-section of the structure at any time  $t$ , that for the insulation the temperature gradient is linear and the heat absorption negligible and that the heat transfer is one-dimensional.

Computations, originating from Eqs. [3.12] and [3.13] provide a systematized design basis for a practical fire design. Such a design basis is published in (11), (18), (19), (22), (23), for a thermal exposure according to the standard temperature-time curve, giving the steel temperature as a function of the time of exposure  $t$  for varying values of the  $A_i/V_s$  and  $d_i/\lambda_i$  ratios. (8), (17), (20) include a corresponding design basis for a natural compartment fire exposure giving the maximum steel temperature  $T_{s,max}$  for varying values of the effective fire load density  $q_{\dot{F}}$ , the effective opening factor  $(A\sqrt{h}/A_t)_{\dot{F}}$  and the  $A_i/V_s$  and  $d_i/\lambda_i$  ratios.

For a specific insulating material, systematized design diagrams or tables can be computed very accurately with regard to the temperature dependence of the thermal properties of the steel as well as the insulating material. The influence of an initial moisture content and of a disintegration of the insulating material can be considered, too. Practically, such a determination can be carried out over a numerical data processing by computers on the basis of a finite difference or a finite element method. A great number of design tables computed according to such an accurate procedure, are presented in (8).

The design basis referred to generally assumes the steel temperature to be uniformly distributed over the cross-section of the beam or column at any time  $t$ . A more accurate theory which enables a determination of the temperature variation over the cross-section of the steel structure, is presented in (35), (36), together with computer routines. The algorithm described can easily be coupled to most finite element programs.

An illustration of the capability of the theory is given in fig. 10, which shows calculated temperature distribution along the line of symmetry of a gypsum insulated steel beam with a concrete slab at the top flange, at selected times of thermal exposure according to the standard temperature-time curve.

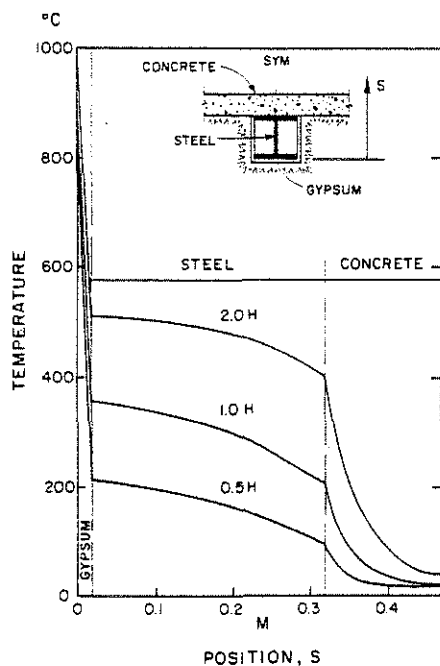

Figure 10 : Calculated temperature distribution along line of symmetry of a steel beam, insulated by a 16 mm gypsum board (density  $770 \text{ kg.m}^{-3}$ ) and carrying a 150 mm concrete slab on top flange, at selected times of a thermal exposure according to the standard temperature-time curve, Eq. [3.4]- (35), (36).

### 3.5 Load bearing capacity of steel structures at fire exposure

A transformation of the transient temperature state of a fire exposed structure or a structural element to data on the structural behaviour and load bearing capacity requires access to validated mathematical models of the mechanical behaviour of the structural material in the temperature range associated with fires.

For steel, such models have been available for many years - cf., for instance, (37) to (40). The models decompose the total strain into thermal strain, instantaneous elastic and plastic strain, and time and temperature dependent creep strain. Some of the models operate with temperature compensated time  $t_T$  according to DORN (37), defined by the formula

$$t_T = \int_0^t e^{-\Delta H/RT} dt \quad [3.14]$$

where

- H = activation energy required for creep ( $\text{J. mol}^{-1}$ )
- R = universal gas constant ( $\text{J. mol}^{-1} \cdot \text{K}^{-1}$ ) and
- T = absolute temperature (K)

Analytical models for a determination of the mechanical behaviour and load bearing capacity of fire exposed isostatic and hyperstatic steel beams, columns and frames are presented in, for instance, (38) - (43). The most general method is the one described in (40), based on a finite element elastic-plastic-creep analysis including the influence of geometrical non-linearities of the structure.

A simplified design basis, giving directly the load bearing capacity for a design load effect can be found in (8), (11), (17) to (23). The design basis can be used for the thermal exposure given by the standard temperature-time curve or the natural fire concept. The design basis is illustrated by figs. 11, 12 and 15. Figures 11 and 12, (8), (20), give the load bearing capacity ( $M_{kr}$ ,  $P_{kr}$ ,  $q_{kr}$ ) of fire exposed beams of constant I cross section at different types of loading and support conditions, as a function of the steel beam temperature  $T_s$ . The design curves in fig. 11 apply to a slow rate of heating - assumed to be  $4^\circ\text{C}\cdot\text{min}^{-1}$ , followed by a cooling with a rate of  $1.33^\circ\text{C}\cdot\text{min}^{-1}$  - and fig.12 gives the correction  $\Delta\beta$  of the load-bearing capacity coefficient  $\beta$  due to a more rapid rate of heating. In the formula for load-bearing capacity

- $\sigma_s$  = yield stress of steel material at room temperature (MPa),
- $L$  = span of beam (m)
- $W$  = elastic modulus of beam cross section ( $\text{m}^3$ )

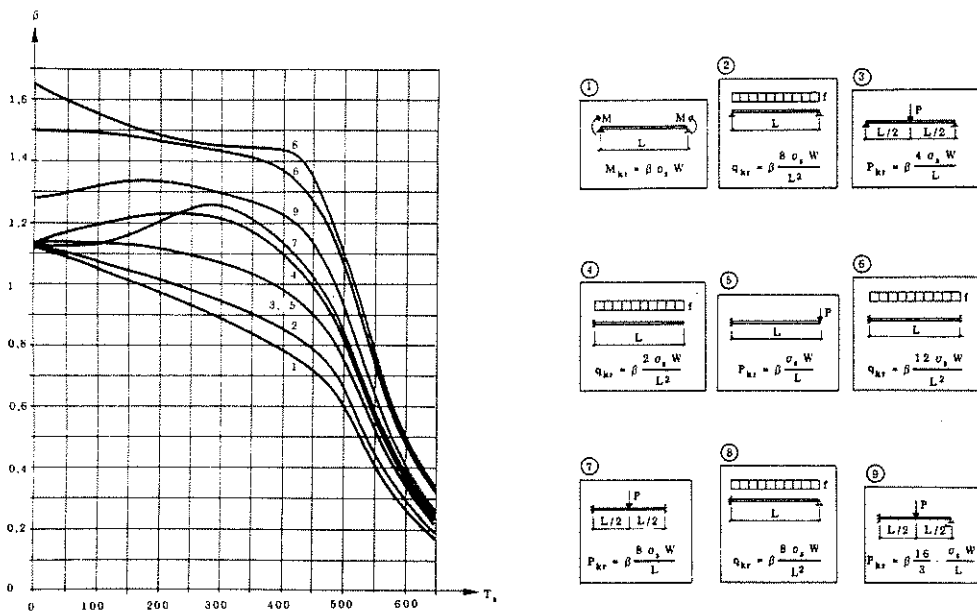

Figure 11 : Coefficient  $\beta$  for determination of critical load ( $M_{kr}$ ,  $P_{kr}$ ,  $q_{kr}$ ) for fire exposed steel beams of I cross section at different types of loading and support conditions as a function of the steel beam temperature  $T_s$ . The curves have been calculated for a slow rate of heating of  $4^\circ\text{C}\cdot\text{min}^{-1}$  and a subsequent cooling, assumed to be one third of the rate of heating (8), (20).

The design curves in figures 11 and 12 have been determined on the basis of the deformation curve of the fire exposed beams calculated by an analytical model, presented in (38), which takes into account the softly rounded shape of the shape of the stress-strain curve of steel at elevated temperatures as well as the influence of creep strain. As can be seen from fig. 12, this influence of creep begins to be noticeable for ordinary structural steels at temperatures in excess of about 450 °C.

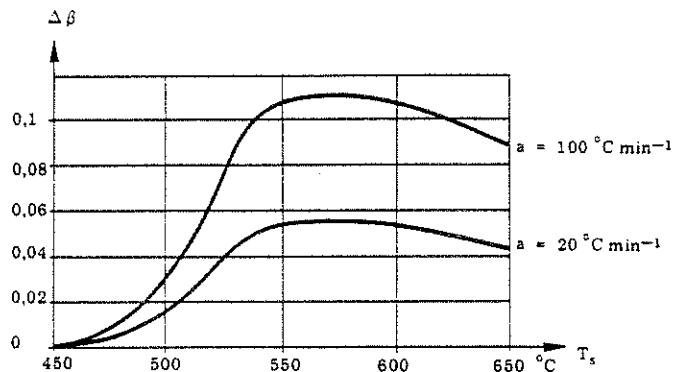

Figure 12 : Increase  $\Delta\beta$  of coefficient  $\beta$  determined according to fig. 11, for a rate of heating  $a \geq 4^\circ\text{C} \cdot \text{min}^{-1}$ , as a function of the steel beam temperature  $T_s$  (8), (20).

In the European Recommendations for the fire safety of steel structures (11), an alternative simplified approach is given for the determination of the load bearing capacity of a steel structure at uniform elevated temperature  $T_s$ . The elementary theory of plasticity is directly applied, related to an effective yield stress  $\sigma_{s,T_s}$  in which the influence of creep is included implicitly.

The basic stress-strain curves are exemplified in fig. 13 for the steel grade Fe 360. The large gap between the curves for 200 and 300°C is due to the so-called "thermally activated flow" (41). For an ultimate limit state design, the curves are cut off at certain stress levels, defining the effective yield stress  $\sigma_{s,T_s}$  as a function of the steel temperature  $T_s$  - fig.14.

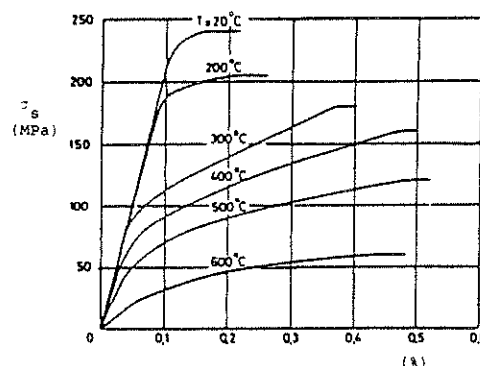

Figure 13 : Stress-strain curves at elevated temperatures  $T_s$  for steel grade Fe 360. In the curves, the influence of creep is included implicitly (11).

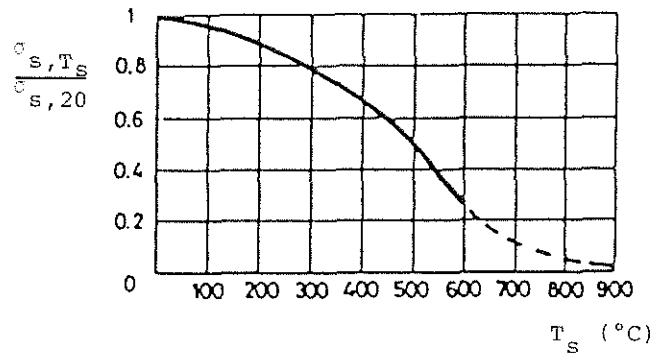

Figure 14 : Quotient between effective yield stress  $T_s, T_s$  at elevated temperature  $T_s$  and yield stress at room temperature as a function of steel temperature  $T_s$ . The curve applies to steel grades Fe 360 to Fe 510 with an accuracy, which is sufficient for practical purposes (11)

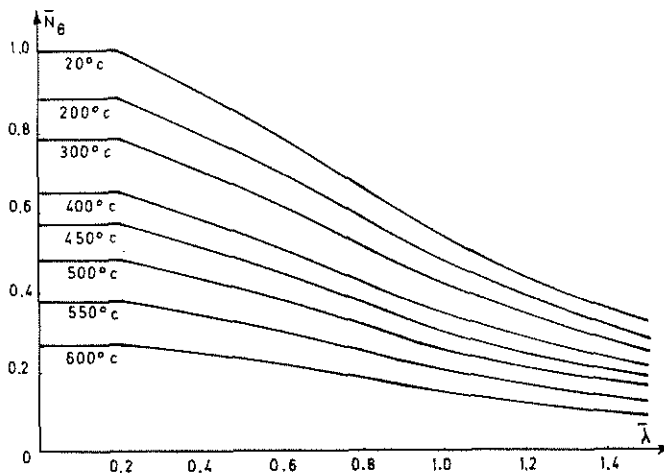

Figure 15 : Relationship between non-dimensional buckling load  $\bar{N}_\theta$  and slenderness factor  $\bar{\lambda}$  at varying steel temperature  $T_s$  for axially compressed steel columns (11), (44).

The curves in fig. 15 (11), (44) give the variation with the steel temperature  $T_s$  of the non-dimensional buckling load  $N_\theta$  for axially compressed columns as a function of the slenderness factor

$$\bar{\lambda} = \frac{\lambda}{\pi \sqrt{E/\sigma_s}} \quad [3.15]$$

where

$\lambda$  = column slenderness ratio  
 $E$  = modulus of elasticity at room temperature, and  
 $\sigma_s$  = yield strength at room temperature

The curves are experimentally validated by tests made recently in several European countries. The curves are applicable under the presumption that the column is unrestrained with respect to longitudinal expansion during the fire exposure. For a fire design of columns, partly restrained to longitudinal expansion, see reference (8).

### 3.6 Consistency between analytical and experimental approaches

The analytical determination of the fire resistance of load bearing structural elements as an alternative to testing has raised a problem of inconsistency, recently analysed in (45), as concerns steel structures.

Due to high costs, a fire resistance test is usually limited to one test specimen - in a few countries to two test specimens. For a single test specimen, the actual material quality represents a random sample from a wide variety. Consequently, a standard fire resistance test is generally carried out on a test specimen with a load bearing capacity which is greater - most often significantly greater - than the load bearing capacity related to the characteristic value of the material strength. In current practice, no corrections are made of the test results with respect to this.

An analytical determination of the load bearing capacity of a structural element is based on the characteristic value of the material strength. This gives an analytically determined fire resistance which is lower - normally significantly lower - than the corresponding value derived from a standard fire resistance test.

Simplified methods for a calculation of the temperature of fire exposed steel structural elements are, as a rule, based on the assumption of a uniformly distributed temperature over the cross section and along the structure at each time of fire exposure. In certain types of steel structures, for example beams with a slab on the upper flange, a considerable temperature variation arises over the cross section as well as in the longitudinal direction during a fire resistance test. A simplified method, which neglects this influence gives a further underestimation of the fire resistance in relation to the corresponding result obtained in a fire resistance test.

In (45) alternative methods of correction are outlined for obtaining better agreement between the analytical and experimental approaches. One of these methods is developed further to a design basis that can be applied easily in practice. In principle, the method implies that the analytically determined load bearing capacity  $R$  is multiplied by a correction factor  $f$ , which is a function of the uniformly distributed calculated steel temperature  $T_s$  and the type of structural element. Fig. 16 gives the correction factor derived<sup>s</sup> and practically applied in the ECCS Recommendations for the fire safety of steel structures (11). The method of correction is a rough approach and should be seen as a temporary solution of the problem.

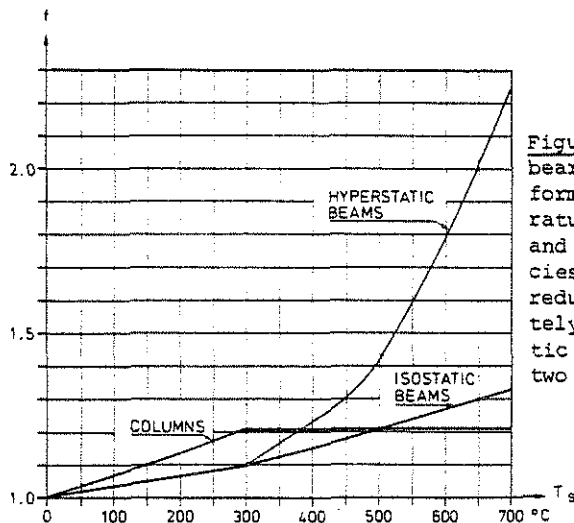

Figure 16 : Correction factor  $f$  for load bearing capacity  $R$  as a function of uniformly distributed calculated steel temperature  $T_s$  for columns, isostatic beams, and hyperstatic beams with two redundancies. For hyperstatic beams with only one redundancy,  $f$  can be chosen as approximately the average of the values for isostatic beams and hyperstatic beams with two redundancies (45).



REFERENCES

1. Law, M. : Fire, the Risk and the Precautions. IABSE Conference - Tall buildings and people, England 1975.
2. Witteveen, J. : Policies for Fire Safety. CIB Symposium on Fire Safety in Buildings, Amsterdam 1977. CIB - Proceedings - Publication 48.
3. Witteveen, J. : Western-European Trends in Fire Protection of Steel Structures. Proceedings ECCS-symposium "Structural steelwork into the 80's". London, June 30 - July 1, 1981.
4. Fire Protection Bulletins, Canadian Steel Industries Construction Council, 201 Consumers Road, Suite 300, Willowdale, Ontario, Canada.
5. ISO : Fire Resistance Tests - Elements of Building Construction. International Standard 834, 1975.
6. Pettersson, O. and Magnusson S.E. : Fire Tests Methods, Background, Philosophy, Trends and Future Needs. Doc. Gen. 011 NORDTEST, Stockholm 1977.
7. Witteveen, J. and Twilt L. : A Critical View on the Results of Standard Fire Resistance Tests on Steel Columns. Fire Safety Journal, Vol.4, N°. 4. 1982.
8. Pettersson, O. Magnusson, S.E. and Thor, J. : Fire Engineering Design of Steel Structures. Swedish Institute of Steel Construction, Publication 50, Stockholm 1976.
9. Bub, H. et al : Baulicher Brandschutz. Institut fur Bautechnik, Berlin 1979
10. DIN 18230 Entwurf : Baulicher Brandschutz im Industriebau, August 1978.
11. ECCS : European Recommendations for the Fire Safety of Steel Structures, July 1981. A summary is published in : Witteveen, J. : Steel Structures exposed to the standard fire : An introduction to the European Recommendations - American Society of Civil Engineers. Spring Convention, New York 1981. Preprint 81-035.
12. CEB : Design of Concrete Structures for Fire Resistance. Bulletin d'Information n° 145, 1982.
13. Law, M. : Design Guide for Fire Safety of Bare Exterior Structural Steel. Ove Arup and Partners, London 1977.
14. CIB/W14 : Towards a Probability Based Code on Structural Fire Safety, 1982.
  - Part A : General Principles. Prepared by L. Twilt, A. Vrouwenvelder and J. Witteveen, with an introduction by M. Kersken-Bradley.
  - Part B : Methods of verification. Prepared by O. Pettersson.
  - Appendix 1 : Statistical Assessment of Test Results. Prepared by M. Kersken-Bradley.
  - Appendix 2 : Simple Fault Tree for Multiple Fatality Disasters. Prepared by D.J. Rasbash.
15. Witteveen, J. : A Systematic Approach Towards Improved Methods of Structural Fire Engineering-Design, Proceedings, 6th International Fire Protection Seminar, organized by VFDB, Karlsruhe 1982.
16. Pettersson, O. : Structural Fire Protection. Report of Group Session 5.2, CIB W14 Commission Meeting, Copenhagen, May 1978. Fire and Materials, Vol.4 No.1, 1980.
17. Pettersson, O. : Theoretical Design of Fire Exposed Structures. Division of Structural Mechanics and Concrete Construction, Lund Institute of Technology, Bulletin 51, Lund, 1976.

18. Barthelémy, B. and Kruppa, J. : Résistance au feu des structures - Béton, Acier, Bois. Editions Eyrolles, Paris 1978.
19. Fruitet, P.L. : Guide pour la Conception des Bâtiments à Structures en Acier. Office Technique pour l'Utilisation de l'Acier (OTUA), Paris, 1978.
20. Pettersson, O. and Ödeen, K : Brandteknisk dimensionering - principer, underlag, exempel (Fire Engineering Design of Building Structures - Principles, Design Basis, Examples). Liber forlag, Stockholm, 1978.
21. Harmathy, T.Z. : Design to Cope with Fully Developed Fires. ASTM Symposium "Design of Building for Fire Safety", ASTM Special Technical Publication 685, Washington, 1979, pp 198-276.
22. Twilt, L. and Witteveen, J. : Brandveiligheid Staalconstructies (Fire Resistance of Steel Structures). Staaicentrum Nederland, 1980.
23. Thrane, E.J. : Brandteknisk dimensjonering av bygningskonstruksjoner (Fire Engineering Design of Building Structures). Tapir forlag, Oslo, 1981.
24. Kawagoe, K. and Sekine, T. : Estimation of Fire Temperature-Time Curve in Rooms. Occasional Report No. 11, Building Research Institute, Tokyo 1963. Kawagoe, K. : Estimation of Fire Temperature-Time Curve in Rooms. Research Paper No. 29, Building Research Institute, Tokyo, 1967.
25. Magnusson, S.E. and Thelandersson, S. : Temperature-Time Curves for the Complete Process of Fire Development - A Theoretical Study of Wood Fuel Fires in Enclosed Spaces. Acta Polytechnica Scandinavica, Ci 65, Stockholm. 1970.
26. Harmathy, T.Z. : A New Look at Compartment Fires. Part I, Fire Technology, Vol. 8, No.3, August 1972. - Part II, Fire Technology, Vol. 8, No.4, November 1972.
27. Thomas, P.H. : Some Problem Aspects of Fully Developed Room Fires, ASTM Symposium "Fire Standards and Safety" held at NBS, Gaithersburg, 5-6 April 1976, ASTM Special Technical Publication 614, Washington, 1977.
28. Babrauskas, V. and Williamson, B. : Post-Flashover Compartment Fires. University of California, Berkeley, Fire Research Group, Report No. UCB FRG 75-1, December 1975 - Post-Flashover Compartment Fires-Basis of a Theoretical Model. Fire and Materials, Vol.2, No.2, 1978.
29. Babrauskas, V. : COMPF2 - A Program for Calculating Post - Flashover Compartment Fire Temperatures. Technical Note 991, National Bureau of Standards, Washington, 1979.
30. Babrauskas, V. : A Closed-form Approximation for Post-Flashover Compartment Fire Temperatures. Fire Safety Journal, Vol. 4, No. 1, August 1981.
31. Pettersson, O. : The Connection between a Real Fire Exposure and the Heating Conditions according to Standard Fire Resistance Tests. European Convention for Constructional Steelwork, Chapter II, CECM - III 74 - 2E.
32. Magnusson, S.E. and Pettersson, O. : Rational Design Methodology for Fire Exposed Load Bearing Structures. Fire Safety Journal, Vol. 3, 1980/81, pp 227-241.
33. Pettersson, O. : Reliability Based Design of Fire Exposed Concrete Structures. Contemporary European Concrete Research, Stockholm, June 9-11, 1981.
34. Magnusson, S.E. and Pettersson, O. : Functional Approaches - An Outline. CIB Symposium on Fire Safety in Buildings : Needs and Criteria, Held in Amsterdam 1977-06-02/03, Publication 48, CIB Proceedings, 1977, pp.120-145.
35. Wickström, U. : A Numerical Procedure for Calculating Temperature in Hollow Structures Exposed to Fire. Department of Structural Mechanics, Lund Institute of Technology, Report No. 79-3, Lund, 1979.

36. Wickström, U. : TASEF-2- A Computer Program for Temperature Analysis of Structures Exposed to Fire . Department of Structural Mechanics, Lund Institute of Technology, Report No.79-2, Lund, 1979
37. Dorn, J.E. : Some Fundamental Experiments on High Temperature Creep. Journal of the Mechanics and Physics of Solids, Vol. 3, 1954.
38. Thor, J. : Deformations and Critical Loads of Steel Beams under Fire Exposure Conditions. Division of Structural Mechanics and Concrete Construction, Lund Institute of Technology, Bulletin 35, Lund 1973.
39. Harmathy, T.Z. : Creep Deflection of Metal Beams in Transient Heating Processes, with Particular Reference to Fire. Canadian Journal of Civil Engineering, Vol. 3, No.2, June 1976.
40. Furumura, F. and Shinohara, Y. : Inelastic Behaviour of Protected Steel Beams and Frames in Fire. Research Laboratory of Engineering Materials, Report No. 3, Tokyo, 1978.
41. Witteveen, J. , Twilt, L. and Bijlaard, F.S.K. : The Stability of Braced and Unbraced Frames at Elevated Temperatures. Symposium on Stability of Steel Structures, Liège, April 1977.
42. Beyer, R. : Der Feuerwiderstand von Tragwerken aus Baustahl. Berechnung mit Hilfe des Traglastverfahrens. Der Stahlbau, 46. Jahrgang, Heft 12, Dezember 1977.
43. Beyer R. and Hartmann, B. : Eine Untersuchung des Lastfalles Brand bei Stahlrahmen, Kolloquium für Finite Elemente in der Baupraxis, Hannover, April 1978.
44. Janns, J. and Minne, R. : Buckling of Steel Columns in Fire Conditions. Fire Safety Journal, Vol. 4, No. 4, 1981/82, pp 227-235.
45. Pettersson, O. and Witteveen, J. : On the Fire Resistance of Structural Steel Elements Derived from Standard Fire Tests or by Calculation. Fire Safety Journal, Vol. 2, 1979/80, pp. 73-87.



ISSN 0377-7278

---

IABSE PERIODICA 2/1983  
PERIODICA AIPC  
IVBH PERIODICA

---

May 1983

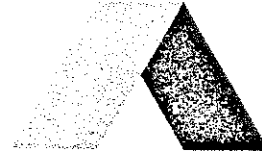

# **IABSE PROCEEDINGS P-61/83**

**M É M O I R E S A I P C  
I V B H A B H A N D L U N G E N**

*Fire Protection of Steel Structures  
Examples of Applications  
J. Brozzetti, M. Law,  
O. Pettersson, J. Witteveen*

International Association for Bridge and Structural Engineering  
Association Internationale des Ponts et Charpentes  
Internationale Vereinigung für Brückenbau und Hochbau

IABSE  
AIPC  
IVBH

The Proceedings are open for discussion until August 31, 1983.

La discussion de ce Mémoire est ouverte jusqu'au 31 août 1983.

Diskussionsbeiträge zu dieser Abhandlung werden bis 31. August 1983 erbeten.

Editor - Publisher - Advertising  
Rédacteur - Editeur - Annonces  
Redaktion - Herausgeber - Inserate

**IABSE - AIPC - IVBH**

ETH-Hönggerberg  
CH-8093 Zürich, Switzerland

Tel.: 01/377 26 47  
Telex: 822 186 IABS CH  
Telegr.: IABSE, CH-8093 Zurich

Papers published under the sole responsibility of the author(s).

Les articles sont publiés sous la seule responsabilité de (des) l'auteur(s).

Die Artikel werden unter der alleinigen Verantwortung des oder der Autoren veröffentlicht.



## Fire Protection of Steel Structures — Examples of Applications

Protection contre le feu des structures acier — Quelques exemples d'applications

Brandschutz der Stahlkonstruktionen — Einige Anwendungsbeispiele

### Jacques BROZZETTI

Dir., Dép. Etudes  
CTICM  
Paris, France

### Margaret LAW

Technical Director  
Ove Arup and Partners  
London, Great Britain

### Ove PETTERSSON

Professor  
Lund Inst. of Technology  
Lund, Sweden

### Jelle WITTEVEEN

Professor  
TNO  
Delft, the Netherlands

### SUMMARY

This paper presents a review of the practical aspects of fire protection of steel structures by different techniques taking the desired fire rating into account. Some guidelines for correct practice are given. A number of these concepts of fire protection are illustrated by recent examples of steel building structures in Dublin, London, Manchester and Paris.

The last part of the paper discusses the priorities for future action and research. The use of calculation methods for the design of structural fire protection is gaining increasing acceptance and there is a growing recognition of the need to clearly identify the safety objectives related to fire within the context of overall safety.

### RÉSUMÉ

Cette contribution présente un rappel des aspects pratiques de la protection contre le feu des constructions métalliques, réalisée au moyen de techniques diverses avec prise en compte de la durée de résistance souhaitée. Quelques indications de bonne pratique sont données. Ces concepts de protection anti-incendie sont illustrés par quelques exemples de constructions récentes.

La deuxième partie est consacrée à la discussion des problèmes qui devraient constituer à l'avenir les priorités en matière de conception et de recherche. L'utilisation de méthodes de calcul pour la conception d'une protection efficace contre le feu est de plus en plus largement acceptée et la nécessité de définir clairement les objectifs de cette sécurité dans le cadre d'une conception globale de la sécurité est largement reconnue.

### ZUSAMMENFASSUNG

Dieser Beitrag gibt einen Überblick über die praktischen Aspekte des durch verschiedene Massnahmen und unter Berücksichtigung der angestrebten Feuerwiderstandsdauer erreichbaren Brandschutzes. Regeln für die praktische Anwendung werden gegeben. Einzelne dieser Konzepte werden an Beispielen illustriert.

Im zweiten Teil werden die Probleme besprochen, welchen die Verfasser die grösste Priorität in der zukünftigen Forschungstätigkeit einräumen. Die Anwendung von rechnerischen Methoden zur Beurteilung eines wirksamen Brandschutzes wird immer mehr akzeptiert und die Notwendigkeit einer klaren Festlegung der Feuersicherheitsziele im Rahmen eines umfassenden Sicherheitskonzepts wird in steigendem Masse anerkannt.



## 1. INTRODUCTION

The decrease of steel strength properties at elevated temperatures ( $> 300$  °C) is now well established. This might induce in the public mind a certain reluctance to use structural steel in buildings. To prevent loss of strength and consequent risk of structural failure due to fire, it is essential to provide protective measures which isolate structural steel elements from direct heat attack.

Obviously the more protection there is, the higher the fire resistance will be, but the question arises, to what extent is the increase in fire resistance justifiable economically ?

After discussing the cases where it is accepted that it might be unreasonable to protect steel structures, this paper presents, in its first part, some current types of passive protection measures and their effectiveness with regard to the expected fire resistance duration. The second part of the paper gives particular examples of recent buildings, which illustrate the applications of different types of structural fire protection, and the third part draws attention to several priorities for research which could stimulate the use of structural steelwork for buildings.

## 2. THE PRACTICAL ASPECTS OF FIRE PROTECTION OF STEEL STRUCTURES, SOME GUIDELINES FOR CORRECT PRACTICE

Under the conventional procedure to determine standard fire resistance, it has been proved that unprotected structural steel sections in common use will carry loads for some ten to fifteen minutes. This period is related to the standard fire exposure and is referred to as the "fire resistance time". With such a reduced response in fire, it may be thought that steel structures are unsafe without protection, but it should be borne in mind that this low fire resistance is related to the standard fire test procedure, which has definite limitations and has been the subject of numerous criticisms.

A major decision for the designer is to determine, whether or not it is necessary to provide fire protection for the steel elements, through insulating materials or cladding, or any protective measures provided by such techniques as screens (e.g. false ceiling) or systems like water-filled hollow sections. The decision is dictated by the necessary safety requirements, the cost and/or aesthetic considerations.

Some national regulations have begun to reflect the relative importance of the fire resistance of structural elements among the fire safety measures in building. Also some national fire codes do not require fire resistance for low-rise construction (1), or for structures used for activities which do not lead to excessive fire loads. In sport halls, certain industrial halls, etc... there are very low risks of flash-over or even fire which could result in any danger for an unprotected steel structure. Experimental evidence (fig. 1) of real fire behaviour shows that for fire loads less than 15 kg of wood equivalent per square metre of floor area, it would generally be unnecessary to improve the structural fire resistance by protective measures. The costs of fire protection are sometimes not fully justified in terms of loss reduction, and more advantages can be obtained from control and fire prevention measures.



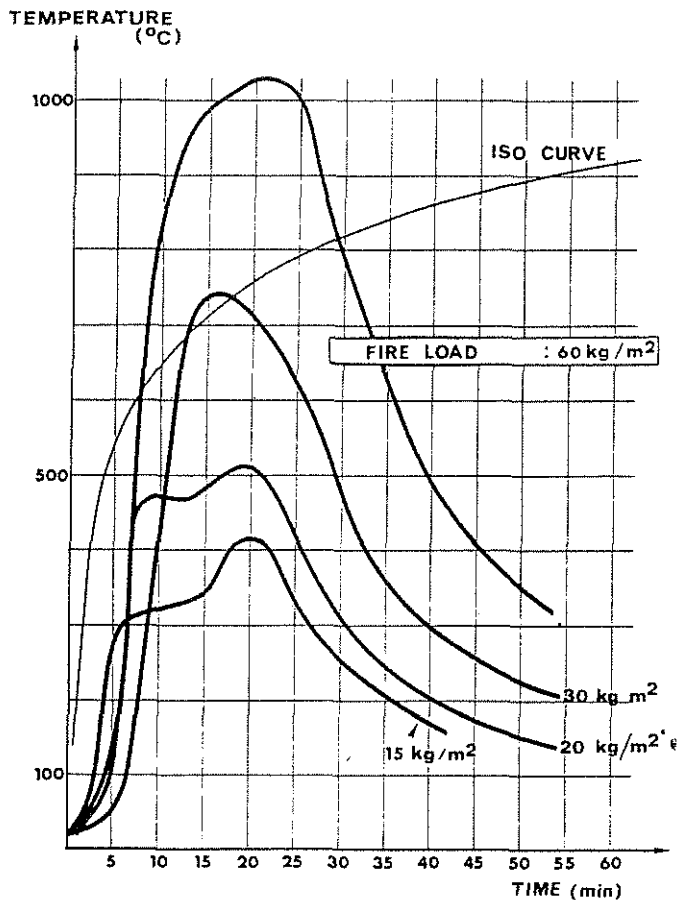

Fig. 1  
Natural fires behaviour  
under different fire loads

It is generally accepted that casualties, structural damage, and damage and loss to the contents of the building are more efficiently avoided by using active fire protection measures rather than passive protection measures.

Active fire protection measures include detection systems, sprinklers, which suppress a fire at an incipient stage, and smoke controlled dilution or ventilation systems.

Clearly, arbitrary requirements for fire resistance serve little purpose. Much can be gained by a careful and coordinated fire design which makes use of complementary fire safety measures.

#### 2.1. Accepted cases of unprotected steel structures

In some countries, the official regulations do not require any fire resistance for single storey buildings. However, specific safety measures may be required by the regulations or be demanded by the controlling authorities depending upon the type of activity associated with the building, the floor area and the number of people occupying or using the building.

#### 2.2. Unprotected steel complying with the 1/2 h resistance requirements

In relation to fire resistance requirements, many building codes single out structural elements according to their particular functions. In general, the only structural elements to be checked for their fire resistance rating are those which actually ensure the proper general load bearing function of the structure, or which contribute to the effectiveness of the fire compartmentation.



Compared to other constructional materials (concrete, wood) the fire resistance time of 1/2 h under standard fire conditions is certainly the most unfavourable requirement for steel construction, from an economical point of view.

#### 2.2.1. Bare structural elements

The fire rating of 1/2 h may be obtained for structural elements with a so called "section factor" or "massivity factor" less than  $F_s/V_s = 30\text{m}^{-1}$ , (where  $F_s$  is the fire exposed surface and  $V_s$  the volume per unit length of the steel structure. However, these massive elements are rare in building construction, where most steel elements in current use have a section factor greater than  $200\text{m}^{-1}$ . Depending upon the critical temperature of the bare steel element, a fire resistance of about 15 minutes may be expected when these elements are subjected to the standard fire test.

To achieve a greater fire resistance, by increasing the critical temperature of the steel elements, it is necessary to alter simultaneously or separately the section factor, the stress level and the grade of steel. Certainly, the most efficient way of improving the fire resistance of a steel structure is to make use of design concepts which involve statically indeterminate structures.

#### 2.2.2. Mixed construction of steel and concrete

By conveniently associating steel and concrete, fire stability may be improved beyond the critical 30 min without externally protecting the steel. The structural elements of composite construction comprise :

- composite floor consisting of a steel beam and a concrete slab,
- concrete-filled hollow tubular sections,
- composite deck composed of a corrugated metal sheet and concrete slab.

The steel which is associated with the concrete slab to form the composite structural element does not itself have improved fire resistance. The increase in fire resistance for standard fire exposure above 30 minutes is generally provided by additional reinforcing bars which are incorporated in and protected by the concrete. In the case of continuous composite beams, special care must be taken in choosing the type of reinforcing bars under negative bending moment, as premature failures have been experienced with low-ductile bars.

A great number of experimental results is given in the literature (2) for these elements, and the data are still being analysed. Calculation methods are being developed, and as soon as their reliability has been established, the methods will be incorporated, in the form of technical notes, in the European Recommendations for the calculation of fire behaviour of steel structures (3). In addition, much information exists in the form of data bases, which may be useful in evaluating the fire resistance of such structural elements by means of a judicious analogy.

#### 2.2.3. External structural elements exposed to fire

It is known that structural elements which are in the open air outside the fire compartment, and thus not exposed directly to the fire, may not reach a critical temperature.

The fire exposure of elements such as external columns and beams varies not only with the position in relation to distance from the façade, but also with the fire load of the compartment, the window opening and shape, and random influence of wind speed and direction.



In order to lower the rate of temperature rise, external columns should be placed at a certain distance from the façade, or should be protected by screens, so as not to be placed in direct contact with the flame and also to be protected from radiated heat. A screen may be naturally provided by the mullions. Furthermore, experimental evidence shows that beam to column connections are of major importance and much can be gained from using rigid connections (4).

But, on account of the very complex fire behaviour, the knowledge concerning the heating process of the external steel elements during these last years has been greatly improved, the evaluation of the external heating process tending to become as reliable as the determination of the temperature field evolution inside the compartments. Compared with experimental observations, calculated structural response gives prediction on the safe side (4,5).

Tests on pins ended columns may provide us with some useful information on the heating process, but more may be gained from sub-assemblies of structural elements. They show the role played in the fire resistance by the connections (4,5); together with the non uniform temperature field, this may explain the remaining difficulty in getting inaccurate prediction of the outside column fire response.

### 2.3. Protected structures

Depending upon the fire insulation material and its thickness, 1/2 hour to 4 hours fire resistance for load bearing structures subjected to the standard fire exposure can be achieved.

A great variety of fire-protection methods and techniques exist which may be summarized under the following headings :

- intumescent paint
- spray applied material
- individual encasement of the steel structural element with wallboard type of material or concrete
- structural elements protected by membrane systems.

#### 2.3.1. Intumescent paint

Although similar in appearance to normal paintwork, intumescent paint is a coating which swells at about 150°C to 300°C to form a "meringue" whose thickness may reach several centimetres and which acts as a heat shield.

Generally, intumescent paint applied to a steel structural element provides a fire rating of up to one hour. Particular attention should be paid to the quality control of those coatings, and particularly to the durability of the intumescent crust.

#### 2.3.2. Spray applied material

The composition of sprayed products generally involves gypsum, which includes 20 % crystallisation water, or cement and expanded vermiculite, perlite, glass or mineral fibres.

The use of abestos fibres mixed with gypsum or cement has been prohibited in many countries, because of the health hazard they represent, both for workers and occupants.

The fire performance of these spray compound product depends largely on :

- the thermal conductivity, specific heat capacity and thickness of the material itself. Test methods have been proposed for measuring these properties (7, 11).
- the mechanical behaviour of the material under impact if subjected to knocks at ambient temperatures and the tendency to fall off during a fire. Good adhesion to the steel surface is an important requirement for spray applied fire protection materials. Spray material may be applied directly to the steel element or on metal lath fixed to the steel. High fire resistance up to 4 hours may be achieved with such protection.

Several methods of calculation now exist which give the thickness of the protection to be sprayed on structural steel elements. The most sophisticated and general (3,8) takes into account the loading to determine the critical temperature, and then the resistance time. Others have derived (9) empirical formulas based on tests which give directly the resistance time for a fixed critical temperature ( 550°C).

#### 2.3.3. Individual steel structural elements encased with concrete or boards

In this case, the concrete encasement serves only as a protective material and does not carry any load. An empirical equation has been developed (9) which is based on the thermal properties of concrete and on the equilibrium moisture content by volume of the concrete.

References (3,8) also provide a general approach to evaluating the fire resistance of steel sections encased in concrete.

Columns or beams may also be protected against fire by gypsum wall-boards, supplied in a range of thicknesses, which are assembled around the steel shape. The fire resistance is very sensitive to the fabrication and special care should be taken, on site, to verify that the wallboard assembly fixing system (type and spacing of fasteners), furring channels, seam joints, and sheet steel covers, if any, are the same as for the particular fire-resistance assembly tested.

#### 2.3.4. Structural elements protected by membrane protection systems

Because of the complexity of a load carrying stress system, the best method of achieving the desired standard of protection is to encase the whole structural element between partition walls, thus preventing the passage of fire. In this case, it is particularly important to give careful consideration to any constructional details which may cause the fire to spread.

The technique of compartmentation is also very important in floor and roof construction. Floors in multi-storey buildings generally constitute the major compartment boundaries which prevent the spread of a fire and provide horizontal barriers which force the smoke into the shafts.

Many tests, under standard fire, have been performed on all types of construction systems. The most common type of floor system used in steel construction is the composite floor, with structural steel beams (steel joist, castellated beams, rolled or welded shape) shear-connected to a concrete slab or a composite slab (cold formed steel floor and concrete). Fire protection methods for these types of floor consist of various suspended ceiling systems and spray-applied fire protection. No calculation method exists for such types of floor systems, and fire resistance performance should be evaluated from results of available tests. Monographs (2) have been published which show how to estimate, on a comparative basis, the structural fire resistance of the proposed construction.



### 2.3.5. Water filled hollow section

Many of the protection systems which have been described do not allow the structural steel to be exposed, and this is detrimental to the architectural character of steel structures.

The idea of liquid-filled columns between floors and unconnected with pipe loops was originally patented in 1884 by G.F. WRIGHT.

Important structural systems have been achieved using the techniques of water-filled hollow structural elements; they are now well accepted methods in the U.S.A. and Europe.

The application of this technique requires particular attention to the design of the water circulation system. The replenishment of the water evaporated is assured either by gravity through a storage tank or by a pressure pump system. Corrosion inhibitors should be incorporated in the water and in cold climates an antifreeze agent is required. The water flow pattern of a locally heated column is not yet well understood.

An experimental standard fire test on a 250 x 250 mm column filled with water shows a fire resistance of 30 minutes. Water cooled steel columns will be largely below the critical temperature value of the steel, if water circulates properly and if the formation of steam traps is avoided.

The concept of water filled structures has been largely extended to fulfil more than one function. Several examples (10) of water filled structures coupled with an integrated heating and cooling system have been built which have permitted greater economies of the project. Moreover truss systems have been erected whose main members are hollow sections, filled with water, which serves as a network for a sprinkler system.

## 3. INTERESTING USES OF STEEL IN BUILDINGS IN RELATION TO FIRE SAFETY

The building described in this chapter illustrate some of the design approaches outlined in paragraphe 2.

### 3.1. U.S. Steel Corporation Headquarters, Pittsburgh, USA (12)

Architects : Harrison & Abramovitch and Abbe

Structural Engineers : Worthington, Skilling, Helle & Jackson, and Edwards & Hjorth.

For this 64-storey office building the external columns are of weathering steel and are filled with water for fire protection. The columns are fully connected and designed on the assumption that the water flow will be induced when fire heats some columns while others remain cool. Despite the columns being at a distance of about 0.9 m from the external façade, the authorities required a fire resistance of 4 hours and it was necessary to provide storage tanks to replenish the water which would be boiled off by this length of exposure. The height of the building (about 257 m) could have produced very high water pressure and therefore the system is divided into 4 vertical zones. The performance of the cooling system and the amount of water storage was established by calculation (13).

### 3.2 W.D. and H.O. Wills, Head Office, Bristol, England (14)

Architects : Skidmore, Owings and Merrill, Chicago ;

York Rosenberg Mardall, London

Structural Engineers : Felix J Samuely and Partners

This an example of the use of exterior weathering steel without cladding, the waiver of the requirements of building regulations for fire resistance being based on calculations.



The head office building for W.D. and H.O. Wills has a five-storey steel frame section above a two-storey concrete podium, the upper floors being 67 x 28.8 m on plan. The exterior structure stands about 1.8 m in front of the glazing line on all sides of the building. The outer columns and the tie beams connecting them in the outer plane are in exposed weathering steel. The transverse beams that penetrate the façade are encased in concrete and clad in weathering steel sheet. A weathering steel grille is placed at each floor level, between the facade and the exterior structure. Calculations were made of flame projections from the windows and the heat transfer to the exterior steel, in conjunction with the Fire Research Station, Borehamwood, to support the application for a waiver.

### 3.3. Liberty Plaza Building, New York City (15)

Architect : Skidmore, Owings and Merrill

Structural Engineers : Weidlinger Associates and Weiskopf & Pickworth (joint venture)

This is an example of using deep spandrel girders to form the façade of the building. Because tests demonstrated that the fire exposure above the window openings would be low, the external face of the web is fully exposed.

The 54-storey office building was developed by the Galbreath-Ruffin Corporation in association with the US Steel Corporation. Each floor is approximately 68.5 x 49.5 m with 2.59 m floor to ceiling height. The structure is a rigid steel frame with wide bays on the exterior and clear span from the exterior to the core.

The long elevations have five structural bays, with three bays on the short sides. The deep spandrel girders are the same depth as the window openings, 1.78 m. The flanges are protected with sheet steel flame shield and sprayed mineral fire protection is applied to the inside surfaces. The webs of the spandrel girders are fully exposed externally, and painted black.

Approval for the use of the exposed spandrel girders was only given by the New York City authorities after full scale fire tests on a mock-up of one bay had been carried out (16,17).

### 3.4. The Royal Exchange Theatre, Manchester, England (18)

Architects : Levitt Bernstein Associates,

Structural Engineers : Ove Arup & Partners

For this building, figure 2, a fire engineering appraisal was used to demonstrate that cladding of the steel was not essential for the purposes of building regulations. The Royal Exchange Theatre is a concentric auditorium standing within the Great Hall of the Manchester Royal Exchange - formerly used for trading in cotton. There is an open-stage auditorium, seven-sided in plan with stage and seating for 450 at the level of the Exchange floor and two galleries above, each of which seats a further 150 people. The Theatre is clad with toughened glass and roofed with metal decking. It was imperative to develop as light a structure as possible and this, taken together with the desire to achieve a high degree of transparency, led to a system of tubular steel trusses from which the galleries are suspended, the trusses being supported by existing brick piers.

A full fire engineering appraisal was carried out, in cooperation with the city authorities, and this led to an agreement that the steelwork could remain unprotected, thus avoiding the cost and additional weight and bulk of fire cladding. The appraisal included an examination of means of escape, smoke generation and crowd movements being carefully analysed, and a generous number of exits was provided. It was established that should the fire remain unchecked after evacuation, the floor of the Exchange could survive collapse of the structure and consequently there would be no additional hazard to fire fighters.

Non-combustible or low flammability materials are used throughout, and arrangements have been made to ensure detection of a fire and for surveillance by the theatre staff whenever the public is present.

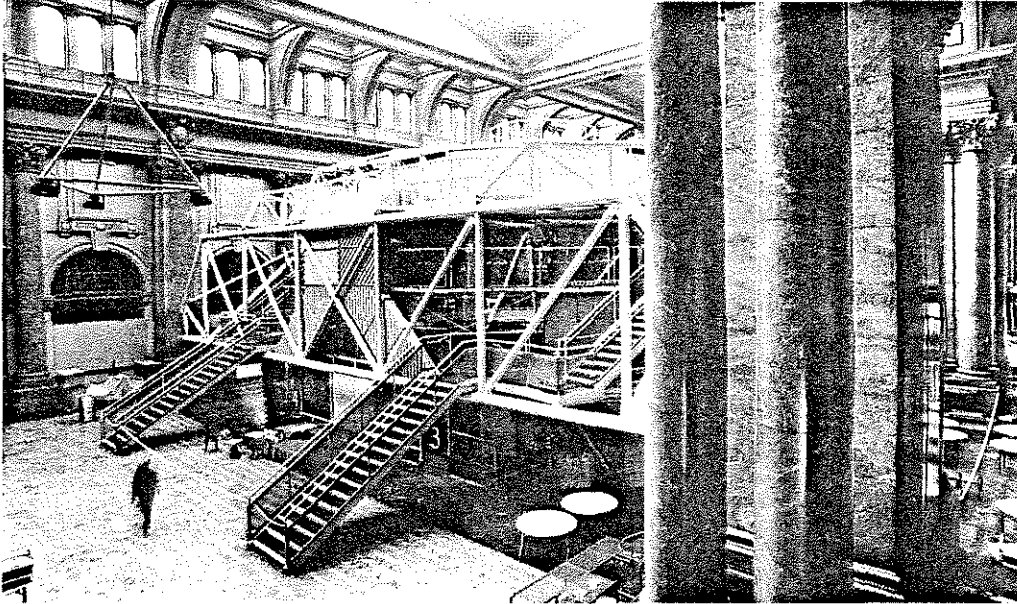

Fig. 2 Royal Exchange Theatre-Manchester

### 3.5 Centre Pompidou, Paris, France (19)

Architects : Piano and Rogers,  
Structural Engineers : Ove Arup & Partners

Much of the structure of this building is exposed externally (figure 3). Where calculation of the external fire exposure showed protection of the elements to be necessary to reach the 2 hours fire rating required, protection was provided generally by water cooling or by shielding although a few parts have conventional fire protection. The Centre Pompidou has a steel superstructure rising above a concrete substructure. The main building has six storeys above ground, each 7 m high and 166 m long. The main lattice girders span 44.8 m between short cantilevers projecting from the main columns, the outer ends of the cantilever members being restrained by vertical ties. The glazing line generally follows the junction between the lattice girders and cantilever brackets. The main columns are 1.6 m outside this line and are water filled for fire protection, circulation being achieved within each column by pumps. The cantilever brackets are 7.6 m long; thus the outer line of tension "columns" and associated bracing members are 7.6 m from the windows. Calculations showed that in the event of fire, all the members on the outer plane are protected by virtue of the 7.6 m distance from the windows; the cantilever brackets are shielded by fire-resistant panels in the façade. There are sprinklers on the external walls and the cantilevers. Horizontal bracing members close to the windows would be lost in a fire, but with each floor divided into two compartments, the loss of a proportion of the bracing does not endanger resistance.

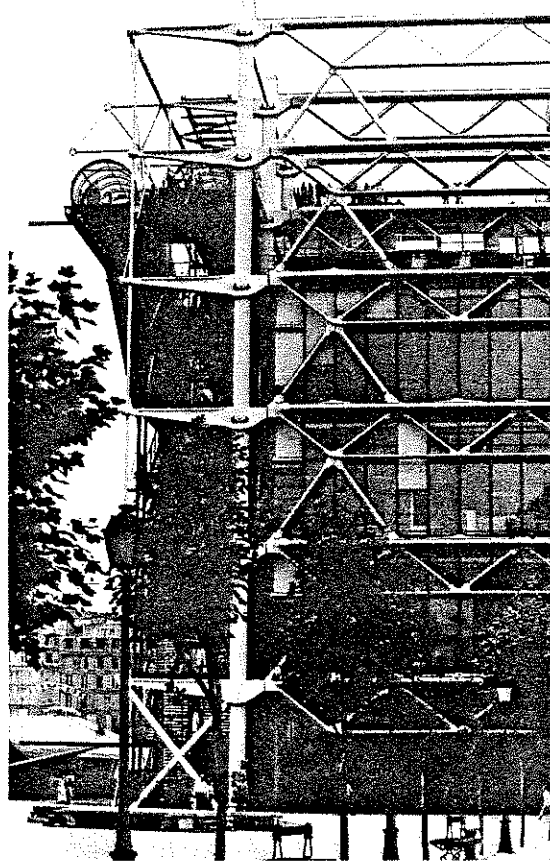

Fig.3. - Pompidou Center  
Paris

3.6) Bush Lane House, London, England (20).

Architects & Structural Engineers : Arup Associates.

Prior to the construction of this building (figure 4), water cooling had only been used for the protection of vertical columns, since its use for beams raises considerable difficulties in ensuring that adequate controlled water flow occurs and no steam pockets develop. In Bush Lane House, water cooling is used for the external structural steel and protects columns, lattice members, and a critical top horizontal member. Bush Lane House provides eight office floors above a first-floor plant room. Each typical floor is approximately 35 m long x 16 m wide, supported by the lift core and three columns set 11 m from the extremities of the building. The stainless steel lattice which transmits the floor loads is external to the building envelope and leaves the office space uninterrupted. The steel members are water filled and inter-connected, so that in the event of fire the water circulates and steam is vented at high level or separated in a tank on the roof. This tank also serves as a reservoir to replenish and keep the system full of water. The patterns of water flow, maximum potential steel temperature, and the amount of water storage were all established by calculation.





Fig. 4 - Bush Lane House  
London

### 3.7) Central Bank Offices, Dublin, Eire (21)

Architects : Stephenson Gibney and Associates,  
Structural Consultants : Ove Arup & Partners, Dublin.

For this building (figure 5) the critical condition for failure of the steel hangers was established by calculation, since no standard test method was appropriate for tension members. In addition, the fire exposure of the hangers, being external, was calculated so that the necessary cladding could be determined. The main building of the Central Bank offices complex in Dame Street, Dublin, is an eight-storey block with 8500m<sup>2</sup> of office space. Uninterrupted floor areas and minimal obstruction to windows were considered to be of significant architectural advantage. The floors, measuring 45 m x 30 m are supported at 12 hanger points around the perimeter and on twin reinforced concrete cores. From the hanger points the loads are transmitted directly to roof level through pairs of high tensile Macalloy steel bars. Cantilever frames transmit the vertical reactions to the cores. The fire protection of the Macalloy bar hangers presented a somewhat unusual problem. They were to be exposed on the façade of the building and it was of considerable architectural importance that they be expressed as separate bars.

It was essential therefore to provide a fire cladding which would give adequate protection without being very thick, since each 40 mm bar was to be encased in an aluminium tube not exceeding 120 mm diameter. A research programme was necessary to establish the Macalloy steel characteristics, thus leading to a definition of the critical condition for the structure under fire exposure. Fire engineering calculations established that the bars would be less severely exposed than internal members and the cladding finally adopted was 20 mm thick Marinite machined to form interlocking sections round the bars.

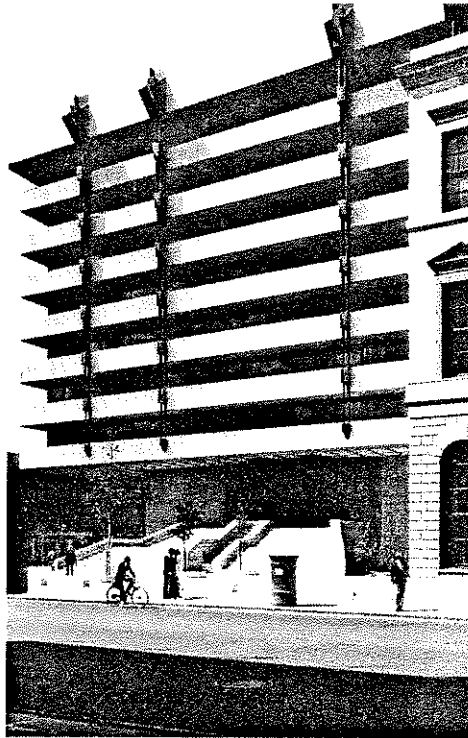

Fig. 5 - The Central Bank,  
Dublin

#### 4. PRIORITIES FOR FUTURE ACTION AND RESEARCH

During the last two decades a great deal of research has been devoted to studying structural behaviour under different fire conditions. Certainly the knowledge gained by the experimental and analytical studies is the reason why the calculation methods to determine fire behaviour and resistance are now recognized on a regulatory basis as equivalent to laboratory tests. Now is the time for a change of priorities for research programmes. They should be more oriented towards a better assessment of fire risks in relation to safety considerations in order to establish more rational requirements for structures and components (25).

a) Most of the existing building regulations for fire safety are not based on a clear definition of safety objectives. The reason may be attributed to the fact that existing building regulations are the results of a compilation of rules based on history and past experience in the country concerned.

Obviously, comparison of the national fire building requirements of different countries will show considerable discrepancies. Consequently, it is thought that harmonization of regulations is unlikely to be achieved through a comparison of existing national code requirements, but it should be the consequence of a thorough examination and definition of the potential risk that society is ready to accept. It should be borne in mind that in some circumstances, it is impossible to guarantee full protection against fire, e.g., when fire has a criminal origin.

Some tentative approaches have been made in this direction (22,23,24,26 ) and they need to be more widely developed and justified.

In this context, a thorough examination of data and a survey of potential hazards is certainly of a major importance.



Quantitative methods need to be derived, to evaluate the fire risks, and to scale the required structural fire protection together with alternative protection measures. For example, statistics indicate that the risk of a serious fire occurring in open parking place is negligible ; despite this fact, not all countries accept unprotected steel structures in open car parks.

b) Substantial reduction in structural fire resistance requirements should be allowed in the presence of an approved automatic sprinkler system. For some countries but not all, recommendations exist for the design, the installation, the quality control and the inspection of sprinkler systems, and the reliability of such systems has been established.

c) Studies should be carried out to determine the fire endurance of various structural components such as floor and ceiling assemblies, load-carrying structural members or stability members encased between wallboards. Attention should be paid to the overall fire behaviour of such assemblies ; for example, a very flexible floor system under fire may fail to prevent flame passage at the horizontal intersection between the floor and the wall or the ceiling and the wall.

d) Codes of good practice need to be developed for architects, and decision makers, which explains when structural fire protection is needed, and which give information on different methods of providing fire protection to steelwork and their relative costs.

e) It has been argued that at present in several countries the insurance policy for individual buildings often discriminates against structural steel. Efforts should be intensified to remove the difference in insurance premiums for steel and concrete structures.

## 5. CONCLUSIONS

The competitiveness of structural steelwork for buildings, in relation to other structural materials, is impaired both by excessive requirements with regards to fire protection and also by higher insurance premiums for steel than concrete structures. Certainly a rethinking of the current fire regulations, with a view to a better assessment of the fire risk and safety objectives, would give a better approach to an optimum level of fire protection design.

Despite the implications of the above mentioned problems on the use of steel in buildings, much will be gained if suitable fire design strategies relative to active or passive protection measures, are clearly defined at an early stage, in the conception of a project. In such a design within the frame work of these strategies, the load bearing structure should be dealt with as a component in an integrated fire hazard evaluation of the total active and passive fire protection for a building. This would open the door for assessing the effects of trades of and for comparing alternative designs for the total fire protection with the same level of safety from the cost point of view.

REFERENCES

1. Sécurité contre l'Incendie. Dispositions Générales.  
J.O. de la République Française, no 1477, 1981.
2. Lamboley G., Barthelemy B : Recueil d'Essais de Planchers Béton avec Bacs en Acier. Première et deuxième partie, Construction Métallique no. 1-1, 1978.
3. ECCS : European Recommendations for the Fire Safety of Steel Structures. July 1981.
4. Kruppa J. : Comportement au Feu des Poteaux Extérieurs en Acier. Rapport No.1012-4, nov. 1979.
5. Law M., O'Brian. : Fire Safety of Bare External Structure Steel. Constrado May 1981.
6. Ryan I., Kruppa J. : Température en Façade, Résultats Expérimentaux d'Incendies Naturels, C.T.I.C.M. - Rapport no 1012-6, Oct.1980.
7. Standard Methods of Fire Tests of Building Construction and Materials. American Society for Testing and Materials, ASTM E119-79.
8. Méthode de Prévision par le Calcul du Comportement au Feu des Structures en Acier. C.T.I.C.M., Dernière édition, fév. 1982.
9. Designing Fire Protection for Steel Columns, American Iron and Steel Institute, Third Edition, March 1980.
10. Hollow Section, Water Filled Structures. CIDECT no3, October 1980.
11. Methodologie de Caractérisation des Produits de Protection Annexe au DTU, C.T.I.C.M. Dernière Edition, fév. 1982.
12. Anon. US Steel Headquarters Building, Civil Engineering - ASCE, April 1970.
13. Seigel. L.G. : Design of Liquid-Filled Structural Members for Fire Resistance. Acier Stahl Steel, June 1969.
14. Winter, J. : Cigarette Factory, Bristol, Architectural Review 158. (944) pp 198-213, 1975.
15. Anon, Research leads to a bolder expression of the steel frame. Architectural Record 154, July 1973, pp 133-138.
16. Nassetta, A.F. : Exposed Steel Framing on High Rise Buildings. AISC Engineering Journal 6 ( 3 ) July 1969.
17. Seigel, L.G. : Fire Test of an Exposed Steel Spandrel Girder. Materials Research and Standards, MTRSA 10 (2) pp 10-13.
18. Morreau, P. and Baldock, N. : Royal Exchange Theatre, Manchester. The Structural Engineer, July 1978, No. 7, Volume 56A, pp 189-197.
19. Ahm, P.B. et al : Design and Construction of the Centre National d'Art et de Culture Georges Pompidou. Proc. Instn Civ. Engrs. Part 1, 1979, 66, Nov 557-593.
20. Eatherley, M.J. : The Design and Construction of Bush Lane House. The Structural Engineer, February 1977, No.2, Volume 55, pp 75-85.
21. Mc Sweeney, M.F. : New HQ for Central Bank. Irish Engineers, Vol 31, No.2, February 1978, pp 3,5,7-8
22. Méthode GRETENER : Détermination des Mesures de Protection Découlant de l'Évaluation du Danger Potentiel d'Incendie. Association des établissements cantonaux d'Assurance contre l'Incendie et le Service de Prévention d'Incendie pour l'Industrie et l'Artisanat (1973).



23. Méthode E.R.I.C. : Evaluation du Risque Incendie par le Calcul. Fédération Nationale du Bâtiment et des Travaux Publics UTI, DR décembre 1977.
24. General Service Administration, Public Building Service : Appendix D, Interim Guide for Goal Oriented Systems Approach to Building Fire Safety. Building Fire Safety Criteria, Whashington D.C., April 27, 1972.
25. Behets, J.F., and Law, M. : Study of Research into the Behaviour of Structural Steel Elements Exposed to Fire, Report to European Coal and Steel Community, November 1980. CBLIA Brussels, Ove Arup and Partners, London.
26. NFPA, National Fire Protection Association : The Systems Approach to Fire Protection. NFPA - Publications No. SPP-36, Boston 1976.

