



LUND UNIVERSITY

The potential of industrial hemp (*Cannabis sativa* L.) for biogas production

Kreuger, Emma

2012

[Link to publication](#)

Citation for published version (APA):

Kreuger, E. (2012). *The potential of industrial hemp (Cannabis sativa L.) for biogas production*. [Doctoral Thesis (compilation), Biotechnology]. Biotechnology, Lund University.

Total number of authors:

1

General rights

Unless other specific re-use rights are stated the following general rights apply:

Copyright and moral rights for the publications made accessible in the public portal are retained by the authors and/or other copyright owners and it is a condition of accessing publications that users recognise and abide by the legal requirements associated with these rights.

- Users may download and print one copy of any publication from the public portal for the purpose of private study or research.
- You may not further distribute the material or use it for any profit-making activity or commercial gain
- You may freely distribute the URL identifying the publication in the public portal

Read more about Creative commons licenses: <https://creativecommons.org/licenses/>

Take down policy

If you believe that this document breaches copyright please contact us providing details, and we will remove access to the work immediately and investigate your claim.

LUND UNIVERSITY

PO Box 117
221 00 Lund
+46 46-222 00 00



LUND
UNIVERSITY

The Potential of Industrial Hemp (*Cannabis sativa* L.) for Biogas Production

Emma Kreuger

Biotechnology
Doctoral Thesis

Akademisk avhandling för avläggande av teknologie doktorsexamen vid Lunds Universitets tekniska fakultet. Avhandlingen kommer att offentligens försvaras fredagen den 31 augusti kl 13.30 på Kemicentrum, Hörsal B, Sölvegatan 39, Lund.

Academic thesis, which by due permission of the Faculty of Engineering at Lund University, will be publicly defended on Friday August 31 at 1:30 p.m., at the Center for Chemistry and Chemical Engineering, Sölvegatan 39, Lund, for the degree of Doctor of Philosophy in Engineering.

The Faculty opponent is Univ. Prof. Dipl.-Ing. Dr. Andreas Gronauer, Institute of Agricultural Engineering, Department of Sustainable Agricultural Systems, University of Natural Resources and Life Sciences, Vienna.

Doctoral Thesis

Lund University
Faculty of Engineering LTH
Biotechnology

The Potential of Industrial Hemp
(*Cannabis sativa* L.) for Biogas Production
© 2012 Emma Kreuger

ISBN 978-91-89627-84-0
ISRN LUTKDH/TKB--12/1138--SE
Printed in Sweden by E-print, Stockholm 2012

Cover photo, Emelie Jikander

Organization LUND UNIVERSITY Faculty of Engineering LTH Biotechnology P.O. Box 124, 221 00 Lund, Sweden	Document name DOCTORAL DISSERTATION
	Date of issue 2012-06-29
	ISRN LUTKDH/TKB--12/1138--SE
Author(s) Emma Kreuger	Sponsoring organization The Swedish Research Council for Environment, Agricultural Sciences and Spatial Planning
Title and subtitle The potential of industrial hemp (<i>Cannabis sativa</i> L.) for biogas production	
Abstract <p>Biofuels are currently produced from agricultural crops, and an increasing use of crops for this application is expected in the EU in the years to come. The dominating crops cultivated in the EU for biofuel production today have a relatively large environmental impact. The European Energy Agency has identified several lignocellulosic crops, including industrial hemp, as more sustainable potential alternatives. However, the biofuel yield from industrial hemp was largely unexplored before the work presented in this thesis was initiated. In this thesis work, the focus was on the potential of using hemp for methane production through anaerobic digestion.</p> <p>The biomass yield per hectare and the specific methane yield were determined at four different hemp harvest times. The specific methane yield did not change with harvest time, the average yield was 234 ± 35 m³/t volatile solids. The most suitable harvest time was therefore at the time of highest biomass yield, in this study found in the beginning of September to the beginning of October. The biomass energy yield was 186 GJ/ha and the methane energy yield 88 GJ/ha. The effect of storing hemp as silage on the methane yield was investigated. It was found that ensiling conserved the energy efficiently as the same methane yield was achieved before and after more than 3 months storage. It was shown that the methane yield of ensiled crops could easily be overestimated when the dry matter was measured with a standard method. The standard method does not include correction for volatile organic compounds formed during ensiling and lost by evaporation during dry matter determination. A previously developed method for correcting dry matter was demonstrated to be useful in avoiding this error.</p> <p>The effect of chopping, grinding and using acid-catalysed steam pretreatment prior to methane production from hemp, and the effect of combining ethanol and methane production were investigated and compared to methane or ethanol production alone. Methane production or co-production of ethanol and methane gave twice the biofuel yield of ethanol production alone. The use of steam pretreatment gave a similar methane yield to that from ground hemp, but higher than that from chopped hemp. Addition of external cellulolytic enzymes in a separate hydrolysis step after steam pretreatment, prior methane production, did not give a higher methane yield, than direct anaerobic digestion after steam pretreatment. The experimental data on production of these biofuels was combined with heat and power production in techno-economical modelling of a large-scale plant. Methane production or co-production of ethanol and methane production together with combined heat and power production showed high energy efficiencies and similar economic performance. Chopped and steam-pretreated hemp performed similarly economically in biogas production when combined with heat and power production. The co-production of methane, heat and power satisfied the energy requirements of the process and yielded a surplus of sellable products such as methane, electricity and district heating corresponding to 71–75% of the energy of the biomass. Despite high energy efficiencies none of the processes analysed would be economically viable today. The cost of the feedstock accounted for more than half of the total process cost. For the co-production of biogas, heat and power to be economically viable, the total cost would have to be reduced by one third. Alternatively, the methane sale price would have to increase by more than 50% to 3.6 SEK/m³. The yields of methane and ethanol were found to influence the process economy considerably. The production of electricity and heat had a significant influence on the energy efficiency but less on the process economy.</p>	
Key words Biogas, anaerobic digestion, bioenergy, <i>Cannabis sativa</i> L., hemp, energy crops	
Classification system and/or index terms (if any)	
Supplementary bibliographical information	Language English
ISSN and key title	ISBN 978-91-89627-84-0
Recipient's notes	Number of pages 124
	Price
	Security classification

Distribution by (name and address)

I, the undersigned, being the copyright owner of the abstract of the above-mentioned dissertation, hereby grant to all reference sources permission to publish and disseminate the abstract of the above-mentioned dissertation.

Signature

Date 2012-06-29

To my family, and coming generations

“All truth comes from nature”
Himalayan nomad saying

Abstract

Biofuels are currently produced from agricultural crops, and an increasing use of crops for this application is expected in the EU in the years to come. The dominating crops cultivated in the EU for biofuel production today have a relatively large environmental impact. The European Energy Agency has identified several lignocellulosic crops, including industrial hemp, as more sustainable potential alternatives. However, the biofuel yield from industrial hemp was largely unexplored before the work presented in this thesis was initiated. In this thesis work, the focus was on the potential of using hemp for methane production through anaerobic digestion.

The biomass yield per hectare and the specific methane yield were determined at four different hemp harvest times. The specific methane yield did not change with harvest time, the average yield was 234 ± 35 m³/t volatile solids. The most suitable harvest time was therefore at the time of highest biomass yield, in this study found in the beginning of September to the beginning of October. The biomass energy yield was 186 GJ/ha and the methane energy yield 88 GJ/ha. The effect of storing hemp as silage on the methane yield was investigated. It was found that ensiling conserved the energy efficiently as the same methane yield was achieved before and after more than 3 months storage. It was shown that the methane yield of ensiled crops could easily be overestimated when the dry matter was measured with a standard method. The standard method does not include correction for volatile organic compounds formed during ensiling and lost by evaporation during dry matter determination. A previously developed method for correcting dry matter was demonstrated to be useful in avoiding this error.

The effect of chopping, grinding and using acid-catalysed steam pretreatment prior to methane production from hemp, and the effect of combining ethanol and methane production were investigated and compared to methane or ethanol production alone. Methane production or co-production of ethanol and methane gave twice the biofuel yield of ethanol production alone. The use of steam pretreatment gave a similar methane yield to that from ground hemp, but higher than that from chopped hemp. Addition of external cellulolytic enzymes in a separate hydrolysis step after steam pretreatment, prior methane production, did not give a higher methane yield, than direct anaerobic digestion after steam pretreatment. The experimental data on production of these biofuels was combined with heat and power production in techno-economical

modelling of a large-scale plant. Methane production or co-production of ethanol and methane production together with combined heat and power production showed high energy efficiencies and similar economic performance. Chopped and steam-pretreated hemp performed similarly economically in biogas production when combined with heat and power production. The co-production of methane, heat and power satisfied the energy requirements of the process and yielded a surplus of sellable products such as methane, electricity and district heating corresponding to 71–75% of the energy of the biomass. Despite high energy efficiencies none of the processes analysed would be economically viable today. The cost of the feedstock accounted for more than half of the total process cost. For the co-production of biogas, heat and power to be economically viable, the total cost would have to be reduced by one third. Alternatively, the methane sale price would have to increase by more than 50% to 3.6 SEK/m³. The yields of methane and ethanol were found to influence the process economy considerably. The production of electricity and heat had a significant influence on the energy efficiency but less on the process economy.

Keywords: biogas, anaerobic digestion, bioenergy, *Cannabis sativa* L., hemp, energy crops

Populärvetenskaplig sammanfattning

Transportsektorn står för 63% av Sveriges användning av kol, olja och gas. Biobränslen som etanol, biodiesel och biogas står bara för 6.8% av energin som används för nationella transporter, biogas står för 12% av detta. Ökad produktion av biobränslen för transporter behöver inte betyda minskad produktion av jordbruks- och skogsråvaror för annat. Dels kan restprodukter användas i ökad omfattning och dels finns det omfattande arealer jordbruksmark runt om i världen som inte används. I Sverige är 177 000 ha eller 7% av åkermarken avställd (2010).

Vilka grödor är då lämpliga som energigrödor? Hur mycket energi man får ut per hektar och hur mycket energi som går åt för produktionen är kanske de första avgörande faktorerna man tänker på. Effekten på växthusgasutsläpp har också diskuterats intensivt de senaste åren. Men, det finns även andra faktorer som är viktiga för hållbar odling, nämligen grödornas effekt på jorden och omgivningen. För en låg påverkan av sjukdomar hos grödor bör man år till år växla vilka grödor man odlar på samma plats. Vid val av energigrödor är det därför fördelaktigt att använda andra grödor än livsmedelsgrödor, då kan de användas som avbrottsgrödor mellan livsmedelsgrödor. För produktion av fordonsbränslen är tyvärr vete, *Triticale* och raps de mest använda grödorna i Sverige idag, vilka alla är vanliga livsmedels- och fodergrödor. Vete och *Triticale* för etanol, raps för biodiesel.

Vi har studerat möjligheten att använda en fibersort av industrihampa (*Cannabis sativa* L.) som energigröda för produktion av biogas. Hampa odlades och användes tidigare för fiberproduktion i Sverige men var länge förbjuden på grund av innehållet av drogen Δ^9 -tetrahydrocannabinol (THC). Nu finns det varianter med mycket låga THC halter som är tillåtna att odla och hampan har blivit en återupptäckt gröda.

Hampan ger hög avkastning av biomassa per hektar. Den blir över två meter hög och formar ett tätt lövverk vilket kväver de flesta ogräs. Den kan framgångsrikt odlas utan kemiska bekämpningsmedel och är lovande som avbrottsgröda i växtföljder.

Vi har utvärderat vilken tid det är lämpligt att skörda hampa för biogasproduktion och hur mycket biogas den ger. Vi fann att september och början av oktober ger högst utbyte biogas per hektar. Biogasutbytet per kilo hampa (jämfört på torrbasis) var inte högt, men eftersom hela plantan används och biomasseutbytet per hektar var relativt högt blev utbytet av fordonsbränsle per hektar högre än exempelvis vid produktion av

etanol från vete och biodiesel från raps.

Förbehandling med syrakatalyserad ångbehandling ökade utbytet lite. Samproduktion av etanol och biogas gav ytterligare lite högre utbyte av fordonsbränslen än ren biogasproduktion. Vi testade också att kombinera förbehandling och tillsatts av cellulosedbrytande enzymer före biogasproduktionen. Dessa enzymer använder man vid etanolproduktion från cellulosa. Enzymtillsattsen gav inte några tydliga fördelar, vi fick lika mycket biogas på ungefär samma tid med och utan enzymtillsatts.

Är det då ekonomiskt möjligt att använda hampa som biogasråvara? Vi gjorde en ekonomisk analys för några olika varianter av biogasproduktion och kombinerad biogas och etanolproduktion i en stor anläggning, med hampa från ca 5% av Skånes jordbruksmark. Utbytet av biogas eller biogas och etanol motsvarade hälften av energin i hampan. Genom kraftvärmeproduktion från resterna kunde anläggningen bli helt självförsörjande på energi och dessutom kunde ytterligare upp till en tredjedel av energin i hampan säljas som el och värme. Ekonomiskt spelade det ingen större roll om man bara hackade hampan grovt eller förbehandlade den med ånga och syra före biogasproduktion, eller om man producerade etanol från en del av materialet alternativt använde allt för biogasproduktion. Men, trots hög energieffektivitet, var ingen av de studerade processkombinationerna ekonomiskt lönsamma. Produktion och transport av hampan stod för upp till två tredjedelar av den totala kostnaden. För att få lönsamhet idag skulle den totala kostnaden behöva minska med en tredjedel, eller så skulle priset för uppgraderad biogas till producenten behöva öka med åtminstone 3,6 kr/m³.

Papers

- I Emma Kreuger, Thomas Prade, Federico Escobar, Sven-Erik Svensson, Jan Erik Englund, Lovisa Björnsson, Anaerobic digestion of industrial hemp – Effect of harvest time on methane energy yield per hectare *Biomass and Bioenergy* **35** (2) 893–900 (2011)
- II Emma Kreuger, Ivo Achu Nges, Lovisa Björnsson, Ensiling of crops for biogas production: Effects on methane yield and total solids determination *Biotechnology for Biofuels* **4**:44 (2011)
- III Bálint Sipos, Emma Kreuger, Sven-Erik Svensson, Kati Réczey, Lovisa Björnsson, Guido Zacchi, Steam pretreatment of dry and ensiled industrial hemp for ethanol production *Biomass and Bioenergy* **34** (12), 1721–1731 (2010)
- IV Emma Kreuger, Bálint Sipos, Guido Zacchi, Sven-Erik Svensson, Lovisa Björnsson, Bioconversion of industrial hemp to ethanol and methane: The benefits of steam pretreatment and co-production *Bioresource Technology* **102** (3) 3457–3465 (2011)
- V Zsolt Barta, Emma Kreuger, Lovisa Björnsson, Effects of steam pretreatment and co-production with ethanol on the energy efficiency and process economics of combined biogas, heat and electricity production from industrial hemp *Manuscript*

My contributions to the papers

- I** I supervised the anaerobic digestion trials. I contributed in the statistical analysis, and wrote the major part of the paper. I coordinated the writing of the paper.
- II** I made a major contribution to the design and planning of the study. I performed the major part of the ensiling experiments and chemical analyses. I performed the statistical analysis and wrote the major part of the paper. I coordinated the writing of the paper.
- III** I was involved in the experimental planning. I read and commented on the manuscript.
- IV** I had the main responsibility for planning the study and made the major contribution to the overall experimental design. I planned and performed the anaerobic digestion trials. I made a major contribution to the data analysis, wrote the major part of the paper and coordinated the writing.
- V** I contributed in the choice and design of scenarios. I provided input data for, and designed, the anaerobic digestion part. I wrote part of the manuscript and read and commented on the other parts.

Abbreviations

AD	anaerobic digestion
AIL	acid insoluble lignin
ASL	acid soluble lignin
BMP	biochemical methane potential test
CHP	combined heat and power
COD	chemical oxygen demand
CSTR	continuously stirred tank reactor
DM	dry matter (regarded as equivalent to TS in this thesis)
EEA	European Environment Agency
HHV	higher heating value
HMF	5-hydroxymethyl-2-furaldehyd
LHV	lower heating value
SSF	simultaneous saccharification and fermentation
SP	steam pretreated
TS	total solids
THC	Δ^9 -tetrahydrocannabinol
TS	total solids (regarded as equivalent to DM in this thesis)
VFA	volatile fatty acid
VS	volatile solids

Table of contents

Introduction.....	I
Aims of the studies.....	4
Background	
Biomass for bioenergy.....	5
Biomass potential.....	5
Political goals for bioenergy.....	6
Transition from fossil energy in Sweden.....	6
Is anaerobic digestion of hemp a sustainable option?.....	6
The influence of crop diversity.....	7
Hemp can be cultivated without herbicides and pesticides.....	8
Soil carbon and soil structure.....	8
Nutrient demand and eutrophication.....	9
Energy output.....	9
Energy input and economic performance.....	10
The structure and composition of hemp.....	11
Hemp stem structure.....	11
Cellulose.....	12
Hemicellulose and pectin.....	12
Lignin and other secondary metabolites.....	12
Anaerobic digestion.....	13
Determining the methane potential.....	14

Anaerobic digestion of lignocellulose.....	15
Cellulose.....	16
Hemicellulose.....	16
Lignin.....	17
Nutrient demand.....	17
Inhibition.....	18
Ensiling for storage.....	19
Co-production of ethanol and methane.....	19
Steam pretreatment and enzymatic hydrolysis.....	20

Materials and methods

Feedstock.....	22
Methods.....	23
Substrate characterisation.....	23
Biochemical methane potential test.....	23
Steam pretreatment.....	24
Simultaneous saccharification and fermentation.....	24
Enzymatic hydrolysis.....	24
Ensiling.....	24

Outcomes

Conversion of hemp biomass to methane.....	25
Specific methane yield not influenced by harvest time.....	25
The highest biomass and energy yields were obtained from hemp harvested in September and October.....	26
Is it possible to increase the methane yield?.....	27
Ensiling did not influence methane yield.....	27
Steam pretreatment and enzymatic pretreatment for the production of methane and ethanol.....	28

Optimising steam pretreatment of dry and ensiled hemp.....	29
Effect of steam pretreatment on methane yield.....	29
Enzymatic hydrolysis.....	30
Co-production of ethanol and methane.....	30
Energy efficiency and economic performance.....	31
Energy efficiency.....	31
Economic performance.....	32
Concluding remarks and future research	
High energy efficiency but poor economy.....	34
Ways of improving the processes and their economy.....	35
Biofuels and agricultural sustainability.....	35
Acknowledgements.....	36
References.....	39

Introduction

Since the industrial revolution, a significant part of human activities have been driven by fossil fuels such as coal, oil and gas. As these reserves are limited, society is faced with the need to develop other sources of fuel, preferably renewable. One alternative is biofuels derived from various kinds of biomass.

Bioenergy currently accounts for close to 7% of the energy consumption in the EU (EurObserv'ER, 2012; Eurostat, 2010). According to the European Environment Agency (EEA) the use of bioenergy could increase from 3.4 EJ today to 8.6 EJ in the EU over the next 20 years (EEA, 2006). It is also believed that agricultural crops will play an important role in the production of transportation fuels. Increased production of energy crops on agricultural land in the EU can be achieved by using agricultural land not currently exploited, decreasing the export of cereals, and increasing the productivity of crops (EEA, 2006).

Sweden has a large energy potential for biomass-based products due to its large areas of forest and agricultural land in relation to its population. Sweden is the country with the highest proportion of renewable energy among the EU member states; 47% coming from renewable sources (Eurostat, 2010). Most of this is hydroelectric power or biomass used to provide heat and electricity, while a much smaller proportion is biofuel used for transportation. The transportation sector accounts for 63% of the total use of oil, coal and gas in Sweden (Swedish Energy Agency, 2011). Biofuels for transportation account for 6.8% of the total energy use in transportation, of this 12% is biogas (Swedish Energy Agency, 2012). Biogas is today mainly produced from waste. However, the waste resources are limited and energy crops could help to increase the production (Linné et al., 2008). Domestic energy crops used for the production of transportation fuels are mainly cereals such as wheat, *Triticale* (a cross between wheat and rye) for ethanol production and rapeseed for biodiesel production (Swedish Board of Agriculture, 2006). At present, it is the most valuable part of the plant, the seeds, that is used for the production of transportation fuels (Borjesson & Tufvesson, 2011).

Cereals are cultivated on about half of the agricultural land in Sweden, and rapeseed is also a common crop (Swedish Board of Agriculture & Statistics Sweden, 2011). Cultivating common crops for conversion into bioenergy is relatively simple and requires no special investments. However, cultivating more of the same crops is not beneficial from

agricultural or environmental sustainability points of view. Crop diversity can help to reduce the influence of crop diseases and pests, and contribute to a more diverse flora and fauna (EEA, 2006). The EEA has identified perennial crops such as perennial grasses, willow or poplar and a few annual crops, including industrial hemp (*Cannabis sativa* L.), as energy crops having less environmental impact than the energy crops dominating today. The practices of double cropping are also recommended.

Biogas production from whole crops and ethanol production from lignocellulosic crops have been suggested as more sustainable alternatives than the current methods of biofuel production based on starch-, sucrose- and oil-rich energy crops such as wheat and maize, sugar beet and rapeseed (EEA, 2006). Hemp is regarded as having a low environmental impact because it can be successfully cultivated with relatively little nitrogen and without pesticides, it has deep roots, which have a positive influence on soil structure, and increased cultivation would increase crop diversity (EEA, 2006).

Apart from its low environmental impact, hemp is interesting as an energy crop due to its relatively high biomass yield, as has been demonstrated in different parts of Europe. However, at the beginning of this work, little was known about the cultivation of modern hemp cultivars in Sweden and other countries with a similar climate, and there was very little, if any, information on the conversion of hemp to biofuels such as biogas and ethanol. Hemp was traditionally grown in Sweden for its fibre, but was prohibited in the EU in the 1960s due to drug abuse issues. In 2003, some cultivars with insignificant drug content were approved for cultivation in Sweden again (Swedish Board of Agriculture, 2006).

The main focus of this work was on investigating the potential of industrial hemp for biogas production. Biogas (mainly methane and carbon dioxide) is produced by microorganisms during anaerobic digestion (AD). The work includes investigation of the integration of AD with ethanol production and combined heat and power production.

In my opinion, AD is an interesting process for the following reasons:

- 1 AD is omnivorous, so a wide range of microorganisms are used and a wide variety of compounds can be fermented.
- 2 A very high proportion of the energy in the feedstock can be recovered as methane due to the low formation of microbial biomass and little heat release.
- 3 The biogas is the end product of the anaerobic degradation chain. Under strictly anaerobic conditions the methane will not be further degraded, regardless of the microorganisms in the process.
- 4 The product is a gas and will spontaneously separate from the microbial cells and unconverted feedstock.

- 5 Methane is an energy-rich molecule that can be used in a wide variety of applications, it can also be used to synthesize other fuels.
- 6 The nutrients are almost completely retained in the liquid phase and are available in forms that can be easily utilized by plants. The residue is thus suitable for use as fertilizer.

The first paper in this thesis (**Paper I**) describes the influence of hemp harvest time on the methane yield. **Paper II** describes the effect of ensiling hemp and other crops on the methane yield. **Paper III** deals with the optimisation of steam pretreatment conditions for dry and ensiled hemp for ethanol production. **Paper IV** describes investigations on the effect of using steam pretreatment prior AD and the effects of combining ethanol production and AD. In **Paper V** the economics and energy efficiency of the co-production of biogas, heat and electricity, with and without steam pretreatment, and the co-production of ethanol, biogas, heat and electricity are presented.

Aims of the studies

- I** To determine at what harvest time the highest methane energy yield per hectare could be achieved from hemp.
- II** To determine how ensiling influences the methane potential of crops. To evaluate the influence of using uncorrected, oven-dry-based values of dry matter and volatile solids in methane potential determinations using silage, and to investigate if there are alternative methods.
- III** To optimize the conditions for steam pretreatment of dry and ensiled hemp in order to achieve the highest glucose yield in enzymatic hydrolysis for conversion to ethanol.
- IV** To evaluate if the methane yield of hemp could be increased by using steam pretreatment, with and without a subsequent enzymatic hydrolysis step, in relation to mechanical pretreatment. To investigate the energy yield of co-production of ethanol and biogas.
- V** To determine the energy efficiency and economic feasibility of using chopped or steam-pretreated hemp for the co-production of methane and combined heat and power (CHP) or steam-pretreated hemp for the co-production of ethanol, methane and CHP.

Background

Biomass for bioenergy

Biomass potential

The technical potential of energy from biomass is considerable. Hoogwijk et al. (Hoogwijk et al., 2005) estimated the technical potential in 2050 to be between 130 and 410 EJ in four scenarios of world development defined by Intergovernmental Panel on Climate Change. They showed that an increase in population and meat consumption would have a significant influence on the biomass available for energy purposes due to a higher demand of land for food production. This potential can be compared to the world energy use of 518 EJ in 2008 (Swedish Energy Agency, 2011). Bengtson and Felby (2012) reviewed 16 biomass potential studies, mainly concerning the EU but some covering the worldwide potential. The study by Hoogwijk et al. (2005) is included and lies in the upper range. The studies in the lower range are those that consider how much biomass can be utilized in a sustainable manner. Among those is a report from the EEA (2006) in which it is predicted that the biomass potential for energy use will be 8.6 EJ in 2030 for the 25 member countries in the EU in 2004 (EU25), half from energy crops (crops grown for energy purposes only, forest included). The current use of biomass for energy purposes in the EU (27 countries) is 3.4 EJ (EurObserv'ER, 2012), and the total energy use 50 EJ (Eurostat, 2010).

The cultivation of energy crops can be increased by using land that is not used today due to low profitability, by reducing the export of cereals and by increased use of double cropping (EEA, 2006). In Sweden, 177 000 ha, or 7%, of the agricultural land was unused in 2010 (Official Statistics of Sweden, 2011). Another 100 000–200 0000 ha were used for production of cereals for export (Swedish Board of Agriculture, 2012). Sweden and Finland are exceptions in the EU, having the largest biomass potential from forest (EEA, 2006). However, in the south of Sweden, where this study was performed, the landscape and climate are more like that of other northern European countries, with large areas of agricultural land.

Political goals for bioenergy

The EU has set up directives for the use of renewable energy. In 2020 at least 20% of the total final energy consumption and at least 10% of the energy used for domestic transportation should be renewable in the entire EU (European Parliament & Council of the European Union, 2009). Due to national variations in the potential for bioenergy, higher national goals have been set for the total share of bioenergy for some countries such as Sweden. The goal for Sweden is 49% of its final energy consumption to be derived from renewable sources in 2020 (Swedish Energy Agency, 2011).

Transition from fossil energy in Sweden

Sweden has already reached 47% renewable energy of total final energy consumption and close to 10% of energy in transportation (Swedish Energy Agency, 2011). This is largely thanks to a high share of hydroelectricity (50%) and electricity from biomass which also powers a part of Swedish rail transports. Given the high potential in Sweden for renewable energy due to its hydroelectric power and large areas of forest and agricultural land, an ambitious political goal of having vehicles in Sweden independent on fossil fuels by 2030 has been set. Today, the transportation sector account for 63% of the consumption of oil, coal and natural gas in Sweden. Biofuels for transportation account for 6.8% of the total energy use in transportation, of this 12% is biogas (Swedish Energy Agency, 2011; Swedish Energy Agency, 2012). An increased use of biofuels in the transportation sector can decrease the Swedish dependency on fossil fuels considerably.

Is anaerobic digestion of hemp a sustainable option?

Estimating the sustainability of the cultivation of energy crops is a difficult task. De Vries et al. (2010) summarized the criteria for sustainability of energy crops in three main categories: *energy yield*, including the energy output:input ratio and the areal efficiency; *greenhouse gas emissions* and *agro-environmental factors*, including the impact on soil erosion, soil organic matter, risk of soil-borne diseases, eutrophication, pesticide usage and water requirements. The EEA report mentioned above (EEA, 2006) has a similar list of criteria for agro-environmental factors, but also includes farmland biodiversity, diversity of crop types and the risk of wildfires (applicable in some regions). In the EEA report the influence of 21 current and potential future potential energy crops are graded

in seven different categories according to their effect on the agro-environment, a high grade indicating low environmental impact. Many crops used for biofuel production in the EU, wheat, sugar beet, rapeseed and maize, received low average grades. The already abundant cultivation of these crops contributes to lowering the grades. Several perennial crops, such as perennial grasses and short-rotation willow and poplar, have high average grades. Likewise, a few annual crops have high average grades; among them hemp (de Vries et al., 2010). Hemp is today grown on very small areas in Sweden and the EU (Prade, 2011).

The focus of the research presented in this thesis is on the conversion of hemp to methane and other energy carriers. Other aspects of the overall sustainability are not evaluated. However, when we decided to study the potential of converting hemp into methane together with our partners at the University of Agricultural Sciences (Agrosystems), not only the energy potential was considered an important factor, but also other characteristics of hemp that can affect sustainability in agriculture.

The influence of crop diversity

Low crop diversity is characteristic of agricultural production both in Sweden and the other member countries of the EU. In the south of Sweden (the county of Scania) the largest crop group is cereals, covering 46% of the agricultural land. Another 26% consists of pastures (grasses or grass-legume mixtures), 10% is used for the cultivation of rapeseed and other oil-rich plants, while 8% is used for sugar beets (Statistics Sweden, 2010).

The same annual crop should, in general, not be grown two years in succession to avoid the propagation of soil-borne diseases. Neither should crops sharing the same soil-borne diseases be cultivated in sequence (Källander, 1989). Crops such as rapeseed and sugar beet should at most be grown in the same location every third year (de Vries et al., 2010). Well-designed crop rotation can reduce the need for pesticides and reduce harvest losses due to disease (Källander, 1989). Greater crop diversity facilitates good crop rotation. Crop diversity can also influence the diversity of wildlife on farmland (EEA, 2006).

Botanical differences between crops generally reduce the risk of them being affected by the same diseases (Kirkegaard et al., 1997). Hemp is interesting as it belongs to a different order (family, genus and species are botanical classifications below order) from the most common annual crops grown in the south of Sweden: wheat, oat, barley, rye, *Triticale*, rapeseed, sugar beet, potatoes, legumes and maize. In a study of three important soil pathogens attacking potato it was shown that the cultivation of fibre hemp reduced the population of two of the three pathogens investigated (Kok et al., 1994). In Sweden, hemp is cultivated on an area less than 1000 ha (Prade, 2011) and an increase may thus have positive effects on the agro-environment.

The dominating crops used for the production of transportation fuels in Sweden are wheat, *Triticale* and rapeseed (Swedish Board of Agriculture, 2006). These also belong

to the dominating crops used for food and animal feed, and their cultivation for biofuel thus does not contribute to a greater crop diversity. Although it is possible to cultivate a wide range of crops for AD the most profitable ones dominate today. In Germany, the country with the largest area devoted to crops for AD in the EU, maize is the dominating crop (FNR, 2012). The cultivation of more varied crops, with good economics and low environmental impact, is thus desirable.

Hemp can be cultivated without herbicides and pesticides

Hemp, like most crops, can be attacked by several diseases and pests, however, it has a rather high tolerance, and the influence on the biomass yield is reported to be relatively small (McPartland, 1999). Based on a seven-year study of hemp in the Netherlands, van der Werf et al. (1995) found that hemp was infested with *Botrytis cinerea* (primarily) and *Sclerotinia sclerotiorum* during rainy years. Since the biomass yield was relatively high even with fungal infection, and the use of fungicides had little or no effect they advised that hemp be grown without fungicides.

A general observation in hemp cultivation is that weeds are suppressed when the hemp is well established; making herbicides unnecessary. Leaves cover the soil relatively quickly (van der Werf, 1995) and fibre cultivars grow very tall, outgrowing most weeds. Lotz et al. (1991) showed that hemp suppressed the weed earth almond almost completely; and that the lack of light was the most likely reason.

Soil carbon and soil structure

Soil carbon is an important factor for soil quality (Jones et al., 2012; McBride et al., 2011). In the cultivation of cereals, the straw is sometimes left on the field and ploughed into the soil to increase the carbon content. In Germany, where maize is used to produce biogas, the whole plant is used in AD. A study of the soil carbon before and after the introduction of biogas production in a number of regions, triggering increased maize cultivation, has shown that the average carbon content of the soils had decreased in the majority of the regions. The introduction of cover crops in the cultivation system was suggested to compensate for carbon losses (Moller et al., 2011)

Hemp has a deep, dense root system leading to positive effects on soil structure (EEA, 2006). Amaducci et al. (2008) showed that the root biomass was one fifth to one sixth of the above-ground biomass of hemp.

Nutrient demand and eutrophication

The addition of nitrogen has a significant influence on both the risk of eutrophication and the energy and greenhouse gas balances (Bachmaier et al., 2010; Borjesson & Tufvesson, 2011; van der Werf, 2004). Hemp can grow well with relatively low nitrogen levels, and increased nitrogen fertilisation has been shown to have no effect on the biomass yield (Prade et al., 2011).

Energy output

The biomass yield per ha and conversion efficiency to biofuels both have large influence on the economical performance and on how much fossil fuel can be replaced with biofuels from the available land resources. Biomass yields of fibre hemp of 9–20 t dry matter (DM) per ha have been reported in the temperate regions of Europe (Cappelletto et al., 2001; Struik et al., 2000; van der Werf, 1995). In parts of Europe with a cold climate, according to the Köppen-Geiger classification (Peel et al., 2007), some crops grow less well. However, promising yields in initial trials, up to 14.5 t DM/ha in southern Sweden, 55° north (Svennerstedt, 2006), and 10 t DM/ha in northern Sweden, 63° north (Finell et al., 2006), has increased the interest in studying the potential of hemp as an energy crop in Sweden. These biomass yields can be compared to average yields per ha of other energy crops when cultivated in the south-western part of Sweden (around 55° north): 10.7 t for wheat with straw, 6.1 t for rapeseed with straw, 13.5 t for sugar beets including leaves and 9.5 t for maize (Borjesson & Tufvesson, 2011). Medium-late or late maturing cultivars are most suitable when aiming for a high biomass yield (Sankari & Mela, 1998; van der Werf, 1995).

When using only the seeds for the production of transportation fuels (e.g. from wheat and rapeseed) only about half of the biomass is used as feedstock. About 50–60% of the energy in the seeds can be recovered as vehicle fuel (ethanol from wheat and biodiesel from rapeseed). Utilization of the lignocellulosic parts of the plants to produce energy, or for other purposes, is crucial for high area efficiency. When producing biogas, all parts of the plant can be used. In the AD of whole-crop maize around 50–80% of the energy value of the plant can be recovered as methane (Borjesson & Tufvesson, 2011).

Data on the energy output in the conversion of hemp to transportation fuels was very limited prior to the studies presented in this thesis. Two studies on the biogas yield from hemp were found. Mallik et al. (1990) investigated hemp in co-digestion, while Kaiser et al. (2005) report the methane yield per ha for hemp. However, neither of them studied the methane yield per kg of hemp or the most suitable harvest time for biogas production.

Energy input and economic performance

For many annual crops, the energy input in cultivation is equivalent to approximately 10% of the energy in the biomass produced, which is about 10–20 GJ/(ha x year) for cultivation in the south of Sweden (Borjesson & Tufvesson, 2011). Van der Werf (2004) determined the energy demand for hemp cultivation to be 11.4 GJ/(ha x year), while Prade et al. (2012) arrived at a somewhat higher value of 15.2 GJ/(ha x year).

Energy balances and economic evaluations for the conversion of biomass to biofuels using AD are generally performed for relatively small plants based on an input of less than 10 000 t DM/year (Borjesson & Tufvesson, 2011; Smyth et al., 2010; Svensson et al., 2005; Walla & Schneeberger, 2008), as this is the size of most crop-based biogas plants in Europe. Walla and Schneeberger (2008) showed that the most economically feasible size of a plant for AD in Austria is one providing 250 kW electricity (~1 500 t DM), due to the higher subsidies available for plants up to this size. Ethanol production, on the other hand, is generally analysed for large plants with a capacity of more than 100 000 t DM/year (Barta et al., 2010; Lee et al., 2011; Lohrasbi et al., 2010; Sassner et al., 2008; Shafiei et al., 2011). Comparisons in the energy efficiency and economic performance of ethanol and biogas production are therefore frequently made between plants that differ in size by a factor of 10 to 100 (Borjesson & Tufvesson, 2011; McEniry et al., 2011). Several studies have found the economic performance of biomass-based processes to be better for larger plants (Lohrasbi et al., 2010; Nguyen & Prince, 1996; Shafiei et al., 2011). The energy balance and economic performance of AD of the residues after ethanol production have recently been analysed for large plants (Barta et al., 2010; Lee et al., 2011; Lohrasbi et al., 2010; Sassner et al., 2008; Shafiei et al., 2011). However, analyses of AD in large-scale plants without ethanol production were to our knowledge still lacking prior the study presented in **Paper V**.

The scale not only influences the economy, but also the energy balance. In larger-scale processes it is possible to employ heat integration and to use residues from the process for heat and power production (Barta et al., 2011), which is commonly not included in small scale AD where it is common to return undigested material to the land without an income from the solid material in the residue (McEniry et al., 2011; Walla & Schneeberger, 2008). A techno-economic analysis of combined ethanol and methane production using hemp, and the residues for combined heat and power production, was performed in this work (**Paper V**) for a plant with an annual capacity of 234 000 t DM.

The structure and composition of hemp

Plants are highly organised, with many different types of cells arranged in organs or tissues. All plants contain primary metabolites: carbohydrates, proteins, lipids and nucleic acids. Some plants and some cells in these plants also contain secondary metabolites: alkaloids, terpenoids and phenolics (Raven et al., 2005). Hemp contains all these groups of secondary metabolites. The major part of hemp consists of lignocellulose, which is a group name of the carbohydrates cellulose and hemicellulose and the phenolic lignin. The seeds contain around 30% oil and 25% protein (Callaway, 2004). Fibre hemp cultivars consist mainly of stem biomass. In this section a brief description of hemp stem structure and composition is given. The anaerobic degradability of different compounds is discussed further below.

Hemp stem structure

The outer part of a hemp stem consists of epidermal cells containing cutin and wax. Inside this protective layer are bundles of fibre cells, which have very thick and cellulose rich secondary walls (Thomsen, 2005), and phloem cells that transport energy in the form of water-soluble carbohydrates (Raven et al., 2005). These layers are called the bark or the bast. The fibre cells provide strength and support. The bast contains the long and economically valuable primary bast fibres and the shorter and less valuable secondary bast fibres. The material inside the bast is called the woody core, the hurds or the shives. The hurds contain parenchyma cells and the water-conducting xylem cells, the latter having thin but highly lignified walls. The hurds also contain short fibre cells. In the middle of the core is a hollow space. The cellulose content is higher and the lignin content lower in the bast than in the core (Barta et al., 2010; Thomsen, 2005; Toonen et al., 2004).

Kamat et al. (2002) showed that the proportion of lignocellulose in stems of fibre hemp (cultivar not given) increased with age compared to the proportion of extractives. Although the content of lignocellulose increased with the age of the plant, the relation between lignin and cellulose did not change in hemp aged up to 120 days. Toonen et al., (2004), on the other hand, reported that the cellulose and hemicellulose content in stems increased between 63 and 112 days, while the lignin content was stable.

Cellulose

Cellulose is found in the primary and secondary cell walls. It consists of linear, but not flat, water-insoluble chains with around 500–14 000 glucose molecules in each strain (Leschine, 1995; Lynd et al., 2002). The chains are linked to each other by hydrogen bonds forming large bundles of hundreds of chains called microfibrils, 3–25 nm in diameter. The microfibrils can be arranged in different orientations in different layers in the secondary wall providing extra strength (Raven et al., 2005). Parts of the cellulose have crystalline properties while others are amorphous. Around 60–90% of the cellulose is crystalline in naturally occurring cellulose. Secondary walls have a higher content of cellulose and larger cellulose molecules than the primary walls (Leschine, 1995). The secondary walls are formed after the primary walls, generally after the cell has stopped growing (Raven et al., 2005).

Hemicellulose and pectin

Hemicellulose is a branched heterogeneous polysaccharide also found in primary walls, secondary walls and middle lamella. It is generally hydrophilic and smaller than cellulose (up to around 200 monomers). Hemicellulose is bound to cellulose by hydrogen bonds (Raven et al., 2005) and to lignin by ester and ether bonds (Jeffries, 1990). The main components are hexoses (glucose, galactose and mannose), pentoses (xylose and arabinose) and acids (acetic acid, glucuronic acid or its 4-*O*-methyl ether, ferulic acid, and *p*-coumaric acid) (Saha, 2003).

Pectin, another branched polysaccharide, is found in the primary cell wall and makes up most of the middle lamella, which keeps the cells together (Raven et al., 2005). Pectin has a backbone of galacturonic acid, and can have side chains of arabinose, galactose and xylose (Carpita & Gibeaut, 1993). Keller et al., (2001) reported a uronic acid content of 4.0–6.4% in hemp bast for the cultivar Kompolti.

Lignin and other secondary metabolites

Lignin belongs to the group of phenolics, which are secondary metabolites, and is the second most abundant organic compound on earth. It can be found in both primary and secondary walls and in the middle lamella, but not in all plants and cells (Raven et al., 2005). Lignin is based on three monomers: *p*-coumaryl, coniferyl and sinapyl alcohol. The relative abundance of each molecule and the degree of cross-linking vary. Lignin provides compressive strength, but also has other functions in plants. The water-conducting tissue, the xylem, is coated with a sheath of lignin. The hydrophobic properties of lignin

facilitate the transport of water. Despite the woody character of hemp, the lignin content is relatively low (Thomsen, 2005). It is similar to that of maize (Pakarinen et al., 2011) and is lower than that of wood from e.g. spruce and *Salix* (Sassner et al., 2008).

The phenolics also include flavonoids, pigments and several other compounds, including the cannabinoids of *Cannabis*. 60 cannabinoids have been detected in cannabis. Another 19 non-cannabinoid phenols, 19 flavonoidglycosides and 2 pigments have also been found in *C. sativa* (Turner et al., 1980).

Hemp contains several alkaloids (Turner et al., 1980). Some plants excrete alkaloids by the roots to inhibit the growth of other plants. Alkaloids can also be toxic to insects and microorganisms, thus providing protection against pests and disease (Raven et al., 2005).

Over 100 terpenes (or terpenoids) have been detected in cannabis plants (Turner et al., 1980). Many terpenes are volatile and some are fragrant. Terpenoids have many functions; some repel herbivores or microorganisms while others attract insects. They may also act as photosynthetic pigments, electron carriers, hormones or structural components, such as the sterols (Raven et al., 2005).

Anaerobic digestion

AD refers to the microbial degradation of organic compounds to biogas (mainly methane and carbon dioxide). Anaerobic microorganisms are in general highly specialised (Leschine, 1995; Schink, 1997; Zehnder, 1988). A wide range of microorganisms is needed for complete degradation of the different compounds present in plants. For efficient degradation sufficient nutrients in relation to the amount of carbon are required. The pH should be close to neutral, the level of inhibitory compounds should be low, and there should be no or low levels of competing electron acceptors such as nitrate, sulphate, oxidised iron and manganese. Also, heating is often needed since the heat formation in AD is very low. A stable temperature is important for stable operation of the process (Gerardi, 2003; Schink, 1997).

Anaerobic digestion is commonly described in four steps: hydrolysis, acidogenesis, acetogenesis and methanogenesis. Macromolecules are first hydrolysed (cleaved by the addition of water) by extracellular enzymes. Proteins are hydrolysed to amino acids, carbohydrate polymers to sugar monomers, and triglycerides to glycerol and fatty acids. This step is performed by facultative or obligate anaerobic bacteria, or fungi, which also ferment the products further in the subsequent step (Gerardi, 2003; Schink, 1997; Zehnder, 1988).

In the next step, acidogenesis, volatile fatty acids (VFAs), succinate, lactate, alcohols, hydrogen and single-carbon compounds are formed. Acetate, hydrogen and single-carbon compounds can be directly converted to methane in the last step, methano-

genesis. Other intermediates need another fermentation step, acetogenesis. Fatty acids with more than two carbons, alcohols with more than one carbon, branched-chain and aromatic fatty acids are degraded syntrophically by obligate proton-reducing bacteria and hydrogenotrophic methanogens. A very low hydrogen partial pressure is necessary for degradation to be thermodynamically favourable. Therefore, there is a very close interaction involving hydrogen transfer between the obligate proton-reducing bacteria and the hydrogenotrophic methanogens. Hydrogen, acetate, carbon dioxide and sometimes formate are formed in this degradation step (Schink, 1997).

In the final step, methanogenesis, hydrogenotrophic methanogens convert hydrogen and carbon dioxide (present as carbonate ions) or formate to methane. Methylo-trophic methanogens convert acetate and some other methyl group containing one-carbon compounds such as methanol to methane. The methanogens belong to the Archaea and are obligate anaerobes. Oxygen is toxic to methanogens. However, if small amounts of oxygen enter an anaerobic reactor it will quickly be consumed by facultative anaerobes (Bjornsson et al., 2000).

Preferably acetate should be, and often is, the main product in fermentation of monomers. However, if the organic loading rate is quickly increased or if compounds toxic to methanogens are present, other VFAs, lactate and alcohols are formed to a higher extent. VFAs can *per se* cause inhibition of methanogens and there is a risk for a negative loop leading to a decrease in pH and completely inhibited methanogenesis (Schink, 1997).

Undefined mixed microbial populations from active AD processes are in general used for AD experiments. When choosing an inoculum for the degradation of a specific substrate the source of the inoculum must be considered. Using an inoculum from an AD plant with a similar substrate is preferable. If this is not possible a mixture of inocula from several plants can be used to obtain a wide range of active microbial populations (Angelidaki et al., 2009).

Determining the methane potential

The theoretical methane potential can be calculated by stoichiometric balancing based on elemental composition, using Buswell's formula (Symons & Buswell, 1933). The methane potential and the proportions of methane and carbon dioxide depend mainly on how reduced the substrate is. Fat is more reduced than carbohydrates and proteins and, therefore, has the highest methane potential per gram substrate and the highest methane-to-carbon dioxide ratio (Alves et al., 2009). Some secondary metabolites, such as lignin, are also highly reduced (Wooley & Putsche, 1996).

Not all substrate will be converted to biogas; part of the substrate is used to nourish microbial growth. The amount of biomass formed varies for different substrates and

conditions, and is higher for carbohydrates than for fat and proteins. At short retention time, about 10–20% of degraded material is used for microbial biomass formation (based on energy), including biomass formation in several degradation steps. However, at longer retention times, such as 30 days, the biomass yield can be half of this or less (Batstone et al., 2002; McCarty, 1964), probably due to the degradation of microbial biomass.

Calorific values like the higher heating value (HHV) or lower heating value (LHV) (ISO, 1995) can also be used to estimate the theoretical methane potential. Than both material for growth of microbial biomass and heat released in AD need to be subtracted. The heat released in AD is low. For cellulose degradation it is 5%. This can be calculated from the HHV of cellulose, 17.35 MJ/kg (Wooley & Putsche, 1996), and methane, 55.5 MJ/kg, and the stoichiometric methane yield from cellulose degradation.

The theoretical methane yields described above accounts for degraded material. However, not all material will be degraded in AD, at least not within the hydraulic retention time applied for AD reactors. Some studies have made attempts to predict the practical methane potential of crops based on their composition and the lignin content has in several studies been found to play a crucial role in the degradability of plants (Klimiuk et al., 2010; Triolo et al., 2011). However, it seems to be difficult to construct a general model for all plants, probably due to their wide variation in the structure and composition. Therefore, it is common to use the biochemical methane potential (BMP) test to determine the practical methane potential of substrates (see further *Materials and methods*). In this test the substrate is mixed with an active microbial inoculum and incubated under a certain time or until the gas production has ceased. The methane yield is commonly related to the DM (regarded as equivalent to total solids in this thesis) or volatile solids (VS) and then called the specific methane yield.

Full-scale reactors are commonly operated with semi-continuous addition of the substrate. The methane yields achieved in batch BMP tests might be higher than those achieved in semi-continuous processes. Further, semi-continuous processes operated in lab might give different yields than achieved in full-scale operation. Despite that the BMP test does not directly reflect full-scale operation it is a useful tool in comparative studies. Methodological recommendations have been suggested for standardisation of the method (Angelidaki et al., 2009).

Anaerobic digestion of lignocellulose

Cellulose, hemicellulose, proteins, fats and nucleic acids can all be degraded in the AD of crops. Many of the secondary metabolites can also be degraded (Zehnder, 1988). Polymeric lignin is the most recalcitrant of the major compounds in plants (Harris & Stone, 2008; Klimiuk et al., 2010; Triolo et al., 2011).

Cellulose

Anaerobic cellulose degradation is a well studied topic that has been reviewed by many authors e.g. (Leschine, 1995; Lynd et al., 2002; Schwarz, 2001; Zehnder, 1988). Anaerobic cellulolytic bacteria are found in many genera of bacteria and in a few fungal genera (Leschine, 1995; Lynd et al., 2002; Schwarz, 2001). Some cellulolytic anaerobes can utilize atmospheric nitrogen (Leschine, 1995). Aerobic fungi and bacteria produce soluble cellulolytic proteins. Anaerobic microorganisms are found to produce primarily cell-bound cellulolytic enzyme complexes, although free enzymes are also found (Lynd et al., 2002). The most well-studied cellulase complex is the cellulosome produced by *Clostridium thermocellum*. It contains both cellulolytic and hemicellulolytic enzymes (Schwarz, 2001).

Yu et al. (2012) recently showed that the abundance of amorphous regions decreased first during degradation of cellulose, followed by a reduction in both crystalline and amorphous regions. Particle surface area, cellulose crystallinity and the association with lignin influences the rate of cellulose hydrolysis (Chang & Holtzapple, 2000; Holtzapple et al., 1989; Klimiuk et al., 2010; Taherzadeh & Karimi, 2008; Triolo et al., 2011; Zhu et al., 2008). Cutting the substrate into pieces a few centimetres or a few millimetres long will only increase the surface area by a limited extent from a microbial perspective. A microbe is about 1–10 μm in size and a plant cell 5–100 μm (Raven et al., 2005). A one-millimetre plant particle can contain 10 to 200 layers of plant cells. Fibre cells have dense layers of microfibrils (10–25 nm), each consisting of several hundreds of cellulose chains, each chain containing some 500–14 000 glucose molecules (Leschine, 1995; Raven et al., 2005), each of which must be cleaved from the other for conversion to biogas. Increasing the surface area considerably by fine grinding is very energy demanding. More energy-efficient chemical and physico-chemical methods of increasing the surface area have been developed (Hendriks & Zeeman, 2009; Holtzapple et al., 1989; Sun & Cheng, 2002). One of them, steam pretreatment, was used in this work and will be described below.

Hemicellulose

Hemicellulose is more heterogeneous than cellulose and requires a more diverse set of enzymes. However, hemicellulose is largely water-soluble, has a lower degree of polymerization and is less compact than cellulose, all of which have a positive effect on degradation rate compared to that of cellulose degradation. The degradability of hemicellulose is influenced by the lignin (Harris & Stone, 2008; Klimiuk et al., 2010; Saha, 2003).

Lignin

Lignin is the most recalcitrant component of lignocellulose (Besle et al., 1995; Harris & Stone, 2008; Klimiuk et al., 2010; Triolo et al., 2011). Lignin monomers can be degraded anaerobically (Besle et al., 1995; Zehnder, 1988). A high metabolic specificity has been found. The B7 microbe can use lignin monomers as a carbon source but not cellulose or pectin (Akin, 1980). Oligomeric and polymeric lignin can also be partly degraded, however, the higher the degree of polymerisation, the more recalcitrant the lignin seems to be. Zehnder et al. (1988) cite the study by Zeikus et al. (1982) in which small fragments of lignin (MW 400 to 1000 Da) were degraded by 25% in 20 days, while fragments of 1000 to 1400 Da were only degraded by about 5% in 20 days.

Not only the content but also the distribution of lignin can influence the degradability. Wilson and Hatfield (1997) reported that only some cells in legumes (belonging to the dicotyledons such as hemp) lignify during aging, while most of the cells in grasses (monocotyledons) lignify. The ruminal degradability of both legumes and grasses decreases with age. However, they suggested that the differences in distribution of lignin might explain why the initial degradation of legumes can be rapid, also in older plants, while the total degradation is slow for old grasses. Wilson and Mertens (1995) presented a theory on how lignification might influence the degradability of older plant cells. Although thick and lignified secondary walls in older cells can be degraded, a higher concentration of lignin in the middle lamella and the primary wall restricts degradation of these cells mainly from the inside. Microorganisms can enter cells via open cell ends and the plasmodesmata between cells. When the secondary walls are very thick, the lumen may be so small that there is only sufficient room for a single microorganism (Wilson & Mertens, 1995). Therefore, the surface-to-substrate-ratio is smaller in older cells with thicker secondary walls than younger cells with thinner walls.

Nutrient demand

For efficient degradation, sufficient nutrients must be available. The macronutrients required by microorganisms are chiefly the same as those required by plants, C, O, H, N, K, Ca, P, Mg and S, although the amounts vary. Microbial biomass contains about 50% C, 20% O, 11–12% N, 2% P, 1% K and 1% S plus 6–7% other compounds (Gerardi, 2003; McCarty, 1964). As in the case of plants, not all microorganisms need Na (Madigan et al., 2009; Raven et al., 2005). Fe is sometimes also classified as a macronutrient for microorganisms (Prescott et al., 2002).

Supplementation of macronutrients can improve degradation if the content is low in the feedstock. Recommended carbon-to-nutrient weight ratios vary. Speece (1988) refers to a study using kelp in a completely stirred tank reactor (CSTR) where a C:N ratio of 15 and a C:P ratio of 75 were found to be appropriate. Speece further refers to a study

using a fixed film reactor where a C:N ratio of 23 and a C:P ratio of 75 were found sufficient. Gerardi (2003) recommends chemical oxygen demand to N to P ratios in waste water of 1000:7:1 or 350:7:1 depending on the strength and load. Converted to C:N ratios these correspond to values from around 14 to 53. Chandra et al. (2012) recommend a C:N ratio of 20–30 in a recent review. Recommendations on K and S are less common, the content in microbial biomass is approximately half of that of P.

The micronutrient requirement of microorganisms can be different from that of plants. Most microorganisms need Co, Cu, Mn, Zn, Mo and Ni (Prescott et al., 2002). Co is special in that it is not considered a nutrient needed by plants (Raven et al., 2005) but is needed by many microorganisms. Some microorganisms also have additional specific requirements, due to their specific metabolism. Feroso et al. (2009) describe the role of Co, Cu, Fe, Mn, Mo, Ni, Se, W, Zn and V in AD. Several studies have shown improvement in anaerobic digestion of crops upon addition of Co (Feroso et al., 2008; Hinken et al., 2008; Jarvis et al., 1997; Leuhn et al., 2008). Also, several studies have shown improvements upon addition of different combinations of the above mentioned micronutrients as reviewed by (Gustavsson, 2011; Schattauer et al., 2011; Takashima et al., 2011). Literature data on recommended and actually present concentrations of micronutrients in AD processes have been found to vary by 1–2 orders of magnitude. Micronutrient recommendations are often given as concentrations rather than as ratios to carbon (Schattauer et al., 2011).

Inhibition

Many compounds can cause inhibition and toxicity in an AD process, e.g., long-chain fatty acids, ammonia, hydrogen sulphide, calcium ions, magnesium ions, potassium ions, sodium ions, heavy metals and a wide range of organic compounds (Batstone et al., 2002; Chen & Cheng, 2007; Fang et al., 2011; Gerardi, 2003; McCarty, 1964; Pereira et al., 2005; Pereira et al., 2004; Schnurer & Nordberg, 2008). Long chain fatty acids and ammonia toxicity is not an issue for fibre hemp having low content of fat and protein. However, several secondary metabolites in crops, such as phenols, terpenes and alkaloids, can also be inhibiting to microorganisms and hemp contains a wide variety of secondary metabolites (Turner et al., 1980).

Korteeckas et al. (1995), encountered inhibition when digesting hemp black liquor. The inhibition could be reduced by removal of extractives extracted with ethylether and the removed extractives were shown to inhibit methanogenic activity with 50% inhibition of activity at chemical oxygen demand (COD) concentrations of 0.25 g/L and 0.65 g/L extractives for core and bark extractives respectively. What compounds caused the inhibition could not be determined but Korteeckas et al. (1995) referred to previous work of Sierra-Alvarez and Lettinga (1990) showing high toxicity of apolar phenols, monoterpenes and terpenols, and concluded that it was likely that the toxicity was caused by any

of these groups.

Some phenols can be used as disinfectants as they denature proteins and disrupt cell membranes (Prescott et al., 2002). However, even some toxic phenols can be degraded in dilute form (Speece, 1983). Phenol can be degraded anaerobically, and the degradation route of phenol is influenced by the hydrogen partial pressure (Karlsson et al., 1999; Karlsson et al., 2000). Levén and co-workers have found that some phenols were degraded under mesophilic conditions but not under thermophilic conditions (Leven et al., 2012; Leven & Schnurer, 2005).

During pretreatment (see *Steam pretreatment and enzymatic hydrolysis*) furfural and 5-hydroxymethyl-2-furaldehyd (HMF) can be formed upon degradation of pentoses and hexoses, respectively. Furfural has been shown to be inhibiting to some methanogens at 20 mM (1.92 g/L) but not at 10 mM (0.96 g/L) (Belay et al., 1997). Also, HMF is inhibitory at higher concentrations (Badshah et al., 2012). However, both furfural and HMF can also be completely degraded by anaerobic microorganisms (Boopathy, 2002; Boopathy, 1996; Rivard & Grohmann, 1991).

Ensiling for storage

It is usually necessary to store biomass prior to use. Drying and ensiling are common methods used to conserve crops during storage. Ensiling is usually applied to biomass intended as fodder and for crops to be used in anaerobic digestion (FNR, 2009). For ethanol production it is common to use dried feedstock (Barta et al., 2010; Öhgren et al., 2005; Sassner et al., 2008). Ensiling is an anaerobic process in which acids are added or formed through fermentation of part of the substrate. Mainly lactic and acetic acid are formed. The acids decrease the pH of the feedstock to levels where most microbial activity is inhibited, thereby conserving the feedstock.

Co-production of ethanol and methane

Hemp can also be a suitable substrate for ethanol production because the cellulose content is relatively high, slightly higher than that of corn stover and wheat straw (Linde et al., 2008; Öhgren et al., 2005). Ethanol is commonly produced by fermentation with the yeast *Saccharomyces cerevisiae*. Unmodified yeast can ferment the hexose sugars from cellulose and hemicellulose to ethanol. Modified strains can also ferment pentose sugars (Öhgren et al., 2005; Olofsson et al., 2008). Pretreatment and enzymatic hydrolysis

with added enzymes are used for the production of ethanol from lignocellulose using *S. cerevisiae* as it is unable to hydrolyse cellulose and hemicellulose. Co-production of ethanol and methane can be advantageous because they are complementary. Methane can be produced from a wider range of substrates and ethanol has the advantage that it can be blended with gasoline. Except from pentoses, protein and fat from the substrate, the enzymes and yeast that are added in ethanol production can also be converted to methane. The co-production of ethanol and methane from hemp was investigated as presented in **Paper IV**.

Steam pretreatment and enzymatic hydrolysis

Although both cellulose and hemicellulose can be degraded during AD, pretreatment has the potential to increase the rate and extent of degradation. Considerable efforts have been made to develop suitable pretreatment methods for ethanol production from lignocellulose, as reviewed by Sun and Cheng (2002), Galbe and Zacchi (2007), Hendriks and Zeeman (2009) and Jørgensen et al. (2007). Pretreatment prior to AD has been less well studied. However, the same methods can be applied as for ethanol production (Taherzadeh & Karimi, 2008).

Steam pretreatment is one of the methods that have been most intensively studied and the method is applied in pilot plants today (Galbe & Zacchi, 2007; Wiman, 2012). An acid or an alkali can be used as a catalyst during pretreatment. Acid catalysts have been shown to be efficient for a wide range of materials including softwood, although an alkali catalyst was not as efficient. An acid catalyst is also more suitable than an alkali for ethanol production as hemicellulose is auto-hydrolysed and there is thus no need for the addition of hemicellulases in the subsequent enzymatic hydrolysis step (Galbe & Zacchi, 2007).

Steam pretreatment has been shown to be more energy efficient than mechanical grinding for reduction to the same particle size (Holtzapfel et al., 1989). Using SEM, Wiman et al. (2010) and Kristensen et al. (2008) illustrated how steam pretreatment prior to ethanol production can break up plant structures. Steam pretreatment is also used to separate fibres for fibre utilisation purposes, as demonstrated for hemp by Garcia-Jaldon et al. (1998).

Due to the considerable variation in the structure and composition of different plant biomasses, pretreatment conditions must be optimised for each feedstock. The degree of hemicellulose hydrolysis and solubilisation, the formation of inhibitors and the accessibility of cellulose for enzymatic hydrolysis will vary depending on the pretreat-

ment conditions. At too harsh conditions, hemicellulose and cellulose sugars will be degraded. Pentoses and hexoses can form hydroxymethylfurfural and furfural respectively, or be degraded even further to formic and levulinic plus formic acid, respectively. All these components cause inhibition of yeast (Almeida & de Franca, 1999).

The parameters used for optimising the pretreatment conditions for ethanol production are also likely good indicators of the influence of pretreatment on AD. Cellulose conversion in enzymatic hydrolysis indicates how accessible the cellulose fibres are and the levels of inhibitors are relevant also for AD. Furfural and HMF can also be inhibiting in AD. However, some methanogens tolerate higher concentrations than the common yeast *S. cerevisiae* (Almeida & de Franca, 1999; Badshah et al., 2012; Belay et al., 1997).

Steam pretreatment was optimised for hemp and the methane yield, ethanol yield and the yield from co-production of ethanol and methane is presented in **Paper III** and **IV**. Although there are anaerobic cellulolytic microorganisms, the addition of efficient cellulolytic enzymes from aerobic microorganism (same as used for ethanol production), could also potentially improve the conversion of hemp to methane, which was investigated in **Paper IV**.

Materials and methods

Feedstock

Information on the hemp used in the different papers are described in **Table 1**. The French medium late maturing cultivar Futura 75 was used in all studies. Except from hemp also maize, sugar beets and sugar beet tops were investigated in paper II.

Table 1	PAPER I	PAPER II	PAPER III	PAPER IV
<i>Process</i>	AD	AD	SSF	SSF and AD
<i>Cultivar</i>	Futura 75	Futura 75	Futura 75	Futura 75
<i>Harvest month</i>	July–October	September	September	September
<i>Year</i>	2006/2007	2007	2007	2007
<i>Cultivation site</i>	Nöbbelöv	Lönnstorp	Nöbbelöv	Nöbbelöv
<i>Fertilizer</i> ¹	120/150 kg	140 kg	Mix ² /200 kg	Mix ²
<i>Storage</i>	Fresh frozen	Fresh frozen/ensiled	Dry ³ /ensiled	Dry ³
<i>Particle size</i>	75% 0.85–4 mm	2–3 cm	SP ⁴	A. 2–3 cm B. <0.5 mm C–H. SP ⁴

¹ Ammonia-N
² Equal mix of material from cultivation with 115, 150 and 200 kg ammonia-N, average 155 kg.
³ Only stems used for SSF. Leaves were not steam pretreated.
⁴ Particle size was not determined for steam pretreated material.

Methods

Substrate characterisation

DM content is determined by drying the material at 105°C until constant weight (APHA, 2005). Generally 20–24 hours. DM can also be determined at other drying temperatures. DM and TS are regarded equivalent in this thesis. VS content is a measure of the organic compounds and is determined as the difference between the dry matter and the ash. The DM is incinerated at 550°C until constant weight, generally 2–4 hours. The ash is left after incineration.

The HHV and LHV are determined by combustion. The HHV reflects all the energy released upon combustion. The LHV corresponds to the HHV minus the energy required for the evaporation of water in the substrate and water formed during combustion (ISO, 1995). The HHV for methane is 55.5 MJ/kg and the LHV is 49.9 MJ/kg.

The extractives, compositional carbohydrates and lignin were determined by first extracting the material with water and then with ethanol (Sluiter et al., 2008b). The structural carbohydrates and lignin was determined by acid hydrolysis after extraction. The polymeric sugars are hydrolysed to monomers and measured by high performance liquid chromatography. The acid soluble lignin (ASL) is measured in the liquid fraction after hydrolysis by UV-Vis spectroscopy. The acid insoluble lignin (AIL) are the solids left after hydrolysis minus ashes. This fraction might also contain structural proteins and a correction can be made by measuring the nitrogen content (Sluiter et al., 2008a). This was not done since the protein content of hemp was relatively low.

Biochemical methane potential test

The BMP test was used in the studies presented in **Papers I, II** and **IV**. The methodology used was basically the same as that recently recommended by Angelidaki et al. (2009). This method is widely used for the determination of the methane potential of substrates. An active microbial inoculum, usually from an active biogas plant, is added to the substrate to be tested and incubated at a chosen temperature. Gas volume and composition are measured until the gas production is very low. The experimental period was 30 days. The temperature used was 50°C in experiments for **Paper I** and 38°C for **Paper II** and 40°C for **Paper IV**. The method used for the measurement of gas volume was different

from that described by Angelidaki et al. (2009). The gas was collected in balloons.

Steam pretreatment

For steam pretreatment chopped hemp was placed in a pressure safe reactor. Steam was injected to reach the desired temperature. The temperature and pressure was kept for 5 minutes and thereafter the pressure was instantaneously released and the material was collected in a flash cyclone. When SO₂ impregnation was used it was done in plastic bags for 20 minutes prior steam pretreatment.

Simultaneous saccharification and fermentation

Simultaneous saccharification and fermentation (SSF) was used for ethanol production. Cellulase and beta-glucosidase (degrading cellobiose to glucose to reduce feedback inhibition on cellulases) were added to the substrate together with yeast for simultaneous hydrolysis and ethanol fermentation. Incubation was done for 72 hours at 37°C.

Enzymatic hydrolysis

Enzymatic hydrolysis with added cellulase and beta-glucosidase was used in experiments for **Paper III** as a tool to evaluate how efficient the steam pretreatment was. In experiments for **Paper IV** enzymatic hydrolysis was used as a pretreatment prior AD. The enzymes could not be added together with the microbial inocula in AD as done in SSF since the enzymes are not active at neutral pH, which is required for methanogenesis.

Ensiling

Ensiling was done for **Paper II** by spraying chopped crops with a bacterial ensiling inoculant, a very small amount, to promote lactic acid fermentation. Then chopped crops were tightly packed into plastic buckets that were sealed. Gas formed was collected in balloons and the amount and composition was measured. The silage was stored for at least three months. For **Paper III**, chopped hemp was ensiled in full-scale in large plastic rolls containing many tonnes in each.

Outcomes

Conversion of hemp biomass to methane

In this section, the results from **Paper I** are presented. The methane yield of a fibre cultivar of industrial hemp harvested at four different times in two years was determined using BMP tests. The biomass yield of hemp was determined from hemp harvested during three years, and the contents of extractive compounds, structural carbohydrates and lignin in hemp were determined at the four harvest times in one year.

Specific methane yield not influenced by harvest time

No significant difference was observed in the specific methane yield (related to DM or VS) when using hemp harvested in July, August, September or October. The average specific methane yield from hemp harvested at four times in two years was 234 ± 35 m³/t VS according to the BMP tests. However, a tendency towards a lower methane yield from hemp harvested in October was observed. The average specific methane yield was determined using ground hemp with the majority of particles in the range of 0.75–4 mm. Pakarinen et al. (2011) have presented methane yields from BMP tests with hemp (cultivar *Uso*) harvested at the end of September. The yield for chopped hemp (1–2 cm pieces) was 239 ± 9 m³/t VS and for ground hemp (smaller than 7 mm) it was 290 ± 13 m³/t VS, both of which are within the confidence interval of the yield presented in **Paper I**. Heiermann et al. (2009) report a methane yield of 300 L/t DM for hemp (cultivar *Feodora 19*), however this value is uncertain since the gas composition was only measured at certain points and not for all biogas produced. The specific methane yield of hemp is lower than that of maize, the dominating biogas crop in Europe. The yield of maize is around 335 m³/t VS according to Schittenhelm et al. (2008), in line with the yield presented in **Paper II** for maize; 360 m³/t VS. The methane yield of hemp was similar to that of some cultivars of willow (Lehtomaki & Bjornsson, 2006; Turick et al., 1991). Willow has also a high content of lignocellulose and has also been pointed out as an interesting energy crop from a sustainability point of view (EEA, 2006).

The methane production in the BMP tests was slightly inhibited initially when us-

ing biomass harvested in July and August. The possible inhibitory role of secondary metabolites in hemp is briefly discussed in **Paper I** but was not further investigated. No signs of inhibition were seen when using samples harvested in September and October. Before any attempts are made to digest hemp as a sole substrate in a continuous full-scale process, it is advisable to perform laboratory-scale digestion to determine whether any inhibition occurs. In the BMP tests used in these studies the substrate was diluted with inoculum. Potential inhibitory compounds will probably be present at higher concentrations in continuous digestion.

The highest biomass and energy yields were obtained from hemp harvested in September and October

Since there was no significant difference in methane yield per unit DM or VS at different harvesting times, the biomass DM or VS yield is the factor determining the highest methane yield per ha. The highest biomass yield, and methane yield, per ha was found in the beginning of September and the beginning of October. The biomass yield was on average 15.6 t/ha. The main components in the hemp harvested at the beginning of September were cellulose (~40%), AIL (~13–15%¹), xylan (~9%), ASL (~5–7%) and protein (~5%) based on **Papers I, III** and **IV**. The optimal harvest time when hemp is used for AD is similar to the harvest time of fibre (Sankari, 2000; van der Werf, 1995). Fibre utilization and AD might therefore be suitable to combine.

A more extensive study on the biomass yield based on the same cultivation trials as in **Paper I** confirm that the biomass yield was highest in the beginning of September and the beginning of October. Inclusion of one more year resulted in an average DM yield of 14.4 t/ha. It also added the information that harvest in November gave significantly lower biomass yield than September and October (Prade et al., 2011). The biomass yield achieved in the study of **Paper I** was for hand-harvested biomass for one location. Prade et al., (2011) later suggested a reduction of the hand-harvested yields with 10% representing harvest losses. The yield was then normalized, resulting in a further reduction in DM yield down to 10.2 t DM/ha, representing expected average yields in the region Götalands södra slättbygder (Gss) that includes 330 000 ha agricultural land (Prade et al., 2011; Prade et al., 2012). This yield was used in the technoeconomical analysis in **Paper V**.

The HHV of hemp harvested in September and October was 18.3 MJ/kg DM (**Paper I**). The total biomass energy yield was 285 GJ/ha and the methane yield 134 GJ/ha, based on the harvest yield given in **Paper I**. When using the adjusted biomass yield for the region (10.2 t DM/ha) the energy yield was 186 GJ/ha and the methane yield 88 GJ/ha. The

¹ The lignin content of leaves was not successfully measured. The range is calculated based on the assumption that leaves has somewhere between 0% lignin and the same lignin content as the stems.

biomass energy yield per ha is similar to the average yields from maize, whole-crop wheat and willow, higher than rapeseed with straw and grass-clover mixtures, but lower than sugar beets with leaves, according to data compiled by Börjesson and Tufvesson (2011). The methane energy yield per ha is similar to that of methane from ley crops and Fischer-Tropsch diesel from willow, higher than biodiesel from rapeseed or ethanol from wheat and lower than methane from maize or sugar beets (Börjesson & Tufvesson, 2011).

Is it possible to increase the methane yield?

The average methane yield reported in **Paper I** represents 47% of the HHV of the biomass. The potential methane yield can be roughly estimated by subtracting the HHV of the acid insoluble lignin (approximately 15% of DM with a HHV of 26.7 MJ/kg (Wooley & Putsche, 1996)), assuming that it is not degraded to a significant extent, and that at least 5% of degradable material is used to nourish microbial growth, and subtracting a 5% heat loss for degraded material. This results in a methane potential of 357 m³/t VS (based on 92.7% VS of DM for harvest in September). The average methane yield achieved experimentally then represents roughly 66% of the potential methane output from hemp using AD.

This shows that it might be possible to increase the methane yield of the hemp, and this was further investigated in **Papers III** and **IV**. Using the solids in the residue, including the energy-dense lignin, for combined heat and power production could likely increase the total energy efficiency from hemp, as evaluated in **Paper V**.

Ensiling did not influence methane yield

Ensiling has been reported to increase the methane yield of crops (Amon et al., 2007; Cirne et al., 2007; Klocke et al., 2007; Koch et al., 2009; Mahnert & Linke, 2009; Parkarinen et al., 2008; Vervaeren et al., 2010). However, the methane yield is often related to DM or VS. When determining DM and VS according to standard methods the first step involves drying. Volatile compounds are lost during drying, and will thus be accounted for as water if no corrections are made. Silage can contain high contents of volatile compounds and therefore methane yields and other results related to DM and VS can be erroneous. At the beginning of the 20th century it was stated that DM determination using oven drying is not suitable for silage without correction for the volatile compounds lost during drying. Although methods have been developed for the correction for losses of volatile compounds in fodder science (Huida et al., 1986; Porter & Murray, 2001), they are not widely used in research on biogas production. Many publi-

cations therefore report DM for silage without correction, which can lead to erroneous conclusions (**Paper II**).

The effect of ensiling on the methane yield was determined using wet weight balances from fresh silage and determining weight changes and energy losses through gas production during ensiling. DM and VS contents were determined using the method of correction for the loss of volatile compounds presented by Porter and Murray (2001). It was shown that ensiling conserved the methane potential of the hemp and three other feedstocks (sugar beet, beet tops and maize) well (**Figure 1 in Paper II**). No significant differences were seen in the methane yields from fresh frozen and ensiled material for any of the feedstocks. The energy losses during ensiling were also shown to be insignificant, and the weight losses small for all four feedstocks (**Table 2 in Paper II**).

The importance of correcting DM and VS measurements for the loss of volatile compounds was also demonstrated. When not correcting the DM and VS for the loss of volatile compounds the VS-related methane yield for sugar beets appeared to be 51% higher after ensiling than before, being unrealistically high. Also, the DM losses during ensiling exceeded the wet weight losses when the DM measurements were not corrected. When the VS content of the silage was corrected for loss of volatile compounds no significant difference was seen in the methane yield before and after ensiling for any of the feedstocks. Hemp silage had a low content of volatile compounds, around 4% of the DM, and there was no significant difference in methane yields when related to corrected and uncorrected DM (**Figure 1 in Paper II**).

Steam pretreatment and enzymatic pretreatment for the production of methane and ethanol

Studies were carried out to determine whether steam pretreatment could increase the methane yield of hemp (**Paper IV**). The steam pretreatment conditions were optimised for both dried and ensiled hemp for ethanol production, and the ethanol yield was determined for dry and ensiled hemp pretreated at optimised conditions (**Paper III**). The optimal pretreatment conditions for ethanol production were assumed to be suitable also for AD. The same batch of SP hemp was used for the ethanol fermentation (**Paper III**) and the AD trials presented in **Paper IV**. Information about this batch is given in **Paper IV**. The residues after ethanol production were used for AD.

The 8 different scenarios investigated are described in **Figure 1 in Paper IV**. Dry hemp stems were used and are referred to simply as hemp below. The leaves were not included in steam pretreatment. The scenarios were: **A**) AD of chopped hemp, **B**) AD of

finely ground hemp, **C**) AD of SP hemp, **D**) AD of SP and enzymatically hydrolysed hemp, **F**) combined ethanol production and AD of SP hemp, **H**) combined ethanol production and AD using the solid fibre fraction after steam pretreatment for ethanol production and subsequent AD, and the liquid fraction after steam pretreatment directly for AD. The results were also compared with 2 scenarios for ethanol production without AD (Scenarios **E** and **G**).

Optimising steam pretreatment of dry and ensiled hemp

For ethanol production it is common to use dried feedstocks (Barta et al., 2010; Öhgren et al., 2005; Sassner et al., 2008). Acids in ensiled material can be inhibiting to yeast and will also not be converted to ethanol (Larsson et al., 1999; Palmqvist & Hahn-Hagerdal, 2000), thereby representing a loss in ethanol potential compared to the potential of fresh or dried feedstock. However, when using the SP silage for AD, or the residues after ethanol production from SP silage for AD, the acids in the silage can be degraded and the situation is therefore different. Also, when combining ethanol production and AD, the liquid fraction after steam pretreatment can be used directly for AD. In this case, only small amounts of acids will enter the ethanol process. Thus, it was considered of importance to investigate whether ensiling could be used as an alternative to drying for storing hemp biomass prior ethanol production. The steam pretreatment conditions were optimized for dry hemp and ensiled whole crop hemp (**Paper III**). The acids in the silage could also act as catalysts in hemicellulose autohydrolysis. Therefore, ensiled material was steam pretreated (SP) with and without SO₂ as catalyst. The highest production of glucose in enzymatic hydrolysis in relation to the original feedstock, combined with low levels of furfural and HMF, were found with the addition of SO₂. The most suitable temperature and time for pretreatment were found to be 210 °C and 5 min (with 2% SO₂) for both dry hemp and ensiled hemp. The ethanol yield for SP dry hemp was 171 g/kg DM hemp (74% of the theoretical), and for SP hemp silage 163 g/kg DM (71% of the theoretical). This is slightly higher than the ethanol yield of hemp hurds presented by Barta et al., (2010), 141 g/kg DM (64% of the theoretical). The SP dry hemp and residues after ethanol production were also used for AD as presented in **Figure 1** in **Paper IV**.

Effect of steam pretreatment on methane yield

As described in **Paper IV**, AD of SP hemp (**C**) gave a significantly higher methane yield than the digestion of hemp chopped to 2–3 cm (**A**), **Figure 3** in **Paper IV**. The methane yield of SP hemp (Scenario **C**) was not significantly higher than that of finely ground hemp (Scenario **B**) (**Paper IV**) or that of roughly ground hemp (**Paper I**). The methane yields for scenario **A**, **B** and **C** (**Paper IV**) represent 56%, 63% and 65% of the methane

potential of the non AIL part of the hemp, respectively, compared to 66% from roughly ground hemp (**Paper I**). Thus, steam pretreatment did not improve the methane yield of hemp. However, the results indicate that SP hemp (Scenario **C**) is degraded more quickly than chopped (Scenario **A**) and ground hemp (Scenario **B**). After 10 days of digestion in the BMP tests 96% of the methane yield during the total digestion time of 30 days was produced, compared to 80–83% for chopped or ground hemp. These results indicate that it might be possible to use a shorter hydraulic retention time for SP material than for mechanically pretreated material. However, as many factors influence an AD process reliable conclusions concerning the retention time cannot be drawn without conducting continuous experiments.

Enzymatic hydrolysis

The enzymes applied in SSF were also applied prior to AD (Scenario **D**). They could not be applied simultaneously to AD as for ethanol fermentation since the activity is very low at neutral pH where AD is performed. Therefore SP hemp was enzymatically hydrolysed prior AD (Scenario **D**). Enzymatic hydrolysis did not improve the final methane yield, or the overall time for conversion to methane, compared to SP hemp (Scenario **C**), when the methane potential from degradation of the added enzymes was subtracted (Scenarios **C** and **D**, **Paper IV**). The time required for enzymatic hydrolysis could potentially be reduced through optimisation, resulting in a slightly faster overall degradation process. However, it is unlikely that a slight reduction in degradation time without an additional methane yield would compensate for the high cost of the enzymes. If cellulolytic enzymes were to be added to SP hemp prior AD, the cost of the enzymes alone would increase the total process costs by 8% (**Paper V**).

Co-production of ethanol and methane

Combining ethanol production and AD (Scenario **H**) was found to be very favourable, in accordance with other studies (Dererie et al., 2011; Kaparaju et al., 2009). The combination gave approximately twice the biofuel yield of producing only ethanol from hemp (Scenario **G**). Combining ethanol production and AD also gave a higher yield than AD alone. Likely mainly due to the degradation of enzymes and yeast added in ethanol production. However, even after subtracting the theoretical methane potential resulting from added enzymes and yeast the combined production (Scenario **H**) gave a slightly higher yield, 12%, than AD alone (Scenario **C**) (**Paper IV**). It is unlikely that this difference is statistically significant. However, results from trials on oat straw have also indicated that combined ethanol and methane production can give higher biofuel yields than AD alone (Dererie et al., 2011). The biofuel yield achieved with SP material (Sce-

nario **F**) was not significantly higher than AD of roughly ground hemp presented in **Paper I**. The energy yield of ethanol and methane corresponds to 72% of the theoretical methane yield of the non AIL part of hemp, compared to 66% for roughly ground hemp (**Paper I**), these yields are not significantly different.

Energy efficiency and economic performance

Paper V presents a techno-economic evaluation based on the three most promising scenarios identified in **Paper IV**. AD of chopped hemp (Scenario **A**) and SP hemp (Scenario **C**), and co-production of ethanol and methane (Scenario **H**) were investigated. Finely ground hemp (**B**) was not included since this degree of grinding is very energy demanding (Holtzapfel et al., 1989). Enzymatically hydrolysed SP hemp (Scenario **D**) was not included since enzymatic hydrolysis did not result in a higher methane yield. Only the scenario with the highest ethanol and methane yield (Scenario **H**) of the two co-production scenarios (**F** and **H**) was included. In all the modelled scenarios it was assumed that the solid residues were used for CHP production. A large-scale plant with a capacity of 234 000 t DM hemp feedstock per year was chosen. It was assumed that the flash stream from steam pretreatment was condensed and used for AD, resulting in an increase in the methane yield compared with the experimental results, due to the conversion of volatile organic compounds. The energy efficiencies reported in this study are based on the LHVs (In **Papers I** to **IV** the HHVs were used). The LHVs was used in the techno-economic evaluation as this is the value used for reporting climate effects in the EU's renewable energy directive (European Parliament & Council of the European Union, 2009). The methane yield expressed as the percentage of the energy of the hemp (dry hemp) is the same when using the HHV or LHV, however, the relation between the output of electricity and heat is different.

Energy efficiency

Scenario **A**, **C** and **H** are called **AD**, **SP-AD** and **Et-AD+** in **Paper V**. However, **A**, **C** and **H** will be used here. It was shown that AD with CHP production (Scenarios **A** and **C**) and co-production of ethanol, methane and CHP (Scenario **H**) can give high energy efficiencies in large-scale production, in accordance with results from Barta et al. (2010). Higher than the combination of ethanol, heat and electricity (Sassner et al., 2008). Co-production of methane and CHP could satisfy its own energy demand and yield a sur-

plus of sellable products such as methane, electricity and district heating corresponding to a total of 71–75% of the energy of the feedstock. Co-production of ethanol, methane and CHP (Scenario **F**) gave slightly higher ethanol and methane yields than methane and CHP (Scenarios **A** and **C**), but the total energy efficiency was lower due to a higher demand for heat and electricity.

The energy consumption of the various scenarios corresponded to 14% of the energy in the feedstock for the co-production of methane and CHP from chopped hemp (Scenario **A**), 20% for the production of methane and CHP from SP hemp (Scenario **B**) and 22% for the co-production of ethanol, methane and CHP (Scenario **F**) (based on LHV). These values are similar to smaller-scale methane production from ley crops, maize and sugar beet, where the energy demand corresponded to 16–20% of the energy in the feedstock (based on HHV), according to a literature survey by Tufvesson and Börjesson (2011). Small-scale methane production differs from large-scale in that the solid residues are generally not used for CHP production to cover the energy demand of the process and produce additional heat and electricity. It should also be noted that the analysis presented in **Paper V** includes non-insulated AD reactors. If using insulation the energy efficiency could be even higher for Scenario **A**. For the other scenarios cooling is needed after the steam pretreatment, part of the cooling is provided by using non-insulated reactors.

Economic performance

The three scenarios **A**, **C** and **H** (**AD**, **SP-AD** and **Et-AD+** in **Paper V**) performed similarly economically. The capital investment for the co-production of ethanol, methane and CHP was found to be higher than for methane and CHP. However, the price of ethanol is also higher than for methane, per unit energy, and therefore the production alternatives were found to have similar economic performance. The economical performance of combined methane and CHP production of chopped or SP hemp were also found to be similar. The higher methane yield for SP hemp than for chopped hemp was sufficient to cover the increased process cost of steam pretreatment. The yields of methane and ethanol were found to influence the process economy considerably. The production of electricity and heat had a significant influence on the energy efficiency but less on the process economy.

Despite the good energy efficiency of all the scenarios analysed in **Paper V**, none of them would be economically viable in Sweden today. The cost of the feedstock was by far the most important cost, constituting 54–67% of the total cost. For the process to be economically profitable, the total cost would have to be reduced by about one third. The cost of the feedstock would then have to be about 1100 SEK/t DM. A recent analysis of grass silage as feedstock for methane production in Ireland revealed a considerable variation in feedstock price, from 85 to 213 €/t DM (765–1917 SEK/t DM) over two winter periods (McEniry et al., 2011). Ekman et al. (2012) have recently shown that com-

bined ethanol, methane and CHP production from straw can be economically viable at the current price of straw, which is only about 360 SEK/t DM. Barta et al. (2010) have shown that co-production of ethanol, methane and CHP from spruce could be economically viable, and Sassner et al. (2008) found that ethanol could be produced from corn stover, *Salix* and spruce at the market price of ethanol, based on the feedstock prices at that time: 500–550 SEK/t DM.

A way of reducing the cost of the hemp feedstock in biofuel production could be to use higher value products such as fibre or seeds from the hemp for other purposes and use the other parts for biofuel production. The ethanol potential of hemp hurds, the residue after mechanical fibre preparation, was evaluated by Barta et al. (2010), and found to be only slightly lower per kg than that of complete hemp stems. If the bast fibres are separated by steam pretreatment, the liquid fraction could also be used for AD, as demonstrated in the present work. Hypothetically, AD could also possibly be used to refine the fibres if the duration of AD were optimised to degrade hemicellulose and pectin rather than the cellulose fibres.

The use of feedstocks with a higher specific methane yield is likely to have a considerable influence on the process economy. Thomsen et al. (2005) reported that the hemp variety Felina has a lower lignin content than Futura and a few other cultivars. It could therefore be interesting to further investigate Felina regarding conversion to biofuel since it may give a higher specific methane yield.

In the analysis described in **Paper V** the same hydraulic retention time for AD was assumed for all cases where CSTR was used. The experimental results (**Paper IV**) indicated that it may be possible to shorten the retention time by using SP hemp instead of chopped hemp, which would influence the process economy. However, continuous experiments must be performed to determine whether the process performance can be maintained. It should also be noted that the modelling was based on the methane yields achieved in BMP trials, which may be higher than those achieved in continuous digestion.

Concluding remarks and future research

High energy efficiency but poor economy

Hemp grown in the south of Sweden, and in other areas of Europe, can have a high biomass yield and has promising characteristics for sustainable agricultural biomass production. In methane production of roughly ground hemp approximately half of the energy yield of the hemp biomass could be converted to methane. Methane production or combined ethanol and methane production from SP hemp was found to give similar yields to that of roughly ground hemp. The methane energy yield per ha is similar to that of methane from ley crops and Fischer-Tropsch diesel from Willow but lower than methane from maize. However, by using the residue after methane production for combined heat and electricity the energy efficiency could be increased to 71–75% of the energy in the hemp feedstock, this after satisfying the heat and electricity requirements of the process.

Despite a high energy efficiency none of the analysed scenarios is economically viable today. The cost of the feedstock was the main problem, accounting for 54–67% of the total process cost. For the process to be economically viable, the total cost would have to be reduced by about one third, which is not unrealistic. Alternatively, the methane price would have to increase by more than 50% to 3.6 SEK/m³. A deeper analysis of the cost of feedstock is needed in order to find ways of reducing it.

Whether the hemp was only chopped or chopped and SP prior to AD had no significant influence on the economy. The increased methane yield after steam pretreatment paid for the increased processing cost. Co-production of ethanol, methane and CHP resulted in a similar economical performance to the co-production of methane and CHP.

Ways of improving the processes and their economy

Combining the production of higher value products from hemp, like textile fibres or products from the seeds, with the production of biofuels and CHP is an interesting option that might improve the economics of the processes.

The investigated process designs for co-production of methane and CHP, as well as ethanol, methane and CHP were found to be interesting from an energy point of view, and are likely to be economically viable for cheaper feedstocks with similar biofuel yields. Analysis of the process economy for AD of feedstocks with higher methane yield, with and without pretreatment, would also be interesting since the economic performance was found to be very sensitive to the biofuel yield. Efforts should be made to find other crops with low environmental impact and high biomass yield, that have a higher specific methane yield. It should also be investigated whether hemp cultivars with lower lignin content perform better. Analysis of the effect of scale and co-production with CHP for feedstocks with higher and lower methane yields would be interesting.

When using steam-pretreated feedstocks it may be possible to improve the process economy by reducing the hydraulic retention time, which remains to be investigated. The energy demand and economical performance of using rough grinding as pretreatment method, which gave the same methane yield as steam pretreatment, also remains to be determined.

Biofuels and agricultural sustainability

Another area of research that deserves further attention is the interconnection between AD and sustainable agriculture. In this work it was found to be very expensive to store the residue after AD prior to using it as a fertilizer, and it would be cheaper to treat the liquid in a wastewater treatment plant. Further research is needed on how to improve the economy in the recycling of nutrients. Another important issue is the trade-off between soil carbon and energy efficiency. It was found to be beneficial from energy efficiency and economic points of view to use the solids remaining after AD for CHP production. However, almost no carbon from the above-ground biomass would be returned to the soil. Further studies are needed on the value of returning solid residues after AD to the soil or leaving parts of the plants in the soil. Can an economical value be set on the soil carbon?

Acknowledgements

Lovisa. My supervisor. Warm thanks for all your support and knowledgeable input over the years. You lift people around you with your positive attitude. Without you and Theodor I would have weighed myself down with self-criticism. You have fertilized and pruned me. Thanks also for arranging the major part of my financial support and the nice social activities for the group.

Thanks **Sven-Erik** and **Gunnar** for initiating studies on hemp. Gunnar, thanks for sharing your wisdom. Sven-Erik, thanks for everything from giving us projects, sharing your ideas, contacts, conference and reading suggestions to practical arrangements.

Thanks to **Thomas, Sven-Erik, Charlotte, Pål, Micke, Jan-Eric, Jan-Erik, Erik** and **Georg** for our fruitful collaboration within and outside the Crops4Biogas project, and for invitations to coming projects. I have learnt many things from you. Special thanks to Thomas for struggling with statistics and writing **Paper I** with me and for helping with hemp samples throughout the studies. Thanks to Jan-Eric for help with the statistics.

Thanks to **Guido, Bálint** and **Zsolti** for a productive and inspiring cooperation. I have learnt much from all three of you.

Thanks **Bo** for receiving me well and for later on, together with **Lovisa**, believing in me as a PhD candidate. Thanks also **Bo** and **Eva** for taking on the tasks as co-supervisors.

Thanks to former and present members of the Biotechnology Department and especially the environmental group for very nice company. I wish I could have spent more time with you all. A special thanks to **Federico, Ivo** and **Xinmei** for friendly collaborations and to **Carla** for figuring out the HPLC with me and for sharing your new insights in the HPLC as well as in your research. Thanks to **Valentine, Carla** and **Federico** for tending my reactors when I have been away and thanks **Valentine** for arranging the nice gift for Sigrid.

Thanks to **Kurt Hansson, Lars Evers, Kalle Svensson**, and **Lennart Thyseius** who

were the first to welcome and encourage my interest in biogas production. Kurt, already when I met you in 2004 you suggested that hemp should be used for biogas production. Lennart I will remember your words: biogas is like a virus, ones you get infected you cannot get rid of it.

Thanks to **Kjell** and **Jesper** at Anneberg and **Bertil** and **Erik** at Lönsstorp for helping with practical issues and for sharing your experience.

Thanks to **Siv** for your kind attitude and help with administration. Thanks to **Frans-Peder**, for being you.

Thank you to all my teachers through the years that have helped me on my path:

Pavel. The supervisor of my master thesis. Thanks for your enthusiasm for research and for giving me a good answer to an awful Question: Am I suited for research? Answer: Do your ideas excite you?

Stefan, thanks for helping me to Zürich and **Franz** and **Sylvia** for helping me there. **Trasan**, thanks for teaching me alternative agricultural practices and **Benny** for teaching me on “agricultural practice with precision”. Thanks **Jaoko** for supervising my project on biogas in high school and for taking us to Baltic Sea Youth Forum. Thanks **Ove** for your endless enthusiasm for collenchyma and everything else in botany.

Last but not least, Thank you to my friends and family:

Pappa Sten. Thanks for inspiring me with your ideas and your way of thinking and for always keeping your home open to me.

Mamma Annette. Thanks for showing the importance of taking initiatives and for being warm-hearted, creative and brave.

Theodor. Thank you for sharing my life and for giving me Sigrid. Thanks for moving with me to Lund. Thanks for encouraging me to act on my ideas and never agreeing when I feel I am not suited for research. Thanks for interesting talks, tasty food, the beauty you create and for sharing your wide knowledge.

My little **Sigrid**. You make me happy every day, thanks for being.

Otto and **Villiam**, my brothers. I am happy that we are family. Thanks for releasing me from responsibilities in my last intensive phase of writing.

Sabrina and **Emelie**, Theodors sisters and my “*African sisters*” as Valentine call you. Thanks for all the support over the years. Without you it would have been difficult to attend full-day project meetings and weeklong courses during parental leave. Thank you very much. Thanks also Emelie for the cover photo of this thesis. Thank you **Rita**, Theodors mother, for all your good advice on parenting and your loving help with Sigrid.

Ann-Marie and **Lennart**, my Godmother and Godfather. Thank you for making me feel that there is always time for me. Thanks for many interesting discussions on wide subjects and for advice in work and life.

Anne, Banafsheh, Christine, Karin and **Tina**. My friends from my early university years. Doctors, if all goes well, I now join your club. Thanks for your support, compassion, patience, enthusiasm, inspiration, laughs and interesting discussions and thanks for sharing. It has been very valuable to talk to you about the ups and downs of my work, you who are outside my work place but understand my experiences. I am so happy that we still keep in touch and hope we continue to be so long after we have become gray-haired, wise old lady doctors.

Thanks to all my **friends** outside the academy. Thanks for giving me relief from the academy now and then, for showing me other ways of thinking and behaving, and making me laugh. A special thanks to **Linda** and **Sara** for keeping in touch. Thanks for the happiness you provide and for sharing your thoughts on life. Thanks Linda for not making life more complicated than it is. Thanks Sara for your strong drive. You both inspire me.

Special thanks also to all my friends that have taken time to visit us here in Lund.

References

- Akin, D.E. 1980. Attack on lignified grass cell-walls by a facultatively anaerobic bacterium. *Applied and Environmental Microbiology*, **40**(4), 809-820.
- Almeida, M.A.N., de Franca, F.P. 1999. Thermophilic and mesophilic bacteria in biofilms associated with corrosion in a heat exchanger. *World Journal of Microbiology & Biotechnology*, **15**(4), 439-442.
- Alves, M.M., Pereira, M.A., Sousa, D.Z., Cavaleiro, A.J., Picavet, M., Smidt, H., Stams, A.J.M. 2009. Waste lipids to energy: how to optimize methane production from long-chain fatty acids (LCFA). *Microbial Biotechnology*, **2**(5), 538-550.
- Amaducci, S., Zatta, A., Raffanini, M., Venturi, G. 2008. Characterisation of hemp (*Cannabis sativa* L.) roots under different growing conditions. *Plant and Soil*, **313**(1-2), 227-235.
- Amon, T., Amon, B., Kryvoruchko, V., Zollitsch, W., Mayer, K., Gruber, L. 2007. Biogas production from maize and dairy cattle manure - Influence of biomass composition on the methane yield. *Agriculture Ecosystems & Environment*, **118**(1-4), 173-182.
- Angelidaki, I., Alves, M., Bolzonella, D., Borzacconi, L., Campos, J.L., Guwy, A.J., Kalyuzhnyi, S., Jenicek, P., van Lier, J.B. 2009. Defining the biomethane potential (BMP) of solid organic wastes and energy crops: a proposed protocol for batch assays. *Water Science and Technology*, **59**(5), 927-934.
- APHA. 2005. 2540 G. Total, fixed, and volatile solids in solid and semisolid samples. 21st ed. in: *Standard methods for the examination of water and wastewater*, (Eds.) A.D. Eaton, L.S. Clesceri, E.W. Rice, A.E. Greenberg, M.A. Franson, American Public Health Association/American Water Works Association/Water Environment Federation. Baltimore.
- Bachmaier, J., Effenberger, M., Gronauer, A. 2010. Greenhouse gas balance and resource demand of biogas plants in agriculture. *Engineering in Life Sciences*, **10**(6), 560-569.
- Badshah, M., Nasir, Z., Liu, J., Mattiasson, B. 2012. Effect of inhibitors formed during the pretreatment of anaerobic digestion process. *Manuscript*.
- Barta, Z., Oliva, J.M., Ballesteros, I., Dienes, D., Ballesteros, M., Reczey, K. 2010b. Refining Hemp Hurds into Fermentable Sugars or Ethanol. *Chemical and Biochemical Engineering Quarterly*, **24**(3), 331-339.
- Barta, Z., Reczey, K., Zacchi, G. 2010. Techno-economic evaluation of stillage treatment with anaerobic digestion in a softwood-to-ethanol process. *Biotechnology for Biofuels*, **3**.
- Batstone, D.J., Keller, J., Angelidaki, I., Kalyuzhnyi, S.V., Pavlostathis, S.G., Rozzi, A., Sanders, W.T.M., Siegrist, H., Vavilin, V.A. 2002. The IWA Anaerobic Digestion Model No 1 (ADM1). *Water Science and Technology*, **45**(10), 65-73.
- Belay, N., Boopathy, R., Voskuilen, G. 1997. Anaerobic transformation of furfural by *Methanococcus deltae* Delta LH. *Applied and Environmental Microbiology*, **63**(5), 2092-2094.
- Bentsen, N.S., Felby, C. 2012. Biomass for energy in the European Union – a review of resource assessments. *Biotechnology for Biofuels*, **5**(25).

- Besle, J.M., Jouany, J.P., Cornu, A. 1995. Transformation of structural phenylpropanoids during cell-wall digestion. *FEMS Microbiology Reviews*, **16**(1), 33-52.
- Bjornsson, L., Murto, M., Mattiasson, B. 2000. Evaluation of parameters for monitoring an anaerobic co-digestion process. *Applied Microbiology and Biotechnology*, **54**(6), 844-849.
- Boopathy, R. 2002. Methanogenesis from furfural by defined mixed cultures. *Current Microbiology*, **44**(6), 406-410.
- Boopathy, R. 1996. Methanogenic transformation of methylfurfural compounds to furfural. *Applied and Environmental Microbiology*, **62**(9), 3483-3485.
- Borjesson, P., Tufvesson, L.M. 2011. Agricultural crop-based biofuels - resource efficiency and environmental performance including direct land use changes. *Journal of Cleaner Production*, **19**(2-3), 108-120.
- Callaway, J.C. 2004. Hempseed as a nutritional resource: An overview. *Euphytica*, **140**(1-2), 65-72.
- Cappelletto, P., Brizzi, M., Mongardini, F., Barberi, B., Sannibale, M., Nenci, G., Poli, M., Corsi, G., Grassi, G., Pasini, P. 2001. Italy-grown hemp: yield, composition and cannabinoid content. *Industrial Crops and Products*, **13**(2), 101-113.
- Carpita, N.C., Gibeaut, D.M. 1993. Structural models of primary-cell walls in flowering plants - consistency of molecular-structure with the physical-properties of the walls during growth. *Plant Journal*, **3**(1), 1-30.
- Chandra, R., Takeuchi, H., Hasegawa, T. 2012. Methane production from lignocellulosic agricultural crop wastes: A review in context to second generation of biofuel production. *Renewable & Sustainable Energy Reviews*, **16**(3), 1462-1476.
- Chang, V.S., Holtzapfel, M.T. 2000. Fundamental factors affecting biomass enzymatic reactivity. *Applied Biochemistry and Biotechnology*, **84-6**, 5-37.
- Chen, Y., Cheng, J.J. 2007. Effect of potassium inhibition on the thermophilic anaerobic digestion of swine waste. *Water Environment Research*, **79**(6), 667-674.
- Cirne, D.G., Lehtomaki, A., Bjornsson, L., Blackall, L.L. 2007. Hydrolysis and microbial community analyses in two-stage anaerobic digestion of energy crops. *Journal of Applied Microbiology*, **103**(3), 516-527.
- de Vries, S.C., van de Ven, G.W.J., van Ittersum, M.K., Giller, K.E. 2010. Resource use efficiency and environmental performance of nine major bio-fuel crops, processed by first-generation conversion techniques. *Biomass & Bioenergy*, **34**(5), 588-601.
- Dererie, D.Y., Trobro, S., Momeni, M.H., Hansson, H., Blomqvist, J., Passoth, V., Schnurer, A., Sandgren, M., Stahlberg, J. 2011. Improved bio-energy yields via sequential ethanol fermentation and biogas digestion of steam exploded oat straw. *Bioresource Technology*, **102**(6), 4449-4455.
- EEA. 2006. How much bioenergy can Europe produce without harming the environment?
- Ekman, A., Wallberg, O., Joelsson, E., Börjesson, P. 2012. Possibilities for sustainable biorefineries based on agricultural residues – A case study of potential straw-based ethanol production in Sweden. in: Environmental assessment of emerging bio-based production – possibilities in a future bio-economy, A. Ekman, Lund University. *Doctoral thesis*.
- EurObserv'ER. 2012. Figure on renewable energy in EU. 16th June 2012. <http://www.eurobserv-er.org/default.asp>
- European Parliament, Council of the European Union. Directive 2009/28/EC of the European parliament and of the council of the council. 2009.
- Eurostat. 2010. Energy, transport and environment indicators.
- Fang, C., Boe, K., Angelidaki, I. 2011. Anaerobic co-digestion of desugared molasses with cow manure; focusing on sodium and potassium inhibition. *Bioresource Technology*, **102**(2), 1005-1011.
- Fermoso, F.G., Bartacek, J., Chung, L.C., Lens, P. 2008. Supplementation of cobalt to UASB reactors

- by pulse dosing: CoCl₂ versus CoEDTA(2-) pulses. *Biochemical Engineering Journal*, **42**(2), 111-119.
- Fermoso, F.G., Bartacek, J., Jansen, S., Lens, P.N.L. 2009. Metal supplementation to UASB bioreactors: from cell-metal interactions to full-scale application. *Science of the Total Environment*, **407**(12), 3652-3667.
- Finell, M., Xiong, S., Olsson, R. 2006. Multifunktionell industriehampa för norra Sverige (Multifunctional industrial hemp for Northern Sweden). Unit for Biomass Technology and Chemistry, Swedish University of Agricultural Sciences, Umeå, Sweden. BTK-rapport 2006:13. Swedish.
- FNR, F.N.R.e.V. 2012. Bioenergy in Germany: Facts and Figures, January 2012.
- FNR, F.N.R.e.V. 2009. Biogas-Messprogram II, 61 Biogasanlagen im vergleich. Johann Heinrich von Thünen-Institut (vTI).
- Galbe, M., Zacchi, G. 2007. Pretreatment of lignocellulosic materials for efficient bioethanol production. in: *Biofuels*, (Ed.) L. Olsson, Vol. 108, pp. 41-65.
- Garcia-Jaldon, C., Dupeyre, D., Vignon, M.R. 1998. Fibres from semi-retted hemp bundles by steam explosion treatment. *Biomass & Bioenergy*, **14**(3), 251-260.
- Gerardi, M. 2003. *The microbiology of anaerobic digesters*. John Wiley & Sons, Inc., Hoboken.
- Gustavsson, J. 2011. Cobalt and nickel bioavailability for biogas formation Faculty of art and sciences. Linköping University.
- Harris, P., Stone, B. 2008. Chemistry and molecular organization of plant cell walls. in: *Biomass recalcitrance, deconstructing the plant cell wall for bioenergy*, (Ed.) M. Himmel, Blackwell publishing, Singapore.
- Heiermann, M., Plöchl, M., Linke, B., Schelle, H., Herrman, C. 2009. Biogas crops - part I: Specifications and suitability of field crops for anaerobic digestion. *Agricultural Engineering International; the CIGR Ejournal*, **XI June**.
- Hendriks, A., Zeeman, G. 2009. Pretreatments to enhance the digestibility of lignocellulosic biomass. *Bioresource Technology*, **100**(1), 10-18.
- Hinken, L., Urban, I., Haun, E., Weichgrebe, D., Rosenwinkel, K.H. 2008. The valuation of malnutrition in the mono-digestion of maize silage by anaerobic batch tests. *Water Science and Technology*, **58**(7), 1453-1459.
- Holtzapple, M.T., Humphrey, A.E., Taylor, J.D. 1989. Energy-requirements for the size reduction of poplar and aspen wood. *Biotechnology and Bioengineering*, **33**(2), 207-210.
- Hoogwijk, M., Faaij, A., Eickhout, B., de Vries, B., Turkenburg, W. 2005. Potential of biomass energy out to 2100, for four IPCC-SRES land-use scenarios. *Biomass & Bioenergy*, **29**(4), 225-257.
- Huida, L., Vaatainen, H., Lampila, M. 1986. Comparison of dry-matter contents in grass silages as determined by oven drying and gas-chromatographic water analysis. *Annales Agriculturae Fenniae*, **25**(3), 215-230.
- ISO. Solid mineral fuels - Determination of gross calorific value by the bomb calorimetric method, and calculation of net calorific value. 1995.
- Jarvis, A., Nordberg, A., Jarlsvik, T., Mathisen, B., Svensson, B.H. 1997. Improvement of a grass-clover silage-fed biogas process by the addition of cobalt. *Biomass & Bioenergy*, **12**(6), 453-460.
- Jeffries, T.W. 1990. Biodegradation of lignin-carbohydrate complexes. *Biodegradation*, **1**, 163-176.
- Jones, A., Panagos, P., Barcelo, S., Bouraoui, F., Bosco, C., Dewitte, O., Gardi, C., Erhard, M., Hervás, J., Hiederer, R., Jeffery, S., Lukwille, A., Marmo, L., Montanarella, L., Olazábal, C., Petersen, J.-E., Penizek, V., Strassburger, T., Tóth, G., Van Den Eeckhaut, M., Van Liedekerke, M., Verheijen, F., Viestova, E., Yigini, Y. 2012. The state of soil in Europe. A contribution of the JRC to the European Environment Agency's Environment State and Outlook report - SOER 2010. EUR 25186 EN.
- Jorgensen, H., Kristensen, J.B., Felby, C. 2007. Enzymatic conversion of lignocellulose into ferment-

- able sugars: challenges and opportunities. *Biofuels Bioproducts & Biorefining-Biofpr*, **1**(2), 119-134.
- Kaiser, F., Diepolder, M., Eder, J., Hartmann, S., Prestele, H., Gronauer, A. 2005. Biogas yields from various renewable raw materials. *7th FAO/SREN - workshop, The future of biogas for sustainable energy production in europe*, Uppsala. pp. 4.
- Källander, I. 1989. *Jordbruksbok för alternativodlare*. LTs förlag, Borås.
- Kamat, J., Roy, D.N., Goel, K. 2002. Effect of harvesting age on the chemical properties of hemp plants. *Journal of Wood Chemistry and Technology*, **22**(4), 285-293.
- Kaparaju, P., Serrano, M., Thomsen, A.B., Kongjan, P., Angelidaki, I. 2009. Bioethanol, biohydrogen and biogas production from wheat straw in a biorefinery concept. *Bioresource Technology*, **100**(9), 2562-2568.
- Karlsson, A., Ejlertsson, J., Nezirevic, D., Svensson, B.H. 1999. Degradation of phenol under meso- and thermophilic, anaerobic conditions. *Anaerobe*, **5**(1), 25-35.
- Karlsson, A., Ejlertsson, J., Svensson, B.H. 2000. CO₂-dependent fermentation of phenol to acetate, butyrate and benzoate by an anaerobic, pasteurised culture. *Archives of Microbiology*, **173**(5-6), 398-402.
- Keller, A., Leupin, M., Mediavilla, V., Wintermantel, E. 2001. Influence of the growth stage of industrial hemp on chemical and physical properties of the fibres. *Industrial Crops and Products*, **13**(1), 35-48.
- Kirkegaard, J.A., Hocking, P.J., Angus, J.F., Howe, G.N., Gardner, P.A. 1997. Comparison of canola, Indian mustard, and Linola in two contrasting environments. II. Break crop and nitrogen effects on subsequent wheat crops. *Field Crops Research*, **52**(1-2), 179-191.
- Klimiuk, E., Pokoj, T., Budzynski, W., Dubis, B. 2010. Theoretical and observed biogas production from plant biomass of different fibre contents. *Bioresource Technology*, **101**(24), 9527-9535.
- Klocke, M., Mahnert, P., Mundt, K., Souidi, K., Linke, B. 2007. Microbial community analysis of a biogas-producing completely stirred tank reactor fed continuously with fodder beet silage as mono-substrate. *Systematic and Applied Microbiology*, **30**(2), 139-151.
- Koch, K., Wichern, M., Lubken, M., Horn, H. 2009. Mono fermentation of grass silage by means of loop reactors. *Bioresource Technology*, **100**(23), 5934-5940.
- Kortekaas, S., Soto, M., Vicent, T., Field, J.A., Lettinga, G. 1995. Contribution of extractives to methanogenic toxicity of hemp black liquor. *Journal of Fermentation and Bioengineering*, **80**(4), 383-388.
- Kristensen, J.B., Thygesen, L.G., Felby, C., Jorgensen, H., Elder, T. 2008. Cell-wall structural changes in wheat straw pretreated for bioethanol production. *Biotechnology for Biofuels*, **1**.
- Larsson, S., Palmqvist, E., Hahn-Hagerdal, B., Tengborg, C., Stenberg, K., Zacchi, G., Nilvebrant, N.O. 1999. The generation of fermentation inhibitors during dilute acid hydrolysis of softwood. *Enzyme and Microbial Technology*, **24**(3-4), 151-159.
- Lebuhn, M., Liu, F., Heuwinkel, H., Gronauer, A. 2008. Biogas production from mono-digestion of maize silage-long-term process stability and requirements. *Water Science and Technology*, **58**(8), 1645-1651.
- Lee, P.H., Bae, J., Kim, J., Chen, W.H. 2011. Mesophilic anaerobic digestion of corn thin stillage: a technical and energetic assessment of the corn-to-ethanol industry integrated with anaerobic digestion. *Journal of Chemical Technology and Biotechnology*, **86**(12), 1514-1520.
- Lehtomaki, A., Bjornsson, L. 2006. Two-stage anaerobic digestion of energy crops: Methane production, nitrogen mineralisation and heavy metal mobilisation. *Environmental Technology*, **27**(2), 209-218.
- Leschine, S.B. 1995. Cellulose degradation in anaerobic environments. *Annual Review of Microbiology*, **49**, 399-426.

- Leven, L., Nyberg, K., Schnurer, A. 2012. Conversion of phenols during anaerobic digestion of organic solid waste - A review of important microorganisms and impact of temperature. *Journal of Environmental Management*, **95**, S99-S103.
- Leven, L., Schnurer, A. 2005. Effects of temperature on biological degradation of phenols, benzoates and phthalates under methanogenic conditions. *International Biodeterioration & Biodegradation*, **55**(2), 153-160.
- Linde, M., Jakobsson, E.L., Galbe, M., Zacchi, G. 2008. Steam inretreatment of dilute H₂SO₄-impregnated wheat straw and SSF with low yeast and enzyme loadings for bioethanol production. *Biomass & Bioenergy*, **32**(4), 326-332.
- Linné, M., Ekstrandh, A., Englesson, R., Persson, E., Björnsson, L., Lantz, M. 2008. Den svenska biogaspotentialen från inhemska råvaror. Avfall Sverige. 2008:02.
- Lohrasbi, M., Pourbafrani, M., Niklasson, C., Taherzadeh, M.J. 2010. Process design and economic analysis of a citrus waste biorefinery with biofuels and limonene as products. *Bioresource Technology*, **101**(19), 7382-7388.
- Lotz, L.A.P., Groeneveld, R.M.W., Habekotte, B., Vanoene, H. 1991. Reduction of growth and reproduction of *Cyperus-esculentus* by specific crops. *Weed Research*, **31**(3), 153-160.
- Lynd, L.R., Weimer, P.J., van Zyl, W.H., Pretorius, I.S. 2002. Microbial cellulose utilization: Fundamentals and biotechnology. *Microbiology and molecular biology reviews*, **66**(3), 506-+.
- Madigan, M.T., Martinko, J.M., Dunlap, P.V., Clark, D.P. 2009. *Brock Biology of microorganisms. Twelfth ed.* San Francisco, USA.
- Mahnert, P., Linke, B. 2009. Kinetic study of biogas production from energy crops and animal waste slurry: Effect of organic loading rate and reactor size. *Environmental Technology*, **30**(1), 93-99.
- Mallik, M.K., Singh, U.K., Ahmad, N. 1990. Batch Digester Studies on Biogas Production from Cannabis-Sativa, Water Hyacinth and Crop Wastes Mixed with Dung and Poultry Litter. *Biological Wastes*, **31**(4), 315-319.
- McBride, A.C., Dale, V.H., Baskaran, L.M., Downing, M.E., Eaton, L.M., Efroymson, R.A., Garten, C.T., Kline, K.L., Jager, H.I., Mulholland, P.J., Parish, E.S., Schweizer, P.E., Storey, J.M. 2011. Indicators to support environmental sustainability of bioenergy systems. *Ecological Indicators*, **11**(5), 1277-1289.
- McCarty, 1964. Anaerobic waste treatment fundamentals. Part one, two, three and four. . *Chemistry and microbiology*(September).
- McEniry, J., O'Kiely, P., Crosson, P., Groom, E., Murphy, J.D. 2011. The effect of feedstock cost on biofuel cost as exemplified by biomethane production from grass silage. *Biofuels Bioproducts & Biorefining-Biofpr*, **5**(6), 670-682.
- McPartland, J.M. 1999. A survey of diseases and pests. in: *Advances in hemp research*, (Ed.) P. Ranalli, CRC Press.
- Moller, K., Schulz, R., Muller, T. 2011. Effects of setup of centralized biogas plants on crop acreage and balances of nutrients and soil humus. *Nutrient Cycling in Agroecosystems*, **89**(2), 303-312.
- Nguyen, M.H., Prince, R.G.H. 1996. A simple rule for bioenergy conversion plant size optimisation: Bioethanol from sugar cane and sweet sorghum. *Biomass & Bioenergy*, **10**(5-6), 361-365.
- Official Statistics of Sweden. 2011. Yearbook of agricultural statistics 2011, including food statistics.
- Öhgren, K., Galbe, M., Zacchi, G. 2005. Optimization of steam pretreatment of SO₂-impregnated corn stover for fuel ethanol production. *Applied Biochemistry and Biotechnology*, **121**, 1055-1067.
- Olofsson, K., Bertilsson, M., Liden, G. 2008. A short review on SSF - an interesting process option for ethanol production from lignocellulosic feedstocks. *Biotechnology for Biofuels*, **1**.
- Pakarinen, A., Maijala, P., Stoddard, F.L., Santanen, A., Tuomainen, P., Kymalainen, M., Viikari, L. 2011.

- Evaluation of annual bioenergy crops in the boreal zone for biogas and ethanol production. *Biomass & Bioenergy*, **35**(7), 3071-3078.
- Pakarinen, O., Lehtomaki, A., Rissanen, S., Rintala, J. 2008. Storing energy crops for methane production: Effects of solids content and biological additive. *Bioresource Technology*, **99**(15), 7074-7082.
- Palmqvist, E., Hahn-Hagerdal, B. 2000. Fermentation of lignocellulosic hydrolysates. II: inhibitors and mechanisms of inhibition. *Bioresource Technology*, **74**(1), 25-33.
- Peel, M.C., Finlayson, B.L., McMahon, T.A. 2007. Updated world map of the Koppen-Geiger climate classification. *Hydrology and Earth System Sciences*, **11**(5), 1633-1644.
- Pereira, M.A., Pires, O.C., Mota, M., Alves, M.M. 2005. Anaerobic biodegradation of oleic and palmitic acids: Evidence of mass transfer limitations caused by long chain fatty acid accumulation onto the anaerobic sludge. *Biotechnology and Bioengineering*, **92**(1), 15-23.
- Pereira, M.A., Sousa, D.Z., Mota, M., Alves, M.M. 2004. Mineralization of LCFA associated with anaerobic sludge: Kinetics, enhancement of methanogenic activity, and effect of VFA. *Biotechnology and Bioengineering*, **88**(4), 502-511.
- Piccolo, C., Wiman, M., Bezzo, F., Liden, G. 2010. Enzyme adsorption on SO₂ catalyzed steam-pretreated wheat and spruce material. *Enzyme and Microbial Technology*, **46**(3-4), 159-169.
- Porter, M.G., Murray, R.S. 2001. The volatility of components of grass silage on oven drying and the inter-relationship between dry-matter content estimated by different analytical methods. *Grass and Forage Science*, **56**(4), 405-411.
- Prade, T. 2011. Industrial hemp (*Cannabis sativa* L.) – a high-yielding energy crop. Faculty of Landscape planning, Horticulture and Agricultural Science. Swedish University of Agricultural Sciences. *Doctoral thesis*.
- Prade, T., Svensson, S.E., Andersson, A., Mattsson, J.E. 2011. Biomass and energy yield of industrial hemp grown for biogas and solid fuel. *Biomass & Bioenergy*, **35**(7), 3040-3049.
- Prade, T., Svensson, S.E., Mattsson, J.E. 2012. Energy balances for biogas and solid biofuel production from industrial hemp. *Biomass & Bioenergy*, **40**, 36-52.
- Prescott, L., Harley, J., Klein, D. 2002. *Microbiology. Fifth edition, International edition ed.* McGraw-Hill Higher Education, New York.
- Raven, P., Evert, R., Eichhorn, S. 2005. *Biology of plants. 7th ed.* W.H. Freeman and Co., New York.
- Rivard, C.J., Grohmann, K. 1991. Degradation of furfural (2-furaldehyde) to methane and carbon dioxide by an anaerobic consortium. *Applied Biochemistry and Biotechnology*, **28-9**, 285-295.
- Saha, B.C. 2003. Hemicellulose bioconversion. *Journal of Industrial Microbiology & Biotechnology*, **30**(5), 279-291.
- Sankari, H.S. 2000. Comparison of bast fibre yield and mechanical fibre properties of hemp (*Cannabis sativa* L.) cultivars. *Industrial Crops and Products*, **11**(1), 73-84.
- Sankari, H.S., Mela, T.J.N. 1998. Plant development and stem yield of non-domestic fibre hemp (*Cannabis sativa* L.) cultivars in long-day growth conditions in Finland. *Journal of Agronomy and Crop Science-Zeitschrift Fur Acker Und Pflanzenbau*, **181**(3), 153-159.
- Sassner, P., Galbe, M., Zacchi, G. 2008. Techno-economic evaluation of bioethanol production from three different lignocellulosic materials. *Biomass & Bioenergy*, **32**(5), 422-430.
- Schattauer, A., Abdoun, E., Weiland, P., Plochl, M., Heiermann, M. 2011. Abundance of trace elements in demonstration biogas plants. *Biosystems Engineering*, **108**(1), 57-65.
- Schink, B. 1997. Energetics of syntrophic cooperation in methanogenic degradation. *Microbiology and molecular biology reviews*, **61**(2), 262-280.

- Schittenhelm, S. 2008. Chemical composition and methane yield of maize hybrids with contrasting maturity. *European Journal of Agronomy*, **29**(2-3), 72-79.
- Schnurer, A., Nordberg, A. 2008. Ammonia, a selective agent for methane production by syntrophic acetate oxidation at mesophilic temperature. *Water Science and Technology*, **57**(5), 735-740.
- Schwarz, W.H. 2001. The cellulosome and cellulose degradation by anaerobic bacteria. *Applied Microbiology and Biotechnology*, **56**(5-6), 634-649.
- Shafei, M., Karimi, K., Taherzadeh, M.J. 2011. Techno-economical study of ethanol and biogas from spruce wood by NMMO-pretreatment and rapid fermentation and digestion. *Bioresource Technology*, **102**(17), 7879-7886.
- Sierraalvarez, R., Lettinga, G. 1990. The methanogenic toxicity of wood resin constituents. *Biological Wastes*, **33**(3), 211-226.
- Sluiter, A., Hames, B., Ruiz, R., Scarlata, C., Sluiter, J., Templeton, D., Crocker, D. 2008a. Determination of Structural Carbohydrates and Lignin in Biomass. National Renewable Energy Laboratory, Midwest Research Institute, Golden, CO. NREL/TP-510-42618.
- Sluiter, A., Ruiz, R., Scarlata, C., Sluiter, J., Templeton, D. 2008b. Determination of Extractives in Biomass. National Renewable Energy Laboratory, Midwest Research Institute, Golden, CO. NREL/TP-510-42619.
- Smyth, B.M., Smyth, H., Murphy, J.D. 2010. Can grass biomethane be an economically viable biofuel for the farmer and the consumer? *Biofuels Bioproducts & Biorefining-Biofr*, **4**(5), 519-537.
- Speece, R.E. 1983. Anaerobic biotechnology for industrial wastewater treatment. *Environmental Science and Technology*, **17**(9), 416a-427a.
- Speece, R.E. 1988. Nutrient requirements. in: *Anaerobic digestion of biomass*, (Eds.) D. Chynoweth, R. Isaacson, Elsevier applied science. Cambridge.
- Statistics Sweden. 2010. Excerpt for county of Scania from the agricultural register 2010. .
- Struik, P.C., Amaducci, S., Bullard, M.J., Stutterheim, N.C., Venturi, G., Cromack, H.T.H. 2000. Agronomy of fibre hemp (*Cannabis sativa* L.) in Europe. *Industrial Crops and Products*, **11**(2-3), 107-118.
- Sun, Y., Cheng, J.Y. 2002. Hydrolysis of lignocellulosic materials for ethanol production: a review. *Bioresource Technology*, **83**(1), 1-11.
- Svennerstedt, B., Svensson G. 2006. Hemp (*Cannabis sativa* L.) Trials in Southern Sweden 1999-2001. *Journal of Industrial Hemp* **11**(1), 17-25.
- Svensson, L.M., Christensson, K., Björnsson, L. 2005. Biogas production from crop residues on a farm-scale level: is it economically feasible under conditions in Sweden? *Bioprocess and Biosystems Engineering*, **28**(3), 139-148.
- Swedish Board of Agriculture. 2006. Bioenergi – Ny energi för jordbruket. The Swedish Board of Agriculture. 2006:1.
- Swedish Board of Agriculture. 2012. I Sverige odlar vi mest vete, korn och havre. 4th June 2012. www.jordbruksverket.se/amnesomraden/handel/politikochframtid/eusjordbrukspolitik/spannmal.4.67e843d911ff9f51db80002996.html
- Swedish Board of Agriculture, Statistics Sweden. 2011. Yearbook of agricultural statistics 2011, including food statistics.
- Swedish Energy Agency. 2011. Energy in Sweden - facts and figures 2011.
- Swedish Energy Agency. 2012. Transportsektorns energianvändning. ES 2012:01. ISSN 1654-7543.
- Symons, G.E., Buswell, A.M. 1933. The methane fermentation of carbohydrates. *Journal of the American Chemical Society*, **55**.
- Taherzadeh, M.J., Karimi, K. 2008. Pretreatment of lignocellulosic wastes to improve ethanol and biogas production: A review. *International Journal of Molecular Sciences*, **9**(9), 1621-1651.

- Takashima, M., Shimada, K., Speece, R.E. 2011. Minimum Requirements for Trace Metals (Iron, Nickel, Cobalt, and Zinc) in Thermophilic and Mesophilic Methane Fermentation from Glucose. *Water Environment Research*, **83**(4), 339-346.
- Thomsen, A.B., Rasmussen, S., Bohn, V., Vad Nielsen, K., Thygesen, A. 2005. Hemp raw materials: The effect of cultivar, growth conditions and pretreatment on the chemical composition of the fibres. Biosystems department, Risø National Laboratory, Roskilde, Denmark.
- Toonen, M.A.J., Maliapaard, C., Reijmers, T.H., van der Voet, H., Mastebroek, D., van den Broeck, H.C., Ebskamp, M.J.M., Kessler, W., Kessler, R.W. 2004. Predicting the chemical composition of fibre and core fraction of hemp (*Cannabis sativa* L.). *Euphytica*, **140**(1-2), 39-45.
- Triolo, J.M., Sommer, S.G., Moller, H.B., Weisbjerg, M.R., Jiang, X.Y. 2011. A new algorithm to characterize biodegradability of biomass during anaerobic digestion: Influence of lignin concentration on methane production potential. *Bioresource Technology*, **102**(20), 9395-9402.
- Turick, C.E., Peck, M.W., Chynoweth, D.P., Jerger, D.E., White, E.H., Zsuffa, L., Kenney, W.A. 1991. Methane fermentation of woody biomass. *Biore-source Technology*, **37**(2), 141-147.
- Turner, C.E., Elsohly, M.A., Boeren, E.G. 1980. Constituents of *Cannabis-sativa* L.17. a review of the natural constituents. *Journal of Natural Products*, **43**(2), 169-234.
- van der Werf, H.M.G. 2004. Life Cycle Analysis of field production of fibre hemp, the effect of production practices on environmental impacts. *Euphytica*, **140**(1-2), 13-23.
- van der Werf, H.M.G., van Geel, W.C.A., Wijlhuizen, M. 1995. Agronomic research on hemp (*Cannabis sativa* L.) in The Netherlands, 1987-1993. *Journal of the International Hemp Association* **2**(1), 14-17.
- Vervaeren, H., Hostyn, K., Ghekiere, G., Willems, B. 2010. Biological ensilage additives as pretreatment for maize to increase the biogas production. *Renewable Energy*, **35**(9), 2089-2093.
- Walla, C., Schneeberger, W. 2008. The optimal size for biogas plants. *Biomass & Bioenergy*, **32**(6), 551-557.
- Wilson, I.G. 1997. Inhibition and facilitation of nucleic acid amplification. *Applied and Environmental Microbiology*, **63**(10), 3741-3751.
- Wilson, J.R., Mertens, D.R. 1995. Cell-wall accessibility and cell structure limitations to microbial digestion of forage. *Crop Science*, **35**(1), 251-259.
- Wiman, M. 2012. Analyzing material properties for efficient processing of spruce ethanol Department of Chemical Engineering. Lund University.
- Wooley, R., Putsche, V. 1996. Development of an ASPEN PLUS physical property database for biofuels components. National Renewable Energy Laboratory, Golden.
- Yu, L., Chen, Z.X., Tong, X., Li, K., Li, W.W. 2012. Anaerobic degradation of microcrystalline cellulose: Kinetics and micro-scale structure evolution. *Chemosphere*, **86**(4), 348-353.
- Zehnder, A.B.J. 1988. *Biology of anaerobic microorganisms*. John Wiley & Sons Inc.
- Zeikus, J.G., Wellstein, A.L., Kirk, T.K. 1982. Molecular-basis for the biodegradative recalcitrance of lignin in anaerobic environments. *FEMS Microbiology Letters*, **15**(3), 193-197.
- Zhu, L., O'Dwyer, J.P., Chang, V.S., Granda, C.B., Holtzapple, M.T. 2008. Structural features affecting biomass enzymatic digestibility. *Biore-source Technology*, **99**(9), 3817-3828.

Available at www.sciencedirect.com<http://www.elsevier.com/locate/biombioe>

Anaerobic digestion of industrial hemp—Effect of harvest time on methane energy yield per hectare

E. Kreuger^{a,*}, T. Prade^b, F. Escobar^a, S.-E. Svensson^b, J.-E. Englund^b, L. Björnsson^a

^a Department of Biotechnology, Lund University, P.O. Box 124, SE-221 00 Lund, Sweden

^b Department of Agriculture—Farming Systems, Technology and Product Quality, Swedish University of Agricultural Sciences, P.O. Box 104, SE-230 53 Alnarp, Sweden

ARTICLE INFO

Article history:

Received 2 April 2010

Received in revised form

31 October 2010

Accepted 1 November 2010

Available online 15 December 2010

Keywords:

Energy crop

Transportation

Lignocellulose

Bio-fuel

Biogas

Cannabis sativa

ABSTRACT

There is a worldwide emphasis to increase the share of renewable transportation fuels. When using agricultural land for production of renewable transportation fuels, the energy output per hectare for different crops and transportation fuels is a crucial factor. In this study, the gross methane energy yield per hectare from anaerobic digestion of industrial hemp (*Cannabis sativa* L.), was determined at four different harvest times between July and October in Southern Sweden, a cold climate region. The biomass yield was determined for three years and the methane yield was determined for two years through the biochemical methane potential test. The highest biomass yield, 16 tonnes dry matter per hectare on an average, and the highest methane energy yield per hectare was achieved when the hemp was harvested in September or October, with an average gross methane energy yield of 136 ± 24 GJ per hectare. There was no significant difference in the specific methane yield between the harvest times; the average being 234 ± 35 m³ per tonne volatile solids. Biogas from hemp turned out to be a high yielding alternative to the currently dominating renewable transportation fuels produced from crops grown in Sweden: ethanol from wheat and biodiesel from rapeseed.

© 2010 Elsevier Ltd. All rights reserved.

1. Introduction

The efficient utilization of biomass as an energy source can reduce our dependency on fossil fuels and decrease greenhouse gas emissions, in line with EU goals [1]. In December 2008, the European Parliament adopted the proposal of an overall binding target of 20% of energy from renewable sources in energy consumption and a binding minimum target of 10% for renewable energy in domestic transport, to be achieved by each Member State by 2020 [1]. Sweden has already fulfilled the overall target as 43% of its energy was produced from renewable energy sources in 2006 [2]. However, in

domestic transportation the proportion of renewable energy is still low. In 2006, it was only 4.6%, dominated by ethanol and biodiesel, electricity from renewable sources, and biogas. While ethanol and biodiesel were mainly imported, or produced from imported raw materials, the biogas was produced mainly from sewage sludge and other domestic waste [2]. Similarly, low shares of renewable energy in the transport sector are found in many countries worldwide.

It has been estimated that the utilization of organic waste from households, agriculture and other industry (excluding forestry) for biogas production could yield at least 38 PJ methane annually in Sweden [3], representing 11% of the

* Corresponding author. Tel.: +46 46 222 81 93; fax: +46 46 222 47 13.

E-mail address: emma.kreuger@biotek.lu.se (E. Kreuger).

0961-9534/\$ – see front matter © 2010 Elsevier Ltd. All rights reserved.

doi:10.1016/j.biombioe.2010.11.005

domestic energy requirement for transportation in 2007. This would be sufficient to fulfill the EU goal for 2020, but other sources are needed to achieve independence from fossil fuels.

The use of dedicated energy crops grown on agricultural land is one option to increase the production of renewable transportation fuels considerably [4]. It has been estimated that up to 20%, or 600 000 ha (1 ha = 1 hectare = 10 000 m²), of agricultural land could be used for bioenergy production in Sweden, which includes previously set aside land and area where bioenergy is produced instead of producing food for export [5]. So far, only 2–3% of Sweden's agricultural land has been used for energy purposes. The dominating energy crops cultivated in Sweden for production of renewable transportation fuels (electricity not included) are wheat and triticale for ethanol production, and rapeseed for biodiesel [6]. In both cases only the seeds are used for the production of transportation fuels, resulting in a comparably low yield of transportation fuel per ha [7,8].

In contrast, biogas production from whole crops has been reported to be a high yielding and energy-efficient method for the production of renewable transportation fuel [7–9]. In Europe, maize is the dominating crop used for biogas production and has been shown to yield 15–30 t (1 t = 1 tonne = 1 Mg) DM (dry matter) per ha in Germany and Austria [10,11]. In Southern Sweden average yields of maize are lower, around 12 t DM/ha [12], and in the other parts of Sweden the biomass yield of maize is uncertain due to the short summer season. The suitability of different crops vary with geographic regions and there are still promising crops that haven't been evaluated for biogas production in the cold climatic region.

Industrial hemp (*Cannabis sativa* L.) gives a high biomass yield per ha. It has also a low environmental impact compared to several other annual crops commonly used in Europe for production of renewable transportation fuels such as maize, wheat, rapeseed and sugar beets [13]. Suppression of weeds, high tolerance to microbial and pest attacks and suppression of some soil born diseases makes hemp a favourable crop in crop rotations [14]. Hemp has traditionally been grown in Sweden for its fibre, but was prohibited in the 1960s due to drug abuse issues [6]. Since January 2007, some cultivars with an insignificant level of the psychoactive substance tetrahydrocannabinol have been approved for cultivation in the entire EU. In Europe, hemp is predominantly used for fibre production (e.g. in the paper and automotive industries). However, hemp has only a small share of the total use of natural fibres [15]. An increase of hemp utilization for energy would therefore influence the fibre market only marginally and likely lead to an increase of the hemp cultivation area.

In Sweden, hemp is mainly used as a solid fuel for combustion as briquettes, bales or pellets, and for this purpose it is harvested at the end of the winter. However, the highest biomass yield per ha is achieved in the autumn before the leaves wither [16–18]. It has been demonstrated that industrial hemp cultivars can yield around 20 t DM/ha above ground biomass in areas with temperate climates such as Italy, the Netherlands and the United Kingdom [19,20]. The climate in Sweden is defined as cold according to the Köppen-Geiger classification [21]. Crops providing high yields in temperate climates may grow poorly in colder climates. However, hemp has been reported to give relatively high

yields in cold climates as well; up to 14.5 t DM/ha in Southern Sweden, 55° north [22], and as much as 10 t DM/ha in Northern Sweden, 63° north [17].

The best harvest time for hemp intended for biogas production has not previously been studied. Mallik et al. [23] used hemp for biogas production, but only in co-digestion. Kaiser et al. [24] have reported a methane yield for hemp, cultivated in Germany, of about 1600 m³ per ha. However, no information about the harvest time, biomass yield and specific methane yield were given.

The aim of this study was to determine the methane energy yield per ha for industrial hemp based on the biomass yield per ha and the specific methane yield. The biomass yield was determined at four different harvest times ranging from July to October during three years in Southern Sweden. The methane yields were determined for the four harvest times in two years using a BMP (biochemical methane potential) assay. The results were compared with the energy yield per ha of the dominating renewable transportation fuels (electricity not included) based on domestic crop production in Southern Sweden.

2. Materials and methods

2.1. Substrate

Industrial hemp (*C. sativa* L.) of the late ripening French cultivar Futura 75 was sown near Lund, Sweden (55° 43' N, 13° 08' E) 9 May 2006, 4 April 2007 and 28 April 2008, on a medium humus-rich (2.7%) sandy soil. The seeding rate was 20 kg/ha at a row distance of 12.5 cm. The amount of nitrogen fertilisation was 120 kg/ha in 2006 and 150 kg/ha in 2007 and 2008, respectively. Samples were hand-harvested at four different times: at the beginning of July, August, September and October (middle of October in 2006). One plot measuring 1 m² was harvested at each time in the pilot year 2006, three replicate plots of 1 m² were harvested in 2007 and four in 2008, for determination of the biomass yield. All biomass above the ground was collected. The DM content was analysed using three representative plants. The higher heating value (HHV) of samples harvested in September and October 2007 was determined for triplicate samples using the bomb calorimetric method according to ISO [25] for triplicate samples. Subsamples of all replicate plots were pooled and frozen for subsequent BMP assays and analysis of extractives and structural carbohydrates.

The proportions of the stems and leaves were determined from frozen samples. For the BMP assays, the stems were chopped with a garden shredder (AXT 2500 HT, Robert Bosch GmbH, Germany) and further ground at 6000 rpm in a Grindomix GM200 (Retsch GmbH, Germany) until the particle size distribution was comparable for all samples; 0–7% below 0.85 mm, 66–83% between 0.85 and 4 mm, and 19–30% above 4 mm, as determined by sieving of wet samples. Leaves were ground directly in the Grindomix. The DM content was determined again after grinding. VS (volatile solids) content were determined from ground samples. The average VS content from 2006 and 2007 samples was used to calculate the VS yield from 2008 dry matter yield of hemp.

2.2. Inoculum

The microbial inoculum for the BMP assays was collected from an anaerobic sewage sludge digester in Källby, Lund, Sweden. The digester was operated under thermophilic conditions (50–55 °C) most of the year and at a lower temperature for a few months during the winter. Inoculum was collected when the process was being operated at 35 °C. The inoculum had the following properties in 2006 and 2007: pH 7.7; 5.0% DM; and 58% VS as % of DM. In 2006, the total bicarbonate alkalinity was 9000 mg/L, and in 2007 it was 5600 mg/L. In 2006, the characteristics of the inoculum were measured directly after collection and it was then stored at room temperature for two days before starting the experiments. In 2007, the inoculum was pre-digested at 50 °C for 48 h to reduce the level of background gas production before the characteristics were analysed. The pre-digested material was stored at room temperature for one day before use.

2.3. Biochemical methane potential assay

The hemp samples collected at four different harvest times each in 2006 and 2007 were digested separately in two BMP assays. The BMP assays were performed as batch experiments in 500 mL Erlenmeyer flasks with an active volume of 300–350 mL. The flasks were incubated at 50 °C in a shaker water bath operated at a speed of 70 rpm. The inoculum-to-substrate VS ratio of 2 was used. Two sets of controls were included: one with only inoculum and the other one with cellulose and inoculum at the same inoculum-to-substrate ratio as the samples. A mixture of cellulose (50% Avicel PH-101 Fluka Biochemika, Switzerland, and 50% Cellulose powder microcrystalline, MP Biomedicals, USA) was used, as recommended by Hansen et al. [26]. Five replicate samples and controls were digested in 2006 and three replicates in 2007.

Nutrients and vitamins were added at the concentrations suggested by Zehnder et al. [27] and Wolin et al. [28] with the following modifications. $\text{NaWO}_4 \cdot 2\text{H}_2\text{O}$ was added at 0.69 mg/L while N, P and K were excluded since the concentrations in the inoculum were already higher than in the suggested medium. NaCl was excluded as it was assumed that there would be sufficient in the inoculum, and the substrate. L-cysteine-HCl was added as a sulphate source instead of the Na_2S and $\text{Na}_2\text{S}_2\text{O}_2$ suggested by Zehnder et al., but corresponding to the same amount of sulphate [27]. The reason was to obtain a lower initial level of sulphide. Addition of resazurin and EDTA was not deemed necessary.

In 2006, liquid samples were taken from two of the five replicates for each substrate and control (on day 2) for pH and VFA analyses. The remaining three replicates were used for determination of methane potential. The gas produced was collected in gas-tight bags. The volume of gas was measured with a 100 mL glass syringe (Fortuna, Germany). Daily measurements of gas volume and gas composition were performed during the first 20 days in 2006 (14 days in 2007), and thereafter every second day. The methane accumulated in the headspace in the flasks was quantified on day 30 and the volume was distributed evenly between the volumes measured on each occasion. The methane produced from the inoculum controls was subtracted from the methane

produced in the flasks containing hemp samples. The assays were terminated after 34 days in 2006 and 32 days in 2007. The results were compared after 30 days digestion when the methane production was below 1 m^3/t VS per day for all samples. The specific methane yield has been expressed as m^3/t VS, as dry gas at 273 K and 101 325 Pa (assumed air pressure of the laboratory). The methane energy yield has been calculated using the HHV of 39.7 MJ/ m^3 .

2.4. Analytical methods

The DM and VS content were determined according to standard methods [29]; DM equals total solids in the method description. Water- and ethanol-soluble extractives fractions were determined according to Sluiter et al. [30], with the modification that the amounts of extractives were determined by weight loss by drying the samples and thimbles at 105 °C before and after each extractive step. Extraction was performed on single samples from each harvest time in 2007 (stems and leaves analysed separately) that were subsequently split in duplicates for analysis of structural carbohydrates. Analysis of structural carbohydrates was performed according to Sluiter et al. [31]. The total bicarbonate alkalinity was measured as described by Jenkins et al. [32]. The nutrient composition of inocula was analysed using Dr Lange test kits (ammonium, LCK303; potassium, LCK328 and ortho-phosphate, LCK348, Dr Bruno Lange GmbH, Germany) after filtering the samples through 0.45 μm filters (Minisart, Sartorius, Germany). Sampling and analysis of volatile fatty acids (VFAs) was carried out as described by Björnsson et al. [33]. The gas composition was analysed using gas chromatography, as described by Parawira et al. [34].

2.5. Statistical analysis

The average biomass yields and the specific methane yields at the different harvest occasions were compared within years with one-way ANOVA and Tukey's multiple comparison test using the statistical software Prism (Prism 5 for Mac OS X, version 5.0b, GraphPad Software Inc., La Jolla California, USA). The specific methane yields for 2006 and 2007 and the biomass yields per ha for 2007 and 2008 were tested with a t-test. Intervals given refer to standard deviations. The significance level 5% was used throughout the calculations. The standard deviations for specific methane yield for hemp samples were based on a combination of the standard deviation for samples with hemp and inoculum and control samples with only inoculum.

3. Results

3.1. Biomass yield

The biomass yields per ha for different harvest times in 2006, 2007 and 2008 are shown in Fig. 1. Higher biomass yields per ha were generally observed in hemp harvested in September and October. In 2007, no significant difference was found between August and October harvests or between September and October harvests, but between all other pairs. It should be noted that the variation in both August and September was

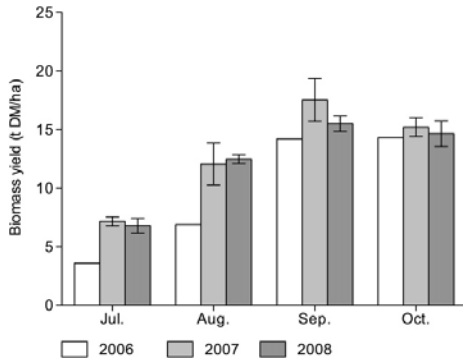

Fig. 1 – Hemp biomass yields for 2006, 2007 and 2008 as t DM/ha. The error bars indicate standard deviations, n = 1 for 2006, n = 3 for 2007 and n = 4 for 2008.

large, making it difficult to ascertain a significant difference. In 2008, no significant difference was found between September and October harvests, but there were significant differences between all other pairs of months. No significant difference was found in biomass yield between 2007 and 2008. The data from the pilot year 2006 are based on only one measurement per harvest occasion and were therefore not included in the statistical analysis. The average biomass yield in September and October 2007 and 2008 was 15.6 ± 1.5 t DM/ha, of which 14.6 ± 1.3 t VS. No significant difference was found in the HHV of the hemp harvested in September 2007 and October 2007, the average HHV of the two months being 18.3 ± 0.1 MJ/kg DM.

3.2. Biomass composition

The proportions of DM and VS content showed a tendency to increase with later harvest time, as can be seen in Table 1.

Fig. 2 shows the composition of hemp harvested in 2007. Leaves and stems were analysed separately and then combined to show the total composition (Fig. 2). The trends were that there were higher amounts of extractives (both ethanol- and water-soluble extractives) while there were lower amounts of structural carbohydrates and lignin at earlier harvest time, based on total hemp DM. There was

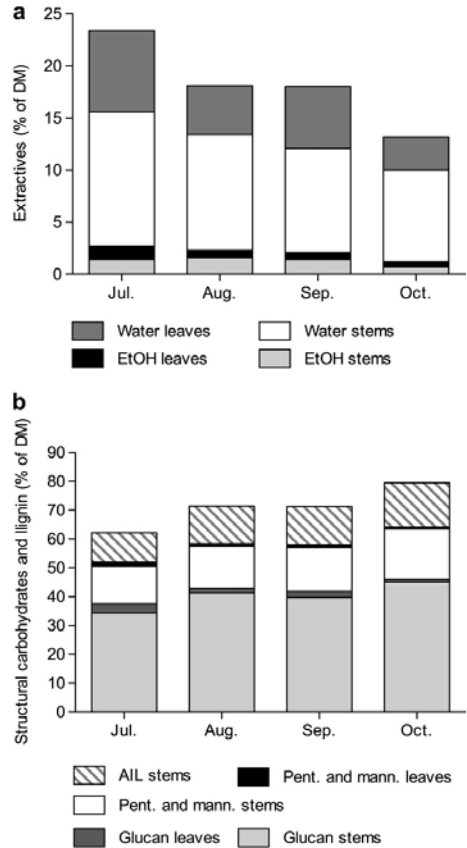

Fig. 2 – Composition of hemp (stems and leaves) harvested at different times in 2007. Expressed as % of total DM. a) Water- and ethanol-soluble extractives. b) Structural carbohydrates and lignin. Abbreviations: EtOH for ethanol extractives; Water for water extractives; AIL for acid insoluble lignin; Pent. and mann. for pentose polymers and mannan (mainly hemicellulose components). Glucan corresponds approximately to the cellulose content.

Table 1 – DM content at harvest, VS content and proportion of stems as % of DM content.

Month of harvest	DM (%)	VS (% of DM)	Stems %
	2006/2007/2008	2006/2007/2008	2006/2007/2008
Jul.	25.0/15.4/20.6	88.7/90.0 ^a	^a /75 ^a
Aug.	30.9/23.8/28.6	92.0/91.6 ^a	70/85 ^a
Sép.	30.5/31.1/28.1	92.5/92.9 ^a	81/83 ^a
Oct.	35.4/31.6/32.2	93.6/94.4 ^a	83/89 ^a

a Not determined.

a tendency that the leaves contained a higher proportion of extractives (around 30% water-soluble extractives and 5% ethanol-soluble extractives of leaf DM) than the stems (around 10–17% water-soluble extractives and 1–2% ethanol-soluble extractives of stem DM). The proportion of stems to leaves tended to increase with later harvest time (Table 1).

3.3. Specific methane yield

There was no significant difference in the specific methane yield between the harvest times within each year after 30 days

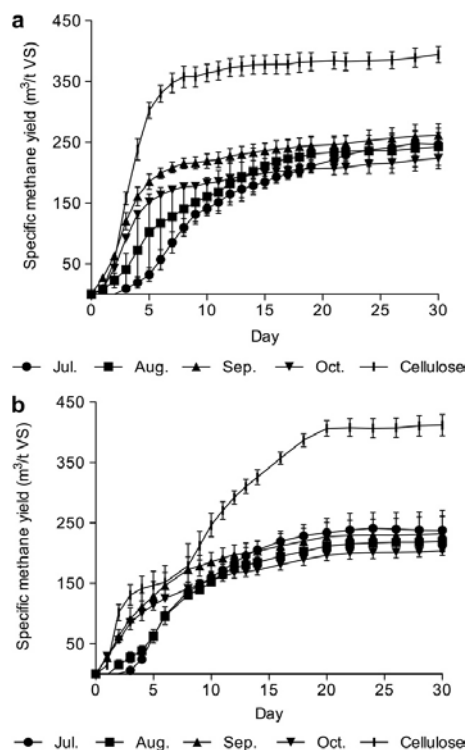

Fig. 3 – Accumulated specific methane yield during 30 days of batch digestion, a) 2006 and b) 2007. Cellulose is included in both assays as a positive control. Bars indicate standard deviations where $n = 3$ of for all samples and controls, except for Oct. and inoculum control 2006 where $n = 2$.

of anaerobic digestion in BMP batch assays (Fig. 3). There was a small but significant difference between the years, the average for 2006 was $245 \pm 25 \text{ m}^3/\text{t VS}$ and for 2007 it was $223 \pm 24 \text{ m}^3/\text{t VS}$. The average specific methane yield for all samples analysed was $234 \pm 35 \text{ m}^3/\text{t VS}$. After 15–17 days of anaerobic digestion all samples except those harvested in July

2006 had produced 90% of the final methane yield at 30 days. The sample collected in July 2006 reached 90% after 21 days. The results from one October sample, one inoculum control and one cellulose control were excluded in 2006 due to gas leakage; the analysis was thus performed on duplicates for these samples.

The methane production of the cellulose control in 2007 (Fig. 3b) was initially unstable. All the samples in 2007 exhibited a lower average methane production rate during the first 5 days than the samples in 2006. But, by the end of the assay in 2007 the cellulose control reached a methane yield of $412 \pm 18 \text{ m}^3/\text{t VS}$, which can be compared to the theoretical yield of $415 \text{ m}^3/\text{t VS}$.

The methane production from the July samples in both 2006 and 2007 and the August sample in 2007 showed an initial lag phase. The concentrations of VFAs and the pH were measured after 2 days of digestion in 2006 (Table 2). There was a tendency of lower pH and higher concentrations of VFAs in the samples harvested in July and August than in those harvested in September and October, but the pH was above 7 for all the samples analysed.

3.4. Methane energy yield per ha

The average methane energy yields per ha of the samples harvested from July to October are shown in Fig. 4, based on biomass yield of 2007 and 2008. Since there was no significant difference in specific methane yield between harvest times the same specific methane yield, the average of all analysed samples from both 2006 and 2007, was used for all calculations. The average methane energy yield per ha of the two months with highest yield, September and October, was $136 \pm 24 \text{ GJ}/\text{ha}$. This can be compared to total energy in the biomass of the same period $286 \pm 27 \text{ GJ}/\text{ha}$, based on the HHV. The biomass yield from 2006 was not included in the analysis since the fertilisation level differed and there were no replicates.

4. Discussion

Methane from anaerobic digestion of hemp was shown to be a new and interesting possibility for production of renewable transportation fuel from agricultural land. The determined gross energy yield per ha for methane from hemp ($136 \text{ GJ} \pm 24 \text{ GJ}$) was higher than reference values for ethanol from wheat grain and biodiesel from rapeseed grown in Southern Sweden (Fig. 5). So far, only the seeds are used for

Table 2 – Average VFA concentrations (mg/L) and average pH after 2 days of digestion of samples harvested in 2006 (average of 2 samples). Detection limit for VFAs was 10 mg/L.

Sample	pH	Acetic	Propionic	i-butyric	n-butyric	i-valeric	n-valeric
Jul.	7.22	2374	403	58	216	1169	<10
Aug.	7.32	1921	458	36	144	87	<10
Sep.	7.54	419	279	25	<10	52	<10
Oct.	7.58	290	290	<10	<10	<10	<10
Cellulose	7.33	1200	257	<10	<10	<10	<10
Inoculum	7.75	514	350	<10	<10	<10	<10

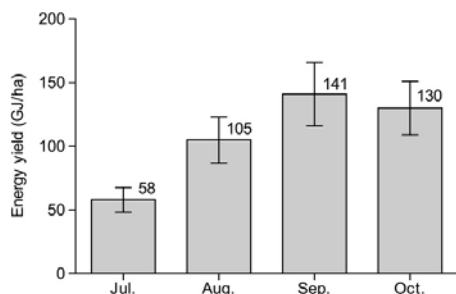

Fig. 4 – Average methane energy yield per ha for each harvest occasion based on the average biomass yield per ha in 2007 and 2008, the average specific methane yield of all analysed samples and the HHV of methane. Bars indicate standard deviation, for n values, see Figs. 1 and 3.

industrial ethanol and biodiesel production, which is one reason for the relatively low yield per hectare for these alternatives (despite this, they nevertheless dominate the production of renewable transportation fuels in Sweden today). The methane energy yield per ha for hemp was similar to reference values for biogas from maize (whole crop) grown in South Sweden (the dominating biogas crop in Europe), despite the low conversion degree of hemp (Fig. 5). The conversion from energy content in biomass to energy content in methane was only 47% for hemp in this study, while energy in maize is converted with around 72% based on literature [7,35], (Fig. 5). The comparison of energy yield per ha is indicative since the biomass yield of hemp is based on this study only and the biomass yield of maize is estimated based

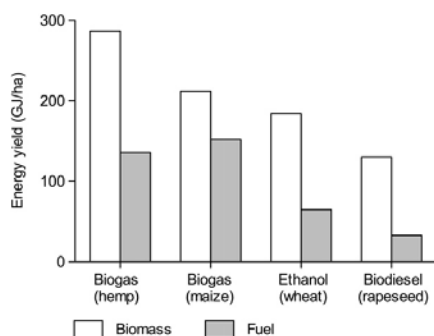

Fig. 5 – Comparison of the gross energy yields per ha for biogas from hemp (this study) with reference values for other renewable transportation fuels from crops cultivated in Southern Sweden [7,12,35]. 'Biomass' corresponds to the HHV of the biomass produced and 'Fuel' corresponds to the HHV of the transportation fuel produced.

on trials in the region, while the biomass yield of wheat and rape seed are based on average yields for the region [7,12]. The high carbohydrate content, the relatively low lignin content and the relatively low conversion degree indicate a promising potential for increasing the methane yield for hemp by improving the carbohydrate conversion. Sun and Cheng [36] have reviewed pretreatment methods aimed at increasing the conversion of structural carbohydrates to methane or ethanol in subsequent fermentation steps.

The French hemp cultivar Futura 75, used in the present study, is a medium-to-late-maturing variety, which is likely to give higher biomass yields at higher latitudes compared to earlier flowering cultivars [14,37]. The harvest time giving the highest biomass yield (September to October) was found to be similar to results from the Netherlands, a temperate region [37]. In the present study it was shown that hemp produces a high biomass yield in Southern Sweden, while other studies have shown that it can also give a relatively high biomass yield in Northern Sweden [16,17] and in Finland [38]. Therefore, hemp may be a suitable crop for methane production at high latitudes in general.

The specific methane yield was not found to be significantly different between the different harvest times, but a small difference in the average specific methane yield was found between the years. The cause of this small difference was not further analysed. Different nitrogen fertilisation levels were used in 2006 and 2007, but Thomsen et al. [39] have shown that the nitrogen fertilisation level has little influence on the chemical composition of hemp stems.

The lag phase in methane production (in BMP) from hemp harvested in July 2006 and 2007 and August 2007 indicates inhibition of the digestion process. But, the inhibition is probably not the result of the accumulation of protonated VFAs since the pH was above 7 when measured on the second day of the BMP assay and only a low amount of the measured organic acids are protonated at this pH. Kortekaas et al. [40] showed that apolar extractives from hemp stems exhibited methanogenic toxicity when tested in a toxicity assay with acetate as substrate. The accumulation of acetic acid in the present study suggests the inhibition of aceticlastic methanogens. The concentration of ethanol-soluble extractives, which could contain inhibiting apolar extractives, tended to be higher at earlier harvest time and could be the reason for inhibition for these samples. Early harvest of hemp for biogas production is probably not a viable option because of the low biomass yield per ha, making the inhibition at early harvest less relevant to study further. The inhibition observed in the BMP was also largely overcome, as shown by the increased methane production after a few days. This could be the result of the degradation of inhibiting compounds or adaptation of the inoculum.

The inoculum used, from a process exposed to alternating mesophilic/thermophilic conditions, could have contributed to the initial instability seen in 2007. Since methane production from both the cellulose control and the hemp samples had ceased at the time of experiment termination in 2007, and the cellulose control showed complete degradation, the initial disturbance is not believed to have significantly affected the final methane yield of the hemp samples.

5. Conclusions

A high methane yield per ha was shown for hemp grown in Southern Sweden, a cold climate region. With an energy conversion of 47% of the higher heating value of hemp the gross methane energy yield per ha was higher than reference values for the dominating renewable transportation fuels produced from domestically grown crops (cereals and rape seed) used in Sweden today. The relatively low conversion degree, despite a relatively low lignin content and high carbohydrate content, implies a potential for increasing the methane yield per ha by improved conversion.

Acknowledgements

The economic support of The Environmental Fund of Region Skåne; The Swedish Research Council for Environment, Agricultural Sciences and Spatial Planning; and Partnership Alnarp at the Swedish University of Agricultural Sciences are gratefully acknowledged.

REFERENCES

- [1] Directive 2009/28/EC of the European parliament and of the council of 23 April 2009 on the promotion of the use of energy from renewable sources and amending and subsequently repealing directives 2001/77/EC and 2003/30/EC. Off J Eur Union 2009;52:16–62.
- [2] Swedish Energy Agency. Energy indicators 2008. Eskilstuna: Energy agency publication service; 2008. Report No.: ET 2008:21.
- [3] Linné M, Ekstrandh A, Englesson R, Persson E, Björnsson L, Lantz M. [The Swedish biogas potential from domestic raw materials]. Malmö: Avfall Sverige utveckling; 2008. Report No.: 2008:02. Swedish.
- [4] Hoogwijk M, Faaij A, Eickhout B, de Vries B, Turkenburg W. Potential of biomass energy out to 2100, for four IPCC-SRES land-use scenarios. Biomass Bioenerg 2005;29(4):225–57.
- [5] Herland E. [The Federation of Swedish Farmers energy scenario for the year 2020]. The Federation of Swedish Farmers; 2005. Report: Andra remissversion Feb 2005. Swedish.
- [6] The Swedish Board of Agriculture. [Bioenergy – A new energy for the agricultural sector]. Jönköping: SJV offset; 2006. Report No.: 2006:1. Swedish.
- [7] Börjesson P. [Bioenergy from the Swedish agriculture – a growing resource]. Official report of the Swedish government. Stockholm: Edita Sverige AB; 2007. Report No.: SOU 2007:36, bilagedel. Swedish.
- [8] Börjesson P, Mattiasson B. Biogas as a resource-efficient vehicle fuel. Trends Biotechnol 2008;26(1):7–13.
- [9] Salter A, Banks CJ. Establishing an energy balance for crop-based digestion. Water Sci Technol 2009;59(6):1053–60.
- [10] Amon T, Amon B, Kryvoruchko V, Machmuller A, Hopfner-Sixt K, Bodiroza V, et al. Methane production through anaerobic digestion of various energy crops grown in sustainable crop rotations. Bioresour Technol 2007;98:3204–12.
- [11] Weiland P. Biomass digestion in agriculture: a successful pathway for the energy production and waste treatment in Germany. Eng Life Sci 2006;6(3):302–9.
- [12] Agriwise.org [internet]. Uppsala: Department of Economics, Swedish University of Agricultural Sciences (Sweden). [updated 2009 Nov 11; cited 2010 Feb 26]. Swedish. Available from: www.agriwise.org.
- [13] van der Werf HMG. Life Cycle Analysis of field production of fibre hemp, the effect of production practices on environmental impacts. Euphytica 2004;140(1–2):13–23.
- [14] van der Werf HMG, van Geel WCA, Wijnhuizen M. Agronomic research on hemp (*Cannabis sativa* L.) in The Netherlands, 1987–1993. J Int Hemp Asso 1995;2(1):14–7.
- [15] Karus M, Vogt D. European hemp industry: cultivation, processing and product lines. Euphytica 2004;140: 7.
- [16] Sundberg M, Westlin, H. [Hemp as a biomass fuel – a preliminary study]. Uppsala: JTI – Swedish Institute for Agricultural and Environmental Engineering; 2005. Report No.: Agriculture and Industry R 341. Swedish.
- [17] Finell M, Xiong S, Olsson R. [Multifunctional industrial hemp for Northern Sweden]. Umeå: SLU – Swedish University of Agricultural Sciences, BTC – Unit for Biomass Technology and Chemistry; 2006. Report No.: BTK-rapport 2006:13. Swedish.
- [18] Pasila A. The dry-line method in bast fibre production [dissertation]. Helsinki: University of Helsinki, Department of Agricultural Engineering and Household Technology; 2004.
- [19] Struik PC, Amaducci S, Bullard MJ, Stutterheim NC, Venturi G, Cromack HTH. Agronomy of fibre hemp (*Cannabis sativa* L.) in Europe. Ind Crops Prod 2000;11:107–18.
- [20] Cappelletto P, Brizzi M, Mongardini F, Barberi B, Sannibale M, Nenci G, et al. Italy-grown hemp: yield, composition and cannabinoid content. Ind Crops Prod 2001;13:101–13.
- [21] Peel MC, Finlayson BL, McMahon TA. Updated world map of the Koppen-Geiger climate classification. Hydrol Earth Sys Sci 2007;11:1633–44.
- [22] Svennerstedt B, Svensson G. Hemp (*Cannabis sativa* L.) trials in southern Sweden 1999–2001. J Ind Hemp 2006;11(1):17–25.
- [23] Malik MK, Singh UK, Ahmad N. Batch digester studies on biogas production from *Cannabis sativa*, water hyacinth and crop wastes mixed with dung and poultry litter. Biol Wastes 1990;31:315–9.
- [24] Kaiser F, Diepolder, M., Eder, J., Hartmann, S., Prestele, H., Gerlach, R., Ziehfrennd, G., Gronauer, A. Biogas yields from various renewable raw materials [Poster]. Proceedings of the 7th FAO/SREEN workshop; 2005 Nov 30-Dec 2; Uppsala, Sweden. Uppsala; 2005.
- [25] ISO. Solid mineral fuels - Determination of gross calorific value by the bomb calorimetric method, and calculation of net calorific value. ISO 1928; 1995. ISO-International Organization for Standardization; 1995.
- [26] Hansen TL, Schmidt JE, Angelidaki I, Marca E, Jansen JL, Mosbaek H, et al. Method for determination of methane potentials of solid organic waste. Waste Manag 2004;24: 393–400.
- [27] Zehnder AJB, Huser BA, Brock TD, Wuhmann K. Characterization of an acetate-decarboxylating, non-hydrogen-oxidizing methane bacterium. Arch Microbiol 1980;124(1):1–11.
- [28] Wolin EA, Wolin MJ, Wolfe RS. Formation of methane by bacterial extracts. J Biol Chem 1963;238(8):2882–6.
- [29] APHA. Standard methods for the examination of water and wastewater. 19th ed. Washington (DC): APHA (American Public Health Association/American Water Works Association/Environment Federation); 1995.
- [30] Sluiter A, Ruiz R, Scarlata C, Sluiter J, Templeton D. Determination of extractives in biomass, laboratory analytical procedure. Golden (CO): Nat Ren Energ Lab; 2005.
- [31] Sluiter A, Hames B, Ruiz R, Scarlata C, Sluiter J, Templeton D, et al. Determination of structural carbohydrates and lignin in biomass, laboratory analytical procedure: Golden (CO). Nat Ren Energ Lab; 2006.

- [32] Jenkins SR, Morgan JM, Zhang X. Measuring the usable carbonate alkalinity of operating anaerobic digesters. *Res J Water Pollut Con Fed* 1991;63(1):28–34.
- [33] Björnsson L, Murto M, Mattiasson B. Evaluation of parameters for monitoring an anaerobic co-digestion process. *Appl Microbiol Biotechnol* 2000;54:844–9.
- [34] Parawira W, Read JS, Mattiasson B, Björnsson L. Energy production from agricultural residues: high methane yields in pilot-scale two-stage anaerobic digestion. *Biomass Bioenerg* 2008;32:44–50.
- [35] Schittenhelm S. Chemical composition and methane yield of maize hybrids with contrasting maturity. *Eur J Agron* 2008;29(2–3):72–9.
- [36] Sun Y, Cheng JY. Hydrolysis of lignocellulosic materials for ethanol production: a review. *Bioresour Technol* 2002;83:1–11.
- [37] van der Werf HMG, Mathijssen EWJM, Haverkort AJ. The potential of hemp (*Cannabis sativa* L.) for sustainable fibre production: a crop physiological appraisal. *Ann Appl Biol* 1996;129:109–23.
- [38] Pahkala K, Pahkala E, Syrjälä H. Northern Limits to fiber hemp production in Europe. *J Ind Hemp* 2008;13(2):104–16.
- [39] Thomsen AB, Rasmussen S, Bohn V, Vad Nielsen K, Thygesen A. Hemp raw materials: the effect of cultivar, growth conditions and pretreatment on the chemical composition of the fibres. Roskilde: Biosystems Department, Risø National Laboratory; 2005. Report No.: Risø-R-1507(EN).
- [40] Kortekaas S, Soto M, Vicent T, Field JA, Lettinga G. Contribution of extractives to methanogenic toxicity of hemp black liquor. *J Ferment Bioeng* 1995;80(4):383–8.



RESEARCH

Open Access

Ensiling of crops for biogas production: effects on methane yield and total solids determination

Emma Kreuger*, Ivo Achu Nges and Lovisa Björnsson

Abstract

Background: Ensiling is a common method of preserving energy crops for anaerobic digestion, and many scientific studies report that ensiling increases the methane yield. In this study, the ensiling process and the methane yields before and after ensiling were studied for four crop materials.

Results: The changes in wet weight and total solids (TS) during ensiling were small and the loss of energy negligible. The methane yields related to wet weight and to volatile solids (VS) were not significantly different before and after ensiling when the VS were corrected for loss of volatile compounds during TS and VS determination. However, when the TS were measured according to standard methods and not corrected for losses of volatile compounds, the TS loss during ensiling was overestimated for maize and sugar beet. The same methodological error leads to overestimation of methane yields; when TS and VS were not corrected the methane yield appeared to be 51% higher for ensiled than fresh sugar beet.

Conclusions: Ensiling did not increase the methane yield of the studied crops. Published methane yields, as well as other information on silage related to uncorrected amounts of TS and VS, should be regarded with caution.

Keywords: biogas, anaerobic digestion, methane potential, biofuel, ethanol, volatile fatty acids, dry matter, total solids, volatile solids, ensiling, silage

Background

Biogas production using energy crops as the main feedstock is attracting increasing attention. Germany is leading the field, with almost 3,900 biogas plants in operation in 2009, the majority using ensiled crops [1]. Ensiling is a traditional method of preserving animal feed, and can also be used to store crops intended for biogas production [2]. The amounts of total solids (TS) or dry matter (DM) and volatile solids (VS) are often used to characterize the ensiled material added to the biogas process, and to calculate the methane yield from the material. A standard method of determining the TS of biomass is oven drying at 105°C [3,4]. Other oven temperatures, such as 60°C, 85°C or 100°C are also common [3,5]. In this paper total solids (TS) and dry matter (DM) are regarded as being equivalent, and the term used is that used in the publications referred to.

At the beginning of the 20th century it was reported that oven drying gives inaccurate values of the DM when the sample contains volatile compounds. It should therefore not be applied to silage as it contains varying amounts of volatile fatty acids (VFAs), lactic acid, ammonia and alcohols formed during the ensiling process [6,7]. McDonald and Dewar [8] quantified the losses of volatile compounds during oven drying by condensing and analyzing the vapor. A year later, they described a method in which the water content was determined through toluene distillation, with corrections for organic acids, ethanol and ammonia in the distillate [9]. The corrected toluene extraction method was long used as a standard method for determining the DM in silage used for fodder production, but was abandoned due to the harmful nature of toluene. The most common method used today to determine the DM in silage is oven drying, with corrections for the volatilization of VFAs, lactic acid, alcohols and ammonia. The type and amount of volatile compounds lost depends on the drying temperature, and different coefficients are used to adjust the DM for the expected losses of individual

* Correspondence: Emma.Kreuger@biotek.lu.se
Department of Biotechnology, Lund University, PO Box 124, SE-22100, Lund, Sweden

compounds at certain drying temperatures [5,10]. The adjusted values are referred to as corrected DM or corrected TS.

Although the limitations of using oven drying without correction for volatile compounds have been known for many years in agricultural sciences, the method is still routinely used in research related to methane production through anaerobic digestion. The methane yield from anaerobic digestion is normally expressed per unit of VS. The amount of VS is based on the amount of TS, which is determined according to standard methods by oven drying, without correction for volatile compounds [4]. After oven drying, the dry material is incinerated at 550°C to determine the ash content. The difference between the TS and the ash is defined as the VS. This means that if the TS are underestimated the VS will also be underestimated. If the VS of the silage are underestimated, the loss of VS during ensiling will be overestimated, and the methane yield per unit VS will be overestimated.

VS losses of 18% to 35% due to ensiling have been reported [11]. At the same time, ensiling has been reported to increase the methane yield of the material by 25% to 42% [11,12]. Results such as these may be the result of losses of volatile compounds during VS determination. There are several other recent examples of this, where the methane yields reported from ensiled grass, maize and beet were based on methods of TS or VS determination without correction for the loss of volatile compounds (see, for example, [13-17]). The VS-based methane yields given for ensiled materials may therefore be overestimated. Yields from silage based on uncorrected TS and VS values have been reported in other biofuel fields as well, such as ethanol research [18,19].

Although no biogas-related research has, until very recently [20], made use of the thorough internationally published studies performed on silage for fodder, some authors have considered the fact that volatile compounds may be lost during the determination of TS and VS. It is mentioned in the standard method of the American Public Health Association (APHA) [4] that losses of volatile organic matter from the sample can cause a negative error, but no further comments are made on how this error can be corrected. Angelidaki *et al.* [21] suggest drying at a lower temperature (90°C) after increasing the pH of the sample. However, according to Porter and Murray [5], neither drying at lower temperature nor increasing the pH decreased the volatilization of alcohols. Demirel and Scherer [22] described a method of VS determination applied to beet silage, in which suspended solids and dissolved solids (VFAs, lactic acid and alcohols) were analyzed separately, by drying and gas chromatography, respectively, and then combined to give the total VS. However, dissolved

organic compounds other than VFAs, lactic acid and alcohols will not be included. Methods, including volatilization coefficients, have been presented in publications by Weissbach and Strubelt [23-26] and Mukengele and Oechsner [27] in a German journal for agricultural technology. Volatilization coefficients for correcting oven-dry-based DM for ensiled crops are outlined, and the methods described are similar to that presented by Porter and Murray [5]. Unfortunately, these articles will not be found via scientific search engines such as ISI Web of Science, Scifinder and SciVerse ScienceDirect, and the articles refer to methods published in German (see, for example, [28]). Two recent publications [20,29] concerning the influence of ensiling on the methane potential do make use of correction factors [10,28]. However, none of them emphasize the importance of correcting TS and VS, to avoid overestimating methane yields, and both refer to previously published results based on uncorrected TS and VS without comment or concern about the reliability.

Among others, McDonald *et al.* [30] have pointed out that, even when using corrected DM, the change in DM during ensiling does not provide a measure of the change in the energy content of the silage, since the two are not correlated (as can be seen in Table 1). The fermentation of sugar to acetic acid or lactic acid will not influence the potential for methane production (Table 1). Fermentation to ethanol results in the concentration of the energy in the dry matter, and part of the dry matter is lost as carbon dioxide, while most of the energy is retained in the product (Table 1). The stoichiometric methane potential of glucose, acetic acid and lactic acid is 374 l/kg VS and, for the more reduced carbon source ethanol it is 731 l/kg VS. Only in cases of undesirable fermentation, such as butyrate fermentation, is a considerable amount of energy truly lost due to the release of hydrogen (see Table 1). In well preserved silage, the butyrate concentration is low [30].

The purpose of the current study was to examine how ensiling influences the methane potential, the mass and the total solids of crops. Furthermore, we wished to draw attention to the errors that can arise from using uncorrected, oven-dry-based values of TS and VS, and to highlight a previously presented method, for correcting oven-dry-based TS and VS values for losses of volatile fermentation products during oven drying [5]. The method developed for grass silage was tested on four other crop materials. Laboratory-scale ensiling was performed, followed by methane production from ensiled and non-ensiled crops. The losses in wet weight, and the production of methane and hydrogen and total gas volume during ensiling were determined. The content of the dominating volatile organic compounds in silage were measured before and after standard TS

Table 1 Mass and energy recovery for fermentation during ensiling

Type of fermentation	Product	Mass recovery	Energy recovery
Homolactic fermentation	$2C_3H_6O_3$	100%	97%
Acetic acid fermentation	$3C_2H_4O_2$	100%	93%
Heterolactic fermentation	$C_3H_6O_3 + C_2H_6O + CO_2$	76%	97%
Ethanol fermentation	$2C_2H_6O + 2CO_2$	51%	97%
Butyrate fermentation ^a	$C_4H_8O_2 + 2CO_2 + 2H_2$	49%	78%

Mass and energy recovery for some common fermentation pathways during ensiling [30]. The examples are based on glucose as substrate. Gases are regarded as lost. Energy recovery is based on the gross energy value (higher heating value) of the products, excluding the energy in ATP.

^aPerformed by many *Clostridia* species.

determination of the ensiled crops and used to calculate corrected TS and VS contents. The TS and VS contents were corrected in two ways: one using the volatilization coefficients presented by Porter and Murray [5], and the other (for validation) by adding the fraction of volatile compounds lost during drying. The volatilization coefficients from Porter and Murray [5] were used since they are based on silages mainly prepared with bacterial inoculants [5] rather than silages prepared with formic acid [10]. Four crop materials were chosen for the study: maize, which is the dominating crop used for anaerobic digestion in Europe; hemp, which is more fibrous than maize; and sugar beet (beets and beet tops ensiled separately), which contain less fiber and more soluble sugars than maize.

Results and Discussion

Comparison of the changes in wet weight, TS and VS during ensiling based on uncorrected and corrected values

The wet weight was found to decrease during ensiling by about 1% for all materials except beets, for which the decrease was about 4% (Table 2). For sugar beets and maize, the decrease in TS during ensiling was significantly higher than the decrease in wet weight when using the uncorrected TS content, demonstrating the error in the method (rows E and F in Table 2). After correcting the TS contents of the silages the decrease in TS (row K, Table 2) was no longer larger than the decrease in wet weight for any of the materials.

Table 2 Changes in wet weight (WW) and total solids (TS) during ensiling

Row		Percentage of	Maize	Hemp	Beets	Beet tops
A	Ensiling replicates, n		4	2	3	4
B	TS prior to ensiling ^a	Fresh WW	26.8 ± 0.2	31.4 ± 2.1	23.0 ± 0.2	13.2 ± 1.6
C	VS prior to ensiling ^a	Fresh WW	25.0 ± 0.1	28.4 ± 0.4	21.3 ± 0.9	10.6 ± 0.6
D	Uncorrected TS after ensiling ^b	Silage WW	24.5 ± 0.8	29.4 ± 0.4	14.2 ± 0.1	10.4 ± 0.4
E	Weight after ensiling	Fresh WW	99.2 ± 0.0	98.4 ± 0.1	95.6 ± 0.3	99.0 ± 0.5
F	Decrease in TS based on uncorrected TS ^c	Fresh WW	2.5 ± 0.8	2.4 ± 2.1	9.5 ± 0.2	2.9 ± 1.6
G	Maximum CO ₂ released ^d	Fresh WW	0.5	1.5	3.3	0.7
H	TS after ensiling based on CO ₂ release ^e	Silage WW	26.5	30.4	20.6	12.6
I	Corrected TS after ensiling according to Porter and Murray ^f	Silage WW	26.4 ± 0.1	30.7 ± 0.5	23.3 ± 1.1	13.1 ± 0.7
J	Corrected TS after ensiling based on measurements ^g	Silage WW	26.5 ± 0.1	30.4 ± 0.5	23.8 ± 1.1	13.6 ± 0.7
K	Decrease in TS, corrected according to Porter and Murray [5] ^h	Fresh WW	0.6 ± 0.2	1.2 ± 2.2	0.7 ± 1.0	0.2 ± 1.8

Changes in W and TS during ensiling, expressed as percentage of fresh crop or silage WW (mean ± SD). TS content was determined in duplicate. Decrease in WW and the maximum amount of CO₂ released were determined for the number of ensiling replicates given in row A.

^aMeasured on fresh crops with ensiling solution.

^bThe TS content was analysed for both ensiled crops directly after opening the buckets (the value given here) and after freezing (the value used for correcting TS and VS, since VFAs, lactic acid and alcohols were determined after freezing). No significant difference was seen between the two measurements.

^cCalculated according to: $B - D \times (E/100)$ (letters indicate rows).

^dBased on the total amount of gas released and the estimated amount of CO₂ in the ensiling buckets minus methane, and hydrogen and the estimated amount of nitrogen gas in the buckets at the start of ensiling.

^eCalculated according to: $(B - G)/(E/100)$ (letters indicate rows).

^fTS values in row D plus 37.5% of the lactic acid, 100% of the ethanol and 89.2% of the acetic and butyric acid present in the silage (Table 3), according to Porter and Murray [5].

^gTS values in row D plus the difference between the contents of lactic acid, ethanol, acetic acid and butyric acid in the ensiled crops before and after TS determination.

^hCalculated according to: $B - I \times (E/100)$ (letters indicate rows).

TS, total solids; VFA, volatile fatty acid; VS, volatile solids; WW, wet weight.

Ethanol and acetic acid were present in all silages (Table 3). Lactic acid was present in all silages except the hemp silage (Table 3). Butyric acid (Table 3) and very small amounts of propionic and succinic acid (less than 0.1% of the wet weight) were detected in hemp silage, but not in the other silages. The pH of the hemp silage was higher than the other silages; namely 4.5, compared with 3.1 for maize, 3.0 for beet tops and 2.9 for beets.

After drying the silages no ethanol could be detected, and lactic, acetic and butyric acid were found at lower concentrations. On average, 100% (\pm 0%) of the ethanol ($n = 8$), 53% (\pm 13%) of the lactic acid ($n = 6$), 72% (\pm 0.01) of the butyric acid ($n = 2$) and 89% (\pm 17%) of the acetic acid ($n = 8$) evaporated during TS determination. The average values are not significantly different from those presented by Porter and Murray [5]: 97.5% for ethanol, 37.5% for lactic acid and 89.2% for acetic and butyric acid. However, there is considerable variation in volatilization between the samples as indicated by the SDs, showing that there is room for further improvement of the method. The volatilization coefficients used by Weissbach and Strubelt [25], included a pH dependency for the VFAs, which may further increase the accuracy of the corrected values. The volatilization coefficients presented in that article cannot be compared to those obtained here since they used different drying conditions (initial drying at 60°C, followed by drying at 105°C) from those used in this study (105°C).

Corrected TS contents are presented in rows I and J in Table 2. The values in row I are calculated based on the concentrations in the silages and the volatilization coefficients given by Porter and Murray [5]. The values in row J are based on the experimentally determined volatilization during oven drying, that is, the difference between the content of volatiles before (Table 2) and after (data not shown) TS determination by oven drying. No significant differences were found between the results obtained with the two methods, showing that the volatilization coefficients presented by Porter and Murray [5] give good estimates of the true TS for the silages investigated. Theoretical calculations of the TS contents after ensiling, based on the gas production and weight changes (row H,

Table 2), gave values in line with those obtained with corrections for losses of volatiles (rows I and J, Table 2).

Gas production and energy losses during ensiling

The production of energy-containing gases such as hydrogen and methane during ensiling was negligible in all cases: less than 0.1 ml per g VS for all substrates except hemp, which gave less than 2 ml hydrogen per g VS. The energy contained in the hydrogen produced by hemp during ensiling corresponded to about 2 ppm of the energy in the methane produced in the biochemical methane potential (BMP) test. For hemp, beets and beet tops, only hydrogen and no methane was detected; for maize, methane but no hydrogen was detected. The low production of energy-containing gases, together with the low pH in all the silages, except hemp, indicates that the silages were well preserved.

For maize, hemp and beet tops, 67% to 89% of the total gas produced (including carbon dioxide) during ensiling was produced during the first 4 days. The gas produced by beet silage was higher than that produced by the other crops, with high gas production during the first 4 days, and a second gas production peak around days 9 to 13, giving 72% of the total gas production between days 6 and 17. All crops produced less than 6% of the total gas between days 30 and 60. After 60 days, the buckets were moved from storage at room temperature to 4°C. Very little gas was produced after this, less than 1% by all crops except hemp, which produced around 5% of the total gas during this time.

The maximum mass loss due to aerobic degradation resulting from entrapped oxygen at the start of the ensiling process was calculated and found to be negligible, at most 0.025% of the wet weight. The calculation was based on the assumption that the maximum volume of entrapped air was the volume of the bucket minus the volume of the substrate at the start of ensiling (assuming a density of the substrate of 1 kg/l), 21% of the air being oxygen.

BMP tests

The methane potential was determined and is expressed per unit wet weight (Figure 1a) and per unit uncorrected and corrected VS for silages (Figure 1b). When

Table 3 Volatile compounds in ensiled crops

Substrate	n	Lactic acid	Ethanol	Acetic acid	Butyric acid	Total
Maize	2	1.26 \pm 0.02	0.21 \pm 0.00	0.74 \pm 0.04	BD	2.21 \pm 0.05
Hemp	2	BD	0.29 \pm 0.01	0.94 \pm 0.04	0.11 \pm 0.01	1.13 \pm 0.04
Beets	2	0.91 \pm 0.07	4.82 \pm 0.86	1.09 \pm 0.14	BD	6.82 \pm 0.87
Beet tops	2	1.08 \pm 0.04	0.53 \pm 0.04	0.56 \pm 0.00	BD	2.18 \pm 0.06

Contents of volatile compounds measured in the ensiled crops, expressed as percentage of wet weight (mean \pm SD). Determinations were made in duplicate starting with the steeping step.

BD, below detection limit.

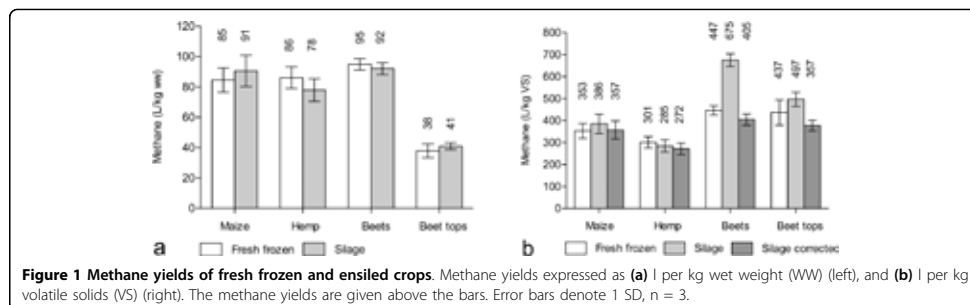

expressing the methane yield per unit wet weight (Figure 1a) or per unit VS corrected according to Porter and Murray [5] (Figure 1b) no significant difference was seen between fresh frozen and ensiled material for any of the crops. Neither was there any significant difference between the methane yields from fresh frozen crops and ensiled crops related to the wet weight or VS of the original materials (taking mass losses during ensiling into account).

When relating the methane yield from ensiled material to uncorrected VS, the results are noticeably different. The apparent methane yield from beets was significantly higher (51%) from ensiled material than from fresh frozen material when expressing the yield per unit uncorrected VS (Figure 1b). A significant difference was also seen between the methane yield from silage expressed per unit uncorrected and corrected VS for beets and beet tops (Figure 1b).

Herrmann *et al.* [29] found that the methane yields were significantly higher after ensiling in 44% of the cases investigated, when the methane yields of the silages were related to the corrected VS of the silages, but not when they were related to the original VS. Pakarinen *et al.* [20] found methane yields after ensiling to be everything from unchanged to decreasing or increasing compared to yields from fresh crops. Pakarinen *et al.* [20] did not relate their results to original VS since changes in TS and VS during ensiling were not recorded.

The overestimated methane yield of beet silage and beet top silage in the current study, and the fact that the TS losses appeared higher than the wet weight losses for beets and maize when using uncorrected TS and VS contents, demonstrate that methane yields of silages based on uncorrected TS and VS are unreliable.

Conclusions

Ensiling was not found to increase the methane yield from any of the crop materials investigated in this study. Instead, it was shown that observations such as

increased VS-based methane yields or TS losses during ensiling may be artifacts caused by errors in the standard methods commonly used for TS and VS determination. Oven-dry-based TS and VS determination without correction for the loss of volatile compounds is an unsuitable method for all substrates containing noteworthy amounts of volatile compounds. This applies to ensiled energy crops as well as other materials, and is important when using the substrate for anaerobic digestion as well as for other purposes. Caution should therefore be exercised when considering published information about silages, and other materials containing volatile compounds, based on TS and VS. The application of a method developed for grass silage for correcting TS and VS [5], to other ensiled crops, eliminated the significant error of using uncorrected TS and VS. However, the method can be improved further.

Methods

Crops

Hemp (Futura 75), maize (Arabica) and sugar beet (EB 726 (Syngenta, Basel, Switzerland), a non-commercially available cultivar with lower sugar content and higher biomass yield than normal sugar beet) were cultivated in southern Sweden (Lönstorp, Lomma, 55 40'N 13 6'E). The crops were harvested on the following dates: hemp on 5 September 2007, maize on 29 September 2008, and sugar beet on 21 October 2008. Hemp and sugar beet were harvested manually. Maize was harvested with a maize forager set at a chopping length of 10 mm. The hemp and sugar beet tops (leaves and the neck of the root) were chopped in a garden shredder (AXT 2500 HT, Robert Bosch GmbH, Germany) into pieces about 2 cm long. The sugar beets were cut into 1 cm slices and then into squares measuring 2 to 3 cm. Part of each crop material was ensiled directly and part was frozen for later analysis. The TS and VS contents were determined in fresh crops before ensiling with and without ensiling inoculant, in fresh crops after freezing, and in

ensiled crops before and after freezing. TS corrected for volatile compounds were determined in frozen ensiled crops. (Frozen samples were used since the authors were not aware of the corrected method prior to freezing the silage.)

Ensiling

Ensiling was carried out in 4.8 l plastic buckets with tightly fitting lids, normally used for food storage (NordicPack, Nykvarn, Sweden). Hemp, maize, sugar beets (beets) and sugar beet leaves including the upper part of the roots (beet tops) were ensiled separately, using four replicate buckets for each kind of crop material. A gas collection system was made by connecting Tygon tubing (VWR International, West Chester, PA, USA) to a balloon made of Transfoil El-OPET/PE (Flextrus AB, Lund, Sweden) with a hose connector (Slangservice i Uppsala AB, Uppsala, Sweden) in each lid. Silicone was used to seal the connection between the hose connector and the lid and between the bucket and the lid. The chopped plant material was sprayed with a bacterial ensiling inoculant, Lactisil Stabil (Chr. Hansen A/S, Hørsholm, Denmark). In all, 20 ml was added per kg wet plant material, according to the manufacturer's instructions (1.25 g powder in 5 l tap water). The decrease in weight was recorded by weighing the material in the buckets before and after the ensiling period. The decrease in TS was determined based on the wet weight and TS of the fresh crops with ensiling solution and of ensiled crops.

The buckets were stored at room temperature (23 to 25°C) for 60 days; after which they were stored at 4°C for a minimum of 100 days. The gas volume and the contents of methane and hydrogen were monitored during the entire ensiling period. The results from one bucket of beets and two buckets of hemp were excluded due to gas leakage.

The replicate samples of each crop material were mixed after ensiling before sampling for TS and VS determination, and for BMP tests. The mixed samples were also frozen for later analyses. TS determination and BMP tests were started immediately after sampling to minimize losses due to volatilization during sample handling. Contents of VFAs, lactic acid and ethanol were determined in silage samples that had been frozen, since this part of the study was included later. Prior to analysis, frozen silages were thawed at 8°C in buckets with tightly fitting lids.

BMP tests

BMP tests were performed as reported elsewhere [31], with the modifications described below. Fresh frozen crops, ensiled crops (not frozen) and control samples (described below) were tested in triplicate. The inoculum-to-sample ratio was 2:1 in terms of VS of the fresh

frozen crops; silage was added based on the same wet weight as the fresh frozen crops. A total of 300 ml of inoculum was added to each test flask. Inoculum was collected from an anaerobic codigestion plant (Söderåsens Bioenergi, Wrams Gunnarstorp, Sweden). This inoculum is rich in macronutrients and also contains relatively high amounts of trace elements, therefore no nutrients were added. The reaction temperature was set to 38°C. The inoculum was preincubated at 38°C for 5 days prior to the start of the experiment.

The total gas volume and the content of methane [31] were monitored every day for the first week, and then every third or fourth day thereafter, until the end of the experiment. Two sets of controls were included: one set in which only the inoculum was used (to measure the indigenous methane production from the inoculum, which was subtracted from the total methane produced), and a second with microcrystalline cellulose (Avicel PH-101, Sigma-Aldrich, St. Louis, MO, USA) to test the activity of the inoculum. The experiments were terminated after 30 days. The methane yield was related to the wet weight and to the TS and VS of fresh substrate with ensiling inoculant and ensiled substrate. For ensiled substrates the methane yields were also related to the VS content corrected according to Porter and Murray [5]; VS contents determined after freezing were used for this since these were the materials used for determination of the volatile compounds.

Analyses

TS and VS were determined in duplicate or quadruplicate according to standard methods [4], using samples of 13 to 240 g instead of 25 to 50 g. The TS of each substrate were measured several times, for example before and after the addition of ensiling solution, before and after freezing, and so on. In each case, the TS value corresponding to the actual material used was used for calculations. Corrected values of TS and VS were determined similarly to those presented by Porter and Murray [5]. Duplicate samples of 60 g thawed frozen silage (mixture of material from all ensiling replicates) were steeped in 300 g deionized water for 15 to 19 h at 8°C in a 500 ml flask with a lid. For beets and beet tops the material was separated into a solid and a liquid part (6% liquid for beets and 15% for beet tops) before sampling. The pH was measured after steeping and the pH of undiluted silage was calculated. Quadruplicate samples of the same material were analyzed by drying 13 to 41 g wet weight in aluminum crucibles at 100 to 105°C for 20 to 24 h, according to standard methods to determine TS [4]. Two of the quadruplicates of the dried samples were steeped in deionized water in the same proportions as for the wet silage (1:5), and the other two samples were used for VS determination according to standard

methods. Steeping was performed in crucibles covered with several layers of Parafilm. Liquid samples were acidified with H₂SO₄ to a pH of 1 to 3 and filtrated through 0.45 μm polypropylene filters (Chromacol, Welwyn Garden City, UK). The content of C₁-C₆ VFAs (including isoforms of butyric and valeric acid), lactic acid, succinic acid and ethanol were determined using high performance liquid chromatography (HPLC) (Jasco Co., Tokyo, Japan) with an Aminex HPX-87H column (Bio-Rad Laboratories Inc., Hercules, CA, USA) and a refractive index detector (Erc Inc., Huntsville, AL, USA). Sulfuric acid (5 mM) was used as the mobile phase (0.6 ml/min), and the oven temperature was 40°C. The concentration of VFAs, lactic acid and ethanol and were calculated for the wet silage according to Equations 1 and 2:

$$\text{Concentration in wet silage (g/kg)} = (m_1 + m_2 - m_3) \times c_1/m_1 \quad (1)$$

$$\text{Concentration after drying related to wet silage (g/kg)} = c_1 \times D \times m_3/m_1 \quad (2)$$

Where m₁ = original wet weight related to TS added, g; m₂ = water added, g; m₃ = substrate TS added, g; c₁ = concentration of analyzed compound, g/kg; and D = dilution factor = 5.

The TS and VS were corrected in two ways: (1) according to the volatilization coefficients for grass silage dried at 100°C presented by Porter and Murray [5]: lactic acid 0.375, total VFAs 0.892 and ethanol 1.000; and (2) the measured losses of VFAs, ethanol and lactic acid during drying (the difference between Equations 1 and 2) were added to the TS and VS values measured using standard methods.

Gas composition with respect to methane was determined using gas chromatography and a thermal conductivity detector, as described elsewhere [32]. Hydrogen was analyzed in an identical system but with argon as the carrier gas. The gas volume was measured using a graduated 100 ml gas-tight glass syringe (Fortuna, Germany) with a sample lock. Gas volumes are expressed as dry gas at 0°C, assuming a constant pressure of 1 atm.

Statistics

All statistical analyses were performed using one-way analysis of variance (ANOVA) and Tukey's multiple comparison test using the statistical software Prism (Prism 5 for Mac OS X, version 5.0b; GraphPad Software Inc., La Jolla, CA, USA). The term 'significant' is only used where a statistical analysis of significance has been performed. The significance level of 5% was used throughout all statistical analyses. Values are given ± 1 SD. The SDs of weight losses during ensiling, of TS and VS determinations, of the concentrations of volatile compounds added to the corrected values of TS and VS

and of tests and controls in BMP were combined according to standard statistical rules [33] to provide a SD of the final result. For linear combinations (Equation 3) the SDs were combined according to Equation 4 [33]. For multiplicative expression (Equation 5) the SDs were combined according to Equation 6 [33]:

$$y = k + k_a a + k_b b + k_c c + \dots \quad (3)$$

$$\sigma_y = \sqrt{((k_a \sigma_a)^2 + (k_b \sigma_b)^2 + (k_c \sigma_c)^2 + \dots)} \quad (4)$$

$$y = kab/cd \quad (5)$$

$$\sigma_y/y = \sqrt{((\sigma_a/a)^2 + (\sigma_b/b)^2 + (\sigma_c/c)^2 + (\sigma_d/d)^2 + \dots)} \quad (6)$$

Where σ = standard deviation; a, b, c, d = independent measured quantities; and k = constant.

Acknowledgements

The Swedish Research Council for Environment, Agricultural Sciences and Spatial Planning (FORMAS) and E.On Gas Sverige AB are acknowledged for their financial support. LB and EK were financed by FORMAS and IAN was financed by E.On Gas Sverige AB. Thanks to Charlott Gissén, Torsten Hörndahl, Sven-Erik Svensson and Thomas Prade, from the Swedish University of Agricultural Sciences (Alnarp, Sweden) for providing crop material, and for advice and useful discussions. Thanks also to Thomas Pauly at the Swedish University of Agricultural Sciences (Uppsala, Sweden) for advice about lab ensiling. Christer Ohlsson at Chr. Hansen A/S (Hørsholm, Denmark) is also thanked for his advice and for providing the ensiling inoculant.

Authors' contributions

LB became aware of the methodological problem investigated, and secured financial support for this study. All authors participated in the design of the study, harvesting of the crops and reviewing of the literature. EK set up the ensiling method and performed most of the ensiling experiments, the TS and VS determinations and all analyses of the volatile compounds. IAN participated in the ensiling trials and carried out the BMP tests. EK performed the statistical analysis and prepared the major part of the manuscript. LB and IAN contributed to writing the manuscript, and all authors read and approved the final manuscript.

Competing interests

The authors declare that they have no competing interests.

Received: 21 June 2011 Accepted: 27 October 2011

Published: 27 October 2011

References

1. Scherer P, Neumann L, Demirel B, Schmidt O, Unbehauen M: Long term fermentation studies about the nutritional requirements for biogasification of fodder beet silage as mono-substrate. *Biomass Bioenerg* 2009, **33**:873-881.
2. Weiland P: Biogas production: current state and perspectives. *Appl Microbiol Biotechnol* 2010, **85**:849-860.
3. Deutsches Institut für Normung (DIN): DIN 38414-8, German Standard Methods for the Examination of Water, Waste Water and Sludge; Sludge and sediments (group 5); determination of the amenability to anaerobic digestion (S8). Berlin; Deutsches Institut für Normung e. V.; 1986.
4. American Public Health Association (APHA): 2540 G. Total, fixed, and volatile solids in solid and semisolid samples. In *Standard Methods for the Examination of Water and Wastewater*. 21 edition. Edited by: Eaton AD, Clesceri LS, Rice EW, Greenberg AE, Franson MA, Baltimore MD.

- Washington: American Public Health Association/American Water Works Association/Water Environment Federation; 2005.
5. Porter MG, Murray RS: The volatility of components of grass silage on oven drying and the inter-relationship between dry-matter content estimated by different analytical methods. *Grass Forage Sci* 2001, **56**:405-411.
 6. Watson SJ, Ferguson WS: The losses of dry matter and digestible nutrients in low-temperature silage, with and without added molasses or mineral acids. *J Agric Sci* 1937, **27**:67-107.
 7. Woodman HE: Critical examination of the methods employed in silage analysis, with observations on some special chemical characteristics of "sour" silage. *J Agric Sci* 1925, **15**:343-357.
 8. McDonald P, Dewar WA: Determination of dry matter and volatiles in silage. *J Sci Food Agric* 1960, **11**:566-570.
 9. Dewar WA, McDonald P: Determination of dry matter in silage by distillation with toluene. *J Sci Food Agric* 1961, **12**:790-795.
 10. Huida L, Vaatainen H, Lampila M: Comparison of dry-matter contents in grass silages as determined by oven drying and gas-chromatographic water analysis. *Annales Agriculturae Fenniae* 1986, **25**:215-230.
 11. Pakarinen O, Lehtomaki A, Rissanen S, Rintala J: Storing energy crops for methane production: effects of solids content and biological additive. *Bioresour Technol* 2008, **99**:7074-7082.
 12. Amon T, Amon B, Kryvoruchko V, Zollitsch W, Mayer K, Gruber L: Biogas production from maize and dairy cattle manure - Influence of biomass composition on the methane yield. *Agric Ecosyst Environ* 2007, **118**:173-182.
 13. Cirne DG, Lehtomaki A, Bjornsson L, Blackall LL: Hydrolysis and microbial community analyses in two-stage anaerobic digestion of energy crops. *J Appl Microbiol* 2007, **103**:516-527.
 14. Klocke M, Mahnert P, Mundt K, Souidi K, Linke B: Microbial community analysis of a biogas-producing completely stirred tank reactor fed continuously with fodder beet silage as mono-substrate. *Syst Appl Microbiol* 2007, **30**:139-151.
 15. Koch K, Wichern M, Lubken M, Horn H: Mono fermentation of grass silage by means of loop reactors. *Bioresour Technol* 2009, **100**:5934-5940.
 16. Mahnert P, Linke B: Kinetic study of biogas production from energy crops and animal waste slurry: effect of organic loading rate and reactor size. *Environ Technol* 2009, **30**:93-99.
 17. Vervaeren H, Hostyn K, Ghekiere G, Willems B: Biological ensilage additives as pretreatment for maize to increase the biogas production. *Renew Energy* 2010, **35**:2089-2093.
 18. Oleskowicz-Popiel P, Thomsen AB, Schmidt JE: Ensiling - Wet-storage method for lignocellulosic biomass for bioethanol production. *Biomass Bioenerg* 2011, **35**:2087-2092.
 19. Sipos B, Kreuger E, Svensson SE, Reczey K, Bjornsson L, Zacchi G: Steam pretreatment of dry and ensiled industrial hemp for ethanol production. *Biomass Bioenerg* 2010, **34**:1721-1731.
 20. Pakarinen A, Majjala P, Jaakkola S, Stoddard FL, Kymalainen M, Viikari L: Evaluation of preservation methods for improving biogas production and enzymatic conversion yields of annual crops. *Biotechnol Biofuels* 2011, **4**:20.
 21. Angelidaki I, Alves M, Bolzonella D, Borzacconi L, Campos JL, Guwy AJ, Kalyuzhnyi S, Jenicek P, van Lier JB: Defining the biomethane potential (BMP) of solid organic wastes and energy crops: a proposed protocol for batch assays. *Water Sci Technol* 2009, **59**:927-934.
 22. Demirel B, Scherer R: Production of methane from sugar beet silage without manure addition by a single-stage anaerobic digestion process. *Biomass Bioenerg* 2008, **32**:203-209.
 23. Weissbach F: Gas production potential of fresh and ensiled sugar beet silages in biogas production. *Landtechnik* 2009, **64**:394-397.
 24. Weissbach F, Strubelt C: Correcting the dry matter content of maize silages as a substrate for biogas production. *Landtechnik* 2008, **63**:82-83.
 25. Weissbach F, Strubelt C: Correcting the dry matter content of grass silages as a substrate for biogas production. *Landtechnik* 2008, **63**:210-211.
 26. Weissbach F, Strubelt C: Correcting the dry matter content in sugar beet silages as a substrate for biogas production. *Landtechnik* 2008, **63**:354-355.
 27. Mukengele M, Oechsner H: Effect of ensiling on the specific methane yield of maize. *Landtechnik* 2007, **62**:21-21.
 28. Weissbach F, Kuhla S: Stoffverluste bei der bestimmung des Trockenmassegehaltes von Silagen und Grünfutter: möglichkeiten der korrektur. *Übersichten Tierernährung* 1995, **23**:189-214.
 29. Hermann C, Heiermann M, Idler C: Effects of ensiling, silage additives and storage period on methane formation of biogas crops. *Bioresour Technol* 2011, **102**:5153-5161.
 30. McDonald P, Henderson Ar, Ralton I: Energy changes during ensilage. *J Sci Food Agric* 1973, **24**:827-834.
 31. Nges IA, Liu J: Effects of anaerobic pre-treatment on the degradation of dewatered-sewage sludge. *Renew Energy* 2009, **34**:1795-1800.
 32. Parawira W, Murto M, Zvauya R, Mattiasson B: Anaerobic batch digestion of solid potato waste alone and in combination with sugar beet leaves. *Renew Energy* 2004, **29**:1811-1823.
 33. Miller JN, Miller JC: 2.11 Propagation of random errors. *Statistics and Chemometrics for Analytical Chemistry* Harlow, UK: Pearson Education Limited; 2005.

doi:10.1186/1754-6834-4-44

Cite this article as: Kreuger et al.: Ensiling of crops for biogas production: effects on methane yield and total solids determination. *Biotechnology for Biofuels* 2011 **4**:44.

Submit your next manuscript to BioMed Central and take full advantage of:

- Convenient online submission
- Thorough peer review
- No space constraints or color figure charges
- Immediate publication on acceptance
- Inclusion in PubMed, CAS, Scopus and Google Scholar
- Research which is freely available for redistribution

Submit your manuscript at
www.biomedcentral.com/submit



Available at www.sciencedirect.com<http://www.elsevier.com/locate/biombioe>

Steam pretreatment of dry and ensiled industrial hemp for ethanol production

Bálint Sipos^{a,*}, Emma Kreuger^b, Sven-Erik Svensson^c, Kati Réczey^a, Lovisa Björnsson^b, Guido Zacchi^d

^aBudapest University of Technology and Economics, Department of Applied Biotechnology and Food Science, Szt. Gellért tér 4., H-1111 Budapest, Hungary

^bLund University, Department of Biotechnology, P.O. Box 124, SE-221 00 Lund, Sweden

^cSwedish University of Agricultural Sciences, Department of Agriculture – Farming Systems, Technology and Product Quality, P.O. Box 104, SE-230 53 Alnarp, Sweden

^dLund University, Department of Chemical Engineering, P.O. Box 124, SE-221 00 Lund, Sweden

ARTICLE INFO

Article history:

Received 6 October 2009

Received in revised form

23 June 2010

Accepted 1 July 2010

Available online 24 July 2010

Keywords:

Energy crops

Cannabis sativa

Lignocellulose

Enzymatic hydrolysis

SSF

Saccharomyces cerevisiae

ABSTRACT

Biomass can be converted into liquid and gaseous biofuels with good efficiency. In this study, the conversion of industrial hemp (*Cannabis sativa* L.), a biomass source that can be cultivated with a high biomass yield per hectare, was used. Steam pretreatment of dry and ensiled hemp was investigated prior to ethanol production. The pretreatment efficiency was evaluated in terms of sugar recovery and polysaccharide conversion in the enzymatic hydrolysis step. For both materials, impregnation with 2% SO₂ followed by steam pretreatment at 210 °C for 5 min were found to be the optimal conditions leading to the highest overall yield of glucose. Simultaneous saccharification and fermentation experiments carried out with optimised pretreatment conditions resulted in ethanol yields of 163 g kg⁻¹ ensiled hemp (dry matter) (71% of the theoretical maximum) and 171 g kg⁻¹ dry hemp (74%), which corresponds to 206–216 l Mg⁻¹ ethanol based on initial dry material.

© 2010 Elsevier Ltd. All rights reserved.

1. Introduction

Interest in biomass-based renewable fuels has increased, and ethanol produced from lignocellulosic feedstock is a promising candidate. The carbohydrate portion of lignocellulose biomass (containing cellulose and hemicellulose) is suitable for ethanol production but difficult to access when cellulose, hemicellulose and lignin are associated. Several pretreatment methods have been developed to increase the accessibility of cellulose [1], and a wide variety of lignocellulosic substrates

have already been proven to be suitable raw materials, including wood materials (spruce [2], willow [3]), agricultural by-products (such as corn stover [4], wheat straw [5]), sugar production by-products (sugar cane bagasse [6], sweet sorghum bagasse [7]), reeds [8] or switchgrass [9]).

The target plant of this study was industrial hemp (*Cannabis sativa* L.), which is an annual plant mostly cultivated for its strong fibres. Hemp has not, to our knowledge, previously been investigated for ethanol production, and has several features that make it an interesting alternative biomass. The plant is

Abbreviations: SPH, steam pretreated hemp; SPHS, steam pretreated hemp silage; WIS, water insoluble solids.

* Corresponding author. Tel.: +36 1 463 3442; fax: +36 1 463 3855.

E-mail address: balint_sipos@mkt.bme.hu (B. Sipos).

0961-9534/\$ – see front matter © 2010 Elsevier Ltd. All rights reserved.

doi:10.1016/j.biombioe.2010.07.003

rather drought tolerant, and can reach high biomass yields per hectare [10]. The need for herbicides can be reduced because hemp is able to overgrow weeds. Thus, it is advantageous to use hemp in a crop rotation, especially in organic farming. Hemp fibre already has many industrial applications, for example in the textile or pulp and paper industries [11]; it can be used in fibre-reinforced composites [12] or as a construction material [13]. Hemp has already been reported to be feasible solid fuel for combustion [14].

Hemp can be cultivated in various climates. In warmer areas, hemp can be dried in the field and stored dry. In other areas where rain is common during the harvest period in the autumn, ensiling can be a more suitable storage method. In addition, during ensiling acids are formed that could later act as catalysts in the physico-chemical pretreatment, which might decrease the need for addition of extra chemicals to the process. When using hemp as a biomass source for fuel production rather than as a fibre crop [15], harvesting should be postponed for 1–2 months to achieve the highest biomass yield.

The cellulose content of the hemp stem is quite high (about 44%) compared to other agricultural lignocellulosic materials, e.g., corn stover [16] or wheat straw [5], both with 37% (dry matter) cellulose. The high cellulose content and high biomass yield make hemp a good potential crop for bioethanol production. The hemp stem consists of bast fibres and a woody core. The bast fibre is rich in cellulose and has rather low lignin content, while the woody core has significantly higher lignin content [17].

Steam pretreatment of hemp fibres has previously been studied in order to separate the fibres from the other components [17]. Treatment with alkali impregnation followed by steam pretreatment at 200 °C with a residence time of 90 s was found to be optimal for this purpose. In another study, steam pretreatment of hemp fibres at 185 °C for 2 min increased the cellulose content from 60% to 74%, whereas enzyme (pectinase) assisted retting followed by steam pretreatment resulted in a 78% cellulose content of the remaining solid material [18]. Enhancing the enzymatic breakdown of hemp via electron

beam irradiation was previously tested [19], where the improvement in enzymatic hydrolysis was more evident in the hydrolysis of xylan than in that of cellulose.

The aim of the present study was to optimise steam pretreatment parameters for hemp in order to achieve the highest glucose yield in enzymatic hydrolysis for conversion to ethanol. Steam pretreatment was performed both on dry hemp stems and hemp silage (stem and leaves together) under different conditions with and without SO₂ impregnation. The efficiency of the pretreatment was evaluated by enzymatic hydrolysis of the whole slurry. Mass balance calculations were performed on the pretreatment and the enzymatic hydrolysis to estimate the overall glucose yield, the efficiency of hemicellulose solubilisation and the sugar degradation. Simultaneous saccharification and fermentation (SSF) was performed on samples at optimised conditions. SSF of both the whole pretreatment slurry and of the separated solid fraction of the pretreated material was performed. Fig. 1 shows the schematic representation of the experiments.

2. Materials and methods

2.1. Raw material

Industrial hemp (*C. sativa* L.) of the variety Futura 75 was cultivated at Nöbbelöv, close to Lund, Sweden (N55°43', E13°08'). The hemp was sown on 4 April 2007 and harvested on 3 and 4 September. Stems were cut a few centimetres above ground. The average dry matter (DM) yield was 16 Mg ha⁻¹. The hemp was air-dried indoors in open air at 10–20 °C after harvest to a DM content of 91.7%. There were no visible signs of microbial degradation during drying. Stems and leaves (including fine stems) were separated manually after drying and weighed. Dry stems were comminuted with a garden shredder (AXT 2500 HT, Robert Bosch GmbH, Germany) to a length of 2–3 cm. For the steam pretreatment equal amounts of air-dried hemp from three different fertilization levels (115, 150 and 200 kg N ha⁻¹) were mixed due to shortage of substrate.

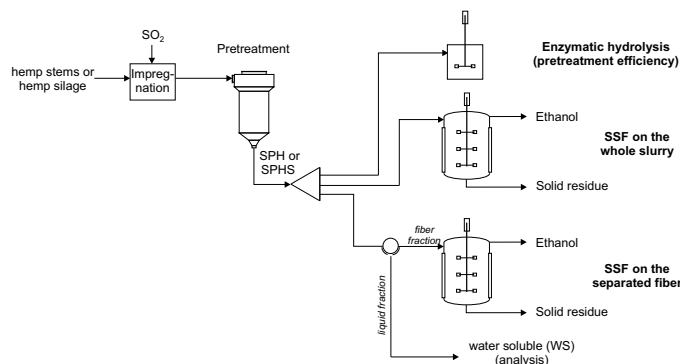

Fig. 1 – Schematic representation of the experimental process (Abbreviations: SPH: steam pretreated hemp, SPHS: steam pretreated hemp silage, SSF: simultaneous saccharification and fermentation).

The mixture is referred to as dry hemp in the paper. The leaves were not pretreated since they easily fell apart into smaller pieces not suitable for the pretreatment unit used. The stems were sprayed with deionised water to a moisture content of 50%, mixed and stored at room temperature for two days prior to steam pretreatment.

Silage was prepared from hemp (full plant including leaves) fertilized with nitrogen at 200 kg ha⁻¹, which was harvested and shredded to ~2 cm pieces using a Claas Jaguar maize forager equipped with a traditional maize header. The hemp was ensiled without additives in round bales made by an Orkel MP 2000 stationary baler. The round bales were wrapped in silage plastic and stored for eight months, from September 2007 to May 2008, when samples were taken from the ensiled hemp. Ensiled hemp samples were stored frozen from May 2008 until pretreatment started (September, 2008). Ensiled hemp (stems and leaves) had oven dry matter content of 25%, therefore no spraying was needed before steam pretreatment.

2.2. Enzyme preparations

The enzymes used in the hydrolysis were Celluclast 1.5L and Novozym 188 (Novozymes A/S, Bagsvaerd, Denmark). Filter paper activity of Celluclast 1.5L was 60.9 FPU ml⁻¹ and β -glucosidase activities were 32.8 IU ml⁻¹ and 502.3 IU ml⁻¹ for Celluclast 1.5L and Novozym 188, respectively. FPA and β -glucosidase activities were measured [20,21] prior to experiments.

2.3. Chemicals

Nutrients for fermentations (KH₂PO₄, (NH₄)₂SO₄, MgSO₄·7H₂O and (NH₄)₂HPO₄) were purchased from Merck (Hochenbrun, Germany). Yeast extract was purchased from Applichem (Gatersleben, Germany). 72% sulphuric acid for analysis of structural carbohydrates was purchased from Fluka (St. Louis, MO, USA). Sugar standards for HPLC analysis were purchased from Sigma–Aldrich (St. Louis, MO, USA).

2.4. Steam pretreatment

Pretreatment conditions for dry hemp and ensiled hemp were tested at different temperatures and SO₂ impregnation was used when indicated. In the case of dry hemp, three different temperatures (205 °C, 210 °C and 215 °C) were investigated with 2% SO₂ impregnation and a 5-min residence time. Ensiled hemp was pretreated at four temperatures without SO₂ impregnation (190 °C, 200 °C, 210 °C and 220 °C) and at two temperatures (200 °C and 210 °C) with 2% SO₂ impregnation.

Impregnation was performed in batches of 300 g dry matter (DM) by injecting SO₂ (2% based on water content) into plastic bags. After 20 min of impregnation, the bags were ventilated before the material was steam pretreated. Pretreatment was performed in a 10 l batch reactor, described earlier [22]. After steam pretreatment, the slurry was collected from the flash cyclone and stored at +5 °C a few days. There were no visible signs of microbial degradation during storage. Samples for analysis were washed with distilled water to remove water soluble from water-insoluble solids (WIS). A part of the pretreatment slurry was separated into solid and liquid

fractions using a manual hydraulic press (Sixten Torne AB, Malmö, Sweden). The solid fraction was used for the SSF without additional washing step in the case, when only the solid fraction was used, and the liquid was used for the yeast cultivation (as described in Section 2.5).

2.5. Enzymatic hydrolysis

Enzymatic hydrolysis was performed to evaluate the effect of different steam pretreatment conditions. A low substrate concentration (2% water-insoluble solids (WIS) using the whole pretreatment slurry) was used to minimise product inhibition. Enzyme loading for hydrolysis was 15 FPU g⁻¹ WIS Celluclast 1.5L and 23 IU g⁻¹ WIS Novozym 188. The hydrolysis was performed with 500 g total mass in 1 l bottles immersed in a water bath at 40 °C. Agitation with a frequency of 5 Hz was ensured by overhead stirring. The pH was set to 4.8 with a 0.05 mol l⁻¹ sodium acetate buffer. Samples were taken after 0, 2, 4, 8, 24, 48, 72 and 96 h and analysed for monomer sugar content by high-performance liquid chromatography (HPLC). All hydrolysis experiments were run in duplicate.

2.6. Yeast cultivation

Yeast cultivation was performed in three steps (propagation, batch and fed-batch cultivation) [5]. The strain of *Saccharomyces cerevisiae* used was purified from commercial yeast (Jästbolaget AB, Rotebro, Sweden). Cells were added to a 300 ml Erlenmeyer flask with 70 ml of a water solution containing 23.8 g l⁻¹ glucose, 10.8 g l⁻¹ (NH₄)₂SO₄, 5.0 g l⁻¹ KH₂PO₄ and 1.1 g l⁻¹ MgSO₄·7H₂O. The water solution also contained 14.4 ml l⁻¹ of a trace-metal solution and 1.4 ml l⁻¹ of a vitamin solution [23]. The pH was adjusted to pH 5 with 0.25 mol l⁻¹ NaOH. The Erlenmeyer flask was closed with a cotton plug and incubated at 30 °C for 24 h on an incubator shaker using an agitation frequency of 2.5 Hz.

Batch cultivation was then performed in a 2 l fermenter (Infors AG, Bottmingen, Switzerland) with a working volume of 250 ml, similarly to the procedure described earlier [24] with some modifications. Cultivation was started by adding a 60 ml inoculum to a medium containing 40.0 g l⁻¹ glucose, 22.5 g l⁻¹ (NH₄)₂SO₄, 10.5 g l⁻¹ KH₂PO₄, 2.2 g l⁻¹ MgSO₄·7H₂O, 60.0 ml l⁻¹ trace-metal solution and 6.0 ml l⁻¹ vitamin solution [23]. The pH was continuously adjusted to pH 5 with 10% NaOH solution. The stirring frequency was 8.3 Hz and the aeration rate was 0.25 l min⁻¹ corresponding to a space velocity of 1 min⁻¹. The dissolved oxygen concentration was continuously measured throughout batch cultivation with an oxygen sensor. Batch cultivation was changed to fed-batch cultivation when a rapid increase in oxygen concentration was observed.

Fed-batch cultivation was performed on the liquid fraction of the pretreatment slurry by continuous addition of 858 ml of liquid fraction supplemented with glucose and salt solutions to a total volume of 1000 ml. The glucose concentration in the pretreatment liquid solution was adjusted to 80 g l⁻¹. Salts were added to the solution to concentrations of 11.3 g l⁻¹ (NH₄)₂SO₄, 5.3 g l⁻¹ KH₂PO₄ and 1.1 g l⁻¹ MgSO₄·7H₂O. The final concentration of the diluted liquid fraction was equivalent to that obtained when the slurry from pretreatment had been diluted to 7.5% WIS. The diluted and adjusted liquid fraction

was added to the fermenter at constant flow rate for 14–16 h. The pH was continuously adjusted to 5 with 10% NaOH solution. The stirring frequency was 13.3 Hz and the aeration rate was 1.875 l min^{-1} at the end of the fed-batch cultivation, corresponding to 1.5 min^{-1} space velocity. Cells were harvested by centrifugation of the broth at 150 Hz for 5 min and were washed two times with deionised water.

2.7. SSF

SSF experiments were performed in 2 l laboratory fermenters (Infors AG, Bottmingen, Switzerland) with 1.4 kg of working mass using 7.5% WIS substrate concentration. As nutrients 0.5 g l^{-1} $(\text{NH}_4)_2\text{HPO}_4$, 0.025 g l^{-1} MgSO_4 and 1 g l^{-1} yeast extract were added. The fermenter with the substrate and the nutrients in separate bottles were sterilised at $121 \text{ }^\circ\text{C}$ for 20 min. Cultivated yeast was added at a concentration of 5 g l^{-1} . The experiments were performed at $37 \text{ }^\circ\text{C}$ and pH 5, maintained using a 10% NaOH solution. The experiments were run for 72 h with 5.8 Hz agitation. Enzyme loading was 20 FPU g^{-1} glucan Celluclast 1.5L and 23 IU g^{-1} glucan Novozym 188. SSF experiment samples were analysed by HPLC for sugars, lactic acid, acetic acid and ethanol content.

2.8. Analysis

Extractive contents of the dry hemp samples were determined according to the NREL protocol [25], with the modification that samples were dried at $105 \text{ }^\circ\text{C}$ before and after extraction and the extractives were calculated as loss in weight by the samples. Analysis of structural carbohydrates and lignin (based on DM) were performed on the extracted dry hemp stem samples as well as on the solid fraction of the silage and on the solid fractions after pretreatment. The analyses were performed according to the NREL protocol [26]. Silage and solid fractions were washed with distilled water prior to analysis. The content of various sugars in the liquid fractions after steam pretreatment and in the liquid fraction of the untreated silage, obtained by filtration, was analysed according to the NREL protocol [27]. The difference in monomer

sugar concentrations with and without dilute acid hydrolysis of the liquid samples was determined as oligomer sugars. Each sample was analysed in duplicate.

2.9. HPLC

The carbohydrate and inhibitor content in the liquid samples were analysed with an HPLC system (Shimadzu, Japan) equipped with a refractive index detector. An Aminex HPX-87H column (Bio-Rad, Hercules, CA, USA) was used for the separation and determination of cellobiose, glucose, mannose, arabinose, lactic acid, glycerol, acetic acid, ethanol, HMF and furfural using 5 mmol l^{-1} H_2SO_4 as the eluent at a flow rate of 0.5 ml min^{-1} and a column temperature of $65 \text{ }^\circ\text{C}$. An Aminex HPX-87P column (Bio-Rad, Hercules, CA, USA) was used for the separation of cellobiose, glucose, xylose, galactose, arabinose and mannose with Millipore quality water as the eluent at a 0.6 ml min^{-1} flow rate and a column temperature of $85 \text{ }^\circ\text{C}$. Calibration of the equipment for each compound was performed with 6 level calibration standards at a range of $0.15\text{--}10.0 \text{ mg ml}^{-1}$.

2.10. Mass balance calculations

During the experiments, process streams were quantified and analysed as described above.

The “volatile/further degraded” fraction in the mass balances was calculated on the basis of the difference in total solids loaded to the reactor and collected from the cyclone. The mass balance calculation includes all measurement errors from the process.

2.11. Statistical evaluation

The effect of fertilization and ensiling on the composition of hemp stems and solid fraction of hemp silage was investigated using Statistica 8.0 software (Statsoft Inc., Tulsa, OK, USA) One-way ANOVA followed by Tukey's HSD test was used for multiple comparison of the fibre characteristics between treatments.

Table 1 – Composition of dry hemp grown at different fertilization levels and solid fraction of hemp silage as percentage of dry weight. Mean values of duplicates are presented. Relative standard deviations in percentage are indicated in parenthesis.

	Dry hemp (115 kg ha ⁻¹ fertilizer)	Dry hemp (150 kg ha ⁻¹ fertilizer)	Dry hemp (200 kg ha ⁻¹ fertilizer)	Solid fraction of hemp silage
Glucan	44.1 (3.6%)	43.7 (1.9%)	43.0 (2.7%)	45.2 (0.4%)
Mannan	2.0 (3.4%)	2.1 (1.0%)	1.8 (1.7%)	2.6 (0.2%)
Xylan	10.1 (4.5%)	11.0 (1.5%)	10.3 (2.8%)	10.1 (3.4%)
Galactan	2.1 (4.4%)	2.0 (0.4%)	2.1 (1.7%)	1.7 (0.2%)
Arabinan	0.7 (4.8%)	0.6 (2.5%)	0.7 (1.4%)	b.d.l.
Acid-soluble lignin	6.5 (0.3%)	6.7 (0.1%)	6.7 (7.2%)	4.7 (3.7%)
Acid-insoluble lignin	14.5 (0.2%)	15.0 (1.3%)	15.3 (0.4%)	18.7 (2.1%)
Water extractives	13.5	11.9		n.d.
Ethanol extractives	2.7	1.4	0.8	n.d.
Total determined compounds	96.1	94.3	91.6	83.0

n.d. – not determined.
b.d.l. – below detection limit.

3. Results and discussion

3.1. Raw material compositions

Three samples of dry hemp (only stems) from different nitrogen-fertilization levels and solid fraction of hemp silage were analysed for their composition (see Table 1). One-way ANOVA was performed to compare the fibre composition of hemp fertilized with different nitrogen levels and hemp silage. The statistical analysis has shown, that the effect of these treatments for carbohydrate content, i.e. glucan and xylan, was not significant ($p = 0.16$ and 0.48 , respectively at 95% confidence limit). For acid-soluble lignin and acid-insoluble lignin, the statistical analysis has shown, that there was a significant difference in lignin content of the materials ($p = 0.005$ and 0.0001 , respectively at 95% confidence limit). Tukey's HSD test showed that the silage had a significantly different content of both acid-soluble lignin and acid-insoluble lignin while the content was not significantly different in the three samples with different fertilization level. The difference in acid-insoluble lignin content of the silage might be due to that no extractive measurement was performed on hemp silage, which may give an overestimation of this fraction. A mixture of the three dry hemp samples (equal parts of stem samples) was used for steam pretreatment due to the shortage of the feedstock. The composition used during the calculations is the average of the compositions in Table 1. The liquid fraction of hemp silage had a pH of 4.5 and contained four main components: 17.6 g l^{-1} lactic acid, 7.6 g l^{-1} acetic acid, 3.0 g l^{-1} glucose and 1.2 g l^{-1} ethanol. The dominance of lactate and acetate as fermentation products and the low pH indicate that the silage was well preserved.

3.2. Composition of WIS after pretreatment

Pretreatment of hemp stem using 2% SO_2 impregnation was performed at 205, 210 and 215 °C. Previous studies at Lund University, Department of Chemical Engineering, suggested

Table 2 – DM and WIS contents of pretreated slurry and composition of washed WIS fraction of steam pretreated (2% SO_2 impregnation) dry hemp (SPH). WIS compositions are presented as percentage of dry weight. Mean values of duplicates are presented. Relative standard deviations in percentage are indicated in parenthesis.

	205 °C	210 °C	215 °C
DM [%]	15.1	11.3	10.9
WIS [%]	12.4	8.2	8.3
Glucan	66.8 (5.3%)	66.8 (4.5%)	64.7 (3.0%)
Mannan	2.1 (0.6%)	1.8 (1.9%)	1.4 (0.4%)
Xylan	3.8 (3.0%)	3.0 (2.0%)	2.7 (1.5%)
Galactan	0.7 (4.8%)	b.d.l.	b.d.l.
Arabinan	0.2 (3.9%)	b.d.l.	b.d.l.
Acid-soluble lignin	3.8 (3.8%)	3.7 (3.1%)	3.7 (1.3%)
Acid-insoluble lignin	19.3 (5.2%)	21.2 (0.3%)	25.9 (1.4%)
Lignin ash	0.3 (3.7%)	0.4 (6.9%)	0.4 (3.5%)
Total determined compounds	96.8	96.7	98.8

b.d.l. – below detection limit.

that SO_2 impregnation and a temperature above 200 °C is needed for sufficient pretreatment of dry hemp (data not published). Table 2 shows the composition of the WIS fractions from the steam pretreated hemp stem (SPH). The solid fraction was mainly composed of glucan (65–67%) and lignin (25–30%) while hemicellulose was solubilised to a large extent. Only small differences in WIS composition were observed after steam pretreatment at 205–215 °C with SO_2 impregnation.

Steam pretreatment of hemp silage was performed both with and without SO_2 impregnation. A wide range of pretreatment temperatures (190–220 °C) were tested due to the scarce available knowledge on steam pretreatment of ensiled materials. Compositions of the WIS of the steam pretreated hemp silage (SPHS) are presented in Table 3. At milder pretreatment conditions without SO_2 impregnation (190 and 200 °C), the solubilisation of the hemicellulose was not sufficient; a significant amount of xylan was present in the WIS

Table 3 – DM and WIS contents of pretreated slurry and composition of washed WIS fraction of steam pretreated hemp silage (SPHS). WIS compositions are presented as percent of dry weight. Mean values of duplicates are presented. Relative standard deviations in percentage are indicated in parenthesis.

	no SO_2				SO_2	
	190 °C	200 °C	210 °C	220 °C	200 °C	210 °C
DM [%]	8.8	10.7	10.9	10.8	12.6	11.0
WIS [%]	6.2	7.5	7.4	7.1	7.8	7.5
Glucan	57.9 (5.8%)	62.4 (1.7%)	67.1 (1.8%)	60.7 (2.3%)	68.7 (1.2%)	66.0 (0.0%)
Mannan	2.7 (9.3%)	2.5 (1.0%)	2.2 (0.0%)	1.8 (4.5%)	2.2 (4.6%)	1.8 (2.5%)
Xylan	8.4 (5.2%)	7.5 (0.1%)	1.3 (2.5%)	0.6 (4.6%)	1.3 (4.2%)	0.4 (0.2%)
Galactan	1.0 (2.8%)	0.7 (0.4%)	0.7 (5.5%)	0.5 (2.6%)	0.7 (0.7%)	0.8 (1.2%)
Arabinan	b.d.l.	b.d.l.	b.d.l.	b.d.l.	b.d.l.	b.d.l.
Acid-soluble lignin	3.6 (6.4%)	3.2 (3.0%)	2.9 (3.3%)	3.3 (6.6%)	2.8 (0.3%)	2.9 (1.0%)
Acid-insoluble lignin	19.4 (8.2%)	19.1 (6.8%)	23.4 (0.5%)	26.0 (0.8%)	21.0 (0.7%)	24.7 (5.6%)
Lignin ash	2.0 (2.3%)	1.5 (2.5%)	1.3 (3.8%)	2.3 (1.7%)	1.6 (2.9%)	0.5 (3.6%)
Total determined compounds	94.9	96.8	98.9	95.2	98.0	97.1

b.d.l. – below detection limit

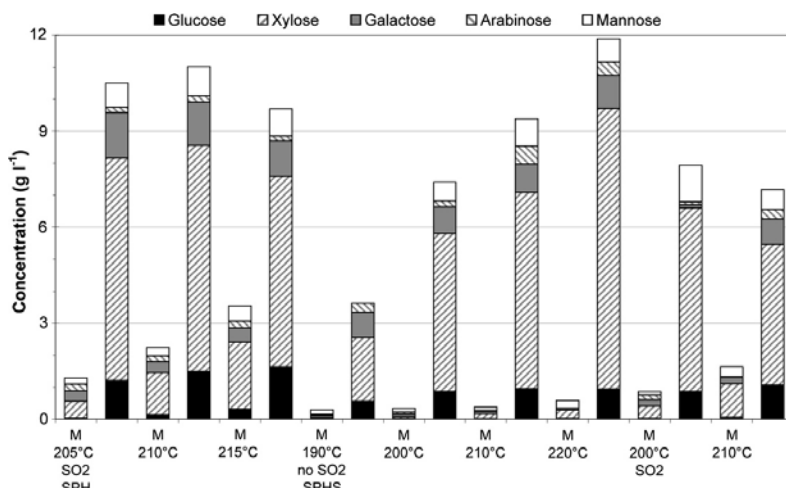

Fig. 2 – Concentrations of monomer (M) and oligomer (O) sugars (g l⁻¹) detected in the liquid fractions of SPH and SPHS (oligomers were measured as monomers after dilute acid hydrolysis, and are presented here as concentrations of monomers).

fraction after pretreatment. At higher temperatures, the xylan content of the WIS decreased to below 1.5%. However, the lower glucan content in case of the 220 °C treatment (without SO₂ impregnation) compared to the 210 °C (with or without SO₂) suggests that using this high temperature, the cellulose component of the solid fraction was partly solubilised or degraded during the pretreatment. It should also be noted that the SPHS slurry had a strong unpleasant smell after pretreatment, in contrast to the SPH slurry.

3.3. Composition of liquid fraction after pretreatment

Fig. 2 shows the sugar concentrations of monomeric and oligomeric sugars in the liquid fractions of the steam pretreated materials. The oligomeric sugars were detected at significantly higher concentrations than the monomeric

sugars. In case of SPH the presence of the oligomers glucose, galactose and mannose were around 1.0–1.5 g l⁻¹ (expressed in monomeric concentration), while the oligomeric xylan concentration was 6.0–7.0 g l⁻¹. These data suggest that during the steam pretreatment the hemicellulose fraction of the hemp stem was solubilised, but not degraded to monomeric sugars. In case of SPHS, similar trends were observed, but generally with lower oligomeric sugar concentrations. In general terms, the harsher pretreatments yielded higher sugar concentrations in the supernatants.

Concentrations of 5-hydroxymethyl-furfural (HMF) and furfural (degradation products of C6 and C5 sugars, respectively) were below reported inhibiting levels for ethanol fermentation [28] for all samples except SPH treated at 215 °C with SO₂ (Table 4). The low concentration of these sugar degradation products suggests that degradation of

Table 4 – Concentrations of organic acids and inhibitory compounds in g l⁻¹ measured in the liquid fractions of pretreated SPH, SPHS and untreated hemp silage.

		Lactic acid (g l ⁻¹)	Acetic acid (g l ⁻¹)	HMF (g l ⁻¹)	Furfural (g l ⁻¹)
SPH	205 °C SO ₂	0.21	1.27	0.08	0.29
	210 °C SO ₂	0.31	1.93	0.16	0.51
	215 °C SO ₂	0.57	3.15	0.31	0.93
SPHS	untreated	17.6	7.6	0.18	b.d.l.
	190 °C	4.86	2.20	0.09	0.06
	200 °C	5.90	3.21	0.05	0.12
	210 °C	6.10	4.02	0.07	0.22
	220 °C	5.47	5.00	0.09	0.55
	200 °C SO ₂	6.85	3.88	0.07	0.21
	210 °C SO ₂	6.26	4.49	0.15	0.54

b.d.l. below detection limit.

Table 5 – Sugar concentrations, glucan conversions in enzymatic hydrolysis (expressed as percentage of the theoretical) and the overall glucose yield (including both pretreatment and enzymatic hydrolysis) for SPH and SPHS substrates pretreated at different conditions. Mean values of duplicate experiments and standard deviations are presented.

		Glucose (g l ⁻¹)	Glucan conversion (%)	Overall glucose yield ^a (g kg ⁻¹ raw material)
SPH	205 °C SO ₂	10.9 ± 2.4	72.4 ± 1.4	328.9 ± 6.4
	210 °C SO ₂	12.7 ± 1.4	83.1 ± 1.0	373.3 ± 4.5
	215 °C SO ₂	13.3 ± 0.9	87.6 ± 6.9	383.1 ± 30.1
SPHS	190 °C	8.4 ± 0.6	64.0 ± 5.3	254.8 ± 21.1
	200 °C	8.3 ± 0.4	58.3 ± 2.9	258.5 ± 12.8
	210 °C	10.8 ± 0.7	71.0 ± 1.4	325.8 ± 6.4
	220 °C	10.6 ± 0.3	78.6 ± 2.0	318.5 ± 8.6
	200 °C SO ₂	11.7 ± 0.5	74.7 ± 3.0	341.8 ± 13.7
	210 °C SO ₂	13.6 ± 0.2	89.3 ± 2.0	372.3 ± 8.3

^afor SPHS, the base of the glucose yield was ensiled hemp.

monomeric sugars from hemicellulose was not significant during the pretreatment. The ratio of sugar degradation products based on the raw material were below 1.2 g kg⁻¹ for HMF and 2.0 g kg⁻¹ for furfural based on untreated material, except for 215 °C SO₂ (SPH), 220 °C and 210 °C SO₂ (SPHS), where 3.7–4.5 g kg⁻¹ furfural formation was observed.

A slight lactic acid formation was observed in case of SPH, while a significantly higher amount was detected in the supernatant of SPHS, which likely originated from the ensiling process. The concentration of acetic acid released during the pretreatment of hemp stem was measured at 1.2–3.1 g l⁻¹. In case of SPHS, it was significantly higher, up to 5 g l⁻¹, which corresponds to 1.8–4.1% of the initial raw material. Acetic acid originates both from the ensiling and from the acetyl groups in the hemicellulose released during the pretreatment. Weak acids have previously been found to have an inhibitory effect on ethanol production by *S. cerevisiae* [29].

3.4. Enzymatic hydrolysis

Enzymatic hydrolysis of the pretreated slurry was performed to evaluate the accessibility of the cellulose and thus the efficiency of the pretreatments. Enzymatic hydrolysis was performed on the pretreated slurries of SPH and SPHS. Table 5 shows the final glucose concentrations and the glucan conversions in the enzymatic hydrolysis as well as the overall glucose yield including both pretreatment and enzymatic hydrolysis. For SPH pretreatment at 215 °C resulted in the highest glucan conversion and overall glucose yield, but it should be kept in mind that this material contained high concentrations of furfural and HMF and thus the ethanol fermentation might be significantly inhibited. Pretreatment at 210 °C gave nearly as high glucan conversion and glucose yield but lower levels of inhibitors. For SPHS pretreatment at 210 °C for 5 min with SO₂ addition gave the highest overall glucose yield among the conditions investigated. Lower temperatures and pretreatments without catalyst resulted insufficient glucan conversion, therefore lower glucan yields. For both SPH and SPHS pretreatment at 210 °C using SO₂ catalyst resulted in a considerable increase in glucan breakdown, resulting in a glucose yield of 373 and 372 g kg⁻¹, respectively.

Although hydrolysis was performed using equal substrate concentrations (2% WIS), higher glucose concentration does not necessarily mean higher glucan conversion, as the

compositions of the WIS fractions differ (Tables 2 and 3). The availability of the glucan varied in different samples, for instance in the case of SPHS pretreated without SO₂ at 210 °C, where the glucan content of the WIS was as high as for the SPH treated with SO₂ at the same temperature (data in Tables 2 and 3), and the conversion was significantly lower for SPHS (Table 5).

Fig. 3 shows conversion values reached in enzymatic hydrolysis as a function of pretreatment temperature. When SO₂ impregnation was applied (closed symbols), the increase of the temperature resulted in more remarkable increased glucan conversion compared to pretreatments without the acid catalyst.

3.5. Mass balance analysis

Mass balance analyses were performed for both the pretreatment alone and in combination with enzymatic hydrolysis. Fig. 4A and B show the carbohydrate recoveries after steam pretreatment for hemp stem and hemp silage, respectively. In the calculations for the pretreatment, the amount of ensiled hemp was taken as 100%, i.e., possible loss during ensiling was not taken into consideration. The exact

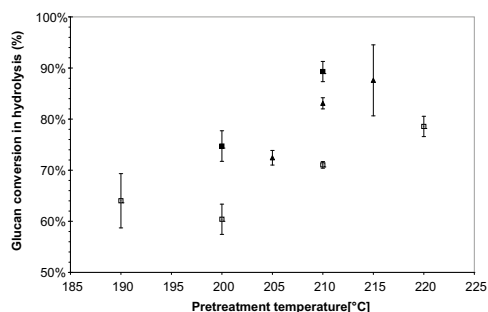

Fig. 3 – Glucan conversion in enzymatic hydrolysis of steam pretreated hemp and hemp silage as a function of pretreatment temperature. Mean values of duplicate experiments and standard deviations are presented (steam pretreated hemp with SO₂ (▲); steam pretreated hemp silage with (■) and without (□) SO₂).

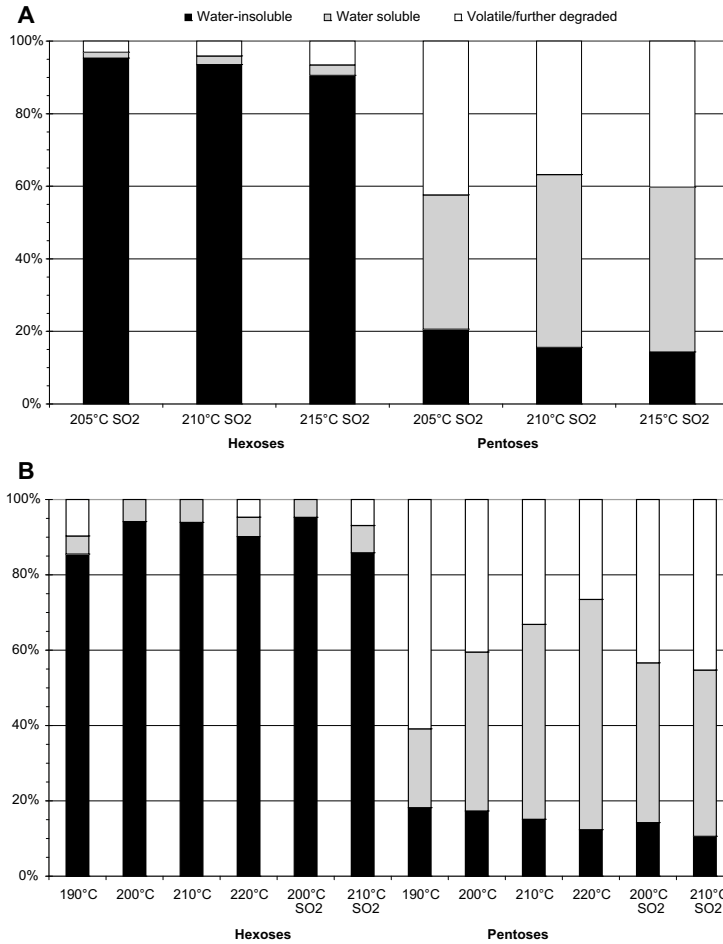

Fig. 4 – Hexose and pentose recoveries after steam pretreatment of dry hemp (A) and hemp silage (B) as percentage of the theoretical. Values are based on carbohydrates in the raw material.

change in DM and energy content during ensiling is difficult to determine if the mass and composition of the material is not determined before and after ensiling [30]. The mass was not determined in the farm scale ensiling used. Based on the amount of solubilised sugars and fermentation products (i.e. lactic acid, acetic acid, glucose and ethanol) measured in the liquid of the silage, a rough estimation of the material balance of ensiling can be performed, which shows that during the ensiling, approximately 8% of the raw material was turned into these products.

SPH hexoses (mainly glucan) remained in the solid fraction (90–95%), and only 1.5–4.0% were solubilised (Fig. 4A). Further degradation of hexoses was not significant. In the case of

pentoses (mainly xylan) only 15–20% of the initial amount remained in the solid fraction. Only 36–48% of the xylan was transferred into the liquid fraction, and the amount of the further-degraded or not-determined material was rather high, 36–42%. Similar mass balances have been achieved for other lignocellulosic materials (corn stover, salix, spruce) [3]. The lowest amount of further-degraded/not-determined compounds and the highest solubilisation of pentoses were obtained with pretreatment at 210 °C for 5 min. For SPHS, similar trends were observed concerning the recovery after pretreatment (Fig. 4B). Hexoses remained in the solid fraction (86–96%), and only a minor part was solubilised (5–7%) or further degraded (0–10%). A minor part of the initial xylan

(10–18%) from SPHS remained in the solid fraction, while 20–75% was solubilised, and a large amount (26–60%) was further degraded or not determined. The reason for the high amount of these compounds for pretreatment at 190 °C is probably that this was the least severe condition which has led to poor pretreatment and rather heterogenous material. The samples taken for analysis could have been non-representative and add an error for mass balance calculation. In this comparison it should be kept in mind that only stems were used from dry hemp while hemp silage contained both stems and leaves.

Fig. 5 shows the mass balances both in the pretreatment and the enzymatic hydrolysis for the different experimental setups. The fractions are represented as percentage of the initial dry raw material and are defined as: i) the water-insoluble fraction (mainly lignin), which can be further utilised as solid fuel; ii) glucan remained in the solid residue after hydrolysis; iii) glucan solubilised during the enzymatic hydrolysis; iv) sugars solubilised in the steam pretreatment; and v) volatile and further degraded compounds, which were not accounted for. The goal of the experiments was to maximise yield of solubilised glucose in the enzymatic hydrolysis of the steam pretreated material (grey part of the bars in the figure).

In the case of dry hemp (Fig. 5 and Table 5) the maximal glucose yields were similar for pretreatment at 210 °C and 215 °C with SO₂ impregnation (373 and 383 g kg⁻¹, respectively), but there was a significant difference in the amount of solubilised hemicellulose sugars (249 and 199 g kg⁻¹). Both pretreatment conditions were found to be efficient for improving cellulose hydrolysis, but the lower temperature resulted in less inhibitor formation. As the process economy is strongly affected by the utilisation of the hemicellulose fraction [31], pretreatment at 210 °C for 5 min after SO₂ impregnation was found to be the best condition for hemp stem. The

optimal pretreatment condition (210/5 min/2% SO₂) for hemp and hemp silage is similar to pretreatment conditions obtained for agricultural lignocellulosics (200 °C/10 min/2% SO₂ for corn stover [16], 190 °C/10 min/0.2% H₂SO₄ for wheat straw [5]; or for woods (210 °C/5 min/2.5%SO₂ for softwood [32], 205 °C/4 min/2% SO₂ for hardwood [33]).

For hemp silage (Fig. 5 and Table 5), the highest glucose yield (372 g kg⁻¹) was obtained by pretreatment at 210 °C for 5 min with SO₂ impregnation, followed by the pretreatment at 200 °C with SO₂ impregnation (342 g kg⁻¹). The highest yield of sugars solubilised during the pretreatment was also obtained in the case of 210 °C with SO₂ impregnation, therefore this was chosen as the best pretreatment condition. Thus, based on glucose yields in enzymatic hydrolysis, steam pretreatment at 210 °C for 5 min with SO₂ impregnation was chosen as the optimal pretreatment conditions both for dry hemp and hemp silage.

3.6. Results of SSF of the whole slurry and of the separated fibre

SSF of SPH and SPHS was performed using either the whole slurry or the separated solid fraction of the materials pretreated using the selected optimal pretreatment conditions: 2% SO₂ impregnation followed by 210 °C/5 min treatment. Fig. 6 shows the glucose, xylose and ethanol concentrations during the 72 h of the SSF. Decrease of xylose concentration is an indicator for microbial contamination of the fermentation, as *S. cerevisiae* can only consume C6 sugars. Neither decrease of xylose concentration nor lactic acid production (data not shown) was observed during the SSF experiments. With SPH, the separated fibre resulted in a slightly higher ethanol concentration compared to the whole slurry (Fig. 6A). Final ethanol concentrations in the case of whole slurry and the separated fibre were determined to 18.4 g l⁻¹ and 21.3 g l⁻¹,

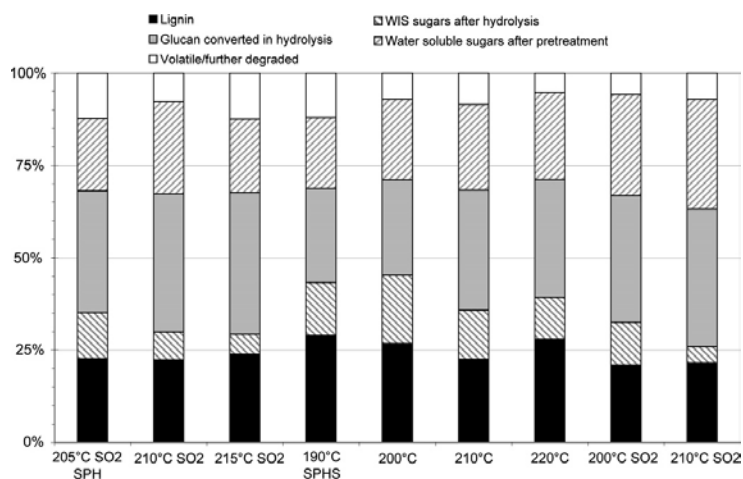

Fig. 5 – Lignin and carbohydrate fractions after steam pretreatment and enzymatic hydrolysis of dry hemp (SPH) and hemp silage (SPHS), as percentage of the dry weight of raw material.

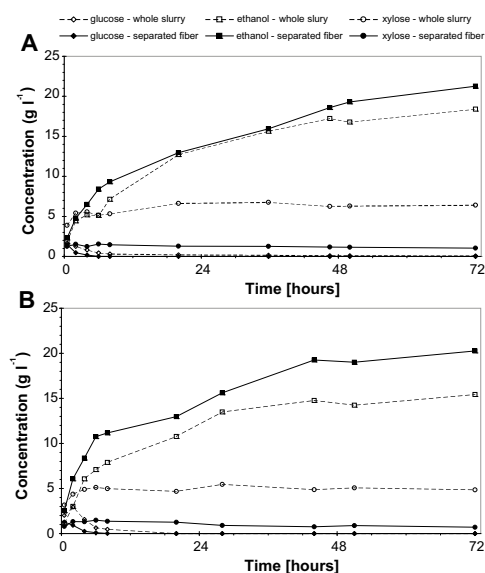

Fig. 6 – Concentrations of glucose, xylose and ethanol in SSF of SPH (A) and SPHS (B). Substrates were pretreated at 210 °C for 5 min using 2% SO₂ impregnation (open symbols and dashed lines – whole slurry, closed symbols and continuous lines – separated fibre).

respectively. This corresponds to a total process yield of 148 and 171 g kg⁻¹ ethanol based on raw dry hemp DM, respectively. The overall ethanol yields were 62.4% and 74.1% of the theoretical maximum based on the glucan content in the raw material.

With SPHS, the difference between the performance of the whole slurry and the separated fibre was more pronounced (Fig. 6B). The final ethanol concentrations were 15.4 and 20.3 g l⁻¹, respectively. The total ethanol yields were 125 and 163 g kg⁻¹ based on hemp silage DM, respectively, corresponding to 53.4% and 71.2% of the theoretical. The significant difference might be caused by the inhibitory effect of the organic acids present in the whole slurry [28,29]. At the beginning of the fermentation of the whole slurry, 6.0 g l⁻¹ lactic acid and 6.8 g l⁻¹ acetic acid were present and the concentrations of these compounds were constant during the process. The presence of acetic acid is rather important, as its pK_a value is rather close to the pH of the SSF. The inhibitory effect of the organic acids is connected with the protonated form, because it can diffuse across the plasma membrane [28] (36% of the acetic acid and 7% of the lactic acid is in protonated form at pH 5). The concentration of protonated acetic acid was calculated to be 40.8 mmol l⁻¹.

Maize silage has previously been tested for ethanol production in SSF [34]. The yield for wet-oxidised (WO) maize silage was found to be 83% (of the theoretical maximum), which corresponds to 308 g kg⁻¹ ethanol based on DM WO maize silage (82% of the theoretical maximum), which is

slightly less than what has been found for WO corn stover [35]. It should be noted, that during WO, beside hemicellulose, a part of the lignin also degrades, which results in a pretreated material rich in cellulose. In the case of wheat straw, 132 g kg⁻¹ ethanol based on dry wheat straw SSF yield was achieved [5], while in case of Salix, 201 g kg⁻¹ ethanol based on dry wood yield was achieved, and the ethanol yield in SSF was higher compared to the theoretical maximum than in the present study [36].

The results obtained both with SPH and SPHS show that separation of fibre and liquid fraction prior to SSF is advantageous. In the case of SPHS, the effect was more pronounced compared to SPH. Separation is beneficial not only because of the removal of inhibitory compounds with the liquid fraction, but also a new fraction arises containing mainly C5 sugars (mono- and oligomers) some C6 sugars and other organic compounds like acetic acid, furfural and HMF, which can be utilised separately, e.g., for biogas production.

4. Conclusions

Steam pretreatment with an SO₂ catalyst was shown to be an efficient pretreatment method prior to ethanol production from both dry hemp and hemp silage. In both cases impregnation with 2% SO₂ followed by steam pretreatment at 210 °C for 5 min were found to be the most suitable pretreatment conditions within the investigated intervals. No significant effect of the ensiling process was detected at the optimal conditions for conversion of hemp to ethanol. In further experiments, utilisation of the liquid fraction and SSF residue for biogas production to increase the energy recovery will be investigated.

Acknowledgements

The Environmental Fund of Region Scania, the Hungarian National Research Fund (OTKA – K 72710) and The Swedish Research Council for Environment, Agricultural Sciences and Spatial Planning are kindly acknowledged for their financial support. Enzymes were kindly donated by Novozymes A/S (Bagsværd, Denmark). Thanks to Thomas Prade at the Swedish University of Agricultural Sciences for providing dry hemp.

REFERENCES

- [1] Sun Y, Cheng J. Hydrolysis of lignocellulosic materials for ethanol production. *Bioresour Technol* 2002;83:1–11.
- [2] Tengborg C, Galbe M, Zacchi G. Influence of enzyme loading and physical parameters on the enzymatic hydrolysis of steam-pretreated softwood. *Biotechnol Progr* 2001;17:110–7.
- [3] Sassner P, Galbe M, Zacchi G. Techno-economic evaluation of bioethanol production from three different lignocellulosic materials. *Biomass Bioenerg* 2008;32:422–30.
- [4] Öhgren K, Rudolf A, Galbe M, Zacchi G. Fuel ethanol production from steam-pretreated corn stover using SSF at higher dry matter content. *Biomass Bioenerg* 2006;30:863–9.

- [5] Linde M, Jakobsson E-L, Galbe M, Zacchi G. Steam pretreatment of dilute H₂SO₄-impregnated wheat straw and SSF with low yeast and enzyme loadings for bioethanol production. *Biomass Bioenerg* 2008;32:326–32.
- [6] Martin C, Galbe M, Wahlbom CF, Hahn-Hägerdal B, Jönsson LJ. Ethanol production from enzymatic hydrolysates of sugarcane bagasse using recombinant xylose-utilising *Saccharomyces cerevisiae*. *Enzym Microb Technol* 2002;31:274–82.
- [7] Sipos B, Réczey J, Somorai Z, Kádár Z, Dienes D, Réczey K. Sweet sorghum as feedstock for ethanol production: enzymatic hydrolysis of steam-pretreated bagasse. *Appl Biochem Biotechnol* 2008;153:151–62.
- [8] Sziájtó N, Kádár Z, Varga E, Thomsen AB, Costa-Ferreira M, Réczey K. Pretreatment of reed by wet oxidation and subsequent utilization of the pretreated fibers for ethanol production. *Appl Biochem Biotechnol* 2009;155:83–93.
- [9] Keshwani DR, Cheng JJ. Switchgrass for bioethanol and other value-added applications: a review. *Bioresour Technol* 2009;100:1515–23.
- [10] Struik PC, Amaducci S, Bullard MJ, Stutterheim NC, Venturi G, Cromack HTH. Agronomy of fibre hemp (*Cannabis sativa* L.) in Europe. *Ind Crops Prod* 2000;11:107–18.
- [11] Harris AT, Riddlestone S, Bell Z, Hartwell PR. Towards zero emission pulp and paper production: the BioRegional MiniMill. *J Clean Prod* 2008;16:1971–9.
- [12] Sgriccia N, Hawley MC, Misra M. Characterization of natural fiber surfaces and natural fiber composites. *Compos Part A* 2008;39:1632–7.
- [13] Kymäläinen H-R, Sjöberg A-M. Flax and hemp fibers as raw materials for thermal insulations. *Build Environ* 2008;43:1261–9.
- [14] Rice B. Hemp as a feedstock for biomass-to-energy conversion. *J Ind Hemp* 2008;13:145–55.
- [15] Keller A, Leupin M, Mediavilla V, Wintermantel E. Influence of the growth stage of industrial hemp on chemical and physical properties of the fibres. *Ind Crops Prod* 2001;13:35–48.
- [16] Öhgren K, Galbe M, Zacchi G. Optimization of steam pretreatment of SO₂ impregnated corn stover for fuel ethanol production. *Appl Biochem Biotechnol* 2005;121–124:1055–68.
- [17] Garcia-Jaldon C, Dupeyre D, Vignon MR. Fibers from semi-retted hemp bundles by steam explosion treatment. *Biomass Bioenerg* 1998;14:251–60.
- [18] Nykter M, Kymäläinen H-R, Thomsen AB, Lilholt H, Koponen H, Sjöberg A-M, et al. Effects of thermal and enzymatic treatments and harvesting time on the microbial quality and chemical composition of fibre hemp (*Cannabis sativa* L.). *Biomass Bioenerg* 2008;32:392–9.
- [19] Shin S-J, Sung YJ. Improving enzymatic hydrolysis of industrial hemp (*Cannabis sativa* L.) by electron beam irradiation. *Radiat Phys Chem* 2008;77:1034–8.
- [20] Ghose TK. Measurement of cellulase activities. *Pure Appl Chem* 1987;59(2):257–68.
- [21] Berghem LER, Pettersson G. The mechanism of enzymatic cellulose degradation. *Eur J Biochem* 1974;46:295–305.
- [22] Palmqvist E, Hahn-Hägerdal B, Galbe M, Larsson S, Stenberg K, Szegyel Z, et al. Design and operation of a bench-scale process development unit for the production of ethanol from lignocellulose. *Bioresour Technol* 1996;58:171–9.
- [23] Taherzadeh MJ, Liden G, Gustafsson L, Niklasson C. The effects of pantothenate deficiency and acetate addition on anaerobic batch fermentation of glucose by *Saccharomyces cerevisiae*. *Appl Microbiol Biotechnol* 1996;46:176–82.
- [24] Rudolf A, Alkasrawi M, Zacchi G, Liden G. A comparison of batch and fed-batch simultaneous saccharification and fermentation of steam pretreated spruce. *Enzym Microb Technol* 2005;37:195–204.
- [25] Sluiter A, Ruiz R, Scarlata C, Sluiter J, Templeton D. Determination of extractives in biomass laboratory analytical procedure. NREL Report No. TP-510-42619; 2008.
- [26] Sluiter A, Hames B, Ruiz R, Scarlata C, Sluiter J, Templeton D, et al. Determination of structural carbohydrates and lignin in biomass, laboratory analytical procedure, NREL Report No. TP-510-42618; 2008.
- [27] Sluiter A, Hames B, Ruiz R, Scarlata C, Sluiter J, Templeton D. Determination of sugars, byproducts, and degradation products in liquid fraction process samples, laboratory analytical procedure, NREL Report No. TP-510-42623; 2008.
- [28] Palmqvist E, Hahn-Hägerdal B. Fermentation of lignocellulosic hydrolysates. II: inhibitors and mechanisms of inhibition. *Bioresour Technol* 2000;74:25–33.
- [29] Larsson S, Palmqvist E, Hahn-Hägerdal B, Tengborg C, Stenberg K, Zacchi G, et al. The generation of fermentation inhibitors during dilute acid hydrolysis of softwood. *Enz Microb Technol* 1999;24:151–9.
- [30] McDonald P, Henderson AR, Ralton I. Energy changes during ensilage. *J Sci Fd Agric* 1973;24:827–34.
- [31] von Silvers M, Zacchi G. A techno-economic comparison of three processes for the production of ethanol from pine. *Bioresour Technol* 1995;51:43–52.
- [32] Stenberg K, Trenborg C, Galbe M, Zacchi G. Optimization of steam pretreatment of SO₂ impregnated mixed softwoods for ethanol production. *J Chem Technol Biotechnol* 1998;71:299–308.
- [33] Sassner P, Galbe M, Zacchi G. Steam pretreatment of Salix with and without SO₂ impregnation for production of bioethanol. *Appl Biochem Biotechnol* 2005;121–124:1101–18.
- [34] Oleskowicz-Popiel P, Lisiecki P, Holm-Nielsen JB, Thomsen AB, Thomsen MH. Ethanol production from maize silage as lignocellulosic biomass in anaerobically digested and wet-oxidized manure. *Bioresour Technol* 2008;99:5327–34.
- [35] Varga E, Klinke HB, Réczey K, Thomsen AB. High solid simultaneous saccharification and fermentation of wet oxidized corn stover to ethanol. *Biotechnol Bioeng* 2004;88:567–74.
- [36] Sassner P, Mårtensson C-G, Galbe M, Zacchi G. Steam pretreatment of H₂SO₄-impregnated Salix for the production of bioethanol. *Bioresour Technol* 2008;99:137–45.



Contents lists available at ScienceDirect

Bioresource Technology

journal homepage: www.elsevier.com/locate/biortech

Bioconversion of industrial hemp to ethanol and methane: The benefits of steam pretreatment and co-production

Emma Kreuger^{a,*}, Bálint Sipos^{b,1}, Guido Zacchi^b, Sven-Erik Svensson^c, Lovisa Björnsson^a

^a Department of Biotechnology, Lund University, P.O. Box 124, SE-221 00 Lund, Sweden

^b Department of Chemical Engineering, Lund University, P.O. Box 124, SE-221 00 Lund, Sweden

^c Department of Agriculture – Farming Systems, Technology and Product Quality, Swedish University of Agricultural Sciences, P.O. Box 104, SE-230 53 Alnarp, Sweden

ARTICLE INFO

Article history:

Received 14 June 2010

Received in revised form 22 October 2010

Accepted 25 October 2010

Available online 31 October 2010

Keywords:

Biofuel

Biogas

Lignocellulose

Energy crops

Cannabis sativa L.

ABSTRACT

Several scenarios for ethanol production, methane production (by anaerobic digestion) and co-production of these, using autumn harvested hemp as substrate, were investigated and compared in terms of gross energy output. Steam pretreatment improved the methane production rate compared with mechanical grinding. The methane yield of steam pretreated stems was similar both with and without pre-hydrolysis with cellulolytic enzymes. Co-production of ethanol and methane from steam pretreated stems gave a high yield of transportation fuel, 11.1–11.7 MJ/kg processed stem dry matter (DM); more than twice that of ethanol production alone from hexoses, 4.4–5.1 MJ/kg processed stem DM. Co-production from the whole hemp plant would give 2600–3000 L ethanol and 2800–2900 m³ methane, in total 171–180 GJ per 10,000 m² of agricultural land, based on a biomass yield of 16 Mg DM. Of this, the yeast and enzymes from ethanol production were estimated to contribute 700 m³ (27 GJ) of methane.

© 2010 Elsevier Ltd. All rights reserved.

1. Introduction

Fossil fuel reserves are becoming depleted and the demand for fuels from renewable energy sources is increasing. The dominating transportation fuels produced from renewable sources throughout the world today are ethanol and biodiesel (electricity not included). However, not only liquid but also gaseous fuels, such as methane and hydrogen produced from renewable substrates, are promising candidates as renewable transportation fuels. Although liquid fuels dominate for transportation purposes, fossil methane (natural gas) is used as transportation fuel in many countries and some, for example Sweden and Germany, distribute methane produced via anaerobic digestion (AD) of biomass from renewable sources as a fuel in the natural gas grid.

The dominating substrates used for ethanol production today are either pure sugars, e.g. sucrose from sugar cane in Brazil, or easily degradable carbohydrates, e.g. starch, from corn in the USA, and from cereals in Europe. A shift to lignocellulosic plant material will make utilisation of other crops possible, and will also enable the production of transportation fuel from crop residues

such as corn stover and cereal straw. Most microorganisms used for ethanol production cannot hydrolyse lignocellulose, which is composed of cellulose in association with hemicellulose and lignin. The conversion process therefore includes pretreatment, to make the cellulose accessible, and enzymatic hydrolysis with added enzymes to release the monomeric sugars (Sun and Cheng, 2002). Enzymatic hydrolysis is preferably performed simultaneously with the fermentation of the released sugars: simultaneous saccharification and fermentation (SSF) (Olofsson et al., 2008). When using ordinary baker's yeast, *Saccharomyces cerevisiae*, for ethanol fermentation, only hexoses will be fermented to ethanol, and the pentoses together with proteins and other carbon sources could be utilised in separate processes, e.g. AD.

A mixed, diverse microbial culture is commonly used for methane production by AD. Most compounds in lignocellulosic plant material can be degraded anaerobically, but the biological degradation of polymeric lignin is very poor, if occurring at all. Lignin can reduce both the degradation rate and the extent of degradation of other cell wall constituents, as well as intracellular content (Anderson and Akin, 2008; Zehnder, 1988). Other factors such as cellulose crystallinity and particle size can also influence the conversion rate. When using lignocellulosic biomass pretreatment is always employed prior to ethanol production. When AD is used, pretreatment is not always necessary, but can reduce the effects of limiting factors and increase both the conversion rate and the total yield as reviewed by Hendriks and Zeeman (2009). Combining the degradation potential of a microbial culture in AD with the

* Corresponding author. Tel.: +46 46 222 81 93; fax: +46 46 222 47 13.

E-mail addresses: Emma.Kreuger@biotek.lu.se (E. Kreuger), Balint.Sipos@mkt.bme.hu (B. Sipos), Guido.Zacchi@chemeng.lth.se (G. Zacchi), Sven-Erik.Svensson@ltj.slu.se (S.-E. Svensson), Lovisa.Bjornsson@biotek.lu.se (L. Björnsson).

¹ Present address: Budapest University of Technology and Economics, Department of Applied Biotechnology and Food Science, Szt. Gellért tér 4, H-1111 Budapest, Hungary.

benefits of pretreatment has the potential to increase the methane yield, when using the substrate for AD only, and to give a high total yield when employing co-production with ethanol (Börjesson and Mattiasson, 2008; Kaporaju et al., 2009).

While methods of converting lignocellulosic plant material into transportation fuels are constantly improving, and are advancing towards economical feasibility, the search for high-yielding crops with low environmental impact is also ongoing. Recently, industrial hemp (*Cannabis sativa* L.) was presented as a candidate (Kreuger et al., 2010; Sipos et al., 2010). Hemp is an annual crop that suppresses weeds and has a low susceptibility to pests and diseases (van der Werf et al., 1995), making it a suitable crop to include in crop rotation, especially in organic crop rotation. An average biomass yield of 16 Mg dry matter (DM) per ha (1 ha = 1 hectare = 10,000 m²) at autumn harvest was reported from a 3-year trial (2006–2008) in the south of Sweden (Kreuger et al., 2010), while a yield of 10 Mg DM/ha has been reported from the north of Sweden (Finell et al., 2006). Sweden has a cold climate without a dry season, with warm summers in the south and cold summers in the north, according to the Köppen–Geiger classification (Peel et al., 2007). The northern parts of North America, Asia and Europe have a similar climate. Higher yields of hemp have been reported for temperate regions of Europe: around 20 Mg DM/ha in Italy, the Netherlands and the United Kingdom (Struik et al., 2000; Cappelletto et al., 2001).

The conversion of hemp biomass (16 Mg DM per ha) to 81 GJ ethanol per ha based on the fermentation of hexoses from steam pretreated dry hemp stems, and the production of 136 GJ methane from AD of ground fresh hemp have been reported previously (Sipos et al., 2010; Kreuger et al., 2010). Although less than 50% of the higher heating value (HHV) of the hemp was converted to methane, the yield of transportation fuel per ha was high compared with some of the currently dominating renewable transportation fuels produced locally and globally. The average ethanol yield from wheat kernels in Sweden is 62 GJ/ha (Bernesson et al., 2006), from corn kernels in the USA, 81 GJ/ha (McDonald et al., 2009), and from sugar cane in Brazil, 176 GJ/ha (Macedo et al., 2008). The energy demand in the cultivation of hemp has been estimated to be 11.4 GJ/ha, corresponding to 8% of the above-mentioned methane energy yield (van der Werf, 2004). The high carbohydrate content and relatively low lignin content of hemp suggests that its conversion to transportation fuel could be improved, potentially through combining the optimized steam pretreatment conditions for ethanol production presented by Sipos et al. (2010) with co-production of ethanol and methane.

In the current study several scenarios for ethanol production, methane production and co-production of these, using autumn harvested dry hemp as substrate, were investigated and compared in terms of gross energy output. Ethanol was produced from hexoses of steam pretreated stems using SSF as described previously (Sipos et al. 2010). Methane was produced through AD of chopped stems, ground stems, crushed leaves, steam pretreated stems, pre-hydrolysed steam pretreated stems and of various process residues from the ethanol production process. The primary aim was to compare the energy output per unit mass of hemp in the different scenarios.

2. Methods

2.1. Experimental design

Methane and ethanol were produced by microbial fermentation of dry hemp in eight different scenarios, as illustrated in Fig. 1. Scenarios A–D include only methane production, E and G only ethanol production, while F and H represent two scenarios

for combined ethanol and methane production. In Scenario F the complete slurry of steam pretreated stems (SP slurry) was used for ethanol production with SSF and the residue after SSF was used for AD. In Scenario H, SP slurry was separated into a solid fraction (SP solids) and a liquid fraction (SP liquid), and the SP solids was used for SSF, while the SP liquid was used directly for AD, and the residue after SSF was used for AD. The steam pretreated material was not washed in any of the scenarios. Leaves were separated and used for methane production in all scenarios except E and G, which involved only ethanol production. Leaves were not subjected to steam pretreatment due to practical reasons, and were therefore not used for ethanol production. The abbreviations defined in Fig. 1 will be used throughout the text. The mass flows and fuel yields shown in Fig. 1 are presented and discussed in the results section. A calculation example for Scenario H is presented in Appendix A.

2.2. Substrate

Industrial hemp (*C. sativa* L.) of the variety Futura 75 was cultivated at Nöbbelöv, close to Lund, Sweden (N55°43', E13°08'). The hemp was sown on the 4th of April 2007 and harvested on the 3rd of and the 4th of September. Stems were cut a few centimetres above the ground. Samples were air-dried indoors at 10–20 °C after harvest to a DM content of 92% for stems and 90% for leaves. Stems and leaves (including fine stems) were separated manually and weighed. Equal amounts of air-dried hemp grown at three different fertilization levels (115, 150 and 200 kg N/ha) were mixed due to a shortage of material. It has been reported in a previous study that the level of fertilization has little effect on the chemical composition of hemp (Sipos et al., 2010). The composition of hemp stems in terms of extractives, structural carbohydrates and lignin had been determined previously, and the data presented here are the average of the three substrates mixed together (for original data see Sipos et al., 2010). The average DM yield was 16 Mg/ha. The HHV of the dry hemp (measured on triplicate samples of the hemp cultivated with 150 kg N/ha) was 18.2 MJ/kg DM with standard deviation 0.1 MJ/kg DM (Prade et al., unpublished results), and was assumed to be representative for our mixed sample.

2.3. Mechanical treatment

Dry stems were chopped in a garden shredder to a length of 2–3 cm (AXT 2500 HT, Robert Bosch GmbH, Germany) for Scenario A to H. Dry leaves were crushed briefly manually in a plastic bag prior to AD. For Scenario B the chopped stems were finely ground (<1 mm particle size) in a hammer mill (SK1, Retsch GmbH, Haan, Germany).

In Scenarios G and H the SP slurry was separated into SP solids and SP liquid with a manual hydraulic press (Sixten Torne AB, Malmö, Sweden). Part of the SP solids was used for SSF without prior washing (Scenarios G and H) and part was washed with distilled water prior to analysis of structural carbohydrates and lignin in the water-insoluble solids (WIS). The DM in the SP solids and SP liquid was determined. The SP liquid was used for AD in Scenario H, and the contents of soluble sugars, lactic acid, acetic acid, 5-hydroxymethylfurfural (HMF) and furfural were analysed.

2.4. Steam pretreatment

Steam pretreatment was performed at optimized conditions, as described by Sipos et al. (2010): i.e. at 210 °C for 5 min after impregnation with 2% SO₂ (based on the water content). The leaves were not pretreated since they easily fell apart into small pieces not suitable for the pretreatment unit used. Stems were sprayed with water (1:1 by weight) and stored for 2 days at room

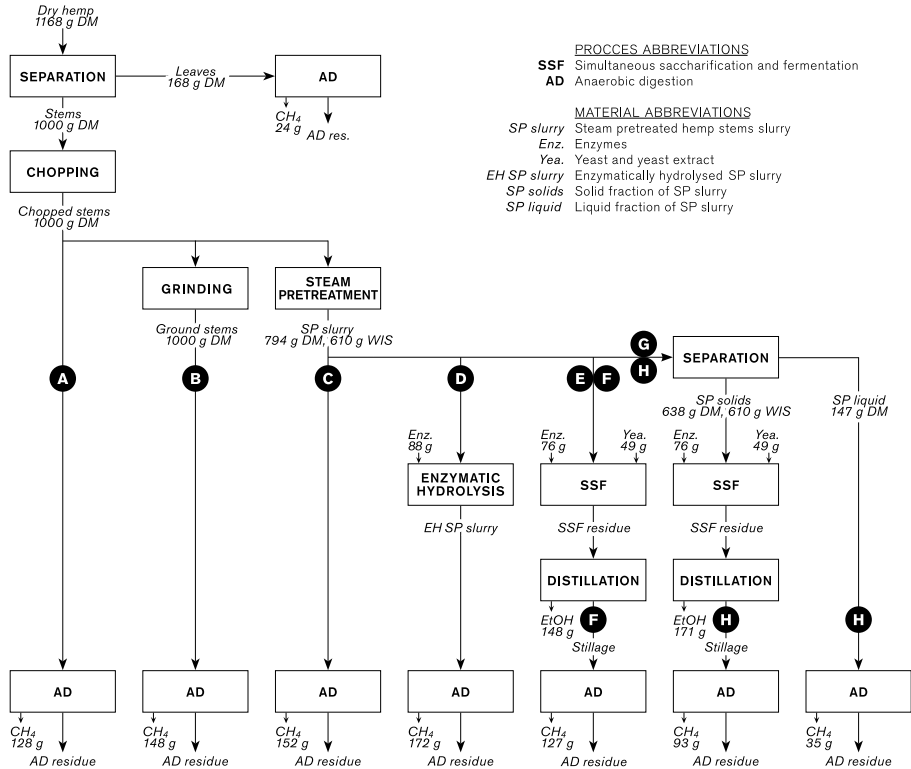

Fig. 1. Process schemes for Scenarios A–H used for the production of ethanol and methane from hemp. DM denotes dry matter, WIS denotes water-insoluble solids.

temperature prior to steam pretreatment. The DM content was determined prior to steam pretreatment. The wet mass before and after steam pretreatment was recorded to take into account material losses in the subsequent experiments. The SP slurry was stored at 5 °C in sealed buckets for 2–5 days, while using parts for solid/liquid separation and analysis (see section 2.3). Thereafter, the steam pretreated material was stored frozen in aliquots until 2–3 days prior to enzymatic hydrolysis, SSF and AD when it was thawed in a cold room.

2.5. Enzyme preparations

The enzymes added during enzymatic hydrolysis (Scenario D) and SSF (Scenarios E and F) were Celluclast 1.5L and Novozym 188 (Novozymes A/S, Bagsvaerd, Denmark). The cellulase activity of Celluclast 1.5L was 61 FPU/mL, measured according to Ghose (1987). The β-glucosidase activity of Novozym 188 was 502 IU/mL and that of Celluclast 1.5L 33 IU/mL, measured according to Berghem and Pettersson (1974). The chemical oxygen demand (COD) of the enzyme solutions was determined to be 0.48 g/mL for Novozym 188 and 0.67 g/mL for Celluclast 1.5L. The DM contents were determined to be 43.4% for Novozym 188 and 50.5% for Celluclast 1.5L, based on duplicate analyses.

2.6. Enzymatic hydrolysis

Enzymatic hydrolysis of SP slurry was performed prior to AD to pre-hydrolyse cellulose (Scenario D). The substrate concentration was 7.5% WIS. The pH was set to 4.8 with 0.05 mol/L sodium acetate buffer. Celluclast 1.5L was added at a cellulase activity corresponding to 15 FPU/g WIS and Novozym 188 was added at a β-glucosidase activity corresponding to 23 IU/g WIS. Experiments were performed in 500 g batches in duplicate in 1 L bottles immersed in a 40 °C water bath. Overhead stirring was used at 300 rpm. Samples were taken for the determination of the glucose concentration after 0, 2, 4, 8, 24, 48 and 72 h. Samples used for AD were stored in sealed bottles at 5 °C for three days before use. Material after 72 h hydrolysis (EH SP slurry) was stored in sealed bottles at 5 °C for three days before AD. It was assumed that there were no mass losses during enzymatic hydrolysis.

2.7. Simultaneous saccharification and fermentation

SSF was performed in Scenarios E and G using SP slurry and the SP solids, respectively, as described by Sipos et al. (2010). The stillage from Scenarios E and G was used for AD in Scenarios F and H, respectively. Briefly, SSF was performed with 7.5% WIS in a batch of

1400 g total working weight. Yeast (*S. cerevisiae*) cultivated on SP liquid supplemented with glucose, to increase the inhibitor tolerance of the microbe, was added at a concentration of 5 g/L. The only organic nutrient added was yeast extract from Applichem (Gatersleben, Germany), 1 g powder/L. The COD of the yeast and the yeast extract were determined to be 1.29 g/g DM and 1.1 g/g powder, respectively. Celluclast 1.5L was added at a cellulase activity corresponding to 20 FPU/g glucan, and Novozym 188 was added at a β -glucosidase activity corresponding to 23 IU/g glucan. The experiments were run for 72 h, after which the sugar and ethanol contents were analysed. The mass after SSF was calculated based on the material added and subtraction of produced CO_2 . The weight was calculated instead of measured to not include handling losses when transferring the material from the SSF reactor. Samples for AD were stored in sealed bottles at 5 °C 1 day before and 7 days after distillation, before use.

2.8. Ethanol distillation

Ethanol from the fermentation broth after SSF was removed by a modified (two vertical coolers) 20 L Büchi Rotavapor R-153, equipped with a Büchi vac-512 vacuum pump (Büchi Labortechnik AG, Flawil, Switzerland). The water bath heating the stillage was maintained at 85 °C and the pressure was gradually decreased to 100–120 mbar. Distillation was continued until the temperature increased above 50 °C at the end of the first cooler. When converting ethanol to energy units a HHV of 29.7 MJ/kg was used. The concentrations of ethanol, acetic acid and lactic acid were measured before and after distillation. The wet masses were measured to enable calculation of the mass of the stillage corresponding to 1 kg initial hemp stems.

2.9. Anaerobic digestion

The methane potential with AD was determined using a biochemical methane potential batch test. Each substrate was incubated in a 500 mL Erlenmeyer flask in a shaking water bath at a speed of 70 rpm at 40 °C. Each experiment was performed in triplicate. The substrates digested are indicated in Fig. 1. Water was added (2:1 by weight) to dry leaves and stems, which were then stored for 2 days at 12 °C prior to AD. The DM and volatile solids (VS) of chopped stems, ground stems and crushed leaves were determined before water was added. Methane production during AD is usually expressed per g VS added. Since volatile compounds, e.g. acetic acid and furfural, can be lost and not accounted for during DM measurements, the VS in samples containing volatile compounds can be underestimated (Porter and Murray, 2001). SP material and downstream samples such as SSF residue and EH SP slurry usually contain volatile compounds. To avoid underestimation of the amount of VS added to AD in Scenarios C, D, F and H the VS was only measured in the initial hemp, and the biogas yields are expressed per g VS in initial hemp. The amount of material corresponding to one g VS in the initial hemp was quantified based on wet mass flows. A calculation example of the methane yield in Scenario H is presented in Appendix A. The reductions in mass in steam pretreatment, separation, SSF and distillation are included, while no losses are included in the cutting and grinding alternatives. Substrate was added corresponding to 4.25 g VS in the initial hemp stems or leaves. In Scenario H, where the SP slurry had been divided into SP solids and SP liquid, substrates were added corresponding to 6.04 and 17.10 g VS in the initial hemp for SP solids and SP liquid, respectively, to not get too low actual VS in the test. The substrate inoculum mixture used with all steam pretreated samples was adjusted to pH 7 with 10% NaOH, to compensate for the pH-reducing effect of the SO_2 added before steam pretreatment

and the organic acids released from hemicellulose during steam pretreatment. The gas produced was collected in gas-tight bags.

To each test flask 200 mL inoculum was added, corresponding to 8.5 g VS. The inoculum was collected from a full-scale anaerobic digester (Svensk Växtkraft AB, Västerås, Sweden), in which the substrate was dominated by organic household waste (about 3/4), and grass-clover silage (1/4). The inoculum was maintained at 10–25 °C during transport (30 h) after collection, after which it was preincubated at 40 °C for 8 days. The inoculum had the following properties: pH 8.1, $\text{NH}_4^+ - \text{N}$ 3.2 g/L, K^+ 4.0 g/L and $\text{PO}_4^{3-} - \text{P}$ 31 mg/L. Two sets of controls were included as recommended by Hansen et al. (2004): one set with only inoculum and one set where cellulose was added to the inoculum at a ratio of 1:2 based on VS. A mixture of cellulose was used: 50% Avicel PH-101 (Fluka, Biochemika, Buchs, Switzerland) and 50% Cellulose powder microcrystalline (MP Biomedicals LLC, Solon, OH, USA). Nutrients were added as described by Kreuger et al. (2010).

The amount and composition of the gas was measured every two days. The amount of methane produced was calculated as the amount accumulated in the gas-tight bag plus the increase in concentration of methane in the reactor headspace, when applicable. The amount of methane produced by the inoculum control was subtracted from the samples. The experiment was terminated after 30 days. The results from one of three replicates with chopped stems were excluded due to gas leakage. The methane yield was expressed as dry gas at 273 K and 101,325 Pa (assumed atmospheric pressure in the laboratory). A HHV of 55.5 MJ/kg and a density 0.7157 kg/m³ were used to convert the volume of methane to energy units. The biomethane potential was not experimentally determined for yeast, yeast extract and enzymes, but the methane contributions in Scenarios D, F and H were calculated based on the COD of these carbon sources. The theoretical methane yield of 1 g COD is 0.35 L at 273 K and 101,325 Pa.

2.10. Analytical methods

The DM (which is the same as the total solids, TS) and VS were determined in duplicate using standard methods (APHA, 1995). Water-soluble solids (WS) were measured as the DM of the liquid. The WIS were calculated from the DM content of the pretreated slurry and the WS using the following equation: $\text{WIS} = (\text{DM} - \text{WS}) / (1 - \text{WS})$. Extractives, structural carbohydrates and lignin were analysed according to Sluiter et al. (2008a,b), with the modification that drying was done at 105 °C until constant weight was obtained, and extractives were determined by weight decrease. Extraction was performed on single samples but structural carbohydrates and lignin were analysed in duplicate. Prior to compositional analysis the samples were finely ground in an SK1 hammer mill (see above). Sugars and acids, HMF and furfural were analysed with a HPLC system (Shimadzu, Japan), equipped with a refractive index detector, as described by Sluiter et al. (2008c). Two different columns were used. An Aminex HPX-87H column was used for the analysis of cellobiose, glucose, xylose, glycerol, lactic acid, acetic acid, furfural, HMF and ethanol in SSF samples, and an Aminex HPX-87P column was used for carbohydrate analysis in samples from EH and for the analysis of structural carbohydrates (cellobiose, glucose, xylose, galactose, arabinose and mannose) (both from Bio-Rad Laboratories Inc., Hercules, California, USA). Sugar oligomers in the SP liquid fraction were determined as total sugars after acid hydrolysis minus the monomer sugars before hydrolysis (Sluiter et al., 2008c).

The nutrient composition of the anaerobic inoculum and the COD of the enzyme solutions, yeast and yeast extract were analysed using Dr. Lange test kits (COD – LCK114 and LCK914, ammonium – LCK303, potassium – LCK328 and ortho-phosphate – LCK348, Hach Lange GmbH, Düsseldorf, Germany). Ammonium, potassium and phosphate were analysed after filtration through 0.45 mm

polyethersulphone filters (Chromacol, ThermoFisher Scientific Inc., MA, USA). The gas volume was measured with a 100 mL glass syringe (Fortuna, Germany). The composition of the gas was analysed by gas chromatography, as described previously (Parawira et al., 2008).

3. Results and discussion

3.1. Hemp composition

The measured content of structural hexoses (glucan, mannan and galactan) in hemp stems was 477 g/kg DM, and the measured content of total structural carbohydrates was 589 g/kg DM, see Table 1. The glucan content, 436 g/kg DM, was similar to or slightly higher than that of corn stover, 368–425 g/kg DM (Öhgren et al., 2005). The total content of structural carbohydrates, 589 g/kg DM, was also similar to that of corn stover, 590–670 g/kg DM (Öhgren et al., 2005). The theoretical ethanol yield from the glucan, mannan and galactan in hemp is 270 g/kg stem DM. The water-extractive fraction may contain soluble sugars, but this was not further analysed. The measured proportion of stems in the harvested hemp was 85.6% of the total DM. The VS of stems was 95.7 ± 0.2% of the DM (± denotes standard deviation here and below) and of leaves 80.0 ± 0.1% of the DM.

3.2. Steam pretreatment and solid/liquid separation

The concentrations of WIS and DM in SP slurry were 11% and 14% of the wet weight, respectively. One kg of stem DM gave 794 ± 32 g DM, of which 610 ± 40 g was WIS, after steam pretreatment. The decrease in DM during steam pretreatment consists of volatile compounds freed or formed during steam pretreatment, e.g. acetic acid and furfural, and residues in the steam pretreatment reactor. The decrease in DM would be less in a full-scale plant where handling losses are smaller, and the flash stream could be collected and used for AD. All data given below describes the practical yield per kg initial hemp stem DM. Table 2 gives the amounts of analysed compounds after steam pretreatment but does not include ash, or many extractives etc., which are included in the total DM. Therefore, the sum of the compounds detected is 631 g DM and not 794 g DM. While Table 1 gives the results for all sugars in polymeric form, Table 2 gives the results for polymers in polymeric form, but monomers and oligomers in monomeric form. For the calculation of sugar recovery and the proportion of sugars present in WIS and liquid after steam pretreatment, the amounts of all the sugars were re-calculated to polymeric form. After steam pretreatment, 82% of the hexoses (glucan, mannan and galactan) and 46% of the pentoses (xylan and arabinan) were recovered, based on the data in Tables 1 and 2. Based on the data in Table 2, 93% of the recovered hexoses and 33% of the recovered pentoses

Table 1
Composition of 1 kg stem DM before SP, average of three substrates, analysed by Sipos et al. (2010). The standard deviations (SD) are based on three substrates analysed in duplicate.

	Mass (g)	SD (g)
Glucan	436	5
Mannan	20	3
Xylan	105	5
Galactan	21	1
Arabinan	7	1
Acid-soluble lignin	66	1
Acid-insoluble lignin	149	4
Water extractives	121	
Ethanol extractives	16	
Total	940	

Table 2

Structural carbohydrates, lignin and inhibitors in WIS and liquid after steam pretreatment, expressed per 794 g DM of SP slurry (1 kg initial stem DM). Values for monomers and oligomers are given as sugar monomers while values for polymers are given as polymers. Means of duplicate measurements are given for carbohydrates and lignin. The standard deviation was below 5% for all duplicate measurements.

	WIS, polymers (g)	Liquid, monomers (g)	Liquid, oligomers (g)	Sum (g)
Glucose	318.4	1.8	9.7	329.9
Mannose	23.5	3.0	4.8	31.3
Xylose	15.1	9.6	34.8	59.6
Galactose	3.2	2.3	7.8	13.3
Arabinose	4.9	1.4	0.8	7.1
Acid-soluble lignin	19.5	n.d. ^a	n.d. ^a	19.5
Acid-insoluble lignin	155.7	n.d. ^a	n.d. ^a	155.7
Lactic acid	n.d. ^a	1.5	n.d. ^a	1.5
Acetic acid	n.d. ^a	9.5	n.d. ^a	9.5
HMF	n.d. ^a	0.8	n.d. ^a	0.8
Furfural	n.d. ^a	2.5	n.d. ^a	2.5
Total g				630.6

^a n.d. – not determined.

were found in the WIS (washed solid fraction) and the rest was detected as soluble mono- and oligo-mers in the liquid. Sugar degradation to furfural from pentoses, and HMF from hexoses, was low: 2.5 g furfural and 0.8 g HMF per kg of stem DM. However, this does not take into account possible losses of furfural in the flash vapour. The acid-insoluble lignin was fully recovered in the WIS after steam pretreatment (compare Tables 1 and 2).

Separation of the SP slurry performed in Scenarios G and H gave 80% of the DM in the SP solids and 19% in the SP liquid. All WIS were found in the SP solids. The DM and WIS contents of the SP solids were 41% and 39% of the wet weight, respectively. The SP liquid had a DM content of 3.7%. One-fifth (20%) of the total soluble compounds was found in the SP solids, based on the assumption that soluble compounds were equally distributed in all liquid after steam pretreatment.

3.3. Enzymatic hydrolysis

The conversion of glucan (in WIS) to glucose was 70 ± 2.5% after 72 h of enzymatic hydrolysis of SP slurry (Scenario D). The conversion followed a hyperbolic curve and had declined (67% after 51 h) but not ceased completely. In Scenario D enzymatic hydrolysis was used as a pretreatment step prior to AD, and similar process conditions, apart from enzyme loading, were used as in Scenarios E and F to allow comparison.

3.4. Simultaneous saccharification and fermentation

SSF of SP slurry and SP solids was performed in a previous study (Sipos et al., 2010), and resulted in a higher ethanol yield from SP solids than SP slurry per kg of initial stem DM. The ethanol concentration after SSF of SP slurry was 18.4 g/L, corresponding to 70% of the theoretical ethanol yield of hexoses in SP slurry. The ethanol concentration after SSF of SP solids was 21.3 g/L, corresponding to 86% of theoretical ethanol yield of hexoses in SP solids. The ethanol yields per kg initial hemp stem DM was 148 g/kg for SP slurry and 171 g/kg for SP solids, 55% and 63% of theoretical from hexoses present in the initial material, respectively. The concentrations of HMF (0.16 g/L) and furfural (0.51 g/L) were below the levels reported to inhibit ethanol fermentation (Palmquist and Hahn-Hägerdal, 2000), regardless of this, the fermentation of only SP solids gave a higher fermentation yield than the fermentation of SP slurry, indicating that there might be other inhibitory compounds in the liquid fraction.

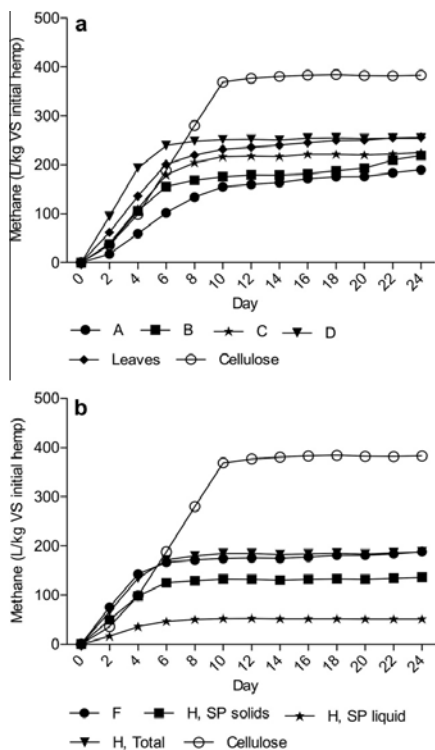

Fig. 2. Methane production as a function of time. The means of triplicate AD runs are given (duplicate for Scenario A). (a) Methane yield from stems in Scenarios A–D, and from leaves and the cellulose control. (b) Methane yield from stems in Scenarios F and H. The methane produced from SP solids and SP liquid in Scenario H is shown separately and as the total. The cellulose control is shown for comparison.

3.5. Distillation

In a full-scale process, distillation can be expected to give an ethanol recovery of above 99%. Under the laboratory-scale experimental conditions used in this study, distillation was less complete (86–88%) and an ethanol residue was left in the stillage: 20 g (2.6 g/L) and 21 g (2.7 g/L) per kg stem DM in Scenarios F and H, respectively. The ethanol remaining in the stillage will contribute to the amount of methane produced by AD. Since a higher ethanol recovery is likely in full-scale operation, the ethanol yield is presented assuming 100% ethanol recovery, and 90% of the theoretical methane yield from ethanol remaining in the stillage was subtracted from the actual methane yield (see Section 3.7 and Fig. 3). The concentrations of acetic acid and lactic acid were measured before and after distillation showing that these compounds were not removed (data not shown).

3.6. Anaerobic digestion

There was no difference in methane yield between 24 days and 30 days of AD in any of the scenarios; therefore, no results are presented after 24 days (Fig. 2). The yield at 24 days is henceforth

called the final yield. The measured standard deviation of the methane yield in the AD batch test varied between 0.3% and 3.6% with an average of 1.1% for the different samples. A statistical comparison of the overall methane yield was not made for samples involving steam pretreatment since the variation in DM decrease during steam pretreatment was not determined.

The methane yield from ground stems (Scenario B) was 219 L per kg VS, which is 15% higher than that from chopped stems (Scenario A), 190 L per kg VS (Fig. 2a). This difference was statistically significant according to a two sample t-test (5% significance level). The methane yield of hemp leaves was 256 L per kg VS, which is significantly higher than that of both chopped and ground stems based on VS (Fig. 2a). However, due to the higher ash content of leaves than stems the yield per g DM was the same for leaves as for ground stems. The total yields from the entire hemp plant were 199 L and 224 L per kg VS in Scenarios A and B, respectively. Both these values for dry hemp fall within the 95% confidence interval for the yield from fresh frozen hemp, including stems and leaves, obtained in a previous study: 199–269 L per kg VS, 80% of particles being 1–4 mm, (Kreuger et al., 2010).

The methane yield from SP slurry (Scenario C) was 225 L per kg VS, which is similar to that from ground stems (Fig. 2a). However, it should be borne in mind that the yields are based on initial hemp VS. The VS of the SP slurry added to AD tests was less than for chopped and ground stems due to the DM decrease during steam pretreatment. Hotlzapple et al. (1989) reported that steam pretreatment demands less energy than mechanical comminution to achieve the same particle size reduction.

After 10 days of AD all the SP fractions (Scenarios C, D, F and H) had reached 93–100% of the final yield, while the stems that were directly subjected to AD (Scenarios A and B) had only reached 80% of the final yield (Fig. 2). The steam pretreatment thus increased the degradation rate.

The methane production rate from EH SP slurry, Scenario D, seems higher than for SP slurry, Scenario C in Fig. 2a, but when taking the time used for enzymatic hydrolysis into account 96–97% of the final methane yield was achieved after about 10 days in both scenarios. Fig. 2a also shows that the final methane yield was higher for EH SP slurry (Scenario D) than for SP slurry (Scenario C), but the contribution of the carbon source from the enzymes added during enzymatic hydrolysis should also be considered. The enzyme solutions, yeast and yeast extract all contain carbon sources that can be converted to methane in Scenarios D, F and H, as is further discussed in Section 3.7. If these carbon sources were quickly converted to methane they could also have increased the initial methane production rate. The methane yields shown in Fig. 2 include the contributions from enzymes, yeast and yeast extract, while in Fig. 3, the estimated contributions of these are shown separately from that of hemp.

The cellulose control reached 92% (383 L per kg VS) of the theoretical yield of cellulose (415 L per kg VS), showing that the inoculum had cellulolytic activity for crystalline cellulose.

3.7. Yield of transportation fuels

As can be seen in Fig. 3, the energy yield, based on the HHV of methane and ethanol, was found to correspond to between 40% and 52% of the total energy (HHV) of the dry hemp (including stems and leaves). Leaves were used for methane production in all scenarios except E and G. A slightly higher ethanol yield (and lower methane yield) could have been obtained in Scenarios F and H if the leaves had also been used for ethanol production.

When the degree of conversion of the energy in the substrate to energy carriers is shown, as in Fig. 3, the contribution to methane from additives such as enzymes and yeast should be subtracted. In

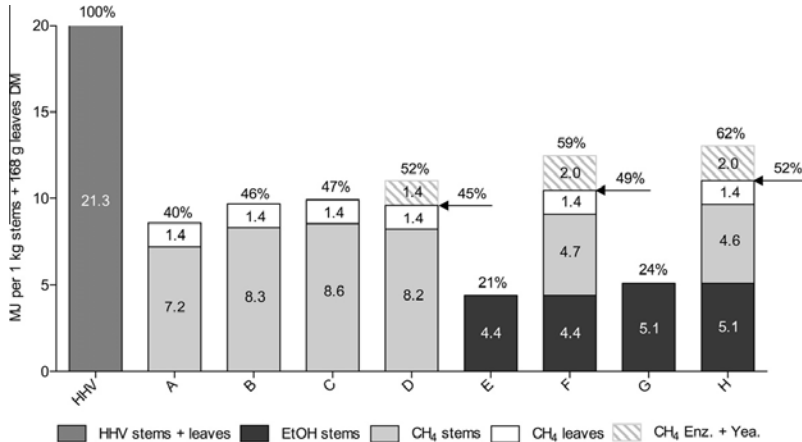

Fig. 3. Energy yield in Scenarios A to H from 1 kg stems plus 168 g leaves DM, expressed as the HHV of ethanol (EtOH) and methane (CH₄) together with the HHV of hemp biomass. The hatched part represents the part of the methane assumed to be produced from the degradation of added enzymes (Scenario D) or added enzymes, yeast and yeast extract (Scenarios F and H).

Scenarios D, F and H, 90% of the theoretical methane yield from enzymes, yeast and yeast extract (shown as hatched bars in Fig. 3) has been subtracted from the methane produced. The theoretical methane yields were based on the COD concentrations of the materials. If not otherwise stated, the yields discussed below refer to those after the subtraction. A calculation example for Scenario H is presented in Appendix A.

The energy yields for SP slurry (Scenario C) and EH SP slurry (Scenario D) were similar. As mentioned in Section 3.6, the total time for conversion including enzymatic hydrolysis and AD was similar in the two scenarios. This implies that the cellulolytic activity of the mixed culture used for AD was high, and the cellulolytic step was unnecessary when using the substrate solely for methane production.

In a previous study, the ethanol yield of SP solids was found to be higher than that following SSF of SP slurry (Sipos et al., 2010) (data from this reference are shown for Scenarios E (SP slurry) and G (SP solids) as well as the ethanol part in Scenarios F and H). The reason for the higher yield from SP solid than SP slurry could be reduced exposure of the yeast to inhibiting compounds in the liquid, as suggested by Sipos et al. (2010).

The co-production of ethanol and methane from steam pretreated hemp stems gave about twice the energy yield than of ethanol production alone, both in Scenario F compared to Scenario E and in Scenario H compared to Scenario G. The total energy yield was higher in Scenario H than in Scenario F. Co-production also gave a higher energy yield than methane production alone (Scenario C). The differences in total energy yield in Scenario C, F and H are small however and are likely to fall within the experimental error.

Co-production was even more beneficial when considering the practical yield without subtracting the potential contribution of methane from enzymes, yeast and yeast extract (including hatched bars in Fig. 3). Co-production from the whole hemp plant would give 2600–3000 L ethanol and 2800–2900 m³ methane, in total 171–180 GJ per 10,000 m² of agricultural land, based on a hemp biomass yield of 16 Mg DM. Of this, the yeast and enzymes from ethanol production were estimated to contribute 700 m³ (27 GJ) of methane.

Lignin residues can be used for heat or heat and power generation. The acid-insoluble (polymeric) lignin of the stems was fully recovered after steam pretreatment and can probably be recovered after both ethanol production and AD since it is poorly degraded, if at all, under anaerobic conditions (Zehnder, 1988). With a HHV of solid lignin of 29.5 MJ/kg (Groode and Heywood, 2008) the acid-insoluble lignin represents around 24% of the HHV of the hemp DM, based on the approximation that the lignin content of the

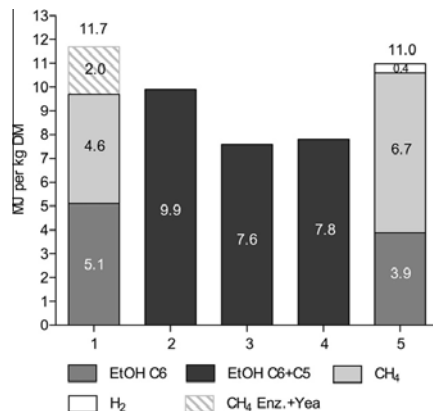

Fig. 4. Yields of transportation fuels (in MJ) after bioconversion of different lignocellulosic substrates, shown as the HHV of the fuels per kg of plant DM. Bar 1: The energy yield from hemp stem DM in Scenario H in the present study. Bar 2: The potential yield, (i.e. 90% of the theoretical ethanol yield) from hexoses and pentoses in hemp stems. Bar 3: The ethanol yield from hexoses and pentoses in corn stover, from Ohgren et al. (2005). Bar 4: The ethanol yield from hexoses and pentoses in Salix, from Sassner et al. (2006). Bar 5: The combined ethanol, hydrogen and methane production from hydrothermally pretreated wheat straw, from Kaparaju et al. (2009). Abbreviations: EtOH C6 = ethanol from hexoses, EtOH C6 + C5 = ethanol from hexoses and pentoses, CH₄ Enz. + Yea. = see legend Fig. 3.

stems represents the lignin content of stems and leaves. Sassner et al. (2008) estimated that steam generation from 34–40% of the solid substrate after hexose and pentose fermentation of corn stover and *Salix* could cover the heat demand for the entire process including SP, distillation, drying of separated solids, etc.

The energy yield of the transportation fuels together with the HHV of the solid lignin accounts for roughly 73–78% of the HHV of the original substrate, indicating that it may be possible to increase the yield of transportation fuel even more, for instance, by condensing and using the flash stream from steam pretreatment for AD.

3.8. Transportation fuel yield from different lignocellulosic materials

As can be seen in Fig. 4, the practical energy yield of combined ethanol and methane production (including the losses in the experiments presented in this article) is similar to the potential ethanol yield (calculated) from both pentoses and hexoses in hemp stems in a process without any losses (bars 1 and 2). Since other compounds than sugars can be utilised in AD the potential energy yield of combined production is higher than the potential energy yield of ethanol from pentoses and hexoses. The high energy output from combined ethanol and methane production is also seen when comparing Scenario H with ethanol production from pentoses and hexoses of other steam pretreated lignocellulosic substrates such as corn stover and *Salix* (compare bar 1 with bars 3 and 4). The ethanol yield of corn stover is calculated based on practical sugar yield after steam pretreatment and enzymatic hydrolysis (Öhgren et al., 2005). The ethanol yield of *Salix* is based on the practical yield from fermentation of hexoses plus an estimated ethanol yield from pentoses (Sassner et al., 2006).

Bar 5 shows the practical results of combined ethanol, methane and hydrogen production from hydrothermally treated wheat straw (Kaparaju et al., 2009). In that study the potential methane production from enzymes and yeast was not subtracted and, therefore, the yield of transportation fuel, 11 MJ/kg DM, should be compared with the energy yield in Scenario H including the potential methane yield from enzymes and yeast; 11.7 MJ/kg stem DM (bar 1 including the hatched part). This comparison shows the importance of considering the energy potential of organic additives when expressing and comparing energy outputs per kg of plant substrate.

4. Conclusions

The co-production of ethanol and methane from steam pretreated hemp stems gave more than twice the energy yield of transportation fuel than ethanol production from hexoses alone. One of the benefits of co-production is that enzymes and yeast added during ethanol production can be converted to methane.

Steam pretreatment resulted in a higher methane production rate than mechanical grinding. It was found unnecessary to pre-hydrolyse the steam pretreated substrate with cellulases when using it solely for methane production.

This study provides practical data needed for evaluation of which production pathways are the most beneficial from energy balance and economic perspectives.

Acknowledgements

The Environmental Fund of Region Skåne, The Swedish Research Council for Environment, Agricultural Sciences and Spatial Planning and the Hungarian National Research Fund (OTKA – K 72710) are kindly acknowledged for their financial support. Enzymes were kindly donated by Novozymes A/S (Bagsværd,

Denmark). Thanks also to Thomas Prade at the Swedish University of Agricultural Sciences for providing the hemp.

Appendix A. Supplementary data

Supplementary data associated with this article can be found, in the online version, at doi:10.1016/j.biortech.2010.10.126.

References

- Anderson, W.F., Akin, D.E., 2008. Structural and chemical properties of grass lignocelluloses related to conversion for biofuels. *J. Ind. Microbiol. Biotechnol.* 35 (5), 355–366.
- APHA, 1995. Standard Methods for the Examination of Water and Wastewater, 19th ed. American Public Health Association/American Water Works Association/Environment Federation, Washington, DC.
- Berghem, L.E.R., Pettersson, G., 1974. Mechanism of enzymatic cellulose degradation – isolation and some properties of a beta-glucosidase from *Trichoderma viride*. *Eur. J. Biochem.* 46 (2), 295–305.
- Bernesson, S., Nilsson, D., Hansson, P.A., 2006. A limited LCA comparing large- and small-scale production of ethanol for heavy engines under Swedish conditions. *Biomass Bioenerg.* 30 (1), 46–57.
- Börjesson, P., Mattiasson, B., 2008. Biogas as a resource-efficient vehicle fuel. *Trends Biotechnol.* 26 (1), 7–13.
- Cappelletto, P., Brizzi, M., Mongardini, F., Barberi, B., Sannibale, M., Nenci, G., Poli, M., Corsi, G., Grassi, G., Pasini, P., 2001. Italy-grown hemp: yield, composition and cannabinoid content. *Industr. Crops Prod.* 13 (2), 101–113.
- Finell, M., Xiong, S., Olsson, R., 2006. Multifunktionell industrihampa för norra Sverige (multifunctional industrial hemp for Northern Sweden). Unit for Biomass Technology and Chemistry, Swedish University of Agricultural Sciences, Umeå, Sweden. BTK-rapport 2006:13, Swedish.
- Ghose, T.K., 1987. Measurement of cellulase activities. *Pure Appl. Chem.* 59 (2), 257–268.
- Groode, T., Heywood, J.B., 2008. Biomass to ethanol: potential production and environmental impacts. MIT Laboratory for Energy and the Environment, Cambridge, Massachusetts. LFEF 2008-02 RP.
- Hansen, T.L., Schmidt, J.E., Angelidaki, I., Marca, E., Jansen, J.L., Mosbaek, H., Christensen, T.H., 2004. Method for determination of methane potentials of solid organic waste. *Waste Manage.* 24 (4), 393–400.
- Hendriks, A., Zeeman, G., 2009. Pretreatments to enhance the digestibility of lignocellulosic biomass. *Bioresour. Technol.* 100 (1), 10–18.
- Holtzapfel, M.T., Humphrey, A.E., Taylor, J.D., 1989. Energy-requirements for the size-reduction of poplar and aspen wood. *Biotechnol. Bioeng.* 33 (2), 207–210.
- Kaparaju, P., Serrano, M., Thomsen, A.B., Kongjan, P., Angelidaki, I., 2009. Bioethanol, biogas and biogas production from wheat straw in a biorefinery concept. *Bioresour. Technol.* 100 (9), 2562–2568.
- Kreuger, E., Prade, T., Escobar, F., Svensson, S.-E., Englund, J.-E., Björnsson, L., 2010. Anaerobic digestion of industrial hemp – effect of harvest time on methane energy yield per hectare. *Biomass Bioenerg.* doi:10.1016/j.biombio.2010.11.005.
- Macedo, I.C., Seabra, J.E.A., Silva, J., 2008. Green house gases emissions in the production and use of ethanol from sugarcane in Brazil: the 2005/2006 averages and a prediction for 2020. *Biomass Bioenerg.* 32 (7), 582–595.
- McDonald, R.L., Fargione, J., Kiesecker, J., Miller, W.M., Powell, J., 2009. Energy sprawl or energy efficiency: climate policy impacts on natural habitat for the United States of America. *PLoS One* 4 (8).
- Olofsson, K., Bertilsson, M., Lidén, G., 2008. A short review on SSF – an interesting process option for ethanol production from lignocellulosic feedstocks. *Biotechnol. Biofuels* 1 (7), 1–14.
- Palmqvist, E., Hahn-Hägerdal, B., 2000. Fermentation of lignocellulosic hydrolysates. II: inhibitors and mechanisms of inhibition. *Biore. Technol.* 74, 25–33.
- Parawira, W., Read, J.S., Mattiasson, B., Björnsson, L., 2008. Energy production from agricultural residues: high methane yields in pilot-scale two-stage anaerobic digestion. *Biomass Bioenerg.* 32 (1), 44–50.
- Peel, M.C., Finlayson, B.L., McMahon, T.A., 2007. Updated world map of the Köppen–Geiger climate classification. *Hydrol. Earth Sys. Sci.* 11 (5), 1633–1644.
- Porter, M.G., Murray, R.S., 2001. The volatility of components of grass silage on oven drying and the inter-relationship between dry-matter content estimated by different analytical methods. *Grass Forage Sci.* 56 (4), 405–411.
- Prade, T., Svensson, S.-E., Mattsson, J.-E., Unpublished results. Biomass and energy yield of industrial hemp grown for biogas and solid fuel. Submitted to *Biomass Bioenerg.*
- Sassner, P., Galbe, M., Zacchi, G., 2006. Bioethanol production based on simultaneous saccharification and fermentation of steam-pretreated *Salix* at high dry-matter content. *Enzyme Microb. Technol.* 39 (4), 756–762.
- Sassner, P., Galbe, M., Zacchi, G., 2008. Techno-economic evaluation of bioethanol production from three different lignocellulosic materials. *Biomass Bioenerg.* 32 (5), 422–430.
- Sipos, B., Kreuger, E., Svensson, S.-E., Récezy, K., Björnsson, L., Guido, Z., 2010. Steam pretreatment of dry and ensiled industrial hemp for ethanol production. *Biomass Bioenerg.* 34 (12), 1721–1731.

- Sluiter, A., Ruiz, R., Scarlata, C., Sluiter, J., Templeton, D. 2008a. Determination of Extractives in Biomass. National Renewable Energy Laboratory, Midwest Research Institute, Golden, CO. NREL/TP-510-42619.
- Sluiter, A., Hames, B., Ruiz, R., Scarlata, C., Sluiter, J., Templeton, D., Crocker, D. 2008b. Determination of Structural Carbohydrates and Lignin in Biomass. National Renewable Energy Laboratory, Midwest Research Institute, Golden, CO. NREL/TP-510-42618.
- Sluiter, A., Hames, B., Ruiz, R., Scarlata, C., Sluiter, J., Templeton, D. 2008c. Determination of Sugars, By-products, and Degradation Products in Liquid Fraction Process Samples. National Renewable Energy Laboratory, Midwest Research Institute, Golden, CO. NREL/TP-510-42623.
- Struik, P.C., Amaducci, S., Bullard, M.J., Stutterheim, N.C., Venturi, G., Cromack, H.T.H., 2000. Agronomy of fibre hemp (*Cannabis sativa* L.) in Europe. *Indust. Crops Prod.* 11 (2–3), 107–118.
- Sun, Y., Cheng, J.Y., 2002. Hydrolysis of lignocellulosic materials for ethanol production: a review. *Bioresour. Technol.* 83 (1), 1–11.
- van der Werf, H.M.G., van Geel, W.C.A., Wijlhuizen, M., 1995. Agronomic research on hemp (*Cannabis sativa* L.) in The Netherlands, 1987–1993. *J. Int. Hemp Assoc.* 2 (1), 14–17.
- van der Werf, H.M.G., 2004. Life Cycle Analysis of field production of fibre hemp, the effect of production practices on environmental impacts. *Euphytica* 140 (1–2), 13–23.
- Zehnder, A.B.J. 1988. *Biology of Anaerobic Microorganisms*. John Wiley and Sons Inc.
- Öhgren, K., Galbe, M., Zacchi, G., 2005. Optimization of steam pretreatment of SO₂-impregnated corn stover for fuel ethanol production. *Appl. Biochem. Biotechnol.* 121, 1055–1067.

Effects of steam pretreatment and co-production with ethanol on the energy efficiency and process economics of combined biogas, heat and electricity production from industrial hemp

Zsolt Barta^{1*}, Emma Kreuger², Lovisa Björnsson²

¹ Budapest University of Technology and Economy, Department of Applied Biotechnology, Ballagi Mór street 3, 2/17, 1115 Budapest, Hungary

² Lund University, Biotechnology, P.O. Box 124, SE-221 00 Lund, Sweden

*Corresponding author

Abstract

Background

For the production of transportation fuels the European Energy Agency has identified industrial hemp (*Cannabis sativa* L.) as one of the energy crops that have lower environmental impacts than the crops used currently. In the south of Sweden, the biofuel yield (methane or ethanol and methane) per hectare from hemp is higher than that of the nationally dominating biofuel productions based on seeds from wheat, *Triticale* and rapeseed. In the current study techno-economic evaluations of large-scale hemp-based processes are carried out using the commercial flow-sheeting program Aspen PlusTM. In scenario 1 and 2 co-production of biogas, district heat and power production from chopped and steam pretreated hemp, respectively, were analyzed. In scenario 3 co-production of ethanol, biogas, heat and power based on steam pretreated hemp was analyzed. The analyses include the assessments of heat demand, energy efficiency and process economics.

Results

The highest overall energy efficiency (84% of the theoretical, based on lower heating values) is obtained in the case of biogas, heat and power production from chopped hemp providing that district heat is delivered at the maximum capacity. However, without district heating combined ethanol, biogas, heat and power production results in the highest energy efficiency (49%). None of the scenarios are economically viable, since the minimum biogas selling prices (920-1140 Swedish kronor per MWh, corresponding to 103-128 euros per MWh) are estimated to be higher than the market price of biogas (600 Swedish kronor per MWh, corresponding to 67 euros per MWh).

Conclusions

The largest cost contributor is the feedstock cost, and it should be reduced approximately to half to achieve an economically feasible hemp-based process. The importance of residence time in cost reduction is demonstrated by introducing upflow anaerobic sludge blanket reactors to partially replace continuously stirred tank reactor system. The yields and prices of methane and

ethanol are shown to have larger influences on the process economics than the outputs and prices of electricity and district heat.

Background

The use of bioenergy in EU is predicted to increase considerably until year 2030 and the production of energy crops on agricultural land is predicted to play an important role (EEA, 2006). When using biomass for energy purposes the environmental and economic performance are crucial factors. Increased specialization in agriculture has resulted in crop rotations with little crop diversity, which increases the risk for negative environmental impact (EEA, 2006). This study is based on the cultivation conditions in Scania, a county in southern Sweden, a region where 64% of the agricultural land is used for cereals, oil crops and beets (Statistics Sweden, 2010), the crops that also are the most commonly utilized crops in the production of ethanol and biodiesel today. Introduction of other crops for bioenergy purposes would thus be attractive. For the production of fuels for transportation the European Environmental Agency (EEA) has identified some crops that have a lower environmental impact than the dominating crops used in EU today. Among these are perennial grasses, perennial willow and poplar and the annual crop *Cannabis sativa* L. (hemp) (EEA, 2006). Hemp is regarded as having a low environmental impact because it can be successfully cultivated with relatively little nitrogen and without pesticides, it has deep roots, which have a positive influence on soil structure, and increased cultivation would increase crop diversity (Amaducci et al., 2008; EEA, 2006; Prade et al., 2011; van der Werf, 2004; van der Werf, 1995).

Hemp has relatively high biomass yield in the south of Sweden as well as in other parts of Europe (Cappelletto et al., 2001; Pahkala, 2008; Prade et al., 2011; Struik et al., 2000). Hemp has a high content of lignocelluloses (Sipos et al., 2010a). Therefore, pretreatment need to be used prior to enzymatic hydrolysis with cellulases and ethanol fermentation with yeast. Sipos et al. (2010a) optimised SO₂ catalysed steam pretreatment of hemp for ethanol production. In a subsequent study the residues after ethanol production were used for biogas (methane and carbon dioxide) production through anaerobic digestion (AD) and the methane potential upon direct AD was determined for steam pretreated hemp. The methane yield was also determined for chopped and ground hemp and a few other variants (Kreuger et al., 2011b). For biogas production harsher pretreatment than chopping or a rough grinding is not a prerequisite (Kreuger et al., 2011a). However, a higher yield was shown after acid catalysed steam pretreatment than after chopping (Kreuger et al., 2011b). Sipos et al. (2010a) and Kreuger et al. (2011b) showed that approximately half of the energy of the biomass could be converted to biogas or ethanol and biogas. However, evaluations of the energy demands of the conversion processes and economic performances have not yet been reported.

Energy balances and economic evaluations for the conversion of biomass to biofuels are for AD of crops in general made for relatively small plants based on less than 10 000 t DM per year (Borjesson & Tufvesson, 2011; Smyth et al., 2010; Walla & Schneeberger, 2008). Walla and Schneeberger (2008) show that the economically most feasible size for AD in Austria is for 250 kW electricity plant size (around 1 500 t DM/year), due to directed subventions up to this size. Ethanol production on the other hand is generally analysed for large plants with more than 100 000 t DM/year (Barta et al., 2010c; Lee et al., 2011; Lohrasbi et al., 2010; Sassner et al., 2008; Shafiei et al., 2011). The energetic and economic performance of ethanol and biogas production

is therefore frequently compared with a difference in plant size of 10 to 100 times (Borjesson & Tufvesson, 2011; McEniry et al., 2011). The economical performances of biomass-based processes are in several analyses reported to be better for larger plants (Lohrasbi et al., 2010; Nguyen & Prince, 1996; Shafiei et al., 2011). Recently several analyses on the energy balance and economic performance of AD from the residues after ethanol production has been analysed for large plants and show promising results (Barta et al., 2010c; Lee et al., 2011; Lohrasbi et al., 2010; Shafiei et al., 2011). However, analyses for AD in large scale without ethanol production are to the best of our knowledge still lacking.

In the current study a techno-economic evaluation of a large scale plant using 234 000 t DM hemp per year was evaluated for three scenarios based on experimental data from Sipos et al. (2010a) and Kreuger et al. (2011b): 1. Chopped hemp for biogas production; 2. Steam pretreated hemp for biogas production; 3. Steam pretreated hemp for combined ethanol and biogas production. For all three scenarios the un-degraded material after biogas production was used for combined heat and power production (CHP). The methodology for the analysis is similar to that of Barta et al (Barta et al., 2010c) for the ethanol part while more detailed input data are used for the AD part of the present paper.

The aims of the current study are

1. To determine if the higher biogas yield from steam pretreated hemp than chopped hemp results in a better energy balance and economic result.
2. To determine if combined ethanol and biogas production performs better than biogas production alone in terms of energy balance and economic result.
3. To determine if it is economically feasible to produce biofuels from hemp.

Methods

General process data and feedstock composition

The modelled plants referred to as Scenarios below are assumed to be located in the County of Scania, Sweden, and process 234 000 t of hemp dry matter annually (200 000 t of stems and the corresponding amount of leaves). Feedstock composition and experimental yields for steam pretreatment, simultaneous saccharification and fermentation, and anaerobic digestion were reported in recent publications (Kreuger et al., 2011a; Nges et al., 2012; Sipos et al., 2010a). Some additional analyses have also been made for this study. All analyses refer to cultivar Futura 75 cultivated 55° north, 13° east and harvested in September. The feedstock composition is summarized in Table 0.

Scenario AD – Direct anaerobic digestion

Anaerobic digestion of chopped hemp is carried out in continuously stirred tank reactor (CSTR) system at 37°C, with a total average hydraulic retention time (HRT) of 30 days. Chopped hemp with a dry matter content of 30% (Kreuger et al., 2011a) is diluted with water before being fed to the first four reactors so that the DM concentration at the end of anaerobic digestion (in the effluent of the final reactor) is 10% (Figure 1A). The CSTR system is composed of identical

reactors of maximum total volume of 10 000 m³ (the working/total volume ratio is 0.85) and height-to-diameter ratio of 1.5. The reactors are arranged in blocks, which consist of five reactors. Four reactors are connected in parallel, and the effluents thereof are mixed and fed to the fifth reactor. Based on this arrangement the retention time in the first four reactors is 24 days, while in the fifth reactor it is 6 days. Serial digestion was chosen based on results from Kaparaju et al. (2009). After taking into account the N and P present in the feedstock urea (CO(NH₂)₂) and ammonium phosphate ((NH₄)H₂PO₄) are added to adjust C/N and C/P ratios in AD to 20 and 100, respectively. Trace metals in the form of FeSO₄·H₂O, NiCl₂ and CoSO₄·7H₂O are added beside the metal contents of the plant to achieve concentrations of 100, 0.2 and 0.5 mg/L, respectively, in AD based on Gustavsson et al. (2011). Power demands of feeding and stirring are 1.9 kWh/kg wet hemp (Läckeby Water Group, 2012) and 10 kWh/m³ slurry (Dachs & Rehm, 2006), respectively. The digesters are not insulated and the overall heat loss is assumed to be 170 W/m² (through the basement and the wall below the liquid level) (Svahn, 2006).

Table 0 Composition, macronutrient (N, P) and trace metal (Fe, Ni, Co) contents of hemp stems and leaves used in the model.

		Stems	Reference	Leaves	Reference
Glucan	% of DM	43.6	(Sipos et al., 2010a)	21.4	(Kreuger et al., 2011a)
Mannan	% of DM	1.9	(Sipos et al., 2010a)	1.8	(Kreuger et al., 2011a)
Galactan	% of DM	2.0	(Sipos et al., 2010a)	3.4	(Kreuger et al., 2011a)
Xylan	% of DM	10.5	(Sipos et al., 2010a)	2.2	(Kreuger et al., 2011a)
Arabinan	% of DM	0.6	(Sipos et al., 2010a)	2.3	(Kreuger et al., 2011a)
Acetate	% of DM	2.3	(Sipos et al., 2010a)	- ¹	
Lignin	% of DM	21.5	(Sipos et al., 2010a)	- ¹	
Proteins	% of DM	3.0	This study ⁴	19.2	This study ⁴
Lipids	% of DM	1.8	This study ³	- ¹	
Volatile extractives	% of DM	1.8	(Sipos et al., 2010a)	- ¹	
Non-volatile extractives	% of DM	7.2	(Sipos et al., 2010a)	38.3	Kreuger et al., 2011a)
Others	% of DM	3.6	(Sipos et al., 2010a)	11.4	Kreuger et al., 2011a)
Total N	g/kg DM	5.0	This study ⁴	35.0	This study ⁴
P	g/kg DM	2.7	This study ⁴	5.0	This study ⁴
Fe	mg/kg DM	86.7 ²			
Ni	mg/kg DM	1.2 ²			
Co	mg/kg DM	0.1 ²			

DM: dry matter

¹ It is not determined for leaves, therefore it is considered to be zero in the model

² It is determined for the whole plant (Nges et al., 2012).

³ Determined for whole plant as raw lipids.

⁴ Determined according to methods in (Nges et al., 2012). The protein content is based on the nitrogen content.

The model of anaerobic digestion is based on the following stoichiometric reactions: hydrolysis of polysaccharides into monomeric sugars, sludge formation and biogas production. Sludge and biogas are produced from the degradable compounds (assumed degradation factors are given in parenthesis): sugars, proteins, lipids, acetic acid (1.00) and extractives (0.25). Hence, part of the

extractives together with the lignin and others is considered to be inert in terms of anaerobic digestion. Ten percent of the degraded amount of each compound is assumed to form sludge, whereas 90% is converted into biogas. Uniform hydrolysis conversion is assumed for all polysaccharides, therefore it can be explicitly calculated from the experimental methane yield.

The entire amount of biogas is upgraded by applying amine absorption technology of CAPure (Läckeby Water Group, 2012) (Figure 1A). This technology guarantees a methane recovery of >99.9% and a methane purity of 99.3%. The upgraded biogas produced is assumed to be injected to main stem of Swedish natural gas grid, therefore its pressure has to be increased to 28 bar. Heat and power demands of upgrading are 0.5 and 0.17 kWh/Nm³ raw biogas, respectively. The heat has to be supplied at least as low-pressure steam (>3.5 bar), and 75% of the heat required can be recovered as 60°C hot water.

The effluent of anaerobic digestion is separated by filter pressing resulting in a solid fraction with a DM concentration of 40% and a solid retention of 99% (Figure 1A). The liquid fraction is subjected to wastewater treatment, whose effluent is regarded as clean water and can be used for dilution in the process. Wastewater treatment is not included in the process model, only the total cost thereof is estimated in the economic evaluation. The solid fraction is incinerated on site to generate steam and electricity. The CHP step is described elsewhere (Barta et al., 2010c). District heat is produced by using the heat of flue-gas condensation and the heat available in the steam cycle. Detailed description of the assumed Swedish district heating system is reported by Sassner and Zacchi (2008).

Scenario SP-AD – Steam pretreatment prior to anaerobic digestion

The process model of steam pretreatment is reported by Sassner et al. (2008). Based on the work of Sipos et al. (2010a) the steam pretreatment of chopped hemp stems is performed at 210°C, for 5 min and by adding 2% SO₂ catalyst (conversion factors for some reactions: glucan to glucose 0.002, xylan to xylose 0.084, xylan to furfural 0.221, water-insoluble lignin to water-soluble lignin 0.100). The steam pretreated slurry together with the condensed flash vapours of pretreatment and the chopped leaves is subjected to anaerobic digestion (Figure 1B), which is implemented in the same way as in Scenario AD (the assumed degradation factor of furfural, hydroxymethylfurfural is 0.9, while soluble lignin is considered to be inert). During pretreatment oligosaccharides are released, and in anaerobic digestion they are entirely converted into biogas and sludge. The biogas upgrading and the effluent processing are identical with those described in Scenario AD.

Scenarios AD-R and SP-AD-R – Recycling of the liquid fraction of anaerobic digestion effluent

Part of the liquid fraction is recycled and used as diluting stream prior to anaerobic digestion instead of water (Figures 1A and 1B). The conversion factors are assumed to be the same as in the corresponding scenarios without recycling, since experimental methane yields have not been determined yet in the case of recycling. Recycling of macronutrients is taken into account with the following residual concentrations: N 5 mg/L, P 2 mg/L.

Scenarios Et-AD and Et-AD+ –Ethanol process and anaerobic digestion

After steam pretreatment the pretreated slurry is filter pressed (Figure 1C). The solid fraction, which contains 30% water-insoluble solid (WIS), is subjected to simultaneous saccharification

and fermentation (SSF) performed at 7.5% WIS and 37°C with ordinary baker's yeast at a concentration of 3 g/L and an enzyme dosage of 20 FPU (filter paper unit)/g glucan. It takes place in 18 agitated non-sterile fermentors with a volume of 930 m³ each. Yeast is cultivated on part of the liquid fraction of pretreated slurry, supplemented with molasses, while enzymes are purchased.

The ethanol concentration obtained after SSF is 2.1 wt-%. Distillation and molecular sieve adsorption are used to produce pure (99.8 wt-%) ethanol. The distillation step consists of two stripper columns and a rectifier, which are heat integrated by operating at different pressures. Ethanol recovery is assumed to be 99.5% in each column. Detailed description of the distillation system can be found in the literature (Wingren et al., 2008).

The stillage together with the liquid fraction not used for yeast propagation and the condensed flash vapours is subjected to anaerobic digestion. Mixing the three streams results in low DM concentration (5.9%), therefore two subscenarios were developed. In Scenario Et-AD the mixed stream is digested anaerobically in CSTRs (Figure 2A), while in Scenario Et-AD+ the stillage is separated by filter pressing, and the thick stillage together with the chopped leaves is treated in CSTRs (Figure 2B). The separation is carried out so that the DM concentration of the effluent of final CSTRs is 10%. The thin stillage, the condensed flash vapours and the liquid fraction of pretreated slurry are fed to one upflow anaerobic sludge blanket (UASB) reactor with residence time of 3 h, upflow velocity of 5 m/h, volume of 790 m³, thereafter the stream is split to 5 parallel second stage UASB reactors each with a volume of 1740 m³, residence time of 33 h, upflow velocity of 1 m/h, m³ based on (Tiwari et al., 2005; Torry-Smith et al, 2003; van Lier et al., 2001). Anaerobic digestion is modelled in the same way as in Scenario SP-AD (the assumed degradation factor of the components associated with SSF such as enzyme, yeast, ethanol, glycerol, succinic acid is 1).

Filter pressing is performed to separate the solid and liquid fractions of the effluent of CSTRs, however, after the UASB reactors separation is not needed, as the sludge granules remain in the reactor resulting in a liquid effluent, which is subjected to wastewater treatment together with the liquid fraction of CSTR effluent. The process steps of biogas upgrading and CHP based on incinerating the solid fraction of the anaerobic digestion effluent are identical with those described in Scenario AD.

Feedstock supply and cost calculations

The scenario for hemp biomass supply is based on cultivation in Scania, a county with an area of 1 095 000 ha whereof 41% was cultivated in 2010 (Swedish Board of Agriculture & Statistics Sweden, 2011). The hemp biomass yield of this region, based on a normalization of yields from cultivation trials, has been reported as 10.2 t DM/ha (Prade et al., 2011). A 5% DM-loss in the handling and storage is subtracted, resulting in a yield of ensiled hemp of 9.7 t DM/ha. With a biomass demand of 233 600 t DM/year, this gives a needed cultivated land area of 24 107 ha/year. Although the input data of the process model is based on experiments carried out with non-ensiled hemp (Kreuger et al., 2011b; Sipos et al., 2010b), cost of ensiling is included in the feedstock price, as fresh hemp cannot serve as feedstock through the whole year.

The actual average road transport distance was calculated from the theoretical (based on a circle radius) based on Berglund and Börjesson (2003) and Sonesson (1996) and using a factor of 1.3

(Borjesson & Gustavsson, 1996). The transport distance was calculated assuming that 5% of the surrounding agricultural land was used for hemp cultivation, giving an average road transport distance of 56 km. The number of transports was calculated by assuming that in containers loaded to 40 m³ with a density of 0.25 t/m³ and 3 containers per vehicle. This gives 9.6 t DM of fresh hemp per vehicle. The transport was made with an average speed of 60 km/h with empty return. The time for handling (loading 3 containers in field, emptying them in the ensiling area of bioenergy plant and unloading the empty containers in the field) was 30 minutes per transport. The cost for the vehicle (truck with trailer) was 1100 SEK/hour. The cost for transport and handling is then 0.28 SEK/kg DM fresh hemp transported, which after ensiling losses gives 0.30 SEK/kg DM ensiled hemp.

Production cost of hemp could not be found. Instead, production cost for ensiled maize was used as a basis. In an overview of maize as cattle feed under Swedish condition, the production cost for ensiled maize with a yield of 10 and 12 t DM/ha was given as 1.23 and 1.04 SEK/kg DM. This cost includes variable costs in cultivation, harvest and ensiling including labour cost and capital cost in machinery and ensiling (Swensson, 2010). The cost for maize with a DM-yield of 10 t/ha was used, 1.23 SEK/kg DM, and this cost was increased by 10% to account for possible additional costs in hemp cultivation. This gives a production cost for ensiled hemp of 1.35 SEK/t DM. With added transport and handling cost, the total feedstock cost of 1.65 SEK/t DM is used for further calculations.

Methodology of process design and economics

Mass and energy balances were solved using the commercial flowsheeting program Aspen Plus, V7.3 (Aspen Technology, Inc., Cambridge, MA, USA). Data on the physical properties of biomass components such as polysaccharides and lignin were taken from the National Renewable Energy Laboratory database (Wooley & Putsche, 1996). Aspen Process Energy Analyzer V7.3 (Aspen Technology, Inc.) was used to design a near-optimal heat exchanger network and to estimate the capital cost thereof, and the overall heating and cooling demands obtained were fed back to the process model in Aspen Plus. The energy efficiency, based on the lower heating values, is defined as the energy output in the products (ethanol, biogas, electricity and district heat) divided by the energy input comprising raw material (155.2 MW), molasses (7.0 MW), enzymes (9.4 MW) and the fuel equivalent of the electric power requirement, which was calculated using an electricity-to-fuel ratio of 0.4.

The fixed capital investment cost (except for the heat exchanger network) was estimated either with Aspen Economic Process Analyzer V7.3 (Aspen Technology, Inc.) setting 2012 as costing year or by using vendor quotation (in the cases of pretreatment unit, filter presses, dehydration system, CSTR anaerobic digesters including feeding system, steam boiler, flue-gas condenser, biogas upgrading system). The construction material used in the Aspen Economic Process Analyzer was stainless steel of SS304 except for the UASB reactors, which were designed as carbon steel tanks. Working capital was calculated using the recommendation of Peters et al. (2004) with a slight modification (Wingren et al., 2008). The annualised fixed capital cost was determined by multiplying the fixed capital investment by an annualisation factor of 0.110, corresponding to a 15-year depreciation period and an interest rate of 7%. The annualised working capital is the product of working capital investment and interest rate.

All costs are presented in Swedish kronor (SEK, 1 euro \approx 8.9 SEK, 1 United States dollar \approx 6.8 SEK). The prices associated with operation costs and products are summarized in Table 1. Cost of pH adjustment in the process is not estimated, since the acid and/or base demands have not been determined experimentally, and pH calculation is not included in Aspen Plus. However, according to former studies (Barta et al., 2010a; Barta et al., 2010c) the cost of pH adjustment does not contribute to the production cost to a large extent. Other costs comprise labour, insurance and maintenance, and are reported in a previous study (Sassner et al., 2008). Minimum ethanol selling price (MESP) and minimum biogas selling price (MBSP) refer to the break-even point, i.e. at these prices, annual costs and incomes, which do not contain the incomes of ethanol and biogas, respectively, are equal.

Table 1. Prices associated with operational costs and products.

	Price (SEK)	Unit	Reference
Feedstock	1.65	kg DM	-
<u>Chemicals</u>			
Sulphur dioxide	1.5	kg	(Sassner et al., 2008)
Antifoam	20	kg	(Sassner et al., 2008)
(NH ₄)H ₂ PO ₄	1.4	kg	(Chemical market reporter, 2005)
MgSO ₄	4.4	kg	(Sassner et al., 2008)
Molasses	1.0	kg	(Sassner et al., 2008)
Urea	3.0	kg	(Chemical market reporter, 2005)
FeSO ₄ ·H ₂ O	1.1	kg	(Sunivo, 2009)
NiCl ₂	41	kg	(Sunivo, 2009)
CoSO ₄ ·7H ₂ O	67	kg	(Sunivo, 2009)
Cellulase enzymes	28.5	MFPU	(Barta et al., 2010a)
<u>Utilities</u>			
Electricity (cost)	450	MWh	(Sassner & Zacchi, 2008)
Cooling water	0.14	m ³	(Sassner et al., 2008)
Process water	1.40	m ³	(Sassner et al., 2008)
<u>Products</u>			
Ethanol	5.5	L	(Sassner & Zacchi, 2008)
Biogas	600	MWh	(Barta et al., 2010c)
Electricity, spot price	350	MWh	(Sassner & Zacchi, 2008)
Electricity certificate	200	MWh	(Sassner & Zacchi, 2008)
District heating	280	MWh	(Sassner & Zacchi, 2008)
Cost of wastewater treatment	0.5	kg COD	(Barta et al., 2010c)

SEK: Swedish Kronor, DM: dry matter, MFPU: million filter-paper unit, COD: chemical oxygen demand.

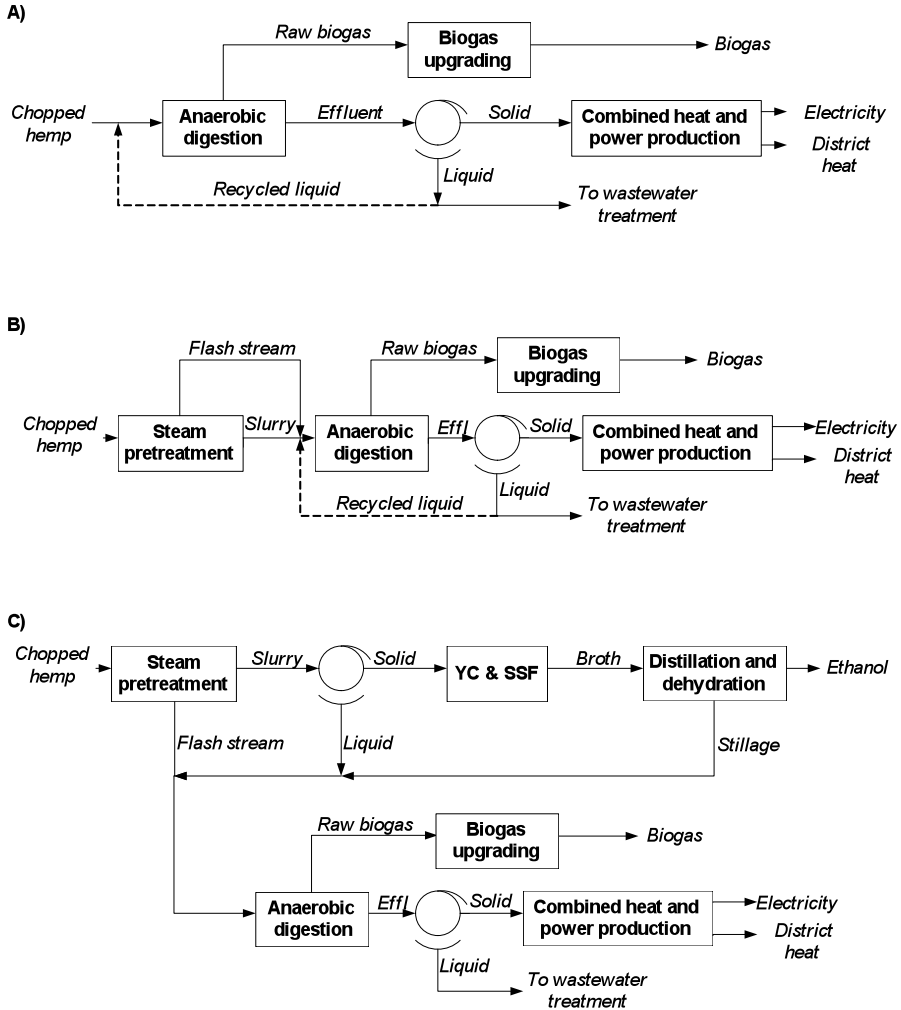

Figure 1

Process schemes of direct anaerobic digestion (Scenarios AD and AD-R, Figure A), steam pretreatment prior to anaerobic digestion (Scenarios SP-AD and SP-AD-R, Figure B) and combined ethanol and biogas production (Scenarios Et-AD and Et-AD+, Figure C). Dashed lines in Figures A and B are present in Scenarios AD-R and SP-AD-R, respectively. In Scenarios AD and SP-AD water is used for dilution (not shown). Effl.: effluent, YC & SSF: yeast cultivation and simultaneous saccharification and fermentation.

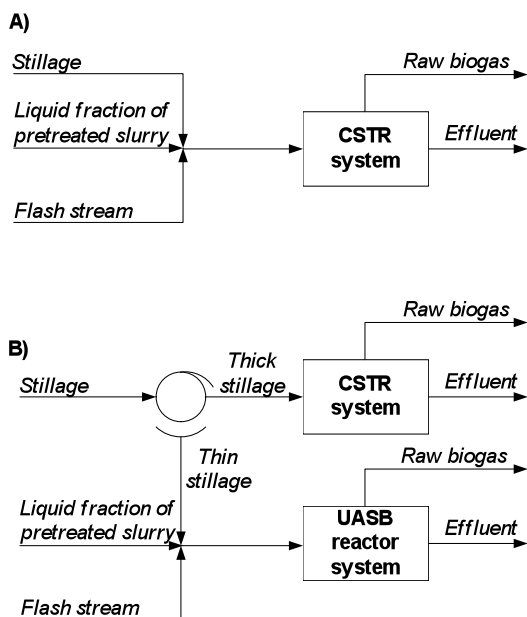

Figure 2

Configurations of anaerobic digestion after ethanol production in Scenarios Et-AD (A) and Et-AD+ (B). CSTR: continuously stirred tank reactor, UASB: upflow anaerobic sludge blanket.

Results and discussion

Process design of anaerobic digestion

According to the model the degradable components are 65-87% of the total (degradable and inert) (Table 2). This ratio is the highest and lowest at the feeds of UASB and CSTR of Scenario Et-AD+, respectively. The recycling increases the mass flows of both the degradable and inert components in the feed of AD (Scenarios AD vs. AD-R and SP-AD vs. SP-AD-R). Although part of the macronutrients is recycled, the increase of macronutrient demands due to the recycled carbon overweighs the amount of recycled macronutrients. The residual trace metal concentrations are assumed to be zero in the liquid phase of AD effluent, hence the recycled amount of the trace metals are zero, i.e. the amounts added prior to AD correspond to the amounts required in AD.

The mass flow of inert components is the same in the feed as in the effluent, while 48-68% of the degradable material is broken down during AD (degradation ratio in Table 2). The components of flash stream are volatile organic substances, hence they are exclusively degradable compounds. Without recycling, the degradable and inert components and the C flow obtained after steam

pretreatment and fed to AD (in Scenario SP-AD) are equal to those fed directly to AD in Scenario AD, since the solid material lost during pretreatment (in the flash stream) is recovered by feeding the flash stream to AD. The equality of C flows results in the same added amounts of macronutrients, as the N and P are entirely recovered after pretreatment, either in the whole slurry, or in the flash stream. However, the addition of trace metals is based on concentration, and the feed of AD after water dilution differs in Scenario SP-AD (168 t/h) and in Scenario AD (198 t/h), therefore less trace metals are added after steam pretreatment (Table 2). The mass flow of feed of direct AD is greater than that of Scenario SP-AD, since the feed dilution is based on DM concentration in AD, and in Scenario SP-AD less DM are fed to AD due to the solid loss in pretreatment. The Ni demand in AD carried out after pretreatment is decreased to such extent that the Ni present in the plant is sufficient, hence extra Ni addition is not required (Table 2). In Scenario Et-AD the added amounts of N and P are the lowest because of the molasses and macronutrients added in the yeast cultivation and SSF steps, respectively. In the case of combined ethanol and biogas production applying both CSTR and UASB systems in AD (Scenario Et-AD+), the overall addition of macronutrients increases compared to Scenario Et-AD due to the distribution of macronutrients between the UASB and CSTR systems. As experimental data of trace metal contents are only available for the feedstock (Table 0), the distribution of trace metals between CSTR and UASB cannot be estimated; hence, the total demands of the two systems are assumed to be the same as those of Scenario Et-AD. In Scenarios AD-R and SP-AD-R 153 and 62 t of liquid fraction per hour, respectively, are recycled. In line with the recycled liquid flows, in the case of AD after pretreatment the degradable material flow, the produced raw biogas and sludge are smaller than those of direct AD (Table 2). As sludge granules are retained in the UASB reactor, the effluent of UASB does not contain sludge.

Overall heat demand and energy output

The overall heat duty can be decreased by means of heat integration to 72, 61 and 30% in the case of direct AD (Scenario AD), steam pretreatment prior to AD (Scenarios AD) and combined ethanol and biogas production (Scenario Et-AD), respectively (calculated from Table 3). Therefore, it can be concluded that the more high-temperature steps (steam pretreatment, distillation) the process contains the more important role the heat integration has. It has to be pointed out that these structures of heat integration are found to be near-optimal in terms of both capital cost and heat demand. At higher extents of integration the increase of capital cost would outweigh the cost reduction effect of decreasing heat demand.

In the case of direct AD without recycling (Scenario AD) 47% of the overall heat duty can be covered by using hot water of 90°C obtained in district heat production. In Scenario AD-R the hot water usage and the overall heat duty decrease (Table 3), since the recycled liquid stream is at the temperature of AD (37°C), and it does not require preheating prior to AD.

At Scenarios SP-AD and SP-AD-R only direct steams injected to steam pretreatment (at 4 and 23 bar) are required from the CHP plant as heating media (Table 3), i.e. the heat losses in AD and the heat demands of biogas upgrading and preheating of the make-up water of the CHP plant can be covered by heat available in the process. At combined scenarios (Et-AD and Et-AD+) 14-15% of the overall heat duty is covered by 4 bar steam used in indirect heating.

Table 2. Details of anaerobic digestion in the various scenarios. A summary of the scenarios is given in Figure 1.

Scenario AD system		AD	AD-R	SP-AD	SP-AD-R	Et-AD	Et-AD+	
		CSTR	CSTR	CSTR	CSTR	CSTR	CSTR	UASB
Degradable components fed¹	t/h	22.6	27.2	22.6	24.3	18.0	10.1	7.9
In main stream ²	t/h	18.7	23.3	17.5	19.2	9.3	6.2	3.1
In leaves	t/h	3.9	3.9	3.9	3.9	3.9	3.9	-
In flash stream	t/h	-	-	1.2	1.2	1.2	-	1.2
In liquid fraction after SP	t/h	-	-	-	-	3.6	-	3.6
Inert components fed⁴	t/h	6.8	7.7	6.8	7.7	6.8	5.6	1.2
In main stream ²	t/h	6.3	7.2	6.3	7.2	5.4	5.1	0.3
In leaves	t/h	0.5	0.5	0.5	0.5	0.5	0.5	-
In flash stream	t/h	-	-	0	0	0	-	0
In liquid fraction after SP	t/h	-	-	-	-	0.9	-	0.9
C flow fed ⁵	t/h	13.2	16.8	13.2	14.8	10.1	4.4	5.6
N added	kg/h	370	533	370	440	67	0	227
P added	kg/h	45.1	80.7	45.1	60.4	0	52.3	0
Fe added	kg/h	17.3	22.0	14.3	16.5	30.1	30.1 ⁶	
Ni added	g/h	4.5	13.8	0	2.9	29.1	29.1 ⁶	
Co added	g/h	97	120	82	93	162	162 ⁶	
Degradation ratio ³	-	0.53	0.48	0.68	0.65	0.66	0.65	0.49
Sludge DM in the effluent	t/h	1.29	1.42	1.55	1.60	1.23	0.67	0
Raw biogas produced	Nm ³ /h	14379	17226	16504	17503	11848	6760	4971

AD: anaerobic digestion, CSTR: continuously stirred tank reactor, UASB: upflow anaerobic sludge blanket, SP: steam pretreatment, DM: dry matter

¹ Refer to carbohydrates, proteins, lipids, extractives, organic acids, ethanol, glycerol, enzymes, yeast, sugar degradation products

² Refers to hemp stems, or steam pretreated hemp stems, or whole stillage, or thin and thick stillages, depending on the scenario. It also includes recycled liquid fraction of AD effluent.

³ Is defined as mass flow of degradable components in the effluent/mass flow of degradable components fed

⁴ Water-insoluble and water-soluble lignin, ashes and other unknown components are considered to be inert

⁵ It also includes carbon flow of the recycled liquid fraction of AD effluent

⁶ As experimental data of trace metal contents are only available for the feedstock (Table 0), the distribution of trace metals between CSTR and UASB cannot be estimated; hence, the total demands of the two systems are assumed to be the same as those of Scenario Et-AD.

While at direct AD scenarios (AD and AD-R) district heat is produced by using heat from flue-gas condensation and steam cycle, in the case of the other scenarios (SP, SP-R, Et-AD and Et-AD+) significant heat duties can be recovered from the process as district heat (Table 3). Recycling increases the generated electricity (comparing Scenarios AD-R vs. AD and SP-AD-R vs. SP-AD in Table 3), as the energy flow to the CHP plant is higher (data not shown). Similarly in the combined scenarios (Et-AD and Et-AD+), less power is generated in Scenario Et-AD+ (Table 3), since only the solid fraction of CSTR effluent is incinerated, the whole effluent of UASB is subjected to wastewater treatment. In all scenarios except Scenario Et-AD, electricity is a co-product. The power requirement of Scenario Et-AD is 48% higher than that of Scenario Et-AD+ (calculated from Table 3). The difference is primarily due to the increased power consumption of pumps and agitators in the AD system. The ethanol (5800 L/h) and biogas productions (5024 Nm³/h) are equal in the Scenarios Et-AD and Et-AD+. As experimental data

are not available for the separate biogas production in CSTR and UASB systems using the distillation stillage of a hemp-based ethanol process, the same overall methane production is assumed as in Scenario Et-AD.

Table 3. Thermal and electrical data and energy flows of products in the various scenarios, expressed in MW. A summary of the scenarios is given in Figure 1.

	AD	AD-R	SP-AD	SP-AD-R	Et-AD	Et-AD+
Heat duty without HI	12.4	10.8	30.3	31.1	73.1	70.0
Heat duty after HI	8.9	6.6	18.4	18.4	21.6	21.3
23 bar steam injected to SP	-	-	13.7	13.7	13.7	13.7
4 bar steam injected to SP	-	-	4.7	4.7	4.7	4.7
4 bar steam, indirect heating	4.7	5.6	-	-	3.2	2.9
90°C hot water	4.2	1.0	-	-	-	-
District heat produced ¹	52.2	56.9	39.9	40.7	22.9	17.9
From FGC	21.2	22.3	16.3	16.6	12.3	9.3
From the process ²	-	-	11.0	11.0	7.0	7.0
From steam cycle	35.2	35.6	12.6	13.2	3.6	1.6
Electricity generated	16.2	16.6	9.3	9.6	6.5	5.5
Electricity sold(+)/purchased(-)	10.9	10.5	4.4	4.2	-1.2	0.3
Biogas (based on LHV)	53.1	63.6	65.9	69.8	50.1	50.1
Ethanol (based on LHV)	-	-	-	-	34.1	34.1

HI: heat integration, SP: steam pretreatment, FGC: flue-gas condensation, LHV: lower heating value

¹ Diminished with the duty of 90°C hot water used for heating the process. It is the maximum capacity; the average capacity through the year can be calculated by applying a factor of 0.56, which corresponds to the following assumption: heat is delivered to the district heating system during a period of time equivalent to 4500 hours of maximum capacity annually. Cooling water is used during the remaining 3500 hours to remove the heat (Sassner & Zacchi, 2008).

² Excluding combined heat and power production

Energy efficiency

The highest overall energy efficiency (84% of the theoretical) is obtained in Scenario AD-R (Figure 3) providing that district heat is delivered at the maximum capacity. However, during summer the district heat delivery is zero, which results that the overall energy efficiency decreases to 41-49%. The highest efficiency without district heating is obtained in the case of combined ethanol and biogas production with separate AD systems (Scenario Et-AD+). Comparing this scenario to the corresponding one of Barta et al. (2010c) (Scenario B), lower overall energy efficiency is obtained in this study. Besides the different feedstock composition and process yields it is due to the lower WIS concentration in SSF (7.5 instead of 10%). Moreover, Barta et al. (2010c) assumed that the aerobic sludge of wastewater treatment is incinerated in the CHP plant, which is not the case in the present study. The higher the heat demand of the process the lower the overall energy efficiency is, since less energy remains in the form of products (Table 3 and Figure 3).

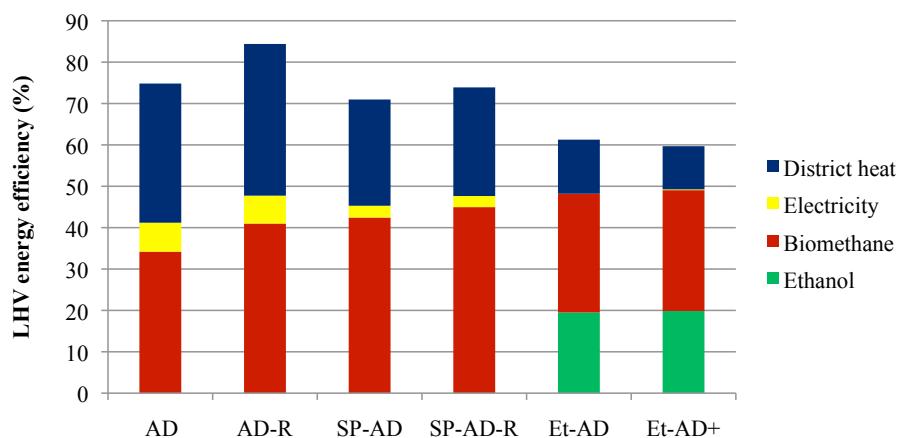

Figure 3

Overall energy efficiency at maximum district heat delivery, based on lower heating values (LHV), expressed as percentage of the input. A summary of the scenarios is given in Figure 1.

Capital investment

The direct costs of pretreatment, SSF, AD and CHP are significant (Table 4). The recycling increases the direct cost of AD, since the increased DM fed requires larger reactor volume. Similarly, higher direct cost is obtained in Scenario AD than in Scenario SP-AD due to the higher DM flow in the case of direct AD. The separate biogas production in CSTR and UASB systems significantly reduces the direct cost of AD, as the shorter residence time in the UASB requires smaller reactor volume. The total indirect costs are higher than the total direct costs in all the scenarios (Table 4). The combined ethanol and biogas production is more capital-intensive than direct AD and steam pretreatment prior to AD. In the case of combined production the total capital investment can be reduced to 83% by applying separate CSTR and UASB reactor systems (Scenario Et-AD+) instead of digesting the whole stillage in CSTR reactors (Scenario Et-AD) (Table 4). However, the capital investment of UASB can be underestimated, as it is based on the tank size and does not include the cost of settlers and patent protected designs. Although the Scenario SP-AD contains an extra process step, namely the steam pretreatment, compared to direct AD, the total capital cost of Scenario SP-AD is found to be lower than that of Scenario AD (Table 4) primarily due to the lower capital costs of AD and CHP.

Annual cash flows

The major cost contributor is the feedstock cost, followed by the capital (Table 5). The difference in chemical cost between Scenarios SP-AD and AD is primarily due to the cost of SO_2 ; the costs of macronutrients are equal, and the costs of trace metals are only 2 and 3% of the total chemical expenses in Scenarios SP-AD and AD, respectively. The separate CSTR and UASB systems in Scenario Et-AD+ increases the chemical expenses by 21%, compared to Scenario Et-AD, due to the increased demand of macronutrients (Table 2), which is a consequence of the unequal distribution of organic materials and macronutrients at separation. In the combined scenarios (Et-

AD and Et-AD+) the enzyme cost contributes to 6-7% of the total expenses. The cost of utilities is negligibly low, since it only contains the cost of cooling water and process water used as make-up water in the CHP plant to produce steam injected directly into steam pretreatment and the cost of electricity purchased in Scenario Et-AD. For dilution prior to AD and SSF process water is not required, as in the model these amounts are covered with water passed through the on-site wastewater treatment. The recycling increases the capital and chemical expenses, however, it significantly reduces the cost of WWT (Table 5). In terms of total cost, Scenarios AD and SP-AD are proved to be identical. The two major incomes are the biogas and the ethanol, while the electricity and the district heat are minor income contributors.

Table 4. Breakdown of the total capital investment cost in million Swedish Kronor. A summary of the scenarios is given in Figure 1.

	AD	AD-R	SP-AD	SP-AD-R	Et-AD	Et-AD+
Feedstock handling	9	9	9	9	9	9
Pretreatment	-	-	115	115	115	115
YC&SSF	-	-	-	-	123	123
Distillation	-	-	-	-	30	30
Anaerobic digestion	228	283	174	215	356	141
Separation	37	42	30	30	59	79
Combined heat and power production ¹	154	157	124	125	104	97
Storage	3	3	9	9	25	25
Heat exchanger network	3	3	8	9	34	37
Total direct cost	433	497	470	513	857	657
Total indirect cost	714	762	580	612	903	793
Fixed capital ²	1148	1259	1050	1125	1760	1450
Working capital	13	13	13	13	32	33
Total capital investment ³	1160	1272	1063	1138	1792	1483

YC: yeast cultivation, SSF: simultaneous saccharification and fermentation

¹ Includes the flue-gas condenser

² Sum of total direct and indirect costs

³ Sum of fixed and working capitals

The option of storing the liquid fraction of AD effluent for fertiliser purpose was investigated. The liquid is stored for 11 months, and it is transported to the fields and spread in the 12th month. The cost of spreading is assumed to be equal with the income of the liquid fraction sold as fertiliser, as data are not available for any of them. In the case of Scenario AD-R, where the least liquid is released to wastewater treatment (Table 5), the annual capital cost would increase with 47 MSEK, while the cost of 'Others' and the income of electricity would decrease with 5 MSEK due to the elimination of wastewater treatment cost and 1 MSEK due to the power consumption of the carbon steel storage tanks, respectively. The other cost elements would remain the same, hence the liquid storage instead of wastewater treatment would result in increased total cost (628 MSEK), slightly decreased total income (422 MSEK) and a storage cost of 153 SEK/t liquid. In Scenario AD-R the N and P contents of the liquid are estimated to be 5 and 2 mg/L, respectively.

Table 5. Annual cash flows in million Swedish Kronor. A summary of the scenarios is given in Figure 1.

	AD	AD-R	SP-AD	SP-AD-R	Et-AD	Et-AD+
<u>Costs</u>						
Feedstock	-388	-388	-388	-388	-388	-388
Capital	-127	-139	-116	-124	-195	-161
Chemicals	-22	-32	-35	-39	-42	-51
Enzymes	-	-	-	-	-48	-48
Utilities	-1	-1	-1	-1	-6	-1
Others ¹	-40	-25	-36	-31	-63	-62
WWT	-19	-5	-16	-10	-41	-41
Total cost	-577	-586	-577	-584	-743	-712
<u>Incomes</u>						
Ethanol	-	-	-	-	255	255
Biogas	255	305	316	335	241	241
Electricity	48	46	19	18	0	1
District heat	66	72	50	51	29	23
Total income	368	423	386	405	525	520
<u>Deficit</u>	209	163	191	179	218	192

¹ 'Others' includes maintenance, insurance, labour and wastewater treatment (WWT)

Minimum selling prices and sensitivity to market prices

Both the MBSP and MESP (Table 6) are above the assumed market prices of biogas and ethanol (Table 1), respectively. The recycling can improve the process economics according to the assumptions applied in the model. Steam pretreatment prior to AD without recycling (Scenario SP-AD) is economically more favourable than direct AD without recycling (Scenario AD), however, in the case of recycling the MBSP is not reduced (Scenarios SP-AD-R vs. AD-R). Therefore it can be concluded that the positive economic effect of steam pretreatment prior to AD largely depends on the increase of methane production caused by steam pretreatment. At the combined biofuel production (Scenarios Et-AD and Et-AD+) the separate CSTR and UASB systems are more favourable in terms of both the MBSP and MESP (Table 6). The MBSP of Scenario Et-AD+ is slightly lower than that of Scenario AD, however, it is higher than that of Scenario SP-AD. The latter is economically the most favourable among the experimentally verified cases, however, if all the scenarios are taken into account, Scenario AD-R has the lowest MBSP (Table 6). The feedstock prices at the break-even point are 44-58% of the assumed feedstock price (Table 6).

The sensitivity of minimum biogas selling price to changes in the prices of feedstock and products is monitored by changing the one price at a time from -50% to +50%. The results are shown in Figure 4 and the data are given in Table 6. The effect of changing price depends on the contribution of the given cost and income elements to the total cost and income, respectively: the higher the contribution the greater the slope of the curve, i.e. the effect. If the feedstock price decreased to 50%, the MBSP of the majority of scenarios (AD-R, SP-AD, SP-AD-R, Et-AD+) would drop below the assumed market price of biogas (600 SEK/MWh), i.e. these scenarios would become economically feasible (Figure 4A). An increase of 75% in the market price of ethanol would result that Scenario Et-AD+ would become economically viable (Figure 4B). Changes in the prices of electricity (Figure 4C) and district heat (Figure 4D) have little influence

on the process economics, and it is not likely that these prices would increase in such extent that the MBSP of any of the scenarios would decrease below the market price of biogas.

Table 6. Minimum biogas and ethanol selling prices (MBSP and MESP, respectively), feedstock price at the break-even point and sensitivity analysis of MBSP. A summary of the scenarios is given in Figure 1.

	AD	AD-R	SP-AD	SP-AD-R	Et-AD	Et-AD+
MBSP (SEK/MWh)	1092	920	962	921	1140	1077
MESP (SEK/L)	-	-	-	-	10.17	9.62
Feedstock price at break-even point (SEK/dry t)	761	958	839	888	729	838
<u>MBSP (SEK/MWh) if prices change</u>						
Feedstock price -50%	635	538	594	574	656	593
Feedstock price +50%	1549	1301	1330	1269	1624	1560
Ethanol price -50%	1092	920	962	921	1458	1395
Ethanol price +50%	1092	920	962	921	822	759
Electricity price -50%	1149	965	981	938	1140	1078
Electricity price +50%	1036	875	944	905	1140	1075
District heat price -50%	1170	990	1010	967	1176	1105
District heat price +50%	1015	849	914	875	1104	1048

SEK: Swedish Kronor.

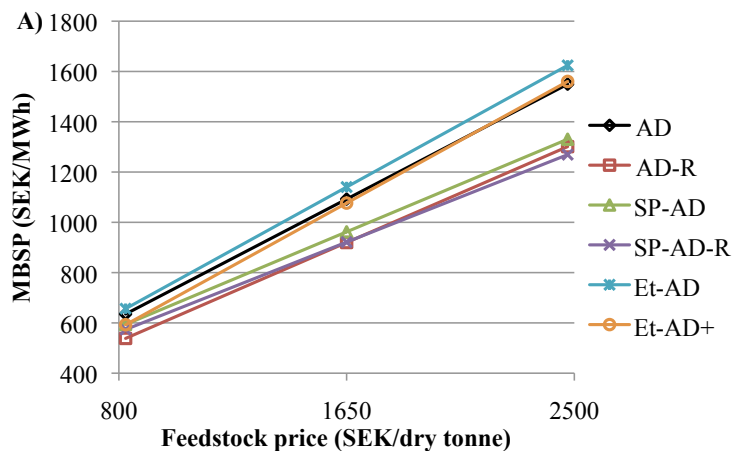

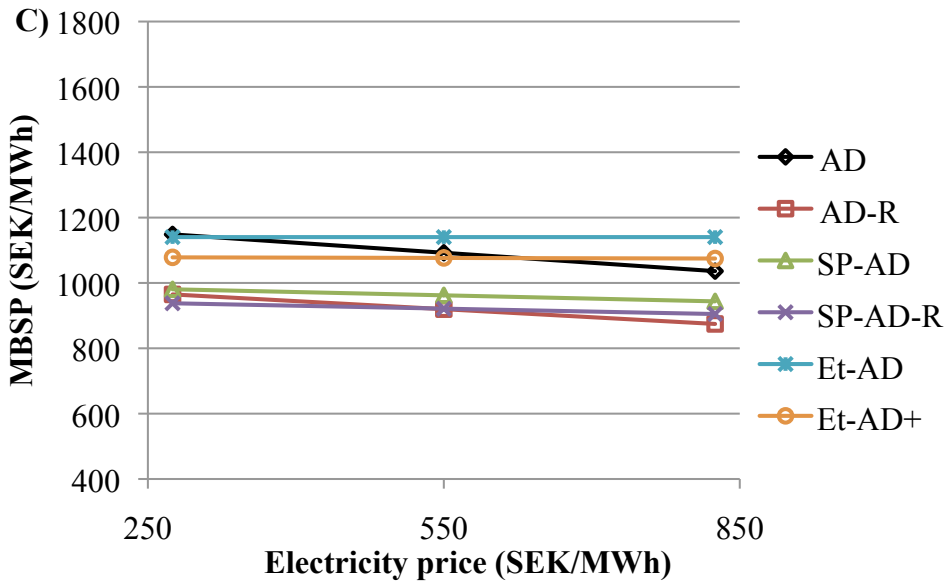
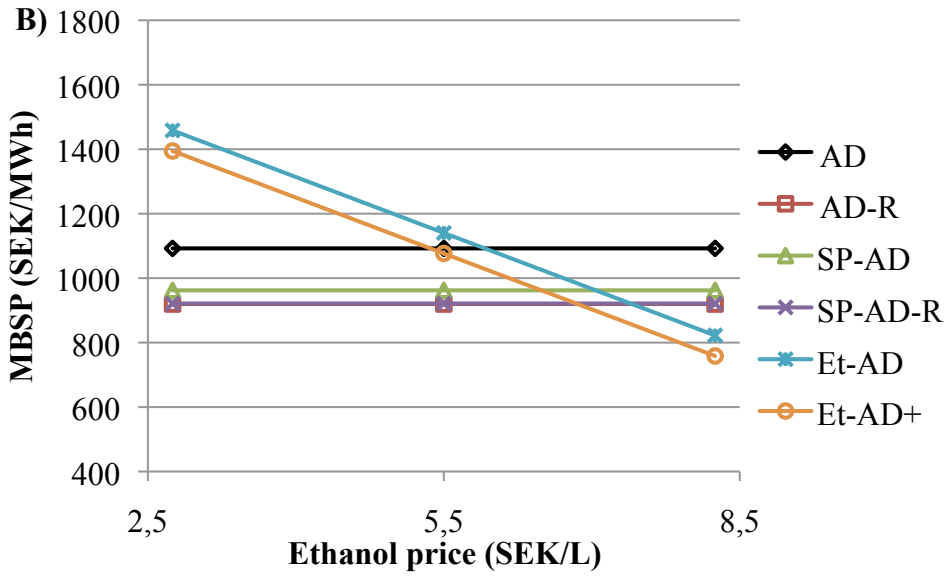

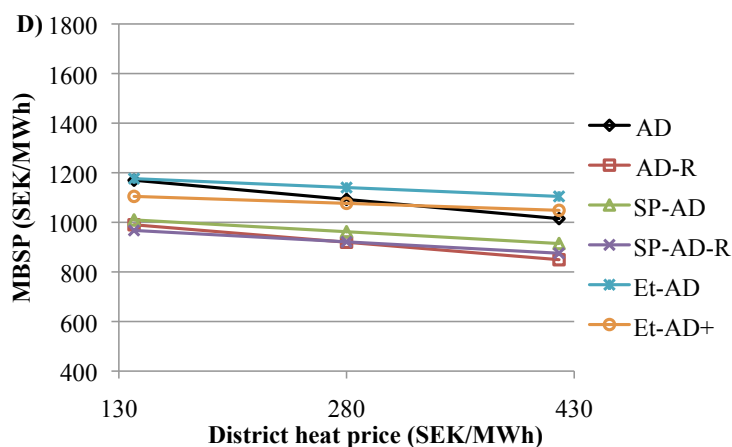

Figure 4

Minimum biogas selling price (MBSEP, in Swedish Kronor (SEK)/MWh) as a function of feedstock (A), ethanol (B), electricity (C) and district heat (D) prices. A summary of the scenarios is given in Figure 1.

Conclusions

In the analysed processes the energy output in the form of biogas, ethanol, heat and electricity varies between 60 and 84% of the energy input. However, none of the analysed processes is economically viable with the current market prices of product. The largest cost contributor is the feedstock cost, however, it must be stressed that the production cost of ensiled hemp is a value with large uncertainty, since currently hemp is not produced for this purpose. Nevertheless, the feedstock price is much higher than what is feasible, and it should be reduced approximately to half to achieve an economically viable hemp-based process. Cost reduction can also be obtained by process improvement, e.g. by increasing the solid concentration in the simultaneous saccharification and fermentation and in the anaerobic digestion, or by decreasing the residence time in these process steps. These changes can significantly decrease the capital investment cost of these process steps, however, increasing the solid concentration also has positive effect on the downstream process after these steps, e.g. distillation and wastewater treatment. The importance of residence time is demonstrated in this study by introducing upflow anaerobic sludge blanket reactors to partially replace the traditional continuous stirred tank reactor system.

The yields and prices of methane and ethanol are shown to have larger influences on the process economics than the outputs and prices of electricity and district heat. Therefore analysis of feedstocks with higher yields of biogas and ethanol would be of interest. If the production cost of hemp cannot be reduced significantly, the economic feasibility of biofuel production could possibly be improved by combined production with value-added products, e.g. hemp fibres. The hemp hurds or hemp core left after mechanical separation of bast fibres can be used for biofuel production as previously demonstrated (Barta et al., 2010b).

Abbreviations

AD	- Anaerobic digestion
CHP	- Combined heat and power production
COD	- Chemical oxygen demand
CSTR	-Continuously stirred tank reactor
DM	- Dry matter
FPU	- Filter paper unit
SEK	- Swedish kronor
SSF	- Simultaneous saccharification and fermentation
UASB	-Upflow anaerobic sludge blanket
WIS	- Water-insoluble solid

Competing interests

The authors declare that they have no competing interests.

Authors' contributions

ZB, EK and LB designed the study. EK provided input data for the anaerobic digestion. ZB carried out the process simulations and economic evaluation. ZB and EK analysed the results and wrote the paper. LB reviewed the manuscript. All authors read and approved the final manuscript.

Acknowledgements

The authors gratefully acknowledge the Swedish Knowledge Centre for Renewable Transportation Fuels, the Swedish Research Council for Environment, Agricultural Sciences and Spatial Planning, the New Hungary Development Plan (Project ID: TÁMOP-4.2.1/B-09/1/KMR-2010-0002) and the Hungarian National Research Fund (OTKA-K72710) for their financial support. Special thanks to Professor Guido Zacchi, Dr. Bálint Sipos, and Dr. Ola Wallberg for their advices and contributions. Thanks also to Assistant Professor Robbert Kleerebezem and Mikael Lantz for advices and to Läckeby Water Group for information on prices and energy demands.

References

- Amaducci, S., Zatta, A., Raffanini, M., Venturi, G. 2008. Characterisation of hemp (*Cannabis sativa* L.) roots under different growing conditions. *Plant and Soil*, **313**(1-2), 227-235.10.1007/s11104-008-9695-0.
- Barta, Z., Kovács, K., Réczey, K., Zacchi, G. 2010a. Process design and economics of on-site cellulase production on various carbon sources in a soft-wood-based ethnaol plant. *Enzyme research*, **734182**.doi:10.4061/2010/734182.
- Barta, Z., Oliva, J.M., Ballesteros, I., Dienes, D., Ballesteros, M., Reczey, K. 2010b. Refining Hemp Hurds into Fermentable Sugars or Ethanol. *Chemical and Biochemical Engineering Quarterly*, **24**(3), 331-339
- Barta, Z., Reczey, K., Zacchi, G. 2010c. Techno-economic evaluation of stillage treatment with anaerobic digestion in a softwood-to-ethanol process. *Biotechnology for Biofuels*, **3**,21 10.1186/1754-6834-3-21.
- Berglund, M., Börjesson, P. 2003. Energianalys av biogassystem. Institutionen för teknik och samhälle, Avdelningen för miljö- och energisystem. Lund.
- Borjesson, P., Gustavsson, L. 1996. Regional production and utilization of biomass in Sweden. *Energy*, **21**(9), 747-764.10.1016/0360-5442(96)00029-1.

- Borjesson, P., Tufvesson, L.M. 2011. Agricultural crop-based biofuels - resource efficiency and environmental performance including direct land use changes. *Journal of Cleaner Production*, **19**(2-3), 108-120.10.1016/j.jclepro.2010.01.001.
- Cappelletto, P., Brizzi, M., Mongardini, F., Barberi, B., Sannibale, M., Nenci, G., Poli, M., Corsi, G., Grassi, G., Pasini, P. 2001. Italy-grown hemp: yield, composition and cannabinoid content. *Industrial Crops and Products*, **13**(2), 101-113
- Chemical market reporter. 2005.
- Dachs, G., Rehm, W. 2006. Eigenstromverbrauch von Biogasanlagen und potenziale zu dessen reduzierung. Base Technologies GmbH in Kooperation mit Fachhochschule Munchen.
- EEA. 2006. How much bioenergy can Europe produce without harming the environment? Copenhagen.
- Gustavsson, J. (2011) The feasibility of trace element supplementation for stable operation of wheat stillage-fed biogas tank reactors. *Water Science and Technology*, **64**(2), 320-325.
- Kaparaju, P., Ellegaard, L., Angelidaki, I. 2009. Optimisation of biogas production from manure through serial digestion: Lab-scale and pilot-scale studies. *Bioresource technology*, 100, 701-709.
- Kreuger, E., Prade, T., Escobar, F., Svensson, S.E., Englund, J.E., Bjornsson, L. 2011a. Anaerobic digestion of industrial hemp-Effect of harvest time on methane energy yield per hectare. *Biomass & Bioenergy*, **35**(2), 893-900.10.1016/j.biombioe.2010.11.005.
- Kreuger, E., Sipos, B., Zacchi, G., Svensson, S.E., Bjornsson, L. 2011b. Bioconversion of industrial hemp to ethanol and methane: The benefits of steam pretreatment and co-production. *Bioresource Technology*, **102**(3), 3457-3465.10.1016/j.biortech.2010.10.126.
- Läckeby Water Group. 2012. Personal communication.
- Lee, P.H., Bae, J., Kim, J., Chen, W.H. 2011. Mesophilic anaerobic digestion of corn thin stillage: a technical and energetic assessment of the corn-to-ethanol industry integrated with anaerobic digestion. *Journal of Chemical Technology and Biotechnology*, **86**(12), 1514-1520.10.1002/jctb.2664.
- Lohrasbi, M., Pourbafrani, M., Niklasson, C., Taherzadeh, M.J. 2010. Process design and economic analysis of a citrus waste biorefinery with biofuels and limonene as products. *Bioresource Technology*, **101**(19), 7382-7388.10.1016/j.biortech.2010.04.078.
- McEniry, J., O'Kiely, P., Crosson, P., Groom, E., Murphy, J.D. 2011. The effect of feedstock cost on biofuel cost as exemplified by biomethane production from grass silage. *Biofuels Bioproducts & Biorefining-Biofpr*, **5**(6), 670-682.10.1002/bbb.322.
- Nges, I., Björn, A., Björnsson, L. 2012. Stable operation during pilot-scale anaerobic digestion of nutrient-supplemented maize/sugar beet silage. *Bioresource Technology* <http://dx.doi.org/10.1016/j.biortech.2012.05.096>.
- Nguyen, M.H., Prince, R.G.H. 1996. A simple rule for bioenergy conversion plant size optimisation: Bioethanol from sugar cane and sweet sorghum. *Biomass & Bioenergy*, **10**(5-6), 361-365.10.1016/0961-9534(96)00003-7.
- Pahkala, K., Pahkala, E., Syrjälä, H. 2008. Northern Limits to Fiber Hemp Production in Europe. *Journal of Industrial Hemp*, **13** (2), 104-116
- Peters, M., Timmerhaus, K., West, R. 2004. *Plant design and economics for chemical engineers*. McGraw-Hill, New York.
- Prade, T., Svensson, S.E., Andersson, A., Mattsson, J.E. 2011. Biomass and energy yield of industrial hemp grown for biogas and solid fuel. *Biomass & Bioenergy*, **35**(7), 3040-3049.10.1016/j.biombioe.2011.04.006.
- Sassner, P., Galbe, M., Zacchi, G. 2008. Techno-economic evaluation of bioethanol production from three different lignocellulosic materials. *Biomass & Bioenergy*, **32**(5), 422-430.10.1016/j.biombioe.2007.10.014.
- Sassner, P., Zacchi, G. 2008. Integration options for high energy efficiency and improved economics in a wood-to-ethanol process. *Biotechnology for Biofuels*, **1**.4 10.1186/1754-6834-1-4.

- Shafiei, M., Karimi, K., Taherzadeh, M.J. 2011. Techno-economical study of ethanol and biogas from spruce wood by NMMO-pretreatment and rapid fermentation and digestion. *Bioresource Technology*, **102**(17), 7879-7886.10.1016/j.biortech.2011.05.071.
- Sipos, B., Kreuger, E., Svensson, S.-E., Réczey, K., Björnsson, L., G., Z. 2010a. Steam pretreatment of dry and ensiled industrial hemp for ethanol production. *Submitted to Biomass Bioenergy*
- Sipos, B., Kreuger, E., Svensson, S.E., Reczey, K., Björnsson, L., Zacchi, G. 2010b. Steam pretreatment of dry and ensiled industrial hemp for ethanol production. *Biomass & Bioenergy*, **34**(12), 1721-1731.10.1016/j.biombioe.2010.07.003.
- Smyth, B.M., Smyth, H., Murphy, J.D. 2010. Can grass biomethane be an economically viable biofuel for the farmer and the consumer? *Biofuels Bioproducts & Biorefining-Biofpr*, **4**(5), 519-537.10.1002/bbb.238.
- Sonesson, U. 1996. Modelling of the compost and transport process in the ORWARE simulation model. Inst. för lantbruksteknik, SLU. Uppsala.
- Statistics Sweden. 2010. Excerpt for county of Scania from the agricultural register 2010. .
- Struik, P.C., Amaducci, S., Bullard, M.J., Stutterheim, N.C., Venturi, G., Cromack, H.T.H. 2000. Agronomy of fibre hemp (*Cannabis sativa* L.) in Europe. *Industrial Crops and Products*, **11**(2-3), 107-118
- Sunivo. 2009. www.sunivo.com
- Svahn, J. 2006. Energioptimering av biogasproduktion, hur primärenergibehovet kan minskas med energiåtervinning och isolering. Umeå University. *Master thesis*.
- Swedish Board of Agriculture, Statistics Sweden. 2011. Yearbook of agricultural statistics 2011, including food statistics.
- Swensson, C. 2010. Majsensilage i Sverige - reflektioner. Workshop: Maize in the Nordic countries. Umeå. 14-15 February.
- Tiwari, M.K., Guha, S., Harendranath, C.S., Tripathi, S. (2006). Influence on extrinsic factors on granulation in UASB reactors. *Applied Microbiology and Biotechnology*, **71**, 145-154.
- Torry-Smith, M., Sommer, P., Ahring, B.K. 2003. Purification of bioethanol effluent in an UASB reactor system with simultaneous biogas formation. *Biotechnology and Bioengineering*, **94**(1), 7-12.
- van der Werf, H.M.G. 2004. Life Cycle Analysis of field production of fibre hemp, the effect of production practices on environmental impacts. *Euphytica*, **140**(1-2), 13-23
- van der Werf, H.M.G., van Geel, W.C.A., Wijlhuizen, M. 1995. Agronomic research on hemp (*Cannabis sativa* L.) in The Netherlands, 1987-1993. *Journal of the International Hemp Association* **2**(1), 14-17
- van Lier, J.B., van Leer, van der Zee, F.P., Tan, N.C.G., Rebac, S., Kleerebezem, R. 2001. Advances in high-rate anaerobic treatment: staging on reactor systems. *Water Science and Technology*, **44**, 15-25.
- Walla, C., Schneeberger, W. 2008. The optimal size for biogas plants. *Biomass & Bioenergy*, **32**(6), 551-557.10.1016/j.biombioe.2007.11.009.
- Wingren, A., Galbe, M., Zacchi, G. 2008. Energy considerations for a SSF-based softwood ethanol plant. *Bioresource Technology*, **99**(7), 2121-2131.10.1016/j.biortech.2007.05.058.
- Wooley, R., Putsche, V. 1996. Development of an ASPEN PLUS physical property database for biofuels components. National Renewable Energy Laboratory, Golden. Golden. MP-425-20685.