



LUND UNIVERSITY

Design of Fire-exposed Steel Structures - The Swedish Approach

Magnusson, Sven Erik; Pettersson, Ove

1981

[Link to publication](#)

Citation for published version (APA):

Magnusson, S. E., & Pettersson, O. (1981). *Design of Fire-exposed Steel Structures - The Swedish Approach*. (LUTVDG/TVBB--3003--SE; Vol. 3003). Division of Building Fire Safety and Technology, Lund Institute of Technology.

Total number of authors:

2

General rights

Unless other specific re-use rights are stated the following general rights apply:

Copyright and moral rights for the publications made accessible in the public portal are retained by the authors and/or other copyright owners and it is a condition of accessing publications that users recognise and abide by the legal requirements associated with these rights.

- Users may download and print one copy of any publication from the public portal for the purpose of private study or research.
- You may not further distribute the material or use it for any profit-making activity or commercial gain
- You may freely distribute the URL identifying the publication in the public portal

Read more about Creative commons licenses: <https://creativecommons.org/licenses/>

Take down policy

If you believe that this document breaches copyright please contact us providing details, and we will remove access to the work immediately and investigate your claim.

LUND UNIVERSITY

PO Box 117
221 00 Lund
+46 46-222 00 00

LUND INSTITUTE OF TECHNOLOGY · LUND · SWEDEN
DIVISION OF BUILDING FIRE SAFETY AND TECHNOLOGY
REPORT LUTVDG/(TVBB -3003)

SVEN ERIK MAGNUSSON - OVE PETTERSSON

DESIGN OF FIRE-EXPOSED STEEL
STRUCTURES - THE SWEDISH APPROACH

LUND 1981

LUND INSTITUTE OF TECHNOLOGY · LUND · SWEDEN

DIVISION OF BUILDING FIRE SAFETY AND TECHNOLOGY
REPORT LUTVDG/(TVBB-3003)

SVEN ERIK MAGNUSSON - OVE PETERSSON

DESIGN OF FIRE-EXPOSED STEEL STRUCTURES -
THE SWEDISH APPROACH

Presented at the May 11-15, 1981, ASCE Spring Convention,
held at New York

LUND 1981

DESIGN OF FIRE-EXPOSED STEEL STRUCTURES-
THE SWEDISH APPROACH

KEY WORDS: Beams; Buildings; Deflection; Failure; Fire protection; Safety; Steels; Structural engineering; Temperature

ABSTRACT: A rational, analytical approach to a fire engineering design of load-bearing steel structures is described. The method of design is directly based on the natural compartment fire concept and on strictly defined functional requirements and performance criteria. The method is permitted to be generally applied in Sweden, as one alternative, since about ten years. For facilitating the practical application, a comprehensive design basis has been worked out in the form of diagrams and tables for a direct determination of the maximum steel temperature during a complete compartment fire and the corresponding design load-bearing capacity of the fire exposed structure. The design basis is presented in a manual which has been given type approval for practical use by the National Swedish Board of Physical Planning and Building.

REFERENCE: Magnusson, Sven Erik, and Pettersson, Ove, "Design of Fire-Exposed Steel Structures - The Swedish Approach".

DESIGN OF FIRE-EXPOSED STEEL STRUCTURES
THE SWEDISH APPROACH

By Sven Erik Magnusson¹ and Ove Pettersson²

INTRODUCTION

For a fire engineering design of load-bearing structures and partitions, a differentiated analytical procedure is permitted to be applied in Sweden, as one alternative, since about ten years. The procedure constitutes a direct design method based on temperature characteristics of the fully developed compartment fire as a function of the fire load

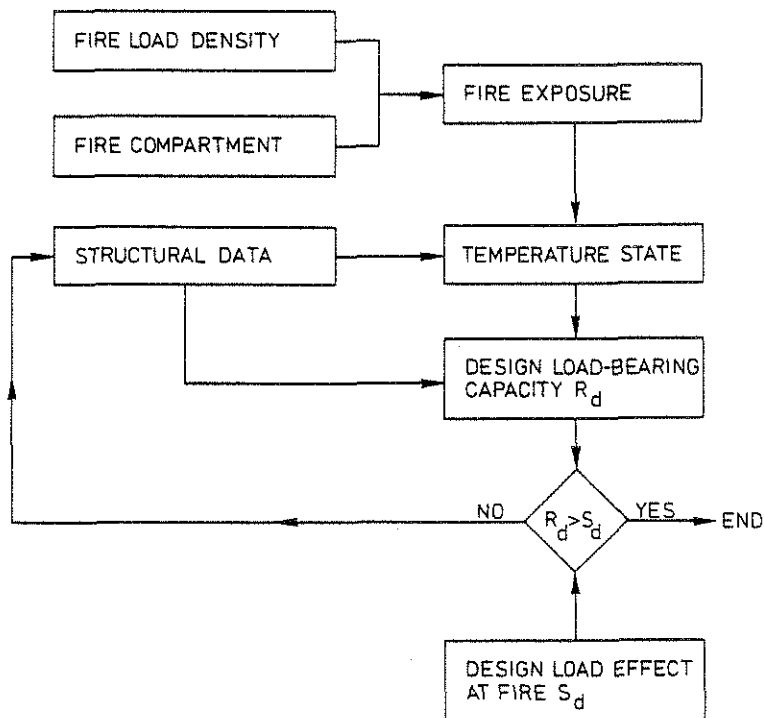

FIG.1.—Summary description of a rational design method for fire exposed load-bearing structures

¹Dr., ²Prof.Dr., Division of Structural Mechanics, Lund Institute of Technology, Lund, Sweden

density, the ventilation of the fire compartment and the thermal properties of the structures enclosing the fire compartment. The design method is approved for a general practical use by the National Swedish Board of Physical Planning and Building [1]. For facilitating the practical application, design diagrams and tables are systematically produced, giving directly, on one hand, the design temperature state of the fire exposed structure, on the other, a transfer of this information to the corresponding design load-bearing capacity of the structure; cf., for instance [2], [3], [4]. Fig. 1 describes the design method in a summary way.

DETAILED DESCRIPTION OF AN ANALYTICAL FIRE ENGINEERING DESIGN OF STEEL STRUCTURES

Applied to fire exposed load-bearing structures or structural members, inside a fire compartment, the design procedure includes the following steps - Fig. 2.

The basis of the design is given by the fully developed compartment fire exposure. Decisive entrance quantities then are

- (1) nominal load and load factor for fire load density,
 - (2) combustion properties of this design fire load,
 - (3) size and geometry of the fire compartment,
 - (4) ventilation characteristics of the fire compartment,
- and
- (5) thermal properties of structures enclosing the fire compartment.

These quantities jointly determine the rate of burning, the rate of heat release, and the design gas temperature-time curve of the complete fire process. Together with

- (6) structural data for the proposed structure,
 - (7) thermal properties of structural materials, and
 - (8) coefficients of heat transfer for various surfaces
- of the structure

this design gas temperature-time curve gives the requisite information for a determination of the transient temperature fields of the fire exposed structure or structural members.

With

- (9) mechanical properties of structural materials and
- (10) load characteristics

as further entrance quantities the time variation of restraint forces and moments, thermal stresses, and load-carrying capacity R can be determined. The lowest value of R during the complete fire process defines the design load-carrying capacity R_d .

Over nominal loads and load factors for dead load, live load, etc., statistically representative of a fire occasion, the design load effect at fire S_d is defined, interdependent on non-fire design procedure.

A direct comparison between the design load-carrying capacity R_d and the design load effect at fire S_d decides whether the structure can fulfil its required function or not at a fire exposure.

Exceptionally, a requirement on re-serviceability of the structure after fire may be included in the fire engineering design. If so, the design residual load-carrying capacity R_{rd} of the structure after fire has to be determined in the

FIG.2.—Procedure of an analytical fire engineering design of load-bearing structures with additional requirement on re-serviceability after fire

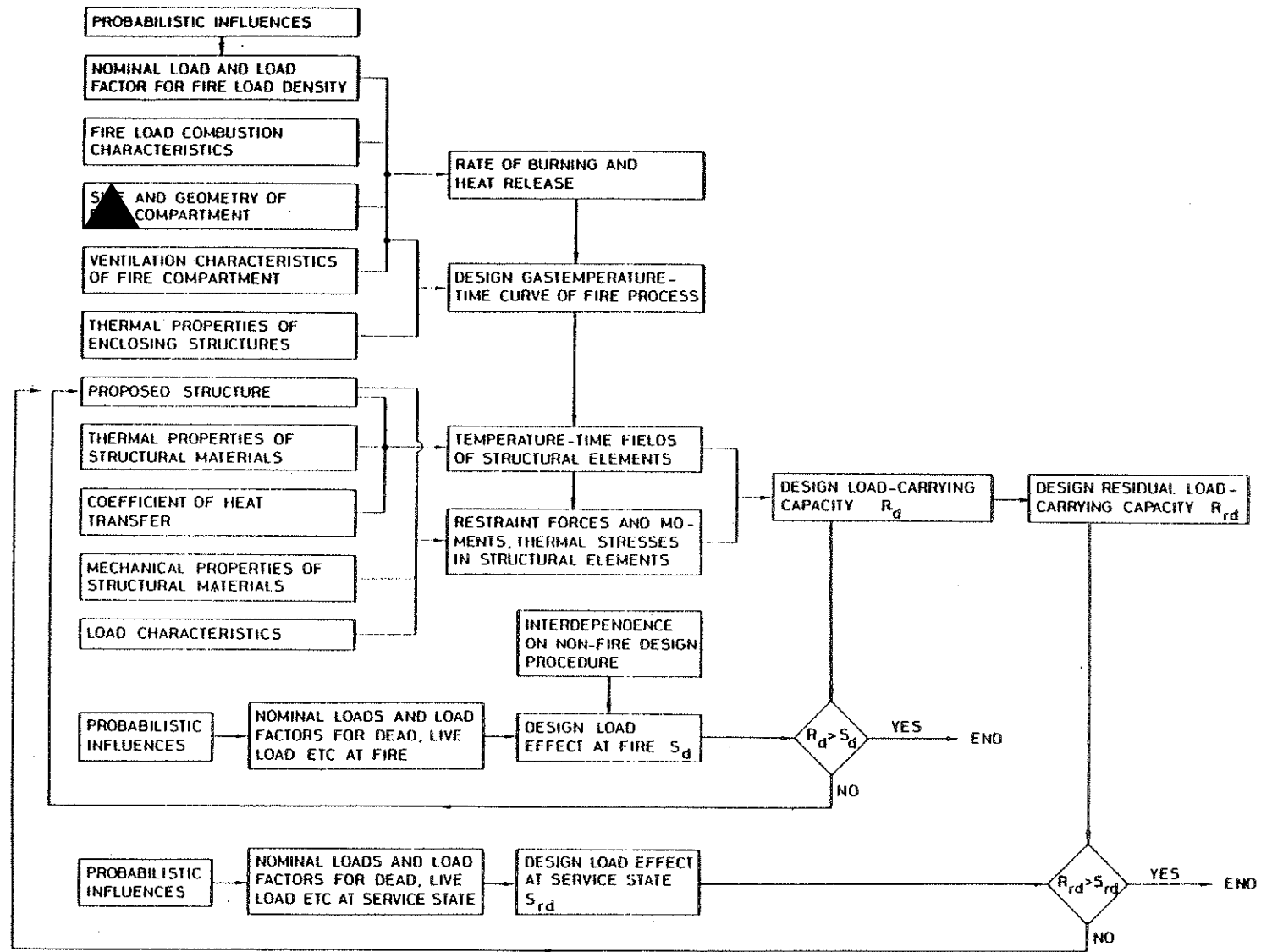

design and compared with the design load effect at service, non-fire state, on the structure S_{rd} .

FIRE LOAD DENSITY AND GAS TEMPERATURE-TIME CURVES OF FULLY DEVELOPED COMPARTMENT FIRE

At known combustion characteristics of the fire load, the gas temperature-time curve of a fully developed compartment fire can be calculated in the individual practical application from the heat and mass balance equations of the fire compartment with regard taken to the size, geometry and ventilation of the compartment, and to the thermal properties of the structures enclosing the compartment - Fig. 3, [1], [2], [4], [5], [6], [7], [8], [9], [10].

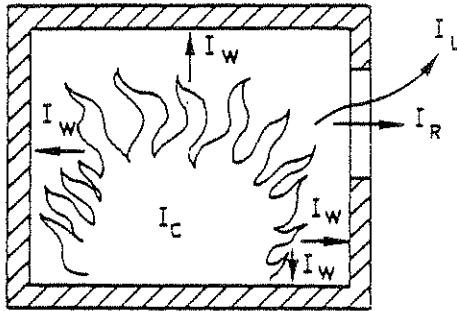

FIG.3.—Energy balance equation $I_C = I_L + I_W + I_R$ of a fire compartment. I_C is the heat release per unit time from the combustion of the fuel, and I_L , I_W and I_R the quantities of energy removed per unit time by change of hot gases against cold air, by heat transfer to the surrounding structures, and by radiation through the openings of the compartment, respectively

For interior, load-bearing structures and partitions, the fire engineering design provisionally can be based on gas temperature-time curves $T_t - t$ according to Fig. 4, [1], [2] [4], [7], which applies to a fire compartment with surrounding structures made of a material with a thermal conductivity $\lambda = 0.81 \text{ W} \cdot \text{m}^{-1} \cdot \text{°C}^{-1}$ and a heat capacity $\rho c_p = 1.67 \text{ MJ} \cdot \text{m}^{-3} \cdot \text{°C}^{-1}$ (fire compartment, type A). Entrance parameters of the diagrams are the fire load density q , defined by the formula

$$q = \frac{1}{A_t} \sum \mu_v m_v H_v \quad (\text{MJ} \cdot \text{m}^{-2}) \quad (1)$$

and the ventilation characteristics of the fire compartment, expressed by the opening factor $A\sqrt{h}/A_t$ ($\text{m}^{1/2}$), where

A = total area of window and door openings (m^2),

h = mean value of the heights of window and door openings, weighed with respect to each individual opening area (m),

A_t = total interior area of the surfaces bounding the compartment, opening areas included (m^2),

m_v = total weight of combustible material v (kg),

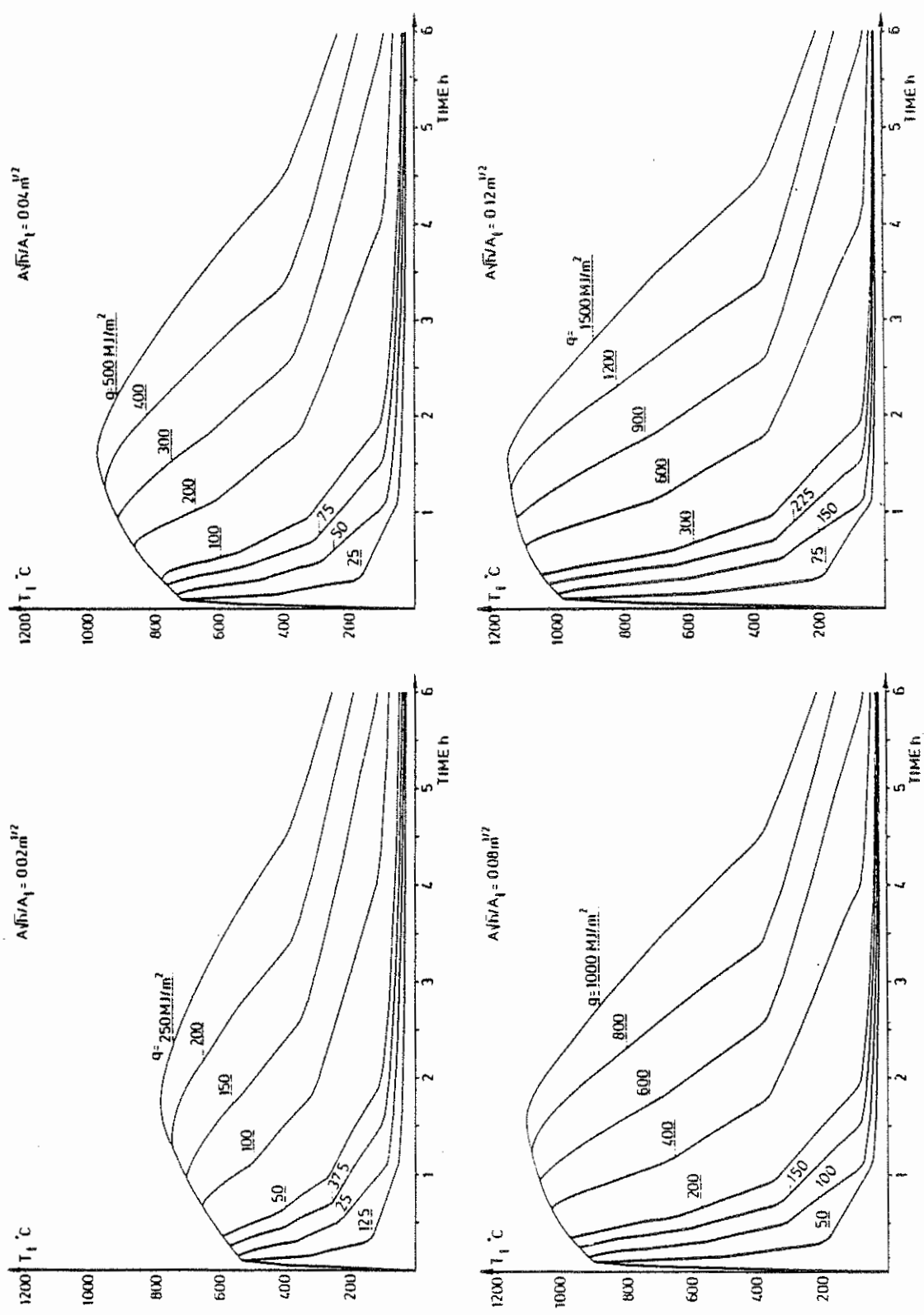

FIG.4.-Gas temperature-time curves T_t-t of the complete process of fire development for different values of the fire load density q and the opening factor $A/h/A_t$. Fire compartment, type A

H_v = effective heat value of combustible material v of the fire load ($\text{MJ} \cdot \text{kg}^{-1}$), and

μ_v = a fraction between 0 and 1, giving the real degree of combustion for each individual component of the fire load.

The non-dimensional factor μ_v depends on properties of fuel in a fire compartment, among other things. For some types of fire load components, μ_v will depend on the time of fire duration and on the gas temperature-time characteristics of the fire compartment. Bookcases and floor coverings are examples of fire components whose real degree of combustion is low, and whose μ_v values are probably appreciably below unity. At present, however, there is a lack of experimentally substantiated and verified μ_v values, and it is therefore usually necessary in the course of practical design to employ a fire load calculation with μ_v generally put equal to unity.

As a rule, the design fire load density is to be determined on the basis of statistical investigations for the type of building or premises in question. Such statistical investigations have been carried out for dwellings, offices, administration buildings, schools, stores, and hospitals [1], [2], [4]. As a temporary regulation, the Swedish Building Code authorizes the 80 percent level of the statistical distribution curve to be applied as the design fire load density.

The gas temperature-time curves in Fig. 4 have generally been determined on the assumption of ventilation controlled fires. For fires, which are fuel bed controlled in reality, this assumption leads to a structural fire engineering design on the safe side in practically every case, giving an overestimation of the maximum gastemperature and a simultaneous, partly balancing underestimation of the fire duration. For the minimum load-bearing capacity, which thermally can be seen as an integrated effect, the gas temperature-time curves in Fig. 4 give reasonably correct results, verified in [2], [8].

As pointed out, the gas temperature-time curves in Fig. 4 apply to a certain fire compartment, type A, specified with respect to the thermal properties of its surrounding structures. Fire compartments with surrounding structures of deviating thermal properties can be transferred to fire compartment, type A, via effective values of the fire load density q_f and the opening factor $(A\sqrt{h}/A_t)_f$ - [1], [2], [4].

DESIGN TEMPERATURE STATE OF FIRE EXPOSED, UNINSULATED STEEL STRUCTURES

For a fire exposed, uninsulated steel structure, the energy balance equation gives the following formula for a determination of the steel temperature-time curve T_s - t -Fig.5

$$\Delta T_s = \frac{\alpha}{\rho_s c_{ps}} \cdot \frac{F_s}{V_s} (T_t - T_s) \Delta t \quad (^\circ\text{C}) \quad (2)$$

where

ΔT_s = change of steel temperature ($^\circ\text{C}$) during time step Δt (s),

α = coefficient of heat transfer at fire exposed surface of structure ($\text{W} \cdot \text{m}^{-2} \cdot ^\circ\text{C}^{-1}$),

ρ_s = density of steel material ($7850 \text{ kg}\cdot\text{m}^{-3}$),
 c_s = specific heat of steel material ($\text{J}\cdot\text{kg}^{-1}\cdot\text{°C}^{-1}$),
 F_s^{PS} = fire exposed surface of steel structure per unit length (m),
 V_s = volume of steel structure per unit length (m^2),
 T_t^s = gas temperature (°C) within fire compartment at time t (s).

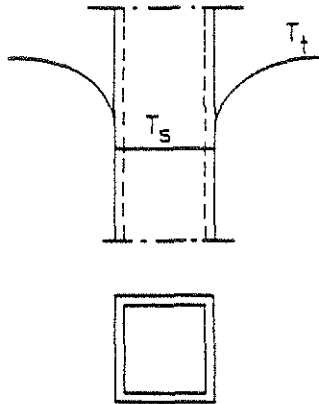

FIG.5.—Fire exposed, uninsulated steel structure. T_t = gas temperature within fire compartment, T_s = steel temperature at time t.

Eq. (2) presupposes that the steel temperature T_s is uniformly distributed over the cross section of the structure at any time t.

The coefficient of heat transfer α can be calculated from the approximate formula

$$\alpha = 23 + \frac{5.77 \epsilon_r}{T_t - T_s} \left[\left(\frac{T_t + 273}{100} \right)^4 - \left(\frac{T_s + 273}{100} \right)^4 \right] \quad (\text{W}\cdot\text{m}^{-2}\cdot\text{°C}^{-1}) \quad (3)$$

giving an accuracy which is sufficient for ordinary practical purposes. ϵ_r is the resultant emissivity which for practical applications can be chosen according to the following table, giving values which generally are on the safe side.

1. Column, fire exposed on all sides	$\epsilon_r = 0.7$
2. Column, outside a facade	0.3
3. Floor structure, composed of steel beams with a concrete slab on the lower flange of the beams	0.5
4. Steel beams with a floor slab on the upper flange of the beams	
4a. Beams of I cross section with width/height > 0.5	0.5
4b. Beams of I cross section with width/height < 0.5	0.7
4c. Beams of box cross section and trusses	0.7

More accurate values of the resultant emissivity ϵ_r can be determined for the application alternative 4 - steel beams with a floor slab, supported on the upper flange of the beams - from the diagrams of Fig. 6 and 7, applicable to floor structures with the flames completely below the steel beams and reaching the slab, respectively [11]. For the emissivity of the flames ϵ_t , the value 0.85 is to be inserted, if not any other value can be proved to be more correct.

At a given gas temperature-time curve $T-t$ of the fire compartment, the steel temperature T_s can be directly calculated from Eqs. (2) and (3) with regard taken to the temperature dependence of c_{ps} and α . Such computations have been carried out in a systematized way, giving design tables as published in [2], [3], [4]. From such tables, the maximum steel temperature $T_{s,max}$ during a complete compartment fire can be determined directly as a function of the effective fire load density q_f , the effective opening factor $(A\sqrt{h}/A_t)_f$, the F_s/V_s ratio and the resultant emissivity ϵ_r . The values are connected to gas temperature characteristics according to Fig. 4.

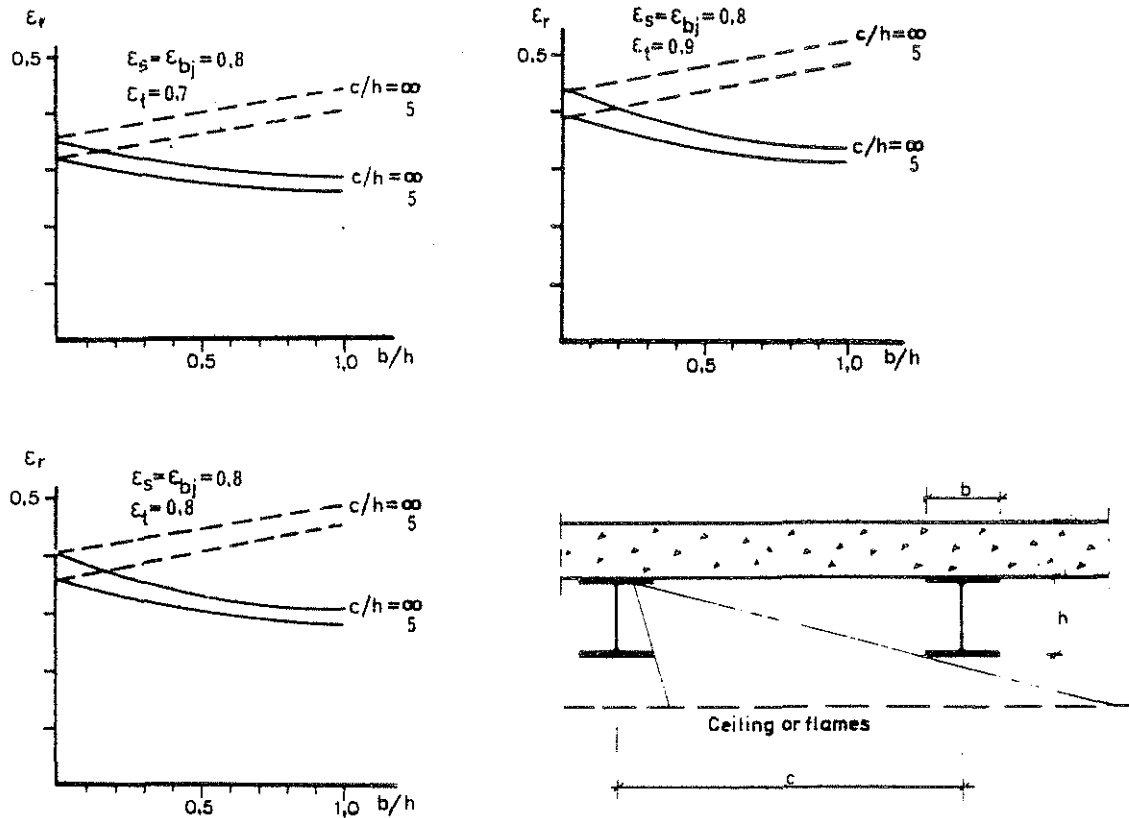

FIG.6.—Resultant emissivity ϵ_r for steel beams with a floor slab, supported on the upper flange of the beams. Flames completely below the steel beams.

ϵ_{bj} = emissivity of the slab, ϵ_s = emissivity of the steel beams, ϵ_t = emissivity of the flames.

— I cross section, ---- box cross section

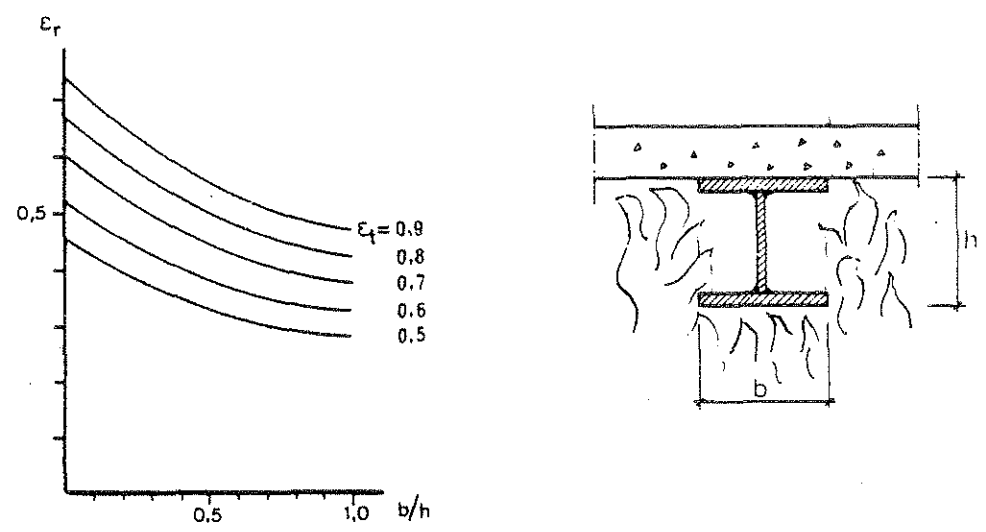

FIG.7.—Resultant emissivity ϵ_r for steel beams of I cross section with a floor slab, supported on the upper flange of the beams. Flames reaching the slab.
 ϵ_t = emissivity of the flames

DESIGN TEMPERATURE STATE OF FIRE EXPOSED, INSULATED STEEL STRUCTURES

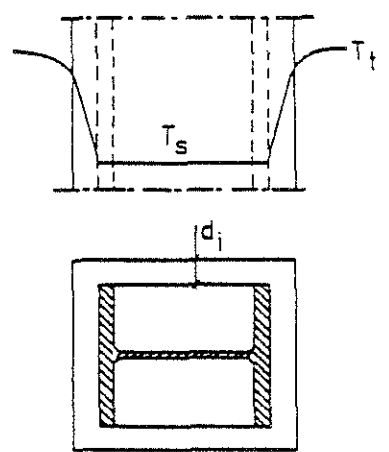

FIG.8.—Fire exposed, insulated steel structure. T_t = gas temperature within fire compartment, T_s = steel temperature at time t

For a fire exposed, insulated steel structure, a simplified energy balance equation gives the following formula for a direct determination of the steel temperature-time curve $T_s - t$ - Fig. 8

$$\Delta T_s = \frac{A_i}{(1/\alpha + d_i/\lambda_i) \rho_s c_p s V_s} (T_t - T_s) \Delta t \quad (^\circ\text{C}) \quad (4)$$

with the additional quantities

A_i = interior jacket surface area of insulation per unit length (m),

d_i = thickness of insulation (m),

λ_i = thermal conductivity of insulating material ($\text{W}\cdot\text{m}^{-1}\cdot^\circ\text{C}^{-1}$).

Eq. (4) presupposes that the steel temperature T_s is uniformly distributed over the cross section of the structure at any time t , that the temperature gradient is linear and the heating contribution negligible for the insulation, and that the heat transfer is one-dimensional.

Computations, originating from Eqs. (3) and (4), enable a production of a systematized design basis, facilitating an analytical, differentiated fire engineering design in practice. Such a design basis is published in [2], [3], [4] in the form of tables, giving the maximum steel temperature $T_{s,\max}$ during a complete compartment fire for varying values of the effective fire load density q_f , the effective opening factor $(A/\sqrt{h}/A_t)_f$, the structural parameter A_i/V_s , and the insulation parameter d_i/λ_i . The values are connected to gas temperature characteristics according to Fig. 4.

For a specific insulating material, systematized design diagrams or tables can be computed very accurately with regard to the temperature dependence of the thermal properties of the steel as well as the insulating material. The influence of an initial moisture content and of a disintegration of the insulating material can be considered, too. Practically, such a determination can be carried out over a numerical data processing by computers on the basis of a finite difference or a finite element method. A great number of design tables, computed according to such an accurate procedure, are presented in [2].

DESIGN LOAD-BEARING CAPACITY OF FIRE EXPOSED STEEL STRUCTURES

In the design, it is to be proved that the design load-bearing capacity of the fire exposed structure does not decrease below the design load effect during the complete process of fire development. The design load effect then is to be chosen on the basis of the most unfavourable combination of dead load, live load, snow load and wind load. Load values, to be used in an analytical structural fire design, are specified in the Swedish Building Code. The specified values are differentiated with respect to whether a complete evacuation of people can be assumed or not in the event of fire. The values include a safety factor which roughly considers the probability of a fully developed fire and the probability of the presence of the maximum load at the fire occasion.

By applying the design tables, referred to in the previous chapter, the maximum steel temperature $T_{s,\max}$ can be determined comparatively quickly for an uninsulated or insulated steel structure, exposed to a complete compartment fire with gas temperature-time characteristics according

to Fig. 4. The corresponding design load-bearing capacity of the structure then is obtained by design diagrams of the type exemplified in Fig. 9 and 10.

Fig 9 and 10 [2], [4] give the design load-bearing capacity (M_{cr} , P_{cr} , q_{cr}) of fire exposed beams of constant I cross section at different types of loading and support conditions, as a function of the steel beam temperature T_s . The design curves in Fig. 9 apply to a slow rate of heating - assumed to be $4^{\circ}\text{C}\cdot\text{min}^{-1}$, followed by a cooling with a rate of $1.33^{\circ}\text{C}\cdot\text{min}^{-1}$ - and Fig. 10 gives the correction $\Delta\beta$ of the load-bearing capacity coefficient β due to a more rapid rate of heating. In the formulas for the load-bearing capacity

σ_s = yield stress of steel material at room temperature (MPa),

L = span of beam (m),

W = elastic modulus of beam cross section (m^3).

The design curves in Fig. 9 and 10 have been determined on the basis of the deformation curve of the fire exposed beams calculated by an analytical model, presented in [12], which takes into account the softly rounded shape of the stress-strain curve of steel at elevated temperatures as well as the influence of creep strain, noticeable at temperatures in excess of about 450°C .

For a structural fire design of columns, unrestrained or partly restrained to a longitudinal expansion during the fire exposure, reference is made to [2].

CONCLUDING REMARKS

Compared with the conventional fire engineering design, based on classification and results of standard fire resistance tests, the presented analytical design procedure has a more logical structure, based on well-defined functional requirements and performance criteria. Of the ensuing advantages, the following are seen to be the main ones:

1. More consistent safety levels [13].
2. Better economy. The cost of structural fire protection is, as a rule, hard to itemize and the cost-saving consequences have been quantified only in a few cases. Rough estimates indicate that while the cost for conventional structural fire protection may exceed 30 per cent of the cost for the steel frame material, the corresponding percentage may be as low as 10 with the design procedure based on analytical modelling, see Fig. 11. This figure is based on the assumption that the advantages are fully exploited of integrating the design of the structural steel fire protection into the overall design process (inner and outer walls are used as fire protection whenever possible, concrete floor slabs are placed on the lower flange of the girders, inherently providing a smaller area to insulate, etc.).

Finally, it is recognized that the design system presented is not homogeneous due to a varying level of the present basis of knowledge for the different design steps. Naturally, this can be put forward as a criticism of the system. However, such a remark is not essential. Instead, this fact

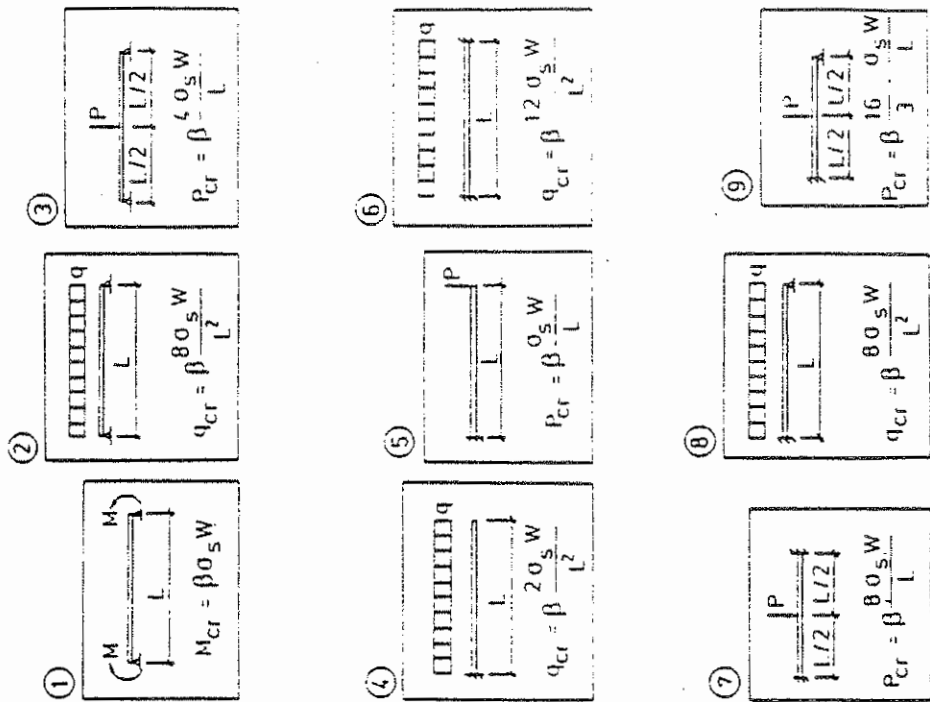
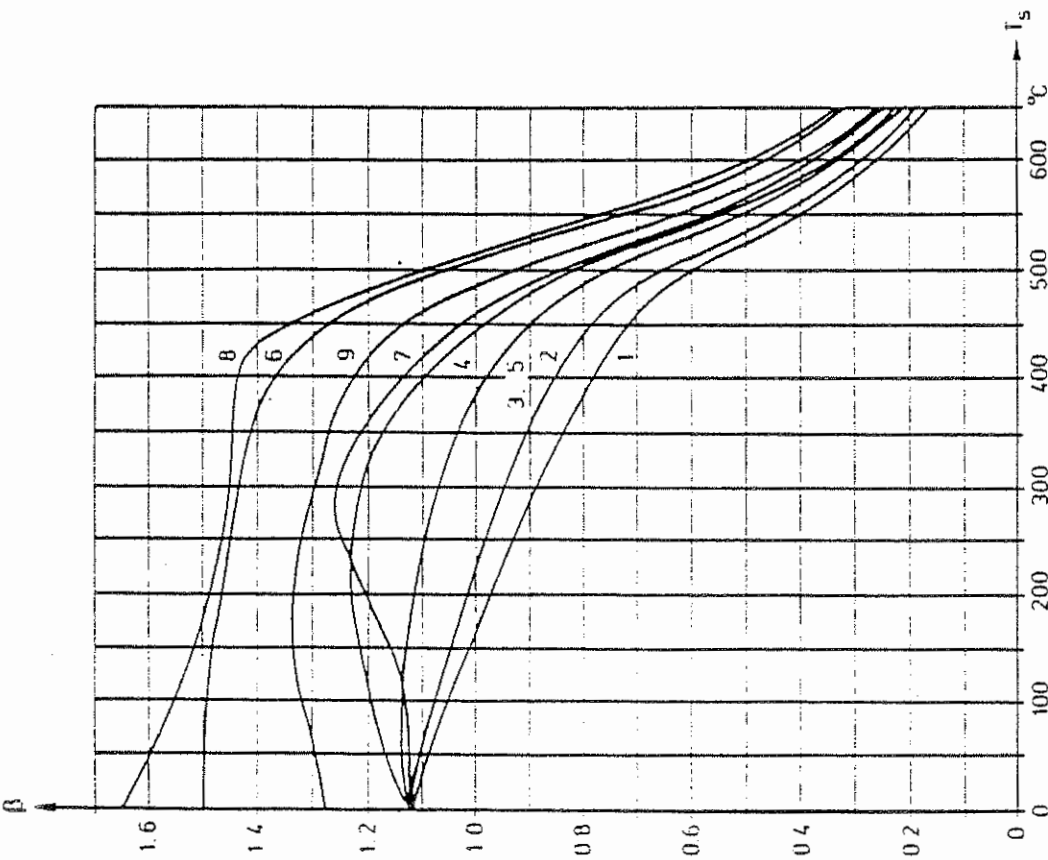

FIG. 9.—Coefficient β for determination of critical load (M_{cr} , P_{cr} , q_{cr}) for fire exposed beams of I cross section at different types of loading and support conditions, as a function of the steel beam temperature T_s . The curves have been calculated for a slow rate of heating of $40^{\circ}\text{C}\cdot\text{min}^{-1}$ and a subsequent cooling, assumed to be one third of the rate of heating [2], [4]

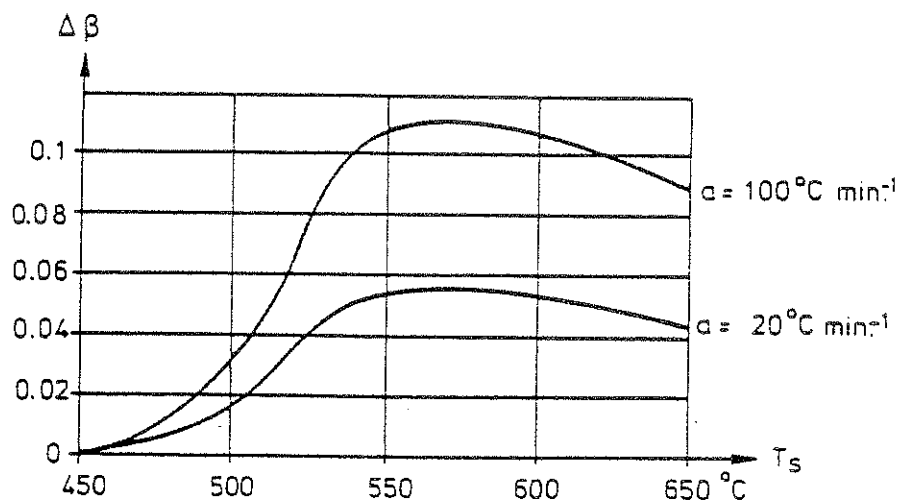

FIG.10.—Increase $\Delta\beta$ of coefficient β , determined according to Fig. 9, for a rate of heating $a > 4^\circ\text{C}\cdot\text{min}^{-1}$, as a function of the steel beam temperature T_s [2], [4]

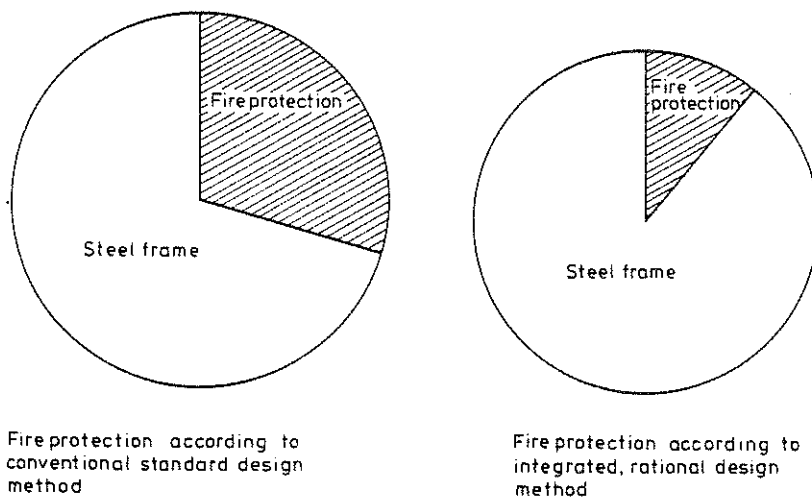

Fig.11.—Costs for fire protection

ought to be used as an important guide on how to systematize a future research work for enabling a successive improvement of the system.

REFERENCES

1. National Swedish Board of Physical Planning and Building, "Brandteknisk dimensionering (Fire Engineering Design). Comments on SBN (Swedish Building Code)," No. 1976:1.
2. Pettersson, O., Magnusson, S. E., and Thor, J., "Fire Engineering Design of Steel Structures," Swedish Institute of Steel Construction, Publication No. 50, Stockholm 1976 (Swedish edition 1974).
3. Pettersson, O., "Calcul Théoretique des Structures Exposées au Feu," Sécurité de la Construction Face à L'Incendie, Séminaire tenu à Saint-Rémy-lès Chevreuse (France) du 18 au 20 Novembre 1975, Editions Eyrolles, Paris, 1977, pp. 175-224.
4. Pettersson, O., and Ödeen, K., "Brandteknisk dimensionering av byggnadskonstruktioner - principer, underlag, exempel (Fire Engineering Design of Building Structures-Principles, Design Basis, Examples)," Liber Förlag, Stockholm, 1978.
5. Kawagoe, K., and Sekine, T., "Estimation of Fire Temperature-Time Curve in Rooms," Research Paper No. 29, Building Research Institute, Tokyo, 1967.
6. Ödeen, K., "Theoretical Study of Fire Characteristics in Enclosed Spaces," Bulletin 19, Division of Building Construction, Royal Institute of Technology, Stockholm, 1963.
7. Magnusson, S. E., and Thelandersson, S., "Temperature-Time Curves for the Complete Process of Fire Development. A Theoretical Study of Wood Fuel Fires in Enclosed Spaces," Acta Polytechnica Scandinavica, Ci 65, Stockholm, 1970.
8. Magnusson, S. E., and Thelandersson, S., "A Discussion of Compartment Fires. Fire Technology, Vol. 10, No. 3, August 1974.
9. Harmathy, T. Z., "A New Look at Compartment Fires," Part I, Fire Technology, Vol. 8, No. 3, August 1972, and Part II, Fire Technology, Vol. 8, No. 4, November 1972.
10. Babrauskas, V., and Williamson, R. B., "Post-Flashover Compartment Fires," University of California, Berkeley, Fire Research Group, Report No. UCB FRG 75-1, December 1975. - "Post-Flashover Compartment Fires: Basis of a Theoretical Model," Fire and Materials, Vol. 2, No. 2, April 1978.
11. Thor, J., "Strålningspåverkan på oisolerade eller undertaksisolerade stålkonstruktioner vid brand (Radiation Effects of Fire on Steel Structures either without Insulation or Insulated by a Ceiling)," Division of Structural Mechanics and Concrete Construction, Lund Institute of Technology, Bulletin No. 29, Lund, Sweden, 1972.
12. Thor, J., "Deformations and Critical Loads of Steel Beams Under Fire Exposure Conditions," National Swedish Building Research, Document D16:1973, Stockholm.
13. Magnusson, S. E., and Pettersson, O., "Functional Approaches - An Outline," Final Report, CIB W14 Symposium "Fire Safety in Buildings: Needs and Criteria", held in Amsterdam 1977-06-02/03, p. 120-145.