



LUND UNIVERSITY

Improving the design process by integrating design analysis

Eriksson, Martin; Burman, Åke

Published in:
[Host publication title missing]

2005

[Link to publication](#)

Citation for published version (APA):
Eriksson, M., & Burman, Å. (2005). Improving the design process by integrating design analysis. In A. Samuel, & W. Lewis (Eds.), [Host publication title missing] (Vol. DS 35). Design Society.

Total number of authors:
2

General rights

Unless other specific re-use rights are stated the following general rights apply:
Copyright and moral rights for the publications made accessible in the public portal are retained by the authors and/or other copyright owners and it is a condition of accessing publications that users recognise and abide by the legal requirements associated with these rights.

- Users may download and print one copy of any publication from the public portal for the purpose of private study or research.
- You may not further distribute the material or use it for any profit-making activity or commercial gain
- You may freely distribute the URL identifying the publication in the public portal

Read more about Creative commons licenses: <https://creativecommons.org/licenses/>

Take down policy

If you believe that this document breaches copyright please contact us providing details, and we will remove access to the work immediately and investigate your claim.

LUND UNIVERSITY

PO Box 117
221 00 Lund
+46 46-222 00 00

IMPROVING THE DESIGN PROCESS BY INTEGRATING DESIGN ANALYSIS

Martin Eriksson and Åke Burman

Keywords: Design process, Design analysis, One-off design

1 Introduction

A common denominator in most design literature is the goal of improving methods and techniques for the design process, thus contributing to increased efficiency of the design activities. It is a striking fact that the majority of the improvements suggested focus solely on qualitative methods and techniques, thereby neglecting to recognize the improvement potential inherent in quantitative methods and techniques. At the Division of Machine Design at Lund University, a number of research projects have been carried out with the objective of introducing computer based design analysis early in the design process – see e.g. Bjärnemo et al. [4] and Eriksson [1]. In the paper presented here, a case in terms of a “one-off” product will be elaborated on in some detail to demonstrate the benefits of employing design analysis throughout the design process.

2 Objective

The overall objective is to provide an insight into the necessity of computer based, quantitative methods and techniques throughout the design process, contributing to the establishment of a *balanced* product design process. A one-off design from the semiconductor industry will exemplify, and prove, that the design process will be improved by the integration of design analysis.

3 Fundamentals

To facilitate the introduction of design analysis and the case study, the fundamentals of the different constituents, disciplines and terminology will be presented, including a brief overview of the design process, design analysis and one-off products.

3.1 The Design Process

The product development process, in which the product design process is a central ingredient, encompasses all the resources/activities within an organization that contribute to the development of the product(s) identified as technologically and economically mature for market introduction. The different projects carried out within the product development process can be divided into different categories based on their relationship to the current products within the organization. For example, Pahl and Beitz [7] mention the following

categories: Novelty, Adaptive design and Variant design. Similarly, Ulrich and Eppinger [8] present the following categorization: New Platforms, Derivatives, Improvements and Fundamentally New. In addition, Ulrich and Eppinger [8] describe another category of product development projects that are related to the unique context of different organizations: Market-Pull Products; Technology-Push Products; Platform Products; Process-Intensive Products; Customized Products; High-Risk Products; Quick-Build Products and Complex Systems. The product development procedure models are usually described in the design literature in terms of a market-pull or novelty perspective, and thus have to be adapted in each specific development situation. The importance of the complete lifecycle of the product(s) is also recognized in the design literature, and Andreasen and Hein [5] give one definition of the product lifecycle: Raw material; Manufacture; Use and Disposal. The aspects of the product(s) lifecycle have to be considered throughout the whole product development process, and especially within the product design process.

The product design process is an arrangement of activities, divided into a number of phases, with the overall objective of designing a product that fulfills the product idea. Disregarding the abundance of product design procedure models available in design literature, there is a consensus that the following "generic" phases are vital for the overall design process: Conceptual design, System level design and Detail design. In order to design a product as efficiently as possible, the general consensus in design literature is to perform the design activities with well-defined specifications with which the product(s) should comply. Thus the first activity in the conceptual design phase is to identify the demands, constraints and environmental boundaries, and to formulate them in product specifications. The objective of the conceptual design phase is to develop a solution to the problem at hand in terms of a conceptual description of a product that fulfills the initially established specifications. Within the conceptual design phase, the product's function structure is also identified and studied along with the parts and components that are required to perform the product functions. In this context, *parts* are those product features that are to be designed in-house, and *components* are those that are to be ordered from suppliers. In the system level design phase, also referred to as embodiment design in design literature, is the selected conceptual solution designed further to give the product a final geometrical and functional layout. Within the detail design phase, the final geometrical description for the manufacturing of the product details is established. Simultaneously to the design of the different parts within the system level and detail design phase, the components are being developed at the supplier sites in close collaboration with the in-house design team.

It is apparent that the generic procedure model within the design process also has to be adapted depending on what category of product is to be designed. Furthermore, from a business strategy point of view, the vast variety of information, knowledge and results data obtained throughout the whole product design process are an important asset. All these data along with other product development data have to be stored for easy and systematic access.

3.2 Design Analysis Tools

Currently, both the research community and industry recognize the value added when design analysis is used in the early design phases to predict the performance of the product to be; see e.g. [2] and [3], and to investigate "what if" scenarios. However, the utilization of analytical/numerical techniques and methodologies within product development and design is seldom discussed in the product design literature. The exclusion of analysis methods and techniques implies that their impact on the development/design procedures is considered

negligible, and is thus not regarded as a constituent part/activity in the establishment of a generic product design procedure model. By introducing appropriate tools for different analyses in the design process, the number of design iterations and the amount of testing can be reduced to a minimum. Hence, reliable products can be designed with an optimum use of resources and time – thereby reducing the time to market. It is quite obvious that this approach, to minimize the number of design iterations by means of introducing analysis in the design process, is valid regardless of product category.

Design tools can be categorized as either qualitative or quantitative. In the available literature, the focus is clearly on qualitative techniques and tools, and quantitative tools – analysis tools of different kinds — are generally more or less omitted or neglected. Design analysis has traditionally been utilized as a verification tool at the latter engineering design phases and, maybe even more, to investigate failed designs or produce results. Design analysis, in this context, refers to, mainly numerical, computer tools for analysis of various physical phenomena. For example, tools for Multi Body System analysis (MBS), Finite Element Analysis (FEA) and Computational Fluid Dynamics (CFD) are available. Design analyses should be performed with a clearly stated objective including utilization of appropriate tools with relevant assumptions regarding abstraction levels and boundary conditions. The theory and applicability of these tools/methods is described in some depth in “The Finite Element Method” by Zienkiewicz and Taylor [6].

3.3 One - off Designs/Products

The importance of analysis cannot be emphasized strongly enough when one-off products/designs are at hand. In the given context, a one-off product is defined as a product where only one physical product is built, serving as prototype, test object and final product. Also note the similarity, from a design process point of view, of one-off designs and the introduction of a new product type into the product portfolio, with the exception that it might be feasible to utilize prototype testing with a new product type. In product development projects concerning one-off products, design analysis serves as the only feasible tool for development and testing throughout the design process. Hence the testing, which actually is design analysis, is “performed” on a virtual prototype. However, certain sub-systems of a one-off product might be built up from components with known working principles that are subjected to physical testing throughout the design process. Of course, non-destructive tests are performed on the final product to both verify the conditions utilized in the virtual prototype testing and to test the product’s functionality and its correspondence to the product specifications. Examples of major one-off product development projects are the “Öresundsbron”, “London Eye”, “Turning Torso”, “Mars Exploration Rovers”, Figure 1. Beyond doubt, these projects would have been impossible to accomplish successfully without the proper analysis tools within the given time and resource frames.



Figure 1. Examples of product types that are of a one-off nature

4 Introduction to Case Study

In the current one-off design project, a Semiconductor device, hereafter referred to the “shipped device” see Figure 2, which is sensitive to high acceleration levels, is to be shipped by different means of transportation. This places demands on a protection system that isolates the shipped device from vibrations and shocks during shipment. The demands on the performance of the Device Transportation System to be developed, hereafter referred to as DTS, are that the acceleration level at any point on the shipped device and at any time should not exceed a specified level. This includes both horizontal and vertical shock loads as well as vibration. The design should also handle landing and takeoff with aircraft without the shipped device to exceed a certain limit on the angle of inclination. Furthermore, there are limitations of the spatial dimensions of the DTS. These limitations emanate from the initial demand that it should be possible to fit the DTS into a container with dimensions that are well suited for airborne shipment. Based on these specifications, the conceptual design phase was initiated.

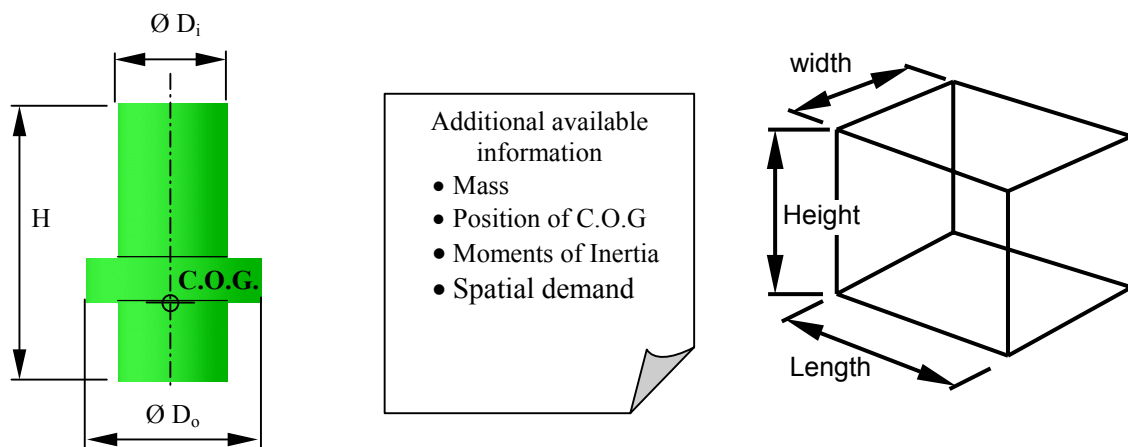

Figure 2. Description of available data regarding the demand on the shipped device

5 Conceptual Design

One of the first activities within the design process is to identify the demands, constraints and environmental boundaries, and to formulate them in Product Specifications. Throughout the duration of the project the product specifications are continuously reviewed and revised. The following activities carried out within the conceptual design phase are of an iterative nature in which the search and evaluation of possible principle solutions, from a functional and technical principle perspective, are carried out. The aim of this phase is to present a solution to the problem at hand in terms of a conceptual description of a product that fulfills the initially established specifications. Furthermore, these initial specifications are revised in order to adapt the specifications to the selected conceptual solution for the downstream design activities and final testing. The conceptual design phase activities are commonly regarded as being creative and qualitative oriented. However, as Bjärnemo et al. [4] mention, there are certain elements within these activities that are of analytical origin suitable for design analysis. The activities identified in which design analysis is successfully utilized are:

1. Searching for solution principles to fulfill the sub-functions.
2. Combining solution principles to fulfill the overall function.
3. Firming up into concept variants.

Depending on the complexity of the product, an initial task within conceptual design is to establish the function structure of the problem and thus identify the different sub-functions with varying complexity that constitute the overall function. In complex situations, the interface with the sub-system must be addressed carefully in order to not do sub-system level development with erroneously defined specifications that violate the overall specifications or impose unwanted constraints on the sub-systems. Thus the established overall system specifications and boundaries have to be studied in order to establish appropriate specifications and boundaries for the identified sub-systems and components. The identified functional/system structure of the DTS is presented in Figure 3. The overall function of facilitating shipment of the shipped device is divided into three sub-functions that are active during different time frames of the shipment procedure. In some of the sub-functions, additional levels are presented.

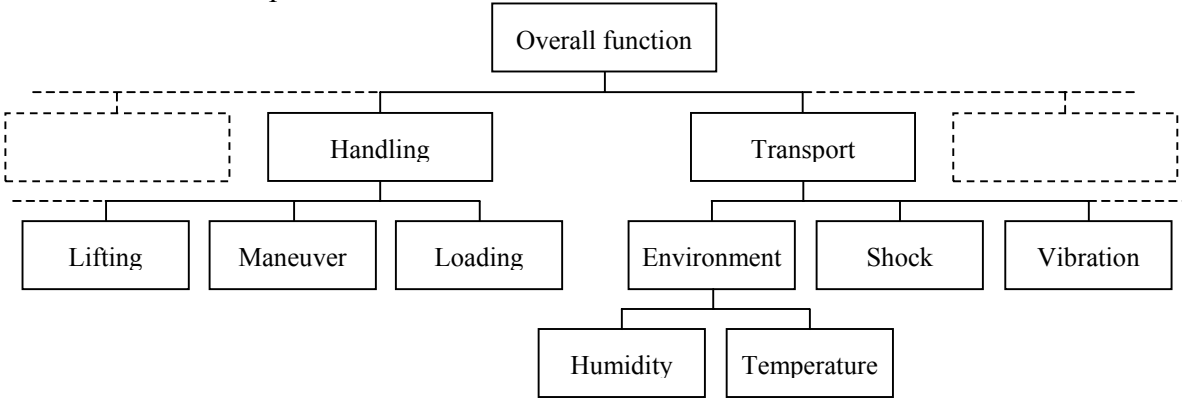

Figure 3. Functional structure of the studied DTS

When the functional structure is established, the search for working principles for the identified sub-functions is performed. A number of different solutions for the transport sub-function are identified, and one of them is presented in Figure 4. The basic idea was taken from the analogy with shipment of consumer electronics where a product is embedded (see left picture) in some cushion material that should absorb the energies during transportation. However, to facilitate the specification of handling, the solution was adjusted to include a frame mounted upon a “cushion pallet”. A number of commercially available foams were analyzed with FEA with the objective to study the feasibility of the concept in terms of force and spatial requirements. The Force displacement curves from four of the studied foams are presented in the right picture. From these analyses it was concluded that the retardation space required were long in relation to the available vertical dimension. Also most material has a fairly long recovery time after impact and decreasing energy absorption for cyclic loading which will introduce unwanted uncertainty in the uncontrolled transportation situations. The conclusion from the analyses was that the utilization of only material stiffness and damping did not look as a promising solution and were therefore not developed further.

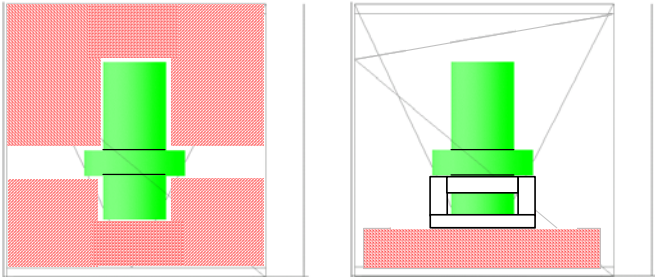

Figure 4. Presentation of the concept with a material working principle

Another idea was to utilize and possibly modify a commercially available transportation pallet based on elastic and damping system. A general description of the working principle along with some spring-damper elements is presented in Figure 5. By studying the technical description of each of the proposed vibration isolators with supplier WWW embedded presentations and evaluation tools, including design analysis, it was concluded that the most promising component technology was the cable isolators. Among the reasons for this conclusion is that the cable isolators give the design team a higher flexibility to adjust properties without altering the physical size and mounting of the component. In addition, the cable isolators allow for maximum displacement relative to the geometrical size of the component. However, if the cable isolator were to be designed to allow for enough retardation space, it would be too stiff in the vibration aspects, and also the inclination aspects are not well addressed by this concept.



Figure 5. Presentation of the concept with a transportation pallet working principle

A third solution was based on the idea that shock absorbers in combination with spring and vibration systems would satisfy the overall behavior of the sub-system. Different working structures were established, see Figure 6, with different levels of complexity ranging from the simpler variants (to the left) to the more advanced variants with gyro and mechanisms (to the right).

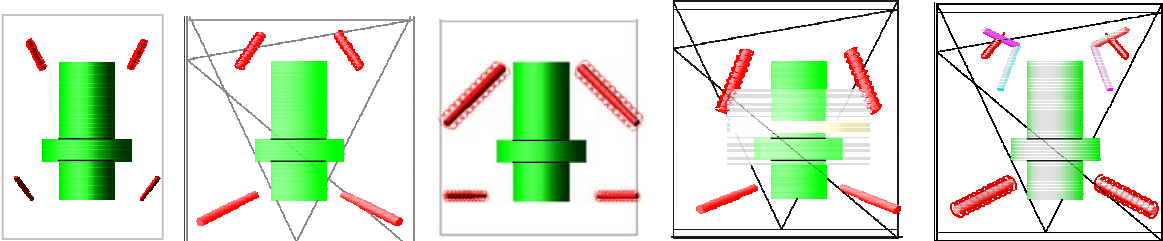

Figure 6. Display of working principles with combination of shock absorbers with spring and vibration systems

The concept variants were modeled in a MBS system with linear elastic spring and shock damping properties. The surroundings were modeled as rigid, with the assumption that the springs, shock absorbers and gyro should be the main active parts during transportation. The interface between the surroundings and the modeled parts was considered frictionless, and the parts were connected to the Center of Gravity (C.O.G.) of the shipped device. The objective established for the analyses was to compare the acceleration levels of all variants to each other and also against the acceleration specification. In Figure 7 the acceleration results over time from the side-collision situations are presented for the C.O.G.

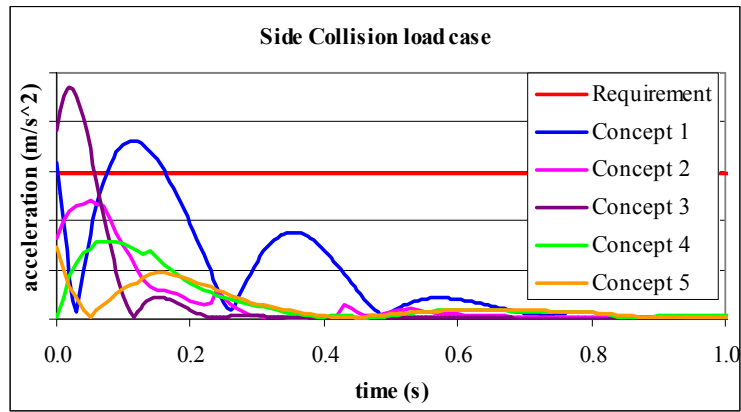

Figure 7. Results from the side collision analyses performed

Based on the analyses performed, it can be concluded that both the advanced working structures and the second variant satisfy the specification. Although the fourth and fifth working structures have slightly better behavior than the second variant, the complexity and additional number of components made the selection of the second principle favorable in the concept evaluation activity, where production and cost criteria were also studied. Figure 8 displays the selected conceptual solution placed into a principle frame design that was introduced mainly to enhance the documentation of the conceptual design. The frame was given only principle beam properties and geometrical layout in order to represent the needed volume of the solution with regards to the movement required as described by the MBS. The principle frame data were established and refined during an iterative process in which the MBS forces were transferred into the FEA where the structural response was studied. The objective of the analyses was to find some overall geometrical beam data that would be feasible from a material yield strength perspective.

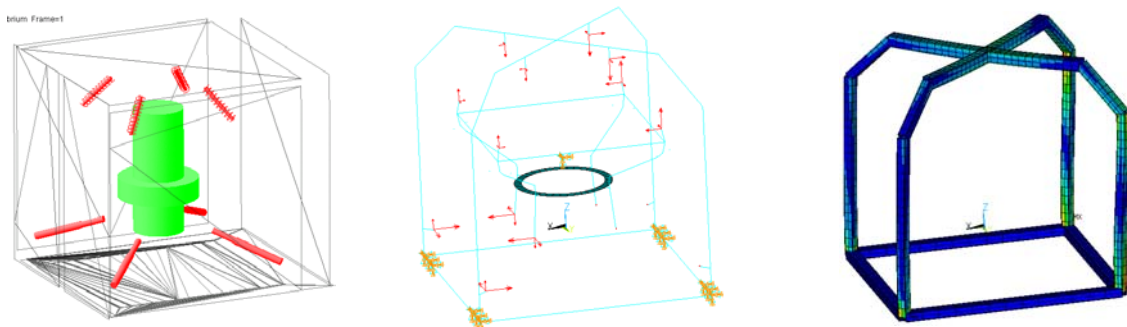

Figure 8. Presentation of selected conceptual design

In the conceptual solution selected, the vibration function could be established by integrating it into the same components as the shock system. However, from an economical as well as technical point of view, it was decided that a separate system would be preferable since this will most certainly give simpler and standardized components that will be more cost effective with higher reliability. The initially established specifications were adapted to the selected conceptual solution so that the comparison of the DTS against the specifications was more easily executed. Furthermore, specifications for the final physical tests that were to be performed were added to the product specification. Note that in situations with One-off designs, the fundamental criteria for testing are that it should be a non-damage test, since the mockup or prototype used in the tests is also the final product. Thus no mechanical damage on the product is allowed after the test procedure.

The advantages gained from using design analysis in the conceptual design phase are mainly illustrated by the possibilities of combining different solution principles to form a conceptual virtual prototype to study primary as well as secondary functions even at this early phase of the design process. This gives the project team the means to predict the behavior of the final design. The influence of and uncertainty in the different components and parts can be analyzed by parameter studies of the virtual prototype.

6 System level design

From a design analysis point of view, the focus within system level design is shifted from studying the conceptual solutions at abstract levels to include more concrete geometrically extracted properties of details and extended properties for components. The initial activities within this phase are to study the established functions and to identify the main and auxiliary functions. The main functions are those that are considered to be most important from the overall function perspective. In the case study, the transport functions (shock and vibration isolation) were identified as the main functions. The shock and vibration isolators along with the frames that enable these functions are displayed in Figure 9.

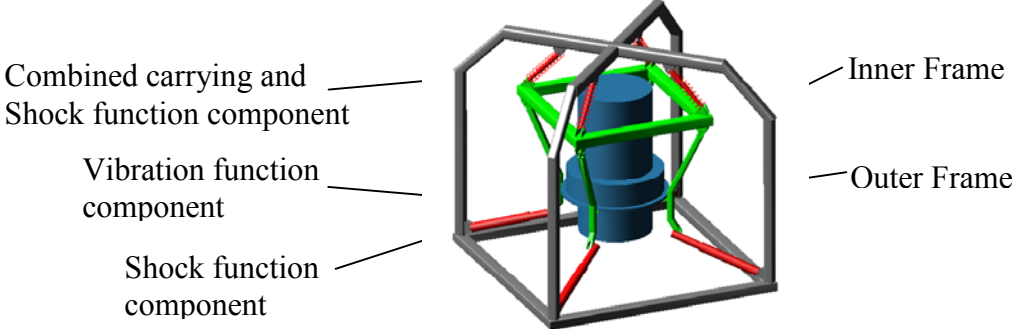

Figure 9. Principle layout along with the components supplying the main functions

In the remainder of the system level and detail design phases presented in this paper, the analyses presented are towards the development of the outer frame. The layout of the conceptually sketched frame design was refined throughout an iterative process of analysis and synthesis in which the shock and vibration components as well as the inner and outer frames were continuously updated based on response from the system simulations. The solution activity can be summarized as displayed in Figure 10.

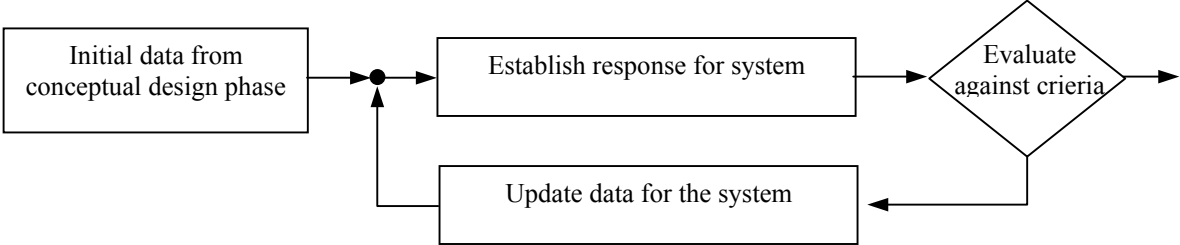

Figure 10. General solution process within the system level design phase

To facilitate the FEA on the complete system, the modeling of the vibration and shock components utilized within the MBS system was adopted to FEM representation. This was based on initial discussions with suppliers of shock absorbers where the damping coefficients shifted from the linear to a non-linear curve as displayed in Figure 11. The damping coefficients utilized were non-linear functions of the velocity. The spring coefficient utilized

in the upper spring-damper system was modeled as linear with respect to the shock damper stroke. The dampers are further described together with the component test; see section 7.

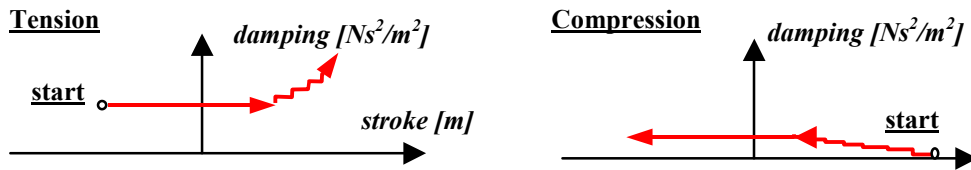

Figure 11. General description of the utilized damping characteristics of the shock absorbers

The FEA modeling of the vibration component was performed as shown in Figure 12 for horizontal orientation with a set of non-linear springs in combination with linear dampers giving the overall component the properties with regards to the relative motion of the two mounting blocks; see right picture in Figure 12. The two mounting blocks were fastened to both the inner frame and the shipped device by a number of bolts modeled with a specific pre-tension.

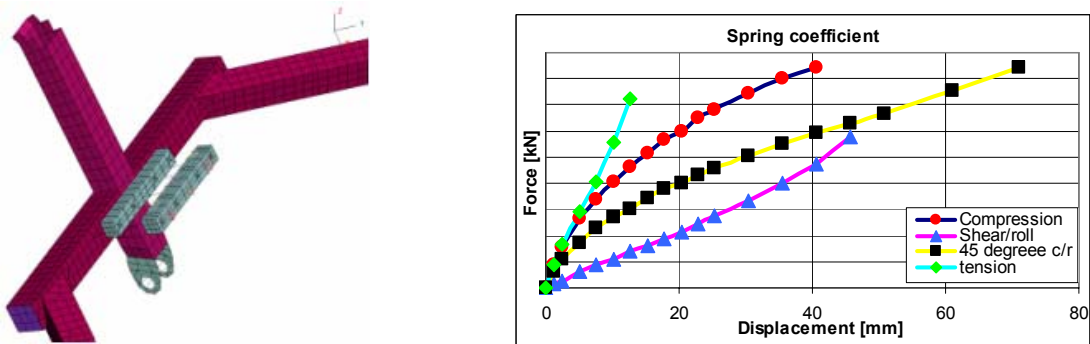

Figure 12. Representation of the modeling and properties of the vibration components

An exploratory study was performed to find the most robust placement of the vibration isolation component. In Figure 13 the results from two of the placements studied (horizontal and vertical) are displayed for two locations (C.O.G and top) on the shipped device. The plots clearly show that the horizontal placement results in a more robust response than the vertical placement. The final placement and mounting of the vibration component is displayed in the left picture in Figure 13.

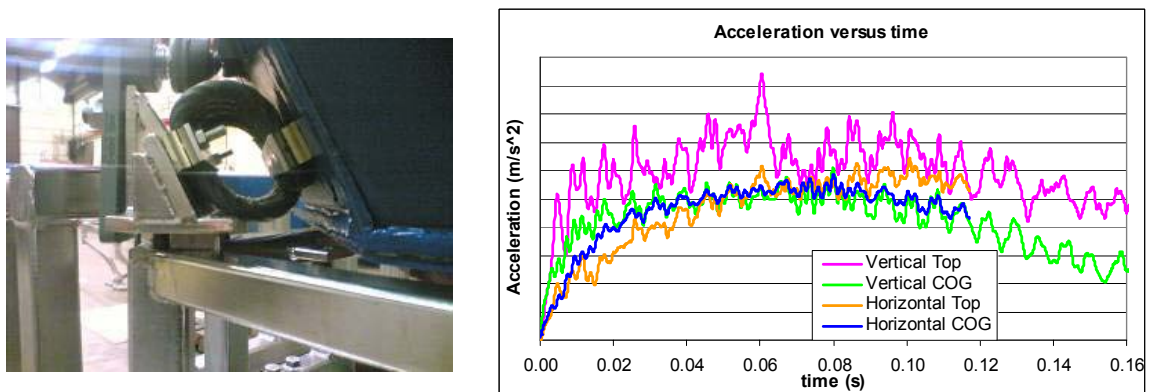

Figure 13. Results from the exploratory study of the vibration isolation components and its final mounting

In Figure 14 the layouts are presented from left to right in the iterative process of finding a suitable overall layout with the initial model on the left and final model on the right. In the

models, preliminary layouts for the auxiliary functions of handling were also included in order to incorporate them into the complete system.

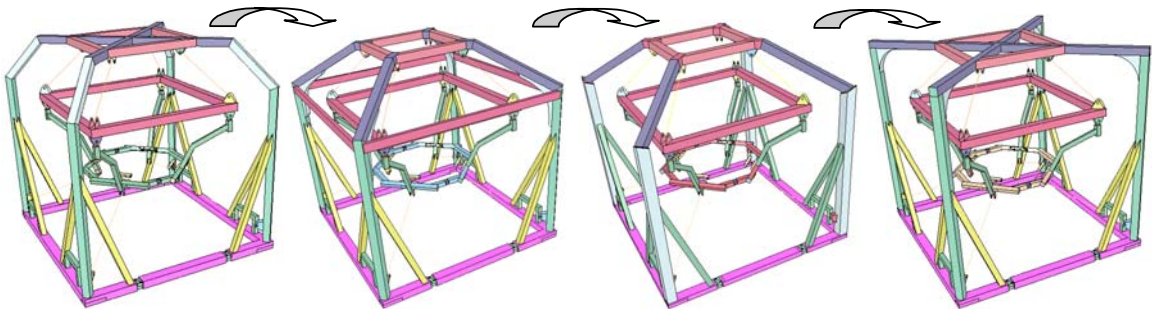

Figure 14. Preliminary layouts for the DTS

In Figure 15 the results from the vertical collision are presented for the four preliminary layouts. All preliminary layouts comply with the acceleration specification, but when also studying the stress levels in the upper corner of the vertical beams in the outer frame it can be seen that the fourth layout has the overall lowest stress levels during the collision. This is the general trend when also studying the other load cases included in the product specifications. The combination of the global and local stiffness together with a general low stress state in the fourth layout made it the most suitable layout for further development in the detail design phase. With the definitive design layout as the basis, a number of virtual prototype analyses were performed to study the behavior of the definitive layout in the different load cases specified in the product specifications. Furthermore, the areas with highest stress levels are identified along with specific characteristics to be given consideration in the detail design phase. Additionally, component specifications were established for the components that were to be ordered from suppliers.

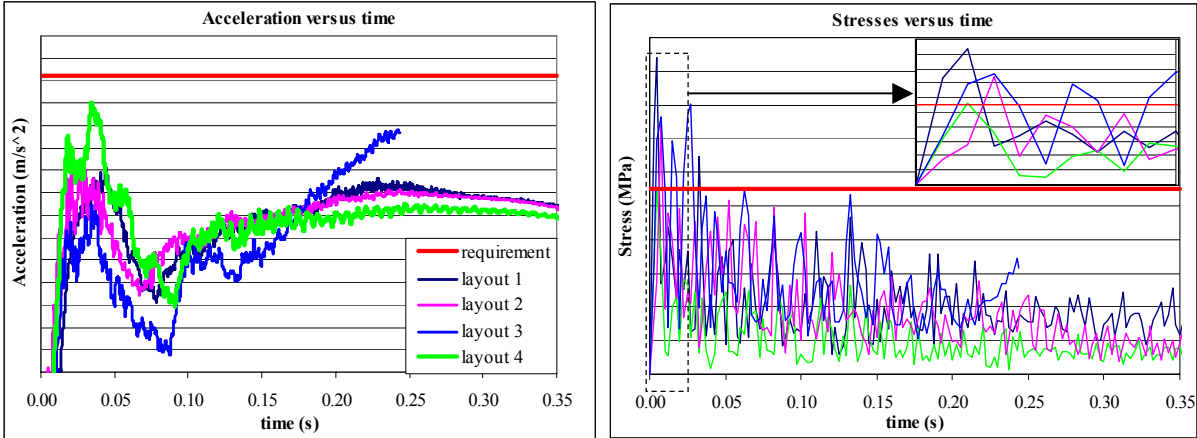

Figure 15. Comparison of results from the different preliminary layouts of the DTS

By utilization of design analysis in the system level design phase, the extracted information from each design iteration can easily be evaluated. By creating parametric design analysis models, the design iteration loops can also be performed with greater efficiency. Furthermore, these models can also be adapted to simulation of the virtual prototype to search for a suitable final layout.

7 Component level development and test

In collaboration with the suppliers, component level analyses were performed throughout the system level design phase and the detail design phase. The characteristics of the supplier-suggested components were incorporated in the different analysis models to determine the feasibilities of the proposed components. Once the final design layout was established in the system level design phase, and acceptance of the virtual prototype analyses was agreed upon, the component specifications were updated and submitted to the suppliers. Simultaneously with the detail design phase activities, the components were being developed at the supplier sites. When the development of a component prototype was finished, the prototype was tested. A typical test rig and results from the shock damper component testing utilized in the current DTS is displayed in Figure 16. The procedure used implies that a number of repetitive tests at different velocities should be performed so that the uncertainty in the results could be validated. These test results were compared to the component specifications and also incorporated as component properties in the overall analysis models utilized in the detail design phase. After final approval of the prototype component, the final components were produced, and they were also subjected to the same test procedure. The results from these tests were utilized as component properties for each individual component in the virtual prototype analyses of the use process and test situations, described further in section 10.

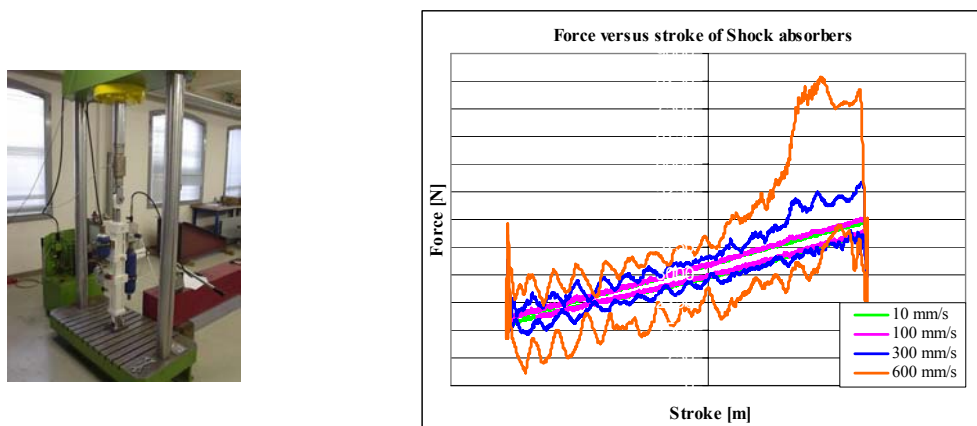

Figure 16. Picture of test rig and component test results for the Shock absorber component

8 Detail design

The general objective of design analyses within the detail design phase is to facilitate the selection of a final design that will withstand the loads that it is exposed to during all applicable phases of its life cycle. In the case study, the dynamic nature of the shipment of the shipped device was identified as the main concern that might initiate durability considerations in the DTS. Thus, in addition to the linear static and dynamic design analyses induced by equilibrium and collisions, lifetime evaluation was being performed in which the effects of the vibration load histories were considered. Since no load history data from the different shipment functions were available in advance of the case study, these data were extracted from various standards. Figure 17 displays a couple of applicable standards where the Power Spectrum Density (PSD) versus frequency is plotted. The total fatigue life estimation of a shipment was calculated by utilizing the Palmgren-Miner rule, in which all relative fatigue damages from the time durations of all shipping activities are combined into an overall fatigue damage that is compared to the material Stress-Life curve (S-N curve), like the utilized frame material displayed in the right picture in Figure 17.

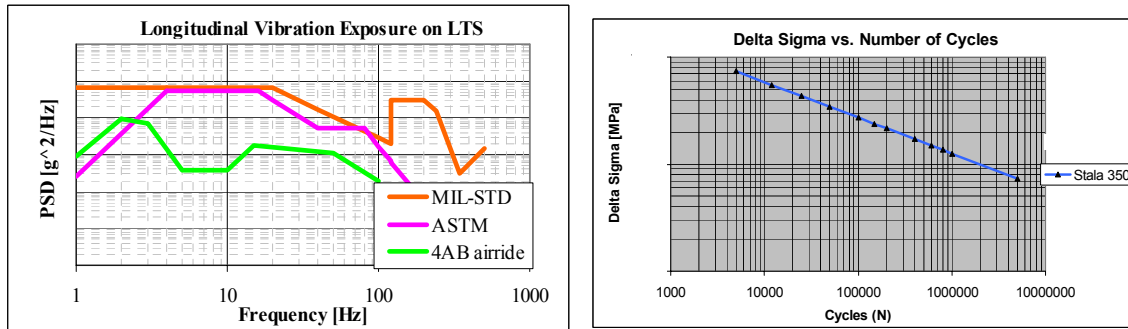

Figure 17. Presentation of Spectra from different standards and the S-N curve for the frame material

These in depth lifetime evaluations were performed on a number of locations on the DTS. The connection points on the top beams on the outer frame structure close to where the upper shock absorbers were placed were identified as critical locations. One of these locations is presented in Figure 18 where the left picture represents the model utilized in the system level design phase. The overall coarse FE discretization is well suited for the system level design phase, in which the overall stiffness and stress levels are more important than the specific stress at a specific point must be validated through some convergence study. Two models with increasing level of detailing (increased number of shell elements and detailed solid elements respectively) established in the convergence study performed are presented in Figure 18. As can be seen in the refined shell element model and solid element model, the stress levels and stress pattern are quite similar, and it was concluded that the refined shell model was sufficient to predict the stresses in the model during the design analyses performed in the detail design phase.

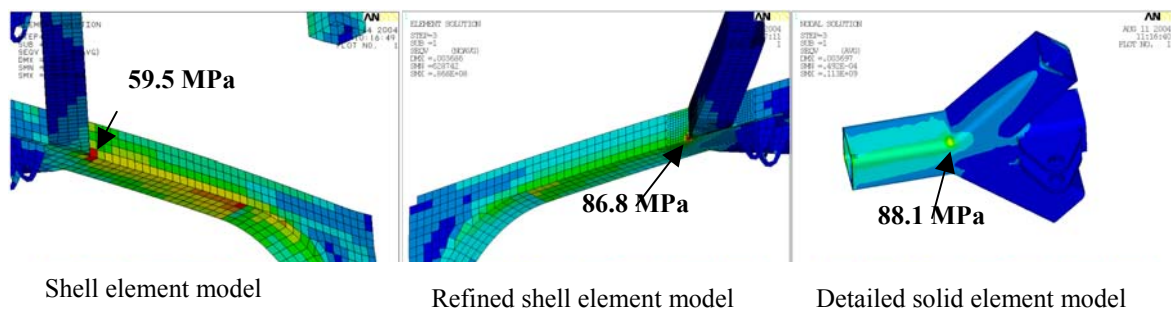

Figure 18. Stress results from the three different mesh densities on the studied connection point

Design analysis can be utilized to predict the structural integrity and also to undertake detailed studies of areas of interest such as the fatigue life predictions discussed above. Employing conventional methods, similar amounts and detailed levels of information and knowledge obtained by utilizing design analyses would not be feasible from an economic and time frame perspective.

9 Documentation and manufacturing

The documentation of the final product design was prepared in different formats such as 3D model presentations, user manual and drawings, see Figure 19. Most of these data were extracted from the models established in the CAD system. To support the documentation animations, showing the proper handling procedures, created in the CAD system as well as in the design analysis tools, were included in the documentation.

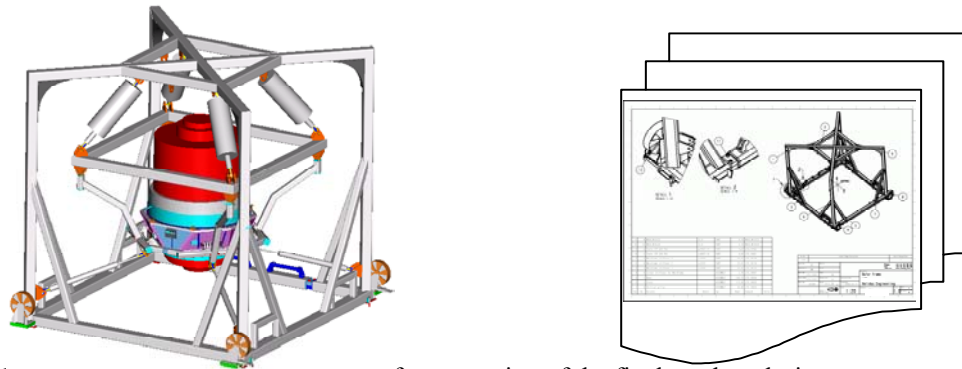

Figure 19. Representation of two different ways of presentation of the final product design

The DTS was manufactured based on the drawings produced. During the manufacturing process, the project development team was involved in a couple of situations where the manufacturing procedure needed to be studied. Additionally design analysis can be used when a problem during manufacturing is discovered of such magnitude and origin that the solution implies certain modifications/decisions regarding the design.

10 Simulation and system level testing of the virtual prototype

Once the final design was established and documented, the virtual prototype was updated to represent the final design and the component characteristics extracted from the component level tests. In this activity, the virtual prototype was utilized in two different areas, namely the virtual simulation of the use process and virtual simulation of the test. In the analyses of the use process, the objective was to verify that the DTS complies with the specifications.

The other area concerns the physical functional testing of the DTS. Since no test rigs that could be utilized during the functional test were available, they had to be developed in collaboration with the test institute. Figure 20 displays the final developed model from one of the performed testing situations. The model is used as the collision load cases was the design mounted on a developed test rig, which is driven into a wall.

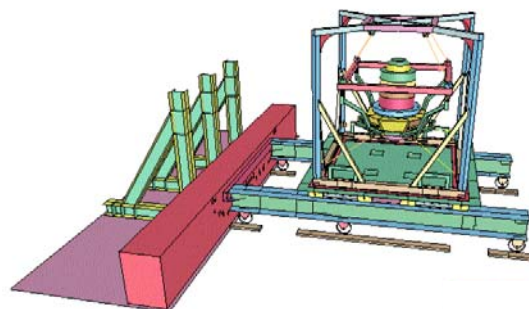

Figure 20. FE-model of the virtual system level prototype testing environments

Besides the objective to simulate the use process and the specific test situations, the analyses indicate where accelerometers and strain gages should be placed on the DTS as well as the shipped device.

11 Functional testing

After all components and details were designed and manufactured, physical testing was performed to evaluate the product compliance with the design specifications. These tests were performed on the system level where the overall function and some of the main functions were studied along with specific lifetime evaluations extracted from strain gages at the locations established in the virtual prototype testing. A number of tests were performed for each situation, and the test curve in Figure 21 displays one the situations. The test curve is the average results from the tests, and the simulation curve is the average results based on the results from analyses with actual initial measured data from the physical test. In Figure 21 the test setup and the correlation of the test results with virtual prototype simulation results are presented for the side collision load cases.

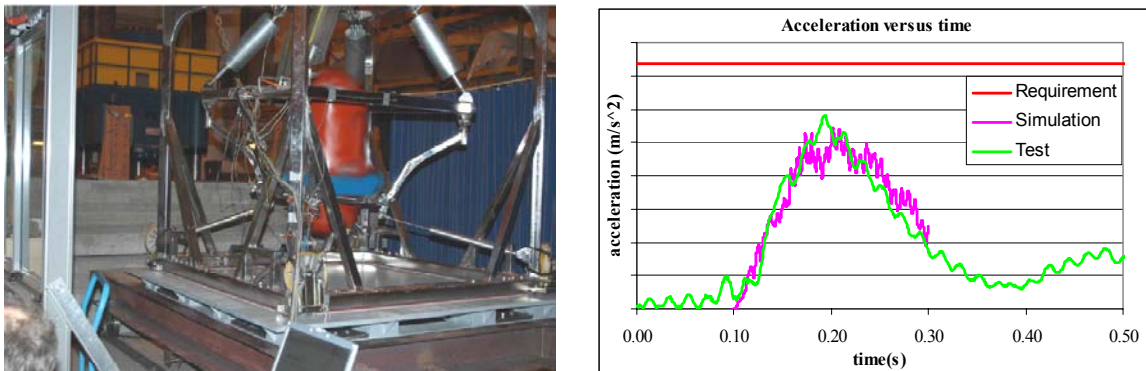

Figure 21. Test setup and comparison of test and analysis results from the side collision load case

Since destructive testing cannot be performed, the results obtained from the functional testing was evaluated against the results from the “Simulation and system level testing of the virtual prototype” to ensure that the analysis model was capable of capturing the overall behavior as well as on a detailed level. Convinced that the analysis model is capable of predicting the load cases that form the basis of the product specifications, it was possible to evaluate the DTS analysis results.

12 Conclusions

From the case study it is concluded that a successful project in the given time and resource frames of the current one-off design would not be achievable without design analysis. By integration of design analysis in the design process, the full potential of design analysis can be employed at different abstraction levels. Furthermore, the case study shows that the utilization of design analyses in the early phases of the design process gives the design team the possibility to early predict the overall behavior of the product during the majority of the phases of the lifecycle. The case study indicates that a procedure model, in which design analysis is integrated as an essential activity, would enhance and improve the engineering design process and thus the final outcome – the product.

References

- Papers in proceedings:

- [1] Eriksson, M., "Efficient Use of Finite Element Analysis in Early Design Phases", Proceedings of DETC'00 ASME 2000 Design Engineering Technical Conferences, Baltimore, USA, 2000.
- [2] Albers, A., Matthiesen, S., Ohmer M., "An innovative new basic model in design methodology for analysis and synthesis of technical systems", Proceedings of ICED 03, WDK 25, Stockholm 2003.
- [3] Brix, T., Döring, U., Reeßing, "Multi-Stage Modeling in early phases of design", proceedings of ICED 03, WDK 25, Stockholm 2003.
- Books:
 - [4] Bjärnemo, R., Burman, Å., Anker, J.C., "FEA in the Engineering Design Process", Computer Aided Design/Computer Aided Engineering (CAD/CAE) Techniques and Their Applications, Volume 58 , Part 1 of 2 Chapter 4, 1993.
 - [5] Andreasen, M. M., Hein, L., "Integrated Product Development", IFS (publications) Ltd./ Springer – Verlag, 1987.
 - [6] Zienkiewicz, O. C., Taylor, R. L., "The Finite Element Method", 4 ed. vol. 1 and 2, McGraw-Hill, London, 1991.
 - [7] Pahl, G., Beitz, W., "Engineering Design – A Systematic Approach", Springer-Verlag, London, 1996.
 - [8] Ulrich K. T., Eppinger, S. D., "Product Design and Development 3.rd ed.", McGraw-Hill, 2004

Martin Eriksson
Lund University
Department of Design Sciences
Division of Machine Design
P.O. Box 118; SE. 221 00 Lund
Sweden
Phone: +46 46 222 85 11
Fax: +46 46 222 80 60
E-mail: martin.eriksson@mkon.lth.se