



# LUND UNIVERSITY

## ESS Energy Design Report

Parker, Thomas; Andersson-Ek, P.; Bengtsson, R.; Blücher, A.; Didriksson, M.; Eriksson, Roger; Fröjd, C.; Gesterling, M.; Gierow, M.; Indebetou, Fredrik; Jensen, Frithiof; Jurns, John; Lindström, Erica; Lundgren, D.; Nilsson, Monica; Persson, Jörgen; Persson, T.; Renntun, M.; Stenlund, J.; Strömberg, S.; Strandberg, G.; Stråth, N.; Swartling-Jung, M.; Wiegert, M.; Österback, R.

2013

[Link to publication](#)

### *Citation for published version (APA):*

Parker, T., Andersson-Ek, P., Bengtsson, R., Blücher, A., Didriksson, M., Eriksson, R., Fröjd, C., Gesterling, M., Gierow, M., Indebetou, F., Jensen, F., Jurns, J., Lindström, E., Lundgren, D., Nilsson, M., Persson, J., Persson, T., Renntun, M., Stenlund, J., ... Österback, R. (2013). *ESS Energy Design Report*. (ESS reports; Vol. ESS-0001761). European Spallation Source ESS AB.

[http://europeanspallationsource.se/sites/default/files/20130131\\_ess\\_edr.pdf](http://europeanspallationsource.se/sites/default/files/20130131_ess_edr.pdf)

*Total number of authors:*

25

### **General rights**

Unless other specific re-use rights are stated the following general rights apply:

Copyright and moral rights for the publications made accessible in the public portal are retained by the authors and/or other copyright owners and it is a condition of accessing publications that users recognise and abide by the legal requirements associated with these rights.

- Users may download and print one copy of any publication from the public portal for the purpose of private study or research.
- You may not further distribute the material or use it for any profit-making activity or commercial gain
- You may freely distribute the URL identifying the publication in the public portal

Read more about Creative commons licenses: <https://creativecommons.org/licenses/>

### **Take down policy**

If you believe that this document breaches copyright please contact us providing details, and we will remove access to the work immediately and investigate your claim.

LUND UNIVERSITY

PO Box 117  
221 00 Lund  
+46 46-222 00 00



EUROPEAN  
SPALLATION  
SOURCE

# ESS Energy Design Report

Outcomes from the collaboration  
between ESS, E.ON and Lunds Energi  
2011-2012

# ESS Energy Design Report

Outcomes from the collaboration between ESS,  
E.ON and Lunds Energi  
2011-2012

## The ESS Energy Proposal

**THE CONCEPT**  
The concept 'Responsible, Renewable, Recyclable and Reliable' will make ESS a net sink for carbon dioxide and therefore contributes greatly to the sustainability of the facility.

**THE RESEARCH**  
With this concept ESS will set a new standard for large-scale research facilities. The research at ESS will put Europe in the lead with regard to sustainable development.

**THE FUTURE**  
ESS is a long-term commitment that will benefit coming generations and contribute to managing global environmental challenges. Setting a new standard is an important statement for the future.

**THE ECONOMY**  
The concept 'Responsible, Renewable, Recyclable and Reliable' will significantly lower the operations cost, making it possible to produce more research for a better future.

**Editor:** T. Parker

**Contributors:** P. Andersson-Ek, R. Bengtsson, A. Blücher, M. Didriksson, R. Eriksson, C. Fröjd, M. Gesterling, M. Gierow, F. Indebetou, F. Jensen, H. Johannesson, J. Jurns, E. Lindström, D. Lundgren, M. Nilsson, J. Persson, T. Persson, M. Renntun, J. Stenlund, G. Strandberg, S. Strömberg, N. Stråth, M. Swartling-Jung, M. Wiegert, R. Österback

ESS Energy Design Report  
January 22, 2013  
ESS-0001761  
ISBN 978-91-980173-1-1

# Contents

<b>Chapter 1 ESS Energy Design Report.....</b>	<b>8</b>
Introduction .....	9
<b>Chapter 2 ESS Energy Management Plan .....</b>	<b>14</b>
Introduction and summary .....	15
ESS Energy Management Plan .....	16
Relevant Publications and Documents .....	17
Acronyms	
1. Energy Management System .....	18
1.1 Introduction .....	18
1.2 Restrictions .....	18
1.3 Energy policy .....	19
1.4 Energy Planning .....	19
2. Planning Inputs .....	20
2.1 External requirements on energy use .....	20
2.2 Internal requirements on energy use .....	21
3. Energy Inventory .....	21
3.1 Methodology and restrictions .....	21
3.2 Prerequisites and assumptions .....	21
3.3 Results from energy inventory .....	24
3.3.1 Overall energy use .....	24
3.3.2 Energy use in different modes of operation .....	25
3.3.3 Processes with significant energy use .....	29
3.3.4 Regarding cooling and heat recovery .....	31
3.3.5 Comment regarding energy use of Conventional Facilities .....	32
4. Energy Management Action Plan .....	32
4.1 Energy baseline .....	32
4.2 Energy performance indicators .....	33
4.3 Energy objectives and targets .....	33
4.4 Energy management action plan .....	34
4.4.1 Overall considerations .....	34
4.4.2 General/Top management .....	34
4.4.3 Accelerator .....	35
4.4.4 Target .....	36
4.4.5 Neutron Scattering Systems .....	37
4.4.6 Conventional Facilities .....	38
4.4.7 Energy Project .....	39
5. Appendix .....	40
<b>Chapter 3 ESS Business Plan Renewable Energy .....</b>	<b>48</b>
Introduction and summary .....	49
ESS Business Plan Renewable Energy .....	50
References .....	51
Executive Summary .....	52
Conclusions .....	52
Next steps/high level action plan .....	53
1. ESS goals/demands with Renewable Electricity .....	54
1.1 Recycling of energy .....	54
1.2 Implications of the choice of ESS's legal status on renewable energy .....	54
1.3 Implications of taxes .....	55
2. Background information .....	56
2.1 About the first years, electricity need for construction .....	56
2.2 Why there is a need for a delivery agreement and an electricity consumption agreement .....	56
2.3 The need for sites (land grabbing) .....	56
3. Risk hedging related to the needs of ESS .....	57

3.1 General description of risks in electricity cost for ESS.....	57
3.2 The spot market.....	57
3.3 The financial market and price hedging .....	57
3.4 Principles of risk management and hedging for consumption and production .....	58
3.5 Profile risk.....	58
3.6 Volume risk.....	58
3.7 Principles on financial hedging for stable electricity costs .....	58
3.8 Comparison of the consumption pattern of the ESS with yearly and monthly profile of wind power production in Sweden .....	59
3.8.1 ESS electricity consumption pattern .....	59
3.8.2 The hourly variation/distribution of wind production .....	59
3.8.3 Monthly variation during one year of operation .....	60
3.8.4 Conclusions .....	60
4. Sensitivity analyses and key financial indicators .....	61
4.1 General assumptions – Base Case.....	61
4.2 Result calculation Base Case.....	61
4.3 Sensitivity analysis .....	61
4.4 Conclusions.....	62
5. Waste heat from ESS to district heating system in Lund .....	63
5.1 Conclusions.....	63
6. The main alternatives.....	64
6.1 Short description of the five main alternatives.....	64
6.2 General assumptions .....	65
6.3 Reference alternative 0, No new wind power plant is built, price hedging, e.g., five years rolling agreements.....	65
6.4 Main alternative 1a, ESS builds and owns a new wind power facility together with a financial partner. Spot delivery and spot consumption agreement.....	65
6.4.1 Concerning risks due to hourly deviations between production and consumption where the ESS own and operate a wind power production plant and where both the electrical and delivery are exposed to spot agreements .....	66
6.5 Main alternative 1b, ESS builds and owns a new wind power facility together with a financial partner. Hedging delivery and consumption agreement .....	67
6.5.1 Securing prices for wind power production .....	67
6.6 Main alternative 2, ESS builds and owns a new wind and solar power production facility together with a financial partner. Spot delivery agreement. Energy company build new bio mass power plant (CHP).....	67
6.6.1 Solar power challenge .....	67
6.6.2 Bio mass CHP (Combined Heat and Power) challenge .....	68
6.7 Main alternative 3, energy company builds, owns and operates new wind power plant on order from ESS. ESS can be a part-owner in the plant.....	68
6.7.1 Example 1: Price formula connected to the economy of a wind power plant.....	68
6.7.2 Example 2: Fixed price with index not connected to products at Nord Pool or to the economy of a wind power plant .....	69
6.8 Conclusions regarding the four alternatives.....	69
7. List of Abbreviations.....	70
8. Appendix .....	71
8.1 The world and Swedish wind power markets and technology trends.....	71
8.2 The Nordic electricity market.....	72
8.3 The green certificate market .....	72
8.4 The onshore wind power process – from a greenfield project to a running plant.....	73
8.4.1 Pre-development.....	73
8.4.2 Development and Permit Application .....	73
8.4.3 Tender .....	74
8.4.4 Construction .....	74
8.4.5 Operational phase .....	74
<b>Chapter 4 Cooling and Heat Recovery .....</b>	<b>75</b>
Introduction and summary .....	76
Cooling and Heat Recovery .....	77

1. Background.....	78
2. Ess Cooling demands .....	78
2.1 Linear accelerator .....	78
2.1.1 Pressure requirement.....	79
2.1.2 Availability requirement.....	79
2.2 Target .....	80
2.2.1 Pressure requirement.....	80
2.2.2 Availability requirement.....	80
2.3 Cryogenic plants.....	81
2.3.1 Pressure requirement.....	81
2.3.2 Availability requirement.....	81
2.4 Instruments.....	81
2.5 Test Stand.....	82
2.6 Others.....	82
2.7 Operating times and modes of operation .....	83
2.8 Summary .....	83
3. Cooling System.....	84
3.1 Overall system design .....	84
3.2 Cooling central.....	87
3.3 Distribution system.....	88
3.4 Substations .....	88
3.4.1 Linac substation options .....	89
3.5 Emergency/back up cooling .....	92
3.6 Heating of ESS buildings .....	93
4. Investments and operational costs .....	93
5. Optimisations calculations .....	95
5.1 Two or three cooling systems?.....	95
5.2 Cooling temperatures and the effect on operating costs .....	96
5.2.1 Background .....	97
5.2.2 Calculations .....	97
6. Heat recovery options .....	98
6.1 Internal systems.....	98
6.1.1 Sorptive cooling.....	98
6.1.2 Absorption heat pump/cooling machine.....	98
6.1.3 ORC/Power box.....	99
6.1.4 Heat driven stirling engine .....	99
6.1.5 Gas engine plant.....	99
6.2 Low-level heat alternatives.....	100
6.2.1 Anti-icing systems.....	100
6.2.2 Greenhouse .....	100
6.2.3 Biogas plant.....	101
7. Time Schedule .....	101
<b>Chapter 5 Business Plan Energy Recycling.....</b>	<b>102</b>
Introduction and summary .....	103
Business Plan Energy Recycling.....	104
References .....	105
Executive Summary .....	105
1.1.1 Conclusions:.....	106
1.1.2 Next steps .....	107
2. ESS Energy goals and demands on Recycling of energy .....	107
2.1 Top-level energy requirements .....	107
2.2 Additional opportunities .....	107
3. Short description of the Four main alternatives .....	107
4. Background information .....	108
4.1 ESS spearheading the development on how to recycle energy.....	108
4.2 General conditions .....	109
4.3 Land requirements .....	109
4.4 Implications of the choice of ESS's legal status on recyclable energy .....	109

4.5 Implications of taxes .....	110
5. The main alternatives.....	110
5.1 General facts and figures.....	110
5.2 Cooling towers – reference solution .....	111
5.3 Recycling high and medium temperatures into the district heating system and rejecting the low temperature with dry chillers.....	111
5.4 Recycling into energy suitable for the district heating system - CDR.....	112
5.5 Recycling into commercial food production.....	113
5.6 Recycling into food, fodder and fuel – Hybrid Cooling chain and CDR.....	114
5.6.1 The hybrid cooling chain .....	114
5.6.2 Biofuel and heat for water treatment.....	117
6. List of Abbreviations.....	117
<b>Chapter 6 Power System.....</b>	<b>118</b>
Power System .....	119
Power System .....	120
1. General requirements on the power system.....	121
2. Power demand .....	121
3. Power quality.....	122
4. Availability of power supply .....	123
5. Primary distribution substation .....	123
5.1 High-voltage grid .....	124
5.2 Substation buildings.....	124
5.3 Power transformers .....	124
5.4 Medium voltage connection .....	125
5.4.1 Medium voltage switchgear .....	125
5.4.2 System earthing and earth fault protection.....	125
6. Secondary distribution substations and medium voltage grid.....	126
6.1 In general .....	126
6.2 Medium –voltage cable system.....	126
6.2.1 Cable requirements .....	127
6.3 Substations .....	128
6.3.1 Medium voltage switchgear .....	129
6.3.2 Low voltage switchgear .....	129
6.3.3 Signs.....	129
6.3.4 Power transformers .....	129
6.3.5 Functional earthing .....	129
7. Distribution system demands.....	130
7.1 Interruption consequences (in total) .....	130
7.1.1 Machine Protection System – MPS .....	131
7.1.2 Personnel Safety System – PSS.....	131
7.1.3 Prioritised power.....	131
7.2 Klystron Gallery.....	131
7.2.1 LINAC.....	132
7.2.1.1 Assumption.....	132
7.2.1.2 Design .....	133
7.2.2 Ion source .....	133
7.2.2.1 Assumptions .....	133
7.2.2.2 Design .....	133
7.2.2.3 Klystron Modulator .....	133
7.2.2.4 Tetrode.....	134
7.2.2.5 Klystron .....	134
7.2.3 Low-level RF (LLRF) .....	134
7.2.4 High energy beam transport .....	134
7.2.5 Beam-line instrumentation.....	135
7.2.6 Vacuum system .....	135
7.2.6.1 Requirements .....	135
7.2.6.2 Assumptions .....	136
7.2.6.3 Design .....	136



7.3 RF test hall .....	136
7.4 Target .....	136
7.4.1 Requirements.....	137
7.4.2 Assumptions .....	137
7.4.3 Design .....	137
7.5 Cryo-plants.....	137
7.5.1 Requirements.....	138
7.5.2 Assumptions .....	138
7.5.3 Design .....	139
7.6 Instruments.....	139
7.6.1 Requirements.....	139
7.6.2 Assumptions .....	140
7.6.3 Design .....	140
7.7 Instrument workshop.....	141
7.8 Facilities and utilities.....	141
7.9 Computing and control system.....	141
7.10 Cooling system.....	141
7.10.1 Requirements .....	141
8. Back-up power and redundancy .....	141
8.1 Uninterruptible Power Supply (UPS).....	141
8.2 Emergency back-up generator.....	142
9. Supervisory Control and Data Acquisition (SCADA).....	142
10. Magnetic fields.....	142
11. Maintenance philosophy.....	143
11.1 Daily maintenance.....	143
11.2 Monthly maintenance.....	143
11.3 Yearly maintenance.....	143
12. Organization .....	143
13. Time plan .....	144
14. APPENDIX I – Single-line diagrams.....	145
15. APPENDIX II – Voltage dip statistics.....	146
16. APPENDIX III –Electrical Standards, Rules and Regulations .....	147
<b>Chapter 7 Grid Simulation .....</b>	<b>148</b>
Grid Simulation .....	149
Grid Simulation .....	150
1 General introduction on modeling approach .....	151
1.1 Lund grid in RTDS.....	151
1.2 ESS accelerators in MATLAB (detailed power-electronic model).....	152
2 Updating of data .....	152
2.1 Available data of Lund grid .....	152
2.2 General grid code of E.ON Sverige AB.....	157
3 Preliminary test results.....	158
3.1 Real time simulation of Lund Grid .....	158
3.2 Test results of the simulation .....	160
3.2.1 Short circuit test .....	160
3.2.2 Tripping of power source .....	172
3.2.3 Loss of branches and transformers.....	173
3.2.4 Connection of ESS to Lund grid.....	174
3.2.5 Disconnection of ESS to Lund grid.....	175
3.2.6 Load of ESS with Charging scheme I and III.....	176
3.2.7 Harmonic tests at different buses.....	177
3.2.8 Impact of wind farm with different generation ratio.....	180
3.2.9 Uncertainty analysis for the variation of loads and wind farm generation .....	181
4 Conclusions.....	192
<b>Chapter 8 ESS Energy Design Report.....</b>	<b>193</b>
Conclusions.....	194

# Chapter 1

## ESS Energy Design Report

# Introduction

## 1.1 Sustainable research infrastructure

"Research infrastructure" is a term coined to describe research facilities of such scale that they can only be built with the aid of a country or group of countries. These facilities are similar in scope to airports or long bridges or tunnels and compete with these types of projects for limited public resources. It is therefore up to the proponents of such facilities to show that research infrastructure contributes as much or more to achieving social goals as other infrastructure investments. This argument is about the new knowledge that facilities allow to be produced, the innovations that the new knowledge can create and the increased well being that both create.

When the costs and benefits of a new research infrastructure are being weighed, the greater part of the argument will be about the difficult business of evaluating the benefits. The costs tend to be comparatively clear, whether they are capital expenditure, operating expenditure or in externalities such as environmental impact. It stands to reason that if these costs can be significantly reduced, or even in some cases turned to a benefit, this could help tilt the balance towards investment in research infrastructure and thereby form not one but two stepping stones towards a sustainable future based on knowledge creation.

At ESS, total operating expenditure is calculated to be three times the initial capital investment. Of the operations costs, before the energy solutions presented here, around 15% was expected to be for energy. A simple sum of the projected energy expenditure over 40 years at ESS comes to 600 million euros.

Conventionally built, ESS would, through its energy use, cause emissions of 165 000 tons of CO<sub>2</sub> per year. Estimates of the social costs of CO<sub>2</sub> emissions vary wildly, from just below (sic!) zero to several hundred dollars per ton. For the sake of example, the average price cited in the latest IPCC (Intergovernmental Panel on Climate Change) report was 43 dollars per ton, corresponding to 33 euros. This corresponds to an annual social cost for CO<sub>2</sub> emissions from a conventionally built ESS of 5.5 million euros per year, or 220 million euros over the lifetime of the facility.

Energy is not only a major cost; it is also the cost that is most volatile. Energy prices have been known to double from one year to the next. Research budgets do not show this tendency. Safeguarding a competitive and stable energy price is therefore vital to secure the uninhibited use of research facilities in operation.

## 1.2 The commitment

In the Scandinavian submission to host ESS, a commitment was made to apply an Energy Management Strategy "in order to minimise costs, lower the environmental impact and factor out the variability in energy" (ESS Scandinavia Secretariat 2008). The strategy had three pillars, called Responsible, Renewable and Recyclable, each with a specific goal. The goal Responsible concerned energy efficiency and the target was to lower the total energy use to 270 GWh per year or even lower (from an estimated 310 GWh per year at the time). The Renewable goal set a target to invest in renewable energy production sufficient to cover "the integrated annual electricity use of ESS". The Recyclable goal commits to a cooling system that recycles waste heat to the district heating system so that "cooling towers that would normally vent this heat into the atmosphere will not need to be built". Together, these goals were called the ESS Energy Concept. In addition to the goals, the Energy Concept also included commitments to performing and maintaining an Energy Inventory and to introducing and maintaining an Energy Culture within the ESS organization.

As soon as the work towards achieving the energy goals commenced, it became clear that the systems involved were critical. Stability in cooling and power systems is vital to continuous accelerator operations. An additional R-word was therefore added to the concept as an absolute requirement, Reliable.

The ESS organisation remains firmly committed to the achievement of these goals. The commitment was recently reaffirmed at a workshop held in Lund with CERN and ERF, "Energy for Sustainable Science" (Bordry 2011). The workshop showcased ESS as the leading science facility in the energy arena, significantly adding to the credibility of the ESS organisation. This was greatly enhanced by a follow-up article in the leading science periodical Nature (Parker, Cutting Science's Electricity Bill 2011).

### 1.3 The collaboration

Even before the site decision, the ESS Scandinavia Secretariat had agreements with a number of energy companies to co-operate on the development of the sustainable research centre. Among them was Lunds Energi. In fact, their local district heating system was the inspiration for the idea of recycling the heat energy, making them an essential partner for the energy goals.

Towards the end of 2009, after the formation of the ESS Steering Committee, with 14 countries participating, E.ON joined the sustainable research centre effort with a similar agreement to the earlier energy companies. E.ON brought on board their valuable "Sustainable City" concept, as demonstrated in the inspiring Västra hamnen ("Western Harbour") area in Malmö, helping us establish an important link between our energy concept and the design of the facility, the site and the surrounding area. E.ON and Lunds Energi agreed to join forces and form a joint ESS-E.ON-Lunds Energi team to develop the design concept for a sustainable research centre. This document constitutes the final report of that collaboration.

The collaboration with two power companies offered an opportunity to include the design of reliable power system in the scope of the work. Although the power system was not in itself initially viewed as a major sustainability issue, it quickly emerged that the quality of power supply is was an important success factor for accelerator operations, and that there was a potential risk for unsustainable detrimental effects from the ESS facility to the power grid.

The collaborating parties have agreed that the results of the work together should be shared openly, and that the collaboration should concern only conceptual designs. By making the results accessible, the parties intend to open the door to innovation and competition. This report should be seen as an invitation to further improvement on the ideas presented and to participation in their realisation.

The collaborating team has had a clear ambition to set a new global standard for research infrastructure, both in the level of commitment to sustainability goals and in the level of achievement. However, the specific results in this report cannot generally be a blueprint for others. Ambient conditions, in the case of ESS meaning cold, dry air, rainy and windy, proximity to populated areas and the ensuing demand for heat, decide the specific sustainability solutions for the facility. The contrast could not be greater with Spallation Neutron Source (SNS) at Oak Ridge National Laboratory, in Tennessee, USA, where the typical weather is warm, humid, barely any wind and a site chosen (for other reasons) to be as remote as possible. Nonetheless, the collaboration team began its work at SNS for the first iteration of the Energy Inventory, and we are most grateful for the generous hospitality with access, time and data offered by the staff there.

### 1.4 The Nordic energy markets

Just as ambient climate conditions affect the energy solutions, so do the local market conditions. The local energy markets have some specific traits enabling the proposed solutions, of which additional detail is given here.

Firstly, the Nordic (i.e. Norway, Sweden, Finland and Denmark) region has the most liberalized market for electrical power in the world. Since 2006, consumers have been able to choose between a hundred plus of suppliers and contracts can be shifted monthly. The suppliers trade on an hourly spot market, and on a liquid futures market. Barriers to entry for new production units are also comparatively low, except for environmental permitting.

The electrical power grid is organised as local, regional and national monopolies, with regulated prices for connection and transfer. The grid connection fee allows trading with all other actors in the Nordic area at no extra cost (albeit with some metering and other issues for cross-boarder trade).

There is comparatively little fossil fuel based power in the Nordic system; Norway is predominantly hydropower and Sweden and Finland have hydro and nuclear. Only Denmark has substantial fossil fuel use. However, the marginal capacity if new production is required or if conditions require exceptional production is considered to be predominantly fossil fuel.

A market-based subsidy system for renewable energy called "Energy Certificates" is in place. Consumers are required to purchase a quota and the lowest-priced new renewable production is awarded the certificate value for 15 years.

A beneficial anomaly of the energy systems in Sweden is the prevalence of district heating. This is the central production of hot water, distributed in pipes under all the urban areas of Sweden and metered and consumed at households, businesses and public buildings for heat and hot water. District heating is the dominant heating form in urban areas.

A great many district heating systems throughout Sweden can make use of industrial waste heat. This heat is purchased by the district heating company. This is typically a municipally owned company, but may also be run directly by the municipal administration or be a private business. District heating is to some extent regulated, and competes with other heating sources on the market. Competing heating forms include heat pumps and wood. Natural gas is available only in the cities in the southwest of Sweden, from Malmö to Gothenburg. Oil has generally been phased out as a heat source.

District heating provides an opportunity for co-generation of heat and power. Household waste that is not recycled is often incinerated at co-generation facilities that produce power and heat. There is also significant recent and on-going investment in co-generation based on biofuels or natural gas.

## 1.5 Strategies

With the support of The Swedish Energy Agency, Vinnova and the Swedish Research Council, an energy management strategy was developed and finalised in 2010 (Parker, Responsible, Renewable, Recyclable An Energy Management Strategy for the European Spallation Source 2010). In this, three management strategies were envisioned to implement the ESS Energy Concept. These were:

- Systematic energy management
- Focus on temperature in cooling system design
- Collaboration with business for development and innovation

Systematic energy management involves creating and maintaining an Energy Inventory of energy flows, including temperature levels and establishing an Energy Culture which focuses the attention of the ESS organisation on energy efficiency. The Energy Inventory and the Energy Culture may be seen as pillars in an Energy Management System. Such a system would encompass, when fully developed, goal breakdown in the organisation, a plan of action for goal fulfilment, follow-up, reporting and corrective action as necessary.

A focus on temperature in the technical design of cooling and heating systems for ESS is fundamental for achievement of the goal Recyclable. Initial reviews showed that profitably achieving energy recycling was largely a question of attention to temperature in the technical design of relevant systems. The challenge is to cool the equipment of the facility at as high temperature as possible, without risking reliability or increasing cost.

Achievement of the goals Renewable and Recyclable will require collaboration with partners in industry and finance. This collaboration will be open and transparent and be based on robust business models developed in the Design Update phase.

A dedicated, new, renewable energy source for ESS is vital to the long-term scientific mission of ESS, because both environmental credibility and energy price stability are fundamental to ensure that ESS can open and operate as planned. However, energy production is not a core activity and is not practical on sufficient scale on the ESS site. Renewable energy options will therefore be explored in partnership with organisations in relevant businesses.

The plan to develop new renewable energy production is to first develop a business model, including options for legal and financial structure, and then to seek partners for development in a broad and transparent process.

The needs of ESS that must be fulfilled in a collaborative effort, and therefore be a basis for evaluation of partnership options include:

1. A clear connection between the new, renewable energy production and ESS consumption,
2. A competitive cost level for power supply,
3. Elimination of long-term exposure to fluctuation in energy prices (short-term exposure can be hedged by tradable contracts).

The business model for recovery of high-grade heat is straightforward. Such agreements exist in many Swedish towns and there are established pricing principles on this market. Current estimates show that about half of the heat produced at ESS will be of high grade. For the remainder, the conceptual design calls for the use of heat pumps to augment temperature levels to the higher grade and thus enable heat recovery. This is technically robust and economically viable, but comes at a cost of increased electricity use. Other options need to be developed and evaluated.

Energy markets in the Nordic countries are the most liberalised in the world, and have the longest history. This makes it possible to calculate Value at Risk by standard methods based on historical price volatility. These types of calculations have their limitations, as they do not account for events that are new on the market, even if the event itself is foreseeable. (A typical such event would be a particularly cold winter period that leads to production not being able to meet demand at any price, meaning that a spot price is not achieved at Nordpool, the Nordic power market). Despite their limitations, Value at Risk calculations are very useful for comparing the risks involved in different options. Such risk calculations will therefore be made to evaluate the energy strategy as it develops.

A purpose of the ESS Energy Strategy is to deliver increased credibility for the ESS project. For this to succeed, ESS must actively communicate with stakeholders about its commitments and performance.

## 1.6 Structure of the document

This report is comprised of a collection of documents produced in the collaboration that together make up the report. Each chapter is also a stand-alone document, in most cases a Technical Note in the ESS Energy Project. Because of the independent nature of the chapters, there may be some perceived inconsistencies in wording or numbers, as the concept implementation continues to evolve. Each chapter is a snapshot of the current level of thinking, with evolving data, an evolving facility design and changing energy markets. In the technical development at least, there has been noticeable convergence over time.

This is mainly a technical report. The main goal of the report is to demonstrate feasibility. As this also includes economic constraints, the report also includes business plans. The financial constraint for the energy solutions is simply that the ESS budget contains no financing for investments in renewable energy or heat recycling. This means that such investments must show sufficient profitability to create revenue streams that can attract other financing. Additionally, the energy solutions are expected to contribute substantially to offsetting operations costs and to provide energy prices stability over the lifetime of the ESS facility.

Furthermore, achievement of the energy goals will also require management. The report therefore also includes the adopted plan for an Energy Management System.

The document structure follows the order of priority for the energy goals: Responsible (chapter 2), Renewable (chapter 3), and then Recyclable (chapters 4 and 5), moving thereafter to the demand of Reliable (Chapter 7-8). Each chapter starts with an introduction and summary, explaining the background to the document and its relevance and importance of the chapter in the context of the report. The report ends with a brief discussion on what has been achieved, what remains and the path forward towards implementation.

A summary of this report is available separately, entitled "Proposal for a Sustainable Research Facility, ESS Energy Concept Final Report January 2013".

# Chapter 2

## ESS Energy Management Plan



# Introduction and Summary

Experiences show that costs related to energy use in the operational phase often have had significant negative impact on the overall economy of the facilities. In the Scandinavian submission to host ESS, a commitment was made to apply an Energy Management Strategy "in order to minimise costs, lower the environmental impact and factor out the variability in energy costs".

This document addresses current best knowledge of the energy consumption at ESS on a project basis, identifies significant energy consumers and proposes activities for each project group to enable them to contribute to the energy efficiency goal. The results from the Energy Inventory (EnI), with respect to overall energy use and including heat pumps, show a total energy use of 278 MWh and a total cooling need of 265 MWh.

Based on the EnI, identified planning outputs are accounted for and broken down for each project group. Currently, since no objectives are formulated for the different project groups, the action plan consists of activities that in general are likely to make the facility more energy efficient and that will contribute to the future energy management work.

This work is cyclical and will be maintained, updated and reassessed twice per year to make sure that energy efficiency remains in focus and the progress with the work is easily monitored.

The overall purpose of the document is to:

- Account for the present best estimates regarding energy use
- Identify significant energy users
- Contribute to the identification of challenges, processes and documents that need to be addressed or further investigated
- Formulate a first version of an Energy Management Action Plan (EnMAP)

The EnI is primarily based on interviews and other input from individuals with detailed knowledge of different parts of the facility. In cases where an energy need has been identified but no detailed information was available at the time of the inventory the reviewer has estimated the energy use. Admittedly some of these estimates are very rough.

The purpose of an energy management system is to form a basis for the organisation to create a good overview regarding its energy system and the handling of all vital energy aspects. Hence that it shall lead to activities that continually improves the energy performance of the organisation and thus aid in reaching the set goals.

Establishing an energy planning process is a fundamental step in becoming a responsible research facility and is done in three general steps described in more detail in the following document.

# ESS Energy Management Plan

**Author:** Tommy Persson

**Reviewers:** Johan Lehander (Chair CCB), Johan Brisfors, Örjan Larsson, Mats Lindroos, Ferenc Mezei, Ken Andersen, Kent Hedin, Stig Skelboe, Peter Jacobsson, Peter Rådahl, Iain Sutton, Robert Connatser, Thomas Parker, Giobatta Lanfranco, Romuald Duperrier, Inger Persson (Secr. CCB), ESS

**Approver:** Kjell Möller, ESS

Approved by EPG on November 12th, 2012

## **Relevant Publications and Documents**

Energy for Sustainable Science, ESS energy solution, 2011

Energy for Sustainable Science, ESS Energy Solution, September 2011

Energy for Sustainable Science, ESS Energy Solution, September 2012

Conceptual Design Report, European Spallation Source, February 2012

ESS Energy Pre-Construction Project Specification, European Spallation Source, June 2012

## **Acronyms**

CDR – Conceptual Design Report

DH – District Heating

EnI – Energy Inventory

EMAP – Energy Management Action Plan

EnMS - Energy Management System

EnPI – Energy Performance Indicator

HP – Heat Pump

LCC – Life Cycle Cost

# 1. Energy Management System

## 1.1 Introduction

Experiences from other science facilities show that costs related to energy use in the operational phase often have had significant negative impact on the overall economy of the facilities. In the case of ESS the importance and challenges associated with reducing the costs due to high energy use was addressed at an early stage. In the Scandinavian submission to host ESS a commitment was made to apply an Energy Management Strategy “in order to minimise costs, lower the environmental impact and factor out the variability in energy costs”. The strategy had three pillars, called Responsible, Renewable and Recyclable, each with a specific goal. The goal Responsible concerned energy efficiency and the target was to lower the total annual energy use to 270 GWh or lower (from an estimated 310 GWh at the time). The Renewable goal set a target to invest in renewable energy production sufficient to cover “the integrated annual electricity use of ESS”. The Recyclable goal commits to a cooling system that recycles waste heat to the District Heating (DH) system so that “cooling towers that would normally vent this heat into the atmosphere will not need to be built”.

This document is directly related to the Responsible and Recyclable goals of the Energy Management Strategy of ESS, where Responsible implies the best possible energy efficiency without impacting negatively on quality or availability and Recyclable dictates avoiding wasteful cooling towers by recycling surplus heat.

With the means of energy management the project will effectuate organizational, technical and behavioural actions in an economically sound manner in order to minimize energy demand. Energy management implies structural attention to energy with the objective of continually reducing the energy consumption and maintaining the achieved improvements.

How does this document then relate to the “Recyclable” goal? The energy supplied to the heat pumps (to increase the temperature of the waste heat to meet the temperature requirements of a third party) is substantial and is directly related to the amount of low-grade heat that needs to be supplied to the DH system and the coefficient of performance of the heat pumps. Thus the temperature requirements of the DH system and the temperature level of the available waste heat from the facility are essential parameters, especially since the high-grade heat that can be transferred directly to the district heating (DH) system via a heat exchanger is very likely to generate an income to ESS. Therefore it’s also essential to find useful applications for the low-grade heat that does not require a temperature increase by means of a heat pump and/or to apply high-temperature cooling where possible to gain greater quantities of profitable high-grade waste heat.

The overall purpose of the document is to:

- Account for the present best guess (as of mid September 2012) regarding energy use (=Energy Inventory)
- Identify significant energy users
- Contribute to the identification of challenges, processes and documents that need to be addressed or further investigated
- Formulate a first version of an Energy Management Action Plan (EnMAP)

## 1.2 Restrictions

The focus of this document is to study energy use within ESS. It is limited to study the energy use within the fully commissioned facility as of 2025 (according to the present time schedule) and as described in the Conceptual Design Report (CDR) of February 6th, 2012. Energy use related to the construction and decommissioning of the facility is at this point not addressed. Neither is energy use induced by ESS but not actually taking place within the premises, such as energy use related to transports, production of components used in the facility, waste management, etc.

The need for installed capacity regarding power, cooling and heat recovery is not studied in this document. These topics are continuously studied in the design process and captured in requirements documents. Similarly, the temperature levels of the cooling and heat recovery circuits of ESS have not been studied in detail. The distribution of waste heat at different temperature levels shown here is based on data from these processes.

### 1.3 Energy policy

The basis for an energy management system is the energy policy. The purpose of this policy is that top management shall state the overall guidelines regarding the organisations energy use and work associated with the energy management system. In the energy policy the organisation should state its overall commitment to achieving energy performance improvement. If desired, the energy policy can constitute a part of the environmental management system in which case the commitments related to energy use should clearly be stated.

At present no energy policy for ESS has been formulated. The statement made by the organisation regarding the concept of Responsible, Renewable and Recyclable (described in section 1.1) could constitute part of the policy. In addition when formulating the energy policy it can be noted that according to the standard SS-EN ISO 50001:2011 top management shall define the energy policy and ensure that it:

1. Is appropriate to the nature and scale of the organisation's energy use and consumption
2. Includes a commitment to continual improvement
3. Includes a commitment to ensure the availability of information and of necessary resources to achieve targets and objectives
4. Includes a commitment to comply with legal requirements and other requirements to which the organisation subscribes related to its energy use
5. Provides the framework for setting and reviewing energy objectives and targets
6. Supports purchase of energy-efficient products and services, and design for energy improvement
7. Is documented and communicated at all levels within the organisation
8. Is regularly reviewed and update as necessary.

It is recommended that an energy policy for ESS be formulated as soon as possible. The energy policy shall be reviewed once a year at the management review and updated if considered needed.

### 1.4 Energy Planning

The purpose of an energy management system is to form a basis for the organisation to create a good overview regarding its energy system and the handling of all vital energy aspects. Hence that it shall lead to activities that continually improve the energy performance of the organisation. To establish an energy planning process is a fundamental step in this process.

The first step of an energy planning process is to identify planning inputs such as internal and external requirements, compile relevant input regarding past and present energy uses, etc. A first version of planning inputs is presented in section 2.

The second step is to perform an Energy Inventory (EnI) where the energy use is analysed and areas of significant energy use and opportunities for improving energy performance are identified. This is compiled in section 3.

The third step of the energy planning process is to identify planning outputs. The planning outputs should involve to establish an energy baseline and to identify appropriate energy performance indicators (EnPI). It should also include establishing and implementing energy objectives and targets. Action plans should be established and implemented in order to achieve the specified objectives and targets. In this document the planning outputs are accounted for in section 4.

## 2. Planning Inputs

In this section presently identified external and internal requirements are summarized and input regarding past and present energy use is accounted for. This is the first version of the document and the list of identified requirements etc. cannot be guaranteed to be complete. The list of external and internal requirements shall be updated regularly, and especially if new information is available.

### 2.1 External requirements on energy use

Requirements on energy use from the external stakeholders have been identified as follows:

#### **The Swedish National Board of Housing, Building and Planning (Boverket)**

In the Swedish Building Regulations (Boverkets Byggregler, BBR) requirements with respect to energy use in buildings are stated. The local municipal authority "Byggnadsnämnden" has the preferential right of interpretation of BBR. It is therefore essential to discuss the issue of energy use within ESS with this party.

Due to the fact that the heating need of all facilities within ESS will be covered by waste heat from the facility our interpretation of the requirements in BBR is that only the following regulation in section 9:1 is directly applicable on ESS: "Buildings shall be designed in such a way that energy use is limited by low heat losses, low cooling demands, efficient use of heat and cooling and efficient use of electricity". Apart from this it has to be verified by means of a special investigation that waste heat from the processes within the building will cover the major part on the heating requirement.

#### **The County Administrative Board (Länsstyrelsen)**

In the Environmental Impact Assessment submitted to the County Council (Miljökonsekvensbeskrivning, March 7th, 2012) by ESS the choice of words is such that definitive commitments regarding energy use have been refrained from. However, based on the description made it is plausible that the authority has the following expectations with respect to energy use:

- The supplied energy should not significantly exceed 250 GWh/year. Exactly how large the deviation from this value can be is subjective but an outcome exceeding it by more than 30% is likely to be scrutinized.
- The supplied electricity should primarily originate from renewable energy sources.
- The major part of the waste heat produced in the facility is to be recovered and supplied to the DH system in Lund.

At the time of writing the County Council have not announced its decision regarding the Environmental Impact Assessment submitted by ESS.

#### **Commitment in the bidding process**

One factor underlying Scandinavia's winning bid was the vision of a sustainable research facility. In the Scandinavian submission to host ESS, a commitment was made to apply an Energy Management Strategy "in order to minimise costs, lower the environmental impact and factor out the variability in energy costs". The strategy had three pillars, called Responsible, Renewable and Recyclable, each with a specific goal. The goal Responsible concerned energy efficiency and the target was to lower the total energy use to 270 GWh per year or lower (from an estimated 310 at the time). The Renewable goal set a target to invest in renewable energy production sufficient to cover "the integrated annual electricity use of ESS". The Recyclable goal commits to a cooling system that recycles waste heat to the DH system so that "cooling towers that would normally vent this heat into the atmosphere will not need to be built". ESS should not only be climate neutral in the operation phase but in addition this should deliver savings and revenue.

From a strictly legal sense not fulfilling these commitments doesn't seem to be directly associated with any fines, lost funding, etc. Still, they are commitments made to the countries financing the facility and should be treated with due importance. In addition to this it would definitely be a significant loss of prestige to ESS not to fulfil them. Thus, the three pillars called Responsible, Renewable and Recyclable must be addressed when formulating the objectives, goals and EMAP of ESS.

### **The general public**

ESS has continuously been communicating the facilities energy concept to the general public, for instance in the information booklet "Energy for Sustainable Science". In the edition dated April 2012 estimates of total electricity use of 250 GWh/year and a total amount of recovered heat of 174 GWh/year were communicated. To significantly exceed the communicated electricity consumption or fall short of the amount of recovered heat would definitely involve the risk of negative publicity.

## **2.2 Internal requirements on energy use**

The internal requirements with respect to energy use are basically the same requirements that have been communicated in the Environmental Impact Assessment, in the bid to host ESS in Lund, etc. as described in section 2.1. The internal requirements can be summarized with the current interpretation of the overall goals and targets as follows:

- Goal Responsible: Greatest possible energy efficiency without impacting quality or availability (Target: 270 GWh or lower total energy use per year)
- Goal Renewable: All energy from new, dedicated renewable production at a stable and competitive cost (Target: Energy production online 2019 with ramp-up to 2025 corresponding to expected use)
- Goal Recyclable: Recycle as much as possible of the waste heat profitably (Target: No cooling towers)

One important factor behind these requirements is to display a facility where not only outstanding research is performed but where in addition it is made in an environmentally responsible way. Another important reason for the requirements/goals is that experiences from similar facilities have shown that high operational costs can be a heavy burden. By limiting the energy use a larger share of the annual budget in the operational phase can be used for funding research instead of paying the electricity bill.

# **3. Energy Inventory**

In this section results, observations and conclusions from the Energy Inventory (EnI) are summarized.

## **3.1 Methodology and restrictions**

### **Methodology**

ESS is a specialized science facility and the number of reference facilities is very limited. In addition ESS is still in the design phase that in it self introduces uncertainties for instance due to lack of detailed specifications for the plant.

The EnI is primarily based on interviews and other input from individuals with detailed knowledge of different parts of the facility. The management has not formally approved the information regarding power and cooling needs provided by the internal projects of ESS. The projects are continuously developing and improving the energy use estimates. In cases where an energy need has been identified but no detailed information was available at the time of the inventory the reviewer has estimated the energy use. Admittedly some of these estimates are very rough. The estimated energy uses accounted for in the EnI should be regarded as the best guess as of mid September 2012.

Most of the investigations performed within ESS have up to date focused on energy use during full operation of the facility. The situation during intermediate or no operation has been less studied. The energy use during these modes has in most cases been estimated based on dialogue with the persons who supplied the information regarding energy use at full operation.

In the inventory, emphasis has been placed on the processes that are considered to use the largest amounts of energy. The ambition has been to identify processes with a collective energy use corresponding to at least 80% of the total energy use of the facility.

The importance of continually updating the EnI and to carefully document these updates must be emphasised.

### Restrictions

This is the first version of the EnI of ESS. As a first step it has been restricted to study the energy use within ESS during the operational phase and focuses on the energy supplied to the facility in the form of electricity and heat and the resulting cooling need.

Energy use related to the construction and decommissioning of the facility is not treated in the EnI. Neither is energy use induced by ESS but not actually taking place within the premises such as energy use related to transports, production of components used in the facility, waste management, etc.

At this stage the requirements for installed capacity have not been studied. The need for installed capacity for electricity and cooling is continuously studied in the Technical Design Reports (TDR) for "Power" and "Cooling and heat recovery".

The temperature levels of the cooling circuits of the facility have not been studied in detail in the EnI. In this case the distribution of waste heat at different temperature levels is assumed to correspond with the findings in the TDR draft of May 23rd, 2012 for "Cooling and heat recovery".

Losses in transformers and switchgears between the 130 kV grid and ESS are not considered in the EnI. One reason being that the interface between the power grid operator and ESS is at present undecided.

## 3.2 Prerequisites and assumptions

This EnI has been based on the ESS design as of mid September 2012. This for instance involves:

- A proton beam power of 5 MW
- An accelerator consisting of normal conducting LEBT, RFQ, MEBT, DTL and HEBT and superconducting Spokes, Medium and High sections
- No accumulator ring
- 22 instruments

The EnI is limited to include the general facility layout as described in the CDR of February 6th, 2012 and for which funding have been granted, i.e. energy use related to possible future upgrades of the accelerator, installation of additional instruments, etc. are not included. Furthermore, the inventory applies for the fully commissioned facility as of 2025 according to the present time schedule.

The operational times of the facility have been assumed as follows:

Mode	Duration per year [h]
Full operation (Beam on, on target)	5400
Intermediate (Beam on, off target)	1260
No operation (Beam off)	2100

Table 1: Assumptions on operating hours per year used in the energy inventory

The operational times in Table 1 originates from a proposed schedule in the Cross Functional Task Group as of May 2012 and is based on experiences from SNS in Oak Ridge. These operational times differ some from those accounted for in the CDR of February 2012 however the impact on the estimated overall energy use according to the performed EnI turns out to be very small.



In Table 1 “Full operation” refers to normal operation with a beam power of 5 MW on the rotating tungsten target. “No operation” refers to situations when the beam is permanently off, for instance due to planned maintenance. “Intermediate” refers to all other situations for instance during start-up, shutdown, tuning of the accelerator, disturbed operating conditions, etc. This mode is not possible to unambiguously define and thus introduces an uncertainty. Limitation of the time, when this mode is active, will be sought to favour the time in “Full operation”. In the EnI performed the “intermediate” mode is simplified as a situation where the power of the proton beam is 50 kW and it is directed on to the beam dump, i.e. the rotating tungsten target is in this case unaffected by the proton beam. Furthermore, the pulse length and frequency of the proton beam in this mode of operation is assumed to be 0,4 ms and 1 Hz respectively while it during full operation is 2,86 ms and 14 Hz (both according to the CDR of February 6th, 2012).

Based on an initial evaluation it was concluded that the total energy use of ESS basically can be derived to the ESS internal projects denominated Accelerator, Target, Conventional Facilities and Neutron Scattering System (NSS). In addition to this the energy use of the Heat Pumps (HP) that is to upgrade the low grade waste heat from the facility to a temperature level accepted by the DH operator is accounted for separately. The reason for this is that currently it is not decided which part of the project that will be responsible for the HP:s or if they should even be constructed and operated by a third party. There are also other areas of responsibility that at present are subject to discussion. Therefore it should be clarified that the following assumptions have been made in the performed EnI:

- **Accelerator. Includes energy use related to:**
  - Cryo-cooling of the superconducting cavities, RF test stands and production of liquid He (primarily used in NSS)
  - RF test stands
- **Target. Includes energy use related to:**
  - Cryo-cooling of the moderators
  - Cooling of the beam dump
- **Conventional Facilities:**
  - Includes estimated energy use for all the facilities (including Accelerator, Target and NSS) with respect to “basic needs” such as ventilation, comfort cooling, lighting, heating, circulation pumps, computers, etc.
  - Based on the following floor areas:
    - Laboratories: 5500 m<sup>2</sup>
    - Offices: 9500 m<sup>2</sup>
    - Public areas: 5000 m<sup>2</sup>
    - Accelerator: 21000 m<sup>2</sup>
    - Target: 6000 m<sup>2</sup>
    - Instruments/NSS: 16500 m<sup>2</sup>
- **Neutron Scattering System (NSS):**
  - The EnI is limited to the 22 instruments included in the construction budget
  - No detailed decisions are made regarding types of instruments to be installed and the EnI is primarily based on experiences from similar facilities
  - It is assumed that it will not be possible to recover any substantial amounts of the waste heat generated in NSS in a cost-efficient way
- **Heat pumps:**
  - Assumed that all the surplus energy of the cooling water is supplied to the DH system and that approximately 50% of the energy can be supplied directly via heat exchangers while the rest needs to be upgraded by means of HP. It should be noted that this is one possible solution but how to recycle the surplus energy in the best way possible is currently being investigated.
- In cases where cryo-cooling needs can be met by liquid nitrogen it is assumed that it is bought from a commercial supplier and delivered to ESS. The energy use associate with this process is not included in the EnI.

The greatest uncertainties in the EnI are considered to be related to the energy use during the Intermediate mode of operation (for all parts of the facility) and to NSS in all modes of operation. In the first case this is due to the fact that the Intermediate mode of operation is not possible to unambiguously define. In the second case it is due to the fact that no decisions at present have been taken regarding the instruments to be installed within NSS.

Finally, it should be commented that the EnI only include energy users that have been identified. In addition to these there are certainly additional energy users that have not presently been identified. It is expected that the most significant energy users have been identified in the EnI but still the overall energy use of many smaller (and unidentified) energy users may be significant. Therefore it is more likely that the real energy use will be higher than that according to the EnI than vice versa.

### 3.3 Results from energy inventory

#### 3.3.1 Overall energy use

In Table 2 the results from the EnI with respect to overall energy use are summarized. A more detailed specification of the data behind the summary is accounted for in Appendix A and will also be further treated in this and the following sections. It is assumed that the heat related to the cooling need of NSS is not recovered and consequently neither supplied to the DH system (but it still has to be discharged somehow).

Part of the facility	Annual electricity use [GWh]	Annual cooling need [GWh]
Accelerator	167	138
Target	31	57
Conventional Facilities	4	-6
Neutron Scattering System	32	32 <sup>1)</sup>
Heat pumps	44	44
Total (incl. heat pumps)	278	265
Total (excl. heat pumps)	234	221

Table 2: Estimated annual electricity use and cooling needs in the performed energy inventory

Excluding the HP the EnI indicates that:

- 71% of the total electricity use and 62% of the total net cooling need is related to Accelerator
- Approximately 13% of the electricity use and 26% of the total net cooling need is associated with Target
- Only 2% of the total electricity use is related to “basic needs” of the buildings, i.e. supplied for lighting, computers, fans, pumps, etc. The heat requirement for space heating, hot water preparation, etc. only amounts to some 3% of the total heat generated within the facility. This internal heat use is in Table 2 accounted for as a negative cooling need
- The electricity use and cooling need of NSS both represent 14% of the total need respectively. It should be noted that these estimates are very preliminary
- The commitment made of a total power consumption of less than 270 GWh/year appears realistic to achieve if the HP:s are excluded

Including the HP:s the EnI indicates that:

- If all the net waste heat from the facility, except from NSS, is supplied to the DH system:
  - The electricity supplied to the HP:s will be about 19% of the electricity supplied to the rest of the facility
  - The total delivered heat will be about 230 GWh/year (=net cooling need of the facility including electricity supplied to the HP but excluding NSS)
- The energy use in all other parts of the facility is small in comparison with Accelerator, Target, NSS and HP:s
- The commitment made of a total power consumption of less than 270 GWh/year appears challenging to achieve if the HP:s are included

Based on an energy balance for the whole of ESS one would expect that all electricity supplied eventually will turn into heat and that the supplied electricity would therefore more or less correspond to the gross cooling need. Disregarding the HP:s, the EnI indicates that a total of 234 GWh/year needs to be

---

<sup>1)</sup> The cooling need of NSS is assumed not to be recovered, should be further investigated

supplied to the facility in the form of electricity. The total net cooling need is estimated to 221 GWh/year. In addition to this some 6 GWh/year of the heat generated is estimated to be a positive contribution to the facility in order to compensate for heat losses from the buildings, preparation of hot water, etc. For the more conventional buildings within ESS it is estimated that about 1/3 of this will be supplied due to heat losses directly to the indoor air and 2/3 needs to be distributed via the building internal heating and domestic hot water systems. The remaining difference between the estimated supplied electricity and cooling need is 7 GWh/year. This is primarily related to the uncertainties in the assumptions made in the performed EnL.

### 3.3.2 Energy use in different modes of operation

In Table 3 is accounted for the estimated annual energy need for supplied electricity and cooling during the three modes of operation. In Table 4 the corresponding average power needs are displayed. A more detailed specification of the data behind these summaries is accounted for in Appendix A and will also be further treated in this section.

Part of the facility	Full operation		Intermediate		No operation	
	Electricity	Cooling	Electricity	Cooling	Electricity	Cooling
Accelerator	148	119	12	13	6	6
Target	24	50	3	3	4	4
Conventional Facilities	3	-4	1	-1	1	-2
Neutron Scattering System	22	22	5	5	4	4
Heat pumps	39	39	3	3	2	2
<b>Total (incl. heat pumps)</b>	<b>236</b>	<b>225</b>	<b>24</b>	<b>23</b>	<b>17</b>	<b>15</b>
<b>Total (excl. heat pumps)</b>	<b>197</b>	<b>187</b>	<b>21</b>	<b>20</b>	<b>15</b>	<b>13</b>

Table 3 Estimated annual electricity use and cooling needs in GWh at different modes of operation

Part of the facility	Full operation		Intermediate		No operation	
	Electricity	Cooling	Electricity	Cooling	Electricity	Cooling
Accelerator	27.4	22.1	9.9	10.1	2.9	2.9
Target	4.5	9.2	2.2	2.4	1.8	1.9
Conventional Facilities	0.5	-0.7	0.5	-0.7	0.5	-0.7
Neutron Scattering System	4.1	4.1	3.9	3.9	2.1	2.1
Heat pumps	7.1	7.1	2.8	2.8	1.0	1.0
<b>Total (incl. heat pumps)</b>	<b>43.6</b>	<b>41.7</b>	<b>19.3</b>	<b>18.5</b>	<b>8.3</b>	<b>7.2</b>
<b>Total (excl. heat pumps)</b>	<b>36.5</b>	<b>34.6</b>	<b>16.5</b>	<b>15.8</b>	<b>7.4</b>	<b>6.3</b>

Table 4 Estimated average electricity and cooling needs in MW at different modes of operation

The energy use in Conventional Facilities (here defined as the energy use due to "basic needs" such as ventilation, space heating, comfort cooling, etc. in all buildings) is small compared to the other parts of the facility and will not be discussed in further detail in this section but will be commented in section 3.3.5.

## Full operation

As expected according to Table 3 the largest share of electricity use and cooling need coincides with the Full operation mode. This is partly due to the high power needs (see Table 4) and partly due to the expected long duration of this mode of operation (see Table 1). When formulating the energy objectives and targets it is important to recognize that a high availability of the facility should not have a negative impact on the possibility to reach said targets and vice versa.

In Accelerator the protons are "generated" and accelerated to a speed near the speed of light. During Full operation, Accelerator dominates both the overall electricity use and cooling need. The electricity use and the cooling need are primarily related to the superconducting part of the accelerator. Compared to more "conventional" electrical machines the overall energy efficiency of the accelerator is low, to obtain a 5 MW proton beam some 27 MW of electricity is supplied. Thus, it is natural to further investigate if there are any possible enhancements of or alternatives to the current design given the present budget and time schedule. It appears that the present time schedule poses the greatest challenge when considering alternative designs of the klystron gallery. Regardless of the exact design of the accelerator it will undoubtedly include substantial cooling needs and it is essential to recover this heat in the best way possible. Efforts to reduce the electricity use and to optimise the heat recovery of Accelerator should be given top priority considering that it is by far the most important of the projects in the facility in order to reach the energy objective of ESS.

In Target the protons from the accelerator hits a tungsten target causing neutrons to be released. The energy use in Target during full operation is directly related to the 5 MW proton beam that hits the rotating tungsten target wheel. When the proton beam hits the target the kinetic energy is converted to heat in different parts of the target station. This converted kinetic energy represents about 50% of the total cooling need of Target. Most of the remaining cooling need and about 75% of the electricity use is related to the cryo-cooling circuit of the moderator and the gas cooling circuits of the target wheel. When designing these cooling circuits factors such as the risk of formation of radioactive by-products and consequences at power shortages are taken into account. These considerations often require technical solutions that involve higher energy use than would otherwise be the case.

During Full operation the neutrons from the target reaches the instruments that are part of NSS. Here they are directed at the samples that are investigated and the event is registered and documented. At the point of writing no decisions are made regarding details of the instruments to be used. The estimated energy use is primarily based on experiences from similar facilities but still the estimations are very preliminary and the uncertainty related to the estimated energy use is substantial. However, even considering this it can be stated that the energy use of NSS will be significant. During full operation the top 3 energy users will be choppers, detectors and vacuum pumps. These are estimated to represent some 70% of the total electricity use of NSS in this mode of operation. In the case of NSS no detailed studies have been made regarding the possibilities to recover the heat generated. Considering the distributed nature of the instruments and their support systems as well as the characteristics of the heat generating equipment efficient heat recovery might prove to be challenging. Still, it should be recognized that there is a significant potential for heat recovery in terms of amount of heat generated and the topic should therefore be further investigated in the future design work.

The purpose of the HP:s is to upgrade the low grade cooling water from the facility to a temperature level accepted by the DH operator. Since the amount of waste heat from the facility is the greatest during full operation so is the electricity supplied to the HP. During full operation the electricity use of the HP is substantial and amounts to approximately one fourth of the electricity supplied to Accelerator and 1,5 times the electricity use of Target. In the EnI it is assumed that all waste heat, apart from that of NSS, is supplied to the DH system. In accordance with the findings in the TDR draft May 23rd 2012 for "Cooling and heat recovery" it is estimated that about 50% of the waste heat is of such a low temperature that it cannot be directly supplied to the DH system. Considering the large amounts of energy in question actions to further investigate how to handle the waste heat in the best possible way should be given high priority. This topic will be further discussed in sections 3.3.3 and 3.3.4.

## Intermediate

During Intermediate operation the estimated average power need is still significant (see Table 4) but compared to Full operation the duration is relatively short (see Table 1) and therefore the energy use is significantly less (see Table 3).

When evaluating the results in Table 3 and Table 4 it is important to recognize that in the EnI the Intermediate operation have been simplified (as elaborated in section 3.2) to a situation where the power of the proton beam is 50 kW and that it hits the beam dump with a pulse length of 0,4 ms and a frequency of 1 Hz.

As is the case during Full operation the overall electricity use and cooling need in the Intermediate operation are dominated by the Accelerator. However, according to Table 4 the electric power and the cooling power of the Accelerator during Intermediate mode are about as large while they differ with about 5 MW during Full operation (=the power supplied to the proton beam). The reason for this is that according to information received from project Accelerator the present design of the klystrons is such that the mean power requirement of the klystrons during a pulse is about the same regardless of the power transferred to the proton beam. If a power less than the nominal value is supplied to the proton beam then the excess power will primarily be converted into heat in the klystron gallery, i.e. it does not result in lower electric power consumption.

As a consequence of the described characteristics of the present klystron design details during operation in the Intermediate mode will have a significant impact on the overall energy use. If for instance the pulse length and frequency of the proton beam during the Intermediate mode is the same as in the full operation mode but at a lower beam power then the power need of the klystron gallery would be the same as during Full operation. The difference between the two modes would then primarily be that in the former the cooling need arises in the klystron gallery instead of in the target station. Compared to the estimates displayed in Table 3 and Table 4 this kind of intermediate operation would imply an annual increase in electricity use and cooling need of approximately 22 GWh. Thus, considering the potentially large impact on total energy use details for operation in intermediate mode should be further investigated and taken into account in the future design work.

During the Intermediate mode the proton beam is directed on to the beam dump and the beam power is significantly less than during Full operation. As a consequence the cooling need in Target is significantly smaller in this case. Although the target apart from this is not really in operation there is non-negligible electricity and cooling needs also in the Intermediate mode. The energy use is also in this case primarily related to the cryo-cooling circuit of the moderator and the gas cooling circuits of the target wheel. In addition the energy use of the active cells, utility rooms, etc. in this mode constitutes a large share of the total energy use. It should be recognized that the intermediate mode involves states prior or subsequent to Full operation why large parts of the facility needs to be in stand-by mode.

As previously stated there is a large degree of uncertainty related to the estimates of energy use in NSS. According to Table 4 the estimated power need during intermediate operation is almost identical to that during full operation. The reason is that preliminary information suggests that most of the systems will not be shut down during shorter interruptions in operation due to concerns regarding the technical lifetime of sensitive components, etc. At the same time it can be noticed that if the power needs during periods when no neutrons are produced can be reduced this will have a large impact on the overall energy use of NSS. This should be further investigated in the future design work.

The electric power need and energy use of the HP:s is directly related to the cooling needs arising from the rest of the facility. If the latter can be reduced or alternative uses of the heat can be found so can the supplied electricity to the HP.

It can be concluded that although the estimated energy use according to Table 3 during the Intermediate mode is only about 10% of that during Full operation there is a significant uncertainty regarding this mode of operation. During the Intermediate mode no research using neutrons can be performed and the energy use in this situation is to be regarded as a pure cost. For several reasons the ambition should naturally be to construct a facility with high availability, short start-up/shut-down times, etc. If this work is successful then it will result in a decreased duration of all operation modes that do not involve full operation. On the other hand if this work is not successful and lots of disruptions are experienced in the completed facility then this will not only involve lost possibilities to perform research but also high operating costs without return on capital employed. Thus, from a cost point of view it should be regarded as good risk management to strive to keep down the costs related to energy use and cooling need in all modes of operation.

### **No operation**

During No operation the estimated power needs are about 40% of that during Intermediate operation but due to the expected longer duration of the former mode the total energy use is more than 2/3 of that during Intermediate.

At No operation no power is transferred to the proton beam in the Accelerator and the electric power use of klystrons, etc. is assumed to be close to zero. The power and cooling need of Accelerator in this mode is therefore almost exclusively related to the RF test stands and to the cryo-cooling of the cavities, etc. The former is assumed to be running always in order to secure a high availability of the accelerator. In the case of the latter it is at present assessed that it is not motivated to shut down the system during shorter shutdown periods. The assessment is based on the risk of fatigue due to thermal cycling of the components and taking into account the energy requirement to cool the components back to the desired temperature after a complete shutdown. However, in order to decrease the energy use in this mode it has been assumed that the cryo temperature is increased a couple of Kelvin and that the equipment is designed with the cooling power need during this mode of operation taken into account. These assumptions have a large influence on the energy use in this mode and it is recommended to continue these investigations in the future design work.

The energy consumption in Target during No operation is primarily related to the assumption of continuous operation of the cryo-cooling circuit of the moderator and the energy use of the active cells, utility rooms, etc. It is recommended to continue the investigations regarding these energy uses in the future design work.

Even during No operation the estimated total power need of NSS is almost 50% of that during Full operation. This is due to the assumption that the detector systems, vacuum pumps and computers of NSS are never shut down. It is recommended that power needs during periods when no neutrons are produced is further investigated in the future design work.

As in the other modes of operation the energy use of the HP:s is directly related to the cooling needs arising from the rest of the facility.

### 3.3.3 Processes with significant energy use

Of all the energy users identified in the EnI the twelve most significant are listed in Table 5. In the table is specified in which part of the facility the systems are located and the estimated annual electricity use.

No. Component	Part of the facility	Electricity use [GWh/year]
<b>HIGH SECTION (RF SYSTEM)</b>		
1. Heat Pumps	Accelerator	78
2. Cryo-cooling cavities, RF test stands, LHe	-	44
3. stands, LHe	Accelerator	28
4. Low section (RF system)	Accelerator	22
5. Cryo-cooling moderator	Target	13
6. RF test stands (RF system)	Accelerator	11
7. Spokes (RF system)	Accelerator	9
8. Target Wheel cooling circuit	Target	9
9. Detector systems	NSS	8
10. Vacuum pumps	NSS	8
11. Chopper systems	NSS	7
12. Drift Tube Linac (DTL) (RF system)	Accelerator	6
<b>Total</b>		<b>243</b>

Table 5 The twelve most significant energy users of ESS identified in the energy inventory

Close to 90% of the total electricity use of ESS (including HP) derives from the energy users in Table 5. Consequently it is absolutely essential to focus on them in the design work to optimise electricity use and the cooling/heat recovery circuits. Considering that they represent an estimated annual electricity use of 243 GWh the cost reducing potential in the operational phase is significant.

The RF systems of the High, Low, Spokes and DTL sections of the accelerator (No. 1, 4, 7 and 12 in Table 5) are all key parts of the facility in terms of energy use. Notable is that the electricity use of the High section alone has been estimated to 1/3 of the electricity use of the whole facility (excluding HP:s). Considering their great importance to the overall energy use it must be made certain that the present general design is the best choice taking future operating costs into account and given restrictions regarding budget and time schedule of the project. Once the general design is established it is recommended that all components are purchased with an LCC analysis as a part of the decision process. In the LCC not only the supplied electricity should be regarded but also the cost/revenue associated with the waste heat generated. It is important that the excess heat generated is recovered in an optimum way.

The energy supplied to the HP:s (No. 2 in Table 5) is directly related to the amount of low grade heat that needs to be supplied to the DH system and the coefficient of performance of the HP. By reducing the electricity demand of key systems in the facility the waste heat generated is reduced and so will the electricity supplied to the HP. In addition it is of great importance to optimise the cooling circuits in the facility in order to minimise the LCC. The high-grade heat that can be transferred directly to the DH system via a heat exchanger is very likely to generate an income to ESS while this might not be the case if the temperature level has to be increased by means of a HP. In this context the temperature requirements of the DH system and the temperature level of the available waste heat from the facility are essential parameters. Furthermore if alternative uses of the low grade heat that do not require HP:s can be found these are likely to be attractive alternatives. Finally, the HP should also be chosen taking into account the LCC of the total investment. With the current design of the facility large amounts of energy will be supplied to the DH system and thus state of the art HP:s with high coefficient of performance can likely be motivated.

Due to the large temperature difference between the heat sink and heat source cryo-cooling systems (No. 3 and 5 in Table 5) are by the laws of thermodynamics bound to be associated with high energy use. Requirements with respect to cooling powers and temperature levels have a very large impact on the energy use of a cryo-cooling system. These parameters should be given special attention in the design of components requiring cryo-cooling. Apart from this the efficiency of the process generating

the cryo-cooling should of course be designing to obtain the most cost-efficient solution possible. In the design of the cryo-cooling systems it is also important to consider the energy use during part or no load operation. In the EnI it has been assumed that all cryo-cooling systems are always running but that they can partly adapt to the current cooling requirement during part load. Even with this assumption the estimated electricity use related to the cryo-cooling systems for Accelerator and Target during the No operation mode alone amounts to an estimated 5 GWh/year.

The purpose of the RF test stands (No. 6 in Table 5) is to provide for back up with respect to key components of the accelerator. The current expectation is that the RF test stands will be running at all times and as a consequence the energy use will be significant. The need for back-up components in the completed facility will be related to the frequency of which components have to be replaced. If an accelerator with reliable components and high availability is erected this will create prerequisites for reducing the energy use of the RF test stands. Based on the current estimate of the energy use of the test stands it is recommended that it is further investigated in the design work and that a plan is made in order to make sure that the energy use in the operating phase is continuously reviewed.

The Target wheel cooling circuit (No. 8 in Table 5) is related to the cooling of the rotating tungsten target in the target station. Considering needs to minimise the formation of radioactive by-products, consequences of a power failure, etc. according to the current design the target wheel is to be cooled with helium. The helium circuit is in turn cooled by a nitrogen circuit, which finally is cooled by a water circuit. The electricity use of these circuits is primarily related to the compressors of the helium and nitrogen circuits. The high power requirements of the compressors are in turn caused by the large volume flows and pressure drops associated with the current design. It is recommended that the current design and/or alternatives to this to be investigated further.

As previously stated the estimates in the EnI regarding energy use for NSS (in all modes of operation) are very preliminary and associated with a high degree of uncertainty. The uncertainty is primarily due to the fact that no decisions at present have been made regarding the types of instruments to be installed. These decisions will have a large influence on the energy use. This should be kept in mind when evaluating the estimates in the EnI.

With the assumptions made the energy use of the detector systems, vacuum pumps and chopper systems of NSS (No. 9, 10 and 11 in Table 5) place them all on the list of top twelve most significant energy users of ESS. These components have in common that the power need per instrument is relatively high and there are many of them, resulting in a high total power need. Moreover, in the EnI it has been assumed that the detector systems and vacuum pumps under normal circumstances are never shut-down. In the case of the detector systems this is primarily due to concerns of damaging the sensitive equipment. The vacuum systems they are typically designed to maintain the very low pressure levels required during operation and not to create these pressures starting from an atmospheric pressure. The latter would therefore typically involve an initial depressurization that is achieved in some other way. Considering the large volumes in question it will in addition be a very time consuming process to create the vacuum required starting from atmospheric pressure. Many of the systems located in NSS have in common that there is some uncertainty regarding the energy use during periods when neutrons are not produced. If the electricity use in these modes of operation can be reduced it will have a significant impact on the overall energy use of NSS. Finally, it should be noted that at present the general assumption is that it will be hard to recover the waste heat of the systems located in NSS in a cost-efficient way. This assumption needs to be further investigated but if it is correct the incentives to reduce the electricity use is even greater.



### 3.3.4 Regarding cooling and heat recovery

Eventually all electricity supplied to ESS will turn into heat in one way or the other. This by-product of the process may:

- Involve a locally positive contribution to the indoor air where it is generated, for instance contributing to a current space heating need
- Be transferred to a waterborne cooling/heat recovery system and utilized in some other part of the facility or delivered/rejected to a third party or to the ambient
- Involve a locally negative contribution to the indoor air where it is generated and needs to be cooled off, for instance through conventional chillers

If the heat can be utilized locally this is of course ideal. In practice when taking into account the possibility to control the amount of heat supplied to the ambient air, the thermal comfort of people residing on the premises, etc. it is normally impossible to maintain an acceptable indoor climate only by relying on heat losses from the process.

If the waste heat from the processes can be transferred to a cooling/heat recovery system this facilitates the possibilities to make good use of the excess heat. In the case of ESS the ambition is to use the heat internally or transfer it to a third party. Preferably the waste heat can be used without supplying significant additional energy but if the temperature requirement of the third party is higher than the temperature available it can be raised by using a HP.

In the two first points of the bullet list the heat generated is primarily regarded as an asset while in the third case it is a liability. In this case typically electricity has to be locally supplied to for instance chillers or fans in order discharge the heat to the ambient. This alternative should be avoided as far as possible.

Considering the large amounts of heat generated within ESS it is essential to design the cooling circuits so that the heat is recovered in an optimum way. The first corner stone to achieve this is to design the processes so that the heat generated is primarily transferred directly to a waterborne cooling system. The second corner stone is to optimise the cooling circuits in terms of the number of different temperature levels to work with. Too many cooling circuits will involve high capital costs while too few circuits will limit the possible uses of the heat or involve higher cost/lower revenue in order to discharge the heat. The third cornerstone is to find uses of the heat that do not require that large amounts of additional energy needs to be supplied and/or high investments.

An important factor when considering the temperature level of the cooling circuits is of course the temperature requirements of the third party that can utilize the heat. For instance, as has been described in section 3.3.3, the energy that needs to be supplied to a HP in order to raise the temperature of low-grade heat is substantial. It is therefore essential to find uses of the low grade heat that do not require a temperature increase by means of a HP. Ideally the alternative heat sinks should be available during the whole year since this means that also the installed capacity (and investment) of the HP can be reduced.

Due to the large amounts of heat that needs to be discharged from ESS the DH system to a large extent will have to be used as a heat sink regardless of if it generates an income or not. If the temperature level of the heat recovered from ESS is higher than the supply temperature of the DH system then it can be transferred directly via a heat exchanger. In this case the heat supplied to the DH system will most likely be associated with net revenue. If the temperature is not high enough and it has to be increased with a HP then it is less likely to generate an income. It is therefore important to clarify the minimum temperature requirements of the DH system and the price the DH operator is prepared to pay for the heat supplied. It should be noted that the supply temperature of Swedish DH systems typically varies between 75-85 °C during summertime and 100-120 °C during wintertime, depending of the geographic location.

One possible solution to increase the amount of heat that can be directly recovered in the DH system is to have local temperature requirements for new buildings to be constructed in the area around ESS. If new buildings are designed for lower temperature levels in the space heating circuit the prerequisites for heat recovery from ESS is improved. This type of local requirements on buildings was for instance applied in the area B01 in the town of Malmö where E.ON is operating the DH system. The solution would require acceptance and collaboration as soon as possible with Lund Municipality and Lunds Energi AB.

Within the project in general and specifically when it comes to heat recovery it is essential to clearly define the limits of scope for each project in order to secure the best possible result. In order to avoid sub optimisations it is likely beneficial to clearly delegate the overall responsibility for optimising all the systems that connects the processes to be cooled with the parts where the heat is utilized (which typically is a third party).

### **3.3.5 Comment regarding energy use of Conventional Facilities**

The energy use related to "basic needs" such as heating, hot tap water preparation, cooling, ventilation, lighting, etc. is small in relation to the total energy use of ESS. In addition to this the waste heat from the processes within the facility by far exceeds the heating and hot tap water needs of the buildings. From this point of view the "conventional needs" is not of great significance to the overall energy use of ESS. On the other hand, even if the electricity use is comparably small it is nevertheless associated with a cost. In this case the buildings should of course be designed in order to keep down the electricity use as far as can be motivated from an economic point of view. In the case of heating and hot tap water the situation is a bit different since it can be argued that the waste heat generated in the processes within the facility is a waste product that needs to be discharged anyway. On the other hand also with respect to heat use the energy performance should not be totally disregarded for at least three reasons. The first is that the thermal comfort of people residing in the buildings must be considered. The second is that poorly insulated buildings are likely to involve higher cooling needs during summertime. Thirdly, it should be recognized that the design of the buildings would have a large symbolic value. If visitors perceive them as "energy intelligent" then it is more credible when stated that the energy concept of the whole of ESS is unique.

## **4. Energy Management Action Plan**

In this section the identified planning outputs are accounted for.

### **4.1 Energy baseline**

The purpose of establishing an energy baseline is to create a point of reference to which changes in energy performance can be related. The baseline is typically established using the information in the initial EnI. When studying the energy use of an existing facility the results from the EnI clarify the present situation. Based on this information suitable and realistic objectives and targets can normally be identified. In the case of ESS the initial EnI (according to section 3) is subject to a large degree of uncertainty since it is purely based on the present best guess regarding a facility in the design phase. This in turn makes it hard to claim that a baseline based on the EnI beyond all doubt is the most relevant one. It also makes it harder to set up suitable objectives and targets. Therefore the EnI needs to be updated regularly.

Despite of the deficiencies associated with an EnI performed at the design stage of a facility it is recommended that an energy baseline is established. The reason for this is that it facilitates the evaluation of future energy management work by defining a point of reference. Even if the energy use according to such a baseline cannot be claimed to be 100% correct it is still significantly better than not to have a baseline at all.

It is recommended that an overall energy use according to Table 2, with the restrictions according to section 3.1 and the prerequisites and assumptions accounted for in section 3.2, is decided to form the energy baseline of ESS.

The energy baseline should be adjusted if any major changes are made regarding the process, operational patterns or energy systems. In addition the relevance of the baseline should be assessed in future energy inventories. If the baseline is then considered irrelevant it should be revised. All changes of the energy baseline shall be documented.

## 4.2 Energy performance indicators

The ISO 50001:2011 states that the organisation shall identify Energy Performance Indicators (EnPI) appropriate for monitoring and measuring its energy performance. This will help to monitor the progress in energy efficiency over time and how to compare this facility to other similar facilities. The benefits with EnPI are to get accurate understanding of improvements and the possibility for instant identification of abnormal situations. The EnPI will be a great bearing on the over all energy goals of ESS and the progress from the energy efficiency will partly finance the operations cost of the facility. The methodology for determining and updating these EnPIs shall be recorded and regularly reviewed. Based on the performed EnI the following EnPIs are suggested for each of the projects:

- Annual electricity use in MWh divided by the number of hours at full operation
- Annual amount of heat recovered in percent of supplied electricity
- Share of annual heat use within the facility originating from recovered heat
- Share of annually recovered heat at specified temperature levels (for instance 20, 40 or 80 °C)
- Share of total electricity use originating from renewable electricity production

In the design phase EnPIs will be based on calculations, experiences from similar facilities, etc. Once the facility is commissioned annual electricity use and annual amount of heat use, etc. needs a long period of time to follow up if one has to wait the full year. Therefore we suggest that the EnPI shall be followed gradually until a steady state level is achieved.

When more extensive EnIs have been carried out other performance indicators can be added. Possible additional performance indicators could for instance be:

- Maximum electric power demand in MW
- Share of heat recovered that is utilized without additional temperature increase
- Specific electricity and heat use per m<sup>2</sup> (floor area) and year for different parts of the facility (offices, public areas, accelerator, etc.)
- Overall efficiency of the accelerator during full operation (beam power divided by supplied power during full operation)

## 4.3 Energy objectives and targets

The organisation needs to establish, implement and maintain energy objectives and targets for each of the projects Accelerator, Target, NSS and Conventional Facilities as well as for the whole of ESS. In addition to this objectives and targets for Energy Project need to be formulated. The objectives should specify outcomes or achievements in order to meet the energy policy. Thus, objectives describe overall goals and should be formulated first. Once the objectives are established the targets can be formulated. Targets are detailed and quantifiable energy performance requirements in order to achieve the objectives. The objectives and targets should be consistent with the energy policy and the targets should be consistent with the objectives. When establishing and reviewing objectives and targets the organisation shall take into account legal and other requirements, significant energy uses and opportunities to improve energy performance. It should also consider its financial, operational and business conditions, technological options and views of interested parties.

Energy objectives and targets should be firmly established and accepted within the organisation. Especially considering that ESS is a specialized research facility in the design phase relevant objectives and targets need to be developed in close dialogue with the parts of the organisation concerned. Detailed dialogues regarding appropriate objectives and targets have not yet been held with the concerned parties and therefore it is here refrained from making any suggestion on how to formulate them. When formulating the energy objectives and targets it should be recognize that a high availability of the facility should not have a negative impact on the possibility to reach said objectives/targets and vice versa. To formulate relevant objectives and targets should be given top priority in the future energy management work.

## 4.4 Energy management action plan

In this section is accounted for actions that are expected to increase the probability that the energy objectives and targets of ESS are achieved. Since at present no objectives and targets are formulated the action plan consists of activities that in general are likely to make the facility more energy efficient and that will contribute to the future energy management work.

The purpose of the work summarized in this report has not been to identify the activities that are already in progress in order to make ESS an energy efficient facility. The reviewers' general impression is actually that energy efficiency is clearly addressed as an important topic by most parts of the ESS internal projects. Considering this it is likely that many or even most of the actions suggested in this section have already been taken or are in progress. In these cases the action plan simply confirms that the organisation is already focusing its efforts on relevant tasks.

### 4.4.1 Overall considerations

Actions to reduce the energy use of ESS should not jeopardize the functionality of the facility nor should it significantly reduce its technical lifespan. The facility must fulfil all legal requirements with respect to indoor climate, safety to use, etc.

Efforts to reduce total energy use in the operational phase should of course primarily focus on the largest energy users. If considering processes with a similar total energy use it is suggested that efforts are prioritized in the following order:

1. Reduction of electricity use in processes where waste heat is
  - a. Not possible to recover in an efficient way
  - b. Possible to recover in an efficient way
2. Heat recovery at the highest temperature level possible
3. Use of recovered low grade heat on the premises
4. Use of recovered heat outside of the facility
  - a. Applications that do not require additional temperature increase
  - b. Applications that require additional temperature increase

Energy use during Full operation is dominating the overall energy use of ESS. However, the energy use during Intermediate and No operation mode should also be regarded in order to reduce the total energy use and to limit the economic consequences if operational problems are experienced.

The purpose of the cooling/heat recovery is twofold. The primary purpose is to supply the necessary cooling of the process. This requires heat sinks with high availability and with sufficient cooling capacity. The heat sinks must be available at all times when the facility needs cooling. The secondary purpose of cooling/heat recovery from the facility is that it is a potential source of income alternatively can be associated with a high or low cost to discharge. In this respect the temperature level of the recovered heat is essential. With respect to future operation costs of ESS it is essential that the question of how to recover and use heat in an optimum way is continuously monitored during the design and construction phase. Consequently it is essential that relevant responsibilities are clearly stated within the organization.

From an energy point of view the design process will typically involve a balance between electricity use, high-grade heat, low grade heat and investment. LCC analysis is a tool that can be used in order to make decisions in these situations. In the LCC analysis the whole system should be considered and sub-optimisations, for instance due to organizational boundaries, should be avoided. A prerequisite in order to perform relevant analysis is that the organisation specifies the basic input to be used. In the cases of ESS there is especially a need to assign electricity price and price of waste heat at different temperature levels.

### 4.4.2 General/Top management

In this section actions concerning the overall energy management are treated. Based on the EnI accounted for in section 3 the following actions are suggested:

Action	Deadline	Responsible
1. Top management shall every sixth month review the organisations Energy Management System to ensure its continuing suitability, adequacy and effectiveness. An updated Energy Management Plan supplied by Energy Project will form the basis for the review.	June 1st, 2013	Programme Director

#### 4.4.3 Accelerator

The electricity use and cooling need of Accelerator have in the performed EnI been estimated to 71% and 62% respectively of the overall use/need of ESS (excluding HP:s). The energy use is primarily related to the RF systems of the High, Low, Spokes and DTL sections of the accelerator, the cryo-cooling systems and the RF test stands. Most important of these is the RF system of the High section which alone represents 1/3 of the overall electricity use (excluding HP:s). Accelerator is the most important project in order to achieve overall goals regarding electricity use and heat recovery.

The information in the EnI presented in section 3 of this document may form the basis on which the project formulates its objectives and targets. However, it is important that the project also assess and validate these estimated energy uses in order to ensure that the objectives and targets are relevant and realistic. Based on the EnI accounted for in section 3 the following actions are suggested for Accelerator:

Action	Deadline	Responsible
1. Establish an inventory of estimated average power needs of the systems in the facility in relevant modes of operation. The inventory should involve electricity use, cooling needs at different temperature levels and heating needs. The inventory should be formally approved by the project and updated every sixth month	March 1st, 2013	Accelerator
2. Formulate energy objectives and targets (with assistance from Energy Project) and incorporate them in the Project Specification for approval in EPG. Objectives/targets should be formulated taking into account the writings in this document. As a minimum the EnPI:s according to 3-5 below should be addressed. Energy Project shall be informed of the objectives/targets set.	February 1st, 2013	Accelerator
3. Set a goal for annual electricity use in MWh per full operation hours	February 1st, 2013	Accelerator
4. Set a goal for totally recovered heat in percent of the supplied electricity	February 1st, 2013	Accelerator
5. Set a goal for the recovered heat at temperature levels 20, 40 and 80 °C	February 1st, 2013	Accelerator
6. Ensure that sufficient resources are allocated in the design phase in order to achieve the best result possible with respect to electricity use and heat recovery given constraints in terms of funding and time	March 1st, 2013	Accelerator
7. Further investigate the design of the RF systems of the High , Low, Spokes and DTL sections in terms of electricity use and heat recovery (including temperature levels) in all modes of operation	As necessary	Accelerator
8. Further investigate the design of components that require cryo-cooling and the cryo-cooling equipment itself in terms of electricity use and heat recovery (including temperature levels) in all modes of operation	As necessary	Accelerator
9. Further investigate the energy use of the RF test stands in terms of energy use and heat recovery (including temperature levels)	As necessary	Accelerator

#### 4.4.4 Target

The electricity use and cooling need of Target have in the performed EnI been estimated to 13% and 26% of the overall use/need of ESS (excluding HP). The electricity use of Target is primarily related to the cryo-cooling of the moderator and the gas cooling of the target wheel and this also constitutes a large share of the overall energy use. The cooling need is primarily related to the heat developed when the proton beam hits the target wheel and to the processes that provide the cooling (whereof the cryo-cooling of the moderator and the gas cooling of the target wheel is the most significant). Target is the second most important project of ESS in order to achieve the overall energy goals.

The information in the EnI presented in section 3 of this document may form the basis on which the project formulates its objectives and targets. However, it is important that the project also assess and validate these estimated energy uses in order to ensure that the objectives and targets are relevant and realistic.

Based on the EnI accounted for in section 3 the following actions are suggested for Target:

Action	Deadline	Responsible
1. Establish an inventory of estimated average power needs of the systems in the facility in relevant modes of operation. The inventory should involve electricity use, cooling needs at different temperature levels and heating needs. The inventory should be formally approved by the project and updated every sixth month	March 1st, 2013	Target
2. Formulate energy objectives and targets (with assistance from Energy Project) and incorporate them in the Project Specification for approval in EPG. Objectives/targets should be formulated taking into account the writings in this document. As a minimum the EnPI:s according to 3-5 below should be addressed. Energy Project shall be informed of the objectives/targets set.	February 1st, 2013	Target
3. Set a goal for annual electricity use in MWh per full operation hours	February 1st, 2013	Target
4. Set a goal for totally recovered heat in percent of the supplied electricity	February 1st, 2013	Target
5. Set a goal for the recovered heat at temperature levels 20, 40 and 80 °C	February 1st, 2013	Target
6. Ensure that sufficient resources are allocated in the design phase in order to achieve the best result possible with respect to electricity use and heat recovery given constraints in terms of funding and time	March 1st, 2013	Target
7. Further investigate the design of the cryo-cooling need of the moderator in terms of cooling power required in all modes of operation	As necessary	Target
8. Further investigate the design of the target wheel that require gas cooling and the gas cooling equipment itself in terms of electricity use and heat recovery (including temperature levels) in all modes of operation	As necessary	Target
9. Further investigate the temperature levels of the cooling/heat recovery circuits other than the moderator and the target wheel	As necessary	Target

#### 4.4.5 Neutron Scattering Systems

At present no decisions have been made regarding what kind of instruments to be installed within ESS and NSS therefore appears to be the project within ESS where at present the least is known about the energy use in the fully commissioned facility. Still based on the first initial guess it can be concluded that the energy use of NSS will be far from negligible.

The information in the EnI presented in section 3 of this document may form the basis on which the project formulates its objectives and targets. However, it is important that the project also assess and validate these estimated energy uses in order to ensure that the objectives and targets are relevant and realistic.

Based on the EnI accounted for in section 3 the following actions are suggested for NSS:

Action	Deadline	Responsible
1. Establish an inventory of estimated average power needs of the systems in the facility in relevant modes of operation. The inventory should involve electricity use, cooling needs at different temperature levels and heating needs. The inventory should be formally approved by the project and updated every sixth month	March 1st, 2013	NSS
2. Formulate energy objectives and targets (with assistance from Energy Project) and incorporate them in the Project Specification for approval in EPG. Objectives/targets should be formulated taking into account the writings in this document. As a minimum the EnPI:s according to 3-5 below should be addressed. Energy Project shall be informed of the objectives/targets set.	February 1st, 2013	NSS
3. Set a goal for annual electricity use in MWh per full operation hours	February 1st, 2013	NSS
4. Set a goal for totally recovered heat in percent of the supplied electricity	February 1st, 2013	NSS
5. Set a goal for the recovered heat at temperature levels 20, 40 and 80 °C	February 1st, 2013	NSS
6. Ensure that sufficient resources are allocated in the design phase in order to achieve the best result possible with respect to electricity use and heat recovery given constraints in terms of funding and time	March 1st, 2013	NSS
7. Further investigate the design of the detector systems, vacuum pumps and chopper systems in terms of electricity use and possibility to recover heat (including temperature levels) in all modes of operation	As necessary	NSS
8. Further investigate the possibility to recover heat generated	As necessary	NSS
9. Further investigate energy use during periods without a flux of neutrons	As necessary	NSS

#### 4.4.6 Conventional Facilities

The electricity use and heating need directly related to Conventional facilities is only a few percent of the overall energy use of ESS. However, even if the energy use is relatively small the design of the buildings with respect to energy performance will be of significant symbolic value to the people working at or visiting ESS. In addition to this a good indoor climate in offices, laboratories, etc. will be of importance to the productivity of people residing on the premises. Finally, Conventional facilities may play a key role in the optimisation of how to transfer the heat generated within ESS to the points were it will be discharged/utilized.

The information in the EnI presented in section 3 of this document may form the basis on which the project formulates its objectives and targets. However, it is important that the project also assess and validate these estimated energy uses in order to ensure that the objectives and targets are relevant and realistic.

Based on the EnI accounted for in section 3 the following actions are suggested for Conventional Facilities:

Action	Deadline	Responsible
1. Formulate energy objectives and targets (with assistance from Energy Project) and incorporate them in the Project Specification for approval in EPG. Objectives/targets should be formulated taking into account the writings in this document. As a minimum the EnPI:s according to 2-4 below should be addressed. Energy Project shall be informed of the objectives/targets set.	March 1st, 2013	Conventional Facilities
2. Set a goal for annual specific electricity use in kWh/m <sup>2</sup>	February 1st, 2013	Conventional Facilities
3. Set a goal for the share of heat use within the facility that should originate from low grade recovered heat	February 1st, 2013	Conventional Facilities
4. Establish a plan on how to transfer the excess heat generated within ESS to the points were it will be discharged/utilized in an optimum way (provided this is assigned Conventional Facilities)	March 1st, 2013	Conventional Facilities
5. Establish a plan on how to secure an energy performance of each of the buildings of ESS that is both motivated from an economic point of view and is likely to be perceived as "energy intelligent"	March 1st, 2013	Conventional Facilities
6. Initiate a dialogue with "Byggnadsnämnden" regarding interpretation of requirements on energy use according to the building regulations (BBR)	March 1st, 2013	Conventional Facilities



#### 4.4.7 Energy Project

Energy Project plays a key role in the energy work within ESS and should be the driving force in order to reach the overall energy objectives and targets.

The information in the EnI presented in section 3 of this document may form the basis on which the project formulates the objectives and targets for the whole of ESS. However, it is important that the project also consider the individual objectives and targets set up by Accelerator, Target, NSS and Conventional Facilities to ensure that the overall objectives and targets are relevant and realistic.

Based on the EnI accounted for in section 3 the following actions are suggested for Energy Project:

Action	Deadline	Responsible
1. Establish an energy policy for the whole of ESS	May 1st, 2013	Energy Project
2. Establish relevant objectives and targets for the whole of ESS (including to define their scope)	March 1st, 2013	Energy Project
3. Establish a first version of an energy baseline (for instance according to Table 2 in this document)	February 1st, 2013	Energy Project
4. Assist the projects within ESS in formulating their objectives and targets	As necessary	Energy Project
5. Every sixth month follow-up, develop and update the previous version of the Energy Management Plan so that it covers all parts of the energy management of ESS including implementation, evaluation and follow-up, etc.	May 1st, 2013 (1st rev)	Energy Project
6. Every sixth month further develop and update the previous version of the EMAP taking into account for instance estimates of: <ul style="list-style-type: none"> <li>▪ Requirements on installed electric power</li> <li>▪ Requirements on installed cooling capacity</li> <li>▪ Heat recovered at different temperature levels</li> </ul>	May 1st, 2013 (1st rev)	Energy Project
7. Identify additional external and internal requirements on energy use of ESS	March 1st, 2013	Energy Project
8. Clarify yearly variations in temperature requirements of the DH system	March 1st, 2013	Energy Project
9. Clarify the maximum heat power that can be supplied to the DH system throughout the year	March 1st, 2013	Energy Project
10. Develop a price model together with the DH operator regarding the heat supplied to the DH system depending on the temperature level, time of year, etc.	March 1st, 2013	Energy Project
11. Set a goal for the amount of heat to be recovered without having to raise the temperature by means of HP:s	March 1st, 2013	Energy Project
12. Set a goal for the annual electricity supplied to HP in MWh per full operation hours	March 1st, 2013	Energy Project
13. Set a goal for the share of total electricity use that should originate from renewable sources	March 1st, 2013	Energy Project
14. Further investigate how to handle recovered heat in the best way possible including to identify alternatives to the DH system for discharging/utilizing recovered heat	October 1st, 2013	Energy Project
15. Further investigate the possibility to apply local (lower) temperature requirements for buildings to be constructed and connected to the DH system in the vicinity of ESS (in order to facilitate heat recovery)	October 1st, 2013	Energy Project
16. Develop a first model for pricing recovered heat at different temperature levels (for instance to be used as input in future LCC analysis within ESS)	December 1st, 2012	Energy Project
17. Further investigate the most favourable form of ownership of the HP:s	October 1st, 2013	Energy Project

# 5. Appendix

Appendix A: Basis of estimate, energy inventory

## Appendix A: Basis Of Estimate, Energy Inventory

In this appendix the input to the performed EnI is specified in more detail. The energy use is calculated based on the operational times according to Table 1. The estimated energy uses accounted for in the EnI should be regarded as best guesses as of mid September 2012. The greatest uncertainties in the EnI are considered to be related to the energy use during the Intermediate mode of operation (for all parts of the facility) and to NSS in all modes of operation. The following persons have contributed with input to the EnI and are gratefully acknowledged: Fredrik Bergstedt, Martin Gierow, Wolfgang Hees, Frithiof Jensen, John Jurns, Oliver Kirstein, Per Nilsson, Thomas Parker, Ronny Sjöholm, Anders Sunesson and John Weisend.

### Accelerator- Estimated power need and energy use

The estimates of average power need and energy use of Accelerator have primarily been based on the following information sources:

- Preliminary estimates regarding power need of key systems during Full operation from personnel at Accelerator
- Dialogue with personnel at Accelerator regarding power need during Intermediate and No operation modes
- Information in TDR draft of May 23rd 2012 for "Cooling and heat recovery"
- Dialogue with personnel at Cryogenics & vacuum regarding the cryo-cooling systems
- Estimates made by Tommy Persson (when no other information was available)

The average power need and energy use of Accelerator during Full, Intermediate and No operation have been estimated as follows:

#### Full operation (5400 h)

Component	Electricity supplied	Cooling needed	Unit
Ion Source	125	125	kW
RFQ	175	140	kW
Bunchers (=MEBT)	19	17	kW
DTL (RF system)	1143	956	kW
Spokes (RF system)	1489	704	kW
Low section (RF system)	3768	2961	kW
High section (RF system)	13894	10066	kW
LEBT & HEBT	500	500	kW
Pumps in cooling circuits	62	62	kW
Fans for ventilation	89	45	kW
Racks for instruments	200	200	kW
RF test stands (RF system)	1300	1300	kW
Cooling of air in klystron gallery	100	100	kW
Linac tunnel	63	380	kW
Cryo-cooling cavities, RF test stands, LHe	4000	4000	kW
Utilities (compressed air, etc.)	500	500	kW
<b>Total, power</b>	<b>27427</b>	<b>22055</b>	<b>kW</b>
<b>Total, energy use</b>	<b>148108</b>	<b>119097</b>	<b>MWh</b>

### Intermediate operation (1260 h)

Component	Electricity supplied	Cooling needed	Unit
Ion Source	63	63	kW
RFQ	25	25	kW
Bunchers (=MEBT)	17	17	kW
DTL (RF system)	104	104	kW
Spokes (RF system)	1047	1047	kW
Low section (RF system)	1108	1108	kW
High section (RF system)	2270	2270	kW
LEBT & HEBT	250	250	kW
Pumps in cooling circuits	62	62	kW
Fans for ventilation	89	45	kW
Racks for instruments	200	200	kW
RF test stands (RF system)	1300	1300	kW
Cooling of air in klystron gallery	100	100	kW
Linac tunnel	63	380	kW
Cryo-cooling cavities, RF test stands, LHe	2667	2667	kW
Utilities (compressed air, etc.)	500	500	kW
<b>Total, power<sup>2</sup></b>	<b>9864</b>	<b>10136</b>	<b>kW</b>
<b>Total, energy use</b>	<b>12429</b>	<b>12772</b>	<b>MWh</b>

### No operation (2100 h)

Component	Electricity supplied	Cooling needed	Unit
Ion Source	0	0	kW
RFQ	0	0	kW
Bunchers (=MEBT)	0	0	kW
DTL (RF system)	0	0	kW
Spokes (RF system)	0	0	kW
Low section (RF system)	0	0	kW
High section (RF system)	0	0	kW
LEBT & HEBT	0	0	kW
Pumps in cooling circuits	0	0	kW
Fans for ventilation	11	6	kW
Racks for instruments	200	200	kW
RF test stands (RF system)	1300	1300	kW
Cooling of air in klystron gallery	0	0	kW
Linac tunnel	0	0	kW
Cryo-cooling cavities, RF test stands, LHe	1333	1333	kW
Utilities (compressed air, etc.)	100	100	kW
<b>Total, power</b>	<b>2944</b>	<b>2939</b>	<b>kW</b>
<b>Total, energy use</b>	<b>6183</b>	<b>6172</b>	<b>MWh</b>

<sup>2)</sup> The estimated cooling is greater than the supplied electricity. This is due to the simplified assumption that the cooling need of the Linac tunnel is equal to that during Full operation. The uncertainty of the first assumption is so large that it wasn't considered motivated to adjust it.

## Target - Estimated power need and energy use

The estimates of average power need and energy use of Target have primarily been based on the following information sources:

- Preliminary estimates regarding power need of key systems during Full operation from personnel at Target
- Dialogue with personnel at Target regarding power need during Intermediate and No operation modes
- Information in TDR draft of May 23rd 2012 for "Cooling and heat recovery"
- Dialogue with personnel at Cryogenics & vacuum regarding the cryo-cooling systems
- Estimates made by Tommy Persson (when no other information was available)

The average power need and energy use of Target during Full, Intermediate and No operation have been estimated as follows:

### Full operation (5400 h)

Component	Electricity supplied	Cooling needed	Unit
Target wheel cooling circuit (He+N <sub>2</sub> )	1622	4622	kW
Moderator cooling circuit (LH <sub>2</sub> +He+N <sub>2</sub> )	1790	1806	kW
Thermal moderators system	0	49	kW
Inner reflectors system	1	351	kW
Monolith shielding system: Reflectors	12	792	kW
Monolith shielding system	4	304	kW
Tuning beam dumps system	0	0	kW
Monolith Flush+Atmosphere system	171	211	kW
PBW system	17	21	kW
Offgas system	0	5	kW
Helium purification systems	10	10	kW
Low temperature adsorber system	0	0	kW
Active cells, utility rooms, etc. HVAC/RGEC	864	997	kW
Water purification and handling system	0	5	kW
Pump energy intermediate water systems	3	3	kW
<b>Total, power</b>	<b>4493</b>	<b>9175</b>	<b>kW</b>
<b>Total, energy use</b>	<b>24263</b>	<b>49545</b>	<b>MWh</b>

<sup>3)</sup> Cryo-cooling requirement that is met by liquid nitrogen. The liquid nitrogen is here assumed to be supplied from a third party. Energy use associated with this process is not included in the EI.

### Intermediate operation (1260 h)

Component	Electricity supplied	Cooling needed	Unit
Target wheel cooling circuit (He+N2)	406	406	kW
Moderator cooling circuit (LH2+He+N2)	895	900	kW
Thermal moderators system	0	0	kW
Inner reflectors system	1	1	kW
Monolith shielding system: Reflectors	12	12	kW
Monolith shielding system	4	4	kW
Tuning beam dumps system	0	50	kW
Monolith Flush+Atmosphere system	43	43	kW
PBW system	4	4	kW
Offgas system	0	5	kW
Helium purification systems	10	10	kW
Low temperature adsorber system <sup>3</sup>			
0	0	kW	
Active cells, utility rooms, etc. HVAC/RGEC	864	997	kW
Water purification and handling system	0	5	kW
Pump energy intermediate water systems	1	1	kW
<b>Total, power</b>	<b>2239</b>	<b>2437</b>	<b>kW</b>
<b>Total, energy use</b>	<b>2821</b>	<b>3071</b>	<b>MWh</b>

## No operation (2100 h)

Component	Electricity supplied	Cooling needed	Unit
Target wheel cooling circuit (He+N2)	0	0	kW
Moderator cooling circuit (LH2+He+N2)	895	900	kW
Thermal moderators system	0	0	kW
Inner reflectors system	1	1	kW
Monolith shielding system: Reflectors	12	12	kW
Monolith shielding system	4	4	kW
Tuning beam dumps system	0	0	kW
Monolith Flush+Atmosphere system	0	0	kW
PBW system	0	0	kW
Offgas system	0	5	kW
Helium purification systems	10	10	kW
Low temperature adsorber system <sup>3</sup>			
0	0	kW	
Active cells, utility rooms, etc. HVAC/RGEC	864	997	kW
Water purification and handling system	0	5	kW
Pump energy intermediate water systems	1	1	kW
Total, power	1786	1935	kW
Total, energy use	3751	4063	MWh

## Conventional facilities - Estimated power need and energy use

When the EnI was made no information regarding "conventional" energy use within ESS was available. The estimates of the energy use of Conventional facilities have therefore primarily been based on the following sources:

- The report "Förbättrad energistatistik för lokaler, – "Stegvis STIL", Rapport för år 1", ER 2007:34 (financed by the Swedish "Energimyndigheten") where statistics regarding energy use in 123 offices and administrative buildings is accounted for
- Rough adjustments made by Tommy Persson of the information in the mentioned report in order to take into account that ESS do not only consist of offices and administrative buildings, that it will be a modern building, etc.

When estimating the total heating need of the buildings it must be recognized that the indoor temperature depends on the relation between heat losses to the surrounding and energy supplied to the building. The energy supplied to the building do not only comprise of the energy supplied via the heating system but also of internally generated heat originating from people, electric appliances, etc. The here specified annual heat use is therefore a rough estimate of the totally supplied energy that is utilized for heating within the buildings (and not only the heat supplied via the heat distribution systems).

The energy use estimates regarding Conventional facilities is admittedly very rough. However, at this point this is considered acceptable considering that it constitutes a small share of the total energy use of the facility.

The average specific and annual heat and electricity use of Conventional facilities have been estimated as follows:

**Average specific and annual heat use during full, intermediate and no operation  
(5400+1260+2100=8760 h)**

Component	Laboratories	Offices	Public areas	Accelerator	Target	NSS	Total	Unit
Specific heat use	101	101	101	101	101	101	-	kWh/m <sup>2</sup>
Floor area	5500	9500	5000	21000	6000	16500	63500	m <sup>2</sup>
<b>Annual heat use</b>	<b>555</b>	<b>958</b>	<b>504</b>	<b>2117</b>	<b>605</b>	<b>1664</b>	<b>6402</b>	<b>MWh/year</b>

**Average specific and annual electricity use during full, intermediate and no operation  
(5400+1260+2100=8760 h)**

Component	Laboratories	Offices	Public areas	Accelerator	Target	NSS	Total	Unit
Lighting	11.5	11.5	11.5	11.5	11.5	11.5	-	kWh/m <sup>2</sup> /year
Computer centre/ server rooms	10.7	10.7	0.0	2.7	2.7	2.7	-	kWh/m <sup>2</sup> /year
Computers	15.4	15.4	0.0	3.9	3.9	3.9	-	kWh/m <sup>2</sup> /year
Other appliances	8.0	8.0	0.0	0.0	0.0	0.0	-	kWh/m <sup>2</sup> /year
Fans	17.9	17.9	17.9	17.9	17.9	17.9	-	kWh/m <sup>2</sup> /year
Electric heating/heat pumps	0.0	0.0	0.0	0.0	0.0	0.0	-	kWh/m <sup>2</sup> /year
Other building electricity	9.5	9.5	9.5	9.5	9.5	9.5	-	kWh/m <sup>2</sup> /year
Chillers	10.6	10.6	10.6	10.6	10.6	10.6	-	kWh/m <sup>2</sup> /year
Miscellaneous	6.8	6.8	6.8	6.8	6.8	6.8	-	kWh/m <sup>2</sup> /year
Total specific electricity use	90.4	90.4	56.3	62.8	62.8	62.8	-	kWh/m <sup>2</sup> /year
Floor area	5500	9500	5000	21000	6000	16500	63500	m <sup>2</sup>
<b>Annual electricity use, total</b>	<b>497</b>	<b>859</b>	<b>282</b>	<b>1319</b>	<b>377</b>	<b>1037</b>	<b>4370</b>	<b>MWh/year</b>

**Neutron Scattering System (NSS) - Estimated power need and energy use**

No decisions have at present been made regarding details for the instruments to be installed. The input regarding energy use within NSS are therefore based on general experiences from similar facilities and are associated with a significant degree of uncertainty. The estimates of average power need and energy use of NSS have primarily been based on the following information sources:

- Very preliminary first estimates regarding power need of key systems during Full operation from personnel at NSS
- Dialogue with personnel at NSS regarding power need during Intermediate and No operation modes
- Estimates made by Tommy Persson (when no other information was available)

Considering the distributed nature of the instruments and details for the equipment in question it is assumed that it will not be possible to recover any substantial amounts of the heat generated within NSS in a cost-efficient way. This needs to be further investigated.

The average power need and energy use of NSS during Full, Intermediate and No operation have been estimated as follows:

#### Full operation (5400 h)

Component	Electricity supplied	Cooling needed	Unit
Motion control	308	308	kW
Vacuum pumps	880	880	kW
Computer systems	374	374	kW
Chopper systems	1100	1100	kW
Sample environment	550	550	kW
Detector system	880	880	kW
Total, power	4092	4092	kW
Total, energy use	22097	22097	MWh

#### Intermediate operation (1260 h)

Component	Electricity supplied	Cooling needed	Unit
Motion control	154	154	kW
Vacuum pumps	880	880	kW
Computer systems	374	374	kW
Chopper systems	1100	1100	kW
Sample environment	550	550	kW
Detector system	880	880	kW
Total, power	3938	3938	kW
Total, energy use	4962	4962	MWh

#### No operation (2100 h)

Component	Electricity supplied	Cooling needed	Unit
Motion control	0	0	kW
Vacuum pumps	880	880	kW
Computer systems	374	374	kW
Chopper systems	0	0	kW
Sample environment	0	0	kW
Detector system	880	880	kW
Total, power	2134	2134	kW
Total, energy use	4481	4481	MWh



### Heat pumps - Estimated power need and energy use

When estimating the energy supplied to HP:s a general assumption have been made that all the heat discharged from the facility to the cooling circuits is supplied to the DH system. The heat generated within NSS is an exception from this and it is assumed not to be recovered. This heat is therefore not included in the energy that is assumed to be supplied to the DH system.

In the TDR draft of May 23rd 2012 for "Cooling and heat recovery" three cooling circuits with different temperature levels are assumed. The circuits are denominated Low, Medium and High with return temperature levels of 35-40, 40-45 and 75-80 °C respectively. It should be noted that these temperature levels are estimated and approximate.

The coefficient of performance (COP) of the HP:s increasing the temperature of the low and medium temperature cooling circuits to the temperature level of the DH system is assumed to be 2,9 and 3,7 respectively. These assumptions are based on information from the on-going work with the TDR draft.

#### Full operation (5400 h)

	Low	Medium	High	Total	Unit
Cooling need	55112	25634	83950	164696	MWh
Coefficient of performance COP	2.9	3.7	-	-	-
Electricity to heat pump	29006	9494	0	38500	MWh
Heat supplied to DH system	84119	35128	83950	203196	MWh

#### Intermediate operation (1260 h)

	Low	Medium	High	Total	Unit
Cooling need	4993	2323	7606	14922	MWh
Coefficient of performance COP	2.9	3.7	-	-	-
Electricity to heat pump	2628	860	0	3488	MWh
Heat supplied to DH system	7622	3183	7606	18410	MWh

#### No operation (2100 h)

	Low	Medium	High	Total	Unit
Cooling need	2911	1354	4435	8700	MWh
Coefficient of performance COP	2.9	3.7	-	-	-
Electricity to heat pump	1532	502	0	2034	MWh
Heat supplied to DH system	4444	1856	4435	10734	MWh

# Chapter 3

ESS Business Plan  
Renewable Energy

# Introduction and Summary

When it comes to the electricity provision of the facility, ESS has two main goals:

1. ESS is committed to new renewable electricity production being built on ESS' initiative to compensate for the electricity consumption (around 250 GWh/year)
2. It is vital for research operations that the electricity cost for running the facility is competitive, stable and predictable

The choice of legal status (ERIC or continue to be a Swedish AB) and the tax status of ESS will have a considerable impact of the choice and design of electricity provision and recycling of surplus heat.

A comparison of the consumption pattern of the ESS with yearly and monthly profile of wind power production in Sweden shows that there is a certain amount of matching, but we need to be active to procure energy when production is low and to sell it when production is higher than consumption. We also need to be active when it comes to hedging of risks and financial exposure.

A sensitivity analysis shows that factors as capital expenditure, load factor, operational expenditure, electricity and green certificate prices have variable impacts on NPV, IRR and pay-off time. The two most important factors are the capital expenditure and the load factor.

At this stage it not possible to make a final choice whether to invest in own power production (together with partner) or to give an external partner (an energy company) the assignment to build and operate a new renewable power production facility. Not until we get answers as a result of a Request For Quotation, will we get the full picture of what we can expect.

The overall purpose of the document is to:

- Probe different alternatives to solve the new renewable energy provision commitment
- Contribute to the identification main challenges and possibilities
- Formulate a first version of business plan

The renewable business plan is based on open sources and interviews with key stakeholders at ESS and at E.ON and Lunds Energi.

The purpose of the new renewable energy provision business plan is to inform the ESS organisation about all possibilities and challenges with different solutions, its financial consequences and act as a basis for decision for the board of ESS.

Establishing a well-designed solution for electricity provision of the spallation facility will serve as financial cushion and risk mitigation. By owning the electricity production facilities or constructing a partnership with an external party in a way that resemble ownership will make a considerable contribution to channel scarce funds to the main purpose, i.e., research.

# ESS Business Plan Renewable Energy

**Authors:** Michael Wiegert, ESS

**Reviewers:** Thomas Parker, ESS, Fredrik Indebetou, ESS, Erica Lindström, ESS,  
Mats Renntun, E.ON, Anette Blücher, E.ON, Mats Didriksson, Lunds Energikoncernen,  
Michael Gesterling, Lunds Energikoncernen, Göran Strandberg, Lunds Energikoncernen

**Approver:** Kjell Möller, ESS

## References

- Programme Plan for ESS [ edition 4 ]
- ESS-EON-LEKAB etapp 2 signerat avtal
- ESS Energy Pre-construction Planning
- Risk Management Plan
- Energy risks, Nov 21, 2011
- Energy Communication Plan
- Energy Organisation Chart
- T. Parker, Responsible, Renewable, Recyclable An Energy Management Strategy for the European Spallation Source 2010
- T. Parker, Cutting Science's Electricity Bill, Nature 2011

# Executive Summary

When it comes to the electricity provision of the facility, ESS has two main goals:

1. ESS is committed to new renewable electricity production being built on ESS' initiative to compensate for the electricity consumption (around 250 GWh/year)
2. It is vital for research operations that the electricity cost for running the facility is **competitive, stable and predictable**

The choice of legal status (ERIC or continue to be a Swedish AB) and the tax status of ESS will have a considerable impact of the choice and design of electricity provision and recycling of surplus heat. These are not deal breakers, but will bring along totally different outcomes.

There are several ways of solving the electricity provision (we have sieved out one reference alternative and four different "real" alternatives), but the final decision of building own production or let somebody else do it cannot be taken until we get binding quotations from energy companies and turbine suppliers.

A comparison of the consumption pattern of the ESS with yearly and monthly profile of wind power production in Sweden shows that there are limited possibilities to match the consumption pattern of ESS with "normal" monthly renewable production distribution. There is a certain amount of matching, but we need to be active to procure energy when production is low and to sell it when production is higher than consumption. We also need to be active when it comes to hedging of risks and financial exposure.

The revenues from the recycling of waste heat emanating from ESS can offer a substantial contribution to lower the energy related operational costs.

A sensitivity analysis shows that factors as investment costs, load factor, OPEX costs, electricity and green certificate prices have variable impacts on NPV, IRR and pay-off time. The two most important factors are the investment costs and the load factor.

At this stage it not possible to make a final choice whether to invest in own power production (together with partner) or to give an external partner (an energy company) the assignment to build and operate a new renewable power production facility. Not until we get answers as a result of an RFQ, we will get the full picture of what we can expect.

## Conclusions:

- ESS can invest in its own renewable power facility or give the assignment to an external partner (energy company) to build new renewable power production to secure a competitive, stable and predictable electricity price
  - The final choice is not possible until we get binding quotations
- Due to the high level goals of ESS (new renewable electricity production + stable and predictable cost), ESS need to hedge electricity/financial positions professionally
- There is a strong need to clarify in what ways the choice of legal status and taxes will have an impact on the choice of how to solve provision of renewable energy to ESS
- We also need to get full understanding of the implication of the government investigation concerning specific taxation rules regarding electricity emanating from wind power production

# Next Steps/ High Level Action Plan

- Autumn 2012: continue work with refining business plan (e.g., develop case for complementary technologies such as solar and CHP)
- Autumn 2012/spring 2013: get clarification regarding choice of legal status and specific taxation rules
  - Liaise with ESS Administration department to fully understand possibilities and restrictions depending on choice of legal status
  - Get full understanding of implications of taxes including specific taxes related to heat pumps
    - Possible development of alternative business cases (with and without taxes) and understand risks associated with these
- Winter/spring of 2013: prepare for an RFI (Request For Information) and an RFQ (Request For Quotation)
- Spring/summer 2013: evaluate RFI/RFQ and in parallel refine business plan
- Spring 2014: final choice of energy partner and signing of agreement

High level action plan 2012-2014

High level activities	Season					
	Autumn 2012	Winter 2012/2013	Spring 2013	Summer 2013	Autumn 2013	Winter 2013/2014
1. Continue work with refining business plan (e.g., develop case for complementary technologies)						
2. Get clarification regarding choice of legal status and specific taxation rules						
3. RFI and an RFQ (preparation, evaluation, negotiations)						
4. Final choice of energy solution and signing of agreement						
Steering Committee						

# 1. ESS Goals/Demands With Renewable Electricity

ESS has two overriding goals with the electricity provision to the facility:

- ESS is committed to a **new renewable** electricity production being built on ESS' initiative to compensate for the electricity consumption of ESS (around 250 GWh/year)
- A **stable and predictable** cost for electricity is vital for research operations
  - Fluctuating electricity costs should not interfere with when researchers want to run the spallation source
  - The cost of electricity for operating the ESS is estimated at approx. EURO 15 million annually. This represents about 15 % of the overall operating cost, thus a sizeable share of overall operating costs. Hence, there is a need for making decisions today to avoid increasing energy costs making inroads in the research budget. A competitive price level for electrical power supply is an important goal for operations costs

The full commission of the facility will not happen until 2025 – hence, there is a need for a flexible solution, and it is important not to invest in “old” technology. A ramp-up of energy supply during a time period of 5-6 years must be taken into consideration when designing a deal or commissioning production.

This business plan is focusing on the Swedish site, but that we are envisaging that we will use the same energy/recycling concept for the Danish site.

## 1.1 Recycling of energy

The renewable energy project and the recycling of energy project are closely intertwined. ESS is committed to recycling of all heat from the cooling process, today estimated to 174 GWh of heat energy. That amount is close to 20% of the municipality of Lund's total demand for heating.

ESS is now investigating multiple options on how to create revenue from the recycling process aimed to lower ESS operational costs, see more in ESS Energy Business Plan Recyclable.

The recycling of surplus heat will be a stable process, using both direct conversion and seasonal storage of the surplus heat and industrial collaboration within the local area. As a result a linear revenue stream will be created to allow mitigation of risks in the renewable supply on the cost side. Early calculations indicate yearly revenues of four to five MEUR from the recycling process.

## 1.2 Implications of the choice of ESS's legal status on renewable energy

The choice of legal status has severe implications on how electricity provision of ESS should be solved. The foreseeable options are limited to three options (see below): Basically, ESS could become an/a

1. ERIC (European Research Infrastructure Consortium). The ERIC-status is missing a legal framework in many areas, i.e., if an ERIC can own a subsidiary that is a profit maximizing entity. ERIC solves the question of how to handle VAT, but not taxes. Due to political reasons, it is highly probable that ESS will become an ERIC.
2. Swedish limited liability company (an “AB”, like today). This is an unlikely outcome due to the fact that several member states will not be able to own shares in foreign companies.

There is a considerable probability that ESS will become an ERIC. Therefore it is important to understand how an ERIC will have an impact on the electricity provision of the ESS. According to the council regulation (EC) No 723/2009, section 8, the principal task of an ERIC is the establishment and operation of a research infrastructure on a non-economic basis and should devote most of its resources to its principal task.



However, in order to promote innovation and knowledge and technology transfer, the ERIC should be allowed to carry out some limited economic activities if they are closely related to its principal task and they do not jeopardize its achievement. Hence, it might be argued that ESS could own shares in a separate company running renewable energy production for the ESS ("...closely related to its principal task...").

### 1.3 Implications of taxes

The tax in Sweden for consumption of electricity is today 32 EUR/MWh. There is a special class of industries (SNI-codes 5-33) where the tax level is considerably lower. For example, for electricity consumed in the manufacturing and mining industry, the tax is 0.5 EUR/MWh. Which tax level (if any tax at all) ESS must pay is probably a lot dependent of the final legal status of ESS, see the section above.

However, there are specific taxation rules regarding electricity emanating from wind power production. The tax rules today state that electricity from a wind power plant is not taxable if the owner of the wind power plant is not a professional supplier of electricity and the electricity is produced and consumed within the same legal entity. However, the Swedish tax authorities have interpreted the rules so that the electricity has to be cleared and settled on an hourly basis. This means that if the wind power plant in any hour produces more than the electricity consumption of ESS in the same hour, then the wind power producer is not allowed to get remuneration, either in money or electricity at another time, for this surplus production. Hence, the tax exemption is not valid and the surplus has to be dumped.

A government investigation has recently been initiated concerning the specific taxation rules regarding electricity emanating from wind power production. This means that the future of these rules is today unsure.

Whether ESS has to buy Green Certificates for the quota obligation is also an issue that remains to be clarified. A quota obligation is a standard requiring that a minimum percentage of the electricity consumption is provided by renewable energy. Obligated utilities are required to ensure that the target is met.

## 2. Background Information

### 2.1 About the first years, electricity need for construction

During 2014-2018, the electricity needs will be moderate: from 3 GWh/year up to 40 GWh/year. During this period, ESS might consider buying the requested volumes on the spot market since the risk of securing production and consumption prices could surpass the benefits of having dedicated production facilities. Of course, there might be other reasons for building dedicated electricity production for ESS (own facilities, through energy company, etc.).

If ESS would consider buying the needed volumes on the market, the cost for 3 GWh would today amount to the following cost levels (see below). The costs below include the forward price, green certificates and grid fees:

- 2014, 3 GWh: 0.17 MEUR
- 2015, 3.5 GWh: 0.2 MEUR
- 2016, 10 GWh: 0.6 MEUR
- 2017, 20 GWh: 1.2 MEUR
- 2018, 40 GWh: 2.4 MEUR

### 2.2 Why there is a need for a delivery agreement and an electricity consumption agreement

If ESS will build and own a wind power plant, there is need for both a delivery agreement for the electricity produced from the wind power plant and an electricity agreement for the electricity consumed at ESS in Lund. This is due to the fact that all electricity produced need to be transferred to the national grid before consumption. There are two reasonable alternatives: 1) no financial hedging of prices and 2) financial hedging of net positions. There is still a need for a physical delivery agreement for both production and consumption.

### 2.3 The need for sites (land grabbing)

If ESS wants to build its own wind power production, then ESS need to find and procure sites (land grabbing). Many within the wind power industry argue that the remaining sites suitable for wind power production (good wind speeds, grid connection possibilities, environmental considerations, proximity to houses, politics, etc.) are scarce/a limited resource. However, there will still be good sites available another 3-5 years ahead, not least due to the fact that wind power prospecting companies now locate their wind power parks in forested areas both in the south and in the north of Sweden. Wind power turbines are placed on elevated areas, the height of the hub is placed higher and the technology and knowledge of how to handle turbulence is increasing. ESS has today a dialogue with the National Property Board of Sweden ("Statens Fastighetsverk"), to investigate the possibilities to procure interesting sites.

When an energy company will be building the wind power facility, there is a choice for ESS to provide the land/site and transfer it to the energy company (i.e., the energy company will procure the site). Another possibility is that the energy company provides the land/site and arrange with necessary environmental permits. The last alternative constitutes a higher risk, due to extensive time delays and higher costs before there is a valid agreement between ESS and the energy company.

# 3. Risk Hedging Related To The Needs Of ESS

## 3.1 General description of risks in electricity cost for ESS

In securing electricity for ESS operations the option with the least variability in costs would most probably be buying fixed price agreements or buying spot electricity and apply a rolling hedge financially via an energy trading company. Electricity prices are mean reverting, meaning they revert to a "normal" price range further out in the forward market. Long term hedging will secure costs at a near normal level and with a risk premium some energy trading companies will give long term, 5 to 10 years, fixed agreements if the consumption pattern is fairly stable.

Building any type of renewable production will add variability to costs since the nature of the production sources available are intermittent to whatever the source of power is, e.g. wind or solar. So even if the importance of market price variation is somewhat diffused by building own production the stability and level of costs are probably lower than the reference case of a fixed price agreement or hedged by the financial electricity market. However, since the commitment of ESS is to contribute with new renewable production at the level of its electricity need for consumption this will be the focus in the coming paragraphs.

## 3.2 The spot market

The electricity spot market is conducted on a day before delivery basis and the trading time resolution is hourly. Also the prices are calculated on physical capacity down to every price area on demand and supply. ESS would for instance procure its planned consumption via a balancing party/energy trading company in price area 4 in Sweden (SE4). If a wind production facility would be built by ESS the planned production would be sold via a balancing party/energy trading company. If consumption or production is different from planned the difference will be traded/settled on the balancing market.

## 3.3 The financial market and price hedging

The financial market for electricity consists mainly of two types of financial instruments, electricity forwards and contracts for differences. The financial market is based in EUR so a hedge in currency might also apply.

The financial forwards are financially settled against a system price. The system price is a calculated Nordic price without technical restrictions in capacity allocation between price areas. The electricity forward products are traded and settled on effect (MW), which means it is settled with same amount of energy per hour for the duration of the delivery period traded. Available periods are days, weeks, months, quarters and years. However the shorter period products (days and weeks) are only traded a limited time in the future and the total forward market extends to present year plus five years. Realistically for ESS the highest resolution for hedging purposes is months which are tradable six months in the future, followed by quarter forwards for two years past present year and year forwards for five years in the future.

Contracts for difference are financially settled contracts regulating the difference in price of a price area and the system price. These contracts are a lot less liquid than the electricity forwards and are tradable for the present year plus three years.

### 3.4 Principles of risk management and hedging for consumption and production

ESS will have roughly 250 GWh consumption per year when fully operational. Given the main case that wind is built to compensate for the consumption, on a yearly basis, the energy cost will consist of mainly investment and running costs for the production facility and more or less costs due to uncertainties. On a slightly more detailed scale the electricity cost for ESS would consist of:

- Costs for investment, running and maintenance of wind production facility
- Revenue from selling produced electricity to the spot market
- Revenue from selling electricity certificates to the spot market
- Cost from procuring electricity from the spot market for consumption
- Costs in balancing and physical trading to balancing party for both production and consumption
- Cost of hedging on financial market (possibly)
- Cost/revenue of financial cash flow from financial hedge (possibly).

The main uncertainty in electricity cost, price risk, is implied in the difference between revenue from selling produced electricity and costs from procuring electricity for the consumption. Two main risks linked to physical electricity trading are likely to cause uncertainty in total costs; profile risk and volume risk.

### 3.5 Profile risk

Even if production and consumption volume match on a monthly basis the revenue from production and cost from procurement will differ because they will likely not occur with the same amount of energy every hour of the day and even on a daily basis. Two factors determine the financial outcome of this risk and that is: how much is the deviation in profiles for consumption and production (net position) and the magnitude of price difference when the deviation occurs. This risk is not possible to hedge on a market and probably very expensive to hedge through an energy trading counterpart.

### 3.6 Volume risk

Even if the expected volume of production and consumption is the same on a given month the actual outcome will differ, mostly due to uncertainty in wind conditions. The financial outcome of this uncertainty will depend on electricity price level and level of deviation from forecast. This risk is also not possible to hedge on a market and will also probably be very expensive to hedge through an energy trading counterpart.

### 3.7 Principles on financial hedging for stable electricity costs

Given the nature of wind production and the load profile on ESS consumption some months there will be differences in forecasted production electricity volumes and consumption volumes. To minimize uncertainty in electricity costs due to spot price volatility between these differences financial hedging of the open net position can be done on the Nord Pool financial market. To minimize uncertainty at a reasonable cost the hedging could for instance be based on the on the following principles:

- Only forecasted net open positions should be financially hedged
- The resolution on determining net position should be monthly or quarterly
- Since yearly production matches consumption the hedge horizon could be relatively short, one to two years rolling, due to high correlation between price levels on quarter forwards further out on the forward curve. Also, since production matches consumption on a yearly basis the "natural" hedge will make long term, beyond 4-5 years, unnecessary
- Net position should be updated before delivery with new information and hedge should be adjusted accordingly

### 3.8 Comparison of the consumption pattern of the ESS with yearly and monthly profile of wind power production in Sweden

#### 3.8.1 ESS electricity consumption pattern

The spallation source has three different positions with different electricity consumptions: 1) beam on (User Service Mode – USM): 37 MW, 2) beam off: 15 MW and 3) shut down: 5 MW. As we can see from the chart below (chart 1), electricity consumption of ESS is concentrated to the periods Feb–June and Sept–Dec. The figures are preliminary; we lack information whether the beam-off mode has the same power consumption as the USM-mode.

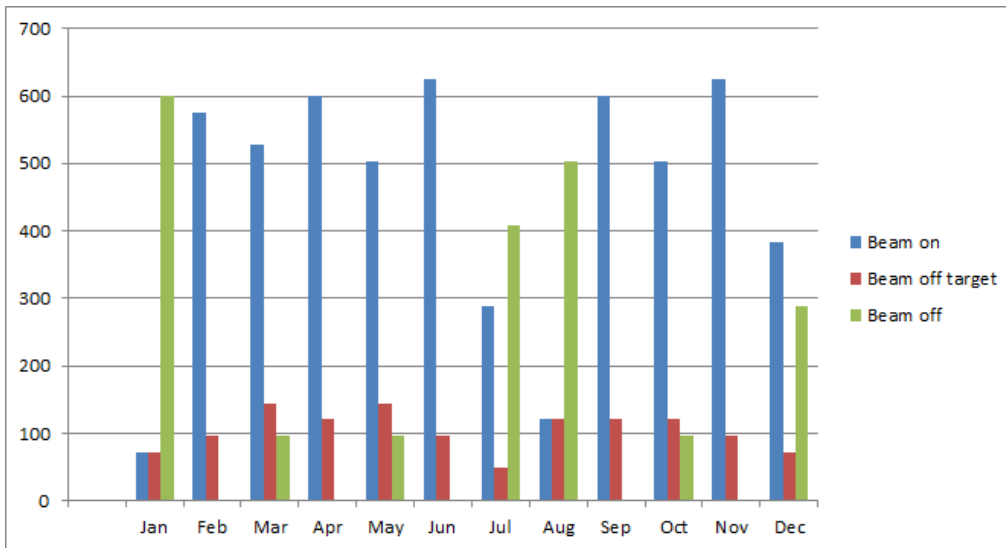

Chart 1. Proposed and preliminary consumption pattern in 2025

#### 3.8.2 The hourly variation/distribution of wind production

The example below comes from 50 MW land based wind power facilities (7-8 facilities spread in Southern Sweden) during the month of February 2012. NB: the values on the horizontal axis are the hours during the month of February 2012 (leap year).

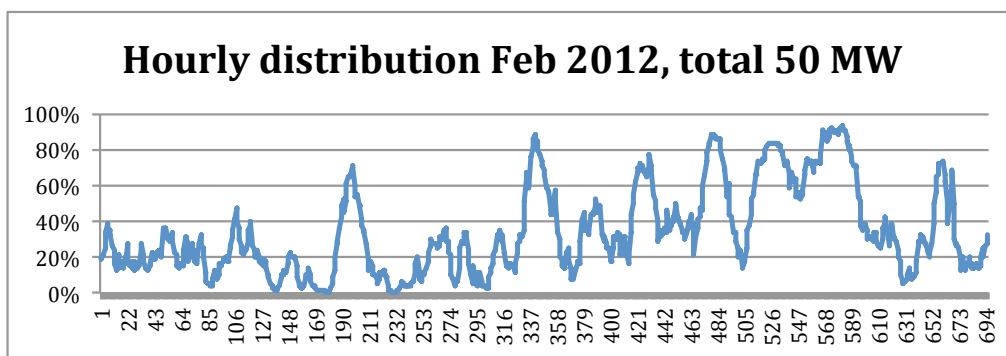

Chart 2. An example of hourly variation/distribution of wind production

### 3.8.3 Monthly variation during one year of operation

The example below is taken from vindstat.nu for the 12 month-period December 2010 to November 2011 (a total of 47 turbines and 91 MW of installed effect – hence comparable to ESS).

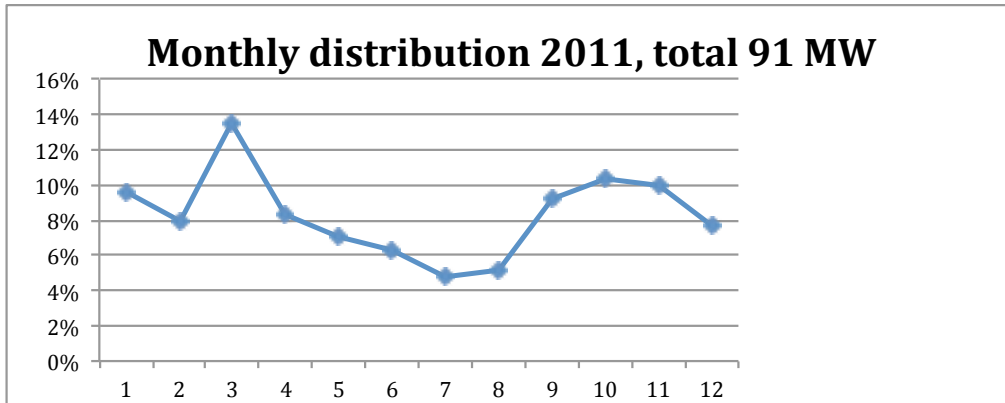

Chart 3. An example of monthly variation during one year of operation

### 3.8.4 Conclusions

We can conclude that there are limited possibilities to match the consumption pattern of ESS with “normal” monthly production distribution. There is a certain amount of matching, but we need to be active to procure energy when production is low and to sell it when production is higher than consumption. We also need to be active when it comes to hedging of risks and financial exposure. The physical transactions need to be done notwithstanding matching. Price hedging can only be done on a forecasted net position on a monthly basis.

# 4. Sensitivity Analyses And Key Financial Indicators

Below we see a general profit/loss calculation for a 250 GWh/year land based wind power facility including sensitivity analyses. Initially we see the prerequisites and result. We have used data from Elforsk report 11:26, a report that is regularly updated. It shows electricity production costs from different types of power plants, i.e., wind power.

## 4.1 General assumptions – Base Case

▪ All wind power stations are built all at once	
▪ Unit size	3 MW
▪ Number of units	32 pcs
▪ Total installed capacity	96 MW
▪ Load factor	30 %
▪ Electrical production	252 GWh/year
▪ Investment	1.8 M€ / MW (15 MSEK / MW)
▪ Total investment	169 M€ (1440 MSEK)
▪ Total OPEX	16.5 € / MWh (140 SEK / MWh)
▪ Inflation yearly	2 %
▪ Electrical price development above inflation	1 %
▪ Electrical price start value	53 € / MWh (450 SEK / MWh)
▪ Green cert price development above inflation	1 %
▪ Green cert price start value	21 € / MWh (175 SEK / MWh)
▪ Depreciation time	25 year
▪ WACC (Weighted Average Cost of Capital), post tax	6.2 % (post tax)

## 4.2 Result calculation Base Case

▪ Net present value (NPV)	26 M€ (225 MSEK)
▪ Nominal Internal Rate of Return (IRR) post tax	8.5 %
▪ Pay-off time	14 years

## 4.3 Sensitivity analysis

Case	NPV (M€)	IRR (%)	Pay-off time (year)
Base Case	26	8.5	14
Investment -10 %	40	10.0	12
Investment +10 %	13	7.2	17
Load factor +10 %	43	9.9	12
Load factor -10 %	10	7.1	17
OPEX -10 %	31	8.9	14
OPEX +10 %	22	8.1	15
El price +2 % above inflation	41	9.6	13
El price 0 % above inflation	14	7.5	16
Green cert price +2 % above inflation	30	8.8	14
Green cert price 0 % above inflation	23	8.2	14

Chart 4. Sensitivity analysis

## 4.4 Conclusions

The sensitivity analysis shows that factors as investment costs, load factor (the ratio of the actual output of a power plant over a period of time and its potential output if it had operated at full name-plate capacity the entire time), OPEX costs, electricity and green certificate prices have variable impacts on NPV, IRR and pay-off time. The two most important factors are the investment costs and the load factor.



# 5. Waste Heat From ESS To District Heating System In Lund

The cooling of the facility gives a large amount of waste heat – around 200 GWh/annually – which can be used in the district heating system in Lund. Before it is transferred in to the district heating system the temperatures of the waste heat have to be lifted to about 90 C. The waste heat from ESS has a financial value since it will replace heat production from other plants in the district heating system. The diagram below shows the relation between cost for electricity, revenues from wind power production and revenues from sale of waste heat. Also, you can see a net revenue/loss excluding production and investment costs.

The following assumptions have been used for the calculations:

- electrical price 53 EUR/MWh
- price of green certificates 21 EUR/MWh
- no electrical tax or costs for green certificates for consumption
- monthly production in year 2011 from 50 wind power plants on-shore in Sweden
- revenue from wind power is revenue from sale of electricity and green certificates minus operation- and maintenance cost
- no production cost for waste heat production is included
- revenue from waste heat is an estimated yearly average of waste heat to district heating system in Sweden (about 80 in total)
- Average waste heat price of 18.9 EUR/MWh
- waste heat sale of 200 GWh/year

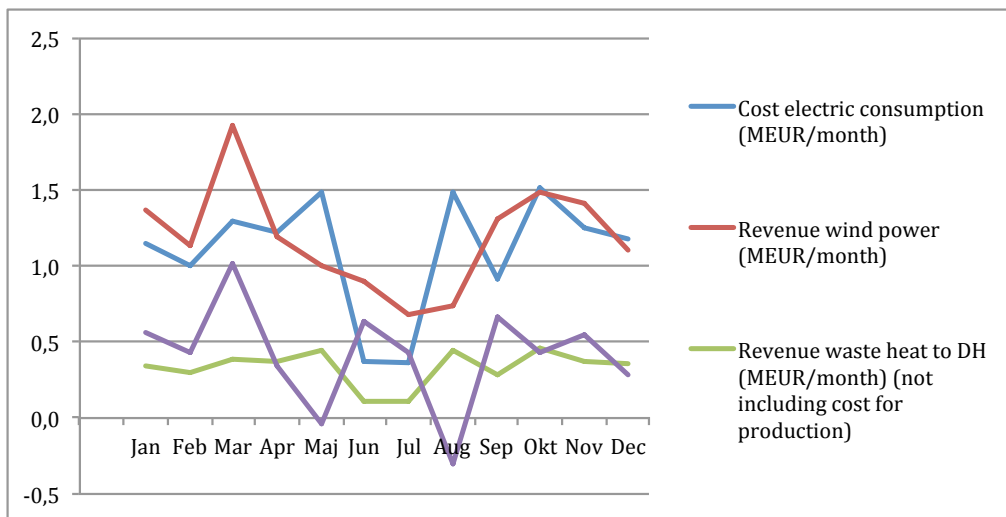

Chart 5. Costs and revenues incl. waste heat to district heating in 2025

## 5.1 Conclusions

The revenues from the recycling of waste heat emanating from ESS can offer a substantial contribution to lower the energy related operational costs. With today's energy consumption profile, it seems that there will be loss in August every year.

# 6. The Main Alternatives

Please notice that the figures below are not the same as under section 6 since the purpose of that section is to provide the reader with a sensitivity analysis based on other assumptions (e.g., all turbines built all at once).

## 6.1 Short description of the five main alternatives

There are a number of ways to solve the electricity supply for ESS. However, due to the demands above, we have sieved out five feasible alternatives below:

Alt	Name	Production plant	Electricity agreement ESS
0	Ref	No new wind power plant is built (not a real alternative since ESS is committed to building new renewable energy), reference alternative	Price hedging, e.g., five years rolling agreements
1a	Wind	ESS builds and owns a new wind power production facility together with a financial partner. Spot delivery agreement	Spot
1b	Wind hedge	ESS builds and owns a new wind power production facility together with a financial partner. Hedging delivery agreement	Price hedging, e.g., five years rolling agreements
2	Wind com-bo	ESS builds and owns a new wind and solar power production facility together with a financial partner. Hedging delivery agreement. Energy company build new bio mass power plant (CHP)	Price hedging, e.g., five years rolling agreements. Electricity agreement with the owner of the bio mass power plant during its life time
3	Wind virtual	Energy company builds, owns and operates a new wind power plant on order from ESS. ESS can be a part-owner in the plant	Creative electricity agreement on a long term basis

Chart 6. The five hypothetical alternatives

## 6.2 General assumptions

One of the biggest challenges with making long term calculations is predicting future electricity prices. However, for calculation reasons, we assume that prices increase 1 % per year above inflation and that the yearly inflation is 2 %. We assume that the starting point for the production price is EUR/MWh 76 (including electricity price, green certificates and grid benefit). To meet the needs of ESS, we assume that we will build 3 MW and 5 MW turbines according to the following chart:

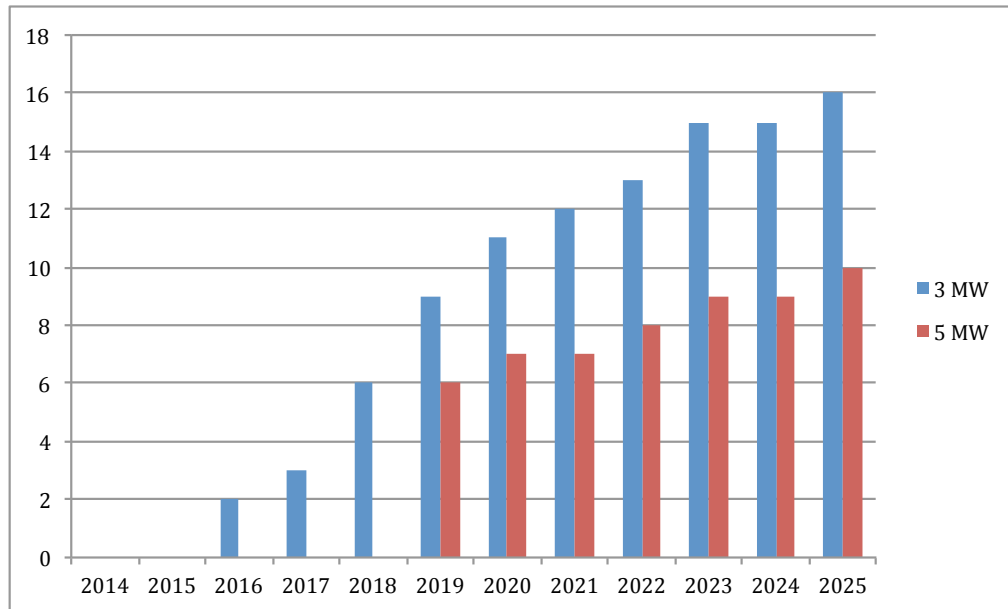

Chart 7. Assumption of number of 3 and 5 MW built from 2016 to 2025

## 6.3 Reference alternative 0, No new wind power plant is built, price hedging, e.g., five years rolling agreements

We are not calling this a “Main alternative” like the other alternatives since it is not complying to the “new renewable” prerequisite – hence, we have “downgraded” it to a “Reference alternative”. On a four-five year horizon, the electricity price can today (09.09.2012) be secured via forward price arrangements at EUR/MWh 39-41.

## 6.4 Main alternative 1a, ESS builds and owns a new wind power facility together with a financial partner. Spot delivery and spot consumption agreement

All in all we assume that we will build sixteen (16) 3MW and ten (10) 5MW producing a yearly total of about 250 GWh by 2025. The investment need for building one 3MW wind mill and one 5MW wind mill amount to EUR 4,3 M and EUR 6,7 M respectively. Hence, there is a total investment need of around 133 MEUR. Normally, a company interested in building its own wind power facility need to put up 25-30 % in equity, hence between 33-40 MEUR in this case. However, we assume that ESS, with guarantees from one or several member states, would only have to put up with a lower level of equity, 10 % or around 13.3 MEUR.

The net present value, NPV, of the cash-flow from the wind power facility with 16 3MW and 10 5MW amounts to 28 MEUR with a pre-tax WACC (Weighted Average Cost of Capital) of 8.3 % (the chosen WACC could be discussed since ESS is owned by 17 national states). This does not include the residual value of the remaining wind power mills during the period 2037-2045 (the last wind power mill will be built 2025 and the life span is 20 years) due to calculation reasons (the NPV will be distorted).

However, due to the fact that ESS is owned by 17 different national states, we could argue that we should not use a pre-tax WACC of 8.3 %. The Government Borrowing Rate, the GBR, is a reference rate which is used in tax legislation but is also used as references in civil law contracts. For the time being the GBR is historically low (1.38%, September 2012), but the average GBR (as calculated by the Swedish tax authorities) is 2.57%. If we use the average GBR, we get a pre-tax WACC of 3.31 % and a PV of 78 MEUR.

Additionally, the European Investment Bank, EIB, and the Nordic Investment Bank, NIB, both have stated that ESS will be able to borrow 50 % of the capital needed at "the lowest interest" (depending on what the interest is when borrowing). Hence, we could argue that the interest used to calculate the pre-tax WACC will be lower since 50% of the capital need will be financed at lower cost. Hence, the WACC will even lower and the PV higher compared to the average GBR calculation above.

#### **6.4.1 Concerning risks due to hourly deviations between production and consumption where the ESS own and operate a wind power production plant and where both the electrical and delivery are exposed to spot agreements**

If ESS builds, owns and operates a wind power production plant with an electricity production a normal year is in the same size as the electrical consumption of ESS a normal year, about 250 GWh/year, the hourly deviation between production and consumption will be a risk/uncertainty for ESS. Even if the volume in a yearly basis is the same, it will differ between production and consumption on an hourly basis. To estimate this risk a calculation have been made where the assumption is that both the electricity delivery agreement for the wind power plant and the electricity consumption agreement are so called spot agreements, that means no selling or buying of electricity in advance to secure the price. In this case both production and consumption meets the same market price for electricity every hour, except possible difference according to price areas.

The financial risk for ESS can differ between hour to hour from one extreme with maximal wind power production, 90 MW, and minimal electrical consumption, approx 5 MW, and at the same time a high spot price, to the other extreme case with minimal wind power production, 0 MW, and maximal electrical consumption, 38 MW, and at the same time a high spot price. In the first case the revenue for ESS can be  $90 - 5 = 85 \text{ MW} * 78 \text{ EUR/MWh} = \text{about } 6600 \text{ EUR/hour}$ . In the other case the cost for ESS can be  $= 38 \text{ MW} * 78 \text{ EUR/MWh} = \text{about } 2960 \text{ EUR/hour}$ . Depending on actual spot price, actual production and consumption the difference in revenues/costs for ESS can be up to about 11000 EUR/hour in extreme cases.

To estimate this risk for ESS a calculation has been made for the 5-month period October 2011 to February 2012. During this period every hour has been calculated with actual hourly production from the wind power plants that E.ON owns in Sweden, adjusted up to an imagine ESS wind power plant on 90 MW, actual spot prices and assumed electrical consumption on an hourly level on ESS when the plant is fully commissioned year 2025. The result of the calculation shows maximal hourly revenue of 2660 EUR/h and a maximal hourly cost of 5660 EUR/h. The outcome of this 5 month period is a total cost of 0.1 MEUR, or about 0.9 EUR/MWh electrical consumption. This corresponds to about 2 % of the total cost of electricity during this period.

## **6.5 Main alternative 1b, ESS builds and owns a new wind power facility together with a financial partner. Hedging delivery and consumption agreement**

In this alternative all things remains the same as alternative 1a, however, the delivery and consumption agreement are hedged, see explanation below.

### **6.5.1 Securing prices for wind power production**

The normal way for an owner of an electrical production plant in the Nordic market, for example a nuclear power plant or a CHP (Combined Heat and Power) based on biomass, is to secure the price of electricity in advance, for example 3 years before the delivery year. The main reason for this is to avoid price fluctuations and to have a more predictable and stable revenue from the electricity production.

With a wind power plant the situation is a bit different. Naturally, there are limited possibilities to predict the production from wind power in advance. This means that it could be very expensive to sell the production in advance if the actual production is zero because of no wind, since the deviation between nominated production and actual production is regulated by the spot price market. The risk could be too big for the producer if they have to buy the promised production, but not produced, back from the spot market. A common strategy among wind power plants is instead to sell only a minor part, or perhaps none, of the expected production in advance in wintertime when there is a risk for rather high spot prices. In the summer time however it could be a good strategy to sell the production, or at least some part of the expected production, in advance since the risk of very high spot prices is much smaller compare to winter time. A risk optimization analysis is needed to find the optimal strategy for how to secure the electricity revenue from the production of a wind power plant in the different seasons. We also need to match the consumption pattern to the forecasted production (depending on our choice of production) since the costs of ESS depend on both parameters. The example above applies only to a production unit and their abilities to secure revenue for production.

## **6.6 Main alternative 2, ESS builds and owns a new wind and solar power production facility together with a financial partner. Spot delivery agreement. Energy company build new bio mass power plant (CHP)**

### **6.6.1 Solar power challenge**

We could consider adding solar power to try to decrease risk exposure. However, it is not completely clear that risks will decrease just by adding another source of energy. Theoretically, adding another source of intermittent production will increase risks. However, it might happen that net positions decrease if we combine the ESS consumption profile, the expected wind production profile and expected solar power production. Current prices on solar power seem to make the calculation somewhat dissuasive due to the sheer size of the investment in relation to output. It must be pointed out that the figures we have at this moment are preliminary – we are waiting for underpinned figures. Quite often, the relation between the investment and the yearly production is used to get an idea regarding the efficiency of a power plant. For a 3MW wind power mill that figure amounts to 0.55 EUR/kWh/year and for a 5MW this would amount to 0.51 EUR/kWh/year. In our case we assume that we can replace 10 % of the wind power generated production, i.e., 25 GWh, with solar power. Currently, the cost for getting that amount of electricity from solar power would amount to a total of 40 MEUR or 1.59 EUR/kWh/year, i.e., around three times more expensive than wind power. It seems that the strategy of lowering risk by adding solar power might be offset by the high cost profile. If this is so, it would be better to lower risk by buying the 10 % on the spot market. However, general experience says that OPEX in solar power facilities is considerably lower than for wind power – this should make the calculations better. Additionally, the need for re-investment in solar panels during the long life-cycle of ESS is limited compared with wind-power. The current information we have regarding investment needs and output gives an inferior calculation compared to wind, but we still recommend that the 10% solar alternative should remain as an alternative – we just have to get more underpinned input data. Finally, it is also possible that the outcome of the cost development the coming years might be favourable for solar power compared to wind. We consider solar power to be a local alternative on site to visualize local electricity production and that it is integrated in the facility (maybe integrate solar cells in the facility itself and thus provide a way to switch building sections for solar cells).

### 6.6.2 Bio mass CHP (Combined Heat and Power) challenge

The suggestions are mainly focused around wind power (90-100%). As described above, wind power could be completed with solar power (10%) to decrease risk. A third source of energy could be to use a CHP (Combined Heat and Power) bio mass power generation plant. The electricity need of the spallation source is 250 GWh and a considerable amount of this energy will be transformed into heat that ESS has promised to make good use of ("Recyclable"). A hypothesis is that the usable (higher temperatures) excess heat will be transmitted in to the district heating system of the municipality of Lund (and maybe Helsingborg, Malmö, etc.).

Normally a CHP is built to address a need for heating, not to solve an electricity need. This is due to the relatively low alpha value (the relation between electricity production and heat production) of a biomass CHP plant. The alpha value is always less than one (1), and the closer the value is to one (1) the more efficient the electricity production of the plant. Typically a CHP has an alpha value of 0.5-0.6. A bio mass CHP normally has a lower alpha value of 0.3. Hence, to produce for example 25 GWh of electricity (10 % of the total need of ESS), we need to produce 75 GWh of heat, which is a considerable amount of heat to add into a district heating system. However, according to Lunds Energi, the owner of the district heating system of the municipality of Lund, they will be able to take care of the additional amount of heat (at the levels described above, and even additional amounts) resulting from electricity production from a bio mass CHP.

Additionally, the by-product heat from the regular energy provision to the ESS represents a considerable addition of supply to the local heating grid. The surplus energy from ESS is at present 180 GWh annually and consists of hot water that is a result of the cooling process in the facility. This represents 20% of the total amount of heat requirement in Lund Municipality district heating net. Adding even more heat from a bio mass CHP to the local heating grid will increase supply, which, of course, will have a lowering effect on prices for excess heat.

According to figures from Lunds Energi, the planned CHP in Örtofta will produce 65 GWh of electricity and 120 GWh of heat. The cost amounts to a total of 70 MEUR or 0.38 EUR/kWh/year, which is slightly lower than wind power production costs (see above).

## 6.7 Main alternative 3, energy company builds, owns and operates new wind power plant on order from ESS. ESS can be a part-owner in the plant

In this case an energy company builds, owns and operates new wind power plant on order from ESS. ESS pays for this through the electricity price. ESS could be a part-owner or a part-investor in the plant. ESS purchases the electricity needed in an electricity consumption agreement with the energy company that has built the new wind power plant. The electricity consumption agreement could have a price formula which is more or less disconnected from the normal market products/prices at Nord Pool. The electricity price for ESS could instead have other parameters in the price formula. The alternative price formulas could be of a rather creative nature. Examples could be a price formula mainly connected to the economy of the wind power plant, another example could be some form of fixed electricity price which have an index which are not direct connected to products at Nord Pool.

It is not necessary that 100 % of the renewable energy is produced by wind power in this alternative. Part of the electricity production can for example be solar energy from Photo Voltaic cells. A reasonable part from solar energy could be 5-10 % of the total production, which means 10-25 GWh/year.

### 6.7.1 Example 1: Price formula connected to the economy of a wind power plant

In this example the electricity price for ESS is connected to the economy of the wind power plant instead of products/prices at Nordpool. The agreement between the energy company and ESS should be on a long-term basis, probably 10-15 years. The price formula could for example have this arrangement:

Electricity price for ESS = A (MEUR/month) + B (EUR/MWh) – C (EUR/MWh) +/- D (EUR/MWh) – E (EUR/MWh)

A = This component corresponds to the capital cost of the wind power plant. The value is in MEUR/month and is fixed over the whole agreement period.

B = This component corresponds to the operational and maintenance cost of the wind power plant. This component includes all operational costs, for example imbalance costs and land rental. The value is in EUR/MWh and could be adjusted yearly by an inflation index.

C = This component is a deduction of the price and corresponds to the revenue from Green Certificates. The value is in EUR/MWh and could be adjusted monthly when the market price of Green Certificates changes.

D = This component could be both positive or negative for ESS and corresponds to the cost/revenue due to hourly deviation in wind power production and electricity consumption at EES plant. The value is in EUR/MWh and should reflect the actual costs for this deviation.

E = A possibility in the price formula could also be a factor E, which is a deduction of the electricity price for the revenues of selling waste heat from ESS plant to the district heating system in Lund. Instead of selling waste heat to the district heating system in EUR/MWh(heat), the revenues for this could be transferred to a deduction of the electricity price in EUR/MWh(el).

It should also be taken into consideration in the price formula the differences in electricity prices between wind power plant(s) and ESS plant according to prices areas.

### **6.7.2 Example 2: Fixed price with index not connected to products at Nord Pool or to the economy of a wind power plant**

In this example the electricity price for ESS is neither connected to the fluctuating prices at Nord Pool, nor to the economy of the wind power plant. The general idea is to create a "fixed" electricity price/kWh to provide ESS with a maximum level of predictability of the annual future energy cost (operation cost). However, reaching 100 % fixed price would probably be too expensive; hence, the price needs to be indexed. Since a high level of predictability of operation costs is crucial for ESS, it might be of interest to negotiate this alternative with an energy company (or a financial institution) to get a price on the predictability – maybe ESS could accept a higher but predictable energy price to secure future operation costs in order not to jeopardize resources needed for research? The agreement between the energy company and ESS should be on a long-term basis, probably 10-15 years. The connection between market prices and the wind power facility will always be there for any part. The only reason for maintaining this alternative would be that one part makes an error in their calculations. Otherwise, ESS will waste valuable research funds on getting a stable but high price level.

## **6.8 Conclusions regarding the four alternatives**

All four alternatives would be possible (reference alternative 0 is not complying to the "new renewable" prerequisite, hence it is not a real alternative). At this stage it not possible to make a final choice since we have no "live" data. Not until we get answers as a result of our RFQ, we will get the full picture of what we can expect.

# 7. List Of Abbreviations

<b>Abbreviation</b>	<b>Explanation of abbreviation</b>
CHP	Combined Heat and Power
EIB	European Investment Bank
ERIC	European Research Infrastructure Consortium
GBR	Government Borrowing Rate
LEKAB	Lunds Energikoncernen AB
NIB	Nordic Investment Bank
PV	Present Value
RFI	Request For Information
RFQ	Request For Quotation
WACC	Weighted Average Cost of Capital

## Document revision history

<b>Version</b>	<b>Reason for revision</b>	<b>Date</b>
1.0	New Document	30 Mar 2012
1.2	Next steps required - Sensitivity analysis, risks section, impact from revenues from selling waste heat	12 Sept 2012
2.0	Conclusions, action plan, green certificates, end-to-end wind mill project description, re-arrangement of structure, recycling connection	23 Sept 2012
2.1	Updating – omitting international organisation alternative, insertion of new chart for electricity consumption, insertion of high level timeplan	3 October 2012



# 8. Appendix

## 8.1 The world and Swedish wind power markets and technology trends

Until recently, Europe has been the leader in the development of wind power, mainly due to energy policies aimed at increasing the proportion of energy from renewable sources. In 2009, China emerged as the largest wind power market, driven primarily by the need to increase the country's energy supply, although also with some politically inspired element. The US market is almost as large as the European market. The change in the market has also influenced suppliers' market shares. Several of the traditionally large European wind turbine manufacturers seem to have stagnated, while Chinese manufacturers have increased their shares, to the extent that four out of the ten largest manufacturers of the world are Chinese today. Additionally, the Chinese are able to offer a 15 % lower price on site compared with other Western manufacturers.

The shift in market and manufacturing is also influencing the technological initiative. Clear evidence of this is not only the breakthrough for direct-drive generators, but also the fact that they are using permanent magnets, a technology that is more up-to-date than the conventional excitation system that has hitherto dominated the market. For the West, there can be additional problems caused by a Chinese monopoly on the rare-earth metals that are used in the magnets (and also used in electric vehicles).

Wind power supplied 1.9 % of world power production in 2011 (6.1 TWh in Sweden). It is estimated that it will have reached 8 % by 2020, and thus be of the same order of magnitude as hydro power and nuclear power (respectively 16 % and 14 % in 2008). Offshore wind power supplies only a small part, estimated as amounting to 3 % of total world power in 2014. Offshore costs are at present too high for the current Swedish support system, of a combination of the ordinary price of electricity and electricity certificates. On the other hand, wind turbines can be built in forest areas and, to a certain extent, in mountainous areas. This means that enough sites for onshore wind turbines are likely to be both available and cost effective for meeting the current Swedish ambitions as expressed in the Swedish electricity certificate system for supporting renewable energy. In much of Sweden, wind power turbines require blade anti- or de-icing systems. However, the manufacturers generally regard this market as being too limited to justify the development of such systems. Development for of anti- or de-icing systems thus might be a critical factor for the introduction of wind power in the Northern parts of Sweden.

Three-bladed horizontal-axis wind turbines are today almost universal on the market. However, new interest in vertical-axis wind turbines has emerged in recent years. In Sweden, for example, a 200 kW vertical-axis wind turbine was erected in Falkenberg at the beginning of 2010. In general, the performance data for this new turbine are normal for vertical-axis machines. The greatest advantage is probably the simplicity, with essentially only one moving part. A major part of the load-bearing structure is made from glulam, which is recognised as cost-effective and resistant to fatigue.

For many years, the dominant principle for constructing towers for wind turbines has been welded steel tubes. In order to use the material most efficiently, the towers should taper. For a MW-size wind turbine, with a hub height of about 100 meters, the necessary base diameter will be about 4.5 meters, which is about the limit for road transportation.

Development of wind turbine electrical systems is driven largely by increasing pressure for power regulation and ability to withstand disturbances that are a consequence of the increasing proportion of wind power in electricity production. A consequence has been a trend towards using synchronous generators, either high-speed in combination with a gearbox, or directly driven. In both cases, they are combined with a converter, rated to carry the total output power of the machine.

In a 10 MW offshore wind turbine, developed by AMSC Windtec, the direct-drive generator is excited by high-temperature superconducting rotor windings, reducing the weight of the generator. Superconducting stator windings may be the next step. Individual blade pitch control is a technology being introduced in order to reduce fatigue loads. Trials of a co-rotating laser-based lidar for measuring the wind speed in front of the turbine have been successful. A further possibility for reducing the loads is individual control of the trailing edges of the turbine blades.

With time, the proportion of the cost of wind power plants represented by the turbine blades has fallen, resulting in changes in the optimisation of the plant, with larger turbine diameters for a given level of generator output. For the operator, this results in longer annual utilisation times. One manufacturer quotes an increase in annual utilisation time at a site with medium wind speeds from around 2000 hours for a ten-year-old design to almost 3500 hours for a new design. This should also make it easier for the grid to handle a certain proportion of wind energy production, since the need for regulation and transmission of power is reduced. Presently, the German manufacturer Enercon is offering a 7.5 MW turbine with a hub height of 135 meters and rotor diameter of 126 meters.

## 8.2 The Nordic electricity market

The electricity prices in the Nordic area are influenced by three main factors: production (supply), demand (consumption) and the level of export/import. The Nordic market is truly one market, and not four different markets (i.e., S, DK, N and SF): 98 % of the total Nordic physical consumption is traded on the Nord Pool exchange (financial contracts are traded on NASDAQ/OMX). In Europe this is seldom the case, where only around 30-70 % of total supply is traded on the exchange and many agreements are made on a bilateral basis (which is more complicated).

Since 2002, the electricity prices on Nord Pool/Nasdaq have fluctuated from 100 EUR/MWh to 10 EUR/MWh. Hence it is a considerable challenge to achieve a stable and predictable cost profile for ESS. However, it might be argued that on a four-five year horizon, the electricity price can today (09.09.2012) be secured via forward price arrangements at 39-41 EUR/MWh (during the former version of this document – 24.04.2012 – the price was 44-46 EUR/MWh). After that it is difficult to predict how the price will develop – for example, it is not possible to establish exactly which impact a new nuclear power plant in Finland or a new large cable to the continent will have on the price. This makes the calculations extremely hard to predict in a longer perspective than five years ahead. At the moment (09.09.2012) the five year forward price is 41.10 EUR/MWh (ENOYR-17).

Sweden is divided into four different price areas (1-4), where price area four is the most expensive and also where ESS is located. The main power generation plants (water and nuclear) are mainly located in the north and in the middle part of Sweden. Of course, there are additional costs to transfer the electricity to the south, hence the price differences. Since the price stated in the Nord Pool exchange is a so called System Price, i.e., a price that is the same in all of the Nordic without any electricity transfer cost included, we also need to take into consideration the price differences in the different price areas. This is adding risk and cost. However, it should be stated here that the price differences between the price areas will probably be offset by considerable capacity enhancements in the grid to the south of Sweden by 2014-2015 ("Sydvästlänken").

## 8.3 The green certificate market

The Green certificate system is a market-based support system for the development of electricity production from renewable energy sources in Sweden. The goal is to increase the production of electricity from renewable energy sources by 25 TWh from 2002 levels by 2020. The Green certificate system, which will run until the end of 2035, will contribute to get a more ecologically sustainable energy system.

The producers, whose electricity production meets the requirements of the law on the certificates, will receive one certificate for each megawatt-hour (MWh) of electricity they produce. The demand for certificates is created in the following way: all electricity suppliers and certain electricity consumers are required to buy certificates corresponding to a certain percentage (quota) of their electricity sales or use. The amount of certificates to be purchased change from year to year as the ratio gradually changes, resulting in an increasing demand for certificates. This increases the incentive to produce more electricity from eligible energy sources.

With the sale of certificates, the producers of electricity from renewable energy sources get an additional income for its production of electricity. The Green certificate system stimulates the expansion of electricity production from renewable sources.

The following electricity sources are entitled to certificates:

- Wind
- Solar
- Wave
- Geothermal
- Biomass
- Peat
- Small hydro

In order to limit electricity customer's costs from older commercially viable plants, there is a time limitation on the right to receive certificates. Facilities that become operational after the certificate system introduction are entitled to certificates for 15 years, until at the end of 2035.

Electricity suppliers are obliged to buy certificates corresponding to a certain percentage of the electricity they sell, the so-called quota obligations. In order to fulfill the quota obligation, the electricity suppliers declares each year to the authorities how much electricity they billed their clients during the preceding year, together with certificates representing a specified percentage (ratio) of sales.

## **8.4 The onshore wind power process – from a greenfield project to a running plant**

### **8.4.1 Pre-development**

Most sites for onshore wind power are located through map studies. Areas are predominately found by identifying areas with a limited number of conflicts combined with good wind conditions. Looking at municipality plans and receiving tips from landowners can be a way of evaluating new leads or identify new ones.

Once a site has been located the pre-assessment starts. Focus lies on terrain and roads and a number of potential turbines and an early layout is laid. The grid is evaluated from a holistic view where main focus lies on getting an indication of time and cost. The grid connection is very central in the development, since it holds a lot of the potential for the site. After a site has been identified with good potential the negotiations with landowners and finally the signing for land takes place. This is usually the most time consuming activity in the process.

### **8.4.2 Development and Permit Application**

During the development the technical evaluation continues. Measuring masts are installed on the site to collect data in order to clarify the wind conditions and to make a production estimate. In order to receive all legal permits for an onshore wind power park, there are two applicable processes: For smaller projects with no more than 6 turbines and a maximum height of 150 meter, the municipality is responsible to review the application according to the environmental law (SW "Miljöbalken"). The project is also reviewed according to the Plan and building law (SW "Plan- och bygglagen"). Larger parks, more than 6 turbines, need to be permitted by a county authority (SW "Länsstyrelsen"). Before any application can be reviewed, the county authorities need to have the consent from the municipalities. Hence, the municipalities of Sweden have a "veto" of whether the park will go through the process or not.

Central to the application is the EIA (Environmental Impact Assessment). This study includes potential impacts on humans and the surrounding environment. The areas of interest for the study includes birds, bats, archeology studies, reindeers (north of Sweden), aviation, defense, noise and shadows analysis, landscape analysis, layout, and other potential conflicts with nature life (special species). An important part of the study is the process and the impact for local stakeholders. In order for the application to be complete a number of referrals need to be submitted.

Depending on if the application is appealed or not, the development of the project can take from two to five years, or even longer in some occasions. For offshore projects periods between eight to ten years need to be considered.

When the consent of a project is granted, the permit itself rule under which conditions the plant is to be operated. The permit also defines when in time the turbines are to be taken down and which measures to consider. A follow up program is also placed for the permit holder to execute on a yearly basis. The permit holder might have to set aside funding for the de-commissioning of a plant.

### 8.4.3 Tender

A number of tenders and contracts are negotiated before construction takes place. The most critical tender is the procurement of wind turbines, since it stands for between 70-80% of the investment. In past years the waiting time for some turbines have been up to two years which puts constraints on some projects.

Connection to the grid is particularly important and can often be a quite complex matter when larger parks are being planned. A common thing is that wind power projects are located in an area where other developers look at projects. Co-investments need to take place in order to optimize the investment cost. These co-investments tend to be time consuming since usually all projects need to be on the same time table. Civil works like foundations vary a lot in quality and price. Turbine suppliers place a lot of constraints on the roads that needs to be constructed accordingly.

### 8.4.4 Construction

Depending on the size of the park, and especially number of turbines, the construction period can take place in a couple of months or up to several years. The terrain and climate conditions also have an impact on the construction timeline.

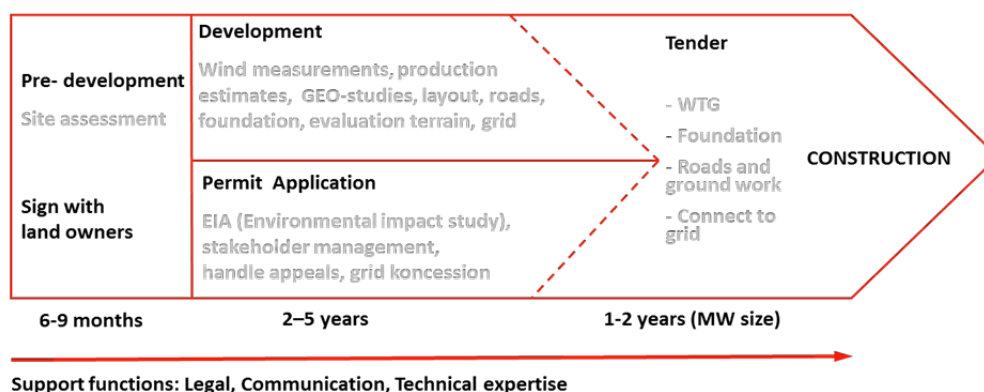

Chart 8. Process for onshore wind power development

### 8.4.5 Operational phase

All kinds of service contracts can be found on the market regarding onshore wind farms, from the smallest entrepreneur to energy companies and turbine suppliers. Most turbine suppliers offer their services to operations and some suppliers even hold their buyers linked to these contracts for years. The cost of the wind farm is linked to a number of factors such as wind production, grid connection fees, scalability, price on spare parts etc.

Recently turbine suppliers and developers have started to focus more on turbulence issues since this has shown to have a greater impact on operations costs than identified initially.

Grid connection fees vary a lot. The price does not only reflect where on the grid you connect (locally, regionally or directly to the central grid) but also where in Sweden you connect. Generally, it is more costly to connect in the north of Sweden.

Operation costs can be more efficient (economies of scale) by choosing the right location and type of turbines. With a substantial fleet with the same type of turbine, costs for spare parts can be negotiated. Economies of scale can also be reached when it comes to service management: It is preferable to have a larger park (+40MW) or a number of smaller assets within a 10 km radius.

# Chapter 4

## Cooling and Heat Recovery

# Introduction and Summary

This chapter describes the design of the water cooling system for ESS. Cooling is provided by centralized heat pumps and cooling water is distributed in underground distribution pipes to cooling substations. The substations are located inside the klystron gallery, the target building, the cryogenic plants and the buildings in the instruments section of ESS.

The water cooling system is divided into three different circuits, based on the cooling temperature demands in the various parts of ESS. The cooling demands are summarized in the table below.

	Low	Medium	High
Supply temperature (°C)	5-10	32	50
Return temperature (°C)	30-35	40-60	75-85
Temperature difference, $\Delta T$ (°C)	25-30	8-28	25-35
Cooling capacity (MW)	12.1	7.7	13.2

Much of the data provided here are preliminary figures, due to the fact that very little cooling data have been published in the CDR and the early versions of the TDR. However, we have had a very good cooperation with the machine design teams and we are convinced that the data used here are reasonably close to the final design values.

By using heat pumps to supply cooling water, it is also possible to recover the heat to the district heating system in Lund. It will be possible to supply approximately 250 GWh/year into the district heating system.

The design described here has been developed in cooperation between ESS, Lunds Energi and EON. The work performed within this cooperation has also included investigation of other heat recovery options than recovery to the district heating system. Some of the ideas we have studied are also included in section 6 of this chapter.

One section of this chapter deals with analyses of certain aspects of the cooling system. One aspect is the question whether it is economical to have three separate cooling circuits rather than just two circuits. This is treated in section 5.1. Another aspect is the importance to keep cooling temperatures as high as possible, this is treated in section 5.2 – this has previously been distributed as a separate report within the ESS project.

# Cooling and Heat Recovery

# 1. Background

The ESS will be an energy intensive plant, with a power consumption of more than 40 MW, or equal to a large scale process industry. Most of this power will be used to accelerate protons, and the high-energy protons will be used to obtain low-energy neutrons. Of the power supplied, only a very small part is in the end used in the actual research work. The vast majority will be released as heat, and therefore a large scale cooling system is needed.

The ESS cooling system exists to accomplish two goals. The primary goal is to remove waste heat and provide adequate cooling and temperature control for all systems to assure safe and efficient facility operation. The second goal is to recycle as much of the waste heat as practicable and provide it to external customers. To accomplish these goals, the cooling system is designed with a series of heat exchangers, pumps, heat pumps, piping, and possibly other chiller systems that use water as the primary heat exchange medium to transport heat generated from facility systems to external customers.

In order to achieve an energy efficient heat recovery, it is of considerable value to cool equipment at as high temperatures as possible. The ambition is to build an energy-efficient, sustainable and robust cooling water system.

## 2. ESS Cooling Demands

The basic design of the plant was first published in 2002. Before the decision on the ESS location, the design was revised, and the changes presented in a basic design update published in 2003. Since then, additional modifications have been made to the plant, substantially affecting the energy demands. Updated descriptions of the overall ESS design have been published in the Conceptual design report and in the preliminary versions of the Technical design report. These reports concentrate mainly on the overall technical design and the specialised equipment needed to accelerate protons, obtain the vital neutrons and the research outcome. Limited detailed information on cooling demands and temperature levels are found in the CDR and TDR.

However, information also on cooling demands is available as preliminary design data. These data have been discussed in a large number of meetings between the cooling design group and the various machine design groups. Therefore, a large proportion of the cooling demand and temperature level data found in this report are based on preliminary information. We are reasonably confident that these data are very close to what will be found out to be actual cooling data once the ESS facility is in operation.

Most data presented in the following sections are valid for full scale operation with a 5 MW proton beam with neutron production for 22 instruments. The estimated operation time with these conditions is 5200 hours/year. During the first years of operation and during the other 3200 hours/year, the ESS facility will be operated in various part-load modes, or will be shut down for maintenance, and the cooling demands will then be considerably lower.

### 2.1 Linear accelerator

The linear accelerator comprises both the linac tunnel itself and the klystron gallery. The total cooling requirement for the system is divided among components in the tunnel and gallery. Most of the cooling demand is klystron gallery equipment. Although a majority of the klystron gallery cooling demands will be met using water, the low level RF (LLRF) equipment requires approximately 500 kW of air cooling.

A minor part of the cooling demand in the linac tunnel is supplied from the cryogenic helium system. The HEBT magnets require approximately 250 kW of cooling with 35 degree C water. The RFQ and DTL tanks in the linac tunnel require not only cooling, but also more stringent temperature control requirements than the rest of the accelerator systems. A separate cooling and temperature control loop may be provided for this equipment. Cooling for the RFQ/DTL is estimated to be less than 200 kW.



The cooling capacity and temperature requirements are found in table 1 below.

Section	Equipment	Cooling demand (kW)	Supply temperature (°C)	Return temperature (°C)
<b>Ion Source</b>	Various	50	20	25
<b>High Beta</b>	Modulator	2136	27	42
60 modulators	Klystron filament	360	20	25
120 klystrons	Klystron body	1379	35	40
	Collector	5520	50	80
	Circulator	132	50	80
	Dummy load	516	50	90
	Linac tunnel	180	20	25
<b>Low beta</b>	Modulator	579	27	42
30 modulators	Klystron filament	90	20	25
60 klystrons	Klystron body	396	35	40
	Collector	1596	50	80
	Circulator	30	50	80
	Dummy load	126	50	90
	Linac tunnel	45	20	25
<b>Spoke</b>	Amplifier	246	20	25
28 tetrodes and	Tetrode	137	35	40
amplifiers	Filament	84	20	25
	Circulator	3	50	80
	Dummy load	11	50	90
<b>DTL+RFQ</b>	Modulator	181	27	42
4 DTL + 1 RFQ	Klystron body	117	35	40
1 klystron and	Collector	467	50	80
1 modulator each	Circulator	4	50	80
	Dummy load	17	50	90
	Linac tunnel	287	20	25
<b>HEBT</b>	Magnets	250	35	45
<b>Total</b>		<b>14939</b>		

Table 1. - Cooling capacity and temperature requirements in the linac section. The cooling demand figures refer to summarised mean figures for all similar types of equipment. As an example, the 60 modulators in the high beta section have a combined cooling demand of 2136 kW.

Temperature stability requirements remain to be decided.

### 2.1.1 Pressure requirement

Water pressure requirements in the klystron gallery are currently planned to be PN10, final determination of pressure rating remains to be decided. The largest known pressure drop presented so far is 3 Bar in the dummy loads in the high beta section.

### 2.1.2 Availability requirement

Cooling water must be available at all normal operating conditions. During linac downtime there is no cooling demand in the accelerator.

## 2.2 Target

The target cooling substation will provide cooling for the following:

- Main system for cooling of the target material. This is a water cooling system connected to an inner gas cooling systems using nitrogen.
- Water cooling system for cooling of those systems that are water cooled (thermal moderators, inner and outer reflectors, the monolith shielding, beam dump, and water purification systems)
- Water cooling system for cooling of those systems that are cooled by gases in the primary system (Monolith flush and atmosphere, helium purification, and proton beam window)
- Water cooling system used to provide constant temperatures in ventilated zones (connection cells, utility rooms, and active cells HVAC)

Target moderators will be kept at cryogenic conditions with a hydrogen system. The small cooling demand is supplied from a cryogenic helium plant. Cooling for the cryogenic plants is treated in section 2.3 below.

The cooling capacity and temperature requirements are found in table 2 below:

Section	Cooling demand (kW)	Supply temperature (°C)	Return temperature (°C)
Main target	4622	5	67
Thermal moderators	49	15	25
Inner reflector	351	15	29
Monolith shielding reflectors	792	25	29
Monolith shielding	304	25	30
Beam dump	50	25	45
Collimator	35	25	45
Monolith flush & atmosphere	211	20	50
Helium purification system	10	20	90
Proton beam window	40	20	27
Active cells ventilation	187	20	25
Connection cell, utility room vent	809	20	25
<b>Total</b>	<b>7460</b>		

Table 2. - Cooling capacity and temperature requirements in the target section. The cooling demand figures include the cooling demands arising from pumps and fans in the internal cooling systems in the target.

Temperature stability requirements remain to be decided.

### 2.2.1 Pressure requirement

The pressure in the main cooling water system should be lower than the pressure in the gas-state nitrogen system for cooling of the target. The purpose is to minimize risk of any activated gas leaking into the water cooling system. The pressure in the nitrogen system will be kept around 10 Bar.

### 2.2.2 Availability requirement

Cooling water must be available at all normal operating conditions. For a short period after a shut-down of the target there is an unknown but small remaining cooling demand. A back-up system, working also during power breaks, will be necessary

## 2.3 Cryogenic plants

There are three separate cryogenic plants, providing helium cooling at cryogenic conditions. The largest system provides helium at 2-4 K for cooling of the linac. A second system provides helium at 16 K to the target moderators.

A third helium liquefier provides batch liquid helium for distributed instruments with varying flow-rate requirements. Cooling requirements for this third system are an order of magnitude lower than the cryoplants for Linac and Target. The main cryopant cooling demands are the gas coolers and oil coolers in the helium compressor stations.

There will be a large difference between supply and return water cooling temperatures for both the condenser cooling and in the oil cooling circuits. Consequently, cooling will be done in several stages to maximize heat recovery.

Helium plant	Cooling system	Cooling demand (kW)	Supply temperature (°C)	Return temperature (°C)
<b>Linac</b>	Oil cooling medium temp	1720	35	63
	Oil cooling high temp	1720	63	90
	Gas cooling low temp	287	12	38
	Gas cooling medium temp	287	38	63
	Gas cooling high temp	286	63	90
<b>Target</b>	Oil cooling medium temp	880	35	63
	Oil cooling high temp	880	63	90
	Gas cooling low temp	147	12	38
	Gas cooling medium temp	147	38	63
	Gas cooling high temp	146	63	90
<b>Instrument</b>	Oil cooling medium temp	160	35	63
	Oil cooling high temp	160	63	90
	Gas cooling low temp	27	12	38
	Gas cooling medium temp	27	38	63
	Gas cooling high temp	26	63	90
<b>Total</b>		<b>6900</b>		

Table 3. - Cooling capacity and temperature requirements in the cryogenic plants.

### 2.3.1 Pressure requirement

Water pressure requirements for cryopant cooling is currently planned to be PN10. Final determination of pressure rating remains to be decided.

### 2.3.2 Availability requirement

The cryogenic plant that provides helium cooling for the linac is likely to be in operation also when the ESS otherwise is shut down or in a stand-by mode. Requirements for cryogenic helium from the target and instrument cryoplants during shut down and standby is anticipated to be small. However, these cryoplants will operate at some reduced capacity to prevent helium loss in the system. The cooling demand during a power break remains to be decided but is likely to be very small.

## 2.4 Instruments

The instrument suite for ESS is currently in review. The current baseline design includes 22 instruments. Cooling will be required for both individual instruments and instrument support equipment. The total estimated cooling requirements for instrumentation is approximately 1.6 MW, and is likely to be highly distributed, making it a challenge to effectively recover this heat. Note that additional cooling

capacity should be included in the design to accommodate new instruments as they are added to the facility in the future. Note also that the cooling temperature requirements for instruments are currently undefined.

Heat loads in the experiment Hall	kW	Quantity	Type
Average heat load per instrument	50	22	Instruments
Sample environment	100	1	Lab
Chopper technologies	40	2	Areas
Science labs	50	4	Labs
Neutron optics	50	1	Lab
Detector technologies	50	2	Labs
<b>Total kW</b>	<b>1630</b>		

Table 4. - Cooling capacity requirements for instruments.

## 2.5 Test Stand

The test stand will consist mainly of a hall equipped with requisite electrical power, grounding, cooling water, and HVAC. The initial intended use of the test stand is for extended soak tests of high power RF equipment to provide a basis for acceptance. Subsequent use of the test stand will be for acceptance testing of ESS cryomodules using accepted modulator and klystron prototypes as RF power sources. Tests on cryomodules will be performed with full cryogenic load at final operating conditions. The test stand will be located at the end of the klystron gallery nearest to the target station.

The test stand will require cooling for four modulators and eight klystrons for testing elliptical cryomodules, and one amplifier and tetrode for testing of spoke cryomodules. Total installed cooling power required is approximately 1200 kW. Temperature ranges for cooling are similar to that provided for klystron gallery equipment. That is, separate cooling loops for low (20°C supply), medium (35°C supply) and high (50°C supply) temperature cooling will be required.

## 2.6 Others

Other cooling demands are currently not known in any detail. These may include cooling for:

- Compressed air systems. Two compressor systems are currently planned – one with dry filtered air for valve actuators and control, and one for general shop air. Cooling demands for this system will likely be around 500 kW.
- Data handling center
- ESS building HVAC requirements
- Other cooling requirements

The project is currently estimating 2 MW cooling required for these systems pending additional definition.

System	Cooling demand (kW)
Utilities (compressed air etc)	500
Internal HVAC requirements	500
Data handling center at ESS	1000

Table 5. - Cooling capacity requirements in those parts of the ESS where design data remain to be decided.

## 2.7 Operating times and modes of operation

The operation modes, as explained in Conceptual Design Report, are as follows:

Mode	Duration [hours / year]
Full operation	5200
Down-time	1900
Intermediate (eg start-up, shutting down)	1700

The full implication of the different operational modes on the cooling system is not yet clarified. However, it can be anticipated that certain ESS systems/machines will run at reduced capacities in the different operation modes. Also some ESS systems may be shut down, thereby not requiring any cooling. This will result in varying demands on the cooling water system.

## 2.8 Summary

Heat is removed from each point that requires cooling with ordinary water/water heat exchangers. This section outlines overall cooling requirements for target, cryoplants and accelerator. There are also cooling points in the facilities. These cooling demands are not currently defined. However, the listed cooling points in this section represents about 80-85 % of the total cooling demand in kW.

The cooling system is required to operate at varying capacities for the different operating modes. These operating modes are still being evaluated. However, the "beam on target" mode has the highest cooling demand, and is presented in the table 6 below.

System	Cooling loop	Supply temp °C	Mixed return °C	Sum P (kW)
Linac	Low	5	34	4240
	Medium	32	39	2281
	High	50	78	8414
	<b>Total Linac</b>			<b>14935</b>
Target	Low	5	31	4270
	Medium	32	54	1650
	High	50	74	1540
	<b>Total Target</b>			<b>7460</b>
Cryoplant	Low	5	35	460
	Medium	32	60	3220
	High	50	87	3220
	<b>Total Cryoplant</b>			<b>6900</b>
Instrument	TBD	TBD	TBD	<b>1630</b>
Other	TBD	TBD	TBD	<b>2000</b>
<b>Total estimated cooling demand</b>				<b>32925</b>

Table 6. - Cooling data summary.

The summarized temperature-load curve for all the cooling demands is shown in the figure below.

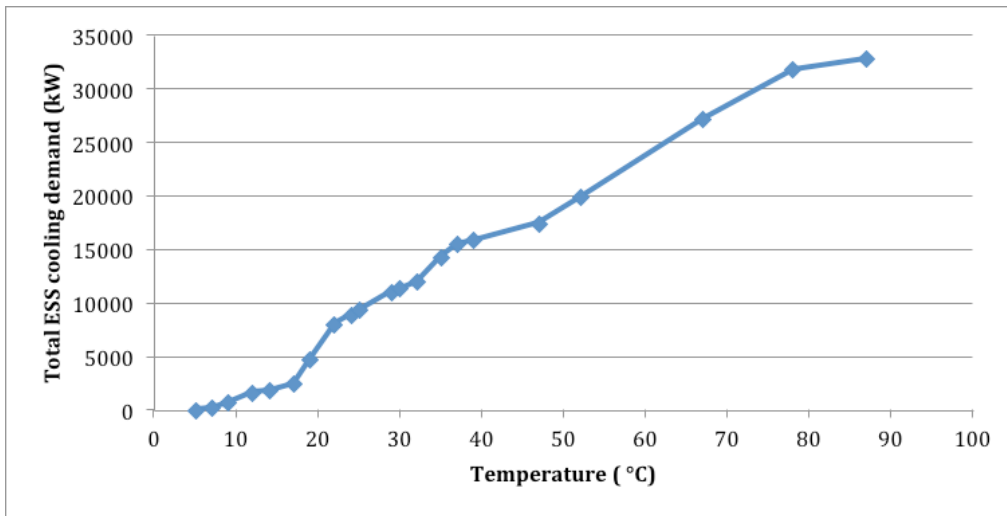

Figure 1 The summarized temperature-load curve for all cooling points in table 6 above

## 3. Cooling System

### 3.1 Overall system design

Cooling water system for ESS facility will be built for the scope according to Figure 2.

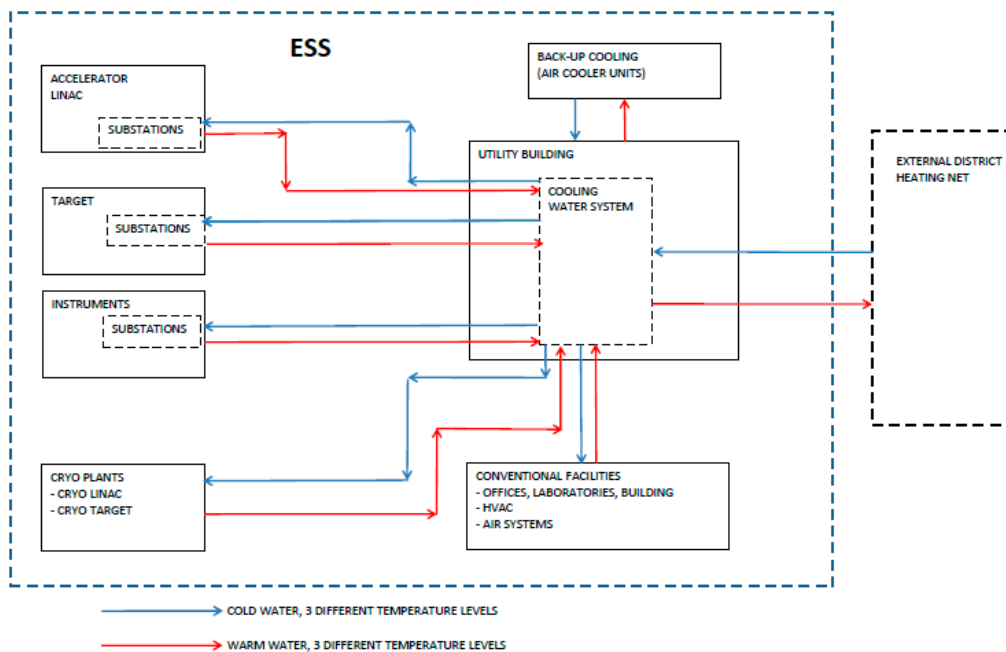

Figure 2. – ESS cooling scheme

The system will be used to cool the different parts/machines in the figure. The main purpose of the system is to provide cooling or heating for ESS systems and facilities.

A secondary purpose of the cooling water system is to recover the energy received into the cooling system so that it can be used in internal and external systems. This can be achieved mainly by:

- Using the excess energy for other applications within ESS. As an example, return water flows at adequate temperatures may be used for heating office buildings.
- Converting the energy into a form more suitable to be used outside the ESS. As an example high temperature cooling water return flows may be directed through heat exchangers to heat a district heating water system outside ESS.

At this stage options are kept open and are to be decided at a later stage in the project.

The cooling capacity is estimated to be 33 MW. To meet these demands, the system will provide cooling water at three different temperature levels as shown in Table 7.

	Low	Medium	High
Supply temperature (°C)	5-10	32	50
Return temperature (°C)	30-35	40-60	75-85
Temperature difference, $\Delta T$ (°C)	25-30	8-28	25-35
Cooling capacity (MW)	12.1	7.7	13.2

Table 7. – Cooling system temperature levels

Although the current plan is to provide three temperature levels, the final determination of number of cooling levels will be made based on machine requirements and an economic evaluation of heat recovery.

The detailed design of the cooling water system will be completed utilizing standard machines, equipment and components such as pumps, heat exchangers, heat pumps, piping components, tanks and vessels. Construction materials are to be standard austenitic stainless and galvanized carbon steel. In some special applications other materials like high-grade steels or thermo plastics may be used. Governing codes are appropriate EU Directives required for CE marking systems and components. Media in cooling water system is primarily deionized/demineralized water and possibly (for some outdoor applications) ethylene glycol/water mixtures.



2012-11-27 10:38:49 Z:\58603100\_Facilities\study\13-11-10\_Rev11\MediaSupply\13-11-10\_V-100-000.dwg



### 3.2 Cooling central

The energy central building contains all necessary heat pumps/cooling machines to produce the required cooling capacity for the three cooling loops. The required cooling capacity is produced by a number of heat pumps/cooling machines.

When a heat pump/cooling machine produces cooling energy, a large amount of heat is produced at the same time on the condenser part of the machines. The heat energy produced is the sum of the cooling energy and the electrical energy to the heat pump compressor. To recover this energy for use in the Lund district heating system, the heat pumps/cooling machines hot side temperature must be lifted to a level which is useful to the district heating system. This means normally a temperature of about 80–90°C. If this temperature lift is not of interest to ESS for economic reasons, the energy has to be released to the ambient air in some type of cooling equipment, which means that this energy will be wasted.

The supply temperature level in the system Low is determined by the cooling point with the lowest required supply temperature, at present the 5°C in the Main Target.

The supply temperature level in the system High is determined by the lowest possible temperature which can be cooled directly by the district heating system and without any cooling machines. This lowest possible temperature is the return temperature of the district heating system. In the part of Lund’s district heating system where ESS will be located the return temperature varies between 40–50°C over the year.

The supply temperature level in the system Medium is determined by the temperature level which leads to the lowest electrical consumption. Too low temperature means higher electrical consumption in the heat pumps/cooling machines due to high temperature lift. Too high temperature means that a larger number of cooling points has to be connected to the system Low, which also means higher electrical consumption in the heat pumps/cooling machines.

The return temperature presented above is the mixed return temperatures after all cooling points in each cooling system, i.e. the return temperature that is entering the energy central.

Figures in Table 8 are calculated based on an assumption that all energy will be recovered and transferred to the district heating system. The energy central will with this assumption consist of the following heat pumps/cooling machines:

Cooling system	Low	Medium
Cooling demand(MW)	12.1	7.7
COP	2.9	3.7
Heat production (MW)	18.5	10.6
Heat pumps	3*4.5 MW cooling	2*4 MW cooling

Table 8.

For back-up reasons it is necessary to install some extra cooling capacity. One or several cooling machines with a combined cooling capacity of 5 MW will be sufficient for this purpose. It is not economically viable to include extra heat pumps for back-up capacity.

The high temperature cooling loop is designed to transfer the heat directly into the district heating system without any heat pumps. Conventional water/water plate heat exchangers are suitable for this purpose:

Cooling system	Cooling/Heating capacity	Number of heat exchangers
High	14 MW	2 * 7 MW heat

The heat exchangers in the high temperature cooling loop will be cooled directly from the return pipe side of the district heating system. In the part of Lund's district heating system where ESS will be located, the return temperature varies between 45-50°C over the year. The supply temperature from the heat exchangers to the supply pipe side of the district heating system will be in the range of 75-80°C. Further investigation is required to determine if this temperature level is enough to feed into the district heating system.

Besides heat pumps and heat exchangers, the energy central building will also include circulating pumps, shutoff valves, regulating valves, pressure holding systems, water treatment plant and switchgear. The total building area required to house this equipment is approximately 900 m<sup>2</sup>.

If companies in business such as green houses, fish farms, bio gas production etc. want to start activities in the vicinity of ESS it is technical possible for them to use the low temperature energy from the cooling systems instead of building their own heat plant. Users with lower temperature requirements could interface with the return pipe side on the cooling system Low or Medium cooling loops. This means that they can have supply temperatures to their heating systems of about 35-45°C.

### 3.3 Distribution system

Generally, cooling water will be supplied from the primary cooling water distribution system to cooling substations located near the accelerator, target, cryoplant and instrument systems. The cooling substations will include heat exchangers that transfer heat to the primary water cooling system from these systems. Distribution pumps, expansion tanks and water treatment equipment will also be located at these cooling substations.

### 3.4 Substations

Cooling water will be supplied from the cooling substation to the different cooling points in the equipment in the klystron gallery. Cooling water for the equipment in the linac tunnel will also be supplied from the cooling substations through ducts down into the linac tunnel. Figure 3 shows schematically the planned cooling system flow for the linac.

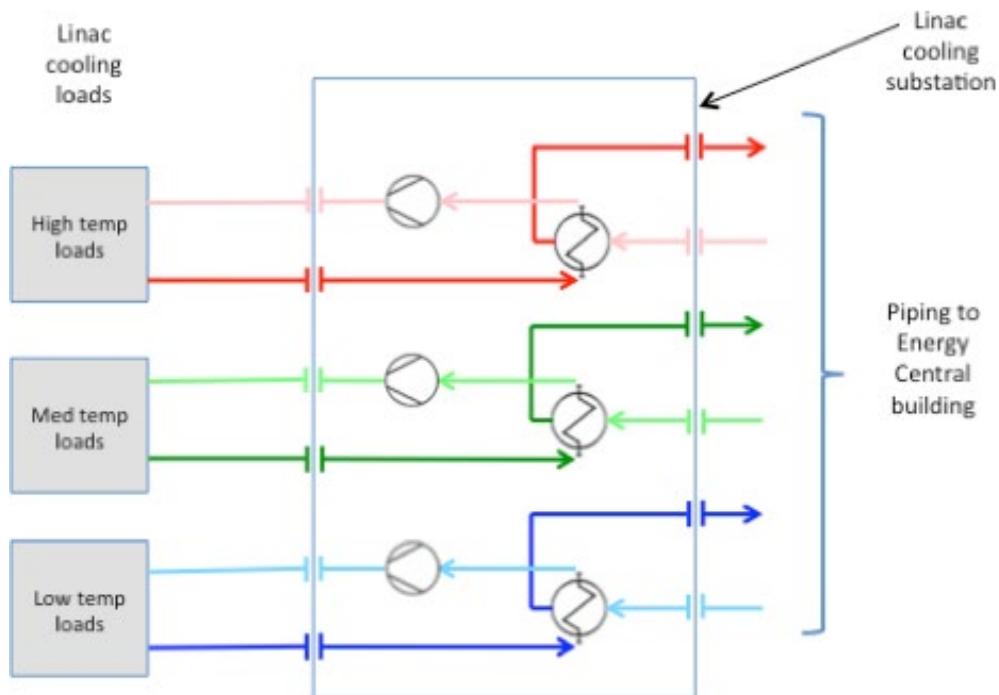

Figure 3. – Linac cooling flow

The linac is located in a beam tunnel, which contains the ion source, LEBT, RFQ, DTL, Spokes, Low cavities, High cavities and HEBT. The klystron gallery equipment is located in a building that runs parallel to the beam tunnel. The klystron gallery equipment connects to the linac through ducts from the klystron gallery building to the linac tunnel.

There are two linac cooling substations, each one requiring approximately 450 m<sup>2</sup> area. These substations will be located in rooms immediately adjacent to the klystron gallery building. A typical cooling substation view is shown in figure 4.

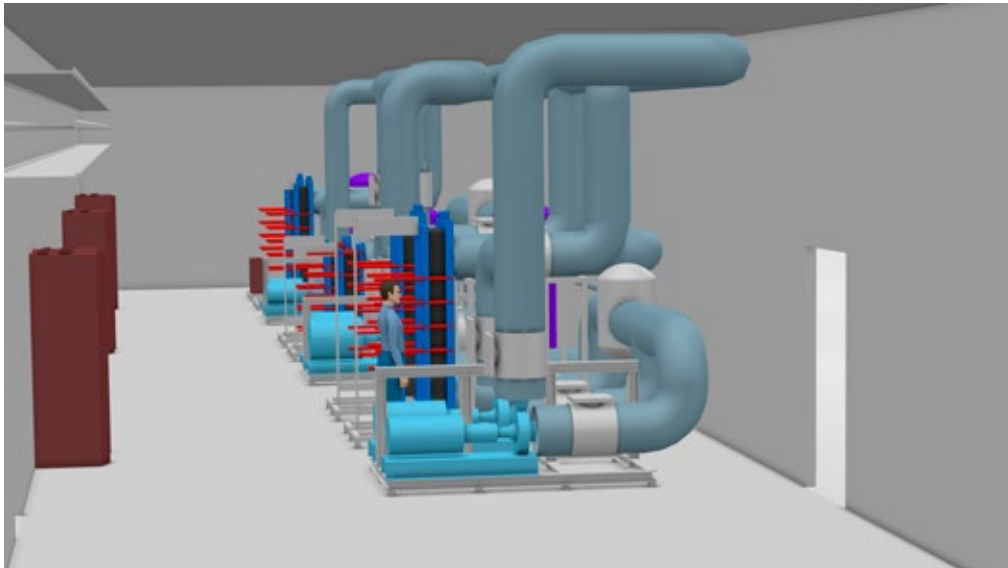

Figure 4 – Typical cooling substation

### 3.4.1 Linac substation options

The length of the klystron gallery and distribution of equipment therein required evaluation to determine if the cooling system pumps and heat exchangers for the low and high klystrons should also be distributed along the gallery, or centralized in a few substations. Figure 5 shows the two cooling system options. A preliminary cost estimate for these two options was performed. Factors evaluated were the cost of heat exchangers, pumps, area (equipment footprint), and piping.

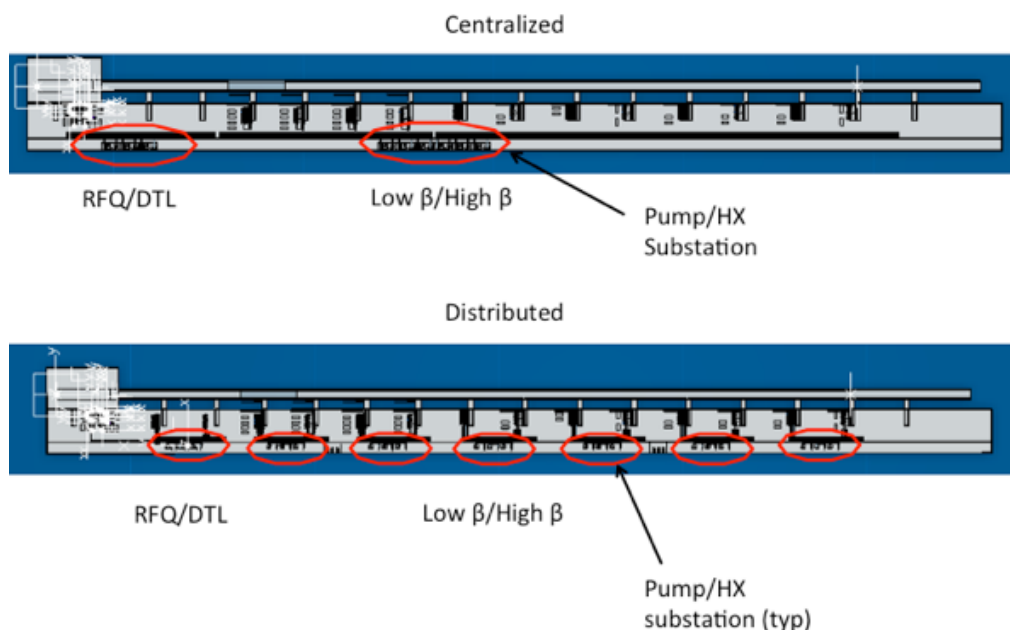

Figure 5. – Klystron gallery cooling substation options

Given the cooling requirements from Table 1, the number of pumps and heat exchanger, estimated piping length, and facility area were estimated for both centralized and distributed cooling systems. The centralized substation resulted in fewer but larger heat exchangers and pumps, and larger diameter piping. The distributed substations resulted in more and smaller heat exchangers and pumps, and smaller diameter piping. The following assumptions were used in developing costs:

- Plate heat exchangers
- Heat exchanger footprint scales to capacity required from Table 1 data
- Pipe diameter based on 2 m/sec flow velocity. Size varies from DN100 to DN250
- Building costs ~ 20,000 SEK/m<sup>2</sup>
- Piping cost estimate ROM based on 2X material cost
- HX cost ROM based on limited research
- Pump cost ROM based on some limited research for new and used pumps.
- Pump footprint ROM based on pump capacity for typical centrifugal pump manufacturer data

Based on required capacity and these assumptions, comparative costs are shown in figures 6 and 7 for both options, for all three temperature cooling loops. This analysis indicates that for each temperature range, the centralized option resulted in lower installed cost than the distributed option. Note that this analysis only includes costs as assumed above, and is only to be considered as a tool to compare options and not as actual costs for these systems.

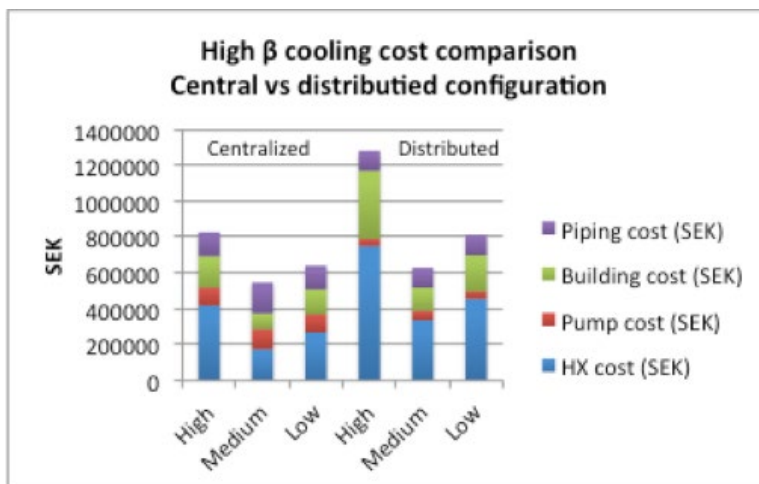

Figure 6. – Distributed vs. centralized substation cost for high cooling substation

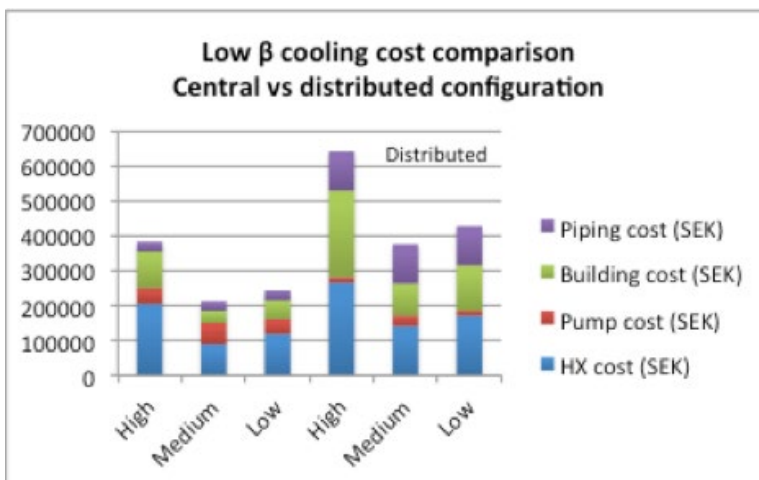

Figure 7. – Distributed vs. centralized substation cost for low cooling substation

The target individual subsystem cooling loads are managed by a cooling system internal to the target system. The interface between this target cooling system and the facility cooling system is a target cooling substation. Cooling water will be supplied from the cooling water distribution system to this target cooling substation located in or near the target building. The cooling substation will include heat exchangers that transfer heat to the water cooling system from the target cooling loop. Figure 8 shows schematically the planned cooling system flow for the target.

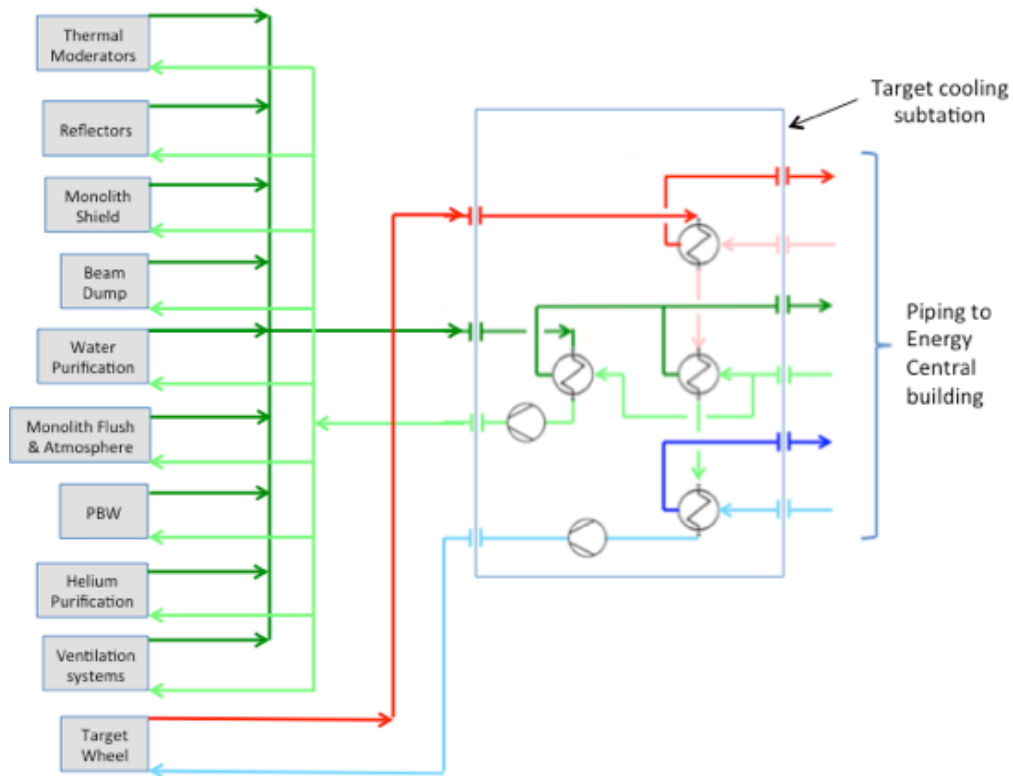

Figure 8. – Target cooling flow

The target cooling substation is located outside of and adjacent to the target station building so that it is outside the boundary of any radioactive zone. The target cooling substation occupies approximately 50 m<sup>2</sup> area.

Cooling water will be supplied from the overall cooling water distribution system to a cooling substation located near the cryoplants. Figure 9 shows schematically the general configuration of the interface between the cooling substation and the cryoplants. Note that a single, integrated cooling substation will support both the linac and target cryoplants. The substation for the smaller instrument cryoplant will be a separate system, as this cryoplant will be operational before the two larger cryoplants.

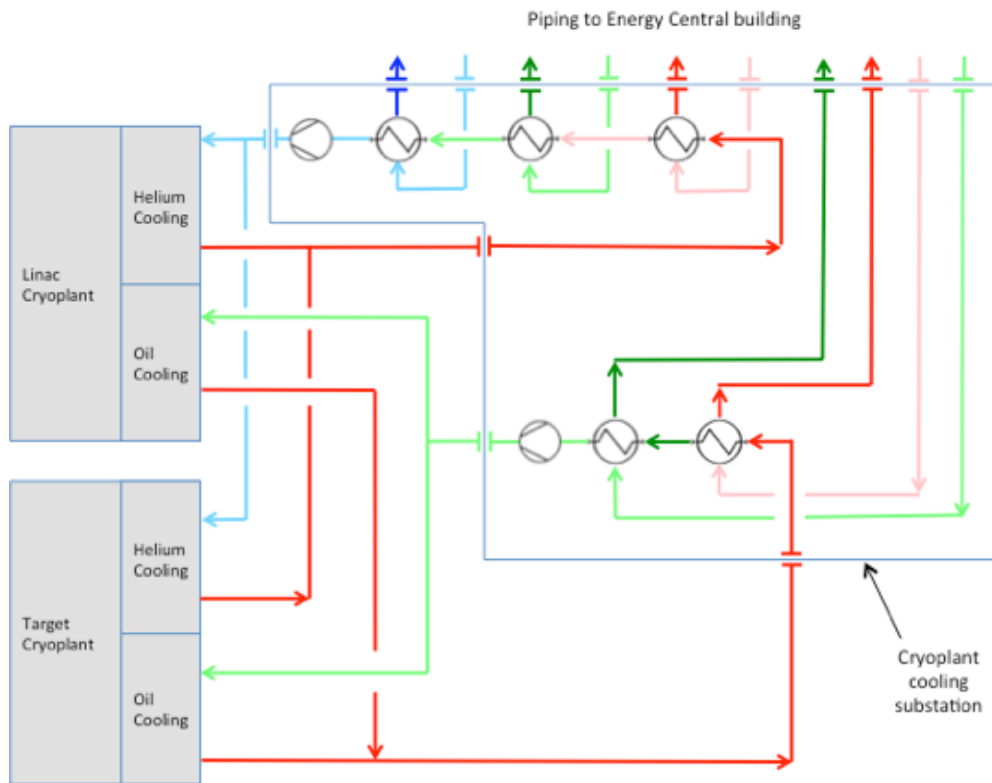

Figure 9. – Cryoplant cooling flow

Instrumentation and controls for the linac cooling system are largely undefined at this point. Instruments will be required to monitor coolant flow rate, temperature, pressure, and cooling water quality. Acoustic noise and pump/compressor vibration, and leak rate monitoring may be required. In addition, instruments will be required to monitor and control circulation pump power and heat pump compressor power.

Cooling water quality and treatment systems are also required for the cooling system. The cooling system will use an integral, continuous, on-line monitoring and control system to manage cooling water quality. Outputs from this system to the integrated control system will be provided for alarms and shut downs.

### 3.5 Emergency/back up cooling

Due to the fact that cooling system is subjected to many variations in operation, it is recommended that a back-up system is installed to ensure personnel safety and to protect valuable ESS systems and machines in the event of unexpected conditions such as the unavailability of the District Heating system.

A possible technical solution for backup is to install a dry air cooler (chiller) or alternatively use tap water. The capacity of the system will be decided later based on requirements to maintain cooling for critical systems.

### 3.6 Heating of ESS buildings

For heating ESS buildings, there is a need for a widely distributed internal heating system. The heating demands of ESS buildings could preferably be supplied from the return pipe side of the Low or Medium cooling system. If required, it should also be possible to supply heat from the district heating system into the ESS heating distribution system.

## 4. Investments And Operational Costs

This section includes a cost calculation. Since the overall ESS design is still preliminary, and the detailed design of vital parts of the cooling system equipment remains to be done, the figures presented here are preliminary.

The calculations are made on the basis of the costs to produce heat from ESS Energy Central to the district heating system in Lund. The calculation has been made as a gross calculation, which means the gross costs to produce heat from ESS without any reduction of the costs that ESS would have to build and operate cooling machines for the necessary cooling of ESS process parts. Note also that this is only production cost, no revenues for selling heat to the district heating system is included.

If all three cooling levels are built with the possibility to produce heat to the district heating system, about 260 GWh heat per year can be produced in ESS energy central, corresponding to about 25 % of the total heat production in the district heating system in Lund in a normal year. The need of electricity to produce this amount of heat is about 55 GWh per year. The result of the calculation shows that the gross production cost for this is about 15 Euro/MWh heat incl. capital cost and about 12 Euro/MWh heat as variable cost. The variable cost for the separate cooling systems is about 1 Euro/MWh heat for the high temperature system, about 15 Euro/MWh heat for the medium temperature system and about 19 Euro/MWh heat for the low temperature system. The electricity price of 50 Euro/MWh and the annuity of 6 % have been used in the calculation.

The cost calculations are summarised in table 9 below.

		Low	Medium	High	Total
T supply (°C)		5	32	47	
T return mixed (°C)		31	46	80	
Cooling capacity max (MW)		12.1	7.7	13.2	32.9
COP heat		2.9	3.7		
Electrical need (MW)		6.4	2.8		
Heat capacity max (MW)		18.5	10.5	13.2	42.1
Heat capacity/Cooling capacity		1.5	1.4	1.0	
<b>Summary</b>					
Full load hours (hour/year)*		6 101	6 168	6 064	
District heating production (GWh/y)		113	65	80	257
Cooling energy (GWh/y)		73.8	47.2	79.9	201
Electrical consumption (GWh/y)		39	17	0	56
<b>Summary</b>					
Electricity price (Euro/MWh)	50				
Energy tax electricity (Euro/MWh)	0				
Net fee (fixed and variable) (Euro/MWh)	0				
Green Certificates (Euro/MWh)	0				
Cost of electricity (MEUR/year)		1.9	0.9	0.0	2.8
<b>Summary</b>					
OPEX HP (Euro/MWh heat)		1.7	1.7	0.6	
OPEX HP (MEUR/year)		0.2	0.1	0.0	0.3
<b>Summary</b>					
Investment HP (MEUR/MWc)	0.5				
Investment HP (MEUR)		6.1	3.8	0	9.9
Investment Back-up CM (MEUR)		1.2			1.2
Investment others in Energy Central (MEUR)		0.5	0.5	0.5	1.5
Total investment (MSEK)		7.8	4.3	0.5	12.6
Annuity (%)	6%				
Cost of capital (MEUR/year)		0.5	0.3	0.0	0.8
Cost of capital (Euro/MWh heat)		4.1	4.0	0.4	2.9
<b>Summary</b>					
<b>Summary</b>					
Cost of electricity (Euro/MWh heat)		17	14	0	11
OPEX HP (Euro/MWh heat)		2	2	1	1
Cost of capital (Euro/MWh heat)		4	4	0	3
Total cost (Euro/MWh heat)		23	19	1	15
<b>Variable cost (Euro/MWh heat)</b>		<b>19</b>	<b>15</b>	<b>1</b>	<b>12</b>

\*This is not the actual estimated number of hours of full operation. It takes into account also the lower cooling demands in various modes of partial operation.

Table 9. – Summarised cost calculations



Only the costs in the energy central are included in the calculations above. The connection to the district heating network has been estimated to cost approx. 5 MEUR. Internal piping systems within the ESS site are roughly estimated to amount to another 4 MEUR.

The dominating operational cost is electricity in the heat pumps. This cost could change depending on several different conditions:

- Cooling temperature level affects the COP of the heat pumps
- High temperature level of the heat produced also affects the COP of the heat pumps
- Chosen heat pump supplier
- Heat pump system configuration

## 5. Optimisations Calculations

### 5.1 Two or three cooling systems?

The cooling system of ESS has so far been designed with three cooling circuits, in order to increase the overall energy efficiency of the heat recovery system. One alternative could be to lump the low- and medium temperature systems into one common circuit. The main advantage with just two systems would be a lower investment cost in the cooling water distribution systems. The main advantage with three systems is the decreased operational cost in the heat pumps. Another advantage is the increased flexibility in the overall energy system – by separating the low- and medium temperature systems it is possible to recover the heat in various systems, or to decide just to recover part of the energy into the district heating system.

We have analysed four different system designs:

- The basic design with three circuits and full heat recovery
- Two circuits and full heat recovery
- Three systems with recovery of heat only from the high and medium temperature circuits
- Two systems with heat recovery only from the high temperature circuit

We have included the investments in heat pumps, chillers, ESS internal underground distribution systems and internal distribution systems within the main buildings (Klystron gallery and target).

The most important figures are summarised in table 10 below.

No of circuits		3	2	3	2
Recovery		Full	Full	Partial	Partial
Investment cost	MEUR	15.1	13.5	12.7	9.5
Operating cost	MEUR/year	2.8	3.2	1.8	1.5
Recovered heat low-mid	MWh	177349	184709	64669	0
Heat pump electricity HP	MWh	56333	63693	17478	0
Cooled off heat	MWh	121016	121016	47191	0
Recovered heat high	MWh	79884	79884	79884	79884
Total	MWh	257233	264593	144553	79884
Recovery cost	Euro/MWh rec	15.9	17.2	13.5	0.0
Recovery rate	%	100	100	63	40

Table 10.

For the two options with a complete heat recovery, the design with just two circuits appear to be approx. 1.5 MEUR cheaper to build, but the operating cost is 0.4 MEUR higher. This implies that the pay-back time for the design with three circuits is relatively short.

The option with three circuits is both 2.5 MEUR cheaper to build and 1 MEUR cheaper to operate per year. However, we also miss out on 110 GWh on recoverable heat. If we assume a modest heat value of 15 Euro/MWh, the not recovered heat represents a value of 1.65 MEUR/year. This again implies a short pay-back for the option with three circuits and full recovery.

The option with just recovery of the heat from the high temperature circuit would be 5.5 MEUR cheaper to build and save 1.3 MEUR in operational costs per year. On the other hand, we would miss recovery of 175 GWh recoverable heat. With the same modest heat value of 15 Euro/MWh, this corresponds to a value of 2.6 MEUR per year. And the conclusion is again the same; these figures imply a short pay-back for the option with three circuits and full recovery.

## 5.2 Cooling temperatures and the effect on operating costs

In order to fulfil the high heat recovery ambitions in the ESS project, it is vital to keep the cooling temperatures as high as possible. In this report we are analysing the economic consequences from losing waste heat temperature quality.

The outcome in operating economy is shown in the pictures below (figure 10 and figure 11). All figures are based on a cooling demand of 1 MW. The first diagram shows a potential waste heat income, the operating cost to recover the heat and the alternative cooling operating cost if there is no heat recovery

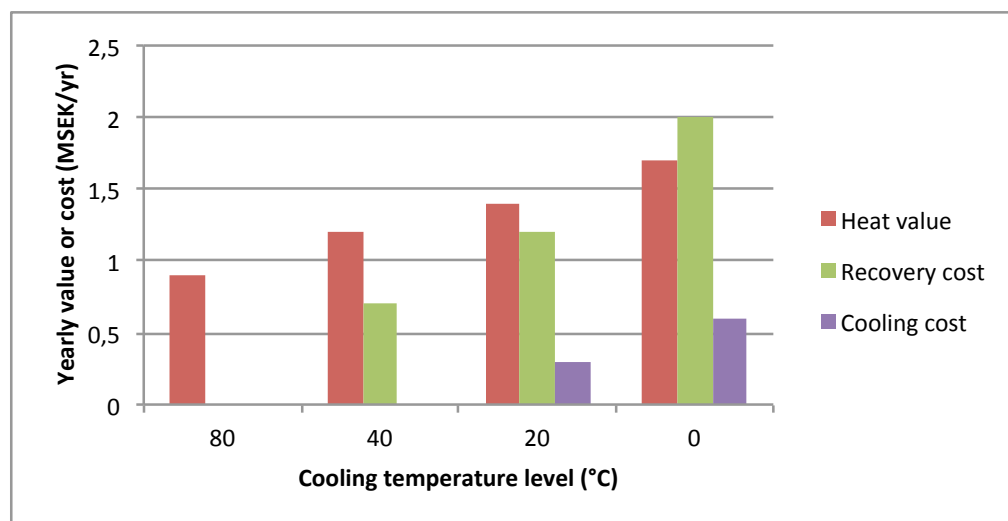

Figure 10. – Value and cost corresponding to specific temperature levels

The second diagram shows the net effect for different cooling temperatures. If a cooling demand is designed for the 0°C-level instead of the 90°C-level, the heat value of 0.9 MSEK/year will instead become a cooling cost of 0.6 MSEK/year.

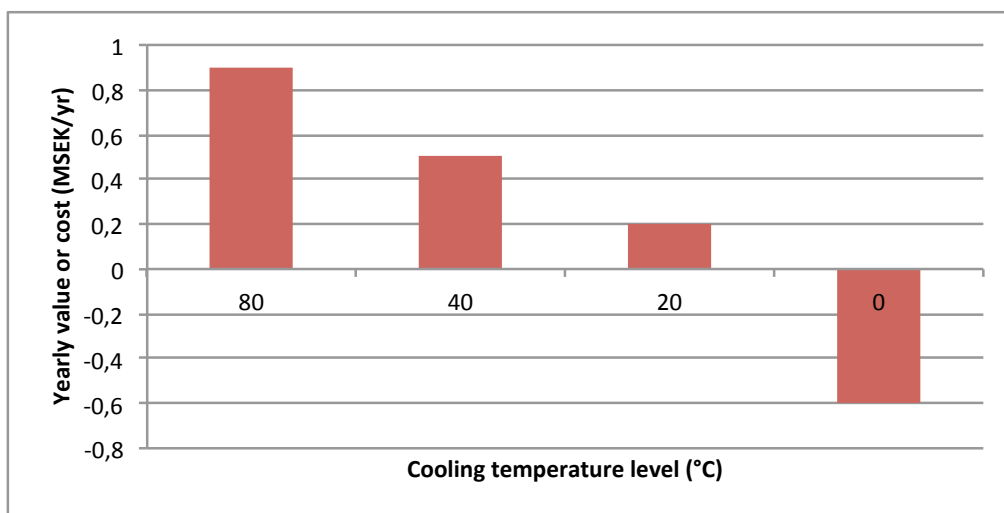

Figure 11. – Net effect for specific cooling temperatures

### 5.2.1 Background

The ESS cooling and heat recovery systems design is governed by four key-words: Renewable, responsible, recyclable and reliable.

The successful campaign that brought the ESS plant to Lund was to a large extent based on the three first "R-words" mentioned above.

The keyword Recyclable was connected to an ambition to recycle at least 60% of the electricity used in ESS as waste heat to the District Heating system in the city of Lund. In order to achieve this ambition, it is vital to keep the cooling temperatures as high as possible.

The amount of heat that is most easily recovered is of course the heat coming from cooling points at such a high temperature that it can be delivered directly to the district heating system. At present, the district heating return temperature is around 45-50°C, and the supply temperature varies from 75 to 100°C. In order to recover waste heat from lower temperature sources, heat pumps are needed. These are operating more efficiently, with less power consumption, if the cooling temperature could be 40°C rather than 20°C.

At a first glance, keeping high cooling temperatures seems rather straight-forward. There are substantial amounts of high temperature-cooling needed in both the Linear Accelerator and the Target System as well as in the helium plants.

However, with the ESS design now in full swing, we can see several occurring constraints such as standard design of certain types of equipment, chosen design of other types of equipment, and available space. If these constraints are not addressed, the heat recovery ambition will be more expensive and difficult to achieve.

### 5.2.2 Calculations

We show the operating economics when comparing a heat recovery option with the standard solution at other major accelerator facilities – to exhaust the heat directly to the surrounding air without any recovery.

All figures are based on a cooling demand of 1 MW and an operating time of 5500 h/year. For certain parts such as the main cryogenic helium plant, the operating time is likely to be longer and consequently the economic effects larger.

Cooling temperature level (°C)	Heat recovery		Conventional cooling
	Heat value (MSEK/year)	Heat recovery cost (MSEK/year)	Cooling cost (MSEK/year)
80	0.9	0	0
40	1.2	0.7	0
20	1.4	1.2	0.3
0	1.7	2.0	0.6

There are of course minor costs also for recovering the heat from the 90°C-level, but they will not affect overall analysis.

It can be concluded that it is not economical to recover heat from the 0°C-level.

Example 1: If a 1 MW cooling demand for some reason will be designed to take place at the 0°C-level instead of the 90°C-level, the ESS project will lose 0.9 MSEK worth of waste heat, but will also have to pay 0.6 MSEK in increased power costs. And an additional investment in cooling machine would also occur. The net effect would be a loss of 1.5 MSEK/year in operating costs.

Example 2: If a 1 MW cooling demand is moved from the 40°C-level to the 0°C-level, the ESS project will lose 1.2 MSEK/year worth of waste heat with a minor decrease in power consumption. The net effect would be an operating cost increase of 1.1 MSEK/year.

## 6. Heat Recovery Options

During the design process, several different heat recovery ideas have been discussed. These are summarised below.

### 6.1 Internal systems

#### 6.1.1 Sorptive cooling

Sorptive cooling is a technique to regulate temperature and humidity levels of the ventilation air by means of using heat, rotating heat exchangers and water injection and condensation. The equipment uses the same physical principal as humans do when we sweat to cool down our body temperature.

The equipment operates with a driving water temperature in the range of 55–60°C (Normal dimensioning criteria of this device: inlet water 60°C and outlet water 43°C to heat exchanger) in cooling mode operation and with a high heat recovery factor in heat mode operation.

Mean efficiency factor of the device operating in cooling mode operation is a CoP of about 1.2 (CoP = Cooling Effect Delivered to Ventilation Air/Heat Used). With this equipment it is also possible to regulate the relative humidity of the inlet ventilation air in a certain range.

The device uses recovered heat to produce climate cooling internally at the ESS site which is favourable. The main heat load of the device could be during the warm season when there will be problems to make good use of the recovered heat from the ESS utility. The major operating cost of the device is connected to the internal price of waste heat from ESS at above defined temperature level.

#### 6.1.2 Absorption heat pump/cooling machine

Absorption heat pumps use a high level primary heat flow into a generator/absorber system to elevate a low level heat flow from the evaporator to produce a heat flow from a condenser. This is achieved

without the power consuming compressor system used in ordinary chillers and heat pumps. From an ESS perspective, we could use the high temperature waste heat to produce cooling in the low temperature circuit. However, this would result in an additional cooling demand at the mid-temperature level. We have therefore concluded that this technique is less applicable at ESS.

### **6.1.3 ORC/Power box**

An ORC (Organic Rankine Cycle) is a power production unit, based on a turbine cycle. The water normally used in a steam cycle is replaced with another working media, with thermodynamic properties suitable for turbine operation at moderate temperatures.

Opcon provides standardised units with a maximum power output of 800 kW. To reach this power production, 6200 kW of heat is supplied at 140°C and 5300 kW is cooled off at 20°C.

Lower driving temperatures, similar to waste water temperatures from ESS, could be used. With a hot water supply at 90°C and a cooling temperature at 20°C, 535 kW of electricity could be produced with a hot water supply of 8.3 MW.

The Opcon ORC produces small amounts of electricity with a larger amount of hot water supply. Since there is no cooling water available at ESS, all heat dissipated from an ORC must be transferred to cooling systems that recycles heat. The result could be that more electricity is used in heat pumps to recover heat than is produced in the ORC.

The ORC is a commercially available product, it could be foreseen that other ORCs will be developed until start-up of ESS. However, without a cooling water system that is not used for heat recovery, any ORC application will be difficult to realise within the ESS system.

### **6.1.4 Heat driven Stirling engine**

The Stirling engine is a heat engine that operates by cyclic compression and expansion of air or other gas, as working fluid, at different temperature levels such that there is a net conversion of heat energy to mechanical work. All of the engine's heat transfer, flows in and out through the engine walls. This is traditionally known as an external combustion engine in contrast to an internal combustion engine where the heat input is by combustion of a fuel within the body of the working fluid.

The Stirling engine encloses a fixed quantity of permanently gaseous fluid such as air or helium thus extremely sensitive for leakages. As in all heat engines, the general cycle consists of compressing cool gas, heating the gas, expanding the hot gas, and finally cooling the gas before repeating the cycle.

The thermal efficiency is comparable (for small engines) with Otto- and Diesel engines, ranging from 15% to 30%. The engine needs operating temperature levels of about 300-600°C to reach these thermal efficiency levels.

In contrast to internal combustion engines, Stirling engines have the potential to use renewable heat sources more easily and to be quieter. They are preferred for applications that value these unique advantages, particularly if the cost per unit energy generated (€/kWh) is more important than the capital cost per unit power (€/kW). On this basis, Stirling engines may be cost competitive up to about 100 kW.

The temperature levels needed to operate a Stirling engine makes it difficult to use the device to produce power from waste heat from ESS. However it may be interesting to use some Stirling solar units to produce power at the ESS site.

### **6.1.5 Gas engine plant**

A solution for reserve power in case of a total break of electricity delivery from the external electrical grid is to install a gas engine at ESS. A possibility is to design this engine as a conventional CHP (Combined Heat and Power) unit and to operate the CHP in base load year around compared to a normal design where it will start only in case of emergency.

A suitable fuel for this gas engine would be some kind of biofuel (liquid or gas). If a biogas plant will be built in the vicinity of ESS, part of the needed biogas for the gas engine can be supplied from this plant. Fuel for reserve situations shall probably be gas oil.

The disadvantage is that it will produce a lot of heat which will increase the surplus of heat from ESS which should be delivered to DH-system.

A gas engine would produce electricity as well as heat at prime district heating temperature level. We have estimated the reserve power demand to 5 MW. A typical power/heat ratio for a gas engine of 5 MWe is about 0.9.

A gas engine would increase the heat delivery from ESS. One solution could be to shut down the engine during those periods when the heat cannot be used without seasonal storage. Operation from November until March will result in a production of 18 GWh electricity, 20 GWh of district heating with a fuel consumption of 42 GWh.

## 6.2 Low-level heat alternatives

### 6.2.1 Anti-icing systems

As ESS will produce vast amounts of low level heat flows at different temperature levels it will be possible to operate large anti-icing systems of roads, pavements and parkings. This measure will eliminate the need of costly and environmentally less attractive present anti-icing logistics by spreading sand, salt with plough vehicles. The sand and salt spreading are eliminated causing the need of extra cleaning in nearby buildings during the winter period also to be eliminated.

The anti-icing system normally uses heat flow temperature levels of about 25-40°C.

The specific investment costs of an anti-icing systems are about 60-120 €/m<sup>2</sup>. The major operating cost of the anti-icing system is connected to the internal price of waste heat from ESS at above defined temperature levels.

The device will consume low level waste heat from the ESS utility. However, the amount of time when the system will be in operation is limited to periods when the value of recovered heat is high. Roughly 120 kWh/m<sup>2</sup> of low-temperature heat could be used for anti-icing. With an assumption of 20,000 m<sup>2</sup> of roads and pavements in the ESS area, this would correspond to a demand of 2.4 GWh of heat at the 40°C level. The need of anti-icing is concentrated to cold winter periods but ESS will deliver waste heat continuously during over the year.

Commercial mature technical equipment from several companies are available on a competitive market.

### 6.2.2 Greenhouse

A potential customer to use waste heat from ESS could be a greenhouse. Greenhouses use a large amount of energy in order to keep the climate similar to a normal day's climate variations. The greenhouse key demand is as light as possible, with the right temperature and atmospheric humidity during a day.

Two temperature levels are often used, 40°C and 60°C. The 60°C level could also be higher temporarily.

One ha of greenhouse area use a heat demand at approx. 3.5 GWh per year. The available ESS area is 14 ha.

The temperature levels for the greenhouse demand needs to be adjusted to the temperature levels from the ESS plant. A study is recommended too see if it is possible to use the waste heat from the ESS plant.

### 6.2.3 Biogas plant

A biogas plant is investigated in a separate part of the report. In this section, it is only treated as a user of low-temperature waste heat.

The main tank/tanks in a biogas production plant is kept at a constant temperature level of 37-38°C, and heat is supplied in order to replace heat losses to the surrounding atmosphere.

The use of heat depends on the size of the biogas plant. For a large size biogas plant, with a production of 60 GWh biogas/year, the heat demand has been calculated to 3 GWh.

The 40°C-temperature level waste heat could be used to supply the heat.

A biogas plant will have a heat demand throughout the year, approximately twice as high during the winter compared to the summer.

A biogas plant in the area is studied in a different part of the ESS project.

## 7. Time Schedule

An overall time schedule for the Cooling System is shown in figure 12 below. The time schedule is based on the assumption that the complete cooling system has to be ready for commercial operation on July 1st 2016.

Version: 2012-12-20																
ESS Cooling & Heat recovery system	Year 2013				Year 2014				Year 2015				Year 2016			
	Q1	Q2	Q3	Q4	Q1	Q2	Q3	Q4	Q1	Q2	Q3	Q4	Q1	Q2	Q3	Q4
<b>1. Energy central</b>																
<b>1.1 Heat pumps/ Cooling machines</b>																
Construction	█															
Procurement documents					█											
Bidding period																
Tender evaluation																
Order																
Manufacturing																
Installation																
Commissioning																
<b>1.2 Mechanical installations (pumps, heat exch, pipes etc)</b>																
Construction	█															
Procurement documents					█											
Bidding period																
Tender evaluation																
Order																
Manufacturing																
Installation																
Commissioning																
<b>1.3 El- &amp; Control system</b>																
Construction	█															
Procurement documents					█											
Bidding period																
Tender evaluation																
Order																
Manufacturing																
Installation																
Commissioning																
<b>2. Pipe installation between Energy central and local heat exchangers</b>																
Construction	█															
Procurement documents					█											
Bidding period																
Tender evaluation																
Order																
Manufacturing																
Installation																
Commissioning																
<b>4. District Heating connection</b>																
Construction and procurement					█											
Installation																
Commissioning																
<b>Commercial operation</b>																

Figure 12. - Preliminary time schedule for the completion of the cooling and heat recovery system.

# Chapter 5

## Business Plan Energy Recycling



# Introduction and Summary

This document is intended to serve as basic information and the first step towards a final choice on how ESS will choose to recycle energy.

ESS is committed to not only recycle the surplus energy from its operations but also do it under a scope that is responsible. The total amount of surplus energy is estimated to 189 GWh annually and consists of hot water that is a result of the cooling process in the facility. In comparison 189 GWh is close to 20% of the total amount of heat requirement in Lund Municipality district heating system.

The document is written based upon the basic material previously produced by the energy team and collaboration with E.ON and Lunds Energi as well as from recent development on how to meet goals on "responsible" for ESS and also to find alternative ways to use the medium and low grade waste energy keeping a net revenue.

The document is produced as a draft for a business plan and will be background for coming documents clearly describing each and one of the alternatives as a solid recycling method for waste energy.

This is the first version of a comprehensive document outlining present possible solutions for recycling of surplus energy at ESS. Today there exist a conceptual design that will serve as solution for the cooling of ESS, avoiding usage of cooling towers but leaving room for further improvement to reach both goals and demands in the ESS energy strategy.

The cooling process is a vital component for the facility to operate and it will be equipped with a back-up system allowing different routes and systems to recycle the energy.

ESS goals and demands offer an opportunity to create a stable revenue stream as well as innovations within the food-production and biofuel industry, however focus is needed and a joint effort is required to set the course.

The current solution, based on heat pumps, is technically robust and would deliver an estimated 2.5 M€ per year in net revenue, including energy savings compared to a conventional solution. However, the energy demands of the heat pumps hinder full goal achievement for the Responsible goal of energy efficiency. Furthermore, this solution entails an exposure to market risk, should the relationship between electricity and heat prices shift. This also includes applicable taxes.

To reach goals and especially demands it is critical to increase the effort and develop other solutions for a final decision.

# Business Plan Energy Recycling

**Authors:** Fredrik Indebetou, ESS

**Reviewers:** Erica Lindström, ESS, Michael Wiegert, ESS,  
Martin Gierow, LEKAB, Tommy Persson, ÅF Industry

**Approver:** Thomas Parker, ESS

# References

- T. Parker, Responsible, Renewable, Recyclable An Energy Management Strategy for the European Spallation Source 2010
- T. Parker, Cutting Science's Electricity Bill, Nature 2011
- Lund NE / Brunnsög, Vision och mål
- L.E. Olsson, Martina Uldal - Anox Kaldnes AB, Brunnsög avloppsvatten och matavfall behandling
- H. Sandin – SLU LTJ, 20120425 Consortium
- Business plan Renewable Energy vv2.0
- T. Persson Energy Management plan 2012 Q4
- Malm, McFaul, Carlsson, Vettier & Carlile, The ESS Scandinavia submission to the ESFRI Working Group on ESS, 25th April 2008, ESS Scandinavia Secretariat
- F. H. Bohn, ESS Costing Report 2011, European Spallation Source ESS AB

# Executive Summary

This is the first, conceptual business plan outlining present possible solutions for recycling of surplus energy at ESS. Today there exists a technical design that will serve as solution for the cooling of ESS, avoiding usage of cooling towers but leaving room for further improvement to reach both goals and demands in the ESS energy strategy.

ESS is committed to not only recycle the surplus energy from its operations but also do it under a scope that is responsible. The total amount of surplus energy is estimated to 189 GWh annually and consists of hot water that is a result of the cooling process in the facility. In comparison, heat produced by ESS is close to 20% of the total amount of heat requirement in Lund Municipality district heating system.

The cooling process is a vital component for the facility to operate and it will be equipped with a back-up system as necessary to allow different routes and systems to recycle the energy.

This business plan is intended to serve as basic information and the first step towards a final choice on how ESS will chose to recycle energy.

Below we have listed five optional ways available today that will:

- a. serve as cooling loop for the research facility
- b. recycle the surplus energy in one or several processes

For each alternative, we estimate, how well our demands on annual energy use, annual revenue, investment and operational cost are met.

	Name	Description	Annual Energy use /GWh	Net Investment / M€	Annual Net operational profit /M€	Annual Net profit /M€
0	Cooling Towers (Reference)	All surplus energy is rejected by means of cooling towers.	23	4.5	0	0
1	Heat pump / Chillers	High grade and medium grade energy is converted into district heating. Low grade is rejected by chillers	27	5.1	2.5	1.99
2	Heat Pumps - CDR	All surplus energy is converted and exchanged into district heating.	44	7.5	3.4	2.65
3	Commercial FOOD	All surplus energy is utilized in commercial food production with standard industrial equipment	44	8.2	4.3	3.55
4	Hybrid cooling chain - CDR	High grade energy is converted to district heating and medium and low grade is utilized in developed industrial food processes	8	1.5	3.8	3.65

### 1.1.1 Conclusions:

ESS goals and demands offer an opportunity to create a stable revenue stream as well as innovations within the food-production and biofuel industry.

The solution proposed in the CDR, based on the use of heat pumps for all low-grade heat is technically robust, but due to the increased demand for electrical power does not completely fulfill requirements and does not in itself offer the best business option.

To reach goals and especially demands it is necessary to continue the effort and develop other solutions for a final decision.

To best attract and organize external financing options, the heat recycling efforts should be organized in a separate legal entity, as soon as possible.

Finally, ESS holds a clear chance to prove that surplus energy is to be regarded as a valued commodity and by so contribute to change for a sustainable energy innovation, both regionally and globally.

### 1.1.2 Next steps

- Q1 2013: Open call for collaboration to attract a broader knowledge and skill base.
- Q2-Q4 2013: Development of detailed business case in collaboration, including both technical solutions, and proposals for contracts and financing.
- Q1 2014: Detailed proposal for launch to ESS board.

## 2. ESS Energy Goals And Demands On Recycling Of Energy

### 2.1 Top-level energy requirements

- a) Total annual energy use must be reduced to less than 270 GWh (ESS Scandinavia Secretariat 2008).
- b) All electrical power used must derive from new, dedicated renewable sources (ESS Scandinavia Secretariat 2008).
- c) Cooling will be based on heat recycling, avoiding the use of cooling towers (ESS Scandinavia Secretariat 2008).
- d) Energy systems must be highly reliable.
- e) Additional investment to achieve energy goals must be financed outside the ESS budget (Bohn 2011).
- f) Energy solutions must contribute to reducing operations costs.
- g) Energy solutions must significantly reduce exposure to energy market risk.

### 2.2 Additional opportunities

- a) The ESS energy solutions are sufficiently attractive to both attract external investment financing and deliver the required net cost reductions.
- b) The envisioned energy solutions could significantly contribute to innovation within the field of recycling of energy.
- c) The ground ESS is built upon is highly valuable farmland. The heat recycling option involving food production could contribute to far more agricultural output than the effect of lost farmland.

## 3. Short Description Of The Four Main Alternatives

There are several ways to recycle the surplus energy generated within ESS. So far the below stated are options that all will resolve the cooling demand.

### 0 – Cooling towers

We use this as a benchmark since the installation of cooling towers is the conventional solution (in the absence of an appropriate body of water) when cooling is required in science facilities. This option offers no recycling and demands a direct investment from ESS. In addition this option will increase power demand and offers no revenue. The solution is conventional and reliable, although large amounts are chemicals are needed to clean the cooling water in these open-loop systems, and failures due to pollutants in the water are known to happen.

### 1 – Heat pumps and dry chillers

The low grade waste heat offers a challenge both technically as well as economically to recycle. The added power demand will also challenge ESS energy goals. A straightforward solution would be to raise

the temperature in the medium heat and directly convert the high temperature into district heating energy. The low grade is cooled of by usage of dry chillers. Still, added power is needed and the net profit will be substantially lower than the more advanced options.

## 2 - Heat Pumps

This solution was presented in the ESS Conceptual Design Report (CDR). The surplus energy is transferred to the district heating system of Lund municipality. Investments for the connection are estimated to 4 MEUR and additional investment for heat pumps for lifting the low grade heat into suitable temperature (above +80°C) amount to 7.5 M€. Lifting the low grade heat will require an annual electricity use for the heat pumps estimated at 44 GWh. In the lower temperature range, this solution shows questionable profitability and there is a significant imbedded market risk if the relationship between electricity and heat prices should shift.

## 3 – Commercial Food

ESS could exchange the 189 GWh surplus energy, both high grade and low grade and allow one or several professional food producers to utilize the energy in their production. Today there exist state of the art greenhouses that can utilize most of the energy in their operations. The Swedish Agricultural University (SLU) and food producers have clearly stated there is an increased demand for locally produced food. This would also create roughly 200-300 new jobs. The ESS surplus energy is estimated to add 25-30 hectares (ha) of food production in the region. The district heating system would serve as backup system for both the cooling and the heat supply to food production. This solution will require a setup with heat pumps similar to solution number 2 above.

## 4 – Hybrid Cooling Chain and CDR

The high-grade heat, representing about half of the heat produced from ESS, would be converted into district heating and the remaining half will be utilized in a Hybrid Cooling Chain that consists of advanced production methods for food, fodder and biofuel. The district heating system will also serve as backup system for both the cooling and the heat supply to food production.

# 4. Background Information

## 4.1 ESS spearheading the development on how to recycle energy

ESS holds a unique possibility to set a new standard on how to recycle energy. This is due to several conditions:

- a. The project is committed to responsibly energy use and heat recycling. This puts a certain demand on the choices that are made. ESS simply cannot settle with standard solutions but needs to push a little further.
- b. ESS is a solid long-term project with steady output of surplus energy. This offers an excellent possibility for other parties to operate on the surplus.
- c. The geographical situation with close connection to the district heating system of Lund municipality offers good redundancy for the usage of surplus energy as well as back up source.
- d. In cases that demand financial support for different research or development project within recycling of energy, ESS is an excellent counterpart due to its international structure.
- e. ESS is located on the border between urban and rural area which opens up for various areas that could utilize recycled energy

These conditions allow ESS to act and stimulate the development of recycling technology and systems by allowing other parties to utilize the surplus of energy.

One vital area is the recycling effort made on the more lukewarm water, below +50°C that ESS will generate up to 92 GWh annually. That area of temperature is available almost everywhere: either as surplus energy or available to extract from incoming solar radiation with already available technology.

## 4.2 General conditions

ESS will have a yearly demand of approximately 270 GWh of renewable electricity, see Business Plan Renewable. The ESS facility will, through its cooling demand, generate an estimated 189 GWh of surplus energy. The 189 GWh comes in three different temperature areas:

96 GWh	29 GWh	63 GWh
80°C	+ 40-45°C	+ 35-40°C

To recycle the energy means to develop a cooling loop that returns a steady flow of "cold" water. It is the recycling that will extract energy and by so generate sufficient cooling.

ESS will have to install a backup cooling system in case of break down in the normal system. Today that system consists of 1-2 air cooled chillers.

A major issue is how to balance systems dependent on the surplus energy with ESS operations. The solution could be to use a combination of connection to the district heating system as well as seasonal storage in ground or aquifer. The main solution could be to use seasonal storage in the ground or preferable aquifer in Lund. An opportunity for large-scale storage exists in the district heating system in Lund. Current district heating operations are partially based on a geothermal source. This geothermal system could also be used as an aquifer for seasonal heat storage.

## 4.3 Land requirements

Depending on what solution finally will be chosen either a small land area within the ESS area is needed or considerably larger land areas will be required. A full-scale food production solution spans up to 25-30 ha in land requirement.

Dialogue is initiated with several landowners. This will be of key importance in the choice of solutions for recycling.

Cooling towers	= 0
Heat pumps	= 0
Commercial Food	= 25-30 ha
Hybrid Cooling chain + CDR	= 12-15 ha

The transportation of surplus energy is limited by cost but a radius of 7-10 km is today set as reasonable for the different alternatives. Loss of energy in transport is expected to be less than 5% of the distributed energy. Cost for infrastructure transporting energy is in the order of 0.6 MEUR (estimate) per kilometer.

## 4.4 Implications of the choice of ESS's legal status on recyclable energy

The choice of legal status will affect how ESS choose to position itself as an energy supplier by recycling surplus energy in order to meet goals and demands on the recycling. The foreseeable options are limited to three options (see below): Basically, ESS could become an/a

1. ERIC (European Research Infrastructure Consortium). The ERIC-status is missing a legal framework in many areas, i.e., if an ERIC can own a subsidiary that is a profit maximizing entity. ERIC solves the question of how to handle VAT, but not taxes. Due to political reasons, it is highly probable that ESS will become an ERIC.
  2. International organization, like CERN. Theoretically, you could design your own legal framework and thus avoid challenges like taxes or whether the spallation source can own a profit maximizing entity or not. It is quite unlikely that ESS will become an international organization due to the fact that this legal status might become a cultural and political challenge and that the ratification process might be too long.
  3. Swedish limited liability company (an "AB", like today). This is an unlikely outcome due to the fact that several member states will not be able to own shares in foreign companies.
- As stated above, there is a considerable probability that ESS will become an ERIC.

According to the council regulation (EC) No 723/2009, section 8, the principal task of an ERIC is the establishment and operation of a research infrastructure on a non-economic basis and should devote most of its resources to its principal task. However, in order to promote innovation and knowledge and technology transfer, the ERIC is allowed to carry out some limited economic activities if they are closely related to its principal task and they do not jeopardize its achievement. Legally, it seems clear that the ESS energy activities fall within this exception. For these "economic activities", separate bookkeeping is required, most easily achieved by creating a separate legal entity, a company.

#### 4.5 Implications of taxes

There is lack of clarity in the future tax structure for ESS. Whether or not the Swedish electricity tax will be levied will naturally make a significant difference in the different calculated revenue streams – short term and long term, but also the possibility for ESS to negotiate or maintain market competitiveness.

For example a solution based on heat pumps is highly dependent on the future energy tax liability for ESS. A full implementation of the heat pumps envisioned in the Conceptual Design might be quite profitable if ESS is relieved from the electricity tax, or taxed at the level for power-intensive industry. Should ESS be liable for full electricity tax, the profitability of running the heat pumps will be more questionable.

The purpose of the electricity tax is, of course, to finance the Swedish Government, but there is also a motive to steer Sweden towards sustainability. In as much as the level of tax can be seen as a reflection of this desire, the responsible strategy for ESS would be to design the facility with the assumption that the tax will be levied.

## 5. The Main Alternatives

### 5.1 General facts and figures

#### Energy data:

Today ESS is chilled on three different levels, 20°C, 40°C and 80°C, each level corresponding to following amount:

20°C:	63	GWh
40°C:	29.3	GWh
80°C:	96	GWh
<b>Total:</b>	<b>188.3</b>	<b>GWh</b>

#### Calculation data:

Currency: 9 SEK/€

Electricity price: 50 €/MWh

<b>COP for heat pumps:</b>	
at temperature 20°C:	2.9
at temperature 40°C:	3.7



## 5.2 Cooling towers – reference solution

This solution is set up as reference with respect to the fact that it is a conventional cooling solutions with high reliability and well-established technology. It provides full control of the cooling process and is not depending on a third party. However it is a non-viable solution for ESS based upon the goals and demands mentioned above.

A solution with cooling towers can be managed on site with an estimated investment cost at 4.5 MEUR and will require 23 GWh in yearly supply of electricity. The maintenance cost is not included here.

### Overview:

Power consumption in chillers and cooling towers:	23 GWh
Power cost:	1.2 M€/Yr
Investments:	4.5 M€
Cooling demand:	72.3 GWh in chillers
<b>Total net investment:</b>	<b>4.5 M€</b>

## 5.3 Recycling high and medium temperatures into the district heating system and rejecting the low temperature with dry chillers

### Summary

The solution is an upgraded version of the reference case where cooling towers are avoided but still the low temperature will be chilled off by usage of dry chillers. The high and medium temperatures will be converted through heat exchangers and usage of heat pumps, uploaded into the district heating net.

### Overview

Heat value:	170 SEK/MWh (18.9 €/MWh)
Power consumption in heat pumps:	11 GWh
Total waste heat production:	136 GWh
Heat value:	2.6 ME/yr
Power cost:	0.5 ME/yr
Chiller COP:	5
Power consumption, chiller:	16 GWh
Power cost, chiller:	0.8 ME/yr
Avoided power cost in chillers:	1.2 ME/yr
Net operational profit:	$2.6 - 1.3 + 1.2 = 2.5$ ME/yr
Cooling demand:	5.3 GWh through heat pump

### Revenue

Investments:	
Heat pump cost:	2.7 ME
Chiller cost:	2.9 ME
DH connection:	4 M€
Total net investment:	$2.7 + 2.9 + 4 - 4.5 = 5.1$ ME
Yearly capital cost:	$10\% * 5.1 \text{ M€} = 0.51 \text{ M€}$ (20 years depreciation time and 5 % interest rate)
Net profit: $2.5 - 0.51 =$	1.99 M€

## Risk and mitigation

By usage of dry chillers ESS will fulfill its goal for Responsible plus avoiding cooling towers. Still the solution will demand additional 16 GWh for the heat pumps. The net revenue is depending on negotiation with LEKAB. One challenge will be to handle the anticipated surplus of heat in the district heating system. LEKAB's current plans include both a connection pipe to Landskrona/Helsingborg DH, a geothermal storage system and heat driven production of district cooling in Lund.

## Conclusions

In a comparison this solution will be with medium risk and low net revenue. The recycling effort is questionable.

## 5.4 Recycling into energy suitable for the district heating system - CDR

### Summary

Today, there exists a fully operable solution where the entire load of 189 GWh is turned into energy that can be sold to Lunds Energi and utilized in its district heating system. This demands investments in heat pumps that supply cooling at the low temperatures required by the equipment and eject the heat at the high temperature required for district heating. To connect to the district heating grid is estimated a cost at to 5 million euro and the heat pumps 7.5 million euro. The total yearly demand for electricity to power the heat pumps is estimated at 44 GWh.

### Overview

Heat value:	170 SEK/MWh (18.9 €/MWh)
Power consumption in heat pumps:	44.0 GWh
Total waste heat production:	232.3 GWh
Heat value: $232.3 * 18.9 / 1000 =$	4.4 M€
Power cost: $44 * 50 / 1000 =$	2.2 M€
Cooling machine COP:	5
Power consumption, cooling machine:	23 GWh (Used to cool 20/40 C cooling circuits)
Avoided power cost in cooling machines: $23 * 50 =$	1.2 M€
Net operational profit: $4.4 - 2.2 + 1.2 =$	3.4 M€

### Revenue

The estimated price for surplus heat of 18.9 €/MWh. This is the average price of similar transactions in Sweden (170 SEK/MWh). For the high-grade heat, this also represents net revenue, as this heat can be exchanged directly with the district heating system.

Investments:	
Cooling demand:	15.0 MW (total in 20 + 40 C circuits)
Heat pump cost:	0.5 M€/MWc => Investment $0.5 * 15 = 7.5$ M€
Cooling machine cost:	0.3 M€/MWc => Investment $0.3 * 15 = 5$ M€
DH connection:	5 M€
Total net investment:	$7.5 - 5 + 5 = 7.5$ M€
Yearly capital cost: $10 \% * 7.5$ M€ =	0.75 M€ (20 years depreciation time and 5 % interest rate)
Net profit: $3.4 - 0.75 =$	2.65 M€

## Risk and mitigation

The tax status of ESS is critical issue with this solution since half the surplus heat needs to be converted to high-grade heat by using heat pumps. Tax liability for power consumption will make it questionable that a net profit can be achieved, for the lower heat grades.

ESS needs to regard the expansion plan that is underway to expand the district heating system by connecting Lund with Landskrona and Helsingborg. This will increase the potential summertime heat delivery from ESS to the district heating system. At the same time new combined heat and power plants will be ready. The result could for certain periods of time be a surplus of heat in the system. Any deals needs to take this into calculation on both the supply side and demand.

### Conclusions

This solution does have a high technological reliability and is "ready to go". One challenge will be to handle the the potential surplus of heat in the district heating system. The solution is to connect with nearby networks such as Landskrona and Helsingborg, a "flooded" market of surplus energy will greatly affect the pricing for surplus energy downwards. The price negotiations have not started.

The major obstacle is the dependence on power supply and cost of power and the ensuing business risk.

The environmental effect is a decrease in carbon dioxide emissions since ESS production will replace other heat production that generates higher carbon dioxide emissions.

## 5.5 Recycling into commercial food production

### Summary

Today more and more food producers are switching to the usage of renewable energy. This industry previously was exempted from energy tax but is now taxed from its energy usage. There is extensive research in this sector on how to improve system design, controlling mechanisms and energy supply as well as supporting growing technologies such as nano enhancements, LED lightning etc.

A typical green house is a high-energy user with a demand of 600 kWh/m<sup>2</sup> yearly. Today there exists technology that could utilize the hot surplus energy from ESS and the low grade to some extent.

Early discussion with producer organizations indicates that a possibility to operate on the surplus energy from ESS would be attractive and also would contribute to the national effort to strengthen Swedish food production.

### Overview

Heat value:	25 €/MWh
Power consumption in heat pumps:	44.0 GWh
Total waste heat production:	232.3 GWh
Waste heat to greenhouse:	144 GWh
Heat to DH network:	88 GWh
Heat value: $(144*25 + 88*18.9) / 1000 =$	3.6 M€
Power cost: $44*50 / 1000 =$	2.2 M€
Cooling machine COP:	5
Power consumption, chillers:	23 GWh (Used to cool 20/40 C cooling circuits)
Avoided power cost in chillers: $23*50 =$	1.2 M€
Net operational profit: $5.3 - 2.2 + 1.2 =$	4.3 M€

### Revenue

This section will be clarified from the pre-study performed by SLU. At this stage SLU have approached ESS with a calculation stating that if food industry would be given access to the surplus energy with a price of 25 €/MWh at a 5% interest rate, it would correspond to a total investment sum of 35 – 70 M€ and could allow between 20-40 ha of high efficient greenhouses to be built. This shows a clear value of the surplus energy.

Cooling demand:	15.0 MW (total in 20 + 40 C circuits)
Heat pump cost: 0.5 M€/Mw => Investment 0.5*15 =	7.5 M€
Cooling machine cost:	
0.3 M€/Mw => Investment 0.3*15 =	5 M€
DH connection:	5 M€
Greenhouse connection:	0.7 M€
Total net investment: 7.5-5+5+0.7 =	8.2 M€
Yearly capital cost: 10 % * 7.5 M€ =	0.75 M€ (20 years depreciation time and 5 % interest rate)
Net profit: 4.3- 0.75 =	3.55 M€

## Risk and mitigation

With regards to early work done this solution needs to be investigated further to even be possible to evaluate. A strong collaboration with the food industry and agricultural department will be required. There will also be an issue on how to handle the surplus heat during the warmer part of the year when heat is not required in the same proportion. One possible solution is to exchange the surplus into seasonal layers either in aquifers or bore holes (energy layer) but most likely usage of the DH system will be the best buffer system.

## Conclusions

This solution is viable from a technological standpoint. It will require a strong business model as well as good collaboration. One benefit is that ESS can quantify the value of the surplus energy in a quite straightforward way and with correct set up it will be reliable and very profitable. The area will benefit from job creation as well as replacing the loss of valuable farmland to some extent.

## 5.6 Recycling into food, fodder and fuel – Hybrid Cooling chain and CDR

This solution consists of two major blocks described below. The entire load of surplus energy is split up in several smaller cooling chains and the temperature is sequentially lowered at different applications in the area around ESS.

### 5.6.1 The hybrid cooling chain

#### Summary

This option is a combination of CDR and advanced food, fodder and fuel production (Hybrid cooling chain) where the high-grade temperature part of the surplus energy is directly converted into district heating equivalent energy and the more luke-warm water is used in the cooling hybrid chain as well as water treatment facility.

This allows ESS to eliminate between up to 44 GWh of electricity and still benefit from sales of surplus energy earlier stated in the energy report.

One possibility is to use surplus heat in the production of food, fodder and fuel therefore ESS have approached SLU, LTJ - Faculty of Alnarp to explore the possibility whether SLU can be of help to find solutions around the cooling and recycling of surplus energy generated by ESS's facility in Lund, see more in "20120215\_Application to partnership Alnarp".

SLU – The Swedish University of Agricultural Sciences is one of Europe's most reputed universities with a high capacity for interdisciplinary research in the fields, landscaping and architecture, agriculture and horticulture. SLU, through high quality research, education and environmental monitoring and assessment to contribute to quality of life and increased growth, both in Sweden and internationally.

The project is in the form of a feasibility study and will provide data on how a partnership can develop between SLU LTJ Faculty and ESS AB related to research and development of tools, methods and solutions for the utilization of surplus energy where main focus is on the low-grade heat. This alternative could both use the entire surplus as well as only the low-grade surplus heat.

The system is shown below in a "cooling chain" where a hybrid system uses the surplus energy at sequential stations extracting energy and lowering the temperature gradually.

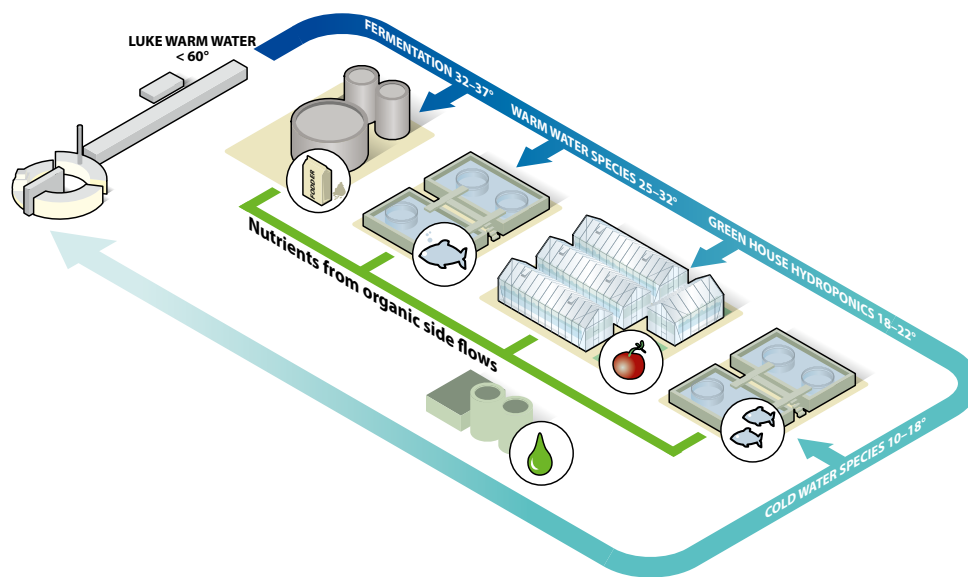

Fig 2 The hybrid cooling chain

In effect this production chain is not only superiorly efficient to stand alone production facilities, but it also consists of a closed system with minimal environmental effects but it also makes it possible to recycle other waste products in the process that the different applications consider as nutrients or amplifiers.

Such a cooling chain would demand extensive land areas around 25 -30 ha and will also require a third party with both financial capabilities as well as know how.

We are now mapping possible counterparts and as a result from this a collaboration with Södra CELL <http://sodra.com/en/> are now forming together with SLU, see more in "växhusprojekt.docx".

In brief Södra CELL have suggested to invest and test a small scale version of the cooling chain above on their grounds outside Mörrum, possibly Mönsterås. The facility will be operated by Elleholms tomat / GRO where the results from the work between ESS and SLU will be tested. Södra CELL will supply with surplus energy and charge for energy used.

Södra CELL expect to have a 400 m<sup>2</sup> test facility up and running by mid 2013. Examples of possible application areas in a hybrid cooling chain are;

- The next generation of greenhouse technology.
- Growing in the open air by means of tunnel greenhouses, protection of culture, land cover and cultural coverage.
- Attractive housing and habitat
- Integrated, high-intensity land-based fish farms
- Next-generation mushroom farms
- Algae cultivation as a resource for bio fuels
- Microbial fermentation for the production of bio-protein
- Nano technology in agricultural systems

There are potentially more applications where low-grade heat can be used and the project will identify, describe and map them.

One major effect is that F3 implemented will create new jobs in the area. Early calculations are between 200-300 new jobs within the food industry and related areas.

## Overview

Heat value:	170 SEK/MWh (18.9 €/MWh)	In comparison to 5.5 we have used a lower energy price based upon the assumption that the food producers will have higher investment costs in their production facilities due to new technology.
Total waste heat production: $96+61 =$	157 GWh	
Heat value: $157*18.9=$	3.0 ME	
Chiller COP:	5	
Power consumption, chillers:	7.9 GWh	
Power cost, chillers: $7.9*50/1000 =$	0.4 ME	
Avoided power consumption, chillers:	23 GWh	
Avoided power cost in chillers: $23*50 =$	1.2 ME	
Net operational profit: $3.0-0.4+1.2=$	3.8 ME	

## Revenue

We are in the process of producing data that will show each applications own energy demand and possible normal energy supply price. Data will be provided from the collaboration with SLU.

One advantage is that there will be several different applications that normally are stand-alone solutions with their own energy supply and by combining them in one circular energy flow efficiency improvements can be achieved and with that a better margin on the price.

There will also be a possibility for ESS to take part in revenue from the produced commodities – a split net income option.

## Investments:

Cooling machine cost:	
$0.3 \text{ M€}/\text{MWhc}$ for 6 MW=> Investment $0.3*6 =$	1.8 M€
Avoided chiller cost:	5 ME
DH connection:	4 M€
Food production connection:	0.7 ME
Total net investment: $1.8-5+4+0.7 =$	1.5 ME
Yearly capital cost: $10 \% * 1.5 \text{ M€} =$	0.15 M€ (20 years depreciation time and 5 % interest rate)
Net profit: $3.8-0.15 =$	3.65 M€

## Risk and mitigation

To implement the hybrid cooling chain fully and CDR it will require a substantial industrial collaboration of several parties and a clear case good enough to be financed by a third party.

The hybrid cooling chain is an innovation and needs to be treated as such. The technology and know how are available but could benefit from further research.

With regards to the fluctuating cooling demand the supply of heat will be likewise. Therefore in order to sustain a stable flow of heating energy, collaboration with the local utility LEKAB is almost certain.

## Conclusions

The innovation "hybrid cooling chain" is a result from early collaboration between ESS – SLU. The benefit is that the various cooling temperatures can be directly utilized in the different applications and this without a major increase in the power supply. If index for surplus energy is used – figures of approximately 200 SEK/MWh and offered as energy price to food producing units it would be a very competitive market price for the energy and would generate revenue without the cost of electricity.

ESS will also substitute the loss of valuable farmland by actually increasing the output by highly efficient food producing units. Job creation is important for the region and an addition outside the science sector would be a benefit.

The hybrid chain will in turn demand a mature industrial partner or several experienced players that can both handle financing issues and food production industry.

The technology required exists but needs to be tested and possibly developed before deploying.

## 5.6.2 Biofuel and heat for water treatment

### Summary

While the developing area named Brunnsbög located west of ESS requires a new water treatment facility, Lund Municipality have approached ESS with a first draft suggesting to utilize ESS low gradient (below +50) surplus energy partly in the purification process but also to produce biogas from the waste deriving from Brunnsbög population. Brunnsbög is planned to finally be populated by around 50,000 individuals.

The biogas production facility is based upon a fully developed Brunnsbög area.

Since the sewage system at Brunnsbög will be completely new it can be tailor made for the districts need and access to surplus energy from ESS. This will allow an anaerobic (absence of oxygen) treatment of the effluent available by raising the temperature above +30°C.

Filtration of nitrogen and phosphorous can be done by algae farming binding the substances into the algae. The algae in turn can be harvested and digested into biogas and bio fertilizers.

The total production of biogas suitable to be used for transportation is 23 GWh annually, in addition to producing bio fertilizer and purifying waste water. A note should be made that the usage of the anaerobic method greatly lowers the energy demand for the treatment process, compared to a conventional water treatment facility.

### Revenue

Since this option is in its cradle we have no estimates that is viable. One benefit is that there will be at least three different revenue streams:

- a. Production of biofuel – biogas. This is raw production of bio gas substrate that needs to be upgrade into bio gas suited for vehicles.
- b. Production of bio fertilizers
- c. Revenue from delivering energy for water treatment

### Risk and mitigation

There is simply to little input to describe risks. However this option will require a stable development of the Brunnsbög area or mitigation of failed development by Lund municipality

### Conclusions

Since this is in its cradle we suggest investigating further and inviting Lund Municipality to continue their development of this solution.

## 6. List Of Abbreviations

Abbreviation	Explanation of abbreviation
CDR	Conceptual Design Report
ha	Hectare (100 * 100 meters)
SLU	Swedish University of Agricultural sciences
BH	Brunnsbög
LEKAB	Lunds Energikoncernen AB
DH	District heating

# Chapter 6

## Power System



# Power System

This document is inter alia developed to aggregate and describe the knowledge regarding the power demands of ESS. The content of this report is therefore intended to be an appropriate framework for the more detailed project planning of ESS internal power system, and also for the connection to the regional power transmission system.

In order to decrease the number of unique designs and equipment, following statements have been guiding:

- The electric power system must not jeopardize the safety for staff and visitors.
- The design of the power system shall facilitate operation and maintenance.
- Consequences of faults in the power system must be limited to a minimum.
- Main principle is to take care of disturbances at the source.
- Dimensioning of the power grid is according to a Life Cycle Cost (LCC) analysis, considering parameters such as losses, maintenance, longevity and risk.

During March 2011 a cooperation agreement was signed between ESS, Lunds Energy and E.ON. One of the tasks in the agreement was to collaboratively develop the conceptual design of the ESS internal electrical power system.

First step was to identify the behaviour of different loads and their power needs. Also, determine how they will affect each other as well as the regional power transmission system, to which ESS will be connected. One principle of the ESS internal electrical power system design is to use well known standard components and appliances that will not jeopardize the operation of ESS or the safety of personnel and equipment. The justification for this is to avoid using less common designs and devices that potentially could endanger the commissioning of ESS and its continued operation.

# Power System

**Authors:** Frithiof Jensen, ESS, Jonas Stenlund, E.ON, Jörgen Persson, ESS, Mats Didriksson, Lunds Energi, Michael Nilsson, Lunds Energi, Niklas Stråth, E.ON, Pierre Andersson Ek, E.ON, Richard Bengtsson, E.ON, Roger Österback, E.ON

**Reviewers:** Frithiof Jensen, ESS, John Jurns, ESS

**Approver:** Thomas Parker, ESS

# 1. General Requirements On The Power System

The purpose of the electric power system at ESS is to supply the different consumers at the site with necessary power to operate the different parts of the facility. The load centres of ESS have requirements on the quality of supply that differs depending on the connected consumers. However, some base requirements are common for the whole plant:

- The electric power system must not jeopardize the safety of staff and visitors.
- The design of the power system shall facilitate operation and maintenance.
- Consequences of faults in the power system must be limited to a minimum.
- Main principle is to take care of disturbances at the source.
- Dimensioning of the power grid is according to a Life Cycle Cost (LCC) analysis, considering parameters such as losses, maintenance, longevity and risk.

These requirements can be fulfilled by following applicable Swedish regulation, Swedish and international standards and good engineering practice.

## 2. Power Demand

ESS will be a considerable load in southern Sweden. However, it is not an issue to handle the load in the sub-transmission grid. But it is of great importance for the design of the internal distribution system that each and every power consumer is identified at an early stage. Missing information today can affect the entire system tomorrow. All specified power demands in the report are installation values, implying that load aggregation is not regarded at the internal system level.

In the Conceptual Design Report a set of design parameters for the electrical power demand were stated. The power demand has since then been revised. Table 1 below shows an updated summary of load levels for the different consumers at ESS. The figures in the table will be used in the future design and construction of the internal distribution system.

<i>Demand</i>	<i>Main Power (kW)</i>	<i>Aux. Power (kW)</i>	<i>Prio. Power (kW)</i>	<i>Note:</i>
LINAC	23000	4200		- Assumes that 15% of total power is LLRF and controls.
RF-Test Hall	1000	TBD		- Power is independent of LINAC supply.
Target Station	4000	300	Yes, TBD	Control-, containment systems need UPS.
Instrument Halls	4 x 400 ("clean power")	4 x 1500	TBD	Need option of 10 MW available at all 4 halls.
Cryo-plant LINAC	4300	220	800*	Helium recovery and control system.
Cryo-plant Target	2200	200	200*	Control system only.
Cryo-plant Test Hall	400	20	TBD	
Heat Recovery	10000	700		- Cooling is not needed if accelerator stops
Facilities	2000	TBD	Yes, TBD	Emergency lighting and security systems require 12 hours of UPS.

Table 1. Estimate of the installed electrical power demand within ESS

Notes for the table:

- All the demands power need are specified on installation size, implying that load aggregation is not regarded.
- \*) The different Cryo-plants will use a common helium recovery and storage system
- TBD – “To Be Decided / Designed”

## 3. Power Quality

ESS will be exposed to power quality disturbances from the external power system. ESS will generate disturbances to the external grid as well. The distribution system operator (DSO) takes measures to minimize the disturbances at the grid in order to keep the power quality at an acceptable level. As part of this work the DSO limits how much noise ESS may generate at the connection point.

There are also good reasons to reduce disturbances at the ESS distribution grid. A low level of power quality at the grid will influence the performance of the whole facility. Unwanted fluctuations in the voltage are one of the main reasons for power supply trips, which can lead to unscheduled beam interruptions. Hence there will be very strict rules on how much each consumer may pollute. The principle is to take care of disturbances at their source. That is the only way to guarantee high power quality to all consumers.

The load profile of ESS shall not contribute to create a sub synchronous resonance circuit in the region. The E.ON Energy Research Center (EERC) at the University in Aachen has specialist expertise in the modelling of complex power systems. Under the supervision of a number of high-profile academics, a simulation model in which the adjacent 130 kV grid and ESS are integrated is being developed and verified. Several scenarios are being investigated to buffer the power flow to ESS. The simulation infrastructure used makes it possible to evaluate different disturbances in real time and study how any impact on the grid and ESS can be avoided. The simulation work performed so far, shows that controlling the 14 Hz power excursions caused by the linear accelerator are critical to the successful operation of ESS.

Another topic is that all equipment shall be adequately designed to ride through voltage dips arising from the external grid. There is no way to mitigate these disturbances at the source since they originate from lightning strikes at overhead lines etc.

The ESS facility's Klystron Modulators may give rise to interference that can be expected to emerge at the 14 Hz frequency. The short power pulses, 3 – 5 milliseconds, from the modulators, can propagate throughout the power grid, where they can generate mechanical oscillations in the shafts of turbine generators in power plants connected to the 130 kV grid, potentially causing the machines to break. The 14 Hz power variations can also be a source of variations in voltage causing annoying flicker in electrical lights. The eye is especially sensitive around the operating frequency of ESS. Therefore, the IEC standards permit only 0.3 per cent voltage variation at the 14 Hz frequency. This limits the permissible power variation from the Klystron Modulators to approximately 4% of nominal power, which is challenging to achieve.

Higher resilience, or immunity level, to various forms of electromagnetic interference results in a sharp reduction in the number of operational disturbances. The transformers in the electrical system are designed to decouple odd harmonics and single-phase short-circuit currents between the power grid and ESS. Nevertheless, all harmonics will cause additional energy losses, typically in cables and transformers.

The most effective solution to minimise electromagnetic interference is to handle the problem at the source. Following current harmonised EU directives for all equipment will go a long way in increasing the overall robustness of the plant. Some systems will require specialised solutions. To reduce the power variations caused by the accelerator to a safe value, novel control algorithms are being developed by the Aachen University. These will be implemented during the design of the klystron modulators.

In the case that it is not possible to meet power quality requirements, filters and static compensators will be deployed at the receiving station.

# 4. Availability Of Power Supply

Some consumers will be very sensitive to outages in the power supply. System wide outages have historically happened once every twenty years in the adjacent sub-transmission system. It is not reasonable to install uninterruptable power supply to the entire facility. It would not be cost effective and the likelihood of success when needed is questionable.

Instead effort has been made to identify the most sensitive loads, where safety for humans and great economic values has been prioritized. The cryo-plant may be equipped with an emergency backup generator to place the plant in a fail-safe mode in case of a longer interruption. The instrument stations will have parts of their loads supplied on a battery secured grid in order to safely shut down equipment. Prolonged interruptions, lasting for several hours, are fairly uncommon in the region. Statistics indicates occurrence of extended black-outs in the meshed transmission and sub transmission power system every 15-20 years.

# 5. Primary Distribution Substation

The sub-transmission grid in the area, to which ESS will be connected, has the nominal voltage of 130 kV. To connect the research facility a new substation will be erected in the immediate vicinity of ESS. The voltage will be transformed to a more suitable medium voltage level and distributed to secondary distribution substations closer to the load centres at ESS. The required area for the primary distribution substation is approximately 100 m by 200 m. A single-line diagram that illustrates the proposed layout of the primary substation is shown in figure 1 below.

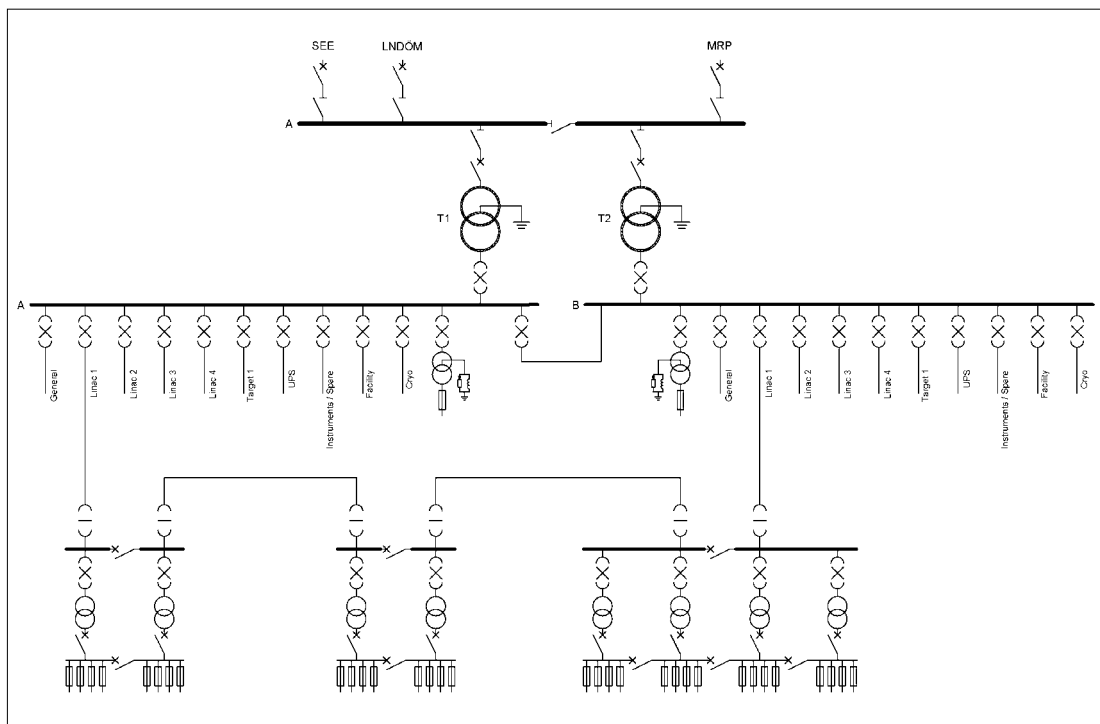

Figure 1. The primary distribution substation illustrated as a single-line diagram. One of the feeder loops is included in the illustration. A more detailed single-line diagram of ESS internal power grid is seen in Appendix I.

## 5.1 High-voltage grid

At the connection point to the 130 kV grid, a switchyard connects the feeding power lines and the transformers. The switchyard makes it possible to operate ESS even with one of the two power lines disconnected for e.g. maintenance. The switchyard can also be designed to facilitate instant redundancy in case of a fault in one of the power transformers or busbars.

Foremost there are three different types of 130 kV switchgears. Below they are listed in the order of investment cost.

- Gas insulated switchgear (GIS)

All components, e.g. switching devices and busbar, are contained in sealed gas caskets with SF<sub>6</sub> gas as dielectric medium. The properties of SF<sub>6</sub> allows the switchgear to be compact, making the switchgear building fairly small. However, SF<sub>6</sub> is one of the most potent green house gases.

- Air insulated switchgear (AIS), installed indoors

This type of switchgear build consists of the same equipment as is used for outdoor installations. Due to the fact that air is the insulant, the building for AIS installed indoors requires more space than the GIS.

- Air insulated switchgear (AIS), installed outdoors

In power distribution grids the outdoor AIS is predominantly the most common. The switchgear does typically not have any infrastructure to cover e.g. the switching devices and the busbar. Because of this there is given more flexibility for reconstruction and maintenance of the switchgear but has a much more visible impact.

## 5.2 Substation buildings

The switchyard area design is in-door, with air or gas insulated 130 kV switchgear along with power transformers and medium voltage switchgear. The design of the substation is either to be fitted in one large building or divided in at least three separate smaller buildings.

## 5.3 Power transformers

Two power transformers, placed close to the high voltage switchgear, will be conventionally designed for power system purposes. The power transformers will become an important component for a robust and safe power supply for ESS. The power transformers need proper air ventilation, which should be considered in the design of the substation buildings. The transformer units will be oil-insulated and placed on concrete foundations, built to contain the entire volume of oil from the transformer tank.

The design of the power transformers has to reflect on the need of low losses because of the high duty cycle. Due to the irregularity of certain loads, low transformer impedance of around 11-12 %, is important to make unwanted voltage deviations throughout ESS less significant.

The vector group of the primary substation power transformers shall be YN/d5. This requirements is foremost to minimise the zero sequence coupling between the two systems on the respective sides of the transformer, but also given that the majority of all power systems in southern Sweden are built with 130/20 kV power transformers with this vector group.

For adequate steady state voltage control On-Load Tap Changers (OLTC) are sufficient. The tap changer steps needs to be investigated for each specific installation. However, there are type values accessible for typical distribution power transformers.

Each of the two power transformers will be designed to bear the whole load of ESS and other, nearby situated loads, such as the district heating circulation pumps. This is necessary for maintenance reasons and to reduce the risk of downtime due to transformer failure. Due to the estimated total power need of ESS, the suggested power rating for each individual power transformer unit is 63 MVA.



Figure 2. Picture of a conventional and typical 130/20 kV 40 MVA power transformer unit. A 63 MVA unit is physically slightly larger. [Ulf Lager E.ON Elnät Sverige AB]

## 5.4 Medium voltage connection

In Sweden, 10 kV and 20 kV are the two predominant voltages in distribution systems. Both levels could be considered at ESS but only one is needed. To make progress possible in design works and system studies a decision to choose 20 kV has been taken. The availability of spare parts for the two voltages is considered to be equal. The installation costs are slightly higher for 20 kV but the losses are generally lower than for 10 kV. 20 kV also provides higher short circuit power, which improves power quality, and the higher voltage gives lower operating currents with lower magnetic fields.

### 5.4.1 Medium voltage switchgear

The ESS medium voltage power grid is to be built and perform as regular distribution power grids. This will open up for usage of standard and conventional medium voltage switchgear devices and equipment, which will assist in a more manageable grid structure for easy operation and monitoring. The switchgear shall be divided into two or more fire containment cells. This is foremost to minimise the risk of fire spreading throughout the whole switchgear.

Reliability, serviceability and environmentally friendly will be prioritized when selecting switchgear design and its type.

### 5.4.2 System earthing and earth fault protection

Medium voltage systems in Sweden are, with a few exceptions, operated as isolated or arc suppression coil compensated networks. It is a good idea to embrace this standard at ESS due to experience and maintenance reasons. Due to the vector group of the primary substation power transformers there is a necessity to create a neutral point in the medium voltage power grid. This is achieved with earthing transformers at each section of the medium voltage busbar, e.g. a transformer with zig-zag winding which also is used for internal substation power supply. To each neutral point an arc suppression coil, connected in parallel with a neutral earthing resistor, is installed. This will create an isolated resonance earthed distribution grid, which reduces the earth fault currents to safe levels. By choosing a proper earthing resistance, fault clearance during earth faults in the system can be achieved without risk of interference to adjacent feeders.

# 6. Secondary Distribution Substations And Medium Voltage Grid

A number of substations will be located inside or close to the ESS facility. The substations will be similarly standardized for easy and safe operation and less spare parts. The internal medium voltage grid will be constructed with feeders interlinked in loops for redundant and flexible supply. Although interlinked with a loop structure, the medium voltage grid will not be operated in a meshed manner.

## 6.1 In general

The variety of delivered components shall be reduced to minimize the number of different manufacturers. The construction and erection must comply with Swedish and European rules and regulations, which shall also apply for single components:

- Swedish law, Ellagen (1997:857)
- Swedish regulation, Starkströmsföreskrifterna (ELSÄK-FS 2008:1 and 2008:2)
- Swedish and European standards, (SEK, CENELEC, IEC)
- Electrical Safety Standards (ESA)

The need for a classification plan, complete documentation and performing a full risk analysis according to the Machine Directive, the Pressure Equipment Directive and SS-ISO 11161 regarding industrial automation systems, is of great importance.

Delivered equipment has to comply with stated degree of protection as minimum.

- Indoors – IP20
- Outdoors – IP65

Outdoor installations of electrical equipment shall be, at minimum, in accordance with:

- SS 421 01 01, power installation exceeding 1 kV AC

Indoor installations of electrical equipment shall be, at minimum, in accordance with:

- SS 436 21 01, Electrical operating areas for low voltage switchgear
- SS 436 40 00, Electrical installations of buildings
- SS 421 01 01, Power installations exceeding 1 kV AC

Testing of relay protections shall be accessible through test sockets for injecting voltage and current with external source.

For electrical safety there shall be visible disconnection points in the feeding area, at all voltage levels. With various suppliers, there should be clear references in the documentation.

For maintenance of electrical devices, all equipment has to be accessible from a safety perspective.

## 6.2 Medium –voltage cable system

Cables in the medium voltage power grid will be designed to be able to handle planned load currents, but also include flexibility for further increased load levels. The default cable dimension in the medium voltage power grid shall be PEX insulated 240 mm<sup>2</sup> with 24 kV as rated voltage, in accordance to the rule of thumb Economical Dimensioning, which includes e.g. costs for load-losses. Deviating cable dimensions need to be justified specifically. The conductors of the power cables needs to be aligned triangularly and twisted. All cables shall be designed to fulfil continuous operation at maximum conductor temperatures of 65°C. Cables shall be limited combustible and shall not contribute significantly to the fire hazards in the process. For both indoors and outdoors cable routing, positioning and rating following standards shall apply



- SS 424 14 24, Power cables – Choice of cables with rated voltage max 0,6/1 kV with regard to current carrying capacity, protection against overload and protection at short circuit
- SS 424 14 37, Underground installation of Cables
- SS 424 14 38, Cable management in buildings

Cables with 6 or more conductors shall contain at least 25% spare cores, although the requirement is limited to 16 spares. Spare conductors shall be connected to connection blocks.

The cable screens shall normally be earthed in one end, i.e. open earth circuit.

Cables joined to a certain loop shall be laid in different cable trenches and thereby be separated.

### 6.2.1 Cable requirements

Cables shall be divided into various classes, based on voltage levels, thermal loading and immunity to interference, with separate cable trays/racks/routings for each class, in accordance with EBR KJ41, Cable routing up to 145 kV.

Cables shall be divided into at least the following classes:

- Cable class 1 – Medium voltage power cables

Cables shall be placed in one layer with a separation of one cable diameter or at least 30 mm.

Excavation depth shall be at least 500 mm.

- Cable class 2 – Low voltage power cables

Cables shall be laid in one layer with a separation of one cable diameter or at least 30 mm. Excavation depth shall be at least 500 mm.

- Cable class 3 – Control and communication cables

Cables shall be laid in one layer. The minimum spacing between different cable classes shall be 300 mm.

Cables, cable racks and cable trays shall always be located in numerical sequence vertically with cable class 1 at the top. Main cable routes including cable penetrations shall contain at least 25 % spare capacity. All cable trays and cable racks and accessories shall be hot-dip galvanized and be of conventional heavy-duty type. The cable trays shall be connected to the earth system at each end and at every 20 metres.

Connection blocks and terminals shall be supplied with disconnecting function and a possibility to connect measuring devices. Deviations have to be justified.

All cables shall be marked with the cable number in both ends. Cables and conductors shall be marked in accordance with SS-EN 60445, Terminal marking and identification of conductors. Cable trays and cable racks shall be marked with their cable class number. Suggested marking system is KKS (Kraftwerk-Kennzeichen-System).

All cables shall be fire resistant. All cables shall be difficult to ignite. They also shall be flameproof, self-extinguishing, smokeless and free from halogens. Cables shall comply with the following requirements, regarding fire ratings, in accordance with proposed Euro classes. According to prEN 50399 class B2ca, following criteria is proposed:

- Test method: FIPEC20 Scen 2
- Fire spread < 1.5 m
- Thermal Heat release<sub>120s</sub> < 15 MJ
- Peak Heat release rate < 30 kW
- Fire Growth rate < 150W/s

Additionally, cables shall be approved in accordance with EN 20265-2-1 where H < 425 mm. Cables shall be tested and approved for the Swedish fire spreading class F3, in accordance with SS 424 14 75, Measurement of smoke density of electric cables burning under defined conditions.

Cables for detection system, lead lighting, emergency lighting and emergency signs shall not be installed with a fire rating below EI30. Indoor cable routes with risk of radioactive exposure needs to be considered. Cable sheath, insulation and conductors could potentially be affected, shorting the cable longevity or even deteriorate the materials.

### 6.3 Substations

Every substation accommodates two power transformers and will be connected to at least two feeders for added flexibility. The standard substation design will accommodate at least power transformers along with medium and low voltage switchgear in separated operating areas. Space for e.g. UPS or back-up power is additional when justified. The standard substation building measures 4 x 9 m. In figure 3 below a drawing of a typical substation is seen.

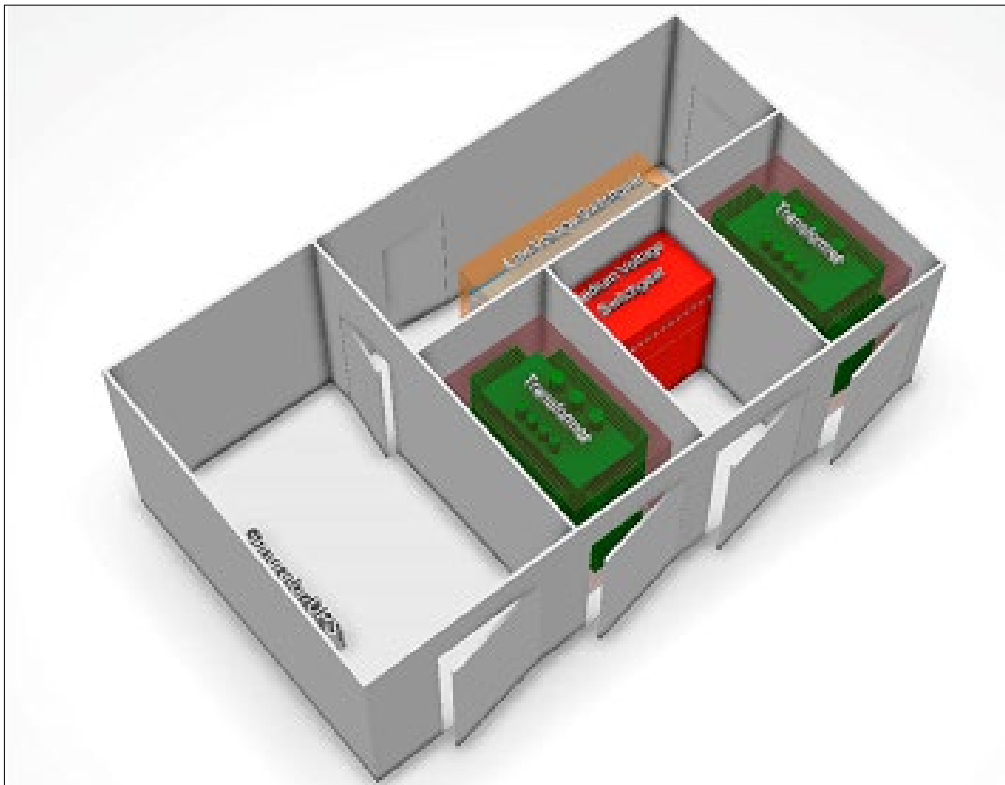
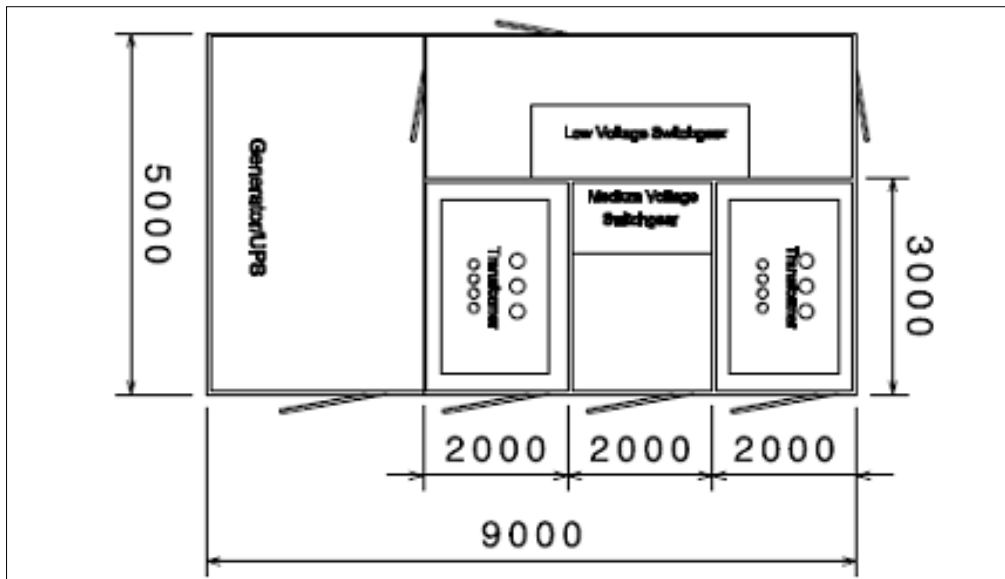

Figure 3. Standard substation layout.

Alternatively, the low-voltage switchgear and UPS systems may be placed inside dedicated electrical rooms inside the buildings. The advantage is that the substations will be smaller and that operating staff has better access to the equipment. For safety reasons, electrical rooms must have two exit doors. One door for access from inside of the building as well as one door for access from outside, both with access control. This gives some restrictions on the location and layout of the switch rooms.

### 6.3.1 Medium voltage switchgear

The medium voltage switchgear in the standard substation design normally includes four switching devices, generally circuit breakers, in cubical cabinets. The switchgear needs to be designed with some free space for future additional switches. The switchgear has to apply to SS EN 60298, A.C. metal-enclosed switchgear and controlgear for rated voltages above 1 kV and up to and including 52 kV, and include an arc guard system. The design of the switchgear has to provide for easy access regarding operational actions and maintenance, where safety for both personal and material injuries is prioritized. This implies that the switchgear has to be arc certified according to valid standards, giving minimized risk for harmful pressure, heat or gas in events of e.g. short circuits. Medium voltage switchgears with SF6 as insulation must be individually justified.

### 6.3.2 Low voltage switchgear

The low voltage switchgear will be accommodated in a separate cell in the substation and will include appropriate number of switches for the given purpose. The low voltage switchgear has to apply to IEC 61439, Low voltage switchgear and controlgear assemblies, and include an arc guard system. The switchgear shall be designed with withdrawable or removable parts where contact with unprotected live parts is prevented. The design of the switchgear must provide for easy access regarding operational actions and maintenance, where safety for both personal and material injuries is prioritized. This implies that the switchgear has to be arc certified according to valid standards, minimising risk for harmful pressure, heat or gas in events of e.g. short circuits.

### 6.3.3 Signs

Both the substation and the switchgears shall have signs that state the designated voltages along with from where the power supply is fed. Signs on incoming and outgoing cables shall be marked with at least the cable type, number of conductors and conductor size.

In the substations, following set of diagrams shall specify

- Cable type, number of conductors, conductor size and length
- Objects supplied by cable
- Type and rating of fuses, maximum permissible current
- Settings for relay protection, if any

### 6.3.4 Power transformers

The power transformers will be accommodated in a separate cell contained in the substation. Power transformers located in standard outdoors substations, shall be oil-insulated and shall comply with SS EN 60076, Power transformers. Power transformers placed inside the ESS facility shall be of dry-type and have to comply with SS EN 60726, Dry-type power transformers.

Proposed largest power rating for the transformer are 1.25 MVA for 20/0.4 kV units and 2.0 MVA for 20/0.69 kV units. The suggested power transformer sizes are for keeping the short circuit current on the low voltage side to reasonable levels, lower than 50 kA, and due to the fact that these are the largest available in the markets standard assortment.

### 6.3.5 Functional earthing

An electrical system with distribution voltage lower than 1 kV will be a direct earthed system, meaning that the over-current protection, mainly fuses, also will work as earth fault protection. To minimize stray currents and EMC-problems, a TN-S type low voltage system shall be used. A TN-S system implies that the protective earth and neutral are separated.

If the substation supplies a system over 1 kV, the system will have an isolated transformer earth with voltage controlled earth fault relay. Earth faults should be immediately disconnected.

Earthing can either be seen as a safety earth or an instrument earth. Safety earth means equalizing voltage potentials to a safe level. Requirements for such systems are described in electrical safety standards. A special case is the earthing for klystrons where significant charging has to be dealt with. An EMC-expert should be consulted for the safety earth system design that shall consider both human safety as well as effects on other equipment. Instrument earth means a low-impedance path for signal-current return, consequently the earthing system has to be optimized for the actual frequency. Likewise, an EMC-expert shall be consulted for the design of the instrument earth design.

## 7. Distribution System Demands

### 7.1 Interruption consequences (in total)

The electrical power supply will not be perfect. The design of the electrical system is to reduce the consequences of faults in the supply to the ESS while balancing the costs. Statistics, based on real-time recordings, have been collected by E.ON that provides a guide to the reliability of the electrical supply to the ESS. However, it must be expected that the overall reliability of the supply on the site will be lowered due to the on-going operations at the ESS facility.

Short drops in the power supply voltage, "voltage dips", will affect equipment differently and in specific ways, but a few general trends apply.

- Large power supplies, like those in modulators and magnets, are more sensitive to voltage dips than small electronics power supplies. This is an advantage because the number of large power supplies will be around 100, while there will be thousands of small rack power supplies powering the LLRF, instruments and control systems. Small electronic power supplies are normally designed for universal voltage 95 – 260 V, which mean that they will provide full power down to 100 V. The energy stored in the filters increases with the voltage squared. For supplies below 2 kW, the standard 240 V supply will typically give a power fault ride-through of up to 100 ms. At 110 V, the output of the same supply might only hold up for one 20 ms period.

The large power supplies will trip within a single period during a phase fault if one or more of the phases dip below 80% of the nominal voltage. This protects both the equipment itself and the up-stream transformers. When a phase voltage is low or missing, the control system will pull the required power from the remaining phases, causing imbalances that can saturate the transformers or overload the input stages.

The consequences of dips in the supply voltage is generally that the electronics racks will tolerate dips up to 50% for 100 ms, and the modulators and magnets will trip on any single- or multiple-phase dip lower than 80% of nominal voltage.

The cryo-compressors represent a special case. They are sensitive to disturbances, but due to the large rotating masses, the compressors can tolerate dips and power losses of up to 400 ms. But, once the compressors trip, the restart procedure of the cryoplant can take up to 8 hours.

The compressors and pumps for cooling and heat-recovery are assumed to share the 400 ms tolerance, but with a much lower restart time, typically 15 minutes (The thermal load on the motor windings during start-up will determine the delay, so this figure may vary considerably).

Dip level, % of Uref	Duration, s			
	0,01 < Δt ≤ 0,1	0,1 < Δt ≤ 0,5	0,5 < Δt ≤ 1	1 < Δt ≤ 3
90 > u ≥ 85	5	1	0	0
85 > u ≥ 70	5	6	0	0
70 > u ≥ 40	5	3	0	0
40 > u ≥ 10	1	1	0	0
10 > u ≥ 0	0	0	0	0
Total < 85%:	11	10	0	0

Table 2: Summary of measured voltage dips on regional grid (Sege, feeder bay 412, 318 days. All dips are added together, treating 1, 2 and 3 phase dips as equal). For more detailed results of the measurements in Sege, see Appendix II.

Estimated from the summarised dip statistics in Table 2, the ESS can expect an average of 21 beam trips per year of operation. There will be 10 trips of the cryoplant and up to 21 beam trips caused by LLRF or similar, depending on the loading and the power failure ride-through capability of the rack supplies. These are very pessimistic values, in practice a three-phase dip is worse than a single-phase, especially for the rack power supplies. The measurement category of 0.1 – 0.5 s dip does not quantify dips shorter than the 0.4 s tolerated by the cryoplant compressors. It is probably safe to assume that the cryo-compressors will trip significantly less often than indicated.

A prolonged loss of power supply happens very rarely in Skåne. The main concern is to protect the vacuum within the LINAC and instruments, preserve the helium supply and keep security- and safety systems operational. These objectives can be achieved with an emergency generator sustaining the essential services, combined with local battery backup systems.

### **7.1.1 Machine Protection System – MPS**

The Machine Protection system protects the machine by interlocking the RF power supplied to the cavities. In case of an event, the LLRF is blocked. The block can be applied to the whole accelerator or just to a single cavity, as required to protect the machine from damage. The MPS will use error counters to count interventions. The counter is reset after each successful pulse. Several interventions in a row will be latched as a “hard” error, requiring operator intervention.

The Machine Protection System may trip the beam, potentially causing a sudden large drop in power consumption. After a full MPS trip, the LINAC power will ramp down fast after completing a 14Hz cycle. The “soft” trips, triggering blocking of the LLRF feeds, will not be visible to the electrical systems because the Klystrons are Class A amplifiers and therefore consuming constant power.

### **7.1.2 Personnel Safety System – PSS**

Personnel Safety System will have an escalating series of actions, depending on the severity of the event. The minimum action blocks the beam, similar to the Machine Protection System. The next level, e.g. a door interlock, will trip the low-voltage circuit breakers feeding the relevant machine. Emergency stops or fire alarms will trip the power to the protected area. Conventional power for e.g. illumination and computers will remain in operation. The PSS can trip the power at any time, independent of the state of the machine. The PSS is allowed to cause damage to equipment in order to protect people.

The electrical system has to be designed to withstand the sudden loss of the full accelerator load, as this will be part of the normal operation of the ESS. These load dumps may have an impact on the dimensioning of the overvoltage protection systems in the receiving station.

### **7.1.3 Prioritised power**

To ensure a stable and continuous power supply for certain functions, even during fault events, the need for prioritised power is justified. The prioritised power will contain UPS systems and/or backup generators. Loads identified as not being able to withstand or even incur damage during a power loss will be connected to the prioritised power feeder loop.

## **7.2 Klystron Gallery**

In order to meet radiation safety and reliability requirements, most of the equipment and systems required to operate the LINAC is installed in the Klystron Gallery. Within the LINAC tunnel the use of electronic equipment will be minimised. Vacuum systems, beam diagnostics, sensors, actuators and valves are the kind of equipment that will be installed in the tunnel. The equipment will be controlled from racks in the Klystron Gallery. The racks will also handle the power distribution and control of the equipment inside the tunnel.

The equipment will be located near the underground penetrations, the stubs, leading into the LINAC tunnel.

Linac Overview		Linac part	Amplifiers	AC to HV power	LLRF racks	Control RF amp	Magnet power racks	BI racks	Vacuum racks	Sum racks
Warm Linac	Front end	Ion source	-	-	-	-	0.5	-	4.0	15.0
		LEBT	-	-	-	-	-	2.0		
		RFO	1.7 MW Klystron (in gal)	in gallery	0.5 (gal)	1.5 (gal)	-	-		
		MEBT	2x 20 kW SS	-	1.0	2.0	2.5	3.0		
	Stub 1	DTL 1-4	4x 2.9 MW klystrons	5x 300 kVA mod	3.5	7.5	-	2.0	4.5	17.5
Spoke section	Stub 2	Spoke CM 1-4 (cav 1-8)	8x dual tetrode 350 kW	16x HV power	8.0	12.0	2.0	7.0	2.0	31.0
	Stub 3	Spoke CM 5-9 (cav 9-18)	10x dual tetrode 350 kW	20x HV power	10.0	15.0	2.5	7.0	2.5	37.0
	Stub 4	Spoke CM 10-14 (cav 19-28)	10x dual tetrode 350 kW	20x HV power	10.0	15.0	2.5	7.0	2.5	37.0
Medium Beta	Stub 5	M beta CM 1-4 (cav 1-16)	16x 1.2 MW klystrons	4x 270 kVA modulator	8.0	24.0	2.0	6.0	2.0	42.0
	Stub 6	M beta CM 5-8 (cav 17-32)	16x 1.2 MW klystrons	4x 270 kVA modulator	8.0	24.0	2.0	6.0	2.0	42.0
	Stub 7	M beta CM 9-12 (cav 33-48)	16x 1.2 MW klystrons	4x 270 kVA modulator	8.0	24.0	2.0	6.0	2.0	42.0
	Stub 8	M beta CM 13-15 (cav 49-60)	12x 1.2 MW klystrons	5x 270 kVA modulator	6.0	18.0	2.0	4.0	2.0	32.0
High Beta	Stub 9	H beta CM 1-4 (cav 1-16)	16x 1.2 MW klystrons	8x 240 kVA modulator	8.0	24.0	1.0	3.0	2.0	38.0
	Stub 10	H beta CM 2-8 (cav 17-32)	16x 1.2 MW klystrons	8x 240 kVA modulator	8.0	24.0	1.0	3.0	2.0	38.0
	Stub 11	H beta CM 9-12 (cav 33-48)	16x 1.2 MW klystrons	8x 240 kVA modulator	8.0	24.0	1.0	3.0	2.0	38.0
	Stub 12	H beta CM 13-16 (cav 49-64)	16x 1.2 MW klystrons	8x 240 kVA modulator	8.0	24.0	1.0	3.0	2.0	38.0
	Stub 13	H beta CM 17-20 (cav 65-80)	16x 1.2 MW klystrons	8x 240 kVA modulator	8.0	24.0	1.0	3.0	2.0	38.0
	Stub 14	H beta CM 21-24 (cav 81-96)	16x 1.2 MW klystrons	8x 240 kVA modulator	8.0	24.0	1.0	3.0	2.0	38.0
	Stub 15	H beta CM 25-28 (cav 97-112)	16x 1.2 MW klystrons	8x 240 kVA modulator	8.0	24.0	1.0	2.0	2.0	37.0
	Stub 16	H beta CM 29-30 (cav 113-120)	8x 1.2 MW klystrons	4x 240 kVA modulator	4.0	12.0	1.0	2.0	1.0	20.0
Upgrade	Stub 17	HEBT	-	-	-	-	5.0	10.0	2.0	17.0
	Stub 18	A27/Dump	-	-	-	-	5.0	10.0	2.0	17.0
Sum Racks					122.5	321.5	36.0	92.0	42.5	614.5

Table 3. LINAC equipment located inside the Klystron Gallery.

In order to reach an estimate of the power requirements, some assumption must be made about the nature of the equipment and power consumption. Some of the equipment in the Klystron Gallery is only well known within the research community.

## 7.2.1 LINAC

The LINAC will be the single largest consumer of power in the ESS and it is physically the largest system, with a total length of approximately 800 meters. The LINAC integrates a diverse collection of sub systems, each with different characteristics and demands from the power system. The most important components will be summarised in separate subsections to derive the total requirements for the LINAC. The power consumption of the LINAC varies along the path between the ion source and the target. To accommodate the power variation along the beam path with standardised substations, the substations will be distributed along the stubs in a way that keep the low voltage cable lengths within reasonable limits. The number of substations necessary depends on the supply voltage required by the modulators. For design purposes, a main power voltage of 690 V has been proposed. This voltage represents a worst-case scenario in the sense that it requires the largest number of substations.

Some functions related to beam diagnostics, safety systems, interlocks, vacuum systems and some control requires backup power to enable controlled shutdown and facilitate start-up when the regular power supply is restored. It is unrealistic to provide backup power for the entire LINAC. Instead essential services will be supplied from a prioritised feed.

### 7.2.1.1 Assumption

The modulators will be assumed to use 690 V as main power. However, as the transformer size is limited by permissible short-circuit current, a higher supply voltage will result in fewer transformers.

The main characteristic of the acceleration process is independent of the way that the RF-power is created. If part of the LINAC uses Inductive Output Tubes (IOT's), the IOT's will draw power at 14 Hz in the same manner as the Klystron modulators.

The Machine Protection System will primarily work by blocking the Low-level RF feed to the amplifiers. This is not visible on the grid side of the Klystron modulators because the Klystron is a Class A amplifier. It will however be visible where IOT's are used.

The Personnel Safety System requires hard-wired status of all low voltage breakers and needs also to be included in the safety interlock chain for all low voltage circuit breakers.

Vacuum packages can tolerate power outages without damaging the vacuum pumps or polluting the evacuated space. The vacuum degrades slowly when the vacuum pumps lack power supply, so it may be justified to use a generator for backup power.

#### **7.2.1.2 Design**

The LLRF and control systems require a low voltage power supply with good quality to operate reliably. To achieve this, the cable lengths must be kept fairly short. The 20/0.40 kV distribution transformers used for control power will be distributed from four substations placed along the LINAC.

The Klystron Modulators are powered from dedicated loops to minimise the interaction between the pulsed power drawn by the modulators and the rest of the loads in the Klystron Gallery.

#### **7.2.2 Ion source**

The ion source generates a continuous stream of protons for the LINAC from ionising hydrogen gas. The ion source contains a high voltage power supply on the order of 75-100kV at 100mA for extraction of the proton beam. A low voltage high power supply is required for the plasma generator. Auxiliary power for cooling pumps and controls, is also needed. It is possible that the ion source will use Klystrons as power source for the ionisation.

The proton stream is shaped into packages by a short section of Bunchers and RF-quadrupoles located immediately after the ion source. The entire assembly require relatively low power.

##### **7.2.2.1 Assumptions**

The ion source is very similar to a modulator driving a single klystron. From Figure 4, there will be a Klystron Modulator, Klystron, LLRF rack Control RF Amplifier, Magnet power supply, vacuum systems and Beam Instrumentation.

##### **7.2.2.2 Design**

The Ion Source main power is supplied with 690 V. The rest of the equipment is serviced by 400 V control power. Prioritised power is needed for the vacuum system.

##### **7.2.2.3 Klystron Modulator**

The Klystron Modulator converts continuous AC power from the power grid into high voltage pulses required by the klystron amplifiers. The pulse rate of the modulator will be 14Hz with a pulse length of 3-5 ms. The actual pulse length depends on the design on the klystron and the RF.

The 14Hz pulse rate represents a serious problem for the electric grid due to the risk of flicker. Simulations of the regional power grid by RWTH, University of Aachen, have shown that operation without any active power compensation will cause unacceptable disturbances at the ESS site. Harmonics and phase-imbalances are other undesirable effects of the pulsed operation because the 14Hz are not locked to the mains frequency, 50 Hz.

Using an Active Front End (AFE), capable of maintaining constant power consumption to the DC-link during the pulse, can reduce flicker. This will place some constraints on the topology of the modulator. Thyristor based capacitor chargers will not be fast enough to ramp up the charging current during the pulse. If thyristors are to be used, a second level of power conversion will be needed. Alternatively, the input rectifier could be built with Insulated-Gate Bipolar Transistors (IGBT's) for rectification and power control in a single step. This still requires some consideration since the required response time of the control loop, in the order of 50µs, needs a switching frequency of 15-20 kHz. This is hard to achieve with large IGBT's.

Using open loop and feed-forward control strategies can lower the bandwidth requirements of the power compensation significantly. These techniques are practical because the modulator will have access to the central timing system. An investigation of possible open-loop control to reduce power fluctuations strategies is being performed by RWTH, University of Aachen.

#### 7.2.2.4 Tetrode

Tetrodes or Inductive Output Tubes (IOT's) are linear amplifier tubes operating at lower maximum frequencies compared to Klystrons, but with higher efficiency. Tetrodes and IOT's do not require a pulsed power supply because the control grid can be biased to block the tube when no RF output is needed. The bunchers, the normally conducting section of the LINAC and perhaps the spokes may be powered by IOT's.

Each tetrode requires a stabilised High Voltage DC anode power supply for main power, as well as cooling water and auxiliary power for the filaments. A Low Level RF (LLRF) rack will control each tetrode.

Tetrodes are sensitive to short losses of control voltage. A voltage dip will trigger a restart of the filament power supply, while the loss of grid voltage can cause the tetrode to conduct uncontrollably. Usually the control system response to supply voltage disturbances is to trip the anode supply and restart the tube. This start-up procedure will typically cause a delay of up to 10 minutes before normal operation can be resumed. If the voltage between anode and cathode becomes too small, the tube may oscillate at ultrahigh frequencies (Barkhausen-Kurtz oscillation) disrupting the surrounding equipment due to Electromagnetic Interference (EMI). This happens when the impedance of the anode supply is too high or the supply voltage is poorly regulated.

Tetrodes or IOT's will have similar flicker and distortion problems to the Klystron Modulators, even though the anode power supplies are, superficially, less complicated than the pulsed power supplies used within the modulator.

#### 7.2.2.5 Klystron

Klystrons are linear high performance Class A, RF amplifier tubes. Because of the constant power operation, klystrons are powered by pulsed power to reduce the average power dissipation to manageable levels. Each klystron will require cooling water, filament power and power for the focusing magnet. Depending on the klystron design, there may be several separate cooling loops, focusing magnets, an ion pump and local controls. The power consumption for all these elements is aggregated into an equivalent 400 V load for each klystron.

Klystrons are sensitive to short losses of control voltage. A supply voltage disturbance will trigger a restart of the klystron filament power supply, focusing magnet and ion-pump. The start-up procedure will cause a delay of up to 10 minutes before normal operation can be resumed.

#### 7.2.3 Low-level RF (LLRF)

The low-level RF provides the input signal for the high power amplifiers (Klystrons or IOT's). The LLRF-signal level will be several watts of RF, locked to a central frequency reference. The frequency, phase and power level is continuously adjusted by local feedback control systems to match the cavities and the beam requirements.

The LLRF additionally provide static tuning of the cavities and dynamic compensation for Lorenz-detuning of the accelerating cavities via piezo-actuators.

The LLRF is likely to contain a small UPS/Ultra-capacitor to maintain full control of the beam in the time between the detection of an error and the shutdown of the beam. If the power to the LLRF trips, there will be a restart time to reacquire the phase lock and reload the control system, assuming Field-Programmable Gate Arrays (FPGA's) are used. The modulators will block pulses until the LLRF system is ready.

#### 7.2.4 High energy beam transport

The High Energy Beam Transport, HEBT, is a 160 m long evacuated tube, that transfers the beam between the end of the accelerator and into the target station.

The transport line from the end of the last acceleration module to the target consists of three parts. The first 100 m on the level of the LINAC tunnel is reserved for upgrades. Here, quadrupole magnets keep the beam focused. Between the magnets there are six empty drift spaces that can be replaced by cryo-modules for a future energy upgrade. After the upgrade space, the beam is brought to the surface



and the level of the Target by two vertical bends, each composed by two dipole magnets in series. After the second bend, where the beam line is horizontal again, a section consisting of quadrupole and octupole magnets expands the beam to the desired 160 × 60 mm<sup>2</sup> footprint on the beam entrance window of the target wheel.

The HEBT magnet system is not fully designed yet. The estimated power consumption of the magnets in the HEBT is expected to be 350 kW. The largest power supply will be the 3 units powering the rad-hard quad close to the Target. These units supply 25 kW each. The magnet power can be supplied from normal 400 V AC supplies.

### 7.2.5 Beam-line instrumentation

The beam-line instrumentation primarily measures the position and the quality of the beam along the LINAC. It also measures the quality of the vacuum. The beam line instrumentation will provide inputs to the MPS and to the machine operators.

The beam line instrumentation uses very little power, but may require either UPS or power supplies with long power failure ride-through to enable MPS control in case of a power failure. This is to be determined.

### 7.2.6 Vacuum system

The LINAC and the Instruments requires vacuum pumps to operate. The vacuum pumps are integrated into packages, distributed along the LINAC and located in the accelerator tunnel. Approximately 100 vacuum packages are expected to be used within the LINAC tunnel, while the instruments may use up 60 units.

A vacuum system package typically has a roughing pump that vents to atmospheric pressure via an oil filter, followed by a high-vacuum pump connected to the evacuated space. Each unit will have isolation valves to allow a shutdown of the pump without leakage (or for maintenance) and a control system. While the roughing pump is robust, the high-vacuum pump can be intolerant to power failures. Turbo-molecular pumps use magnetic bearings and must often spin down before they can be safely powered off.

The cryo-modules and the cryogenic transfer lines are vacuum-insulated. Since no gas normally enters the insulation vacuum, this vacuum is pumped down by mobile vacuum packages, “vacuum trolleys”, and maintained by ion-pumps. Ion-pumps are robust, trouble-free and consume a very small amount of power, typically 60-100 W per unit. In the case of a leakage, a “vacuum-trolley” may be left permanently connected until the problem can be repaired. Allowance for this should be made when deciding on power outlets in the LINAC tunnel.

Getting a good vacuum involves several time-consuming processes such as baking, flushing with clean gasses, leak detection, glow discharge cleaning etc. To minimise system downtime, the vacuum shall be maintained during power outages.

Power to the LINAC vacuum system should be available independent from the process power to aid commissioning.

#### 7.2.6.1 Requirements

	<i>Main Power (kW)</i>	<i>Aux. Power (kW)</i>	<i>Prio. Power (kW)</i>
Vacuum LINAC	-	200	200
Vacuum Instruments	-	60	60
Insulation space	-	10	No

Table 4. Total power requirement for vacuum systems.

### 7.2.6.2 Assumptions

The total power consumption for a single vacuum package is estimated to 2 kW per unit. The vacuum packages are all similar in functionality and power requirements. The control system included in each vacuum package can handle power interruptions without damaging the vacuum pumps or polluting the evacuated space.

### 7.2.6.3 Design

The vacuum must be maintained during power outages. The vacuum systems shall be supplied from the 400 V prioritised supply.

## 7.3 RF test hall

The RF Test Hall is located in the Klystron Gallery, where the equipment required for the LINAC upgrade will be placed. The RF Test Hall will mainly be used to test Klystron Modulators, to burn in new Klystrons, and to service test and repair cryo-modules. The RF test hall will require very similar facilities as the LINAC, but on a smaller scale. The power requirements and the influence on the grid will also be similar, though to a far lesser extent. The RF test hall requires a cryo-plant. However, this will be located within the cryo-plant for Target and LINAC.

The test stand will power eight klystrons from four modulators into either dummy loads or cavities, depending on the work performed. The High Voltage power needed to power the test stand will be 800 kW, assuming a klystron efficiency of 60%, which is 200 kW per modulator.

The testing of cavities requires a hot cell with access control, similar to that of the LINAC tunnel, because the high voltages generated inside the cryo-modules will create a dangerous amount of high-energy X-rays.

The RF test hall and its auxiliary systems such as cooling must be expected to operate at times when the LINAC is shut down. The power supplies should be designed so that it is possible to service the medium voltage system for the LINAC without having to shut down the RF test hall.

## 7.4 Target

The main function of the Target station is to convert the high-energy proton beam from the accelerator into low-energy neutron beams with the greatest possible efficiency, while containing the radiation produced by the spallation process.

The Target station contains three groups of Target station subsystems. The first group consists of the target monolith and the components it houses, including among others the Target wheel, the moderatorreflector and the beam extraction systems. The second group is made up of fluid systems. The third group includes the handling and logistics subsystems for radioactive components of the Target station operation.

The baseline technology chosen for the Target is a rotating tungsten wheel cooled by inert helium gas. The surface area of the wheel is large enough that, in the event of a loss of power, passive cooling would prevent unsafe target temperatures with a significant safety margin. The design goal for the Target is a passive confinement system to control the radiation, but it is a possibility that a pressure cascade system will be needed. Such a system will need a backup power supply.

The important loads within the Target station will be the helium compressors used for cooling the Target wheel and the cooling station removing the 5 MW of heat from the beam.

The operation of the Target wheel does not require much power. The torque motor for the wheel is rated at 10 kW. Due to the inertia of the wheel, it will take a long time to spin it up to the required speed, so it is possible that the motor will require a backup supply.

### 7.4.1 Requirements

	<i>Main Power (kW)</i>	<i>Aux. Power (kW)</i>	<i>Prio. Power (kW)</i>
Target Wheel circuit	900	90	TBD
Intm. Target Wheel system	400	40	TBD
Intermediate Cryo system	see "cryo-plant"		
Monolith Flush circuit	460	46	TBD
Monolith Atmosphere	-	40	TBD
PBW circuit	-	10	TBD
Hot Cells Ventilation circuit	-	45	TBD
Pump Rooms Ventilation circuit	460	45	TBD
Intermediate Water Systems	-	6	TBD
Lightning and HVAC	-	TBD	TBD

Table 5. Preliminary power requirements for Target Station.

### 7.4.2 Assumptions

The helium compressors in the target station are similar to those within the cryo-plant in their sensitivity to voltage dips. No special measures are required because the Target will be designed for passive safety. If higher reliability is needed, the Multi-drive solution proposed for the cryo-plant can be used at the Target station.

Lighting and HVAC power needs are small, so the total power requirement is about 4 MW.

The instruments, neutron guides, access ways and radiation shields severely restrict the access through the building and the location of the substation. This has an impact on cable lengths and routing.

### 7.4.3 Design

The power will be supplied by a substation containing 3x2000 KVA transformers. One of the transformers will be 20/0.4 kV for prioritised power. The others will be 20/3.3 kV (or 20/0.69 kV) for powering the large pumps or compressors. The 690 V is preferred but the length of the cables might make it difficult to handle.

## 7.5 Cryo-plants

The facility will require 3 different cryo-plants to operate. The largest of the cryo-plants produces the cryogenic helium needed for cooling of the superconducting section of the LINAC. The second cryo-plant will mainly produce cryogenic helium cooling for liquid hydrogen for the neutron moderators, while the smallest cryo-plant will mainly produce cryogenic helium for cooling LINAC components undergoing tests within the RF-test facility. While the size and scale differ, the three cryo-plants are similar in operation and requirements, so they will be treated together in this section.

The cryo-system for Target and LINAC will be separated, also physically given individual cells in the cryo-plant building. The main reason is the risk of radioactive contamination through tritium, created in Targets hydrogen loop, which can transfer into the system.

The cryo-plants are sensitive to both long- and short-term interruptions in the power supplies. The cryo-compressors are sensitive to voltage dips lower than 80% of nominal voltage level with a duration lasting for more than 400 ms. The tripping of a cryo-compressor is likely to result in a manual restart of the cryo-plant, lasting for several hours, minimum.

An interruption lasting more than approximately 2 hours threatens the helium supply. Helium is a finite resource. Consequently, bulk amounts of helium are expensive, have long delivery times and are occasionally under rationing. If ESS loses the helium supply, operations might be stopped for more than one year.

Due to the large power consumption, it is not considered economic to provide full backup power to the entire cryo-plant to protect against the very rare event of a total power loss. Instead, the cryo-plant will transfer the liquid helium supply to a large dewar. The insulation of a modern dewar is of a very high quality: a 10 m<sup>3</sup> Liquid-He dewar has a total heat flux of only 2-3 W. Once the He is inside the Dewar it can be stored for a very long time with minimum cooling from the cryo-system. To transfer the helium to the safe storage and provide the minimum cooling needed to maintain it, power is needed for the cryo-plant control systems and for a recovery compressor that can collect the helium from the cryo-modules and transfer lines before it evaporates.

Large industries relying on continuous flows, such as paper- or steel- mills, have similar problems as the ESS cryo-plant. In these industries sensitivity to power variations is greatly reduced by running the essential motors from a common motor drive. The motor drive is equipped with a common rectifier and shared DC-link, backed up by ultra-capacitors, providing "power failure ride-through" for a short time. These drives are commercially available in sizes from 2 MVA to 10 MVA, providing "power failure ride-through" for up to 5 seconds.

### 7.5.1 Requirements

	<i>Main Power (kW)</i>	<i>Aux. Power (kW)</i>	<i>Prio. Power (kW)</i>
Linac cryoplant	4300	215	TBD
Target cryoplant	2200	110	TBD
RF Test facility cryoplant	400	20	TBD
Cryo-transfer system	N/A	N/A	TBD
Recovery Compressor	N/A	N/A	800

Table 6. Summary of power consumption related to the cryo-systems.

### 7.5.2 Assumptions

The dip-statistics collected by E.ON indicate that short-term disturbances will not cause enough problems to warrant the expense of using motor drives with "power failure ride-through" for the main compressors. The highest probability for a long-term power interruption will be from within the ESS itself and not from the external power grid.

The cryo-plant controls and the control for the transfer lines must always operate in order to preserve the helium and to restore full operation of the cryo-plant after trips. Some parts of the control system rely on pneumatic actuators, which require compressed air to operate.

The controls use less than 5% of the main power consumed by the generators. For simplicity, the recovery compressor and all of the cryo-plant controls could be supplied from prioritised power.

Helium will not begin to escape immediately when the cooling is lost. Heating of the helium in the cryo-modules and transfer lines to boiling point will take at least two hours, which gives some time to reconfigure the plant to recover the liquid helium.

Helium recovery requires that actuators and control systems for the cryo-modules and transfer lines will have backup power also.

### 7.5.3 Design

The LINAC and cryo-plant shall be supplied from separated loop due to the power required and because the cryo-plants must operate continuously independently of LINAC and Target Station. The RF Test Facility also needs to operate independently from the LINAC, but this plant has much lower power requirements. The cryo-plant will share the supply with the RF Test facility and the Instrument Workshops.

UPS backup shall be provided for the cryo-plant controls and for the helium transfer lines. The recovery compressor will run from a generator, the thermal delay in the cryo-system is such that there is ample margin to start the generator and begin the helium recovery process as long as the control system have power available.

The provisioning of a reserve low-voltage feed for the LINAC cryo-plant from another substation should be considered.

## 7.6 Instruments

The instruments create the output from the ESS. Within the instrument halls there will be laboratories and more permanent infrastructure supporting the experimental work. It is important that the electrical system for the instruments is flexible and have sufficient design margin to adapt to changes in the configuration and location of the neutron instruments. Basically, neutron instruments are always "work-in-progress". New instruments will be developed and obsolete instruments retired over the entire lifetime of the ESS.

Four instrument stations are planned for the ESS. Each instrument station is expected to expand as the number of beam-lines and experiments grow. One end of each station is fixed. The electrical substation and other facilities shall be located at the fixed end of each instrument station. Cables shall be placed where they will not interfere with the expansion of an instrument station. This restriction applies to the positioning of the neutron guides as well.

To fit with the expansion of the instruments along sectors, it is more convenient to route power to the neutron guides themselves along each guide rather than across the guides. Each instrument hall will eventually receive approximately 10 beam lines.

Neutron instruments are very sensitive to EMI and require a very clean power source. At the same time, certain instruments will consume high power and some will use high levels of pulsed power. Therefore, the earthing system and a flexible power supply with excess capacity for future needs for the instrument halls is critical to achieving optimal performance from the instruments. Specific instruments, neutron spin echo in particular, are intolerant of magnetic fields. This will place restrictions on the location of electrical equipment and will probably have some consequences on the earthing system design to keep earth currents away from restricted zones.

Some instruments may be sensitive to power outages. Some types of choppers use magnetic bearings that may be damaged if power is lost at full speed. Parts of the neutron guides will be evacuated by vacuum packages. To preserve the vacuum and reduce the down time in the case of a power loss, a generator unit should provide backup supply for the vacuum pumps.

### 7.6.1 Requirements

#### Per Instrument

The number of axes to control is about 36-40, distributed over sample movements and detector. E.g. inside SANS tank, collimation, sample environment such as Eulerian cradles, sample changers etc.

- Motion control 24V / 8 A stepper motors ~192 W (factor 2 for power delivered control cabinets to power amplifiers, driver etc.) approximately 14 kW
- Vacuum pumps 240 V/ 10 A ~ 12 systems per beam line, guide and tank, approximately 40 kW
- Computer systems 240V / 10 A ~ 5 systems per beam line approximately 17 kW
- Chopper systems approx. 10kW per systems and about 5 systems per beam line approximately 50 kW
- Sample environment approximately 25 kW
- Total requirements approximately 146 kW per instrument.

Clean power requirements for detector systems, on average 40 kW, with an exception for Neutron spin-echo instruments require, at least, about 500 kW

**Per sector**

- As assumption, approximately 10 instruments per sector

1460 kW normal power

400 kW clean power

**High-field pulsed magnets**

Power requirement is set to approximately 5 MW for 200 ms.

**Estimated number of vacuum systems**

Vacuum Level: 1e-6 to 1e-3 mbar: 100 – 110 pump systems (turbo pumps, ion pumps).

Level: > 1e-3 mbar: 380 pump systems (roughing pumps).

The vacuum pump systems will be distributed over 22 instruments, support laboratories and user laboratories.

	<i>Clean Power (kW)</i>	<i>Aux. Power (kW)</i>	<i>Prio. Power (kW)</i>
Hall 1	400	1460	40
Hall 2	400	1460	40
Hall 3	400	1460	40
Hall 4	400	1460	40

Table 7. Estimated power consumption of the instrument halls.

**7.6.2 Assumptions**

The average power consumption for each instrument hall will be approximately 1 MW. However the peak power used by instruments in any single experimental hall could be as high as 10 MW.

The instruments using the high peak power, pulsed magnetic field and neutron spin-echo, will provide their own power supplies. It is sufficient to provide a connection point at 20 kV together with adequate space for a second transformer with each instrument hall. When the optimal location for the equipment is decided, the power system can be installed.

No central UPS is required. Sensitive items (choppers), detectors, will provide their own protection scheme.

**7.6.3 Design**

The four instrument halls will be supplied with power via a conventional ring-connection. The ring is made with 3 individual loops, each capable of delivering at least 10 MW of power. Only two of the loops will be connected initially, one for normal power and one for supplying prioritised and “clean” power. Each instrument substation will be equipped with ring main units, two single 20/0.4 kV 2000 kVA transformers, supplying “clean and “normal” power, with empty bays for more distribution transformer units as required.

The spare ring will be reserved for pulsed power. When the neutron spin echo instruments arrive on site, an appropriate transformer will be installed at a substation near the instrument. This configuration provides some isolation between the different instrument loads as well as providing operational flexibility and adaptations for future needs.

## 7.7 Instrument workshop

Not fully investigated and the electrical power supply is therefore not yet designed.

## 7.8 Facilities and utilities

On the ESS site there will be ordinary buildings, such as offices and laboratories. The load variations and power demand for these buildings will not be as intricate as other demands within ESS, such as the Klystron Gallery or Instruments. The power demand for the ordinary facilities is expected to supply foremost illumination, computer and other conventional household loads.

The feeders for facilities and utilities will also include power supply for e.g. illumination and computers throughout all buildings on the ESS site. A reason for separating the power supply of conventional loads from other power supplies, such as equipment which are intended for beam and experiment operation, within ESS is mainly to ensure that lighting and computers are online even when other functions are out of operation. The importance of backup power services, which shall be able to operate for at least 12 hours, for the conventional power demands is essential.

## 7.9 Computing and control system

Not fully investigated and the electrical power supply is therefore not yet designed.

## 7.10 Cooling system

The main function of the cooling system is to make sure that the temperatures of certain systems is kept within acceptable levels. This will be accomplished with a number of heat pumps, which will require a fair amount of aggregated power. As with all other functions in the ESS function chain the electrical power supply to the heat pumps has to be redundant and robust, given that lack of heat pump operation may result in a holdup in the ESS normal operation.

Another function of the cooling system is to recover the excess heat and thus feed it into the nearby district heating system. The excess heat will be transferred via heat exchangers. This implies that there also will be a number of district heating circulation pumps installed near the heat exchangers and heat pumps.

### 7.10.1 Requirements

Estimated power demand for the heat pumps is 8 MW. The heat exchangers and district heating circulation pumps have an estimated power need of about 2 MW.

# 8. Back-Up Power And Redundancy

In the worst case, prolonged interruptions could occur due to e.g. major black-outs. Without proper measures, process components can be damaged or valuable data can be lost. Every function within ESS has a specific requirement for back-up power. In many cases, the need for back-up power is for safe and controlled shutdown of specific functions and keeping computer system online. This can often be achieved by ordinary uninterruptible power supply (UPS).

## 8.1 Uninterruptible Power Supply (UPS)

The UPS system build implies that all the UPS services for emergency back-up are linked together through one or more centralized systems. However, the centralized UPS system is divided into smaller subsystems that provide better redundancy conditions compared to individual independent UPS systems. The centralized battery pack should be constructed with interlinked smaller battery units to improve redundancy.

UPS will be designed with DC batteries in a redundant and parallel manner. The UPS will need to have test sockets for capacity testing and shall include over-current and over-voltage protection. Minimum operation time must be at least 8 hours.

## 8.2 Emergency back-up generator

Backup power will be delivered by a normal medium voltage loop distributing prioritised power to the entire site. The backup power, approximately 2000- 4000 kW, permits a cable length of approximately 20 km to be used. The backup power supply will be located at the primary distribution station. During normal operation, the backup power loop will be energised from the medium voltage switchgear. When the supply fails, the medium voltage busbar circuit breakers open and the backup power take over the supply for the prioritised loop automatically. For safety reasons, the Emergency back-up system shall be designed so that a manual operator manoeuvre is required to restore normal operation. The potentially small difference between normal load and the short circuit power available from the back-up system does present a challenge in designing a suitable protection scheme for the prioritised power supply. It is possible that the prioritised distribution system will be designed for a lower MV to achieve an adequate design margin for the protective devices.

Dedicated low-voltage racks supplying prioritised power will be co-located with the ordinary switchgear to achieve simplicity in deployment and operation of the back-up power system. Equipment requiring backup power is connected to these racks.

The technology of the backup power supply must be considered carefully. Diesel generators, while being relatively cheap and known COTS technology, require continuous maintenance and fuel storage. The diesel fuel is flammable, an environmental hazard and requires special storage and handling.

Battery supplies may be available in the power range required but they are relatively expensive. However, these systems require less maintenance, the failover is "immediate" and they will not leak fuel. An emerging power technology for data centers is hydrogen fuel cells. Considering the lifetime of the ESS, they may become COTS for medium voltage during the construction phase.

# 9. Supervisory Control And Data Acquisition (Scada)

The entire ESS distribution power grid system shall be monitored by a SCADA system. The main purpose of the SCADA system is surveillance of the power grid status. The possibility of operating manoeuvres on specific equipment needs to be included. Essential information, e.g. voltage, active and reactive power along with an event list, must be included in the monitoring system. The power grid SCADA could be, to some extent, integrated as a part of the ESS process monitoring system. Low voltage appliances may be appropriate to manoeuvre from the process surveillance system, whereas manoeuvring of medium voltage appliances has to have eligibility criteria and may only be serviced by authorized and competent personnel.

# 10. Magnetic Fields

Electric current produces a magnetic field. Magnetic fields can mutually interfere with each other. This can become a problem if a magnetic field has an adverse influence on other important objects. Therefore, shielding of components that produce greater magnetic fields or shielding of devices and cables that are sensitive can become essential.



Another important issue regarding the influence of magnetic fields is how it affects humans. This subject has been researched and discussed for many years without giving any definitive guidelines concerning both the impact and severity on humans. However, the recommended level 0.2  $\mu\text{T}$  is usually set as a maximum level. The level is based on areas where people are situated daily. In areas accommodating e.g. switchgears and transformers, the magnetic fields often exceeds the recommended magnetic field level.

## 11. Maintenance Philosophy

Every electrical installation needs maintenance, in some respect, to maintain a reliable supply and not to give rise to unnecessary interruptions. Because of the extensive amount of electrical installations in ESS, the importance of easy and accessible maintenance is significant. Well written, and drawn, documentation of the electrical installations is crucial, where the proper action for each maintenance procedure and fault event is clearly stated.

### 11.1 Daily maintenance

The daily maintenance is foremost based on making rounds of certain key components and devices. This is mainly to detect e.g. leakages and overheating.

### 11.2 Monthly maintenance

The monthly maintenance should include the daily rounding and visual inspection of e.g. power transformers, switchgear and battery systems. It could also include functionality control of the emergency exits and emergency shutdown.

### 11.3 Yearly maintenance

The yearly maintenance should include, besides the daily and monthly maintenance, inspection of passive and secondary components. Control in accordance with Starkströmsföreskrifterna section C should also be performed. Thermography of specific devices to identify corona and discharge is also advised.

## 12. Organization

Usually the final organization is not established in the beginning of a project. However, it is important that operating and maintenance staff have the opportunity to participate during the different project phases; such as e.g. Factory Acceptance Tests (FAT), erection of power system components along with commissioning of the power system and its appliances. It is also crucial that the designated staff get proper training before the plant goes in to commercial operation.

# 13. Time Plan

With regard to the master time plan of ESS an additional specific time plan for the electrical power supply is of importance, with a number of milestones presented.

Activity	Start	Finish	2012	2013	2014	2015	2016	2017	2018	2019	2020	2021	2022	2023	2024	2025
<b>ESS programme phases, gates and milestones</b>																
Day one	2019-06-15	2019-06-15								X						
Start of operations	2019-12-01	2019-12-01								X						
Full beam power	2024-09-01	2024-09-01													X	
Ground break	2014-03-01	2014-03-01			X											
Accelerator building construction	2014-08-01	2016-10-31														
Target building construction	2014-10-01	2016-12-31														
Instruments building construction	2015-03-01	2023-10-31														
Electrical and cooling supply installed	2016-04-01	2016-04-01					X									
<b>Aachen Reliable electrical system ESS</b>																
Planning & Design, ESS internal electrical power grid	2011-11-01	2014-12-31														
Consultation, Planning and Ordering relocation of 145 kV regional grid	2011-11-01	2013-06-30														
Concession for relocation of 145 kV regional power grid	2011-11-01	2014-01-01														
Planning & Design, connection to regional power grid	2011-11-01	2016-01-01														
Ordering, connection to regional power grid	2013-06-30	2013-06-30		X												
Commissioning, connection to regional power grid	2016-01-01	2016-01-01					X									

Table 8. Time plan for the electrical power supply design.

# 14. Appendix I – Single-Line Diagrams

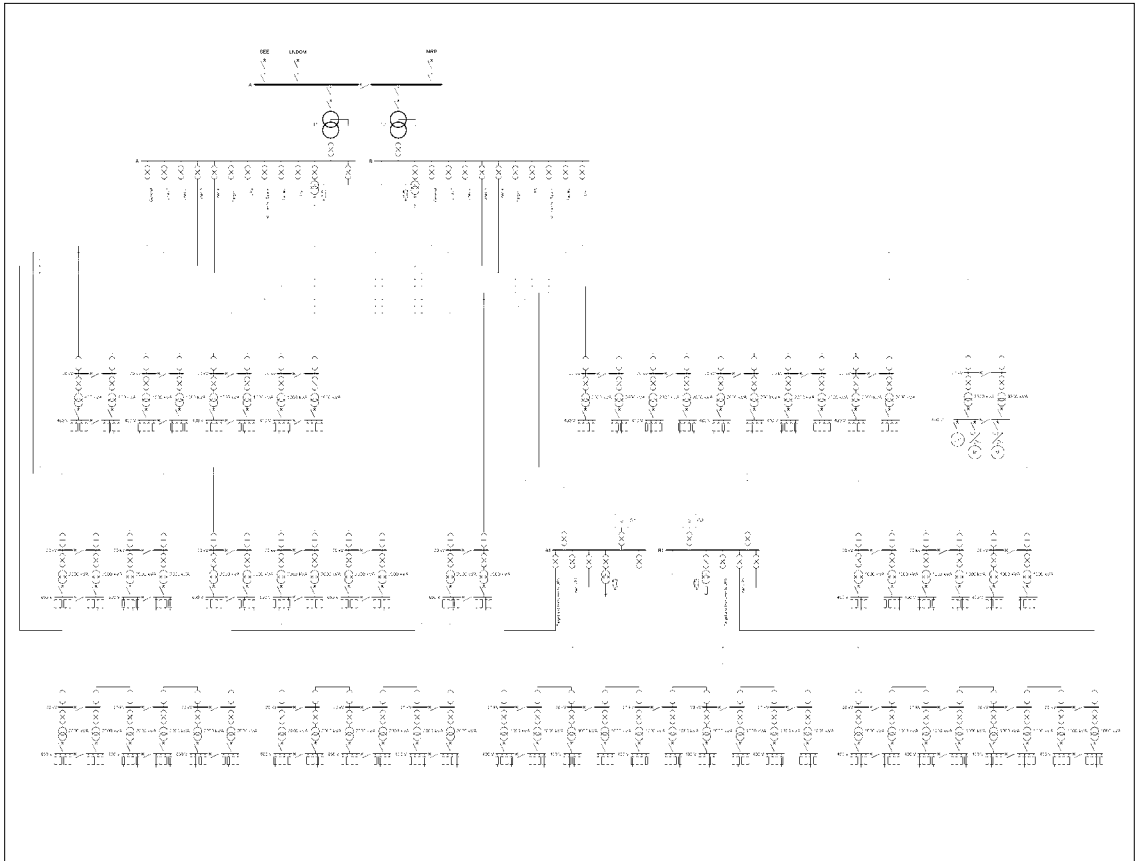

# 15. Appendix II – Voltage Dip Statistics

Recordings from substation Sege, feeder bay 412, Aug 2010 - Feb 2011, approx. 200 days  
1- or 2-phase voltage dips, the occurrence during measuring interval

Residual voltage u % of Uref	Duration, s							
	0.01 < Δt ≤ 0.02	0.02 < Δt ≤ 0.1	0.1 < Δt ≤ 0.5	0.5 < Δt ≤ 1	1 < Δt ≤ 3	3 < Δt ≤ 20	20 < Δt ≤ 60	60 < Δt ≤ 180
90 > u ≥ 85	0	2	1	0	0	0	0	0
85 > u ≥ 70	0	2	4	0	0	0	0	0
70 > u ≥ 40	0	3	0	0	0	0	0	0
40 > u ≥ 10	0	1	0	0	0	0	0	0
10 > u ≥ 0	0	0	0	0	0	0	0	0

Recordings from substation Sege, feeder bay 412, Aug 2010 - Feb 2011, approx. 200 days  
3-phase voltage dips, the occurrence during measuring interval

Residual voltage u % of Uref	Duration, s							
	0.01 < Δt ≤ 0.02	0.02 < Δt ≤ 0.1	0.1 < Δt ≤ 0.5	0.5 < Δt ≤ 1	1 < Δt ≤ 3	3 < Δt ≤ 20	20 < Δt ≤ 60	60 < Δt ≤ 180
90 > u ≥ 85	0	1	0	0	0	0	0	0
85 > u ≥ 70	0	0	0	0	0	0	0	0
70 > u ≥ 40	0	1	2	0	0	0	0	0
40 > u ≥ 10	0	0	1	0	0	0	0	0
10 > u ≥ 0	0	0	0	0	0	0	0	0

Recordings from substation Sege, feeder bay 412, July 2011 - Sept 2012, approx. 425 days  
1- or 2-phase voltage dips, the occurrence during measuring interval

Residual voltage u % of Uref	Duration, s							
	0.01 < Δt ≤ 0.02	0.02 < Δt ≤ 0.1	0.1 < Δt ≤ 0.5	0.5 < Δt ≤ 1	1 < Δt ≤ 3	3 < Δt ≤ 20	20 < Δt ≤ 60	60 < Δt ≤ 180
90 > u ≥ 85	3	17	0	0	0	0	0	0
85 > u ≥ 70	0	9	2	0	0	0	0	0
70 > u ≥ 40	0	2	1	0	0	0	0	0
40 > u ≥ 10	0	0	0	0	0	0	0	0
10 > u ≥ 0	0	0	0	0	0	0	0	0

Recordings from substation Sege, feeder bay 412, July 2011 - Sept 2012, approx. 425 days  
3-phase voltage dips, the occurrence during measuring interval

Residual voltage u % of Uref	Duration, s							
	0.01 < Δt ≤ 0.02	0.02 < Δt ≤ 0.1	0.1 < Δt ≤ 0.5	0.5 < Δt ≤ 1	1 < Δt ≤ 3	3 < Δt ≤ 20	20 < Δt ≤ 60	60 < Δt ≤ 180
90 > u ≥ 85	0	3	0	0	0	0	0	0
85 > u ≥ 70	0	10	2	0	0	0	0	0
70 > u ≥ 40	0	1	0	0	0	0	0	0
40 > u ≥ 10	0	0	0	0	0	0	0	0
10 > u ≥ 0	0	0	0	0	0	0	0	0

# 16. Appendix III – Electrical Standards, Rules And Regulations

This appendix is a summary of standards, rules and regulations that is mentioned throughout the report. The bullets are specified without regards to priority hierarchy or disposition in the report.

- **Ellagen (1997:857)**  
Swedish Law on Electrical business
- **Starkströmsföreskrifterna (ELSÄK-FS 2008:1 and 2008:2)**  
Regulation regarding Power Current Appliances
- **SS-ISO 11161**  
Swedish Standard concerning Industrial automation systems – Safety of integrated manufacturing systems – Basic requirements
- **IEC 61439**  
International Standard which covers low voltage switchgear and controlgear assemblies
- **EBR KJ41**  
Industry best-practise publication regarding cable routing up to 145 kV, published by Elbyggnadsrationalisering (EBR) which are a part of Swede Energy.
- **SS 421 01 01**  
Swedish Standard on power installation exceeding 1 kV AC
- **SS 436 21 01**  
Swedish Standard on Electrical operating areas for low voltage switchgear
- **SS 436 40 00**  
Swedish Standard on Rules for Low Voltage Electrical Installations
- **SS 424 14 24**  
Swedish Standard on Power cables – Choice of cables with rated voltage max 0,6/1 kV with regard to current carrying capacity, protection against overload and protection at short circuit
- **SS 424 14 37**  
Swedish Standard on Underground installation of Cables
- **SS 424 14 38**  
Swedish Standard on Cable management in buildings
- **SS 424 14 75**  
Swedish Standard on Measurement of smoke density of electric cables burning under defined conditions – Test apparatus
- **SS-EN 60445**  
Swedish Standard on Basic and safety principles for man-machine interface, marking and identification – Identification of equipment terminals and conductor terminations
- **SS EN 60298**  
Swedish Standard on A.C. metal-enclosed switchgear and controlgear for rated voltages above 1 kV and up to and including 52 kV
- **SS EN 60076**  
Swedish Standard on Power Transformers
- **SS EN 60726**  
Swedish Standard on Dry-type power transformers
- **prEN 50399**  
European standard on Common test methods for cables under fire conditions  
– Heat release and smoke production measurement on cables during flame spread test

# Chapter 7

## Grid Simulation

# Grid Simulation

The ESS facilities will not only be a very large and demanding consumer of electricity in southern Sweden, but due to the pulsed operation of the LINAC, the facility also has the potential to disturb the stability of the electrical system. It is prudent to investigate the effect that the ESS may have on the electrical grid and to define the conditions for successful integration between the ESS and the electrical system.

The project will build a model of the electrical grid and investigate how different power supply topologies will affect the electrical system.

The work is the result of collaboration between the stakeholders: ESS, Lunds Energi, E.ON Energy Research Center and RWTH Aachen University.

The first report "Modeling Development, Report for Work Package Two (Part I – Grid Simulation)" describes the modeling of the regional grid and some of the first results obtained.

Main conclusions and results:

- A model of the regional electrical system up to the main receiving station at the ESS site has been built and validated.
- The simulations show that it is very important to control the 14Hz power excursions caused by the operation of the LINAC.
- The electrical grid has adequate capacity to carry the load of the ESS even allowing for failures. Stochastic analysis of the power flow in the grid with wind-power included has also been carried out.
- The simulation shows that attention needs to be paid to the branches (SEE-ESS) and (Lillgrund-BFO), as branch (SEE-ESS) transfers more power than the others, while branch (Lillgrund-BFO) is the unique path connecting the wind farm with Lund grid;

## Further work:

When more data on the electrical generators is available, the model can be used to identifying sub-synchronous resonance (a condition where load variations excite low-frequency mechanical oscillations in generators and turbines, potentially causing them to fail).

The project will propose control strategies for the Klystron Modulator that can keep the power variations within safe limits. The intention is that manufacturers will have the choice of licensing the technology and integrate it into their own products or developing their own methods to meet the requirements.

# Grid Simulation

E.ON Energy Research Center,  
RWTH Aachen University, Germany



# 1. General introduction on modeling approach

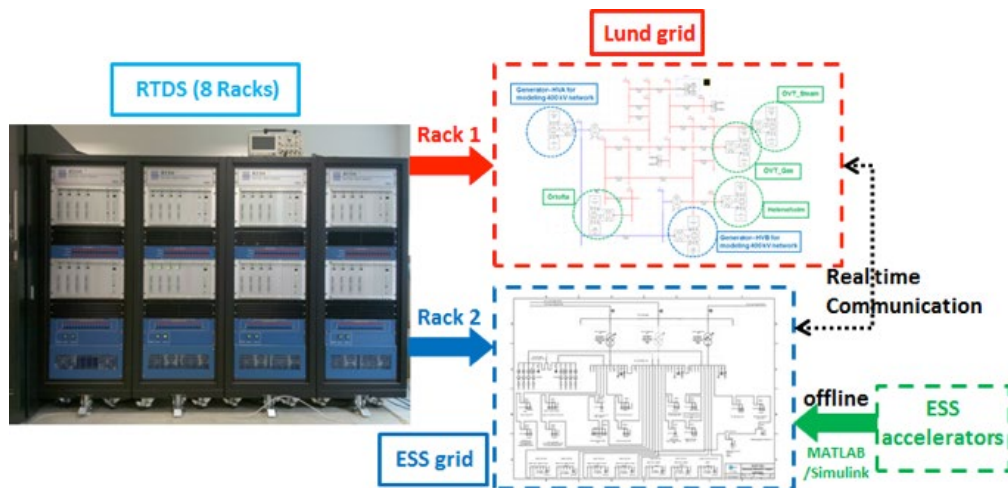

Fig. 1: Main structure of modeling approach

Technically, the simulation work consists of two parts: the Lund grid and the ESS grid. As a powerful simulator that solves electromagnetic simulations in real time and being widely used in power system, RTDS (Real Time Digital Simulator) is selected as the main simulation tool in this project. Both Lund grid and ESS grid will be modeled in RTDS, each of the grids in a separate rack, so that the co-simulation will be realized through the control signal across the racks. However, the modeling of ESS accelerators is established in MATLAB/Simulink in a first step, with a more detailed power electronic model. Finally the electrical characteristics of the ESS grid will be equivalently modeled in RTDS, to finish the co-simulation for the whole system.

## 1.1 Lund grid in RTDS

According to the data received from the project partner E.ON, the models in Lund grid are created in RSCAD/Draft software module, including: generators, transmission lines, transformers, breakers and loads. Three issues require special attention:

- for the equivalent power supply modeling of the high-voltage transmission network interface, the large-capacity generator is applied in the modeling to see the frequency variation more obviously;
- currently, a dynamic load modeling which is controlled by a load profile is used to equivalently model the load characteristics of ESS, and the load profile is produced in advance referring to the corresponding materials provided by ESS;
- a breaker between Lund grid and the dynamic load can determine the state of the ESS grid connection or disconnection to the Lund grid by its state being opened or closed.

After compiling the modeling circuit in the Draft module successfully, the simulation case is executed in the RSCAD/RunTime module. The components 'meters for monitoring the voltage and frequency of each bus', 'switch for controlling the status of breaker', and 'plots for recoding the data of whole simulation process' are created in the RunTime module. The recorded data will be used for the post-processing analysis in MATLAB, which results are introduced in chapter 3.1.

## 1.2 ESS accelerators in MATLAB (detailed power-electronic model)

The modulator design mainly affects the overlay grid. The RTDS simulation servers are not capable of simulating fast-switching devices. Therefore, a standalone simulation with ideal sources is created in MATLAB/Simulink and PLECS. With the results a load analysis can be conducted. Finally, a second modulator model in RTDS shall be created. This model shall map the active and reactive power consumption, the harmonics and the fault behavior of the RTDS based ESS model.

# 2 Updating of data

Until now, E.ON ERC has received the third batch of data from our partners E.ON Sverige AB and ESS. According to the new data and information, the model characteristics of Lund grid and ESS grid have been updated and new tests have been finished.

## 2.1 Available data of Lund grid

The data concerning Lund grid includes network topology, parameters of branch, transformer and generator, and information about the power consumption at each load bus, which is summarized as follows, particularly for the updating parts.

### ▪ Network configuration

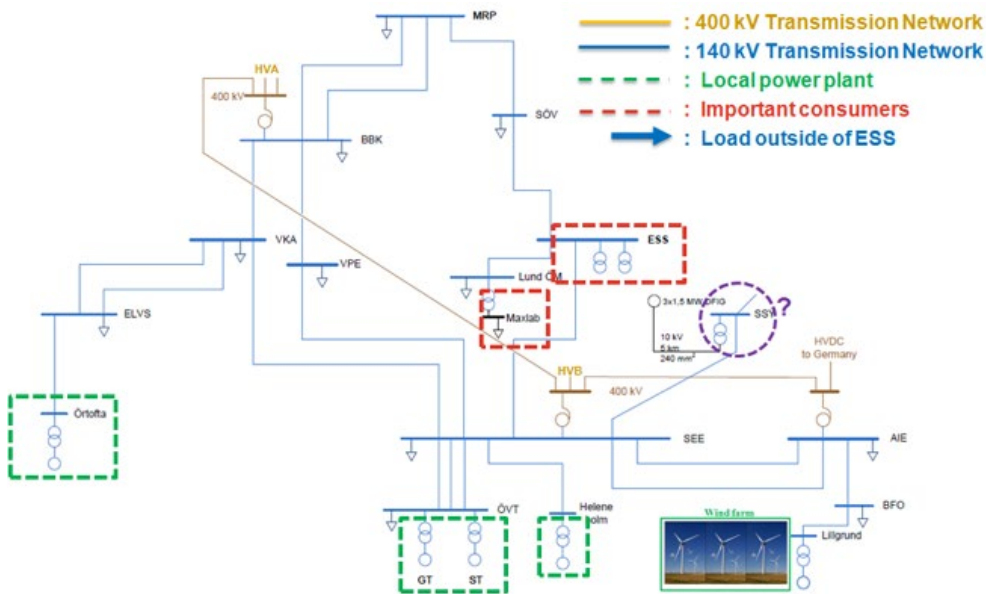

Fig.2: New configuration of Lund grid

The main voltage level of the grid is still 140 kV, which can be regarded as a Medium Voltage (MV) network. Based on the new data, several new buses are added, namely, Bus "HVDC", "AIE", "BFO", "Lillgrund" and "SSY". In particular, a wind farm located in Bus "Lillgrund" has been modeled in RTDS for simulation.

▪ Branch and transformer data

140 kV voltage level				
First bus	End bus	Branch No.	R ( $\Omega$ )	X ( $\Omega$ )
MRP	SÖV	--	1.26	10.05
SÖV	ESS	--	1.03	8.17
ESS	Lund ÖM	--	0.08	0.59
ESS	SEE	--	0.94	7.21
MRP	BBK	1	2.47	15.71
MRP	BBK	2	2.69	16.92
BBK	VKA	--	0.74	5.12
VKA	SEE	--	0.81	5.62
BBK	VPE	--	0.85	5.92
VPE	SEE	--	0.69	4.82
VKA	ELVS	1	0.81	5.62
VKA	ELVS	2	0.81	5.62
SEE	ÖVT	1	0.18	1.25
SEE	ÖVT	2	0.09	0.95
SEE	ÖVT	3	0.09	0.95
SEE	Heleneholm	--	0.27	1.08
SEE	AIE	1	1.37	7.25
SEE	AIE	2	1.37	7.25
AIE	BFO	--	0.87	6.23
BFO	Lillgrund	--	0.8	1.21
ELVS	Örtofta	--	0.37	0.79
400 kV voltage level				
First bus	End bus	Branch No.	R ( $\Omega$ )	X ( $\Omega$ )
BBK	SEE	--	0.56	7.85
SEE	AIE	--	0.32	4.9
400/140 kV transformers				
Transformer	Capacity	Ratio	X	R
BBK T8	750 MVA	410/145 kV	11.9%	0.2%
SEE T2	750 MVA	410/143.8 kV	14.9%	0.2%
AIE T1	750 MVA	410/145 kV	16.5%	0.25%

Table 1. Data of the branches and transformers in the regional grid

▪ **High voltage network and local power plant**

In Lund grid, except the 140 kV main voltage level and some 23 kV load buses in distribution network, there are three 400 kV buses in the transmission network, including "HVA", "HVB" and "HVDC". They are modeled with large-capacity synchronous generators in RTDS to simulate the infinite systems. Moreover, four local power plants are distributed in Lund grid, which are modeled with synchronous generators; the parameters can be found from TABLE II. All of the load buses are supplied by the transmission network and local power plants together, and the corresponding ratio has been shown in Fig.3.

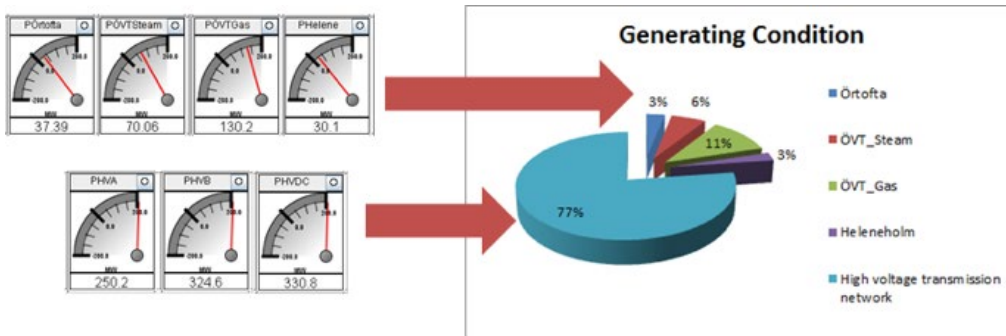

Fig.3: Ratio of power supply from high voltage network and local power plant in Lund grid

Obviously, the transmission network provides the majority of power to the loads in Lund grid.

Parameters \ Generator	Örtofta	ÖVT_Steam	ÖVT_Gas	Heleneholm
Rated MVA	48	190.6	--	59.375
Inertia Constant (H)	--	1.42	--	--
Xa	--	0.146	--	--
Xd	2.41	2.3	--	1.96
Xd'	0.325	0.226	--	0.215
Xd''	0.255	0.128	--	0.18
Xq	1.34	--	--	--
Xq'	--	--	--	--
Xq''	0.365	--	--	--
Ra	--	0.00998	--	--
Tdo'	10.452	10.124	--	8.5
Tdo''	0.03	--	--	0.9
Tqo'	--	--	--	--
Tqo''	0.036	--	--	--

Table 2. Data of different generators in the regional grid

For the research on subsynchronous oscillations among the generators, detailed parameters about the excitation and governor of corresponding generators are necessary.

## Loads in ESS

The loads in ESS are classified with klystron load and basic load, which are generally introduced in TABLE II. The characteristics of the klystron are closely relevant to the charging schemes. Two charging schemes are compared at the grid level; the differences can be seen in Fig.4.

Base load (estimation)	Active Power P (MW)	Reactive Power Q (MVar)
Transformer Rating	26 MVA (Q is assumed 15% of P)	
Maximum load level	20	3
Minimum load level	6	0.9

Charging Scheme according to report by Carlos Martins	Active Power P	Reactive Power Q
I	27 MW for 67.9 ms 0 MW for 3.5 ms	Option 1: diode component, 12 MVar Option 2: IGBT component, 2 MVar
III	25.7 MW constant	

Table 3. Information about the loads in ess

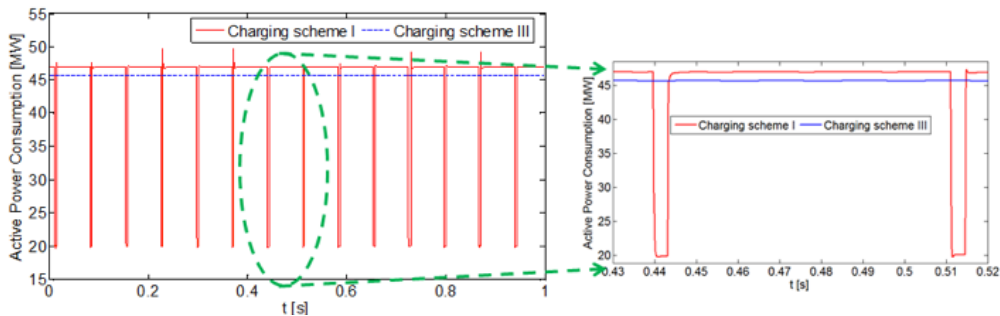

Fig.4: Klystron load of ESS with different charging schemes

### Surrounding loads in Lund grid

Load condition		
Substation	Maximum (MW)	Minimum (MW)
AIE	400	45
BBK	75	25
BFO	15	4
ELVS	55	10
Heleneholm	25	10
Lund ÖM	35	15
Maxlab	20	15
MRP	110	25
SEE	235	100
SÖV	15	2
VKA	15	4
VPE	110	50
ÖVT	10	2.5
ESS (Charging Scheme I)	47	3

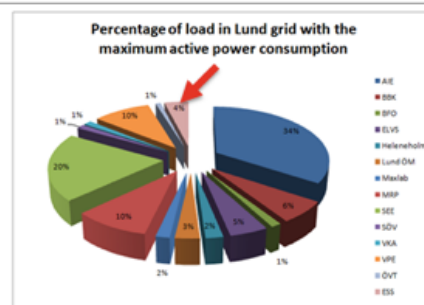
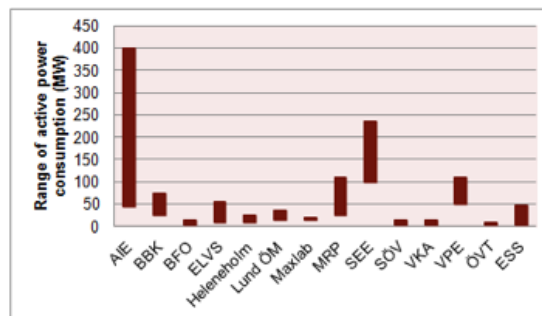

Fig.5: Distribution of load in Lund grid

Fig.5 demonstrates the varying range of each load bus with maximum and minimum power consumptions. Moreover, the ratio of the individual buses in the whole system is obtained with respect to maximum active power consumption. Since the information about the load is only the range of variation, uniform distribution and Monte Carlo sampling are adopted to generate the load data for the RTDS simulation.

▪ **Wind farm located in Lillgrund**

In this wind farm, there are 48×2.3 MW (totally 110.4 MW) wind turbines, which are produced by Siemens. According to the information on the homepage of Siemens wind power, the pattern of the wind turbines could be

- \* SWT-2.3-82
- \* SWT-2.3-93
- \* SWT-2.3-101
- \* SWT-2.3-108
- \* SWT-2.3-113

[www.energy.siemens.com/mx/en/power-generation/renewables/wind-power/wind-turbines/](http://www.energy.siemens.com/mx/en/power-generation/renewables/wind-power/wind-turbines/)

SWT-2.3-82 is adopted here; the detailed operational data is given by

Cut-in wind speed	3.0-5.0 m/s
Cut-out wind speed	25 m/s
Rated wind speed	13-14 m/s
Rated power	2.3 MW

Table 4. Information about speed and generation of swt.2.3-82

It has been widely accepted that the power curve of the Wind Turbine can be modeled by means of the following quadratic function

where

- P is the rated power;
- $v_r$  is the rated wind speed;
- $v_i$  is the cut-in wind speed;
- $v_o$  is the cut-out speed.

$$P = \begin{cases} 0, & v \leq v_i \\ P_r \frac{v^2 - v_i^2}{v_r^2 - v_i^2}, & v_i \leq v \leq v_r \\ P_r, & v_r < v \leq v_o \\ 0, & v_o < v \end{cases}$$

Let the cut-in wind speed  $v_i$  and rated wind speed  $v_r$  be 4 m/s and 13 m/s separately, the wind power production P as a piecewise function wind speed can be shown as

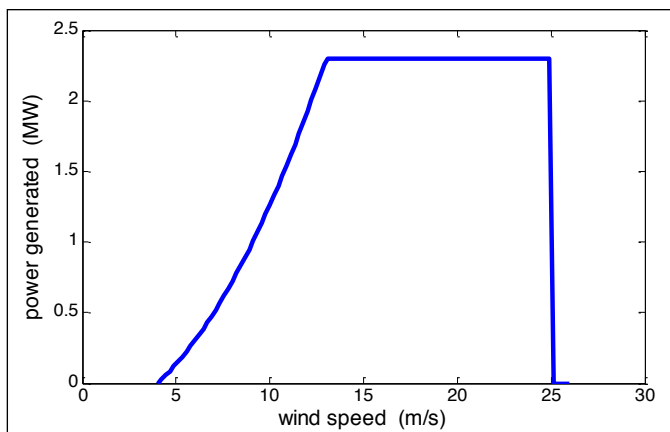

Fig.6: Relationship between wind speed and power generation

The wind speed  $V$  at a certain location is generally described by a Weibull distribution. The Weibull probability density function is given by

where

$V$  is the wind speed

$k$  is the shape coefficient

$c$  is the scale coefficient

$$f(v) = \left(\frac{k}{c}\right) \left(\frac{v}{c}\right)^{k-1} \cdot \exp\left[-\left(\frac{v}{c}\right)^k\right]$$

For a given  $c$  and  $k$  the wind speed  $V$  can be simulated.  $c$  indicates how windy the location is on average while  $k$  describes how often the distribution peaks. The values of  $c$  and  $k$  depend on the terrain in which the wind turbine is installed. This work considers  $c=9.1$  and  $k=2.26$ , the corresponding probability density function curve is shown in Fig.7.

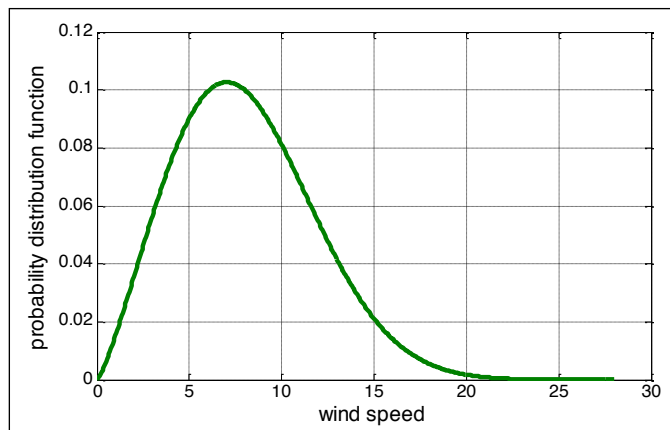

Fig.7: Wind speed with Weibull distribution

#### ▪ Modeling of the transformers between ESS and Lund grid

Two transformers with low impedance 11.5% (suggested 11-12%) are added between ESS and Lund grid. The capacity of individual transformer is 40 MVA, and the ratio is 145/23 kV.

## 2.2 General grid code of E.ON Sverige AB

For tests of the impact of various test scenarios on the power system's operation, power quality based standards are required, (called grid codes). In this project, a general grid code of E.ON Sverige AB is provided which has been drafted earlier but most likely still valid. The summarized information has been listed below, while the original document has been included as appendix of this report.

**Normal voltage:** 130 kV    **Supply voltage:** 135 kV ( $U_a$ )

**Normal voltage variation range:**  $\pm 10\% U_a$

**Fast voltage variation:**  $\leq 5\% U_a$

**Normal frequency range:** 50 Hz  $\pm 1\%$  (49.5-50.5 Hz)

**Flicker:** Upp till  $Plt=1.0$

**Asymmetry:**  $\leq 2\%$

**THD (total harmonic distortion):**  $\leq 8\%$

# 3 Preliminary test results

## 3.1 Real time simulation of Lund Grid

### ▪ Modeling in RTDS

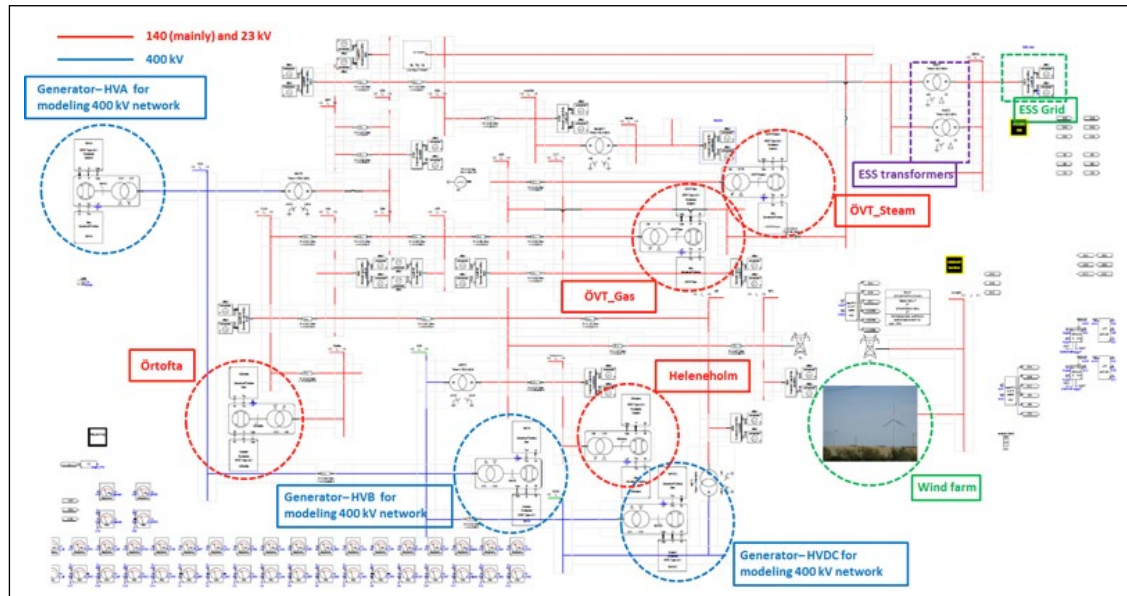

Fig.8: Lund grid modeling in RTDS

- Based on the newly received data, the Lund grid is updated in RTDS;
- Until now, a simplified dynamic load model representing ESS internal grid is used;
- As the transformers (noted as T1-ESS and T2-ESS) between ESS and Lund grid have been added, so the original Bus "ESS" are divided into two buses with denoted as "ESS\_in" (low voltage side) and "ESS\_out" (high voltage side) respectively;
- In this simulation, normally the total recording time is 1 s, while the applied sampling frequency of RTDS is 20 kHz;
- Test scenarios mainly focus on the different types of faults.

### ▪ Wind farms

Since it is not realistic to model each wind turbine completely in the wind farm, a large-capacity (110 MW) wind turbine is used for equivalent modeling. In RTDS, we choose a controllable induction machine to simulate the large wind turbine. Currently, the corresponding electronics and control of the wind turbine are not under consideration. However, the reactive power consumption in the wind farm has been accounted for, which means the wind farm will generate purely active power without a big reactive consumption from the grid.

### ▪ Test scenarios

There are two types of tests: fault tests for emergency condition and uncertainty tests for normal operating condition.

In the emergency tests, the applied faults include three-phase or asymmetric line to ground (L-G) or line to line (L-L) short circuit, tripping of local power plant (also for the wind farm), and the loss of branch or transformer. The details can be found in the list in Table 5.



Test scenarios	Location	Type	Purpose	Section
Short circuit	ESS_in	three phase L-G	with different fault clearing times: 0.05 s, 0.1 s and 0.3 s	3.2.1.1--1)
	ESS_in	three phase L-G	with different impedances of T1-ESS and T2-ESS: 11.5%, 15% and 20%	3.2.1.1--2)
	ESS_in	three phase L-G	with different short circuit impedance: 0.01 Ohm , 0.1 Ohm and 1 Ohm	3.2.1.1--3)
	ESS_in	Phase A and B L-L	compare with three phase L-G	3.2.1.1--4)
	ESS_in	Phase A L-G	compare with three phase L-G	
	ESS_out	three phase L-G	with different impedances of T1-ESS and T2-ESS: 11.5%, 15% and 20%	3.2.1.2--1)
	ESS_out	three phase L-G	with different fault clearing times: 0.05 s, 0.1 s and 0.3 s	3.2.1.2--2)
	ESS_out	Phase A and B L-L	compare with three phase L-G	3.2.1.2--3)
	ESS_out	Phase A L-G	compare with three phase L-G	
	SEE	three phase L-G	compare with faults at different buses	3.2.1.3
	SEE	Phase A and B L-L	compare with three phase L-G at SEE	
	SEE	Phase A L-G	compare with three phase L-G at SEE	
	VKA	three phase L-G	compare with faults at different buses	3.2.1.4
	Tripping of power source	HVA	tripping	compare with such kind of faults at different buses
HVB				
HVDC				
Wind farm		tripping		3.2.2.2
Örtofta and Helene simultaneously				
ÖVT Steam and Gas simultaneously				
Loss of branch and transformer	(SEE-ESS) and (ESS-Lund) simultaneously	loss	compare with such kind of faults at different buses	3.2.3.1
	(SEE-ESS) and (HVA-BBK simultaneously)			
	(SEE-ESS) and (SEE-VKA) simultaneously			
	T2-ESS	loss		3.2.3.2

Table 5. Types of faults for testing

While a general introduction about the normal operation can be found from Table 6.

Test scenarios	Location	Purpose	Section
Connection	ESS_in	check the impact of such operations on the grid	3.2.4
Disconnection	ESS_in		3.2.5
Charging schemes	ESS_in	compare with the impact caused by charging scheme I and III on grid	3.2.6
Harmonics	ESS_in	analysis for realistic data based harmonics	3.2.7.1
	ESS_in	analysis for the threshold of THD 8% (as defined in the grid code of E.ON Sverige AB) based harmonics	3.2.7.2
	SEE		3.2.7.3
	Maxlab		3.2.7.4
Wind farm	Lillgrund	check the impact of wind farm with different generation ratio: 0%, 50%, 100%, in aspect of power flow	3.2.8

Table 6 . Types of testing in normal operation

## 3.2 Test results of the simulation

### 3.2.1 Short circuit test

#### 3.2.1.1 Three-phase L-G fault at ESS internal

##### 1) With different clearing times

In this test, a three-phase L-G fault happens at the bus ESS\_in, with different clearing times 0.05 s, 0.01 s and 0.3 s respectively for comparison.

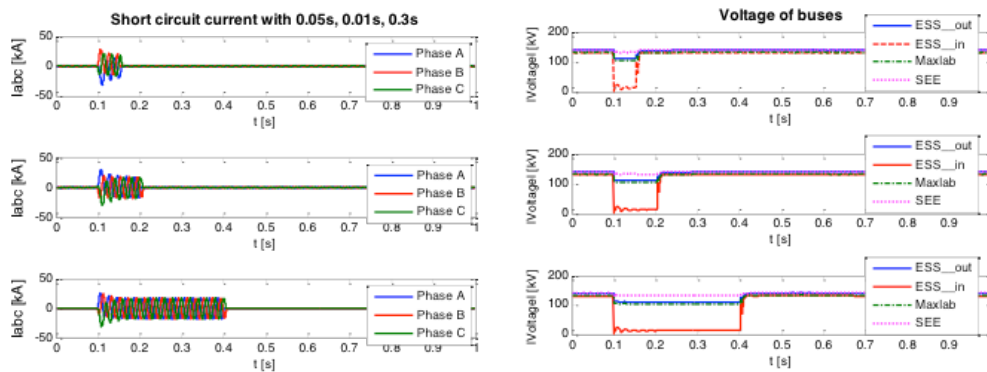

Fig.9: System response with different clearing time when a 3-phase L-G short circuit happens at ESS\_in

Normally, the fault clearing time is critical in the emergency condition, which will lead to different results. Too early will bring unnecessary loss to the system, while too late will make the system fall into collapse. In our test case, because of the sufficient power support from the strong high-voltage transmission network, the fault clearing time does not create any big difference into the response from the grid. Moreover, it is evident that the impact from ESS\_in is local regardless of in voltage, phase angle and frequency.

## 2) With different impedances of T1-ESS and T2-ESS

As the two transformers are newly added into the test model, a three-phase L-G fault happens at the bus ESS\_in, modeled with different impedances of theirs 11.5%, 15% and 20%, respectively, for comparison.

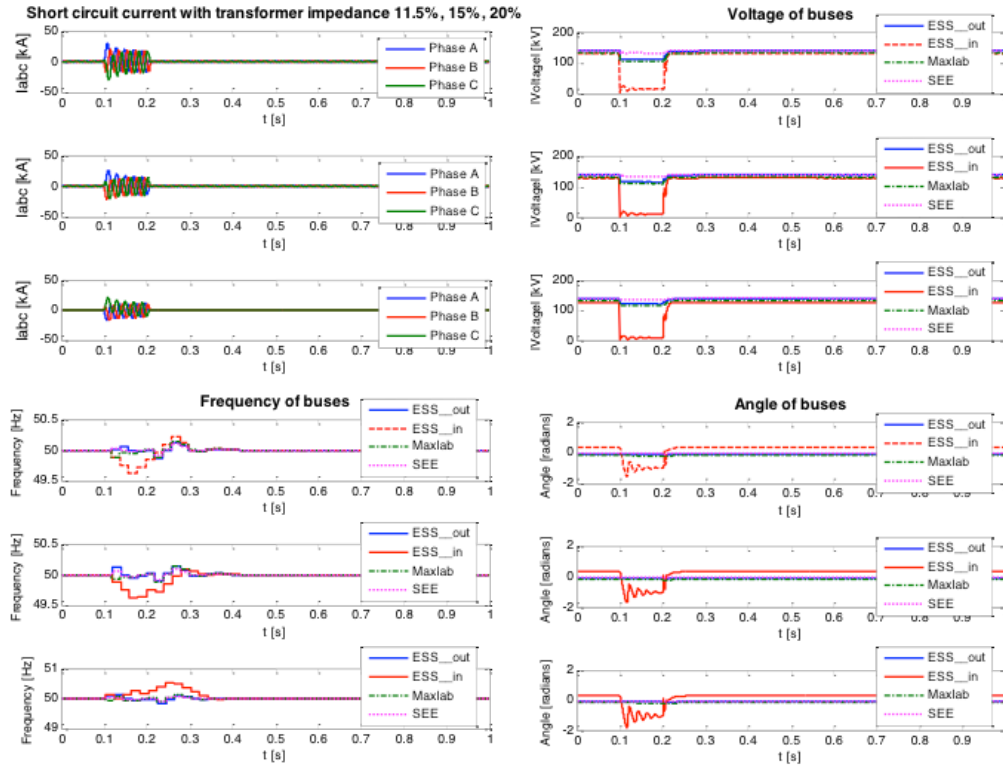

Fig.10: System response with different impedance of ESS transformers when a 3-phase L-G short circuit happens at ESS\_in

Seen from Fig.10, the maximum magnitudes of the AC short circuit current are 30.16, 26.54 and 21.59 kA individually, which means lower impedance of the transformers will lead to larger short circuit if a such kind fault happens at ESS internal.

### 3) With different ground fault resistance

As a main factor, the ground fault resistance largely decides the magnitude of the short circuit. In this test, a three-phase L-G fault happens at Bus ESS\_in, with different ground fault resistance of 0.01 Ohm, 0.1 Ohm and 1 Ohm respectively.

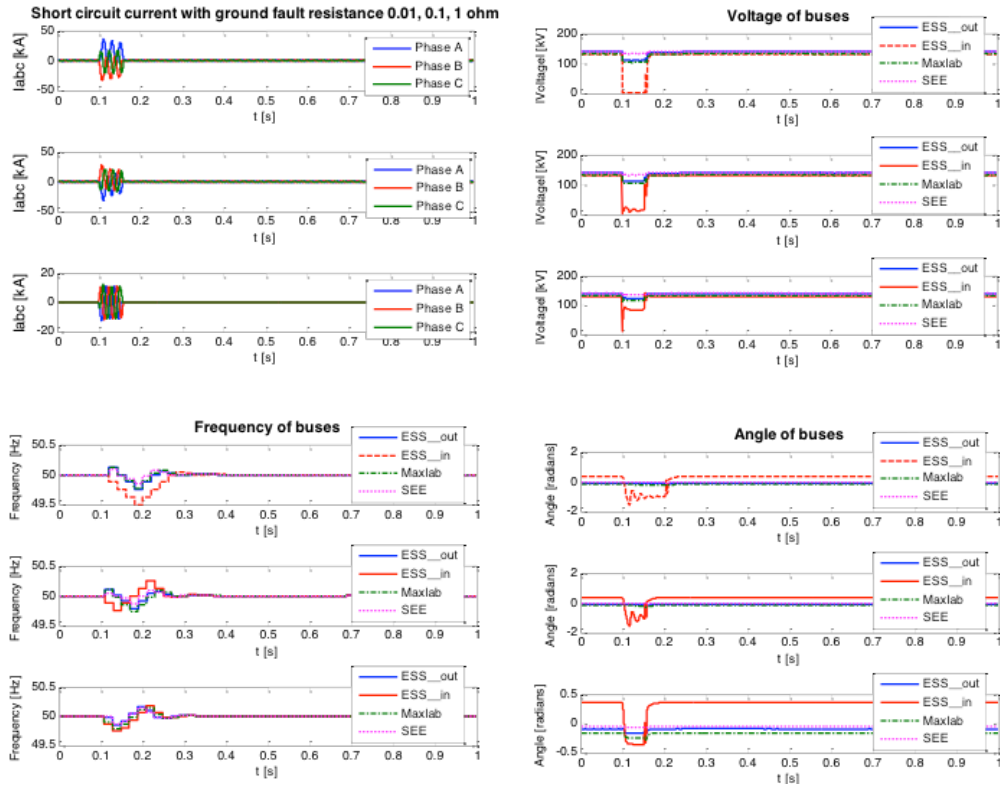

Fig.11: System response with different ground fault resistances when a 3-phase L-G short circuit happens at ESS\_in

In Fig.11, the short circuit currents are 36.05, 28.70 and 12.17 kA respectively. This evidently indicates a bigger ground fault resistance is able to reduce the short circuit current and to keep the system in better operating condition, which can be reflected from the fact that the voltage does not drop near zero in the case of the ground fault resistance of 1 Ohm. But this impedance is nearly impossible to control. Thus, we just want to check its potential influence when the short circuit happens.

#### 4) With different fault types

As known, among the short circuit faults at a same location, the three-phase L-G fault will lead to the maximum short circuit current and also the worst impact on the whole grid. Meanwhile, the single phase L-G fault and two-phase L-L fault occur more frequently in the power systems, although their impact is less than the three-phase L-G fault. Therefore, this test is designed to compare their different influences.

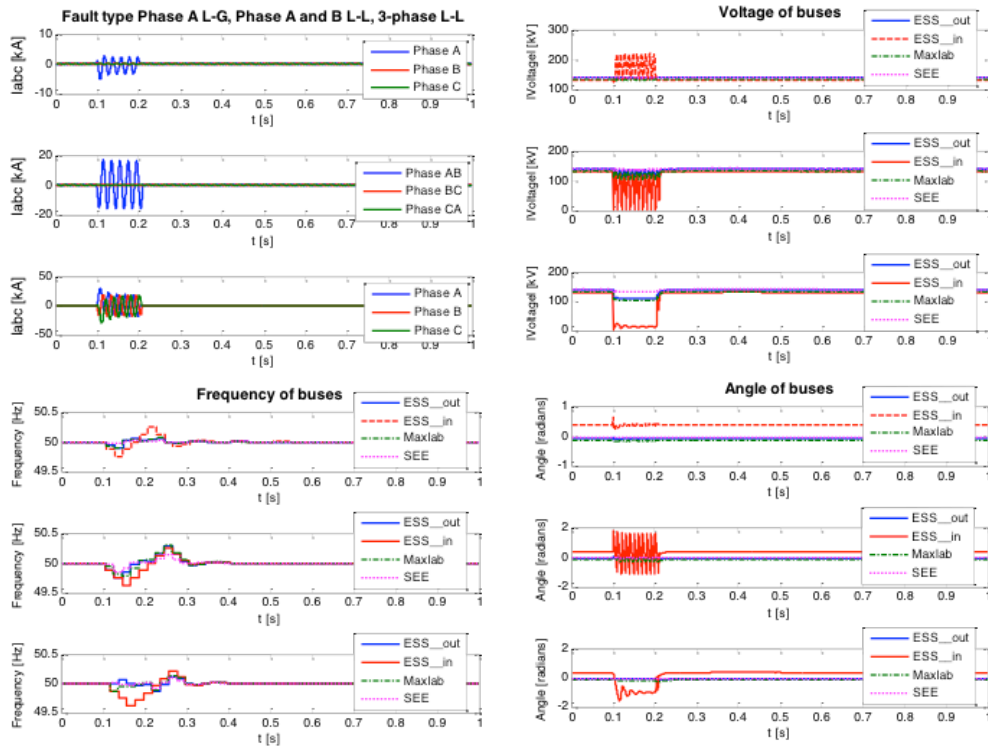

Fig.12: System response with different types of short circuit happens at ESS\_in

As shown in Fig.12, the short circuit currents are 5.45, 17.10 and 30.16 kA respectively, from single phase L-G, two-phase L-L to three-phase L-G, which are consistent with what stated in the previous paragraph. The oscillations of voltage magnitude and phase angle in the case of single phase L-G and two-phase L-L are a phenomenon of RTDS, because the measurements used in RTDS are based on a three-phase information, so an asymmetrical fault will lead to some inaccuracy.

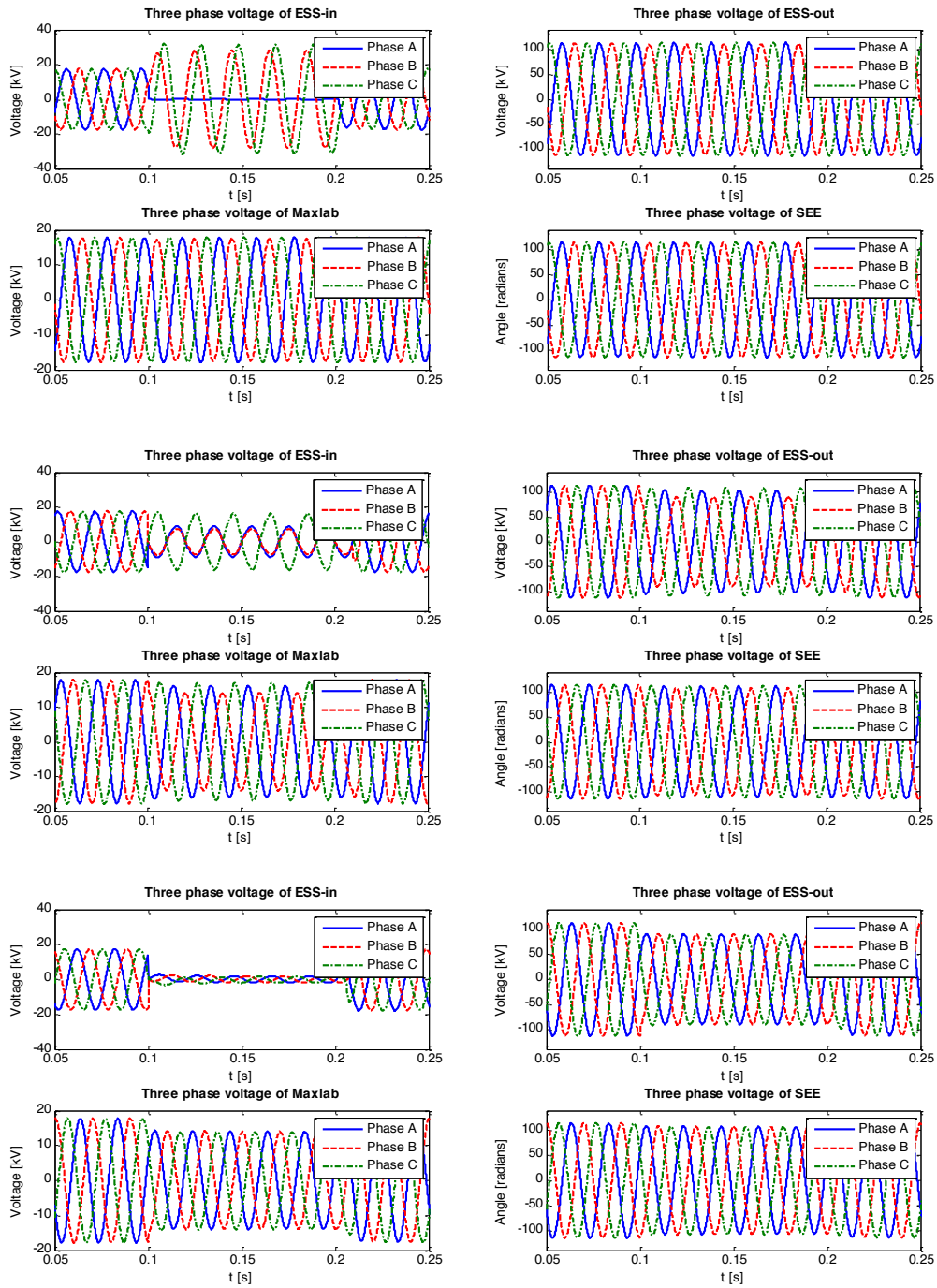

Fig.13: Instantaneous three-phase voltage of buses when different types of short circuit happen at ESS\_in

To make a deeper investigation, some interesting buses are chosen, such as Bus "ESS\_in", "ESS\_out", "Maxlab" and "SEE". The instantaneous three-phase voltages of these are shown in Fig.13. The maximum magnitudes of the instantaneous three-phase voltages of ESS\_in during the transient are recoded in TABLE VII. For the other buses, the impacts are not very significant even in the three-phase short circuit. Moreover, the impacts on the other buses closely depend on the electrical distance to the fault location, so the influence on SEE is very slight.

Fault type	Va (kV)	Vb (kV)	Vc (kV)
Single phase A L-G	0.3778	28.04	31.48
Phase AB L-L	8.94	7.48	16.37
Three phase L-G	2.14	2.06	2.39

Table 7. Maximum magnitudes of instantaneous three-phase voltages of ess\_in

### 3.2.1.2 3 phase LG fault at ESS external

#### 1) different impedances of T1-ESS and T2-ESS

In this test, the fault is moved to ESS\_out, which is connected with ESS\_in with two transformers.

Thus, the different impedances of the transformers will lead to various impacts especially on ESS\_in.

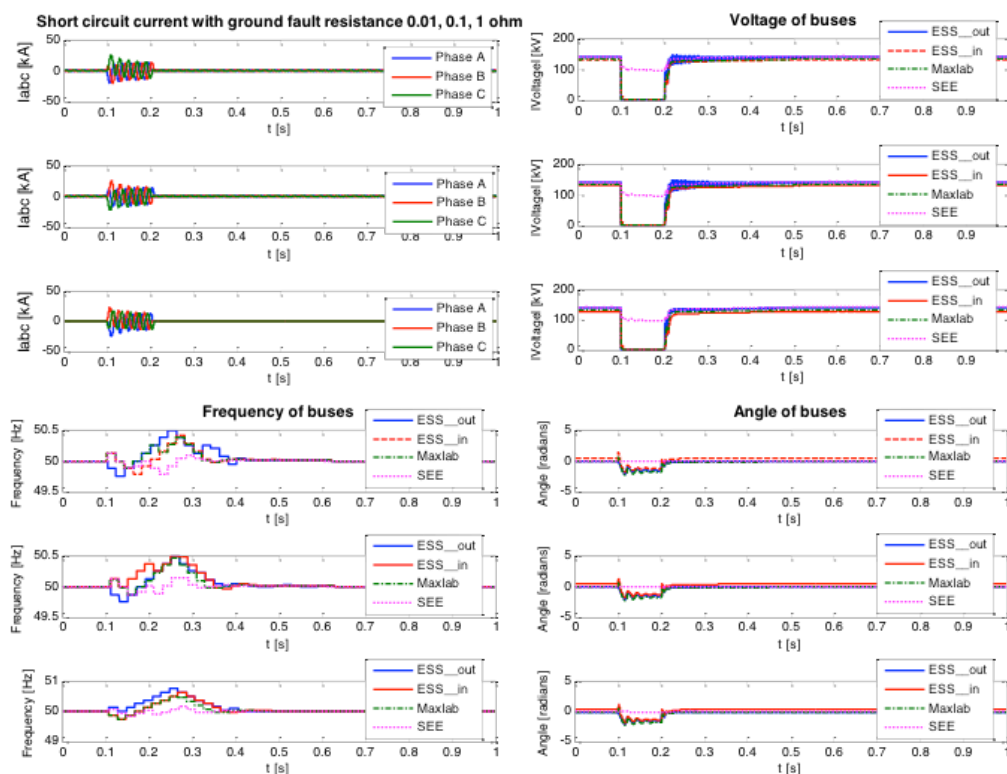

Fig.14: System response with different impedance of ESS transformers when a 3-phase L-G short circuit happens at ESS\_out

Unlike the same fault at ESS\_in, in Fig.14, the maximum magnitudes of the AC short circuit current are nearly the same, which means the impact caused by the impedance of the transformers is neglectable if the fault is outside of ESS. For ESS\_in, the isolation provided by transformer could reduce the external influence, but the effect is not obvious based on the observations.

## 2) different clearing times

In the test, a three-phase L-G fault happens at Bus ESS\_in, with different clearing time 0.05 s, 0.01 s and 0.3 s respectively for comparison.

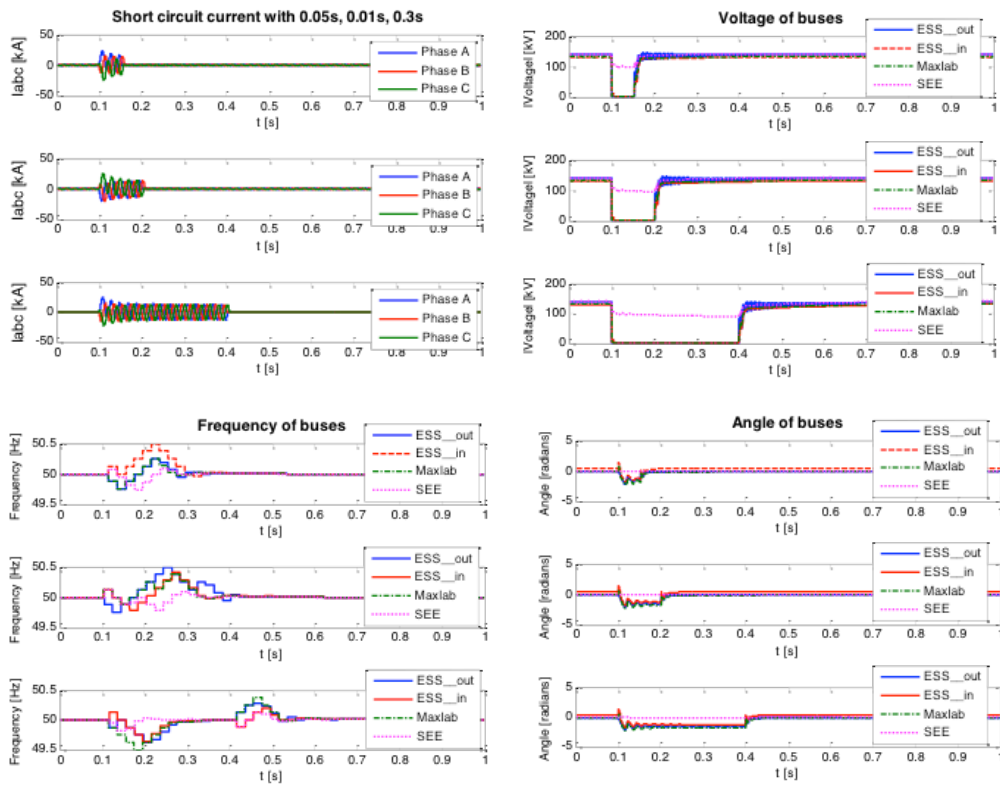

Fig.15: System response with different clearing time when a 3-phase L-G short circuit happens at ESS\_out

Owing to sufficient power support from the strong high-voltage transmission network, the fault clearing leads to no big different response from the grid. However, the impacts from ESS\_out to the other buses are different, except SEE, ESS\_in and Maxlab are sensitive to the fault.



### 3) With different fault type

Similar to the tests at ESS\_in, different types of faults are considered at ESS\_out.

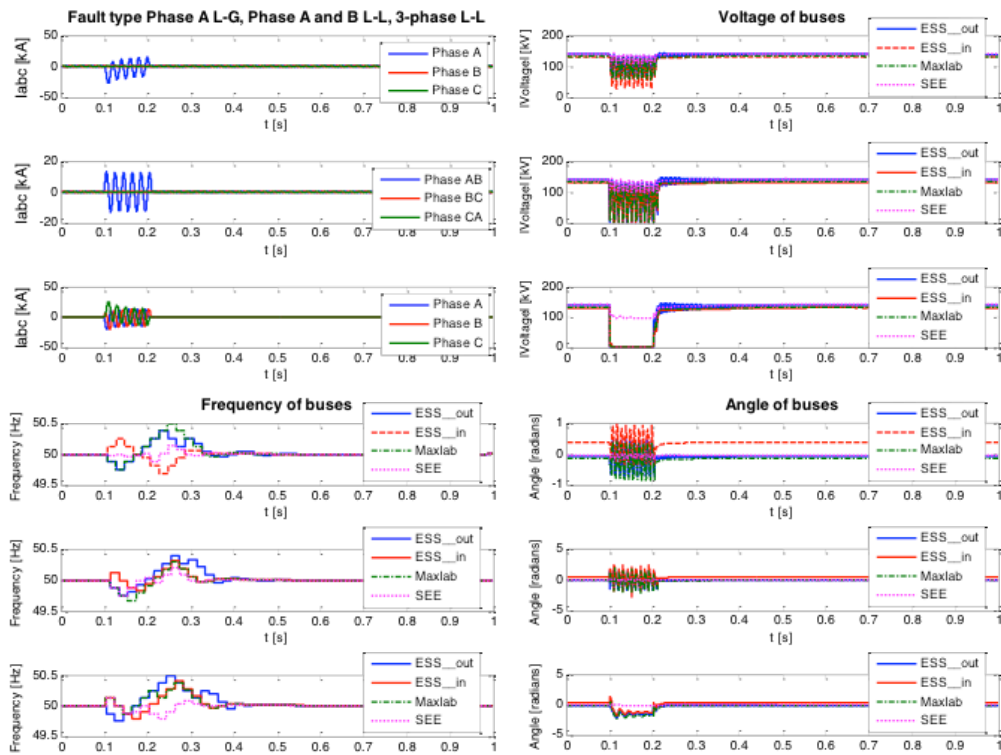

Fig.16: System response with different types of short circuit happens at ESS\_out

Seen from Fig.16, the test results are also similar with the ones of ESS\_in. The three-phase short circuit fault is still most challengeable for the whole grid.

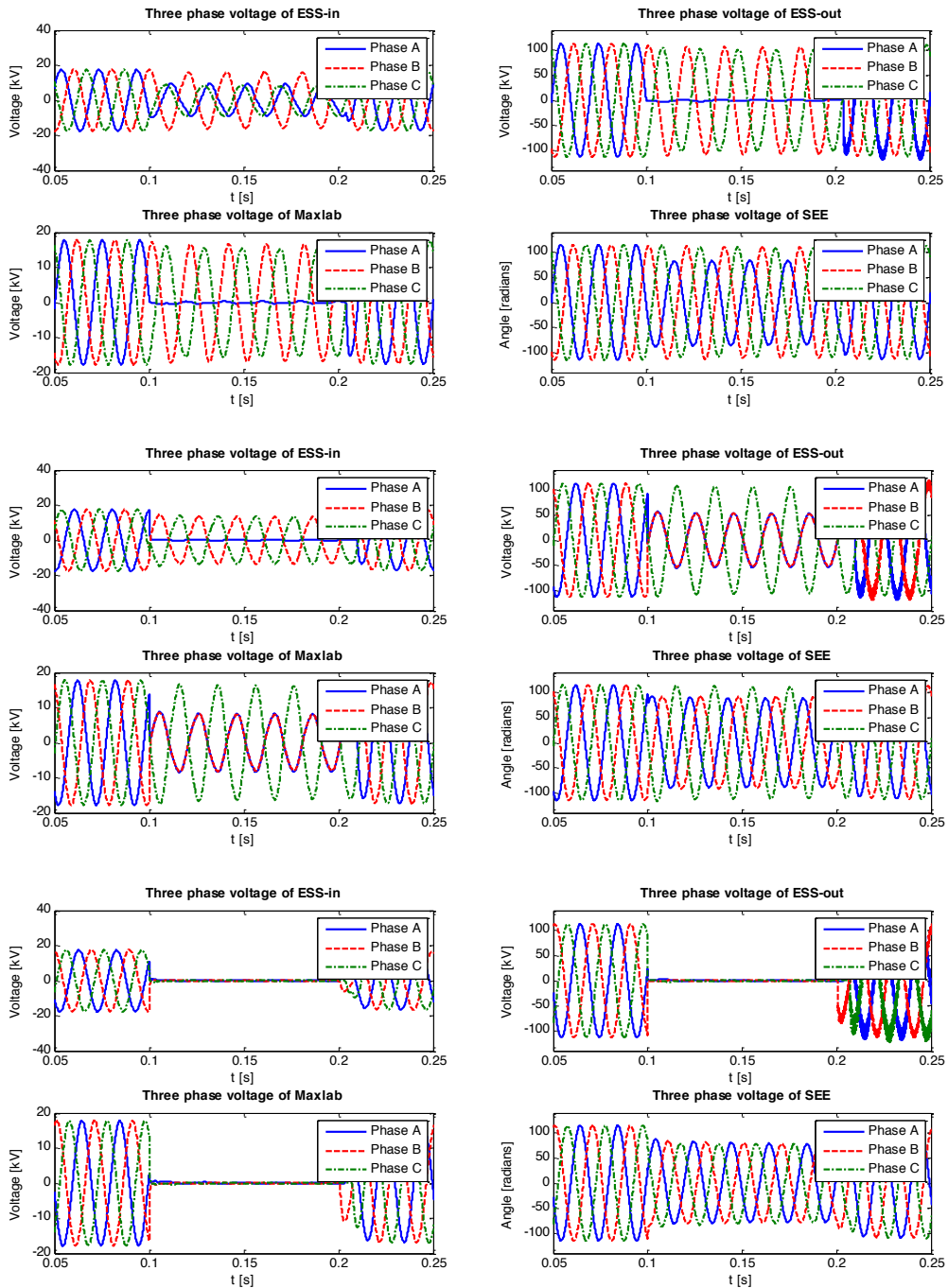

Fig.17: Instantaneous three-phase voltage of buses when different types of short circuit happen at ESS\_out

The instantaneous three-phase voltages of ESS\_in, ESS\_out, Maxlab and SEE are shown in Fig.17. From this point view, regardless of in the fault being single phase L-G, two-phase L-L or three-phase L-G, ESS\_in and Maxlab are sensitive to the fault at ESS\_out while SEE is immune to it.

### 3.2.1.3 Different types of faults at SEE

As SEE is located in the center of Lund grid, which connects with many other buses and supplies a big group of consumers, a series of fault tests is also run here to check the corresponding impacts on the whole grid.

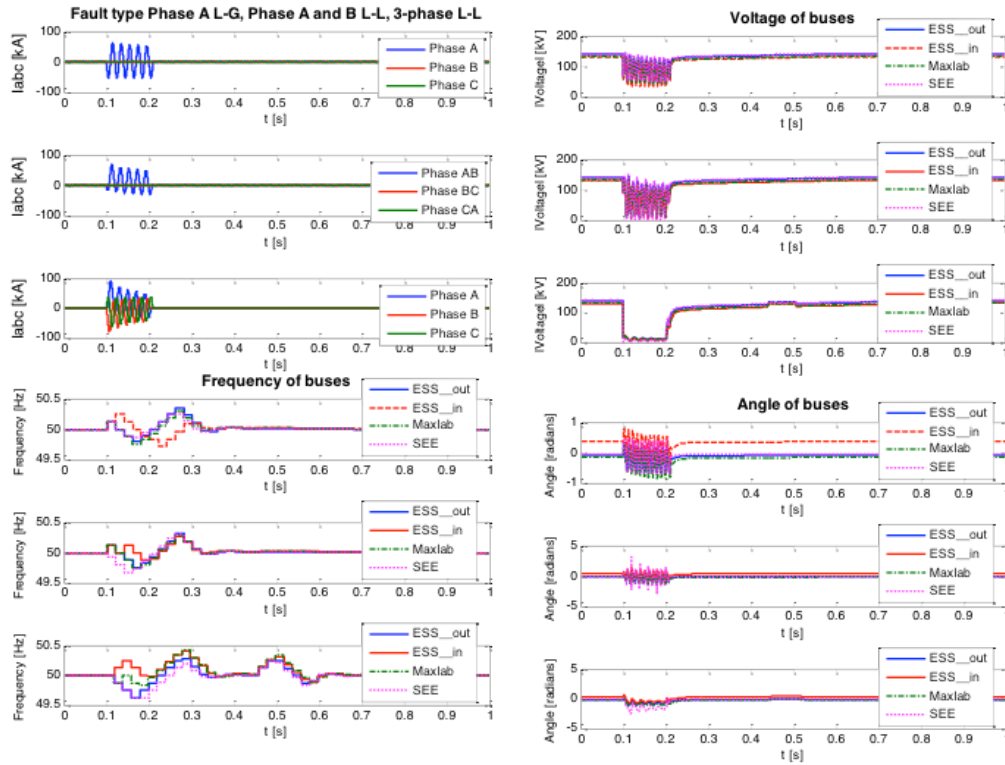

Fig.18: System response with different types of short circuit happen at SEE

As indicated in Fig.18, the impact caused by the faults at SEE is larger and wider than the other fault locations, thus all the buses are closely relevant to this kind of fault, which confirms again the critical role of SEE in the system.

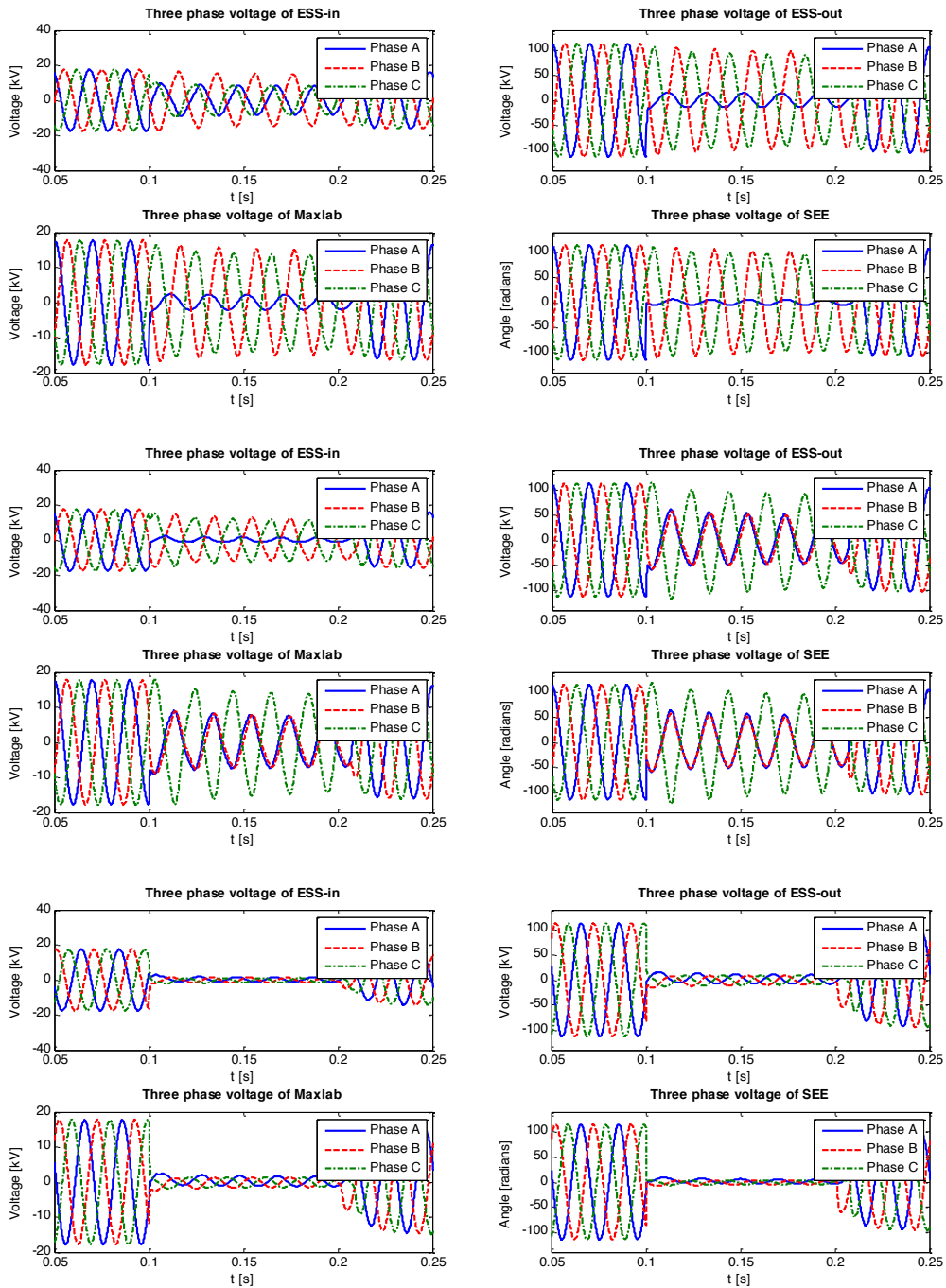

Fig.19: Instantaneous three-phase voltage of buses when different types of short circuit happen at SEE

In Fig.19, seem from the instantaneous three-phase voltages of ESS\_in, ESS\_out, Maxlab and SEE, the faults at SEE have a large and dominant impact on the rest buses of the network.

### 3.2.1.4 Three phase L-G fault at different buses

Based on the previous tests, it is indicated that the influence of fault largely depends on its location. In this test, we attend to show the difference directly.

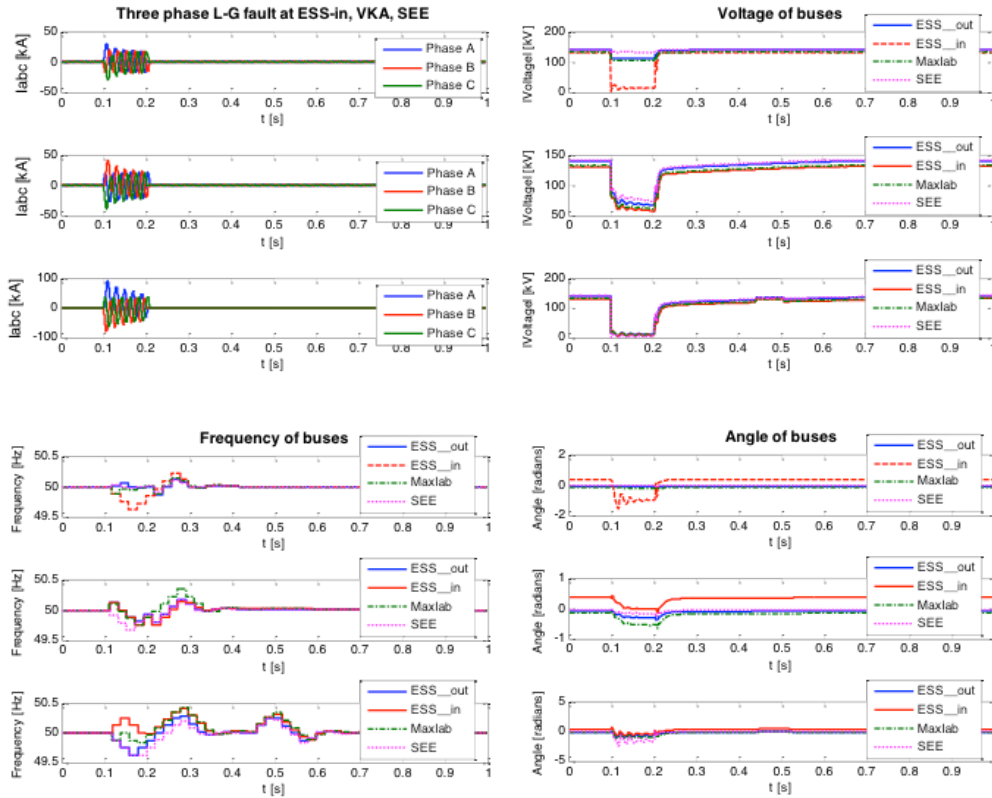

Fig.20: System response with three-phase short circuit at different locations

Seen from the subfigure in the upper left corner of Fig.20, the maximum current short circuit of ESS\_in, VKA, SEE are 30.16, 41.69, 91.29 kA respectively. In the upper right corner subfigure of Fig.20, the average voltages during the transient of faults at ESS\_in, VKA, SEE are 102.35 kV (not account for the ESS\_in), 53.82 kV and 3.49 kV individually. In summary, the impact is increasing when the fault moves from ESS\_in to VKA and further to SEE.

### 3.2.2 Tripping of power source

#### 3.2.2.1 Equivalent high voltage buses

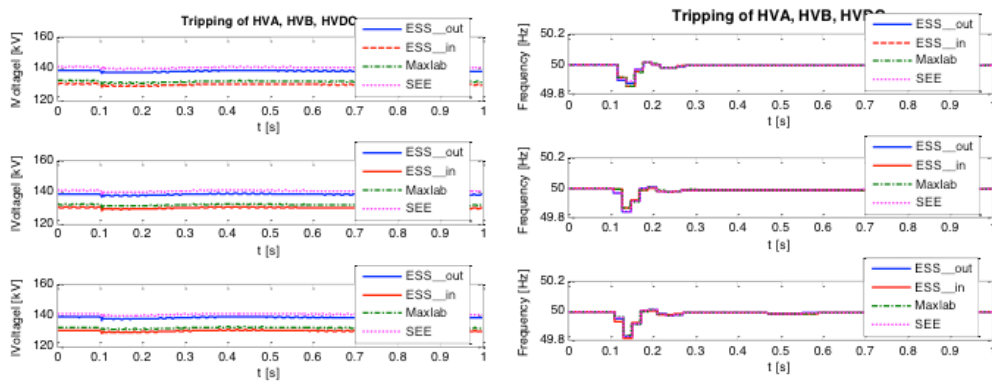

Fig.21: Voltage and frequency variation in case of HVA, HVB and HVDC loss

In this test, although the variations are caused by loss of HVA, HVB and HVDC, the voltage and frequency still remain in the normal range required by the corresponding grid code.

#### 3.2.2.2 Local power plant

Case 1: Tripping of wind farm

Case 2: Simultaneous tripping of Örtofta and Helene

Case 3: Simultaneous tripping of ÖVT Stream and Gas

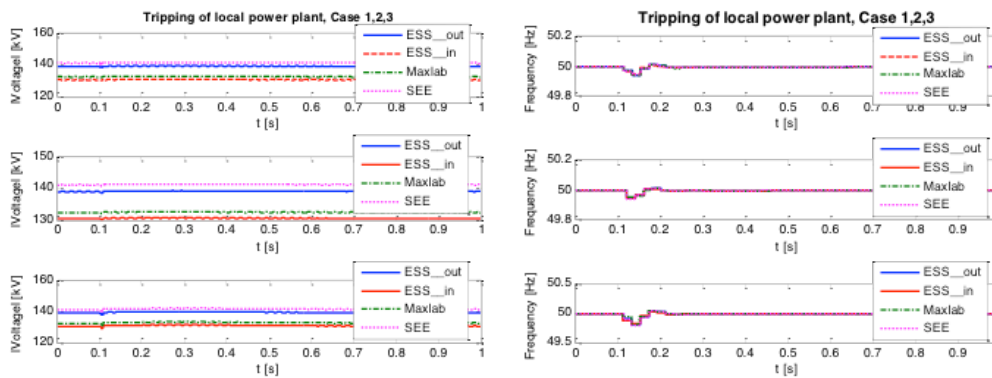

Fig.22: Voltage and frequency variation in case 1, case 2 and case 3

Similar to the tests above, no significant variations are caused in the case 1, case 2 and case 3, so the voltage and frequency still distribute in the normal range.

### 3.2.3 Loss of branches and transformers

#### 3.2.3.1 Loss of branches

Case 1: Simultaneous loss of branches (SEE-ESS) and (ESS-Lund)

Case 2: Simultaneous loss of branches (SEE-ESS) and (HVA-BBK)

Case 3: Simultaneous loss of branches (SEE-ESS) and (SEE-VKA)

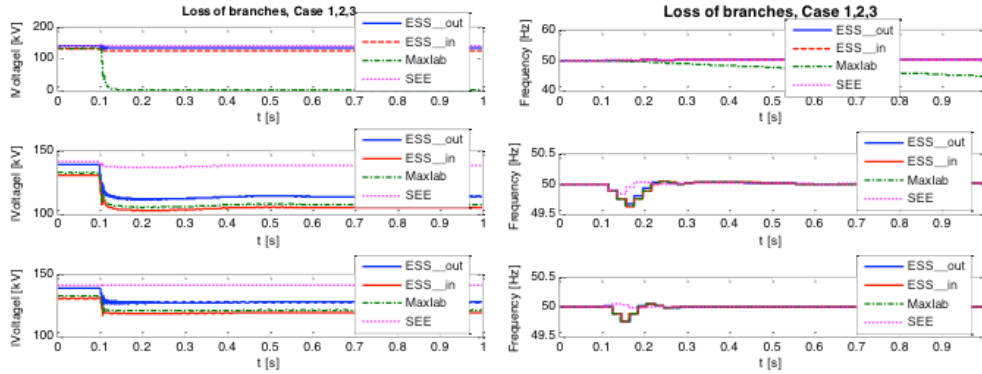

Fig.23: Voltage and frequency variation in case 1, case 2 and case 3

From Fig.23, in case 1, after loss of the branch (ESS-Lund), Bus "Maxlab" loses the power supply, thus its voltage and frequency will decrease to zero gradually. In case 2 and 3, all the frequencies are normal, however, except SEE, the voltage of all the rest buses will fall to voltage level lower than 90% of their original voltages. Attention should be paid to this problem.

#### 3.2.3.2 Loss of transformer T2-ESS

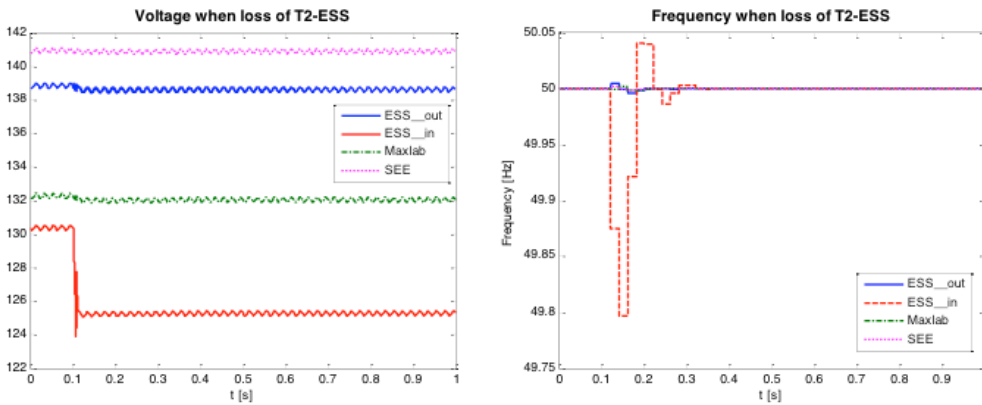

Fig.24: Voltage and frequency variation once the loss of T2-ESS

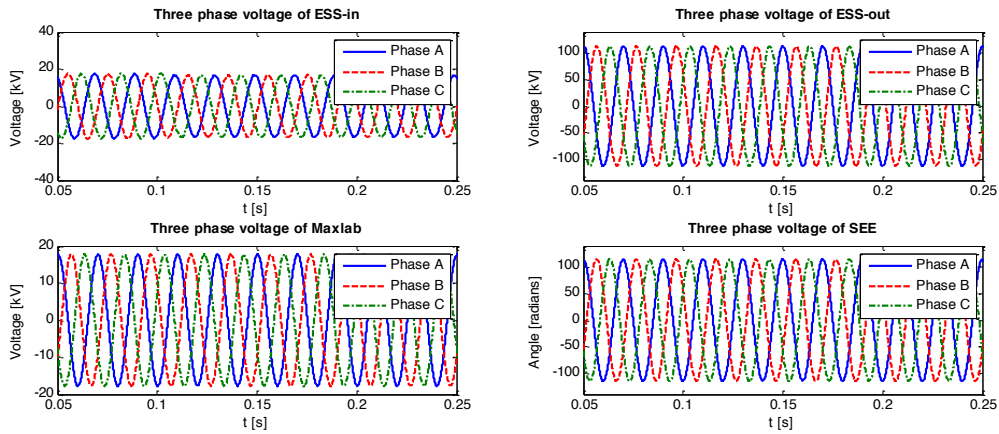

Fig.25: Instantaneous three-phase voltage of buses once the loss of T2-ESS

The maximum total power consumption of ESS could be close to 47 MW, while the capacity of T1-ESS and T2-ESS is 40 MVA for each. Therefore, once any one of the transformers is out of work, there is a potential risk of overload for the other one. Moreover, as shown in Fig.24 and Fig.25, there is a big fluctuation for the frequency of ESS\_in, but it is still in the normal range. For the voltage of ESS\_in, the decrease is over 10%, thus some actions needs to be taken to address this issue.

### 3.2.4 Connection of ESS to Lund grid

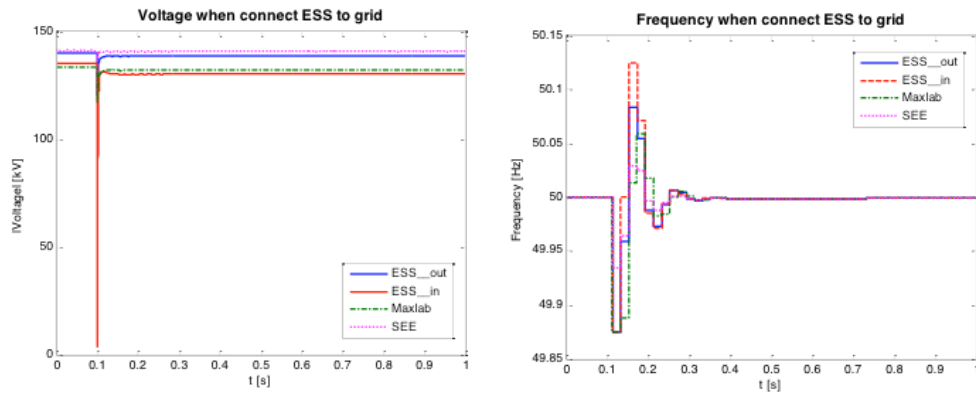

Fig.26: Voltage and frequency variation when connect ESS to Lund grid

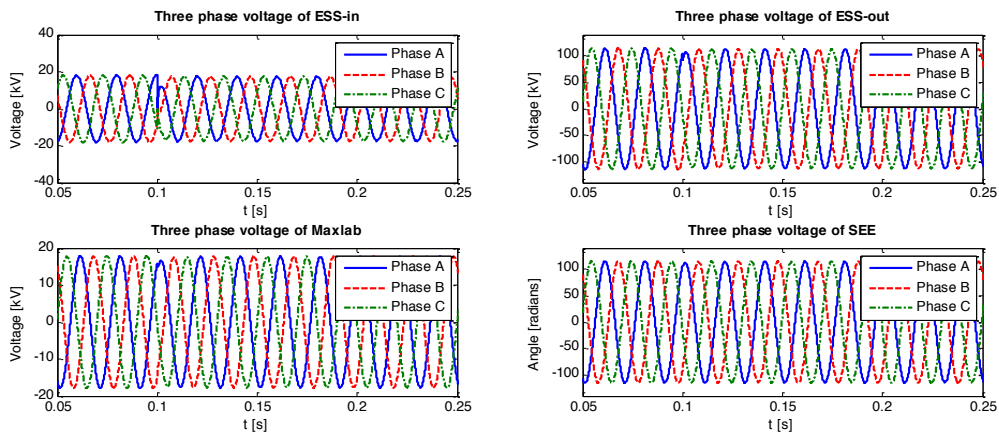

Fig.27: Instantaneous three-phase voltage of buses when connect ESS to Lund grid

Fig.26 and Fig.27 display the voltage and frequency variation as recorded, except for the instantaneous voltage dip appears at ESS\_in, the connection operation of ESS will not cause any other serious problem.



### 3.2.5 Disconnection of ESS to Lund grid

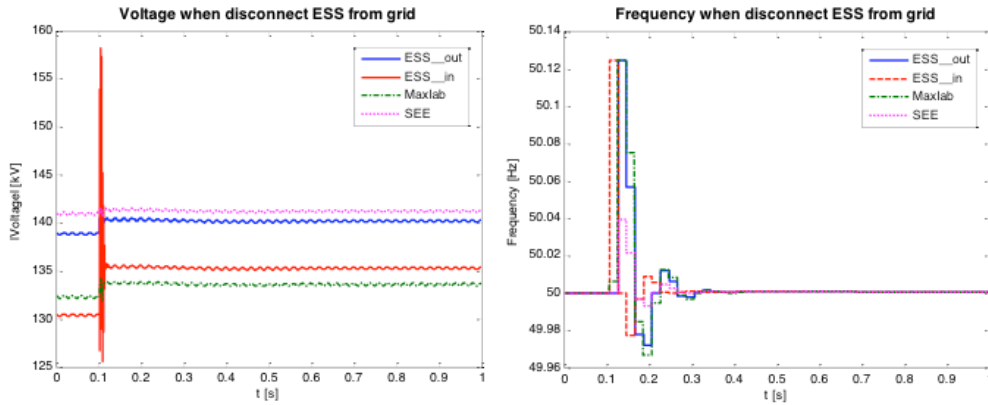

Fig.28: Voltage and frequency variation when disconnect ESS from Lund grid

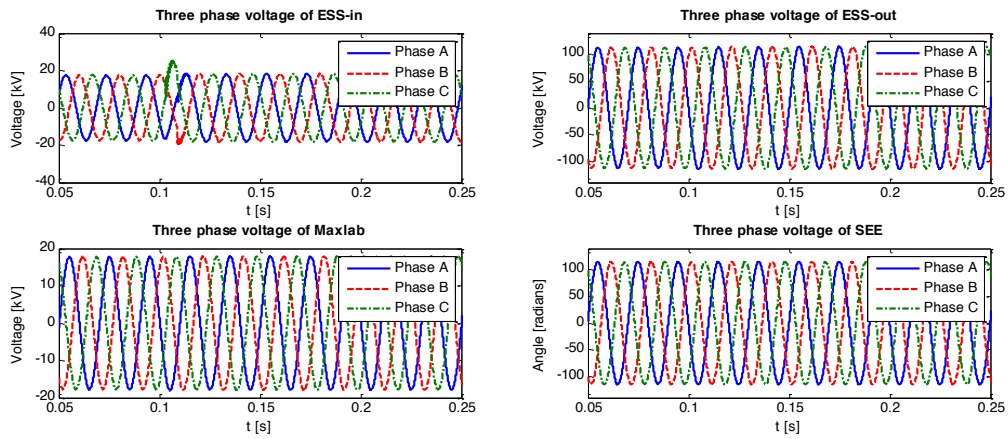

Fig.29: Instantaneous three-phase voltage of buses when disconnect ESS from Lund grid

Seen from Fig.28 and Fig.29, apart from the instantaneous overvoltage and undervoltage occurring at ESS\_in, the disconnection operation of ESS will also not lead to any other serious problem.

### 3.2.6 Load of ESS with Charging scheme I and III

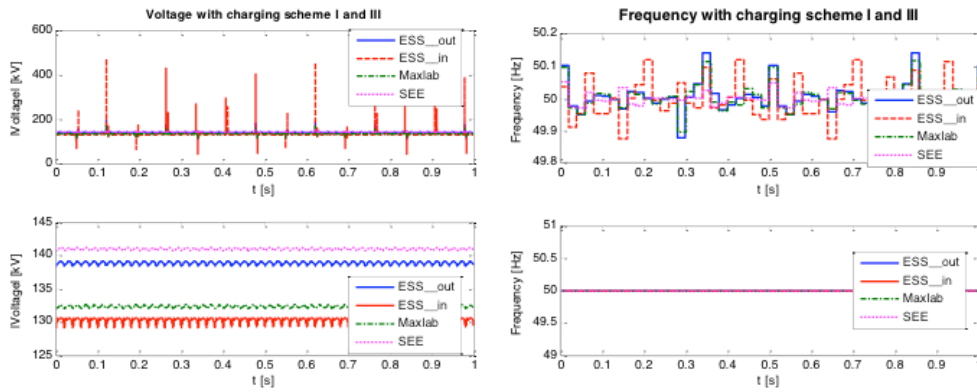

Fig.30: Voltage and frequency variation caused by different charging schemes of ESS load

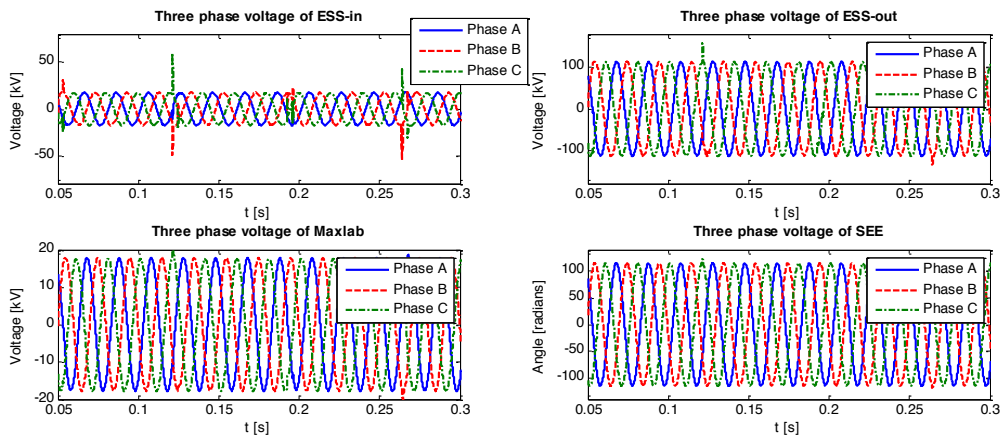

Fig.31: Instantaneous three-phase voltage of buses with charging scheme I for ESS load

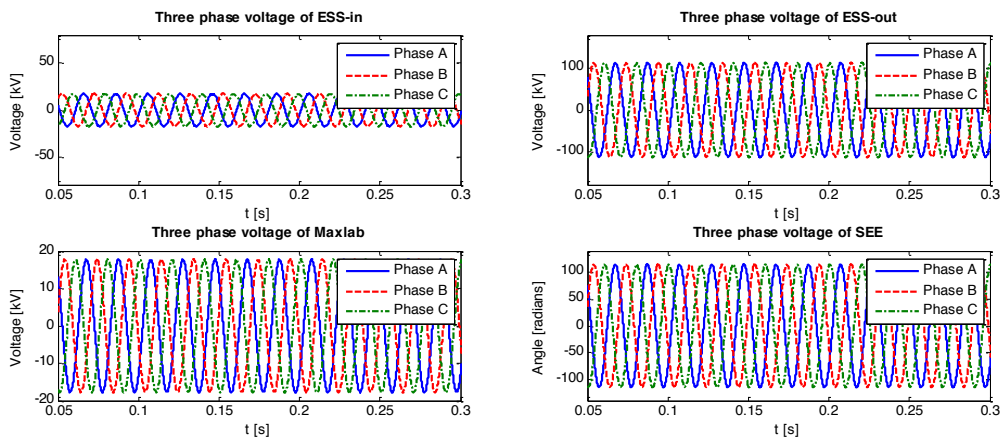

Fig.32: Instantaneous three-phase voltage of buses with charging scheme III for ESS load

Combining the results shown in Fig.30, Fig.31 and Fig.32, we can conclude that the voltage fluctuation is too severe especially for ESS\_in itself with charging scheme I. This is unacceptable, thus charging scheme III is a better choice relatively in this aspect.

### 3.2.7 Harmonic tests at different buses

Harmonics have been the main concern of the power systems till now. As power electronics are applied more frequently than before, this problem becomes more evident. In this project, the power to the klystrons will be provided with power electronics thus harmonics will be introduced to ESS grid but also to the Lund grid. Up to now there has been no co-simulation with ESS grid and Lund grid, so some ideal harmonic sources are added at different locations to observe the effect in the simulation.

#### 3.2.7.1 At ESS\_in with THD (1.94%, realistic control data)

Order	2nd	3rd	4th	17th
Harmonics magnitude	0.8%	1.5%	0.8%	0.5%

Table 8. Compositions of harmonics with thd 1.94%

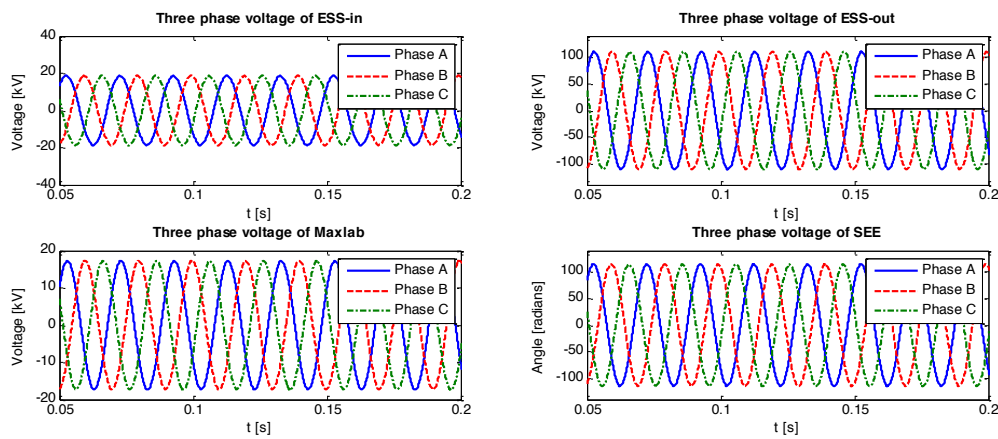

Fig.33: Instantaneous three-phase voltage of buses when low harmonic source at ESS\_in

For a good control approach for the power electronics, the harmonic is very slight that will not have a too adverse impact to the power quality of the other buses. This can be judged from the resulting THD of Maxlab, ESS\_in, ESS\_out and SEE: 0.47%, 2.06%, 0.52% and 0.47%, when the harmonics source located at ESS\_in. The compositions of caused harmonics are shown in table 8.

### 3.2.7.2 At ESS\_in with THD (8%, limit in the standard)

Order	2nd	3rd	5th	7th
Harmonics magnitude	1.5%	5%	5%	3.5%

Table 9. Compositions of harmonics with thd 8%

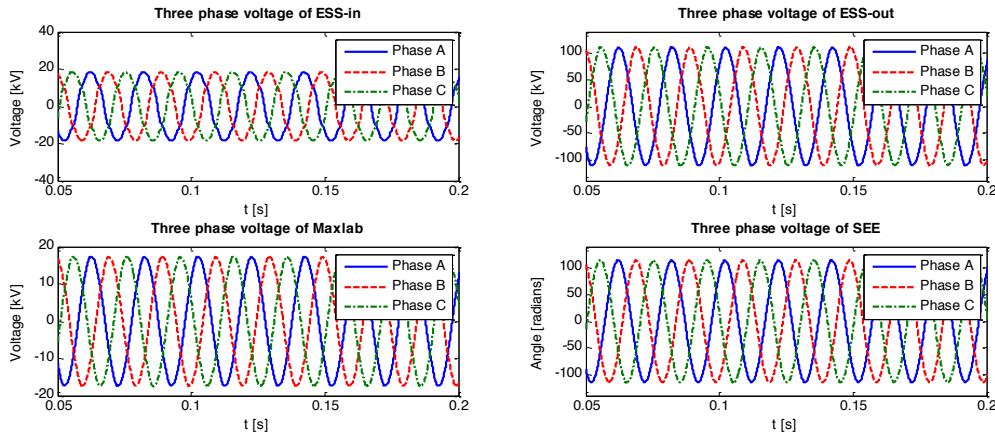

Fig.34: Instantaneous three-phase voltage of buses when high harmonic source at ESS\_in

To check the extreme case, harmonics with THD 8% is applied at ESS\_in, consequently THD of Maxlab, ESS\_in, ESS\_out and SEE are 1.22%, 8.04%, 1.31% and 0.55% respectively. The harmonics with THD 8% are generated according to the compositions as shown in TABLE IX. In the following tests, the same compositions are applied to all the harmonics with THD 8%.

### 3.2.7.3 At SEE with THD (8%, limit in the standard)

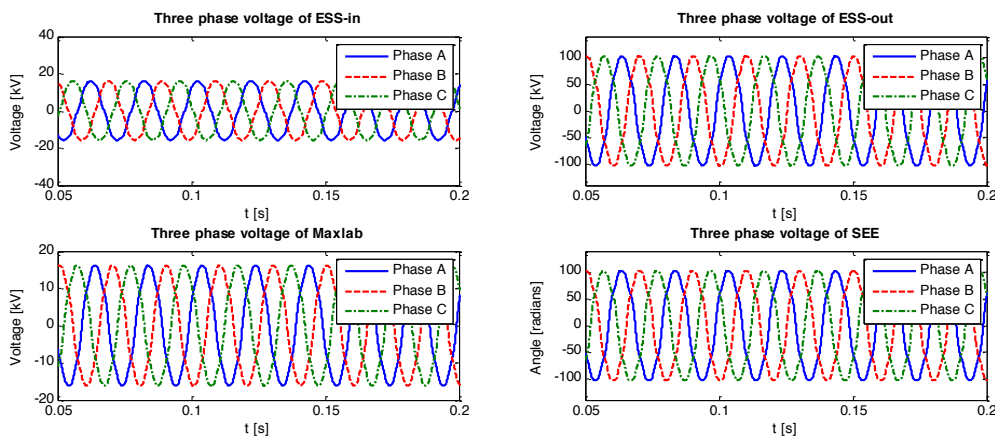

Fig.35: Instantaneous three-phase voltage of buses when high harmonic source at SEE

To check the extreme impacts at different locations, harmonics with THD 8% is applied at SEE, resulting that THD of Maxlab, ESS\_in, ESS\_out and SEE are 6.1%, 4.82%, 6.43% and 8.03% respectively.

### 3.2.7.4 At Maxlab with THD (8%, limit in the standard)

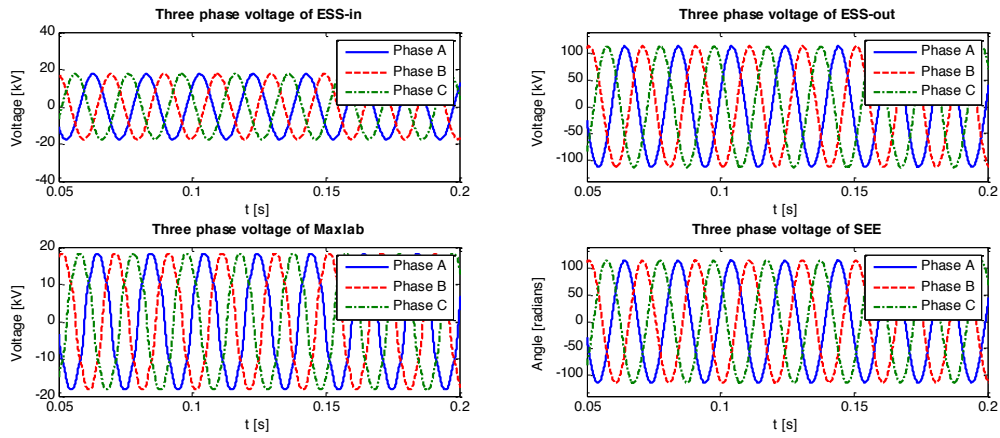

Fig.36: Instantaneous three-phase voltage of buses when high harmonic source at Maxlab

To check the extreme impact due to different locations, harmonics with THD 8% is applied at Maxlab, and it results in that THD of Maxlab, ESS\_in, ESS\_out and SEE are 8.04%, 0.75%, 0.87% and 0.5% respectively.

To conclude, many nodes are unavoidable to experience the adverse impact from harmonics in different degrees, depending on the locations of the harmonics and the nodes. From harmonics to the suffering nodes, the impact decreases in the process of propagation. To some extent, a good control approach can effectively reduce the harmonics at the source. Otherwise, some preventions (e.g. harmonics filters) must be taken at the sensitive and influential nodes, such as SEE in the Lund grid.

### 3.2.8 Impact of wind farm with different generation ratio

To check the impact of the wind farm on the grid operation, different generation ratios of 0%, 50%, 100% are tested in simulation. The analysis focuses on the power flow.

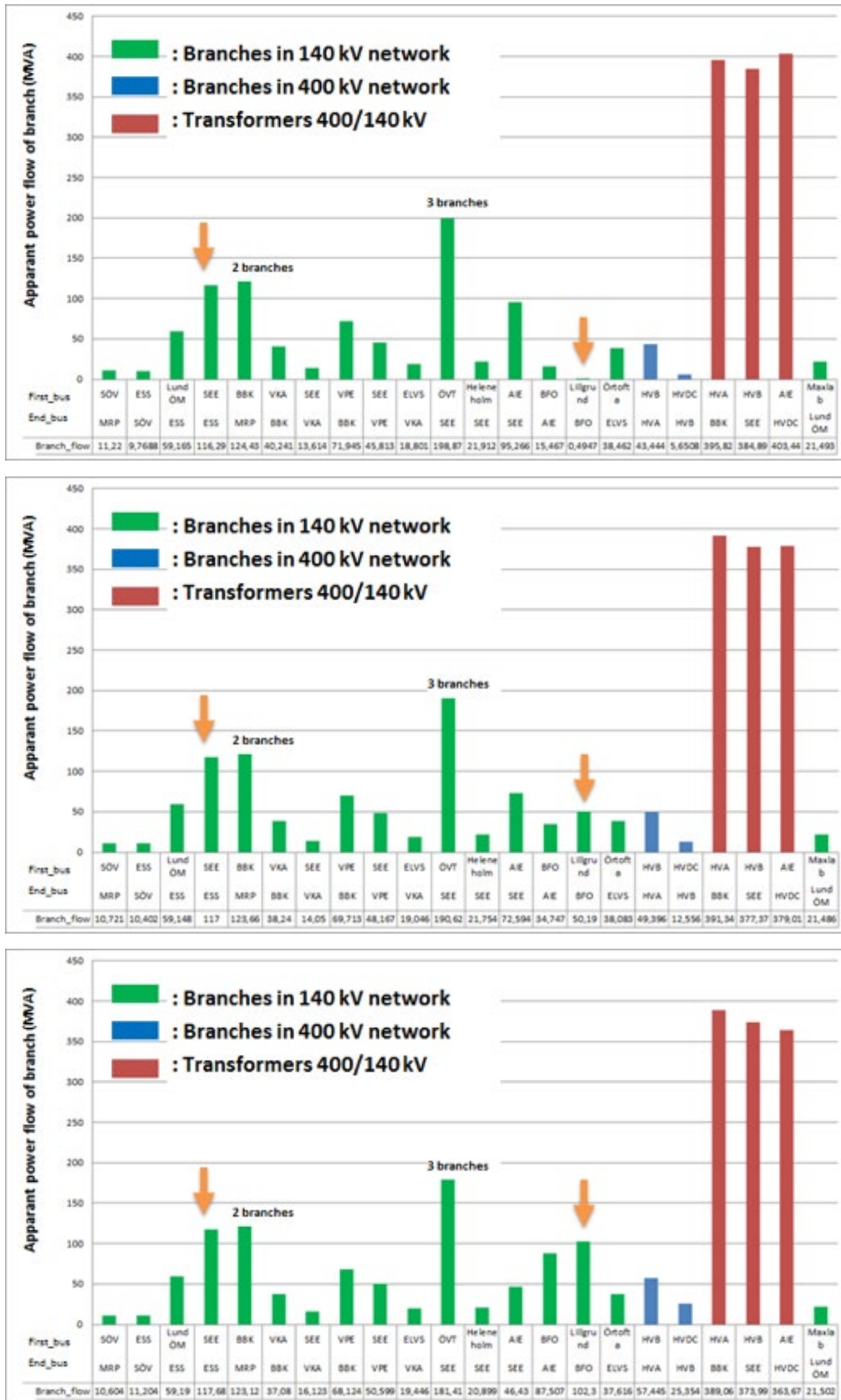

Fig.37: Distribution of branch power flows with 0%, 50% and 100% integrated in Lund grid

As shown in Fig.37, the three transformers (400/140 kV) deliver most of the power to the loads of Lund grid in all the cases. Attention needs to be paid to the branches (SEE-ESS) and (Lillgrund-BFO), as branch (SEE-ESS) transfers more power than the others among the single branches while branch (Lillgrund-BFO) is the unique path connecting the wind farm with Lund grid. With the generation of the wind farm increasing, power flow through branch (Lillgrund-BFO) grows obviously, but there is no big difference for branch (SEE-ESS). The other branches or transformers, although more or less change in power flow can be observed, they are not discussed further here. In a word, due to the power being mostly provided by transmission network, the impact aroused by the wind farm (located at Lillgrund) is limited, from the point view of power flow.

### 3.2.9 Uncertainty analysis for the variation of loads and wind farm generation

Most of the previous analysis is based on the steady and transient states, however, the dynamic behavior of power system is still not reflected. Normally, the dynamic variation is determined by the fluctuation in load and intermittent distributed generation (DG). Thus, their impacts are always stochastic on the operation of power systems. In this project, the five biggest load buses including ESS, AIE, MRP, SEE and VPE are selected to investigate the random load variation. Uniform distribution is assumed to describe the load variations according to the information in Fig.5.

Meanwhile, a Weibull distribution is adopted to consider the wind speed. Combined with technical parameters (only about the wind speed part) of the Siemens SWT-2.3-82, the power generated by the wind turbines is simulated. The single wind turbine power generation is then multiplied by a ratio to equivalently model the output of the complete wind farm.

On one hand, the recordings from RTDS simulation have corresponding time tag, which means the results can be observed from time histogram. We want to highlight that this does not correspond to any load profile, but only to generate the different scenarios for Monte Carlo test. Due to the sampling frequency is 20 kHz in RTDS and the total simulation time is 100 s, thus there are totally 125000 time points recorded for each state. Loads and generations of the wind farm change once per 0.1 s, while the change is decided by the random values which have been generated according to the corresponding distributions in advance. On the other hand, we attempt to analyze statistical characteristics of these data, thus frequency histogram is applied for this purpose.

#### 3.2.9.1 Frequency histogram of frequency, voltage magnitude and phase angle

According to the recordings from RTDS simulation, the corresponding frequency, voltage magnitude and phase angle of each bus under variations of five large load consumers and the wind farm are obtained. Based on the statistical analysis (Monte Carlo approach), the frequency histogram of all the states are drawn, as shown from Fig.38 to Fig.40. Due to the limited space, only the results of HVA, ESS, MAXLAB, SEE, Lillgrund and ELVS are displayed here.

- For the voltage magnitude, different voltage levels are distinguished by different colors. As indicated in Fig.38, different statistical appearances highly depend on the different locations in the grid;
- For voltage phase angle, they are distinguished by different colors as well according to the buses at different voltage levels. Seen from Fig.39, the shapes look similar to each other, however there are big differences in the range. This is determined by the impedances of the branches and the branch power flows jointly;
- For frequency, both shape and range of each bus are nearly identical. This is not surprising as the system should be synchronously running all the time, otherwise there is or will be potential problem for the stability and safety of the system.

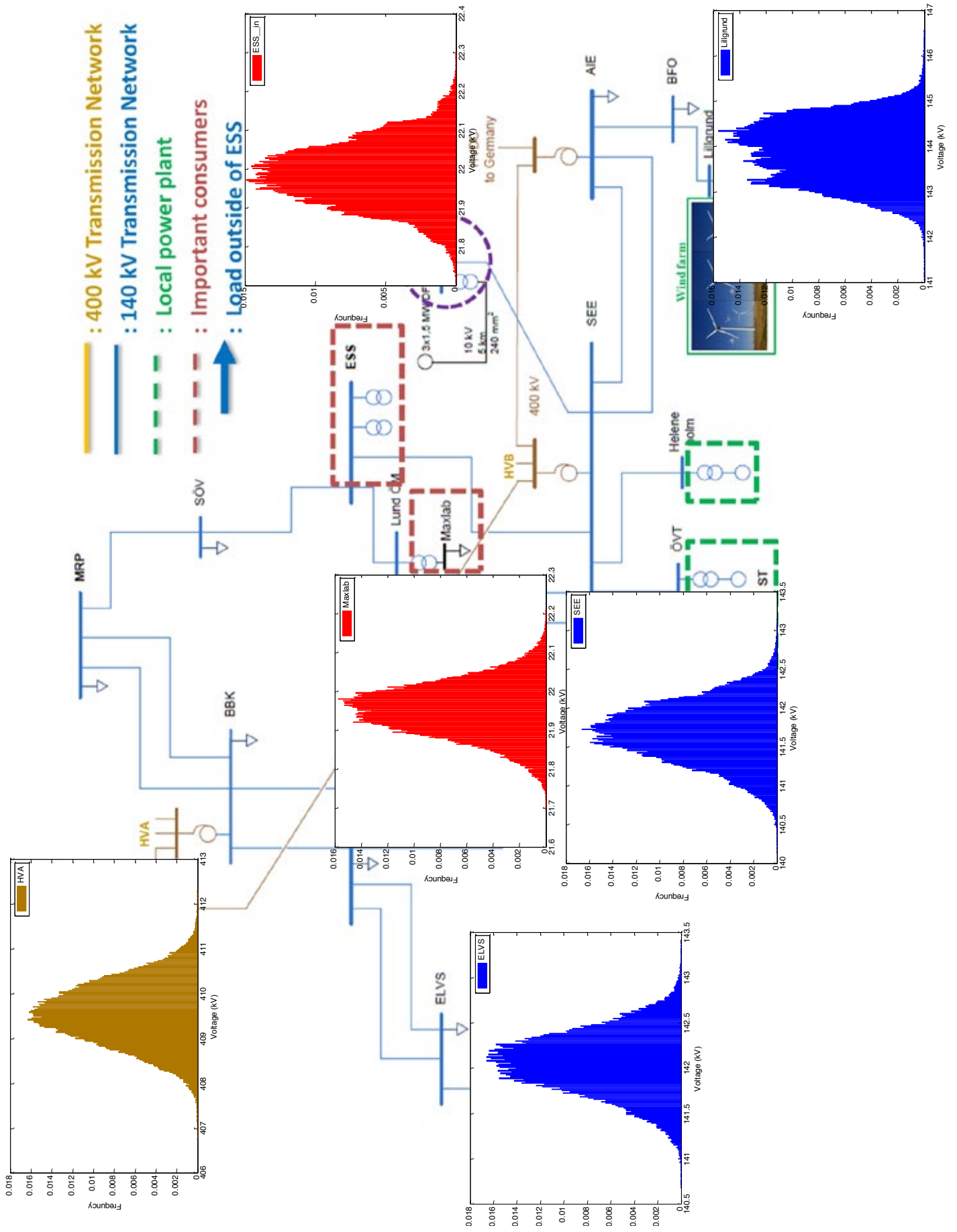

Fig.38: Frequency histogram of voltage magnitude of buses in Lund grid



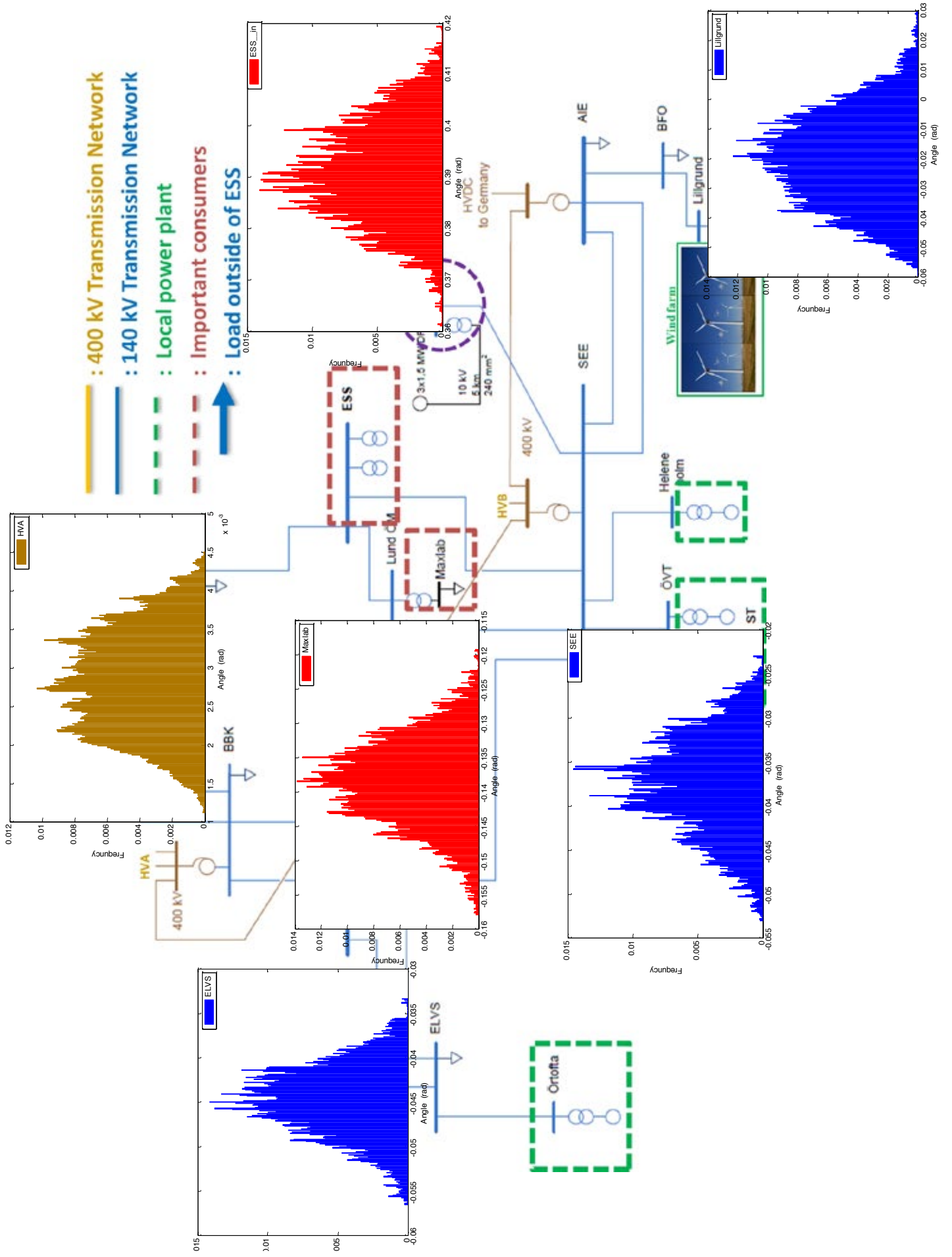

Fig.39: Frequency histogram of voltage phase angle of buses in Lund grid

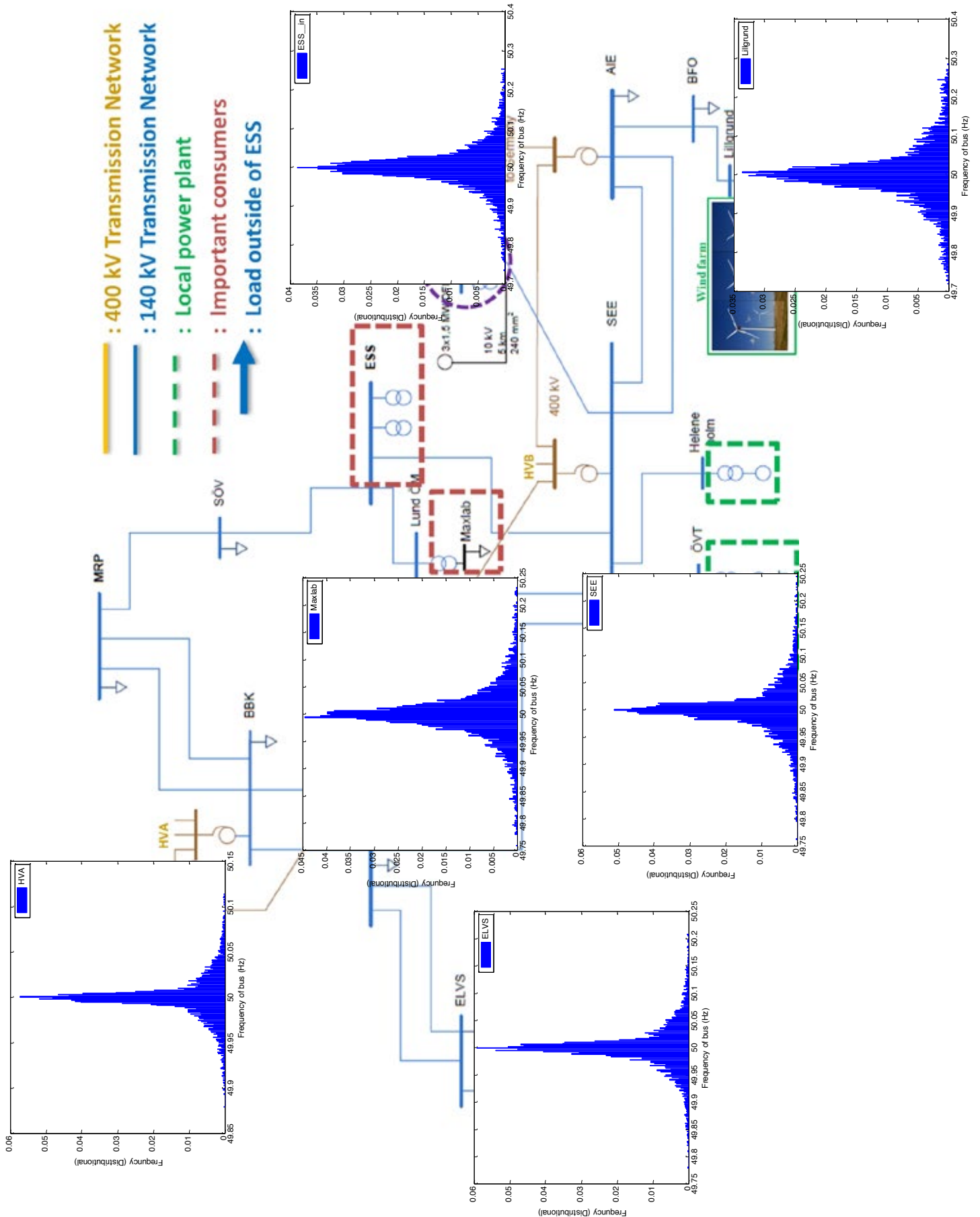

Fig.40: Frequency histogram of frequency of buses in Lund grid

### 3.2.9.2 Varying range of voltage magnitude, phase angle and frequency of each bus

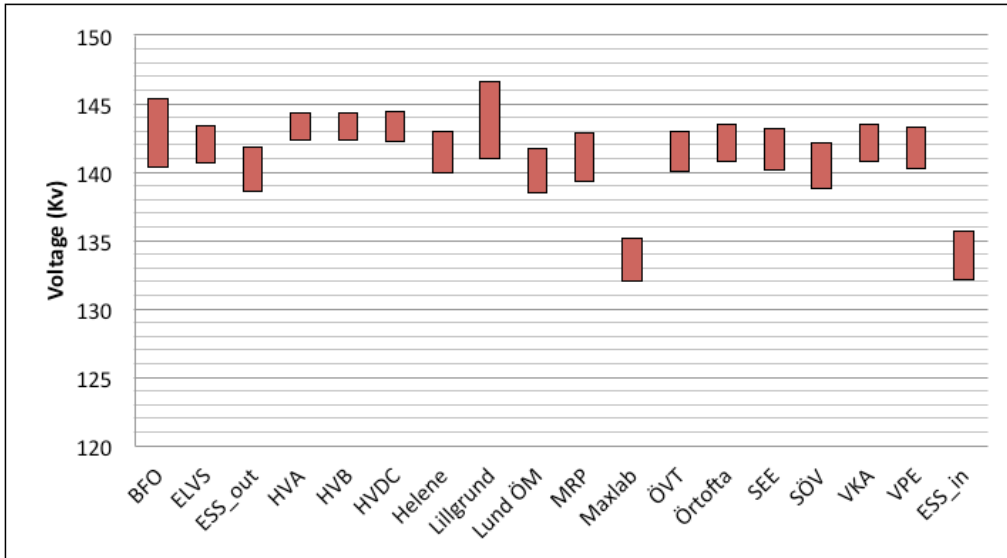

Fig.41: Varying range of voltage magnitude

In Fig.41, more detailed differences can be inspected by comparing the individual voltage of frequency histograms. Currently, as no large-scale distributed generations (DGs) are located in the Lund grid, the power flow is still unidirectional and vertical. Thus, the voltage drops gradually from power sources to the end load buses. It is evident that the voltage is more stable at the strong power sources, e.g. HVA, HVB and HVDC, which can be reflected from their smaller range of voltage variation.

While for the phase angle, as shown in Fig.42, it is not difficult to find that HVA is selected as the slack bus with zero angle. For most phase angles, they always stay at low positive or negative values. Except for Lillgrund located next to the wind farm, that is because the volatile wind speed leads to uncertain wind power generation, without considering any control. As a result, the angle oscillation at Lillgrund is the most severe. Attention should be paid to for the angle of ESS\_in, owing to the phase shift caused by the newly added transformers (Y- $\Delta$  wiring) between ESS\_out and ESS\_in, the angle of ESS\_in stays far from the other buses.

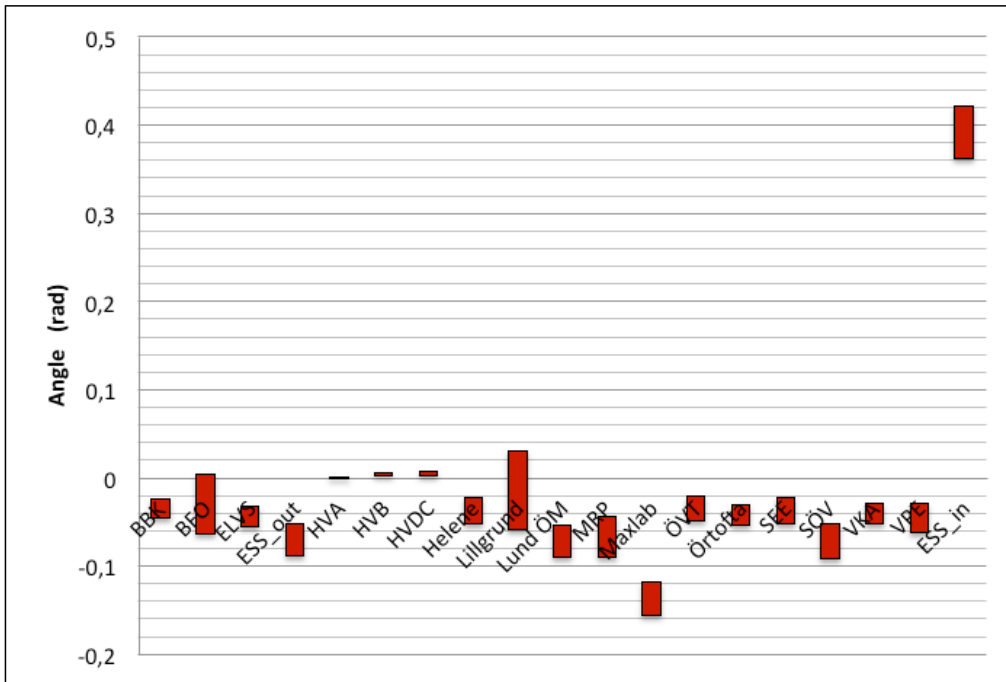

Fig.42: Varying range of voltage phase angle

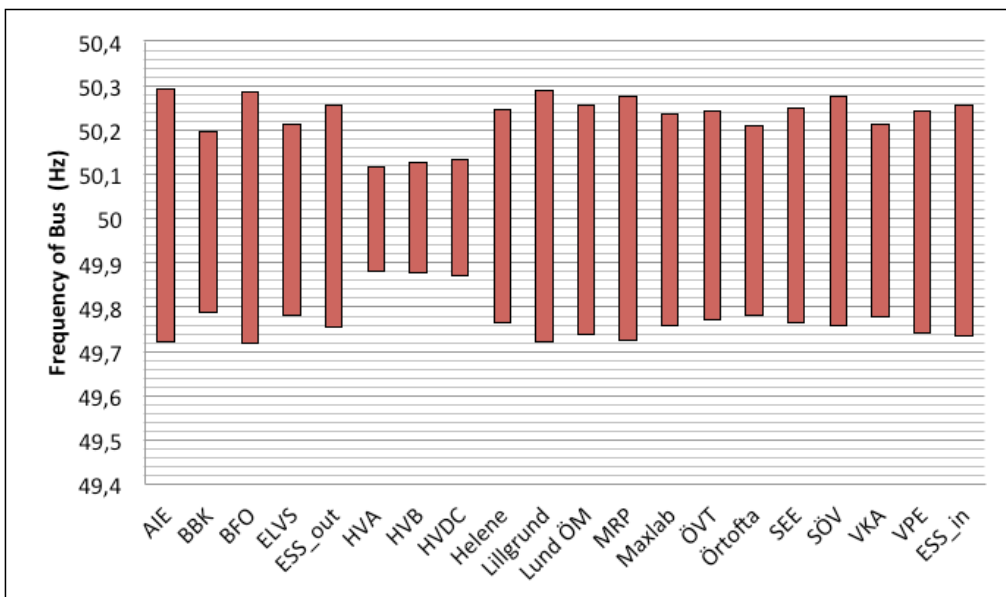

Fig.43: Varying range of frequency

The range of frequency variation of each bus is displayed in Fig.43. Similar conclusions can be obtained as in voltage magnitude that strong power sources are also able to keep stable in frequency. The frequencies of Lillgrund (wind farm) and its neighbor buses including AIE and BFO, oscillate more seriously than the others.

### 3.2.9.3 Time histogram of large power consumption

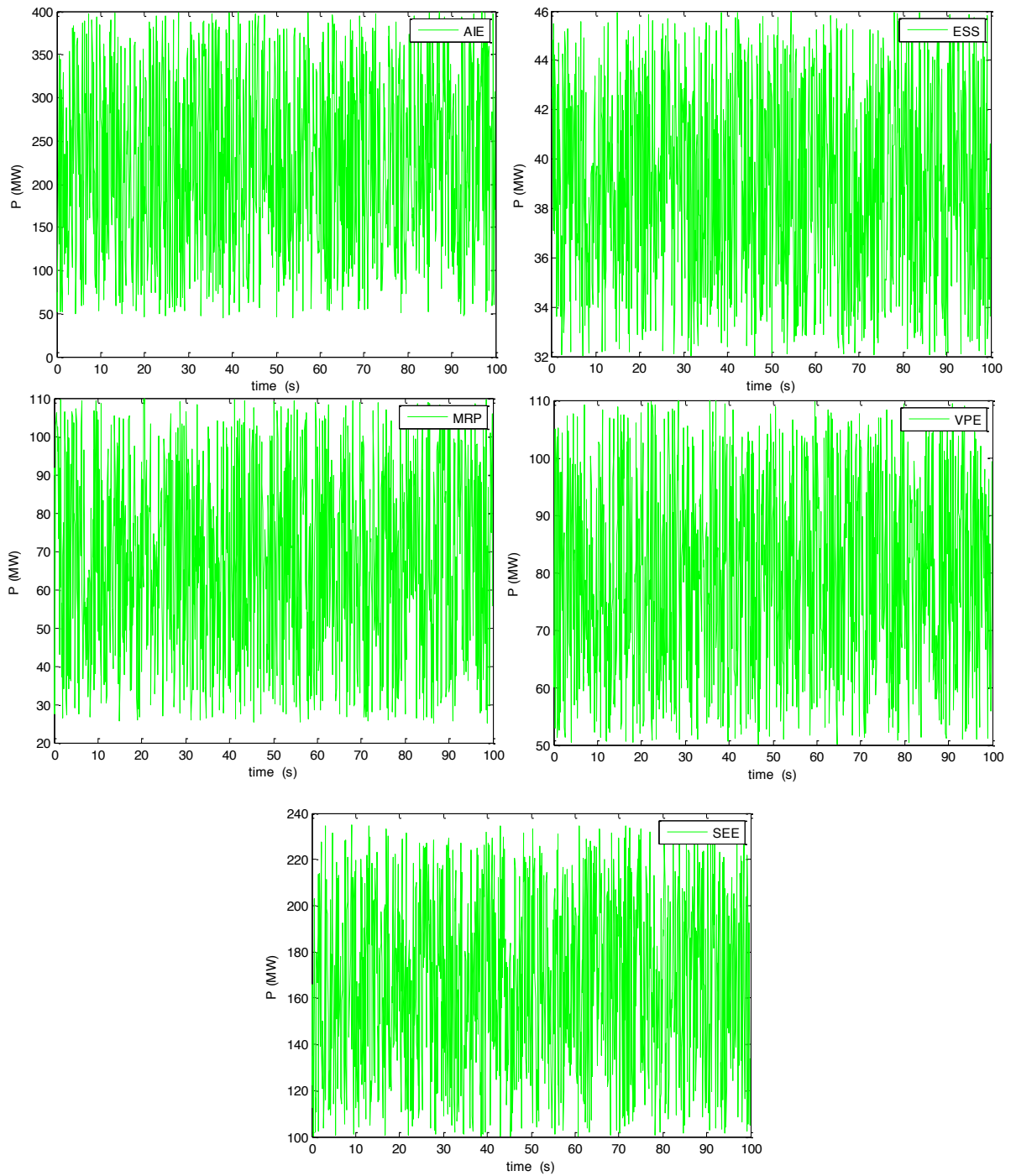

Fig.44: Time histogram of large load variation

As mentioned previously, the variation of the five large loads are assumed to follow the uniform distribution, in order to simulate the real behavior of power consumers. Together with the simulated behavior of wind farm's generation, many scenarios about the realistic operation of power systems are considered in the simulation.

### 3.2.9.4 Time histogram of voltage magnitude of different buses

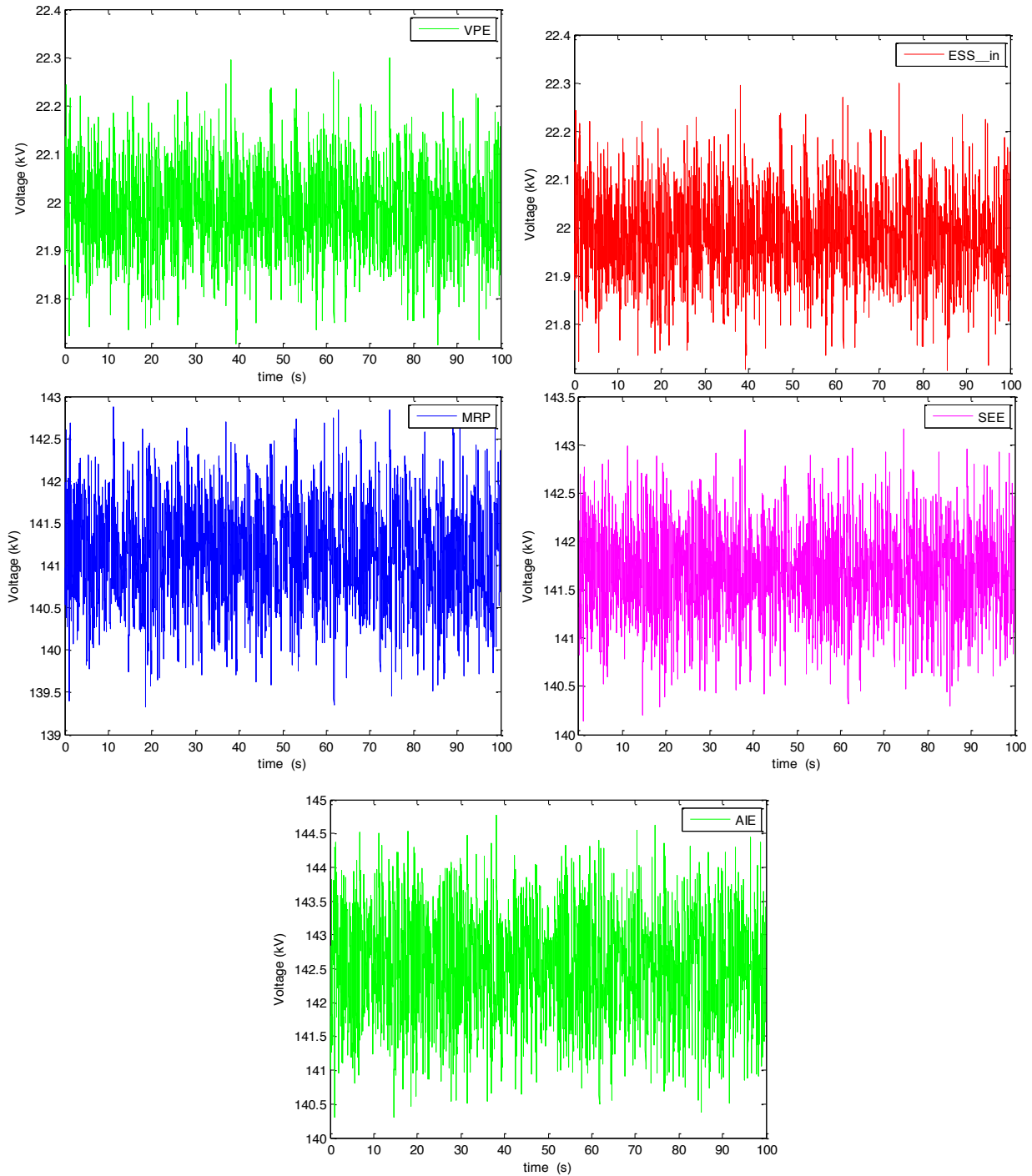

Fig.47: Time histogram of voltage magnitude at different buses

Fig.47 shows the voltage magnitude of some selected buses varying with time, according to the simulation results.

### 3.2.9.5 Time histogram of voltage phase angle of different buses

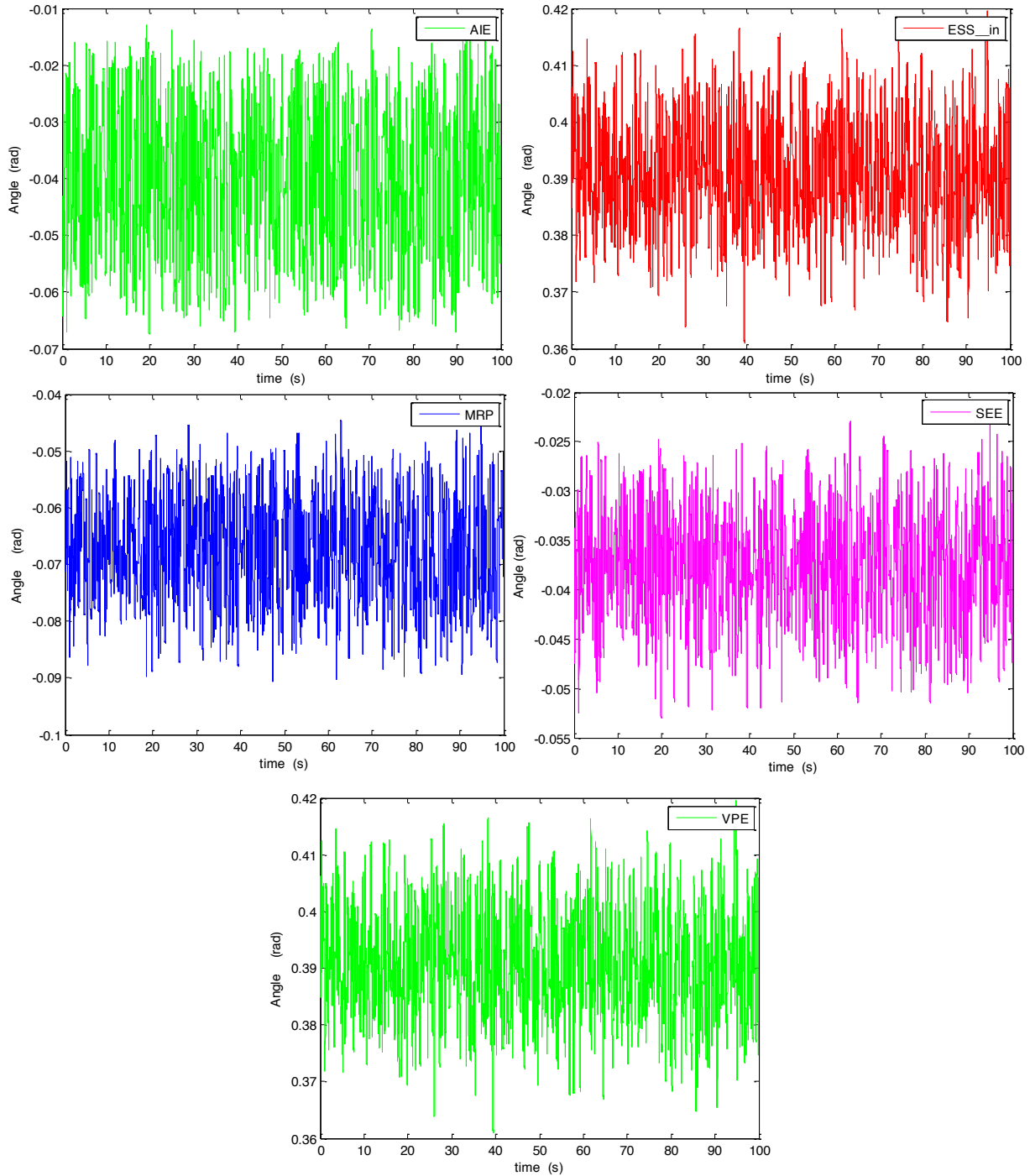

Fig.48: Time histogram of phase angle at different buses

Fig.48 shows the phase angle of some selected buses changing with time, on the basis of the simulation results.

### 3.2.9.6 Time histogram of frequency of different buses

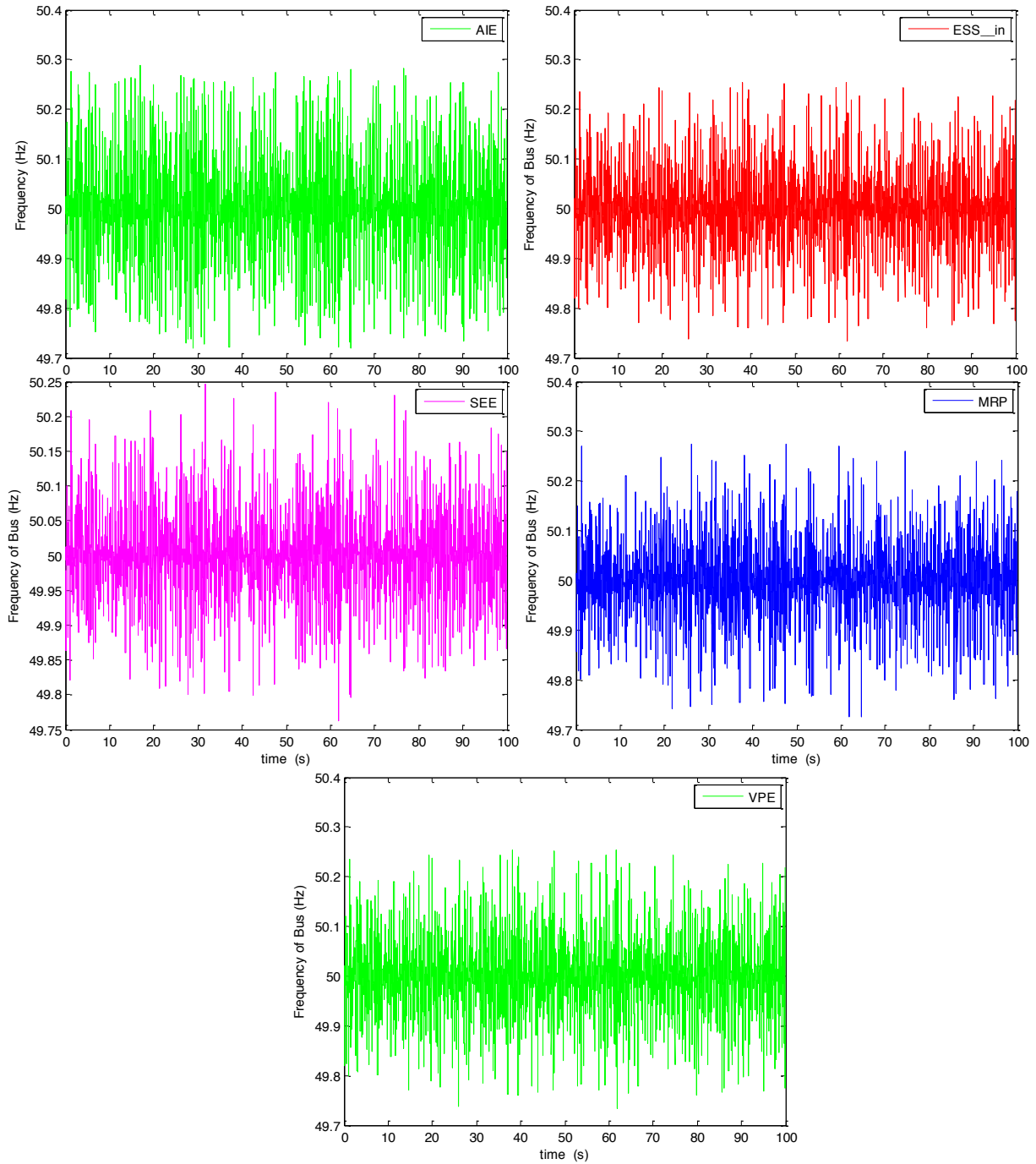

Fig.49: Time histogram of frequency at different buses

Fig.49 indicates the time-related behavior of some selected buses in terms of frequency, based on the simulation recordings.



### 3.2.9.7 Frequency and time histogram of power generation from wind farm

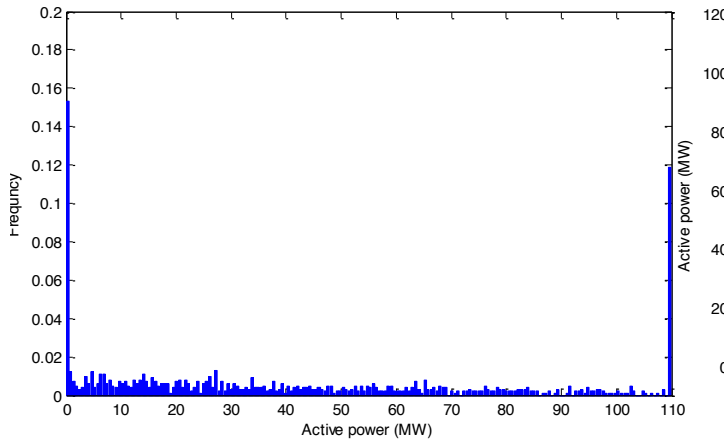

Fig.50: Frequency histogram of frequency of buses in Lund grid

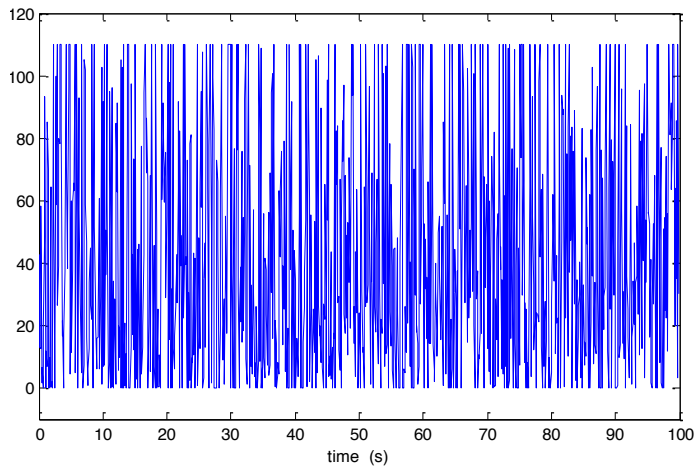

Fig.51: Time histogram of frequency of buses in Lund grid

According to the results in Fig.50, it indicates that the wind farm's power output are more probable to distribute at zero or rated power generation, which is decided by the characteristics of the wind turbines. In Fig.51, as the amplitude of the variation is very large with time, it can be regarded as the biggest uncertainty source in this project. More tests are planned to run in the next steps.

## 4. Conclusions

- Impedances of transformers T1-ESS and T2-ESS highly decide the short circuit current of ESS\_in, while the transformers' isolation from the external influences seems not significant based on the observations;
- To some extent, the newly added wind farm has an impact on the steady-state power flow distribution of the whole grid; Furthermore, it plays a critical role in the uncertainty analysis for dynamic process;
- Various kinds of short circuit faults are tested at different locations. In summary, the three phase L-G short circuit introduces the worst influence to the grid, and even the impact can be amplified at some sensitive bus, e.g. SEE in Lund grid;
- In the fault tests on components of power systems, the loss of branches is more challenging than the tripping of power sources for the operation of the whole grid; in addition, the loss of T2-ESS will bring large influence to the power quality of ESS\_in locally;
- Operations to connect/disconnect ESS to/from Lund grid, leads to a transient impulse especially in terms of voltage that overvoltage or undervoltage sustains for a very short time;
- Charging scheme I for the klystron modulators seriously disturbs the power quality of buses in Lund grid, thus Charging scheme III could be a rational choice;
- Harmonics have been added into simulation with sample voltage sources. Preliminary investigations show that a proper control approach can reduce the harmonics, and the impact of harmonics on the surroundings decrease in the propagation. Deeper research about the harmonics filter design is needed in next step;
- Unlike the conventional steady and transient tests, a dynamic test is executed with considering the stochastic changes of selected big loads and power output of wind farm varying with time. Combined with uncertainty analysis, the stochastic and comprehensive states of each bus in the dynamic process are obtained. This interesting and innovative analysis will proceed in next step.

# Chapter 8

## ESS Energy Design Report

# Conclusions

This report demonstrates that the implementation of the ESS Energy Concept is feasible. It describes systems and methods that are very close to achieving all the energy goals, and a clear path forward to achieving and surpassing all of them.

Three aspects of viability are explored. First and foremost, in this report, is the technical viability. Power and cooling are critical systems to ESS operations and high reliability is therefore required. The proposed closed-loop cooling system, based on heat exchangers and heat pumps, rather than cooling towers, eliminates the risks of contamination associated with open systems.

The second aspect of viability is environmental. Compared to the same facility built conventionally, the ESS with the proposed energy solutions avoids CO<sup>2</sup> emissions of 190,000 tonnes per year for 40 years: 40,000 tonnes come from reduced power demand, 135,000 from using renewable sources from the remaining demand, and 15,000 tonnes per year is from the recycled heat replacing other heating sources in the district heating system. The reduced power demand is calculated from a baseline figure of 350 GWh, set in 2008. The CO<sup>2</sup> emissions from power demand are calculated using the effect of marginal production in the Nordic system.

The third aspect of viability is financial. The business cases indicate profitability levels sufficient to attract necessary investment capital and to contribute to offering ESS a competitive and stable cost structure for the duration of operations. The net benefits, after financial costs, are estimated at 8-10 million euros per year. Of these, 4 million are savings from reduced power demand. The renewable energy solution is expected to deliver 3-4 million euros net, compared to corresponding purchases of power on the open market. In addition, ESS long-term risk exposure to energy market fluctuations is greatly reduced. The financial "cushion" is achieved due to the fact that the ESS will have its own energy production facilities – when electricity prices are high, ESS would both pay the high prices but also incur high revenues, thus creating a net risk considerably lower than being exposed to the highly fluctuating electricity market without own production. This is not a trivial achievement. The energy costs are, after staff, the largest operating expense for a facility like ESS and by far the most volatile cost. Rising energy costs are therefore the greatest risk to operations in the operations cost budget.

The proposed solutions, without the benefit of the additional improvement that can be expected and is envisioned in the business plans, will bring ESS to the brink of fulfilling its energy goals. The remaining challenge is that the heat recycling, using heat pumps for lower temperatures is not sufficiently efficient, causing total power usage over the target level. There are two possible paths for further improvement. One is to substitute some part of the electrically driven heat pumps with equipment such as absorption heat pumps and sorptive coolers, which are powered by heat rather than electricity. The other path is to create uses for the lower grade heat at the available temperature levels, such as for space heating or production processes. Both of these methods are likely to be used.

The heat-recycling goal poses the greatest technical challenge in the Energy Concept. The use of high-temperature cooling in the complex environment of the accelerator is a critical success factor for the entire energy effort, as it both increases the recyclability of the heat and dramatically reduces electrical power use in the cooling process. This is also the greatest novelty in the Energy Concept, and will surely set a worldwide precedent for the accelerator community, as well as for industry using large-scale power components.

A positive effect of the energy efforts that was not envisioned beforehand is that work with energy efficiency has benefited reliability, not just for energy systems, but also for the facility as a whole. The power simulations at RWTH Aachen, although only halfway finished, have already identified points were design choices at ESS that potentially could have caused havoc in the power distribution networks in the region, and require expensive corrective equipment to avoid. These types of win-wins are an effect of the grid simulations and the energy inventories. The savings in finding appropriate designs that avoid expensive retrofitting are potentially enormous.

In summary, this report demonstrates four key deliveries from the ESS Energy Project to ESS as whole:

1. Fulfilment of commitments in the site competition
2. Significant reduction and stabilisation of operations costs
3. Increased public acceptance of the facility, due to environmental best practice
4. Integrated technical improvement in critical systems at ESS

An important function of this report is to make the results of two years of collaboration between ESS, E.ON and Lunds Energi available to all. As the ESS now goes into Construction Phase, with detailed engineering design, procurement and contracting, it is of great value for the ESS to spread the knowledge and ideas widely, so that all companies, researchers and others can build on this and contribute to both the implementation of these ideas and the generation of new ones that achieve even more.

ESS will continue to collaborate with industry, research organisations and others. There will certainly be continued collaboration with partners behind this work, E.ON and Lunds Energi, which have invested significantly in the work behind this report, and also own the technical grid infrastructure to which the ESS energy solutions must connect and interface. There will also be wider collaboration with researchers, industry, municipalities, agriculture, and finance to continue creating and start implementing solutions that benefit ESS and set a positive example for research infrastructure and industry everywhere.



EUROPEAN  
SPALLATION  
SOURCE

---

SUSTAINABILITY PARTNERS

---

