



LUND UNIVERSITY

Naphthoxylosides Investigations into glycosaminoglycan biosynthesis

Jacobsson, Mårten

2007

[Link to publication](#)

Citation for published version (APA):

Jacobsson, M. (2007). *Naphthoxylosides Investigations into glycosaminoglycan biosynthesis*. [Doctoral Thesis (compilation), Centre for Analysis and Synthesis]. Organic Chemistry, Lund University.

Total number of authors:

1

General rights

Unless other specific re-use rights are stated the following general rights apply:

Copyright and moral rights for the publications made accessible in the public portal are retained by the authors and/or other copyright owners and it is a condition of accessing publications that users recognise and abide by the legal requirements associated with these rights.

- Users may download and print one copy of any publication from the public portal for the purpose of private study or research.
- You may not further distribute the material or use it for any profit-making activity or commercial gain
- You may freely distribute the URL identifying the publication in the public portal

Read more about Creative commons licenses: <https://creativecommons.org/licenses/>

Take down policy

If you believe that this document breaches copyright please contact us providing details, and we will remove access to the work immediately and investigate your claim.

LUND UNIVERSITY

PO Box 117
221 00 Lund
+46 46-222 00 00

NAPHTHOXYLOSIDES

Investigations into glycosaminoglycan biosynthesis

Mårten Jacobsson

Organic Chemistry
Lund 2007



LUND
UNIVERSITY

Akademisk avhandling som för avläggande av teknisk doktorsexamen vid Tekniska fakulteten vid Lunds Universitet kommer att offentligen försvaras på Kemicentrum, sal K:C, fredagen den 25 maj 2007, kl. 9.30. Fakultetsopponent är Docent Mikael Elofsson, Umeå Universitet.

A doctoral thesis at a university in Sweden is produced as a monograph or as a collection of papers. In the latter case, the introductory part constitutes the formal thesis, which summarises the accompanying papers. These have either already been published or are manuscripts at various stages (*accepted, submitted or in manuscript*).

Naphthoxylosides

Investigations into glycosaminoglycan biosynthesis

Copyright © Märten Jacobsson

All rights reserved

Division of Organic Chemistry

Lund University

P.O. Box 124

SE-22100 Lund

Sweden

ISBN 978-91-7422-153-4

Printed in Sweden by Media-Tryck, Lund 2007.

Organisation LUND UNIVERSITY Division of Organic Chemistry Chemical Centre P.O. Box 124 SE-221 00 Lund Sweden	Document name DOCTORAL DISSERTATION	
	Date of issue 2007-04-27	
Author(s) Märten Jacobsson	Sponsoring organisation	
Title and subtitle Naphthoxylosides Investigations into glycosaminoglycan biosynthesis		
Abstract <p>Glycosaminoglycans (GAGs) are members of a family of polysaccharide structures consisting mostly of repeating disaccharide units. Most GAGs are attached to specific serine residues in proteins to form proteoglycans (PGs). GAGs and PGs show a large and diverse number of biological functions ranging from cell cycle regulation and control of formation of blood vessels to modification of tissue transparency and lubrication in joints.</p> <p>Glycosaminoglycan biosynthesis is initiated by the formation of a linker tetrasaccharide common to most glycosaminoglycans. Addition of the fifth monosaccharide then determines whether dermatan sulphate/chondroitin sulphate or heparin sulphate/heparin is synthesised. Since the GAGs are attached to a protein, it is complicated to study their structure and biosynthesis. Therefore lipophilic compounds carrying a xylose residue are used as artificial primers.</p> <p>Xylosides carrying naphthalenic aglycon proved to be efficient primers of heparan sulphate and due to possible implications in anti-cancer therapy, further explorations into the so called naphthoxylosides were initiated.</p> <p>The present thesis discusses my efforts towards a systematic investigation into the effects of aglycon structure on the antiproliferative and glycosaminoglycan priming properties of naphthoxylosides.</p> <p>Varying the substitution pattern on the naphthalene framework of hydroxynaphthyl β-D-xylosides confirmed previous indications that the aglycon structure is important for the biological activity of xylosides. Also, for healthy human lung fibroblasts a clear correlation between xyloside lipophilicity and toxicity, indicative of a passive uptake dependency, was found. However, for several compounds this correlation was absent in transformed cells, indicating the presence of a different mechanism of uptake or toxicity in these cells. Further, increased levels of apoptosis was shown in transformed cells treated with a hydroxynaphthyl β-D-xylopyranoside with tumour-selective antiproliferative properties.</p> <p>Substitution of the oxygen atoms attached to the naphthalene moiety for sulphur increased the diversity of naphthoxylosides available for study. The toxicity and glycosaminoglycan priming properties of these reinforced the complexity of the structure-activity relationship. Also, as part of the synthesis of sulphur-containing xylosides, the mechanism for the acid-catalysed nucleophilic aromatic substitution of phenolic hydroxyls in non-polar solvents was investigated. Kinetic studies indicated a mechanism involving a change in the rate-determining step depending on reaction temperature. Theoretical studies allowed a mechanism involving an unusual concerted step with a highly ordered eight-membered ring to be proposed.</p>		
Key words Xylosides, naphthoxylosides, glycosaminoglycan, proteoglycan, thioether, nucleophilic aromatic substitution		
Classification system and/or index terms (if any)		
Supplementary bibliographical information		Language English
ISSN and key title		ISBN 978-91-7422-153-4
Recipient's notes	Number of pages 129	Price
	Security classification	

Distribution by (name and address) Organic Chemistry, P.O. Box 124, SE-221 00 Lund, Sweden

I, the undersigned, being the copyright owner of the abstract of the above-mentioned dissertation, hereby grant to all reference sources permission to publish and disseminate the abstract of the above-mentioned dissertation.

Signature _____



Date _____ 2007-04-16 _____

“a gold mine is awaiting the organic chemist who would look to solid supports for controlling and directing his synthetic reactions”

— Robert Bruce Merrifield, 1969.¹

“Many gold nuggets have now been mined...and some iron pyrites”

— Clifford Clarke Leznoff, 1978.²

*“Another turning point;
a fork stuck in the road.
Time grabs you by the wrist;
directs you where to go.
So make the best of this test
and don't ask why.
It's not a question
but a lesson learned in time.
It's something unpredictable
but in the end it's right.
I hope you had the time of your life.”*

— Good Riddance (Time of your life).

Billie Joe Armstrong, Green Day, 1997.³

Preface

The basis of this thesis is work performed by me during my time involved in research at the division of Organic Chemistry at Lund University. Also, results obtained by other researchers, especially those involved in the structure and function of glycosaminoglycans and glycoside primers, will be discussed as much of this work is of great importance to the results presented here.

The first chapter introduces carbohydrates and glycoconjugate chemistry and some of the tools used in modern research. Chapter 2 presents the biological background and rationale behind the use of naphthoxylosides^{i,4} as glycosaminoglycan primers.

The third chapter presents the aims of my research and the results are then discussed in depth in chapters 4-6. From the results presented, conclusions drawn and perspectives on future directions which could be taken in naphthoxyloside research are discussed in chapter 7.

ⁱ Whilst the term “naphthoxyloside” is not strictly correct according to IUPAC’s carbohydrate nomenclature recommendations,⁴ we define the term as “molecules in which a naphthalenic system is attached to a xylose moiety or a mimic thereof, including but not limited to *O*-, 1-*C*-, 1-*S*- and 1-*N*-xylopyranosides, cyclitols, imino sugars and thio sugars”.

Abstract

Glycosaminoglycans (GAGs) are members of a family of polysaccharide structures consisting mostly of repeating disaccharide units. Most GAGs are attached to specific serine residues in proteins to form proteoglycans (PGs). GAGs and PGs show a large and diverse number of biological functions ranging from cell cycle regulation and control of formation of blood vessels to modification of tissue transparency and lubrication in joints.

Glycosaminoglycan biosynthesis is initiated by the formation of a linker tetrasaccharide common to most glycosaminoglycans. Addition of the fifth monosaccharide then determines whether dermatan sulphate/chondroitin sulphate or heparin sulphate/heparin is synthesised. Since the GAGs are attached to a protein, it is complicated to study their structure and biosynthesis. Therefore lipophilic compounds carrying a xylose residue are used as artificial primers.

Xylosides carrying naphthalenic aglycon proved to be efficient primers of heparan sulphate and due to possible implications in anti-cancer therapy, further explorations into the so called naphthoxylosides were initiated.

The present thesis discusses my efforts towards a systematic investigation into the effects of aglycon structure on the antiproliferative and glycosaminoglycan priming properties of naphthoxylosides.

Varying the substitution pattern on the naphthalene framework of hydroxynaphthyl β -D-xylosides confirmed previous indications that the aglycon structure is important for the biological activity of xylosides. Also, for healthy human lung fibroblasts a clear correlation between xyloside lipophilicity and toxicity, indicative of a passive uptake dependency, was found. However, for several compounds this correlation was absent in transformed cells, indicating the presence of a different mechanism of uptake or toxicity in these cells. Further, increased levels of apoptosis was shown in transformed cells treated with a hydroxynaphthyl β -D-xylopyranoside with tumour-selective antiproliferative properties.

Substitution of the oxygen atoms attached to the naphthalene moiety for sulphur increased the diversity of naphthoxylosides available for study. The toxicity and glycosaminoglycan priming properties of these reinforced the complexity of the structure-activity relationship. Also, as part of the synthesis of sulphur-containing xylosides, the mechanism for the acid-catalysed nucleophilic aromatic substitution of phenolic hydroxyls in non-polar solvents was investigated. Kinetic studies indicated a mechanism involving a change in the rate-determining step depending on reaction temperature. Theoretical studies allowed a mechanism involving an unusual concerted step with a highly ordered eight-membered ring to be proposed.

Populärvetenskaplig sammanfattning

Många av cellernas reglerings-, kommunikations- och interaktionssystem styrs av kolhydrater. Dessa kolhydrater sitter ofta bundna på proteiner och bildar då så kallade makromolekyler. En sådan grupp av makromolekyler kallas för glykosaminoglykaner. I de flesta medlemmar av denna grupp sitter långa kolhydratkedjor fast på proteinet via sockret xylos, även känt som björksocker.

För att studera strukturen på kolhydratkedjorna, utan den försvårande närvaron av proteindelen, kan xylos-molekyler bundna till feta strukturer användas. Dessa molekyler, som kallas för xylosider, kan ta sig in i celler och där agera som startpunkt för biosyntesen av glykosaminoglykankedjor.

Det har visat sig att xylosider inte bara agerar som startpunkt för denna biosyntes – de kan även ha egna intressanta egenskaper. Till exempel kan xylosider där xylos sitter bundet till naftalen, så kallade naftoxylosider, öka proportionen av heparan sulfat som är en sorts glykosaminoglykan. Vissa sådana strukturer visade sig även ha en tillväxthämmande effekt på celler, och var mer giftiga mot vissa former av mänskliga cancerceller än mot friska celler.

Denna avhandling diskuterar min systematiska undersökning av hur en naftoxylosids kemiska struktur påverkar vilken sorts kolhydratkedjor som byggs på xylos av cellernas maskineri samt till vilken grad det sker. Effekten av strukturen på molekylernas toxicitet och selektivitet undersöks också och påvisar tydligt den komplexitet som ligger bakom de mekanismer som gör naftoxylosider giftiga.

En spännande framtid för forskning om naftoxylosider utlovas då studien visar att en av naftoxylosiderna som uppvisar selektivitet mot cancerceller verkar genom att få cellerna att begå självmord, något som är mycket attraktivt för presumtiva anticancerläkemedel.

List of Papers

This thesis summarises the following papers. Papers I, II and III are reproduced with kind permission from Elsevier. Paper IV is reproduced with kind permission from the American Chemical Society.

- I.** Mårten Jacobsson, Jesper Malmberg, Ulf Ellervik
Aromatic O-glycosylation
Carbohydrate Research **2006**, *341*, 1266-1281
- II.** Ulf Ellervik, Mårten Jacobsson, Jörgen Ohlsson
2-Bromoethyl glycosides for synthesis of glycoconjugates on solid support
Tetrahedron **2005**, *61*, 2421-2429
- III.** Mårten Jacobsson, Ulf Ellervik
Synthesis of naphthoxylosides on solid support
Tetrahedron Letters **2002**, *43*, 6549-6552
- IV.** Mårten Jacobsson, Ulf Ellervik, Mattias Belting, Katrin Mani
Selective Antiproliferative Activity of Hydroxynaphthyl- β -D-xylosides
Journal of Medicinal Chemistry **2006**, *49*, 1932-1938
- V.** Mårten Jacobsson, Katrin Mani, Ulf Ellervik
Effects of oxygen-sulfur substitution on glycosaminoglycan-priming naphthoxylosides
Accepted for publication in *Bioorganic & Medicinal Chemistry*.
- VI.** Mårten Jacobsson, Jonas Oxgaard, Carl-Olof Abrahamsson, Per-Ola Norrby, William A. Goddard III, Ulf Ellervik
Mechanisms for acid-catalyzed nucleophilic aromatic substitution in non-polar solvents.
In manuscript.

Abbreviations and acronyms

CS	Chondroitin sulphate
DFT	Density functional theory
DIC	<i>N,N'</i> -Diisopropylcarbodiimide
DIPEA	<i>N,N</i> -Diisopropylethylamine
DMAP	4- <i>N,N</i> -Dimethylaminopyridine
DS	Dermatan sulphate
ER	Endoplasmic reticulum
GAG	Glycosaminoglycan
Gal	Galactose
GalNAc	<i>N</i> -Acetylgalactosamine
Glc	Glucose
GlcA	Glucuronic acid
GlcNAc	<i>N</i> -Acetylglucosamine
HA	Hyaluronic acid
HS	Heparan sulphate
IdoA	Iduronic acid
KS	Keratan sulphate
PAPS	3'-Phosphoadenosine 5'-phosphosulphate
PG	Proteoglycan
Ph ₃ P-PS	Polystyryldiphenylphosphine (Polystyrene-bound triphenyl phosphine)
PrtG	Protecting group
<i>p</i> -TsOH	<i>para</i> -Toluene sulphonic acid
SCID	Severely combined immunodeficient
TUNEL	Terminal deoxynucleotidyl transferase-mediated dUTP nick-end labeling
UDP	Uridine 5'-diphosphate
Xyl	Xylose

PREFACE	VII
ABSTRACT	IX
POPULÄRVETENSKAPLIG SAMMANFATTNING	XI
LIST OF PAPERS	XIII
ABBREVIATIONS AND ACRONYMS	XV
1 INTRODUCTION (PAPERS I AND II)	1
1.1 CARBOHYDRATES	2
1.2 GLYCOCONJUGATE SYNTHESIS (PAPER I).....	3
1.3 MODERN METHODS IN ORGANIC CHEMISTRY (PAPER II).....	8
2 GLYCOSAMINOGLYCANS	15
2.1 GLYCOSAMINOGLYCANS AND PROTEOGLYCANS	15
2.2 BIOSYNTHESIS OF GLYCOSAMINOGLYCANS	19
2.3 XYLOSIDES AS ARTIFICIAL PRIMERS OF GLYCOSAMINOGLYCAN BIOSYNTHESIS.....	21
3 AIMS OF THE THESIS	25
4 SYNTHESIS AND BIOLOGY OF HYDROXYNAPHTHYL XYLOSIDES (PAPERS III AND IV) ..	27
4.1 SOLUTION PHASE SYNTHESIS OF NAPHTHOXYLOSIDES.	28
4.2 SOLID-PHASE SYNTHESIS OF XYLOSYLATED DIHYDROXYNAPHTHALENES.....	30
4.3 PHYSICAL PROPERTIES OF HYDROXYNAPHTHYL β -D-XYLOPYRANOSIDES	34
4.4 BIOLOGICAL EVALUATION OF FIRST GENERATION NAPHTHOXYLOSIDES	40
4.5 CORRELATIONS BETWEEN ANTIPROLIFERATIVE PROPERTIES AND PHYSICAL PROPERTIES.....	47
5 SYNTHESIS AND BIOLOGY OF SULPHUR-CONTAINING NAPHTHOXYLOSIDES (PAPERS V AND VI)	49
5.1 FORMATION OF NAPHTHYL-ALKYL THIOETHERS.....	52
5.2 FORMATION OF DISULPHIDES	65
5.3 ATTEMPTED SOLID-PHASE SYNTHETIC ROUTE TO XYLOSIDES	67
5.4 SYNTHESIS OF SULPHUR-CONTAINING NAPHTHOXYLOSIDES.....	69
5.5 PHYSICAL PROPERTIES OF SULPHUR-CONTAINING NAPHTHOXYLOSIDES	72
5.6 BIOLOGICAL EVALUATION OF SULPHUR-CONTAINING NAPHTHOXYLOSIDES.....	73
5.7 CORRELATIONS BETWEEN ANTIPROLIFERATIVE PROPERTIES AND PHYSICAL PROPERTIES.....	78
6 SYNTHESIS OF NAPHTHOXYLOSIDE-AMINO ACID CONJUGATES	81
6.1 SYNTHESIS OF XYLOSYLATED HYDROXYNAPHTHOIC ACIDS.....	81
6.2 PHYSICAL PROPERTIES AND BIOLOGICAL ACTIVITY OF NAPHTHOXYLOSIDE-AMINO ACID CONJUGATES..	88
7 SUMMARY AND FUTURE PERSPECTIVES	91
8 ACKNOWLEDGEMENTS	93
9 SUPPLEMENTARY INFORMATION	95
9.1 SYNTHETIC WORK.....	95
9.2 DESCRIPTION OF PROLIFERATION AND PRIMING ASSAYS	111
9.3 COMPUTATIONAL CHEMISTRY	114
9.4 PRINCIPLES OF FLOW CYTOMETRY	119
REFERENCES	121

1 Introduction (Papers I and II)

Organic chemistry is the science which deals with the properties, composition, structure and transformations of compounds containing carbon and hydrogen.⁵ Modern organic chemistry has come to bridge into biology and medicine as well as the materials sciences and physics. This broad range of applications of organic chemistry is due to the large range of properties which can be bestowed on organic compounds in terms of physical properties and reactivities, for example as illustrated in Figure 1.1.

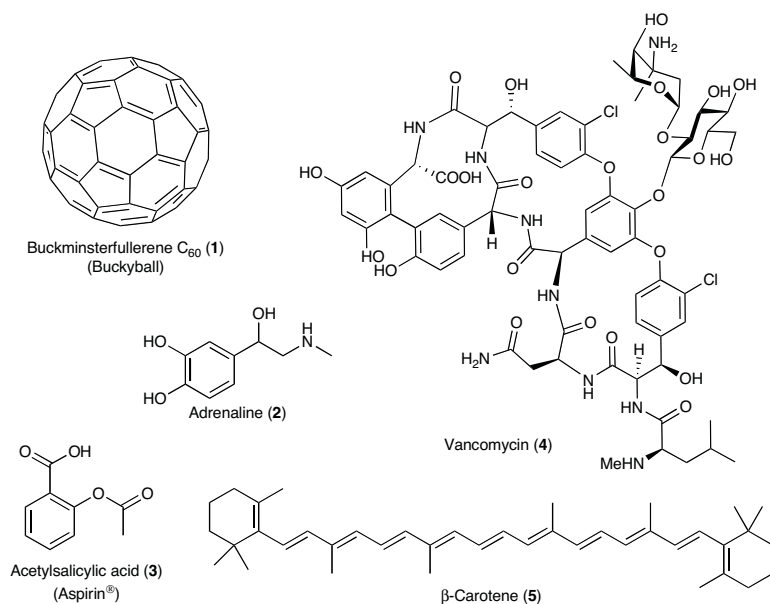

Figure 1.1. Organic compounds with varying properties and uses. Buckminsterfullerene (1) used as, for example, ligands, in nanoscience and with new uses being postulated frequently. The neurotransmitter adrenaline (2), the common painkiller and anticoagulant acetylsalicylic acid (3), the strong antibiotic vancomycin (4) given intravenously to treat infections of gram positive bacteria and β-carotene (5), a provitamin (biosynthetic precursor to Vitamin A) and pigment giving, for example, carrots their colour.

Even in the same family of compounds, for example the carbohydrates, varying properties and reactivities can be obtained and thus a large scope of functions.

1.1 Carbohydrates

Carbohydrates are a large class of compounds containing mono- and polysaccharides. The name refers to the general formula $C_x(H_2O)_n$ of monosaccharides,^{i,6,7} but has come to be used for the entire compound class even if the general formula is not always adhered to.

At first, the role of carbohydrates in nature was thought to be limited to energy (e.g. starch) and bulk construction material (e.g. cellulose) but is now known to include also functions such as regulators of cell-cell interactions, cell cycle control, ABO-blood grouping and many other vital roles.⁸ Regulation of the cell cycle is, for example, seen as a promising approach to cancer therapy.⁹

As the understanding of the biological importance of carbohydrates grew, interest in their synthesis also increased. This has led to a large and prolonged effort into improving and expanding the methods for carbohydrate synthesis.^{ii,10}

1.1.1 Basic structure and terminology

The smallest carbohydrate building blocks are the monosaccharides. These consist of polyhydroxylated carbonyl compounds of at least three carbon atoms. Some examples of monosaccharides discussed in this thesis are shown in Figure 1.2.

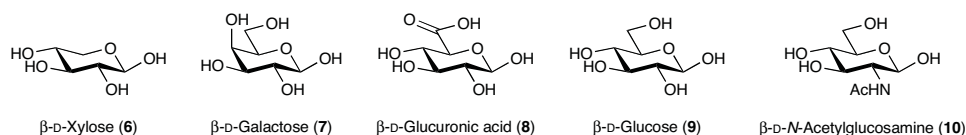

Figure 1.2. Examples of monosaccharides discussed in this thesis shown in their cyclic form.

In solution, the monosaccharides are in equilibrium between their acyclic and cyclic forms with the position of the equilibrium dependent on the structure of the compound. The numbering of the carbon atoms is the same for the cyclic and acyclic forms and is, amongst other things, used to determine the form (D or L and α or β) of the different sugars (Figure 1.3).

ⁱ The term carbohydrates refers to the general formula $C_x(H_2O)_n$. In 1831 William Prout (1785-1850) used the term “hydrates of carbon” in reference to “saccharinous” components of food (carbohydrates).⁶ The term carbohydrates (or “Kohlehydraten” as the paper is in German) was first used in 1844 by Carl Schmidt (1822-1894).⁷

ⁱⁱ The area of carbohydrate synthesis has been extensively reviewed in the primary literature and in monographs. See for example paper I and reference 10, and references cited therein.

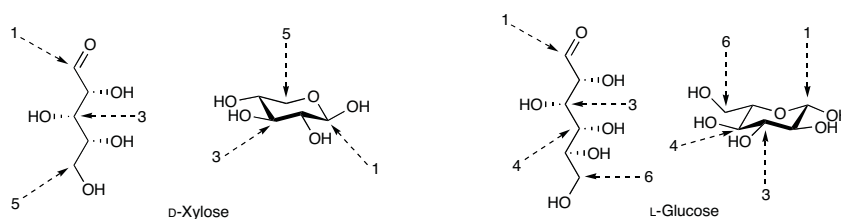

Figure 1.3. Numbering of the acyclic and cyclic forms of D-xylose and L-glucose.

The stereogenic centre formed upon cyclisation through attack of a hydroxyl group on the keto or aldehyde functionality is called the anomeric centre. This centre can have either an α or a β configuration and interconversion between the two is acid-catalysed (Figure 1.4).

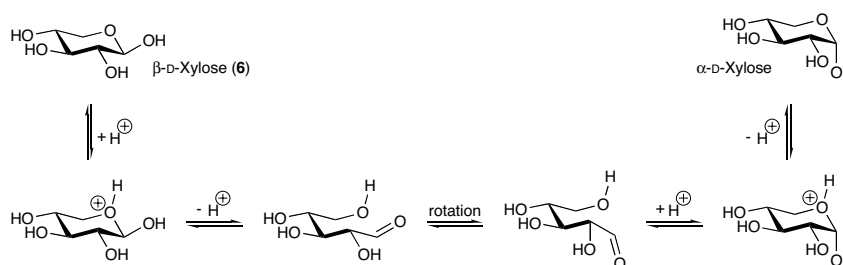

Figure 1.4. The acid-catalysed interconversion (anomerisation) of xylose.

Whether the anomeric centre has an α - or β -configuration is decided by comparison with an anomeric reference atom in the sugar ring (C-4 in xylose). The relative *cis*- or *trans*-configuration of the oxygen on the reference atom and the anomeric oxygen determines the anomeric configuration with *cis* giving the α -anomer and *trans* the β -anomer.

1.2 Glycoconjugate synthesis (Paper I)

A glycoconjugate consists of one or more carbohydrate units covalently linked with other types of chemical constituents.¹¹ The synthesis of a glycoconjugate often involves the formation of a bond between the anomeric carbon of a saccharide (the donor) and a nucleophilic atom of the so called aglycon (the acceptor). This bond is called a glycosidic bond and can be formed either via an S_N2 - or an S_N1 -type reaction. In the S_N2 -type reaction a nucleophile displaces a leaving group, normally under basic conditions with a halogen atom as the leaving group, from the anomeric carbon and thus inverting the anomeric configuration.

The S_N1 -type reaction involves the selective activation of a leaving group in the anomeric position of the saccharide (the donor) and nucleophilic attack by a nucleophile (the acceptor).

The activation of the leaving group is normally performed under acidic conditions which facilitates its departure, thus creating an oxocarbenium ion which acts as the electrophile and is attacked by the acceptor (Scheme 1.1).

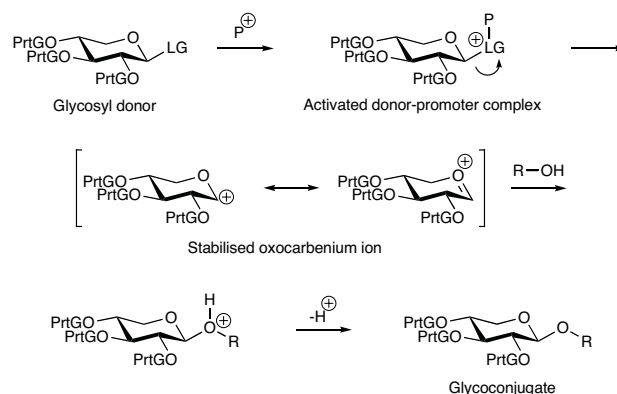

Scheme 1.1. Formation of a glycoconjugate under Lewis acid promoted conditions. After formation of a glycosyl donor-promoter complex, the oxocarbenium ion is formed upon departure of the leaving group. Nucleophilic attack by the acceptor forms the glycoconjugate.

The stereochemical outcome of Lewis acid-promoted glycosylations is influenced by several factors. The anomeric effect generally directs the aglycon to the thermodynamically preferred axial orientation. However, participating groups (e.g. esters) at C2 of the donor can interact with the formed oxocarbenium ion intermediate to form a cyclic acyloxonium ion (Scheme 1.2). The acyloxonium ion is subsequently opened by the acceptor in an S_N2 manner resulting in a 1,2-*trans*-glycosidic bond (i.e. β -glucosides and α -mannosides). β -Glucosides are therefore fairly easily synthesised by standard methods.



Scheme 1.2. Preferential formation of a β -glycoside through the use of a participating group on C2. Steric hindrance prevents attack from the α -position thus promoting β -attack. Formation of an orthoester can occur via attack on the positively charged carbon atom.

Several groups have reported low yields when phenols are used as acceptors, but aromatic O-glycosylation had not, with the exception of a publication in 2002 by Jensen covering glycosylation under neutral and basic conditions,¹² been thoroughly reviewed since 1957.¹³ We therefore performed a critical review of the literature in the area (Paper I).

The formation of a glycoconjugate is a process with many inherent difficulties such as protection of the hydroxyl groups on the glycosyl donor, acid catalysed anomerisation of the product, base induced elimination and moisture sensitivity of the activated donor, all of which contribute to the complexity of the process.

1.2.1 The nature of the anomeric leaving group

The extensive research conducted on glycosylations has resulted in a plethora of different anomeric leaving groups. Examples of methods used for interconversion between the most commonly used groups are shown in Scheme 1.3. Choosing the correct group for the application at hand is a compromise between factors such as synthetic availability, reactivity and stability to conditions used in the synthesis. For aromatic glycosyl acceptors care must also be taken to choose a leaving group suitable to the steric and electronic properties of the acceptor. In the work described in this thesis, the xylopyranoside donors used for aromatic O-xylosylations are the anomeric acetate (**11**), anomeric bromide (**12**) and anomeric trichloroacetimidate (**13**).

Syntheses of the xylopyranoside donors used in this work are described in detail in the Supplementary information chapter.

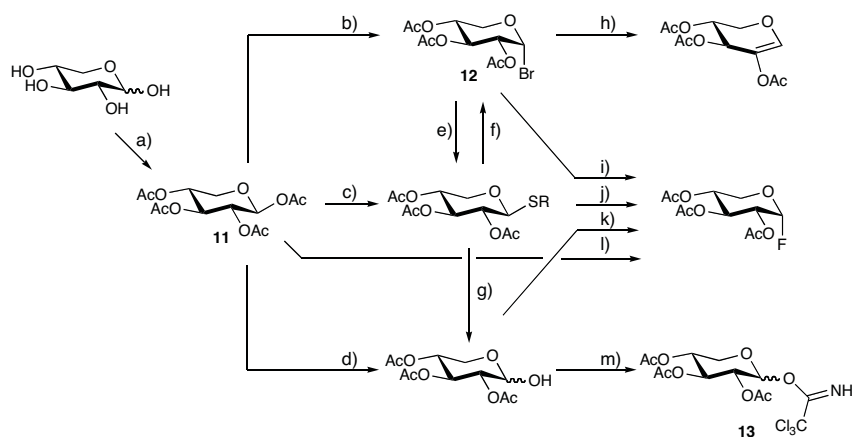

Scheme 1.3. Examples of interconversions between xylopyranoside donors. a) Ac_2O , NaOAc , $140\text{ }^\circ\text{C}$, 1 h .¹⁴ b) HBr/HOAc , Ac_2O , r.t., 1 h .¹⁵ c) RSH , $\text{BF}_3\cdot\text{OEt}_2$, CH_2Cl_2 , $0\text{ }^\circ\text{C}$, 45 min .¹⁶ d) Amine, THF , $75\text{ }^\circ\text{C}$, 18 h .^{17,18} e) NaSPh , Et_2O , r.t., 2 d .¹⁹ f) IBr , CH_2Cl_2 , $0\text{ }^\circ\text{C}$, 10 min .²⁰ g) NBS , acetone, H_2O , r.t., 1 h .²¹ h) $\text{Zn}/\text{Ag}-\text{C}$, THF , $-20\text{ }^\circ\text{C}$, 10 min .²² i) AgF , CH_3CN , r.t., 2 h .²³ j) DAST , NBS , CH_2Cl_2 , $0\text{ }^\circ\text{C}$ to r.t., 25 min .^{24,25} k) DAST , CH_2Cl_2 , $78\text{ }^\circ\text{C}$, 15 min .²⁵ l) $\text{HF}/\text{pyridine}$, $0\text{ }^\circ\text{C}$, 6 h .²⁶ m) Cl_3CCN , DBU , CH_2Cl_2 , $-10\text{ }^\circ\text{C}$ to r.t., 3 h .²⁷ Adapted from paper I.

1.2.2 The acceptor

For the formation of aryl glycosides, complications arise from the low nucleophilicity of the protonated phenol and the possibility of Lewis acid catalysed Fries rearrangement of the product.

Compared to alkyl chains in alcohols, the aromatic rings of phenols are electron withdrawing, thus decreasing the nucleophilicity of the protonated phenol. If the aryl moiety is carrying electron donating groups, acceptable yields can normally still be obtained using the anomeric acetate donor. Phenols are more acidic than alcohols (pK_a about 8-11 compared to 15-20 for alkyl alcohols), and are thus easily deprotonated and good yields can normally be obtained for glycosylation under basic conditions, especially for aromatic acceptors carrying electron withdrawing substituents.

The Fries rearrangement, which is promoted by electron donating groups on the aromatic system, can be used synthetically to give C-glycosides but also prevents the use of the active trichloroacetimidate donor for O-glycosylation of these acceptors. This donor is well suited for complex and sterically hindered substrates or, due to the need for only a catalytic amount of Lewis acid, for acid sensitive acceptors.

The use of thioglycosides and halonium ions as promoters, which has been successful in polysaccharide synthesis, is not suitable for aromatic O-glycosylation since the aromatic system is easily halogenated under the conditions used.²⁸

The review of the literature allowed us to formulate recommendations for the choice of glycosyl donor to be used in aromatic O-glycosylation as presented in Table 1.1.

In paper V, the use of all three donors (**11**, **12** and **13**) with a variety of acceptors will be demonstrated and discussed further. Also, the use of a method presented by Lee et al.²⁹ for the suppression of anomerisation in glycosylation with anomeric acetates will be examined.

Table 1.1. Recommendations regarding choice of donor for aromatic O-glycosylations. Abbreviations used are EDG = electron donating group, EWG = electron withdrawing group. Recommended donor - acceptor combinations are indicated as preferred (+++), suitable (++), less suitable (+), not suitable (-) Adapted from paper I.

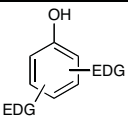
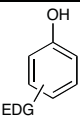
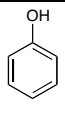
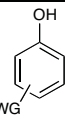
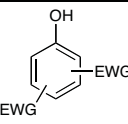
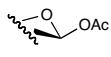
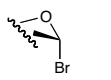
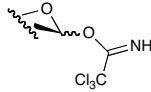
Donor	Acceptor 				
	+++	++	+	-	-
	-	-	+	++	++
	+ ^a	++	+++	+	-

^aA short reaction time is necessary and a reaction temperature below 0 °C to avoid Fries rearrangement.

1.2.3 Protecting groups

Protecting groups (PrtGs) are used to facilitate the discrimination between functional groups with similar reactivities. Whilst protecting groups are avoided in industrial processes their use is still of great importance in the synthesis of new compounds.

In carbohydrate chemistry the protecting group on C2 of the donor is of importance since it can, as mentioned previously, be used to influence the α/β -selectivity of a glycosylation reaction. Groups which can interact with the oxocarbenium ion (participating groups), such as esters, are commonly used to give predominantly the β -glycosidic bond in gluco- and xylopyranosides. Also, use of protecting groups can modulate the solubility and lipophilicity of compounds as will be discussed later.

The main difficulty in protecting group chemistry is to obtain orthogonally protected substrates, i.e. obtaining a protecting group pattern which allows for the selective removal of specific groups when needed, without deprotection of functional groups which are to remain protected.

An abundance of different protecting groups are available and for each group several methods are known for their introduction and removal. In this thesis only a few protecting groups are discussed, namely acetate (OAc), benzoate (OBz), benzyl (OBn), pivaloylate (OPiv), *tert*-butoxycarbonyl (Boc) and protection of thiols by disulphide bond formation (Figure 1.5).

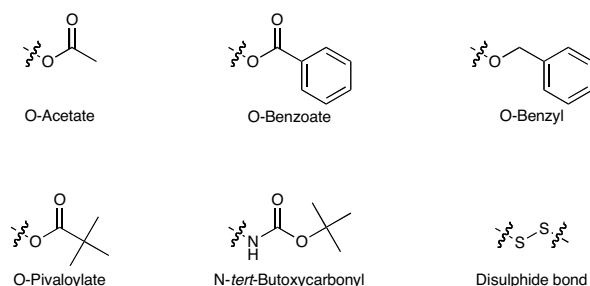

Figure 1.5. The protecting groups discussed in this thesis are acetate ester, benzoate ester, benzyl ether, pivaloylate ester, *tert*-butoxycarbonyl ester and disulphide bond.

1.3 Modern methods in organic chemistry (Paper II)

From the very beginning of organic chemistry and until not long ago, reactions were generally carried out in a single vessel and painstakingly purified through crystallisation and later extraction and chromatography. After characterisation of the synthesised compound it could be carried on to the next reaction in the synthetic sequence.

Since the purification steps can be more time consuming than the actual reaction time, the sequential addition of reagents to affect several transformations in one pot without purification speeded up multi-step syntheses.

To further facilitate the speedy synthesis of large numbers of new compounds, especially driven by the needs of the pharmaceutical industry for new biologically active substances, several modern methods have become widely used in synthetic organic chemistry.^{i,30}

1.3.1 Solid-phase chemistry

In the 1950's the synthesis of biologically active peptides was of great interest and the development of new reagents had made the synthesis of small oligopeptides possible in most laboratories. The goal of synthesising longer polypeptides was now obstructed mostly by the problematic purification and low solubilities of such compounds.

To circumvent this problem, in 1963 R. Bruce Merrifield introduced a new methodology which he called solid phase peptide synthesis.^{ii,31} The approach is based on the stepwise addition

ⁱ The interested reader is strongly encouraged to read the excellent review from 2002 by Ley and Baxendale which discusses many of the modern methods used in organic synthesis (reference 30).

ⁱⁱ Robert Bruce Merrifield (1921-2006) introduced the concept of solid-phase synthesis in 1963 and for this he was awarded the 1984 Nobel Prize in Chemistry. The original paper published in the *Journal of the American Chemical Society* is one of the most cited papers in the history of the journal.³¹

of monomers to a solid support and washing away of unbound material and reagents (Figure 1.6).

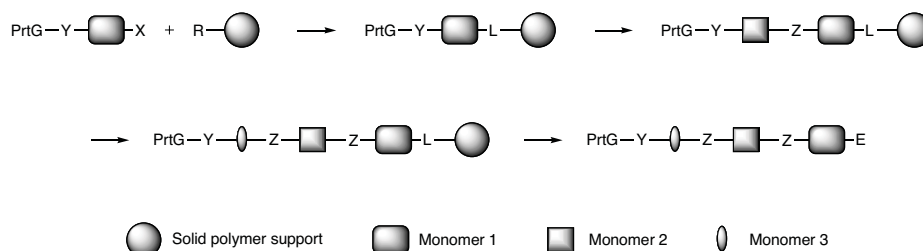

Figure 1.6. Schematic description of the principle behind solid-phase synthesis. A monomer with a free reactive group (X), and a suitably protected (PrtG) second reactive group (Y), is coupled to a solid polymer support with a reactive group (R). The monomer binds to the solid support via a linker region (L). After deprotection of Y a second monomer is coupled to the first. The monomers are connected via their linker (Z). The process is repeated with a third monomer after which the trimer is released from the solid support by cleavage of the linker region L giving a group E at the released end.

The success of solid-phase peptide synthesis encouraged the application of the methodology in the synthesis of other oligomeric materials. Solid-phase synthesis has since been successfully applied to the synthesis of, for example, biologically active oligosaccharides,^{32,33} DNA-binding polyamides,^{34,35} and glycopeptides,³³ and has been extensively reviewed.^{1,32,33,36-38} Recently, the full potential of solid-phase synthesis is on the verge of being realised through automated procedures allowing for more efficient use of manpower.^{39,40} Also, the use of reagents and scavengers bound to a solid support thus allowing their removal by filtration has increased and a very elegant stereocontrolled multi-step synthesis of the antitumour natural product epithilone C has been published, highlighting the convenience of such reagents.⁴¹ The use of one such reagent, polystyrene-bound triphenyl phosphine (Ph₃P-PS), is discussed in paper V.

One of the major difficulties in solid-phase synthesis is the stability of the linker region (L) in combination with protection/deprotection of functional groups. Fortunately, both the areas of linkers and protecting group used in solid-phase synthesis have been reviewed.⁴²⁻⁴⁴

Also, new linker systems have been developed to allow for variation of the group (E) given upon cleavage. Also, traceless linkers have been developed which, after cleavage, do not add new groups to the monomer attached to it.⁴⁵

In the work presented in paper III we successfully used solid supports not only as a tool for the minimisation of chromatography but also as a protecting group. Encouraged by this we

ⁱ For a thorough discussion of most aspects concerning solid-phase chemistry, see for example the book *Organic Synthesis on Solid Phase* by Florencio Zaragoza Dörwald (reference 38).

investigated the use of solid supports in the synthesis of glycoconjugates using the bromoethyl anomeric protecting group as a traceless linker (paper II).

The bromoethyl anomeric protecting group has been used as a spacer in the synthesis of glycoconjugates but has not previously been seen as a removable protecting group.^{46,47} We noted that by transforming the bromoethyl glycoside (**14**) into an aryl sulphide (**15**) followed by oxidation to the sulphone (**16**), β -elimination could give the free hemiacetal (**17**) (Scheme 1.4).

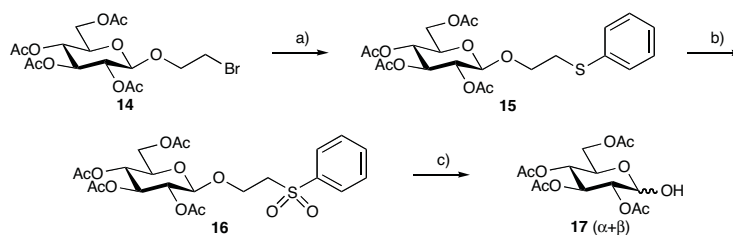

Scheme 1.4. Conversion of the bromoethyl anomeric protecting group into an aryl sulphone and cleavage to release the anomeric hemiacetal. a) Thiophenol, CsCO₃, DMF, 2 h, 95%. b) *m*-CPBA, EtOAc, 30 min, 98%. c) NaOMe-MeOH, 4-56 h, quant.

To apply the bromoethyl linker as a traceless linker in the solid-phase synthesis of glycoconjugates we first studied the binding of a fluorescent analogue of **14**, using a newly developed anthraldehyde acetal protecting group,⁴⁸ to a thiol scavenger resin. Our results showed a near complete loss of fluorescence in the solution after 10 min, indicating complete binding of the substrate to the resin. Also, we determined that, prior to oxidation to the sulphone, the linker is stable to typical conditions employed in glycoconjugate synthesis.

Finally, we demonstrated the use of the linker in the synthesis of the naphthamido galactose derivate **19** from azido galactopyranoside **18**.

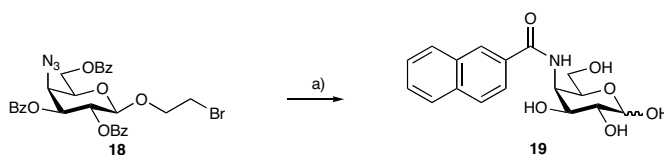

Scheme 1.5. Synthesis of a glycoconjugate using the new traceless bromoethyl linker. a) i) DMF, DBU, thiophenol polystyrene resin, 1 h. ii) DMF, DBU, MeI, 10 min. iii) NaOMe-MeOH-CH₂Cl₂ (0.05 M), 1 h. iv) DTT, DMF, DBU, o.n. v) DMF, pyridine, 2-naphthoyl chloride, 4 h. vi) CH₂Cl₂, EtOAc, 30 min. vii) NaOMe-MeOH-CH₂Cl₂ (0.2 M), o.n., 27% over 7 steps.

Further use of solid supports will be discussed in connection with papers III, V and in Chapter 6.

Whilst combinatorial library synthesis easily produces large numbers of substances, the exact composition of each substance is not always known since isolation and full characterisation is not always performed. In parallel library synthesis, a smaller number of substances is normally synthesised, but all products are normally purified and at least a proportion of these are fully characterised prior to testing and therefore the identity of products which show biological activity is known.

1.3.3 Microwave chemistry

A general rule of thumb in chemistry is that an increase of the reaction temperature by 10 °C approximately doubles the rate of reaction. Energy, in the form of heat, was originally applied to a reaction mixture by fire and by the second half of the 19th century Bunsen burners were being used to focus the heat source.^{i,57-59} Heating reactions by fire has been more or less abandoned and heating mantles, oil baths and hot plates are now commonly used. All of these methods rely on the application of heat to the reaction vessel after which heat is transferred to the reaction mixture from the vessel.

In 1986 two groups reported the use of microwaves in organic synthesis and reported significant enhancements of reaction rates, sometimes several hundred-fold.^{60,61} Both reports used commercial domestic microwave ovens and stressed the importance of safety with one publication even reporting a violent explosion during a run. Due to safety issues, problems with controlling the input of energy, reaction temperatures and low reproducibility in other laboratories, the use of microwaves in organic synthesis did not increase greatly at first. In the 1990's dedicated instruments allowing for the better control of reaction parameters started to appear and the use of microwaves in synthesis increased quickly.^{ii,62,63}

The significant enhancements of reaction rates were seen in a multitude of reactions and whilst the 1986 report by Giguere et al.⁶¹ had attributed this to the increased temperatures achievable, a handful of researchers attributed some of the effects seen to a “specific” microwave effect. The belief in the existence of such an effect has now been all but abandoned although the debate was intense even into this millennium.^{64,65}

ⁱ The Bunsen burner, described in an 1857 paper by Robert Bunsen (1811-1899),⁵⁷ was actually designed by Peter Desaga who worked as a laboratory technician at the University of Heidelberg. Desaga modified previous designs by, amongst others, Michael Faraday (1791-1867). Bunsen granted Desaga the right to sell the modified burners which he did using the name of Bunsen.^{58,59}

ⁱⁱ For further discussion and references regarding microwave synthesis and other modern techniques, see references 62, 63 (microwaves), 30, 66 and 67 (many techniques).

Microwave chemistry is becoming commonplace in many fields of organic chemistry and its use is discussed briefly in paper V.

These new technologies and, in the last few years, combinations of them and others such as flow chemistry with online microwave heating, polymer supported reagents, purification techniques and automation,^{66,67} have greatly increased the speed at which new compounds can be synthesised.

Even with the large array of tools available to the synthetic chemist, the search for safe and efficient biologically active molecules for the use as pharmaceutical agents is time consuming and expensive, and most of the molecules developed are discarded along the way.

2 Glycosaminoglycans

The monosaccharide xylose is abundant in plants but unusual in mammalian cells. The large amount present in plants makes it the second most prevalent monosaccharide in nature.⁶⁸ Still it is considered one of eight sugars necessary for the normal function of human metabolic processes.¹ The importance of xylose in mammalian cells arises from it being found more or less in only one single position – as the carbohydrate-protein link in proteoglycans.

2.1 Glycosaminoglycans and proteoglycans

Glycosaminoglycans (GAGs) are acidic, unbranched and polydisperse polysaccharides. Their existence has been known since the first half of the 19th century but the study of GAGs did not take place until the discovery of hyaluronic acid (hyaluronan, HA) by Meyer et al. in 1934.⁶⁹ In the years following, Meyer presented their discoveries of, amongst other, dermatan sulphate (DS)⁷⁰ and keratan sulphate (KS) I and II.⁷¹

As further GAGs were discovered it became evident that they often formed complexes with proteins although it was at first not clear whether a covalent bond between the GAG and the protein was involved. In 1954, Shatton and Shubert showed that chondroitin sulphate was indeed covalently linked to a protein,⁷² and such a glycosaminoglycan-protein macromolecule is now termed a proteoglycan (Figure 2.1).^{ii,73}

2.1.1 Structure of glycosaminoglycans and proteoglycans

Whilst GAGs are highly disperse, several key structural features are shared between them (Table 2.1).^{iii,74} Most GAGs share a common linker tetrasaccharide which links them to the core

ⁱ The other seven are glucose, galactose, mannose, *N*-acetylglucosamine, *N*-acetylgalactosamine, fucose and sialic acid.

ⁱⁱ For a further discussion regarding the history of, and recent developments regarding, proteoglycans see reference 73.

ⁱⁱⁱ The interested reader is encouraged to study reference 74 for a more detailed discussion and reference list regarding the chemistry and biochemistry of GAGs which is outside the scope of this thesis.

protein. This tetrasaccharide has been shown to be GlcA(β 1 \rightarrow 3)Gal(β 1 \rightarrow 3)Gal(β 1 \rightarrow 4)Xyl β and is connected to the core protein via the hydroxyl group of a serine (Ser) residue on the polypeptide chain (Figure 2.1).^{75,76}

Table 2.1. The major glycosaminoglycans with their most commonly occurring disaccharide units, polymer modifications and examples of the core proteins to which the GAGs are attached to give the corresponding PGs and the number of GAG chains typically attached to the core protein.⁷⁷

GAG	Disaccharide units	Modifications	Core proteins	No. GAG
Chondroitin sulphate (CS)/ Dermatan sulphate (DS)	[GlcA(β 1 \rightarrow 3)GalNAc(β 1 \rightarrow 4)]/ [IdoA(β 1 \rightarrow 3)GalNAc(β 1 \rightarrow 4)]	Epimerisation O-Sulphation	Decorin Biglycan Syndecan 1-4 Glypican Perlecan Betaglycan	1 2 1-5 1-3 1-3 1-3
Heparan sulphate (HS)/ Heparin	[GlcA(β 1 \rightarrow 4)GlcNAc(α 1 \rightarrow 4)]/ [IdoA(β 1 \rightarrow 4)GlcNR(α 1 \rightarrow 4)] (R=Ac or SO ₃)	N-Deacetylation N-Sulphation Epimerisation O-Sulphation	Glypican Syndecans 1-4 Betaglycan Perlecan Agrin	1-3 1-3
Keratan sulphate (KS)	[Gal(β 1 \rightarrow 3)GlcNAc(β 1 \rightarrow 4)]	O-Sulphation	Cartilage PG Lumican Fibromodulin	>100 1-3 1-3
Hyaluronic acid (HA)	[GlcA(β 1 \rightarrow 3)GlcNAc(β 1 \rightarrow 4)]	None	No protein but the chains can contain up to 25 000 repeating disaccharide units	

Major exceptions are KS which instead of the Xyl- β -Ser linkage is instead either linked via an N-glycosidic bond from GlcNAc to an asparagine (Asp) residue or via an O-glycosidic bond from GalNAc to either a Ser or threonine (Thr) residue and HA which is not connected to a core protein.^{78,79}

GAG chains are highly substituted and modified (see Table 2.1) with large amounts of O-sulphation giving GAGs their anionic character. Also, glucosamine may be N-acetylated and galactosamine can be N-sulphated and N-acetylated. The amount of sulphation also correlates to the amount of epimerisation of glucuronic acid to iduronic acid. In CS/DS all galactosamines are N-acetylated to give GalNAc.⁸⁰

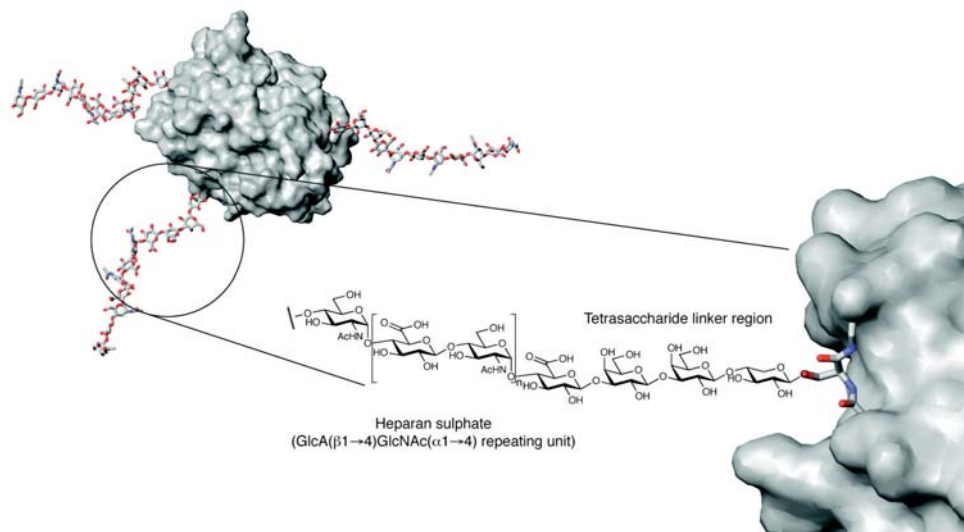

Figure 2.1. Figure showing the structure of a hypothetical proteoglycan. GAG chains are attached via a serine residue to the core protein. A linker tetrasaccharide common for nearly all GAGs consists of GlcA(β 1 \rightarrow 3)Gal(β 1 \rightarrow 3)Gal(β 1 \rightarrow 4)Xyl β with the xylose connected to the serine through a β -glycosidic linkage.

Heparin is highly complex both at PG and GAG level and the PG is broken down into first peptidoglycan heparin (a small peptide carrying a single polysaccharide) and then into smaller polysaccharide chains. The starting GAG chains are also highly disperse.

HS GAG is similar to heparin GAG but the O-sulphation and N-acetylation ratios are different. Also, HS and heparin PGs have different core proteins and whilst heparin is found only inside the cell, HS is localised mainly in the extracellular matrix and in the plasma membranes.⁸¹ As many as 23 disaccharides have been identified in heparin, HS and in their biosynthetic intermediates and the composition of the GAG seems to be determined by the cell type of origin and not on the structure of the PG core protein.⁸²

2.1.2 Applications of glycosaminoglycans and proteoglycans

The biological function of PGs is complex and believed to be mainly due to the presence of the GAG chains. Also, some PG core proteins have been shown to have catalytic and binding domains.⁸⁰ PGs are involved in as diverse roles as bulk construction material in cartilage to regulation of cell growth, cell adhesion and extracellular matrix turnover.⁸³

The multitude of biological activities is usually attributed to the binding of the PGs to a large array of proteins and growth factors.⁸⁴ The most well-known biological activity of a PG is

the anticoagulant activity of heparin. Discovered in the early 20th century,^{i,85-87} heparin, and more recently low molecular weight heparin, is administered in more than 500 million doses a year worldwide.⁸⁸ Apart from its antithromboticⁱⁱ activity which is, in part, due to interactions with a serine protease inhibitor,⁸⁹ heparin also has antiatheroscleroticⁱⁱⁱ activity.⁹⁰ Further, heparin can, via interactions with C1 esterase inhibitor,⁹¹ act as an inhibitor of the activation of the complement system which, upon activation, causes the lysis and death of cells.⁹²

HS and heparin can interact with selectins and chemokines,^{iv,93} and thus inhibit some inflammatory processes.^{94,95} HS and heparin also play several roles in angiogenesis^v and can both inhibit and activate the formation of new capillary blood vessels, and thus have both a negative and positive effect on the growth and metastasis of tumour cells.^{96,97} Further, the ability of cells to synthesise HS has been shown to be crucial for their capability to form tumours.⁹⁸ HS PGs can be involved in the processes by which viruses and parasites enter cells,⁹⁹ and also in the formation of the amyloid plaques and neurofibrillary tangles which are characteristic of Alzheimer's disease.¹⁰⁰ Also, HS PGs have been shown to play important regulatory roles in the tissue distribution of extracellular molecules crucial to signal transduction pathways controlling tissue development.¹⁰¹

DS PGs such as decorin play an important role in the organisation of collagen fibrils by binding to collagen, thus influencing the elasticity and transparency of tissue.^{102,103} Also, DS shows anticoagulant properties and whilst DS is about 70 times less potent than heparin it produces fewer side effects, especially in regard to haemorrhagic complications, and is thus important clinically as it can be used as a prophylactic.^{104,105}

CS has been used as a nutraceutical (food supplement) in the treatment of osteoarthritis,¹⁰⁶ and clinical trials has given some support for its use.¹⁰⁷ HA is used in eye surgery and in biomaterials,¹⁰⁸ and also as a nutraceutical for osteoarthritis sufferers.¹⁰⁹

ⁱ The discovery of heparin is often attributed to Jay McLean in 1916,⁸⁷ but its true discovery was in 1918 by L. Emmett Holt, Jr. and McLean's supervisor William Henry Howell,⁸⁵ although McLean probably influenced the direction of the research in the Howell group. See reference 86 for an entertaining essay regarding the dispute over who was behind the discovery.

ⁱⁱ Thrombosis is the formation of blood clots within blood vessels and can, if the clots cause obstructions in blood flow, be fatal.

ⁱⁱⁱ Atherosclerosis is the build up of fatty deposits inside arteries and can obstruct blood flow.

^{iv} Selectins are transmembrane glycoproteins which are found on endothelium, platelets and leukocytes.⁹³ Chemokines are proteins which bind to GAGs and are involved in leukocyte activation and recruitment.

^v Angiogenesis is the formation and differentiation of blood vessels and is vital for normal development. In cancer cells angiogenesis is unregulated which removes the limit imposed on tumour growth by low blood (oxygen) supply.

As shown, a plethora of medical applications exist for PGs even though the exact mechanisms are not always known. The large complexity of the systems and the dual role of PGs as both activators and inhibitors of many processes show the difficulties of developing PG or GAG based pharmaceuticals. Further complexity is added by the difficulties of isolating core protein bound GAGs and by the heterogeneity of the GAG chains.

2.2 Biosynthesis of glycosaminoglycans

The biosynthesis of GAGs starts by the synthesis of the common linker tetrasaccharide (GlcA(β 1 \rightarrow 3)Gal(β 1 \rightarrow 3)Gal(β 1 \rightarrow 4)Xyl β) through sequential, enzyme mediated addition of UDP-activated sugars to the hydroxyl group in serine residues in the core protein.^{i,110} The necessary starting materials (monosaccharides and sulphate) are taken up by the cells by specialised plasma membrane transporter complexes and are activated by the consumption of nucleotides. The activated sugars (UDP-sugars) and 3'-phosphoadenosine 5'-phosphosulphate (PAPS) are translocated into the endoplasmic reticulum (ER) and the lumen of the Golgi apparatus. The lumen of the Golgi is the main site for the GAG synthesis although the synthesis of the linker tetrasaccharide is initiated earlier.

Several enzymes are involved in the synthesis of GAGs. The serine in the PG core protein is xylosylated through the action of xylosyl transferase (XT) after which the two Gal residues are added by galactosyl transferase I (GT I) and galactosyl transferase II (GT II) respectively. The fourth monosaccharide, GlcA, is added by the action of glucuronic acid transferase I (GlcAT I).

After the synthesis of the common linker region, the addition of the fifth saccharide commits the growing chain to the type of GAG it is to become. For CS/DS the fifth residue is GalNAc and for HS/Heparin it is GlcNAc. The regulation behind the choice of GAG to be synthesised is complex and not fully understood, but several main areas have been identified as being of importance.

The synthesis of CS can be controlled by the addition of GalNAc with an α -anomeric configuration. The so formed pentasaccharide is unable to become CS/DS since the anomeric linkage is of the wrong configuration,¹¹¹ and the enzyme responsible for this capping, an α -GalNAcT, might thus be involved in the regulation process due to its blocking of CS/DS

ⁱ For further details regarding the biosynthesis of GAGs and localisation of synthetic steps, including a comprehensive list of references and clear, detailed figures, reference 110 is highly recommended. See also reference 101 for further figures.

synthesis. Other important enzymes are those responsible for the elongation, epimerisation and sulphation of the growing polymer chains and it has been shown in Chinese hamster ovary (CHO) cells that two proteins necessary for the synthesis of HS proteoglycans are products of two tumour suppressor genes.^{112,113}

Not only are CS/DS and HS/Heparin chain elongation and modification performed by different sets of enzymes, the localisation of these enzymes in the Golgi also differs.¹¹⁰

Another point of regulation is the access to the necessary starting materials (UDP-sugars) and it has for example been shown that the ratio of UDP-GlcNAc and UDP-GlcA available influences the chain length of heparin.¹¹⁴ The amount of UDP-sugars available in the lumen of the Golgi could be regulated both via the enzymatic systems involved in their synthesis and by the translocator systems which transport them into the lumen.

Whilst all GAG attachment sites have nearby clusters of acidic amino acids, the consensus amino acid sequences of the GAG attachment sites on the core proteins show significant differences between HS and CS proteoglycans.¹¹⁵ HS-carrying core proteins normally have a repeating glycine-serine motif of two or more repeats. Mutation studies have shown that the acidic clusters are necessary but not sufficient for HS priming. Also, nearby lipophilic residues enhance HS priming. Exchanging a tryptophan residue for a less hydrophobic alanine residue decreased HS priming and insertion of tryptophan next to a CS attachment site with nearby acidic residues increased the priming of HS.

Also, it has been shown that a globular domain on the glypican-1 core protein is vital for the synthesis of HS GAG chains on the tetrasaccharide.¹¹⁶ Removal of this domain changed the proportion of GAG chains on glypican-1 from 90% HS to 10% HS. Coexpression of the globular domain with core proteins to which it is not attached enhances the amount of HS PG formed, seemingly by inhibiting the formation of CS chains. This may indicate that CS/DS synthesis is the default action and that a regulatory signal is needed to initiate HS synthesis.

A point of attack which, for synthetic medicinal chemistry, is of most interest as a point of possible regulation is, apart from peptide sequences, the linker tetrasaccharide. Whilst the repeating disaccharide units of the GAG chains are heavily modified, not as many modifications of the linker have been discovered. C-2 in the xylose residue is a major site of phosphorylation in both CS and HS PGs from some tissues but not in those from other tissues.^{117,118} In decorin biosynthesis transient phosphorylation occurs during tetrasaccharide synthesis with a peak after the addition of the two Gal residues. Dephosphorylation occurs

rapidly after formation of the full tetrasaccharide,^{119,120} but the function of the phosphorylation and dephosphorylation is not yet known.

The linker region of CS/DS can be sulphated at HO-4 of the second Gal residue,¹²¹ and the first GalNAc after the linker may be sulphated on HO-4 or HO-6. No sulphation of the linker region has been observed for HS/heparin but this is most likely due to HS/heparin not being a suitable substrate for the enzymes responsible.

The regulation between CS and DS, and between HS and heparin, is most likely controlled by the enzymes in the Golgi responsible for the elongation and modifications of the GAG chains and by regulation of the synthesis and breakdown of these enzymes.

2.3 Xylosides as artificial primers of glycosaminoglycan biosynthesis

In 1968, the complexity of PGs led Helting and Rodén to use exogenous substances to study, in cell free systems, the enzymes involved in the addition of the Gal and GlcA residues to xylose (see Table 2.2 for examples of exogenous substances used as GAG primers).¹²²⁻¹²⁴ Their studies showed that Xyl (**6**), Xyl(β 1 \rightarrow)OSer (**20**), Gal(β 1 \rightarrow 4)Xyl β and, Gal(β 1 \rightarrow 4)Xyl(β 1 \rightarrow)OSer can serve as acceptors for the addition of Gal from UDP-Gal and that elongation of the formed substrates was initiated. A few years later, Okayama et al. conducted virtually the same studies using *p*-nitrophenyl β -D-xylopyranoside (**21**) and found that it also primed the synthesis of GAGs.^{125,126} More importantly, they found that whilst neither Xyl (unless at 20 mM) or Xyl(β 1 \rightarrow)OSer, primed GAG synthesis in embryonic chick cartilage, GAG synthesis was primed on **21** and on xylosides carrying alkyl aglycon (**23-25**).^{125,127} Also, they postulated that **21** is transported across the matrix and cell membranes and that the core protein is not necessary for the subsequent saccharide chain modifications. In 1975, Fukunaga et al. studied the synthesis of CS on 4-methyl-umbelliferyl β -D-xylopyranoside (**22**) and found, besides CS, a fraction of GAG which was not sensitive to chondroitinase-ABC, testicular hyaluronidase, papain or keratan sulphate-endogalactosidase,ⁱ but was cleaved by an extract containing heparin/HS degrading eliminases.^{128,129} Fukunaga et al. were thus the first to report that xylosides carrying aromatic aglycon can prime HS synthesis.

ⁱ Chondroitinase-ABC cleaves CS/DS (see Supplementary information), testicular hyaluronidase cleaves HA, keratan sulphate-endogalactosidase cleaves KS and papain (an enzyme from green papaya) cleaves the GAG chain from the core protein.

Table 2.2. Structures of xylosides **20-35** tested for GAG biosynthesis priming capabilities and/or toxicity in mammalian cells.

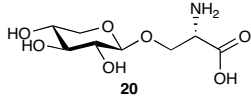
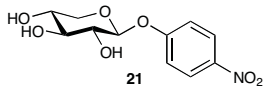
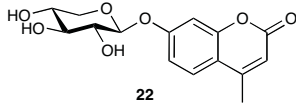
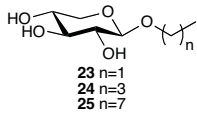
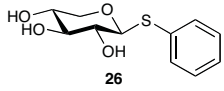
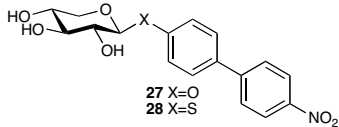
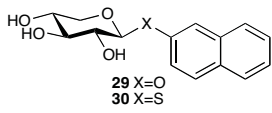
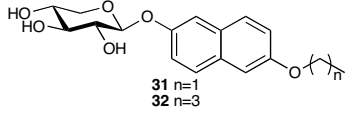
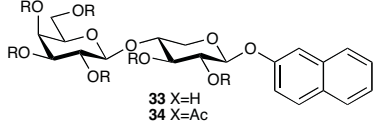
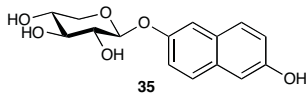
Xyloside	Year	Ref	Comments
 <p>20</p>	1969	123	First reported use of an exogenous O-β-D-xyloside.
 <p>21</p>	1973	125,126	First aryl O-β-D-xyloside reported. Shows the increased GAG priming capability of aryl xylosides.
 <p>22</p>	1975	128	First to show priming of HS.
 <p>23 n=1 24 n=3 25 n=7</p>	1975	127, 130	First systematic study on the effect of aglycon structure. Present several new xylosides and show a correlation to lipophilicity although do not discuss it. Mention transport through cell membranes and show differences in GAG structure.
 <p>26</p>	1975	127, 131	First reported thioxyloside.
 <p>27 X=O 28 X=S</p>	1993, 1995	135, 136	Showed that xylosides can assert biological activity in vivo upon oral administration.
 <p>29 X=O 30 X=S</p>	1994	138	First naphthalene based xyloside. Shows an increased HS priming and correlations to log P.
 <p>31 n=1 32 n=3</p>	1994	138	Shows that ether substitution still allows GAG priming.
 <p>33 X=H 34 X=Ac</p>	1995	139, 140	Shows that disaccharide-naphthyl xylosides can prime GAG synthesis and correlates lipophilicity to cellular uptake. Reference 139 also shows that 29 is taken up by cells within minutes.
 <p>35</p>	1998	141, 142	First hydroxynaphthyl β-D-xylopyranoside reported. Reports selectivity towards transformed cells, anti-tumour properties in vivo and that HS priming is required for antiproliferative activity.

During the 1970's and 1980's, several investigations showed the effect of the aglycon structure on the priming of GAGs (a further discussion is presented in chapter 4.3).^{127,132-134} In their 1975 paper, Robinson et al. showed that the priming of CS was strongly dependent on the aglycon structure in both O-alkyl (**23-25**) and O-aryl xylosides and also presented the first use of a thio- β -D-xyloside (**26**).¹²⁷ Sobue et al. presented further studies regarding the effect of aglycon structure on GAG priming properties, and showed the dramatic effects xylosides can assert on developmental processes through studies on their effect in fertilised hens' eggs.¹³⁴ Bellamy et al. synthesised a series of O- and S-xylosides (e.g. **27** and **28**) and showed their activity as antithrombotic agents *in vitro* as well as when administered orally *in vivo*.^{135,136}

After the discovery in 1991 that the xyloside of estradiol efficiently primed the synthesis of HS,¹³⁷ Fritz et al. synthesised a series of naphthalene based xylosides (e.g. **29** and **30**) and found that they also primed HS synthesis efficiently.¹³⁸

2.3.1 Naphthoxylosides and their role as glycosaminoglycan primers

Fritz et al. showed that the structure of the naphthyl moiety of naphthalene-based xylosides, and its coupling to the xylose, influenced the priming efficiency and the proportion HS synthesised of total GAG. They showed that, with some exceptions, there exists a clear correlation between lipophilicity and properties as GAG primer. In later work from the group, Sarkar et al. showed that the uptake of **29** by cells is very fast and that acetylation of naphthyl xylosides (**33** and **34**) can increase the priming efficiency, probably due to increased uptake.^{139,140} In 1998, whilst searching for xylosides with aglycon which could be iodinated, and with HS priming capabilities, Mani et al. noted that 2-(6-hydroxynaphthyl) β -D-xylopyranoside (**35**) primed HS and exerted a growth inhibitory effect on several cell lines.¹⁴¹ This xyloside was later shown to be active *in vivo* upon subcutaneous, intraperitoneal and peroral administration and reduced the tumour load in a SCID mouse model by 70-97% and was therefore suggested to serve as a lead compound for the development of novel antitumour strategies.¹⁴²

3 Aims of the thesis

The long-term goal of research into naphthoxylosides and their role as primers of glycosaminoglycan synthesis is to develop compounds with promising anti-tumour properties to be used in the treatment of cancer.

Development of novel pharmaceuticals is expensive and time-consuming, with large multinational companies needing 10-15 years from the birth of an idea to the launch of a medicine onto the market. It is therefore highly unlikely that one Ph.D.-project can accomplish this and the aims of this thesis are therefore more modestly set.

It is well established that naphthoxylosides are efficient primers of glycosaminoglycan synthesis but the reasons behind their more efficient priming of heparan sulphate compared to xylosides with aglycon composed of alkyl substituents or smaller aromatic systems are not known. Also, the underlying causes behind the tumour-selective antiproliferative property shown by 2-(6-hydroxynaphthyl) β -D-xylopyranoside are not known and it is investigations into these two intriguing properties of naphthoxylosides which is the aim of this thesis.

By varying the substituents and the pattern of substitution on the naphthalene moiety we hoped to learn more about the factors involved in determining the biological properties of naphthoxylosides.

4 Synthesis and biology of hydroxynaphthyl xylosides (Papers III and IV)

After the discovery in 1998 that 2-(6-hydroxynaphthyl) β -D-xylopyranoside (**35**) primes glycosaminoglycan biosynthesis and has a more pronounced antiproliferative effect on transformed cells than on healthy cells,¹⁴¹ two other hydroxynaphthyl β -D-xylopyranosides were synthesised and tested (compounds **45** and **58**).^{142,143} Whilst **45** showed some antiproliferative activity, selectivity towards transformed cells was absent. Also, a significant effect *in vivo* was shown by **35**.¹⁴² Encouraged by these results and interested in investigating the effect of the substitution pattern on the naphthalene skeleton, we initiated studies aiming at the synthesis and biological evaluation of all possible hydroxynaphthyl β -D-xylopyranosides.

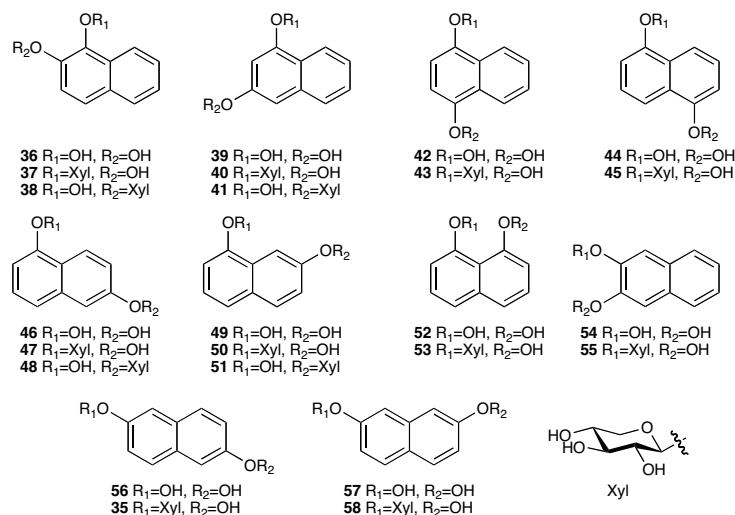
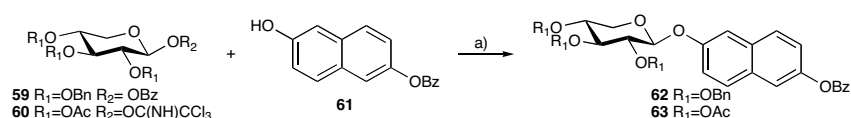

Figure 4.1. Structures of the 10 possible dihydroxynaphthalenes ($R_1=R_2=OH$) and 14 hydroxynaphthyl β -D-xylopyranosides (R_1 or $R_2=Xyl$).

4.1 Solution phase synthesis of naphthoxylosides.

Since only three of the 14 possible isomeric hydroxynaphthyl β -D-xylopyranosides (Figure 4.1) had been synthesised and tested, we set out to find a common synthetic route for all 14 analogues.

The previous synthetic route was based on xylosylation of the monoprotected form of the appropriate dihydroxynaphthalene (Scheme 4.1).^{141,142,143}



Scheme 4.1. Previously presented route towards **35**. a) For **59**: TMSOTf, CH_2Cl_2 , 4 Å MS, 45%. For **60**: $BF_3 \cdot OEt_2$, CH_3CN , 70% after deprotection (**63** not isolated prior to deprotection to give **35**).

The yield of this route was not seen as satisfactory using either of the two xylopyranoside donors (**59** or **60**), especially since the deprotection of **62** (debenzoylation and hydrogenolysis) only gave the purified product in 45% yield. The route using the trichloroacetimidate donor **60** gave a higher yield but access to this donor requires several synthetic steps.

Irrespective of the xylopyranose donor used, appropriate mono-protected dihydroxynaphthalenes must be synthesised. Access to these is hampered by the fact that protection gives a mixture of the wanted compound, the starting material and the diprotected dihydroxynaphthalene. The exact ratios in the mixture is dependent on which dihydroxynaphthalene is used. Column chromatography to isolate the product is time-consuming and expensive with regard to the amount of solvents used. An enzymatic mono-acetylation approach using *Chromobacterium viscosum* lipase has been reported,¹⁴⁴ and whilst some substrates gave excellent selectivities the conversions were often low. The enzyme showed complete selectivity towards mono-acetylation of 2,3-dihydroxynaphthalene (**54**) but the conversion was only 8%. Similar selectivity (97%) was shown towards 1,5-dihydroxynaphthalene (**44**) but yet again the conversion was a low 27%. The enzyme did produce both mono-acetylated isomers of the asymmetric dihydroxynaphthalenes investigated but investigation into the acetylation of the 1,2- (**36**), 1,4- (**42**), 1,7- (**49**), and 1,8-dihydroxynaphthalenes (**52**) was not reported.

To optimise the ratio of wanted product we screened several methods for mono-protection of dihydroxynaphthalenes (Table 4.1).

Table 4.1. Examples of methods for the mono-benzoylation of dihydroxynaphthalenes.

Entry	Reagents ^a	Substrate	Yield	Comments
1	BzCl, CH ₂ Cl ₂	56	34%	1.0 equiv. BzCl, -78 °C to r.t.
2	BzCl, pyridine, CH ₂ Cl ₂	42	43%	1.0 equiv. BzCl, -78 °C to r.t.
3	BzCl, pyridine, dioxane	56	28%	2.8 equiv., reflux
4	BzCl, QI, NaOH (aq.), CH ₂ Cl ₂	56	Mostly dibenzoylated product	1.0 equiv. BzCl
5	BzCl, NaOH (aq.), H ₂ O	54	58%	Kept at pH 11
6	BzCl, NaOH (aq.), H ₂ O	56	Mostly dibenzoylated product	Kept at pH 11
7	i) TMSCl, pyridine, CH ₂ Cl ₂ ii) BzCl iii) H ₂ O iv) EtOH, AcOH	56	70%	1.0 equiv. TMSCl, 1.5 equiv. BzCl
8	i) TMSCl, pyridine, CH ₂ Cl ₂ ii) BzCl iii) H ₂ O iv) EtOH, AcOH	42	52%	1.0 equiv. TMSCl, 1.5 equiv. BzCl
9	i) TMSCl, pyridine, CH ₂ Cl ₂ ii) BzCl iii) H ₂ O iv) EtOH, AcOH	44	45%	1.0 equiv. TMSCl, 1.5 equiv. BzCl
10	i) TMSCl, pyridine, CH ₂ Cl ₂ ii) BzCl iii) H ₂ O iv) EtOH, AcOH	57	44%	1.0 equiv. TMSCl, 1.5 equiv. BzCl

^aSee the Supplementary information chapter for experimental procedures for entries 5-10.

Even after extensive optimisation attempts, the synthetic route to the required mono-protected dihydroxynaphthalenes was not satisfactory due to the large variation in yield between the different isomers. Whilst an acceptable yield was obtained for protection of **56**, yields were still low with **42**, **44** and **57** as substrates and time consuming chromatography was needed to give pure product.

Protection of both available hydroxyl groups followed by partial deprotection to give the desired mono-protected compound can, after optimisation, give acceptable yields but the differences between the isomers are still substantial and chromatography is needed. Utilisation of a lipase enzyme from *Pseudomonas* has been reported to give excellent yields of some mono-acetylated dihydroxynaphthalenes (Scheme 4.2),¹⁴⁵ but this is not a universal method since it, for example, only gives 2-hydroxynaphthalen-4-yl acetate (**63**) from 1,3-diacetoxynaphthalene (**61**).

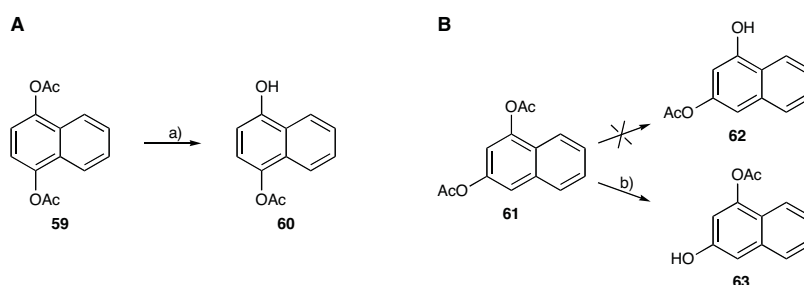

Scheme 4.2. Monodeacetylation of 1,4-diacetoxynaphthalene (**59**) (A) and of 1,3-diacetoxynaphthalene (**61**) (B). a) *Pseudomonas* sp. lipase, *t*-BuOMe, H₂O, 25 °C, 2.5 h, 92%. b) *Pseudomonas* sp. lipase, *t*-BuOMe, H₂O, 25 °C, 1 h, 84%.

To circumvent these problems and find a common method for all isomers, we turned our attention to a solid-phase approach.

4.2 Solid-phase synthesis of xylosylated dihydroxynaphthalenes

Polymer supports were introduced as scaffolds for synthesis (see Chapter 1.3.1) and in 1972 Leznoff and co-workers presented their use as a blocking group to solve the problem of mono-protection of symmetrical diols.¹⁴⁶ By attaching one hydroxyl group of 1,4-butanediol to an acid chloride Merrifield resin, the diol could effectively be monotritylated. Release from the resin under basic conditions gave the monotritylated diol **64** in 37% yield (Scheme 4.3).

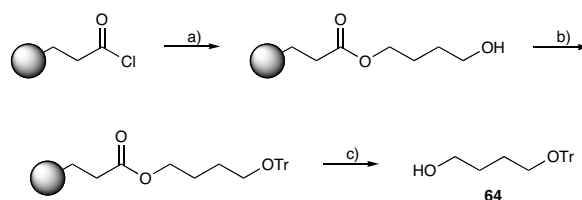

Scheme 4.3. Monoprotection of 1,4-butanediol using an acid chloride resin as a blocking group. a) 1,4-Butanediol, pyridine. b) Trityl chloride, pyridine. c) Dioxane/concentrated ammonium hydroxide solution 1:1. 37% over 3 steps.

Following this first publication, Leznoff and co-workers demonstrated the advantages of this methodology with other protecting groups such as tetrahydropyranyl (THP),¹⁴⁷ acetate¹⁴⁸ and methoxyether¹⁴⁹ as well as other linkages to the resin.¹⁴⁸

Whilst their method did present a solution to the problem of selectively targeting only one of two symmetrical hydroxyl groups we needed to adapt their method to the synthesis of

mono-xylosylated dihydroxynaphthalenes. Monoprotection and release of xylopyranoside acceptor was feasible but deprotection of the protected hydroxyl group after xylosylation would be problematic if a THP or ether group was used, due to the acid-sensitivity of the xylopyranosidic linkage. Use of an aryl acetate would give facile deprotection but the stability of the aryl acetate to the acidic cleavage conditions present by Leznoff et al. would be questionable.

Instead of blocking one hydroxyl group, protecting the remaining hydroxyl group and releasing the monoprotected substrate from the solid support, we realised that the blocking reaction with the solid support could be viewed as the protection step and xylosylation could be performed on the resin-bound dihydroxynaphthalene (Scheme 4.4).

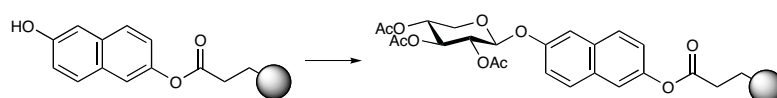

Scheme 4.4. Xylosylation of resin-bound dihydroxynaphthalene with the solid support acting as a protecting group.

This route would give several advantages:

1. The dihydroxynaphthalene which is not protected (does not bind to the resin) is removed upon washing of the resin.
2. The resin is washed after the xylosylation step, removing excess donor. Therefore a large excess of donor can be used without hampering purification. Also, any hemiacetal formed in the xylosylation step is washed away.
3. No chromatography is needed until after cleavage from the resin.
4. Hydrolysis of the ester linkage will not only release the xyloside from the solid support but will also deprotect the sugar to give the fully deprotected naphthoxyloside.

Using commercially available benzoic acid resin we studied the binding and release of dihydroxynaphthalenes (Scheme 4.5). After conversion of the carboxylic acid to the acid chloride, 2,6-dihydroxynaphthalene (**56**) was attached to the solid support under standard acylating conditions.

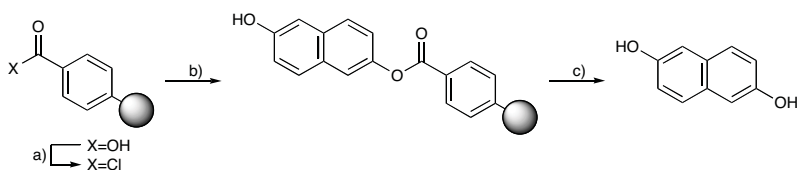

Scheme 4.5. Coupling of 2,6-dihydroxynaphthalene (**56**) to solid support and hydrolysis. a) Benzene, thionyl chloride. b) 2,6-Dihydroxynaphthalene, DIPEA, DMAP, CH₂Cl₂. c) NaOH (1 M, aq.), dioxane.

The yields obtained after cleavage of **56** from the solid support were similar to those reported by Leznoff et al.¹⁴⁹ and we proceeded to investigate the xylosylation reaction.

Using a threefold excess of peracetylated xylose (**11**) we attempted to xylosylate the free phenolic group of resin-bound **56**. Cleavage and deprotection under standard Zemplén conditions (NaOMe-MeOH, CH₂Cl₂, MeOH)¹⁵⁰ did not yield xyloside **35** even though xylosylation under the same conditions in solution followed by deprotection yields product.

The possibility of both hydroxy groups of dihydroxy compounds binding to the resin, thus effectively bis-protecting the substrate has been reported previously.¹⁴⁹ The commercial resin used had a relatively high loading of about 1.5 mmol/g which increases the possibility of double binding. To circumvent this problem we modified a commercially available aminomethylated polystyrene resin with a lower loading (Scheme 4.6).¹⁵¹ The aminomethyl group was reacted with succinic anhydride and the resulting carboxylic acid was converted into the acid chloride using oxalyl chloride.

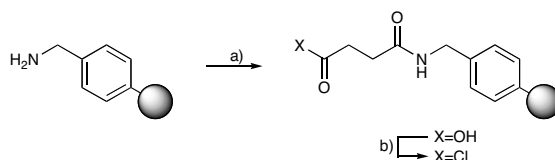

Scheme 4.6. Conversion of commercially available aminomethylated polystyrene resin to acid chloride resin. a) Aminomethylated polystyrene resin, succinic anhydride, DIPEA, DMAP, toluene, r.t. b) Oxalyl chloride, toluene.

The starting aminomethylated resin had a loading of 1.3 mmol/g. After conversion to the acid chloride the maximum theoretical loading, as calculated using Equation 4.1, was 1.0 mmol/g.

Equation 4.1. Equation for calculating new loading of solid-phase resins after modifications. L=loading, M=molecular weight.

$$L_{new} = \frac{L_{old}}{1 + L_{old}(M_{new} - M_{old}) \times 10^{-3}}$$

We now tested xylosylation of **56** attached to this new, lower loading, resin. Using $\text{BF}_3 \cdot \text{OEt}_2$ -promoted xylosylation with 5 equiv. of peracetylated xylose followed by saponification to release and deprotect the xyloside gave **35** in 21% yield after purification by HPLC.

To ensure that the yield was not hampered by anomerisation of the product to the more stable α -xyloside we studied the rate of anomerisation. Samples of the xylosylation of 6-benzoyloxy-2-hydroxynaphthalene (**61**) in solution were treated with NaOMe-MeOH as were samples of the xylosylation of resin-bound **56**. Analysis of these samples by reverse-phase HPLC revealed large differences in the rate of anomerisation for the solution-phase and solid-phase xylosylation reactions. The amount of α -xyloside formed after 45 min for the solid-phase method was minimal. Encouraged by these results we prepared for the synthesis of all 14 hydroxynaphthyl β -D-xylopyranoside isomers by synthesising the two dihydroxynaphthalenes (**36**¹⁵² and **52**^{153,154}) which were not readily available from commercial sources (Scheme 4.7).

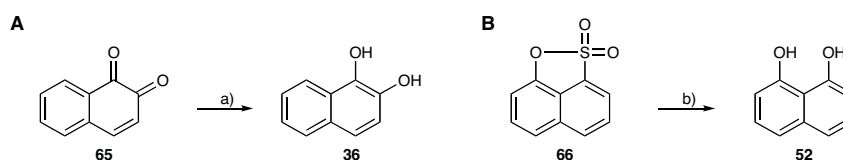

Scheme 4.7. Synthesis of 1,2-dihydroxynaphthalene (**36**) and 1,8-dihydroxynaphthalene (**52**). a) NaBH_4 , EtOH, r.t., quantitative. b) KOH, 250-300 °C, 44%. See Supplementary information for full experimental details.

With all 10 dihydroxynaphthalenes and a working protocol (Scheme 4.8) in hand we synthesised all 14 hydroxynaphthyl β -D-xylopyranosides in 5 steps from the commercially available aminomethylated polystyrene resin (Table 4.2).

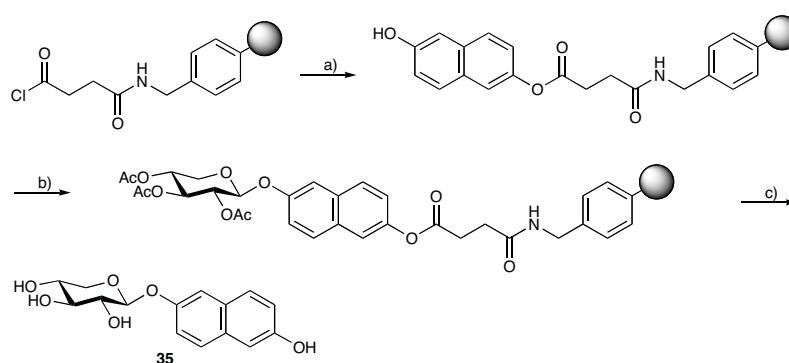

Scheme 4.8. Solid-phase synthesis of hydroxynaphthyl β -D-xylopyranosides as illustrated with **35**. a) 2,6-Dihydroxynaphthalene (**56**), CH_2Cl_2 , pyridine, DMAP, r.t. b) 1,2,3,4-Tetra-*O*-acetyl- β -D-xylopyranoside, $\text{BF}_3 \cdot \text{OEt}_2$, CH_2Cl_2 , r.t. c) CH_2Cl_2 , MeOH, NaOMe-MeOH (1 M), r.t.

The yields of hydroxynaphthyl β -D-xylopyranosides obtained from the solid-phase synthetic method ranged from 6% to 42% and are presented in Table 4.2.

Table 4.2. Yields for the solid-phase synthesis hydroxynaphthyl β -D-xylopyranosides as calculated from the amine loading of aminomethylated polystyrene resin.

Compound	Starting aglycon	Yield
37	36	6% ^a
38	36	10% ^a
40	39	16% ^a
41	39	9% ^a
43	42	16%
45	44	27%
47	46	16% ^a
48	46	9% ^a
50	49	14% ^a
51	49	15% ^a
53	52	7%
55	54	42%
35	56	28%
24	23	21%

^aMaximum theoretical yield of 100% is shared between the two possible products from the same starting aglycon since both are synthesised in the same reactor.

The yields presented are calculated from the starting aminomethylated polystyrene resin, over 5 steps and after purification by semi-preparative HPLC. It should be noted that for the unsymmetrical dihydroxynaphthalenes two hydroxynaphthyl β -D-xylopyranosides are obtained in the same reactor and the total yield of xyloside is therefore the sum of the two yields.

4.3 Physical properties of hydroxynaphthyl β -D-xylopyranosides

Several earlier reports have indicated correlations between the physical properties of xylosides and their biological activity. Sobue et al. synthesised a large number of S- and O-alkyl xylosides and tested their ability to prime the synthesis of GAGs (Figure 4.2).¹³⁴ Their study clearly showed that the length of the alkyl chains in S- and C-alkyl xylosides has a substantial effect on their ability to prime GAG synthesis in chick-embryo cartilage with a maximum effect at 7 to 8 carbon atoms. For rat-embryo skin and rat aorta, similar patterns were obtained but the optimal alkyl chain length was shorter (skin n=5, aorta n=4).

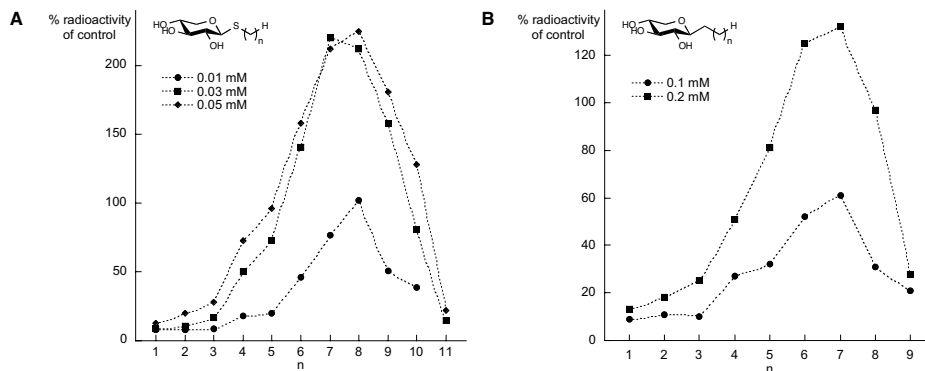

Figure 4.2. The effect of the alkyl-chain length on stimulation of CS-priming by S- (A) and C-alkyl (B) xylosides in chick-embryo cartilage as investigated by Sobue et al. (Modified with permission from Sobue et al. *Biochem. J.* **1987**, *241*, 591-601).¹³⁴

The authors attributed this dependence on the balance between lipophilic and hydrophilic moieties to the necessary transport of the xyloside through cell membranes.

Fritz et al. studied the effect of aromatic aglycon of xylosides on heparan sulphate biosynthesis.¹³⁸ For a series of aryl xylosides they measured octanol-water partitioning constants and percentage heparan sulphate in the total amount of GAG. They found good correlation between the lipophilicity of the xyloside and the ability to prime HS synthesis with only some very lipophilic compounds not following the trend (Figure 4.3).

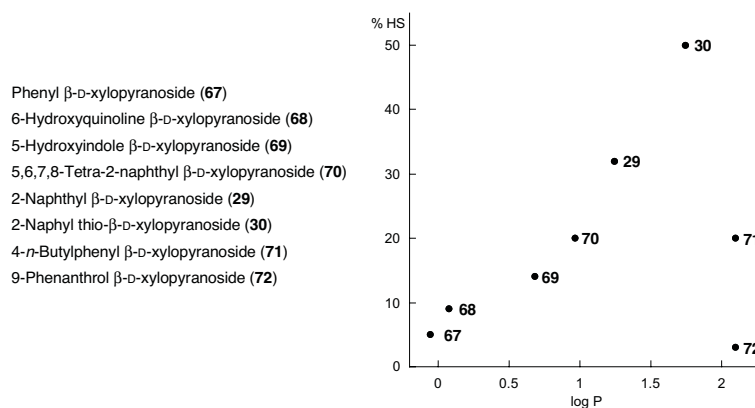

Figure 4.3. Plot of log P of **67-72**, **29** and **30** versus % HS of total GAG primed as investigated by Fritz et al. (from data presented by Fritz et al. 1994).¹³⁸

Fritz et al. discuss the possibility of the correlation to hydrophobicity arising from selective entry of the xylosides into the subcellular compartments where GAG biosynthesis takes place.

Sarkar et al. showed a strong dependence of priming on the proportion of free hydroxyl groups on naphthyl β -D-pyranosides.¹³⁹ Methylation or acetylation of the hydroxyl groups on sugar residues increased the uptake of and priming by 2-naphthyl β -D-xylopyranoside (**29**) and naphthyl disaccharides (**33** and **34**).

A correlation between the lipophilicities of *o*-nitrophenyl β -D-xylopyranoside and *p*-nitrophenyl β -D-xylopyranoside (**21**) and their effect on HS priming was shown by Moreira et al.¹⁵⁵ They also attributed this to the increased localisation of the more lipophilic xyloside in the necessary subcellular compartments.

Due to the amount of evidence concerning the importance of the lipophilicity of xylosides for their biological properties, we embarked on a study of the physical properties of the 14 hydroxynaphthyl β -D-xylopyranosides.

Table 4.3. Measured pK_a values and gradient HPLC retention times for the 14 hydroxynaphthyl β -D-xylopyranosides and calculated log P (C log P) and pK_a values using ACD/Labs¹⁵⁶ software and Schrödinger QikProp¹⁵⁷ and Jaguar software¹⁵⁸.

Compound	pK_a (exp)	Calculated pK_a		Retention time (min)	C log P	
		ACD	Jaguar ^a		ACD	QikProp
37	8.63 \pm 0.02	7.93	9.8	20.70 \pm 0.05	0.45	0.348
38	8.72 \pm 0.04	7.99	10	21.18 \pm 0.07	0.45	0.369
40	9.22 \pm 0.04	9.13	9.8	15.82 \pm 0.09	0.7	0.231
41	8.66 \pm 0.01	8.96	9.8	17.95 \pm 0.09	0.7	0.285
43	9.40 \pm 0.04	9.97	10.4	13.45 \pm 0.11	0.7	0.288
45	9.16 \pm 0.04	9.35	9.9	13.22 \pm 0.07	0.65	0.286
47	9.34 \pm 0.02	9.15	9.9	14.84 \pm 0.08	0.65	0.285
48	9.17 \pm 0.03	9.32	9.9	13.66 \pm 0.08	0.65	0.233
50	9.35 \pm 0.01	9.35	9.9	18.07 \pm 0.08	0.65	0.288
51	9.29 \pm 0.03	9.56	10	16.61 \pm 0.09	0.65	0.244
53	10.13 \pm 0.11	8.96	11.5	21.84 \pm 0.04	0.65	0.469
55	8.76 \pm 0.02	9.41	9.7	19.12 \pm 0.01	0.45	0.434
35	9.63 \pm 0.02	9.64	10.2	12.49 \pm 0.01	0.65	0.232
58	9.41 \pm 0.01	9.35	9.9	14.53 \pm 0.01	0.65	0.234

^aThe calculated pK_a values are for the corresponding methoxynaphthols. See text for discussion.

Measurement of log P values by octanol-water partitioning requires a large amount of hands-on time as well as substantial amounts of substance. The same applies to measuring affinities to

micelles and therefore an alternative method for measuring the lipophilicity of xylosides was needed.

Gradient HPLC retention times have been shown to be an alternative to log P values in the biological evaluation of active compounds.¹⁵⁹ This led us to measure the retention times of the hydroxynaphthyl β -D-xylopyranosides on a reverse-phase HPLC column with a positive gradient of acetonitrile in water. The mean retention times from three separate runs are shown in Table 4.3.

The results show that both the acidity of the phenolic proton and the lipophilicity of the xyloside varies greatly with substitution pattern. The retention times were also measured for the corresponding dihydroxynaphthalenes (Table 4.4) and a clear correlation was shown to the distance between the phenolic oxygen atoms (Figure 4.4) as has been observed in similar investigations.¹⁶⁰ Some dihydroxynaphthalenes (e.g. **52**) had a substantially longer retention time than expected, probably due to internal hydrogen bonding between the two optimally positioned hydroxyl groups. The most polar compounds are those with the hydroxyls located as far apart as possible (**56** and **57**).

Table 4.4. Measured gradient HPLC retention times for the 10 dihydroxynaphthalenes and distance between the phenolic oxygens.

Compound	Retention time (min)	Distance (nm)
36	19.58 \pm 0.03	0.27
39	19.05 \pm 0.04	0.48
42	15.46 \pm 0.02	0.56
44	13.71 \pm 0.02	0.60
46	14.72 \pm 0.01	0.63
49	18.43 \pm 0.09	0.51
52	24.50 \pm 0.02	0.26
54	18.86 \pm 0.01	0.27
56	13.58 \pm 0.01	0.78
57	16.19 \pm 0.00	0.73

The same pattern is obvious for the mono-xylosylated dihydroxynaphthalenes but here the possibilities of hydrogen bonds between the free phenol and the hydroxyl groups on the sugar residue also seems to affect the polarity since **38** and **53** (21.18 and 21.84 min respectively) have nearly the same retention time whilst their starting aglycon (**36** and **52**) differ with 5 minutes (24.50 and 19.58 min respectively). Also noteworthy is the fact that the products from the unsymmetrical dihydroxynaphthalenes vary in lipophilicity.

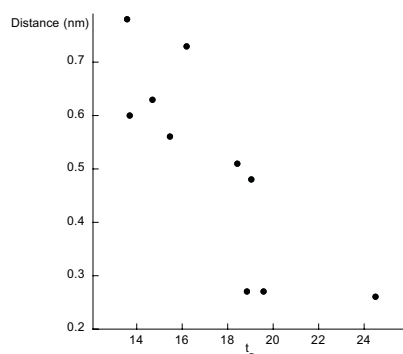

Figure 4.4. Correlation of distance between the phenolic oxygens of dihydroxynaphthalenes and measured gradient HPLC retention times.

Predicting pK_a values of phenolic compounds by computational methods has been shown to be difficult.¹⁶¹ Therefore we turned to a spectrophotometric method to determine the acidity constants of the xylosides. By measuring the UV-absorbance of a solution of the xyloside at pH 9, 10 and 11 and comparing these to the absorbance of a solution of the xyloside with the phenolic hydroxyl fully protonated and fully deprotonated, the pK_a values could be determined using Equation 4.2.

Equation 4.2. Relation of pK_a to pH and measured ratio of protonated/deprotonated hydroxynaphthyl β -D-xylopyranoside.

$$pK_a = pH + \log \frac{[\text{XylONapOH}]}{[\text{XylONapO}]}$$

The measurements were performed for all 14 hydroxynaphthyl β -D-xylopyranosides and the results are presented in Table 4.3.

4.3.1 Comparison of experimentally obtained physical properties with those obtained by computational chemistry

Even though HPLC analysis does not require large amounts of hands-on time, it does require machine time and large amounts of solvent. Also, measurement of pK_a values by spectrophotometric methods is time consuming. Therefore, obtaining these values through computational methods would be a great advantage. The $C \log P^i$ values of the 14 hydroxynaphthyl β -D-xylopyranosides were calculated using the Advanced Chemistry Development, Inc. (ACD/Labs)¹⁵⁶ log P module and Schrödinger QikProp¹⁵⁷, and the pK_a

ⁱ Calculated log P values are denoted $C \log P$ to distinguish them from experimentally determined log P values.

values were calculated by ACD/Labs pK_a module and Schrödinger Jaguar¹⁵⁸ software.ⁱ The results are presented in Table 4.3.

Comparison of the calculated values with the experimentally determined values highlights that calculation of acidity constants, as mentioned earlier, are indeed problematic. Whilst some of the values given by ACD/Labs are very close (e.g. 9.63 determined experimentally and 9.64 calculated for **35** and 9.35 both determined and calculated for **50**) some are far from accurate (e.g. 10.13 determined experimentally and 8.96 calculated for **53**). Also, the general trend is that ACD/Labs gives a slightly higher value than that determined experimentally (Figure 4.5A).

Calculation of the pK_a values was also conducted using the pK_a module of Jaguar. This module performs a set of calculations and returns a pK_a value for the selected atom. Calculations on the hydroxynaphthyl β -D-xylosides gave varying results. Not only were the pK_a values quite far from the measured values but the correct trend was not observed. Also, we noted that the starting conformation of the xyloside could drastically influence the results. To obtain better results it would have been necessary to conduct a proper conformational search for both the protonated and deprotonated species for each xyloside and the results would have to be carefully analysed prior to running the pK_a calculations. Since such a procedure would defeat the intended purpose of obtaining quickly and without expertise in computational chemistry reasonable values for the acidity constants we attempted a different approach. The acidity constants for the corresponding methoxynaphthols were calculated using the module (Table 4.3). The results show a trend which is comparable to that of ACD/Labs but whilst ACD/Labs generally gives too high values, Jaguar gives too low values.

For the lipophilicity of the 14 compounds, the results from the calculations are similarly disappointing. The results from ACD/Labs shows that the program does not take into account the three dimensional structure of the compound, for example giving the same value (0.65) for both **53** and **58**. These two compounds have retention times which differ by over 7 minutes. QikProp gives better results putting these two compounds at the extremes of the scale drawn up by the results (**53** = 0.469 and **58** = 0.234 on a scale of 0.231 to 0.469). Also, Figure 4.5B shows that QikProp indeed gives a correct trend for the log P values whilst ACD/Labs fails drastically, although the differences between the compounds are underestimated.

ⁱ See the Supplementary information chapter for a discussion regarding the methods used by the ACD/log P and ACD/ pK_a modules and Schrödinger QikProp and Jaguar pK_a calculations.

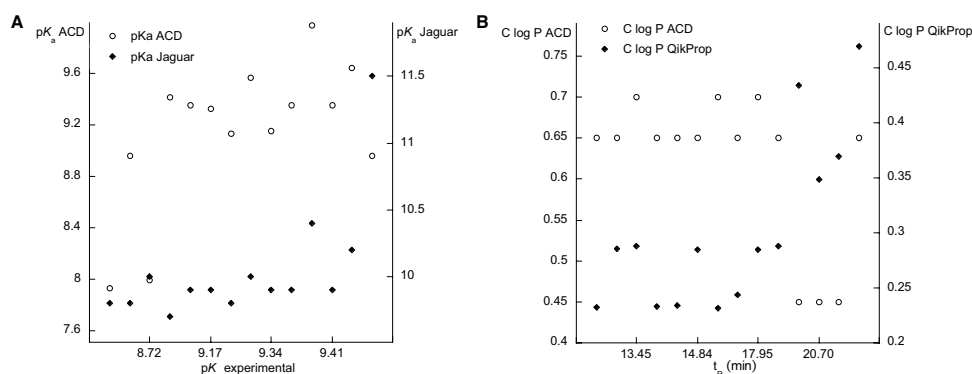

Figure 4.5. Comparison of experimentally determined pK_a values and values calculated in ACD/Labs (A) and Jaguar and experimentally determined gradient HPLC retention times and C log P values calculated in ACD/Labs and QikProp (B), showing the difficulties in prediction of physical properties by computational methods.

These results show that, as mentioned earlier, the determination of physical properties of compounds remains a difficult task for computational methods and whilst the experimental methods are time and labour intensive they are still of great importance.

4.4 Biological evaluation of first generation naphthoxylosides

The biological action of xylosides is not trivial, and several factors need to be examined. Therefore we studied both the antiproliferative properties of the 14 hydroxynaphthyl β -D-xylopyranosides, their ability to prime the biosynthesis of heparan sulphate chains and whether apoptosis is induced in cells treated with an antiproliferative xyloside.

4.4.1 Antiproliferative effects of hydroxynaphthyl β -D-xylopyranosides

To measure the antiproliferative properties of the hydroxynaphthyl β -D-xylopyranosides, confluent, adherent cells were allowed to proliferate in the presence of varying concentrations of xyloside for 96 hours. After fixing the cells, the amount of proliferation compared to untreated cells was measured using the crystal violet method.^{i,162}

ⁱ After the treatment period and removal of the growth medium, cells are fixed for 15 min with a salt solution containing 1% glutaraldehyde. The cell nuclei are then stained using a 0.1% solution of crystal violet for 30 minutes. After washing, cells are lysed over 24 h using Triton X-100 solution. The amount of dye which was bound by the cells is then measured spectrophotometrically at 600 nm. The staining of treated cells is compared to that of untreated cells. See the Supplementary information chapter for further information.

For this study four cell lines were used. Mouse 3T3 fibroblasts (3T3 A31), SV40 virus transformed mouse 3T3 fibroblasts (3T3 SV40), human fetal lung fibroblasts (HFL-1) and human bladder carcinoma cells (T24) were allowed to proliferate at 0.025, 0.05, 0.1, 0.2 and 0.5 mM xyloside. The inhibitory effects of the xylosides were expressed as ED₅₀ (μM) and are presented in Table 4.5.

Table 4.5. Antiproliferative activity of hydroxynaphthyl β-D-xylopyranosides on 3T3 A31, 3T3 SV40, HFL-1 and T24 cells expressed as ED₅₀ (μM) after 96 h exposure. Values are mean values from 5 replicates.

Compound	3T3 A31	3T3 SV40	HFL-1	T24
37	10	65	80	150
38	120	120	40	160
40	130	275	240	100
41	410	575	320	25
43	165	105	6	1
45	> 500	> 500	500	470
47	210	> 500	370	125
48	> 500	430	500	600
50	260	550	370	370
51	160	510	330	420
53	185	340	180	220
55	25	180	190	400
35	440	320	500	100
58	300	460	500	500

The results show that most of the xylosides have ED₅₀ values in the range of 100-500 μM towards most of the four cell lines. Some xylosides (**37**, **38**, **43** and **55**) show higher toxicity towards some cell lines with **43** having a very low ED₅₀ value for HFL-1 and T24 cells. The mouse fibroblasts are with few exceptions (**37** and **55** for normal fibroblasts and **37** for transformed fibroblasts) not highly sensitive to the xylosides and transformation by SV40 virus did not significantly increase sensitivity to any particular xyloside. Some of the xylosides show a significant selectivity towards T24 cells as compared to HFL-1 cells. **43** and **51** show a 5-6 fold selectivity towards the transformed cells and the efficiency of **35** against tumour cells has been demonstrated *in vivo*.¹⁴² **41** shows a remarkable 13-fold selectivity towards T24 cells in preference to HFL-1 cells.

To ascertain whether any noted selectivity effects were due to the xyloside and not inherent in the aglycon itself, the antiproliferative effects of the free aglycon were measured in

HFL-1 and T24 cells (Table 4.6). The free aglycon were highly antiproliferative with T24 cells being somewhat more sensitive than HFL-1 cells.

Table 4.6. Antiproliferative activity of dihydroxynaphthalenes on HFL-1 and T24 cells expressed as ED₅₀ (μM) after 96 h exposure. Values are mean values from five replicates.

Compound	HFL-1	T24
36	25	13
39	100	70
42	1	0.7
44	20	< 10
46	70	20
49	< 25	< 10
52	20	10
54	40	30
56	< 25	< 10
57	70	30

These results clearly show that the free dihydroxynaphthalenes do not show any significant selectivity towards either of the cells lines and thus the selectivities shown by some hydroxynaphthyl β-D-xylopyranosides are not inherent in the aglycon but dependent on its incorporation in a xyloside. Also, the results support the view that the xylosides are not hydrolysed early on in the GAG biosynthetic process

4.4.2 Stability of hydroxynaphthyl β-D-xylopyranosides

The proliferation studies are performed in a slightly basic medium at an elevated temperature (37 °C) for an extended period of time (96 h). To evaluate the stability of the hydroxynaphthyl β-D-xylopyranosides over this period, 20 mM stock solutions of the respective xylosides were diluted with Ham's F-12 medium to 0.2 mM and stored at 37 °C. To ensure reliable analysis, 4,4'-dihydroxybiphenyl was included as an internal standard. The solution was sampled at different intervals and analysed by analytical HPLC to give the stability profiles of the xylosides (Figure 4.6).

The results showed that 10 of the 14 xylosides were stable at the assay conditions for 96 h. Also, **41** and **51** did decompose, but only slightly. In contrast, **38** decomposed entirely within 48 h and **43** within 72 h.

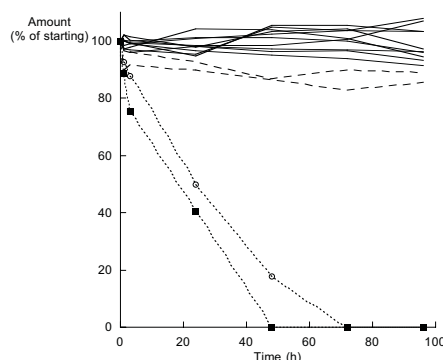

Figure 4.6. Stability profiles of hydroxynaphthyl β -D-xylopyranosides in Ham's F-12 medium at 37 °C. The graph shows the concentration of xyloside compared to an internal standard as analysed by HPLC. Whilst 10 of the xylosides are stable (unbroken lines), **40** and **51** show slight decomposition (dashed lines) and **38** (■) and **43** (○) decompose totally.

To analyse further the degradation of **38** and **43** we subjected larger amounts of these xylosides to the same conditions for 68 h after which the solutions were filtered and the UV-active degradation products were isolated by semi-preparative HPLC.

NMR analysis of the isolated compounds showed that whilst **38** decomposed by hydrolysis of the xylosidic linkage to give several modified aromatic products, **43** gave one major decomposition product containing a modified naphthalene moiety and a xylopyranoside structure. Analysis of the data showed the product to be **73**. The $^1\text{H-NMR}$ spectra (Figure 4.7) clearly show the disappearance of the signal for H-3 and the loss of the H-3 coupling for H-2, transforming this doublet into a sharp singlet. The pattern for the unsubstituted ring remains the same with only minor changes in the chemical shifts of H-5, H-6, H-7 and H-8 whilst the anomeric proton is shifted 0.15 ppm downfield to 5.00 ppm.

Subjecting the free aglycon **42** to the same conditions and purification by HPLC gave several major products which were identified as oxidised forms of **42**. Polyhydroxylated naphthalenes such as juglone (6-hydroxy-1,4-naphthoquinone) and lawsone (2-hydroxy-1,4-naphthoquinone) are known to be highly toxic,¹⁶³ and enhancing their cellular uptake via conjugation to a carbohydrate carrier such as in **73** could be expected to increase their effective toxicity drastically.

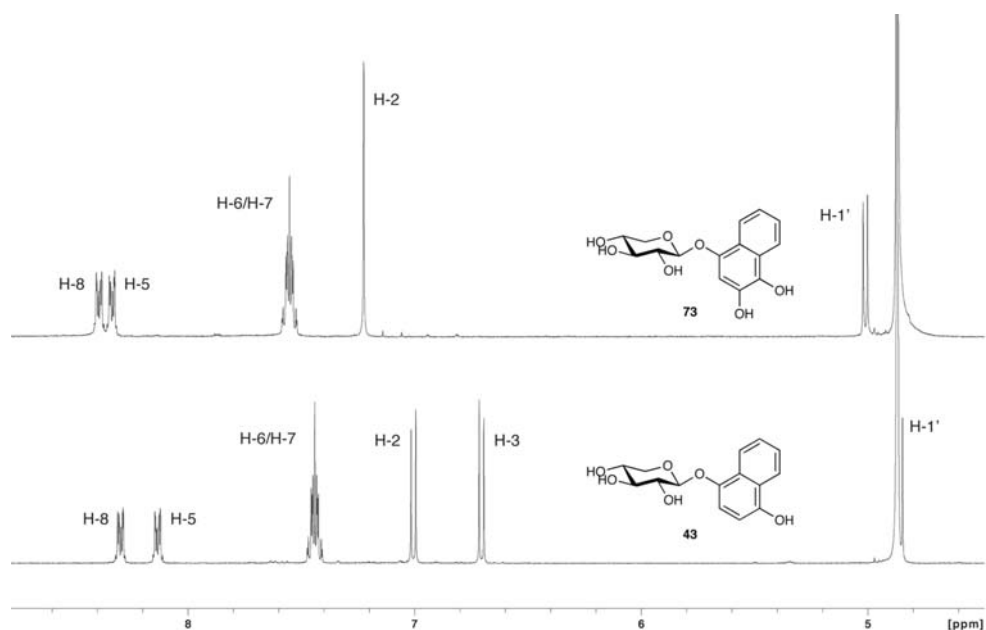

Figure 4.7. $^1\text{H-NMR}$ spectra of **43** (bottom trace) and **73** (top trace) showing the anomeric ($\text{H-1}'$) and aromatic proton signals.

The formation of **73** from **43** could explain the very low ED_{50} value found for this compound when administered to HFL-1 and T24 cells. The free aglycon **42** was also found to be highly toxic towards HFL-1 and T24 cells and this could also be explained by the formation of toxic polyhydroxylated naphthalenes and naphthoquinones (e.g. juglone or lawsone).

4.4.3 Heparan sulphate priming of hydroxynaphthyl β -D-xylopyranosides

Xylosides carrying aglycon with two fused aromatic rings (i.e. naphthalene based systems) have been shown to induce HS synthesis to levels not normally associated with healthy cells.¹³⁸ Also, HS synthesis has been shown to be a necessary (but not sufficient) requirement for the tumour selective effect of 2-(6-hydroxynaphthyl) β -D-xylopyranoside (**35**).¹⁴² Therefore, the proportion of HS of the total amount of GAG synthesised in T24 cells after treatment with 0.1 mM xyloside for 24 h was measured by cleaving CS/DS with ABC lyase and analysis by gel-permeation chromatography (Table 4.7).ⁱ

ⁱ After treatment with xyloside for 24 h the culture medium is collected and pooled. Extraction of cells is performed by lysing cells with Triton X-100 prior to extraction. GAG pools are then separated from PG protein and analysed by gel permeation chromatography. See Supplementary information for further information.

Table 4.7. Effect of hydroxynaphthyl β -D-xylopyranosides on the proportion of HS synthesised in T24 cells. Results are presented as percentage of HS of the total GAG content as measured by ^{35}S -activity after separation by gel-permeation chromatography.

Compound	% HS (medium)	% HS (cells)
37	15	2
38	8	22
40	2	14
41	4	20
43	0	12
45	6	29
47	4	13
48	2	12
50	3	15
51	6	27
53	6	27
55	5	28
35	12	30
58	7	37

As mentioned, other studies have indicated that xylosides carrying naphthalene based aglycon increase the proportion of HS,^{138,141} and that HS priming is necessary for the tumour-selective antiproliferative property of **35**.¹⁴² The present study supports the finding that naphthoxylosides increase the proportion of HS primed in cells but we found no correlation between the proportion of HS to the antiproliferative effect on T24 cells.

4.4.4 Induction of apoptosis in T24 cells by 2-(6-hydroxynaphthyl) β -D-xylopyranoside

Apoptosis^{i,164,165} is one of the most important mechanisms behind the death of tumour cells from chemotherapeutic drugs or radiation treatment. By selectively inducing apoptosis in tumour cells, damage to healthy cells can be minimised and this is therefore of importance within the field of chemotherapeutics. That 2-(6-hydroxynaphthyl) β -D-xylopyranoside (**35**) selectively hinders the growth of transformed cells has been established previously,^{141,142}

ⁱ Apoptosis, from the greek word for “falling off” of leaves from a tree (suggested by Prof. James Cormack, Aberdeen University, to Kerr et al., see reference 164), is the normal physiological process in which cells self-destruct after the addition or removal of a stimulus. Apoptosis is genetically determined and characterised by the fragmentation of nuclear DNA into pieces of about 185 base pairs. Apoptosis does not induce inflammation (or at least to a smaller extent) in surrounding tissue in contrast to non-programmed cell-death (often referred to as cell murder), necrosis, where swelling of the cell and rupture of the plasma membrane leaks the cytoplasmic contents, including proteolytic enzymes, into the surroundings.¹⁶⁵ The pronunciation of the word “apoptosis”, and whether the second “p” should be pronounced or not, is quite debated with the original reference claiming it should be silent whilst its pronunciation has become more frequent.

although the mechanism behind the effect was not determined. To study whether the effect was due to the induction of apoptosis, T24 cells were treated for 24 h with 0.2 mM of either the antiproliferative **35** or the inactive, but GAG priming 2-naphthyl β -D-xylopyranoside, (**29**) and a terminal deoxynucleotidyl transferase mediated dUTP nick end labelling (TUNEL) assay was performed.^{i,166,167} The results of the TUNEL assay were evaluated by confocal laser fluorescence microscopy and flow cytometry (Figure 4.8).^{ii,168,169}

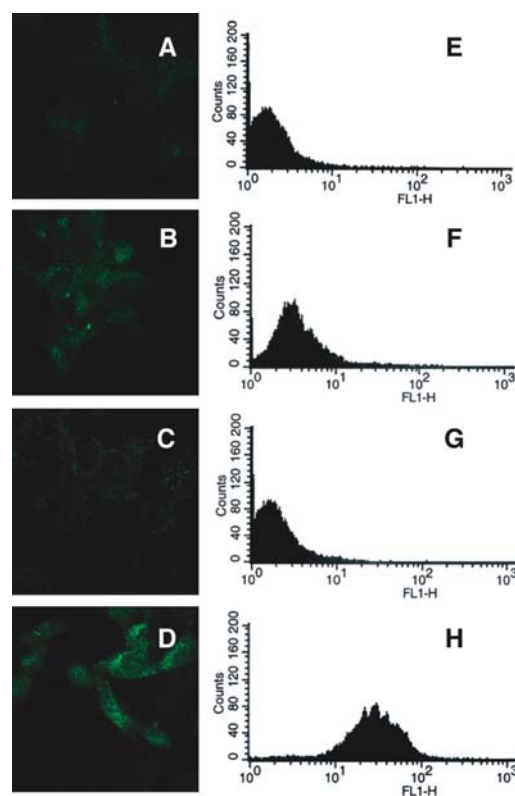

Figure 4.8. Study of apoptosis in T24 cells using TUNEL assay evaluated using confocal laser fluorescence microscopy (A-D) and flow cytometry (E-H) on untreated cells (A and E), cells treated for 24 h with 0.2 mM 2-(6-hydroxynaphthyl) β -D-xylopyranoside (**35**) (B and F), cells treated for 24 h with 0.2 mM 2-hydroxynaphthyl β -D-xylopyranoside (**29**) (C and G) and cells treated with nuclease (D and H) as positive control. The images show equatorial sections of cells observed through confocal laser microscopy and the graphs show the cell count versus fluorescence intensity.

ⁱ During apoptosis DNA is cleaved by specific calcium-dependent endonucleases (nucleases capable of cleaving internal phosphodiester bonds in DNA) yielding fragments with double stranded breaks. Introduced in 1992 and since developed,¹⁶⁶ the TUNEL assay works by, after permeabilisation of the cell membranes by a detergent, using terminal deoxynucleotidyl transferase (TdT) to transfer biotin labelled nucleotides (biotin-dNTP) to the free 3'-OH groups of the DNA fragments. The biotinylated sites are then visualised by specific conjugation with streptavidin-conjugated fluorescein isothiocyanate (FITC). The fluorescence can then be detected by confocal laser fluorescence microscopy or flow cytometry (see the Supplementary information chapter for a description of the principle behind flow cytometry).

ⁱⁱ See reference 169 for a description of confocal microscopy.

The increase in the number of T24 cells showing high fluorescence after treatment with 2-(6-hydroxynaphthyl) β -D-xylopyranoside (**35**) (Figure 4.8F) as opposed to the increase for cells treated with the non-toxic 2-naphthyl β -D-xylopyranoside (**29**) (Figure 4.8G) indicates an increased DNA damage upon treatment with the antiproliferative xyloside. Morphological analysis of the treated cells (Figure 4.8B and C) indicates that the binding of fluorescence is not associated with a necrotic process. Thus it can be concluded that the antiproliferative effect of xylosides is, in T24 cells, accompanied by increased induction of apoptosis.

4.5 Correlations between antiproliferative properties and physical properties

As was discussed earlier, correlations between the lipophilicity of xylosides and their biological activity have been shown.^{134,138,139,155} We therefore studied our results to ascertain whether correlations between toxicity and physical properties could be found. Whilst we found no correlations between biological properties of the aglycon and the acidity of the phenolic proton, correlations between toxicity and lipophilicity (retention time) were found for some cell lines (Figure 4.9).

For HFL-1 cells (Figure 4.9A), a correlation was found for all compounds except for **43**. This is one of the two compounds which decomposed quickly to give the more lipophilic **73** (t_R 23.2 min). For T24 cells (Figure 4.9B) the toxicity of 9 of the xylosides correlated well whilst 5 had lower ED_{50} values than predicted. These 5 xylosides all show selectivity towards T24 cells. We found no clear correlation between ED_{50} and lipophilicity of the xylosides for 3T3 A31 or 3T3 SV40 cells (Figure 4.9C and D).

Taken together, the results of this study indicate that the antiproliferative effect of xylosides is dependent both on the cell line and the structure of the aglycon. Varying the substitution pattern of hydroxynaphthyl aglycon has a large influence on both the selectivity and toxicity.

The uptake of xylosides has been shown to be dependent on the lipophilicity of the compound. Our results show that whilst uptake and priming are necessary for the antiproliferative effect of some xylosides these factors are not sufficient. The toxicity of most xylosides is, for some cell lines, correlated to their polarity but for some xylosides and cell lines a different mechanism seems to be involved.

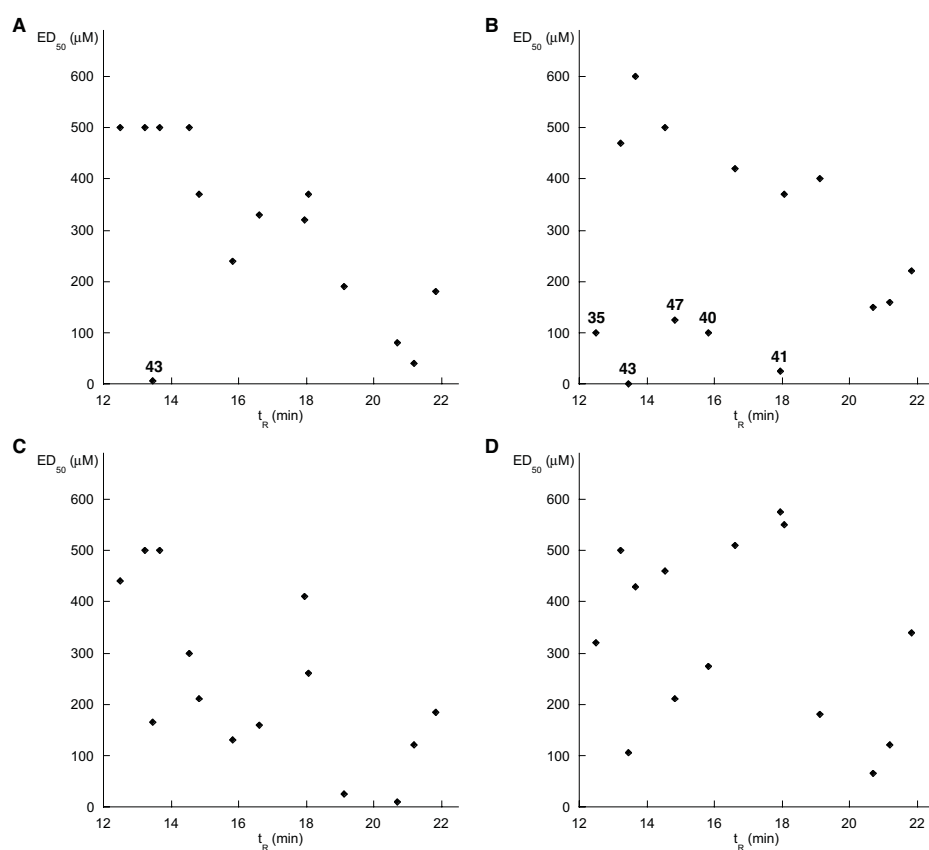

Figure 4.9. Antiproliferative activity (ED₅₀, μM) of hydroxynaphthyl β-D-xylopyranosides for HFL-1 cells (A), T24 cells (B), 3T3 A31 cells (C) and 3T3 SV40 cells (D) plotted against their gradient HPLC retention times (min).

It has previously been shown that the degradation products of xyloside-primed GAGs are internalised by cells and transported into the nucleus.¹⁴² Our studies show that the antiproliferative effect of 6-(2-hydroxynaphthyl) β-D-xylopyranoside (**35**) results in increased apoptosis of the cellular population which is of importance for the future use of xylosides in the treatment of tumours.

5 Synthesis and biology of sulphur-containing naphthoxylosides (Papers V and VI)

To extend our investigation into the structure-activity relationships of naphthoxylosides we wanted to synthesise sulphur-containing naphthoxylosides. Sulphur is a classical isosterⁱ for oxygen and the substitution would expand the range of physical as well as chemical properties of our library of naphthoxylosides.

To span as large a structural space as possible we wanted to synthesise both the S-xylosides with a free aromatic hydroxyl group (**80-85**) and the O-xylosides with a free aryl thiol (**74-79**). To decrease the number of compounds to be synthesised, and to simplify purification and characterisation, we decided to synthesise only the isomers corresponding to the 6 symmetric dihydroxynaphthalenes (Figure 5.1).

Aryl thiols are more acidic (pK_a 6-8) compared to the corresponding phenols (pK_a 8-11), and this could be expected to influence cellular uptake of the xylosides as well as redox properties and electron density distribution of the aglycon. Also, the possibility of forming the disulphide bond would allow the use of aryl thiol O-xylosides to create libraries of diverse naphthoxylosides.

Disulphides have recently been used to create dynamic libraries, i.e. collections of compounds whose constitution is adjusted depending on the conditions, using dynamic combinatorial chemistry (DCC).⁵⁴ Recent successful uses of DCC include the generation and screening of a library of possible concanavalin A vaccines and the discovery of a psammaphin A

ⁱ A classical isoster is an atom containing the same valence electron configuration as the atom it is being compared to. The definition has, since its introduction, been broadened to include groups with similar properties.

type antibacterial agent with good activity against methicillin-resistant *Staphylococcus aureus*.^{170,56} In both cases the reversibility of the thiol-disulphide linkage was used as the dynamic bond.

Xylosides with S-xylosidic bonds are of great biological interest since the length of the carbon-sulphur bond renders an increased stability towards glycosidases.¹⁷¹ As has been discussed earlier, S-xylosides have previously been shown to prime GAG synthesis with comparable or even higher efficiency than the corresponding O-xylosides and have also been shown to have activity *in vivo*.^{134,136,136}

Also, 2-naphthyl 1-thio- β -D-xylopyranoside (**30**) shows a higher proportion of HS priming compared to 2-naphthyl β -D-xylopyranoside (**29**) but both these compounds have shown low toxicity. To infer toxicity on these compounds, with a view to investigate further the antiproliferative properties of mono-xylosylated dihydroxynaphthalenes,^{141,142} we wanted to add a hydroxyl group to the aglycon.

Synthesis of these sulphur-containing xylosides requires as xylopyranoside acceptors naphthalene moieties carrying both a hydroxyl group and a thiol and the possibility of selective protection of hydroxyl and thiol groups (Figure 5.2).

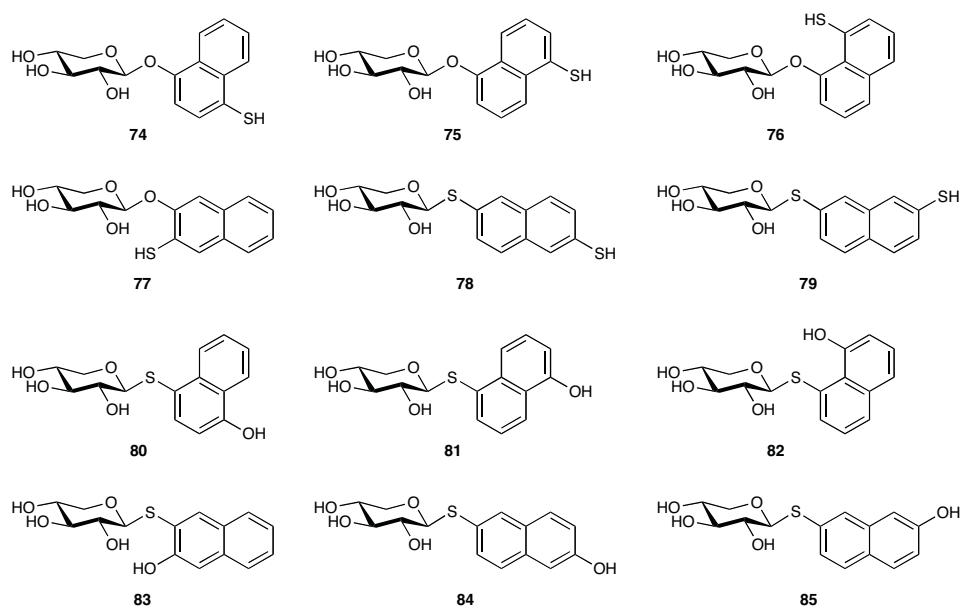

Figure 5.1. Structures of thionaphthyl β -D-xylopyranosides (**74-79**) and hydroxynaphthyl 1-thio β -D-xylopyranosides (**80-85**).



Figure 5.2. Orthogonally protected difunctional naphthalenes needed for the synthesis of sulphur-containing naphthoxyosides.

Most of the protecting groups suitable for hydroxyls will also react with thiols and vice versa. We therefore needed to develop a protecting group strategy which could circumvent this problem and yield orthogonally protected, difunctional naphthalenes as shown in Figure 5.2.

The disulphide bond is a protecting group which is unique for thiols. With the thiol protected as the disulphide in a hydroxynaphthyl disulphide we could selectively perform transformations on the hydroxyl group. The disulphide can then easily be reduced/deprotected to the corresponding thiol by a variety of reagents, solution based or immobilised on solid-support (e.g. aryl- and alkyl phosphines,^{172,173} polystyrene-bound triphenyl phosphine (Ph₃P-PS),¹⁷⁴ and nucleophilic hydrides^{175,176}) as exemplified in Figure 5.3. Due to the variety of reagents available for the transformations the probability of finding conditions which leave other protecting groups intact is good and we could thus protect the aromatic hydroxyl groups prior to thiol cleavage to give the O-protected thiol nucleophile.



Figure 5.3. Protection and deprotection of thiols using the reversibility of the disulphide bond. Some examples of the reagents which can be used for the transformations are shown.

With a promising thiol-protecting group determined, we next turned to the availability of hydroxynaphthyl disulphides. Unfortunately, only one isomer (the 2,6 isomer, **116**) was commercially available due to its use as a probe in molecular biology.^{177,178}

Whilst several of the other isomers have also been reported in the literature,¹⁷⁹⁻¹⁸² not all are known and the reported syntheses are not facile and the corresponding starting materials are not available for the future synthesis of all possible isomers.

Aryl thiols and disulphides can be synthesised by reduction of sulphonyl chlorides or sulphonic acids using, for example, hydrides,^{183,184} zinc metal,¹⁸⁵ samarium metal,¹⁸⁶ aluminium iodide,¹⁸⁷ triphenyl phosphine and iodine,¹⁸⁸ and various silane systems.^{189,190} Whilst these methods can be high-yielding and facile, they all rely on the availability of the aryl sulphur compound. The corresponding phenol can also be converted into a thiol using the

Newman-Karnes procedure over three steps including one high-temperature rearrangement.^{191,192} A third possibility is reductive cleavage of the sulphur-carbon bond of aryl-alkyl or aryl-benzyl thioethers by dissolving-metal reduction.¹⁹³⁻¹⁹⁶ Also, methyl thioethers can be cleaved under harsh conditions using thiolates,¹⁹⁷ and for specially designed alkyl chains, β -elimination can be used.¹⁹⁸

To ensure the future availability of all possible regioisomers we looked towards a synthetic route starting from the dihydroxynaphthalenes since all possible isomers are available (either commercially or in one step from commercially available materials, see paper III and references 152-154).

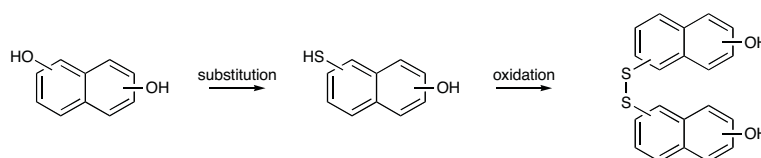
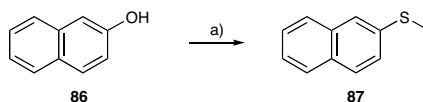

Figure 5.4. Synthetic plan for the synthesis of hydroxynaphthyl disulphides from dihydroxynaphthalenes.

We turned our attention to obtaining the disulphide-protected thiols from cleavage of an aryl-alkyl thioether bond. Aryl-alkyl thioethers are usually synthesised by coupling of aromatic halides with alkyl thiols,¹⁹⁹ or nucleophilic substitution of alkyl halides with aryl thiols, when the thiol is available.²⁰⁰ While the yields are normally high, the approaches require the availability of a suitable aryl halide or aryl thiol, which in our case was the target compound.

5.1 Formation of naphthyl-alkyl thioethers

A method for the formation of aryl-alkyl thioethers by the acid-mediated displacement of phenolic hydroxyls by thiols was presented Furman et al. in 1959.²⁰¹ By heating 1-naphthol or 2-naphthol (**86**), 6-bromo-2-naphthol or 1,5-dihydroxynaphthalene (**44**) at 110-120 °C with various thiols, in the presence of a catalytic amount of acid, good to excellent yields of the corresponding thioethers were obtained (Scheme 5.1).



Scheme 5.1. Formation of 2-thiomethylnaphthalene (**87**) from 2-naphthol (**86**). a) MeSH, *p*-TsOH, 100 °C, 99%.²⁰¹

The reaction introduced by Furman et al. gave excellent yields for the substitution of the hydroxyl group of naphthols for thioalkyl substituents with 1,5-dihydroxynaphthalene (**44**) giving the bis-substituted compound. Nakazawa et al.²⁰² and Charoonniporn et al.²⁰³ also showed that the reaction could give the bis-substituted thioethers from dihydroxynaphthalenes but no attempts to form the mono-substituted compounds were reported.

5.1.1 Optimisation of the reaction to give mono-substitution

For the method to be useful in our synthesis, the mono-substituted thiopropynaphthols had to be readily available. In the paper by Charoonniporn et al.,²⁰³ 12 equiv. of propanethiol were used to give the bis-substituted naphthalenes from 5 of the 10 possible dihydroxynaphthalenes. The large excess of thiol used opened up the possibility of optimising the reaction conditions towards mono-substitution and we initiated studies using the six symmetrical dihydroxynaphthalenes which would yield the six monothiopropynaphthols **88-93** (Figure 5.5).

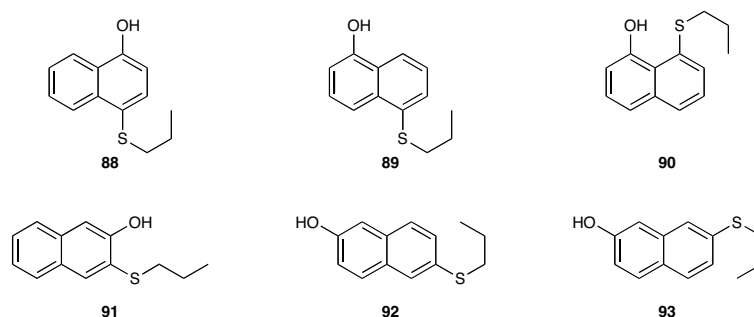
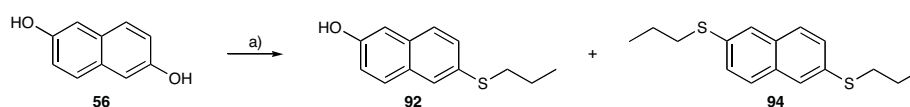

Figure 5.5. Structure of the monothiopropynaphthols **88-93** obtained from the 6 symmetric dihydroxynaphthalenes.

A minor optimisation study in which the reactions were performed with varying equivalents of thiol and temperatures was conducted with the goal of optimising the yield of monothioether.



Scheme 5.2. Synthesis of monothiopropynaphthols (**88-93**) from dihydroxynaphthalenes as illustrated with **92**. a) *p*-TsOH, *n*-PrSH, Toluene, 100 °C, 62%.

The difficulty lies in the further reaction of the product to give the bistiopropynaphthalene (i.e. **94**) as shown in Scheme 5.2. The optimal results obtained in the study are reported in Table 5.1.

Table 5.1. Optimised yields for the synthesis of thiopropyl naphthols (**88-93**) from dihydroxynaphthalenes. Mass balance is the sum of the yields of monothiopropyl naphthol and bithiopropyl naphthalene plus percentage of starting material recovered.

Substrate	Product	Yield mono	Yield bis	Mass balance
42	88	75% ^a	0%	89%
44	89	33% ^b	41%	96%
52	90	76%	0%	100%
54	91	86%	6%	100%
56	92	62% ^c	38%	100%
57	93	61% ^d	24%	99%

^a1.2 equiv. of propanethiol to **42** used. Reaction was run at 75 °C. Higher temperatures did not significantly raise the conversion but made purification more difficult due to formation of a larger amount of side-product. The side-products are responsible for the low mass balance for this entry.

^bThe low yield of **89** is explained by the high reactivity of the product to further substitution to give the bis-substituted product.

^c3.0 equiv. of propanethiol to **56** used.

^d1.4 equiv. of propanethiol to **57** used.

Whilst the results from the optimisation study were satisfactory for our continued synthetic endeavours, the reaction continued to intrigue us. Our study, as well as that of Charoonniyomporn et al., showed large differences in reactivity depending on which dihydroxynaphthalene was used.

5.1.2 Kinetic and mechanistic study of the formation of naphthyl-aryl thioethers

Charoonniyomporn et al. explained the differences in reactivity through the ease of formation of the keto-tautomer of the corresponding dihydroxynaphthalene as per the mechanism proposed by Furman et al. (Scheme 5.3).²⁰¹ The formation of the tautomeric keto-form of naphthols under acid-catalysis is well known,²⁰⁴ and has been investigated both experimentally and theoretically.^{205,206}

Furman et al. stated that the mechanism is somewhat analogous to the Bucherer reaction,²⁰⁷ formally resembling the formation of a hemithioacetal.

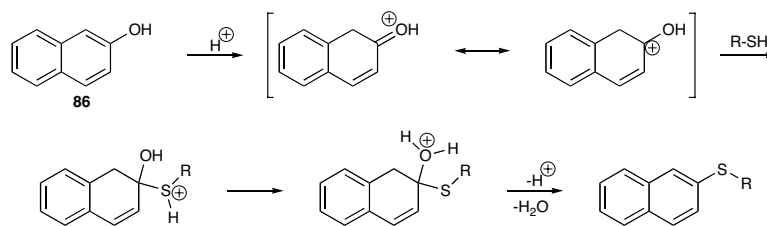

Scheme 5.3. The mechanism for the acid-catalysed displacement of phenolic hydroxyls by thiols as proposed by Furman et al.²⁰¹

Since the original observation of sulphite-catalysed interconversion of naphthols and naphthylamines by Lepetit in 1896,²⁰⁸ and subsequent work by Bucherer,^{207,209} the mechanism of the Bucherer reaction has been much debated and several structures for the intermediates have been proposed.²¹⁰⁻²¹²

In 1946, Cowdrey and Hinshelwood performed kinetic studies of the Bucherer reaction,²¹³ finding it to be of second order and supporting the intermediates postulated by Fuchs and Stix in 1922.²¹¹ Later work has criticised this mechanism and in a series of papers in 1960, Rieche and Seeboth presented what has become the established mechanism for the Bucherer reaction (summarised in Scheme 5.4).²¹⁴⁻²²¹

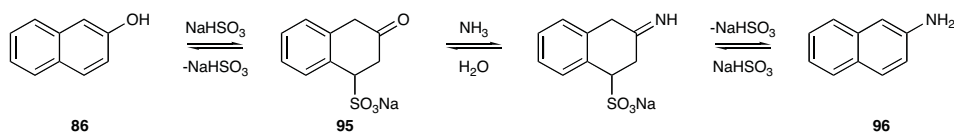

Scheme 5.4. The established course of the Bucherer reaction illustrated using the conversion of 2-naphthol (**86**) into β -naphthylamine (**96**).

Seeboth also reports that the tetralone-sulphonate **95** can be converted into β -naphthyl sulphides,²¹⁴ i.e. compounds such as our target aryl-alkyl thioethers, but no reference was made to the work seven years earlier by Furman et al.²⁰¹ nor was any reference to this report made by Nakazawa et al.²⁰² or Charoonnuyomporn et al.²⁰³

Whilst the Bucherer reaction is performed in aqueous media, we were interested in if the reaction proceeds via the mechanism suggested by Furman et al. (Scheme 5.3) in the non-polar solvent toluene. Preliminary calculations on the cationic mechanism in toluene showed that the energies were all in the excess of 200 kJ/mol indicating that the pathway is highly unlikely (Scheme 5.5).

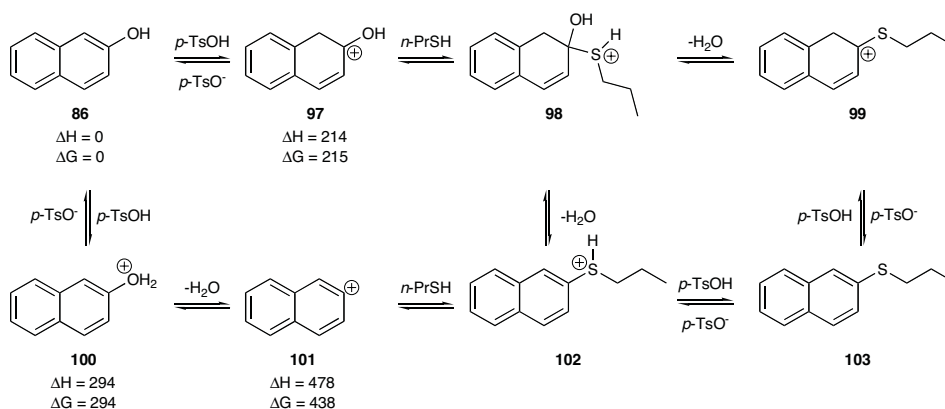

Scheme 5.5. Computational investigation of the suggested cationic mechanism in non-polar media using DFT showing that this pathway is highly unlikely. Values are in kJ/mol.

We also explored the other possible protonated isomers but found these to be even higher in energy than **97** (**104** and **105**) or unstable (**106**) rearranging to **100** upon optimisation (Figure 5.6).

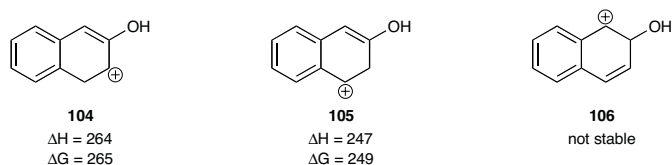
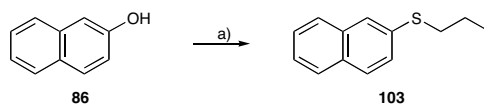

Figure 5.6. Structures and energies of **104** and **105** and structure of the unstable **106**.

These results prompted us to initiate a more detailed study of the reaction, and to aid the theoretical investigations a study of the kinetics of the reaction was undertaken using 2-naphthol (**86**) as a model substrate and *n*-propanethiol as the nucleophile.

To study the kinetics of the reaction, a method for measuring the formation of the known naphthyl propyl thioetherⁱ (**103**²²³) from 2-naphthol (**86**) and *n*-propanethiol catalysed by *p*-toluenesulphonic acid (*p*-TsOH) had to be developed (Scheme 5.6).



Scheme 5.6. Formation of naphthyl propyl thioether (**103**) from 2-naphthol (**86**). a) *n*-Propanethiol, *p*-TsOH, toluene.

ⁱ The systematic name for **103** is (naphthalen-2-yl)(propyl)sulphane.

Our first choice, simple measurement of UV-absorbance, was abandoned due to the lack of well-separated peaks in the UV-spectra of substrate and product (Figure 5.7). This necessitated the development of a chromatographic method for the separation of substrate and product.

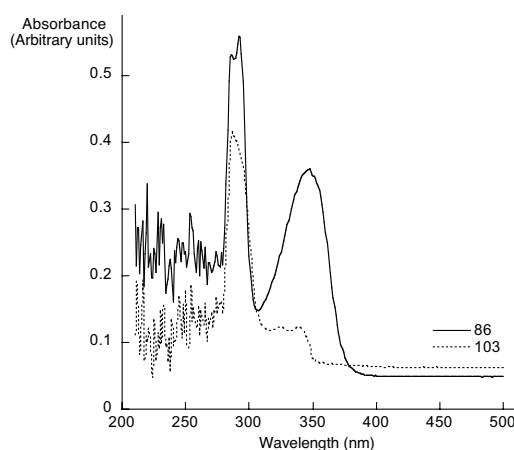

Figure 5.7. UV-spectra of **86** and **103** in MeOH showing the absence of well-separated peaks for the two compounds.

Due to the high lipophilicity of the product, an HPLC-based method was developed using a normal-phase column running a gradient of ethyl acetate in heptane. Excellent separation of **86** ($t_R=3.7$ min) from **103** ($t_R=9.4$ min) was obtained and the time needed between injections was less than 15 minutes. Sample work-up consisted of washing a small sample of the reaction mixture with NaHCO_3 -solution followed by dilution with heptane-ethyl acetate. Work-up was performed on solutions containing known amounts of substrate and product and through the use of a previously determined calibration curve it was determined that losses in the work-up procedure were insignificant.

For chromatographic methods to be used for quantification, an internal standard should be used.ⁱ This allows for the compensation of minor losses in sample work-up and errors in dilution. A suitable internal standard should be entirely stable to reaction conditions over the entire range of temperatures studied, should not be lost during work-up, needs to be detectable by the method used and be separable from all other compounds by the chromatographic method. *p*-Nitrotoluene was found to be stable to the reaction conditions at 80 °C for 20 h followed by 24 h at 110 °C and losses during the work-up procedure described above were

ⁱ An internal standard is a compound which is present through the entire sequence of events, i.e. reaction, work-up and analysis.

negligible. Also, base-line separation from the other reaction components was obtained using the developed method ($t_R=5.4$ min).

As a first step to understanding the reaction, analysis of the reaction order of the participating components was performed. By performing the reaction at 100 °C with varying concentrations of **86**, *n*-propanethiol and *p*-TsOH initial observed rates could be extracted (Figure 5.8 and Table 5.2).ⁱ Constructing a plot of the logarithm of the initial rate versus the logarithm of the starting concentration for the component being varied gave the reaction order for that component from the gradient of the linear fit (Figure 5.8D).

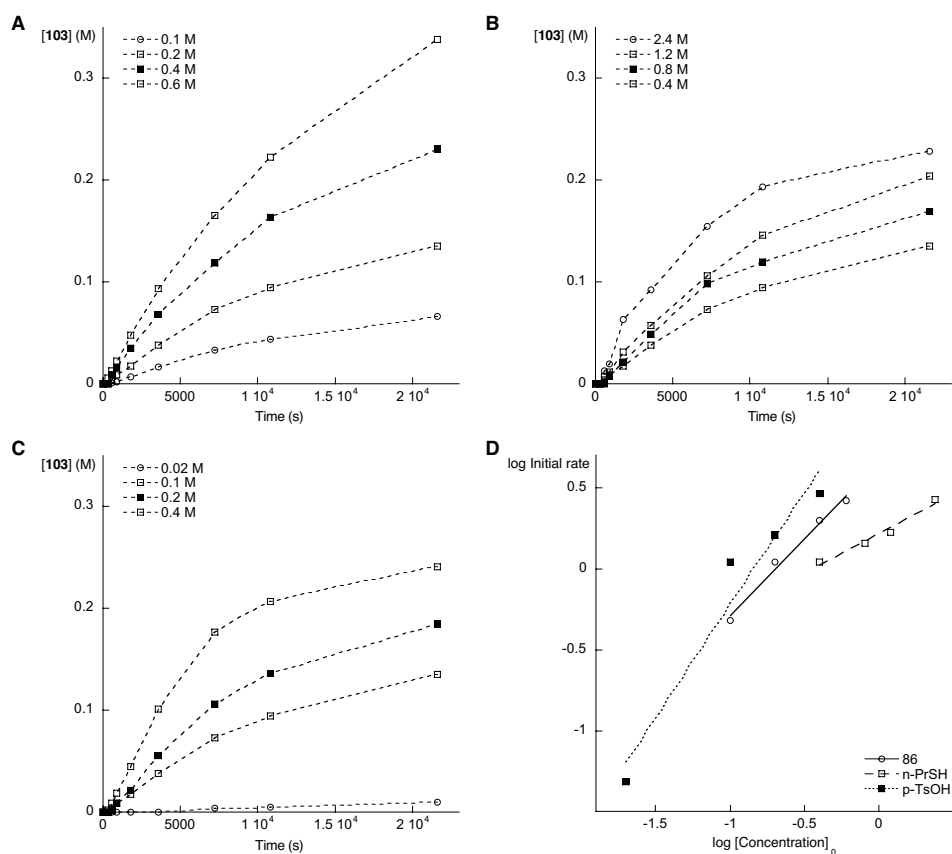

Figure 5.8. Rate of formation of naphthyl propyl thioether (**103**) at varying starting concentrations of **86** (A), *n*-propanethiol (B) and *p*-TsOH (C) and linear fits of the logarithm of the initial rate versus the logarithm of starting concentrations (D) at 100 °C in toluene. See Table 5.2 for all reactant concentrations.

ⁱ Initial observed rates are determined by the *method of initial rates* through linear fit of approximately the first 10% of a plot of concentration of formed product versus time.

Table 5.2. Concentrations of reactants and calculated initial rates at 100 °C and gradient and R²-values for linear fits of observed initial rate constant versus concentration of reactant. The values in parenthesis for *p*-TsOH are for linear fit excluding [*p*-TsOH]=0.02 M.

[86] ₀ (M)	[<i>n</i> -PrSH] ₀ (M)	[<i>p</i> -TsOH] ₀ (M)	Rate _{init.} (mol/sL)	Gradient (log vs log)	R ²
Variation of starting concentration of 2-naphthol (86)					
0.1			0.482		
0.2	0.4	0.1	1.099	0.95	0.988
0.4			1.993		
0.6			2.645		
Variation of starting concentration of <i>n</i> -propanethiol					
	0.4		1.099		
0.2	0.8	0.1	1.441	0.49	0.978
	1.2		1.690		
	2.4		2.652		
Variation of starting concentration of <i>p</i> -TsOH					
		0.02	0.049		
0.2	0.4	0.1	1.099	1.4	0.944
		0.2	1.621	(0.7)	(0.987)
		0.4	2.914		

The reaction is first order with respect to **86** and *p*-TsOH but of half order with respect to *n*-propanethiol. A reaction component being of half order is normally indicative of its presence as the dimer in solution necessitating a fast and reversible dissociation prior to reaction. The expected energies for the dissociation process were expected to be low and the kinetics fast and therefore not expected to influence our further studies.

The poor fit for *p*-TsOH can be rationalised from the uncertainty of the rate for the lowest concentration of this component and performing the fit without this point increases the goodness of fit and decreases the gradient slightly.

From the obtained reaction orders the rate equation for the reaction can now be written as in Equation 5.1. Fitting the data sets to Equation 5.1 below gives excellent R²-values confirming the reaction order.

Equation 5.1. Rate equation for the formation of **103** from **86**, *n*-propanethiol and *p*-TsOH in toluene.

$$\frac{d[\mathbf{103}]}{dt} = k[\mathbf{86}][n\text{-Propanethiol}]^{0.5}[p\text{-TsOH}]$$

Since the acid is catalytic, (substoichiometric amounts can afford complete conversion, reference 203 and Paper V), the rate equation can be simplified as in Equation 5.2.

Equation 5.2. Simplified rate expression obtained by setting [*p*-TsOH] as constant due to its catalytic property.

$$\frac{d[\mathbf{103}]}{dt} = k_{\text{obs}}[\mathbf{86}][n\text{-Propanethiol}]^{0.5}$$

After performing identical reactions at at 5 °C intervals from 70 °C to 110 °C, determination of the rate constants was to be performed. Due to the mathematical complications from the half power of the thiol, the rate expression for a second order reaction was used (Equation 5.3).

Equation 5.3. Second order rate expression for the formation of **103** from **86** in toluene.

$$\frac{d[\mathbf{103}]}{dt} = k_{\text{obs}}[\mathbf{86}][n\text{-Propanethiol}]$$

The integrated form of a second order rate expression (Equation 5.4) then gave the observed rate constants, k_{obs} , and actual rate constants, k (Table 5.3). Comparison of the values obtained from Equation 5.4 with those obtained using a pseudo-first order rate expression gives only minor differences in the rate constants and the uncertainties propagated to the activation parameters are within the standard error limits.

Equation 5.4. Integrated form of the second-order rate expression.

$$\frac{1}{[\mathbf{86}]_0 - [n\text{-Propanethiol}]_0} \ln \frac{[n\text{-Propanethiol}]_0 ([\mathbf{86}]_0 - [\mathbf{103}])}{[\mathbf{86}] ([n\text{-Propanethiol}]_0 - [\mathbf{103}])} = k_{\text{obs}} t$$

To learn more about the reaction, an Eyring plot was constructed and a linear model was fitted to the data (Figure 5.9A). However, an analysis of the residuals from a fit to a single straight line shows a pattern indicating that this is an imperfect model for the data in hand (Figure 5.9C).

Table 5.3. Observed rate constants, k_{obs} , and rate constants, k , for the formation of **103** from **86** in toluene at different temperatures. Starting concentrations were 0.2 M **86**, 0.2 M *p*-TsOH, 0.4 M propanethiol.

Temperature (°C)	$k_{\text{obs}} * 10^5$	$k * 10^5$
70	1.013 ± 0.0512	0.2026 ± 0.0102
75	2.521 ± 0.1154	0.5043 ± 0.0231
80	6.652 ± 0.4985	1.331 ± 0.0997
85	8.003 ± 0.3401	1.601 ± 0.0680
90	15.87 ± 0.6767	3.175 ± 0.1353
95	27.98 ± 1.107	5.596 ± 0.2214
100	38.06 ± 1.298	7.612 ± 0.2597
105	48.90 ± 1.871	9.780 ± 0.3742
110	53.79 ± 1.457	10.76 ± 0.2913

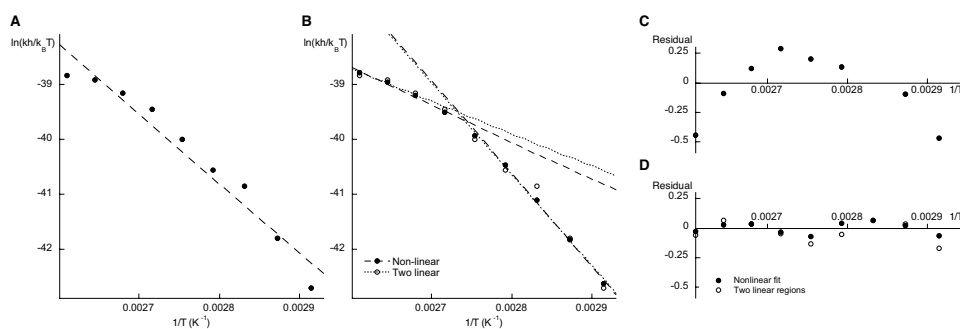

Figure 5.9. Eyring plots (top) and residual analysis (bottom) for linear (A) and stepwise linear models (B) as given by second-order rate constants for the formation of **103** from **86**, *n*-propanethiol and *p*-TsOH within the temperature interval 70 °C to 110 °C.

It has been established that Eyring plots can be of non-linear nature.²²³⁻²²⁵ Therefore, we searched for a non-linear (stepwise linear) model with good correlation to our data. A stepwise linear model with independent linear regions with a “concave down” breaking region at about 91 °C gave a better fit to our data (Figure 5.9B, open circles and dotted line) and is indicative of a change in rate determining step in a multi-step reaction.²²³ Analysis of the residuals after finding the best stepwise linear fit (Figure 5.9D, open circles) showed the absence of a systematic error.

Furthermore, an F-test was performed in which the stepwise linear model (two linear regions with two degrees of freedom each) was set against the single linear model (two degrees of freedom). A p-value of 0.039 was obtained showing the statistical significance of the stepwise linear model at the 0.05 level of significance. Further improvement of the model was sought by performing a full non-linear fit by iterative optimisation of the activation parameters (ΔH_{1}^{\ddagger} , ΔS_{1}^{\ddagger} , $\Delta \Delta H^{\ddagger}$ and $\Delta \Delta S^{\ddagger}$).

To perform this optimisation, a set of relationships between the different parameters are needed. For a multistep-step reaction, the rate constant for the entire reaction, k , is a function of the forward and back rate constants, k_1 and k_{-1} , for the first step and the rate constant of the second step, k_2 , (Equation 5.5). Equation 5.5 can be simplified to Equation 5.6 in which $k_{\text{rel}} = k_1/k_2$.

Equation 5.5. Relationship between the rate constant for the entire reaction, k , and the forward reactions for the first, k_1 , and second steps, k_2 , and the backward reaction from the intermediate, k_{-1} , in a consecutive reaction.

$$k = k_1 \frac{k_2}{k_{-1} + k_2}$$

Equation 5.6. Relationship between the rate constant for the entire reaction, k , and the rate constants for the first step and the relative rate constant, k_{rel} , between the back and forward reactions from the intermediate.

$$k = \frac{k_1}{1 + k_{rel}}$$

Equation 5.7 and Equation 5.8 then relate the rate constants to the obtained activation parameters which allows for the iterative optimisation.

Equation 5.7. Relationship between the Gibbs free energy of activation for the first step and the forward rate constant, k_1 , for the same step.

$$k_1 = \frac{k_B T}{h} e^{\left(\frac{\Delta G_1^\ddagger}{RT}\right)}$$

Equation 5.8. Relationship between the change in Gibbs free energy of activation between the first and second step and the relative rate constant, k_{rel} .

$$k_{rel} = e^{\left(\frac{\Delta\Delta G^\ddagger}{RT}\right)}$$

From the step-wise linear model, starting values for ΔH_1^\ddagger , ΔS_1^\ddagger , $\Delta\Delta H^\ddagger$ and $\Delta\Delta S^\ddagger$ were obtained and used to calculate ΔG_1^\ddagger and $\Delta\Delta G^\ddagger$. Then k_1 and k_{rel} were calculated (Equation 5.7 and Equation 5.8) to give the calculated k , k_{calc} , (Equation 5.6) and thus value for $\ln(k_{calc} \cdot h / k_B \cdot T)$ (Figure 5.9B, filled circles).

An iterative computer-aided method was then used to minimise the difference between $\ln(k_{calc} \cdot h / k_B \cdot T)$ and $\ln(k \cdot h / k_B \cdot T)$ and the optimised activation parameters are shown in Table 5.4. Plotting $\Delta\Delta G^\ddagger$ versus temperature gives the isoinversion point at 92 °C which is in the middle of our studied temperature interval and as a control we re-performed the reaction order analysis described above at 80 °C to ensure that the reaction order was the same and found this to be the case.

Table 5.4. Activation parameters, ΔH_1^\ddagger , ΔS_1^\ddagger , $\Delta\Delta H^\ddagger$, $\Delta\Delta S^\ddagger$, ΔH_2^\ddagger , ΔS_2^\ddagger for the formation of **103** from **86** in toluene obtained from an Eyring plot using a non-linear model.

ΔH_1^\ddagger	24 kJ/mol
ΔS_1^\ddagger	-258 J/molK
$\Delta\Delta H^\ddagger$	143 kJ/mol
$\Delta\Delta S^\ddagger$	391 J/molK
ΔH_2^\ddagger	167 kJ/mol
ΔS_2^\ddagger	133 J/molK

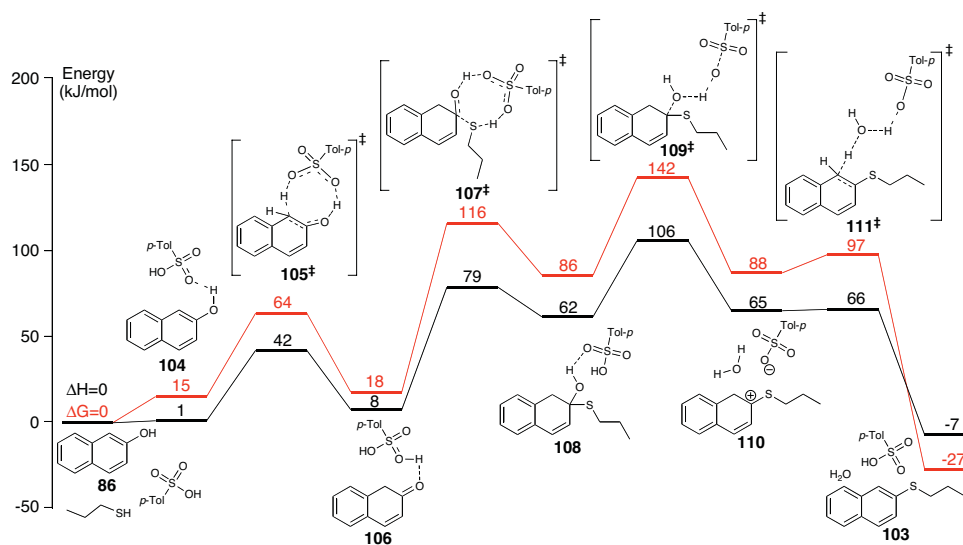

Figure 5.10. Calculated reaction profile for acid-catalysed nucleophilic aromatic substitution in non-polar solvents. ΔH and ΔH^\ddagger values and profile are in black and ΔG and ΔG^\ddagger values and profile are in red. All values are in kJ/mol and are calculated relative to the starting materials. For details regarding the calculations see paper VI.

To gain more knowledge of the reaction mechanism we returned to investigations using DFT calculations (see the Supplementary information chapter). Since we had already found that the protonated species were not accessible in non-polar media (Scheme 5.5), a mechanism not involving the explicit protonation of **86** was investigated (Figure 5.10). A direct nucleophilic attack of the thiol on the electron rich π -system of **86** is unlikely and we therefore reasoned that the previously discussed tautomerisation to **106** is necessary. To avoid the high energies of the cationic species, this would proceed via complexation of the phenolic proton with the sulphonic oxygen of the acid to give the **104**. Tautomerisation then proceeds via a concerted transition state (**105[‡]**, Figure 5.11A) involving the transfer of the sulphonic acid proton to the arene and transfer of the phenolic proton to one of the S=O moieties of the acid to give **106**.

The thiol can now perform a nucleophilic attack on the carbonyl carbon, but only if aided by the acid in another complicated eight-centre transition state (**107[‡]**, Figure 5.11B). In **107[‡]** the ketone is protonated by the acid, breaking the C=O bond as the C-S bond is formed. The energy of **107[‡]** was calculated to $\Delta H^\ddagger = 79$ ($\Delta G^\ddagger = 116$) kJ/mol. Passing transition state **107[‡]** gives the hemithioketal **108** postulated by Furman et al.^{i,201}

ⁱ For consistency the catalytic acid was kept associated with the starting materials during the entire mechanism. Whilst in solution a rapid association-dissociation would be expected, the association energy is expected to be at the most a few kJ and should therefore not appreciably influence the results.

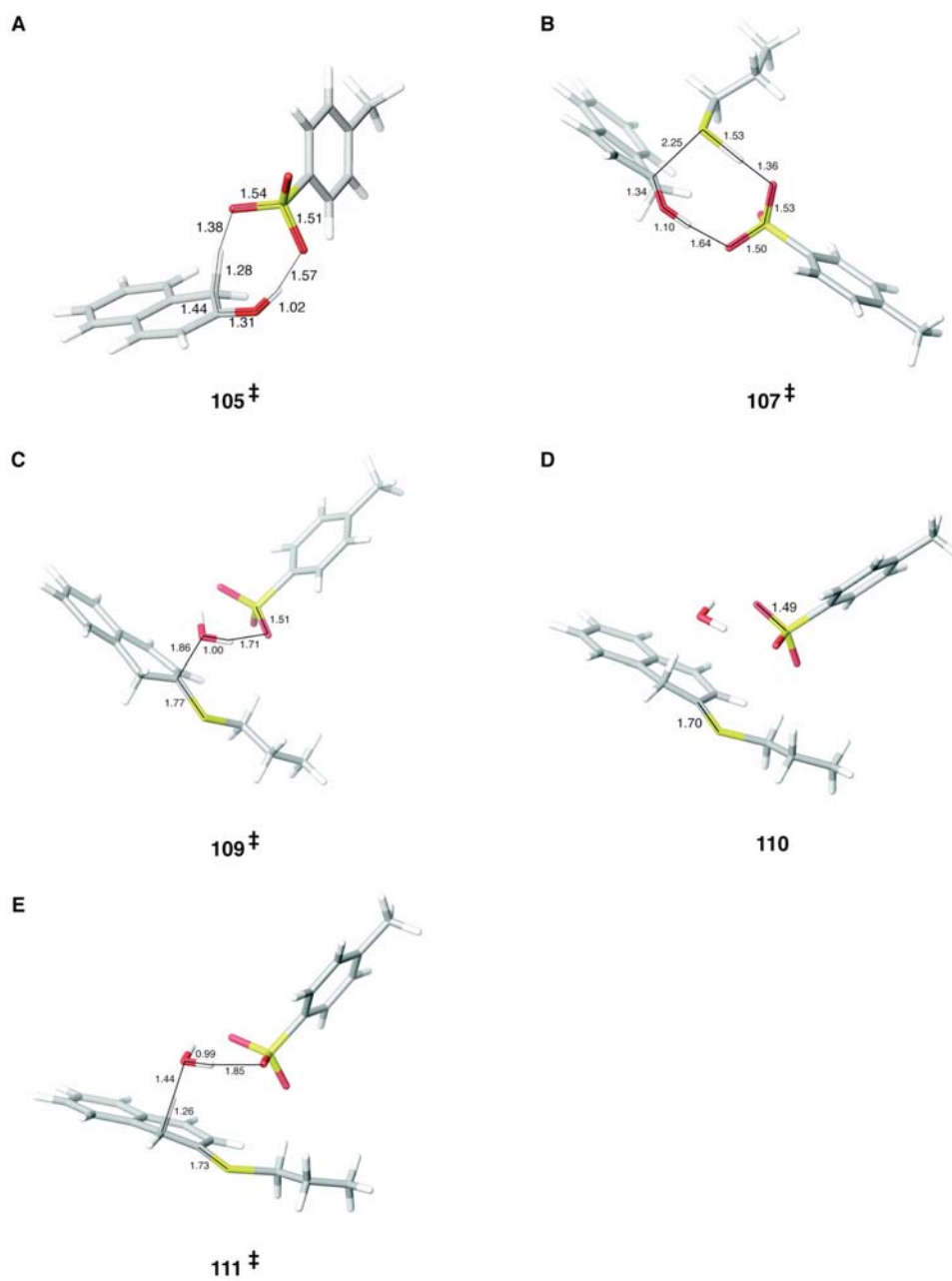

Figure 5.11. Structures of the transition states **105[‡]** (A), **107[‡]** (B), **109[‡]** (C) and **111[‡]** (D) and ion pair **110** (E). All bond lengths and distances are in Å.

Product formation was anticipated to occur through a further concerted transition state similar to **107[‡]** but no such pathway was found. Instead **109[‡]**, in which *p*-TsOH protonates the phenolic hydroxyl group (Figure 5.11C), was repeatedly found. The result of this transition state

is the release of the hydroxyl as free water generating the tight ion pair **110** (Figure 5.11D). The aromatic system is then regenerated passing only a very small activation barrier via **111[‡]** (Figure 5.11E), aided by proton shuffling between *p*-TsOH and water, to give the products with a relative energy of $\Delta H^\ddagger = -7$ ($\Delta G^\ddagger = -27$) kJ/mol.

The complexity of the mechanism shows that, whilst as discussed earlier the reaction is synthetically successful, it might work only under specific conditions. A scan of some other solvents for the reaction showed that the similarly non-polar heptane also gives excellent yields. However, neither water, THF or acetonitrile gave product. For water and THF this can be explained by the basicity of these solvents compared to the strong acid *p*-TsOH.

Further investigations into the reaction should yield more knowledge about the proposed mechanism.

5.2 Formation of disulphides

With the 6 thioethers **88-93** in hand, the cleavage of the S-alkyl bond was studied to afford the corresponding thiols on route to the target disulphides **112-117** (Figure 5.12).

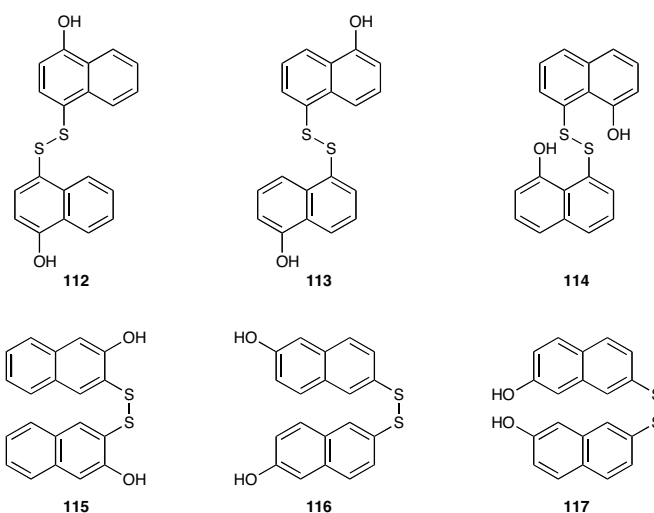

Figure 5.12. Structure of the symmetrical hydroxynaphthyl disulphides **112-117**.

As mentioned previously, cleavage of aryl-alkyl and aryl-benzyl thioethers by dissolving metal reduction to give the aryl thiol has been reported and was expected to be suitable for our application. We also studied the possibility of nucleophilic cleavage by boiling the thioether in DMF in the presence of sodium thiolate but this did not give the wanted product.

We therefore investigated the reductive cleavage using sodium in liquid ammonia and the yields were satisfactory even from the first attempts. After performing the reaction a few times, several important observations were made.

The most practical method for conducting the reaction is by dissolution of the substrate in diethyl ether and addition of the required amount of liquid ammonia via condensation at $-78\text{ }^{\circ}\text{C}$. Small pieces of sodium are added allowing for the blue colour of the solvated electrons to dissipate between additions. When the blue colour remains for more than 15-30 minutes the reaction can be considered complete and after quenching by the addition of solid NH_4Cl and addition of Et_2O , the ammonia is allowed to evaporate and the organic phase is acidified with concentrated aqueous HCl .

The purity of the starting thioether was crucial to the subsequent purification step, especially for the 1,4- and 1,8-isomers, and too fast addition of Na or addition of too large an excess gave reduced product purity and yield.

Purification of the thiol is hampered by air oxidation and since the disulphide was the synthetic target it was concluded that oxidation of the crude thiol/disulphide mix would greatly increase product yield and speed up the process.

Oxidation of thiols to disulphides can, as has previously been mentioned, be achieved by a large array of organic and inorganic reagents. We opted for the use of molecular iodine in a H_2O - MeOH solution due to previous positive reports of this reagent.²²⁶ By dissolution of the crude in H_2O - MeOH and addition of a methanolic solution of I_2 until the colour of iodine persisted, all thiol in the crude was effectively oxidised to the disulphide and using this procedure all six disulphides could easily be obtained from the thiopropyl naphthols (Scheme 5.7).

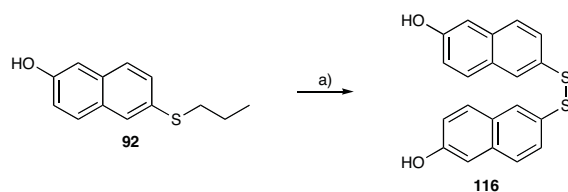

Scheme 5.7. Synthesis of hydroxynaphthyl disulphides as illustrated by **116**. a) i) Na , NH_3 , Et_2O , $-33\text{ }^{\circ}\text{C}$. ii) I_2 , MeOH , H_2O , r.t., 83%.

The crude disulphides could, after a washing step, be recrystallised in 40-80% yields. Chromatography of the mother liquor raised the yields to 77-96% (Table 5.5).

Table 5.5. Cleavage of aryl-alkyl thioethers with concomitant oxidation of formed thiols to the disulphides (**112-117**). Reported yields are from crystallisation only, and from crystallisation and chromatography of the mother liquor.

Substrate	Product	Yield (crystallisation)	Yield (after chromatography)
88	112	59%	77%
89	113	79%	95%
90	114	69%	96%
91	115	40%	95%
92	116	56%	83%
93	117	80%	86%

The procedure developed by us could easily be applied to the synthesis of a wide range of disulphides from phenolic systems and all possible hydroxynaphthyl disulphides are now within synthetic reach using one method.

With the series of six hydroxynaphthyl disulphides corresponding to the six symmetric dihydroxynaphthalenes now available to us we set about our goal of synthesising sulphur-containing xylosides.

5.3 Attempted solid-phase synthetic route to xylosides

In a first attempt we investigated an approach similar to that we had successfully applied to the synthesis of the 14 hydroxynaphthyl β -D-xylopyranosides. We envisaged using the same acid chloride functionalised resin to mono-protect one hydroxyl group of the hydroxynaphthyl disulphides. Xylosylation of the free hydroxyl group followed by disulphide bond cleavage would release the O-xyloside into solution and give a resin bound naphthalene thiol available for S-xylosylation prior to release and deprotection of the S-xyloside (Scheme 5.8).

Initial studies of the proposed strategy yielded small amounts of product, encouraging further work. Using the same conditions for coupling of the substrate to the resin and O-xylosylation as presented earlier, cleavage of the disulphide using Ph_3P , Bu_3P or Me_3P in $\text{THF-H}_2\text{O}$ gave the triacetylated O-xyloside in very low to acceptable yields but low purity. Deprotection followed by purification lowered the yields of **78** to 0% to 20%.

Xylosylation of the resin-bound naphthalene thiol with peracetylated xylose (**11**) under acidic conditions followed by deprotection and release typically gave the S-xyloside (**84**) in yields from 5% to 35%.

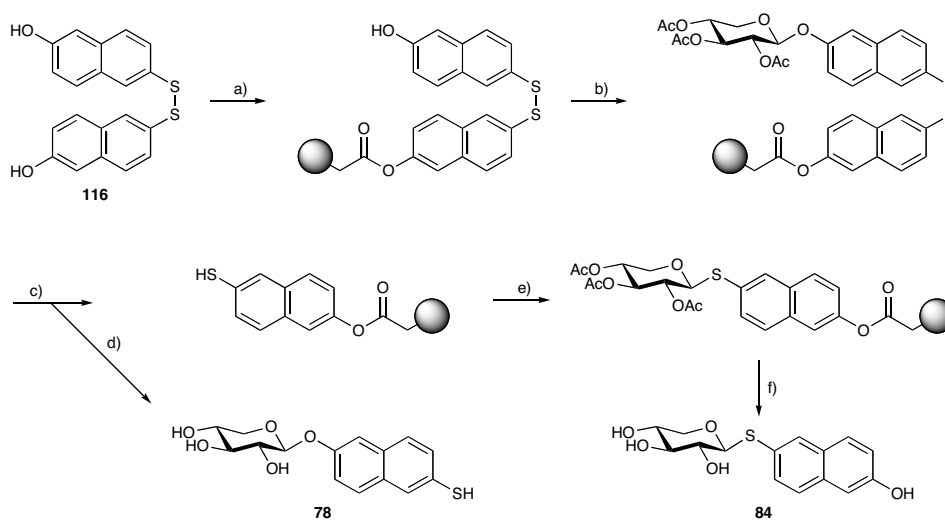

Scheme 5.8. Description of a solid-phase, sequential release strategy for the synthesis of sulphur-containing naphthoxylosides illustrated with **116** to give **78** and **84**. a) i) Carboxypolystyrene, DMAP, CH_2Cl_2 , r.t. ii) DIC, CH_2Cl_2 , r.t. b) 1,2,3,4-Tetra-*O*-acetyl- β -D-xylopyranoside, $\text{BF}_3 \cdot \text{OEt}_2$, CH_2Cl_2 , r.t. c) Me_3P (1.0 M in toluene), THF, H_2O , r.t. d) NaOMe, MeOH, CH_2Cl_2 , r.t. e) 1,2,3,4-Tetra-*O*-acetyl- β -D-xylopyranoside, $\text{BF}_3 \cdot \text{OEt}_2$, CH_2Cl_2 , r.t. f) NaOMe, MeOH, CH_2Cl_2 , r.t., varying yields. Detailed experimental conditions are described in the Supplementary information chapter.

Disappointed by the low and unreliable yields we investigated the binding to and cleavage from the resin of the unmodified hydroxynaphthyl disulphides and found that recoveries could vary from a few percent to 74% depending on the method used. Highest recoveries were obtained using a commercially available carboxypolystyrene resin and coupling using DIC/DMAP in CH_2Cl_2 ,²²⁷ although this did not give xylosides using our method.

The fluctuation in yield was at first attributed only to possible binding of both hydroxyl groups on the substrate binding to the resin. This explanation is consistent with some runs yielding S-xyloside (**84**) but no O-xyloside (**78**) and the fact that DIC/DMAP gave excellent binding of hydroxynaphthyl disulphides but no xylosides. As is described in the following sections, further hurdles in the synthesis of the sulphur-containing xylosides were discovered during studies in solution and these most likely also contributed to the unreliable yields obtained in the solid-phase synthesis.

Whilst the method presented can give both the O- and S-xylosides with minimal chromatography in under 48 h, the unreliability of the method caused us to abandon it. The observation that coupling of phenolic hydroxyls to carboxypolystyrene resin using DIC/DMAP was highly effective could however be used in the future to improve the present synthetic protocol for the solid phase synthesis of hydroxynaphthyl β -D-xylopyranosides.

5.4 Synthesis of sulphur-containing naphthoxylosides

Solid-phase synthesis is an excellent tool in synthetic chemistry but the development of working protocols can be difficult and time consuming, partly because of the difficulty in monitoring the progress of the reaction and structure of intermediates. Therefore, we decided to focus our synthetic effort on the solution phase synthesis of sulphur-containing naphthoxylosides.

Instead of using monoprotection of the hydroxynaphthyl disulphides to achieve our goal we decided to utilise the inherent symmetry in the substrate given by the disulphide bond (Scheme 5.9). Our strategy was now to obtain the O-xylosides by xylosylation of both hydroxyls followed by disulphide bond cleavage. Likewise, the S-xylosides were to be synthesised by the protection of the hydroxyls, disulphide bond cleavage to make the thiol nucleophile available as the xylosyl acceptor.

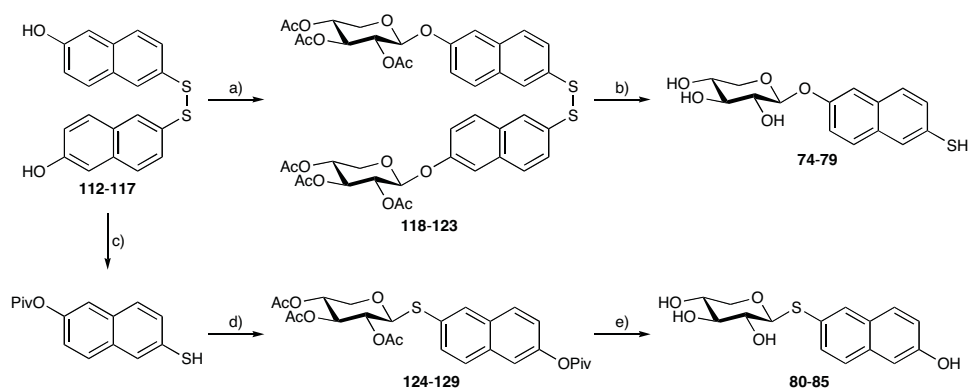

Scheme 5.9. Synthetic scheme for the solution phase synthesis of O- and S-xylosides (**74-85**) from a common hydroxynaphthyl disulphide precursor (**112-117**) as exemplified by the 2,6-isomers. a) 2,3,4-Tri-O-acetyl- β -D-xylopyranoside trichloroacetimidate, $\text{BF}_3 \cdot \text{OEt}_2$, CH_2Cl_2 , 0 °C, 75%. b) i) $\text{Ph}_3\text{P-PS}$, HCl (aq), THF, 80 °C, sealed tube. ii) NaOMe-MeOH , MeOH, r.t. iii) Amberlite IR-120H⁺, r.t., 98%. c) i) Piv_2O , 110 °C. ii) $\text{Ph}_3\text{P-PS}$, HCl (aq), THF, 110 °C, sealed tube, microwave irradiation. Or 80 °C thermal heating. d) i) $t\text{-BuONa}$, DMF, 0 °C. ii) 2,3,4-Tri-O-acetyl- α -D-xylopyranosyl bromide, THF, 0 °C to r.t., 76%. e) NaOMe-MeOH , MeOH, CH_2Cl_2 , r.t. 95%. See paper V for full experimental details and yields for all isomers.

Bis-O-xylosylation of the hydroxynaphthyl disulphides was first investigated using the peracetylated xylose donor (**11**) following the method presented by Lee et al. in which anomerisation is prevented by the addition of triethylamine.²⁹ Whilst this method has previously been successful for the bis-xylosylation of several dihydroxynaphthalenes,¹⁶⁰ the yields were disappointingly low in this case. As discussed earlier, and presented in paper I, trichloroacetimidate donors can give good results for aromatic O-glycosylation reactions. Using a two-fold excess of trichloroacetimidate xylopyranoside donor (**13**) per phenolic hydroxyl gave

excellent yields of the bis-xylosylated hydroxynaphthyl disulphides **118-123** and at 0 °C no Fries-rearrangement was detected (Scheme 5.9). At temperatures above 0 °C, purification became troublesome due to the increasing presence of C-xyloside products which were difficult to remove by chromatography.

To obtain the O-xylosides with free aryl thiol groups (**74-79**), deacetylation followed by disulphide cleavage was first investigated. This order of deprotection encountered difficulties due to the very low solubilities of the deprotected bis-O-xylosylated hydroxynaphthyl disulphides across a range of solvents. Solubility was low even in DMSO and in CH₂Cl₂-MeOH mixtures. Therefore, an alternative route was attempted in which the disulphide was cleaved using Ph₃P-PS in THF with catalytic acid. After stirring at 80 °C in a sealed tube overnight, NaOMe-MeOH was added to remove the acetate groups. After 10 min the reaction was neutralised by the addition of an acidic ion exchange resin. The solution was carefully filtered, taking care not to introduce unnecessary air into the solution, and immediately concentrated to give the fully deprotected O-xylosides (**74-79**). After removal of the ion exchange resin, only one compound was detected by TLC except in the case of **76** for which the cleavage reaction was repeated using fresh Ph₃P-PS and microwave heating to give a single product, as judged by TLC. NMR analysis of the products was troublesome due to spontaneous oxidation in methanolic solution of the thiols to the corresponding disulphides. All attempts to purify the thiols using chromatography or crystallisation gave partial oxidation to the disulphide giving a more contaminated product and the compounds were therefore not purified further prior to biological testing. The purity of the crude products was judged to be at least 90-95% by NMR and TLC analysis.

To synthesise the S-xylosides (**80-85**) carrying free aromatic hydroxyl groups, we needed to protect the free phenolic hydroxyl groups. Whilst the protection is facile, the stability of phenolic protecting groups to the cleavage conditions showed to be problematic. Early attempts using acetate as the phenolic protecting group gave deprotection during the cleavage step. Phenolic acetates are labile under acidic conditions, and the use of Ph₃P-PS requires a catalytic amount of acid to lower the reaction times,¹⁷⁴ causing deprotection of the phenol. Therefore an alternative protecting group was needed, preferably one which could be removed in the same step as the deprotection of the acetates to avoid further manipulations.

Aryl pivaloates are more stable towards acid compared to the acetates, yet readily cleavable with NaOMe-MeOH. Pivaloylation of disulphide **116** in hot pivaloyl anhydride overnight gave a single product, which upon NMR-analysis was shown to be the bis-O-pivaloylated derivate.

The pivaloyl groups were stable under the disulphide bond cleavage conditions using Ph₃P-PS both at 80 °C in a sealed tube overnight and at 110 °C under microwave irradiation for 15 minutes and both gave full conversion of the pivaloylated hydroxynaphthyl disulphides into single products with slightly lower R_F-values as measured by SiO₂-based TLC. For the 1,8-isomer (**114**), TLC analysis was difficult due to the similar R_F-values of the disulphide and the thiol. To avoid reoxidation to the disulphide, the crude products should be stored dry and preferably in a freezer until their further use.

Xylosylation of the crude thiols was first attempted using trichloroacetimidate donor but this gave a complex mixture as judged by TLC. Next, the use of peracetylated xylose (**11**) was investigated. Whilst the correct product was obtained, the method gave unreliable and low yields (20-40%), as well as low purity even after multiple chromatographic steps with different mobile phases and recrystallisation. The impurities probably arose from Fries-rearrangement and were not avoidable even using lower amounts of promoter.

Instead, a basic procedure using xylosyl bromide donor (**12**) was used (Scheme 5.9). Deprotonation of the thiol using *t*-butoxide at 0 °C followed by addition of a solution of the donor,²²⁸ gave the thio-xylosides in satisfactory yields. For **126** and **127**, purification was troublesome and lowered the yields substantially. Therefore these were deprotected prior to full purification and characterisation. Deprotection under Zemplén conditions gave the S-xylosides **80-85** (Scheme 5.9). The difficulties in purification of **126** and **127** probably arose from non-quantitative conversion in the pivaloylation step giving traces of hydroxynaphthyl 1-thio-2,3,4-tri-*O*-acetyl-β-D-xylopyranoside, which was converted into final product upon deprotection.

Naphthyl β-D-xylopyranosides carrying aryl *O*-alkyl ethers have previously been reported to prime GAG synthesis. The ethyl ether analog¹³⁸ gave a slight increase, while the methyl¹⁴² and butyl¹³⁸ derivatives decreased the proportion of HS as compared to priming by 2-naphthyl β-D-xylopyranoside. The synthesis of the hydroxynaphthyl disulphides gave six thiopropyl-substituted naphthols (**88-93**), which in two steps were transformed into naphthoxylosides **136-141** (Scheme 5.10). Xylosylation of **88-93** using peracetylated xylose in the presence of Et₃N to minimise anomerisation was successful and gave **130-131** and **133-135** in high yields and purity. Only for **132**, was the yield a disappointing 28% but the use of trichloroacetimidate donor and one-pot deacetylation gave the desired xyloside **138** in 90% over two steps. The remaining five xylosides were easily deacetylated in near quantitative yields.

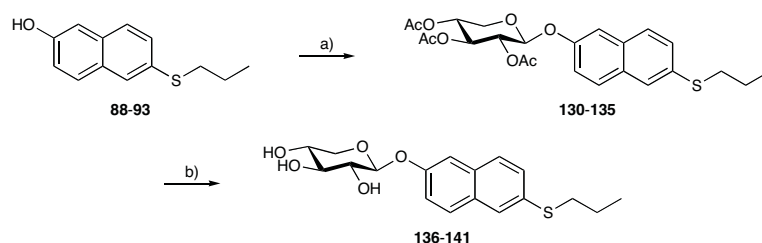

Scheme 5.10. Xylosylation of thiopropyl substituted naphthols as illustrated with **92**. a) 1,2,3,4-Tetra-*O*-acetyl-β-D-xylopyranoside, BF₃•OEt₂, Et₃N, CH₂Cl₂, r.t., 100%. b) NaOMe-MeOH, MeOH, CH₂Cl₂, 98%. For **90**: a) 2,3,4-Tri-*O*-acetyl-β-D-xylopyranoside trichloroacetimidate, BF₃•OEt₂, CH₂Cl₂, 0 °C. b) NaOMe-MeOH, MeOH, CH₂Cl₂, 90% over two steps. See paper V for full experimental details and yields for all isomers.

5.5 Physical properties of sulphur-containing naphthoxylosides

The importance of the lipophilicity of xylosides on their GAG-priming and antiproliferative properties has been shown. To investigate further this structure-activity relationship we conducted analytical gradient HPLC studies according to the previously discussed protocol (paper IV and reference 160).

The results, presented in Table 5.6, show some general features. Unfortunately, due to change of HPLC column, the retention times can not be quantitatively compared to those presented in paper IV, but retention times for the hydroxynaphthyl β-D-xylopyranosides using the new column have been presented in another paper by this research group and were found to be between 17.9 and 28.6 min (Table 5.6).¹⁶⁰

Table 5.6. Gradient HPLC retention times (min) for sulphur-containing naphthoxylosides. Retention times for hydroxynaphthyl β-D-xylopyranosides from Johnsson et al. 2006.¹⁶⁰

Cmp.	t _R (min)	Cmp.	t _R (min)	Cmp.	t _R (min)	Cmp.	t _R (min)
43	19.60 ± 0.01	80	22.25 ± 0.07	74	29.64 ± 0.19	136	37.90 ± 0.01
45	18.70 ± 0.01	81	20.44 ± 0.08	75	28.93 ± 0.03	137	37.92 ± 0.36
53	28.54 ± 0.02	82	25.82 ± 0.04	76	29.76 ± 0.01	138	34.77 ± 0.11
55	25.73 ± 0.03	83	25.52 ± 0.06	77	29.76 ± 0.05	139	35.33 ± 0.05
35	17.94 ± 0.09	84	20.42 ± 0.06	78	28.56 ± 0.01	140	37.13 ± 0.05
58	20.25 ± 0.01	85	21.81 ± 0.10	79	28.56 ± 0.08	141	37.00 ± 0.09

Comparison of the retention times of the sulphur-containing naphthoxylosides to the previously presented compounds shows a smaller spread for the sulphur-containing compounds. Also, these compounds are slightly more lipophilic due to the diminished hydrogen bonding capability of sulphur, but the trend for retention times versus substitution

pattern is similar. For example, the compounds with vicinal substituents (i.e. **82** and **83**) are generally less polar compared to the other analogues since a larger hydrophobic surface is exposed.

As expected, the retention times for the thionaphthyl β -D-xylopyranosides indicate that these compounds are less polar compared to the hydroxynaphthyl 1-thio- β -D-xylopyranosides. Aromatic thiols are less hydrophilic and also less prone to be protonated compared to phenols. Also, the difference in lipophilicity between the most and least polar is less than for the hydroxynaphthyl β -D-xylosides.

Alkylation of the aromatic thiol gives several effects, such as the elimination of the possibility of disulphide formation and the introduction of a highly hydrophobic alkylthio group. As expected, the lipophilicities of the propylthio-naphthyl β -D-xylopyranosides (**136-141**) is higher than for either **74-79** or **80-85**.

Also, as seen for **74-79**, substitution of the highly hydrophilic phenolic hydroxyl group for a more lipophilic group decreases the difference in retention time between the isomers. Contrary to the results from both **74-79** or **80-85**, and from the previously presented hydroxynaphthyl β -D-xylopyranosides (paper IV and reference 160) the isomers in which the substituents on the naphthalene moiety are placed in the 1,8- and 2,3-positions (**138** and **139**) are less lipophilic. This is probably due to “masking” of the highly lipophilic thiopropyl group by the xylose residue.

Computational determination of the lipophilicities of the sulphur-containing naphthoxylosides was initiated but the results were quickly determined to be of as low accuracy in predicting trends as shown for the hydroxynaphthyl β -D-xylopyranosides and a full computational study was therefore not performed.

5.6 Biological evaluation of sulphur-containing naphthoxylosides

To evaluate the biological properties of sulphur-containing naphthoxylosides their antiproliferative and GAG priming properties were investigated.

5.6.1 Antiproliferative properties of sulphur-containing naphthoxylosides

The antiproliferative activity of sulphur-containing naphthoxylosides towards HFL-1 (human fetal lung fibroblasts) and T24 cells (human bladder carcinoma cells) was investigated using the crystal violet method (see chapter 4.4.1 and the Supplementary information chapter). The growth retardation of treated cells compared to untreated cells was used to measure the ED₅₀ values for the xylosides, and these are presented in Table 5.7.

Table 5.7. Antiproliferative activities of hydroxynaphthyl 1-thio- β -D-xylopyranosides (**80-85**), thionaphthyl β -D-xylopyranosides (**74-79**) and propylthio-naphthyl β -D-xylopyranosides (**136-141**) towards HFL-1 and T24 cells presented as ED₅₀ (μ M) scored after 96 h exposure.

Compound	ED ₅₀ HFL-1 (μ M)	ED ₅₀ T24 (μ M)
80	130	160
81	135	320
82	120	225
83	100	260
84	145	355
85	125	230
74	70	55
75	60	110
76	60	45
77	60	145
78	60	135
79	100	360
136	30	30
137	20	40
138	100	155
139	30	70
140	30	40
141	25	60

It can be noted that, contrary to the analogous hydroxynaphthyl β -D-xylopyranosides, the sulphur-containing naphthoxylosides are generally more toxic towards normal HFL-1 cells compared to transformed T24 cells.

The hydroxynaphthyl 1-thio- β -D-xylopyranosides (**80-85**) show ED₅₀ values which are similar to those of the corresponding hydroxynaphthyl β -D-xylopyranosides but roughly a two-fold selectivity towards HFL-1 cells.

The thionaphthyl β -D-xylopyranosides (**74-79**) have ED₅₀ values about half that of the corresponding hydroxynaphthyl 1-thio- β -D-xylopyranoside with **74** and **76** having similar

toxicity towards HFL-1 and T24 cells whilst the other four are about twice as active towards the untransformed cells.

The propylthio-naphthyl β -D-xylopyranosides (**136-141**) show strong antiproliferative properties but discriminate only weakly between different cell lines.

5.6.2 Stability of sulphur-containing naphthoxylosides

We have previously shown that some mono-xylosylated dihydroxynaphthalenes are unstable in the culture media used (paper IV), with **38** decomposing and **43** being oxidised to **73**. Bis-xylosylated dihydroxynaphthalenes have, on the other hand, been shown to be stable for 96 h at 37 °C.¹⁶⁰

We therefore conducted stability studies in the same manner as described previously and found that for **80**, two more lipophilic UV-active peaks appeared in the HPLC trace as the xyloside decomposed but since the xyloside was not highly toxic to cells this was not expected to influence the priming studies. Xyloside **82** also decomposed but no major UV-active decomposition products were seen.

The thionaphthyl β -D-xylopyranosides **74-79** are sensitive towards air oxidation, yielding the analogous disulphides and in all cases complete conversion to the disulphide was seen in less than 48 h with only **76** and **77** having half lives of more than about 1 h in the weakly basic growth medium. The increased stability of these two isomers is most probably due to steric interactions upon disulphide formation. The disulphides had significantly longer retention times as compared to their corresponding thiols, with all disulphides eluting at between 36 and 40 min.

Due to their sensitivity to oxidation, we could not perform quantitative stability tests for these compounds although no major UV-active decomposition products was seen over 96 h. Biological evaluation of the pure disulphides was not possible due to their low solubility, hampering both their synthesis and their administration in solution. It is reasonable to suggest that both the free thiol and the disulphide are present in the cells in various proportions depending on the cellular redox conditions. During the proliferation studies no precipitates were seen in the medium, indicating rapid uptake of the thiols into the cells.

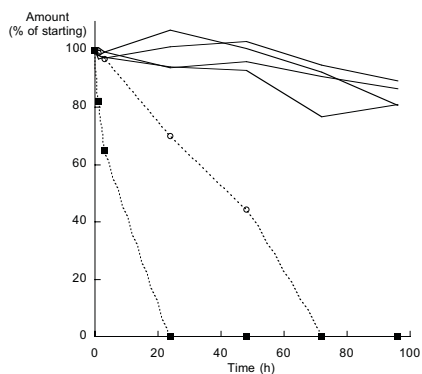

Figure 5.13. Stability profiles of hydroxynaphthyl 1-thio- β -D-xylopyranosides (**80-85**) in Ham's F-12 medium at 37 °C. The graph shows the concentration of xyloside compared to an internal standard as analysed by HPLC. Whilst 4 of the xylosides show only slight decomposition (solid lines), **80** (○) and **82** (■) decompose totally.

All six propylthio-naphthyl β -D-xylopyranosides were stable at 37 °C for 96 h in the growth medium used in the priming and proliferation studies.

5.6.3 GAG priming of sulphur-containing naphthoxylosides

The ability of the sulphur-containing naphthoxylosides to prime the synthesis of GAG chains was investigated by incubation of T24 cells in the presence of 0.1 mM xyloside and [35 S]sulphate.

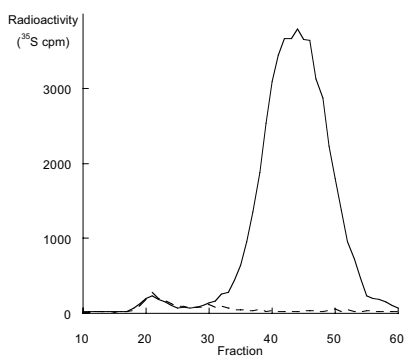

Figure 5.14. Priming of GAG chains in T24 cells treated with **84** (0.1 mM, solid line) or untreated (dashed line). Xyloside primed GAG chains elute in pool II whilst PG primed GAG chains elute in pool I.

The GAG synthesised was assayed as mentioned previously and described in detail in the Supplementary information chapter. Alkali sensitive PGs (Figure 5.14, pool I) were secreted by all cells and, in addition, treatment with xylosides initiated synthesis of free GAG chains (Figure 5.14, pool II). The amount of GAG priming and the length of GAG chains primed on the xylosides were determined and the results are shown in Table 5.8.

The results show that all the hydroxynaphthyl 1-thio- β -D-xylopyranosides (**80-85**) gave very strong priming of GAG chains but the chains are relatively short. We could not see any correlation between the GAG priming capability and the antiproliferative effect.

For the thionaphthyl β -D-xylopyranosides (**74-79**) the GAG priming capability is lowered by four to six times as compared to the hydroxynaphthyl 1-thio- β -D-xylopyranosides although the GAG chains are longer.

Table 5.8. GAG priming characteristics of hydroxynaphthyl 1-thio- β -D-xylopyranosides (**80-85**), thionaphthyl β -D-xylopyranosides (**74-79**) and propylthio-naphthyl β -D-xylopyranosides (**136-141**) in T24 cells. GAG priming efficiency is given as the integrated value of ^{35}S detected per minute for fractions containing soluble GAG chains compared to integrated value of same fractions for untreated cells. The length of the synthesised GAG chains is indicated by the fraction which shows the maximum radioactivity.

Compound	GAG priming (cpm ^{35}S)	Peak maximum (fraction)
80	40.7	44
81	29.8	44
82	32.6	41
83	43.5	42
84	44.3	44
85	37.4	44
74	9.6	38
75	5.8	33
76	5.2	37
77	6.2	38
78	7.6	37
79	10.2	38
136	12.4	37
137	11.1	34
138	2.5	34
139	5.5	35
140	10.5	37
141	8.1	37

With a few exceptions, the propylthio-naphthyl β -D-xylopyranosides (**136-141**) prime GAG synthesis to a greater extent than the thionaphthyl 1-thio- β -D-xylopyranosides but the

synthesised chains are similar in length to those primed by the hydroxynaphthyl 1-thio- β -D-xylopyranosides.

The HS priming ability of 2-(6-thionaphthyl) β -D-xylopyranoside (**78**), in which the phenolic hydroxyl group of **35** has been changed to an aryl thiol group, and 2-(6-hydroxynaphthyl) thio- β -D-xylopyranoside (**84**), in which the O-glycosidic linkage has been replaced with an S-glycosidic linkage, in tumour derived T24 cells was determined to investigate whether a correlation between the structure of the aglycon, HS priming and selective antiproliferative activity of xylosides exists. By digestion of the total GAG pool with HS-cleaving HNO_2 at pH 1.5, the amount of HS chains primed in the cells was determined. Both **78** and **84** initiated priming of HS chains to some extent (14% and 8% of total GAG respectively) but none of these xylosides showed any selective antiproliferative properties towards tumour cells, nor did we find any correlation between HS priming and antiproliferative activity. This could, however, be due to the production of HS with different microstructure or different HS degradation in these cells.

5.7 Correlations between antiproliferative properties and physical properties

Correlations between the lipophilicity of xylosides and their biological activities have been shown previously and we have shown clear correlations between the ED_{50} values for HFL-1 cells and HPLC retention times (see chapters 2.3 and 4.5, and paper IV). The toxicity increased with the lipophilicity which is indicative of effects on cellular uptake. For T24 cells, most compounds followed a similar pattern but some analogues showed a much stronger activity (paper IV).

For the sulphur-containing naphthoxylosides we could not find any clear correlations between HPLC retention times and biological activity. This could be due to an actual absence of correlation or due to the short interval of retention times shown by the three sets of compounds.

The results do show that hydrophobic, uncharged naphthoxylosides in which an oxygen has been substituted for a sulphur atom enter cells and initiate priming of protein-free GAGs. The priming efficiencies and antiproliferative properties are dependent on the structure of the aglycon. The 18 compounds studied did not show significant tumour-selective properties which

supports previous hypotheses that HS priming is necessary but not sufficient for the selective antiproliferative properties.

Further investigations of naphthoxylosides and their antiproliferative properties are warranted and investigations into their HS priming properties are of great importance. Thus the synthesis of xylosides which efficiently prime HS synthesis as opposed to CS/DS synthesis are of great interest.

6 Synthesis of naphthoxyloside-amino acid conjugates

It has been well established that xylosides carrying naphthalenic aglycon can enter cells and prime the synthesis of GAG chains.¹³⁸⁻¹⁴² Also, naphthalene-based xylosides have been shown to prime the synthesis of HS to a greater degree than xylosides carrying alkyl chains or smaller aromatic systems.^{138,142}

We have shown that the priming of HS is necessary for the tumour selective effect of 2-(6-hydroxynaphthyl) β -D-xylopyranoside (**35**) and that this xyloside induces increased apoptosis in T24 cells (paper IV).

As mentioned earlier, synthesis of xylosides which to a great extent prime HS as opposed to CD/DS would be of great interest. It is known that the amino acid sequence of the core protein has a large effect on the type of GAG synthesised. Coupling of a serine residue directly to the xylose has been investigated,¹²³ and whilst such xylosides prime GAG synthesis they lack the naphthalenic moiety needed for increased HS priming.

We therefore looked into the synthesis of naphthoxyloside-amino acid conjugates. In a first stage we envisaged coupling amino acids with a carboxylic acid group on the naphthalene moiety of a naphthoxyloside. Since the naphthalene moiety would not carry two oxygen atoms, its inherent toxicity would most likely be low. This would enable us to study the effect of the amino acid on priming with minimal effect on cell proliferation.

6.1 Synthesis of xylosylated hydroxynaphthoic acids

We intended to synthesise the naphthoxyloside-amino acid conjugates by coupling of xylosylated hydroxynaphthoic acids such as **142** and **144** (Figure 6.1) with suitably protected

amino acids. The deprotected xylosides **143** and **145** were also needed as reference to ascertain the level of HS priming by the xyloside lacking the amino acid part.

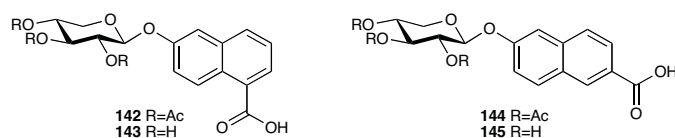

Figure 6.1. Structures of xylosylated hydroxynaphthoic acids used in the study.

6.1.1 Synthesis of xylopyranoside acceptors

Both 6-hydroxy-1-naphthoic acid (**146**) and 6-hydroxy-2-naphthoic acid (**148**) are commercially available and were thus selected as suitable starting materials (Figure 6.2). We also wanted to use 3-hydroxy-1-naphthoic acid (**150**) since this would place the amino acid residues in close proximity to the pyranose ring of the monosaccharide and might thus more closely mimic the xylose-core protein linkage region.

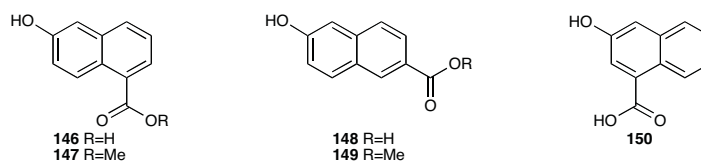
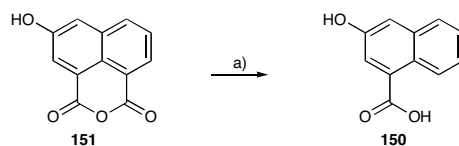

Figure 6.2. Structures of the three isomeric hydroxynaphthoic acids 6-hydroxy-1-naphthoic acid (**146**) and its methyl ester **147**, 6-hydroxy-2-naphthoic acid (**148**) and its methyl ester **149** and 3-hydroxy-1-naphthoic acid (**150**).

Whilst **150** is known in the literature it is not commercially available and during the time-frame available to us we were limited to investigating only one synthetic route to this compound, namely the previously reported Pesci reaction²²⁹ of the naphthalic anhydride **151** (Scheme 6.1).²³⁰



Scheme 6.1. The mercury-mediated decarboxylation (Pesci reaction) of 3-hydroxy-1,8-naphthalic anhydride (**151**) to give 3-hydroxy-1-naphthoic acid (**150**). a) i) NaOH (1 M, aq.), 100 °C, 1 min, microwave irradiation. ii) Hg(OAc)₂, 180 °C, 15 min, microwave irradiation. iii) HCl (conc.), 120 °C, 15 min, microwave irradiation. No isolated yield reported. See text for discussion.

The previous report of the reaction using the same substrate did not entail isolation of the product, instead only reporting the conversion (70%) without resolving the two possible

isomers. Also, they stated that the product was contaminated by both starting material and elemental mercury, giving a mass balance of 181%.

We also found that isolation of the product was immensely difficult even after attempts to methylate the acid to improve solubility in organic solvents and a different route would therefore have to be used for the synthesis of **150** in future studies.

Synthesis of **150** has been reported using a longer route,²³¹ and has also been successfully synthesised by another group even though the route was not published. Their route, outlined in Scheme 6.2, would be of interest for future studies toward **150**.²³²

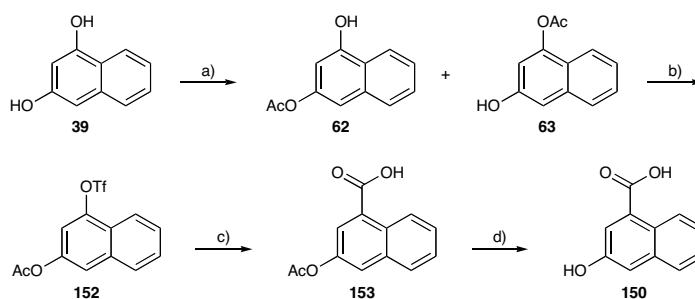

Scheme 6.2. Synthesis of **150** as developed by J. S. Albert.²³² Examples of possible reagents to affect the conversions: a) AcCl, pyridine. c) Tf₂O. c) Pd(OAc)₂, dppf, CO. d) NaOH (aq.).

First attempts to xylosylate the hydroxynaphthoic acids **146** and **148** failed. The solubility of these is low in CH₂Cl₂ and also hydroxyaromatic acids are known to be difficult acceptors.²³³ Therefore we protected the carboxylic acid as the methyl ester. Surprisingly, stirring the acid in MeOH in the presence of an acidic ion exchange resin at elevated temperatures did not give the desired product. We therefore synthesised **147** and **149** by conversion into the acid chloride followed by addition of methanol in a one-pot procedure using thionyl chloride (Scheme 6.3).

With the protected substrates in hand we attempted xylosylation using trichloroacetimidate donor **13**, but to our surprise yields were below 50%. We therefore turned our attention to the use of peracetylated xylose (**11**) with addition of triethylamine to suppress anomerisation.²⁹ This method, as has been shown earlier (see for example paper V), can give excellent yields of naphthoxylosides, and **147** and **149** were xylosylated in 95 and 83% yield respectively.

After successfully having obtained **154** and the isomeric protected xyloside from **147**, deprotection of the carboxylic acid was needed. At the time we did not find a selective method for the deprotection and therefore deprotected both the sugar moiety and the acid following the two step procedure of Gryniewicz et al.²³³

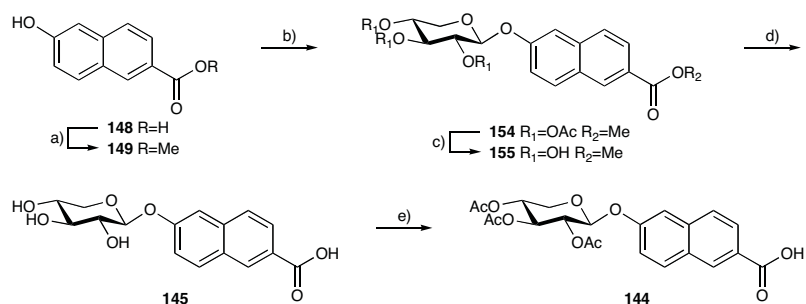

Scheme 6.3. Synthesis of xylosylated hydroxynaphthoic acids **142** and **144** as illustrated with **144**. a) SOCl_2 , MeOH, 75 °C, sealed tube, 91% (81%). b) 1,2,3,4-Tetra-*O*- β -D-xylopyranoside, $\text{BF}_3 \cdot \text{OEt}_2$, CH_2Cl_2 , r.t., 83% (95%). c) NaOMe, MeOH, r.t., 97% (90%). d) NaOH, MeOH, r.t. 95% (99%). e) Ac_2O , pyridine, r.t., 90% (91%). Yields within parentheses are for the same reactions using **146** as starting material to give **142**. See the Supplementary information chapter for experimental details.

Selective protection of the sugar was then performed using Ac_2O in pyridine at room temperature as heating in acetic anhydride gave substantial anhydride formation.

With both **142** and **144** in hand, the stage was set for amide couplings with amino acids. Peptide chemistry is often conducted on solid-phase and whilst this approach was of interest, we choose to ensure the coupling reactions were successful by first synthesising a series of mono-peptide conjugates in solution.

6.1.2 Solution phase synthesis of mono-peptide conjugates

The formation of an amide bond by reaction of an ester with an amine is thermodynamically troublesome due to an acid-base reaction occurring to yield the protonated amine and deprotonated acid. To overcome this, a plethora of reagents have been developed for the activation of the acid thus facilitating the attack by the amine. The use of one of the oldest methods, activation as an acid chloride, has already been discussed in this thesis in the context of ester bond formation but this method is not particularly suitable for peptide bond formation due to risks of, for example, hydrolysis and racemisation. A listing of even a fraction of the available reagents and their pros and cons is far outside the scope of this thesis and therefore only the carbodiimide reagents will be briefly discussed. The interested reader is referred to one of the many reviews in the area, for example those by Han et al.²³⁴ or Montalbetti et al.²³⁵

Carbodiimide coupling reagents, such as diisopropylcarbodiimide (**156**) (DIC), work by reaction between the acid and the carbodiimide to form an activated *O*-acylisourea mixed anhydride (Scheme 6.4). The isourea is then displaced by the amine to give the amide and the

highly stable carbamate. The formation of the carbamate, which can have varying solubilities depending on structure, is the driving force for the reaction.

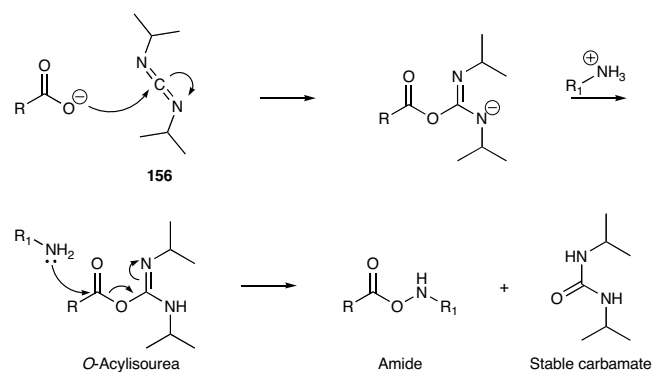

Scheme 6.4. Mechanism for the formation of amides through the use of carbodiimide reagents as illustrated with diisopropylcarbodiimide (**156**) (DIC). The carboxylate ion attacks the diimide carbon forming an activated *O*-acylisourea anhydride. The isourea moiety is then displaced by the amine to give the amide and the carbamate product.

Apart from displacement by the amine, the activated *O*-acylisourea can rearrange to give the non reactive *N*-acylurea effectively quenching the reaction. This rearrangement can be suppressed by the addition of nucleophiles which displace the isourea at a rate higher than that of the rearrangement yet still form an activated acid for the amine to react with. In the present work DMAP is used although the use of hydroxybenzotriazole (HOBt) is also often reported.

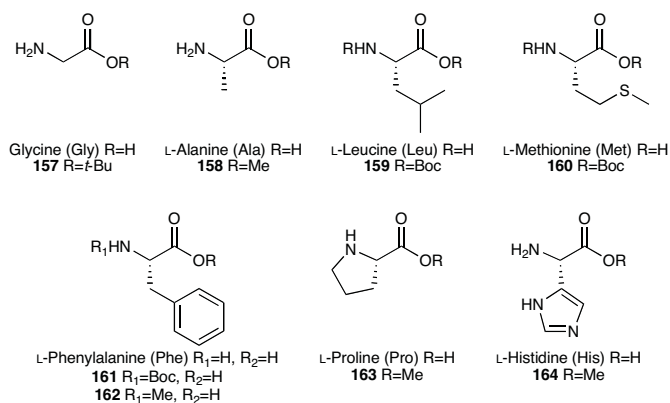
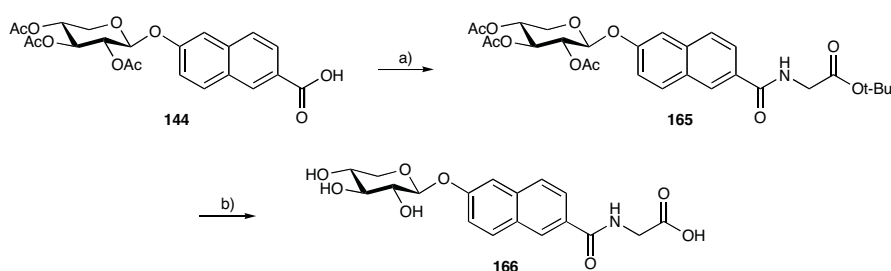

Figure 6.3. Structures of the protected amino acids used in this study with names and abbreviations of the unprotected parent amino acids. The structures are drawn as the free bases although they are commonly obtained and used as the HCl salts.

A selection of ester-protected amino acids (**157**, **158**, **162**, **163** and **164**) were chosen for the solution phase synthesis (Figure 6.3). For this primary study, the selection criteria were in-house availability and cost of purchase.

Couplings of the xylosylated hydroxynaphthoic acids **142** and **144** with the protected amino acids in CH_2Cl_2 proceeded very smoothly and in excellent yields in all but two cases (Scheme 6.5). In the case of coupling of **144** with proline, purification was unsuccessful and the couplings with histidine also failed, possibly due to the low solubility of this compound in CH_2Cl_2 .



Scheme 6.5. Solution phase synthesis of naphthyl xyloside-amino acid conjugates as illustrated using **144** and **157** to give **166**. a) i) DMAP, **157**, CH_2Cl_2 , r.t., ii) DIC in CH_2Cl_2 , r.t., 99%. b) i) NaOMe, MeOH, CH_2Cl_2 , r.t. ii) NaOH (1 M, aq.), MeOH, r.t., 79%. See the Supplementary information chapter for experimental details.

Two methods were used for the deprotection of the conjugates. First, a method using NaOMe-MeOH- CH_2Cl_2 was used to deprotect the sugar moiety. We noted that this method partially deprotected the carboxylic acid and therefore full deprotection was performed using NaOH. Several of the conjugates were fully deprotected with NaOH without the prior use of NaOMe (see notes in Table 6.1).

The structures of the naphthoxyloside-amino acid conjugates **166-172** and the yields for the solution phase coupling and deprotection steps are reported in Table 6.1.

As the conjugates will be submitted for biological testing, they were further purified using semi-preparative HPLC and lyophilised.

These syntheses showed us that DIC/DMAP was very useful for our compounds. We therefore progressed to the solid-phase synthesis of dipeptide conjugates.

Table 6.1. Naphthoxyloside-amino acid conjugates synthesised in solution. Coupling steps were performed using DIC/DMAP in CH₂Cl₂. Deprotection was performed with NaOMe-MeOH-CH₂Cl₂ followed by NaOH (aq.)-MeOH (denoted with *) or with just NaOH (aq.)-MeOH (no asterix).

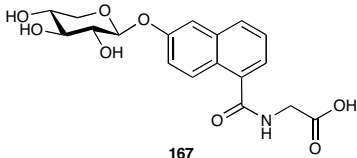
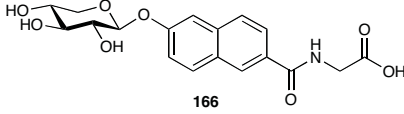
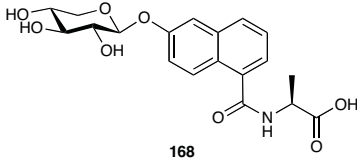
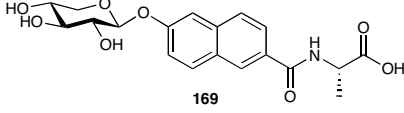
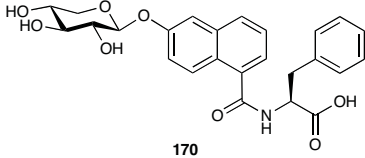
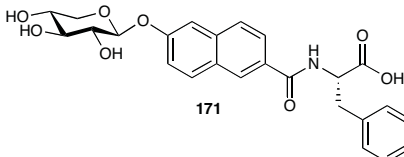
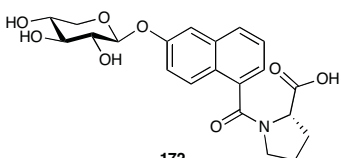
Compound	Yield coupling step	Yield deprotection
 <p>167</p>	94%	97%
 <p>166</p>	99%	79%*
 <p>168</p>	87%	96%
 <p>169</p>	87%	82%
 <p>170</p>	98%	69%*
 <p>171</p>	92%	65%*
 <p>172</p>	85%	63%*

6.1.3 Solid-phase synthesis of dipeptide conjugates

Synthesis of polypeptides is often best performed on solid-phase followed by purification using reversed phase HPLC due to the often problematic purification of such compounds using SiO₂-based columns. Binding of the amino acid to a solid support allows for simple washing of

the resin between deprotection and coupling steps which, under optimal conditions, gives the product as the sole compound in solution after the cleavage step.

We investigated the use of commercially available Boc-N-protected amino acids bound to a solid support. After deprotection of the amino group using TFA in CH_2Cl_2 , a dipeptide was formed by peptide coupling with a Boc-N-protected amino acid using DIC/DMAP (Scheme 6.6). Unbound peptide was removed by washing and the terminal Boc-group was removed prior to coupling with the xylosylated hydroxynaphthoic acid. Cleavage from the resin and deprotection of the conjugate gave the products **173-178** in yields from 61% to 95% and with purities of more than 90% (Table 6.2).

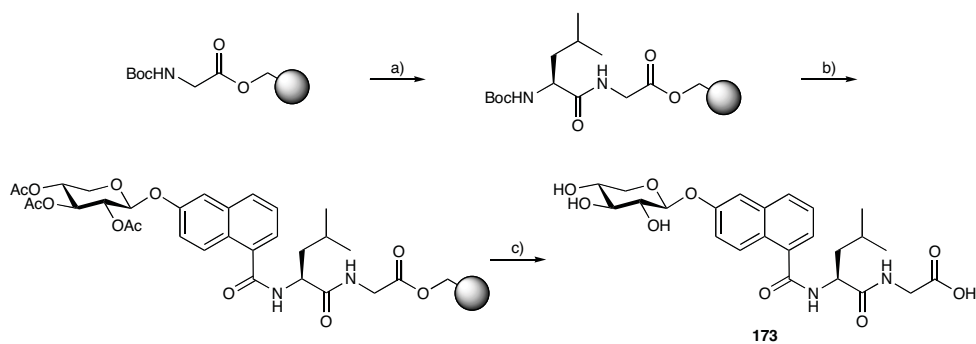

Scheme 6.6. Solid-phase synthesis of naphthyl xyloside-amino acid conjugates as illustrated using the synthesis of **173**. a) i) TFA (80% in CH_2Cl_2 containing 0.4 M thiophenol), r.t. ii) DMAP, **159** (HCl salt), CH_2Cl_2 , r.t. iii) DIC in CH_2Cl_2 , r.t. b) i) TFA (80% in CH_2Cl_2 containing 0.4 M thiophenol), r.t. ii) DMAP, **142**, CH_2Cl_2 , r.t. iii) DIC in CH_2Cl_2 , r.t. c) i) NaOMe, MeOH, CH_2Cl_2 , r.t. ii) NaOH (1 M, aq.), MeOH, r.t. 61%. See the Supplementary information chapter for experimental details.

The dipeptide conjugates were, as for the mono-peptide conjugates described previously, further purified by semi-preparative HPLC and lyophilised. The yields reported in Table 6.2 are acceptable for routine synthesis and no noticeable epimerisation was detected.

6.2 Physical properties and biological activity of naphthoxyloside-amino acid conjugates

The physical properties of xylosides may, as has been discussed previously, exert an influence on their biological properties and thus the gradient HPLC retention times of the naphthoxyloside-amino acid conjugates are of interest. Unfortunately, due to time constraints and instrumental failure, it has not been possible to perform these measurements at this time.

Also, the measurement of the GAG priming characteristics of the synthesised compounds has not yet been performed.

Table 6.2. Naphthoxyamide-amino acid conjugates synthesised on solid-phase. Yields reported are prior to purification by HPLC but material was of acceptable purity (>90%).

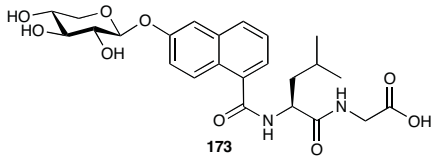
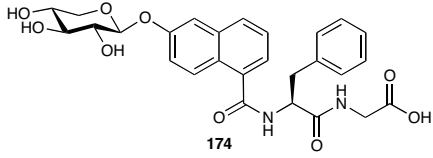
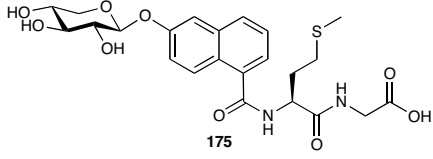
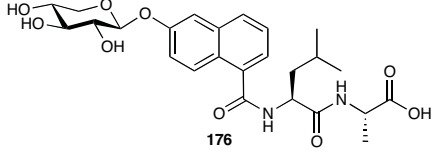
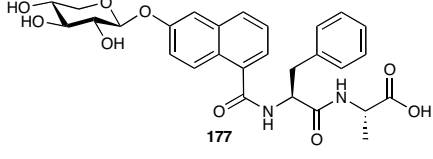
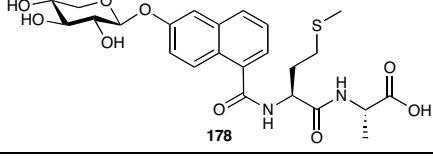
Compound	Yield
 <p>173</p>	61%
 <p>174</p>	66%
 <p>175</p>	78%
 <p>176</p>	88%
 <p>177</p>	95%
 <p>178</p>	81%

7 Summary and future perspectives

Exogenous xylosides capable of crossing cell membranes are effective primers of glycosaminoglycan biosynthesis. Lipophilic aglycon increase the cell membrane permeability and increase the uptake of xyloside. If the aglycon contains an extended aromatic system, for example a naphthalenic system, an increased proportion of heparan sulphate chains may be synthesised on the xyloside.

In the work presented in this thesis we have shown that the priming capacity and characteristics of naphthoxylosides varies to a large extent with the structure of the aglycon. Also, we have demonstrated that correlations can be found between the lipophilicity of a xyloside and its toxicity in some cell lines. Whilst healthy lung fibroblasts showed a clear correlation between lipophilicity and toxicity indicating passive uptake dependent activity, transformed cells showed a clearly different behaviour for several xylosides. This is indicative of a different mechanism of uptake or action than for the healthy cells.

By studying the mechanism of cell death in transformed cells treated with 2-(6-hydroxynaphthyl) β -D-xylopyranoside (**35**) we clearly showed that cell death occurs via apoptosis, thus indicating that selectively antiproliferative xylosides are of interest for further studies toward anti-tumour compounds.

As is often the case in academic research, interesting side-tracks appear, and it was on one of these that we initiated studies into the mechanism of a reaction which inserts a sulphur atom onto aromatic systems. This gave us the opportunity to delve deep into the fascinating world of physical organic chemistry and enabled us to present a proposal for a mechanism for nucleophilic aromatic substitution in non-polar solvents.

Utilising this reaction we developed a general route to the synthesis of naphthyl disulphides and used these to synthesise new sulphur-containing naphthoxylosides. Observations made during the synthesis reinforced our recommendations regarding the choice of monosaccharide donor to be used for aromatic O-glycosylation.

Biological testing of the sulphur-containing xylosides confirmed our previous results that the antiproliferative and glycosaminoglycan-priming properties of xylosides vary greatly with the structure of the aglycon. Also, our results show that the increase in proportion of heparan sulphate priming seen for the O- to S- switch in 2-naphthyl xyloside (**29** to **30**) does not necessarily transfer to other naphthoxylosides, thus indicating the complexity of the regulation behind the type of glycosaminoglycan synthesised on exogenous xylosides.

Whilst this complexity does make the design process more difficult, it also increases the possibility of fine-tuning the priming and toxicological properties of naphthoxylosides and opens up new exciting avenues for naphthoxyloside research.

Modification of the electronic properties of the dihydroxynaphthalene system by the addition of electron-withdrawing and –donating groups would influence the toxicity of the aglycon by changing its redox-potential. Also, the conformation of the xylopyranoside ring might be influenced due to the changed electron-densities and this might influence how well the galactosyl transferase responsible for the addition of the first galactose recognises the xylose. Also, the phosphorylation of C2 of the xylose during the synthesis of the linker tetrasaccharide might be influenced and studying the biological effect of this would be of great interest to ascertain the function of this transient modification of the linker region.

Thus, whilst the continued study of naphthoxylosides might not achieve the long-term, immodest goal of developing a new anti-cancer treatment, further insights into the biosynthesis of glycosaminoglycans are anticipated.

8 Acknowledgements

First, and quite possibly foremost, I would like to thank my supervisor **Ulf Ellervik**. Thank you for taking me into your group, for years of undergraduate research, for giving me the chance to go to CalTech and for these four years of graduate studies. They have been long and tough, but never boring. You have always been full of ideas and inspiration for new projects – sometimes even scientific in nature. It has been a pleasure working for you.

Also, I am indebted to **Katrin Mani** for her part in running the xyloside project. Thank you for all the discussions, paper writing, biological results and for teaching me cell work.

Large thanks are also due to **Lars-Åke Fransson** whom, together with Göran Magnusson, initiated our studies into naphthoxylosides and has given valuable input into our research papers and my thesis.

Past and present members of **the Ellervik group** have also contributed to the work, both actively in discussion and by working in other areas of the xyloside project; **Niklas Falk**, **Andreas Meijer**, **Richard Johnsson**, **Jesper Malmberg** and project and diploma workers. Also, **Johan Eriksson-Bajtner** – thank you for taking us on as a special project during Ulf's paternity leave "vacation".

A very large thank you also goes out to **Carl-Olof Abrahamsson** for his work on the kinetics and amino acid conjugate projects. The HPLC runs would never have been performed without you!

Years of research would have been impossible without the support of an excellent team of staff. Thank you **Bodil Eliasson**, **Maria Levin**, **Anders Sundin**, **Karl-Erik Bergquist** and **Einar Nilsson** for making things work!

To all the former and present staff at the **Division of Organic Chemistry**, departments of **Bioorganic Chemistry**, **Organic Chemistry 2** and **Organic Chemistry 1** – thank you!

I gratefully acknowledge **Vetenskapsrådet**, **Crafoordska stiftelsen**, **Lund University**, **The Royal Academy of Sciences** and **Kungliga Fysiografiska Sällskapet i Lund** for funding our research and am indebted to **Ernhold Lundströms Stiftelse**, **Carl Swartz memorial fund** at Lund Institute of Technology, the **Swedish Chemical Society** and **Acta Chemica Scandinavica** for grants allowing me to travel to and participate in national and international conferences.

Also, thanks are due to **Per-Ola Norrby** for his late but valuable entry into the kinetics project, yielding valuable input and fascinating conversations concerning non-linear Eyring plots. For their much needed discussions regarding statistics I am much obliged to **Rickard Elmqvist** and **Morten Krogh**.

I would not have entered into the field of chemistry had it not been for the early inspiration by two brilliant teachers, and for that I am greatly indebted to **Bengt Eriksson** and **Margaret Hay**.

Apart from his scientific contribution to the kinetics project, **Jonas Oxgaard** deserves thanks for so much more. For our constant discussions regarding chemistry over a bottle of pink wine, for Thai take-out, for many nights on your couch and the trip to Vegas. Also, thank you proving that you are more suitable in front of a computer than with flammable liquids and a gas stove.

To all my beloved friends who have all but given up on me, thank you for not letting go of that last hope to see me again. In no special order and with apologies to any who might have been overlooked. **Lars, Magnus, Amir, Alexander, Johan 24/7, pickniCk, Jonas, Anna Y, Rickard, Marthina, Emil, Stina, Peter M, Tessa, Wixe, ölyT, Jenny R, De Aderton, Christine A, Carl H, Katarina, Bodin, Sällskapet, Alexandra, Johanna J, Per, Buchhis** and many others.

To my family, who has always supported me no matter what, I will always be grateful and in debt. My sister **Anna**, aunt **Lena**, uncle **Nisse** and above all my loving parents **Måns** och **Margareta**. Thank you!

9 Supplementary information

Experimental details for some work described in this thesis not available otherwise are described here, together with a discussion concerning some of the methods used. Supplementary information for papers III and IV is available online. Supplementary information for paper V will become available online soon. Supplementary information for paper VI is available upon request.

9.1 Synthetic work

9.1.1 General experimental details

Solvents for reactions were dried by passing through a column of Al₂O₃ (neutral, activity grade I). Anhydrous DMF was commercial grade and used without further purification. NMR-spectra were recorded with a Bruker DRX 400 spectrometer at 400 MHz (¹H) and 100 MHz (¹³C) and assigned using 2D-methods (COSY, HMQC, HMBC). 2D-experiments were recorded with gradient enhancements using sine shaped gradient pulses. The chemical shifts are reported in ppm with the residual solvent peaks (¹H) and solvent signals (¹³C) as reference (δ H CDCl₃=7.26 ppm, δ C CHCl₃=77.0, δ H CD₃OD=3.31 ppm, δ C CD₃OD=49.0).

High-resolution mass-spectra were recorded on a Micromass Q-ToF (ESI) or JEOL SX-102 (FAB). Reactions using microwave irradiation were performed in a Smith Creator microwave reactor from Personal Chemistry i Uppsala AB. Reactions were monitored by TLC using alumina plates coated with silica gel and visualised using either UV-light or by charring with an ethanolic anisaldehyde solution. Preparative chromatography was performed with silica gel (35-70 μ m, 60 Å).

9.1.2 Synthesis of xylopyranoside donors

Whilst the syntheses of the xylopyranoside donors used in this thesis are known previously, they are presented here, with references, to allow for easy access to the procedures and their references.

1,2,3,4-Tetra-O-acetyl- β -D-xylopyranose (11):¹⁴ KOAc (66.7 g, 0.68 mol) was dissolved in Ac₂O and heated to 130 °C. β -D-Xylose (84.0 g, 0.56 mol) was added in portions during 20 minutes after which the solution was removed from the heat source and allowed to cool to r.t. The mixture was poured onto ice (1 L) and allowed to stand o.n. The suspension was extracted with CH₂Cl₂ (3 times 600 mL) and the combined organic phase was washed with NaHCO₃ (sat. aq.), dried (MgSO₄) and filtered. Activated charcoal was added after which the solution was filtered through a plug of SiO₂ (eluted with CH₂Cl₂). The solution was concentrated and the residue was recrystallised with EtOH to give 1,2,3,4-tetra-O-acetyl- β -D-xylopyranose (**11**) (72.2 g, 41%). Spectroscopic data was consistent with published data.

2,3,4-Tri-O-acetyl- α,β -D-xylopyranose:¹⁸ 1,2,3,4-Tetra-O-acetyl- β -D-xylopyranose (**11**) (25.4 g, 79.8 mmol) was dissolved in THF (150 mL) and benzylamine (13.3 mL, 122 mmol) was added. The mixture was stirred at r.t. o.n. after which it was diluted with ice-cold H₂O (150 mL) and the mixture was extracted three times with CH₂Cl₂. The combined organic phases were washed with HCl (1 M, aq.), NaHCO₃ (sat. aq.), NaCl (sat. aq.) and H₂O, dried (MgSO₄), filtered and concentrated. The residue was filtered through a pad of SiO₂ (Heptane-EtOAc 1:1), concentrated and chromatographed (SiO₂, Heptane-EtOAc 1:1) to give 2,3,4-tri-O-acetyl-D-xylopyranose (13.8 g, 63%). Spectroscopic data was consistent with published data.

2,3,4-Tri-O-acetyl- α,β -D-xylopyranosyl trichloroacetimidate (13):²⁷ 2,3,4-Tri-O-acetyl- α,β -D-xylopyranose (13.8 g, 49.9 mmol) was dissolved in CH₂Cl₂ (110 mL) and cooled to -10 °C. Trichloroacetonitrile (31 mL, 309 mmol) was added followed by DBU (0.85 mL, 5.7 mmol) and the solution was stirred at -10 °C for 90 minutes after which it was allowed to regain r.t., stirred for 10 min and concentrated. The residue was filtered through a pad of SiO₂ (Heptane-EtOAc 1:1), concentrated and chromatographed (SiO₂, Heptane-EtOAc 2:1) to give 2,3,4-Tri-O-acetyl- α,β -D-xylopyranosyl trichloroacetimidate (**13**) (16.2 g, 77%). Spectroscopic data was consistent with published data.

2,3,4-Tri-O-acetyl- α -D-xylopyranosyl bromide (12):¹⁵ 1,2,3,4-Tetra-O-acetyl- β -D-xylopyranose (**11**) (3.0 g, 0.01 mmol) was dissolved in AcOH (11 mL) and Ac₂O (2 mL) was added. The mixture was stirred for 10 minutes after which HBr (12 mL, 33% in AcOH) was

added and the solution was stirred at r.t. for 80 min. Excess HBr was removed by bubbling N₂ (g) through the solution after which it was lyophilised to give 2,3,4-tri-*O*-acetyl- α -D-xylopyranosyl bromide (**12**) (3.2 g, 100%). Spectroscopic data was consistent with published data.

9.1.3 Mono-protection of dihydroxynaphthalenes

Description of the general experimental procedures used for the mono-benzoylation of dihydroxynaphthalenes according to Table 4.1.

Basic procedure (entries 5-6): 2,3-Dihydroxynaphthalene (**54**) (1.6 g, 10.0 mmol) was suspended in H₂O (26 mL). NaOH (10% aq.) was added until pH 11. BzCl (1.3 mL, 11.0 mmol) was added and pH was kept at about 11 by dropwise addition of NaOH (10% aq.). The suspension was stirred at r.t. for 20 min and filtered. The solid was washed with H₂O, dried in vacuo and recrystallised from toluene to give 2-hydroxynaphthalen-3-yl benzoate (1.52 g, 58%). For 2,6-dihydroxynaphthalene (**56**) the procedure gave mostly 2,6-dibenzoyloxy naphthalene and starting material.

Procedure using TMSCl (entries 7-10): 1,4-Dihydroxynaphthalene (**42**) (254 mg, 1.6 mmol) was dissolved in pyridine (2.5 mL) and CH₂Cl₂ (5 mL). TMSCl (0.2 mL, 1.6 mmol) was added and the mixture was stirred for 35 min at r.t. after which BzCl (0.276 mL, 2.4 mmol) was added. After 1 h H₂O (5 mL) was added. The mixture was stirred at r.t. for 1 h after which it was diluted with CH₂Cl₂ and washed with HCl (1 M, aq.) and H₂O. The combined aqueous phase was extracted with CH₂Cl₂ and EtOAc. The combined organic phases were dried (Na₂SO₄), filtered and concentrated. The residue was dissolved in EtOH (25 mL), AcOH (2 mL) was added and the mixture was stirred for 3 h and concentrated. The residue was chromatographed (SiO₂; toluene-acetone 10:1) to give 1-hydroxynaphthalen-4-yl benzoate (218 mg, 52%). **56** (254 mg, 1.6 mmol) gave 2-hydroxynaphthalen-6-yl benzoate (292 mg, 70%). **57** (256 mg, 1.6 mmol) gave 2-hydroxynaphthalen-7-yl benzoate (181 mg, 44%). **44** (257 mg, 1.6 mmol) gave 1-hydroxynaphthalen-5-yl benzoate (193 mg, 45.4%).

9.1.4 Synthesis of non commercially available dihydroxynaphthalenes

Of the 10 dihydroxynaphthalenes possible, eight are readily available from commercial sources. The synthesis of the last two are presented here with the appropriate references.

1,2-Dihydroxynaphthalene (36)¹⁵²: 1,2-Naphthoquinone (**65**) (509 mg, 3.2 mmol) was dissolved in EtOH and NaBH₄ (1.59 g, 42 mmol) was added in portions over 5 min. The mixture was stirred for 50 minutes, poured onto an ice-H₂O mixture (250 mL) and acidified with 2 M HCl (aq). The aqueous phase was extracted with CH₂Cl₂, dried (MgSO₄), filtered and concentrated to give **36** (513 mg, quantitative).

1,8-Dihydroxynaphthalene (52)^{153,154}: 1,8-Naphthosultone (**66**) (4.15 g, 20.1 mmol) and KOH (17.1 g, 306 mmol) were placed in a stainless steel crucible and heated to 250-300 °C with a hot air gun with occasional stirring for 30 min. (CAUTION: Hot and caustic pieces of the molten mass may fly from melt). The melt was allowed to cool to r.t. after which the solid mass was dissolved in 2 M HCl and neutralised using HCl of increasing concentrations. The black aqueous solution was diluted and extracted with EtOAc. The combined organic phases were dried (MgSO₄), filtered and concentrated. The residue was dissolved in EtOAc and filtered through a pad of SiO₂. Chromatography (Heptane-EtOAc 3:1→2:1) gave **52** (1.43 g, 44%).

9.1.5 Conversion of aminomethylated polystyrene resin to acid chloride resin

The general procedure for the conversion of aminomethylated polystyrene resin into the acid chloride resin is independent of the resin loading. For the calculation of new loading see Equation 4.1. Aminomethylated polystyrene resin (2.1 g, 1.9 mmol amine) was swelled in toluene (5 mL) for 15 min. Succinic anhydride (686 mg, 6.9 mmol), DIPEA (4 mL) and DMAP (catalytic amount) was added and the mixture was heated at 80 °C under agitation overnight. The resin was washed consecutively with toluene, CH₂Cl₂, MeOH, Et₂O and dried in vacuum. The carboxylic acid resin was swelled in toluene (8 mL) and oxalyl chloride (2 mL) was added. The mixture was agitated at 65 °C overnight after which the resin was washed consecutively with toluene, CH₂Cl₂, Et₂O and dried in vacuum.

9.1.6 Solid-phase synthesis of sulphur-containing naphthoxylosides

Examples of the conditions used in the solid-phase route towards sulphur-containing naphthoxylosides are presented here even though the method was shown not to be suitable for routine use due to unreliable yields.

Coupling of hydroxynaphthyl disulphides to acid chloride resin: Coupling of hydroxynaphthyl disulphides to acid chloride resin was performed according to the procedure

presented in Paper III and Chapter 4. Amount of binding to the resin by this method varies greatly.

Coupling of hydroxynaphthyl disulphides to carboxylic acid resin:

Carboxypolystyrene (99.6 mg, 0.143 mmol carboxylic acid) was swelled in CH_2Cl_2 (1.5 mL) for 50 minutes and purged with inert gas. DMAP (19.2 mg, 0.157 mmol) and 6-hydroxy-2-naphthyl disulphide (60.7 mg, 0.173 mmol) was added. The mixture was agitated for 30 min after which DIC (19.3 mg in 0.1 mL CH_2Cl_2) was added slowly under inert atmosphere. The mixture was agitated overnight after which the resin was washed thoroughly with CH_2Cl_2 and MeOH. Typical amount of binding to the resin using this method was about 70%.

O-Xylosylation, disulphide bond cleavage and deprotection of O-xyloside: Resin carrying 6-hydroxy-2-naphthyl disulphide (**116**) (0.119 mmol maximum theoretical loading) was swelled in CH_2Cl_2 (2 mL). 1,2,3,4-Tetra-O-acetyl- β -D-xylopyranoside (193 mg, 0.61 mmol) and $\text{BF}_3 \cdot \text{OEt}_2$ (86 mg, 0.61 mmol) were added and the mixture was agitated for 45 minutes after which the resin was washed with CH_2Cl_2 and Et_2O and dried *in vacuo*. The xylosylated resin was swelled in THF (2 mL) under inert atmosphere and Me_3P (1.0 M in toluene, 0.2 mL) was added followed by H_2O (0.2 mL) and the mixture was agitated for 26 h. The solution was filtered of, the resin washed with THF- H_2O (10:1) twice and the combined organic phases were concentrated, dissolved in CH_2Cl_2 and washed with H_2O . The organic phase was dried (Na_2SO_4), filtered and concentrated to give crude 2-(6-thionaphthyl) 2,3,4-tri-O-acetyl- β -D-xylopyranoside. The crude was dissolved in CH_2Cl_2 (1 mL) and MeOH (1 mL) and NaOMe-MeOH (1 M, 0.5 mL) were added. The solution was stirred for 20 min, neutralised with Amberlite IR-120 H^+ , filtered and concentrated. Semi-preparative HPLC gave nearly pure 2-(6-thionaphthyl) β -D-xylopyranoside (**78**) (6.6 mg, 18%). Impurities were later determined to be the disulphide.

S-Xylosylation and deprotection/cleavage: The resin from after the disulphide cleavage step above was dried *in vacuo* after which it was swelled in CH_2Cl_2 (2 mL). 1,2,3,4-Tetra-O-acetyl- β -D-xylopyranoside (193 mg, 0.61 mmol) and $\text{BF}_3 \cdot \text{OEt}_2$ (86 mg, 0.61 mmol) were added and the mixture was agitated for 35 minutes after which the resin was washed with CH_2Cl_2 . The resin was suspended in CH_2Cl_2 (1 mL) and MeOH (1 mL) and NaOMe-MeOH (1 M, 0.5 mL) were added. The mixture was agitated for 2 h and filtered. Fresh CH_2Cl_2 -MeOH-NaOMe was added and the mixture was agitated for 2 h and filtered. The combined solutions were neutralised with Amberlite IR-120 H^+ , filtered and concentrated to give a highly impure crude.

Semi-preparative HPLC gave pure 2-(6-hydroxynaphthyl) 1-thio- β -D-xylopyranoside (**84**) (7.1 mg, 20%).

9.1.7 Synthesis of naphthoxyloside-amino acid conjugates

Experimental details for the syntheses described in Chapter 6 are described here together with structures for the compounds for which structures have not yet been shown.

Methyl 6-hydroxy-1-naphthoate (147): **146** (600 mg, 3.2 mmol) was suspended in MeOH (10 mL). SOCl_2 (0.46 mL, 6.4 mmol) was added dropwise after which the tube was sealed. The suspension was stirred at 75 °C for 3 h and allowed to cool to r.t. Column chromatography (SiO_2 , heptane-EtOAc 1:1) gave **147** (521.7 mg, 81%). Recrystallisation (heptane/EtOAc 9:1) gave an analytical sample as orange crystals; mp 113°C. $^1\text{H-NMR}$ (CDCl_3): δ 8.86 (d, 1H, $J=9.1$ Hz, H-8), 8.04 (dd, 1H, $J=7.4, 1.4$ Hz, H-2), 7.87 (d, 1H, $J=8.3$ Hz, H-4), 7.46 (dd, 1H, $J=8.2, 7.3$ Hz, H-3), 7.19-7.25 (m, 2H, H-5, H-7), 5.08 (s, 1H, OH), 4.00 (s, 3H, OMe). $^{13}\text{C-NMR}$ (CDCl_3): δ 168.3, 153.6, 135.5 131.9, 128.2, 128.1, 127.2, 126.8, 125.4, 119.6, 110.2, 52.3. FAB HRMS calcd. for $\text{C}_{12}\text{H}_{10}\text{O}_3$: 202.0630; found 202.0628.

6-(1-methoxycarbonyl naphthyl) 1,2,3-tri-O-acetyl- β -D-xylopyranoside (179): **147** (95 mg, 0.47 mmol) and 1,2,3,4-tetra-O-acetyl- β -D-xylopyranose (299 mg, 0.94 mmol) were dissolved in CH_2Cl_2 (10 mL). Et_3N (0.07 mL, 0.47 mmol) followed by $\text{BF}_3 \cdot \text{OEt}_2$ (0.295 mL, 2.34 mmol) was added. The solution was stirred at r.t. for 3 h, quenched by the addition of Et_3N and concentrated. Chromatography (SiO_2 , CH_2Cl_2 -acetone 40:1) gave **179** as a white foam (204.7 mg, 95%); $[\alpha]_{\text{D}}^{25} -31.2^\circ$ (c 0.17, CHCl_3). $^1\text{H-NMR}$ (CDCl_3): δ 8.90 (d, 1H, $J=9.4$ Hz, H-8), 8.11 (dd, 1H, $J=7.3, 1.3$ Hz, H-2), 7.93 (d, 1H, $J=8.3$ Hz, H-4), 7.49 (dd, 1H, $J=8.3, 7.4$ Hz, H-3), 7.41 (d, 1H, $J=2.6$ Hz, H-5), 7.31 (dd, 1H, $J=9.4, 2.6$ Hz, H-7), 5.38 (d, 1H, $J=5.5$ Hz, H-1'), 5.22-5.31 (m, 2H, H-2', H-3'), 5.05 (dt, 1H, $J=7.3, 4.6$ Hz, H-4'), 4.29 (dd, 1H, $J=12.2, 4.6$ Hz, H-5'), 4.00 (s, 3H, OMe), 3.63 (dd, 1H, $J=12.2, 7.2$ Hz, H-5), 2.13, 2.12, 2.11 (s, 3H each, OAc). $^{13}\text{C-NMR}$ (CDCl_3): δ 170.1, 170.0, 169.6, 168.1, 154.4, 135.1, 132.7, 129.1, 128.1, 128.0, 127.2, 125.5, 120.5, 111.8, 98.4, 70.5, 70.1, 68.5, 62.0, 52.3, 21.0, 20.9, 20.9. HRMS calcd. for $\text{C}_{23}\text{H}_{24}\text{O}_{10}\text{Na}$ (M+Na): 483.1267; found 483.1250.

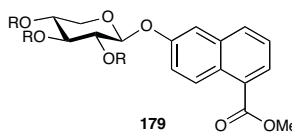

6-(1-methoxycarbonylnaphthyl) β -D-xylopyranoside (180): **179** (178.7 mg, 0.39 mmol) was dissolved in methanol (10 mL). NaOMe (0.25 M, 0.62 mL) was added and the solution was stirred for 45 min at r.t. The reaction was neutralised with solid CO_2 , concentrated and

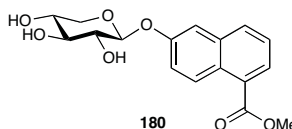

chromatographed (SiO₂, CHCl₃-MeOH 1:1) to give **180** as a white solid (117.2 mg, 90%). [α]_D²⁵ -39.4° (c 0.14, MeOH). ¹H-NMR (CD₃OD): δ 8.81 (d, 1H, *J*=9.4 Hz, H-8), 8.05 (dd, 1H, *J*=7.1, 1.3 Hz, H-2), 8.01 (d, 1H, *J*=8.4 Hz, H-4), 7.46-7.54 (m, 2H, H-3, H-5), 7.39 (dd, 1H, *J*=9.2, 2.6 Hz, H-7), 5.07 (d, 1H, *J*=7.1 Hz, H-1'), 3.98 (dd, 1H, *J*=11.5, 5.2 Hz, H-5'), 3.98 (s, 3H, OMe), 3.57-3.66 (m, 1H, H-4'), 3.43-3.55 (m, 3H, H-2', H-3', H-5'). ¹³C-NMR (CD₃OD): δ 169.5, 156.7, 136.6, 133.7, 129.5, 128.7, 128.4, 128.2, 126.3, 121.5, 112.3, 102.6, 77.7, 74.8, 71.0, 67.0, 52.6. HRMS calcd. for C₁₇H₁₈O₇Na (M+Na): 357.0950; found 357.0969.

6-(1-carboxynaphthyl) β -D-xylopyranoside (143): **180** (117.2 mg, 0.35 mmol) was dissolved in MeOH (15 mL). NaOH (7 mL, 7.01 mmol) was added and the solution was stirred for 19 h at r.t. The reaction was neutralised with Amberlite IR-120 H⁺, filtered and evaporated to give **143** as a white amorphous solid (112 mg, quant.). [α]_D²⁵ -31.0° (c 0.25, MeOH). ¹H-NMR (CD₃OD): δ 8.88 (d, 1H, *J*=9.5 Hz, H-8), 8.09 (dd, 1H, *J*=7.3, 1.3 Hz, H-2), 8.00 (d, 1H, *J*=8.3 Hz, H-4), 7.46-7.53 (m, 2H, H-3', H-5'), 7.37 (dd, 1H, *J*=9.4, 2.7 Hz, H-7'), 5.07 (d, 1H, *J*=7.2 Hz, H-1'), 3.98 (dd, 1H, *J*=11.3, 5.1 Hz, H-5'), 3.57-3.66 (m, 1H, H-4'), 3.43-3.55 (m, 3H, H-2', H-3', H-5'). ¹³C-NMR (CD₃OD): δ 171.0, 156.6, 136.7, 133.5, 129.6, 128.9, 128.9, 128.7, 126.3, 121.3, 112.3, 102.7, 77.7, 74.8, 71.1, 67.0. HRMS calcd. for C₁₆H₁₆O₇Na (M+Na): 343.0794; found 343.0811.

6-(1-carboxynaphthyl) 1,2,3-tri-O-acetyl- β -D-xylopyranoside (142): **143** (241 mg, 0.75 mmol) was dissolved in pyridine (15 mL). Acetic anhydride (0.71 mL, 7.5 mmol) was added and the mixture was stirred for 4 h at r.t. The solution was concentrated and the residue was dissolved in EtOAc (30 mL). The solution was washed three times with HCl (10% aq.) and the organic layer was dried (MgSO₄), filtered and concentrated to give **142** (305 mg, 91%). [α]_D²⁵ -44.4° (c 0.099, CHCl₃). ¹H-NMR: (CDCl₃) δ 9.04 (d, 1H, *J*=9.5 Hz, H-8), 8.30 (dd, 1H, *J*=7.4, 1.2 Hz, H-2), 8.00 (d, 1H, *J*=8.2 Hz, H-4), 7.54 (d, 1H, *J*=8.2, 7.4 Hz, H-3), 7.44 (d, 1H, *J*=2.6 Hz, H-5), 7.35 (dd, 1H, *J*=9.5, 2.6 Hz, H-7), 5.40 (d, 1H, *J*=5.5 Hz, H-1'), 5.23-5.32 (m, 2H, H-2', H-3'), 5.06 (dt, 1H, *J*=7.1, 4.8 Hz, H-4'), 4.30 (dd, 1H, *J*=12.2, 4.5 Hz, H-5'), 3.64 (dd, 1H, *J*=12.2, 7.2 Hz, H-5'), 2.13, 2.124, 2.119 (s, 3H each, OAc). ¹³C-NMR (CDCl₃): 170.8, 170.1, 170.0, 169.6, 154.5, 135.2, 133.8, 130.5, 128.3, 128.1, 125.5, 125.4, 120.8, 111.9, 98.3, 70.5, 70.1, 68.5, 62.0, 21.0, 20.9, 20.9. HRMS calcd. for C₂₂H₂₂O₁₀Na (M+Na): 469.1111; found 469.1108.

Methyl 6-hydroxy-2-naphthoate (149): **148** (400 mg, 2.1 mmol) was suspended in MeOH (10 mL). SOCl₂ (0.31 mL, 4.3 mmol) was added dropwise after which the tube was sealed. The suspension was stirred at 75 °C for 3 h and allowed to cool to r.t. Chromatography (SiO₂, heptane-EtOAc 1:1) gave **149** (393.1 mg, 91%). ¹H-NMR (CDCl₃): δ 8.55 (s, 1H, H-1),

8.02 (dd, 1H, $J=8.7, 1.7$ Hz, H-3), 7.88 (d, 1H, $J=8.6$ Hz, H-8), 7.72 (d, 1H, $J=8.6$ Hz, H-4), 7.14-7.21 (m, 2H, H-5, H-7), 5.29 (s, 1H, OH), 3.98 (s, 3H, OMe). $^{13}\text{C-NMR}$ (CDCl_3): δ 167.5, 155.6, 137.2, 131.6, 131.2, 128.0, 126.6, 126.2, 125.4, 118.7, 109.6, 52.3. FAB HRMS calcd. for $\text{C}_{12}\text{H}_{10}\text{O}_3$, 202.0630; found 202.0634.

6-(2-methoxycarbonyl naphthyl) 1,2,3-tri-O-acetyl- β -D-xylopyranoside (154): 149 (108.8 mg, 0.54 mmol) and 1,2,3,4-tri-O-acetyl- β -D-xylopyranose (342.5 mg, 1.08 mmol) were dissolved in CH_2Cl_2 (10 mL). Et_3N (0.076 mL, 0.54 mmol) followed by $\text{BF}_3 \cdot \text{OEt}_2$ (0.34 mL, 2.69 mmol) was added. The solution was stirred at r.t. for 3 h, quenched with Et_3N and concentrated. Chromatography (SiO_2 , CH_2Cl_2 -acetone 40:1 followed by heptane-EtOAc 1:1) gave **154** as a white foam (204.7 mg, 83%); $[\alpha]_{\text{D}}^{25} -31.8^\circ$ (c 0.25, CHCl_3). $^1\text{H-NMR}$ (CDCl_3): δ 8.56 (s, 1H, H-1), 8.06 (dd, 1H, $J=8.6, 1.6$ Hz, H-3), 7.90 (d, 1H, $J=9.0$ Hz, H-8), 7.78 (d, 1H, $J=8.6$ Hz, H-4), 7.39 (d, 1H, $J=2.2$ Hz, H-5), 7.24 (dd, 1H, $J=9.0, 2.5$ Hz, H-7), 5.40 (d, 1H, $J=5.3$ Hz, H-1'), 5.21-5.31 (m, 2H, H-2', H-3'), 5.05 (dt, 1H, $J=7.0, 4.6$ Hz, H-4'), 4.29 (dd, 1H, $J=12.1, 4.5$ Hz, H-5'), 3.98 (s, 3H, OMe), 3.64 (dd, 1H, $J=12.2, 7.1$ Hz, H-5'), 2.13, 2.117, 2.115 (s, 3H each, OAc). $^{13}\text{C-NMR}$ (CDCl_3): δ 170.0, 170.0, 169.5, 167.4, 156.2, 136.8, 131.4, 131.0, 129.1, 127.5, 126.4, 126.2, 119.7, 110.9, 98.2, 70.5, 70.0, 68.5, 62.0, 52.3, 21.0, 20.9, 20.9. HRMS calcd. for $\text{C}_{23}\text{H}_{24}\text{O}_{10}\text{Na}$ (M+Na): 483.1267; found 483.1236.

6-(2-methoxycarbonylnaphthyl) β -D-xylopyranoside (155): 154 (130.7 mg, 0.28 mmol) was dissolved in MeOH (10 mL). NaOMe (0.25 M, 0.45 mL) was added and the solution was stirred for 30 min at r.t. The reaction was neutralised with solid CO_2 , concentrated and filtered. Chromatography (SiO_2 , CHCl_3 -MeOH 1:1) gave **155** as a white amorphous solid (90.4 mg, 97%). $[\alpha]_{\text{D}}^{25} -26.4^\circ$ (c 0.11, MeOH). $^1\text{H-NMR}$ (CD_3OD): δ 8.54 (d, 1H, $J=0.8$ Hz, H-1), 7.99 (dd, 1H, $J=8.8, 1.8$ Hz, H-3), 7.94 (d, 1H, $J=9.0$ Hz, H-8), 7.85 (d, 1H, $J=8.8$ Hz, H-4), 7.48 (d, 1H, $J=2.3$ Hz, H-5), 7.35 (dd, 1H, $J=8.9, 2.3$ Hz, H-7), 5.09 (d, 1H, $J=7.3$ Hz, H-1'), 3.98 (dd, 1H, $J=11.2, 5.2$ Hz, H-5'), 3.95 (s, 3H, OMe), 3.57-3.66 (m, 1H, H-4'), 3.45-3.66 (m, 3H, H-2', H-3', H-5'). $^{13}\text{C-NMR}$ (CD_3OD): 168.8, 158.7, 138.4, 132.0, 131.8, 130.1, 128.5, 126.9, 126.6, 121.0, 111.5, 102.5, 77.7, 74.7, 71.0, 67.0, 52.6. HRMS calcd. for $\text{C}_{17}\text{H}_{18}\text{O}_7\text{Na}$ (M+Na): 357.0950; found 357.0949.

6-(2-carboxynaphthyl) β -D-xylopyranoside (145): 155 (111.6 mg, 0.33 mmol) was dissolved in MeOH (20 mL). NaOH (6.7 mL, 6.7 mmol) was added and the solution was stirred for 19 h at r.t. The reaction was neutralised with Amberlite IR-120 H^+ . The mixture was filtered and concentrated to give **145** as a white amorphous solid (101.5 mg, 95%). $[\alpha]_{\text{D}}^{25} -25.5^\circ$ (c 0.14, MeOH). $^1\text{H-NMR}$ (CD_3OD): δ 8.55 (s, 1H, H-1), 8.00 (dd, 1H, $J=8.7, 1.7$ Hz, H-3), 7.94 (d,

1H, $J=9.1$ Hz, H-8), 7.84 (d, 1H, $J=8.7$ Hz, H-4), 7.48 (d, 1H, $J=2.4$ Hz, H-5), 7.34 (dd, 1H, $J=9.0, 2.4$ Hz, H-7), 5.09 (d, 1H, $J=7.1$ Hz, H-1'), 3.98 (dd, 1H, $J=11.3, 5.2$ Hz, H-5'), 3.57-3.66 (m, 1H, H-4'), 3.43-3.56 (m, 3H, H-2', H-3', H-5'). $^{13}\text{C-NMR}$ (CD_3OD): 170.2, 158.6, 138.3, 132.0, 131.9, 130.1, 128.3, 127.8, 127.0, 120.9, 111.5, 102.5, 77.7, 74.7, 71.0, 67.0. HRMS calcd. for $\text{C}_{16}\text{H}_{16}\text{O}_7\text{Na}$ ($\text{M}+\text{Na}$): 343.0794; found 343.0806.

6-(2-carboxynaphthyl) 1,2,3-tri-O-acetyl- β -D-xylopyranoside (144): 145 (456.7 mg, 1.43 mmol) was dissolved in pyridine (30 mL). Ac_2O (1.35 mL, 14.3 mmol) was added and the mixture was stirred over night at r.t. The solution was concentrated and the residue was dissolved in EtOAc (60 mL), washed three times with HCl (10% aq.), dried (MgSO_4) and concentrated to give **144** (576 mg, 90%) as a white amorphous solid. $[\alpha]_{\text{D}}^{25} -31.9^\circ$ (c 0.39, CHCl_3). $^1\text{H-NMR}$ (CDCl_3): δ 8.66 (d, 1H, $J=0.8$ Hz, H-1), 8.11 (dd, 1H, $J=8.6, 1.7$ Hz, H-3), 7.94 (d, 1H, $J=9.1$ Hz, H-8), 7.82 (d, 1H, $J=8.8$ Hz, H-4), 7.41 (d, 1H, $J=2.4$, H-5), 7.27 (dd, 1H, $J=9.0, 2.4$ Hz, H-7), 5.42 (d, 1H, $J=5.5$ Hz, H-1'), 5.23-5.32 (m, 2H, H-2', H-3'), 5.06 (dt, 1H, $J=6.8, 4.7$ Hz, H-4'), 4.30 (dd, 1H, $J=12.2, 4.6$ Hz, H-5'), 3.66 (dd, 1H, $J=12.2, 7.1$ Hz, H-5'), 2.13 (s, 3H, OAc), 2.12 (s, 6H, OAc), $^{13}\text{C-NMR}$ (CDCl_3): δ 172.2, 170.0, 170.0, 169.6, 156.5, 137.2, 132.0, 131.6, 129.0, 127.6, 126.4, 125.4, 119.8, 110.9, 98.1, 70.4, 70.0, 68.5, 62.0, 21.0, 20.9, 20.8. HRMS calcd. for $\text{C}_{22}\text{H}_{22}\text{O}_{10}\text{Na}$ ($\text{M}+\text{Na}$): 469.1111; found 469.1109.

Xyl(OAc)₃-(β 1 \rightarrow 6O)-Nap-1-CONH-Gly-COO-*t*-Bu (181): 142 (10 mg, 0.022 mmol) and glycine-*t*-Bu-ester hydrochloride (4.88 mg, 0.029 mmol) were dissolved in CH_2Cl_2 (1.5 mL). DMAP

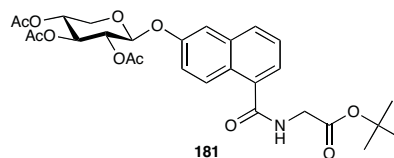

(4.1 mg, 0.034 mmol) was added and the solution was stirred for 15 min. DIC (4.4 μL , 0.028 mmol) in 0.1 mL CH_2Cl_2 was added. The solution was stirred at r.t. for 3 h. The mixture was concentrated and chromatographed (SiO_2 , heptane-EtOAc 1:10) to give **181** (11.6 mg, 94%). $[\alpha]_{\text{D}}^{25} -23.6^\circ$ (c 0.75, CHCl_3). $^1\text{H-NMR}$ (CDCl_3): δ 8.37 (d, 1H, $J=9.3$ Hz, H-8), 7.83 (d, 1H, $J=8.2$ Hz, H-4), 7.60 (dd, 1H, $J=7.1, 1.2$ Hz, H-2), 7.45 (dd, 1H, $J=7.1, 1.2$ Hz, H-3), 7.39 (d, 1H, $J=2.5$ Hz, H-5), 7.23-7.29 (m, 1H, H-7), 6.48 (t, 1H, $J=5.0$, NHCH_2) 5.36 (d, 1H, $J=5.5$ Hz, H-1'), 5.20-5.31 (m, 2H, H-2', H-3'), 5.04 (dt, 1H, $J=7.0, 4.7$ Hz, H-4'), 4.28 (dd, 1H, $J=12.2, 4.5$ Hz, H-5'), 4.22 (d, 2H, $J=5.2$, NHCH_2), 3.62 (dd, 1H, $J=12.2, 7.2$ Hz, H-5'), 2.12 (s, 3H, OAc), 2.09-2.11 (m, 6H, OAc), (s, 9H, O-*t*-Bu). $^{13}\text{C-NMR}$ (CDCl_3): δ 170.0, 170.0, 169.6, 169.2, 154.7, 134.9, 133.8, 130.3, 127.7, 126.9, 125.7, 124.1, 120.0, 111.7, 98.5, 82.7, 70.5, 70.1, 68.6, 62.0, 42.7, 28.2, 20.9, 20.9, 20.9. HRMS calcd. for $\text{C}_{28}\text{H}_{33}\text{NO}_{11}$ ($\text{M}+\text{H}$): 560.2132; found 560.2149.

Xyl(OAc)₃-(β1→6O)-Nap-1-CONH-Ala-

COOMe (182): 142 (10 mg, 0.022 mmol) and L-alanine methyl ester hydrochloride (4.1 mg, 0.029 mmol) were dissolved in CH₂Cl₂ (1.5 mL). DMAP (4.1 mg, 0.034

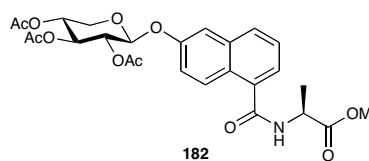

mmol) was added and the solution was stirred for 15 min. DIC (4.4 μL, 0.028 mmol) in 0.1 mL CH₂Cl₂ was added. The solution was stirred at r.t. for 3 h. The mixture was concentrated and chromatographed (SiO₂, heptane-EtOAc 1:10) to give **182** (10.2 mg, 87%). [α]_D²⁵ -31.2° (c 0.66, CHCl₃). ¹H-NMR (CDCl₃): δ 8.33 (s, 1H, H-8), 7.83 (d, 1H, *J*=8.3 Hz, H-4), 7.58 (dd, 1H, *J*=7.1, 1.2 Hz, H-2), 7.45 (dd, 1H, *J*=8.2, 7.1 Hz, H-3), 7.39 (d, 1H, *J*=2.5 Hz, H-5), 7.24-7.34 (m, 1H, H-7), 6.55 (d, 1H, *J*=7.2 Hz, NHCH), 5.36 (d, 1H, *J*=5.5 Hz, H-1'), 5.21-5.32 (m, 2H, H-2', H-3'), 5.04 (dt, 1H, *J*=6.9, 4.7 Hz, H-4'), 4.91 (m, 1H, NHCH), 4.28 (dd, 1H, *J*=12.1, 4.6 Hz, H-5'), 3.82 (s, 3H, OMe), 3.62 (dd, 1H, *J*=12.1, 7.2 Hz, H-5'), 2.12 (s, 3H, OAc), 2.11 (m, 6H, OAc), 1.58 (d, 1H, *J*=7.2 Hz, CHCH₃). ¹³C-NMR (CDCl₃): δ 173.6, 170.0, 170.0, 169.5, 169.0, 154.7, 134.9, 133.8, 130.3, 127.6, 126.8, 125.6, 124.0, 120.0, 111.7, 98.4, 70.5, 70.0, 68.5, 61.9, 52.7, 20.9, 20.9, 20.8, 18.7. HRMS calcd. for C₂₆H₃₀NO₁₁ (M+H): 532.1819; found 532.1779.

Xyl(OAc)₃-(β1→6O)-Nap-1-CONH-Pro-COOMe

(183): 142 (10 mg, 0.022 mmol) and L-proline methyl ester hydrochloride (4.8 mg, 0.029 mmol) were dissolved in CH₂Cl₂ (1.5 mL). DMAP (4.1 mg, 0.034 mmol) was

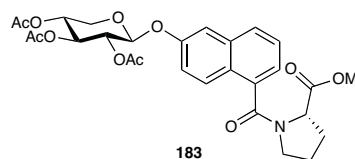

added and the solution was stirred for 15 min. DIC (4.4 μL, 0.028 mmol) in 0.1 mL CH₂Cl₂ and added. The solution was stirred r.t. for 3 h. The mixture was concentrated and chromatographed (SiO₂, heptane-ethyl acetate 1:10) to give **183** (10.4 mg, 85%). [α]_D²⁵ -67.0° (c 0.64, CHCl₃). ¹H-NMR (CDCl₃): δ 8.12 (d, 1H, *J*=9.1 Hz, H-8), 7.80 (d, 1H, *J*=8.2 Hz, H-4), 7.47 (dd, 1H, *J*=8.1, 7.0 Hz, H-3), 7.38-7.42 (m, 2H, H-2, H-5), 7.28 (dd, 1H, *J*=9.1, 2.6 Hz, H-7), 5.36 (d, 1H, *J*=5.6 Hz, H-1'), 5.22-5.29 (m, 2H, H-2', H-3'), 5.04 (dt, 1H, *J*=7.1, 4.7 Hz, H-4'), 4.81 (dd, 1H, *J*=8.6, 4.9 Hz, NCHCH₂), 4.28 (dd, 1H, *J*=12.2, 4.5 Hz, H-5'), 3.86 (s, 3H, OMe), 3.62 (dd, 1H, *J*=12.2, 7.3 Hz, H-5'), 3.27-3.36 (m, 1H, NCH₂CH₂), 3.16-3.25 (m, 1H, NCH₂CH₂), 2.29-2.43 (m, 1H, NCHCH₂), 2.12, 2.11, 2.11 (s, 3H each, OAc), 2.03-2.10 (m, 1H, NCHCH₂), 1.80-2.00 (m, 2H, NCH₂CH₂). ¹³C-NMR (CDCl₃): δ 172.9, 170.0, 170.0, 169.5, 169.5, 154.7, 135.0, 134.6, 128.8, 127.4, 126.1, 126.0, 122.6, 120.1, 111.7, 98.4, 70.5, 68.5, 61.9, 58.7, 51.8, 29.8, 25.0, 20.9, 20.9, 20.9. HRMS calcd. for C₂₈H₃₂NO₁₁ (M+H): 558.1975; found 558.1927.

Xyl(OAc)₃-(β1→6O)-Nap-1-CONH-Phe-COOMe (184): **142** (10 mg, 0.022 mmol) and L-phenylalanine methyl ester hydrochloride (6.28 mg, 0.029 mmol) were dissolved in CH₂Cl₂ (1.5 mL). DMAP

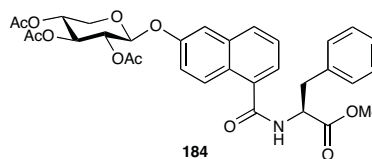

(4.1 mg, 0.034 mmol) was added and the solution was stirred for 15 min. DIC (4.4 μL, 0.028 mmol) in 0.1 mL CH₂Cl₂ was added. The solution was stirred at r.t. for 3 h. The mixture was concentrated and chromatographed (SiO₂, heptane-EtOAc 1:10) to give **184** (13.4 mg, 98%). [α]_D²⁵ +14.8° (c 0.64, CHCl₃). ¹H-NMR (CDCl₃): δ 8.16 (d, 1H, *J*=9.3 Hz, H-8), 7.81 (dd, 1H, *J*=7.59 1.7 Hz, H-4), 7.38-7.46 (m, 2H, H-2, H-3), 7.37 (d, 1H, H-5), 7.27-7.35 (m, 3H, ArH), 7.16-7.24 (m, 3H, H-7, ArH) 6.41 (d, 1H, *J*=8.0, NHCH), 5.35 (d, 1H, *J*=5.5 Hz, H-1'), 5.17-5.31 (m, 3H, H-2', H-3', NHCH), 5.04 (dt, 1H, *J*=7.1 4.8 Hz, H-4'), 4.27 (dd, 1H, *J*=12.2 4.6 Hz, H-5'), 3.82 (s, 3H, OMe), 3.61 (dd, 1H, *J*=14.0 5.7 Hz, H-5'), 3.40 (dd, 1H, *J*=14.0 5.7 Hz, NHCH₂), 3.22 (dd, 1H, *J*=14.0 6.4 Hz, NHCH₂), 2.12 (s, 3H, OAc), 2.11 (s, 3H, OAc), 2.11 (s, 3H, OAc). ¹³C-NMR (CDCl₃): δ 172.1, 170.0, 170.0, 169.5, 168.9, 154.7, 135.9, 134.9, 133.7, 130.3, 129.5, 128.9, 127.6, 127.4, 126.8, 125.6, 124.0, 120.0, 111.6, 98.4, 70.5, 70.1, 68.5, 61.9, 53.7, 52.7, 38.1, 20.9, 20.9, 20.9. HRMS calcd. for C₃₂H₃₄NO₁₁ (M+H): 608.2132; found 608.2179.

Xyl(OAc)₃-(β1→6O)-Nap-2-CONH-Gly-COO*t*-Bu (185): **144** (10 mg, 0.022 mmol) and glycine-*t*-Bu-esterhydrochloride (4.88 mg, 0.029

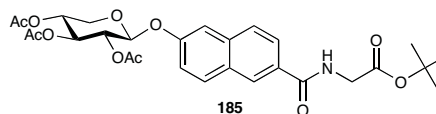

mmol) were dissolved in CH₂Cl₂ (1.5 mL). DMAP (4.1 mg, 0.034 mmol) was added and the solution was stirred for 15 min. DIC (4.4 μL, 0.028 mmol) in 0.1 mL CH₂Cl₂ was added. The solution was stirred r.t. for 3 h. The mixture was concentrated and chromatographed (SiO₂, heptane-EtOAc 1:10) to give **185** (12.5 mg, 99%). [α]_D²⁵ -21.1° (c 0.78, CHCl₃). ¹H-NMR (CDCl₃): δ 8.29 (s, 1H, H-1), 7.76-7.90 (m, 2H, H-3, H-8), 7.79 (d, 1H, *J*=8.7 Hz, H-4), 7.38 (d, 1H, *J*=2.5 Hz, H-5), 7.24 (dd, 1H, *J*=8.9, 2.5 Hz, H-7), 6.78 (t, 1H, *J*=4.7 Hz, NHCH₂), 5.38 (d, 1H, *J*=5.4 Hz, H-1'), 5.21-5.31 (m, 2H, H-2', H-3'), 5.05 (dt, 1H, *J*=6.8, 4.7 Hz, H-4'), 4.23 (dd, 1H, *J*=12.3, 4.6 Hz, H-5'), 4.20 (d, 2H, *J*=4.8 Hz, NHCH₂), 3.64 (dd, 1H, *J*=12.3 7.2 Hz, H-5'), 2.12 (s, 3H, OAc), 2.11 (s, 6H, OAc), 1.53 (s, 9H, O*t*-Bu). ¹³C-NMR (CDCl₃): δ 170.0, 170.0, 169.5, 167.3, 155.8, 136.0, 131.0, 130.0, 129.2, 127.8, 127.6, 124.5, 119.8, 111.0, 98.3, 82.8, 70.5, 70.0, 68.5, 62.0, 42.8, 28.2, 20.9, 20.9, 20.9. HRMS calcd. for C₂₈H₃₄NO₁₁ (M+H): 560.2132; found 560.2137.

Xyl(OAc)₃-(β1→6O)-Nap-2-CONH-Ala-COOMe (186): 144 (10 mg, 0.022 mmol) and L-alanine methyl ester hydrochloride (4.1 mg, 0.029

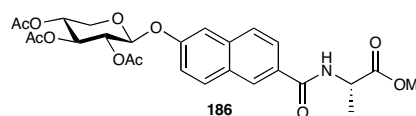

mmol) were dissolved in CH₂Cl₂ (1.5 mL). DMAP (4.1 mg, 0.034 mmol) was added and the solution was stirred for 15 min. DIC (4.4 μL, 0.028 mmol) in 0.1 mL CH₂Cl₂ was added. The solution was stirred at r.t. for 3 h. The mixture was concentrated and chromatographed (SiO₂, heptane-EtOAc 1:10) to give **186** (10.4 mg, 87%). [α]_D²⁵ +1.0° (c 0.69, CHCl₃). ¹H-NMR (CDCl₃): δ 8.28 (s, 1H, H-1), 7.82-7.91 (m, 2H, H-3, H-8), 7.79 (d, 1H, *J*=8.5 Hz, H-4), 7.39 (d, 1H, *J*=2.4 Hz, H-5), 7.24 (dd, 1H, *J*=9.3, 2.4 Hz, H-7), 6.88 (d, 1H, *J*=7.2 Hz, NHCH), 5.37 (d, 1H, *J*=5.5 Hz, H-1'), 5.21-5.32 (m, 2H, H-2', H-3'), 5.05 (dt, 1H, *J*=7.2, 4.7 Hz, H-4'), 4.87 (p, 1H, *J*=7.1 Hz, NHCH), 4.29 (d, 1H, *J*=12.3, 4.6 Hz, H-5'), 3.82 (s, 3H, OMe), 3.64 (dd, 1H, *J*=12.3, 7.3 Hz, H-5'), 2.12 (s, 3H, OAc), 2.11 (s, 6H, OAc), 1.57 (d, 1H, *J*=7.3 Hz, CHCH₃). ¹³C-NMR (CDCl₃): δ 174.0, 170.0, 170.0, 169.5, 166.8, 155.9, 136.0, 131.0, 130.0, 129.2, 127.8, 127.6, 124.5, 119.8, 110.9, 98.2, 70.5, 70.0, 68.5, 62.0, 52.8, 20.9, 20.9, 20.9, 18.9. HRMS calcd. for C₂₆H₃₀NO₁₁ (M+H): 532.1819; found 532.1769.

Xyl(OAc)₃-(β1→6O)-Nap-2-CONH-Phe-COOMe (187): 144 (10 mg, 0.022 mmol) and L-phenylalanine methyl ester hydrochloride (6.28 mg, 0.029 mmol) were dissolved in CH₂Cl₂ (1.5 mL).

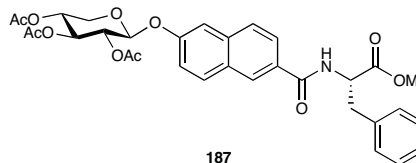

DMAP (4.1 mg, 0.034 mmol) was added and the solution was stirred for 15 min. DIC (4.4 μL, 0.028 mmol) in 0.1 mL CH₂Cl₂ was added. The solution was stirred at r.t. for 3 h. The mixture was concentrated and chromatographed (SiO₂, heptane-EtOAc 1:10) to give **187** (12.6 mg, 92%). [α]_D²⁵ +37.7° (c 0.85, CHCl₃). ¹H-NMR (CDCl₃): δ 8.20 (s, 1H, H-1), 7.85 (d, 1H, *J*=8.9 Hz, H-8), 7.78 (d, 2H, *J*=0.97 Hz, H-3, H-4), 7.38 (d, 1H, *J*=2.5 Hz, H-5), 7.28-7.34 (m, 3H, ArH), 7.24 (d, 1H, *J*=8.9, 2.4 Hz, H-7), 7.20-7.14 (m, 2H, ArH), 6.71 (d, 1H, *J*=7.6 Hz, NHCH), 5.39 (d, 1H, *J*=5.4 Hz, H-1'), 5.22-5.32 (m, 2H, H-2', H-3'), 5.16 (dt, 1H, *J*=5.7, 5.5 Hz, NHCH), 5.05 (dt, 1H, *J*=7.2, 4.7 Hz, H-4'), 4.29 (dd, 1H, *J*=12.3, 4.6 Hz, H-5'), 3.64 (dd, 1H, *J*=12.3, 7.3 Hz, H-5'), 3.80 (s, 3H, OMe), 3.35 (dd, 1H, *J*=13.9, 5.8 Hz, CHCH₂), 3.27 (dd, 1H, *J*=13.9, 5.5 Hz, CHCH₂), 2.13 (s, 3H, OAc), 2.12 (s, 6H, OAc). ¹³C-NMR (CDCl₃): δ 172.3, 170.0, 170.0, 169.5, 166.8, 155.9, 136.1, 136.0, 131.0, 130.0, 129.5, 129.2, 128.8, 127.9, 127.6, 127.4, 124.4, 119.9, 111.0, 98.2, 70.5, 70.0, 68.5, 62.0, 52.8, 52.6, 38.1, 20.9, 20.9, 20.9. HRMS calcd. for C₃₂H₃₄NO₁₁ (M+H): 608.2132; found 608.2119.

Xyl(β 1 \rightarrow 6O)-Nap-1-CONH-Gly-COOH (167): 181 (11.2 mg, 0.020 mmol) was dissolved in MeOH (2mL). NaOH 1M (0.40 mL, 0.40 mmol) was added and the mixture was stirred for 5 hours. The reaction was neutralised with Amberlite IR-120 H⁺, filtered and concentrated to give **167** (7.3 mg, 97%) as a white amorphous solid. $[\alpha]_D^{25}$ -21.0° (c 0.47, MeOH). ¹H-NMR (CD₃OD): δ 8.31 (d, 1H, $J=9.3$ Hz, H-8), 7.90 (d, 1H, $J=8.3$ Hz, H-4), 7.59 (dd, 1H, $J=7.1, 1.2$ Hz, H-2), 7.45-7.53 (m, 2H, H-3, H-5), 7.34 (dd, 1H, $J=9.3, 2.6$ Hz, H-7), 5.06 (d, 1H, $J=7.1$ Hz, H-1'), 4.13 (s, 2H, NHCH₂), 3.97 (dd, 1H, $J=11.3, 5.2$ Hz, H-5') 3.56-3.66 (m, 1H, H-4'), 3.43-3.54 (m, 3H, H-2', H-3', H-5'). ¹³C-NMR (CD₃OD): δ 172.3, 156.9, 136.3, 135.3, 130.8, 128.2, 127.7, 126.5, 124.8, 120.9, 112.0, 102.7, 77.7, 74.7, 67.0. HRMS calcd. for C₁₈H₂₀NO₈ (M+H): 378.1189; found 378.1188.

Xyl(β 1 \rightarrow 6O)-Nap-1-CONH-Ala-COOH (168): 182 (9.1 mg, 0.0171 mmol) was dissolved in MeOH. NaOH 1M (0.34 mL, 0.34 mmol) was added and the mixture was stirred for 5 hours. The reaction was neutralised with Amberlite IR-120 H⁺, filtered and concentrated to give **168** (6.4 mg, 96%) as white amorphous solid. $[\alpha]_D^{25}$ -33.1° (c 0.43, MeOH). ¹H-NMR (CD₃OD): δ 8.25 (d, 1H, $J=9.3$ Hz, H-8), 7.89 (d, 1H, $J=8.3$ Hz, H-4), 7.56 (dd, 1H, $J=7.0, 1.1$ Hz, H-2), 7.43-7.51 (m, 2H, H-3, H-5), 7.33 (dd, 1H, $J=9.3, 2.5$ Hz, H-7), 5.05 (d, 1H, $J=7.0$ Hz, H-1'), 4.60 (q, $J=7.2$, 1H, NHCH), 3.94-4.01 (m, 1H, H-5') 3.56-3.66 (m, 1H, H-4'), 3.42-3.55 (m, 3H, H-2', H-3', H-5'), 1.52 (d, 3H, $J=7.2$, CHCH₃). ¹³C-NMR (CD₃OD): δ 171.9, 156.9, 136.3, 135.5, 130.7, 128.2, 127.7, 126.5, 124.7, 120.8, 112.0, 102.7, 77.7, 74.8, 71.0, 67.0, 18.3 HRMS calcd. for C₁₉H₂₂NO₈ (M+H): 392.1345; found 378.1339.

Xyl(β 1 \rightarrow 6O)-Nap-1-CONH-Pro-COOH (172): 183 (9.6 mg, 0.017 mmol) was dissolved in MeOH-CH₂Cl₂ (2 mL, 1:1). NaOMe (0.5 mL, 1 M in MeOH, 0.50 mmol) was added and the mixture was stirred for 20 minutes, neutralised with Amberlite IR-120 H⁺, filtered and concentrated. The crude was dissolved in MeOH (2 mL), NaOH was added (0.24 mL, 0.24 mmol) and the reaction was stirred over night. The reaction was neutralised with Amberlite IR-120 H⁺, filtered and concentrated to give **172** (4.9 mg, 68%) as a white amorphous solid. $[\alpha]_D^{25}$ -54.0° (c 0.33, MeOH). ¹H NMR (CD₃OD): δ 8.09 (d, 1H, $J=8.5$ Hz, H-8), 7.89 (d, 1H, $J=8.5$ Hz, H-4), 7.47-7.55 (m, 2H, H-3, H-5), 7.39 (dd, 1H, $J=7.1, 1.2$ Hz, H-2), 7.35 (dd, 1H, $J=9.2, 2.4$ Hz, H-7), 5.06 (d, 1H, $J=7.1$ Hz, H-1'), 4.72 (dd, 1H, $J=8.9, 5.0$ Hz, NCHCH₂), 3.98 (dd, 1H, $J=11.3, 5.1$ Hz, H-5') 3.56-3.66 (m, 1H, H-4'), 3.43-3.55 (m, 3H, H-2', H-3', H-5'), 3.19-3.30 (m, 2H, NCH₂CH₂), 2.36-2.50 (m, 1H, NCHCH₂), 2.02-2.17 (m, 1H, NCHCH₂), 1.83-2.00 (m, 2H, NCH₂CH₂). ¹³C-NMR (CD₃OD): δ 171.8, 157.1, 136.1, 135.7, 130.0, 127.7, 126.7,

123.2, 112.3, 102.7, 77.7, 74.7, 71.0, 67.0, 60.2, 30.8, 25.8. HRMS calcd. for $C_{21}H_{24}NO_8$ (M+H): 418.1502; found 418.1469.

Xyl(β 1 \rightarrow 6O) Nap-1-CONH-Phe-COOH (170): 184 (10.7 mg, 0.018 mmol) was dissolved in MeOH- CH_2Cl_2 (2 mL, 1:1). NaOMe (0.5mL, 1 M in MeOH, 0.50 mmol) was added and the mixture was stirred for 20 minutes neutralised with Amberlite IR-120 H^+ , filtered and concentrated. The crude was dissolved in MeOH (2 mL), NaOMe was added (0.30 mL, 0.30 mmol) and the reaction was stirred for 5 hours. The reaction was neutralised with Amberlite IR-120 H^+ , filtered and concentrated to give **170** (7.1 mg, 86%) as a white amorphous solid. $[\alpha]_D^{25}$ -12.0° (c 0.46, MeOH). 1H -NMR (CD_3OD): δ 7.83 (d, 1H, $J=7.7$ Hz, H-4), 7.75 (d, 1H, $J=9.2$, Hz, H-8), 7.21-7.44 (m, 8H, H-2, H-3, H-5, ArH), 7.19 (dd, 1H, $J=9.3$, 2.6 Hz, H-7), 5.02 (d, 1H, $J=7.1$ Hz, H-1'), 4.90 (m, 1H, NHCH), 3.97 (dd, 1H, $J=11.3$, 5.1 Hz, H-5') 3.56-3.67 (m, 1H, H-4'), 3.40-3.54 (m, 4H, H-2',H-3',H-5', CHCH₂), 3.04 (dd, 1H, $J=13.8$, 9.1 Hz, CHCH₂). ^{13}C -NMR (CD_3OD): δ 174.9, 170.2, 158.2, 138.8, 137.5, 131.6, 130.9, 130.3, 130.3, 130.1, 129.5, 129.5, 128.8, 128.4, 127.8, 125.5, 120.9, 111.5, 102.6, 77.7, 74.7, 71.0, 67.0, 55.7, 38.2. HRMS calcd. for $C_{25}H_{26}NO_8$ (M+H): 468.1658; found 468.1640.

Xyl(β 1 \rightarrow 6O) Nap-2-CONH-Gly-COOH (166): 185 (8.6 mg, 0.015 mmol) was dissolved in MeOH- CH_2Cl_2 (2 mL, 1:1). NaOMe (0.5mL, 1 M in MeOH, 0.50 mmol) was added and the mixture was stirred for 20 minutes, neutralised with Amberlite IR-120 H^+ , filtered and concentrated. The crude was dissolved in MeOH (2 mL), NaOH was added (1 M, 0.256 mL, 0.256 mmol) and the reaction was stirred for 5 hours. The reaction was neutralised with Amberlite IR-120 H^+ , filtered and concentrated to give **166** (4.9 mg, 79%) as a white amorphous solid. $[\alpha]_D^{25}$ -19.9° (c 0.31, MeOH). 1H -NMR (CD_3OD): δ 8.37 (s, 1H, H-1), 7.93 (d, 1H, $J=9.0$, Hz, H-8), 7.84-7.91 (m, 2H, H-3, H-4), 7.48 (d, 1H, $J=2.5$, Hz, H-5), 7.35 (dd, 1H, $J=8.9$, 2.5 Hz, H-7), 5.08 (d, 1H, $J=7.1$ Hz, H-1'), 4.15 (s, 2H, NHCH₂), 3.98 (dd, 1H, $J=11.3$, 5.2 Hz, H-5') 3.57-3.66 (m, 1H, H-4'), 3.44-3.55 (m, 3H, H-2',H-3',H-5'). ^{13}C -NMR (CD_3OD): δ 173.2, 170.5, 158.2, 137.6, 131.7, 130.7, 130.2, 128.9, 128.5, 125.4, 121.0, 111.5, 102.6, 77.7, 74.7, 71.0, 67.0, 42.3. HRMS calcd. for $C_{18}H_{20}NO_8$ (M+H): 378.1189; found 378.1185.

Xyl(β 1 \rightarrow 6O) Nap-2-CONH-Ala-COOH (169): 186 (10.2 mg, 0.0191 mmol) was dissolved in MeOH (2 mL). NaOH 1M (0.382 mL, 0.382 mmol) was added and the mixture was stirred for 5 hours, neutralised with Amberlite IR-120 H^+ , filtered and concentrated to give **169** (6.1 mg, 82%) as white amorphous solid. $[\alpha]_D^{25}$ $+7.9^\circ$ (c 0.38, MeOH). 1H -NMR (CD_3OD): δ 8.37 (s, 1H, H-1), 7.92 (d, 1H, $J=9.0$, Hz, H-8), 7.89 (dd, 1H, $J=8.8$, 1.8 Hz, H-3), 7.85 (d, 1H,

$J=8.6$, Hz, H-4), 7.47 (d, 1H, $J=2.2$, Hz, H-5), 7.34 (dd, 1H, $J=8.9$, 2.4 Hz, H-7), 5.08 (d, 1H, $J=7.2$ Hz, H-1'), 4.61 (q, $J=7.2$ Hz, 1H, NHCH), 3.98 (dd, 1H, $J=11.3$, 5.1 Hz, H-5'), 3.56-3.67 (m, 1H, H-4'), 3.42-3.55 (m, 3H, H-2', H-3', H-5'), 1.54 (d, 3H, $J=7.2$, CHCH₃). ¹³C-NMR (CD₃OD): δ 169.9, 158.2, 137.5, 131.6, 131.0, 130.2, 128.8, 128.4, 125.5, 120.9, 111.5, 102.6, 77.7, 74.7, 71.0, 67.0, 18.0. HRMS calcd. for C₁₉H₂₂NO₈ (M+H): 392.1345; found 378.1339.

Xyl(β 1 \rightarrow 6O) Nap-2-CONH-Phe-COOH (171): 187 (10.3 mg, 0.017 mmol) was dissolved in MeOH-CH₂Cl₂ (2 mL, 1:1). NaOMe 1M (0.5mL, 0.500 mmol) was added and the mixture was stirred for 20 minutes, neutralised with Amberlite IR-120 H⁺, filtered and concentrated. The crude was dissolved in MeOH (2mL), NaOH was added (0.290 mL, 0.290 mmol) and the reaction was stirred for 5 hours. The reaction was neutralised with Amberlite IR-120 H⁺, filtered and concentrated to give **171** (6.3 mg, 80%) as a white amorphous solid. $[\alpha]_D^{25}$ -31.8° (c 0.45, MeOH). ¹H-NMR (CD₃OD): δ 8.22 (d, 1H, $J=1.3$ Hz, H-1), 7.88 (d, 1H, $J=9.1$, Hz, H-8), 7.82 (d, 1H, $J=8.7$, Hz, H-4), 7.75 (dd, 1H, $J=8.7$, 1.7 Hz, H-3), 7.45 (d, 1H, $J=2.4$ Hz, H-5), 7.24-7.36 (m, 5H, H-7, ArH), 7.17-7.23 (m, 1H, ArH), 5.07 (d, 1H, $J=7.1$ Hz, H-1'), 4.88-4.93 (m, 1H, NHCH), 3.98 (dd, 1H, $J=11.3$, 5.1 Hz, H-5') 3.57-3.66 (m, 1H, H-4'), 3.40-3.54 (m, 4H, H-2', H-3', H-5'), 3.38 (dd, 1H, $J=13.9$, 4.9 Hz, CHCH₂), 3.16 (dd, 1H, $J=13.8$, 9.6 Hz, CHCH₂). ¹³C-NMR (CD₃OD): δ 174.9, 170.2, 158.2, 138.2, 137.5, 131.6, 130.9, 130.3, 130.1, 129.5, 129.5, 128.8, 128.4, 128.0, 125.5, 120.9, 111.5, 102.6, 77.7, 74.7, 71.0, 67.0, 55.7, 38.2. HRMS calcd. for C₂₃H₂₆NO₈ (M+H): 468.1658; found 468.1627.

General procedure for solid-phase dipeptide synthesis: Dipeptides were synthesised using CH₂Cl₂ as solvent in mechanically agitated reactor tubes. Pre-loaded Merrifield resin with Boc-protected glycine (0.5 mmol/g, 0.020 mmol) or Boc-protected alanine (0.7 mmol/g, 0.021 mmol) were used. After swelling, Boc-removal was performed using TFA/CH₂Cl₂ (8:2, 2 mL + 0.4 M PhSH) after which the resin was washed with CH₂Cl₂. The second Boc-protected amino acid, DMAP and CH₂Cl₂ were added and the tube was agitated for 15 min after which DIC was added. The mixture was agitated for 3 h after which the resin was washed with CH₂Cl₂ and MeOH. The Boc-group on the second amino acid was removed as described earlier. The resins were swelled for 10 minutes was followed by the addition of **145** (10.7 mg, 0.024 mmol), for the glycine pre-loaded resin, DMAP and CH₂Cl₂ and agitation for 15 min. DIC was added and the tube was agitated for 3 h. The resins were washed as previously described. Swelling in CH₂Cl₂ was followed by cleavage from the resin using NaOMe-CH₂Cl₂-MeOH (2.5 mL, 1:2:2) for 10 min after which reaction was neutralised with Amberlite IR-120 H⁺, filtered and concentrated. Deprotection of the ester was conducted using NaOH for 5 h. The reaction was neutralised

with Amberlite IR-120 H⁺, filtered and concentrated. Purification was performed by preparative HPLC. Yields and data for the synthesised peptides are presented below.

Xyl(β 1 \rightarrow 6O)-Nap-1-CONH-Leu-CONH-Gly-COOH (173): Gave (6.0 mg, 61%). $[\alpha]_{\text{D}}^{25}$ -42.3° (c 0.096, MeOH). $^1\text{H-NMR}$ (CD_3OD): δ 8.72 (d, 1H, $J=8.2$, NHCH), 8.38 (t, 1H, $J=5.6$ Hz, NHCH₂), 8.18 (d, 1H, $J=9.3$ Hz, H-8), 7.90 (d, 1H, $J=8.2$ Hz, H-4), 7.56 (dd, 1H, $J=7.0$, 1.3 Hz, H-2), 7.45-7.53 (m, 2H H-, H-3, H-5), 7.34 (dd, 1H, $J=9.3$, 2.6 Hz, H-7), 5.05 (d, 1H, $J=7.1$ Hz, H-1'), 4.78 (dd, 1H, $J=9.0$, 6.3, NHCH) 4.02-4.12 (m, 1H, NHCH₂), 3.86-4.02 (m, 2H, NHCH₂, H-5'), 3.55-3.66 (m, 1H, H-4'), 3.45-3.52 (m, 3H, H-2', H-3', H-5'), 1.78-1.90 (m, 1H, CH(CH₃)₂), 1.68-1.77 (m, 2H, NHCHCH₂), 0.95-1.12 (m, 6H, CH(CH₃)). $^{13}\text{C-NMR}$ (CD_3OD): δ 175.3, 172.5, 156.9, 136.3, 135.2, 130.8, 128.1, 127.7, 126.5, 124.8, 120.9, 112.1, 102.7, 77.7, 74.7, 71.0, 67.0, 53.6, 41.8, 41.8, 26.1, 23.4, 22.0. HRMS calcd. for C₂₄H₃₀N₂O₉ (M+H): 491.2030; found 491.1992.

Xyl(β 1 \rightarrow 6O)-Nap-1-CONH-Phe-CONH-Gly-COOH (174): Gave (6.9 mg, 66%). $[\alpha]_{\text{D}}^{25}$ -37.9° (c 0.087, MeOH). $^1\text{H-NMR}$ (CD_3OD): δ 8.42 (t, 1H, $J=5.5$ Hz, NHCH₂), 7.85 (d, 1H, $J=8.2$ Hz, H-4), 7.62 (d, 1H, $J=9.3$ Hz, H-8), 7.24-7.45 (m, 8H, H-2, H-3, H-5, ArH), 7.17 (dd, 1H, $J=9.2$, 2.5 Hz, H-7), 5.08 (dd, 1H, $J=10.6$, 4.7 Hz, NHCH), 5.02 (d, 1H, $J=7.1$, H-1) 3.91-4.08 (m, 3H, NHCH₂, H-5'), 3.56-3.65 (m, 1H, H-4'), 3.42-3.54 (m, 3H, H-2', H-3', H-5'), 3.33-3.40 (m, 1H, CHCH₂), 2.98 (dd, 1H, $J=14.0$, 10.7 Hz, CHCH₂). $^{13}\text{C-NMR}$ (CD_3OD): δ 174.1, 172.7, 172.3, 156.8, 138.8, 136.1 135.2, 130.7, 130.5, 129.6, 128.2, 127.9, 127.4, 126.4, 124.6, 120.8, 111.9, 102.7, 77.7, 74.7, 71.0, 67.0, 56.3, 41.9, 38.8. HRMS calcd. for C₂₇H₂₉N₂O₉ (M+H): 525.1873; found 525.1866.

Xyl(β 1 \rightarrow 6O)-Nap-1-CONH-Met-CONH-Gly-COOH (175): Gave (18.2 mg, 78%). $[\alpha]_{\text{D}}^{25}$ -42.1° (c 0.39, MeOH). (CD_3OD): δ 8.41 (t, 1H, $J=5.7$ Hz, NHCH₂) 8.20 (d, 1H, $J=9.2$ Hz, H-8), 7.90 (d, 1H, $J=8.3$ Hz, H-4), 7.58 (dd, 1H, $J=7.1$, 1.3 Hz, H-2), 7.44-7.53 (m, 2H, H-3, H-5), 7.34 (dd, 1H, $J=9.2$, 2.7 Hz, H-7), 5.05 (d, 1H, $J=7.1$ Hz, H-1'), 4.80-4.85 (m, 1H, NHCH), 4.02-4.13 (m, 1H, NHCH₂), 3.80-4.01 (m, 2H, NHCH₂, H-5') 3.56-3.68 (m, 1H, H-4'), 3.42-3.54 (m, 3H, H-2', H-3', H-4'), 2.63-2.76 (m, 2H, CH₂SCH₃), 2.17-2.31 (m, 1H, NHCHCH₂), 1.98-2.16 (m, 4H, NHCHCH₂, CH₂SCH₃). $^{13}\text{C-NMR}$ (CD_3OD): δ 174.3, 172.7, 172.5, 156.9, 136.2, 135.0, 130.9, 128.1, 127.7, 126.5, 124.9, 121.0, 112.1, 102.7, 77.7, 74.7, 71.0, 67.0, 54.3, 41.9, 32.5, 31.2, 15.3. HRMS calcd. for C₂₄H₃₁N₂O₉S (M+H): 509.1594; found 509.1573.

Xyl(β 1 \rightarrow 6O)-Nap-1-CONH-Leu-CONH-Ala-COOH (176): Gave (9.3 mg, 88%). $[\alpha]_D^{25} -41.6^\circ$ (c 0.20, MeOD). $^1\text{H-NMR}$ (CD_3OD): δ 8.68 (d, 1H, $J=7.6$ Hz, NHCHCH_2), 8.43 (d, 1H, $J=7.2$ Hz, NHCH_2CH_3), 8.16 (d, 1H, $J=9.2$ Hz, H-8), 7.90 (d, 1H, $J=8.0$ Hz, H-4), 7.43-7.57 (m, 3H, H-2, H-3, H-5), 7.34 (dd, 1H, $J=9.3, 2.6$ Hz, H-7), 5.05 (d, 1H, $J=7.2$ Hz, H-1'), 4.70-4.78 (m, 1H, NHCHCH_2) 4.43-4.52 (m, 1H, NHCHCH_3), 3.97 (dd, 1H, $J=11.3, 5.1$ Hz, H-5'), 3.56-3.66 (m, 1H, H-4'), 3.43-3.55 (m, 3H, H-2', H-3', H-5'), 1.79-1.92 (m, 1H, $\text{CH}(\text{CH}_3)_2$), 1.69-1.75 (m, 2H, $\text{CH}_2\text{CH}(\text{CH}_3)_2$), 1.46 (d, 3H, $J=7.5$ Hz, NHCHCH_3), 0.95-1.12 (m, 6H, $\text{CH}_2\text{CH}(\text{CH}_3)_2$). $^{13}\text{C-NMR}$ (CD_3OD): δ 174.7, 172.5, 156.9, 136.3, 135.3, 130.8, 128.1, 127.7, 126.5, 124.8, 120.9, 112.1, 102.7, 77.7, 74.8, 71.1, 67.0, 53.6, 41.8, 40.4, 26.1, 23.5, 22.0, 17.7. HRMS calcd. for $\text{C}_{25}\text{H}_{33}\text{N}_2\text{O}_9$ (M+H): 505.2186; found 505.2141.

Xyl(β 1 \rightarrow 6O)-Nap-1-CONH-Phe-CONH-Ala-COOH (177): Gave (23.9 mg, 95%). $[\alpha]_D^{25} -28.8^\circ$ (c 0.52, MeOH). $^1\text{H-NMR}$ (CD_3OD): δ 8.50 (t, 1H, $J=7.5$ Hz, NHCHCH_3), 7.84 (d, 1H, $J=8.4$ Hz, H-4), 7.62 (d, 1H, $J=9.4$ Hz, H-8), 7.23-7.47 (m, 8H, H-2, H-3, H-5, ArH), 7.17 (dd, 1H, $J=9.2, 2.5$ Hz, H-7), 4.97-5.09 (m, 2H, H-1', CHCH_2), 4.49-4.56 (m, 1H, NHCHCH_3), 3.97 (dd, 1H, $J=11.2, 5.2$ Hz, H-5'), 3.55-3.67 (m, 1H, H-4'), 3.40-3.55 (m, 3H, H-2', H-3', H-5'), 3.32-3.39 (m, 1H, CHCH_2), 2.98 (dd, 1H, $J=14.1, 10.8$ Hz, CHCH_2), 1.48 (d, 3H, $J=7.3$ Hz, NHCHCH_3). $^{13}\text{C-NMR}$ (CD_3OD): δ 175.7, 173.5, 172.3, 156.8, 138.8, 136.1, 135.3, 130.7, 130.5, 129.6, 128.1, 127.8, 127.4, 126.4, 124.6, 120.8, 111.9, 102.6, 77.7, 74.8, 71.0, 67.0, 56.3, 38.9, 17.8. HRMS calcd. for $\text{C}_{27}\text{H}_{29}\text{N}_2\text{O}_9$ (M+H): 539.2030; found 539.1997.

Xyl(β 1 \rightarrow 6O)-Nap-1-CONH-Met-CONH-Ala-COOH (178): Gave (9.1 mg, 81%). $[\alpha]_D^{25} -51.1^\circ$ (c 0.094, MeOH). (CD_3OD): δ 8.18 (d, 1H, $J=9.3$ Hz, H-8), 7.90 (d, 1H, $J=8.2$ Hz, H-4), 7.55 (dd, 1H, $J=7.1, 1.3$ Hz, H-2), 7.44-7.52 (m, 2H, H-3, H-5), 7.34 (dd, 1H, $J=9.3, 2.5$ Hz, H-7), 5.05 (d, 1H, $J=7.1$ Hz, H-1'), 4.77 (dd, 1H, $J=8.6, 5.8$ Hz, NHCHCH_2) 4.45-4.54 (m, 1H, CHCH_3), 3.97 (dd, 1H, $J=11.2, 5.1$ Hz, H-5'), 3.56-3.67 (m, 1H, H-4'), 3.42-3.55 (m, 3H, H-2', H-3', H-4'), 2.62-2.75 (m, 2H, CH_2SCH_3) 1.95-2.24 (m, 5H, $\text{NHCHCH}_2, \text{SCH}_3$), 1.46 (d, 3H, $J=7.4$ Hz, CHCH_3). $^{13}\text{C-NMR}$ (CD_3OD): δ 173.8, 156.9, 136.3, 130.8, 128.1, 127.7, 126.5, 124.8, 120.9, 112.1, 102.7, 77.7, 74.8, 71.0, 67.0, 54.4, 32.6, 31.1, 17.3, 15.3. HRMS calcd. for $\text{C}_{24}\text{H}_{31}\text{N}_2\text{O}_9\text{S}$ (M+H): 523.1750; found 523.1736.

9.2 Description of proliferation and priming assays

The assay methods used for cell proliferation and priming are described here to help the non-specialist follow the procedures mentioned in this thesis and described in Papers IV and V.

***In vitro* growth assay using crystal violet method:** The crystal violet growth assay used was developed by Westergren-Thorsson et al.¹⁶² by modification of a procedure described by Gilles et al,²³⁶ and demonstrated excellent ($r = 0.996$) correlation between the results given by the modified assay and by manual counting of cells in a Coulter Counter. In the assay, cells are seeded in 96-well plates (optimal number of cells per well varies depending on cell line but is approximately 4000) and allowed to adhere to the plate during a few hours in serum containing medium.

Normally, a layout similar to that in Figure 9.1A is used with the outermost wells containing only medium to minimise evaporation of medium in wells containing cells. The medium is then changed to serum free medium and the cells are allowed to proliferate for 24 hours. The medium is then again changed to medium containing necessary growth factors and the desired concentration of the compound under investigation. The cells are then incubated at constant temperature (37 °C) and partial pressure of CO₂ for the time period investigated (96 h). After this period the medium is discarded by inverting the plate and cells are fixed with a 1% glutaraldehyde solution for 15 min. The fixing solution is removed and the cell nuclei are stained using an aqueous solution of crystal violet (**188**) (Figure 9.1B) for 30 min at r.t.

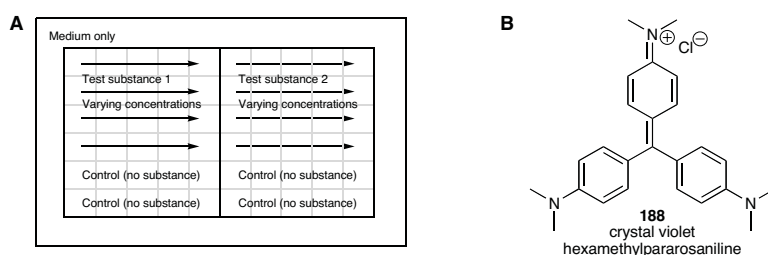

Figure 9.1. Typical layout of well contents for 96-well plates for *in vitro* growth assay using crystal violet method (A) and structure and chemical name of crystal violet (**188**) (B).

After staining, the cells are washed with distilled H₂O and excess fluid is allowed to drain. The cell and nuclear membranes are then lysed by the addition of a detergent (Triton X-100) solution. Lysis is performed over 24 h to ensure the complete lysis of cells and disappearance of bubbles which would interfere with the absorbance measurements. The absorbance of the solution in the wells is measured in a microplate photometer at 600 nm and the absorbance data is converted into percent growth by comparison to the untreated control cells with correction for the absorbance of the cell number at the start of the experiment (from cells fixed, stained and lysed in the same way at the start of the treatment period for the other plates). Data handling and statistical analysis was performed using Microsoft Excel.

GAG priming assay and analysis of proportion HS of total GAG: The method for isolation of GAG from cell media and cells has been described in detail previously.^{237,238} Confluent cells are incubated for 1 h in medium with a low concentration of sulphate after which the medium is changed to medium containing 0.1 mM of the xyloside and 50 mCi/mL of [³⁵S]-sulphate. The cells are incubated for 24 h and the medium is collected. The cells are washed twice with ice-cold phosphate buffered saline (PBS) and the washings are pooled with the medium (medium pool). Cells are then lysed with a Triton X-100 solution containing protease inhibitors and EDTA to release GAG and PG from inside the cells (cell pool).

Isolation of [³⁵S]-sulphate labelled polyanionic macromolecules (GAG and PG) is performed by ion exchange chromatography on a DE-53 cellulose column and pooling of the radioactive fractions. Dextran is added as a carrier and GAGs and PGs are precipitated overnight at -20 °C by the addition of ethanol. After centrifugation the pellet is redissolved in an acidic buffer and free GAGs are separated from PGs by hydrophobic interaction chromatography (octyl-sepharose column) in which nearly all PG remains bound to the column. The amount of GAG is then determined by separation from remaining PG by size exclusion chromatography with on a Superose 6 column and radioactivity measurement in a β -counter.

The proportion of HS in the total GAG pool can be determined in two principally different ways – by chemical depolymerisation of HS by nitrous acid,^{239,240} or by the cleavage of CS/DS into disaccharide units by chondroitinase ABC (cleaves on the reducing side of all GalNAc residues regardless of its sulphation pattern). The methods differ in implementation and how the results are obtained as follows.

Cleavage of CS/DS with chondroitinase ABC does not affect HS (and heparin) and upon size exclusion chromatography HS elutes faster than the disaccharide fragments produced by the CS/DS cleavage. The total GAG pool after the separation from PG is degraded following the procedure of Zhang et al.¹¹⁵. After lyophilisation, the sample is redissolved and separation is performed on a Superose 6 column. The areas for the two peaks in the chromatogram thus represent HS (pool I, Figure 9.2A) and CS/DS (pool II, Figure 9.2A). This method is useful since the structure of the HS is left intact allowing for further analysis if needed.

Cleavage of HS with nitrous acid pH 1.5 is performed by the method of Shively and Conrad,²⁴⁰ by treating GAG for 10 min at r.t. with 1 M nitrous acid (HNO₂), prepared by mixing 1 M H₂SO₄ with 1.0 equiv Ba(NO₂) at -5 °C, centrifugation of the formed BaSO₄

precipitate and withdrawal of the supernatant nitrous acid. Nitrous acid at pH 1.5 cleaves HS at the reducing end of N-sulphated glucosamine but does not cleave CS/DS. Lyophilisation followed by analysis by size exclusion chromatography on Superose 6 with HS degradation products now eluting at a later time (pool II, Figure 9.2B) than CS/DS (pool I, Figure 9.2B) gives the proportion HS of total GAG.

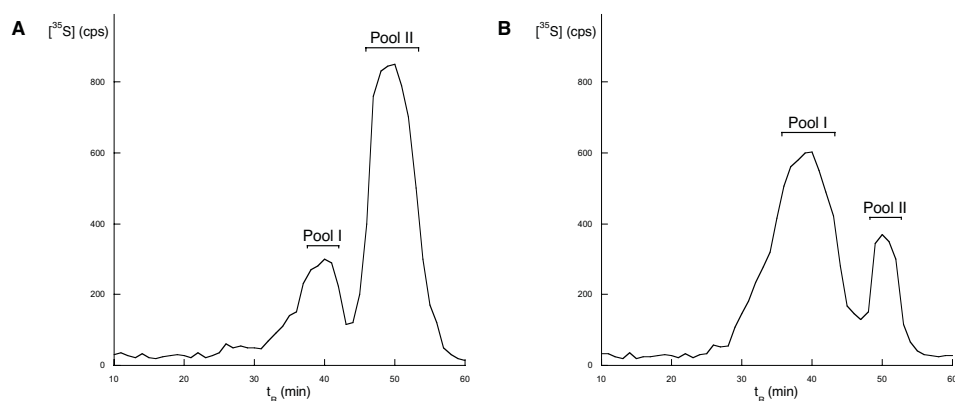

Figure 9.2. Schematic of typical size exclusion chromatograms from degradation of total GAG pool with chondroitinase ABC (pool I is HS and pool II CS/DS) (A) and nitrous acid pH 1.5 (pool I is CS/DS and pool II is HS) (B). The y-axis shows counts per second of β radiation.

9.3 Computational chemistry

Apart from the computational calculations of physical properties discussed in Chapter 4.3, Chapter 5.1.2 and Paper VI also contain discussions based on modern computational methodologies. Whilst a full discussion regarding the theories and methods used in density functional theory (DFT) calculations is far outside the scope of this thesis, some terms are explained and basic concepts discussed here briefly to aid the non-computational chemist.

9.3.1 A basic introduction to density functional theory calculations

The structure of a molecule can be described by viewing the system as masses connected by springs (molecular mechanics). For many applications this is satisfactory but if reactivities, spectral properties and transition states are to be investigated a description which takes into account the electronics of the system must be used. Quantum mechanics (QM) is the field of describing the electronic properties and nuclear localisations of chemical systems. There are two main theories used in QM. The first, molecular orbital (MO) theory, uses the Schrödinger

equation (Equation 9.1), in which \mathbf{H} is the Hamiltonian operator acting on Ψ which is the wave function describing the system and E is the energy eigenvalue to Ψ .

Equation 9.1. The Schrödinger equation.

$$\mathbf{H}\Psi = E\Psi$$

Whilst Equation 9.1 looks deceptively simple at first glance, approximations must be made to allow for its numerical solution in systems with more than one electron. Unfortunately, the simplifications applied can for some systems (open shell species and metal-containing compounds) cause MO to fail drastically. More accurate versions of MO theory have been developed, but the computational costs are high limiting their use to small systems (about 12 heavy atoms and below). Therefore, during the last ten years, a method called density functional theory (DFT) has become increasingly popular. DFT derives the energy of a system from the electron density instead of from the wave function. The popularity of DFT has arisen from its implicit treatment of correlations between electrons and its high accuracy compared to computational cost.

DFT is based on the Hohenberg-Kohn theorems which, in abbreviated form, state that the exact energy of a system may be expressed as a functional depending only on the electron density of that system.²⁴¹ Were it not for the fact that the form of the functional is not exactly known, DFT calculations would give the exact energy for the system. Kohn and Sham showed that the functional could be described by a series of functionals,²⁴² thus allowing the system to be described by a series of functionals and a term correcting for the correlations between electrons. In the work described in this thesis the Becke three-parameter functional (B3)²⁴³ combined with the correlation functional presented by Lee, Yang and Parr (LYP)²⁴⁴ is used.

A functional, such as B3LYP, must be applied to a mathematical model describing the electrons of the system and such a model is called a basis set. If the basis set contained all the information about the system (a complete basis set) an exact description would result. Due to the impossibility of using the infinite number of functions necessary for a complete basis set, a reduced basis set must be used to describe the system. Basis sets are described by the type and number of functions included in them and most software packages allow the choice between a large number of basis sets. For the work presented in Chapter V and Paper VI, the Pople style basis set 6-311G** was used,^{245,246} with diffuse functions (indicated by ⁺⁺) for gas phase calculations (6-311G⁺⁺) and without for solvation calculations.

9.3.2 Transition state searches

A transition state (TS) is the structure of reactants at the saddle point on the potential-energy surface between the starting materials and the products and is characterised by having one imaginary frequency (corresponding to a negative spring constant). At the saddle point the a maximum energy is obtained on the path between the starting material (or previous TS) and the products (or next TS) and while the second derivate of the energy curve is thus zero, the second derivate is negative, indicating a maximum (Figure 9.3). A transition state search attempts to find this point by making small changes to the structure of the reactants until the results converge toward a zero derivate and a negative second derivate.

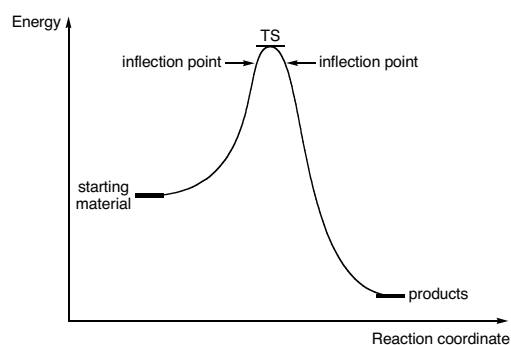

Figure 9.3. Illustration of the energetics of a reaction showing the transition state (TS) and the inflection points surrounding the maximum along the path of the reaction.

Finding a transition state requires making a good guess as to the structure of the actual TS structure. This can be difficult and quite a large understanding of the system studied is needed. If one is very familiar with the system a good enough guess can be constructed simply from intuition. If this familiarity does not exist, of guesses are not close enough, a search for a good guess must be performed prior to the actual TS structure optimisation. Whilst many methods for this search exist, two general methods are commonly employed. The first is the scanning of coordinates along an axis. This is computationally demanding since a DFT optimisation must be performed for each structure along the axis but is useful when even the approximate structure of the TS is not known. The other method, which requires more chemical know-how, is to input a structure close to the actual TS and freeze parts of the molecule one is “certain” about, whilst optimising the rest of the structure. Eventually, a guess structure will hopefully be found which is close enough to the real TS – namely between the two inflection points on the energy curve (Figure 9.3). If the guess is outside of the inflection points the optimisation will fail and a new guess must be entered.

9.3.3 Calculation of pK_a values and C log P

Computational calculations of physical properties were performed using ACD/Labs software suite and Schrödinger suite. The methods utilised by the different software suites and the influence this exerts on the results will be discussed.

Calculations of pK_a and C log P with ACD/Labs¹⁵⁶: Calculation of the pK_a values and C log P values for the hydroxynaphthyl β -D-xylopyranosides was kindly performed by Niklas Falk. Structures created in Maestro²⁴⁷ were exported and entered into ACD/Labs as an SD-file. Calculations in ACD/Labs modules are performed by using values obtained from an internal database.

For the log P calculations the database contains values for three different types of contributions to log P – fragmental contributions, carbon atom contributions and intramolecular interaction contributions. By summing up the contributions of different parts of the input molecule, for example an aromatic system, an hydroxyl group or an alkyl chain, a log P value for the entire molecule is obtained.

For pK_a calculations the ACD/Labs module contains three databases. The first database contains about 16 000 substances with reported pK_a values. The second database contains a collection of Hammett-type equations which have been parameterised to be able to handle over 1 000 functional groups. The third database contains electronic substituent constants (σ) of varying types (e.g. σ_{ortho} , σ_{para} and σ^*). These σ -values are used in the parameterised Hammett-type equations to calculate the pK_a value for the molecule entered. When a σ -value is not available for a substituent it is calculated from one of several equations describing the transmission of electronic effects through the molecule, with special equations for aliphatic cycles and polyaromatic systems.

Calculations of C log P with QikProp^{157,248}: Structures were created in Maestro and geometry optimised before being submitted to QikProp. The results from QikProp are not very sensitive to the exact conformation of the structure even though a three-dimensional molecule is required. The QikProp module calculated the solvent-accessible surface area (SASA) using a 1.4 Å probe radius. Further, the number of potential hydrogen bond acceptors in aqueous solution, amine groups, nitro groups and acid groups is calculated. The log P value is then calculated using a formula weighting these factors.

Calculations of pK_a with Jaguar¹⁵⁸: Structures were created in Maestro and pK_a values were calculated using the pK_a module in Jaguar with manual picking of the acidic proton. A series of DFT energy and solvation calculations then give values for B, C and D in Scheme 9.1.

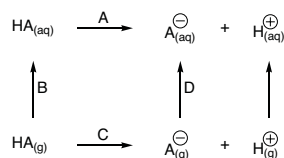

Scheme 9.1. Thermodynamic cycle for pK_a calculations using Jaguar.

These calculations use the B3LYP functional and 6-31G* basis set for geometry minimisations followed by single-point energy calculations using the high-level cc-pVTZ(+) basis set and give C from Equation 9.2.

Equation 9.2. Equation relating the energy of the deprotonation step to the single point energies of HA and H:

$$C = \Delta H - T\Delta S = E_{\text{A}_{(\text{g})}^{\ominus}} - E_{\text{HA}_{(\text{g})}} + \frac{5}{2}RT - T\Delta S$$

Also, the solvation energies for the species in solution are calculated (B and D). The value for A is obtained by summing of A, B and C and the pK_a is then calculated using Equation 9.3.

Equation 9.3. Equation relating the pK_a to the energy of the deprotonation step (A).

$$pK_a = \frac{1}{2.3RT} A$$

The thus obtained pK_a value is then corrected using empirically obtained data to compensate for intrinsic errors in each step.

As can be seen from the description above, different methods are used by the ACD/Labs and Schrödinger software suites. ACD/Labs is very useful for large numbers of molecules since it uses a non-computer intensive method. The same applies for the QikProp module of the Schrödinger suite. The Jaguar pK_a module can, with more effort, yield very good results but is much more demanding of both the user and of the computational resources needed.

Therefore, we conclude that all methods discussed serve as valuable tools and the choice of which to use will depend on factors such as precision needed, in-house availability (the software suites are expensive), computer capacity available, whether exact values or trends are required

and whether time and know-how is available to correctly set up the more demanding calculations of the Jaguar pK_s module.

9.4 Principles of flow cytometry

Cytometry is the science of quantification of nuclear DNA content and can be either as flow cytometry or as static cytometry. In static cytometry cells are prepared on a slide and DNA is visualised and detected by microscopy. In flow cytometry, a suspension of cells is pumped through a small opening forcing the cells to enter a channel one at a time. Cells then pass a focused laser-beam where fluorescent tags incorporated into the cells absorb light and reemit it as light of a different wavelength. A series of photodiode arrays detect the emitted light and the information is analysed by computer programs. Several thousand cells can be detected every second giving statistically valid information in short amounts of time. The information can be used to automatically sort cells according to certain properties and the machine is then termed a Fluorescence Activated Cell Sorter (FACSTM)ⁱ.

The results from a flow cytometry assay are given as a plot of the number of cells against fluorescence intensity (Figure 9.4). A shift in the number of cells having low to high fluorescence indicates an increased incorporation of the fluorescent tag used in the assay.

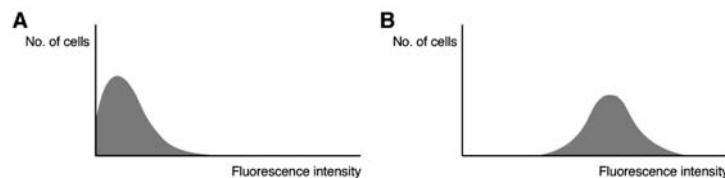

Figure 9.4. Schematic illustration of results from a flow cytometry experiment. In (A) most cells give little fluorescence upon irradiation. In (B) most cells have an increased fluorescence indicating incorporation of a fluorescent tag.

In the TUNEL assay the fluorescent tag is incorporated in cells which are apoptotic and therefore a shift of the cells towards higher fluorescence is indicative of increased apoptosis in the population.

ⁱ FACSTM was developed by Leonard Arthur Herzenberg (b. 1931) in cooperation with BD Immunocytometry Systems (BDIS, previously Becton Dickinson and Company) in 1973 and is trademarked but has come to be used as a general term in the scientific community.

References

- ¹ Merrifield, R. B. Solid-phase peptide synthesis. *Adv. Enzymol. Relat. Areas Mol. Biol.* **1969**, *32*, 221-296.
- ² Leznoff, C. C. The Use of Insoluble Polymer Supports in General Organic Synthesis. *Acc. Chem. Res.* **1978**, *11*, 327-333.
- ³ Green Day, Good Riddance (Time of your life), Nimrod. Reprise Records; 1997.
- ⁴ McNaught, A. D. Nomenclature of carbohydrates. *Carbohydr. Res.* **1997**, *297*, 1-92.
- ⁵ Adapted from "Chemistry". *Encyclopædia Britannica* [Online], Encyclopædia Britannica. <http://www.britannica.com/eb/article-9022790> (accessed December 25, 2006).
- ⁶ Prout, W. Observations on the application of chemistry to physiology, pathology, and practice. *Lond. Med. Gaz.* **1831**, *8*, 257-265.
- ⁷ Schmidt, C. Ueber Pflanzenschleim und Bassorin. *Ann. Chem. Pharm.* **1844**, 29-62.
- ⁸ Varki, A. Biological roles of oligosaccharides: all of the theories are correct. *Glycobiology* **1993**, *3*, 97-130.
- ⁹ Schwartz, G. K.; Shah, M. A. Targeting the Cell Cycle: A New Approach to Cancer Therapy. *J. Clin. Oncol.* **2005**, *23*, 9408-9421.
- ¹⁰ Nicolaou, K. C.; Mitchell, H. J. Adventures in Carbohydrate Chemistry: New Synthetic Technologies, Chemical Synthesis, Molecular Design, and Chemical Biology. *Angew. Chem., Int. Ed.* **2001**, *40*, 1576-1624.
- ¹¹ IUPAC Compendium of Chemical Terminology, Electronic version, <http://goldbook.iupac.org/G02651.html> (accessed April 5, 2007).
- ¹² Jensen, K. J. O-Glycosylations under neutral or basic conditions. *J. Chem. Soc., Perkin Trans. 1* **2002**, 2219-2233.
- ¹³ Conchie, J.; Levvy, G. A.; Marsh, C. A. Methyl and phenyl glycosides of the common sugars. *Adv. Carbohydr. Chem.* **1957**, *12*, 157-187.
- ¹⁴ Wolfrom, M. L.; Thompson, A. Acetylation. *Methods Carbohydr. Chem.* **1963**, *2*, 211-215.
- ¹⁵ Lemieux, R. U. Tetra-O-acetyl- α -D-glucopyranosyl Bromide. *Methods Carbohydr. Chem.* **1963**, *2*, 221-222.
- ¹⁶ Ferrier, R. J.; Furneaux, R. H. 1,2-*trans*-1-Thioglycosides. *Methods Carbohydr. Chem.* **1980**, *8*, 251-253.
- ¹⁷ Johnsson, R.; Ellervik, U. Selective 1-O-Deacetylation of Carbohydrates Using Polymer-Bound Benzylamine. *Synlett* **2005**, 2939-2940, and references therein.
- ¹⁸ Helferich, B.; Portz, W. Über N-Glykoside, II. Mitteilung. *Chem. Ber.* **1953**, *86*, 604-612.
- ¹⁹ Fisher, E.; Delbrück, K. Über Thiophenol-glycoside. *Chem. Ber.* **1909**, *42*, 1476-1482.
- ²⁰ Kartha, K. P. R.; Field, R. A. Glycosylation Chemistry Promoted by Iodine Monobromide: Efficient Synthesis of Glycosyl Bromides from Thioglycosides, and O-Glycosides from 'Disarmed' Thioglycosides and Glycosyl Bromides. *Tetrahedron Lett.* **1997**, *38*, 8233-8236.
- ²¹ Motawia, M. S.; Marcussen, J.; Lindberg Møller, B. J. A general method based on the use of N-bromosuccinimide for the removal of the thiophenyl group at the anomeric position to generate a reducing sugar with the original protecting groups still present. *Carbohydr. Chem.* **1995**, *14*, 1279-1294.
- ²² Csuk, R.; Fürstner, A.; Glänzer, B. I.; Weidmann, H. A New, Zinc-promoted Synthesis of 1,4-(1,5)-Anhydro-2-deoxy-pent-(hex)-1-enitols (Furanoid and Pyranoid Glycals). *J. Chem. Soc., Chem. Commun.* **1986**, 1149-1150.
- ²³ Teichmann, M.; Descotes, G.; Lafont, D. Bromination of 1,5-Anhydrohex-1-enitols (Glycals) Using Quaternary Ammonium Tribromides as Bromine Donors: Synthesis of α -1,2-*trans*-2-Bromo-2-deoxyglycopyranosyl Bromides and Fluorides. *Synthesis*, **1993**, 889-894.
- ²⁴ Nicolaou, K. C.; Dolle, R. E.; Papahatjis, D. P.; Randall, J. L. Practical Synthesis of Oligosaccharides. Partial Synthesis of Avermectin B_{1a}. *J. Am. Chem. Soc.* **1984**, *106*, 4189-4192.
- ²⁵ Nicolaou, K. C.; Ueno, H. Oligosaccharide Synthesis by *n*-Pentenyl Glycosides. In *Preparative Carbohydrate Chemistry*, 1st ed.; Hanessian, S., Ed.; Marcel Dekker: New York, 1997; Chapter 13, pp 313-338.
- ²⁶ Yokoyama, M. Methods of synthesis of glycosyl fluorides. *Carbohydr. Res.* **2000**, *327*, 5-14.
- ²⁷ Schmidt, R. R.; Jung, K.-H. Oligosaccharide Synthesis with Trichloroacetimidates. In *Preparative Carbohydrate Chemistry*, 1st ed.; Hanessian, S., Ed.; Marcel Dekker: New York, 1997; Chapter 12, pp 283-312.

- ²⁸ Johnsson, R.; Meijer, A.; Ellervik, U. Mild and efficient direct aromatic iodination. *Tetrahedron* **2005**, *61*, 11657-11663.
- ²⁹ Lee, Y. S.; Rho, E. S.; Min, Y. K.; Kim, B. T.; Kim, K. H. Practical β -stereoselective O-glycosylation of phenols with penta-O-acetyl- β -D-glucopyranose. *J. Carbohydr. Chem.* **2001**, *20*, 503-506.
- ³⁰ Ley, S. V.; Baxendale, I. R. New tools and concepts for modern organic synthesis. *Nat. Rev. Drug Discovery* **2002**, *1*, 573-586.
- ³¹ Merrifield, R. B. Solid Phase Peptide Synthesis. I. The Synthesis of a Tetrapeptide. *J. Am. Chem. Soc.* **1963**, *85*, 2149-2154.
- ³² Seeberger, P. H.; Haase, W.-C. Solid-Phase Oligosaccharide Synthesis and Combinatorial Carbohydrate Libraries. *Chem. Rev.* **2000**, *100*, 4349-4393.
- ³³ Osborn, H. M. I.; Khan, T. H. Recent Developments in Polymer Supported Synthesis of Oligosaccharides and Glycopeptides. *Tetrahedron* **1999**, *55*, 1807-1850.
- ³⁴ Baird, E. E.; Dervan, P. B. Solid Phase Synthesis of Polyamides Containing Imidazole and Pyrrole Amino Acids. *J. Am. Chem. Soc.* **1996**, *118*, 6141-6146.
- ³⁵ Dervan, P. B. Molecular Recognition of DNA by Small Molecules. *Bioorg. Med. Chem.* **2001**, *9*, 2215-2235.
- ³⁶ Früchtel, J. S.; Jung, G. Organic Chemistry on Solid Supports. *Angew. Chem., Int. Ed.* **1996**, *35*, 17-42.
- ³⁷ Brown, R. C. D. Recent developments in solid-phase organic synthesis. *J. Chem. Soc., Perkin Trans. 1* **1998**, 3293-3320.
- ³⁸ Zaragoza Dörwald, F. Organic Synthesis on Solid Phase. Supports, Linkers, Reactions, 2nd ed.; Wiley-VCH, Weinheim, Germany, 2002.
- ³⁹ Seeberger P. H. Automated Carbohydrate Synthesis to Drive Chemical Glycomics. *Chem. Commun.* **2003**, 1115-1121.
- ⁴⁰ Seeberger P. H, Werz D. B. Automated synthesis of oligosaccharides as a basis for drug discovery. *Nat. Rev. Drug Discovery* **2005**, *4*, 751-763.
- ⁴¹ Storer, R. I.; Takemoto, T.; Jackson, P. S.; Brown, D. S.; Baxendale, I. R.; Ley, S. V. Multi-Step Application of Immobilized Reagents and Scavengers: A Total Synthesis of Epothilone C. *Chem. -Eur. J.* **2004**, *10*, 2529-2547.
- ⁴² James, I. W.; Linkers for Solid Phase Synthesis. *Tetrahedron* **1999**, *55*, 4855-4946.
- ⁴³ Guillier, F.; Orain, D.; Bradley, M. Linkers and Cleavage Strategies in Solid-Phase Organic Synthesis and Combinatorial Chemistry. *Chem. Rev.* **2000**, *100*, 2091-2157.
- ⁴⁴ Orain, D. Ellard, J.; Bradley, M. Protecting Groups in Solid-Phase Organic Synthesis. *J. Comb. Chem.* **2002**, *4*, 1-16.
- ⁴⁵ Blaney, P.; Grigg, R.; Sridharan, V. Traceless Solid-Phase Organic Synthesis. *Chem. Rev.* **2002**, *102*, 2607-2624.
- ⁴⁶ Dahmén, J.; Frejd, T.; Magnusson, G.; Noori, G. Preparation and applications of 2-bromoethyl glycosides: synthesis of spacer-arm glycosides and agglutination inhibitors. *Carbohydr. Res.* **1982**, *111*, C1-C4.
- ⁴⁷ Dahmén, J.; Frejd, T.; Grönberg, G.; Lave, T.; Magnusson, G.; Noori, G. 2-Bromoethyl glycosides: synthesis and characterisation. *Carbohydr. Res.* **1983**, *116*, 303-307.
- ⁴⁸ Ellervik, U. 9-Anthraldehyde acetals as protecting groups. *Tetrahedron Lett.* **2003**, *44*, 2279-2281.
- ⁴⁹ Terrett, N. K.; Gardner, M.; Gordon, D. W.; Kobylecki, R. J.; Steele, J. Combinatorial Synthesis – The Design of Compound Libraries and their Application to Drug Discovery. *Tetrahedron* **1995**, *51*, 8135-8173.
- ⁵⁰ Gallop, M. A.; Barrett, R. W.; Dower, W. J.; Fodor, S. P. A.; Gordon, E. M. Applications of Combinatorial Technologies to Drug Discovery. 1. Background and Peptide Combinatorial Libraries. *J. Med. Chem.* **1994**, *37*, 1233-1251.
- ⁵¹ Gordon, E. M.; Barrett, R. W.; Dower, W. J.; Fodor, S. P. A.; Gallop, M. A. Applications of Combinatorial Technologies to Drug Discovery. 2. Combinatorial Organic Synthesis, Library Screening Strategies, and Future Directions. *J. Med. Chem.* **1994**, *37*, 1385-1401.
- ⁵² Boger, D. L.; Desharnais, J.; Capps, K. Solution-Phase Combinatorial Libraries: Modulating Cellular Signaling by Targeting Protein-Protein or Protein-DNA Interactions. *Angew. Chem., Int. Ed.* **2003**, *42*, 4138-4176..
- ⁵³ Janda, K. D. Tagged versus untagged libraries: Methods for the generation and screening of combinatorial chemical libraries. *Proc. Natl. Acad. Sci. U.S.A.* **1994**, *91*, 10779-10785.
- ⁵⁴ Lehn, J.-M. Dynamic Combinatorial Chemistry and Virtual Combinatorial Libraries. *Chem. -Eur. J.* **1999**, *5*, 2455-2463.
- ⁵⁵ Lehn, J.-M.; Eliseev, A. V. Dynamic Combinatorial Chemistry. *Science* **2001**, *291*, 2331-2332.
- ⁵⁶ Nicolaou, K. C.; Hughes, R.; Pfefferkorn, J. A.; Barluenga, S.; Roecker, A. J. Combinatorial Synthesis through Disulfide Exchange: Discovery of Potent Psammaphin A Type Antibacterial Agents Active against Methicillin-Resistant *Staphylococcus aureus* (MRSA). *Chem. -Eur. J.* **2001**, *7*, 4280-4295.
- ⁵⁷ Bunsen, R.; Roscoe, H. E. Photochemische Untersuchungen. *Poggendorff's Ann. Chem. Phys.* **1857**, *100*, 43-88.
- ⁵⁸ Russel, C. A. Bunsen without his burner. *Phys. Educ.* **1999**, *34*, 321-326.
- ⁵⁹ Jensen, W. B. The Origin of the Bunsen Burner. *J. Chem. Educ.* **2005**, *82*, 518.

- ⁶⁰ Gedye, R.; Smith, F.; Westaway, K.; Ali, H.; Baldisera, L.; Laberge, L.; Rousell J. The use of microwave ovens for rapid organic synthesis. *Tetrahedron Lett.* **1986**, *27*, 279-282.
- ⁶¹ Giguere, R. J.; Bray, T. L.; Duncan, S. M.; Majetich, G. Applications of commercial microwave oven to organic synthesis. *Tetrahedron Lett.* **1986**, *27*, 4945-4948.
- ⁶² Kappe, C. O.; Controlled Microwave Heating in Modern Organic Synthesis. *Angew. Chem., Int. Ed.* **2004**, *43*, 6250-6284.
- ⁶³ Kappe, C. O.; Dallinger, D. The impact of microwave synthesis on drug discovery. *Nat. Rev. Drug Discovery* **2006**, *5*, 51-63.
- ⁶⁴ Kuhnert, N. Microwave-Assisted Reactions in Organic Synthesis – Are There Any Nonthermal Microwave Effects? *Angew. Chem., Int. Ed.* **2002**, *41*, 1863-1866.
- ⁶⁵ Strauss, C. R. Microwave-Assisted Reactions in Organic Synthesis – Are There Any Nonthermal Microwave Effects? Response to the Highlight by N. Kuhnert. *Angew. Chem., Int. Ed.* **2002**, *41*, 3589-3590.
- ⁶⁶ Ley, S. V.; Baxendale, I. R. Organic Synthesis in a Changing World. *Chem. Rec.* **2002**, *2*, 377-388.
- ⁶⁷ Vickerstaffe, E.; Warrington, B. H.; Ladlow, M.; Ley, S. V. Fully automated multi-step solution phase synthesis using polymer supported reagents: preparation of histone deacetylase inhibitors. *Org. Biomol. Chem.* **2003**, *1*, 2419-2422.
- ⁶⁸ Jeffries, T. W.; Alexander, M. A.. Production of ethanol from xylose by *Candida shehatae* grown under continuous or fed-batch conditions. In *Biotechnology in pulp and paper manufacture: applications and fundamental investigations*. Proceedings of the Fourth International Conference on Biotechnology in the Pulp and Paper Industry. Butterworth-Heinemann: Boston, 1990; c1990, pp 311-321.
- ⁶⁹ Meyer, K.; Palmer, J. W. The polysaccharide of the vitreous humor. *J. Biol. Chem.* **1934**, *107*, 629-634.
- ⁷⁰ Meyer, K.; Chafee, E. The mucopolysaccharides of skin. *J. Biol. Chem.* **1941**, *138*, 491-499.
- ⁷¹ Meyer, K. Linker, A.; Davidsson, E. A.; Weissmann, B. The mucopolysaccharides of bovine cornea. *J. Biol. Chem.* **1953**, *205*, 611-616.
- ⁷² Shatton, J.; Schubert, M. Isolation of a mucoprotein from cartilage. *J. Biol. Chem.* **1954**, *211*, 565-573.
- ⁷³ Yanagishita, M. A brief history of proteoglycans. *Cell. Mol. Life Sci.* **1993**, *49*, 366-368.
- ⁷⁴ Islam, T.; Linhardt, R. J. Chemistry, Biochemistry, and Pharmaceutical Potentials of Glycosaminoglycans and Related Saccharides. In *Carbohydrate-based Drug Discovery*, 1st ed.; Wong, C.-H. Ed.; Wiley-VCH: Weinheim, Germany, 2003; Vol. 1, Chapter 15, pp 407-439.
- ⁷⁵ Rodén, L.; Smith, R. Structure of the Neutral Trisaccharide of the Chondroitin 4-Sulfate-Protein Linkage Region. *J. Biol. Chem.* **1966**, *241*, 5949-5954.
- ⁷⁶ Muir, H. The Nature of the Link Between Protein and Carbohydrate of a Chondroitin Sulphate Complex from Hyaline Cartilage. *Biochem. J.* **1958**, *69*, 195-204.
- ⁷⁷ Iozzo, R. V. Matrix Proteoglycans: From Molecular Design to Cellular Function. *Annu. Rev. Biochem.* **1998**, *67*, 609-652.
- ⁷⁸ Baker, J. R.; Cifonelli, J. A.; Roden, L. The linkage of corneal keratan sulfate to protein. *Connect. Tissue Res.* **1975**, *3*, 149-156.
- ⁷⁹ Stein, T.; Keller, R.; Stuhlsatz, H. W.; Greiling, H.; Ohst, E.; Muller, E.; Scharf, H. D. Structure of the linkage-region between polysaccharide chain and core protein in bovine corneal proteokeratan sulfate. *Hoppe Seylers. Z. Physiol. Chem.* **1982**, *363*, 825-833.
- ⁸⁰ Fransson, L.-Å. Structure and function of cell-associated proteoglycans. *Trends Biochem. Sci.* **1987**, *12*, 406-411.
- ⁸¹ Bernfield, M.; Kokenyesi, R.; Kato, M.; Hinkes, M. T.; Spring, J.; Gallo, R. L.; Lose, E. J. Biology of the Syndecans: A Family of Transmembrane Heparan Sulfate Proteoglycans. *Annu. Rev. Cell. Biol.* **1992**, *8*, 365-393.
- ⁸² Esko, J. D.; Sellek, S. B. Order Out of Chaos: Assembly of Ligand Binding Sites in Heparan Sulfate. *Annu. Rev. Biochem.* **2002**, *71*, 435-471.
- ⁸³ David, G. Biology and pathology of the pericellular heparan sulphate proteoglycans. *Biochem. Soc. Trans.* **1991**, *19*, 816-820.
- ⁸⁴ Jackson, R. L.; Busch, S. J.; Cardin, A. D. Glycosaminoglycans: molecular properties, protein interactions, and role in physiological processes. *Physiol. Rev.* **1991**, *71*, 481-537.
- ⁸⁵ Howell, W. H.; Holt, E. Two new factors in blood coagulation – heparin and pro-antithrombin. *Am. J. Physiol.* **1918**, *47*, 328-341.
- ⁸⁶ Marcum, J. A. The Origin of the Dispute over the Discovery of Heparin. *J. Hist. Med. Allied Sci.* **2000**, *55*, 37-66.
- ⁸⁷ McLean, J. The thromboplastic action of cephalin. *Am. J. Physiol.* **1916**, *41*, 250-257.
- ⁸⁸ Linhardt, R. J. Heparin: An Important Drug Enters Its Seventh Decade. *Chem. Ind.* **1991**, *2*, 45-50.
- ⁸⁹ Björk, I.; Lindahl, U. Mechanism of the anticoagulant activity of heparin. *Mol. Cell. Biochem.* **1982**, *48*, 161-182.
- ⁹⁰ Merchant, Z. M.; Erbe, E. E.; Eddy, W. P.; Patel, D.; Linhardt, R. J. Effect of Very Low Molecular Weight Heparin-Derived Oligosaccharides on Lipoprotein Lipase Release in Rabbits. *Atherosclerosis* **1986**, *62*, 151-158.
- ⁹¹ Caughman, G. B.; Boackle, R. J.; Vesely, J. A postulated mechanism for heparin's potentiation of C1 inhibitor function. *Mol. Immunol.* **1982**, *19*, 287-295.

- ⁹² Müller-Eberhard, H. J. Molecular organization and function of the complement system. *Annu. Rev. Biochem.* **1988**, *57*, 321-347.
- ⁹³ McEver, R. P. Selectins. *Curr. Opin. Immunol.* **1994**, *6*, 75-84.
- ⁹⁴ Nelson, R. M.; Venot, A.; Bevilacqua, M. P.; Linhardt, R. J.; Stamenkovic, I. Carbohydrate-protein interactions in vascular biology. *Annu. Rev. Cell Dev. Biol.* **1995**, *11*, 601-631.
- ⁹⁵ Nelson, R. M.; Cecconi, O.; Roberts, W. G.; Aruffo, A.; Linhardt, R. J.; Bevilacqua, M. P. Heparin Oligosaccharides Bind L- and P-Selectin and Inhibit Acute Inflammation. *Blood* **1993**, *82*, 3253-3258.
- ⁹⁶ Long, W. F.; Williamson, F. B. Heparan structure and the modulation of angiogenesis. *Med. Hypoth.* **1984**, *13*, 385-394.
- ⁹⁷ Folkman, J. Anti-Angiogenesis: New Concept for Therapy of Solid Tumors. *Ann. Surg.* **1972**, *175*, 409-416.
- ⁹⁸ Esko, J. D.; Rostand, K. S.; Weinke, J. L. Tumor Formation Dependent on Proteoglycan Biosynthesis. *Science* **1988**, *241*, 1092-1096.
- ⁹⁹ Rathore, D.; McCutchan, T. F.; Garboczi, D. N.; Toida, T. Hernáiz, M. J.; LeBrun, L. A.; Lang, S. C.; Linhardt, R. J. Direct Measurement of the Interactions of Glycosaminoglycans and a Heparin Decasaccharide with the Malaria Circumsporozoite Protein. *Biochemistry* **2001**, *40*, 11518-11524.
- ¹⁰⁰ Buée, L.; Ding, W.; Delacourte, A.; Fillit, H. Binding of secreted human neuroblastoma proteoglycans to the Alzheimer's amyloid A4 peptide. *Brain Res.* **1993**, *601*, 154-163.
- ¹⁰¹ Häcker, U.; Nybakken, K.; Perrimon, N. Heparan sulphate Proteoglycans: The sweet side of development. *Nat. Rev. Mol. Cell Biol.* **2005**, *6*, 530-540.
- ¹⁰² Cöster, L. Structure and properties of dermatan sulphate proteoglycans. *Biochem. Soc. Trans.* **1991**, *19*, 866-868.
- ¹⁰³ Takahashi, T.; Cho, H.-I.; Kublin, C. L.; Cintron, C. Keratan Sulfate and Dermatan Sulfate Proteoglycans Associate with Typ VI Collagen in Fetal Rabbit Cornea. *J. Histochem. Cytochem.* **1993**, *41*, 1447-1457.
- ¹⁰⁴ Hoppensteadt, D.; Walenga, J. M.; Fareed, J. Comparative antithrombotic and hemorrhagic effects of dermatan sulfate and heparin. *Thromb. Res.* **1990**, *60*, 191-200.
- ¹⁰⁵ Dettori, A. G.; Milani, M. R.; Manotti, C.; Zamboni, V.; Palazzini, E.; Barbanti, M. Pharmacology of desmin (low molecular weight dermatan sulphate) in healthy volunteers following intravenous bolus of different doses (200, 400, 800 mg) *Thromb. Res.* **1995**, *79*, 249-600.
- ¹⁰⁶ Häuselmann, H. J. Nutripharmaceuticals for osteoarthritis. *Best. Prac. Res. Clin. Rheumatol.* **2001**, *15*, 595-607.
- ¹⁰⁷ Reginster, J. Y.; Gillot, V.; Bruyere, O.; Henrotin, Y. Evidence of Nutriceutical Effectiveness in the Treatment of Osteoarthritis. *Curr. Rheumatol. Rep.* **2000**, *2*, 472-477.
- ¹⁰⁸ Liesegang, T. J. Viscoelastic Substances in Ophthalmology. *Surv. Ophthalmol.* **1990**, *34*, 268-293.
- ¹⁰⁹ Moskowitz, R. W. Hyaluronic Acid Supplementation. *Curr. Rev. Rheumatol.* **2000**, *2*, 466-471.
- ¹¹⁰ Prydz, K.; Dalen, K. T. Synthesis and sorting of proteoglycans. *J. Cell Sci.* **2000**, *113*, 193-205.
- ¹¹¹ Kitagawa, H.; Tanaka, Y.; Tsuchida, K.; Goto, F.; Ogawa, T.; Lidholt, K.; Lindahl, U.; Sugahara, K. N-Acetylgalactosamine (GalNAc) Transfer to the Common Carbohydrate-Protein Linkage Region of Sulfated Glycosaminoglycans. *J. Biol. Chem.* **1995**, *270*, 22190-22195.
- ¹¹² McCormick, C.; Leduc, Y.; Martindale, D.; Mattison, K.; Esford, L. E.; Dyer, A. P.; Tufaro, F. The putative tumour suppressor EXT1 alters the expression of cell-surface heparan sulfate. *Nat. Genet.* **1998**, *19*, 158-161.
- ¹¹³ Lind, T.; Tufaro, F.; McCormick, C.; Lindahl, U.; Lidholt, K. The Putative Tumor Suppressors EXT1 and EXT2 are Glycosyltransferases Required for the Biosynthesis of Heparan Sulfate. *J. Biol. Chem.* **1998**, *273*, 26265-26268.
- ¹¹⁴ Lidholt, K.; Kjellén, L.; Lindahl, U. Biosynthesis of heparin. Relationship between the polymerization and sulphation process. *Biochem. J.* **1989**, *261*, 999-1007.
- ¹¹⁵ Zhang, L.; David, G.; Esko, J. D. Repetitive Ser-Gly Sequences Enhance Heparan Sulfate Assembly in Proteoglycans. *J. Biol. Chem.* **1995**, *270*, 27127-27135.
- ¹¹⁶ Chen, R. L.; Lander, A. D. Mechanisms Underlying Preferential Assembly of Heparan Sulfate on Glypican-1. *J. Biol. Chem.* **2001**, *276*, 7507-7517.
- ¹¹⁷ Oegema, T. R.; Kraft, E. L.; Jourdain, G. W.; Van Valen, T. R. Phosphorylation of Chondroitin Sulfate in Proteoglycans from the Swarm Rat Chondrosarcoma. *J. Biol. Chem.* **1984**, *259*, 1720-1726.
- ¹¹⁸ Fransson, L.-Å.; Silverberg, I.; Carlstedt, I. Structure of the Heparan Sulfate-Protein Linkage Region. Demonstration of the sequence galactosyl-galactosyl-xylose-2-phosphate. *J. Biol. Chem.* **1985**, *260*, 14722-14726.
- ¹¹⁹ Moses, J.; Oldberg, Å.; Cheng, F.; Fransson, L.-Å. Biosynthesis of the proteoglycan decorin. Transient 2-phosphorylation of xylose during formation of the trisaccharide linkage region. *Eur. J. Biochem.* **1997**, *248*, 521-526.
- ¹²⁰ Moses, J.; Oldberg, Å.; Fransson, L.-Å. Initiation of galactosaminoglycan biosynthesis. Separate galactosylation and dephosphorylation pathways for phosphoxylosylated decorin protein and exogenous xyloside. *Eur. J. Biochem.* **1999**, *260*, 879-884.
- ¹²¹ Cheng, F. Heinegård, D. Fransson, L.-Å.; Bayliss, M.; Bielicki, J.; Hopwood, J.; Yoshida, K. Variations in the Chondroitin Sulfate-Protein Linkage Region of Aggrecans from Bovine Nasal and Human Articular Cartilages. *J. Biol. Chem.* **1996**, *271*, 28572-28580.

- ¹²² Helting, T.; Rodén, L. Studies on the biosynthesis of the chondroitin sulfate-linkage region. *Biochem. Biophys. Res. Commun.* **1968**, *31*, 786-791.
- ¹²³ Helting, T.; Rodén, L. Biosynthesis of Chondroitin Sulfate. I. Galactosyl transfer in the formation of the carbohydrate-protein linkage region. *J. Biol. Chem.* **1969**, *244*, 2790-2798.
- ¹²⁴ Helting, T.; Rodén, L. Biosynthesis of Chondroitin Sulfate. II. Glucuronosyl transfer in the formation of the carbohydrate-protein linkage region. *J. Biol. Chem.* **1969**, *244*, 2799-2805.
- ¹²⁵ Okayama, M.; Kimata, K.; Suzuki, S. Synthesis of glycosaminoglycan by a piece of cartilage in the presence of *p*-nitrophenyl-xyloside (translated). *Seikagaku* **1971**, *43*, 454. (Abstract 2-L-13 for a *Biochemistry of complex carbohydrates* symposium)
- ¹²⁶ Okayama, M.; Kimata, K.; Suzuki, S. The Influence of *p*-Nitrophenyl β -D-Xyloside on the Synthesis of Proteochondroitin Sulfate by Slices of Embryonic Chick Cartilage. *J. Biochem. (Tokyo)* **1973**, *74*, 1069-1073.
- ¹²⁷ Robinson, H. C.; Brett, M. J.; Tralagga, P. J.; Lowther, D. A.; Okayama, M. The Effect of D-Xylose, β -D-Xylosides and β -D-Galactosides on Chondroitin Sulphate Biosynthesis in Embryonic Chicken Cartilage. *Biochem. J.* **1975**, *148*, 25-34.
- ¹²⁸ Fukunaga, Y.; Sobue, M.; Suzuki, N.; Kushida, H.; Suzuki, S.; Suzuki, S. Synthesis of a fluorogenic mucopolysaccharide by chondrocytes in cell culture with 4-methylumbelliferyl- β -D-xyloside. *Biochim. Biophys. Acta* **1975**, *381*, 443-447.
- ¹²⁹ Linker, A.; Hovingh, P. Heparinase and Heparitinase from Flavobacteria. *Methods Enzymol.* **1972**, *28*, 902-911.
- ¹³⁰ De Bruyne, C. K.; Loontjens, F. G. Synthesis of Alkyl- β -D-xylopyranosides in the Presence of Mercuric Salts. *Nature* **1966**, *209*, 396-397.
- ¹³¹ Purves, C. B. Relations between rotary power and structure in the sugar group. XXI. Beta-thiophenol glycosides of glucose, xylose, lactose and cellobiose. *J. Am. Chem. Soc.* **1929**, *51*, 3619-3627.
- ¹³² Sandy, J. D.; Brown, H. L. G.; Lowther, D. A. Control of Proteoglycan Synthesis. Studies on the activation of synthesis observed during culture of articular cartilages. *Biochem. J.* **1980**, *188*, 119-130.
- ¹³³ Robinson, J. A.; Robinson, H. C. Control of chondroitin sulphate biosynthesis. β -D-Xylopyranosides as substrates for UDP-galactose: D-xylose transferase from embryonic-chicken cartilage. *Biochem. J.* **1981**, *194*, 839-846.
- ¹³⁴ Sobue, M.; Habuchi, H.; Ito, K.; Yonekura, H.; Oguri, K.; Sakurai, K.; Kamohara, S.; Ueno, Y.; Noyori, R.; Suzuki, S. β -D-Xylosides and their analogues as artificial initiators of glycosaminoglycan chain synthesis. Aglycone-related variation in their effectiveness *in vitro* and *in vivo*. *Biochem. J.* **1987**, *241*, 591-601.
- ¹³⁵ Bellamy, F.; Horton, D.; Millet, J.; Picart, F.; Samreth, S.; Chazan, J. B. Glycosylated Derivatives of Benzophenone, Benzhydrol, and Benzhydril as Potential Venous Antithrombotic Agents. *J. Med. Chem.* **1993**, *36*, 898-903.
- ¹³⁶ Bellamy, F.; Barberousse, V.; Martin, N.; Masson, P.; Millet, J.; Samreth, S.; Sepulchre, C.; Theveniaux, J.; Horton, D. Thioxyloside derivatives as orally active venous antithrombotics. *Eur. J. Med. Chem.* **1995**, *30*, 101S-115S.
- ¹³⁷ Lagemwa, F. N.; Esko, J. D. Estradiol- β -D-Xyloside, an Efficient Primer for Heparan Sulfate Biosynthesis. *J. Biol. Chem.* **1991**, *266*, 6674-6677.
- ¹³⁸ Fritz, T. A.; Lagemwa, F. N.; Sarkar, A. K.; Esko, J. D. Biosynthesis of Heparan Sulfate in β -D-Xylosides Depends on Aglycone Structure. *J. Biol. Chem.* **1994**, *269*, 300-307.
- ¹³⁹ Sarkar, A. K.; Fritz, T. A.; Taylor, W. H.; Esko, J. D. Disaccharide uptake and priming in animal cells: Inhibition of sialyl Lewis X by acetylated Gal β 1 \rightarrow 4GlcNAc β -O-naphthalenemethanol. *Proc. Natl. Acad. Sci. U.S.A* **1995**, *92*, 3323-3327.
- ¹⁴⁰ Sarkar, A. K.; Esko, J. D. Synthesis and glycosaminoglycan priming activity of three disaccharides related to the linkage region tetrasaccharide of proteoglycans. *Carbohydr. Res.* **1995**, *279*, 161-171.
- ¹⁴¹ Mani, K.; Havsmark, B.; Persson, S.; Kaneda, Y.; Yamamoto, H.; Sakurai, K.; Ashikari, S.; Habuchi, H.; Suzuki, S.; Kimata, K.; Malmström, A.; Westergren-Thorsson, G.; Fransson, L.-Å. Heparan/Chondroitin/Dermatan Sulfate Primer 2-(6-Hydroxynaphthyl)-O- β -D-Xylopyranoside Preferentially Inhibits Growth of Transformed Cells. *Cancer Res.* **1998**, *58*, 1099-1104.
- ¹⁴² Mani, K.; Belting, M.; Ellervik, U.; Falk, N.; Svensson, G.; Sandgren, S.; Cheng, F.; Fransson, L.-Å. Tumor attenuation by 2-(6-hydroxynaphthyl)- β -D-xylopyranoside requires priming of heparan sulfate and nuclear targeting of the products. *Glycobiology* **2004**, *14*, 387-397.
- ¹⁴³ Falk, F. Design and Synthesis of Xylosides with Antiproliferative Properties. Thesis, Lund University, Lund, Sweden, 2001.
- ¹⁴⁴ Lambusta, D.; Nicolosi, G.; Piattelli, M.; Sanfilippo, C. Lipase catalyzed acylation of phenols in organic solvents. *Indian J. Chem., Sect. B: Org. Chem. Incl. Med. Chem.* **1993**, *32B*, 58-60.
- ¹⁴⁵ Ciuffreda, P.; Casati, S.; Santaniello, E. Regioselective Hydrolysis of Diacetoxynaphthalenes Catalyzed by *Pseudomonas* sp. Lipase in an Organic solvent. *Tetrahedron* **2000**, *56*, 317-321.

- ¹⁴⁶ Leznoff, C. C.; Wong, J. Y. The Use of Polymer Supports in Organic Synthesis. The Synthesis of Monotryl Ethers of Symmetrical Diols. *Can. J. Chem.* **1972**, *50*, 2892-2893.
- ¹⁴⁷ Wong, J. Y.; Leznoff, C. C. The Use of Polymer Supports in Organic Synthesis. II. The Synthesis of Monoethers of Symmetrical Diols. *Can. J. Chem.* **1973**, *51*, 2454-2456.
- ¹⁴⁸ Fyles, T. M.; Leznoff, C. C. The use of polymer supports in organic synthesis. V. The preparation of monoacetates of symmetrical diols. *Can. J. Chem.* **1976**, *54*, 935-942.
- ¹⁴⁹ Leznoff, C. C.; Dixit, D. M. The use of polymer supports in organic synthesis. XI. The preparation of monoethers of symmetrical dihydroxy aromatic compounds. *Can. J. Chem.* **1977**, *55*, 3351-3355.
- ¹⁵⁰ Zemplén, G.; Kunz, A. *Ber. Discb. Chem. Ges.* **1923**, *56*, 1705-1710.
- ¹⁵¹ Devraj, R.; Cushman, M. A Versatile Solid Phase Synthesis of Lavendustin A and Certain Biologically Active Analogs. *J. Org. Chem.* **1996**, *61*, 9368-9373.
- ¹⁵² Platt, K. L.; Oesch, F. Efficient Synthesis of Non-K-Region *trans*-Dihydro Diols of Polycyclic Aromatic Hydrocarbons from *o*-Quinones and Catechols. *J. Org. Chem.* **1983**, *48*, 265-268.
- ¹⁵³ Erdmann, H. Die Constitution der isomeren Naphtalin-derivate. I. Die α,α -disubstituierten Verbindungen. *Liebigs Ann.* **1888**, *247*, 306-366.
- ¹⁵⁴ Ragot, J. P.; Steeneck, C.; Alcaraz, M.-L.; Taylor, R. J. K. The synthesis of 1,8-dihydroxynaphthalene-derived natural products: palmarumycin CP₁, palmarumycin CP₂, palmarumycin C₁₁, CJ-12,371, deoxypreussomerin A and novel analogues. *J. Chem. Soc., Perkin Trans. 1* **1999**, 1073-1082.
- ¹⁵⁵ Moreira, C. R.; Lopes, C. C.; Cuccovia, I. M.; Porcionatto, M. A.; Dietrich, C. P.; Nader, H. B. Heparan sulfate and control of endothelial cell proliferation: increased synthesis during the S phase of the cell cycle and inhibition of thymidine incorporation induced by *ortho*-nitrophenyl- β -D-xylose. *Biochim. Biophys. Acta* **2004**, *1673*, 178-185.
- ¹⁵⁶ ACD/PhysChem, Advanced Chemistry Development, Inc., Toronto ON, Canada, www.acdlabs.com, 2003. ACD/LogP v9.03. and ACD/pK_a v8.
- ¹⁵⁷ QikProp, version 2.5, Schrödinger, LLC, New York, NY, 2005.
- ¹⁵⁸ Jaguar, version 6.5, Schrödinger, LLC, New York, NY, 2005.
- ¹⁵⁹ Valkó, K.; Plass, K.; Bevan, C.; Reynolds, D.; Abraham, M. H. Relationships between the chromatographic hydrophobicity indices and solute descriptors obtained by using several reversed-phase, diol, nitrile, cyclodextrin and immobilised artificial membrane-bonded high-performance liquid chromatography columns. *J. Chromatogr. A* **1998**, *797*, 41-55.
- ¹⁶⁰ Johnsson, R.; Mani, K.; Ellervik, U. Synthesis and Biology of Bis-xylosylated Dihydroxynaphthalenes. *In press Bioorg. Med. Chem.* **2007**, doi:10.1016/j.bmc.2007.02.020
- ¹⁶¹ Hanai, T.; Koizumi, K.; Kinoshita, T.; Arora, R. Ahmed, F. Prediction of pK_a values of phenolic and nitrogen-containing compounds by computational chemical analysis compared to those measured by liquid chromatography. *J. Chromatogr. A* **1997**, *762*, 55-61.
- ¹⁶² Westergren-Thorsson, G.; Önnervik, P.-O.; Fransson, L.-Å.; Malmström, A. Proliferation of Cultured Fibroblasts Is Inhibited by L-Iduronate-Containing Glycosaminoglycans. *J. Cell. Physiol.* **1991**, *147*, 523-530.
- ¹⁶³ Fluerau, M.; Chichirau, A.; Chepelev, L. L.; Willmore, W. G.; Durst, T.; Charron, M.; Barclay, L. R. C.; Wright, J. S. Cytotoxicity and cytoprotective activity in naphthalenediols depends on their tendency to form naphthoquinones. *Free Radical Biol. Med.* **2005**, *39*, 1368-1377.
- ¹⁶⁴ Kerr, J. F. R.; Wyllie, A. H.; Currie, A. R. Apoptosis: A basic biological phenomenon with wide-ranging implications in tissue kinetics. *Br. J. Cancer* **1972**, *26*, 239-257.
- ¹⁶⁵ Majno, G.; Joris, I. Apoptosis, Oncosis, and Necrosis. An Overview of Cell Death. *Am. J. Pathol.* **1995**, *146*, 3-15.
- ¹⁶⁶ Gavrieli, Y.; Sherman, Y.; Ben-Sasson, S. Identification of Programmed Cell Death In Situ via Specific Labeling of Nuclear DNA Fragmentation. *J. Cell. Biol.* **1992**, *119*, 493-501.
- ¹⁶⁷ R&D Systems FlowTACS™
- ¹⁶⁸ Darzynkiewicz, Z.; Juan, G.; Li, X.; Gorczyca, W.; Murakami, T.; Traganos, F. Cytometry in Cell Necrobiology: Analysis of Apoptosis and Accidental Cell Death (Necrosis). *Cytometry* **1997**, *27*, 1-20.
- ¹⁶⁹ Wilhelm, S.; Gröbler, B.; Gluch, M.; Heinz, H. Confocal Laser Scanning Microscopy; Technical information sheet 45-0029 e/09.03: Carl Zeiss Jena GmbH, Jena, Germany.
- ¹⁷⁰ Ramström, O.; Lehn, J.-M. In Situ Generation and Screening of a Dynamic Combinatorial Carbohydrate Library against Concanavalin A. *ChemBioChem* **2000**, *1*, 41-48.
- ¹⁷¹ Nilsson, U.; Johansson, R.; Magnusson, G. Synthesis, Conformational Analysis and Comparative Protein Binding of a Galabioside and Its Thioglycoside Analogues. *Chem. -Eur. J.* **1996**, *2*, 295-302.
- ¹⁷² Overman, L. E.; Smoot, J.; Overman J. D. The Reduction of Aryl Disulfides with Triphenylphosphine and Water. *Synthesis* **1974**, *1*, 59-60.
- ¹⁷³ Humphrey, R. E.; Potter, J. L. Reduction of Disulfides with Tributylphosphine. *Anal. Chemistry*, **1965**, *37*, 164-165.

- ¹⁷⁴ Amos, R. A.; Fawcett, S. M. Reductive Cleavage of Aromatic Disulfides Using a Polymer-Supported Phosphine Reagent. *J. Org. Chem.* **1984**, *49*, 2637-2639.
- ¹⁷⁵ Stahl, C. R.; Siggia, S. Determination of Organic Disulfides by Reduction with Sodium Borohydride. *Anal. Chemistry* **1957**, *29*, 154-155.
- ¹⁷⁶ Krishnamurthy, S.; Aimino, D. Rapid and Selective Reduction of Functionalized Aromatic Disulfides with Lithium Tri-*tert*-butoxyaluminumhydride. A Remarkable Steric and Electronic Control. Comparison of Various Hydride Reagents. *J. Org. Chem.* **1989**, *54*, 4458-4462.
- ¹⁷⁷ Zincke, T.; Dereser, R. Über 2-Naphthol-6-mercaptan. *Chem. Ber.* **1918**, *51*, 352-360.
- ¹⁷⁸ Barnett, R. J.; Seligman, A. M. Histochemical Demonstration of Protein-bound Sulfhydryl Groups. *Science* **1952**, *116*, 323-327.
- ¹⁷⁹ Zincke, T.; Ruppertsberg, J. Über 1-Naphthol-4-mercaptan. *Chem. Ber.* **1915**, *48*, 120-129.
- ¹⁸⁰ Rennert, H. Über 1-Naphthol-5-mercaptan. *Chem. Ber.* **1915**, *48*, 459-470.
- ¹⁸¹ Mustafa, A.; Asker, W.; Hishmat, O. H.; Shalaby, A. F. A.; Kamel, M. Action of Grignard Reagents. VI. (a) Cleavage by Organomagnesium and Lithium Compounds and by Lithium Aluminum Hydride; (b) Action of Phenyllithium on Phenanthraquinone and Benzil Monoximes. *J. Am. Chem. Soc.* **1954**, *76*, 5447-5452.
- ¹⁸² Jusa, E.; Breuer, G. Einfluß der Stellung der Merkaptobzw. Methylmerkaptogruppe auf die Farbe von monosubstituierten β -Naphtholazofarbstoffen. *Monatsh. Chem.* **1934**, *64*, 247-266
- ¹⁸³ Nose, A.; Kudo, T. Reactions of Sodium Borohydride. IV. Reduction of Aromatic Sulfonyl Chlorides with Sodium Borohydride. *Chem. Pharm. Bull.* **1987**, *35*, 1770-1776.
- ¹⁸⁴ Runge, F.; El-Hewehi, Z.; Taeger, E. Zur Kenntnis der Trithiokohlensäure. II. Darstellung von Trithiokohlensäure-diester durch die Umsetzung von Thiophosgen mit Thiolen und Thiophenolen. *J. Prakt. Chem.* **1959**, *4*, 279-285.
- ¹⁸⁵ Still, I. W. J.; Arora, P. C.; Hasan, S. K.; Kutney, G. W.; Lo, L. Y. T.; Turnbull, K. Conformational analysis and photochemical behavior of sulfoxides in the naphtho[1,2-*b*]thiopyran and naphtho[2,1-*b*]thiopyran series. *Can. J. Chem.* **1981**, *59*, 199-209.
- ¹⁸⁶ Liu, Y.; Zhang Y. Temperature-controlled selective reduction of arenesulfonyl chlorides promoted by samarium metal in DMF. *Tetrahedron Lett.* **2003**, *44*, 4291-4294.
- ¹⁸⁷ Babu, J. R.; Bhatt, M. V. New reagents 4. Reduction of sulphonyl chlorides and sulphoxides with aluminium iodide. *Tetrahedron Lett.* **1986**, *27*, 1073-1074.
- ¹⁸⁸ Fujimori, K.; Togo, H.; Oae, S. Iodine catalyzed reduction of arenesulfonic acid to the arenethiol with triphenylphosphine. *Tetrahedron Lett.* **1980**, *21*, 4921-4924.
- ¹⁸⁹ Uchiro, H.; Kobayashi, S. Non-aqueous Reduction of Aromatic Sulfonyl Chlorides to Thiols Using a Dichloromethylsilane-Zinc-Dimethylacetamide System. *Tetrahedron Lett.* **1999**, *40*, 3179-3182.
- ¹⁹⁰ Olah, G. A.; Narang, S. C.; Field, L. D.; Salem, G. F. Synthetic Methods and Reactions. 93. Preparation of Disulfides via Iodotrimethylsilane-Mediated Reductive Dimerization of Sulfonyl Halides. *J. Org. Chem.* **1980**, *45*, 4792-4793.
- ¹⁹¹ Newman, M. S.; Karnes, H. A. The Conversion of Phenols to Thiophenols *via* Dialkylthiocarbamates. *J. Org. Chem.* **1966**, *31*, 3980-3984.
- ¹⁹² Field, L.; Engelhardt, P. R. Organic Disulfides and Related Substances. XXX. Preparations and Reactions of Mercaptoterephthalic Acids and Derivatives. *J. Org. Chem.* **1970**, *35*, 3647-3655.
- ¹⁹³ Hughes, G. K.; Thompson, E. O. P. Synthesis of dithiohexestrol dimethyl ether. *J. Proc. Roy. Soc. N.S. Wales* **1948**, *82*, 262-264.
- ¹⁹⁴ Adams, R.; Ferretti, A. Thioethers. III. Preparation of Aromatic Di- and Tri-mercapto Compounds by Dealkylation of Aryl Alkyl Thioethers. *J. Am. Chem. Soc.* **1959**, *81*, 4939-4940.
- ¹⁹⁵ Ferretti, A. 1,2-Dimercaptobenzene (*o*-Benzenedithiol). *Organic Syntheses*; Wiley & Sons: New York, 1973; Collect. Vol. 5, 419-421.
- ¹⁹⁶ Gleiter, R.; Uschmann, J. Electronic Structure of Heterospirenes – PE Spectroscopic Investigations. *J. Org. Chem.* **1986**, *51*, 370-380.
- ¹⁹⁷ Pinchart, A.; Dallaire, C.; Bierbeek, A.; Gingras, M. Efficient Formation of Aromatic Thiols From Thiomethylated Precursors. *Tetrahedron Lett.* **1999**, *40*, 5479-5482.
- ¹⁹⁸ Becht, J.- M.; Wagner, A.; Mioskowski, C. Facile Introduction of SH Group on Aromatic Substrates via Electrophilic Substitution Reactions. *J. Org. Chem.* **2003**, *68*, 5758-5761.
- ¹⁹⁹ Adams, R.; Reifschneider, W.; Ferretti, A. 1,2-Bis(*n*-butylthio)benzene [Benzene, *o*-bis(butylthio)-]. *Organic Syntheses*; Wiley & Sons: New York, 1973; Collect. Vol. 5, 107-110.
- ²⁰⁰ Fraser, P. K.; Woodward, S. Highly Enantioselective Conjugate Addition of AlMe_3 to Linear Aliphatic Enones by a Designed Catalyst. *Chem. Eur. J.* **2003**, *9*, 776-783.
- ²⁰¹ Furman, F. M.; Thelin, J. H.; Hein, D. W.; Hardy, W. B. Novel Reactions of 2-Naphthol with Thioglycolic Acid and Other Mercaptans *J. Am. Chem. Soc.* **1960**, *82*, 1450-1452.

- ²⁰² Nakazawa, T.; Hirose, N.; Itabashi, K. An Efficient Synthesis of Naphthyl Alkyl and Aryl Sulfides by the Reaction of Naphthols with Alkane- and Arenethiols *Synthesis* **1989**, 955-957.
- ²⁰³ Charoonniyomporn, P.; Thongpanchang, T.; Witayakran, S.; Thebtaranonth, Y.; Phillips, K. E. S.; Katz, T. J. An Efficient one-pot synthesis of bisalkylthioarenes *Tetrahedron Lett.* **2004**, *45*, 457-459.
- ²⁰⁴ Rodd's Chemistry of Carbon Compounds, Vol. III – Aromatic compounds part G; Ed. Coffey, S.; 2nd Ed.; Elsevier Amsterdam, 1978.
- ²⁰⁵ Golounin, A.V.; Shchedron, Y. S.; Fedorov, V. A. Interactions of Phenols with Lewis Acids: XVII. Thermodynamics of Naphthols Complexing with Aluminum Bromide. *Russ. J. Org. Chem.* **2001**, *37*, 1111-1113.
- ²⁰⁶ Golounin, A.V.; Shchedron, Y. S.; Ivanova, E. A. Reactions of Phenols with Lewis Acids: XX. Tautomerism of Naphthols. *Russ. J. Org. Chem.* **2001**, *37*, 1270-1272.
- ²⁰⁷ Bucherer, H. T. Über die Einwirkung schwefligsaurer Salze auf aromatische Amido- und Hydroxylverbindungen. *J. Prakt. Chem.* **1904**, *69*, 49-91.
- ²⁰⁸ Lepetit, R. Préparation d'acide α -naphtholmonosulfonique 1:4. En traitant l'acide α -naphthylamine monosulfonique 1:4 par le bisulfite de soude. *Bull. Soc. Mulhouse* **1903**, 326-328.
- ²⁰⁹ Bucherer, H. T. Über die Einwirkung schwefligsaurer Salze auf aromatische Amido- und Hydroxylverbindungen. *J. Prakt. Chem.* **1904**, *69*, 345-364.
- ²¹⁰ Woroshtzow, N. N. About bisulphite compounds of azodyes (translated). *J. Russ. Phys. Chem. Soc.* **1915**, *47*, 1669-1737.
- ²¹¹ Fuchs, W.; Stix, W. Über die Tautomerie der Phenole, V.: Dioxy-1.5- und dioxy-2.7-naphthalin. *Ber.* **1922**, *55*, 658-670.
- ²¹² Raschig, F.; Prah, W. Die Konstitution der Aldehyd- und Keton-Bisulfite. *Annalen*, **1926**, *448*, 265-312.
- ²¹³ Cowdrey, W. A.; Hinshelwood, C. N. The Mechanism of the Bucherer Reaction. Part I. The Kinetics of the Conversion of Naphthylamines into Naphthols. *J. Chem. Soc.* **1946**, 1036-1041.
- ²¹⁴ Rieche, A.; Seeboth, H. Über die Einwirkung schwefligsaurer Salze auf aromatische Amido- und Hydroxylverbindungen. I. Eigenschaften und Struktur von Zwischenverbindungen der Buchererreaktion. *Liebigs Ann. Chem.* **1960**, *638*, 43-56.
- ²¹⁵ Rieche, A.; Seeboth, H. Über Reaktionen von Naphtholen und Naphthyl-aminen unter dem Einfluß von Hydrogensulfid (Bucherer-Reaktion), II. M-Tetralonsulfonsäuren als Zwischenstufen der Buchererreaktion. *Liebigs Ann. Chem.* **1960**, *638*, 57-66.
- ²¹⁶ Rieche, A.; Seeboth, H. Über Reaktionen von Naphtholen und Naphthyl-aminen unter dem Einfluß von Hydrogensulfid (Bucherer-Reaktion), III. Zum Mechanismus der Bucherer-Reaktion. *Liebigs Ann. Chem.* **1960**, *638*, 66-75.
- ²¹⁷ Rieche, A.; Seeboth, H. Über Reaktionen von Naphtholen und Naphthyl-aminen unter dem Einfluß von Hydrogensulfid (Bucherer-Reaktion), IV. Die Anlagerungsverbindung von β -Naphthol und NaHSO_3 . *Liebigs Ann. Chem.* **1960**, *638*, 76-81.
- ²¹⁸ Rieche, A.; Seeboth, H. Über Reaktionen von Naphtholen und Naphthyl-aminen unter dem Einfluß von Hydrogensulfid (Bucherer-Reaktion), V. Die Carbazolsynthese aus Naphtholen oder Naphthylaminen und Phenylhydrazin mittels Hydrogensulfids. *Liebigs Ann. Chem.* **1960**, *638*, 81-92.
- ²¹⁹ Rieche, A.; Seeboth, H. Über Reaktionen von Naphtholen und Naphthyl-aminen unter dem Einfluß von Hydrogensulfid (Bucherer-Reaktion), VI. Darstellung von N-arylierten α -Naphthylaminen. *Liebigs Ann. Chem.* **1960**, *638*, 92-100.
- ²²⁰ Rieche, A.; Seeboth, H. Über Reaktionen von Naphtholen und Naphthyl-aminen unter dem Einfluß von Hydrogensulfid (Bucherer-Reaktion), VII. Eine neue Darstellungsmethode von Naphthol-(1)-sulfonsäuren-(3). *Liebigs Ann. Chem.* **1960**, *638*, 101-110.
- ²²¹ Seeboth, H. The Bucherer Reaction and the Preparative Use of its Intermediate Products. *Angew. Chem. Int. Ed.* **1967**, *6*, 307-317.
- ²²² Pitchen, P.; Duñach, E.; Desmukh, M. N.; Kagan, H. B. An Efficient Asymmetric Oxidation of Sulfides to Sulfoxides. *J. Am. Chem. Soc.* **1984**, *106*, 8188-8193.
- ²²³ Gypser, A.; Norrby, P.-O. The theoretical basis of the isoinversion principle. *J. Chem. Soc. Perkin Trans. 2* **1997**, 939-943.
- ²²⁴ Liu, L.; Guo, Q.-X. Isokinetic Relationship, Isoequilibrium Relationship, and Enthalpy-Entropy Compensation. *Chem. Rev.* **2001**, *101*, 673-695.
- ²²⁵ Buschmann, H.; Scharf, H.-D.; Hoffman, N.; Esser, P. The Isoinversion Principle – a General Model of Chemical Selectivity. *Angew. Chem. Int. Ed. Engl.* **1991**, *30*, 477-515.
- ²²⁶ Sengar, R. S.; Nemykin, V. N.; Basu, P. Electronic properties of *para*-substituted thiophenols and disulfides from ^{13}C NMR spectroscopy and *ab initio* calculations: relations to the Hammett parameters and atomic charges. *New J. Chem.* **2003**, *27*, 1115-1123.
- ²²⁷ Shelkov, R.; Nahmany, M.; Melman, A. Selective esterifications of alcohols and phenols through carbodiimide couplings. *Org. Biomol. Chem.* **2004**, *2*, 397-401.

- ²²⁸ See for example Yu, H. N.; Furukawa, J.-i.; Ikeda, T.; Wong, C.-H. Novel Efficient Routes to Heparin Monosaccharides and Disaccharides Achieved via Regio- and Stereoselective Glycosidation. *Org. Lett.* **2004**, *6*, 723-726.
- ²²⁹ Pesci, L. Costituzione dei composti organo-mercurici del-l'acido benzoico. *Atti. R. Accad. Dei Lincei Roma* **1901**, *10*, 362-363.
- ²³⁰ Moseley, J. D.; Gilday, J. P. The mercury-mediated decarboxylation (Pesci reaction) of naphthoic anhydrides investigated by microwave synthesis. *Tetrahedron* **2006**, *62*, 4690-4697.
- ²³¹ Duffy, K. J.; Darcy, M. G.; Delorme, E.; Dillon, S. B.; Eppley, D. F.; Erickson-Miller, C.; Giampa, L.; Hopson, C. B.; Huang, Y.; Keenan, R. M.; Lamb, P.; Leong, L.; Liu, N.; Miller, S. G.; Price, A. T.; Rosen, J.; Shah, R.; Shaw, T. N.; Smith, H.; Stark, K. C.; Tian, S.-S.; Tyree, C.; Wiggall, K. J.; Zhang, L.; Luengo, J. I. Hydrazinonaphthalene and Azonaphthalene Thrombopoietin Mimics Are Nonpeptidyl Promoters of Megakaryocytopoieses. *J. Med. Chem.* **2001**, *44*, 3730-3745.
- ²³² Albert, J. S. Astra Zeneca. Private communication, 2006.
- ²³³ Gryniewicz, G.; Achmatowicz, O.; Hennig, J.; Indulski, J.; Klessig, D. F. Synthesis and Characterization of the Salicylic Acid β -D-glucopyranoside. *Pol. J. Chem.* **1993**, *67*, 1251-1254.
- ²³⁴ Han, S.-Y.; Kim, Y.-A. Recent development of peptide coupling reagents in organic synthesis. *Tetrahedron* **2004**, *60*, 2447-2467.
- ²³⁵ Montalbetti, C. A. G. N.; Falque, V. Amide bond formation and peptide coupling. *Tetrahedron* **2005**, *61*, 10827-10852.
- ²³⁶ Gillies, R. J.; Didier, N.; Denton, M. Determination of Cell Number in Monolayer Cultures. *Anal. Biochem.* **1986**, *159*, 109-113.
- ²³⁷ Fransson, L.-Å.; Karlsson, P.; Schmidtchen, A. Effects of cycloheximide, brefeldin A, suramin, heparin and primaquine on proteoglycan and glycosaminoglycan biosynthesis in human embryonic skin fibroblasts. *Biochim. Biophys. Acta.* **1992**, *1137*, 287-297.
- ²³⁸ Fransson, L.-Å.; Havsmark, B.; Sakurai, K.; Suzuki, S. Sequence analysis of *p*-hydroxyphenyl-O- β -D-xyloside initiated and radio-iodinated dermatan sulfate from skin fibroblasts. *Glycoconjugate J.* **1992**, *9*, 45-55.
- ²³⁹ Shively, J. E.; Conrad, H. E. Stoichiometry of the Nitrous Acid Deaminative Cleavage of Model Amino Sugar Glycosides and Glycosaminoglycuronans. *Biochemistry* **1970**, *9*, 33-43.
- ²⁴⁰ Shively, J. E.; Conrad, H. E. Formation of Anhydrosugars in the Chemical Depolymerisation of Heparin. *Biochemistry* **1976**, *15*, 3932-3942.
- ²⁴¹ Hohenberg, P.; Kohn, W. Inhomogeneous Electron Gas. *Phys. Rev. B* **1964**, *136*, 864-871.
- ²⁴² Kohn, W.; Sham, L. J. *Phys. Rev. A* **1965**, *140*, 1133-1138.
- ²⁴³ Becke, A. D. *J. Chem. Phys.* **1993**, *98*, 5648-5652.
- ²⁴⁴ Lee, C.; Yang, W.; Parr, R. G. *Phys. Rev. B* **1988**, *37*, 785-789.
- ²⁴⁵ Hariharan, P. C.; Pople, J. A. *Chem. Phys. Lett.* **1972**, *16*, 217-219.
- ²⁴⁶ Francl, M. M.; Pietro, W. J.; Hehre, W. J.; Binkley, J. S.; Gordon, M. S.; DeFrees, D. J.; Pople, J. A. *J. Chem. Phys.* **1982**, *77*, 3654-3665.
- ²⁴⁷ Maestro, version 7.5, Schrödinger, LLC, New York, NY, 2005.
- ²⁴⁸ Duffy, E. M.; Jorgensen, W. L. Prediction of Properties from Simulations: Free Energies of Solvation in Hexadecane, Octanol, and Water. *J. Am. Chem. Soc.* **2000**, *122*, 2878-2888.

