



# LUND UNIVERSITY

## Universal Medium Range Radar and IEEE 802.11p Modem Solution for Integrated Traffic Safety

Vlastaras, Dimitrios; Abbas, Taimoor; Leston, Daniel; Tufvesson, Fredrik

*Published in:*  
13th International Conference on ITS Telecommunications

*DOI:*  
[10.1109/ITST.2013.6685544](https://doi.org/10.1109/ITST.2013.6685544)

2013

[Link to publication](#)

*Citation for published version (APA):*  
Vlastaras, D., Abbas, T., Leston, D., & Tufvesson, F. (2013). Universal Medium Range Radar and IEEE 802.11p Modem Solution for Integrated Traffic Safety. In *13th International Conference on ITS Telecommunications* (pp. 193-197). IEEE - Institute of Electrical and Electronics Engineers Inc..  
<https://doi.org/10.1109/ITST.2013.6685544>

*Total number of authors:*  
4

### General rights

Unless other specific re-use rights are stated the following general rights apply:  
Copyright and moral rights for the publications made accessible in the public portal are retained by the authors and/or other copyright owners and it is a condition of accessing publications that users recognise and abide by the legal requirements associated with these rights.

- Users may download and print one copy of any publication from the public portal for the purpose of private study or research.
- You may not further distribute the material or use it for any profit-making activity or commercial gain
- You may freely distribute the URL identifying the publication in the public portal

Read more about Creative commons licenses: <https://creativecommons.org/licenses/>

### Take down policy

If you believe that this document breaches copyright please contact us providing details, and we will remove access to the work immediately and investigate your claim.

LUND UNIVERSITY

PO Box 117  
221 00 Lund  
+46 46-222 00 00

# Universal Medium Range Radar and IEEE 802.11p Modem Solution for Integrated Traffic Safety

Dimitrios Vlastaras, Taimoor Abbas, Daniel Leston, Fredrik Tufvesson  
Department of Electrical and Information Technology, Lund University, Sweden  
email: dimitrios.vlastaras@eit.lth.se

**Abstract**—Vehicles in the future are anticipated to have the ability to communicate and exchange useful information in order to avoid collisions. However, for this cooperation to be possible all vehicles will have to be equipped with compatible wireless IEEE 802.11p modules that implement intelligent transport systems operating in the 5 GHz frequency band standard (ITS-G5 or WAVE). During the implementation phase of the system there will be many older vehicles without such equipment that can cause hazard as information about them will not be available to vehicles equipped with IEEE 802.11p modules.

In this paper we present a system, to be used as a road side unit (RSU), developed explicitly for vehicle-to-infrastructure (V2I) communication that can solve the aforementioned traffic safety problems. The system consists of a universal medium range radar (UMRR) and an IEEE 802.11p modem integrated together to detect vehicles, with or without communication capabilities, and forward their position and speed vectors to vehicles, with IEEE 802.11p modules installed, for collision avoidance.

Tests have been performed by using our system in parallel with vehicles in which IEEE 802.11p modules are installed and comparing the content in the Cooperative Awareness Messages obtained from both systems. Accuracy tests have also been performed in order to verify the accuracy of the system in the time and spatial domains.

## I. INTRODUCTION

Intelligent Transportation Systems (ITS) can be defined as a group of technological solutions in telematics designed to improve the safety and efficiency of terrestrial transportation. Both the European standard for ITS, ITS-G5, and its American counterpart, WAVE, are based on the IEEE 802.11p amendment to the IEEE 802.11 standard. Those standards define procedures to broadcast the position and speed vectors of each individual vehicle so other nearby vehicles can collect this information and use it for safety purposes.

This technology comes with a problem during the implementation phase, as just a few of the vehicles in circulation will actually be equipped with onboard devices. This paper focuses on addressing this problem by implementing a road side unit (RSU) that scans for vehicles and emulates Cooperative Awareness Messages from them as if they had their own IEEE 802.11p onboard broadcasting modules [5]. This has been done using an IEEE 802.11p wireless modem together with a radar.

In the example portrayed in Fig. 1, the intelligent car in grey color, reaches an intersection where there is a known risk of crash with other vehicles due to the low visibility of the cars that approach from the right.

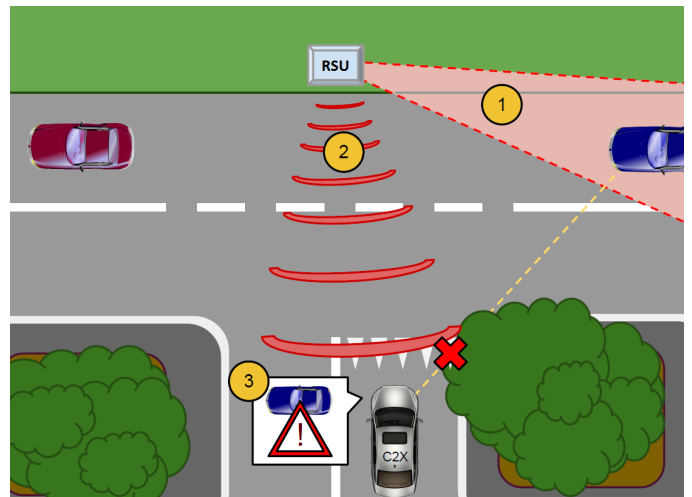

Fig. 1. Possible traffic outcome where the line of sight of the grey vehicle towards the blue vehicle is blocked by some trees.

If all the vehicles in the example had a car-to-car/infrastructure (C2X) communication system, they would broadcast their position and speed vectors and therefore the vehicle that aims to enter the main road would be aware of the risk of an accident. Nevertheless, a more realistic scenario would be that where the majority of the vehicles are not equipped such a system.

However, the device described in this paper can be placed in the intersection, monitoring all the vehicles that approach from the east and broadcasting their position and speed vectors as if they had their own onboard devices.

In the example above, the blue car is not equipped with a C2X communication system and it is driving at a high speed. The driver in the grey car, equipped with C2X, is not capable of seeing it since there are some trees blocking the line of sight. Since the RSU is placed at the intersection, it will detect the blue car (1) and will transmit instant values of its position and speed vectors to the grey car (2). The C2X vehicle will then be notified about the approaching car and will alert the driver of the risk of crash if he or she decides to enter the main road (3).

Traffic accidents, especially those taking place nearby or at intersections, have been studied during recent years and methods have been developed to be able to predict and avoid them [1]–[4]. However, a solution such as this RSU for detection of older vehicles in conjunction with automatic

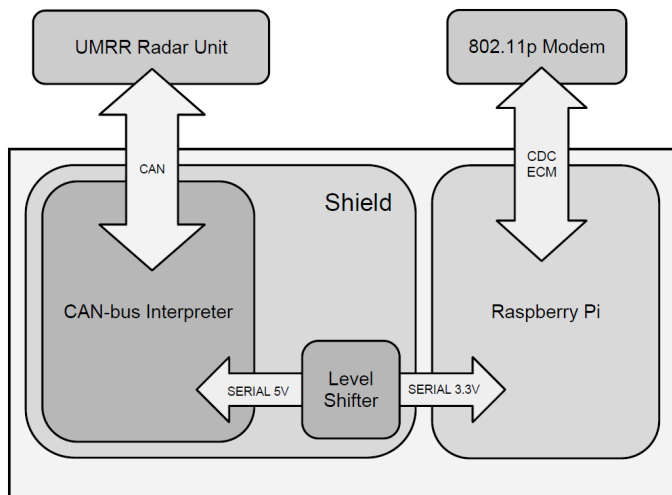

Fig. 2. Block diagram of the system.

breaking systems or warning systems in newer vehicles is to the authors' best knowledge new and has not been done before. It can significantly improve the safety of terrestrial transportation by avoiding accidents rather than predicting them.

## II. SYSTEM DESCRIPTION

The road side unit (RSU) consists of three main parts; a universal medium range radar (UMRR) unit, an IEEE 802.11p wireless modem and an embedded system that provides interfaces and intelligence to them both as seen in Fig. 2.

### A. Universal Medium Range Radar

The radar has the capability of detecting vehicles up to 160m of distance and with 25cm of accuracy [12]. The technology utilizes microwaves in the 24GHz band for detection of objects. It also incorporates smart functionality such as detection of vehicles that are solely moving in one direction, distinguishing between different kinds of vehicles and/or pedestrians and also providing their speed and position vectors. This information is later being embedded into wireless frames and broadcasted to other vehicles.

This UMRR was designed for in-vehicle and traffic monitoring installations and it communicates with its surroundings over the CAN-bus protocol [6]. Therefore, the rest of the system has to implement the same protocol in order to send commands and receive responses to/from the UMRR.

### B. IEEE 802.11p Wireless Modem

The modem incorporated in this RSU is a very simple one. It does not implement the full ITS-G5 standard, however it is transmitting and receiving information on the 5.9GHz band using the IEEE 802.11p amendment.

The modem connects to the embedded system using the CDC-ECM<sup>1</sup> standard. Frames are sent to the modem over the UDP protocol. The only task that the modem has to perform is

<sup>1</sup>CDC-ECM is an implementation for Ethernet over USB.

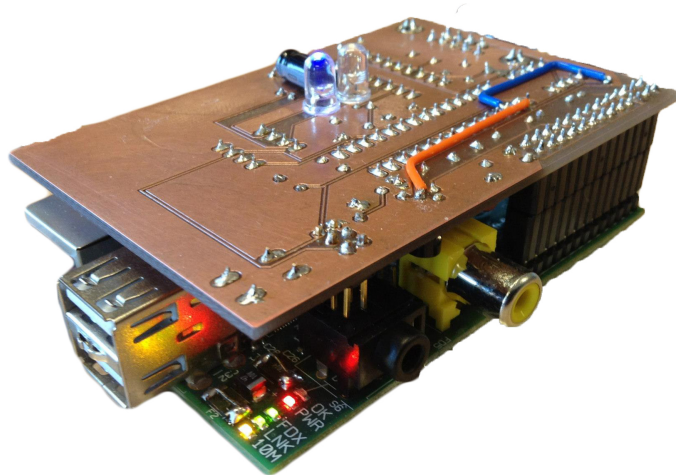

Fig. 3. A picture of the completed embedded system, the upper part (CAN-bus interpreter) is connected to the lower part (Raspberry Pi) over their respective RS-232 serial ports.

to open up those UDP datagrams and broadcast their payload wirelessly. The payload is expected to be frames according to the ITS-G5 standard.

### C. Embedded System

The responsibility of the embedded system is to connect the UMRR unit and the IEEE 802.11p modem and run all the required software in order to meet the system requirements. The speed and position vectors of each vehicle are reported using GeoNetworking [14], BTP [15] and CAM [16] frames.

The embedded system is composed of two main parts; a CAN-bus shield and a Raspberry Pi<sup>2</sup> as seen in Fig. 3. The CAN-bus shield is responsible for the communications with the UMRR unit over CAN-bus and the Raspberry Pi is responsible for running the main algorithms and for the communications with the IEEE 802.11p modem over CDC-ECM.

The two parts communicate with each other over their respective RS-232 serial ports. The CAN-bus shield uses 5V as reference for logic voltage while the Raspberry Pi uses 3.3V. A voltage level shifter has been placed in between to solve this problem.

## III. FUNCTIONAL TESTS

Two different tests were performed in Gothenburg, Sweden. The first test, communication test, was to determine whether the IEEE 802.11p Modem could successfully communicate with Volvo Drive C2X<sup>3</sup> equipment or not. The second test, verification test, was to determine whether the RSU ITS-G5 implementation followed the ITS-G5 specifications [14]–[16] by comparing frames from another ITS-G5 source, e.g. a Drive C2X Volvo car, to frames generated by the RSU.

<sup>2</sup>The Raspberry Pi is a credit-card-sized single-board computer.

<sup>3</sup>Drive C2X is a European integrated project on ITS deployment.



Latitude: 57°44'2647.69"N (577354698)  
 Longitude: 11°51'3102.12"E (118616989)  
 Speed: 10.44 m/s | 37.58 km/h (1044)  
 Heading: 5.4° (54)

(a)

Latitude: 57°44'2647.97"N (577355470)  
 Longitude: 11°51'3102.42"E (118617823)  
 Speed: 10.00 m/s | 36.00 km/h (1000)  
 Heading: 240.0° (2400)

(b)

Fig. 4. (a) Frame received from the RSU and (b) frame received from a Drive C2X Volvo car.

#### A. Communication test

The RSU was powered up and started broadcasting simulated traffic frames. A Drive C2X receiver was configured and all received wireless frames were saved to a binary file that was later inspected in Wireshark<sup>4</sup> using ITS-G5 dissectors<sup>5</sup>. The acquired frames could successfully be interpreted by the Wireshark dissectors, which meant that the RSU was generating valid GN, BTP and CAM frames with correct format and that the IEEE 802.11p modem was compatible with Drive C2X equipment.

#### B. Verification test

During this test a setup with 3 main components was used; The RSU, a Drive C2X receiver and a Drive C2X Volvo car with an ITS-G5 implementation.

The RSU was installed and configured next to a road and the Drive C2X receiver was also installed and configured in the same spot. The Volvo car was driven on the road next to the RSU a few times. The external Drive C2X receiver was capturing frames during this time.

Once the test was completed the captured frames were analyzed and compared side by side in Wireshark. An example of logged frames can be seen in Fig. 4. The logged frames were almost identical with the only deviation being the car heading as the heading reported by the RSU was in relation to the direction of the radar while the heading reported by the Drive C2X car was in relation to the North.

The radar bearing was roughly measured with a smart phone, and after compensating for the radar alignment the heading of the car was calculated to 230°, which is close to the reported heading of 240°, and within an acceptable error margin for a smartphone.

### IV. ACCURACY TESTS

Functional tests were performed on the RSU as mentioned above, but other aspects also needed to be tested. One of those was the accuracy of the reported time in conjunction with the accuracy of the coordinates in the GN/CAM frames down to centimeter level. Accuracy measurements were performed with the help of a state of the art GPS positioning device [11].

<sup>4</sup>Wireshark is a free and open-source packet analyzer.

<sup>5</sup>The ITS-G5 dissectors were fetched from AMB Consulting.

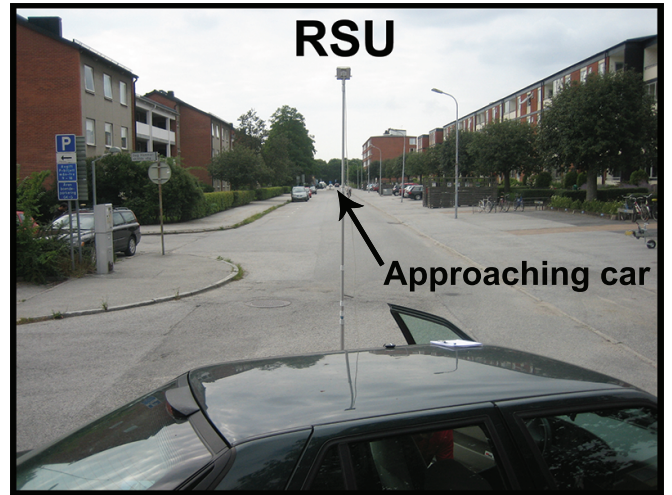

Fig. 5. The RSU pointing towards the street.



Fig. 6. High accuracy GPS with an external antenna mounted on the top of the car.



Fig. 7. The long straight part of Dag Hammarskjölds street in Lund, Sweden. The RSU was placed at point A pointing towards point B. Images: ©2013 Cnes/Spot Image, DigitalGlobe, Lantmäteriet/Metria. Map data: ©2013 Google.

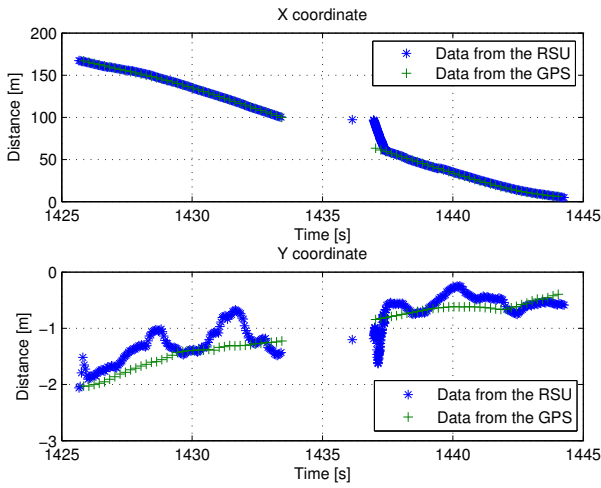

Fig. 8. Positions reported during one of the 22 sample runs. The upper graph displays data for the distance from the RSU to the vehicle (X) and the lower graph displays data for the sidewise movement of the vehicle (Y).

### A. Objectives

GeoNetworking and CAM frames contain a timestamp as well as the WGS84<sup>6</sup> geographic coordinates of a vehicle [14], [16]. It is very important that the reported timestamp is actually the correct timestamp when the vehicle was at the reported coordinate, because the accuracy of the position estimate depends on the accuracy of the timestamp. Delays might be introduced as a result of processing time that various algorithms utilize. Therefore, it is important to measure and report these delays and their impact on the accuracy of the position estimate.

### B. Methodology

The measurement setup consisted of the RSU on a 5 m tripod, see Fig. 5, a high precision GPS receiver that reports coordinates with errors in the centimeter level range [11] mounted on a Volvo-V70 car, see Fig. 6. A 350 m straight patch of road selected as measurement route, see Fig. 7.

The car drove 22 times down the street towards the RSU while logging its coordinates and timestamps with the high precision GPS receiver. At the same time the RSU was detecting the car and also logging its coordinates and timestamps.

GPS time was used on both systems. A GPS receiver was temporarily fitted on the RSU for time synchronization. According to [7] GPS time is typically accurate within 40 ns, which is more than enough since the maximum logging resolution of the RSU is 1 ms.

### C. Results

1) *Time errors*: The first measurement was used as a calibration run. The goal with this measurement was to find possible errors in the time domain.

The RSU was using UTC time, since its Network Time Protocol (NTP) daemon was compensating for leap seconds [8].

<sup>6</sup>WGS84: World Geodetic System 1984, last revised in 2004 according to the National Geospatial-Intelligence Agency.

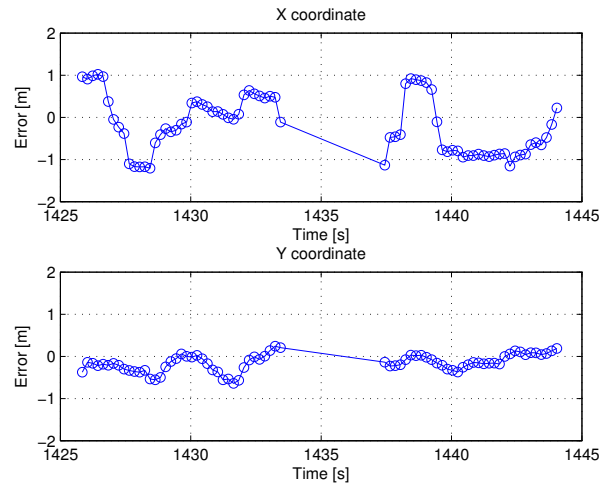

Fig. 9. The error between RSU and GPS data from the same measurement as in Fig. 8, as a function of time.

However, the GPS was using pure GPS time and therefore the extra leap seconds were compensated for the RSU. According to [9] the offset between GPS time and Coordinated Universal Time (UTC) is 16 s, as the current number of leap seconds is 16 s [10].

Also a millisecond level fine-tuning was made numerically on the time offset. The offset that minimized the distance error was selected.

2) *Spatial errors*: The RSU can detect both distance to a vehicle (X coordinate) and sidewise movement of a vehicle (Y coordinate). Thus both directions and their errors were studied separately.

In order to find possible errors in the spatial domain all measurements were compensated for the time offset. The distance from the RSU to the car was compensated for the

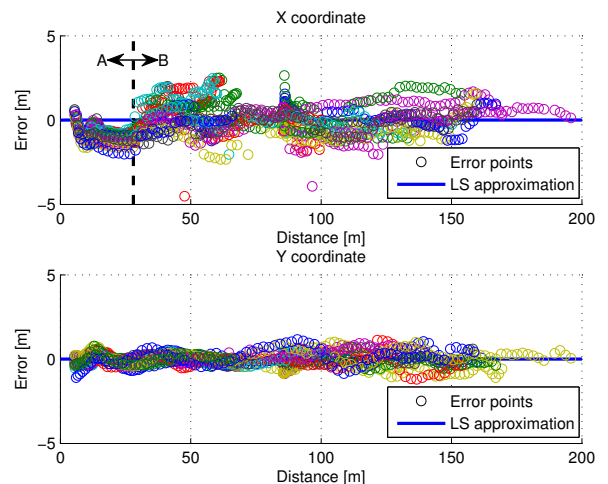

Fig. 10. Scatter plot displaying the error as a function of distance from the RSU to the car for all measurements. For the X coordinate a deterministic behaviour can be seen near the radar in section A, which can be compensated for by an appropriate model. The standard deviation for X, based on section B, is  $\sigma_x = 89$  cm and for Y is  $\sigma_y = 38$  cm.

value that minimized the mean X-error, and the sidewise movement of the car was compensated for the position of the GPS device on the car.

In Fig. 8 a sample measurement can be seen. The difference in distance between the RSU and GPS data is the spatial error which can be seen in Fig. 9. However, what is more interesting to analyze is the error of all the measurements as a function of the distance from the RSU to the car as seen in Fig. 10. From that we can read the standard deviation as a measure of accuracy. For X;  $\sigma_x = 89$  cm and for Y;  $\sigma_y = 38$  cm.

When the car is within 28 m from the RSU, a deterministic behaviour can be observed, as the car is going out of the main beam of the radar, as seen in section A of the upper graph of Fig. 10. A least squares model that describes this behaviour can be found, reversed and added to the data in order to eliminate the error.

3) *Vehicle reference point*: It is also of interest to investigate whether the reference point of the RSU on the car is changing as the car is approaching the RSU. A slope different from zero on the least squares approximation in Fig. 10 would indicate that. As it can be seen the slope is equal to 0 both for the X and Y directions. Therefore it can be concluded that the reference point of the RSU on the car is static.

## V. CONCLUSION

Throughout the article a road side unit (RSU) that implements the ITS-G5 standard has been described. It is able to emulate car-to-car/infrastructure (C2X) communications of non-intelligent vehicles within the sight of a radar, thus providing a better integration of ITS-G5 vehicles in the future.

An embedded system succeeds on connecting a microwave radar and an IEEE 802.11p modem, providing an intelligent device in the middle that is powerful enough to perform all needed calculations.

Functional tests have been performed in order to confirm the RSU's ability to communicate with other devices that implement the same standard and to verify the system's reported values such as coordinates and speed. Both tests have been successful. Accuracy tests have been performed and the system's accuracy shows promising results. The accuracy in X and Y directions has been measured to  $\pm 89$  cm and  $\pm 38$  cm respectively.

With this technology, intelligent transportation will be realized earlier during the implementation phase, where just a small portion of vehicles on public roads will feature a cooperative communications system. It is also a long-term solution, since older vehicles will keep driving on public roads for a long time. By implementing the system in blind spots, intelligent vehicles will benefit from extra active safety as they will be warned about surrounding vehicles.

## ACKNOWLEDGMENTS

The authors would like to thank Volvo Cars Corporation for their cooperation and supply of equipment and vehicles during the tests and also the GIS center at Lund University for providing the high precision GPS receiver.

## REFERENCES

- [1] M. S. Short, G. A. Woelfl, and C.-J. Chang, "Effects of traffic signal installation on accidents" *Accident Analysis & Prevention*, vol. 14, no. 2, pp. 135 – 145, 1982.
- [2] N. Stamatiadis, W. C. Taylor, and F. X. McKelvey, "Elderly drivers and intersection accidents" Eno Transportation Foundation, Westport, USA, Tech. Rep. 3, July 1991.
- [3] M. Poch and F. Mannering, "Negative binomial analysis of intersection-accident frequencies" *Journal of Transportation Engineering*, vol. 122, no. 2, pp. 105–113, 1996.
- [4] E. Belyaev, P. Molchanov, A. Vinel, Y. Koucheryavy, "The Use of Automotive Radars in Video-Based Overtaking Assistance Applications" *IEEE Transactions on Intelligent Transportation Systems*, vol. 14, no. 3, pp. 1035–1042, 2013.
- [5] D. Vlastaras and D. Lestón, "Improved Traffic Safety by Wireless Vehicular Communication" Department of Electrical and Information Technology, Lund University, Lund, Sweden, 2013.
- [6] Robert Bosch GmbH, "CAN Specification" Bosch, Germany, 1991.
- [7] D. W. Allan, N. Ashby, C. C. Hodge, "The Science of Timekeeping, Application Note 1289" Hewlett Packard, 1997.
- [8] D. Mills, U. Delaware, J. Martin Ed., ISC, J. Burbank, W. Kasch, JHU/APL, "Network Time Protocol Version 4: Protocol and Algorithms Specification (RFC5905)" Internet Engineering Task Force (IETF), 2010.
- [9] Time Service Department, "Leap Seconds" U.S. Naval Observatory, Washington, DC, USA, 2012.
- [10] D. Gambis, "Bulletin C 43" Earth Orientation Center of International Earth Rotation and Reference Systems Service (IERS), Paris, France, 2012.
- [11] Topcon Positioning Systems, Inc. "Topcon GRS-1, GNSS Receiver and Field Controller, Brochure" Topcon, USA, 2013.
- [12] Smart Microwave Sensors GmbH, "UMRR Traffic Management Sensor Full Documentation" Smartmicro, Germany, 2012.
- [13] Kapsch TrafficCom AB, "Product Specification, Test Modem" Kapsch, Sweden, 2012.
- [14] European Telecommunications Standards Institute, "ETSI TS 102 636-4-1 V1.1.1" ETSI, France, 2011.
- [15] European Telecommunications Standards Institute, "ETSI TS 102 636-5-1 V1.1.1" ETSI, France, 2011.
- [16] European Telecommunications Standards Institute, "ETSI TS 102 637-2 V1.2.1" ETSI, France, 2011.