



# LUND UNIVERSITY

## Strategic Energy Solutions: A Case Study of the Öresund Region

Aguilera, Paulina; Beckham Hooff, Sarah; Cheong, Natalie; Gutiérrez, Hilda Maria; Leshchynskyy, Alex; Mathew, Rowena; Mutter, Amelia; Policzer, Jacob; Radmilovic, Sonja; Sin, Janice Kei-Yau; Stefánsdóttir, Birgitta; Sterk, Leonie; Sum, Christine; Wagle, Paroma

2012

[Link to publication](#)

### Citation for published version (APA):

Aguilera, P., Beckham Hooff, S., Cheong, N., Gutiérrez, H. M., Leshchynskyy, A., Mathew, R., Mutter, A., Policzer, J., Radmilovic, S., Sin, J. K.-Y., Stefánsdóttir, B., Sterk, L., Sum, C., & Wagle, P. (2012). *Strategic Energy Solutions: A Case Study of the Öresund Region*. International Institute for Industrial Environmental Economics, Lund University.

### Total number of authors:

14

### General rights

Unless other specific re-use rights are stated the following general rights apply:

Copyright and moral rights for the publications made accessible in the public portal are retained by the authors and/or other copyright owners and it is a condition of accessing publications that users recognise and abide by the legal requirements associated with these rights.

- Users may download and print one copy of any publication from the public portal for the purpose of private study or research.
- You may not further distribute the material or use it for any profit-making activity or commercial gain
- You may freely distribute the URL identifying the publication in the public portal

Read more about Creative commons licenses: <https://creativecommons.org/licenses/>

### Take down policy

If you believe that this document breaches copyright please contact us providing details, and we will remove access to the work immediately and investigate your claim.

LUND UNIVERSITY

PO Box 117  
221 00 Lund  
+46 46-222 00 00

The logo consists of the lowercase letters 'iiiiee' in a white, sans-serif font, set against a red rectangular background. This logo is positioned in the top-left corner of the page, which has a dark green background.

iiiiee



# Strategic Energy Solutions

## A Case Study of the Öresund Region

Paulina Aguilera, Sarah Beckham Hooff, Natalie Cheong, Hilda Maria Gutiérrez, Alex Leshchynskyy, Rowena Mathew, Amelia Mutter, Jacob Policzer, Sonja Radmilovic, Janice Kei-Yau Sin, Birgitta Stefánsdóttir, Leonie Sterk, Christine Sum, & Paroma Wagle

Research Coordinators:  
Thomas Lindqvist &  
Mikael Backman

Funded by:



European Regional  
Development Fund



Interreg IVA

ÖRESUND – KATTEGAT – SKAGERRAK



ENERGI ÖRESUND



MESPOM  
Masters in  
Environmental  
Science, Policy  
and Management

“Strategic Energy Solutions” is the final report on energy solutions for a zero emission Öresund region. It consists of numerous solutions that have been, or can be, applied in the region in order to minimise the environmental impact of the energy sector. Additionally it includes a case study of energy transition projects on Lolland Island in Denmark.

The report seeks to provide recommendations for future strategic energy planning of the Energi Öresund project - a European Union Interreg IVA funded cross-border co-operation between municipalities, energy companies and universities across the Öresund region. This report is the outcome of the Strategic Environmental Development (SED) course at the International Institute for Industrial Environmental Economics (IIIEE) at Lund University in Sweden. The authors are Master’s students of the Erasmus Mundus funded MESPOM programme.

Photo Credits for Cover Page:

“Sunset at Lomma Beach” by Gabriela Schliwa, taken October 2012.

“Offshore Windmills” by Anette Greenfurt at Dansk InfoDesign, date unknown.

This publication should be cited as:

International Institute for Industrial Environmental Economics [IIIEE]. (2012). *Strategic Energy Solutions – A Case Study of the Öresund Region*. Lund: IIIEE.

# TABLE OF CONTENTS

## STRATEGIC ENERGY SOLUTIONS

- 2 Introduction
- 4 Comparative Analysis of Wind Turbine Regulations
- 11 Wind Energy
- 18 Hydrogen Fuel Cells
- 25 Biogas for Transport
- 33 Increasing Consumer Awareness in Energy-Efficient Housing
- 39 Win-Win Solutions for Energy Efficiency in Private Residences
- 46 Building Networks and Partnerships for Green and Sustainable Buildings
- 53 Energy Efficiency in New Urban Areas

## LOLLAND CASE STUDY

- 59 Lolland – Top Runner in Sustainability

## AUTHORS

- 67 The International Institute for Industrial Environmental Economics (IIIEE)
- 68 Masters of Environmental Sciences, Policy and Management (MESPOM)

# INTRODUCTION



By Sarah Beckham Hooff

“Strategic Energy Solutions – A Case Study of the Öresund Region” is designed to supplement and expand upon the 2011 report “Energy Futures Öresund – Bridging the Gaps to a Greener Tomorrow,” produced by students at the International Institute for Industrial Environmental Economics (IIIEE) in cooperation with Energy Öresund and its partners. It outlines information and offers suggestions to promote strategic action designed to meet the ambitious energy goals set forth by local municipalities in the Öresund region, by Denmark and Sweden, and by the European Union as a whole.

Indeed, it is not a coincidence that a report with such a thematic and geographic focus was produced for Energy Öresund, an EU-funded INTERREG IV initiative. Projects bearing this distinction are tasked with promoting cooperation and knowledge transfer between municipalities and stakeholder groups across the borders of neighbouring European countries. Energy Öresund, in turn, seeks to promote cooperative and strategic energy planning between southern Sweden (Skåne region) and Southeast Denmark (regions Sjælland (English Zealand) and Hovedstaden). The production of reports in cooperation with IIIEE students is just one way that this organisation furthers its mission of knowledge transfer and cooperation among its 16 Danish and Swedish partners, one of which is Lund University and IIIEE.

The 2011 “Energy Futures” report outlines the energy context of the Öresund region and explores technical problems which act as barriers to energy transitions. The report includes a broad introduction to the energy goals of Sweden and Denmark, and outlines the particularities of the regions Hovedstaden and Zealand in Denmark and the Skåne region in Sweden. Next, the 2011 authors highlight challenges related to seasonal energy storage, district heating, energy-efficient buildings, waste storage, and other energy-related topics.

In the report, special emphasis is given to the common energy goals shared among all municipalities of the Öresund region, not the least of which is the obligation to contribute to the “20-20-20 by 2020” energy goal set forth by the European Council Climate and Energy Package from March 2007. This ambition suite of goals includes reducing EU emissions of greenhouse gas by 20% compared to 1990 levels, raising EU renewable energy consumption by 20%, and improving EU energy efficiency by 20% – all by the year 2020. As such, the 2011 report provides information and offers a concise review of issues relevant to the development of sustainable energy solutions in the Öresund region. The report does not, however, investigate in detail social aspects or offer extensive recommendations for improvement.

The 2012 report, “Strategic Energy Solutions – A Case Study of the Öresund Region”, builds upon the informative base of the 2011 report



to explore a broad variety of both technical and social topics and, in many cases, offer specific recommendations for improvement. In addition to this, a multi-faceted case study of Lolland Island, Denmark, describes sustainable energy technologies that are currently being implemented.

Several chapters in this year's report explore *technologies* that may contribute to increasing energy sustainability in the Öresund region; for example, sections related to biogas in transport and the feasibility of hydrogen cells for energy storage are included. In contrast to the 2011 report, there is a notable emphasis in this year's report on the *political and social aspects of sustainability transitions*. The interaction between wind legislation and turbine placement is discussed, as the challenge of gaining public acceptance of wind development; the motivations and incentives of homeowners, developers, and real-

estate agents to support energy-efficient housing options are outlined; and the development of different kinds of environmental communication networks is compared. While the Lolland case study includes discussions of technology-based strategies for energy sustainability, the authors of this year's report also discuss the role of environmental education and local NGOs.

"Strategic Energy Solutions – Case Study for the Öresund Region" hopes to promote the transfer of information and insight among the Energy Öresund partners in order to promote and accelerate the shift to a sustainable energy future in the Öresund region of Denmark and Sweden.



IIEE students at a study visit in Skåne in September 2012.

# COMPARATIVE ANALYSIS OF WIND TURBINE REGULATIONS

## Proximity to Infrastructure in Non-Residential Areas

By Sonja Radmilovic



At present, both in Sweden and in Denmark wind power is increasing. Specifically, Sweden aims to produce 30 TWh from wind power by 2020 that is comprised of 20 TWh from onshore wind turbines and 10 TWh from off-shore wind turbines [1]. Denmark aims to supply 35% of all its energy from renewable energy, 50% of which will be from wind power [2]. Furthermore, as onshore wind turbines are significantly cheaper than offshore, therefore they will be significantly higher portion of wind energy production. More onshore wind turbines require more space for them to be located and set up on [3].

As suitable space is becoming limited in Denmark and parts of Sweden, it is becoming challenging to place wind turbines [4]. Therefore, it is important to examine the different policies and legislation in Sweden and Denmark so as to examine the approval process regarding physical proximity of infrastructure to wind turbines in non-residential urban environments.

It is important that the current legislation is explored in order to establish:

1. Whether it is possible to place wind turbines in close proximity to industrial or commercial areas in Sweden and Denmark?
2. What is the difference in legislation for industrial and commercial areas for setting

up wind turbines in Sweden and Denmark? and

3. How could a wind turbine be placed next to the Bella Center in Denmark, while the proposed turbine by IKEA in Malmö was rejected?

This will provide municipalities clarity on how to best proceed with locating onshore wind turbines and compare and evaluate the most effective way in handling such issues. Similarly, positive and negative attributes that may require revision for the establishment of a common and most efficient path towards their goal of becoming the first carbon dioxide (CO<sub>2</sub>) neutral area in the EU will be addressed.

## Bella Center & IKEA

The Bella Center in Copenhagen, Denmark has a wind turbine of the total height of 75 m with blades of 52 m in diameter, estimated to produce 1.6 million kilowatt hours a year [5]. However, just recently in Malmö, Sweden, IKEA was rejected the permit to set up a wind turbine in its vicinity. Therefore, what legislative difference explains this occurrence?

## Findings

Within both Sweden and Denmark, there is no legislative difference between commercial, industrial or general residential and housing guidelines for the set-up of wind turbines.

Therefore, it was necessary to look at the general setup and installation requirements for windmills next to habitation.

### Wind Turbines in Denmark

In Denmark, the legislation for setting up and installing new wind turbines is much more set and structured. The national government sets up a national policy for wind turbine and wind power development. Then, based on this policy, municipalities have to make land reservations for potential wind turbine developments within their municipality and align them with local plans [4]. For wind turbines that are over the height of 150 m, the National Environmental Centre is granted planning authority. In addition, an Environmental Impact Assessment (EIA) has to be carried out for all wind turbines that are over the height of 80 m or are built in a group of three or more turbines. Furthermore, EIAs consist of both environmental impacts and the compliance of the turbines to the national legislation [6].

The national legislation currently sets a standard for distance from habitation of four times the height of the turbine. This is applicable to all wind turbines that are over 25 m of height.

SUMMARY OF THE NOISE REGULATIONS IN DENMARK		
AREA TYPE	6 m/s WIND SPEEDS	8 m/s WIND SPEEDS
Residential & Noise Sensitive	37 dB	39 dB
Dwellings in Open Countryside	42 dB	44 dB
Low Frequency at Evening & Night	20 dB	20 dB
Low Frequency During the Day	25 dB	25 dB

However, if it is distanced less than six times the height of the turbine away from the building, then an estimation of the property value depreciation is carried out. If it is estimated to be more than 1% value loss, full compensation needs to be provided by the owner of the turbine [7].

The national legislation for noise for wind speeds of 6 m/s is 37 dB for residential and noise sensitive areas and 42 dB for dwellings in open countryside. For wind speeds of 8 m/s it is 39 dB for residential and noise sensitive areas and 44 dB for dwellings in open country side. For low frequency noise the limitations are calculated slightly differently [8,9,10]. They consider the indoor/inside noise limit in dwellings and are the same for 6 and 8 m/s wind speeds. However, there is a differentiation between the day limit that is 25 dB and the evening and night limit that is 20 dB [8,11].

In addition, household and small turbines that are less than 25 m of height and have a rotor area of 1-5 m<sup>2</sup> are different as they can be connected to or installed on a building in open country side, most typically in rural zones. For small and household turbines, only registration, notification and screening in accordance to EIA are necessary [6].

### Wind Turbines in Sweden

For the set-up and establishment of new wind turbines in Sweden there are certain environmental assessment guidelines, most of the legislation is established and stems from: The Planning and Building Act and The Environmental Code [12,13]. Specifically, the Planning and Building Act gives the municipalities a monopoly and through the Environmental Code municipalities are given the ultimate decisive power for wind turbine decisions as approval is necessary for their establishment. In addition, municipalities do not need to disclose the reasoning behind their decisions [4,14]. This not only permits and opens opportunities for the municipalities to bypass national poli-



cies but also establishes different conditions and factors for wind turbine establishment in different regions. For example, there is no national legislation or policy on the setback distance of turbines from habitation or infrastructure [7].

Consequently, different regions in Sweden have adopted different general guidelines for wind turbine siting. In northern Sweden where space is more abundant, there is a recommendation of a distance of 1000 m from the turbine, while in southern Sweden where space is not so readily available there are more constraints and the recommendation is between 400 - 1000 m [7].

The noise limitation is 40 dB near habitation, and there are no policies or guidelines on low frequency noise. For small wind turbines that produce up to 25 MW, only a building permit and notification to the municipality are required. While for wind turbines that produce over 25 MW a building permit and permission from the county administrative board is necessary [7,14].

## Legislation Differences & Implications

The Swedish Planning and Building Act and Environmental Code require numerous amounts of permits (more than in Denmark) and sometimes even detailed plans. This process of just approving new wind turbines and wind power projects can take a long time and be burdensome for the developer, as it can take more than five years to get all the paper work in order. Sometimes in Sweden it can take even ten years, while in Denmark this process is more expedited due to the lower amount of permits necessary [17].

Furthermore, the municipal strength in the legislative and administrative process in Sweden hinders the wind power expansion. The wind energy production is adversely affected by

the imprecise rules and regulations for establishing new wind turbines. As it leaves investors and developers uncertain of the outcome of their project proposals, that in turn significantly increases their risks that may lead investors to look for alternatives in neighbouring countries instead. In other words, in Sweden developers have to take into account legislation, weather conditions and municipal attitude towards wind turbines. However, the fact that the law is imprecise and regulations for establishing new wind turbines are up to the municipalities to decide, there is the possibility of doing more things in Sweden that would not occur in other countries. This provides developers with new opportunities as long as they are able to convince the municipalities and receive their approval [17].

This further demonstrates the disconnection between the top level government and lower level. While there is a goal to expand wind power production to 20 TWh by 2020 the legislation puts no pressure onto local and municipal authorities to follow with this and develop new wind turbines within their municipalities. Instead, municipalities can choose not to accept any wind turbine projects and not be required to have transparency and provide reasoning in the decision-making process. In Denmark, however, legislation (distribution of authority) provides a uniform platform that allows for a more transparent and predictable wind energy development [4].

To summarise:

- Sweden requires more permits than Denmark;
- There is a better connection between lower level government and top level in Denmark than in Sweden;
- A municipal veto for wind turbine establishment exists only in Sweden; and
- Sweden has no distance and low frequency regulation or shadow flickering policy, while Denmark does.

## Analysis of Bella Center & IKEA

The Bella Center wind turbine is a unique exception to the Danish legislation. It is questionable how and under what terms it was approved. This wind turbine was initially set up as a temporary turbine. It was supposed to stay at the Bella Center for just one year and then be sold to a permanent location. It is assumed that this wind turbine was set up as an exhibition for the COP-15 on climate change in order to promote the current wind technology and Copenhagen for its modernity and greenness. For some unknown reasons the turbine was never sold off and placed elsewhere, so the Bella Center now has a wind turbine in such close proximity.

The IKEA case in Malmö was no exception to the legislation. What is presumed to have occurred is that the municipality simply rejected the wind turbine plans on the municipal level, well within their legal right. Due to the fact that the legislation does not require the municipality to disclose reasoning behind their actions, it is presumed that the reason was the simple dislike and fear of negative repercussions from either the general public (who would not like to shop or pass near a turbine) or the surrounding businesses (who would fear that the turbine would negatively impact them by lowering the number of consumers and shoppers who frequent their business).

## Wind Turbines Next to Infrastructure?

Surprisingly, even though Denmark does already have a wind turbine in close proximity to a building, it is not possible to build wind turbines next to commercial or industrial infrastructure. Due to Danish legislation, all turbines are to be placed at a minimum distance of four times the height of the turbine away from any houses or buildings. This leaves no

possibility for flexibility or space to manoeuvre with in order to place wind turbines closer.

On the contrary, even though the wind turbine set up next to the IKEA in Malmö (commercial area) was rejected, this was rejected on a municipal level. Due to the lack of national regulation, and the flexibility on a municipal and local level, in Sweden it is possible to establish new wind turbines in close proximity to commercial and industrial infrastructure. However, as witnessed in the IKEA case, municipalities are reluctant to make such concessions fearing repercussions and problems that come with wind turbines.

The main issues and problems wind turbines cause are:

1. Aesthetic appeal;
2. Safety;
3. Noise;
4. Low Frequency Noise;
5. Shadowing and Flickering; and
6. Reflection [15].

However, there are possible solutions that can be applied in order to mitigate these problems.

### *Aesthetic Appeal*

Many argue that wind turbines ruin the beauty of the landscape [18]. While this may be so, placing wind turbines in close proximity to commercial and industrial infrastructure will not necessarily have the same negative aesthetic impact because in industrial areas there is already a lack of aesthetic appeal. There is a possibility that the general public might not find commercial areas as appealing as without the wind turbines. In both instances however, the low aesthetic value can be dealt with by doing the complete opposite and increasing the beauty of an area. This can be done by carefully designing the area around the wind turbine to look more appealing and even adding to the recreational value. In addition, currently industrial designers have helped improve their look by making newer wind turbines with more cy-

lindrical towers instead of the old frame towers and making their nacelle (the shell of the generator and gearbox) shapes more sleek and refined.

## **Safety**

There exists a general belief amongst the public that there are safety problems with wind turbines. However, this is far from the truth as currently there are only two situations where the wind turbines could be hazardous and damaging to the general public: 1) when a part or the entire blade of the wind turbine shreds due to either mechanical problems or the weather, specifically only if lightning strikes the blade; and 2) in cold weather, ice can form on the blade and fall to the ground eventually when the wind turbine starts up again. However these incidences usually occur in bad weather when few people are outside and around turbines. As such, in Europe there has not yet been any known cases of turbines causing injury or harm to any individual. These, however, can also be managed by equipping wind turbines with vibration sensors that can shut down the turbine if it notices any imbalance with the rotor blades, use cold resistant steel, limit the running of wind turbines during times of ice formation, install ice sensors and heaters, use blades that are coated with fluoro-ethane, use synthetic lubricant that are for cold weather [16,17].

## **Noise**

The wind turbine produced high frequency noise is usually the strongest and can come in two different forms: 1) aerodynamics as the result of the blade rotation a humming or some even say swishing sound; and 2) mechanical noise caused by the gears and generators. The latter is usually a wailing sound at higher frequencies and in lower frequencies it is more of a humming sound [8,9]. The mechanical noises are constantly being minimised through new engineering designs, so that the newer the

model the less noisy it will be. In fact modern designs have almost completely removed the mechanical noise through usage of good isolative materials within the nacelle [6]. Therefore the biggest contributor is the aerodynamic noise that is produced. This can also be reduced through two designs: incorporating a pitch control and lowering the tip rotating speed to be below 65 m/s. However, as a precautionary approach when installing a wind turbine in close proximity to commercial or industrial infrastructure, either caution should be taken that these establishments are noisy enough on their own to not be bothered by the external noise coming from the wind turbine, or extra insulation can be added to insulate the buildings from the external noise of the wind turbines [15,16].

## **Low Frequency Noise**

Wind turbines do not generate more low frequency noise than traffic does. In addition, most low frequency noise is not audible by human sensory. The main problem with low frequency noise is that if it is loud enough for the humans to hear it then it can be very annoying [8,11]. A solution is to increase the distance between the rotor and the tower, thereby reducing the low frequency noise. Another solution is to have wings mounted on the blades of the wind turbines in order to make the infrasound inaudible [15,16].

## **Shadowing & Flickering**

Wind turbines produce shadows from the rotation of the turbine blades for short periods of the day at high frequency during early morning and late evening. So the solution can either be to place the turbines next to commercial or industrial infrastructure that does not have much external visibility. Another solution is to install a timer on the wind turbine that would turn it off for the small periods of intense frequency [16,17].

## Reflection

The blades can produce reflective flashes. However, this can easily be solved by making sure the blades have gone through an anti-reflective treatment before being installed [6].

## Conclusions

There are no specific differences in legislation in Sweden and in Denmark for the establishment of wind turbines in commercial or industrial areas. Instead, the regular legislation for wind turbines and buildings within habitation areas applies. So, while in Denmark the Bella Center was established in close proximity to a building this was only possible by an exception to the law. Due to the clearly defined legal regulations in Denmark, setting up wind turbines in close proximity to infrastructure is not possible. However, even though in Malmö the establishment of the wind turbine in close proximity to infrastructure in a commercial area was rejected, there is still the possibility that wind turbines can be set up in commercial and industrial areas with little distance from buildings due to the flexibility in the law that grants the ultimate deciding factor on the municipalities. Municipalities in Sweden are currently reluctant (as demonstrated in the IKEA case) to allow this due to the issues of aesthetic appeal, safety, noise, low frequency noise, shadowing and flickering and reflection. Hence, it is important to demonstrate and convince the individual municipalities that there are ways to solve and mitigate these externalities.

## References

- [1] Swedish Government. (2011). Vindkraft. 02.11.2012 retrieved from <http://www.regeringen.se/sb/d/12245>.
- [2] Lewis, B. (2012). Denmark's Renewable Energy Market Strives To Be Carbon-Free In The Face Of Economic Hardship. The Huffington Post. 19.11.2012 retrieved from [http://www.huffingtonpost.com/2012/05/17/denmark-wind-energy-debt-carbon\\_n\\_1523445.html](http://www.huffingtonpost.com/2012/05/17/denmark-wind-energy-debt-carbon_n_1523445.html).
- [3] U.S. Energy Information Administration. (2010). Levelized Cost of New Generation Resources in the Annual Energy Outlook 2011. 19.11.2012 retrieved from [http://www.eia.gov/oiaf/aeo/electricity\\_generation.html](http://www.eia.gov/oiaf/aeo/electricity_generation.html).
- [4] Pettersson, M. (2006). *Legal preconditions are crucial for wind power expansion*. Licentiate Thesis: Luleå University of Technology.
- [5] Vestas Northern Europe A/S. (2008). *Vestas and Bella Center secures clean energy for UN Climate Summit in Copenhagen (COP 15)*. Local Press Re-lease No. 6/2008.
- [6] Danish Energy Agency. (2009). *Wind Turbines in Denmark*.
- [7] Haugen, K. (2011). *International Review of Policies and Recommendations for Wind Turbine Setbacks from residences: Setbacks, Noise, Shadow Flicker, and Other Concerns*. Minnesota Department of Commerce: Energy Facility Permitting.
- [8] Aalborg Universitet. (2012). New Danish Regulations for wind turbine noise. 10.11.2012 retrieved from <http://www.es.aau.dk/sections/acoustics/press/new-danish-regulations-for-wind-turbine-noise/>.
- [9] Danish Ministry of Environment. Noise from wind turbines. 15.11.2012 retrieved from [http://www.mst.dk/English/Noise/wind\\_turbine\\_noise/noise\\_from\\_wind\\_turbines/](http://www.mst.dk/English/Noise/wind_turbine_noise/noise_from_wind_turbines/).
- [10] Danish Ministry of Environment. Regulations on noise from wind turbines. 15.11.2012 retrieved from [http://www.mst.dk/English/Noise/wind\\_turbine\\_noise/wind\\_turbine\\_regulations/](http://www.mst.dk/English/Noise/wind_turbine_noise/wind_turbine_regulations/).
- [11] Danish Ministry of Environment. Low frequency noise from wind turbines. 15.11.2012 from [http://www.mst.dk/English/Noise/wind\\_turbine\\_noise/low\\_frequency\\_noise\\_from\\_wind\\_turbines/](http://www.mst.dk/English/Noise/wind_turbine_noise/low_frequency_noise_from_wind_turbines/).
- [12] Swedish Government. (1998). The Environmental Code.
- [13] Swedish Government. (2006). The Planning and Building Act.
- [14] Honnson, K., Mathisen, B. & Connolly, D. (2011). *Framework conditions and public regulation for wind turbines in the Öresund Region*. Department of Development and Planning, Aalborg University.



- [15] DTI Sustainable Energy Programmes. (2001). Wind power: environmental and safety issue – Wind Energy Fact Sheet 4. Renewable Energy Enquiries Bureau ETSU.
- [16] SDC. (2005). *Wind power in the UK. A guide to the key issues surrounding onshore wind power development in the UK*. Sustainable Development Commission, London, UK.
- [17] International Finance Corporation & World Bank Group. (2007). Environmental, Health, and Safety Guidelines for Wind Energy.

“Bella Center” photo taken by Hilda Maria Gutiérrez on December 12, 2012, in Copenhagen, Denmark.

# WIND ENERGY

## Public Communication and Strategies to Facilitate Acceptance



By Natalie Cheong & Sarah Beckham Hooff

In European Union Member States, the development of large wind farms is becoming an increasingly popular strategy for meeting renewable energy needs [1], particularly in countries with large wind potential and a tradition of supporting renewable energies. However, some regions have encountered development roadblocks when local community members protest the installation of wind farms [2]. Levels of public acceptance may play a key role in determining the viability of a proposed wind development [3]. As such, both scholars and wind sector practitioners have become interested in better understanding how public acceptance (or rejection) of wind developments is cultivated [4].

Large-scale wind developments are often novel to the residents of regions with high wind potential. It follows that opinions about wind development are in large part based upon the portrayal of the proposed wind project in public media. Depending upon local geographical, social, and political factors, certain arguments for and against the installation of wind parks may be employed more frequently and may be more effective in influencing public opinion. Understanding which arguments are more popular in a region may help to identify key concerns and barriers toward the public acceptance of wind projects in a given region and also to craft more effective strategies for public communication.

Difficulties related to public acceptance of wind projects have been noted in Denmark and Sweden [5]. However, to our knowledge, a methodical analysis and classification of arguments employed by pro and anti wind development interests in Skåne has not been undertaken in the past.

Thus, in an effort to provide insight to the Energy Öresund partners and others interested in the development of wind installations in the Öresund region, this section will outline the most popular arguments employed by both pro and anti wind development groups active in the Skåne region. Past master's students from the region have investigated this topic in general and identified several categories of arguments that typically feature in discussions of wind development [6]. The findings will point out which of these arguments are most prominent in the Skåne region in particular. Further, a discussion of how sample stakeholders in the private, NPO (non-profit organisation) and business sectors perceived these arguments will follow.

This investigation will provide insight and guidance to Energy Öresund partners, allowing them to enhance their ability to effectively communicate with the public to encourage the acceptance of wind development. While past advisory reports for Energy Öresund by the Institute of Industrial Environmental Economics (IIIEE) have focused on relationships between partners and corporations, this research

herein will address relationships between Energy Öresund partner organisations and the public at large, thus filling an important gap in understanding.

## Research Methods

Investigation into arguments surrounding the wind development debate in Skåne was undertaken in two steps:

1. Initially, we conducted a review of relevant online print materials related to wind development in Skåne;
2. After gaining an understanding of how the wind development debate is represented in the public media, we moved on to interview relevant stakeholders.

### *PART 1: Review of Articles*

Our initial review of print materials about wind development in the Öresund region was guided by web searches and suggestions provided by academics at the IIIIEE and Skånes Vindkraftsakademi (the Wind Academy Skåne). Publically available materials produced by wind energy companies were also sought out. The Lillgrund pilot project of Vattenfall was taken as a special case study, and together with this case study, Swedish news articles available online were reviewed with the Google Translate service. The main arguments for and against wind development in Skånian communities were noted.

After reviewing all of the mentioned materials, we attempted to make broad generalisations about the most commonly featured arguments attributed to both pro and anti interests. The identification of categories was based upon the schematic classification of arguments discussed in the master's thesis of Elizabeth Devlin (2002).

### *PART 2: Interviews*

We conducted interviews with stakeholders representing various interests in the Skåne region. Representing industry interests was Mr. Andrén-Sandberg, business developer at the Lunds Energi Group. To capture the views of the NPO sector, we actively corresponded with and interviewed Ms. Tibbelin of Skånes indkraftsakademi. Finally, to understand the views of anti wind protesters, an interview was held with Mr. Bentz, a bird watcher from the Skåne Ornithological Society who provided his own personal views. Interviews were held in person or by telephone, and recorded when possible.

### Results of Article Review

After reviewing the online news items and sample materials, arguments that were mentioned most often in these materials were identified. The Masters thesis of a Lund University student, Elizabeth Devlin (2002) was used to categorise pro and anti wind arguments and identify broad categories of arguments.

As highlighted in the figure below modified from Devlin (2002), we concluded that the *most popular anti arguments* include those related to: landscape, noise, and proximity of the turbines.

The arguments found in the case study from the Vattenfall Company were likewise reflected upon and compared to the categories found in Devlin. As depicted below we noted the *most popular pro arguments* focused upon: the preferable nature of wind relative to alternative energy sources, CO<sub>2</sub> savings, local production, and the goal of meeting required environmental targets.

It is with this “hypothesis” ranking of the most important pro and anti wind development arguments that we began to interview regional stakeholders.

## Results of Interviews

There are general themes which each stakeholder group identified as important in the wind development debate in Skåne. However, profound differences between how said stakeholders identify and perceive key arguments were also noted.

### Anti Wind Arguments

During our interviews, each interviewee was requested to identify the top three arguments used by the anti wind development interests. As expected, each of the three interviewees identified concerns involving the landscape of the Skåne region as important. However, similarities between the responses of the interviewees ended there. There was little observed consensus about important anti arguments; rather, the arguments pointed out by the stakeholders were typically ‘pet’ concerns. That is, interviewees mentioned those arguments, which are encountered most often by the organisation the interviewee is affiliated with. For example, Mr. Bentz, a bird-watcher from the Skåne Ornithological Society, included in his discussion of important arguments the impact of wind turbines on migratory birds, while this concern was not mentioned by other interviewees; Mr. Andrén-Sandberg placed particular emphasis on the anti-wind argument that wind power is

not needed as an alternative to fossil-fuel or hydro energy sources, an argument which he encounters as a developer of the Lunds Energi Group’s wind projects; Ms. Tibbelin was unique among our interviewees in mentioning from the start very specific arguments related to wind turbines. These include for example, blinking lights and shadows. Her organisation hosts an archive of news features on wind development and protest from the region, which often mention such site-specific arguments.

As such, two broad observations can be made regarding the stakeholder perception of anti wind development interests:

- Firstly, it is apparent that the full range of anti stakeholder concerns is not being expressed in all types of publically available media. During our interviews, several arguments featured against wind development which did not feature prominently in the regional press; and
- Secondly, the interviews elucidated the fact that the anti wind movement in the Skåne region is both:
  - a) Relatively diverse, with many different arguments against the development of wind; and
  - b) Not understood in the same way by all relevant stakeholders. Each of our inter-

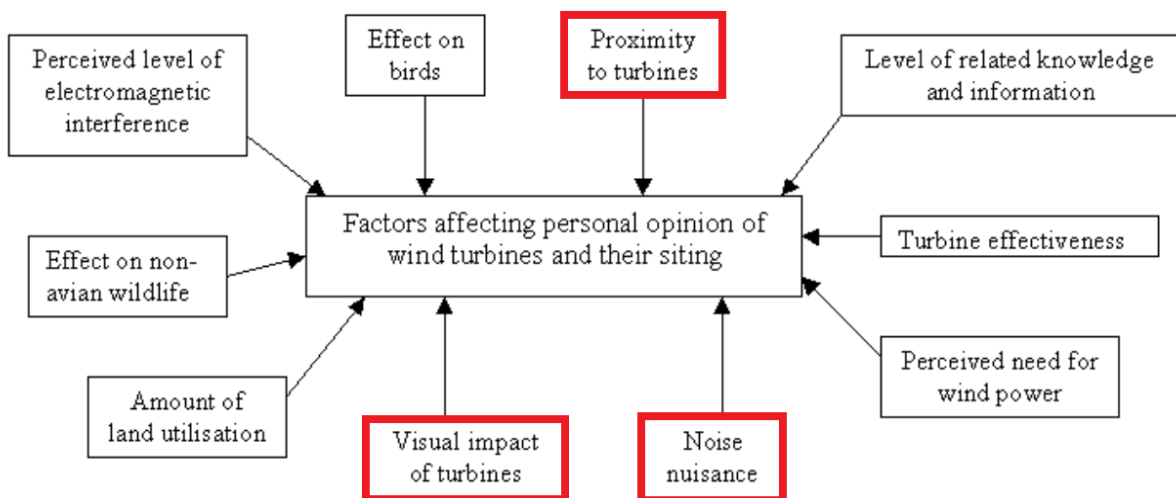

Key anti-wind arguments in the Skåne region. Figure modified from Devlin (2002) [6].



viewees is active in the wind development debate in Skåne. Their lack of general agreement about the basic nature of the protest movement suggests that each stakeholder understands the problem in a unique way.

Thus, while there is broad agreement about the importance of the landscape in the debate, the other arguments are diverse and unique to each stakeholder. This has the potential to create significant challenges related to the effective communication of pro wind arguments. In short, the potential for pro wind parties to ‘miss-the-point’ while engaging in debate with anti wind interests is enhanced.

### Pro Wind Arguments

The opinions of our interviewees regarding the nature of pro wind arguments were solicited during interviews. Several commonalities among the specific arguments which were mentioned by stakeholders were identified.

However, it was notable that two interviewees mentioned the use of similar argumentative strategies. These interviewees described a situation in which highly specific, fact-based arguments are provided to anti wind protesters. This argumentation style was mentioned during

discussions of how pro wind interests are often faced with the challenge of countering the largely ‘illogical’ concerns/arguments of local community members. Both stakeholders mentioned the importance of the initial information-provision phase of the development process, and one stakeholder discussed the distribution of ‘FAQ’ sheets containing facts designed to dispel intuitive, rather than fact-based, protestations.

There is a prevalence of using a ‘reactionary’ strategy to respond to specific arguments made by the anti wind proponents is dominant. What was noted was the absence of ‘broader’ environmental arguments, such as the moral imperative of individuals to support renewable energy. In the Vattenfall case study materials, broader environmental themes, like CO<sub>2</sub> savings and alternative energy sources, were frequently mentioned and formed the backbone of the pro wind argument.

As such, two broad observations about the perception of the pro wind development position in Skåne can be made:

- Firstly, there is little agreement among stakeholders about what the main arguments of the pro wind development position are in Skåne, although offering fact-

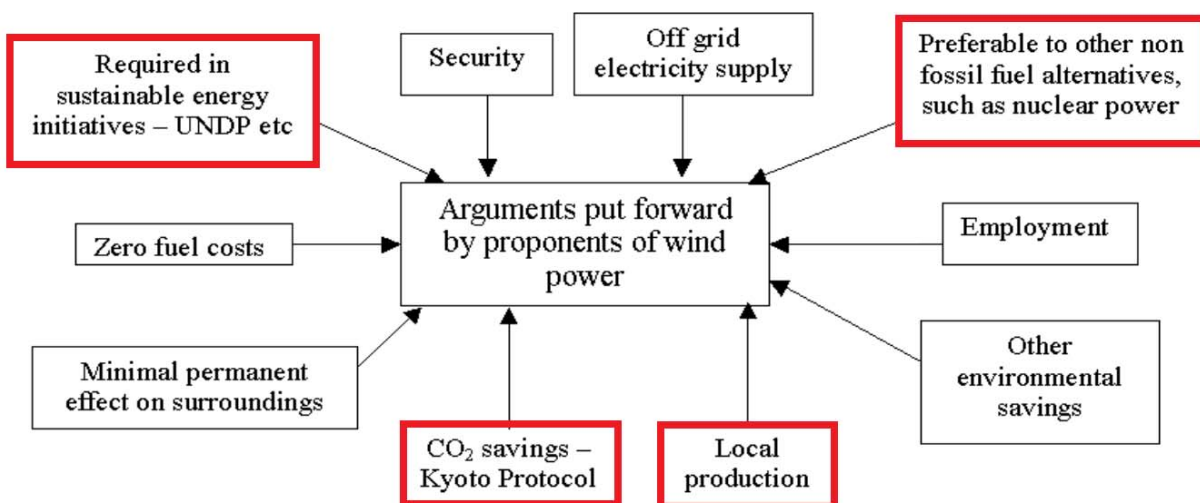

Key pro wind arguments in the Skåne region. Figure modified from Devlin (2002) [6].

based rebuttals to local concerns seems to be a common strategy for “promoting” wind development; and

- Secondly, while broad environmental themes were featured in some general pro wind literature produced in Skåne, stakeholders rarely mention these arguments. This suggests that environmental arguments are not as influential and perhaps therefore not as well understood by all stakeholders, as might be expected.

Thus, there is again evidence of a lack of clarity in the wind debate in Skåne. In such a context, there is a high potential for pro wind interests to provide irrelevant or ineffective information to stakeholders. This risk is enhanced by the apparent popularity of a public communication strategy focusing on the reactionary provision of facts about wind turbines. There is also the danger that if the reactionary approach is followed, the broader environmental themes capable of motivating the acceptance of local wind turbines, and of wind power, as a viable energy alternative in general, will cease to be understood by the public.

## Results Summary

To summarise the results of our data collection, it is possible to highlight the reactionary nature of the Skånian debate over wind development. The wind development debate in Skåne can be generalised into two reactionary discourses:

- (a) Anti wind interests are reacting negatively to wind farm proposals in specific locations while;
- (b) Pro wind interests are reacting to the specific arguments, which are typically provided by local communities with specific and fact-based information.

In general, broader environmental themes are not included in these reactionary discourses. Pro wind interests’ communication strategies

may become highly homogenised through the provision of ‘FAQ’ sheets and similar fact-based materials intended to neutralise opposition. Given the broad goal of promoting wind energy in the region, a risk that a stylised and reactionary communication strategy may have the ultimate effect of prolonging the trend for local opposition to wind development, while also stunting the public’s acceptance and understanding of wind power in general.

## Recommendations

The following recommendations for furthering public acceptance of wind development have been themed into three main categories, including: (i) improving social legitimacy (ii) improving communication methods and (iii) improving communication content. These recommendations include broader strategic recommendations as well as specific ones.

### I. Social Legitimacy

*Increase the public service value of the area.* A net social disbenefit is often perceived by anti wind proponents. Developing wind-turbine sites into recreational areas for the public is a social good that could increase social legitimacy. This could be especially useful when brownfield sites that have been ecologically damaged are rehabilitated. Geographic Information Systems (GIS) would be key in identifying wind-suitable areas that overlap with brownfield sites.

*Resolve issues regarding transparency of biological surveys.* There is currently a perceived lack of transparency between wind companies and consultancy companies who conduct biological surveys of an area to examine site-suitability for windmills. These studies could be made more transparent and open to public input.

*Improve the neutrality of dialogue platforms.* Skånes vindkraftsakademi, the existing platform to facilitate dialogue between stakeholders, is perceived by anti wind proponents as biased towards wind development. This hinders the

process towards negotiation of a suitable outcome. Efforts should be made to modify the neutrality and image of the existing platform; alternatively, a new platform for negotiation should be developed.

## II. Communication Methods

*Develop a tiered response system.* Divide the budget for advertisement into two stages to more adequately meet the information demands of stakeholders. This will allow the company to identify information gaps that stakeholders demand, which were not been adequately covered by the first-stage advertisement. The second advertisement campaign can thus bridge these gaps. This is known as a tiered response system.

*Develop context-specific stakeholder responses.* Stakeholders, which may include NPOs, interest groups and residents, have varying needs. Developing stakeholder-specific responses that demonstrate understanding towards their demands is essential. Responses should therefore go beyond fixed-answer FAQs and should be tailored to the context.

*Broaden communication with the press.* Communication with the press is at present reactionary for both pro and anti interests. It is recommended that communication with the public via the media also occur for the purpose of education. These articles will provide the opportunity to include broader arguments that speak to the development of wind as a moral obligation of society. These arguments are at present missing in the wind development discourse.

## III. Communication Content

Communication content recommendations are part of the broader environmental arguments that require more emphasis in the media discussion. It is recommended that they should be included in the press to improve communication with stakeholders. These include:

- *Highlighting potential for neutrality* to stakeholders by demonstrating that laws have and will prevail if bias towards a particular interest group is present. Cite cases, for example, where the judge overruled a decision to develop wind-turbines because the biological survey of the area was found to have been biased. This will serve to increase the public's trust in both the corporate, political and legislative systems;
- *Explaining the rationale for government subsidies for wind development;* and
- *The moral imperative of society* towards accepting renewable energy sources.

## Limitations

While we feel confident that our findings and conclusions can contribute to an increased understanding of the wind development debate in the Skåne region, our insights have been limited by several factors. This includes research scope, time limitations, and language barriers. The scope was limited by access to material and scope of material covered. Together with time limitations, this may not encompass all discourses in the media. Finally Google translate was used to translate news articles and documents from Swedish to English. This we felt was adequate for its purpose, as we required only the key arguments of articles.

## Conclusion

This article has outlined the main pro and anti arguments found in print media. It has supplemented these findings by interviewing stakeholders, and from this, developed recommendations for wind companies to increase public acceptance for wind development.

## References

- [1] EWEA (European Wind Energy Association). (2011). *2011 European statistics*. Available from:

- [http://www.ewea.org/fileadmin/files/library/publications/statistics/Wind\\_in\\_power\\_2011\\_European\\_statistics.pdf](http://www.ewea.org/fileadmin/files/library/publications/statistics/Wind_in_power_2011_European_statistics.pdf). Accessed 13/10/2012.
- [2] Bernadi. (2012). *732 websites protesting wind turbines*. Available from: <http://www.windturbinesyndrome.com/2012/732-websites-protesting-wind-turbines-the-world/?var=wts>. Accessed 20/10/2012
- [3] Devine-Wright, P. (2004). Beyond NIMBYism: towards an integrated framework for understanding public perceptions of wind energy. *Wind Energy*, 8, 2, 125-139.
- [4] Jobert, A. Laborgne, P. & Mimler, S. (2007). Local acceptance of wind turbines in Sweden. *Multi Science Publishing*, 29, 6, 503-511.
- [5] Söderholm, P. & Pettersson, M. (2007). Wind power development in Sweden - Global policies and local obstacles. *Renewable and sustainable energy reviews*, 11, 365-400.
- [6] Devlin, E. (2005.) Factors affecting public acceptance of wind turbines in Sweden. *Multi Science Publishing*, 29, 6, 503-511.

“Windy girl” photo taken by Annette Greenfort at Dansk InfoDesign. Photo undated.



# HYDROGEN FUEL CELLS

## Storage of Energy from Intermittent Renewable Sources

By Paulina Aguilera & Rowena Mathew



The current energy system in the Öresund Region faces the challenge of coping with energy availability during critical periods of high demand [1]. The increasing use of renewable energy sources (RES) and its intermittent supply fosters the exploration of new technologies that can contribute to stabilise the energy supply from RES. Therefore, energy storage plays a key role as a system benefit, integral to the successful realisation of a carbon neutral goal.

Hydrogen has different applications in the energy sector. However, this section will only focus on hydrogen fuel cells (HFCs) for electricity storage.

Questions to consider in storage systems are:

- What type and size of storage are required?;
- How often should the storage system be charged/discharged?; and
- What are the costs and benefits?

Wherever relevant, these points have been addressed in the discussion of the various technologies related to hydrogen fuel cells.

The importance of energy storage from intermittent renewable sources has already been outlined above and this section further explores chemical energy storage using HFC technologies. The following pages will cover a brief overview of current HFCs, the rationale behind choosing them, their applicability in different sectors and their practical application

in the Hydrogen Community in Lolland, Denmark.

### Brief Picture of Hydrogen

The use of HFCs for electricity storage has developed at different paces due to the energy policy-making in Sweden and Denmark [2]. The public authorities' interest in hydrogen technologies varies depending on the energy mix of each country, since this determines the resources that they can potentially include to develop more efficient energy strategies and achieve their own environmental goals.

Denmark, for instance, is expected to raise its electricity production coming from RES from 33.3% in the year 2010, to 46.2% by 2015 of which 32.4% will come from wind [3]. The energy prices in Denmark are already showing negative trends, and if the share of wind increases for electricity production, the risk of having volatile electricity prices will also increase [4]. Therefore, there is stronger regional and national support for projects related to the exploration of hydrogen technologies for energy storage.

In the case of Sweden, RES have already reached a 45.0% share of energy production in 2009 [5]. From that amount, 46.9% comes from hydro, and 12.0% from cogeneration. Wind turbines, in contrast, only generate 1.4% of the total share of energy production [6]. For this reason, Sweden has a lower incentive to

accelerate the exploration on hydrogen technologies for electricity storage at a national level.

Even so, there are several ongoing hydrogen research projects in Sweden supported by two institutions: Vätgas Sverige (a Swedish public private partnership), and H<sub>2</sub>Skåne (a regional project) [7]. The region of Skåne is particularly interested in expanding research on hydrogen fuel cells as a potential for energy storage [7].

The Öresund Region is challenged with adopting the Danish and Swedish energy efficiency policies, coping with the different contexts in each country. However, both countries share common goals for developing projects aimed to becoming the first carbon neutral region.

Recently, Skåne and Copenhagen signed a memorandum of understanding (MoU) with Nordic non-governmental organizations (NGOs), hydrogen infrastructure companies and car manufacturers (Hyundai, Honda, Toyota and Nissan), to strengthen the market for hydrogen and fuel cell electric vehicles (FCEV) in Scandinavia [8]. This is proof that hydrogen technologies are building up trust within the Scandinavian countries, and signals the importance that further research needs to be done.

## Why HFCs?

Hydrogen production is one of the promising ways to store large amounts of intermittent renewable energy for short or long term. The integration of hydrogen technologies in renewable energy systems has been carried out worldwide since 1970.

Hydrogen can be produced in several ways – isolated as an industrial by-product (from chlor-alkali or petrochemical plants), or by using renewable energy (from wind and solar)

*Hydrogen fuel cell electricity generation.*

to split water using an electrolyser. This section focuses on the latter.

Among hydrogen production technologies, electrolysis is the most established with alkaline electrolysers as the leading device. Once obtained, hydrogen can be stored in a gas tank to generate electricity through fuel cells. With only water as the by-product H<sub>2</sub> provides considerable overall environmental benefit along the supply chain (“well-to-wheel”) in terms of pollutants and greenhouse gases emissions compared to the conventional energy supply [9].

Hydrogen also has high energy density per unit mass. Its low boiling point makes liquefaction very energy intensive but decreases transportation costs, as it is stored as compressed gas [9].

Energy efficiency of conversion averages 35-45% but can be up to 50% (though the combined wind-HFC efficiency is 80%). This is a low figure with respect to other available alternatives (e.g. batteries have round trip efficiency of 72-78%) and the costs remain too high. The break-even efficiency of HFCs ranges between 55-60% [10].

## Operation of HFCs

Hydrogen is an element that is hardly found in its pure state in the environment because of its high reactivity with other elements [4]. Although hydrogen is present in water (H<sub>2</sub>O), it is also present in hydrocarbons that are commonly used as fuels such as methane (CH<sub>4</sub>), ethane (C<sub>2</sub>H<sub>6</sub>), propane (C<sub>3</sub>H<sub>8</sub>), butane (C<sub>4</sub>H<sub>10</sub>), methanol (CH<sub>2</sub>OH), and ethanol (C<sub>2</sub>H<sub>5</sub>OH) [11].

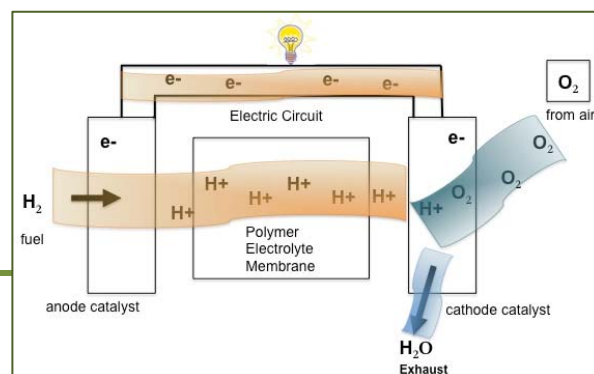

Nevertheless, the intention of using HFCs is not to promote the use of hydrocarbons as its main input, but the use of cleaner sources such as H<sub>2</sub>O, or even the H<sub>2</sub> that can be found in petrochemical industries as a by-product [12]. In Stenungsund, Sweden for instance, companies such as Ineos Chlor Vinyls are already researching the use of H<sub>2</sub> for fuel cell applications [12].

The diagram on the previous page shows the basic process of a HFC utilising the surplus of electricity coming from RES. The main components needed for the HFC to operate are H<sub>2</sub>O, and electricity. The electricity is used to split the water molecule via electrolysis into its two basic components H<sub>2</sub> (hydrogen), and O<sub>2</sub> (oxygen). The O<sub>2</sub> is released into the atmosphere (or can be utilised for waste management systems) [13], whereas the H<sub>2</sub> is stored in the fuel cell until the electricity is required. A HFC generates electricity through a chemical process when the H<sub>2</sub> reacts with O<sub>2</sub>.

The fuel cell consists of two flow plates built

around a Membrane Electrode Assembly (MEA) [14]. When the H<sub>2</sub> comes into the fuel cell (anode), and the O<sub>2</sub> is taken inside the fuel cell from the other side (cathode), the H<sub>2</sub> is forced through a catalyst where it is ionised [14].

The electrons from the H<sub>2</sub> then pass through an external electric circuit where electricity can be harnessed from their flow on their way to the cathode. At the cathode, oxygen reacts with the protons and electrons, and produces H<sub>2</sub>O as the main by-product, along with heat [14].

### Cost Estimation

The ongoing research and development (R&D) on hydrogen fuel cells technologies makes it difficult to have a real estimate on the costs of implementation. Based on the Lolland study case, in Denmark, the company IRD manufactured the first micro combined heat and power (CHP) unit with a selling price of EUR 760 000, and EUR 53 200 for the second line of production [15]. IRD aims to reach a selling

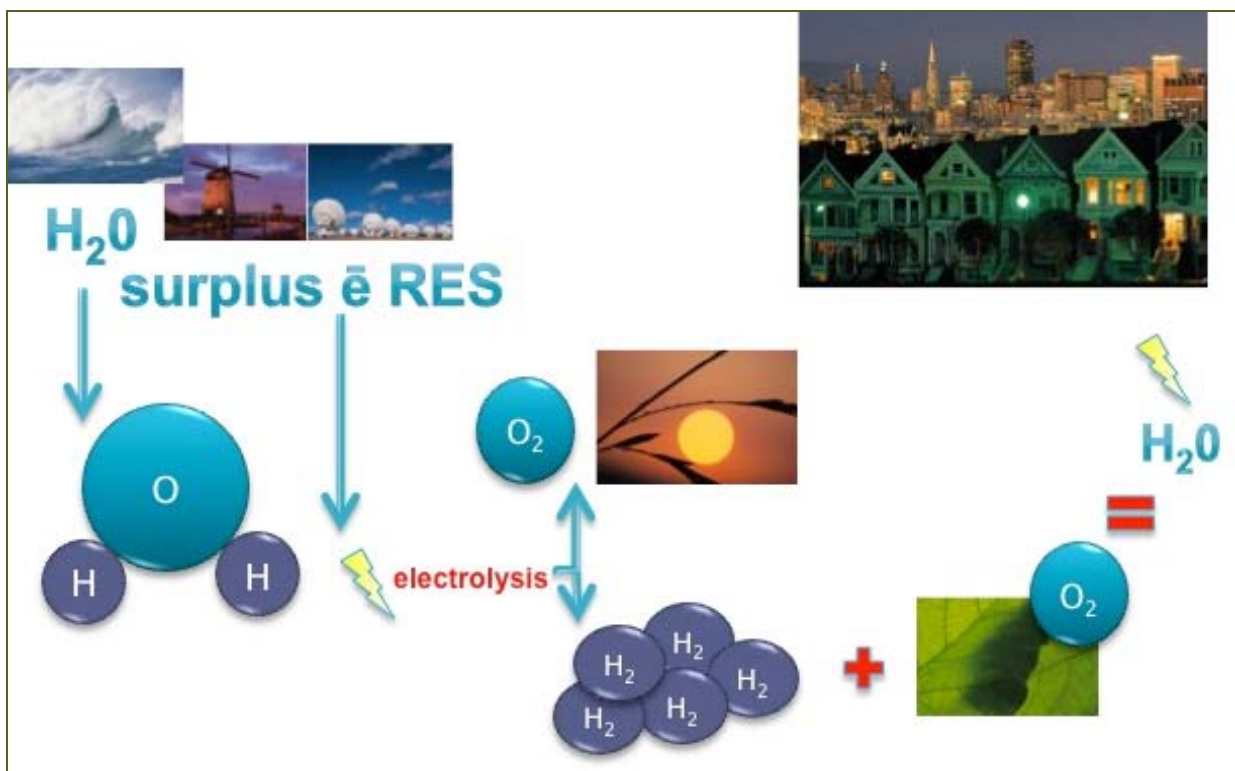

Basic diagram of the functioning of a hydrogen fuel cell.

price of EUR 10 000. They are doing further research on microelectrolyser new units, which can have a combined electrolysis [15]. This is one example of investments in R&D leading to more competitive prices in the HFC technology. IRD has managed to reduce the price of the second line of production to only 7% of the first micro CHP price, using the first price of the micro CHP as a baseline year. If they reach their target price of EUR 10 000 it will be around 1% of the initial price. Therefore, rough estimates can be made at this point about the prices of hydrogen fuel cells as they become competitive.

## **Sector Applicability**

The sectors in which HFCs are used are:

1. Transport;
2. Combined Heat and Power (CHP); and
3. Uninterrupted Power Supply (UPS).

Large-scale use of HFCs are for energy management, medium-scale for consolidation, distribution asset replacement and ancillary services, and small-scale for customer benefits.

**Transport:** This is the sector in Sweden which is most dependent on oil and least able to achieve clean emissions from fuel combustion [7].

The HyFLEET project was an operation of 33 HFC-powered buses in nine cities around the world from 2006-2009. The buses performed well in a wide range of climatic and geographic conditions from hot and dry in Madrid, to cold and humid in Reykjavik; flat in Hamburg, hilly in Luxembourg; congested in London to full speed in Perth. Ambient temperatures ranged from - 5 °C to 36 °C. Fuel consumption was 21.9 kg per 100 km and average speed was 16.4 km/h. These buses had very low noise and low costs over lifetime, while their operating costs reduced over the period of the project [9].

HFC cars have also performed reliably and demonstrate much higher fuel efficiency than that of conventional internal combustion en-

gines (ICE) cars. The electromobility associated with HFC electric vehicles (HFCEVs) is better as compared to batteries because the fuel cells are lighter and require to be charged less often, leading to a longer drive period [16]. However, these vehicles have had 99% of their travelling below 120-150 km/h [4].

There have been major events in the hydrogen transport field in the past five years:

In 2009, Daimler, Ford, GM/Opel, Honda, Hyundai/Kia, Renault, Nissan and Toyota signed a MoU (as was discussed previously) that they will have a series of hydrogen cars for sale by 2015. The car industry's joint statement points to a larger hydrogen role in the automotive industry in the future.

Scandinavian Hydrogen Highway Partnership, in collaboration with Hydrogen Link, Denmark aims to make Scandinavia one of the first regions where one can drive a fuel cell electric vehicle and fill it up with hydrogen on a commercial basis. Around 20 HFCEVs are used on a daily basis in Denmark [12].

The four regions of Skåne, Halland, Västra Götaland and Värmland are members in HyER, the European Association for Hydrogen and fuel cells and Electro-mobility in European Regions.

**Micro-CHP:** An example of the use of hydrogen as primary energy source for domestic consumption was seen on the island of Lolland-Falster, Denmark. A detailed description of the technologies utilised has been used as a showcase for the applicability for HFCs. The micro-CHP in these houses have decentralised electricity generation capacity of 2 kW and 2 kW for heat [13,15]. They provide the same amount of energy as an ordinary domestic boiler. The fuel cell unit is installed as a secondary facility in the house and connected to the existing energy facility. The hydrogen supply is adjusted for each individual household and surplus electricity is sold back to the public electricity grid.

Additionally, an adequate hydrogen distribution network (micro-grid) has been developed to connect each household to a centralised electrolyser, running on wind power.

However, micro-CHP for hydrogen may not be as feasible when electricity is expensive and gas is cheap, because the alternative natural gas grid will work out to be more economical [2].

**Uninterrupted Power Supply (UPS):** This can be used for supporting grids or in industries for backup power for operations.

It has larger scale energy storage capacity over longer periods of time, compared to other energy storage systems like batteries [2]. High power and flow batteries have maximum power of up to 5 MW and stored energy of up to 10 MWh. Hydrogen on the other hand can have maximum power up to 10 GW and stored energy of up to 10 GWh. Larger storage for hydrogen fuel cells are also cheaper because of up scaling, batteries operate at a loss despite being more efficient (refer to figure below) [17].

The HFC-UPS systems interact with the power grid at transmission level and operate on diurnal cycle of charge and discharge. Another interaction with the grid is to respond within minutes to compensate for generation or transmission outages and accommodate some of the utilities’ spinning reserve requirements, though the ancillary service market is still in its infancy.

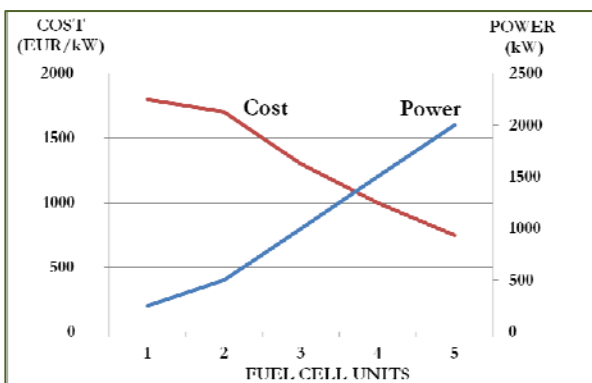

For on the ground practical systems, the Robust Project will demonstrate how HFCs function in a system for backup power. The demonstration system is developed jointly by two Göteborg companies; the fuel cell company PowerCell Sweden and FOAB, along with Vätgas Sverige. This emergency power system will have an output of around 5 kW. This kind of HFC technology is ready for commercialisation [12].

## Lolland Hydrogen Community

The island of Lolland, Denmark has had many years of experience in implementing renewable energy projects like the Hydrogen Community. This Community is located on the western part of the island where five private hydrogen powered houses have existed since 2009, and by January 2013, there will be 35 [15]. The triple helix development strategy is a concept of the Lolland Community Testing Facilities (CTF) which has been credited with this successful implementation. This developmental strategy facilitates a forum between the private sector, research institutions and local political authorities by exploiting synergies between green investments and providing an international testing and demonstration platform [13].

The main Lolland CTF objectives are:

1. Offering financial incentives to private industries working with carbon dioxide neutral technologies;
2. Developing new integrated solutions through public-private partnerships; and
3. Offering educational and research programs e.g. the demonstrative Hydrogen

*Inverse proportionality of cost and power in hydrogen fuel cells [17].*



House. The demonstration was within the structure of the Danish Energy Agency, aiming at developing and producing Danish (from company IRD) market-ready hydrogen technology, components and fuel cell systems [13].

By making renewable energy a growth driver, CTF brought about concrete benefits to the inhabitants, municipalities and private businesses (refer to Table below). The returns on these clean investments have made Lolland acquire clean-tech expertise and business opportunities [13]. The Lolland residents also pride themselves on being environmentally conscious and being the testing ground for renewable energy based local development [15].

Synergies at various levels drive this entire community – with hydrogen specifically at the technical level. The surplus of wind power available at night, instead of being sold for low prices outside of the island, is used for hydrogen production and storage, via electrolysis. The oxygen obtained is used to increase efficiency of water purification in municipal water treatment plant. These system synergies contribute to the energy sector being highly efficient and well integrated.

## Conclusion

Storage of intermittent renewable energy is an important discussion topic currently and in the future, especially for countries like Sweden and

Denmark that have a significant share of energy coming from renewables. HFCs for storage are important as they are able to support

base load, improve reserves and flexibility, provide heating to houses and contribute to transport sector emissions reductions. However, the urgency for storage differs between Sweden and Denmark, due to different sources and electricity pricing.

Though storage is a flexibility option, it competes with grid extension, and due to its small deployment rates and partial technical immaturity, it is not the most economical option yet. Major challenges to overcome are of high costs and low efficiency. With the Lolland-IRD micro-CHP units, real examples have been seen through economies of scale helping to reduce costs. There is still a lot of potential that has been recognised in many instances with increasing funding for R&D in private-public ventures and national and regional goals.

However, there is no single silver bullet, and there are several technologies that come into use for storage of intermittent energy. The aim of this section was to provide an objective view on the current situation related to HFCs in the Öresund and other similar regions. The section has also aimed to provide an idea about the potential applicability of such technologies for storage in the Öresund Region.

BENEFITS TO EACH ACTOR WITHIN THE TRIPLE HELIX FRAMEWORK IN LOLLAND		
INDUSTRY	RESEARCH	GOVERNMENT (EU/NORDIC)
Low-cost testing and demonstration on real environment, systems and people	Research with full scale application	Bottom-up tool for achieving macro-political goals for sustainability and competitiveness
Faster product commercialisation	Socio-economic impact analysis	Growth beyond metropolises (Lolland is considered a peripheral region [13])
Branding	Well defined geography, demographics, economy, energy grid/system	Retain population, jobs and improve utility services by focusing on local resources (people, land, natural elements, waste)

## References

- [1] International Institute for Industrial Environmental Economics [IIIEE]. (2011). *Energy Futures Oresund – Bridging the gaps to a greener tomorrow*. Lund: IIIEE.
- [2] Wiberg, E. (2012, December 11). Hydrogen fuel cells and its use implications. Malmö, Sweden. Personal communication in an informal interview.
- [3] Danish Energy Agency. (2010). *Danish Energy Agency's preliminary statistics*. Copenhagen: Danish Energy Agency.
- [4] Vad Mathiesen, B. (29 November 2012). Aalborg University. Fuel cells and electrolyzers in future energy systems (R. Mathew, & P. Aguilera, Interviewers).
- [5] Swedish Institute. (2011, February 01). Energy: Generating power for a sustainable future. Retrieved December 14, 2012, from SWEDEN.SE: <http://www.sweden.se/eng/Home/Society/Sustainability/Facts/Energy/>
- [6] World Nuclear Association. (2012, November 01). Nuclear Energy in Sweden. Retrieved December 13, 2012, from Swedish Nuclear Power: <http://www.world-nuclear.org/info/inf42.html>
- [7] Cornander, A. (2012, December 11). A scope of the inclusion of hydrogen fuel cells technology in Sweden. (R. Mathew, & P. Aguilera, Interviewers)
- [8] Scandinavian Hydrogen Highway Partnership. (2012, October 09). Toyota, Nissan, Honda & Hyundai sign MoU on market introduction of fuel cell vehicles in Nordic Countries. Retrieved December 13, 2012, from Scandinavian Hydrogen: <http://www.scandinavianhydrogen.org/shhp/news/toyota-nissan-honda-hyundai-sign-mou-on-market-introduction-of-fuel-cell-vehicles-in-nor-0>
- [9] HyFLEET:CUTE (n.d.). A report on the achievements and learnings from the HyFLEET:CUTE Project 2006-2009. URL: [http://hyfleetcute.com/data/HyFLEETCUTE\\_Brochure\\_Web.pdf](http://hyfleetcute.com/data/HyFLEETCUTE_Brochure_Web.pdf). Accessed: December 2012.
- [10] Tina, G. & Brunetto, C. (2010). Short-term scheduling of a wind generation and hydrogen storage in the electricity market. *European Transactions on Electrical Power* 20, 559-574.
- [11] College of the Desert. (2001). *Hydrogen Fuel Cell Engines and Related Technologies; Module 1: Hydrogen Properties*. College of the Dessert. Monterey, CA: College of the Dessert.
- [12] Vätgas Sverige. (2012). Hydrogen and Fuel Cell Guide of Sweden.  
URL: [http://jom01.webadmin1.net/~cu-jdkbtx/images/stories/pdf/VatgasSverigeBranchkatalog\\_lagupplost.pdf](http://jom01.webadmin1.net/~cu-jdkbtx/images/stories/pdf/VatgasSverigeBranchkatalog_lagupplost.pdf). Accessed: December 2012.
- [13] Magnoni, S. & Bassi, A. (2009) Creating Synergies from Renewable Energy Investments, a Community Success Story from Lolland, Denmark. *Energies* 2009, 2, 1151-1169.
- [14] IRD. (2012, January 01). *How do fuel cells work?* Retrieved December 13, 2012, from IRD: <http://www.ird.dk/FAQ/How-does-fuel-cells-work.aspx>
- [15] Christensen, L. (27 November 2012). Vice-President at Lolland Energy Holding A/S. Personal communication during site visit at Onsevig Climate Park, Lolland.
- [16] European Commission. (n.d.). Mobility and Transport. URL: [http://ec.europa.eu/transport/themes/urban/vehicles/road/hydrogen\\_en.htm](http://ec.europa.eu/transport/themes/urban/vehicles/road/hydrogen_en.htm). Accessed: December 2012.
- [17] Hauptmeier, E. (2012). ACI Energy Storage Conference, Luxemburg. Presentation on “Energy Storage within a Utility Strategy” accessed in December 2012.

“H2 Hydrogen House” photo taken by Paulina Aguilera on November 27, 2012 in Lolland, Denmark.

“Hydrogen fuel cell electricity generation” diagram created by Paulina Aguilera.

“Basic functioning of hydrogen fuel cell functioning” diagram created by Paulina Aguilera.

“Inverse proportionality” graph created by Rowena Mathew.

# BIOGAS FOR TRANSPORT

## Promoting the World's Most Environmentally Friendly Vehicle Fuel



By Alex Leshchynskyy & Birgitta Stefánsdóttir

Today the European transport sector remains 95% dependent on fossil fuels, and thus accounts for as much as a quarter of all of the EU's CO<sub>2</sub> emissions [1,2]. In the face of rising global oil prices and the recent extension of the Kyoto Protocol until the year 2020 at the Doha UN climate talks, it is evident that a transition towards less greenhouse gas (GHG) intensive transportation is not only high on the global environmental agenda, but is also indispensable for the overall competitiveness of the EU economy [3]. The promotion of cleaner fuels for public and private mobility is an undeniable requisite for achieving this transformation.

Fuels derived from biogenic material are known to offer a cheap, abundant and locally-produced fuel alternative. It is thus not surprising that the EU Member States are already striving to achieve a "10 % minimum target for the share of biofuels in transport petrol and diesel consumption by 2020" [4]. This move is expected not only to reduce immediate GHG emissions, but also to diversify the EU's fuel supply and thus create novel job opportunities [2].

Among the variety of biofuels available today, waste-derived biogas certainly stands out due to its undisputable environmental performance, and possibility of abundant local production. The gas is comprised largely of methane (CH<sub>4</sub>) (as well as carbon dioxide (CO<sub>2</sub>), and small

amounts of hydrogen sulphide and ammonia) produced by anaerobic digestion of biodegradable agricultural, industrial and municipal waste material. This means that compared to other modern biofuels, the production of biogas presents no conflict with agricultural land and is not associated with the environmental impacts of growing crops specifically for fuel [5]. What is more, methane is a renewable fuel that can be used to replace fossil fuels in heat and power generation as well as vehicle propulsion. Simultaneously this reduces the volume of waste that would otherwise have to be managed. Finally, the production of biogas creates a residual nutrient-rich digestate that can be utilised as an agricultural fertiliser – thereby ensuring a sustainable eco-cycling of nutrients [6].

There is a large body of evidence to suggest that the biggest environmental benefits are observed when biogas is used as a vehicle fuel [6,7]. Vehicles powered by biogas indeed emit significantly lower amounts of CO<sub>2</sub>, nitrous oxides (NO<sub>x</sub>), non-methane hydrocarbons (NMHC), fine particles and soot – even when compared to the most modern diesel engines fitted with particle filters [8]. Despite the fact that that biogas remains a marginal fuel in global transportation, there is evidence to suggest that consumer interest as well as overall commercial availability of biogas can be encouraged by the adoption of this fuel by the public sector [9,10].

The Scandinavian region of Öresund presents an excellent case study for the development and transfer of biogas-for-transport strategies. While the Swedish region of Skåne has a widely biogas-powered regional public transport sector, the neighboring Danish region is struggling to increase the penetration of this green fuel. This is somewhat surprising considering that Denmark has one of the most pro-active climate change mitigation policies in the world [11]. This section will investigate how and why the Swedish part of the Öresund region was capable of improving and utilizing its biogas infrastructure to the levels observed today, and whether there are any lessons that could be utilised by Danish policy-makers in promoting the use of biogas in domestic transportation.

## Findings

The following findings are based on numerous interviews with stakeholders on both sides of the Öresund along with a short review of domestic policies. The aim is to explain the differences between the two areas concerning the production and use of biogas. The findings are summarised in the table below.

### *Domestic Energy Sources*

To understand why there are such strong disparities in biogas production and distribution, one must first consider the broader context of domestic energy security within the two countries. Despite historical and cultural similarities, Denmark and Sweden differ greatly in terms of resource availability.

When considering electricity generation, Sweden currently derives its electricity from hydro-power stations and nuclear power plants. This leaves Sweden with a renewable energy share of 48% with the rest of the supplied electricity being essentially carbon free (nuclear). Denmark on the other hand, still relies on coal imports for its primary source of electricity. Similarly, the renewable energy sources available at

the national level (wind & solar) do not offer a stable power output. Thus, only around 22% of gross final energy consumption in Denmark is currently derived from renewable sources. This share of renewables does meet the EUs 20-20-20 target, which calls for an average of 20% renewable by 2020. Denmark however has set prestigious goals of deriving 50% of its electricity from wind by 2020 and being carbon neutral as a nation by 2050 [12,13,14]. What is more, Denmark has substantial oil- and gas-production capacities in the North Sea making it a net exporter of oil. Sweden is completely dependent on oil *imports* to sustain its largely fossil fuel dependent transport sector [14].

The differences in domestic energy supply pointed out above are important when examining the different focus in energy policies in the two countries. When looking at biogas as a transport fuel, it is of no surprise, that the Swedes are more focused on establishing production and distribution systems for alternative fuels so as to improve national energy security through reduced dependency on oil imports. At the same time the Danes are faced with the challenge of moving away from predominantly carbon-based electricity generation and are strongly focused on promotion and development of intermediate renewables.

### *Driving Forces in Skåne*

There appear to be a number of driving forces responsible for the diversification of biogas end use in Sweden. First and foremost, it must be noted that in the mid-1990s, the development of biogas production and distribution systems in Sweden was strongly supported by national financial incentives. These were in place to make upgrading of biogas economically feasible and to spur the penetration of biogas into the transport sector [15]. Formerly, fiscal incentives – such as the 2006 Swedish Environment Protection Agency’s regulation on subsidies for promotion of the distribution of renewable fuels – have focused on promoting



the building of fuelling stations for alternative fuels [16]. Such direct incentives are lacking today [6]. Existing incentives in Sweden are more focused on the general promotion of green cars rather than on biogas in particular (carbon-taxes, tax breaks for green cars etc.).

In the case of Kristianstad, local biogas production and distribution was driven by the excessive waste from the agricultural practices in the municipality. Currently biogas is produced in the municipality's wastewater treatment plants, collected in landfills, or derived from the Karpalund biogas plant that digests agricultural (manure), slaughterhouse, household and industrial wastes. The gas is upgraded and distributed in a fully enclosed local distribution system (thus 100% locally-sourced biogas). The municipality already boasts five biogas fuelling stations and – aside from catering for local heat and power generation – it has sufficient capacity to supply an entire municipal car pool, all public and school buses, and ten heavy freight vehicles. Similarly, farmers that provide the agricultural waste can decrease their own use of imported fertiliser as the nutrients from the waste are returned back to the land. Kristianstad is thus a prime example of how a local biogas infrastructure is not only environmentally friendly (as it minimises the use of fossil fuels), but also how it ensures that municipal waste streams are given extra value - ultimately enabling an improved flow of money *within* the municipality [6].

In Lund municipality, local air quality was the original driving force behind the current usage of biogas in all public busses. The strategic decision to focus on biogas in the public transportation sector was initially driven by the increased concern about the health effects of particle emissions from traffic [17]. This is a reminder that the more immediate local benefits of alternative transport fuels are often disregarded, especially as the issues of CO<sub>2</sub> emissions and climate change remain at the centre of political and media attention. Lund municipi-

pality has therefore demonstrated that particles, NO<sub>x</sub> and SO<sub>x</sub> emission reductions also have a pivotal role in incentivising the transition to a biogas-based public transport system.

### ***Slow Penetration in Sjælland***

In order to maximize the share of renewables in their energy mix, the Danes have by and large chosen to use biogas for Combined Heat and Power generation (CHP) rather than for vehicle fuel [18]. As CHP plants can supply a stable energy output, it is a good complement to the high percentage of less-stable wind energy in the electricity grid. The production of biogas for CHP has been subsidized by the Danish government for some years [18], and it is only this year that subsidisation of other end uses of biogas has begun to emerge in text of domestic energy outlooks [19,20]. At the same time, the cost of upgrading biogas to the quality needed for vehicles is a big portion of the final cost of the fuel. When used in CHP only minimal upgrading is needed (only the SO<sub>x</sub> needs to be removed), making it more economically feasible to use biogas in decentralized CHP plants [21]. Additionally, the increased share of biogas in CHP plants substitutes the use of wood, which Denmark has a low supply of.

One of the problems with depending on intermediate energy sources is that the production and the demand do not occur at the same time. Therefore, Danish policy-makers have been forced to focus on the development of technologies to store this excess energy. These kinds of solutions are available in the transportation sector and are preferred as they solve the problem of energy storage, while at the same time decrease the dependency on fossil fuels. For these reasons, smart-grid projects such as the one in Lolland and Kalundborg tend to focus more on electric batteries or hydrogen cells as solutions in the transportation sector [6,21,22]. This focus can be seen in the new Danish Energy Agreement wherein hybrids,



plug-ins and hydrogen fuelled vehicles are somewhat preferred over biogas and other biofuels [19].

## Recommendations

It is clear that the business opportunities and environmental benefits of biogas have ensured that Denmark will maintain ongoing experiments aimed at improving its long-term biogas production capacity [23]. Although there appear to be several obstacles for the penetration of biogas into the Danish vehicle fuel infrastructure, the story certainly does not end here. After all, vehicle fuel production could provide an additional stimulus to the appeal and profitability of the biogas sector as a whole. Not surprisingly, alongside its broader commitment to improving the overall conditions for biogas production, the Danish Ministry for Climate and Energy is indeed proposing grants and subsidies destined to make biogas more economically attractive within the domestic transport sector [19]. Assuming that the potential for biogas in the Danish transport sector is *not* exhausted, we identify several starting points for further exploration, as well as exist-

ing opportunities that Denmark could potentially capitalise upon in an attempt to diversify its biogas usage.

## Consider Regional Bio-waste Supplies

Although, on the national scale the use of biogas for transport will continue to compete with power generation, one cannot exclude the possibility that local production capacities could be sufficient to satisfy more than just a single end use of this fuel; as has been observed in Sweden’s Kristianstad municipality [6]. The monitoring of industrial and agricultural bio-waste production rates and characteristics on an administrative regional level could better guide not only infrastructural development and optimal feedstock fractions, but also end-use diversification capacity. In Skåne, an analysis of several raw material sources (wastewater sludge, food and industrial waste etc.) has enabled a comprehensive biogas potential database to be established across the region [24]. Hence it is suggested that a GIS-based calculating tool be used to assess current and future biogas potential for small, well-defined geographical areas within Denmark. It must be remembered

SWEDEN	DENMARK
<b>Energy mix</b> <ul style="list-style-type: none"> <li>• Electricity: hydro- and nuclear power</li> <li>• Around 48% renewable energy</li> <li>• Limited possibilities for reduced emissions in the electricity sector</li> <li>• Oil importer</li> </ul>	<b>Energy mix</b> <ul style="list-style-type: none"> <li>• Electricity: high percentage of coal</li> <li>• Around 22% renewable energy</li> <li>• Possibilities for reduced emissions in the electricity sector</li> <li>• Oil exporter</li> </ul>
<b>Energy policy</b> <ul style="list-style-type: none"> <li>• 2020 (EU): Share of renewables 49%</li> <li>• 1% increase needed</li> <li>• 2020: Skåne carbon-neutral</li> </ul>	<b>Energy policy</b> <ul style="list-style-type: none"> <li>• 2020: Share of wind 50%</li> <li>• 28% increase needed</li> <li>• 2025: København carbon-neutral</li> </ul>
<b>Driving forces for biogas as vehicle fuel</b> <ul style="list-style-type: none"> <li>• Great quantity of agricultural waste</li> <li>• Nutrient eco-cycling</li> <li>• Air quality/health issues</li> <li>• Former governmental incentives</li> </ul>	<b>Driving forces for <u>not</u> focusing on transport</b> <ul style="list-style-type: none"> <li>• Cheaper to use for CHP – no upgrading</li> <li>• The focus on wind – need to store energy – electric vehicles or hydrogen cells in transport</li> </ul>

*Differences in Swedish and Danish energy mix, energy policies and biogas-related driving forces.*

that in this de-centralised fuel production approach, fuel quality may differ regionally, creating possible incompatibilities with fuel and engine systems. Thus national standards for the chemical composition of bio-methane will have to be set [18].

### **Utilise Existing Infrastructure**

In urban areas such as Copenhagen, the existing infrastructure (natural gas grid) could be utilised to minimise distribution costs. However, it is questionable whether domestic production can provide enough biogas to ensure for carbon-neutral transportation across the city. In rural areas, a smart-grid approach wherein local demand is met entirely through local production and distribution is preferable [6].

### **Municipal Heavy Vehicles**

Information drawn from several Swedish municipalities has validated previous claims that the adoption of biogas by the public sector is a strong step towards establishing consumer interest and a market for this alternative fuel. Thus, should areas where biogas production is sufficient for vehicle fuel use be identified, it is suggested that initial focus be put on fuelling heavy vehicles such as public buses, waste collection trucks and small-range delivery vehicles. The Swedish examples have illustrated that such vehicles are particularly attractive because their day to day operations occur within a small geographical range that can be easily supplied by even a mere handful of biogas filling stations. Similarly these vehicles do not require the fast (2-3 minute) fuelling rates that personal vehicle owners would demand at fuelling sta-



tions [6,15]. Hence the added costs of energy-intensive fuel compression and liquefaction are reduced and “at the pump” biogas remains more price-competitive in light of other vehicle fuels. Evidently, such measures are hinged upon dialogue with local transportation authorities and it must be mentioned that former governmental clean-investment incentives strongly contributed to the proactive approach that the local public transport authority – Skånetrafiken – developed with regards to utilising biogas for its vehicles [15].

### **Reducing Added Costs**

Although the exact added value of cleaning and upgrading of biogas for transport depends on the characteristics of the upgrading facility and the upgrading technique itself [25], it is evident that a considerable proportion of the final “at the pump” price of biogas continues to stem from upgrading expenses [6,15]. This effectively reduces the price difference between biogas and petrol or diesel. It is therefore essential that new upgrading facilities are selected according to local operating costs (electricity, heat, water prices) and that possible synergies with neighbouring industries are not overseen. For example, an upgrading facility located near an industrial entity that generates excess heat could employ heat-treatment to upgrade biogas at minimal added cost [26]. In Sweden virtually all upgrading facilities employ a water scrubbing technique and Malmberg – a leading Swedish biogas upgrading provider – indeed offers only these types of facilities [26,27]. Given the myriad of available upgrading technologies [26], it is advisable to assess whether this well-established approach is truly the most cost effective option on a case by case basis in Denmark.

*A bus from Skånetrafiken filling up at the companies lot in Kristianstad.*

## *Incentivisation of the Private Sector*

The popularity of personal biogas-powered vehicles has shown little growth even in Sweden [6,15]. Biogas vehicles seem to have little competitive edge against cheaper petrol equivalents and the continually improving fuel economy of diesel vehicles [28]. There is thus a clear need for more information and stronger fiscal incentives surrounding

biogas vehicles, ranging from initial purchasing cost subsidies to the updating of annual vehicle tax schemes so these are better able to differentiate between conventional combustion engine vehicles, and bi-fuel vehicles that predominantly run on environmentally friendlier fuels [15].

## **Concluding remarks**

In many ways the low penetration of biogas into the vehicle fuel market in Sjælland is logical, especially considering the profitability of other end uses for this fuel. However, it is clear that if Copenhagen is to achieve carbon-neutrality by 2025, approaches within the transport sector need to be diversified. Biogas remains an interesting alternative fuel candidate because of its sustainable production chain and health benefits. While Sweden certainly offers several lessons for how this vehicle fuel can be better promoted, the question of whether the Danish socio-political environment can be changed to make biogas have a more direct role in the transport sector remains to be further investigated.



*A small-scale biogas upgrading facility in Kristianstad based on the water-scrubbing technique.*

## References

- [1] European Commission. (2012). Research and innovation for Europe's future mobility. MEMO/12/678. Brussels, 18/09/2012.
- [2] Intelligent Energy. (2008). Biofuels: Topping up the fuel mix: Project Report. *Intelligent Energy Europe* April 2008.
- [3] United Nations Framework Convention on Climate Change (UNFCCC). (2012). Outcome of the work of the Ad Hoc Working Group on Further Commitments for Annex I Parties under the Kyoto Protocol. FCCC/KP/CMP/2012/L.9. Eighth session in Doha, 26 November to 7 December 2012.
- [4] European Union. (2009). Directive 2009/28/EC of the European Parliament and of the Council on the promotion of the use of energy from renewable sources. *Official Journal of the European Union* L/140 16-62.
- [5] Börjeson, P. & Mattiasson, B. (2007). Biogas as a resource-efficient vehicle fuel. *Trends in Biotechnology* 26(1): 7-13.
- [6] Lennart Erfors (6 December 2012). Kristianstad municipality strategic planning and development. Personal communication.
- [7] Uusitalo, V., Soukka, R., Horttanainen, M., Niskanen, A. & Havukainen, J. (2012). Economics and greenhouse gas balance of biogas use systems in the Finnish transportation sector. *Renewable Energy* 51: 132-140.
- [8] Al Seadi, T., Rutz, D., Prassl, H., Köttner, M., Finsterwalder, T., Volk, S. & Janssen, R. (2008). *Biogas Handbook*. University of Southern Denmark Esbjerg.
- [9] Intelligent Energy. (2007). Common Procurement of collective and public service transport clean vehicles. *Intelligent Energy Europe* January 2007.
- [10] Green Fleet. (2012). A boost for green vehicle procurement. Retrieved October 13, 2012 from: <http://www.greenfleet.net/features/114/795-a-boost-for-green-vehicle-procurement>
- [11] State of green. (2012). Denmark has the most climate-friendly policies in the worlds. Retrieved December 3, 2012 from: <http://www.stateofgreen.com/en/Newsroom/Denmark-Has-Most-Climate-Friendly-Policies-in-the-World>
- [12] Eurostat. (2007a). *Denmark – Energy Mix Fact Sheet*. European Commission – Eurostat.
- [13] Eurostat. (2007b). *Sweden – Energy Mix Fact Sheet*. European Commission – Eurostat.
- [14] Bruno Sander Nielsen (4 December 2012). Landbrug og Fødevarer. Personal communication.
- [15] Gabriella Eliasson (28 November 2012). Malmö municipality environmental administration for biogas strategies. Personal communication.
- [16] Miljödepartementet. (2006). Förordning (2006:1591) om stadlig stöd till åtgärder för främjande av distribution av förnybara drivmedel. SFS 2006:1591.
- [17] Markus Paulsson (13 November 2012). Biogas coach in Lund Municipality. Personal communication.
- [18] Leo Christensen (27 November 2012). Vice-President at Lolland Energy Holding A/S. Personal communication.
- [19] Danske Regeringen. (2012). Aftale mellem regeringen (Socialdemokraterne, Det Radikale Venstre, Socialistisk Folkeparti) og Venstre, Dansk Folkeparti, Enhedslisten og det Konservative Folkeparti om den danske energipolitik 2012-2020. Agreement made 22nd of March 2012.
- [20] Kurt Hjort-Gregersen (4 December 2012). Agrotech-Jordbrugsinnovation og Fødevarerinnovation. Personal communication.
- [21] Brian Vad Mathiesen (29 November 2012). Aalborg university professor of energy planning at the department of development and planning. Personal communication.
- [22] Martin Andersen (19 November 2012). Environmental department Kalundborg municipality. Personal communication.
- [23] Padfield, E. (2010). Danish biogas research is more than just hot air. *Farmers Weekly* 152 (2): 62.
- [24] Länsstyrelsen i Skåne län. (2011). *Biogaspotential i Skåne – inventering och planeringsunderlag på översiktsnivå*. Miljöavdelningen, Malmö.
- [25] Persson, M., Jönsson, O. & Wellinger, A. (2006). *Biogas upgrading to vehicle fuel standards and grid injection*. IEA Bioenergy .
- [26] Ryckebosch, E., Drouillon, M. & Vervaeren, H. (2011). Techniques for transformation of biogas to biomethane. *Biomass and bioenergy* 35: 1633-1645.
- [27] Malmberg. (2012). *Biogas technology with high purification and low energy usage*. Retrieved December 15, 2012, from: [http://www.malmberg.se/en/malmberg\\_biogas\\_en/biogas\\_technology](http://www.malmberg.se/en/malmberg_biogas_en/biogas_technology).

[28] Rydberg, T., Belhaj, M., Bolin, L., Lindblad, M., Sjödin, Å. & Wolf, C. (2010). *Market conditions for biogas vehicles*. Swedish Environmental Research Institute (IVL), Göteborg.

“Dangerous gas” photo taken by Birgitta Stefánsdóttir on December 6, 2012 in Kristianstad, Sweden.

“Filling it up” photo taken by Birgitta Stefánsdóttir on December 6, 2012 in Kristianstad, Sweden.

“Upgrading station in crisp winter” photo taken by Birgitta Stefánsdóttir on December 6, 2012 in Kristianstad, Sweden.



# INCREASING CONSUMER AWARENESS IN ENERGY-EFFICIENT HOUSING



By Amelia Mutter & Leonie Sterk

Increased evidence of global climate change, along with the commitment established in the 1997 Kyoto Protocol have led to worldwide efforts to reduce carbon dioxide emissions. The European Union (EU) in particular has committed to climate issues through its Climate Action Programme and Energy Trading Scheme. Residential consumption makes up a considerable portion of overall consumption accounting for about 37% of energy use in Sweden and 28% of energy use in Denmark [1,2]. Efforts to meet carbon emission reduction goals combined with rising energy prices have led to increased attention paid to energy efficiency as a way to reduce impact.

## Lack of Consumer Demand for Energy-Efficient Housing

The Öresund region has generally taken the lead in terms of environmental policies and standards, including working to reach stringent goals relating to energy consumption and carbon emissions [3]. In 2011 they even declared the goal of becoming carbon neutral within 15-20 years [4]. Logically, one would expect commitment to energy-efficient housing to be a priority as well, but this is not necessarily the case. In her thesis entitled *Carrots, Sticks, Tigers and Wheels: A Case Study of Municipal Governance for Energy Efficient Housing in the Öresund Region*, Rachel Armstead establishes a performance gap in energy-efficient housing in the region.

The primary motivation identified suggests that energy-efficient housing has not taken off due to a lack of consumer demand [3]. Buyers in the Öresund region tend to set energy efficiency as a low priority when choosing their homes.

This phenomenon is backed by the supply and demand theory of economics, which suggests that if consumers are not willing to pay for energy-efficient housing, developers will not produce it. Despite a generally high level of environmentalism, Öresund homebuyers do not prioritise low-energy housing. A literature review in the subject identified three driving factors behind this low demand:

- Failure of Öresund homebuyers to consider the long-term cost savings against the higher initial investment of energy-efficient houses;
- The reality that housing is not purchased in isolation from its surroundings allowing “social and material characteristics of the surrounding locale” to have an impact [5]; and
- Limited interaction with energy-efficient homes.

While the first point is drawn directly from the Armstead thesis, the second and third stem from a United Kingdom case study [5]. This study argues that preference for new products is not developed remotely from other factors and can only develop when customers are able to interact with new products. In the case of

energy-efficient housing, people have limited experience with actual low-energy homes and their features, thereby reducing the possibility of forming preferences.

In general, it seems that stunted consumer demand for energy-efficient housing is a result of low consumer knowledge on the topic. Additionally, small-scale municipal action could improve demand for energy-efficient housing by increasing the information available to the consumer. This would in turn lead to an increase in developer interest as they work to meet consumer demand. This section will focus on information related instruments that can be implemented by municipalities in the Öresund region to encourage purchasing of energy-efficient housing. Specifically, energy performance labelling and public service announcement programmes will be discussed as well as their potential to influence consumer buying in the region. The findings are based on a literature review as well as personal communication with employees from the Environmental Departments of the Municipalities of Malmö and Copenhagen and real estate agencies in Lund and Copenhagen.

## Awareness Raising Instruments

There are several policy tools focused on raising public awareness by providing relevant information. In the case of energy-efficient housing energy performance labels and general information campaigns appear to be the most suitable instruments for effective municipal action.

### Energy Performance Labelling

One instrument that seeks to encourage consumers to choose energy-efficient homes when looking to move are energy performance labels

for buildings and, in particular, the prominent display of such labels. An energy performance label can help to overcome the knowledge and information barriers surrounding energy efficiency in the residential sector and increase the visibility of the issue for the consumer. In the EU there is a Directive on the Energy Performance of Buildings (EPBD) (2010/31/EU) that calls for the introduction of relevant laws pertaining to the use of these labels in Member States. One of the EPBD's key features is the requirement for real estate agencies to display energy performance labels in advertisements (Article 12.4). Giving energy performance labels a conspicuous position within the whole purchasing process is believed to create more transparency on the building's energy efficiency and to increase awareness among consumers. The aim is to establish energy efficiency as a key marketing feature for sellers [1].

Denmark has a long tradition of energy performance labels for buildings with the first label being introduced as early as 1979 [6]. The current energy performance label (like other EU Member States such as France and Luxembourg) follows the design of the well-known, easily intelligible EU energy label for electrical appliances, ranking homes on a colour-coded scale from A (best) to G (worst). It is issued following an energy performance audit and has to be put up for display in the building. As of July 2010 it is also mandatory for real estate agencies to include information on the energy performance of all objects to be



*Danish energy performance label.*

sold in the advertisement [7]. For display in commercial advertisements a special symbol was designed: a small house with the appropriate letter grade and in the corresponding colour.

An examination of several web sites and advertisements of real estate agencies, as well as interviews with a real estate agent in Copenhagen and a stakeholder from the municipality of Copenhagen suggest that in Denmark the use of energy performance labels in advertisements is widespread [8,9]. In addition, general awareness of energy efficiency in buildings appears to be higher in Denmark when compared to Sweden. However, findings from the literature and interviews suggest that despite the high diffusion rate in the Danish housing market the overall level of trust in energy performance labels is comparatively low with only around 50% [10]. While consumers are familiar with the label and its meaning they often do not believe in its accuracy and truthfulness. Therefore, many Danish homebuyers still effectively neglect the issue of energy efficiency in their decision-making process.

In Sweden energy performance labelling for buildings was introduced more recently in 2006 [6]. The Swedish label consists of a series of concentric outlines of houses increasing in size

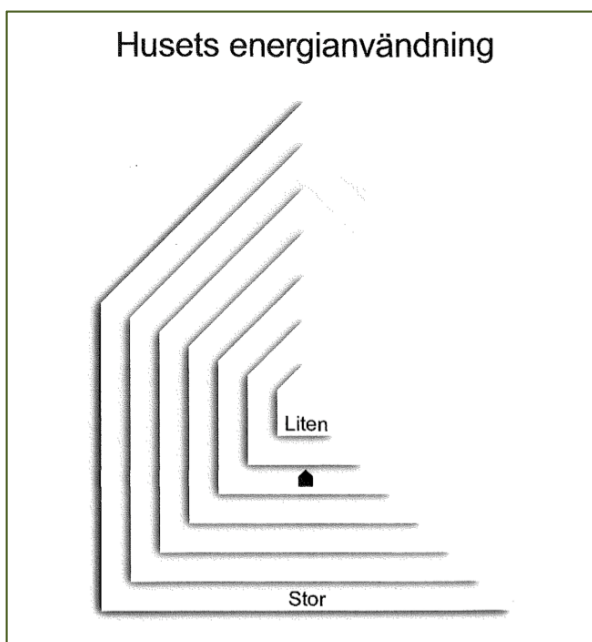

symbolising the energy demand per m<sup>2</sup>. The placement of a small black house within this diagram indicates the energy performance of the property. Two years later than in Denmark, in July 2012, Sweden adopted a law that requires every home sold through a real estate agency to display its energy performance label on the advertisement. However, drawing on findings from the examination of several web sites and advertisements of real estate agencies, an interview with a real estate agent in Lund and an interview with a stakeholder from the municipality of Malmö, it seems that the implementation of the law is weak [11,12]: None of the advertisements observed included the energy performance label. In an interview a real estate agent explained that the label is only shown to the prospective buyer when the property is visited or the purchase contract is signed. In addition to a lack of enforcement, the Swedish energy performance label itself is difficult to understand as it lacks an intuitively comprehensible grading scale and eye-catching colour scheme.

### Public Service Announcements

Another effective method of increasing consumer awareness is from public service announcements (PSAs) composed of mixed media, such as commercials, magazine ads and billboards directed at a large audience. These campaigns can have a variety of scopes, but usually address issues related to public well-being. In some cases, media campaigns are designed to educate the public on ways their behaviour influence environmental. Several regions have implemented energy related PSAs but these tend to focus more on overall energy saving.

One example of this is from the United States where the non-profit Ad Council produced a campaign in conjunction with the Department of Energy on household energy use [13]. This

*Swedish energy performance label.*

programme is centred on the slogan “saving energy saves you money” connecting energy consumption to a medium of more value. By highlighting the financial aspects this campaign helps families to identify with the benefits of energy saving. It also relates money saved back to the ability to purchase real goods by using posters such as “Save Energy, Save Vacation” or commercials featuring a couple throwing personal items (such as a bicycle or a television) off a cliff. These ads speak to the emotions of homeowners inspiring them to save more energy.

Sweden and Denmark have also introduced information campaigns in relation to energy saving, but on a smaller scale. Both campaigns seem to focus on information websites that consumers can visit if trying to better understand energy-efficient housing [7,10]. Media has been used in some cases but with limited permeation. One example from Denmark included a television programme where a famous journalist looks into the energy consumption of households [9]. Environmental awareness in the region is generally advanced so they would most likely benefit from a broader perspective in contrast to basic “turn off the lights” campaigns that have been used in the past [12].







## Recommendations

Based on the findings of this study, municipalities in the Öresund region should consider the following recommendations in order to stimulate demand for energy-efficient housing:

### Energy Performance Labels

Although both Denmark and Sweden have introduced energy performance labels for buildings, albeit to varying degrees of success, there is a lack of awareness among consumers when it comes to understanding and using these labels.

In Denmark, where energy performance labels for buildings are well-known and the requirement to include them in commercial advertisements for homes has been implemented successfully, the main problem relates to a lack of trust in the label. Therefore, municipal action should aim at increasing the credibility of the label. Gaining trust is not an easy task but the first action should be to examine what the reasons for people not trusting the energy performance label are. Based on this specific measures should be taken, for example in the form of an information campaign.

<b>Pris: 1.995.000,-</b>		<b>Brt.: 11.185,-</b>		
<b>Udb.: 100.000,-</b>		<b>Nt.: 10.070,-</b>		
				
83	2	st.tv.	2006	Ja
* Brutto- og nettoydelsen er baseret på kurser gældende den 08-11-2012				

Example of usage of Danish energy performance label in real estate advertisement.



In Sweden problems are of a more basic nature. First of all, the design of the energy performance label should be reconsidered. The Swedish label is complicated and not intuitively comprehensible. Switching to a simpler, colour-coded design, possibly modelled after the renowned EU energy label for electrical appliances (as already used in, inter alia, Denmark, France and Luxembourg), might help to improve the overall awareness and proliferation of the label. In addition, stronger enforcement of the relevant legal requirements is necessary. Exposing prospective house buyers to energy performance labels on a regular basis will allow them to get familiar with the issue of energy efficiency.

### **Public Service Announcements**

Although the Öresund region has introduced information campaigns in the past, these have not been particularly widespread. Due to the high environmental awareness in the area, the region could benefit from a more developed campaign than the traditional “turn off the lights” approach. This could be done by implementing a catchy PSA series as seen in Sweden’s “Pantamera” campaign which integrates popular music with a commercial to advocate returning bottles and cans within the deposit-refund system. To increase knowledge this campaign could be designed to address some of the problems identified in the initial literature review. One angle could be to focus the campaign on the long-term financial benefits of purchasing energy-efficient housing, as this seems to be a major barrier to consumer interest [3]. Another option is to address the lack of consumer interaction with energy-efficient homes. By creating media that introduce common features of low-energy homes, such as improved insulation and natural lighting, this would increase familiarity and awareness among consumers.

### **Financial Instruments**

While this research is focused on information instruments it seems worthwhile to also take into consideration other measures to complement informative tools in order to increase consumer demand for energy-efficient housing. One potential instrument could be financial incentives, such as tax deductions, tax credits for energy-efficient home improvements, and lower interest rates for loans for energy-efficient homes. As pointed out previously consumers often lack an understanding of the long-term savings in terms of energy costs offered by energy-efficient homes. Tax deductions and credits as well as lower interest rates are more tangible and visible which may further add to the attractiveness of these properties.

### **Conclusions**

In the Öresund region prospective homebuyers were found to be uninterested in the energy performance of properties despite the many benefits energy-efficient buildings offer and the overall high level of environmental awareness in the region. Since a lack of knowledge seems to be one of the major reasons for this, awareness raising instruments can contribute to increasing the demand. Both energy performance labels and public service announcements are already used to some extent in the Öresund region but have not reached their full potential. By building upon existing programmes and schemes, municipalities can work towards reaching their goal of reaching carbon neutrality within the next 15-20 years [4].

### **References**

- [1] Nair, G., Gustavsson, L., & Mahapatra, K. (2010). Factors influencing energy efficient investments in existing Swedish residential buildings. *Energy Policy*, 38, 2956- 2963.
- [2] European Commission. (2007). Denmark: *Energy mix: fact sheet*. Retrieved December 10, 2012 from



[http://ec.europa.eu/energy/energy\\_policy/doc/factsheets/mix/mix\\_dk\\_en.pdf](http://ec.europa.eu/energy/energy_policy/doc/factsheets/mix/mix_dk_en.pdf)

Council-Launch-Consumer-Education-Campaign-Save-Money-By-Saving-Energy2

- [3] Armstead, R. (2012). *Carrots, sticks, tigers and wheels: A case study of municipal governance for energy efficient housing in the Öresund region*. Lund, Sweden: International Institute for Industrial Environmental Economics, Lund University.
- [4] Harboe, C. (2012). *Urban transition Öresund*. INTERREG-IV-A. Retrieved December 10, 2012, from <http://www.interreg-oks.eu/en/Menu/Projects/Project+List+%C3%96resund/Urban+Transition+%C3%98resund>
- [5] Lovell, H. (2005). Supply and demand for low energy housing in the UK: Insights from a science and technology studies approach. *Housing Studies*, 20, 5, 815-829.
- [6] McCormick, K. & Neij, L. 2009. *Experience of policy instruments for energy efficiency in buildings in the Nordic Countries*. Lund: International Institute for Industrial Environmental Economics (IIIEE).
- [7] Aggerholm, S., Thomsen, T. E., & Wittchen, K.B. 2011. *Implementation of the EPBD in Denmark. Status in November 2010*. Retrieved December 9, 2012 from: [http://www.epbd-ca.org/Medias/Pdf/country\\_reports\\_14-04-2011/Denmark.pdf](http://www.epbd-ca.org/Medias/Pdf/country_reports_14-04-2011/Denmark.pdf)
- [8] Maya Gürtler Lorentzen (6 December 2012). Chief Communication Officer at Scandia Housing. Personal communication.
- [9] Annette Egetoft (4 December 2012). Senior Advisor in the Environmental Department of the Municipality of Copenhagen.
- [10] Gram-Hanssen, K., & Christensen, T. 2011. *Improving the energy labelling scheme. Findings and recommendations for Denmark*. Hørsholm: Danish Building Research Institute, Aalborg University.
- [11] Joakim Vesterlund (December 6 2012). Real estate agent at Husera. Personal communication.
- [12] Malin Norling (23 November 2012). Climate Strategist and Project Manager at the Environmental Department of the Municipality of Malmö. Personal communication.
- [13] Cullen, L. & Mahaffey, M. (2011). *Press release: U.S. Department of Energy and Ad Council launch consumer education campaign: save money by saving energy*. Retrieved December 12, 2012 from [http://www.adcouncil.org/News-Events/Press-Releases/U.S.-Department-of-Energy-and-Ad-](http://www.adcouncil.org/News-Events/Press-Releases/U.S.-Department-of-Energy-and-Ad-Council-Launch-Consumer-Education-Campaign-Save-Money-By-Saving-Energy2)
- “House” photo taken by Leonie Sterk on September 5, 2012 in Lund, Sweden.
- “Example of usage of Danish energy performance label” photo taken by Leonie Sterk on December 12, 2012, in Copenhagen, Denmark.

# WIN-WIN SOLUTIONS FOR ENERGY EFFICIENCY IN PRIVATE RESIDENCES

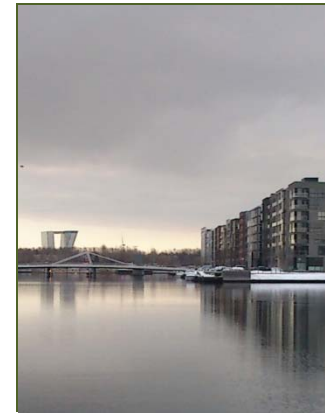

By Jacob Policzer, Janice Kei-Yau Sin & Christine Sum

The Öresund region has taken on the ambitious task of becoming energy neutral within 15-20 years [1]. In order to achieve this goal, which goes above and beyond Sweden and Denmark's national goals, energy efficiency in residential buildings should be maximised, given that energy consumption in buildings is responsible for 40% of EU carbon emissions [2]. In the Öresund region, the residential sector accounts for approximately 30% of total energy use with 60% used for heating and hot water [3,4]. Household energy use is increasing due to rising consumer use of electronics. Currently, lighting is the largest user of domestic electricity followed by refrigerators and freezers.

Paving the way for energy efficiency in buildings is the EU Directive on Energy Performance of Buildings (2010/31/EC) stipulating that national policy must include new building performance standards and energy certifications of buildings [2]. Sweden has adopted these measures through the Swedish National Board of Housing, Building, and Planning, which outline energy use performance stand-

ards [3]. Denmark has a similar law through the Act on the Promotion of Energy Savings in Buildings [5].

However, an energy efficiency gap (a gap between what is possible and what is implemented) exists in private residential sector [6,7] due to split incentives, despite the significant energy saving potential of this sector. For example, in Denmark, the residential sector contributes approximately 49% to the floor area of existing buildings [8].

Both the Swedish and Danish governments have attempted to tackle the issue of split incentive through public awareness campaigns. These campaigns have targeted potential energy efficiency measures such as wall and roof insulation, heat pumps, boilers, solar water heaters, and energy efficient appliances [3].

This section aims to propose supply-side solutions to energy efficiency in the private residential sector.

## Split Incentives

Split incentives (also referred to as broken agency and principal-agent problem) are identified as a key barrier to energy efficiency investments in the Öresund region [4]. The term describes the situation where the end user, instead of the investors, benefits from the energy efficiency investments (i.e. lower energy bills).

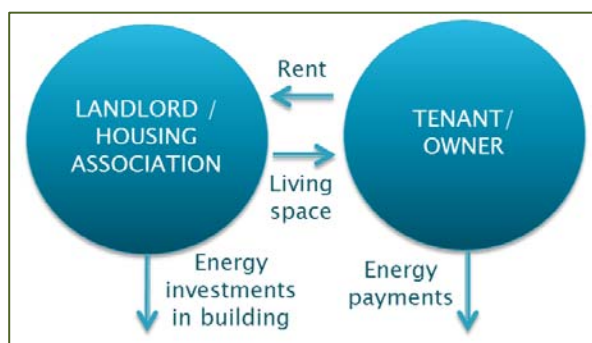

*Split incentives in private residential housing.*

Such differing incentives can lead to less investment in energy efficiency than if the end user and investor had the same incentives [9]. In the private residential sector, split incentive is most likely to occur in private rental or co-operative housing association situations, which is potentially up to 40% of total housing stock in Denmark and Sweden [10,11]. The investor is the landlord or housing association, and the end user bearing the energy costs (i.e. electricity and heating) is the tenant or owner.

Two key solutions to split incentives identified by The International Energy Agency are regulatory measures (such as Minimum Energy Performance Standards, MEPS) and the use of contracts that incorporate energy price signals [9]. The Energy Performance Contract (EPC) commonly used by Energy Services Companies (ESCO) is based on the latter. EPC aligns the incentives of end users (energy savings) and investors (profit from energy savings), where investors are energy suppliers or ESCOs. Maximum profit and energy savings are the goals of EPC. In contrast, MEPS do not facilitate maximisation of energy savings, but only work to reduce the effect of split incentives. For this reason, ESCO activities and their applicability to the private residential market will be explored in the following section.

The role of ESCOs to improving energy efficiency in private residences is studied using literature, informal semi-structured interviews with relevant actors in Denmark and Sweden, and examining lessons learnt and success factors from relevant case studies. Relevant actors include academia, energy agencies, ESCO associations, municipalities, housing associations, third party financiers, and ESCOs – including

property developers, facilities management and energy companies.

## ESCOs

ESCOs are essentially energy services providers, which guarantee savings in energy costs or a certain level of improvement in energy efficiency [12]. Targeting the end users, ESCOs' services include, for example, energy audit, installation of energy-efficient measures, retrofitting, on-going maintenance of the installed facilities etc. The financing of such services, measures or facilities are made possible through EPC, in which the end users and ESCOs agree on how and how much of the cost savings will be shared between the two parties. In other words, ESCOs are remunerated based on the performance they achieve. Depending on the agreement with the end users, ESCOs may provide the funding or help arrange third-party financing. In short, the technical risks, and in some cases, the financial risks of enhancing energy efficiency are shifted from the end users to the ESCOs. The removal of such risks will motivate end users to raise the energy efficiency of their properties. ESCOs in the Öresund region are typically small to medium sized international manufacturers of building automation and control systems, and facility and operation companies with EPC as a side business [13,14]. In Denmark, the most commonly found type of energy service agreement is the combined offer of advice and operations, while in Sweden the dominant type is the combination of advice, implementation and operations [15].

While ESCOs have been developed since the 1980s in Sweden, the Danish market for ES-

ESCO MARKETS IN SWEDEN & DENMARK [13,14]				
	NO. OF ESCOS		SIZE OF MARKET (EUR MILLION)	
	2007	2010	2007	2010
Sweden	12-15	5-10	50	60-80
Denmark	2-4	10	5	8-25

COs started to pick up around 2009 when the Danish government incorporated ESCOs in its strategy [7,8].

### ***Barriers to Implementation***

At present, ESCOs have posed a solution to energy efficiency in the public sector, but have had little success in the private residential sector. Barriers to implementation include low awareness among private home owners [7], high transaction costs (e.g. to collect information on energy efficiency technologies [16]), uncertainty in end user behaviour and hence payback periods of energy efficiency investments, as well as regulations that do not easily facilitate energy efficiency investments. Regarding the latter, in Sweden's highly regulated rental market, landlords are forbidden to recoup energy savings from tenants, which has resulted in housing associations and building owners reluctance to invest in energy efficient solutions [3,17]. Moreover, low energy costs in Sweden exacerbate the split incentive problem [18]. Recent national and EU policy discussions have revolved around how the ESCO model can be refined to overcome barriers to energy efficiency investments in the private residential sector as well as be commercially viable [16,19].

### ***Role of Energy Companies***

From interviews, energy companies appear to be the stakeholders with the largest incentives for energy efficiency. Additional generation capacity required to meet peak demand is typically fossil fuel based, and can be more expensive and carbon intensive [20]. Thus, reducing both the electricity and heating demand can be more cost-effective than increasing production by energy companies [4]. The EU Directive on Energy Efficiency (2012/27/EU) requirement for energy companies to reduce sales by 1.5% per year provides further impetus for reducing final consumption. Targeting energy reductions in residential buildings, which are significant energy consumers [21,22], is an increasingly

important business strategy for energy companies.

### ***Recent ESCO Experience in the Commercial Sector***

The Swedish real estate association recently developed a "model contract" based on EPC with shared savings. A property management company interviewed has plans to renew commercial leases incorporating EPCs, where the level of energy improvement can be easily determined using tenants' historic energy usage data [23]. Clearly, having a long-term tenant with a record of energy usage is conducive to energy performance contracting as it enhances the certainty of payback.

### ***Case Study 1: Middelfart, Denmark***

Middelfart, situated on the Western coast of the island of Funen, was the first Danish municipality to undertake ESCO projects in 2008, resulting in a 21% reduction in energy consumption in 100 public buildings [8,24]. Following this success, the municipality launched the first pilot programme "My Climate Plan" to raise energy efficiency in private housing in 2009 [25].

Acting as a coordinator, the municipality set up a network involving the energy company Trefer, the district heating company, local energy services and installations providers. It invited owners of single-family houses to participate in a free energy audit provided by Trefer. Trefer, in return, could include the households' final energy savings as part of its energy reduction targets set by the government. Based on the audit, recommended solutions, their costs and payback period were provided. The households were then directed to the banks and local contractors to finance and implement the selected solutions. Unlike conventional ESCO agreements, energy saving performance was not

guaranteed because of the high level of uncertainty in end users' behaviour.

The first pilot project has now evolved into the "ESCO Light" model. Under the new scheme, Middelfart focuses on (1) engaging energy companies to provide subsidies to end users for every unit of energy saved, which will in turn help energy companies achieve the new energy saving targets, as well as (2) decentralise knowledge on energy efficiency to local contractors to spread energy efficient solutions.

ESCO LIGHT PROJECT IN MIDDELFART [24]	
<b>Energy Saving (MWh)</b>	
Achieved	638
Booked	490
<b>Carbon dioxide emissions (tonnes)</b>	
Achieved	305
Booked	235
<b>Investment (EUR)</b>	
Achieved	700 000
Booked	550 000

## Case Study 2: Alingsås, Sweden

The Brogården renovation project located in Alingsås, Sweden is an on-going programme to renovate ageing apartments into modern passive housing units. The project covers 299 apartments in 16 three-storey buildings built in the 1970s as part of the Million Homes Project, a major social housing construction in the post-war era [26]. The public housing company, Alingsåshem, that own the units has partnered with Skanska AB and local contractors for this multi-year renovation. The major renovations are part of the 30-40 year maintenance plan and necessitated by the current poor state of the buildings. All funding was provided by Alingsåshem and estimated at SEK 300 million (EUR 34 million) or SEK 1 million (EUR 114 000) per apartment [27]. The renovations were 25-30% more expensive than convention-

al renovations but by following passive housing standards have achieved an over 50% reduction in energy use from 216 kWh/m<sup>2</sup>/year to 92 kWh/m<sup>2</sup>/year.

To achieve these results replacements of the walls, ceiling, windows, and doors with high efficient technologies was required. In addition, heat recovery ventilation systems were installed and district heating was added as a back-up. Like many Million Homes Projects, the balcony was a continuous extension of the interior floor and acted as a thermal bridge between the inside and outside. To correct this inefficiency the balcony was removed and a new balcony was attached to the exterior. Improvements were also made to the living standard of the units allowing Alingsåshem to increase rental rates by approximately SEK 1 000 (EUR 114) a month [27]. The renovations took eight months per building with up to three buildings worked on simultaneously. The payback period for the improvements is 30 years and the residents will now have to pay for electricity separately. This is a major shift in utility practices in Sweden and has demonstrated the potential for changing consumer behaviour by incentivising energy-efficient usage. This behavioural change was made possible through an open dialogue amongst stakeholders throughout the project.

For this programme to be successful all stakeholders needed to be engaged at the planning stage and continuously informed thereafter. Communication, trust, and transparency on behalf of the building association, architect, construction firms, and tenants contributed to Brogården's success. These findings confirm the analysis conducted by the EU when examining successes for energy efficiency services [28]. There are currently 400 000 units in Sweden built similar to these models, to which the same process could be applied [26, 27]. This major renovation programme has proven that the highest levels of energy efficiency in buildings can be achieved cost effectively if tenants and owners are informed of the issues and



benefits and decide to take a long-term approach.

## Recommendations

Based on the analysis of split incentive and cases studies, a model whereby the municipality takes the lead in coordinating relevant actors to maximise energy efficiency in residential buildings is proposed. This will narrow the gap between the lack of incentives among stakeholders to enhance building energy efficiency and the potential benefits for them and the wider society. This model incorporates the underlying principles of the ESCO model, as well as measures to overcome the barriers to energy efficiency in private residences that ESCOs by themselves have not been able to overcome. The following model can be applied to both retrofit and new developments, such as that intended by the Green Building Guidelines for the Öresund region, which is currently in development and aims at incorporating sustainability in the planning process.

In this model, the municipality serves as the coordinator among various stakeholders, facilitating communications and the flow of information, and at the same time trying to identify and match their interests. The end goal is to motivate stakeholders to collaborate to enhance the energy efficiency of buildings and achieve win-win solutions as much as possible.

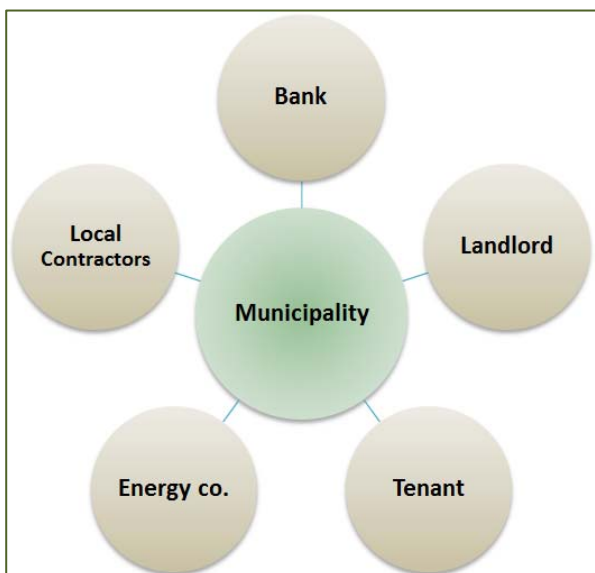

One way of motivation is reducing the transaction costs of such collaborations. For instance, municipalities can help reach out to potential landlords or housing associations, promote the benefits of higher energy efficiency (e.g. invite home owners to share their first-hand experience) and organise interested landlords into collective action. This will allow economies of scale, so that energy companies and local contractors can better meet their bottom line. Municipalities can also consider engaging energy companies to offer subsidies to end users similar to Middelfart. This can be a powerful incentive to alter end users' energy use patterns.

Also, by training up local contractors (e.g. renovation companies) to provide audit and energy efficiency consultancies to households, municipalities enable them to explore new business opportunities and help end users reduce energy consumption. Contractors then become ambassadors for energy efficiency promoting energy efficient options when expensive items need replacement. This model of “replace on failure” has shown success in the U.S. especially when owners do not have the financial means for large renovations [29]. New businesses can also be extended to banks and other financial institutions if they can provide green financing measures (e.g. preferential interest rates for loans for installing energy efficient measures).

While the interests of energy companies, local contractors, banks and tenants are easily identified and can be matched with relatively simple incentive schemes, the stakeholder group of landlords remain the most difficult to motivate in a split incentive situation. Although long-term benefit such as increase in property value is possible, there is still a lack of concrete short-term gains. As such, it is proposed that municipalities can work with energy companies to devise a type of cash-back system, so that

*Municipality as the facilitator between stakeholders in enhancing energy efficiency in residential buildings.*

landlords can have a share in the energy savings made possible by their initial investment in energy-efficient installations.

Although the proposed collaborative model may not fully remove split incentives, especially from the landlord's perspective, it is still relevant and can potentially contribute to lowering the transaction costs of raising building energy efficiency, stimulating local economy, increasing awareness among stakeholders, as well as reducing the uncertainty and risks of energy investments. Moreover, with favourable policies on the horizon, such as the upcoming Danish policy to implement energy-saving projects in private rental housing [30], stakeholders will be more driven to work with each other. When applying the proposed model, specific local factors should be taken into consideration in order to make it relevant. For instance, when housing associations instead of individual homeowners are involved, a different set of incentives and negotiations may be required. It is anticipated that such a model can contribute to lessen the impact of split incentives, whilst achieving win-win solutions for multiple stakeholders in the Öresund region.

## References

- [1] Harboe, C. (2012). *Urban transition Öresund*. IN-TERREG-IV-A. Retrieved 10 December, 2012, from <http://www.interreg-oks.eu/en/Menu/Projects/Project+List+%C3%96resund/Urban+Transition+%C3%98resund>.
- [2] European Commission. (2009). *EU Energy Policy for Buildings after the recast*. European Commission (EC) Retrieved December 5, 2012 from [http://ec.europa.eu/energy/efficiency/doc/buildings/presentation\\_general\\_short.pdf](http://ec.europa.eu/energy/efficiency/doc/buildings/presentation_general_short.pdf).
- [3] Swedish Energy Agency. (2012). *Energy Efficiency Policies and Measures in Sweden in 2012*. Retrieved December 6, 2012 from [http://www.odyssee-indicators.org/publications/PDF/sweden\\_nr.pdf](http://www.odyssee-indicators.org/publications/PDF/sweden_nr.pdf).
- [4] Armstead, R. (2012). Carrots, Sticks, Tigers and Wheels: A Case Study of Municipal Governance for Energy Efficiency in New Buildings in the Öresund Region. The International Institute for Industrial Environmental Economics, Lund University.
- [5] Swedish Energy Agency (2011) *Energy in Sweden 2011*. Retrieved December 5, 2012, from [www.energimyndigheten.se](http://www.energimyndigheten.se).
- [6] Linden, A.L. and Femenias, P. (2010). *Energy efficiency in the housing sector – The Swedish Case*. Proceedings from International European Network for Housing Research (ENHR) conference, Istanbul July 2010 ‘Changing Housing Markets: Integration and Segmentation’. Retrieved December 5, 2012 from <http://publications.lib.chalmers.se/publication/126426-energy-efficiency-in-the-housing-sector-the-swedish-case>.
- [7] Soroye, K.L., Nilsson, L.J. (2010). Building a business to close the efficiency gap: the Swedish ESCO Experience. *Energy Efficiency* 3:237–256.
- [8] Jensen, J., Oesten, P., and Nielsen, S. (2010). *ESCO as innovative facilities management in Danish municipalities*. Paper presented at the 9th EuroFM Research Symposium.
- [9] International Energy Agency (IEA). (2007). *Mind the Gap- Quantifying Principal-agent Problems in Energy Efficiency*. Retrieved 27 November, 2012 from [http://www.iea.org/publications/freepublications/publication/mind\\_the\\_gap.pdf](http://www.iea.org/publications/freepublications/publication/mind_the_gap.pdf).
- [10] Eurostat (European Commission). (2012). *Housing statistics*. Retrieved December 7, 2012 from [http://epp.eurostat.ec.europa.eu/statistics\\_explained/index.php/Housing\\_statistics](http://epp.eurostat.ec.europa.eu/statistics_explained/index.php/Housing_statistics).
- [11] CECODHAS Housing Europe. (2012). *2012 Housing Europe Review: The nuts and bolts of European social housing systems*. Retrieved December 7, 2012 from [www.housingeurope.eu/www.housingeurope.eu/uploads/file\\_/HER%202012%20EN%20web2\\_1.pdf](http://www.housingeurope.eu/www.housingeurope.eu/uploads/file_/HER%202012%20EN%20web2_1.pdf).
- [12] Bertoldi, P. and Rezessy, S. (2005). *Energy service companies in Europe status report 2005*. Ispra, Italy: European Commission DG Joint Research Center.
- [13] Marino, A., Bertoldi, P., and Rezessy, S. (2010). *Energy Service Companies Market in Europe - Status Report 2010*. European Commission Joint Research Centre Institute for Energy: Italy.
- [14] Bertoldi, P. Boza-Kiss, B. and Rezessy, S. (2007). *Latest Development of Energy Service Companies across Europe - A European ESCO Update*. European Commission Joint Research Centre Institute Environment and Sustainability: Italy.

- [15] Danish Energy Saving Trust (DEST). (2010). *4 types of energy service agreements*. Retrieved 6 December, 2012, from <http://www.savingtrust.dk/public-and-commerce/are-you-responsible-for/energy/energy-in-a-municipality/energy-services/types-of-energy-service-agreements>.
- [16] Martha Sørensen (29 November 2012). Center for Teknik og Miljø, Københavns Kommune. Personal communication in an informal phone interview.
- [17] Üрге-Vorsatz, D., Köppel, S., Liang, C., Kiss, B., Goopalan Nair, G. and Celikyilmaz, G. (2007). *An Assessment of on Energy Service Companies (ESCOs) Worldwide*. Retrieved November 27, 2012 from [www.worldenergy.org/documents/esco\\_synthesis.pdf](http://www.worldenergy.org/documents/esco_synthesis.pdf).
- [18] Luis Mundaca. (4 December 2012.) Assistant Senior Lecturer, The International Institute for Industrial Environmental Economics. Personal communication in an informal interview.
- [19] Casper Andersen. (7 December 2012). Confederation of Danish Industry (Energy Branch). Personal communication in an informal phone interview.
- [20] Göran Strandberg. (7 December 2012). Business Developer, Lunds Energi Group AB. Personal communication in an informal interview.
- [21] International Energy Agency (IEA). (2008). *Energy Policies of IEA Countries - Sweden Review*. Retrieved December 12, 2012 from <http://www.iea.org/publications/freepublications/publication/Sweden2008.pdf>.
- [22] International Energy Agency (IEA). (2006). *Energy Policies of IEA Countries- Denmark Review* Retrieved December 12, 2012 from <http://www.iea.org/publications/freepublications/publication/denmark2006.pdf/>.
- [23] Ulrika Hammargren. (3 December 2012). Environmental Coordinator, Ikano Fastigheter Real Estate. Personal communication in an informal phone interview.
- [24] Middelfart Municipality. (n.d.). *ESCO-light in the Municipality of Middelfart* (not published).
- [25] Morten Westergaard. (6 December 2012). Head of Climate and Energy, Technology and Environment Department, Middelfart Municipality. Personal communication in an informal phone interview.
- [26] Skanska (2009). *Case Study 64: Brogården, Sweden*. Retrieved December 5, 2012 from <http://www.skanska-sustainability-case-studies.com/index.php/latest-case-studies/item/133-brogården-sweden/133-brogården-sweden?start=4>.
- [27] Femenias, P. and Linden, A.L. (2012). Sweden: integrated strategies to overcome market barriers. (eds.) Nieboer, N., Tsenkova, S., Gruis, V. and van Hal, A. *Energy Efficiency in Housing Management: Policies and practice in eleven countries*. Routledge: New York.
- [28] Renner, G. (2012). *Overall analysis and documentation of Change. Best field tests of new energy efficiency services developed and introduced into the market in 16 EU Member States*. Intelligent Energy Europe.
- [29] Hynek, D., Levy, M. and Smith, B. (2012). *Follow the Money: Overcoming the Split Incentive for Effective Energy Efficiency Program Design in Multi-family Buildings*. ACEEE Summer Study on Energy Efficiency in Buildings.
- [30] Ministeriet for By, Bolig og Landdistrikter (Ministry of Housing, Urban and Rural Affairs). (2012). *Aftale om udmøntning af energiaftalen for private lejeboliger*. (Press release on energy agreement for private rented housing). Retrieved December 13, 2012 from <http://mbbl.dk/nyheder/nyhed/aftale-om-udmoentning-af-energiaftalen-private-lejeboliger>.
- “Residential buildings at Teglværkshavnen”. Photo by Janice Kei-Yau Sin, taken on December 12, 2012 in Copenhagen, Denmark
- “Split incentives in private residential housing”. Diagram by Christine Sum, created on December 12, 2012.
- “Municipality as the facilitator between stakeholders in enhancing energy efficiency in residential buildings”. Diagram by Janice Kei-Yau Sin, created on December 12, 2012.

# BUILDING NETWORKS FOR GREEN BUILDINGS

## Lessons from Sweden and Denmark

By Paroma Wagle



Promotion of energy efficient urban development and green buildings is considered as an effective and cost-effective approach to reducing the climate change impact of buildings.

In the Masters thesis titled *Carrots, Sticks, Tigers and Wheels: A case study of Municipal Governance for Energy Efficiency in New Buildings in the Öresund Region* a past IIIIEE student, Rachel Armstead noted that “the levels of energy performance technically feasible in new buildings persistently fail to be realized.” This limitation is said to be rooted in a number of barriers which “limit the adoption and optimization” of these new developments. One of the major types of barriers is related to the “acceptance of energy efficiency.” The study suggested that, in order to deal effectively with the “barriers related to acceptance,” it is necessary to establish and improve communication, trust, and confidence among stakeholders [2].



In this context, development and strengthening of industry and municipal networks, as the study suggests, is seen as an effective tool for facilitating the sharing of information and experience with regards to energy-efficient green buildings. In other words, networks of stakeholders could help facilitate effective communication among themselves and are expected to build trust and confidence apart from spreading awareness and knowledge. There are efforts to develop networks and partnerships in Sweden and Denmark. It is important to learn from these on-going efforts and draw lessons for similar efforts in the other parts of the Nordic region [2].

This section is based on interviews with officials from two municipalities who are involved in building and maintaining networks and partnerships. The municipalities are: (a) Lomma, Sweden and (b) North Harbour, Copenhagen in Denmark. Both the networks are not completely established, and have significantly different features, mainly because of differences in policy regime, as well as, administrative setups, procedures, and culture. However, effort has been made here in this section to draw lessons that will be applicable to a wide range of municipalities in the Nordic region [1,3].

*Example of a Network: Energi Öresund.*



## Models of Networks

The striking difference found in the two cases studied here is the entirely different models of evolution or development of the networks. While the model of network development in Lomma (Sweden) could be seen as gradual and evolutionary with a bottom-up approach, the model emerging at North Harbour in Copenhagen could be called as driven and purposeful with the top-down approach. The network at Lomma is informal, but the partnership at North Harbour is formal. Similarly, there are significant differences in the drivers underlying these two networks. The details of these models are discussed in the subsequent segments.

### *The Lomma Model*

The current loose network of municipality and developers in Lomma emerged out gradually over a period of ten years, during implementation of the Environmental Programme of the municipality. This programme is voluntary, in which building companies are encouraged to implement measures for sustainability and then the municipality grades their performance on different environmental aspects. The requirements are very flexible and give the developers space to develop new thinking and innovations.

The municipality developed this programme with the help of academic bodies like the International Institute of Industry Environmental Economics (IIIEE) and Swedish University of Agricultural Sciences (SLU). The programme



also has a monitoring procedure, which entails answering of questions by developers. A virtual document is sent out to the developer to fill. Once the municipality receives the answers to these questions, clarifications are sought from the builders. Additionally, feedback is sought from the developers on this 'Follow-up Document' to improve documentation process and collaboration efforts initiated by the Municipality.

This two-way communication between the municipality and developers gradually evolved into a network. It was then realised that the developers should communicate with each other, in addition to communicating with the municipality. It was also realised that the municipality should facilitate these interactions, as developers are competitive and are apprehensive that inter-company communication will harm their competitive edge. Developers then were encouraged to sit together and talk to each other to explore in what manner they can learn from each other and find new ways to incorporate sustainability principles in development of buildings. The municipality also tries to foster a sense of ownership and achievement in the developers as a driver for better performance.

To summarise, main stakeholders involved include the municipality and the developers. The municipality also collaborates with different academic bodies like IIIEE and SLU, especially regarding the environmental programme and the follow-up system. The customers of the developers or the actual building users are not part of the network. The main driving factors are the environmental programme of the municipality and the system developed to implement and monitor it. The building companies are not pushing for the programme, as it is not their priority. The main driving factor for the sustenance and growth of the network, according to the Lomma Municipality official,

*Lomma Harbour.*



is that this development project and region is considered an ambitious initiative and is a matter of pride and ownership for the municipality and the developers. This feeling has motivated developers trying to move beyond the competitive mindset and learn from each other

### *The North Harbour Model*

In North Harbour, Copenhagen, the partners include City of Copenhagen, City Port Development Authority, DONG Energy, Copenhagen Energy, Ministry of Climate and Energy apart from the landowners in the North Harbour area. These partners came together to enter into a formal declaration around 2010.

The main driver of the development of this partnership has been the municipality (specifically the high-ranking officials in the municipality), in conjunction with other broader level factors, including the national level ministry and its policies. On the ground, the partnership is formed by a dynamic and interested high-ranking municipal official, who used his personal contacts with the equally high-level officials in the other partnering agencies to encourage the development of the partnership.

The partners are expected to engage the other stakeholders and help them participate in the collaborative efforts. These stakeholders may not be in the official partnership (at least in the near future). So landowners and the district heating companies are expected to bring in developers by working out win-win sustainable solution with them. The partnership has strong dialogue with its partners, which is expected to



*Copenhagen by Night.*

motivate the partners to exert themselves to take the mandate ahead by involving other stakeholders.

Again the long-term sustenance of the partnership is seen as dependent on the continuation of commitment of the partners, which, in turn, will be developed on broader factors including international discourse and action as well as national policies and strategies.

### *Comparing the Models*

In comparison with the Lomma model, the North Harbour model seems to be highly dependent on the external macro-level agencies. In fact, the main weakness appears to be not just absence of developers in the current partnership, but also the lack of serious consideration of developers as a critical stakeholder. An apprehension was expressed during the interview [3] that this partnership will remain as what it is now, namely, a high-sounding political-level declaration and would not get translated into a demonstration project. The apprehension in the course of the interview was linked to the concern that by being a ‘no-cost’ partnership, there would be serious lack of financial sources and the key question remains unanswered, viz., who will bear the cost of actual constructions?

The answer to this apprehension and concern is rooted in involvement of developers, who will act as a crucial link with the customers. This is essential as customers will be the ultimate ‘payers’ of the additional costs and efforts involved in greening of the buildings. The developers – through their branding and other marketing strategies – are expected to make the customers aware and on the basis of their awareness encourage them to demand for greener buildings and pay for the costs.

In this model, the burden of engaging and involving developers in making developments

sustainable and green (or to build smart houses) is to be shouldered by landowners. However, it is doubtful that they will be able to bear this burden. Landowners, even if they are convinced about the idea of smart houses, are need not necessarily be ready to find value in the idea during their transaction with developers. It also seems unlikely that they can ensure sustained interests on the part of developers in this idea of 'green urban solutions'.

Another weakness in the North Harbour model seems to be that it is highly individual-centric. Although it is a product of the commitment of high-ranking officials in the agencies, there is no guarantee that this individual commitment will translate into organisational commitment, and it will be sustained after departure of the concerned individuals. However, at the same time, the broader-level (national and international) driving forces behind the North harbour model could be seen as having more chances of continued commitment to the green concerns, and, in this sense the model driven by these forces does have greater chances of long term survival.

As against this, the Lomma model is highly dependent on the ground level functionaries of developers. However, normally the decisions related to energy use and other key green aspects are made at much higher level in building companies. These authorities are not in the communication loop of the network created by Lomma municipality. The local official who is in the loop is expected to communicate up the hierarchy that the other companies are doing these things for sustainability and that their company should also try to be at the same level.

Another critical roadblock in this model is the apprehension of developers that such networking would harm their competitive edge. It then becomes the task before the municipality to convince them that collaborating would provide win-win outcomes, instead of harming their competitive edge.

## Lessons and Suggestions

There are many encouraging outcomes of the networking and communication efforts at Lomma. Successful efforts increase awareness, encourage participation, create voluntary benchmarks for developers and encourage them to aspire to achieve and surpass them. These efforts act as a continuous mechanism for training of employees of building companies, which have high turnover rate. The efforts also help the municipality to know how people in building companies think, and acts as a mechanism for the reality check on practicality of various green measures.

At the same time, there are certain limitations on contribution that these networks can make. First, experience suggests that in the efforts to incorporate sustainability in the building, networking is very important but not the key factor. Second, it is very difficult to work on getting developers together, what best the municipalities can do is create a system that create opportunities and encourages them to come together. This is because energy efficiency and environmental issues are not a key concern for developing companies. It needs to be understood that a 'green and sustainable building' is not yet a main selling point; it is just an add-on tag, or 'bonus' or a 'pride-factor.' In this context, it is important to talk to and include buyers of the buildings. This may encourage them to demand 'sustainable and green buildings'. It will also encourage them to use the buildings in sustainable manner.

Experiences at Lomma also bring out many valuable lessons for other municipalities interested in making similar efforts. It is suggested that, right from the initial stage, it is good to have clarity about (a) the exact objectives and targets (in the minds of the builders) and (b) the monitoring process. Further, building off of this clarity, the networking efforts should be preceded by a well-designed 'environmental programme' for encouraging greening of build-

ings and developments, which would also have a monitoring component. As energy efficiency is not on the agenda of the builders or their customers, it would be a good idea to expand the agenda of the programme and bring in other elements of sustainability, in order to cash in the general public acceptance of the need for sustainability. To this effect, the programme may bring in additional dimensions of sustainability, similar to the ones included in the Environmental Programme implemented at Lomma. The dimensions in the Lomma programme are: (a) Reduction in Climate Impact, (b) Greening of the Area or Tree Plantation (especially diversity in species and presence of rain-harvesting species), (c) Indoor Climate (especially the levels of emissions and noise), (d) Resource Use (especially level of energy savings achieved and use of recycled material), and (e) Safety and Aesthetic Qualities of the area. [1]

Considering the limitations of the appeal of the green proposition, it is also suggested that the programme should be kept simple, with straightforward objective of having the developed areas should be safe and sustainable. Too many and bold innovations should not be expected, while expensive solutions need not be encouraged. As the interview in Lomma suggests, the municipality should be happy “as long as developers show [that] they thought of the environmental aspects.” Further, for the same reason, the programme should provide flexibility to builders over time and space for implementing measures for sustainability.

Considering various barriers of development of networks, it is suggested to treat the whole effort as a learning process, and hence the municipality should be ready to learn online, especially learn from mistakes, and make necessary changes in the network processes. The network should facilitate two-way learning and deliberation process. Learning from builders would be critical for municipalities, as builders would be more equipped to decide what would work in the field, while municipality might tend to be

rather utopian in its expectations. The clarity in objective and targets would help to maintain consistency in the ‘environmental programme’ over time.

The component of monitoring in the ‘environmental programme’ should also be designed carefully. Developers should not see it as coercive, encroaching, or threatening to their business. Rather, it should be designed in such a manner that it would be seen as helpful to them for garnering more information and knowledge. In fact, a properly designed follow-up programme would have the interactive mode, encouraging the desired ‘two-way’ communication described earlier.

It is suggested to include research and academic institutions in the networks. They would provide multiple benefits. Firstly, they would be a source of new technical as well as managerial knowledge and innovative ideas. Second, their inclusion as sources of new ideas and information would attract developers to join and encourage developers to take activities of networks seriously. Third, their inclusion would make networks multi-lateral, assuaging apprehensions of developers to sit with their competitors and municipality. Learning from the North harbour experience, it might be a good idea to draw support from higher level, i.e., national and international agencies and make use of the programmes and policies at these higher levels.

Finally, and very critically, efforts should be made to inculcate among all the stakeholders a sense of pride and ownership of the efforts for green buildings. It is also suggested that the approach of municipalities should be to learn from developers what is possible, instead of hankering for utopia, which does not work. So one has to be flexible and voluntary measures including networks are important in this context.

Regarding the feedback about the networking efforts, some developers gave the feedback that

it is interesting to understand and learn what other developers are thinking and doing on the issues of sustainability. Municipal officials were found to be happy, as according to them, the network and communication worked well and helped the municipality to achieve certain level of success in the area of green buildings and there was a feeling of pride and achievement.

## Conclusions

Some very useful lessons can be drawn from this study. The first major lesson is that the process of development of network could take any shape or model, and it is highly dependent on the local contextual factors. Similarly, the drivers and prerequisites for sustenance of the networks would be different.

Second, the two models that came out of this research for building and maintaining networks

have different pros and cons. As the process is highly dependent on the local actors and factors, it is difficult to emulate any one of these models per se. However, one important note is that it is necessary to involve the direct and ground level stakeholders in networking as they are going to be the ultimate payers of the costs.

The third important lesson is that the efforts for developing networks would be severely constrained by a set of mutually reinforcing factors including the lack of interests and motivation on the part of developers, lack of pressure of demands from customers, political difficulties in imposing mandatory regulations. These, in turn, are rooted in broader-level economic and political, and social factors, which are not in the control of local actors.

As a result, while the efforts for building net-

Lomma Model	North Harbour Model	Desired Amalgamated Model
Developer-Centred	Centred on Macro-level Agencies	Has to be developer-centred, but could be strengthened by inclusion of macro-level (i.e., national and international) agencies
Initiation at the Micro-level	Initiation at the top level	Where to initiate can be seen as a strategic decision depending on the local context
Bottoms up, with no vision to go up or to link up with higher-level actors	Top Down, with no feasible plans to reach at the bottom	Combining both the approaches, with adequate emphasis on bottom level activities aimed at ensuring involvement of developers, but with supportive and facilitating activities at the top level drawing from the strengths of higher level actors and factors.
Gradually evolving	One-Time Event	The gradual process of evolution, ideally, can be provided initial impetus through an event, and can also be, time and again, boosted through similar higher-level events.
Agency-Driven	Personality Driven	Combination is desired, wherein official involvement and commitment of agencies is matched by the personal interest and commitment of individuals at the top level as well as those on frontiers.
Cementing Factor: Knowledge Benefits	Cementing Factor: Political Commitment	Combination can be evolved where the knowledge and related benefits to developers could be buttressed by other types of benefits to developers and other stakeholders (including customers) that may flow to of the political commitment at various levels

works will have to be serious and consistent, the expectations about outcomes of these efforts, especially in short term will have to be moderate. Voluntary measures, including networking, will continue to have limitations due to this reason, it was suggested that some stricter regulation for sustainable buildings, in combination with voluntary measures would be required. On the basis of the discussion in the earlier segments of this section, an effort is made here to come up with a combination of the two models discussed here. This is called as the Desired Amalgamated Model and is presented in the third column of the table on the previous page.

## References

- [1] Jacob Thollonen. (2012, December 3). Municipality-Developers Network in Lomma.
- [2] Rachel Armstead. (2012). *Carrots, Sticks, Tigers and Wheels: A case study of Municipal Governance for Energy Efficiency in New Buildings in the Öresund Region*. Master's Thesis. IITEE, Lund University.
- [3] Signe Gaarde. (2012, December 4). Network in North Harbour.

“Connections” photo by Paroma Wagle on November 26 2012 at the Climate Centre in Lolland, Denmark .

“Network example: Energi Oresund meeting” photo taken by Paroma Wagle on December 12,2012 in Copenhagen, Denmark.

“Lomma Harbour” by Anja Hackfurth taken in in Lomma, Sweden. Date unknown

“Copenhagen by night” photo by Paroma Wagle on December 12, 2012 in Copenhagen, Denmark.



# ENERGY EFFICIENCY IN NEW URBAN AREAS



By Hilda Maria Gutiérrez

The purpose of this section is to highlight some of the trends found in the conundrum of the energy landscapes, in particular in the Öresund Region, with a special focus on technology innovations and measures within the concept of sustainable urban planning at the district level. This section will go from theory to practice by first discussing some of the urban sustainability concepts and technological innovations being put forward by the literature. Then presenting two case studies from the Öresund Region that show what are the actual priorities and trends found in new low energy projects.

From the production perspective, the urban energy landscape is undergoing significant changes as more integrated patterns in cities trigger innovation initiatives in areas as diverse and interconnected as public transport systems; building design and construction; fiscal funding; energy efficiency monitoring systems; and investments in renewable energy generation, storage and management, among others [1].

The current energy transitions are being advanced with the impetus of greater collective consciousness as the result of more awareness about environmental degradation, climate change and the trend that price and extraction costs of fossil fuels are becoming more expensive [1]. Possible ways forward may include renewable energy sources and efficiency technology to be based at the local and community level and be produced, used, owned and man-

aged in distributed ways. In this sense, renewable energy and efficiency technology can contribute to a change in the lens of urban planning and offer new opportunities for community based and municipality supported innovation, commitments and programmes [1]. However, from a sustainability perspective, urban energy transitions will only be effective if technological advancements are accompanied by changes in lifestyles that result in less energy consumption [2].

## Discourse & Concepts

An exciting prospect for sustainable urban planning is its ability to bring together different disciplines in a common effort of providing for sustainable solutions for the array of challenges facing urban environments. Sustainable urban planning requires economists, urban designers, architects and transport planners, energy policymakers and technologists, among others, to talk to each other and begin to negotiate sustainable solutions to common problems [1].

The call for urban transformation has become louder in recent years and it is being embodied by different discourses that represent diverse paradigms within the urban sustainability debate. Solutions to the energy challenge being put forward vary from technological fixes focusing on renewable energy and sustainable designs to more holistic approaches that focus on the need to change values, attitudes and perceptions. The following section highlights

some of the discourses found in the literature on sustainable cities.

### **The Natural City**

The value system is placed at the heart of urban sustainability solutions by calling for a “re-positioning of fundamental values, paradigms and world views” [4]. The task is seen as one of critical engagement with both the values and structures shaping solutions for urban sustainability with an emphasis also on the interdependence of social and biophysical processes.

When framing questions and answers to urban sustainability the aim is to look at everything from an integrative lens including our understanding of and connection to the ecological system. Connecting people to the support system that keeps cities afloat (e.g. water, energy, food, wastes) is seen as key to urban sustainability.

The Natural City paradigm calls for city planners to think of ways to connect people to the support system of their cities in ways that are simultaneously physical and emotional, in order to try to internalize natural resources within our cognitive patterns. Furthermore, it seeks to expand the conceptual framework of energy to account for it in the flows between different systems [4].

### **Green Urbanism**

The main idea of Green Urbanism is to rethink the city itself and understand the linkages between energy, waste, food and water. Green urbanisation is driven by the principles of zero emissions, total recycling of waste, sustainable transport, extensive use of local materials, locally produced food, energy generation from renewable and sustainable use of water and energy [5]. The goal is to apply these principles together and make city districts as renewable energy power stations, water catchments and sources of local food supply.

Embedded in these principles are ideas about onsite decentralised system for energy generation in compact self-sufficient communities. The concept proposes a shift from centralised power stations run on non-renewable sources to small, decentralised power places run on local renewable sources in the city’s districts, that can be connected to a smart community grid; thereby connecting energy production with final place of consumption. The shift lies in transforming city districts into producers of renewable energy sources.

A notable proposition is to make citizens producers of the renewable energy for self-consumption and give them the opportunity to sell surplus energy back into the smart grid. A main concern is how to best deal with the entire urban metabolism and how to deal with resources in a more integrated approach. One idea is to focus on density and compactness at the district level to avoid urban sprawling and reduce the need for travelling long distances by car. This is accompanied with sustainable mobility options within the city’s infrastructure planning (e.g. good public transport, bicycle lanes and short distances between residential areas, shops, and work places) [5].

### **Transition Technologies**

Plans for energy efficiency measures and technologies are being taken at the district level and being promoted by visions of eco-cities and eco-districts. Future solutions may involve *distributed energy generation systems* that cut the need for long distance grid networks. Distributed energy systems can have the potential of improving the energy efficiency of power generation and distribution thereby affecting both supply side management (generation and distribution on a small-scale and close to end consumer) and demand side management (consumer usage and energy efficiency). Distributed systems can be used to meet peaking power, backup power, cooling and heating needs [6]. Distributed energy technologies include com-

bined cooling, heating and power application (CHP); which can lower costs and improve efficiency.

There is increased attention being paid to the optimal utilisation of waste streams for energy recovery. This includes *waste to energy technology* as well as measures to implement a waste stream reuse strategy from heat loss [5]. *Solar Cells* are becoming trendier as they become more efficient and affordable. *Solar panels* (to generate electricity) and *solar thermal collectors* (to heat up water) are examples of technologies being used to harness energy from the sun [5] Wind turbines are widely used for electricity. Solar energy, wind energy and groundwater are being used for cooling purposes. Heat from air, earth, groundwater and hot bedrock can be extracted using *heat pump* technology which can reduce energy consumption by 75% [5].

On the energy consumption side, *smart meters* that measure personal consumption on a daily basis can make visible consumption figures that could potentially lead to behavioural changes [5]. A solution for the management of energy is the use of *smart grid* technology to monitor electricity flowing through the grid and interact with the production, transmission, distribution and consumption side of the grid in order to provide dynamic solutions to the end user. Smart grids provide end user with the option of becoming energy suppliers by integrating renewable energy into the grid thereby helping to decentralise power generation. Also, this digital technology is able to communicate with appliances plugged into the grid at the end users level in order to increase efficiency and reduce costs by giving costumers the option of automatically unplugging their appliances during peak hours when the energy prices will be higher [7].

## Case Studies

One of the aims of this section is to provide information about the priorities and trends of new urban low energy areas. Two case studies

were measured against the principles of *Natural City and Green Urbanism* [4, 5]. The two case studies indicate that emphasis is placed on powerstations based on renewable sources for the purpose of making cities self-sufficient energy producers.

There is great attention being paid to densification of existing districts including mix usage of districts and eco-mobility, for example, mixing housing, commercial and recreational areas within short distances to promote sustainable transport. Regarding the energy priorities of the case studies, the first priority is to reduce energy demand by having energy efficient buildings; and the second priority is to use the best accessible energy supply [8, 11].

### **Nordhavnen Project**

The Nordhavnen project in Copenhagen has been described as “probably the most extensive and most ambitious metropolis development project in Scandinavia in the years to come” [9]. The overall structure will be divided into a number of islets forming integral units conceived as local districts that will be connected through a series of canals and basins. The development will take place during the next 40 to 45 years and the district will be located four kilometres from the city centre of Copenhagen. It will provide space for 40 000 residents and workspace for another 40 000 people. The exact location is on the Öresund coast, which will give the district direct access to seawater, which can be used for cooling [9].

Regarding energy usage, the development strategy is based on themes related to reductions of carbon dioxide (CO<sub>2</sub>) emissions and sustainable transport. There will be low CO<sub>2</sub> emissions as the result of its energy-efficient buildings, infrastructure and energy supply forms. There are plans to provide electricity, heating and cooling in a sustainable manner and have buildings and urban infrastructure use shared energy supply systems.

Concerning the district's energy infrastructure, the energy supply structure in general will use the best possible options, with the flexibility that future energy solutions can easily be implemented. There are plans to use a shared district heating system using geothermal heating (heat coming from the ground).

Instead of using solar heat, the summer surplus heat from waste incineration will be re-used. Wind, solar and groundwater will be used for cooling. One of the challenges is the technology available to reduce energy demand in buildings. Developers are not always willing to pay more to make energy-efficient buildings using expensive technology [8].

### **Brunnshög**

Brunnshög in Lund is another example of a project aiming to develop urban areas in a sustainable way. The project aspires to be a demonstration model as well as facilitate the dissemination of green technology and know-how. One of the things that characterises Brunnshög is collaboration amongst different actors in both planning and implementation process.

The municipality of Lund is playing an important role in the creation of the vision and long-term goals for sustainability as well as developing action platforms that can serve as models for developers and energy companies and other actors to build upon. The municipality together with municipality-owned energy companies is setting the overall framework for the infrastructure of Brunnshög.

The project is aiming to demonstrate how systems are linked together and how to achieve synergies amongst energy, water and waste management through a coordinated approach to infrastructure planning. Moreover, the municipality of Lund is involved in the process of identifying the different actors and bringing them together for open dialogue for the pur-

pose of advancing a new way of making business [10]. The last phase of the project is to be completed by 2050 and the first phase, known as Solbjer, is to be completed by around 2015. The whole Brunnshög area will have between 30 000 to 40 000 people.

The energy vision for the project is to produce at least 100% of the energy needed by the area and, in the far future, become a power plant by producing 150% of energy needed. At this stage, only the long-term goals have been drafted, with no decision being made about how they will be achieved or the types of technologies that will be employed in the future [11]. It is difficult, as it is unknown what future technology will look like, and the technology of today cannot reach those goals; yet it is still necessary to set the goals, as their purpose is to drive technological innovation and development.

From the municipality's perspective, one of the challenges is to find ways to make alternative technology economically viable. As of today, technologies for distributed energy systems are available but many have a long payback period and there are only a few companies willing to make those kinds of investments [9]. The actual implementation of distributed energy generation systems is low. Centralised systems such as district heating are still the preferred modus operandi, mainly because it is cheaper to implement [12].

One of the main challenges for the energy transitions is that developers are seldom willing to pay to invest in new technology because there is uncertainty about how much people are willing to pay for distributed energy systems. If the costs for alternative energy systems are too high, developers will seldom make the investments needed. Another bottleneck has to do with energy companies and their ability to implement the above mentioned new measures and technologies.

Another main challenge for energy companies is to help developers with new products and services [11,12]. The EU Directive 2012/27/EU can help address this situation. The rules in the EU Directive 2012/27/EU are designed to remove failures in the energy market and overcome barriers that impede efficiency in the supply and use of energy. Each Member State is obliged to set up an energy efficiency scheme; to ensure that energy distributors and retail energy sales companies achieve a cumulative end-use energy saving target [13]. Cooperation between developers, energy companies and the municipality is essential in order to find viable solutions for today's energy challenge. Dialogue is an important ingredient in the recipe for sustainable solutions.

## Analysis

The findings from the case studies suggest that energy and trade are not being connected in urban planning. For example, local food and short supply chains are not addressed. The various aspects of this principle include local food production and regional supply. There is no explicit mention of making land available for either community food production or urban agriculture. Within the EU, one third of the environmental impacts at the household level (energy use, land use, water, soil pollution and greenhouse gas emissions) are related to food and drink consumption [14]. The Brunshög Project in Lund is an exception. Recognising that the soil in the area is very fertile, there have been some discussions about including local food production; although no concrete goals have been established yet [11].

Urban energy transitions will only be effective if technological advancements are accompanied by changes in lifestyles that result in less energy consumption [2]. To this end, it is important to understand the difference between *direct energy consumption* (which includes residential and transport energy) and *embodied energy* which in-

cludes the energy that is needed through the entire life cycle of a product or service consumed by an end user [2]. When discussing energy sustainability and sustainable urban planning, the embodied energy use by consumer is often left out of the picture. All the commodities consumed in urban areas often do not evoke any association with energy.

Oftentimes, people are not aware of the amount of energy that is needed to produce goods and services. Looking at energy patterns from a consumer's perspective, it becomes evident that in high income countries embodied energy is higher than direct energy consumption. While efficiency and technological improvements decrease energy demand, and save money, time and effort for the consumer; savings are often spent elsewhere leading to a *rebound effect* resulting in either increased consumption or increase energy use. The impacts of the rebound effect have the potential of offsetting the gains from technological efficiency. This means that when discussing sustainability solutions within urban planning, attention needs to be paid also to lifestyle and education for sustainability [2].

Globalisation has made urban cities complex trade networks that bring into cities resources imported from foreign countries. The energy coming from these imports can be described as *foreign energy* [2]. Despite energy efficiency measures and technology, global trade renders many cities importers of products made with high energy intensity process in foreign countries. In other words, the energy that is saved by energy efficiency technology in the North is offset by the foreign energy.

## Recommendations

When configuring the blueprint for the city of the future, accounting the energy embedded in international trade could lead to substantial transformation because cities seeking to reduce their total energy consumption or greenhouse



gas emissions would therefore limit the foreign energy that is imported and prioritise local or regional production [2].

Accounting for the energy reality of globalised trade could result in a different way of organising the production of goods and services at the local level as much as possible. Efforts for distributed energy generation could be accompanied by a system of *distributed economies* as embedded in the concept of Green Urbanism. It consists of decentralised and self-reliant systems of production and consumption of goods and services [15]. Distributed economies are local in scale and flexible in nature; emphasising the use of local resources and in maintaining their deployment at the regional level thereby localising the energy and material flows [15]. Connecting sustainable urban planning and design with concepts like distributed economies is an essential step for the urban energy transformation and transition that are needed for solutions to be viable and effective.

## References

- [1] Droege, P. (2008). Urban Energy Transition: An Introduction. In: Droege, P., (ed.) *Urban Energy Transitions: From Fossil Fuel to Renewable Energy*. 1<sup>st</sup> Edition. Oxford: Elsevier.
- [2] Lenzen, M., Wood, R. & Foran, B. (2006). Direct Versus Embodied Energy-The Need for Urban Lifestyle Transitions. In: Droege, P., (ed.) *Urban Energy Transitions: From Fossil Fuel to Renewable Energy*. 1<sup>st</sup> Edition. Oxford: Elsevier.
- [3] Janicke, M., (2008). Ecological Modernization: New Perspectives, *Journal of Cleaner Production*. 16:557-565.
- [4] Stefanovic, I. & Scharper, S. (Eds). (2012). *The Natural City: Re-Envisioning the Built Environment*. Toronto: University of Toronto Press.
- [5] Lehmann, S. (2010). *The principles of green urbanism: transforming the city for sustainability*. London: Earthscan.
- [6] Gardner, J. & Ashworth, P. (2008). Towards an Intelligent Grid: A Review of the Literature. In: Droege, P., (ed.) *Urban Energy Transitions: From Fossil Fuel to Renewable Energy*. 1<sup>st</sup> Edition. Oxford: Elsevier.
- [7] Mulvaney, D., & Robbins, P. (Eds.) (2011). *The SAGE Reference Series on Green Society toward a Sustainable Future. Green technology: An A-to-Z guide*. Thousand Oaks, CA: SAGE Publications.
- [8] Hanne Christensen (11 December 2012). Climate director at Ramboll. Personal communication in an interview.
- [9] Model Kobenhavn (2009). Nordhavnen Urban Strategy.
- [10] Marc Friesen (14 December 2012). Lund Municipality's Project Office. Personal communication in an interview.
- [11] Maria Pettersson (14 December 2012). Lunds Energikoncernen. Personal Communication in an interview.
- [12] Anders Edvardsson (10 December 2012). Energikontoret Skåne. Personal Communication in an interview.
- [13] European Parliament and Council. (2012). Directive 2012/27/EU of the European Parliament and of the Council of 25 October 2012 on energy efficiency, amending Directives 2009/125/EC and 2010/30/EU and repealing Directives 2004/8/EC and 2006/32/EC.
- [14] Reisch, L., Scholl, G., et al. (2010). Sustainable Food Consumption CORPUS-Enhancing the Connectivity between Research and Policymaking in Sustainable Consumption. CORPUS.
- [15] Murat, M. (2012). *Distributed Economies: An Alternative Approach to Sustainability*. Lecture in Environmental Management in Organization, International Institute for Industrial Environmental Economics, Lund in Autumn 2012.

“Residential buildings at Teglvaerkshavnen” photo taken by Hilda Maria Gutiérrez on 11 December, 2012 in Copenhagen, Denmark.

# LOLLAND – TOP RUNNER IN SUSTAINABILITY

By Paulina Aguilera, Sarah Beckham Hooff, Natalie Cheong, Hilda Maria Gutiérrez, Alex Leshchynskyy, Rowena Mathew, Amelia Mutter, Jacob Policzer, Sonja Radmilovic, Janice Kei-Yau Sin, Birgitta Stefánsdóttir, Leonie Sterk, Christine Sum, & Paroma Wagle



Nestled in the Baltic Sea, Denmark’s fourth largest island – Lolland – has re-invented itself as a living laboratory for sustainability. Through the initiatives described hereafter, the island has successfully recovered from times of severe economic hardship and developed itself into a thriving region – capable of preserving both its natural and cultural heritage while also being exemplary to the broader international community. Shifting the economic focus towards green alternative research after the collapse of its ship building industry, Lolland has been able to reverse its downward unemployment and emigration trends [1].

Today the municipality boasts a highly attractive investment environment from collaboration amongst the private sector, research institutions and local government. This collaboration is known as the “Triple Helix Network” designed to streamline the testing, development and implementation of cutting edge renewable energy technology. Current research projects focus predominantly on renewable energy (wind, hydrogen, wave and biomass), biotechnology and the associated infrastructural capacity development [2]. The innovative public private partnerships have ensured a rapid full-scale testing of these initiatives and ensure that Lolland remains a business-friendly hub well into the future.

This section aims to describe the policies, projects and research being conducted in the field of sustainability in Lolland, Denmark from a study visit on November 26-27, 2012.

## Community Testing Facility (CTF)

The Lolland Island is a showcase of sustainable solutions to the energy challenge. The island has many years of experience with local solutions that create economic opportunities and sustainable development through the implementation of renewable energy projects and technology. The sustainable development strategy is rooted in an innovative concept called Lolland Community Testing Facility (CTF). Lolland provides a testing and demonstration ground for technology and products using renewable energy sources.

The CTF model is a locally initiated, bottom-up strategy that has attracted new business and supported research on renewable energy. This has produced long-lasting partnerships between business, research and educational institutes that combine the interest of the business sector for innovation, the interest of research institutions for testing and municipalities’ need for creating job opportunities. Municipalities have actively given industry the opportunity to test renewable energy technologies and products on a full-scale in real communities, allowing quick implementation. This closes the gaps that often exist between ideas, investment and implementation. The CTF was developed with the understanding that solutions had to be based on the local community using participatory approaches for the successful implementation of policies.

The CTF activities on Lolland include several renewable energy sources like wind, biomass, and solar. One of the projects of Lolland Municipality is to establish the Lolland Hydrogen Community as a showcase for stationary fuel cell technology and integration with intermittent renewable energy sources and grid. In addition, Lolland CTF has established an energy education programmes aimed at school and university students [3]. One such initiative is the Science on a Sphere.

## Science on a Sphere: Innovative Education

The town of Holeby is the home of the Visual Climate Centre – Lolland. The centre holds one of the five Science On a Sphere (SOS) globes in Europe, which is a visual presentation of our planet.

The SOS project was initiated by the National Oceanic and Atmospheric Administration (NOAA) as an innovative way to educate people of all ages on planetary and atmospheric science [4]. The display consists of a 2 meter globe and four video projectors. The NOAA, along with National Aeronautics and Space Administration (NASA), develops a datasets that can be projected onto the sphere showcasing among other things atmospheric trends, past and potential future scenarios.

As Lolland has developed a holistic approach to address environmental challenges in the area, it is of great importance to educate the



local community how to address environmental issues on a local level whilst understanding the bigger picture. By inviting the local primary schools to visit the Visual Climate Centre, the students will gain a better understanding of the significance of minimising their environmental impacts. The intention is for students to engage their own families.

## Onsevig Climate Park

Onsevig Climate Park, located at the coastal village of Onsevig, is an example of the significance of strong commitment from municipalities for successfully addressing climate change. Following a strong storm surge that flooded the village in November 2006, the municipality decided to take action and to turn it into a test area for several climate change adaptation and renewable energy projects. The Climate Park is characterised by a holistic approach focusing on the creation of a multifunctional dyke system and the exploration of potential coastal symbioses. It is part of Lolland's CTF, which include a dyke system, algae cultivation tanks, an offshore and an onshore wind park as well as a combined wave and wind power plant. All projects aim to combine innovative climate adaptation strategies and business opportunities while being backed up by dedicated research and sound science [5].

## Multifunctional Dyke System

Lolland belongs to one of the lowest parts of Denmark, making it especially vulnerable to rising sea levels and climate change induced floods and storms. In reaction to the flood surge of 2006 a new dyke system was erected, consisting of a 3.5 m high front dyke with a coupure. However, as dykes are expensive and the municipality has researched strategies to balance the high investment costs with profits and benefits generated by the dyke itself. This

*The sphere displaying the temperature and movement of ocean currents.*

led to the construction of (a) a run-off water management system and (b) the construction of algae tanks. Instead of pumping run-off fresh water from fields over the dykes and into the sea it is collected in basins. It is then treated by the algae grown in the tanks in order to recycle valuable nutrients (such as phosphorous and nitrogen) and to reuse the clean water for irrigation.

### ***Algae Cultivation***

There are four 10 metre by 12 metre open basins for algae cultivation behind the dykes, which provide researchers a unique perspective on coastal symbioses. Algae are cultivated to treat runoff with high nitrogen content from the surrounding farmlands and capture carbon. They are later harvested as biomass for industrial purposes, such as raw materials for biodiesel and other valuable chemicals [6]. For example, the biomass can be degassed and returned to farmers as fertiliser. Researchers have also discovered that the basins form a micro-ecosystem, in which a new food chain is composed as plankton and fish begins to emerge. This indicates the possibility of harvesting protein and nutrition for human and animal consumption. For example, the biomass can be refined to produce protein suitable for fish farms [7].

More in-depth research on the optimal cultivating environment of algae is currently underway at the Algae Innovations Center (ACI) Lolland. It is a three-year project initiated in 2010 with the aim of establishing a demonstration and pilot plant for algae cultivation using various algae species, and carrying out research on how



community and business can exploit the economic potential of algae [7].

As well as learning from the basins behind the dykes the pilot plant tests productivity of different algae species under different conditions (pH, temperature, and light intensity). Scientists at the ACI have observed that growing a natural mixture is more beneficial because the algae species self-select. Algae can be grown outdoors all year-round, even in winter when days are shorter, and temperatures and light intensity are lower. It is cultivated using manure (as a source of nitrogen and phosphorous) or industrial wastewater to determine energy content from biomass harvested. It has been found that industrial waste containing metals results in biomass with lower energy content compared to manure.

Although the ACI is making strides in understanding the use of algae, there are still many challenges to widespread commercialisation. For use in a biodigester, algae is inefficient requiring much more space than traditional bacteria. As a biofuel, algae is not ready for widespread use mainly due to cost of production. In particular, capital costs are high, for example centrifuge technology used to convert the product to biofuel is expensive. Ultimately, the long-term objective of the ACI project is to gain new knowledge and methods of algae production, and exploit the role that algae can play in solving current and future environmental and energy problems.

### ***Onshore and Offshore Wind Farms***

Onsevig's coastal location makes it one of the most ideal locations to harvest wind energy. Located in the southwest of Onsevig, an onshore wind farm with 25 wind turbines, each with a production capacity of 450 kW, was established. In 1991, DONG Energy built the

---

*Multifunctional dyke.*



world's first offshore wind farm in Onsevig harbour. This wind park consists of 11 wind turbines, 450 kW each, producing a total of 10 GWh of electricity per year, which is approximately 20% more than an onshore wind farm of similar size.

### **Combined Wave and Wind Energy: The "Floating" Power Plant**

In addition to more established renewable energy such as wind power, Lolland is also interested in investigating the potential of wave energy. The world's first combined wave and wind energy extraction power plant, called Poseidon 37, which was launched in November 2008. Poseidon 37 (called so because of its width) is a hybrid prototype of both wind and wave energy extraction, and transforms wave energy into electricity, as well as provides a floating foundation for the offshore windmills to stand on. It consists of a triangular shaped floating anchored platform of wave energy converters and three wind turbines created by the Danish company Floating Power Plant A/S [5,8]. The key components are the floats which absorb the wave energy using a double function piston pump to transform it into water pressure. This water pressure is sent through a turbine which generates electricity with an efficiency of 35% [3], using simple hydroelectric mechanics. The total wave production capacity is 99 kW. Of note are also the unique form of the floats and their dynamic ballasting [5] that

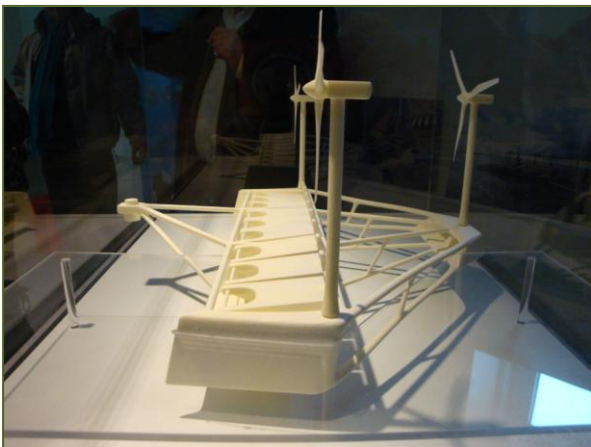

ensure maximum absorption of the wave energy. The three wind turbine themselves are standard offshore wind turbines with a total production capacity of 3 kW.

Poseidon 37 had three test phases [8]:

- The stability of the platform including wave absorption was tested;
- The wind turbines were installed to test the grid connection; and
- The jointly produced power to the grid.

This sustainable energy hybrid system has a significantly higher installed effect, efficiency and energy production compared to other wave energy systems [8]. This is due to the cost of production and maintenance (in EUR/kW) being lower than the energy output from the combined hybrid system. Offshore wind is currently limited to shallow waters only 20 meters deep because of limitations with the foundation. The hybrid system taps into the unexploited deep-water high wind potential. There are plans to look into fish farming close to the Poseidon. The structure underneath the surface of the sea forms a niche habitat for algae and small fish, which in turn attract bigger fish. This can potentially be converted into a pisciculture area [5].

### **Wind Academy Lolland & Rødsand II Wind Farm**

Wind power on Lolland is quickly expanding, and organisations and companies related to wind power on the island can be taken as examples of effective institutions for promoting the development of wind energy.

#### **Wind Academy Lolland**

The Wind Power Academy of Lolland, established in 2006, is an organisation which seeks to facilitate interactions between stakeholders

*Model of Poseidon 37.*



in the wind energy development industry and members of the international scientific community. To meet this goal, the Wind Academy sponsors a platform and facilities for research related to technological development and innovation. In addition to this, it provides services to the local community, namely in the form of skills-building vocational courses focused on the employee needs of the wind industry on Lolland.

As such, the Wind Academy Lolland focuses on increasing the utility of two distinct value chains related to wind energy development on Lolland:

1. The first value chain involves the design and establishment of the wind farms per se. Developing new technologies and strategies which make the exploitation of wind energy more efficient is at the core of many Wind Academy initiatives and projects.
2. The second value chain is related to the post-construction operation and maintenance of wind farms and their component turbines [9].

### ***Value Chain I: Efficiency Technology & Strategies***

Establishing and seeking funding for research initiatives on various aspects of wind turbine efficiency in one of the Wind Academy's major activities. Often, projects are conducted in consort with outside academic institutions or funding organisations. This can be a mutually beneficial arrangement; wind academy gains access to highly trained research professionals, and academics gain exposure to research opportunities, which would be unavailable to them without cooperation with the academy. For example, the Wind Academy has established positive relationships with local municipalities, scientists have in some cases been able to gain access to otherwise restricted areas [9]. Some

---

*A wind turbine's impact on the landscape can be significant.*

examples of current research include projects related to methods for locating the optimal position of offshore wind turbines. Another focuses on developing new methods for testing bolt integrity among turbine component parts, and the use of ultrasonic signals for this purpose is being investigated.

The Wind Academy provides facilities for testing research ideas related to various aspects of turbine efficiency, but in doing so also creates opportunities for broader innovation [10]. A unique academic and social community is formed when participants from various research projects interact, and brainstorming generated during casual meetings among researchers may prove to be the greatest outputs arising from the Wind Academy's academic initiatives.

### ***Value Chain II: Turbine Maintenance for Sustained Efficiency***

As the warranty period for most turbines is much shorter than their expected lifespan, the realisation of full wind energy potential will depend greatly on appropriate maintenance. The Wind Academy Lolland has acknowledged this, and their initiatives to support research related to turbine efficiency are complemented by programmes designed to increase local capacity to maintain wind turbines.

In order to enhance the utility of the "post-construction" value chain for local residents and energy companies alike, the Wind Academy organises training programs designed to increase the vocational capacity of the local



population. A representative of the Wind Academy reports that the organisation has trained between 150 and 200 locals in subjects such as height rescue and fall protection, first aid, ergonomics and manual work, fire safety and fire-fighting, which are skills necessary for the maintenance of wind turbines. The Wind Academy facility hosts the training walls and other structures needed to run trainings on site [11].

Although there has been criticism of wind development in the region, the Academy's strong academic and international focus enhances its legitimacy in the wind power debate.

### ***Rødsand II Wind Farm***

The Rødsand II wind farm is located off the shore of Lolland in the Baltic Sea. It is located adjacent to the Rødsand I project, but is immediately distinguishable from the later due to its curved shape. While the turbines of the Rødsand I project are arranged in straight rows parallel to the coast, the 90 turbines of the Rødsand II project are arranged in five arching bows [12]. This produces the same amount of energy as would be generated by 91 turbines arranged in parallel rows due to reduced drag and turbulent effects. Given the high capital costs of purchasing and installing wind turbines, this innovation in turbine positioning, which economises the power of one turbine for free is significant. The wind power capacity of the project totals a high 48%, whereas typical figures range from 20-40% [13].

The Rødsand II wind farm is not only remarkable for its efficiency; effective maintenance and a conscientious work culture have resulted in the farm being ready for exploitation of 98% of the time – reportedly the best in the world. This can be attributed to Rødsand II work philosophy that everything done during the work day should contribute to:

1. Making the Rødsand II wind farm the best in the world; and/or
2. Making the Rødsand II wind farm the best place to work.

The Rødsand II wind farm is slated to generate wind electricity for 25 years. That is, from its opening in 2010 until 2035, at which time the managing company E.ON is obliged by its contract issued by the Danish government to re-negotiate conditions to extend production life or dismantle the wind farm.

## **Biomass for District Heating**

Denmark has committed to supplying carbon neutral district heating as heating is one of the highest energy-consuming sectors. District heating was introduced with the aim of replacing the individual oil burners for households. Today, the heat for 6 300 households and businesses in Nakskov and Søllested comes from Heating A/S, a group of municipality-owned heat-producing plants.

These plants are run on:

1. Straw;
2. Wood chips; and
3. Organic oil.

Altogether, they generate approximately 110 000 MWh of heat per year.

There are several benefits for using local biomass for district heating systems. The most relevant is lower production costs as biomass is



*Bale storage in straw heating plant.*

sourced locally. This is advantageous in particular when resources are by-products from local industries, such as straw from farms. The heat produced is sold to neighbouring municipalities.

However, recent policies in Scandinavia are trying to reduce the use of biomass for energy and heating production. Also, national political ambitions to reach carbon neutrality could significantly decrease demand for heating.

### **Straw Heating Plant**

Straw is highly abundant in Lolland; therefore, the largest supply for district heating comes from 9 800 tonnes of straw. The straw plant in Sølsted produces approximately 12 000 MWh of heat per year. The straw is collected and compressed in bales and kept in piles stored in the plant. With regards to the quality of the straw, the straw used for burning processes can only contain 16% water [5]. The straw-burning process is fully automatic and consists of two 10 MW boilers. Excess heat is stored in a tank outside the plant. One of the benefits of using straw as an energy source is that when it burns at 650°C, the air pollutant NO<sub>x</sub> from fertilisers is no longer released into the atmosphere.

### **Woodchips Heating Plant**

The woodchips plant is the second alternative used for district heating in Nakskov. This plant produces steam from burning woodchips. Around 25 000 tonnes of woodchips are imported from Sweden, whereas only 5 000 tonnes come from local wood. Moreover, the costs of producing heat in these plants are 20% higher than the costs from the straw heating plants [5].

### **Organic Oil Heating Plant**

The third energy source used for heating is

organic oil. However, this alternative is only used as a back-up for heat production since the price is three times more expensive than producing heat from straw. The organic oil price is based on the market price, and usually comes from the waste oil in industry, for instance the fish industry [5].

## **Waste Management**

The Waste Management of Lolland and Falster is conducted by the inter-municipal company REFA, operating waste incinerators, combined heat and power plants, waste collection systems, and recycling stations [13]. REFA has successfully reduced its rates of landfilling by 72% between 1988 and 2010 [14] along with decreasing dioxin emissions, increasing recycling rates and waste-to-energy recovery. The municipality is looking to further reduce the environmental impacts, aspiring to become “zero-waste” and “zero CO<sub>2</sub> emissions”.

Education is a key driver in facilitating effective and efficient action, and has played a key role in the implementation of the system. In Lolland, education occurs in two forms (1) communication of knowledge to the users of the system – which includes residents and companies and (2) continual collaboration with universities and companies.

Recycling and waste recovery are key elements of this strategy. Indeed Lolland has 14 recycling centres, two waste disposal centres, and one composting facility for sewerage sludge, as well as, energy generation through wood-to-



*Information regarding segregation at waste collection facility.*

heat, straw-to-heat and biogas facilities. 11 of the 14 recycling facilities are designed according to the REFA-model. REFA's goal is that customer should not have to travel further than a maximum of 10 km to the nearest recycling facility. They are arranged in a circular manner where the cars drive on a one-way-path which leads them by the 32 recycling containers. REFA ensures safe disposal of these waste streams; a large portion is incinerated to produce heat and electricity and only asbestos and certain building materials are landfilled [13]. The customer is given the opportunity to leave functioning goods such as electronics and furniture in second hand containers for other customers to reuse.

## Conclusion

The Lolland case study demonstrates how addressing environmental issues can be accompanied by benefits related to socio-economic development. By adopting the Triple Helix development strategy, Lolland has transformed the health of its economy, created jobs and knowledge for the local community and increased the sustainability of its economic basis.

## References

- [1] Magnoni, S. & Bassi, A. (2009). Creating synergies from renewable energy investments, a community success story from Lolland, Denmark. *Energies*, 2, 1151- 1169.
  - [2] Theel, C. (2009). Lolland Community Testing Facilities. Baltic Sea NGO Forum. Retrieved December 5, 2012, from <http://ebookbrowse.com/ch-theel-presentation-baltic-sea-ngo-forum-1-ppt-d118012555>.
  - [3] Christensen, L. (2012). Lolland CTF, from PowerPoint slides. Lolland Municipality, Lolland on November 26, 2012.
  - [4] National Oceanic and Atmospheric Administration (NOAA). (2012). Science On a Sphere. Retrieved December 1, 2012, from [www.sos.noaa.gov](http://www.sos.noaa.gov).
  - [5] Leo Christensen. (27 November 2012). Vice-President at Lolland Energy Holding A/S. Personal communication during site visit at Onsevig Climate Park, Lolland.
  - [6] Lolland Kommune (LK). (n.d.) Leaflet of Lolland Energy Tours – Visit Lolland's climate and environment initiatives. Maribo: Lolland Kommune.
  - [7] Algae Innovation Center. (n.y.) Algae Innovation Center Lolland - Innovative paths towards a future bio-based society brochure.
  - [8] Poseidon Floating Power. (2012). Concept and Technology. Retrieved November 29, 2012, from <http://www.floatingpowerplant.com/?pageid=336>.
  - [9] Representative of Wind Academy Lolland. (28 November 2012). Project manager. Personal communication during site visit at Wind Academy Lolland, Lolland.
  - [10] Representative of Wind Academy Lolland. (28 November 2012). Project manager, PowerPoint presentation given during site visit at Wind Academy Lolland, Lolland.
  - [11] Wind Energy Lolland. Basic safety training. Retrieved 29 November 2012, from <http://www.iwal.dk/index.php?page=english>.
  - [12] Lyck, Jens. (28 November 2012). Technical manager of Rødsand II wind farm. Personal communication and PowerPoint presentation during site visit at Rødsand II main office building, Lolland.
  - [13] REFA. (2012). Genbrugspladser. Retrieved December 1, 2012 from <http://www.refa.dk/REFA/Genbrugspladser.aspx>
  - [14] Representative of REFA. (27 November 2012). Project manager, Power-Point presentation given during site visit at REFA Waste-to-Energy Plant.
- “The Dynamic Sphere” photo taken by Rowena Mathew on November 26, 2012 in Lolland, Denmark.
- “Multifunctional Dyke” photo reprinted with permission of Lolland Municipality.
- “Model of Poseidon 37” photo taken by Paulina Aguilera on November 27 2012 in Lolland, Denmark.
- “A wind turbine’s impact on the landscape can be significant.” photo reprinted with permission of Annette Greenfort at Dansk InfoDesign.
- “Bale storage in straw heating plant” photo taken by Paulina Aguilera on November 27 2012 in Lolland, Denmark.
- “Information regarding segregation at waste collection facility” photo taken by Paulina Aguilera on November 27 2012 in Lolland, Denmark.



# THE IIIEE

## The International Institute for Industrial Environmental Economics



**E**stablished in 1994 by the Swedish Parliament, the International Institute for Industrial Environmental Economics (IIIIEE) has grown to become a leading international research and teaching centre pursuing strategic preventative solutions in sustainable development. As part of the Lund University, IIIIEE offers undergraduate, masters, and postgraduate programmes in a multidisciplinary environment that focuses on pragmatic approaches to fostering the transition towards a sustainable society.



The IIIIEE seeks to facilitate this transformation by engaging in a combination of education and research activities with the aim of bridging academia and practice in the public and private sectors. The Institute's researchers and teachers have backgrounds in natural sciences, technology, law, economics, and other social sciences.

The IIIIEE is proud of its multidisciplinary and multicultural approach to sustainability, stemming from its international students, faculty and staff.

By collaborating with other departments at Lund University and with other universities worldwide, the Institute explores and advances knowledge in the design, application, and evaluation of strategies, policies, and tools for a transition towards these sustainable solutions.



Alumni are found within consulting, industry, research, NGOs, international and national governments, and other fields. The IIIIEE has a strong alumni network consists of over 640 members representing over 80 countries.

*For more information, please visit:*

[www.iiiiee.lu.se](http://www.iiiiee.lu.se)



# MESPOM

## Masters in Environmental Sciences, Policy and Management



This report was compiled as part of the international Master's degree in Environmental Sciences, Policy and Management (MESPOM). The degree is a two-year Erasmus Mundus course that is supported by the European Commission and is a consortium of four European and two North American universities. As part of the programme, MESPOM students spend the first two semesters studying at Central European University in Budapest, Hungary before travelling to the island of Lesvos, Greece for six weeks of study at the University of the Aegean.

In the second year of the programme, students are divided with roughly half choosing to continue courses at the International Institute for Industrial and Environmental Economic (IIIEE) at Lund University. Other students continue their studies at Manchester University in England. In the final semester of the programme, students disperse to compose their master's theses at any of the consortium universities: Lund University in Lund, Sweden;

Central European University in Budapest, Hungary; Manchester University in Manchester, UK; the University of the Aegean in Lesvos, Greece; the Monterey Institute for International Studies in Monterey, United States; and the University of Saskatchewan in Saskatoon, Canada.

The authors of this report are MESPOM batch 7 students presently completing their third semester at the IIIEE. The group is composed of 14 students from Australia, Germany, Hong Kong, Iceland, India, Mexico, Nicaragua, Serbia, Singapore, Ukraine, and United States of America. This publication is part of the Strategic Environmental Development course, which examines possible environmental futures for energy in the Öresund region. **Mikael Backman** and **Thomas Lindhqvist** lead the project and the course. Both are IIIEE professors, with backgrounds in sustainable tourism and environmental product policy, respectively.



*The whole MESPOM class in Sigrí, Greece - summer 2012.*

#### **ACKNOWLEDGEMENTS:**

The MESPOM programme and IIIEE attracts students from all over the world, and the students contributing to this report hail from Australia, North and South America, and several countries of Asia and Europe. It is with great pleasure that we have engaged in the research for this report. In the process, we have learned to appreciate our current home, the Öresund region, not only for its picturesque Nordic beauty, but also for its progressive commitment to sustainability.

With this in mind, we would like to note that gaining new insights, knowledge, and experiences would not have been possible without the help of many individuals:

We express our gratitude for the pedagogical skill and patience of our instructors at IIIEE, and of Mikael Backman and Thomas Lindqvist in particular.

Many thanks to the representatives and stakeholders of Energi Öresund, who provided us with valuable guidance and information, in addition to teaching us about rice pudding, herring, and glug at an excellent Christmas party!

The Lolland case study section of this report would not have been possible without the fabulously organised study tour of the island. We express thanks to all who shared their time and knowledge during study visits, of which Leo Christensen was especially generous.

Finally, we would like to offer a concluding thanks to all those whom we interviewed for this report. While interviewees are mentioned in each report section, it cannot be emphasised enough how essential these individuals were in cultivating an appreciation of the Öresund region context. **Thank you!**



# LUNDS UNIVERSITET

**International Institute for  
Industrial Environmental Economics  
at Lund University**

P.O. Box 196, Tegnérsplassen 4,  
SE-221 00 Lund, Sweden

Tel: +46 46 222 0200

[iiiee@iiiee.lu.se](mailto:iiiee@iiiee.lu.se)

[www.iiiee.lu.se](http://www.iiiee.lu.se)