



LUND UNIVERSITY

Progress Report 1987-1988

[unknown], [unknown]

1988

[Link to publication](#)

Citation for published version (APA):

[unknown], . (1988). *Progress Report 1987-1988*. (Lund Reports in Atomic Physics; Vol. LRAP-90). Atomic Physics, Department of Physics, Lund University.

Total number of authors:

1

General rights

Unless other specific re-use rights are stated the following general rights apply:

Copyright and moral rights for the publications made accessible in the public portal are retained by the authors and/or other copyright owners and it is a condition of accessing publications that users recognise and abide by the legal requirements associated with these rights.

- Users may download and print one copy of any publication from the public portal for the purpose of private study or research.
- You may not further distribute the material or use it for any profit-making activity or commercial gain
- You may freely distribute the URL identifying the publication in the public portal

Read more about Creative commons licenses: <https://creativecommons.org/licenses/>

Take down policy

If you believe that this document breaches copyright please contact us providing details, and we will remove access to the work immediately and investigate your claim.

LUND UNIVERSITY

PO Box 117
221 00 Lund
+46 46-222 00 00

BIENNIAL REPORT
1987 - 1988

Division of Atomic Physics
Lund Institute of Technology
P.O. Box 118
S-221 00 Lund
Sweden

Editor: S. Andersson-Engels

Lund Reports on Atomic Physics
LRAP - 90

CONTENTS

	PAGE
INTRODUCTION	1
RESEARCH PROGRAMMES	9
A. EMISSION SPECTROSCOPY	9
B. BASIC LASER SPECTROSCOPY	11
B1. Theoretical calculations	16
B2. VUV spectroscopy	18
B3. Laser evaporation as a source of free atoms and ions	25
B4. Accurate lifetime measurements	26
C. COMBUSTION DIAGNOSTICS	32
C1. Laser-induced fluorescence and related techniques	33
C2. Experiments related to soot formation	36
C3. Vibrational CARS activities	39
C4. Rotational CARS and noise in the CARS process	40
C5. Optical tomography	42
C6. Ignition studies	46
C7. Further technique developments	48
D. ENVIRONMENTAL REMOTE SENSING	59
D1. Monitoring of atmospheric pollutants	59
D1.1. Laser methods	59
D1.2. Non-laser methods	65
D2. Laser-induced fluorescence of marine oil-spills and land vegetation	68

E. MEDICAL APPLICATIONS	73
E1. LIF studies of malignant tumours in animal experiments	76
E2. LIF experiments of human tumours <i>in vitro</i>	79
E3. Clinical investigations of laser-induced fluorescence	79
E4. LIF studies of human atherosclerotic plaque <i>in vitro</i>	81
E5. Laser lithotripsy	83
E6. Development of instrumentation	84
 F. INDUSTRIAL APPLICATIONS	 93
F1. Optical spectroscopy for control of pyrometal- lurgical processes	93
 TEACHING PROGRAMME	 97
A. Undergraduate teaching 1987-1988	97
B. Basic courses	100
C. Specialized courses	101

INTRODUCTION

The Division of Atomic Physics, Lund Institute of Technology (LTH), is responsible for the basic physics teaching at all sections of LTH and for specialised teaching in Optics, Atomic Physics, Atomic and Molecular Spectroscopy and Laser Physics. The Division has research activities in basic and applied optical spectroscopy, to a large extent based on lasers. It is also part of the Physics Department, Lund University, where it forms one of six divisions. Since the beginning of 1980 the research activities of our division have been centred around the use of lasers. The activities during the 1980 - 1982 building-up period and during the subsequent four years have been described in previous Progress Reports (Lund Reports on Atomic Physics, LRAP-20, LRAP-43 and LRAP-85). During the last two years the research programme has been further expanded.

Research on emission spectroscopy and term analysis, a classical field for atomic physics in Lund, is being pursued with emphasis on the analysis of the spectra of multiply ionized inert gases. The study of such ions is strongly motivated by their importance in laser and collisional physics and for interesting interplay with theory in the interpretation of the spectra. This programme is supported by the Swedish Natural Science Research Council (NFR).

Basic atomic laser spectroscopy is being performed both with CW high-resolution techniques and with time-resolved methods. In a programme which is supported by the NFR, excited atomic states are investigated with regard to radiative properties and hyperfine structure. During the last two years the activities have concerned light elements such as boron, carbon and silicon, ions such as Gd^+ and group Ib elements such as Cu. New techniques for producing atoms using laser plasma generation and effusive atomic beam formation from a hollow-cathode discharge have been used. A precision method for lifetime measurements using a mode-locked dye laser in conjunction with photon counting techniques has been developed and used for studies of sodium, bismuth, copper and iron. Additional spectroscopic techniques have been introduced during the last two-year period, such as pulsed level-crossing spectroscopy and Doppler-free frequency modulation

and degenerate four-wave mixing spectroscopy. In addition, static and dynamic properties of saturation spectroscopy have been studied. Our experimental laser spectroscopy programme is closely integrated with corresponding theoretical calculations using many-body perturbation theory, Hartree-Fock and configuration interaction schemes. A project for generating VUV laser radiation is supported by the Research Council of the Swedish Board for Technical Development (STUF). Coherent radiation down to 93 nm has been generated by nonlinear optical techniques and has been applied in the study of the CO molecule.

Several projects within applied laser spectroscopy are being pursued. For several years, a major project regarding combustion diagnostics with lasers has been supported at the Division of Atomic Physics by STU and the Swedish Energy Board (STEV). Based on our diagnostic activities a Combustion Centre was formed at the Lund Institute of Technology in 1985. In addition to the physicists, researchers from the Mechanical Engineering, the Civil Engineering and the Chemical Engineering Sections now participate in the Centre's activities, which are coordinated by Prof. Thure Högberg and Docent Marcus Aldén. Most of the graduate students active within the Centre are enrolled in the Division of Atomic Physics. Many aspects of flame kinetics, NO_x and soot formation, turbulence and spark ignition are being studied using laser-induced fluorescence, Raman and CARS spectroscopy. Theoretical work on kinetics and spark ignition supplements the extensive programme. A close coupling to industry is maintained through special projects with partial industrial funding (ABB, SYDKRAFT, VOLVO).

An additional STU-funded combustion spectroscopy programme is being pursued at the Division in coordination with our other spectroscopic programmes. New methods for combustion and flow diagnostics based on degenerate four-wave mixing, frequency modulation spectroscopy and gas-correlation are being developed.

Environmental remote sensing using optical techniques is another applied spectroscopy project. The programme includes the development of new optical measurement techniques for air pollution monitoring and field experiments to facilitate the transfer of technology to

practical applications in industry and air quality management. A powerful mobile lidar system is used for techniques development and field work. Range-resolved mapping of atomic mercury and NO was demonstrated for the first time. Geophysical aspects were added in a field experiment aimed at mercury detection in Icelandic geothermal fields. In parallel with the lidar work, differential optical absorption spectroscopy (DOAS) is being pursued. A powerful research doas system overlooking the city of Lund is being installed. The remote sensing group is participating in two European projects, TESLAS and TOPAS, within the EUROTRAC collaboration, dealing with vertical lidar ozone sounding and DOAS development, respectively. Basic research in remote sensing is supported by the Swedish Board for Space Activities (DFR) while applied work is supported by the Swedish Environmental Protection Board (SNV). Close cooperation with the Swedish Environmental Research Institute (IVL) in Göteborg is maintained. As a spin-off from our research with the doas technique a company, OPSIS AB, is rapidly expanding in the IDEON Research Park in Lund under the directorship of two former group members.

Other spectroscopic projects of industrial interest are also being pursued. A project concerning the development of diagnostics techniques in connection with ore smelting and processing has shown very interesting potential. A spin-off company (SEMTECH AB) has been formed at IDEON with participation of division members.

During the last two years our activities in the medical field have further increased. A research programme on cancer tumour detection and treatment using lasers is being pursued jointly with the Lund University Hospital. The techniques rely on the properties of the tumour-seeking agent hematoporphyrin derivative (HPD). The first successful treatment of patients in Scandinavia has been performed within our group. Investigations of other photosensitizing agents are being performed. The possibility of performing tissue diagnostics without any drug administration is being actively explored. In particular, work on spectroscopic diagnostics of atherosclerotic plaque is in progress, aimed at spectroscopic guidance in fibre-optic plaque ablation using excimer laser radiation. Advanced diagnostic

equipment for point measurements and imaging, based on fluorescence is being constructed. This programme is supported by the Swedish Cancer Foundation (RmC), The Swedish Medical Research Council (MFR), STU and Radians Innova AB.

The Division of Atomic Physics arranged the Eighth International Conference on Laser Spectroscopy in Åre, Sweden, June 22-26, 1987. We have also been actively involved in the arrangement of several other international and national conferences.

In our report series "Lund Reports on Atomic Physics" (LRAP) material which is not published in international journals is presented. The reports include dissertations, diploma papers and special investigations. So far 100 papers have appeared. At the end of the period covered by this progress report the staff of the Division totalled 47. This number includes 19 graduate students and 13 supporting personnel. In addition about 10 diploma students perform their projects within our division every year. It is through the dedicated work of these people that the research and teaching accomplishments reported here have been made.

We are very grateful for the support of various funding agencies, in particular the Swedish Natural Science Research Council (NFR), the Swedish Board for Technical Development (STU and STUF), the Swedish Energy Authority (STEV), the Swedish Board for Space Activities (DFR), the Swedish Environmental Protection Board (SNV), the Swedish Cancer Society (RmC), the Swedish Medical Research Council (MFR) and the Knut and Alice Wallenberg Foundation. In addition, the support and co-operation of the Swedish Environmental Research Institute (IVL) and industries such as ABB, SYDKRAFT AB, SAAB SCANIA AB, Radians Innova AB and the Swedish Space Corporation (RB) are gratefully acknowledged. Special thanks are due to Stefan Andersson-Engels, who has invested a great deal of time, patience and skill in serving as the editor of this progress report.

Sune Svanberg
Head of the Division of Atomic Physics

STAFF

Head of Division:

Prof. Sune Svanberg

Emeritus Prof. Lennart Minnhagen

Deputy Head:

Docent Willy Persson

Adjoint Professor:

Prof. Thure Högberg

(Head, Combustion Centre)

University lecturers:

Docent Elvir Andersson, dean

Dr Göran Jönsson

Dr Stig Borgström

Docent Rune Kullberg

Dr Bodil Jönsson

Dr Sven-Göran Pettersson

Docent Gilbert Jönsson

Senior scientists:

Docent Marcus Aldén

Docent Hans Lundberg

Post-doctoral researchers:

Dr Hans Edner

Dr Stefan Kröll

Dr Hans Hertz

Dr Claes-Göran Wahlström

Post-graduate students:

Sara Agrup, M.Sc. (tech.)

Jörgen Larsson, M.Sc. (tech.)

Stefan Andersson-Engels, M.Sc. (tech.)

Lars Martinsson, M.Sc. (tech.)

Juha-Petri Aunola, M.Sc. (tech.)

David Nilsson, M.Sc. (tech.)

Jonas Bengtsson, M.Sc. (tech.)

Anders Persson, M.Sc. (tech.)

Per-Erik Bengtsson, M.Sc. (tech.)

Lennart Sturesson, M.Sc. (tech.)

Håkan Bergström, M.Sc. (tech.)

Anders Sunesson, M.Sc. (tech.)

Jörgen Carlsson, M.Sc. (tech.)

Svante Wallin^b, M.Sc. (tech.)

Bo Galle^a, M.Sc. (tech.)

Eva Wallinder, M.Sc. (tech.)

Hans Hallstadius, M.Sc. (tech.)

Wilhelm Wendt, M.Sc. (tech.)

Per Jönsson, M.Sc.

Ulf Westblom, M.Sc. (tech.)

Diploma and project students:

Per Ove Almeflo	Peter Kauranen
Lars Andersson	Ingmar Kronfeldt
Petra Andersson	Mats Lindelöw
Charlotte Arfwidsson	Marina Månsson
Jonas Bengtsson	Lars Nilsson
Peter Bengtsson	Carina Palmqvist
Rikard Carlsson	Håkan Pettersson
Sven-Inge Cederfelt	Pär Ragnarsson
Stefan Dungner	Thomas Starczewski
Petra Hansson	Jörgen Strand
Niklas Hildesbrand	Hans Sturesson
Bengt Johnsson	Bo Sörheim
Lars Jönsson	Stellan Trappe

Technical staff:

Margareta Arnwald	Lennart Nilsson
John Bergin	Rolf Olofsson
Åke Bergqvist	Jan Olsson
Lars Gramstad	Georg Romerius
Bertil Hermansson	Helen Sheppard
Carin Holmqvist	Göran Werner
Gunnel Mattsson	

Guest researchers:

Dr Gregory Faris (Stanford University)
Dr John Goldsmith (Sandia Laboratory)
Dr Raafat Amer (Alexandria University)
Ms Malini Olivo (University of Malaya)
Dr Kanda Sinkarat (Chiang Mai University)

Ph.D. Theses:

Sune Montán	1987-04-23	On the Use of Laser-Induced Fluorescence in Industrial and Medical Applications
-------------	------------	---

Hans Edner	1987-05-27	Applications of Laser Spectroscopy to Combustion and Environmental Probing
Anders Sunesson	1988-04-08	Laser and Optical Techniques Employed in Environmental Monitoring
Hans Hertz	1988-05-27	Optical Diagnostic Techniques for Studies of Combustion and High-Voltage Systems

- a) External student, Address: Swedish Environmental Research Institute, P.O. Box 47086, S-402 58 Göteborg
 - b) External student, Adress: OPSIS AB, Idéon, S-223 70 Lund.
-

FIELDS OF RESEARCH - PERSONNEL

DECEMBER 1988

DIVISION OF ATOMIC PHYSICS
 LUND INSTITUTE OF TECHNOLOGY
 Head: S. SVANBERG
 Deputy head: W. PERSSON

BASIC RESEARCH		APPLIED RESEARCH		
EMISSION SPECTROSCOPY	ATOMIC LASER SPECTROSCOPY	COMBUSTION DIAGNOSTICS	ATMOSPHERIC OPTICAL REM. SENSING	MEDICAL AND INDUSTRIAL SPECTR. APPL.
W. PERSSON	H. LUNDBERG	M. ALDÉN	H. EDNER	S. ANDERSSON-E
L. MINNHAGEN	C-G WAHLSTRÖM	T. HÖGBERG	R. AMER	S. BORGSTRÖM
S-G PETTERSON	G. JÖNSSON	S. KRÖLL	B. GALLE	J. JOHANSSON
	J. BENGTSSON	H. HERTZ	E. WALLINDER	P. Hansson
	H. BERGSTRÖM	S. AGRUP	P. Ragnarsson	N. Hilderbrand
	J. CARLSSON	J-P AUNOLA	
	H HALLSTADIUS	P-E BENGTSSON		W. WENDT
	P. JÖNSSON	L. MARTINSSON		(M. ALDÉN)
	J. LARSSON	D. NILSSON		(W. PERSSON)
	A. PERSSON	S. WALLIN		
	L. STURESSON	U. WESTBLOM		
	L. Jönsson	P. Kauranen		
		P. Bengtsson		
		S. Trappe		
		J. Strand		

34 Research Personnel (13 Ph.D., 20 Grad. Students, 1 Visitor)

8 Diploma Students (M.Sc.)

13 Ext. Positions

7 Post-graduate Fellowships

Total Personnel, Div. of Atomic Physics: 47 + (8) = 55

A. EMISSION SPECTROSCOPY

Lars Jönsson, Lennart Minnhagen, Willy Persson, Sven-Göran Pettersson, Claes-Göran Wahlström

The optical spectroscopy group has continued the studies of the emission spectra and energy-level structures of low and intermediate ionization stages of the rare gases outlined in the preceding progress report. The main interest has been directed towards the spectra of doubly ionized xenon (Xe III) and doubly ionized neon (Ne III). Both studies are part of the long-lasting collaboration with the spectroscopy groups in La Plata and Tandil, Argentina.

In the Xe III investigation [1] the number of classified lines was increased from about 300 to about 1400. The lines were classified as transitions between 73 even levels belonging to the configurations $5s^2 5p^4$, $5s^0 5p^6$, $5s^2 5p^3 6p$, $4f$, and $5f$ and 83 odd levels belonging to the $5s^1 5p^5$, $5s^2 5p^3 6s$, $7s$, $5d$ and $6d$ configurations. The experimentally observed level structure was compared with the results of Hartree-Fock calculations and parametric fits. In particular, the effect of Rydberg-series configuration interaction on the level distributions in the $5s^2 5p^3 nd$ configurations was studied. A comparison was also made between the results of our analysis and published data on the Xe $N_{4,5} 00$ Auger spectrum.

The spectrum of doubly ionized neon has been studied in the 7000-300 Å range [2]. The number of classified lines has been increased from about 100 to about 750, while the number of experimentally established energy levels has been increased from about 60 to almost 250. The known energy level system now includes levels in the configurations $2s^2 2p^4$, $2s 2p^5$, $2s^0 2p^6$, $2s^2 2p^3 3s - 8s$, $3p - 5p$, $3d - 5d$, $4f - 8f$ and $5g - 7g$.

For some $2s^2 2p^3 3p$ levels a parametric fit using the single-configuration approximation shows large discrepancies between observed and calculated level values. It is possible to improve on the fit by the introduction of the α parameter. However, a still

better fit is obtained by omitting α and explicitly including the $2s^2 2p^3 np - 2s^0 2p^5 np$ interaction, even if the number of free parameters is kept the same. This interaction is of the same type and of the same strength as the $2s^2 2p^4 - 2s^0 2p^6$ interaction, which is known to significantly distort the $(^1S - ^1D)/(^1D - ^3P)$ interval ratio in the ground configuration.

In the fit to the even levels we include the $2s^2 2p^4 + 2s^0 2p^6 + \{2s^2 2p^3 + 2s^0 2p^5\}(3p+4p+5p+4f+5f) + 2s 2p^4 3s$ configurations while in the fit to the odd levels the following configurations were included: $2s 2p^5 + \{2s^2 2p^3 + 2s^0 2p^5\}(3s+4s+5s+3d+4d+5d) + 2s 2p^4 3p$. For both even and odd levels the results are compared with the results of similar calculations for F II.

The spectrum of singly ionized oxygen, O II, has been observed in the 1070 Å - 2150 Å wavelength range [3]. The spectrum was excited in a theta-pinch discharge. The majority of the observed lines connect previously known levels of O II but some 30 lines are transitions to newly established levels. On the basis of the measurements and known levels, calculated wavelengths, suitable as reference wavelengths, are given for a number of lines in the 1070 Å - 2140 Å wavelength range.

References

- A1. W. Persson, C.-G. Wahlström, G. Bertuccelli, H. O. Di Rocco, J. G. Reyna Almandos and M. Gallardo, Spectrum of Doubly Ionized Xenon (Xe III), *Physica Scripta* 38, 347 (1988).
- A2. W. Persson, C.-G. Wahlström, L. Jönsson and H. O. Di Rocco, Extended analysis of the spectrum of doubly ionized neon, Abstract to 3rd ECAMP, Bordeaux 1989.
- A3. S.-G. Pettersson and I. Wenåker, Vacuum-ultraviolet lines in the spectrum of O II, submitted to *Physica Scripta*.

B. BASIC LASER SPECTROSCOPY

Jonas Bengtsson, Håkan Bergström, Jörgen Carlsson, Gregory Faris*, Hans Hallstadius, Jörgen Larsson, Hans Lundberg, Per Jönsson, Anders Persson, Lennart Stureson, Sune Svanberg, Claes-Göran Wahlström.

* Visiting scientist

The group engaged in basic laser spectroscopy and fundamental atomic investigations has continued its experimental and theoretical work on hyperfine interactions and radiative lifetimes. This work, as will be outlined below, has led to a number of technical achievements and new experimental techniques. The development of experimental techniques has been complemented by a simultaneous development of an improved software package for computer analysis and evaluation of the experimental data [1]. The theoretical program, including *ab initio* calculations of atomic oscillator strengths, lifetimes and hyperfine interactions, will be described in section B1.

The development of sources of coherent radiation at wavelengths in the vacuum ultra-violet (VUV) range has also continued. A number of methods are now available, and tunable wavelengths as short as 93 nm have been generated. The work dealing with this development and recent lifetime measurements in CO around 122 nm is presented in section B2.

Spectroscopic investigations of inherent atomic properties require some means of producing free atoms (or ions) at a suitable density. This is often done by heating the material in an oven which has a small orifice. The evaporated atoms form an atomic beam which can then be investigated. However, certain elements of interest require very high temperatures to produce a sufficiently high vapour pressure, and oven material then becomes a severe problem. Different types of hollow-cathode discharges for laser spectroscopic studies have been investigated and compared [2]. One of these, "the diffusive discharge source", was described in the previous biennial report. A

quite different approach is to use a laser-produced plasma. This technique, which is described in section B3, has been introduced, investigated and successfully applied in a number of cases.

Time-resolved laser spectroscopy for the investigation of lifetimes and quantum beats and corresponding theoretical calculations have played a central role in our activities for several years. This has resulted in a large number of papers published on this topic, as described in our previous reports. Techniques have been developed during the last two-year period leading to significantly increased measurement accuracy, especially for short lifetimes. These developments, and some relevant examples, are presented in section B4.

New techniques for the measurement of hyperfine splittings using pulsed lasers have also been introduced and are being further developed in our group. This work focuses on level crossing and optical double-resonance spectroscopy using pulsed laser excitation, and has been found to be very promising [3,4]. Pulsed lasers can generate radiation at considerably shorter wavelengths than continuous lasers, and these methods will therefore increase the possibilities to measure hyperfine structures in higher-lying excited states. By using delayed detection, signal resolution beyond the Heisenberg limit can also be obtained, as illustrated in Fig.1, where level crossing signals for the $9\ ^2D_{3/2}$ level of ^{133}Cs are shown. Presently the structure of the $5p\ ^2P_{3/2}$ state in neutral Cu is under study at an excitation wavelength of 202 nm.

During the last two-year period, some new investigations, dealing with the interaction between resonant laser radiation and atomic vapours, have been included in our research programme. In the biennial report 85-86 a new technique for Doppler-free laser spectroscopy was described: "High contrast saturation spectroscopy on optically thick atomic samples". An optically thick sample, e.g. sodium vapour in a cell, is exposed to a high-intensity (saturating) pump beam and a counterpropagating probe beam of the same frequency. When the frequencies of the beams are tuned, within the Doppler

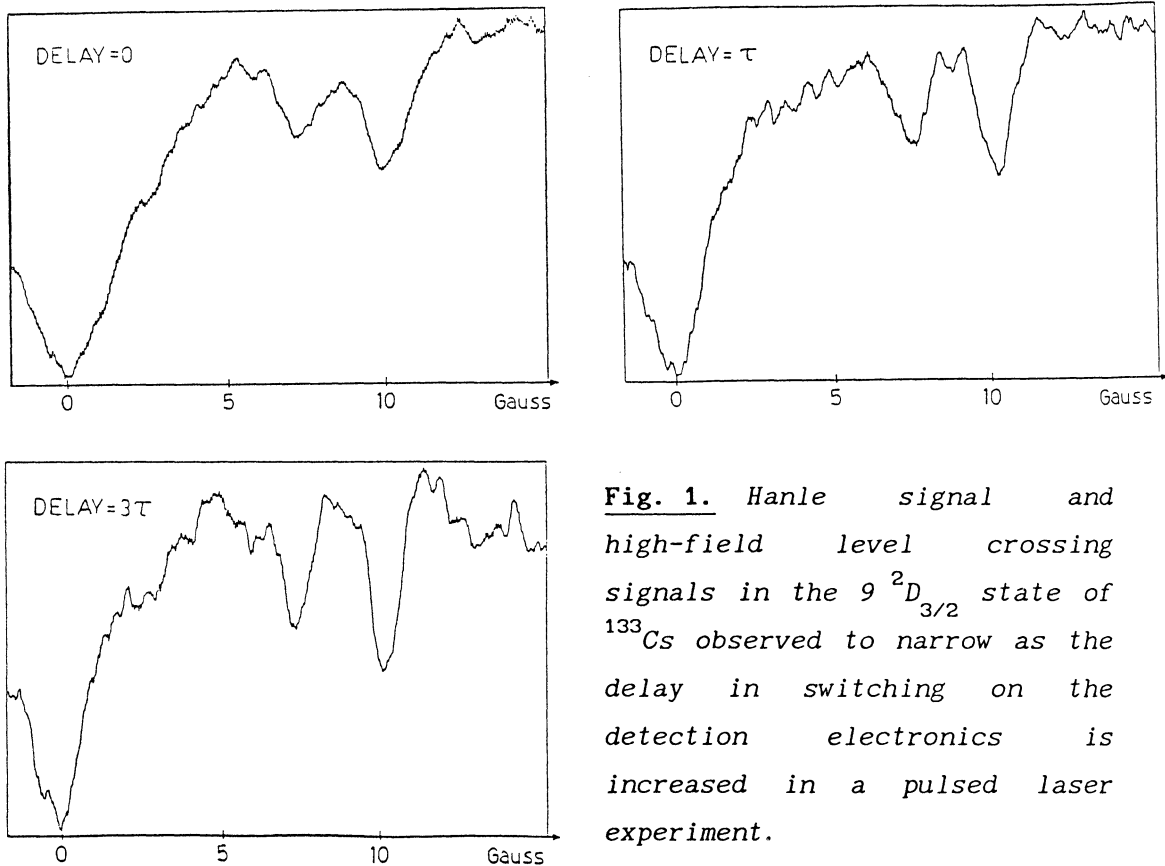

Fig. 1. Hanle signal and high-field level crossing signals in the $9^2D_{3/2}$ state of ^{133}Cs observed to narrow as the delay in switching on the detection electronics is increased in a pulsed laser experiment.

profile of the resonance line, the weaker probe beam can only penetrate the sample when the absorption is low, and this occurs only at the line centre where the cell is "opened up" by the strong saturating pump beam. This technique and the physical processes involved are now being analysed further in our laboratory. A more complete theoretical model for the "hole burning" process is being developed and computer simulations are being performed. The effect of possible signal shifts is being especially investigated [5]. Certain time-resolved experiments are also being performed on the high-contrast setup. The dynamic properties of pump - probe interaction are being investigated by pulse-modulating the pump beam with an acousto-optical modulator and studying the rise and fall time of the penetrating probe beam. Interesting effects are expected due to the strong nonlinearity inherent in the high-contrast regime and experiments show that these times can differ drastically, depending on the experimental condition [27]. Data are shown in Fig. 2. Further experiments and theoretical modelling are planned in order to gain a more complete understanding of the underlying phenomenon.

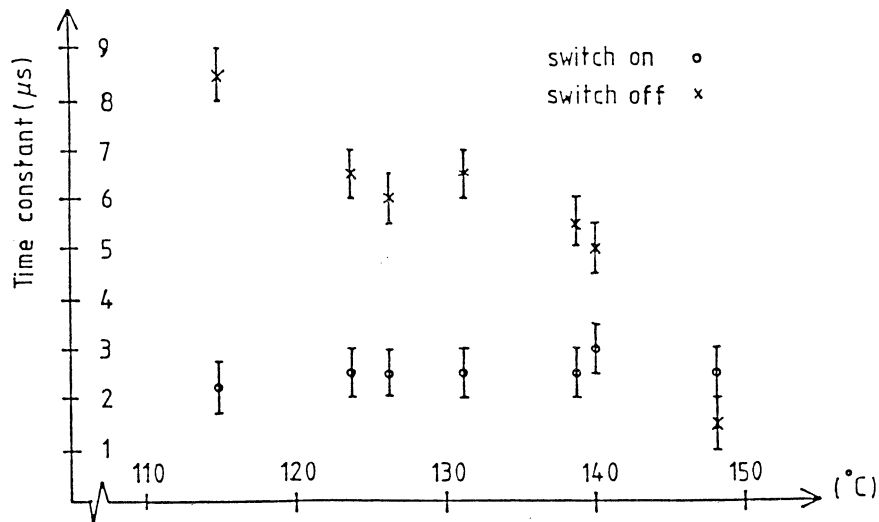

Fig. 2. *Temperature dependence of the rise- and fall time for the Doppler-free signal of the sodium D_2 line.*

Another of these new types of investigation is the study of degenerate four-wave mixing (DFWM). This project is closely related to the combustion project outlined in section C, Combustion diagnostics, in this report, and is described further there. DFWM is a special case of the four-wave mixing technique used in, for example CARS. A demonstration, illustrating different aspects of the method, using sodium vapour as mixing medium, has been performed as a diploma project [6]. In this technique the signal, as in CARS, is in the form of a coherent beam and is therefore well suited for spectroscopic investigations where background light would normally be a limiting factor. Furthermore, the signal is a phase-conjugated replica of a coherent laser beam, and this makes the method ideal for investigations in, for example, turbulent media. Of special interest for the basic laser spectroscopy programme is that Doppler-free signals are obtained from low-pressure samples. A further non-linear laser spectroscopic tool has been added to our arsenal: frequency modulation (FM) spectroscopy. Here side-bands on a single-mode laser beam are produced using an electro-optic modulator. The side-bands are equally strong and 180° out of phase and normally the beat frequency cancels. However, a sample absorption results in an FM modulation that can be detected with high sensitivity. In Fig. 3 Doppler-free DFWM and FM spectroscopy are illustrated, together with ordinary saturation spectroscopy.

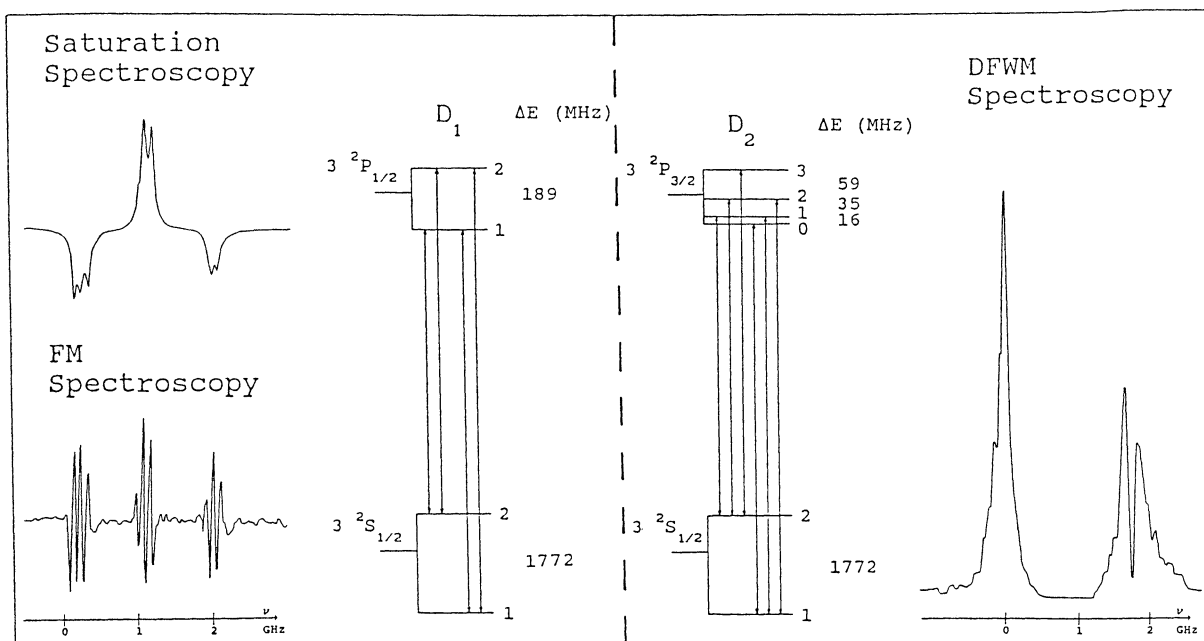

Fig. 3. *Examples of sodium D-line Doppler-free recording with Degenerate four-wave mixing, frequency modulation spectroscopy and ordinary saturation spectroscopy.*

As a complement to narrow-band CW dye lasers, semiconductor lasers offer interesting possibilities. Such a system has been used for collimated atomic beam spectroscopy on the resonance line of rubidium, an experiment which is now available in the undergraduate laboratories.

Results of our measurements and theoretical calculations have been presented at several major international conferences [19-27]. We have also arranged a major international conference, Eighth International Conference on Laser Spectroscopy in Åre, Sweden, June 22-26 1987. Over 230 scientists from 20 countries participated in this conference, and the proceedings have been published by Springer Verlag [28]. In collaboration with the Dept. of Atomic Spectroscopy, we have also organized a local conference dealing with the frontiers in atomic structure calculations and spectroscopy.

The manuscript for a comprehensive textbook on Atomic and Molecular Spectroscopy has been submitted to Springer Verlag. The book will appear as volume 6 of Springer Series in Atoms and Plasmas [29].

B1. Theoretical calculations

Most of the experimental results obtained have been compared with results of theoretical calculations. In some cases theoretical predictions have already been used in the planning stages of an experimental study. The theoretical *ab initio* methods we have used are many-body perturbation theory (MBPT) and multi-configuration Hartree-Fock calculations (MCHF).

The MBPT method was employed for the hyperfine interactions in the $4p^2P$ states in neutral boron [7]. In this approach the hyperfine interactions and the non-central part of the electrostatic interactions are treated as perturbations to a spherically symmetric ion-core. It was found that correlation effects are extremely important in this light system with only one valence electron ($4p$) outside the closed $1s^22s^2$ core. The correlation contribution to the magnetic dipole-interaction constant, $A(^2P_{3/2})$, is larger than the entire central-field contribution from the valence p electron, and to obtain convergence the perturbation expansion had to be carried to high orders. The contribution to the Fermi contact interaction from core polarization and correlation have the same sign in excited 2P states, and add constructively. In the ground state, $2s^22p^2P$, however, the core polarization contribution is of the same order of magnitude but with the opposite sign to that of the correlation effect. Accurate calculations of the net contribution are therefore more elaborate for the ground state. Work is in progress regarding this matter in collaboration with the Atomic Physics Group at Chalmers University.

During the last few years, the experimental work of the group has extended from group II and III elements to atoms with a more complicated electronic structure. This leads to new difficulties, particularly in connection with theoretical calculations. An experiment is not necessarily more complicated by the atom having several open shells, whereas a theoretical calculation certainly is. Our present computer code, the MBPT method, however accurate and

elaborate, is limited to systems which can be treated as having a single electron outside a closed core (filled shells or sub shells). Neutral group IA, IB and IIIA atoms are examples of such systems.

An alternative method of calculating *ab initio* values for the hyperfine interactions in systems with more than one "valence" electron is to use MCHF wavefunctions and series expansions. A computer program for the evaluation of magnetic and electric hyperfine interaction constants and effective radial integrals has been developed during the last two-year period [8]. Due to its simplicity, relative to MBPT, this MCHF approach allows fast estimations of *ab initio* values and has proven useful on several occasions during the initial stage of an experimental study. A theoretical analysis of the magnetic hyperfine interaction in the $3snd\ ^1D_2$ sequence in neutral Mg has recently been completed [9]. The hyperfine interaction in this sequence would be small, and not experimentally resolvable, in the absence of any interaction with the $3p^2$ configuration. One way to probe this configuration mixing is therefore to measure the hyperfine structure splittings and to compare them with the theoretical results. The possibility of performing such measurements is presently being investigated.

The MCHF method has mainly been used for oscillator strength and lifetime calculations. Accurate results were obtained for neutral boron [7] in connection with the experimental study of that element. Another system, which has been studied quite intensely during the last two years, is the copper atom. Copper, and also silver and gold, lie between the simpler systems, where the excited states form Rydberg series, and the transition metals which have electrons in several open shells. The ground state in copper is $3d^{10}4s\ ^2S_{1/2}$. By exciting the 4s electron the same Rydberg series as in potassium are formed, as can be seen in Fig. 4. But in copper there are also bound states in which one of the 3d electrons has been excited to a 4s or 4p orbital. One effect of this is a strong configuration interaction between the many different $3d^94s4p$ states and the $3d^{10}np$ and $3d^{10}nf$ states. The most obvious symptom of this configuration interaction is the highly irregular fine-structure in the $3d^{10}np\ ^2P$ series.

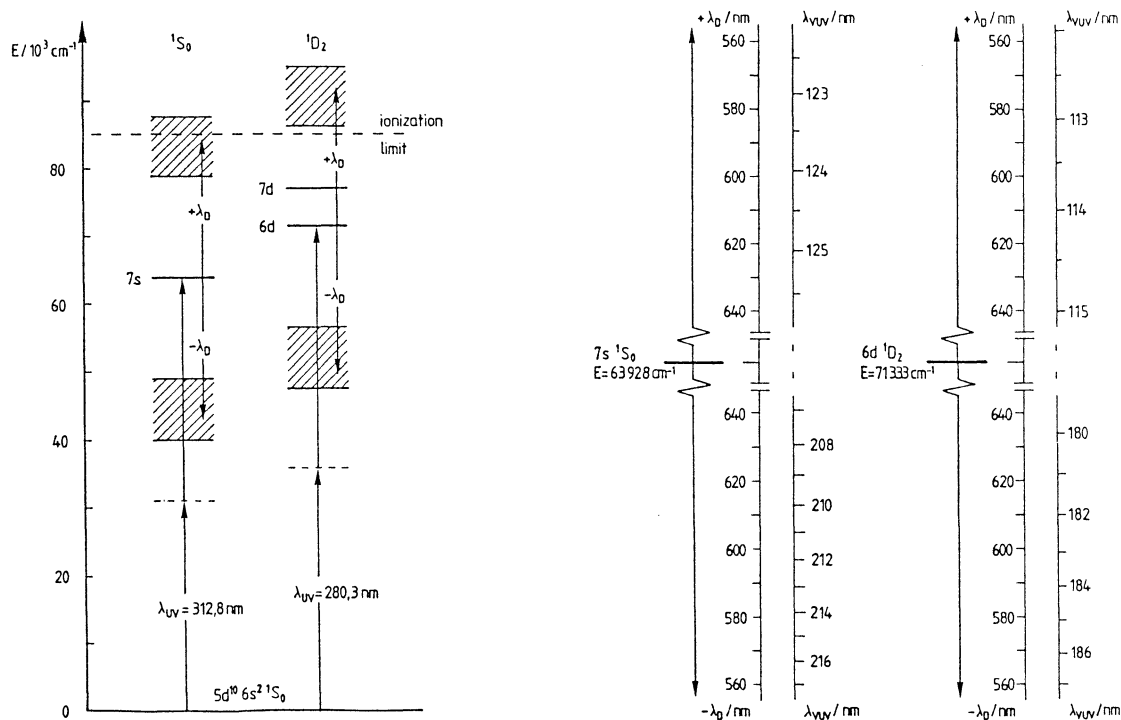

Fig. 7. Level diagram (left) showing the singlet states in mercury. Two-photon resonant frequency mixing generates VUV radiation in the shaded regions. $\omega_{\text{vuv}} = 2\omega_{\text{uv}} \pm \omega_D$. Here λ_D is tuned between 420 and 670 nm. In the figure to the right, parts of the shaded regions are shown with enlarged wavelength scales.

laser is necessary. For example, in Krypton, VUV radiation was produced around 202 nm and 122 nm using R640 as laser dye. Changing to Xenon and R6G, radiation in the regions around 185 and 112 nm was generated instead. However, the mixing processes in these gases are non-resonant and therefore the generated VUV power, as yet, is too low to be practically useful.

Using mercury vapour as the non-linear medium, the VUV output can be strongly enhanced by tuning $2\omega_{\text{uv}}$ into resonance with any of the two-photon transitions $6^1S_0 - 7^1S_0$ ($2 \cdot 312.8$ nm), $6^1S_0 - 6^1D_2$ ($2 \cdot 280.3$ nm) or $6^1S_0 - 7^1D_2$ ($2 \cdot 259.4$ nm). A second tunable dye laser (ω_D) makes it possible to scan the output wavelength in the VUV, with a pulse energy high enough for that required in laser spectroscopy. The shortest wavelength that has been generated so far is 93 nm, which is the third harmonic of 280.3 nm.

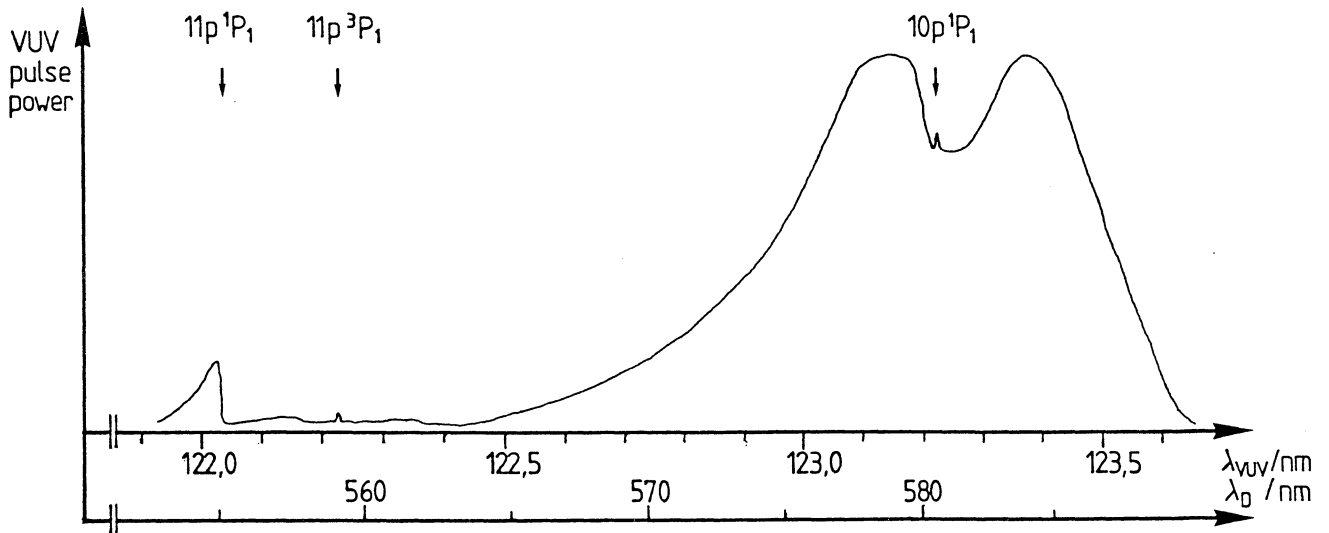

Fig. 8. The sum frequency signal in VUV generated in mercury vapour as a function of the second dye laser wavelength λ_D , when λ_{UV} is set to 312.8 nm. The vapour pressure was 10 torr and the mercury was mixed with about 15 torr of argon, used as buffer gas.

The details of the system used for doing laser spectroscopic studies in the VUV wavelength region are shown in Fig. 9.

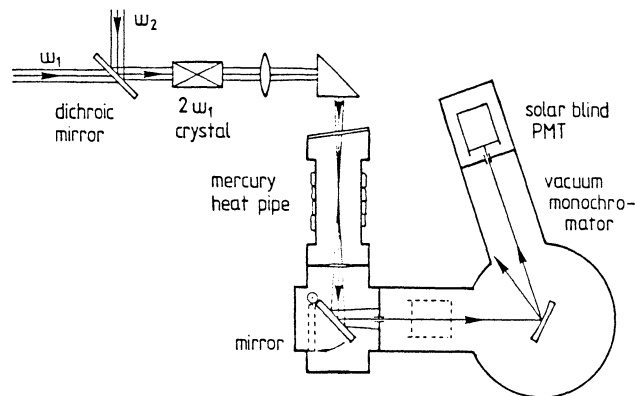

Fig. 9. Details of the experimental setup. In this arrangement, $\omega_{UV} = 2\omega_1$ while $\omega_D = \omega_2$. Two separate dye lasers allow the VUV output to be tuned with a high conversion efficiency, using resonant sum or difference frequency mixing. The PMT is movable. When studying the induced fluorescence in a gas, the PMT is placed close to the entrance slit of the monochromator (broken lines in the figure).

The energy of the transition $X^1\Sigma - A^1\Pi$ (0-13) in the CO system is about 81300 cm^{-1} . Tunable radiation in this region was produced using sum frequency mixing in mercury vapour (see Fig.7). 123 nm radiation was generated by scanning λ_D around 576 nm (R6G+R610) and the fluorescence was captured with the detector placed close to the CO cell (as shown in Fig.9). At a CO pressure of 0.1 torr the rotation structure was clearly resolved (Fig.10). Through laser excitation of high-lying vibrational levels, we can improve our knowledge regarding molecular constants in the electronic level. The lifetime of this vibrational level was determined to be 11.9 ns [15].

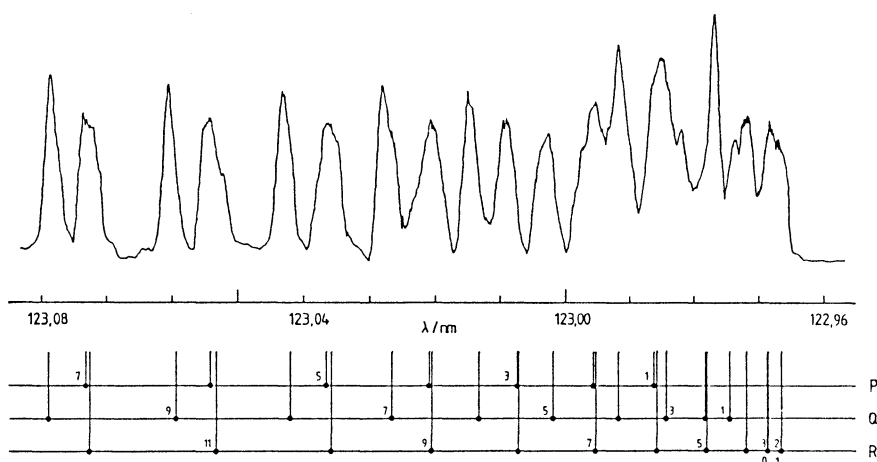

Fig. 10. Fluorescence spectrum of the $X^1\Pi - A^1\Sigma$ (0-13) transition in CO. The pressure was 0.08 torr.

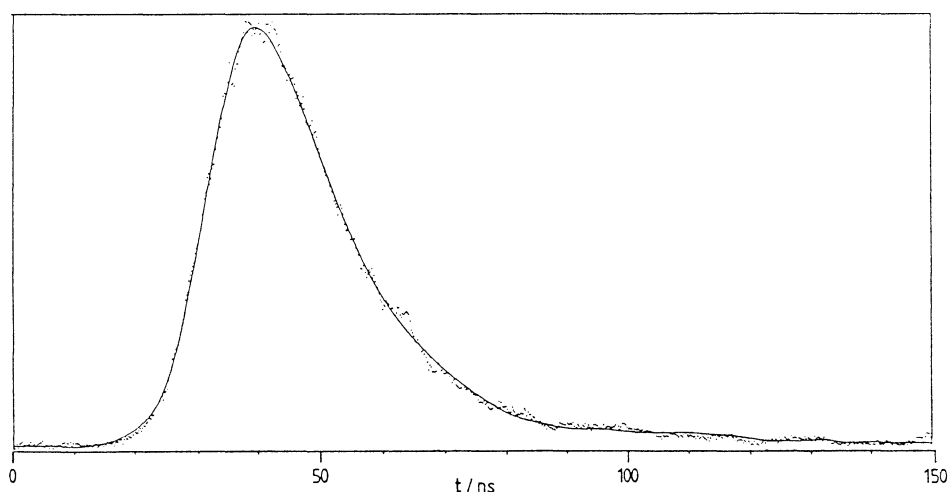

Fig. 11. Decay curve for the $A^1\Pi v=13 J=2$ level in CO.

B3. Laser evaporation as a source of free atoms and ions

For several materials it is very difficult to produce free atoms with standard methods such as evaporation from an oven. Among these elements are the theoretically interesting light elements boron and carbon, which have very low vapour pressures. Other elements from which it is difficult to produce free atoms are oxygen and nitrogen, which form diatomic molecules in the gas phase. We have produced free atoms of some of these elements with laser evaporation and have made measurements of some atomic properties of boron and carbon [7,13].

The element that is to be studied is placed on a rotating shaft in a vacuum chamber and is irradiated with the focused light from a Q-switched Nd:YAG laser. The evaporating laser needs only a modest energy of about 25 mJ/pulse. When the pulse hits the target a plasma is created and a shower of particles, molecules, atoms, ions and electrons, expands from the target. The velocity of the atoms and ions is of the order of 10-20 km/s. Performing measurements of atomic properties in this chaotic environment could produce erroneous results due to collisions, Doppler shift etc. To avoid systematic errors we waited a few microseconds after the laser pulse to allow the plasma to "settle down" before directing a laser beam from a dye laser into the plasma region. The dye laser beam(s) excites the atomic state we wish to study. In this way, we have measured lifetimes and hyperfine structure splittings in boron using time-resolved spectroscopy. In Ref. [13] we also report on measured number densities. The plasma can also be used without an exciting laser pulse. By detecting the fluorescence from the plasma with time- and spectrally-resolved detection it is easy to distinguish between the light from different species and from different ions of one element. By detecting the fluorescence light at a certain distance from the target and in a small time window after the laser pulse, we could preferentially detect only neutral boron and suppress the signal from singly and doubly ionized boron.

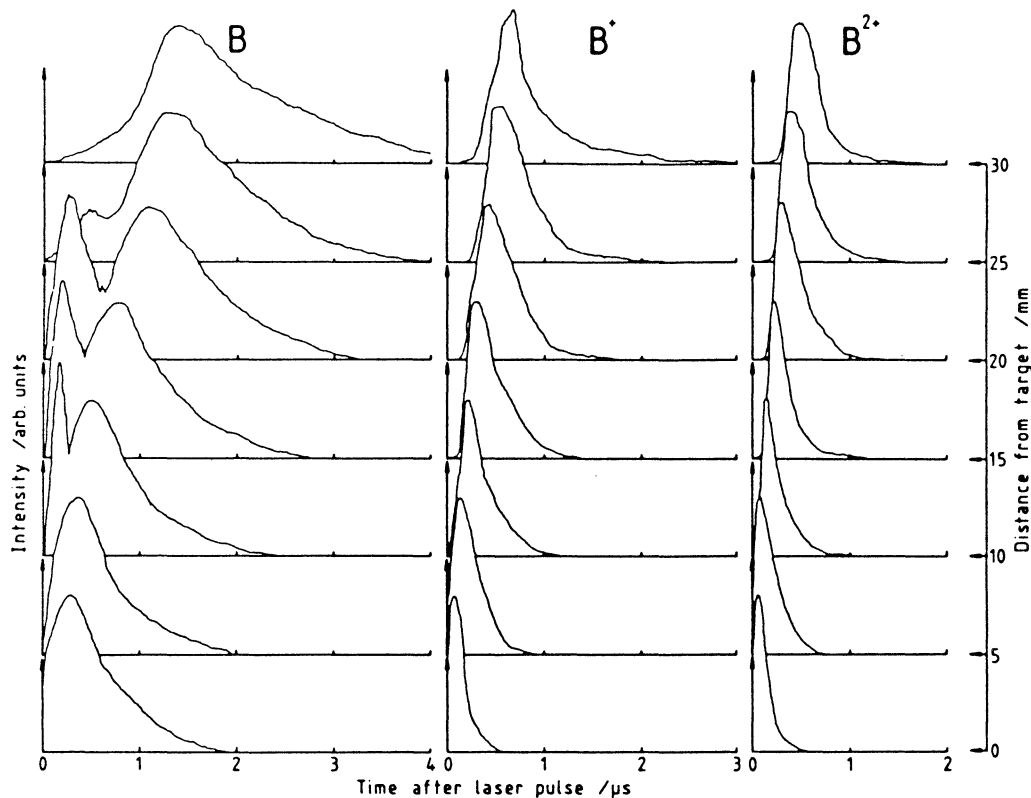

Fig. 12. Diagram showing the propagation of B , B^+ and B^{2+} in an expanding boron plasma. The detected transitions are, in B : $3s\ ^2S-2p\ ^2P$ at 249.7 nm, in B^+ : $4f\ ^1F-3d\ ^1D$ at 494.0 nm and in B^{2+} : $5g\ ^2G-4f\ ^2F$ at 449.9 nm. The intensities of the pulses are normalized to one.

B4. Accurate lifetime measurements

In the group's long established study of lifetimes of excited states in atoms, an effort has now been made to make very accurate measurements. Lifetime measurements with laser excitation are basically quite reliable because of the selective excitation of one state. However, laser-based measurements usually give lifetime values with uncertainties of the order of five percent, or more. This is due to a number of difficulties, such as the non-linearity of the photomultiplier tube when making a direct, time-resolved recording of a short transient, the influence of the shape of the laser pulse (for short lifetimes) and the movement of the atoms during the time from excitation to de-excitation (for long lifetimes). We have been able

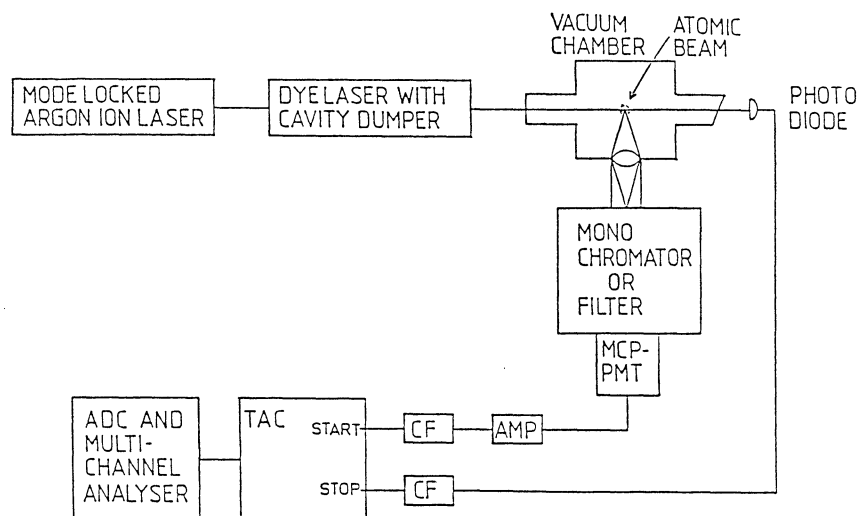

Fig. 13. *The setup of the mode-locked laser - delayed coincidence experiments.*

to avoid, or at least reduce, the effects of these difficulties when measuring short lifetimes, by using a mode-locked dye laser and the delayed coincidence technique. The experimental setup is illustrated in Fig. 13.

The first measurements with this technique were performed on resonance lines of sodium and bismuth. Lifetime values with an uncertainty of 0.5% were obtained [16]. A comparison between this technique and other methods for measuring lifetimes is made in [17]. Recently, this technique has been extended to states in copper and iron [18]. Copper and iron atoms were produced in a rare-gas discharge from which they diffused into a vacuum chamber. The investigated states were then populated, starting from meta-stable states. Lifetime values with uncertainties around 1% were obtained.

This technique can also be used to record fast quantum beats. This is demonstrated in the case of copper, where the hyperfine structure of the $3d^{10}4p^2P_{3/2}$ state causes quantum beats with frequencies up to 1 GHz, as can be seen in Fig. 14.

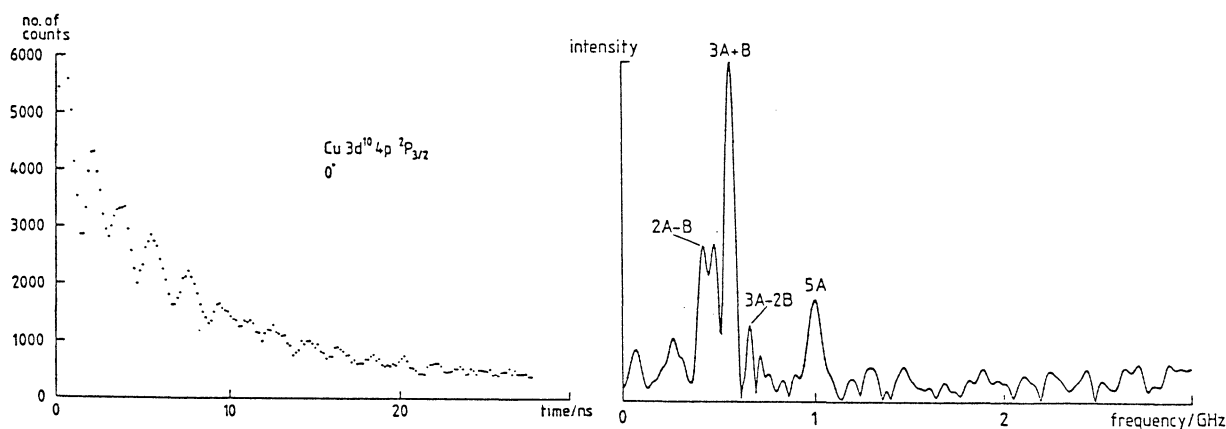

Fig. 14 Quantum beats from the $\text{Cu } 3d^{10}4p \ ^2P_{3/2}$ state and the corresponding Fourier transform.

References

- B1. A. Persson, Programpaket för utvärdering och anpassning av fysikaliska mätdata, Lund Reports on Atomic Physics LRAP-93 (1988).
- B2. H. Bergström, W.X. Peng and A. Persson, Two different types of hollow-cathode discharges used for high resolution laser spectroscopy on copper, Manuscript in preparation.
- B3. J. Larsson, Optical Double resonance and level crossing spectroscopy under pulsed laser excitation, Diploma Paper, Lund Reports on Atomic Physics LRAP-81 (1987)
- B4. J. Larsson, L. Stureson and S. Svanberg, Manipulation of level-crossing signals using narrow-band or pulsed laser excitation, Physica Scripta, in press.

- B5. W.X. Peng, A. Persson, L. Sturesson and S. Svanberg, Investigation of possible signal shifts in high-contrast transmission spectroscopy, manuscript in preparation.
- B6. J. Bengtsson, Studies of degenerate four-wave mixing - cell and flame experiments, Diploma Paper, Lund Reports on Atomic Physics LRAP-95 (1988).
- B7. H. Bergström, G.W. Faris, H. Hallstadius, H. Lundberg, A. Persson, and C.-G. Wahlström, Radiative lifetime and hyperfine-structure studies on laser-evaporated boron, Z. Phys. D. - atoms, molecules and clusters 8, 17 (1988).
- B8. C. Froese Fischer, K.M.S. Saxena and C.-G. Wahlström, Manuscript in preparation.
- B9. P. Jönsson and C.-G. Wahlström, MCHF calculations of the hyperfine splittings in the the Mg I $1D_2$ sequence, manuscript in preparation.
- B10. J. Carlsson, Configuration interaction in the neutral copper atom, Phys. Rev. A 38, 1702 (1988).
- B11. H. Pettersson, A study on the vacuum ultraviolet radiation from laser-produced plasmas, Lund Reports on Atomic Physics, LRAP-92 (1988).
- B12. H. Bergström, G.W. Faris, H. Hallstadius, H. Lundberg and A. Persson, Lifetimes in the Si I 3p5p configuration, manuscript in preparation.
- B13. H. Bergström, H. Hallstadius, H. Lundberg and A. Persson, Detection of carbon using amplified laser-induced fluorescence, accepted for publication in Chem. Phys. Lett.

- B14. H. Hallstadius and H. Lundberg, Generation of coherent vacuum ultraviolet radiation, Lund Reports on Atomic Physics LRAP-86 (1988).
- B15. H. Hallstadius and H. Lundberg, Investigation of the A $^1\Pi$ $v=13$ level in CO using VUV radiation generated by resonant sum frequency mixing in Hg vapour, in manuscript.
- B16. J. Carlsson, Accurate time-resolved laser spectroscopy on sodium and bismuth atoms, Z. Phys. D - Atoms, Molecules and Clusters, 9, 147 (1988).
- B17. J. Carlsson, Laser spectroscopy studies of lifetimes in neutral atoms, Accepted for publication in Physica Scripta.
- B18. J. Carlsson, L. Sturesson and S. Svanberg, Accurate time-resolved laser spectroscopy on sputtered metal atoms, submitted to Z. Phys. D.- Atoms, Molecules and Clusters.
- B19. H. Bergström, G.W. Faris, H. Hallstadius, H. Lundberg, A. Persson and C.-G. Wahlström, Spectroscopy on laser-evaporated boron and carbon, 8th ICOLS, Åre, June 22-26, 1987.
- B20. H. Bergström, G.W. Faris, H. Hallstadius, H. Lundberg, A. Persson and C.-G. Wahlström, Spectroscopy on laser-evaporated boron and carbon, 19th EGAS, Dublin, July 14-17, 1987.
- B21. J. Carlsson, A. Dönszelmann, H. Lundberg, A. Persson, L. Sturesson and S. Svanberg, Radiative properties of the copper atom: Theory and experiment, 19th EGAS Dublin, July 14-17, 1987.
- B22. H. Bergström, E. Biémont, H. Lundberg and A. Persson, Transition probabilities for Gd II and a new determination of the solar abundance of gadolinium, 19th EGAS Dublin, July 14-17, 1987.

- B23. H. Bergström, H. Hallstadius, H. Lundberg and A. Persson, Investigations of radiative lifetimes and stimulated emission in two-photon excited carbon atoms, 11th ICAP, Paris, July 4-8, 1988.
- B24. J. Carlsson, Accurate time-resolved laser spectroscopy on atoms using single photon counting, 11th ICAP, Paris, July 4-8, 1988.
- B25. H. Bergström, H. Hallstadius, H. Lundberg and A. Persson, Detection of Carbon using amplified laser-induced fluorescence, EQEC, Hannover, September 12-15, 1988.
- B26. J. Carlsson, L. Sturesson and S. Svanberg, Accurate lifetime measurements on copper and iron atoms, Abstract submitted to 3rd ECAMP, Bordeaux, 1989.
- B27. J. Bengtsson, J. Larsson, A. Persson, L. Sturesson, S. Svanberg and C.-G. Wahlström, Saturation spectroscopy for dense atomic samples studied with time-integrated and time-resolved techniques, Abstract submitted to 3rd ECAMP, Bordeaux, 1989.
- B28. W. Persson and S. Svanberg (eds.), Laser Spectroscopy VIII, Springer Series in Optical Sciences, Vol 55, (Springer, Berlin, Heidelberg 1988).
- B29. S. Svanberg, Atomic and Molecular Spectroscopy, Springer Series in Atoms and Plasmas, Vol. 6 (Springer, Berlin, Heidelberg) in press.

C. COMBUSTION DIAGNOSTICS

Sara Agrup, Muhammad Akram^{*}, Marcus Aldén, Juha-Petri Aunola, Per-Erik Bengtsson, Gregory Faris^{**}, Hans Hertz, Göran Holmstedt^{***}, Thure Högberg, Stefan Kröll, Ebbe Lundgren^{*}, Lars Martinsson, David Nilsson, Sune Svanberg, Wilhelm Wendt, Ulf Westblom

^{*} Dept. of Mechanics; ^{**} Visiting scientist; ^{***} Dept. of Fire Safety Engineering

In the field of combustion diagnostics several projects are currently in progress. The majority of these are administrated by the Combustion Centre (FTC) to which most of the above are affiliated. The Combustion Centre is operating projects in laser diagnostics, chemical kinetics and spark ignition. The largest project in the field of laser diagnostics is a framework project financially supported by the Swedish Board for Technical Development, STU, and the National Swedish Energy Administration, SEV. In total, five persons are financially supported by this project, which is concerned with spatially and temporally resolved flow velocity measurements, sooty flame diagnostics, picosecond investigations, theoretical aspects of nonlinear diagnostic techniques and practical applications of CARS spectroscopy. There is significant industrial interest in these activities, and one project is sponsored by Sydkraft AB. Discussions are in progress with VOLVO Flygmotor AB and United Turbine AB regarding projects in the fields of laser diagnostics and autoignition studies, respectively. In the field of ignition currently four persons work full time. They are financially supported by STU and SAAB. In terms of equipment for combustion diagnostics, grants have been awarded for a streak camera (FRN) and a mobile CARS system (STU), which are currently being purchased.

During the last two years members of the department have taken part in two international collaborations; one with the International Energy Administration, IEA, and one within the CEC, where the FTC has been granted special permission to join this collaboration which includes most major combustion laboratories in Europe.

C1. Laser-induced fluorescence and related techniques

Several projects have been completed in the field of laser-induced fluorescence. Firstly, it was shown how atomic oxygen, O, nitric oxide, NO, and the hydroxyl radical could be simultaneously detected using one single laser pulse [1-4]. This was achieved by spectral coincidences between the one-photon transition of NO and the two-photon transition of O around 226 nm. Since this wavelength was

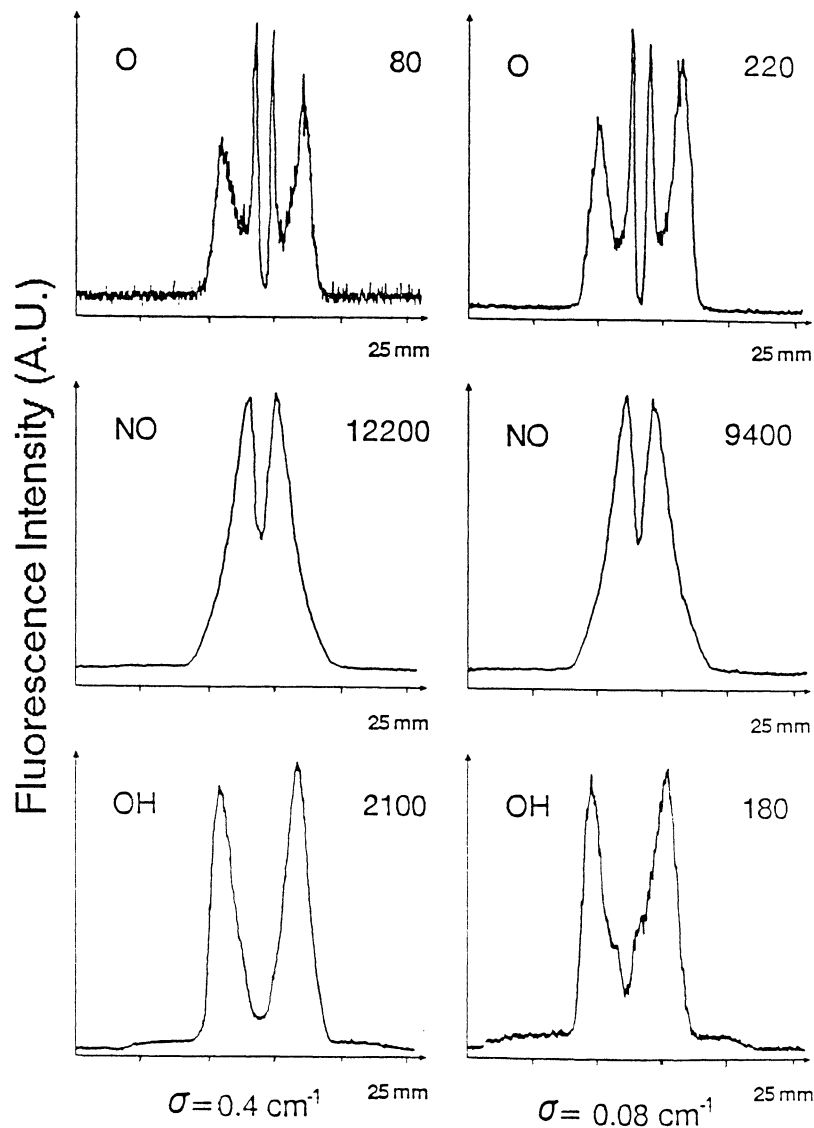

Fig. 1. Spatially resolved distributions of NO, OH and in a N_2O/H_2 flame.

produced by frequency doubling of a dye laser beam at 574 nm and mixing with the residual YAG beam at 1.06 μm , a laser beam at 287 nm was also produced which was used for excitation of OH. It was also demonstrated how spatially resolved distributions of NO, OH and O could be measured using a diode-array detector. Some of these distributions recorded using a $\text{N}_2\text{O}/\text{H}_2$ flame are shown in Fig. 1. The left curves were recorded using a broadband dye laser (0.4 cm^{-1}) whereas for the right ones a narrow band dye laser (0.08 cm^{-1}) was used. The numbers indicate the peak intensities.

In another project it has been demonstrated how spatially and temporally resolved velocity measurements can be achieved [5-7]. A single-mode laser beam was pulse-amplified using a Nd:YAG laser and, by tuning the narrow band pulsed laser to the wing of a Doppler broadened line of I_2 that was seeded to the flow, two counter propagating laser beams could give both spatially and temporally resolved velocity measurements, utilizing the Doppler effect. In Fig. 2 spatially resolved velocities are shown using both the "conventional" CW laser approach as well as the results using the pulse-amplified laser. As was described above, in these experiments

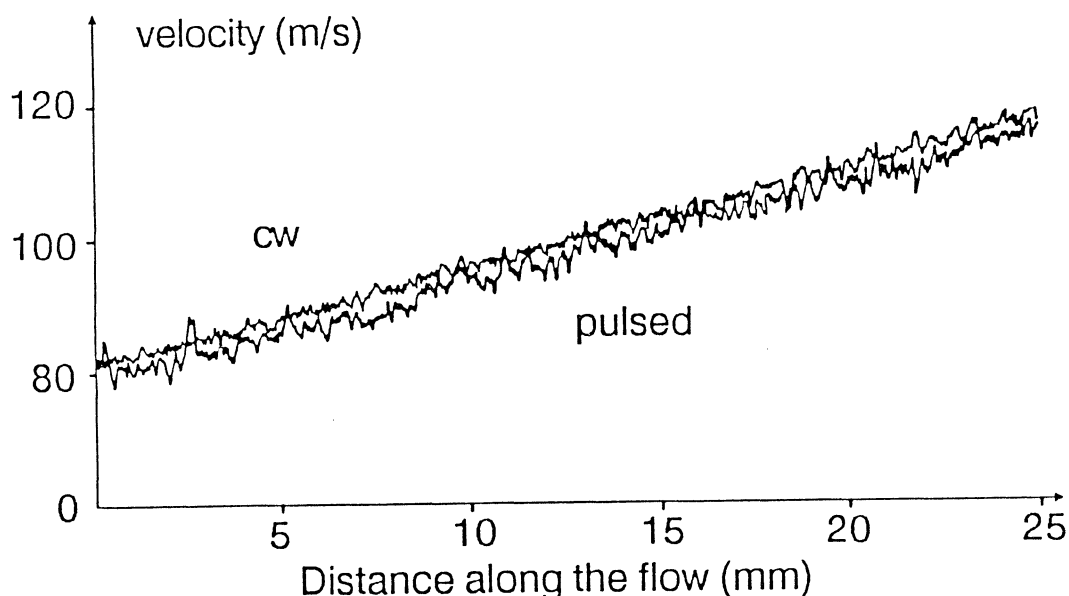

Fig. 2. Spatially resolved velocities using cw and pulsed lasers.

I_2 was used as test species. However, this species is not ideal for this purpose since it is corrosive and poisonous and since the concentration is comparatively low. The optimum choice in many respects would be N_2 , however, its resonances lie well down in the VUV. We have, however, recently been able to detect N_2 in a flow at atmospheric pressure by using a five photon process exciting an intermediate state, followed by ionization and fluorescence detection in N_2^+ [8]. We are now in the process of investigating this technique for velocity measurements and also for temperature measurements.

During laser-induced multi-photon flame experiments it has been commonly assumed that the main optical radiation was the fluorescence decay. However, it was recently realized that in addition to the fluorescence signal there is a stimulated signal in the direction of the primary laser beam [9,10]. In the case of oxygen atoms in flames it was found that this laser-induced stimulated emission was more than 10^4 times stronger than the fluorescence signal. In Fig. 3 relative distributions of the fluorescence and stimulated emission intensities from oxygen atoms are shown as a function of height above

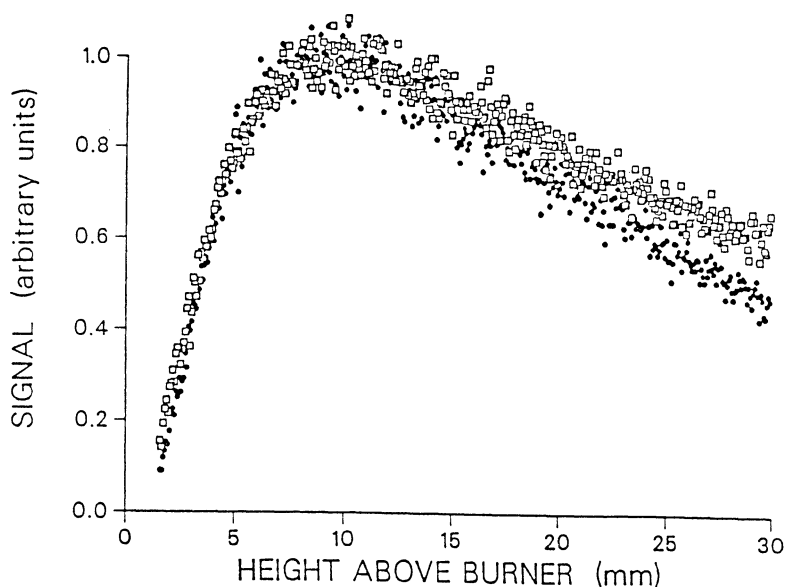

Fig. 3. *Relative distribution of fluorescence (open squares) and stimulated emission (filled circles) intensities from 0 as a function of height above the burner in an H_2/O_2 flame.*

the burner in an H_2/O_2 flame at 15 torr. Using the same technique, we have also recently for the first time, to our knowledge, detected carbon atoms in a hydrocarbon flame [11]. A more detailed investigation of the technique for diagnostic purposes is in progress [12].

When making imaging measurements it is of course essential that the image really mirrors the actual distribution in the probe volume. We have observed that if great care is not taken in the optical collection optics, severe distortion can arise [13]. However, it was also shown that this optical distortion could be corrected for by using a Fourier convolution technique.

C2. Experiments related to soot formation

One project has been directed towards studies of soot formation in premixed flames. In this project, a technique has been developed where a pulsed Nd:YAG laser is used for scattering and extinction measurements in atmospheric pressure methane/oxygen flames yielding information about soot particle properties, such as soot particle sizes, number densities and volume fractions [14-16]. By probing at different heights in the flame, the time evolution of these parameters was studied and information on soot formation processes, such as nucleation, surface growth and coagulation was obtained. Since we would like to probe the flame temperatures through vibrational CARS thermometry of nitrogen, we have started to work with a new flame system where an ethylene/oxygen/nitrogen mixture is being burnt. This flame system was chosen as several other combustion groups are working with it. A commercially available burner has been purchased in order to be able to compare our results with those presented by others. The scattering/extinction technique mentioned above has been applied to the ethylene/oxygen/nitrogen flames and in Fig. 4 (a and b) the size profiles and concentration profiles are illustrated for fuel-oxidant mixtures at different C/O ratios [17]. The nucleated soot particles are very small (1-2 nm) and can be measured with the

scattering/extinction technique from about 3-4 nm. After nucleation, a rapid increase in size occurs and the only process which affects the concentration is coagulation (inelastic collision between particles which stick together) which leads to a decrease in the soot particle concentration, as illustrated in Fig. 4 b. Carbon atom profiles have also been measured in these flames through the stimulated emission technique mentioned above [11]. PAH-profiles have been obtained through laser-induced fluorescence [18] and a project has recently been started where temperature profiles will be obtained through rotational CARS and vibrational CARS thermometry, as described below. Also, projects on detection of the phenyl radical, which is thought to be crucial in soot formation, and measurements of the ground-state concentrations of C_2 and C_3 radicals are planned.

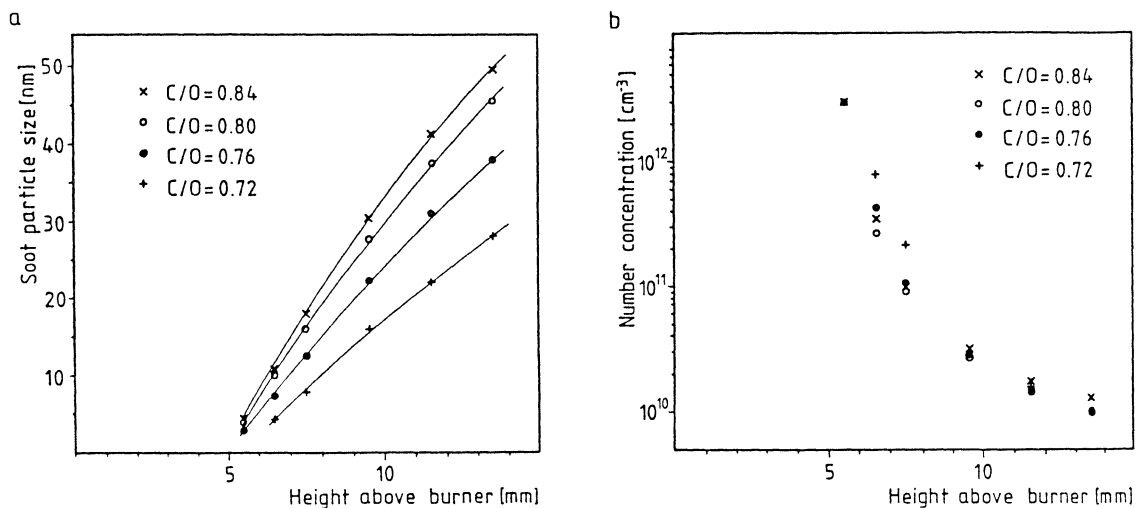

Fig. 4. Profiles of a) soot particle size and b) soot particle concentration evaluated from the scattering/extinction equations at different C/O ratios.

Another project on sooty ethylene/oxygen/nitrogen flames has been concentrated with the laser-induced C_2 emission which is associated with the use of intense pulsed lasers in sooty environments [18]. It is important to study and understand such interferences, since they can give undesired signals in diagnostic situations. It has generally been thought that C_2 production originates from laser ablation of

soot particles. However, it was found that under the premixed flame conditions studied here, large molecules associated with soot formation, such as aromatic hydrocarbons are probable source species. In Fig. 5 a spectrum is shown where Nd:YAG pulses with energies of 162 mJ at 532 nm have been focused with an $f=20$ cm lens, and the detection has been performed perpendicularly to the propagating laser beam. Together with the residual Rayleigh scattering at 532 nm, the Swan bands of the C_2 radical are seen.

A diploma project has dealt with optical detection of the broadband fluorescence from aromatic hydrocarbons when exciting at different wavelengths, both in a heated cell and when seeded into a flame [19]. Development of diagnostic methods for aromatic hydrocarbons is essential since these hydrocarbons are important intermediates in the soot formation mechanisms. They are often both carcinogenic and mutagenic and also contribute to the contamination of the ambient air since when soot is spread in the environment and then ages, the aromatics which are incorporated into the soot evaporate.

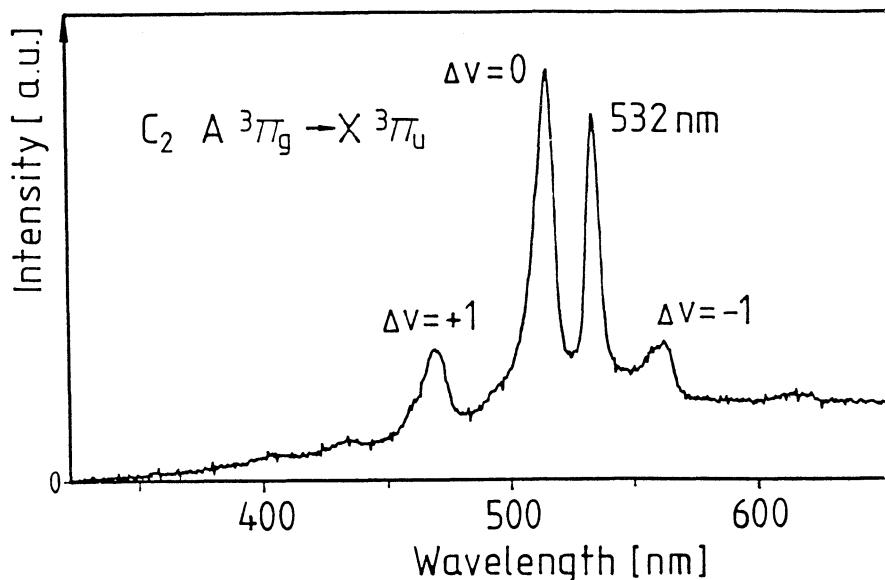

Fig. 5. C_2 production in a sooty ethylene flame, when laser pulses at 532 nm and pulse energies of 162 mJ have been focussed with an $f=20$ cm lens.

C3. Vibrational CARS activities

The project on vibrational CARS thermometry has continued with an investigation of precision and systematic errors [20]. Consequently, different sources of error have been considered, such as uncertainty in input parameters in the computer code, saturation phenomena in the probed molecules and detector non-linearities. Regarding saturation, the use of intense lasers can give rise to a hot band, even at room temperature, since the $v=1$ vibrational energy level can be populated through stimulated Raman scattering. In the case of detector characteristics, non-linearities were found at low signals when partially illuminating the pixel areas but was absent for total illumination. An effect of gain reduction was observed when using less than about 1000 counts in single-shot mode which may give a systematic error in the evaluated temperature of about 50 K. Also, temperature profiles in a low-pressure acetylene/air flame have been obtained and an example of such a profile from a flame at a pressure of 51 torr is shown in Fig. 6. A fast rise in temperature occurs for the unburned

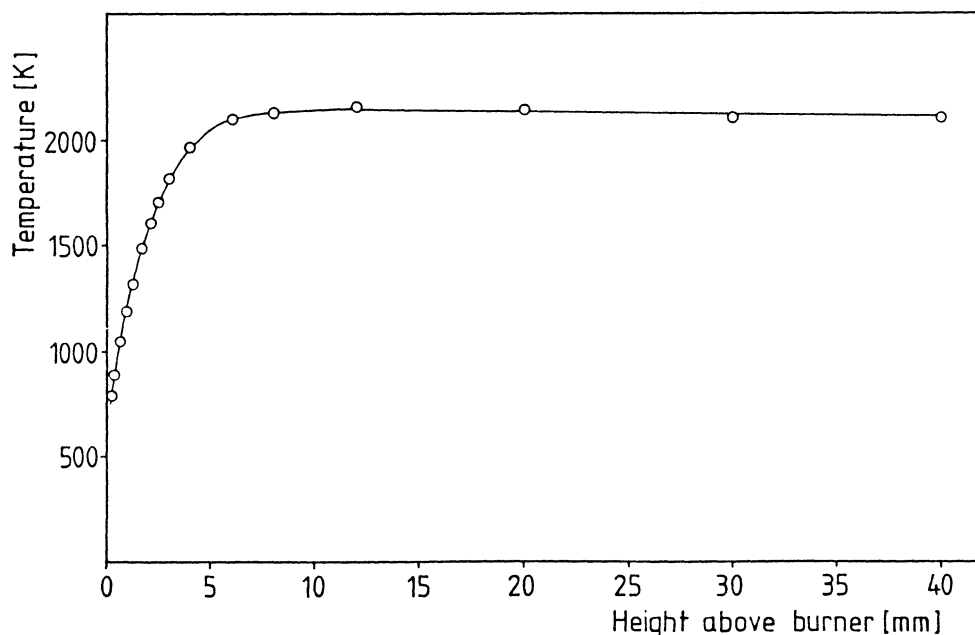

Fig. 6. *Temperature profile in an acetylene/air flame at 51 torr measured with vibrational CARS thermometry of N_2 .*

mixture due to heat conduction from the reaction zone. In the reaction zone the chemically bound energy is released and the maximum temperature is reached. After the reaction zone the species concentrations have reached their equilibrium values, and the small drop in temperature is the result of heat losses to the environment. The evaluated temperatures in Fig. 6 are assumed to be correct within 50 K.

In the field of vibrational CARS, activity has also been directed towards the investigation of the potential for the detection of SO₂ [21,22]. These experiments were performed both in a heated cell and in an SO₂-seeded flame.

C4. Rotational CARS and noise in the CARS process

In the field of pure rotational CARS, effort has been concentrated on examining and improving the accuracy of temperature determination, both at room and flame temperatures. Different techniques have been compared experimentally [23-25] and a theoretical and quantitative model that can be used to estimate the noise in a general nonlinear optical process, e.g. CARS, has been developed [26-31]. In this model it is possible to separate noise contributions from laser mode amplitude and phase fluctuations and also to identify the noise contribution from each laser source. In the dual-broadband rotational CARS technique (RDBC - presented at several conferences [32,33]) a dye laser beam is split into two components. To a large extent, for any frequency component in one of these beams, one can select a frequency component in the other beam such that these together can excite an arbitrarily chosen rotational Raman transition. According to the theoretical calculations the averaging of the stochastic laser intensity fluctuations over all these pairs make RDBC superior to conventional rotational CARS, as regards temperature accuracy. This was also verified by the experimental results. The theoretical model also showed that a multimode pump laser gives better temperature

accuracy in single-shot CARS at lower pressures. A single mode laser may, however, still be better at higher pressures.

Parallel with the experimental development, improvements in the computer codes have been achieved [34], leading to more rapid and accurate data evaluation. With rotational CARS in moderate pressure environments the possibility of fitting only the areas of the well separated Raman resonances, instead of the usual contour fitting (Fig. 7), reduces the computer time required to determine the temperature to about one second.

At lower temperatures, rotational CARS definitely offers a competitive alternative to the more conventional vibrational CARS technique, but at higher temperatures ($>1000\text{K}$) rotational CARS may suffer from low signal levels and rather temperature-insensitive spectral shapes. An absolute temperature calibration of the rotational CARS method is planned for the near future, followed by temperature measurements in sooty flames and in high-pressure environments.

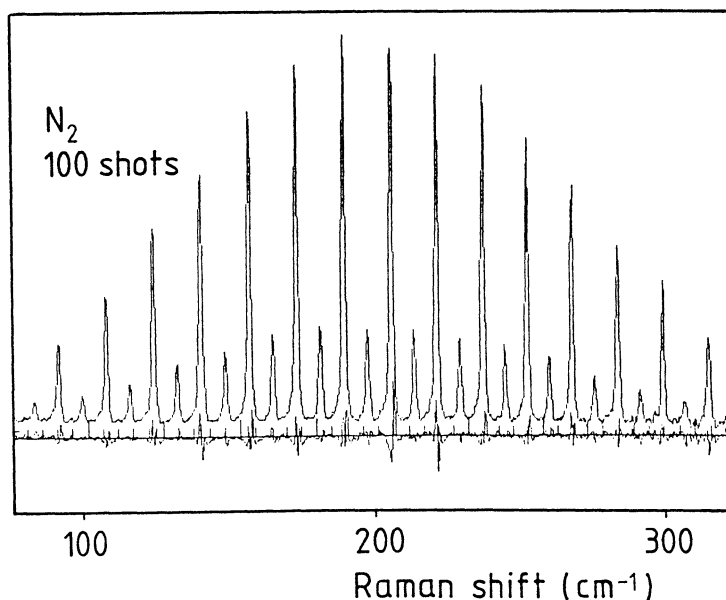

Fig. 7. *Rotational dual broadband CARS spectrum from a flame and difference to a fitted spectrum [23].*

C5. Optical tomography

Tomography is an established method for the reconstruction of quantitative 2-D or 3-D spatially resolved measurements from multi-angular, integrated measurements (projections) [35]. Optical tomography is a versatile diagnostic technique for the study of combustion and fluid flows. However, much of the previous optical tomography work has examined stable flames and flows using sequentially recorded projections. Since many interesting flows are highly fluctuating, such as explosions or turbulence, techniques for simultaneous recordings of the projections are desirable. We have developed two such techniques: an arrangement for simultaneous recording of emission projections for the determination of excited-state species distributions in flames and a tunable differential interferometer for temperature and density determination through interferometric tomography.

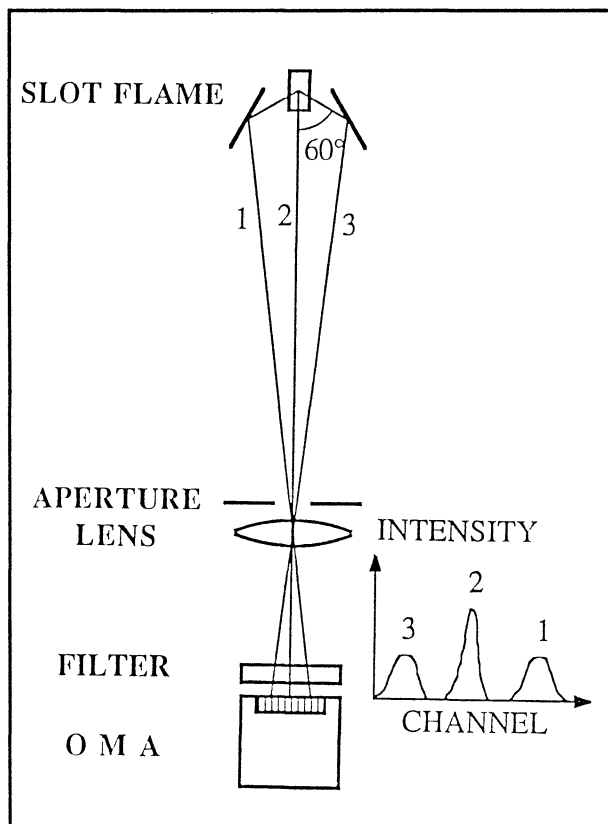

Fig. 8.
Experimental arrangement for simultaneous recording of 3 emission projections.

We have demonstrated that emission tomography can yield spatially-resolved distributions of the excited-state radicals in flames [36,37]. Measurements with high temporal resolution of, for example, CH provide important information about flame front motion. Such information is useful for monitoring the development of explosions or turbulent combustion. Fig. 8 shows the experimental arrangement for simultaneous recording of 3 emission projections. Reconstructions are performed with a modified MART (Multiplicative Algebraic Reconstruction Technique) algorithm which has proven to yield good quality reconstructions from as few as 2 or 3 projections. Fig. 9 shows the distribution of excited state CH in a slot Bunsen flame reconstructed from 3 projections. Using a Rayleigh scattering technique the distributions can be calibrated to absolute number density.

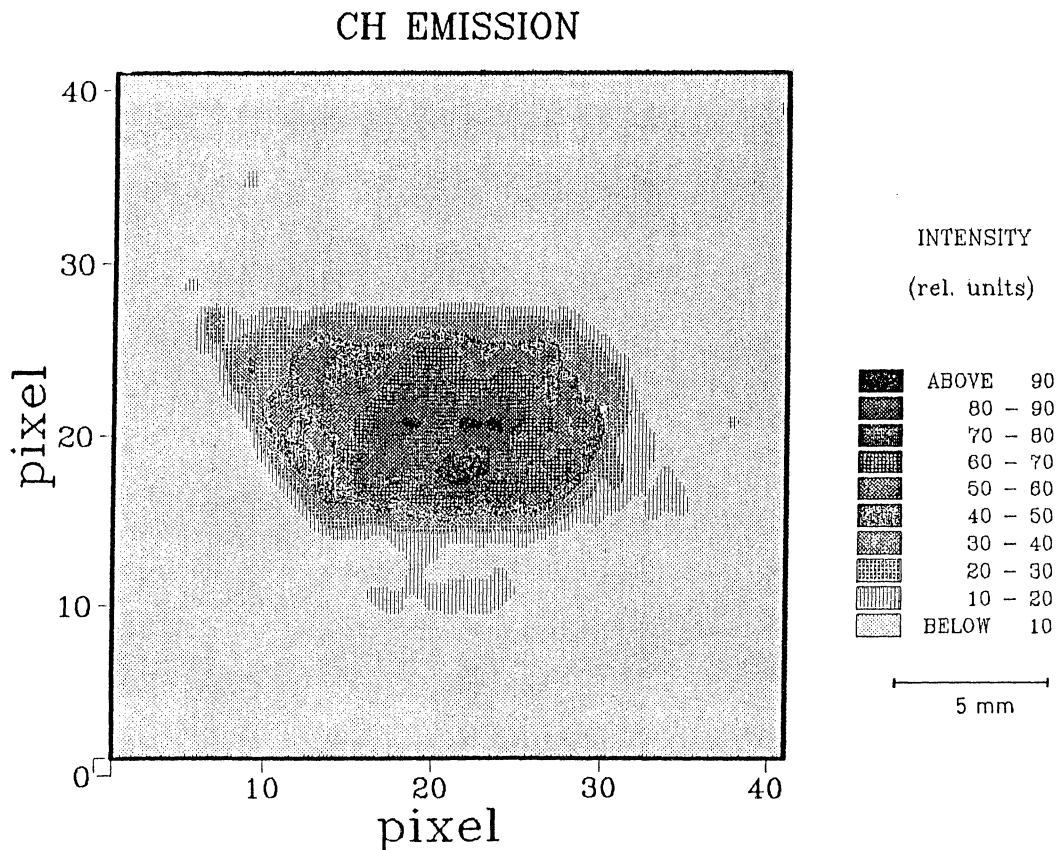

Fig. 9. *Distribution of excited state CH in premixed slot Bunsen flame.*

Tomographic reconstructions from integrated measurements of phase (refractive index) can yield spatially resolved values of temperature or density. Previously demonstrated techniques using a Mach-Zehnder interferometer and scanned beam deflection suffer from sensitivity to drift and slow data acquisition, respectively. Differential interferometers are much less sensitive than conventional interferometers to mechanical and thermal drifts, since both interfering beams are geometrically superimposed. We have constructed a tunable stable differential interferometer which allows measurements on a wide range of fluid flows and flames. A diagram of the interferometer is shown in Fig. 10. The birefringent calcite crystal separates the vertically and horizontally polarized light by a distance Δx , resulting in an intensity profile after the polarizer which is a function of the integrated gradient of the refractive index in the flow. The separation Δx is varied by tilting the crystal, allowing the sensitivity of the interferometer to be matched to the gradients

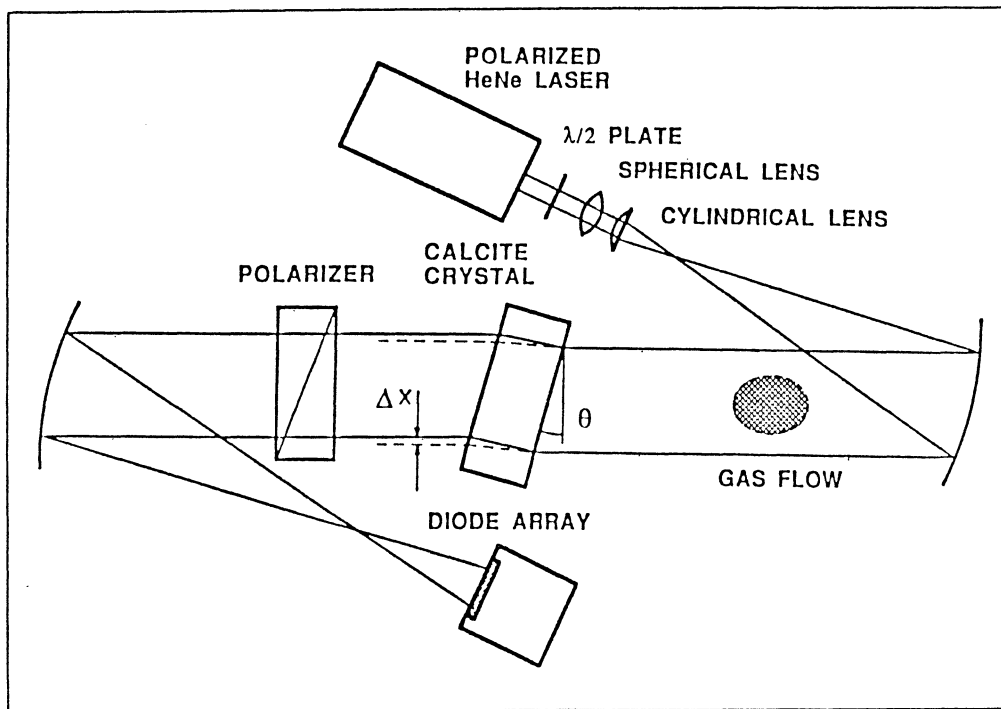

Fig. 10. *Experimental arrangement of the tunable, stable differential interferometer.*

of the flow. Fig. 11 shows a tomographic reconstruction of a rectangular methane jet in air. A multiple arm arrangement with this interferometer would allow instantaneous recording of the projections without problems due to fringe ambiguity and drift.

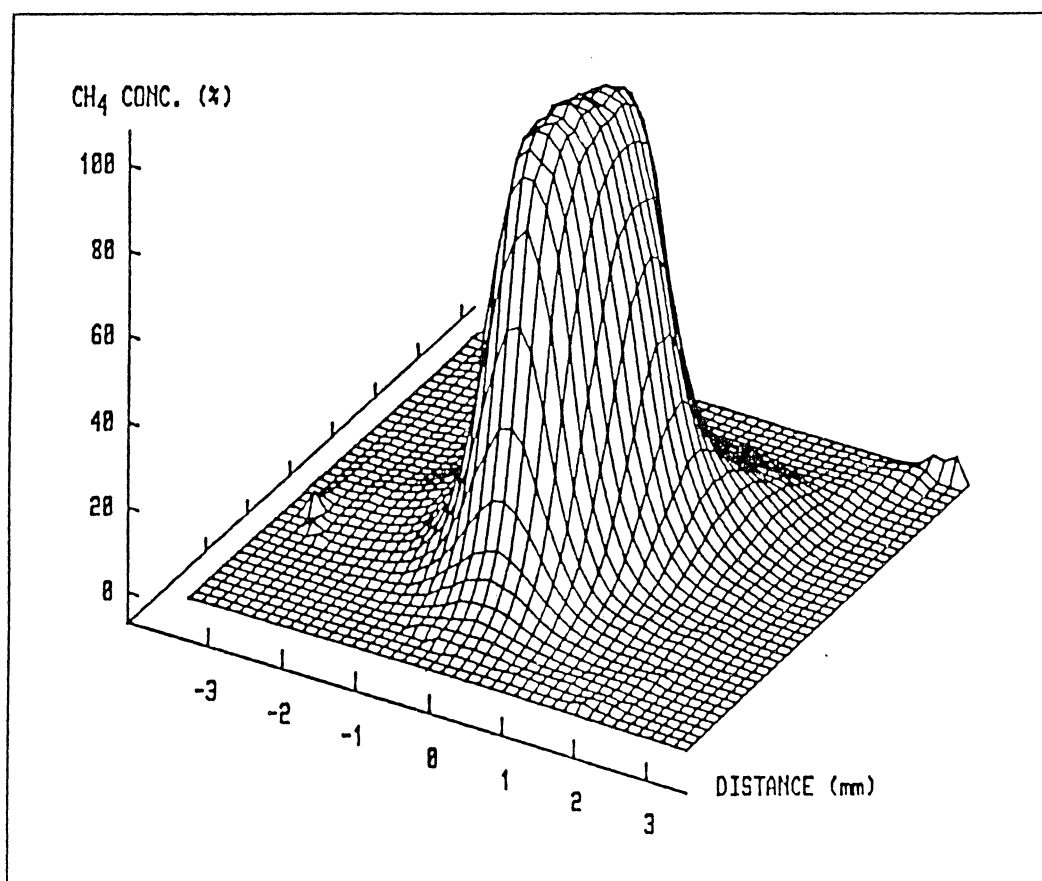

Fig. 11. Tomographic measurement on an asymmetric methane jet in air.

C6. Ignition studies

The experimental and theoretical study has continued on the temporal development of ultra-short high-current spark discharges. From an earlier experiment on ultra-short sparks produced in nitrogen of atmospheric pressure, the spatially and temporally resolved number densities of electrons and neutrals and ions are known. From these values the electron temperature, the plasma composition and the pressure in the spark are calculated under the assumption of local thermodynamic equilibrium. Examples of the results are shown in Fig. 12.

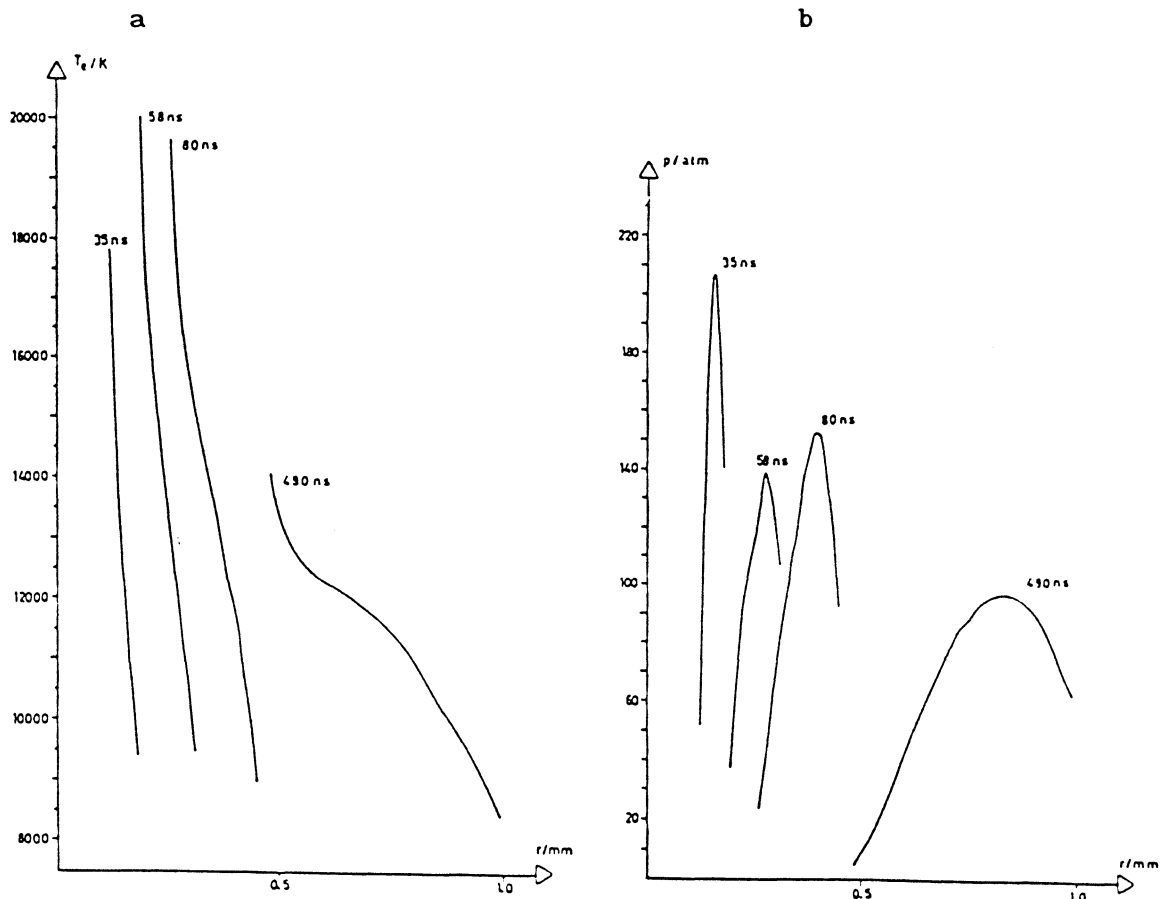

Fig. 12. The electron temperature (a) and the pressure (b) versus radius for different times in nanoseconds, calculated from experimental values

The condition for the validity of the assumption of local thermodynamic equilibrium is essentially that the local concentration of free electrons is high enough, and it is shown to hold for the results above. A spark-discharge simulation program [39], based on Plooster's model, has been implemented and modified. It contains a hydrodynamical model for one-dimensional super-sonic flow coupled with simple laws governing the state of the gas and the transport of heat and radiative energy in the spark. The only inputs to the simulation program are the experimental values of the current versus time and parameters necessary in the shock-fitting procedure. Despite this, a surprisingly good agreement is obtained between the experimental and simulated results, shown in Figs. 13 and 14 [40-41].

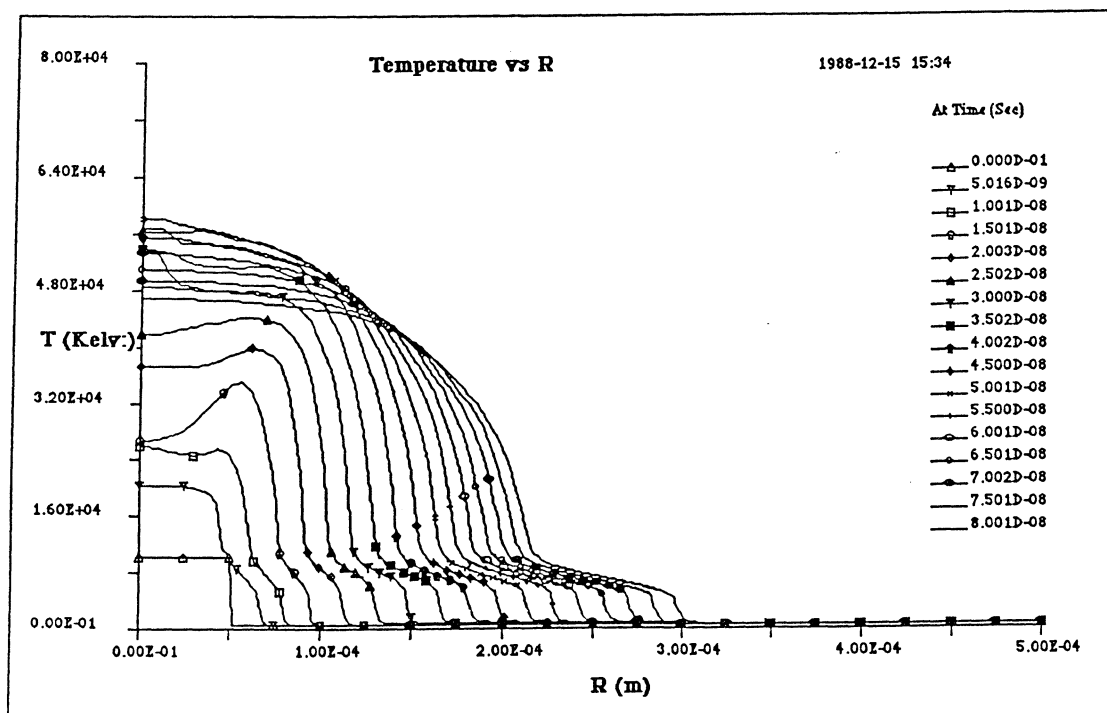

Fig. 13. *The electron temperature versus radius in a spark, from the simulation.*

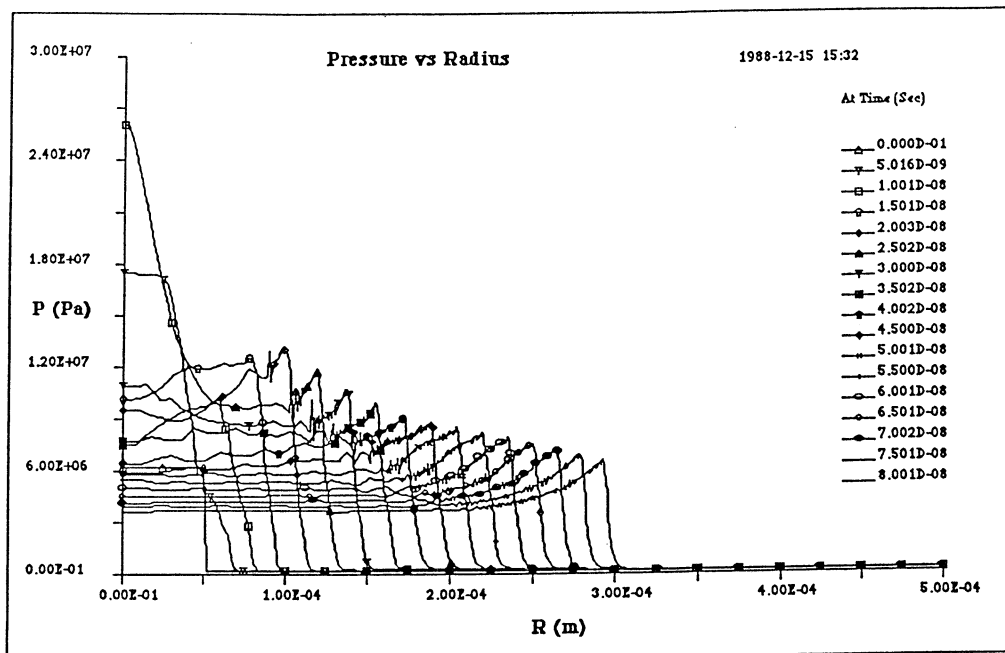

Fig. 14. The pressure versus radius in a spark, from the simulation.

C7. Further technique developments

In addition to the above-mentioned activities a further project concerning development of new techniques is supported by STU. These activities are pursued in close coupling to the atomic spectroscopy, remote sensing and medical spectroscopy programmes at the department.

Three projects have been pursued recently: degenerate four-wave mixing spectroscopy, frequency modulation spectroscopy and gas correlation velocimetry. Experiments on multi-colour fluorescence imaging of flames are being prepared.

Degenerate four-wave mixing spectroscopy - This method combines advantages of laser-induced fluorescence (sensitivity) and CARS (coherent signal). Extensive experiments with CW and pulsed dye lasers have been performed on sodium atoms in a cell and seeded to a flame. The signal is phase conjugated, i.e. an exact compensation for turbulence in the flame is obtained. An example of a degenerate four-wave mixing signal is shown in Fig. 15. The dependence of the signal strength on the atomic concentration and the laser power has been studied. It is also possible to perform coherent imaging. Different aspects of degenerate four-wave mixing are covered in two diploma papers [42, 43].

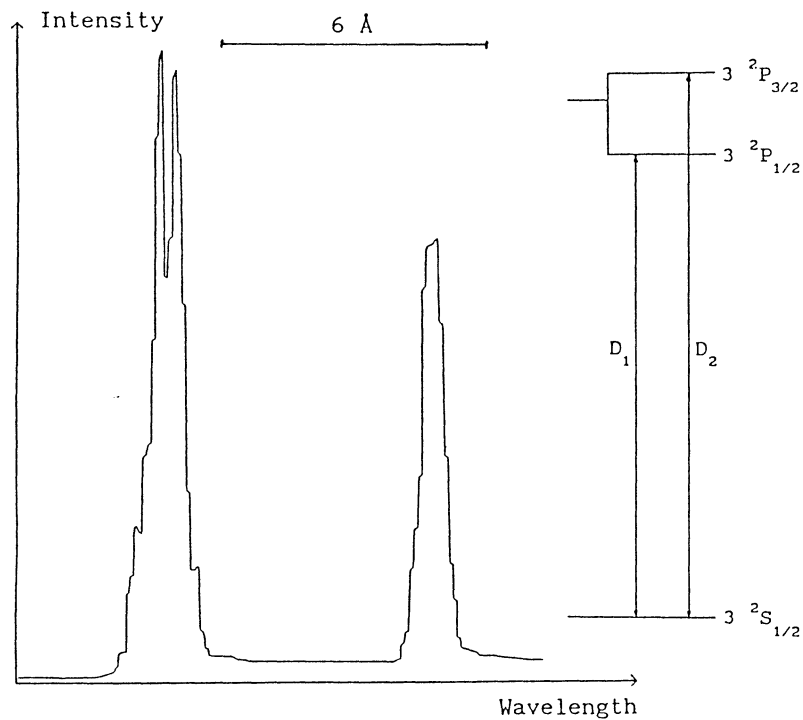

Fig. 15. *Degenerate four-wave mixing signal in a flame seeded with 500 ppm sodium.*

Frequency modulation spectroscopy - This technique combines laser- and microwave spectroscopy in an interesting way. Using an electro-optic modulator driven by microwaves, sidebands are generated on the optical carrier frequency. Since the sidebands are equally strong and of opposite phase a microwave modulation in the transmitted beam is normally cancelled. However, if one of the sidebands coincides with an absorption line an asymmetry occurs and a modulation can be detected. Very weak absorptions can be detected in this way. Measurements with this technique have been performed at 50 MHz and at 8.45 GHz. At the latter frequency a modulator utilizing a lithium tantalate crystal was employed. Experiments on sodium and iodine have been performed demonstrating a very high sensitivity. Measurements on flame radicals of low concentration will be feasible and the technique can be combined with tomographic reconstruction. Our experimental arrangement for frequency modulation spectroscopy is shown in Fig. 16, whereas an example of a signal corresponding to a sample absorption of 0.01 per cent is shown in Fig. 17 [44].

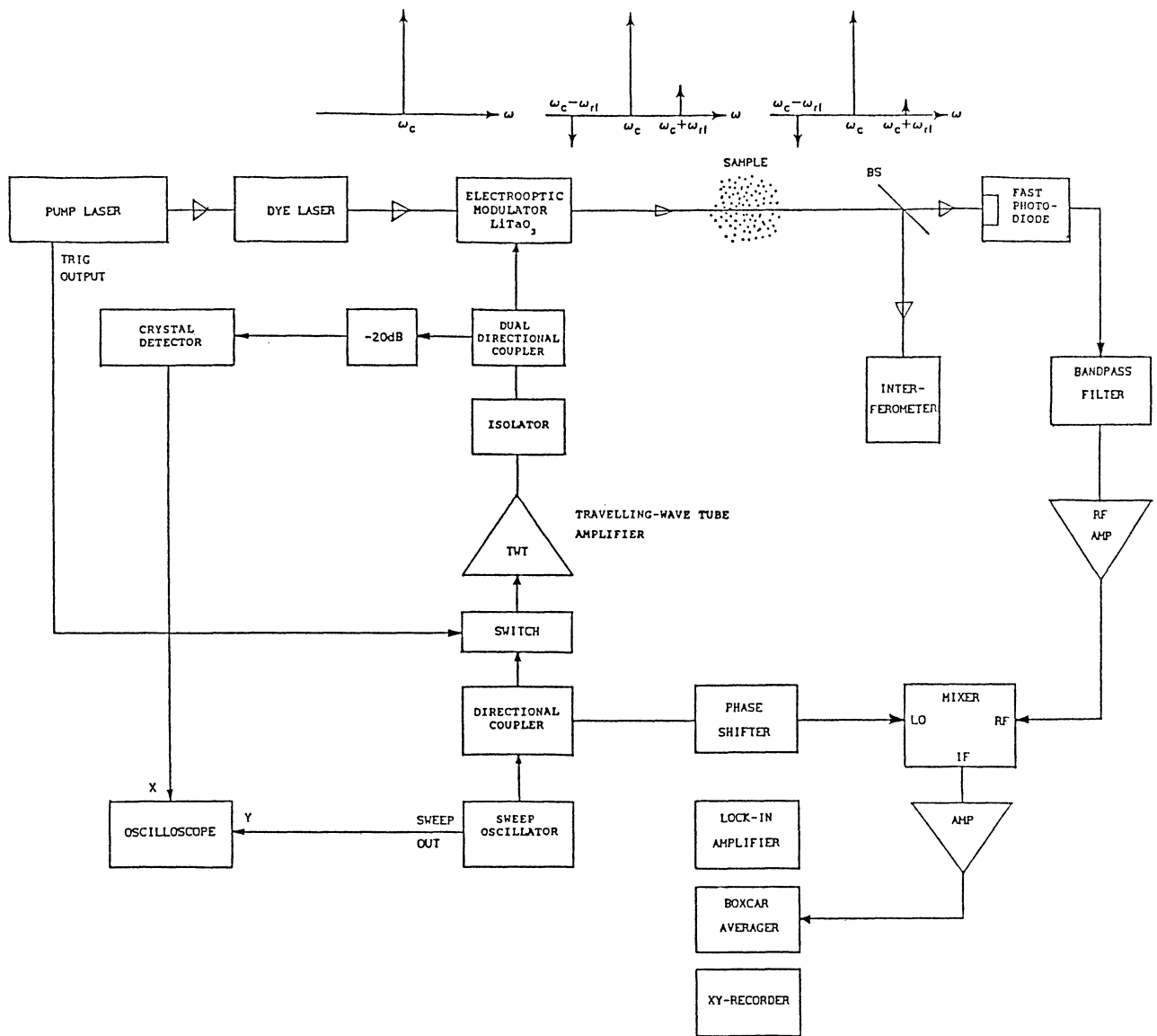

Fig. 16. Experimental arrangement for FM spectroscopy using microwaves.

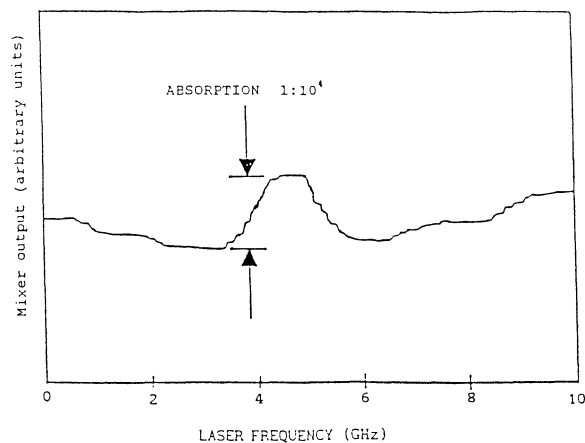

Fig. 17. FM spectroscopy signal from a sample of atomic sodium exhibiting a 0.01 percent absorption.

Gas correlation velocimetry - This technique is based on a new approach for imaging of a velocity field through a cell containing an optically dense absorbing gas, that blocks light from the corresponding emitting gas constituents in a hot flow. Only if the gas is flowing the light is shifted in frequency and can pass at the side of the absorption filter line and reach the detector. The principle is shown in Fig. 18.

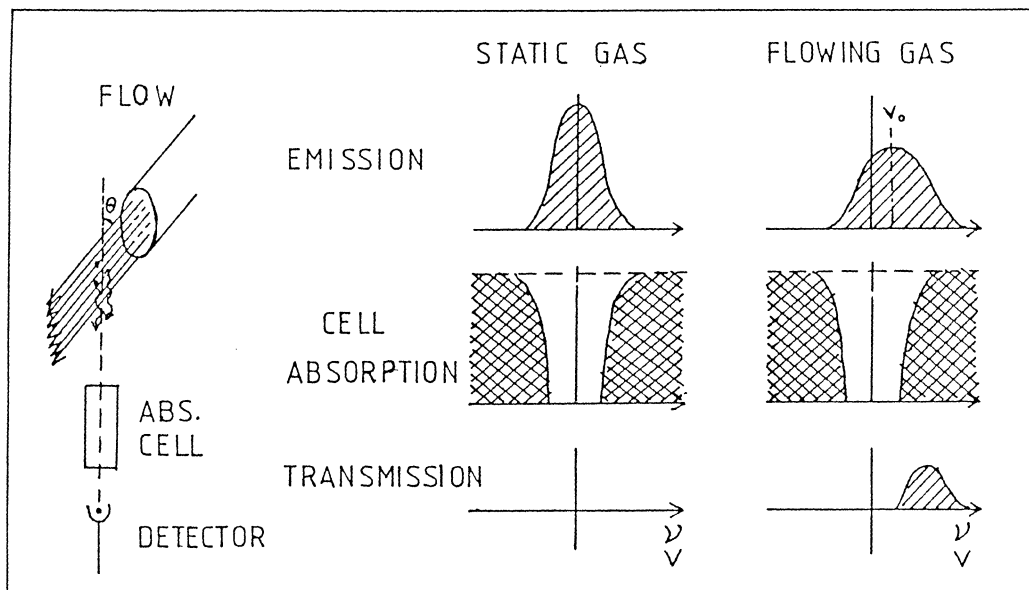

Fig. 18. Principles of velocimetry using gas correlation techniques.

A model experiment using this technique has been performed on a laser-excited sodium atomic beam, that was observed at an angle of 135° through a hot sodium cell. We are planning experiment at the exit of a jet engine.

During the years of 1987 and 1988 members of the combustion diagnostics group gave invited talks at the CARS conference in Stuttgart in 1987 [45], at the IX Vavilov Conference on Nonlinear Optics in Novosibirsk in 1987 [46] and at the CARS conference in Pisa in 1988 [47]. At the XIth International Raman Conference an oral presentation was also given on industrial applications of CARS [48]. The conference poster contributions that have not been mentioned above are listed as Refs. 49 and 50. In addition to the diploma

projects already mentioned, another diploma project directed towards the construction of a single mode pulsed dye laser has been carried out [51]. Furthermore, combustion diagnostics has been discussed in several invited talks on applied laser spectroscopy. Two published papers are listed in Refs. 52 and 53. Important aspects of combustion diagnostics with lasers were covered at a conference arranged jointly by the Royal Swedish Academy of Engineering and the Swedish Board for Technical Developments [54].

References

- C1. U. Westblom and M. Aldén, Simultaneous multiple-species detection in a flame using laser-induced fluorescence. Submitted to Appl. Opt.
- C2. M. Aldén and U. Westblom, Simultaneous multiple species detection in a flame using laser-induced fluorescence. Paper presented at 22nd Int. Conference on Combustion, Seattle 1988.
- C3. U. Westblom, P. Cederbalk, C. Löfström and M. Aldén, Simultaneous multiple species detection in a flame using laser-induced fluorescence. Paper presented at CLEO-88, Anaheim 1988.
- C4. U. Westblom and M. Aldén, Multiple species detection in a flame using laser-induced fluorescence. Paper presented at IEA Taskleaders conference, Amalfi 1988.
- C5. U. Westblom and M. Aldén, Spatially resolved flow velocity measurements using laser-induced fluorescence from a pulsed laser. Opt. Lett. Jan. 1989.

- C6. U. Westblom and M. Aldén, Spatially resolved flow velocity measurements using laser-induced fluorescence from a pulsed laser. Paper presented at IEA Taskleaders conference, Amalfi 1988.
- C7. U. Westblom and M. Aldén, Application of laser-induced fluorescence for spatially and temporally resolved gas flow velocity measurements. Paper presented at the European Aerosol Conference, Lund 1988.
- C8. M. Aldén and W. Wendt, Detection of nitrogen molecules through multi-photon laser excitation and N_2^+ fluorescence. Opt. Commun., In press.
- C9. M. Aldén, U. Westblom and J. E. M. Goldsmith, Two-photon excited stimulated emission from atomic oxygen in flames and cold gases. Submitted to Opt. Lett.
- C10. J. E. M. Goldsmith, M. Aldén and U. Westblom, Two-photon excited stimulated emission from atomic oxygen in flames and cold gases. Paper submitted to CLEO-89.
- C11. M. Aldén, P.-E. Bengtsson and U. Westblom, Detection of carbon atoms in flames using two-photon laser excited stimulated emission. In preparation.
- C12. U. Westblom, S. Agrup, M. Aldén, H. M. Hertz and J. E. M. Goldsmith, Properties of laser-induced stimulated emission for diagnostic purposes. In preparation.
- C13. H. M. Hertz, M. Aldén and S. Svanberg, Correction of imaging errors in spatially resolved laser scattering experiments in flames. Appl. Phys. **B45**, 33 (1988).

- C14. Per-Erik Bengtsson and Marcus Aldén, Soot particle measurements in flat premixed flames using a pulsed laser and a scattering/extinction technique. Lund Reports on Atomic Physics, LRAP-87 (1988).
- C15. Per-Erik Bengtsson and Marcus Aldén, Application of a pulsed laser for soot measurements in premixed flames. Appl. Phys. B, In press
- C16. Per-Erik Bengtsson and Marcus Aldén, Pulsed laser technique for soot particle measurements in flat premixed flames. Paper presented at IEA Taskleaders Conference, Ottawa, Canada, 24-27/8 1987
- C17. Per-Erik Bengtsson and Marcus Aldén, Soot particle measurements in premixed ethylene flames using a pulsed laser method. Paper presented at European Aerosol Conference, Lund, 30/8-2/9 1988
- C18. Per-Erik Bengtsson and Marcus Aldén, Investigation of laser-induced C_2 emission in premixed sooty ethylene flames. In Preparation.
- C19. Jörgen Strand, Investigation of optical detection of polyaromatic hydrocarbons. Diploma Paper, In preparation
- C20. Stefan Kröll, Marcus Aldén, Per-Erik Bengtsson and Christer Löfström, An evaluation of precision and systematic errors in vibrational CARS thermometry. In preparation.
- C21. M. Aldén and W. Wendt, CARS spectroscopy of SO_2 . Paper presented at the European CARS meeting in Stuttgart, 1987.
- C22. M. Aldén and W. Wendt, Application of CARS spectroscopy to the detection of SO_2 . Appl. Spectroscopy, In press.

- C23. M. Aldén, P.-E. Bengtsson, H. Edner, S. Kröll and D. Nilsson, Rotational CARS: A comparison of different techniques with emphasis on accuracy in temperature determination. Submitted to Applied Optics.
- C24. M. Aldén, P.-E. Bengtsson, H. Edner and S. Kröll, Accuracies and signal strengths of rotational CARS - comparison between different experimental methods. Paper presented at the XXII Int. Symp. on Combustion, Seattle, USA, August 15-19, 1988.
- C25. M. Aldén, P.-E. Bengtsson, H. Edner, S. Kröll and D. Nilsson, Rotational coherent anti-Stokes Raman scattering for temperature determination - applicability and accuracy. Paper presented at XI Int. Conf. on Raman Spectroscopy, London, September 1988.
- C26. S. Kröll, M. Aldén, T. Berglind and R.J. Hall, Effects of laser bandwidths and mode structure on noise in CARS spectra. Paper presented at the European CARS meeting in Stuttgart, March 16-17, 1987.
- C27. M. Aldén, P.-E. Bengtsson, H. Edner, S. Kröll, D. Nilsson och D. Sandell, The rotational dual broadband technique and noise considerations in CARS spectroscopy. EICOLS '87, 8th International Conference on Laser Spectroscopy, Åre, Sweden, June 22-26, 1987.
- C28. S. Kröll, M. Aldén, D. Sandell, T. Berglind, R.J. Hall and P.-E. Bengtsson, Effects of laser bandwidths on signal/noise in broadband CARS - theoretical analysis of experimental approaches. Paper presented at IEA Taskleaders conference, Ottawa, Canada, August 24-27, 1987.
- C29. S. Kröll, M. Aldén, T. Berglind and R.J. Hall, Noise characteristics of single shot broadband Raman-resonant CARS with single- and multimode lasers. Appl. Opt. 26, 1068 (1987).

- C30. S. Kröll, A model for calculating the noise due to the stochastic nature of multimode laser radiation in nonlinear optical processes. Int. Conf. on Nonlinear Optics, Ashford Castle, Ireland, May 3-6, 1988.
- C31. S. Kröll and D. Sandell, Influence of laser mode statistics on noise in nonlinear optical processes - application to single-shot broadband coherent anti-Stokes Raman scattering thermometry. JOSA B9, 1910 (1988).
- C32. M. Aldén, P.-E. Bengtsson and H. Edner, Simultaneous rotational and vibrational CARS generation by using multiple frequency combination (m.f.c.) within a single dye. Paper presented at the CLEO conference, Baltimore, USA, 26 April - 1 May 1987.
- C33. M. Aldén, P.-E. Bengtsson, H. Edner, S. Kröll and D. Nilsson, Rotational CARS through a multiple four-colour interaction. Paper presented at the European CARS meeting in Stuttgart, March 16-17 1987.
- C34. D. Nilsson, Theoretical and experimental investigations of rotational CARS as a technique for temperature probing. Lund Reports on Atomic Physics, LRAP-76, (1987).
- C35. H M Hertz, Optical techniques for nonintrusive studies on combustion and high-voltage systems. Ph.D. Dissertation, Lund Reports on Atomic Physics LRAP-88, Lund Inst. of Tech. Lund, Sweden (1988)
- C36. H M Hertz and G W Faris, Techniques for instantaneous optical tomography in flames and fluid flows. Proc. Conf. on Lasers and Electro-Optics 1988, THC2
- C37. H M Hertz and G W Faris, Emission tomography of flame radicals. Opt. Lett. 13, 351 (1988)

- C38. G W Faris and H M Hertz, A tunable differential interferometer for optical tomography. To be submitted in Appl. Opt.
- C39. G. Russberg, Numerisk modell för gnisturladdning i luft. Lund Reports on Atomic Physics, LRAP-72 (1987) (In swedish)
- C40. M. Akram, G. Holmstedt and L. Martinsson, Studies of inductive and capacitive ignition systems. Proc. IEA Task Leaders Meeting, Amalfi (1988)
- C41 M Akram, Computations for spark-discharge simulations. Avd. för Mekanik, Lund (1988) (In swedish)
- C42. Jonas Bengtsson, Studies of degenerate four-wave mixing - cell and flame experiments. Lund Reports on Atomic Physics LRAP-95 (1988)
- C43. Peter Bengtsson, Degenerate four-wave mixing - sensitive detection of atoms and flame radicals. Lund Reports on Atomic Physics, to appear
- C44. Peter Kauranen, Frequency modulation laser spectroscopy for sensitive analysis and diagnostics. Lund Reports on Atomic Physics, to appear.
- C45. M. Aldén, An introduction to CARS as diagnostic tool. Invited talk at the 6th European CARS Conference in Stuttgart, March 16-17, 1987.
- C46. M. Aldén, Application of CARS spectroscopy for diagnostics in high demperature environment. Invited talk at the IX Vavilov Conference on Nonlinear Optics, Novosibirsk, USSR, 1987.

- C47. M. Aldén and S. Kröll, Application of rotational CARS technique and noise considerations in CARS spectroscopy. Invited talk at the 7th European CARS Conference in Pisa, Italy, March 17-18, 1988.
- C48. M. Aldén, Industrial applications of CARS. Paper presented at XI'th International Conference on Raman spectroscopy, London Sept. 1988.
- C49. M. Aldén, P.-E. Bengtsson, S. Kröll and C. Löfström, Current CARS activities at the Combustion Centre at Lund Institute of Technology. Poster presented at the 7th European CARS Conference, Pisa, Italy, March 17-18, 1988.
- C50. M. Aldén, P.-E. Bengtsson, H. Edner, S. Kröll, D. Nilsson and W. Wendt, CARS activities at Lund Institute of Technology. Gordon Research Conference, Plymouth, N.H., USA, July 13-17, 1987.
- C51. S. Trappe, Construction of a single mode pulsed dye-laser. Diploma Paper, Lund Reports on Atomic Physics, to appear
- C52. S. Svanberg, Laser spectroscopy applied to energy, environmental and medical research. *Appl. Phys.* **B46**, 271 (1988)
- C53. S. Svanberg, Laser spectroscopy applied to energy, environmental and medical research. *Physica Scripta* **T23**, 281 (1988)
- C54. H. Medin, S. Svanberg (eds.), *Laser Technology in Chemistry* (Springer, Berlin, Heidelberg 1988).

D. ENVIRONMENTAL REMOTE SENSING

D1. Monitoring of atmospheric pollutants

Raafat Amer^{*}, Hans Edner, Gregory Faris^{*}, Bo Galle^{**}, Pär Ragnarson, Anders Sunesson, Sune Svanberg, Eva Wallinder

* Visiting scientist; ** Swedish Environmental Research Institute (IVL)

The remote sensing work at the department is supported by the Swedish National Environment Protection Board and the Swedish Board for Space Activities. General interest lies in developing different optical techniques, both laser and non-laser, to measure atmospheric parameters, mostly pollutant concentrations. The laser method used is the differential absorption lidar (DIAL) technique, which has been employed during the last two years in several measurements of atmospheric mercury and nitrogen oxides. The non-laser methods consist of passive gas-correlation techniques and active long-path absorption; differential optical absorption spectroscopy (DOAS). During the last two years the work has resulted in two Ph.D. Theses [1,2]. Several presentations at various international conferences (5 invited) have also been given [3-9].

D1.1. Laser methods

The new mobile laser radar system [10] has now been in operation for some years, but is being continuously updated, especially with regard to software. During the later field campaigns, the lidar set-up was equipped with a new more powerful laser source (Quantel YG581C Nd:YAG and TDL-50 dye laser). This laser system is shared with other projects at the department, but the group now has sufficient funds to buy a similar system, which will be installed in early 1989.

Several field campaigns have been devoted to DIAL measurements of atomic mercury, which is an atmospheric pollutant that is directly generated from chlorine-alkali plants, coal-fired power plants and refuse-incineration plants. A complex and not fully understood

interaction between water and gas phases occurs in the environmental mercury cycle. Atomic mercury is also an interesting geophysical tracer gas associated with certain ore deposits, as well as geothermal, seismic and volcanic activities. Typical background concentrations of the gas are a few ng/m^3 . Such exceedingly low number densities can still be measured by the DIAL technique as the oscillator strength of the electronic transition at 254 nm is concentrated in an atomic line rather than spread out over the large number of rotational-vibrational molecular transitions normally encountered. Range-resolved measurements of atomic mercury around a chlorine-alkali plant are described in a forthcoming paper [11]. The field measurements were supplemented with extensive laboratory investigations of absorption cross sections and interfering lines of molecular oxygen. A White multipass cell was utilized in order to identify possible interference from oxygen in a measurement of mercury vapor in the atmosphere. Fig. 1a shows the measured

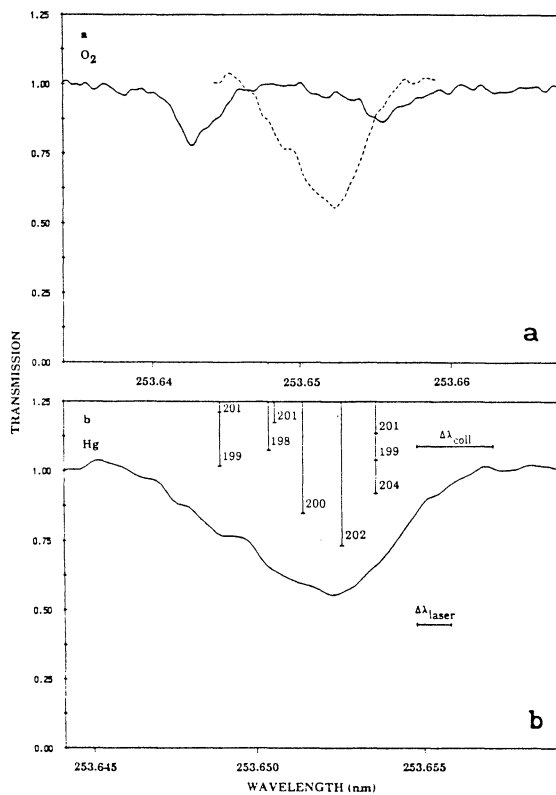

Fig. 1.
Oxygen absorption spectrum taken with a 340 m pathlength in a White cell, compared with the mercury resonance line.

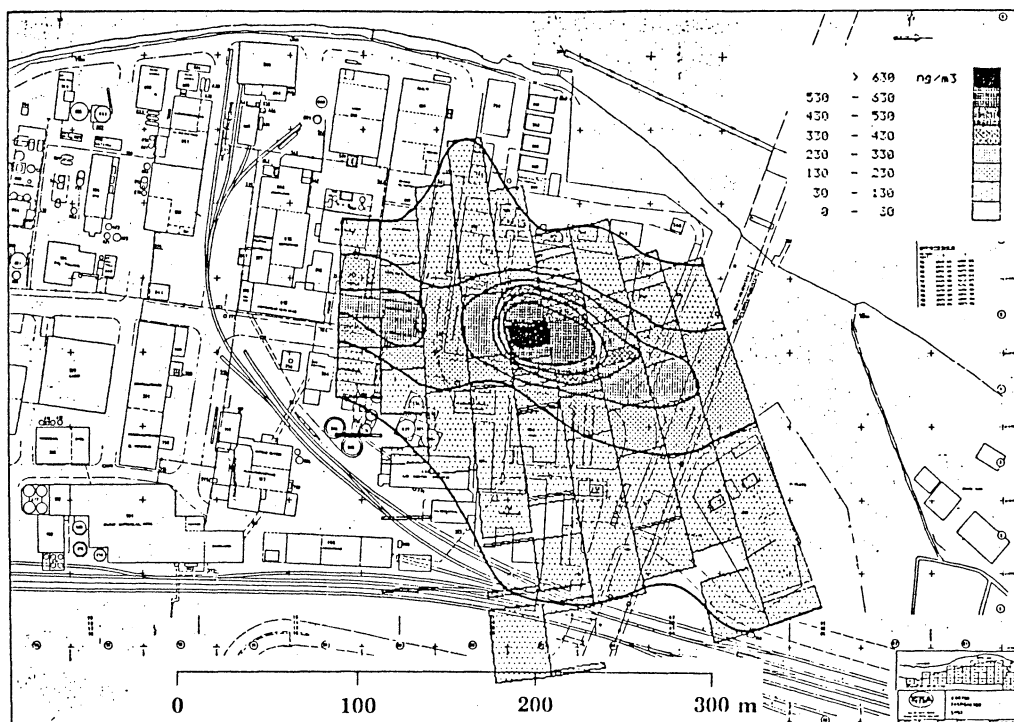

Fig. 2. *Horizontal scan of Hg distribution over a chlorine-alkali plant.*

absorption in a region close to the mercury resonance line with a recorded Hg spectrum inserted as a dotted line. An enlargement of the Hg cell spectrum is shown in Fig. 1b, where the comparatively broad structure is due to the different isotopic and hyperfine lines present, as indicated in the figure. By using frequency doubling of a coumarin dye with a betabariumborate (BBO) crystal it was possible to generate pulse energies up to 5 mJ at 254 nm. This made it possible to carry out three-dimensional mapping of atomic mercury to a distance of about 1 km at normal visibility. An example of a Hg concentration map from the chlorine-alkali plant is shown in Fig. 2, where a horizontal scan was performed at low height. Several scans were averaged to give a more representative picture. The result here

is copied directly onto a map of the plant, which is often a useful representation, for examples in locating different sources. In Ref. 11 the effects of Hg resonance fluorescence are also discussed. The fluorescence contribution to the lidar signal leads to a displacement of the calculated concentration curve and a distortion of the concentration profile. We have presented a theoretical technique for correcting for these effects, and an experimental technique for measuring the fluorescence to background factor necessary to implement this correction.

Mercury in connection with geothermal fields was investigated in a field campaign in Iceland in August 1987. The project was carried out in cooperation with the Geothermal Division of Orkustofnun in Iceland and was sponsored by the Nordic Industrial Foundation and the Swedish Natural Science Research Council. The aim of the project was to assess the possibility of using atmospheric atomic mercury anomalies for geothermal prospecting. Previous independent studies with point monitors in California and Mexico revealed very high concentrations of atomic mercury in the steam emerging from wellheads, and also elevated concentrations in the ambient air. The Hg DIAL technique, being a remote sensing technique, is of particular interest for geophysical surveys, since it could potentially cover large areas, particularly if the equipment were airborne. During the campaign, DIAL measurements were performed in three different Icelandic geothermal fields, each of different character. All measurements gave surprisingly low values, both of plume content and ambient air concentration. The levels were often close to or under the detection limit of the DIAL system. The absence of elevated concentrations of atomic Hg can have two different explanations. Either the Icelandic geological formations in the investigated areas contain very little mercury, or chemical reactions occur, induced by geogas constituents resulting in mercury compounds that are undetectable with the lidar technique. Comparative measurements of the total mercury content have since been performed with conventional techniques. The results of these and the DIAL measurements will be discussed in a forthcoming paper [12].

Preliminary studies of the emission of mercury from a water surface were performed during the summer of 1988 [13]. It is known that volatile mercury vapour is oxidized in the atmosphere to unknown forms that are soluble and can be scavenged by precipitation or dry deposited at the surface. The oxidation process is not known but photochemical oxidants (including ozone) are likely to be important. Some of the mercury bound in soil and water may slowly be transformed to volatile species that are re-emitted to the atmosphere. This evasion from continents and oceans is probably mainly due to atomic mercury and dimethyl mercury, which can both be formed by biochemical processes. Which of the two volatile compounds that dominates the evasion process is not known and others may also contribute. A test with DIAL techniques to measure atomic mercury over a water surface was performed at a lake north of Göteborg, where simultaneous measurement of the total mercury content was performed by a group from the Department of Inorganic Chemistry at Chalmers University of Technology with an amalgamation technique. With a mirror system DIAL measurements could be performed at two different heights above the water surface against a topographic target. A background value of 2 ng/m^3 was measured but no gradient could be seen in these preliminary measurements. This is probably due to the fact that the lowest height of about 50 cm was still too high, but the accuracy in the DIAL result must also be improved. The amalgamation technique yielded 2.3 ng/m^3 as background value and 3.7 ng/m^3 a few cm over the surface.

The emission of nitrogen oxides, NO_x , constitutes a significant environmental problem. NO is formed in all high-temperature combustion processes and is emitted from stationary sources as well as vehicles. In the atmosphere, NO is oxidized to NO_2 in a process that is believed to be the major source of atmospheric NO_2 . In photochemical smog situations, NO_x and several organic molecules are involved in the formation of ozone, peroxyacetyl nitrate, and other secondary pollutants. In the normal unpolluted atmosphere, NO and NO_2 together control the formation of ozone. Earlier DIAL measurements of NO_2 during inversion situations in an urban area have recently been

reported [14]. During the last year the first range-resolved measurements of NO have been performed [15]. The $\gamma(0,0)$ band of the NO molecule near 226 nm was used to monitor the NO level. The part chosen is a bandhead at 226.8 nm, where the baseline absorption is smaller than at the centre of the band, and where the interference from SO_2 absorption in a DIAL measurement is negligible. The wavelength was generated by frequency-mixing of the frequency-doubled dye laser and the fundamental 1.06 μm from the Nd:YAG laser. Enough power could be achieved to carry out mapping of the NO content in a spreading plume from a small heating plant. An example of a vertical scan in 5 directions through the plume is shown in Fig. 3. Ambient monitoring was also investigated, with an estimated detection limit of 3 $\mu\text{g}/\text{m}^3$ for an integration interval of 350 m. The range at this short UV wavelength was limited to about 500 m due mostly to the oxygen dissociation continuum. An obvious refinement of the measurement technique is to adapt it for simultaneous monitoring of NO and NO_2 . This can be performed with only one laser source if the

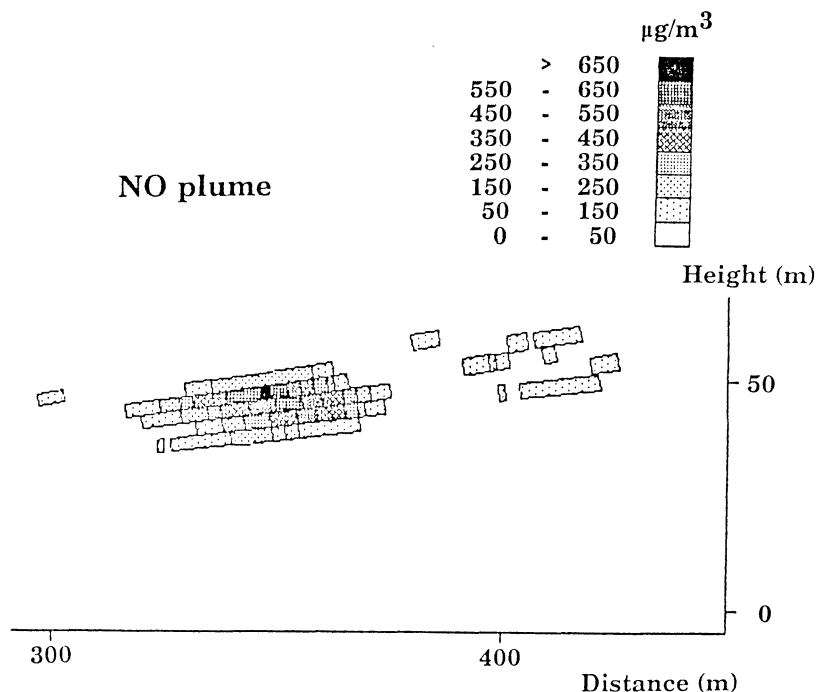

Fig. 3. NO plume mapping.

UV radiation is generated by direct doubling of a blue wavelength with a BBO crystal. Spectroscopic studies of the best wavelength pair have been performed [16].

The group has also been involved for some time in a European project called TESLAS (Tropospheric Environmental Studies by Laser Sounding), which is a subproject of EUROTRAC. EUROTRAC is a joint European environmental project studying the impact of human activities on the troposphere over Europe. It is an interdisciplinary project involving field measurements, laboratory studies and comprehensive model simulations of the physical and chemical processes involved in atmospheric chemistry. The objectives of EUROTRAC are to increase the basic knowledge in atmospheric science and to improve the scientific basis for future political decisions on environmental management in the European countries. It should also promote the technological development of sensitive, specific and fast-response instruments for environmental research and monitoring. EUROTRAC is scheduled for 8 years with a reassessment after the first 4 years. The goal of the subproject TESLAS is to reach, in a first phase, a consensus on the performances of a state-of-the-art lidar for ozone measurement in the planetary boundary layer and the free troposphere, to develop optimized systems and validate the data during intercomparison campaigns. In a second phase, the development of measurements for other species of interest (water vapour) and of an industrial standardized system for ozone will be undertaken in order to maximize scientific return.

D1.2. Non-laser methods

The possibility of imaging effluent gases in the atmosphere with a passive gas-correlation technique in the UV and visible regions has been investigated in a diploma project [17]. The basic gas-correlation technique is nondispersive and all wavelengths are present at the detector making it fully multiplexed. The fundamental advantage compared with many other spectroscopic methods is the simplicity in handling. A gas cell filled with the gas to be detected is used as a

matched spectral filter to identify the gas in a mixture of gases, and the gas itself is therefore active in the discrimination against interfering gases. Gas-correlation techniques have the advantage of working with dimensionless ratios, where the detection geometry is eliminated and has no effect on the signal. In the present paper, the combination of gas-correlation and an image detector to produce images of effluent gases in a plume, using the background sky as a light source was studied. The present system used a 1-D diode array detector but the extension to a 2-D matrix detector is being planned. The final image could be presented using a false-colour technique showing the gas plume only, together with a normal black and white TV monitor to display the gas in its proper environment.

Departmental activities in the DOAS field have been somewhat reduced for some time since two members of the group left to form a company (OPSIS) which markets DOAS systems for urban monitoring. A new effort has, however, been made during 1988. Laboratory studies of the UV absorption cross section of H_2S have been performed in a diploma project [18]. At present, the absorption of NH_3 in the deep UV is being studied and compared with different interfering gases. This is part of a joint contribution, together with the Swedish Environmental Research Institute (IVL), to the TOPAS (Tropospheric Optical Absorption Spectroscopy) project, another subproject of EUROTRAC. The general goal of TOPAS is to develop high-performance instruments capable of simultaneous observation of several atmospheric constituents, and to improve the sensitivity of the technique by at least one order of magnitude. At a later stage, intercomparison campaigns should also be performed. As a part of the development work, a fixed link over Lund is being set up (December 1988). A 2 km path over the central city (Fig. 4) will be used with the detection system in the rooftop laboratory at the department. Other lamps or retroreflectors will be installed later in order to provide additional paths.

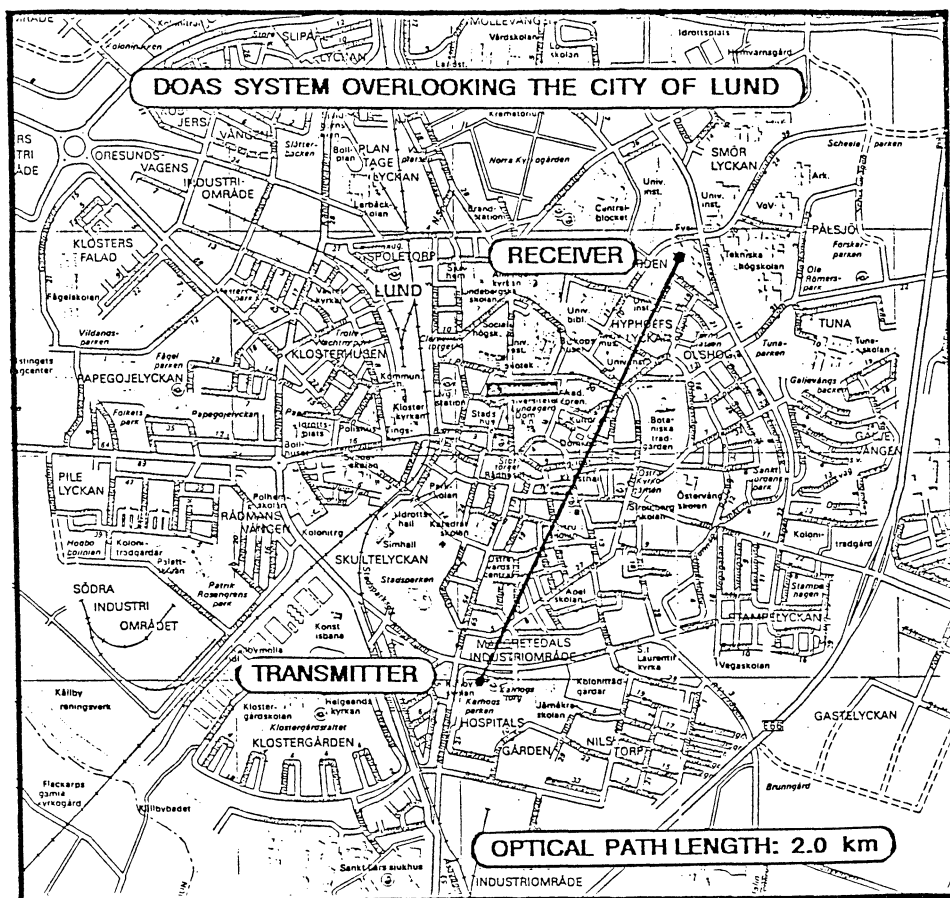

Fig. 4. DOAS measurement path over Lund.

D.2. Laser-induced fluorescence of marine oil-spills and land vegetation

Stefan Andersson-Engels, Bo Galle^{*}, Sune Montán and Sune Svanberg

^{*} Swedish Environmental Research Institute (IVL)

Laser-induced fluorescence has been investigated as a tool for marine oil-spill identification and for detection of early damage to conifers due to ozone. It would be interesting to be able to classify the oil contained in a oil-spill from an aircraft into three types of oil, light oil, crude oil and heavy oil. Much time could then be saved from the moment when the oil-spill is detected until it can be combated, since the combat procedures are totally different for the various kinds of oils. The aim of the measurements on conifer needles was to study whether laser-induced chlorophyll fluorescence could be used as a tool for diagnosis of damage to the respiratory process caused by ozone in the air. If fluorescence could give a significantly better discrimination between diseased vegetation and normal vegetation than studies using reflected light, then this modality could be used as a remote sensing method.

To be able to detect weak fluorescence signals remotely, the optical arrangement and detection scheme have to be carefully considered. Parameters such as laser pulse length, telescope field of view and background light level have been studied theoretically and in practical measurements [19]. Utilizing these results it was possible to suggest how an airborne fluorensensor could be designed in order to be capable of remotely differentiating between the three types of oil mentioned and sea-water [20].

Chlorophyll fluorescence in spruce needles was recorded from plants growing in open-top field chambers with a well controlled atmosphere with a 50% increased concentration of ozone compared with normal air at the same location (i.e. 45 ppb compared with 30 ppb). At the time of the measurements the plants were three years old and they had been in this environment during all three years. The equipment used was

the mobile medical fluorensensor described in the next chapter. Two kinds of measurements were performed, one comparing the shape of the fluorescence spectra for ozone-stressed plants and plants grown in chambers where no ozone was added to the air, and one studying the response in time of the chlorophyll fluorescence during irradiation for normal and diseased plants. In Fig. 5 a fluorescence spectrum of an ozone-stressed spruce needle is shown, where the three wavelength bands used in the statistical evaluation of the spectra are indicated. This evaluation for both kinds of investigation showed that the variations within the groups were larger than the difference between the groups. Laser-induced fluorescence seems thus not to be a method well suited for remote detection of early ozone damage to conifers.

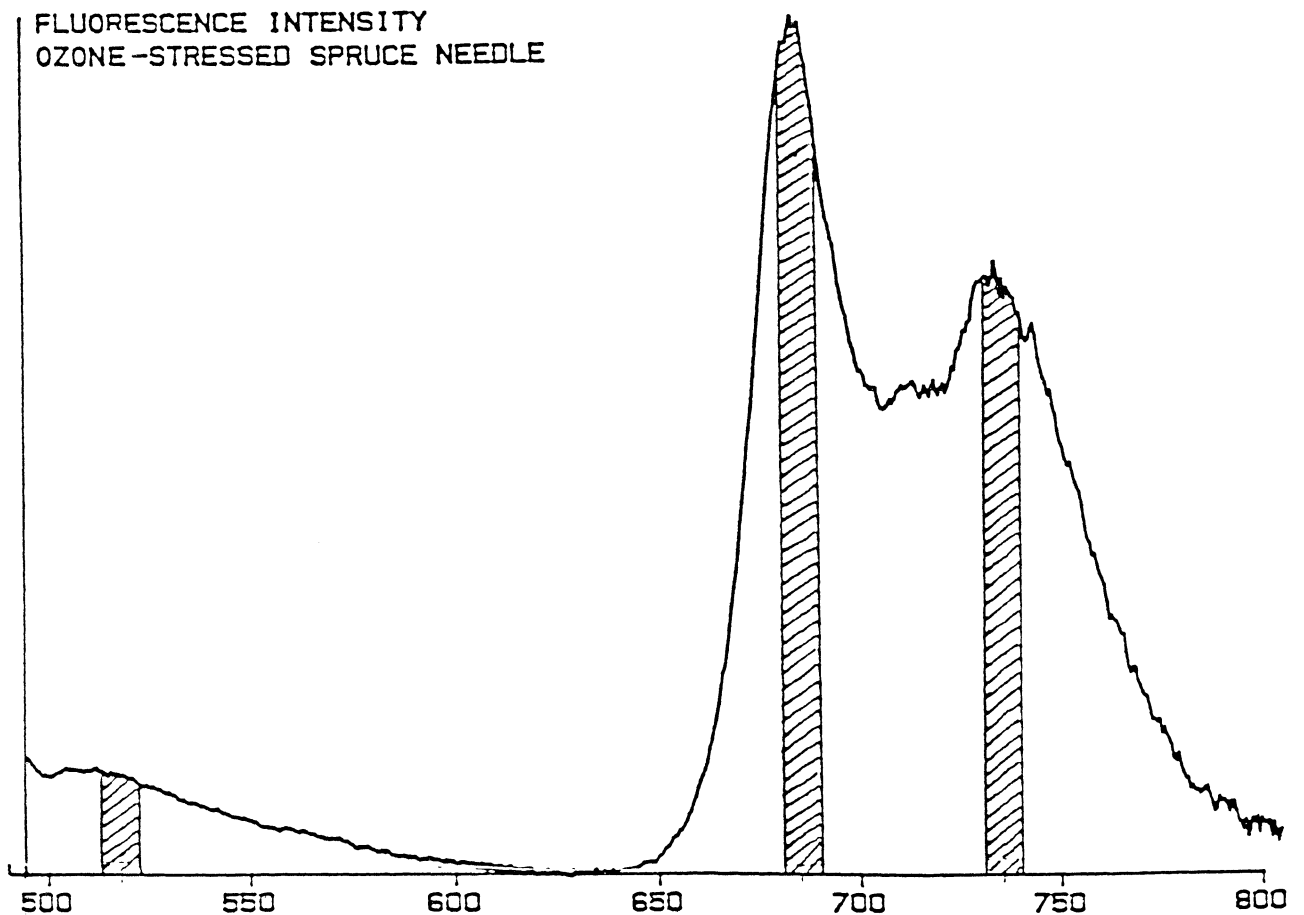

Fig. 5. A typical fluorescence spectrum of an ozone-stressed spruce needle excited at 405 nm.

References

- D1. H. Edner, Application of laser spectroscopy to combustion and environmental probing, Ph.D. Thesis, Lund Reports on Atomic Physics LRAP-77 (1987).
- D2. A. Sunesson, Laser and optical techniques employed in environmental monitoring, Ph.D. Thesis, Lund Reports on Atomic Physics LRAP-84 (1988).
- D3. H. Edner, B. Galle, A. Sunesson, S. Svanberg, L. Unéus, S. Wallin and W. Wendt, Optical remote sensing of atmospheric pollutants, Topical meeting on Laser Applications to Chemical Analysis, Incline Village, Nevada, Jan. 26-29, 1987.
- D4. H. Edner, K. Fredriksson, A. Sunesson, S. Svanberg, L. Unéus and W. Wendt, Mobile laser remote-sensing for environmental monitoring, Conference on Lasers and Electro-Optics (CLEO'87), Baltimore, Maryland, April 26-May 1, 1987.
- D5. S. Svanberg, Laser spectroscopy applied to energy, environmental and medical research, 7th General Conference of the European Physical Society, Helsinki, Aug. 10-14, 1987. Physica Scripta **T23**, 281 (1988).
- D6. S. Svanberg, Laser spectroscopy applied to energy, environmental and medical research, Appl. Phys. B **46**, 271 (1988).
- D7. H. Edner, G.W. Faris, A. Sunesson and S. Svanberg, Mapping of atmospheric atomic mercury using differential absorption lidar techniques, Conference on Lasers and Electro-Optics (CLEO'88), Anaheim, California, April 25-29, 1988.

- D8. H. Edner, G.W. Faris, A. Sunesson and S. Svanberg, Progress in DIAL measurements at short UV wavelengths, 14th International Laser Radar Conference, Innichen-San Candido, Italy, June 20-24, 1988.
- D9. H. Edner, G.W. Faris, A. Sunesson and S. Svanberg, Mapping of atmospheric atomic mercury using differential absorption lidar techniques, European Conference on Quantum Electronics (EQEC'88), Hannover, Sept. 12-15, 1988.
- D10. H. Edner, K. Fredriksson, A. Sunesson, S. Svanberg, L. Unéus and W. Wendt, Mobile remote sensing system for atmospheric monitoring, Appl. Opt. 26, 4330 (1987).
- D11. H. Edner, G.W. Faris, A. Sunesson and S. Svanberg, Atmospheric atomic mercury monitoring using differential absorption lidar techniques, to be published in Applied Optics, March 1 (1989)
- D12. H. Edner, G.W. Faris, A. Sunesson, S. Svanberg, J. . Bjarnasson, H. Kristmansdóttir and K.H. Sigurdsson, Lidar search for atmospheric atomic mercury in Icelandic geothermal fields, in preparation for J. Geophys. Res..
- D13. H. Edner and P. Ragnarson, Preliminary studies of the emission of atomic mercury from a lake surface using lidar techniques, to appear.
- D14. B. Galle, A. Sunesson and W. Wendt, NO₂-mapping using laser-radar techniques, Atmos. Environ. 22, 569 (1988).
- D15. H. Edner, A. Sunesson and S. Svanberg, NO plume mapping by laser-radar techniques, Opt. Lett. 13, 704 (1988).
- D16. Zh. Nickolov and S. Svanberg, On the possibilities of NO/NO₂ simultaneous detection by DIAL, Lund Reports on Atomic Physics LRAP-71 (1987).

- D17. P. Ragnarson, Spectroscopic imaging of effluent gases, Diploma paper, Lund Reports on Atomic Physics, LRAP-83 (1988).
- D18. S.-I. Cederfelt, Investigation of the absorption cross-section of hydrogen sulphide in the ultraviolet region using a White cell, Diploma paper (1988).
- D19. P.S. Andersson, S. Montán and S. Svanberg, Remote sample characterization based on fluorescence monitoring, Appl. Phys. **B-44**, 19-28 (1987).
- D20. P.S. Andersson, S. Montán and S. Svanberg, Fluoresensor for remote characterization of marine oil-slicks, In Proceeding for Remote Sensing of Pollution of the Sea, R. Reuter and R.H. Gillot (eds.), Oldenburg, FRG, April (1987).
- D21. Stefan Andersson-Engels, Karin Callander and Bo Galle, Investigation of the possibilities to use laser-induced fluorescence to map conifer forest damage caused by ozone, IVL-report L88/146 (1988) (In Swedish).

E. MEDICAL APPLICATIONS

Stefan Andersson-Engels, Jaro Ankerst*, Arne Brun*, Åke Elner*, Anders Gustafson*, Jonas Johansson, Sven-Erik Karlsson, Dick Killander, Elisabeth Kjellén*, Erik Lindstedt*, Sune Montán, Leif Salford*, Bo Simonsson*, Unne Stenram*, Lars-Göran Strömblad*, Katarina Svanberg*, Sune Svanberg.

*
Lund University Hospital

Laser-induced fluorescence (LIF) has been investigated as a tool for tissue diagnostics in Lund since 1983. The main project in this context has been to optimize the discrimination between cancer tumours and surrounding normal tissue through animal studies. During the last two years clinical measurements have been initiated and studies on the demarcation of atherosclerotic plaque regions have also been performed. Reviews of this work are given in Refs [1-4] and in a thesis that mainly focuses on this subject [5].

In a model of a large molecule several parameters important for the understanding of tissue fluorescence can be illustrated. Following the absorption of a photon, a large molecule can be de-excited in several ways, see Fig. 1. Internal conversion to the lowest energy level in the first excited singlet state is a very fast process (of the order of femtoseconds). From this state several processes can occur, among them transitions to the ground state yielding fluorescence, intersystem crossing to the first excited triplet state and internal conversion to the ground state. Internal conversion is a non-emitting thermal relaxation process. Transitions from the triplet to the singlet state are said to be forbidden, that is they have a much lower probability than corresponding processes within the same multiplet system, due to the difference in electronic spin. Due to the broad energy bands of a large molecule, the wavelength of the excitation light does not need to be very precisely tuned to the specific molecule to make absorption possible, even if various wavelengths are absorbed with varying efficiencies. A high quantum

yield for the fluorescence is of course of importance but, as will be shown later, what is most important is to obtain as high a contrast as possible between diseased and normal tissue. Another parameter that should be taken into account in the choice of excitation wavelength is the penetration depth of the excitation light in tissue. The shorter the wavelength in the near UV and blue wavelength region, the shorter the penetration depth, and thus the sample probe volume. The fluorescence peaks obtained from tissue are broad due to the broad energy bands and therefore contain only little information. Further, the shape of the fluorescence spectra will not only be a superposition of the fluorescence spectra of the different chromophores in the tissue, but reabsorption of fluorescence light can also be seen in the resulting fluorescence spectra. Parameters useful for analysis are not only the shape of the fluorescence spectra, but also the absolute fluorescence intensity and lifetimes.

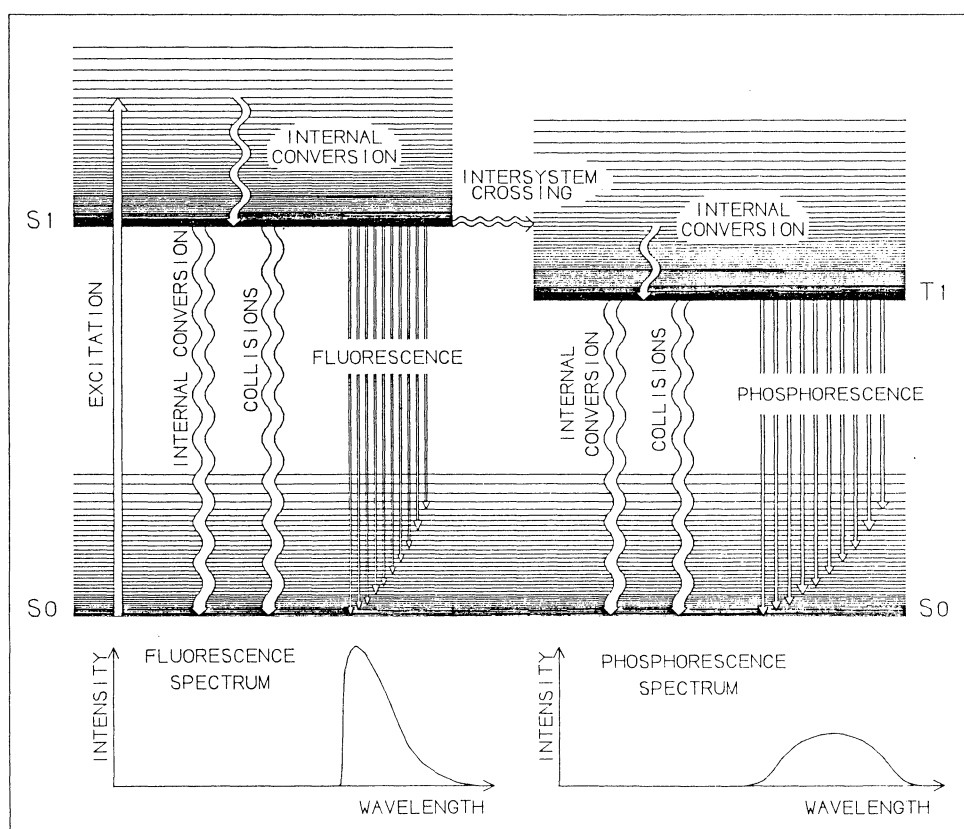

Fig. 1. Energy levels of a large molecule together with some processes competing with fluorescence. General fluorescence and phosphorescence spectra are outlined (From Ref. [5]).

Although little information is contained in the fluorescence from large molecules, the development of fluorescence techniques for the detection and identification of different diseases has advanced during the last years. Utilizing a fluorescent tumour-seeking dye, cancer tumours can be distinguished from normal tissue by studying the tissue fluorescence. This drug, which is selectively accumulated in cancer tumours, can also be used for therapy, by destroying the tumour tissue upon light irradiation, i.e. photodynamic therapy (PDT). The drug molecules are excited by the absorption of light and the excitation energy is transferred to the oxygen molecules in the cells, converting them to their singlet state, in which they are toxic.

A mixture of porphyrins, denoted haematoporphyrin derivative (HPD) has been used throughout the world for this purpose since 1978, while a purified form of haematoporphyrin derivative, in which the therapeutically effective component, dihaematoporphyrin ether (DHE), is concentrated, has now been available for some years. A permit to use DHE clinically for therapy has been obtained from the Swedish health authorities. In Sweden, a few patients have been treated with this modality during the last two years. The two first patients in Scandinavia were treated at the Oncology Clinic at Lund University Hospital. During the actual treatment sessions, the radiation with laser light was performed at the Department of Physics.

New drugs are under investigation to enhance the performance of PDT and fluorescence diagnostics. These tests show that it is not necessarily the same drug that optimizes PDT effect and tumour marking capability by means of fluorescence, but parallel developments of drugs for the two modalities can be foreseen.

During recent years, the potential of laser angioplasty in the removal of atherosclerotic plaque in the blood vessels has been demonstrated. This kind of treatment of occluded blood vessels is at present under clinical trials in the USA. To make this form of treatment safer and more successful, new techniques for plaque

identification must be developed. Two possible ways of guiding the treatment to the correct location is to probe the target with laser-induced fluorescence using a UV light source or to use the plasma emission during ablation.

The work presented here has been performed as a collaboration between the Department of Physics and several clinics at Lund University Hospital. It can be divided into six smaller areas. Firstly, we have tried to optimize the contrast between tumours and surrounding normal tissue in animal tumour models. Parameters varied in the more recent studies are tumour marking drug, drug concentration, and excitation and detection wavelengths. Secondly, some experiments have also been performed with samples extracted from humans. Here, fluorescence spectra from various kinds of tumours as well as effects on the fluorescence signal of different sample preparations will be presented. Thirdly, clinical studies have started involving photodynamic treatment of tumours and the demarcation of different cancer tumours in patients both with and without DHE is being investigated. After these investigations of laser-induced fluorescence in oncology, our studies on the identification of atherosclerotic plaque regions and kidney stones using laser-induced fluorescence and plasma emission will be discussed in the following two subsections. Parallel to the investigations of different tissue types, instrumentation has been developed. This will be described in the last subsection.

E1. LIF studies of malignant tumours in animal experiments

The tumour marking capabilities of haematoporphyrin derivative (HPD) and its purified form dihaematoporphyrin ether (DHE) have been investigated for an adenocarcinoma tumour model implanted in the hind legs of Wistar Furth rats [6]. Both the dependence of drug concentration and excitation wavelength were tested. In rats injected with HPD the tumours were somewhat better demarcated in fluorescence compared with rats injected with DHE. Also, as can be seen in Fig. 2, the demarcation increased significantly by changing the excitation

wavelength from the porphyrin excitation peak at 405 nm to the shorter wavelength of 337 nm. This increase was found to be due to a higher contrast in the intrinsic fluorescence from tumours and the surrounding muscle tissue when using the shorter excitation wavelength.

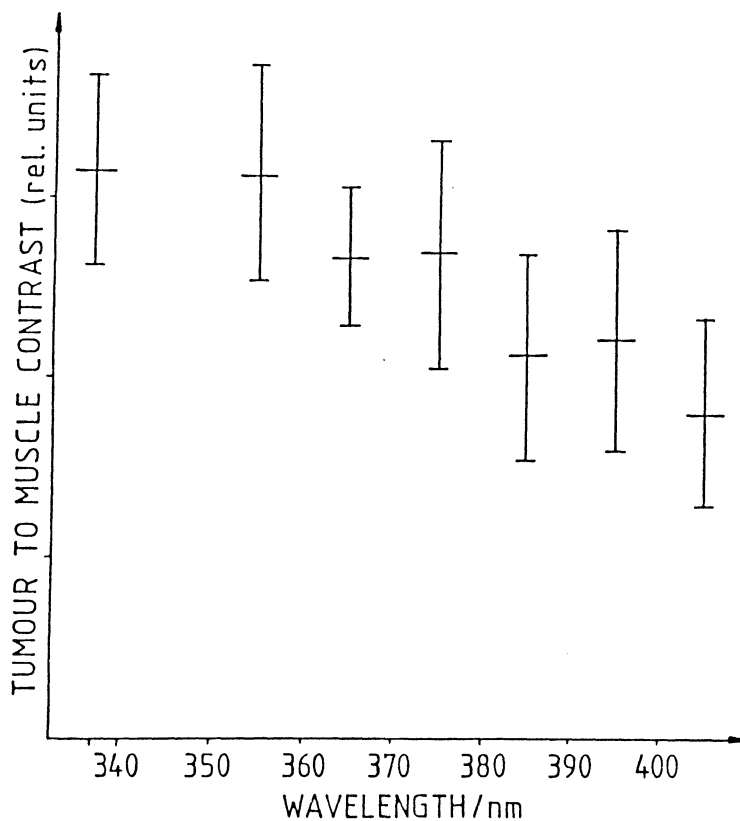

Fig. 2. The dimensionless ratio A/B for tumour exterior and muscle, evaluated for different excitation wavelengths. (From Ref. [6])

The appearance of the intrinsic tissue fluorescence, or autofluorescence, in various organs of a rat and the above tumour model is discussed in Ref. [7]. Here the spectral shapes of autofluorescence spectra obtained with 337 nm excitation are presented. Paper [7] stresses both the potential of using pure autofluorescence in tumour demarcation and gives information on the shape of the tissue fluorescence spectra without any tumour-marking drug.

The tumour marking properties of drugs other than HPD and DHE were tested in the same tumour model [8,9,10]. These experiments showed that the monomeric compound haematoporphyrin (Hp) gives a contrast of about 4:1 between tumour and surrounding tissue using our fluorescence criteria. This is about half the contrast obtained using DHE. Hp can, however, despite the resulting lower contrast, still be very useful for tumour marking, since Hp does not cause skin hypersensitization of the patient and it needs only to be administered 2 h prior to the examination, compared with 2 days for DHE. Tetra sulphonated phthalocyanine and poly-haematoporphyrin ester, two drugs under investigation for PDT, were also tested in these experiments. Neither of these drugs had better properties than DHE for tumour delineation using laser-induced fluorescence.

The fluorescence in DHE-injected animals using two other tumour models, TCVC and RG-2 glioma models in Fisher rat brains, was examined, and the result presented in Ref. [11]. The contrast between these tumour models and the normal surrounding brain tissue was found to be much better than the contrast between any other tumour model and surrounding tissue studied by us, although only a small dose, 1 mg/kg b. w., was utilized. The high contrast in the HPD retention is thought to be due to the fact that the blood brain barrier is intact in the unaffected brain tissue, whereas it is not in the tumour tissue.

A new, more basic, project has just been initiated. In this project we intend to study fluorescence lifetimes and polarization effects of the fluorescence at different fluorescence wavelengths of tissue and various tumour-marking drugs in order to try to improve the discrimination criterion for cancer tumours by means of laser-induced fluorescence. It is hoped that results from these investigations will help to give a better understanding of retention mechanisms and binding sites within the tissue for these drugs. In this project we hope to start a collaboration with biochemists to be able to better interpret the information obtained from the fluorescence signals.

E2. LIF experiments of human tumours *in vitro*

The autofluorescence of certain human brain tumour samples *in vitro* was studied and compared with the fluorescence from normal brain tissue samples. The investigation showed that biopsies of astrocytoma can not be distinguished from biopsies from normal brain tissue, but biopsies from meningiomas can. Further, fluorescence signals from a number of fresh samples were compared with the signals from the same samples after various kinds of sample preparation. Both fluorescence intensity and spectral shape were changed after the samples had been stored at -20° C, while formaldehyde fixation did not alter the fluorescence shape, but only the fluorescence intensity [12].

E3. Clinical investigations of laser-induced fluorescence

Clinical recording of laser-induced fluorescence spectra in Lund was initiated with the start of the local PDT programme in April 1987. Fluorescence spectra from two patients injected with DHE were recorded. One patient had seven basaliomas spread all over the body, while the other showed eight superficial recurrent breast cancer lesions on the chest wall. Fluorescence spectra of one of the basalioma and surrounding skin, as well as the fluorescence intensities at selected wavelength bands in a scan from normal skin over the tumour and out onto the skin on the other side of the tumour are shown in Fig. 3. Details of the PDT treatment and the results are thoroughly discussed in [13,14]. Our intention was to monitor as many important parameters as possible during the PDT procedure, so that the effect could be computer-simulated according to the best model that was available for PDT at that time. After the evaluation of a large number of similar treatment sessions, the model could be modified to better fit the results. In order to measure all the most important parameters in the correct manner, the work was carried out in close collaboration with Prof. Lars Svaasand at The Norwegian Institute of Technology in Trondheim, who is a leading expert in the field of PDT modelling. The work later resulted in a protocol for the treatment of basalioma and recurrent breast cancer metastasis [15].

The PDT programme in Lund, and worldwide, was suspended during the latter half of 1987 and the first half of 1988 while production of DHE was moved from one factory in the USA to another one in Canada.

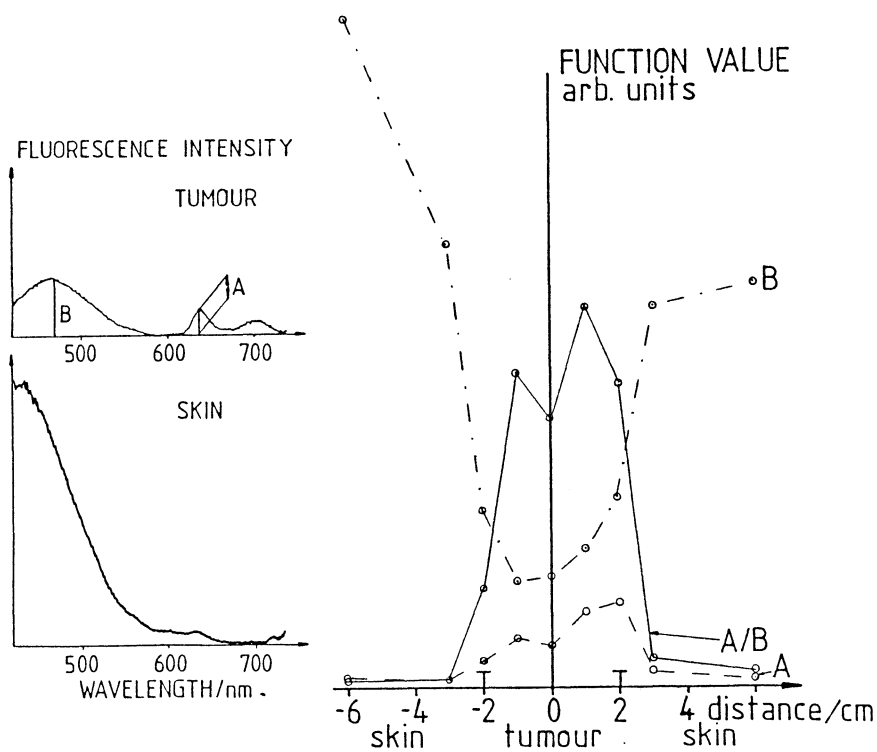

Fig. 3. Fluorescence spectra for a basalioma and normal skin as well as fluorescence intensity functions in a scan from the skin over the basalioma lesion and out onto the skin on the other side of the tumour (From Ref. [14]).

Meanwhile, more extensive clinical autofluorescence measurements have been performed at three different clinics at Lund University Hospital [16,17]. The results show that one may be able to demarcate some cancer tumour types by using the tissue autofluorescence only, whereas other tumour types need the higher contrast provided by a tumour-marking drug. Further investigations are under way, the results of which will help us to draw more precise conclusions about the potential of autofluorescence as a tool for tissue diagnosis for different tumour types.

E4. LIF studies of human atherosclerotic plaque *in vitro*

In 1985-86 a few groups started to investigate whether it was possible to differentiate atherosclerotic plaques from the normal vessel wall by using Ar-ion laser-induced autofluorescence. This is a very interesting method for guiding the laser light in laser angioplasty. Small differences could be seen, but it was later shown that the criteria used in the diagnostics were sensitive to sample geometry and the presence of blood. However, it was shown by us for the first time that the autofluorescence from an atherosclerotic plaque lesion *in vitro* is different from that from the normal vessel wall when using a nitrogen laser as an excitation source [18,19]. Later, further investigations have confirmed these observations and that the criteria can be very consistent in *in vitro* studies. One can actually distinguish between three different classes of transformation to more and more severe atherosclerotic damage and normal vessel wall [20,21]. In Fig. 4 a comparison between four discrimination criteria is shown for 23 different plaques and surrounding normal vessel wall.

As can be seen, the functions F_1 and F_2 discriminate the diseased from the normal regions very well. In this study, ablation of atherosclerotic plaque lesions was also performed using a XeCl excimer laser. During the ablation, emission spectra from the plasma were recorded. A typical series of plasma spectra obtained while ablating through a calcified plaque down into the normal underlying vessel wall is illustrated in Fig. 5. Ca lines and the sodium D line are present then ablating the calcified region, while only the sodium line is present from the normal vessel wall. This observation suggests that the plasma emission can be used for laser guidance in laser angioplasty.

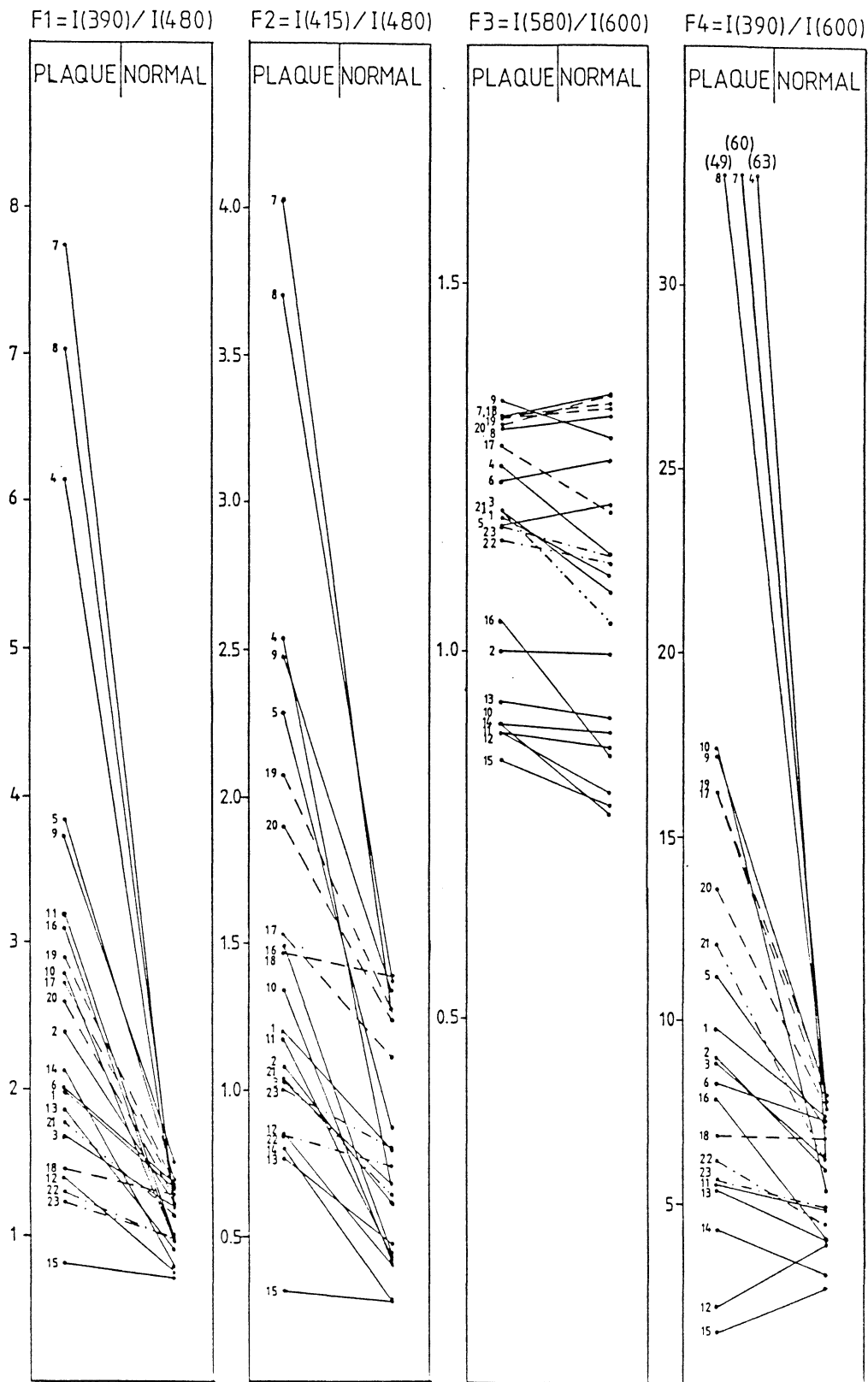

Fig. 4. Discrimination using four different discrimination functions for 23 atherosclerotic plaque samples (From Ref. [21]).

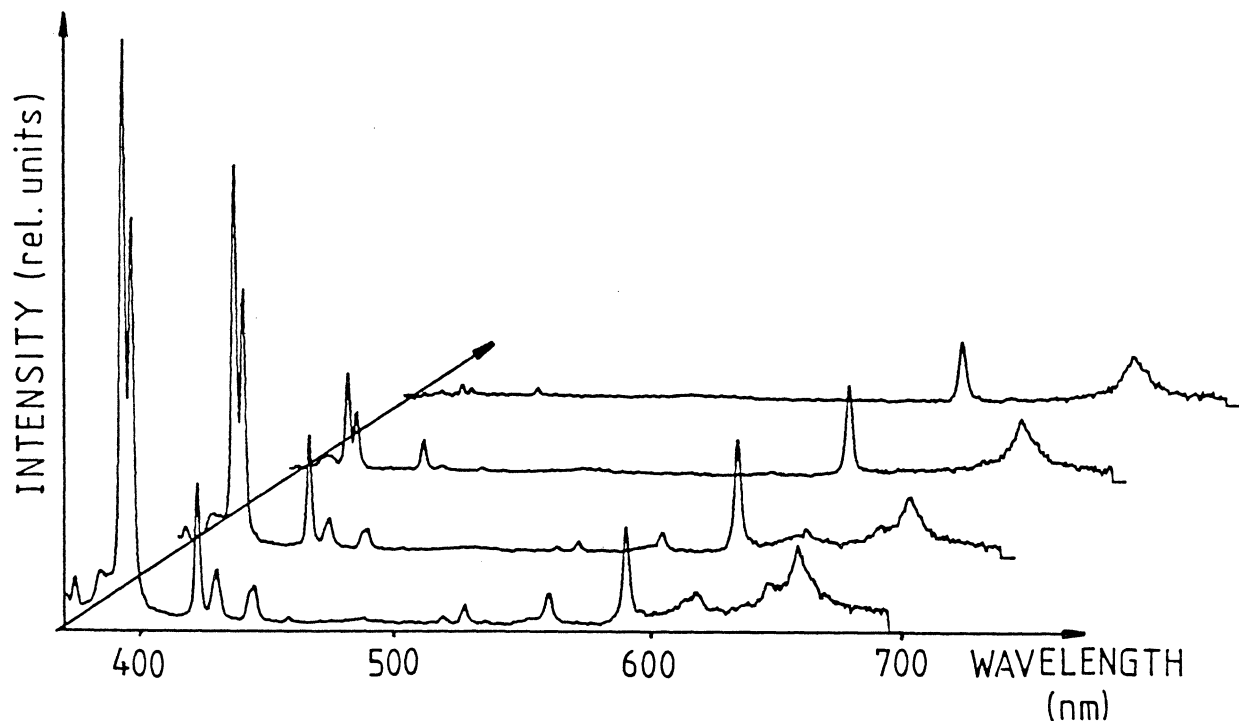

Fig. 5. *Plasma emission spectra at different depths when ablating a calcified atherosclerotic plaque (From Ref [21]).*

E5. Laser lithotripsy

One diploma project focused on spectroscopy for diagnostic purposes in connection with the fracturing of kidney stones using high-intensity light pulses from a Nd:YAG laser or a XeCl excimer laser. To guide the firing of the laser, ensuring that the optical fibre is pointing towards the target stone, both the fluorescence spectrum following UV light excitation and the plasma spectrum from the previous laser pulse can be utilized [22]. This investigation gives examples of fluorescence spectra as well as plasma emission spectra from a number of kidney stones and a porcine urethra.

E6. Development of instrumentation

In all the investigations presented above the entire fluorescence spectra have been recorded. But, as pointed out previously, tissue fluorescence spectra have very broad peaks, and the intensities at a few characteristic wavelength bands contain all the information about the spectrum. After the characteristic wavelengths have been determined for the tissue types of interest, it is only necessary to measure the intensities at these wavelengths. Furthermore, in a clinically useful system one would like to process the signals to the degree that the system is able to classify the tissue into a few types of different degrees of diseased tissue as well differentiating normal from diseased tissue. For technical reasons, it is a clear advantage to form a dimensionless function of the measured fluorescence intensities. One of the aims of the more basic spectrally resolved measurements discussed above is to find the optimal dimensionless contrast function which can be used to demarcate the diseased regions and also to try to find the appropriate discrimination level for this function.

In order to fulfil the intentions in these concepts three different medical fluoressors are under development at the department. One is a point monitoring filter fluoressor based on a high-pressure mercury lamp and constructed with a chopper/filter wheel that contains a number of excitation and detection filters [23]. In further developments of this equipment the filter wheel has been reconstructed to suppress stray light and the signal processing has been improved in two diploma projects [24,25] with the help of two summer school students [26]. The present status is that six independent fluorescence signals as well as the background light for each filter are detected. The electrical signal from the photomultiplier tube is amplified in an electrical amplifier and integrated in a gated integrator. The integrated signal from each detection filter is converted to a digital signal in a 12-bit analogue to digital converter. This signal is then fed to an IBM-compatible personal computer for further processing.

Another point monitoring system, which has been used in the clinical measurements discussed above, can record the entire fluorescence spectrum of a sample after pulsed nitrogen laser excitation. The excitation source, optics, fibre-optics and detection unit are all placed on the shelf in the middle of a mobile trolley, while the electronics and computer mainframe are placed on top and dry air supply for the detector and cables are at the bottom. The trolley is mobile and totally covered to ensure sterility. An optical fibre guides the excitation light to the tumour location and the fluorescence light back to the equipment. A photo of this equipment is shown in Fig. 6.

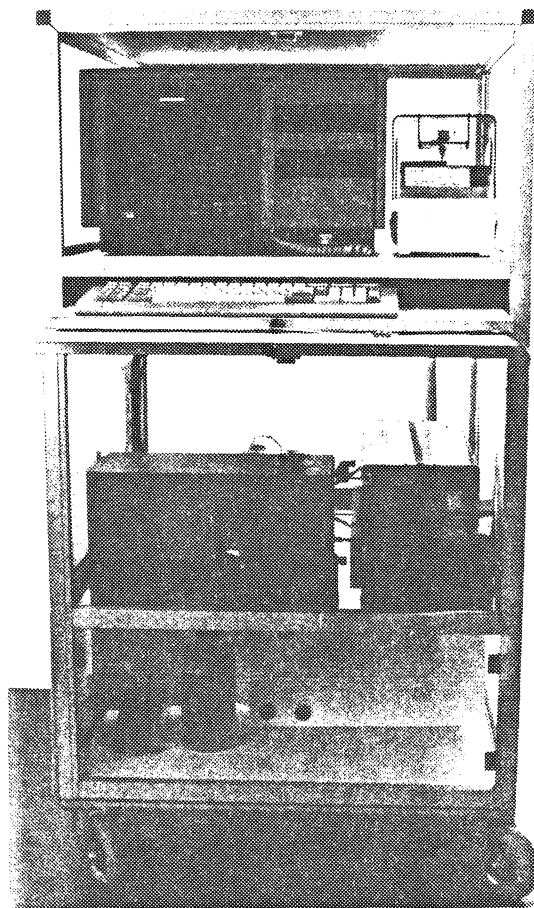

Fig. 6. *Photograph of the fluorescence system used clinically.
(From Ref. [17])*

Imaging instrumentation utilizing the concept of an optimizing discrimination function is also under construction. The concept and planned optical arrangement as well as measurements in one-dimension are discussed in Ref. [27]. The two-dimensional version that we are working on now is illustrated in Fig. 7. Apart from spatial resolution and the possibility of displaying an optimized contrast function calculated from the fluorescence intensities in four fluorescence bands, it will also include the option of very fast gating (5 ns) giving a temporal resolution of the order of tissue fluorescence lifetimes. This feature is very interesting in combination with the newly initiated project in which we are studying the fluorescence lifetimes of tissue and various tumour markers using picosecond spectroscopy.

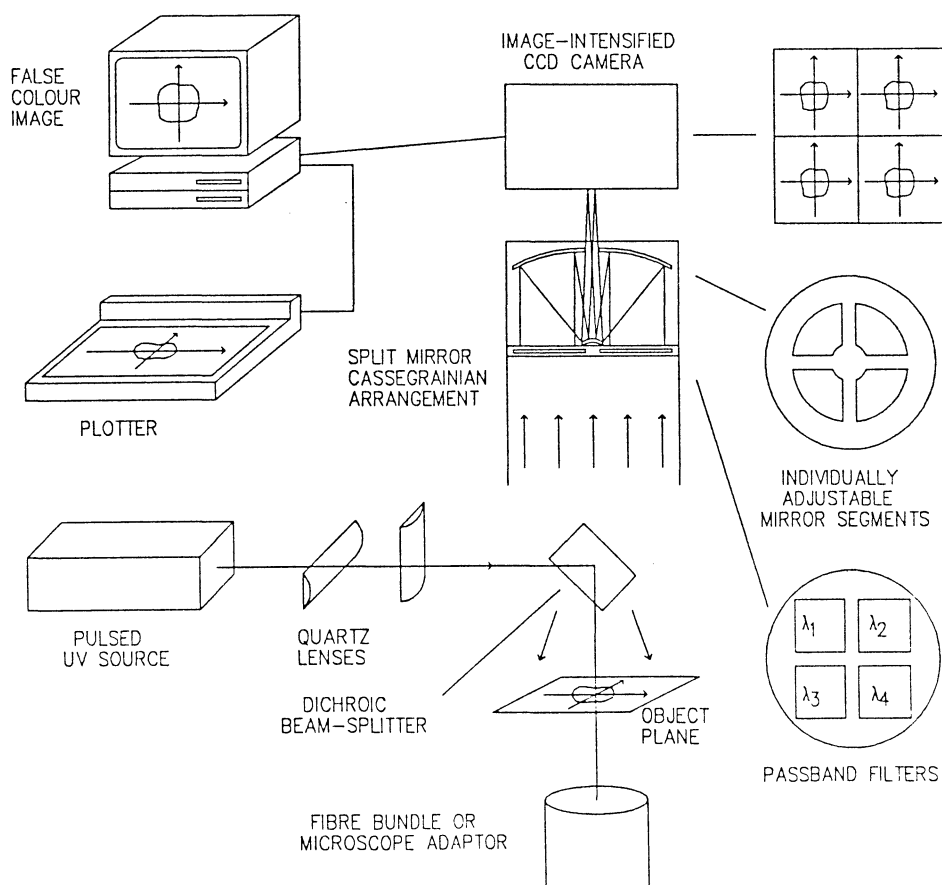

Fig. 7. Schematic diagram of the two-dimensional fluorensensor under development at the department (From Ref. [4]).

References

- E1. S. Svanberg, Medical Diagnostics using Laser-Induced Fluorescence, *Physica Scripta* **T19**, 469 (1987) (Invited paper)
- E2. S. Svanberg, Medical Applications of Laser Spectroscopy, *Physica Scripta*, in press (1988) (Invited paper)
- E3. S. Svanberg, Nachweis und Behandlungen von Tumoren unter Verwendung von Laserstrahlung Hämatoporphyrin-Derivat, Invited paper for *Physikalische Blätter* (1988)
- E4. S. Andersson-Engels, J. Ankerst, A. Brun, Å. Elner, A. Gustafson, J. Johansson, S.-E. Karlsson, D. Killander, E. Kjellén, E. Lindstedt, S. Montán, L. G. Salford, B. Simonsson, U. Stenram, L.-G. Strömblad, K. Svanberg and S. Svanberg, Tissue Diagnostics using Laser-Induced Fluorescence, *Ber. Bunsenges. Phys. Chem.* in press (1988) (Invited paper)
- E5. S. Montán, On the use of Laser-induced Fluorescence in Medical and Industrial Applications, Dissertation thesis, Lund Institute of Technology, Lund Reports on Atomic Physics LRAP-75 (1987)
- E6. S. Andersson-Engels, J. Ankerst, S. Montán, K. Svanberg and S. Svanberg, Aspects of Tumour Demarcation in Rats by Means of Laser-Induced Fluorescence and Haematoporphyrin Derivatives, *Lasers in Med. Sci.* **3**, 239 (1988)
- E7. P. S. Andersson, E. Kjellén, S. Montán, K. Svanberg and S. Svanberg, Autofluorescence of Rodent Tissues and some Human Skin Samples, *Lasers Med. Sci.* **2**, 41 (1987)

- E8. S. Andersson-Engels, J. Ankerst, J. Johansson, K. Svanberg and S. Svanberg, A Comparison of Tumor Demarcation Potential for Various Hematoporphyrin Derivatives and Phthalocyanine Using Laser-Induced Fluorescence, SPIE Vol. 907, p. 80 (SPIE, Bellingham 1987)
- E9. S. Andersson-Engels, J. Ankerst, J. Johansson, K. Svanberg and S. Svanberg, Malignant Tumour Demarcation Potential of Various Photosensitizers Using Laser-Induced Fluorescence, Lasers Med. Sci., Conference Abstract Issue, July 1988, No 121
- E10. S. Andersson-Engels, J. Ankerst, J. Johansson, K. Svanberg and S. Svanberg, Tumour Marking Properties of Different Haematoporphyrins and Tetrasulphonated Phthalocyanine - a Comparison, accepted for publication in Lasers Med. Sci. (1989)
- E11. S. Andersson-Engels, A. Brun, E. Kjellén, L. G. Salford, L.-G. Strömblad, K. Svanberg and S. Svanberg, Identification of Brain Tumours in Rats Using Laser-Induced Fluorescence and Haematoporphyrin Derivative, subm. to Lasers Med. Sci, (1988)
- E12. S. Montán and L.-G. Strömblad, Spectral Characterization of Brain Tumours Utilizing Laser-Induced Fluorescence, Lasers Life Sci. 1, 275 (1987)
- E13. S. Andersson-Engels, J. Johansson, D. Killander, E. Kjellén, M. Olivio, L. O. Svaasand, K. Svanberg and S. Svanberg, Photodynamic Therapy and Simultaneous Near-Infrared Light-Induced Hyperthermia in Human Malignant Tumors: A Methodological Case Study, L. I. A. ICALEO 60, 67 (1987)

- E14. S. Andersson-Engels, J. Johansson, D. Killander, E. Kjellén, L. O. Svaasand, K. Svanberg and S. Svanberg, Photodynamic Therapy Alone and in Conjunction with Near-Infrared Light-Induced Hyperthermia in Human Malignant Tumors: A Methodological Case Study, SPIE Vol. 908, p. 116 (SPIE, Bellingham 1987)
- E15. K. Svanberg, D. Killander and E. Kjellén, Protocol for Photodynamic Therapy (PDT) Utilizing Photofrin II and Laser Light, Oncology Department, Lund University Hospital (1988)
- E16. S. Andersson-Engels, Å. Elner, J. Johansson, S.-E. Karlsson, L. G. Salford, L.-G. Strömblad, K. Svanberg and S. Svanberg, Clinical Recording of Laser-Induced Autofluorescence Spectra for Evaluation of Tumour Demarcation Feasibility in Selected Clinical Specialities, Lasers Med. Sci., Conference Abstract Issue, July 1988, No 342
- E17. S. Andersson-Engels, Å. Elner, J. Johansson, S.-E. Karlsson, L. G. Salford, L.-G. Strömblad, K. Svanberg and S. Svanberg, Clinical Recording of Laser-Induced Fluorescence Spectra for Evaluation of Tumour Demarcation Feasibility in Selected Clinical Specialities, submitted to Lasers Med. Sci. (1989)
- E18. P. S. Andersson, J. Ankerst, E. Kjellén, S. Montán, K. Svanberg and S. Svanberg, Tissue Diagnostics Using Laser-Induced Fluorescence Techniques, Advances in Laser Science-II American Inst. of Physics Conference Series No 160 (American Institute of Physics, New York 1987), pp. 715-721 (Invited paper)
- E19. P. S. Andersson, A. Gustafson, U. Stenram, K. Svanberg and S. Svanberg, Diagnosis of Arterial Atherosclerosis using Laser-Induced Fluorescence, Lasers Med. Sci. 2, 261 (1987)

- E20. S. Andersson-Engels, A. Gustafson, J. Johansson, U. Stenram, K. Svanberg and S. Svanberg, Spectral Laser-Induced Fluorescence Characteristics of Atherosclerotic Plaques, Lasers Med. Sci., Conference Abstract Issue, July 1988, No 302
- E21. S. Andersson-Engels, A. Gustafson, J. Johansson, U. Stenram, K. Svanberg and S. Svanberg, Laser-Induced Fluorescence used in Localizing Atherosclerotic Lesions, accepted for publication in to Lasers Med. Sci. (1989)
- E22. C. Palmqvist, Laser Lithotripsy of Kidney Calculi with a Nd:YAG Laser, Diploma Paper, Lund Institute of Technology, Lund Reports on Atomic Physics LRAP-94 (1988)
- E23. P. S. Andersson, S.-E. Karlsson, S. Montán, T. Persson, S. Svanberg and S. Tapper, Fluorescence Endoscopy Instrumentation for Improved Tissue Characterization, Med. Phys. **14**, 633 (1987)
- E24. Charlotte Arfwidsson, A Computer-Controlled Fluorescence-Monitoring System, Diploma Paper, Lund Institute of Technology, Lund Reports on Atomic Physics LRAP-79 (1987)
- E25. Petra Hansson, Signal Processing Developments for a Medical Filter Fluoresensor based on a High Pressure Mercury Lamp, Diploma Paper, Lund Institute of Technology, Lund Reports on Atomic Physics, in preparation (1989)
- E26. Annika Nilsson och Christian Stureson, Lumisond - ett instrument för detektion av cancerceller, Forskarskolerapport (1987) (In Swedish)
- E27. P. S. Andersson, S. Montán and S. Svanberg, Multispectral System for Medical Fluorescence Imaging, IEEE J. Quantum Electr., QE-23, 1798 (1987)

- E28. S. Svanberg, Laser Spectroscopy Applied to Energy, Environmental and Medical Research, Applied Physics **B46**, 271 (1988) (Invited paper)
- E29. S. Svanberg, Laser Spectroscopy Applied to Energy, Environmental and Medical Research, Physica Scripta (in press) (Invited paper)
- E30. P. S. Andersson, J. Ankerst, E. Kjellén, S. Montán, L. G. Salford, K. Svanberg and S. Svanberg, Tissue Diagnostics Using Laser-Induced Fluorescence, Proc. Conference on Lasers and Electro-Optics '87, Baltimore, Md (1987)
- E31. P. S. Andersson, J. Johansson, E. Kjellén, S. Montán, K. Svanberg and S. Svanberg, Diagnostics of Cancer Tumours and Atherosclerotic Plaque using Laser-Induced Fluorescence, in Laser Spectroscopy VIII, Springer Series in Optical Sciences Vol. 55, Eds. W. Persson and S. Svanberg (Springer Verlag, Heidelberg, 1987)
- E32. P. S. Andersson, J. Ankerst, A. Gustafson, J. Johansson, E. Kjellén, S. Montán, L. G. Salford, K. Svanberg and S. Svanberg, Abstract for invited talk, 2nd Congress of the European Society for Photobiology, Padova, September 6-10, 1987
- E33. S. Svanberg, Tissue Diagnostics Using Laser-Induced Fluorescence, Invited talk at the Arne Engström Symposium, Karolinska Institute, Stockholm (1987)
- E34. S. Svanberg, Laser-Induced Fluorescence from Malignant Tumours and Atherosclerotic Plaques, Invited talk at the Lasers in Medicine Seminar, Soria Moria, Oslo Norway (1988)
- E35. S. Andersson-Engels, Report from a Study Trip in the USA (1987) (In Swedish)

E36. S. Andersson-Engels and K. Svanberg, Fluorescence Diagnostics and Photodynamic Therapy - Report from a Study Trip in the USA (1988) (In Swedish)

F. INDUSTRIAL APPLICATIONS

F1. Optical spectroscopy for control of pyrometallurgical processes

Marcus Aldén, Willy Persson, Wilhelm Wendt

Optical techniques and optical spectroscopy have for a long time formed integral parts of metallurgy. However, during the last few years very rapid development has taken place in the field of optical techniques and it is reasonable to expect new applications of optics and spectroscopy also in metallurgy.

For process control purposes, an optical technique in combination with advanced atomic and molecular spectroscopy has a number of attractive features, in particular in hostile environments such as those found in metallurgical plants. Optical spectroscopy has the following advantages:

- * it is a remote sensing technique meaning that
 - the measurement does not affect the process or the measured process parameters;
 - there is no need that into the process introduce probes or sensors, which might be damaged or destroyed during the measurements;

- * it is an on-line technique meaning that
 - it diminishes the need for sampling and subsequent chemical analysis;
 - it facilitates the detection of unstable constituents such as radicals or atoms and molecules in unstable states;
 - it offers real-time information on the progress of the process with time constants of the order of seconds or even less;

- * it is a perturbation-insensitive technique in the sense that
 - the detector system and all electronics can be placed far away and shielded from sources of electronic noise.

Preliminary studies of the flame above a copper converter were described in the preceding report. These investigations have been continued and extended to include studies of steel converting processes [1-4].

The possibility of monitoring the slag-blowing stage of the copper-converting process by observing the relative intensity of the light emission from gas-phase PbO and PbS in the converter flame was discussed in the preceding progress report. Typical behaviour of the PbO/PbS intensity ratio close to the end of a slag blow is shown in Figure 1. The ratio increases drastically during the last ten minutes of the blow (a full blow lasts for about one hour).

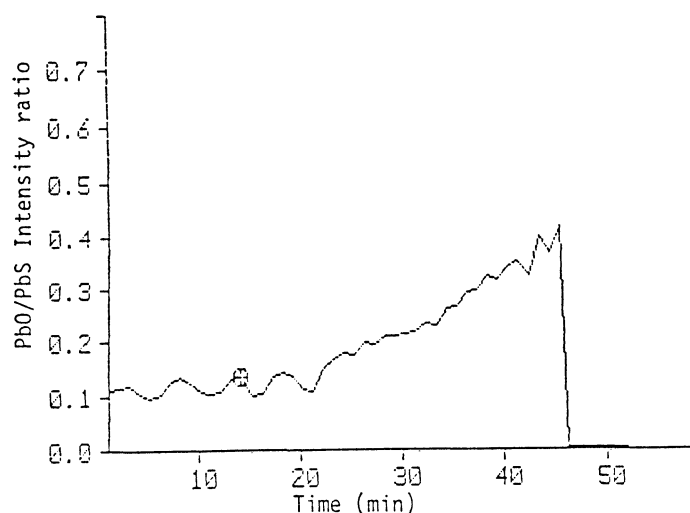

Fig. 1.
Time behaviour of the PbO/PbS intensity ratio close to the end of a slag blow.

Repeated measurements show that there is a strong correlation between the PbO/PbS intensity ratio and the copper content in the white metal. This is illustrated in Figure 2, which shows the copper content in the white metal, determined by X-ray fluorescence analysis of a sample taken just after the end of a blow, versus the PbO/PbS intensity ratio measured just before the interruption of the blow. The scatter between the individual measurements shows that it is possible to determine the copper content to within 0.5 % in the range 75-78% copper.

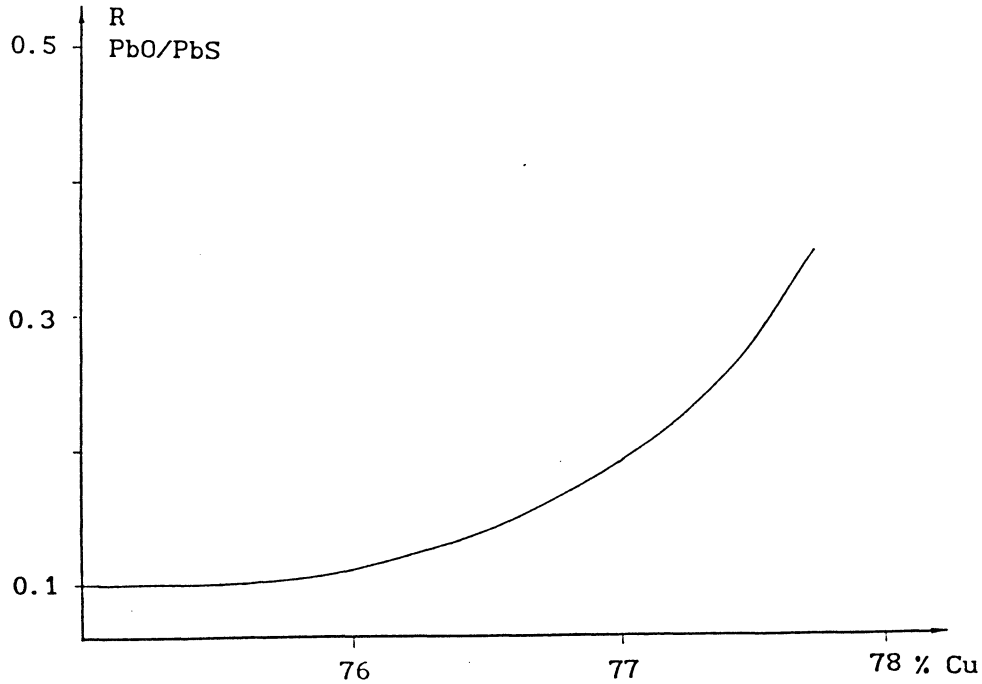

Fig. 2. Relation between the PbO/PbS intensity ratio and the copper content in the white metal.

The possibility of interrupting a slag blow at a predetermined copper concentration (generally 77 - 78%) has a number of attracting features. For instance, it would be possible to avoid under- and over-blows which are often disastrous to the process. It is also possible to optimise the ratio between copper losses to slag and impurity removal from the white metal and thereby achieve a more effective slag handling.

Whereas the observed discrete features in the spectrum of a copper-converter flame are of molecular origin, the spectrum emitted during the steel-converting process is dominated by atomic emissions. Recordings have been performed at an LD converter and also at a CLU converter for alloy steel production. The spectra observed are very rich in iron lines. In addition, a large number of lines from impurities and from alloy metals are present.

The preliminary results from the steel-converter measurements indicate that it should be possible to monitor the temperature of the

off-gases continuously and thereby to obtain information on the average temperature of the melt. It is also possible to monitor the relative intensities of the light emission from different elements such as iron and manganese or iron and chromium and thereby to control critical process steps.

In conclusion, the prospects for using optical spectroscopy in conjunction with atomic and molecular spectroscopy for on-line monitoring and control of smelt-metallurgical processes look very favourable. The studies of both the copper- and the steel-converting processes are being continued and will be extended to include other smelt-metallurgical processes. The techniques are now being made commercially available through cooperation with a R&D company (Scandinavian Emission Technology AB) at the Ideon Research Park in Lund.

References

- F1. W. Wendt, M. Aldén, W. Persson, B. Björkman and T. Lehner, Process Control of the Copper Converting Process by Emission and Absorption Spectroscopic Measurements. Paper presented at the 26th Annual Conference of Metallurgists, August 23-26, 1987, Winnipeg, Canada.
- F2. W. Wendt, M. Aldén, B. Björkman, T. Lehner and W. Persson, Controlling Copper Conversion via Optical Spectroscopy, *Journal of Metals* 39, 14 (1987).
- F3. W. Wendt, M. Aldén and W. Persson, Application of Emission and Absorption Spectroscopy for Characterization of a Copper Converting Process, *Applied Spectroscopy* 42, 128 (1988).
- F4. W. Persson and W. Wendt, From Visual Observation to Optical Measurement. Invited paper at the International Conference on Technological Advances in Metallurgy, September 20-21, 1988, Luleå, Sweden.

TEACHING PROGRAMME

A. Undergraduate teaching 1987-1988

Elvir Andersson, Håkan Bergström, Per-Erik Bengtsson, Stig Borgström, Jörgen Carlsson, Hans Hallstadius, Hans Hertz, Bodil Jönsson, Gilbert Jönsson, Göran Jönsson, Per Jönsson, Rune Kullberg, Jörgen Larsson, Hans Lundberg, Anders Persson, Sven-Göran Pettersson, Rolf Petersson, Lennart Stuesson, Sune Svanberg, Claes-Göran Wahlström + about 25 junior assistants.

At the Department of Physics, basic physics teaching is provided for the schools of Engineering Physics (F), Electrical Engineering (E), Computer Science and Technology (D), Mechanical Engineering (M), Civil Engineering (V) and Chemical Engineering (K). Furthermore, specialised courses in atomic physics, laser physics, optics and spectroscopy are given.

The basic courses are, with one exception (M3), given for students in their first year (F1, E1, D1, M1, V1 and K1) while the other more specialised courses are given in later years, e.g. F2, F3 and F4. It is also possible for students from other schools (mostly E, M and K) to follow these more specialised courses.

The courses contain both theory (lectures and problem solving) and laboratory practicals. The number of hours devoted to experimental work is, as a rule, about the same as the number of hours used for theoretical education (See Fig. 1). During experimental training on basic courses the students generally work in groups of two, and each supervisor teaches four such groups, i.e. 8 students at a time. For the specialised courses each supervisor can teach only 4 or 6 students at a time since the amount of equipment is limited, for economical reasons, to two sets. In the course on atomic and molecular spectroscopy, research equipment is used by the students in their experimental work.

B. Basic courses

For the school of engineering physics (courses F1, F2 and F3) the basic course Physics, Extended course is given. This consists of three parts, Introductory course, Waves and Atomic Physics coupled with laboratory practicals of 44, 50 and 35 hours, respectively. The Introductory course comprises experimental methods, gas physics, thermodynamics and geometrical optics. The Wave physics course makes the students well acquainted with phenomena in physical optics and acoustics. Atomic physics gives basic knowledge on the building of atoms and molecules and their properties. The course also gives some orientation in spectroscopic methods in different energy ranges.

For the schools of electrical engineering (course E1) and computer science and technology (course D1) the basic course Physics course for E and D is given. This comprises gas physics, thermodynamics, waves and modern physics combined with 48 (E) or 60 (D) hours of laboratory practicals.

For the school of civil engineering (course V1) and fire defence engineering (course B1) the basic course Physics basic course for V is given. This consists of gas physics with thermodynamics and fundamental electricity combined with 18 hours of laboratory practicals. For the course V4 the specialised course Physics continued course is given, which is directed towards physical measuring techniques with 36 hours of laboratory practicals. This course is attended by about 20 students.

For the school of chemical engineering (course K1) the basic course Physics course for K is given. It consists of electricity, wave physics, geometrical optics and nuclear physics combined with 32 hours of laboratory practicals.

The course on the History of Science is given for all sections of the Inst. of Technology. This course, given in collaboration with teachers from the Faculty of Humanities, illuminates the impact of science in relation to the development of society.

C. Specialized courses

The specialised course Laser Physics is designed to give the students knowledge concerning the physical principles of laser physics and to teach them about the most general types of lasers and their most important fields of application. In laboratory practicals the students learn to make simple adjustments and measurements with different types of lasers. This year the course will be followed by about 50 students from the schools F, E, M and D.

The specialised course Atomic and Molecular Spectroscopy is intended to give knowledge about modern atomic and molecular spectroscopy with special emphasis on technical applications. About 25 students follow this course. Together with the laser physics course this course forms the natural introduction to post-graduate studies at the Department.

A course in Holography is also given to those interested in photography, image techniques and optical measurements. The course starts with lectures in ray optics and wave optics and, together with laboratory practicals, the fundamentals of holography and related topics are discussed and different types of holograms are made.

A new specialised course in Optical Techniques has been set up at the Department. This course, emphasising Fourier optics, interferometry, fibre-optics, holography and phase-conjugation techniques was given for the first time in the autumn of 1985.

