



LUND UNIVERSITY

Aerosol Particle Sources Affecting the Swedish Air Quality at Urban and Rural Level.

Kristensson, Adam

2005

[Link to publication](#)

Citation for published version (APA):

Kristensson, A. (2005). *Aerosol Particle Sources Affecting the Swedish Air Quality at Urban and Rural Level*. [Doctoral Thesis (compilation)]. Department of Physics, Lund University.

Total number of authors:

1

General rights

Unless other specific re-use rights are stated the following general rights apply:

Copyright and moral rights for the publications made accessible in the public portal are retained by the authors and/or other copyright owners and it is a condition of accessing publications that users recognise and abide by the legal requirements associated with these rights.

- Users may download and print one copy of any publication from the public portal for the purpose of private study or research.
- You may not further distribute the material or use it for any profit-making activity or commercial gain
- You may freely distribute the URL identifying the publication in the public portal

Read more about Creative commons licenses: <https://creativecommons.org/licenses/>

Take down policy

If you believe that this document breaches copyright please contact us providing details, and we will remove access to the work immediately and investigate your claim.

LUND UNIVERSITY

PO Box 117
221 00 Lund
+46 46-222 00 00

Aerosol Particle Sources Affecting the Swedish Air Quality at Urban and Rural Level

Adam Kristensson

Division of Nuclear Physics

Department of Physics

2005



LUND INSTITUTE OF TECHNOLOGY

Lund University

Akademisk avhandling som för avläggande av teknologie doktorsexamen vid Lunds universitets tekniska fakultet, offentligen kommer att försvaras i föreläsningssal B på Fysiska institutionen i Lund, fredagen den 9 september 2005, kl. 13.15. Fakultetsopponent är Wolfram Birmili, Institute for Tropospheric Research (IFT), Leipzig, Tyskland.

Doctoral Thesis
Division of Nuclear Physics
Department of Physics
Lund University
P.O. Box 118
SE-221 00 Lund, Sweden

© 2005 Adam Kristensson (pp 1-54)
Printed in Sweden by the printers at the Department of Sociology,
Lund University, 2005

The papers in this thesis are reprinted with permission from the
copyright holders.

ISBN 91-628-6573-0
LUTFD2/(TFKF-1032)/1-54/(2005)

Dla Ani i Viktora

Organisation LUND UNIVERSITY Lund Institute of Technology Department of Physics Division of Nuclear Physics P.O. Box 118 SE-221 00 Lund	Document name DOCTORAL THESIS	
	Date of issue 26 June 2005	
	CODEN LUTFD2 / (TFKF-1032) / 1-54 / (2005)	
Author(s) Adam Kristensson	Sponsoring organization	
Title and subtitle Aerosol Particle Sources Affecting the Swedish Air Quality at Urban and Rural Level.		
Abstract <p>During recent decades anthropogenic aerosol particles have attracted much attention due to their adverse health effects and their influence on climate change. In Sweden, there are three main aerosol sources that affect air quality: traffic, long-distance transport and domestic wood combustion. This work concerns the characterization of these sources and an estimate of how much they contribute to the aerosol particle number and mass concentrations (PM) in Swedish cities and rural locations. The aims were achieved with the help of extensive measurement campaigns, characterizing emissions from the sources and with measurements and modelling at receptor points, where people are exposed to particulate pollution.</p> <p>The most important outcomes of these studies show that, in urban areas both traffic and domestic wood combustion make very important contributions to high levels of particle number and PM. It is especially during cold days in northern Sweden that domestic wood combustion is an important source of particles. Both trucks and cars contribute significantly to the particle emission. However, exhaust particles mainly affect particle number concentrations, while most of the PM_{2.5} and PM₁₀ (total particle mass below 2.5 and 10 µm diameter respectively) emissions come from road dust generated by the moving vehicles. Already at distances of a few hundred meters away from the traffic streets in cities, the long-distance transported fraction is beginning to dominate contributions to PM₁₀, and it has both natural and anthropogenic sources. The exhaust emissions from traffic, on the other hand, can make a significant contribution to increased particle number concentrations even at distances about 50 km away from the urban area. New particle formation, which is observed on more than 1/3 of the days in southern Sweden, is observed in both cleaner and polluted air masses. However, particle formation in polluted air has less impact on the frequency of events and on the particle number concentration than in cleaner air.</p>		
Key words Aerosol particle, sources, emissions, wood combustion, traffic, long-distance transport, size distribution, nucleation, urban, background, source contribution, PM _{2.5} , PM ₁₀ , PIXE.		
Classification system and/or index terms (if any):		
Supplementary bibliographical information:	Language English	
ISSN and key title:	ISBN 91-628-6573-0	
Recipient's notes	Number of pages 54	Price
	Security classification	

Distribution by (name and address): Department of Physics, see address above.

I, the undersigned, being the copyright owner of the abstract of the above-mentioned dissertation, hereby grant to all reference sources permission to publish and disseminate the abstract of the above-mentioned dissertation.

Signature 

Date: 26 June 2005

Table of Contents

List of Publications	2
Papers included in the thesis and the author's contribution.....	2
Other Publications	3
Abbreviations and Concepts	6
1. Introduction.....	9
2. The Aerosol, Climate and Health	12
2.1 The Atmospheric Aerosol.....	12
2.2 Airborne Particles and Health	13
2.3 Airborne Particles and Climate.....	15
3. Source Characterization Analysis	18
3.1 Emission Inventories	18
3.1.1 <i>Domestic Wood Combustion Emission Inventory</i>	18
3.1.2 <i>Traffic Emission Inventory</i>	19
3.2 Source Apportionment Analysis	21
3.2.1 <i>The APCA Method</i>	22
3.2.2 <i>The COPREM Model</i>	22
3.2.3 <i>The PMF Model</i>	23
3.3 New Particle Formation Characterization.....	23
3.3.1 <i>Classification of Events</i>	24
3.3.2 <i>Physical Characterization of Events</i>	24
4. Instrumentation.....	30
4.1 TEOM.....	30
4.2 ACPM.....	30
4.3 DMPS	30
4.4 Elemental Composition Mass Estimation.....	31
5. Compilation of Source Studies in Sweden.....	34
5.1 Research Incentives in Sweden.....	34
5.2 Urban Source Apportionment.....	35
5.2.1 <i>Domestic Wood Combustion</i>	35
5.2.2 <i>Traffic</i>	39
5.3 Rural Source Characterization	41
5.4 Future Prospects	42
5.4.1 <i>Wood Combustion</i>	42
5.4.2 <i>Traffic</i>	44
5.4.3 <i>Long-Distance Transport</i>	46
Acknowledgements.....	48
References	49

List of Publications

Papers included in the thesis and the author's contribution

Paper I "Chemical and Physical Characterization of Emissions from Birch Wood Combustion in a Wood Stove"

Emma Hedberg, Adam Kristensson, Mikael Ohlsson, Christer Johansson, Per-Åke Johansson, Erik Swietlicki, Vaclav Vesely, Ulla Wideqvist and Roger Westerholm

Atmospheric Environment, 36, 2002, 4823-4837

The author has prepared part of the instrumentation, and participated in the measurements. He has furthermore analysed the particle data and wrote this section in the paper.

Paper II "Real-world Traffic Emission Factors of Gases and Particles Measured in a Road Tunnel in Stockholm, Sweden"

Adam Kristensson, Christer Johansson, Roger Westerholm, Erik Swietlicki, Lars Gidhagen, Ulla Wideqvist and Vaclav Vesely

Atmospheric Environment, 38, 2004, 657-673

The author has analysed the data, and wrote the paper, except for the part on PAH.

Paper III "Contribution from Domestic Wood Combustion to Size-resolved Sub-micrometer Aerosol Particles in a Residential Area in Northern Sweden"

Adam Kristensson, Erik Swietlicki, Jenny Rissler, Jingchuan Zhou, Lars Gidhagen, Christer Johansson and Heikki Lihavainen

Manuscript.

The author planned, prepared and participated in the particle measurements in the Forsdala district. He analysed and modelled the data and wrote the paper, except the part on dispersion modelling.

Paper IV "Particle Size Distribution and Particle Mass Measurements at Urban, Near-city and Rural Level in the Copenhagen Area and Southern Sweden"

Matthias Ketznel, Peter Wählin, Adam Kristensson, Erik Swietlicki, Ruwin Berkowicz, O. J. Nielsen and Finn Palmgren

Atmospheric Chemistry and Physics, 4, 2004, 281-292

The author, above all, performed the measurements and processed the data from the Swedish site and helped write some parts of the paper.

Paper V “Source Apportionment of PM10 and PM2.5 at a Background Site in Southern Sweden”

Erik Swietlicki, Adam Kristensson, Hans Areskoug and Hans-Christen Hansson

For publication in *Atmospheric Environment*.

The author participated in the planning and execution of the campaign, and the analysis of the PIXE data.

Paper VI “Characterization of New Particle Formation Events at a Background Site in Southern Sweden: Relation to Air Mass History”

Adam Kristensson, Miikka Dal Maso, Erik Swietlicki, Tareq Hussein, Jingchuan Zhou and Veli-Matti Kerminen.

Manuscript

The author was mainly responsible for the construction of the DMPS system and the construction and maintenance of the Vavihill station. He analysed most of the data, and wrote the paper.

Other Publications

In peer-reviewed journals:

3. Lars Gidhagen., Christer Johansson, Johan Ström, Adam Kristensson, Erik Swietlicki, Liisa Pirjola, Hans-Christen Hansson, ”Model simulation of ultrafine particles inside a road tunnel”, *Atmos. Env.*, 37, 2023-2036, 2003.
2. Peter Tunved, Hans-Christen Hansson, Markku Kulmala, Paasi Aalto, Yrjö Viisanen, Hans Karlsson, Adam Kristensson, Erik Swietlicki, Miikka Dal Maso, Johan Ström, Markku Komppula, ”One year boundary layer aerosol size distribution data from five Nordic background stations”, *Atmos. Chem. Phys.*, 3, 2183-2205, 2003.
1. Adam Kristensson, Jean-Francois Gayet, Johan Ström, Frederique Auriol, ”In situ observations of a reduction in effective crystal diameter in cirrus clouds near flight corridors”, *Geoph. Res. Letters*, 27, 681-684, 2000.

Conference abstracts:

13. Adam Kristensson, Erik Swietlicki, Miikka Dal Maso, Tareq Hussein, Jingchuan Zhou, Veli-Matti Kerminen, “Characterization of new particle formation events at a background site in southern Sweden; Relation to air mass history”, BACCI-workshop, Kuopio, Finland, June, 2005.

12. Adam Kristensson, Miikka Dal Maso, Veli-Matti Kerminen, Erik Swietlicki, "Characterization of new particle formation events at a background site in southern Sweden", EAC-Conference, Gent, Belgium, September, 2005.
11. Erik Swietlicki, Gunnar Omstedt, Christer Johansson, Torsten Nilsson, Lars Gidhagen, Adam Kristensson, "Measured and modelled PM10 emission factors from on-road traffic sources", EAC-Conference, Gent, Belgium, September, 2005.
10. Adam Kristensson, Erik Swietlicki, Jenny Rissler, Jingchuan Zhou, Christer Johansson, "Contribution from domestic wood combustion to the aerosol number size distribution in a residential area", NOSA Symposium, Stockholm, Sweden, November, 2004.
9. Erik Swietlicki, Gunnar Omstedt, Torsten Nilsson, Christer Johansson, Lars Gidhagen, Adam Kristensson, "Model validation for traffic-related PM10", NOSA Symposium, Stockholm, Sweden, November, 2004.
8. Erik Swietlicki, Adam Kristensson, Jingchuan Zhou, Jenny Rissler, Joakim Pagels, Jakob Löndahl, "Predicted size-resolved lung deposition of sub-micrometer aerosol particles from domestic wood combustion in a residential area", EAC-Conference, Budapest, September, 2004.
7. Erik Swietlicki, Torsten Nilsson, Adam Kristensson, Christer Johansson, Gunnar Omstedt, Lars Gidhagen, "Traffic-related source contributions to PM10 near a highway", EAC-Conference, Budapest, September, 2004.
6. Erik Swietlicki, Adam Kristensson, Jingchuan Zhou, Jenny Rissler, "Predicted size-resolved lung deposition of sub-micrometer aerosol particles from domestic wood combustion in a residential area", NOSA Symposium, Copenhagen, Denmark, November, 2003.
5. Adam Kristensson, Erik Swietlicki, Lars Gidhagen, Christer Johansson, "Measured real-world traffic emission factors of particle number size distribution and mass in Stockholm, Sweden", 2003 AAAR PM Meeting, Pittsburgh, USA, March, 2003.
4. Erik Swietlicki, Adam Kristensson, Hans Areskoug, Hans-Christen Hansson, "Source apportionment of PM10 and PM2.5 at a background site in southern Sweden", 2003 AAAR PM Meeting, Pittsburgh, USA, March, 2003.
3. Peter Tunved, Adam Kristensson, Erik Swietlicki, Hans-Christen Hansson, "Atmospheric Aerosols – Sources and Dispersion: Studies of the Nordic Aerosol", EGS XXVI General Assembly, Nice, France, March, 2001.
2. Adam Kristensson, Christer Johansson, Erik Swietlicki, Roger Westerholm, Ulla Wideqvist, Vaclav Vesely, Jingchuan Zhou, Giorgos Papaspiropoulos, "Traffic emission estimation of gaseous and particulate matter measured in a road tunnel", 3rd Urban Air Quality Conference, Loutraki, Greece, March 2001.
1. Adam Kristensson, Christer Johansson, Erik Swietlicki, Jingchuan Zhou, Roger Westerholm, Ulla Wideqvist, Vaclav Vesely, "Traffic source characterization using factor analysis of gas- and particle phase measured in

a road tunnel”, EUROTRAC Symposium, Garmisch-Partenkirchen, Germany, March 2000.

Internal Stockholm University reports:

5. C. Johansson, H.-C. Hansson, J. Ström, E. Hedberg, G. Olivares, H. Karlsson, U. Wideqvist, E. Swietlicki, T. Nilsson, A. Kristensson, E. Brorström-Lundén, ”Den småskaliga vedeldningens betydelse för luftkvaliteten i Lycksele och Växjö”, ITM-report no. 133, ITM, Stockholm, Sweden.
4. C. Johansson, E. Hedberg, G. Olivares, L. Gidhagen, H. Karlsson, U. Wideqvist, V. Vesely, E. Swietlicki, A. Kristensson, J. Zhou, J. Rissler, P. Brohammer, E. Brorström-Lundén, K. Peterson, M. Remberger, A. Potter, E. Junedahl, K. Persson, K. Sjöberg, E. Sellin-Lindgren, J. Jacobsson, C. Tranefors, L. Andersson, E. Eltahir, G. Omstedt, J. Langner, V. Foltescu, M. Pettersson, R. Ahlinder, B. Sjövall, B. Norberg, L. Burman, ”Mätningar och beräkningar av vedeldningens påverkan på luftföroreningshalter. Del 2 – Växjö”, ITM-report no. 125, ITM, Stockholm, Sweden.
3. C. Johansson, E. Hedberg, G. Olivares, L. Gidhagen, H. Karlsson, U. Wideqvist, V. Vesely, E. Swietlicki, A. Kristensson, J. Zhou, J. Rissler, P. Brohammer, E. Brorström-Lundén, K. Peterson, M. Remberger, A. Potter, E. Junedahl, K. Persson, K. Sjöberg, E. Sellin-Lindgren, J. Jacobsson, C. Tranefors, L. Andersson, E. Eltahir, G. Omstedt, J. Langner, V. Foltescu, M. Pettersson, R. Ahlinder, B. Sjövall, B. Norberg, L. Burman, ”Mätningar och beräkningar av vedeldningens påverkan på luftföroreningshalter. Del 1 – Lycksele”, ITM-report no. 124, ITM, Stockholm, Sweden.
2. E. Hedberg, H.-C. Hansson, C. Johansson, V. Vesely, U. Wideqvist, A. Kristensson, ”Characterization of particles in Lycksele and Gothenburg”, ITM-report no. 92, ITM, Stockholm, Sweden.
1. C. Johansson, U. Wideqvist, E. Hedberg, V. Vesely, E. Swietlicki, A. Kristensson, R. Westerholm, L. Elswer, P.-Å. Johansson, L. Burman, M. Pettersson, ”Cancerframkallande ämnen – Olika källors betydelse för spridningen och förekomsten i Stockholm”, ITM-report no. 90, ITM, Stockholm, Sweden.

Abbreviations and Concepts

- *Accumulation mode particles* – Aerosol particles with a GMD larger than about 100 nm, but smaller than 1 μm .
- *ACPM* – Ambient carbon particulate monitor: an instrument that measures the organic and elemental carbon mass fraction of aerosol particles.
- *Aitken mode particles* – Aerosol particles with a GMD between 30 and 100 nm.
- *APCA* – Absolute principal component analysis: a source/receptor model with a mathematical approach, which is useful as a first test, and when sources are not known in detail.
- *Background* – See *Rural*.
- *CCN* – Cloud condensation nuclei: aerosols that can activate to form cloud droplets.
- *Coagulation* – The sticking of particles together as a consequence of the inertia between them.
- *Coarse particles* – Particles with a GMD larger than 2.5 μm , often referred to as smaller than 10 μm .
- *Condensation* – The condensation of gases to aerosol particles.
- *COPREM* – Constrained physical receptor model: finds non-negative solutions, with a user-friendly function to beforehand choose the level of knowledge of sources.
- *CoagS* – Coagulation sink of smaller particles to larger ones.
- *CS* – Condensation sink of gases on the aerosol population.
- C_{vapour} – Concentration of vapours that can condense on aerosols.
- *Dispersion modelling* – The modelled levels of pollutants in a whole region/city or in the vicinity of the emissions based on meteorology and emission data as input.
- *DMA* – Differential mobility analyser, the heart of the DMPS: probes sorts particles according to their size.
- *DMPS* – Differential mobility particle sizer: an instrument that measures the particle number size distribution.
- dN_3/dt – The observed formation rate of aerosol particles larger than 3 nm in diameter during formation events (smaller than J_3).
- *Domestic burner* – Small-scale domestic wood combustion device heating small compartments, e.g. one room (e.g. wood stoves, tiled stoves, open fires, etc).
- *Dry particle size* – The size of aerosol particles at $\text{RH} < \sim 30\%$.
- *Emission factors* – The emission of a certain pollutant per kg fuel burned, per vehicle km driven, or relative to other emitted species.
- *Fine particles* – Particles smaller than 2.5 μm in diameter).

- *Forcing* – The radiative response in W m^{-2} to radiation changes (both short- and long-wave radiation) in the atmosphere.
- *Formation event* – See *Nucleation event*.
- *GMD* – Geometric mean diameter.
- *GF* – The growth of aerosols from the dry size when exposed to higher relative humidity.
- *GR* – The rate at which formation mode aerosols grow by condensation of gases on the aerosols.
- *HDV* – Heavy-duty vehicles (heavier than about 3.5 metric tons).
- *Health impact assessments* – Studies that rely on calculations based on an assembly of epidemiological studies to estimate effects on health resulting from exposure to aerosol particles.
- *Inlet* – Device that separates particles before they enter the instrumentation, it is often size-selective, e.g. PM2.5-inlet.
- $J_{1,3}$ – Formation rate of aerosols larger than 1 and 3 nm in diameter respectively. Corrected for polydisperse coagulation losses.
- *LDV* – Light-duty vehicles (lighter than about 3.5 metric tons).
- N_{nuc} – The number of formation mode aerosols at the end of the day following a nucleation event.
- NO_X – NO and NO_2 .
- *Nucleation event* – The formation of new small nanometre-sized particles in air observed during the day-time.
- *Nucleation mode particles* – Aerosol particles with a GMD smaller than about 30 nm.
- *Particle size distribution* – The concentration of particles as a function of particle size.
- *PIXE* – Particle-induced X-ray emission: Accelerator-based method to measure the content of elements (lightest Al).
- *PM* – Particulate matter: often the total mass of particles.
- *PM10* – Total mass of particles smaller than 10 μm in diameter (the inhalable fraction).
- *PM2.5* – Total mass of particles smaller than 2.5 μm in diameter (fine particles).
- *PMF* – Positive matrix formulation: source/receptor model, which finds non-negative solutions, and is useful in situations where detailed information on sources is not available.
- Q – Vapour production rate of gases that can condense on aerosols.
- *Re-suspended* – Previously deposited particles that leave the surface due to wind or turbulence.
- *RH* – Relative humidity.
- *Rural* – Far away from local sources (e.g. the countryside, forest, etc.).

- *Source/Receptor modelling* - Modelling of source contributions at a receptor site of pollutant levels based on measured data as input.
- *Source profile* – Matrix in source/receptor modelling that gives information about how different compounds are emitted relative to each other from a specific particle source.
- *TEOM* – Tapered element oscillation microbalance monitor: an instrument that measures the PM_{2.5} or PM₁₀ in real time.
- *ToN* – Total particle number concentration.
- *Trajectory* – A line that depicts the movement of an air parcel.
- *Ultrafine particles* – Particles smaller than 100 nm in diameter.
- *Urban* – In a city, either close to the source (e.g. pavement, so called “kerbside” or “street level”) or further away (e.g. roof of a high building, park, suburb, etc., so-called “urban background”).
- *Wood-log boiler* – Small-scale domestic wood combustion device that heats an entire home.

1. Introduction

One of the reasons for concern about ambient anthropogenic aerosols in Sweden is the effect they have on health when inhaled in the human respiratory system. An epidemiological study shows that a reduction of annual mean values of PM10 (the total mass of airborne particles smaller than 10 μm diameter) by 5 $\mu\text{g m}^{-3}$ in Gothenburg and Stockholm, could reduce the death rate by about 300 individuals per year in these cities (Figure 1). In these cities, traffic and long-distance transported pollutants are the largest sources of anthropogenic PM10. Health impact estimates by Hansson (2003) also show that elevated levels of PM10 from domestic wood combustion may lead to an increase in death rate of about 90-330 people each year in Swedish cities, where wood combustion is common during wintertime. Another assessment estimates that the long-range-transported fraction of PM10 may be responsible for as much as 2/3 of the estimated excess mortality of about 5300 people each year in Sweden due to anthropogenic aerosols (Forsberg et al., 2005).

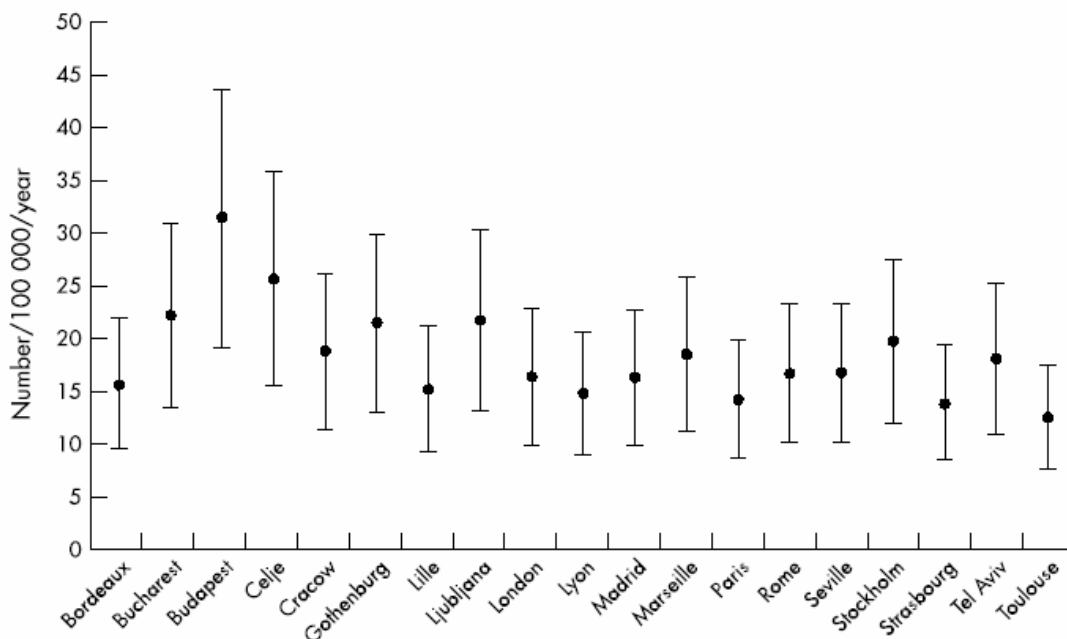

Figure 1: *Number of “preventable” early deaths per 100 000 residents (95% confidence limits) associated with a 5 $\mu\text{g m}^{-3}$ reduction in annual mean values of PM10 in 19 cities (from Medina et al., 2004).*

Not only health is under close surveillance by Scandinavian aerosol researchers; anthropogenic aerosol particles also affect the regional climate in these countries. One example is shown in Figure 2, where it can be seen that the sulphate aerosols have the ability to cool the climate in northern Europe through participation in cloud formation.

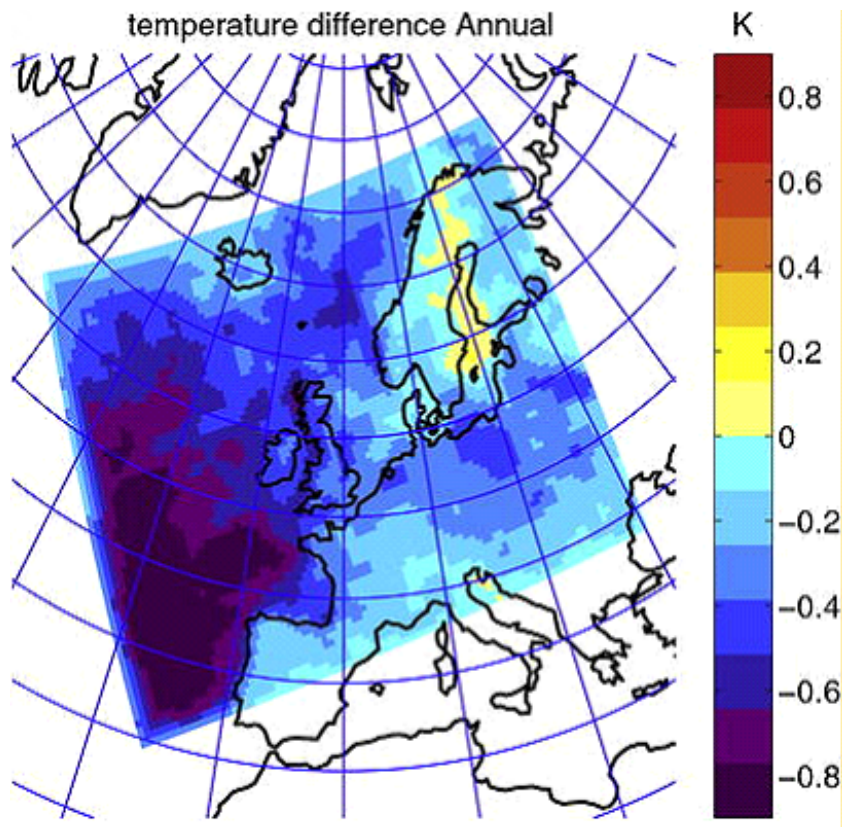

Figure 2: *The average annual temperature response in northern Europe due to anthropogenic sulphate aerosol forcing on cloud reflectivity. The magnitude of the temperature response over the sea should be regarded with caution (from Ekman and Rodhe, 2003).*

Since aerosol particles affect both health and climate, it is important to find their sources. Only then is it possible to take measures to reduce harmful particle concentrations.

Many research groups are involved in characterizing the emissions from different aerosol sources and their contribution to particle pollution in Swedish cities. This work is part of this research. Two sources were characterized, namely the emissions from traffic and domestic wood combustion. These are the most important local sources of aerosol pollution in Swedish cities. A small-scale wood stove fuelled with birch logs was used to measure the emissions of PM_{2.5} and the particle number size distribution from wood combustion (Paper I). The emissions of PM_{2.5}, PM₁₀, and the particle number size distribution were also measured in a car tunnel, in Stockholm, Sweden (Paper II) to characterize the traffic source. Measurements were then performed to calculate the contribution from these sources to urban pollution. Paper III reports on the contribution to the particle number size distribution in a northern Swedish town called Lycksele.

In addition, there are background sources contributing to the particle levels in Sweden, which may be natural or anthropogenic in origin. A measurement campaign was undertaken in Vavihill, a background station in southernmost

Sweden, to calculate the contribution to PM10 and PM2.5 from long distance-sources (Paper V). Furthermore, data on the particle size distribution collected over 2 years at Vavihill were characterized to investigate the so called new particle formation events (Paper VI), which is another important source of aerosols in Sweden. Formation events were studied separately in “clean” and “polluted” environments. Finally, a study was performed to investigate the relative importance of urban and long-distance sources in PM10 and the particle number concentration in Copenhagen, Denmark, and Vavihill (Paper IV).

2. The Aerosol, Climate and Health

2.1 The Atmospheric Aerosol

An aerosol is defined as a suspension of solid or liquid particles in a gas (Hinds, 1999). There are always particles present in the atmosphere, which means that the air we breathe is an aerosol. This atmospheric aerosol can have many sources, some of which are natural and others anthropogenic in origin, and they can be divided into different size classes (modes). The production of aerosol particles can be primary (in the immediate vicinity of the source) or secondary (from gas to particle conversion in the atmosphere), and various kinds of aerosol particles are described below.

1. Mechanically generated (primary), from the wind acting on the sea surface, creating particles around a few hundred nm (accumulation mode) to several μm in size (coarse mode). The wind and vehicles acting on the ground or roads also generate coarse particles.
2. Primary, formed by condensation in the cooling vapour within tenths of a second or few seconds after combustion, from motorized vehicles, chimneys, wood combustion, etc., creating particles with sizes around 10 nm diameter (nucleation mode) or around 40-100 nm (Aitken mode).
3. Secondary, from nucleation of gases during so-called gas-to-particle conversion, forming particles below 10 nm diameter (nucleation mode). Condensation of gases to pre-existing (larger) particles can also be included in this definition.
4. Cloud droplet evaporation, shrinking the droplet particle to aerosol particles between 0.1 and 1 μm diameter (accumulation mode).

The coagulation of nucleation and Aitken particles and the condensation of gases on pre-existing particles lead to the transformation of the two modes into one aged Aitken mode, around 100 nm diameter, or to the accumulation mode, above 100 nm diameter. During cloud formation, the accumulation mode particles and the largest Aitken particles are activated into cloud droplets, and therefore wet deposition in the form of precipitation presents the greatest sink of Aitken and accumulation mode particles. The average lifetime of an accumulation aerosol particle is about one week due to wet deposition. Dry deposition is important as a sink for coarse and nucleation mode particles.

The aerosol population as function of size in the atmosphere will consist of a combination of aerosol modes. This is called the aerosol size distribution and an idealized atmospheric distribution is illustrated in Figure 3, together with the processes through which the different modes are formed. The size distribution is an important measure for aerosol scientists, since it gives information about the transformation and evolution with time and the sources of the aerosol particles (see e.g. Birmili et al., 2001).

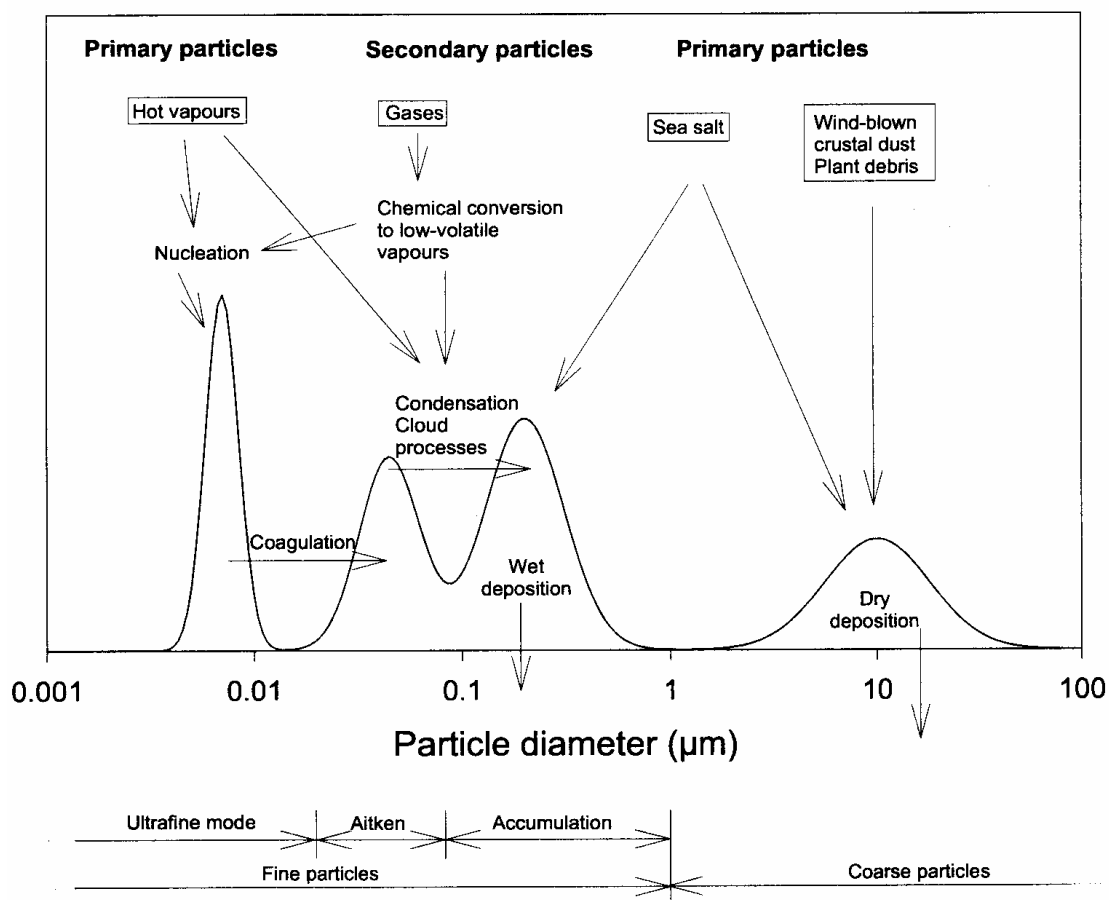

Figure 3: *Simplified and idealized size distribution of atmospheric aerosols showing the different modes, including sources, transformations and sinks.*

The chemical composition of the aerosol naturally varies since it has different sources. Species found in the liquid and solid phases of the particles are organic and elemental carbon, sulphuric acid, ammonium, salt ions, metals, oxides, poly-aromatic hydrocarbons, etc. (Heintzenberg, 1989). However, the organic content of the aerosol is today not well known, since analytic methods are lacking to characterize the many species present (Jacobsson et al., 2000).

2.2 Airborne Particles and Health

No threshold value has been found below which no health effects are revealed for PM₁₀, which means that health effects can be observed in relatively clean environments such as Scandinavia. In general, short-term and long-term epidemiological studies have shown that an average increase in mortality of about 1% is expected at an elevation of PM₁₀ levels of about 10 μg m⁻³ (for PM₁₀ concentrations normally found in ambient environments, Pope and Dockery, 1999). Besides mortality, increases in hospitalization and disease are dependent on PM levels. The main diseases associated with aerosol particles are cancer, asthma, and cardiovascular and pulmonary diseases.

Many epidemiological studies rely on PM₁₀ or PM_{2.5} as an indicator of particle pollution. However, these indicators can have several sources at the

same time, at one measurement location, e.g. exhaust emissions from traffic, long-distance-transported pollutants, and dust generated by vehicles. Therefore, health effects resulting from different sources should be differentiated and the relation between health effects and type of aerosol may be stronger when other more source-specific indicators are considered.

A large fraction of PM₁₀ in a number of urban areas consists of wind-blown and re-suspended road dust generated by moving vehicles (Johansson et al., 2005), which is totally independent of the particles produced in car exhaust. Consequently, epidemiological studies should be performed on the coarse fraction of PM₁₀ separately to investigate the health effects of re-suspended particles. These coarse particles have significant effects on pulmonary diseases that are as great as, or greater than, the fine fraction, observed in both international studies and in a study conducted on the coarse fraction in Stockholm, Sweden (Forsberg and Segerstedt, 2004). The effects on mortality are, however not conclusive for these particles.

It is more likely that the combustion-related fraction, i.e. the fine fraction of PM₁₀, will have the greatest effects on mortality and on cardiovascular diseases in urban areas (Le Tertre et al., 2002). Furthermore, several laboratory experiments have already shown that diesel particles can have adverse health effects (short review by Pagels, 2005). Few studies have been performed on the health effects of fine particles arising from domestic wood combustion. Substantial quantitative information was only found for acute asthma in relation to PM₁₀. However, the relative risk is higher, where wood combustion is considered a major particle source than in other environments (Boman et al., 2003). Thus, there is no reason to believe that the PM effects in areas where wood combustion is widespread are less considerable than elsewhere.

The anthropogenic fraction of background PM_{2.5} and PM₁₀ is rather high in southern Scandinavia, especially during dry episodes when winds come from southerly directions. However, no studies have been performed to the best of the author's knowledge on the health effects of these particles.

A large fraction of coarse particles are deposited in the nose and throat of human subjects, while the ultrafine particles have a greater probability of reaching the bronchi and the lungs, including alveoli (Figure 4). The ultrafine particles are also more numerous in urban areas, and may therefore be an important indicator of health effects of combustion particles. Health effects have been observed for these particles in several epidemiological studies worldwide (review by Ibald-Mulli et al., 2002). However, the mechanisms and chemical composition that are important in particle-mediated diseases are still not well understood, although significant progress has been made in the area (references found in Pagels, 2005).

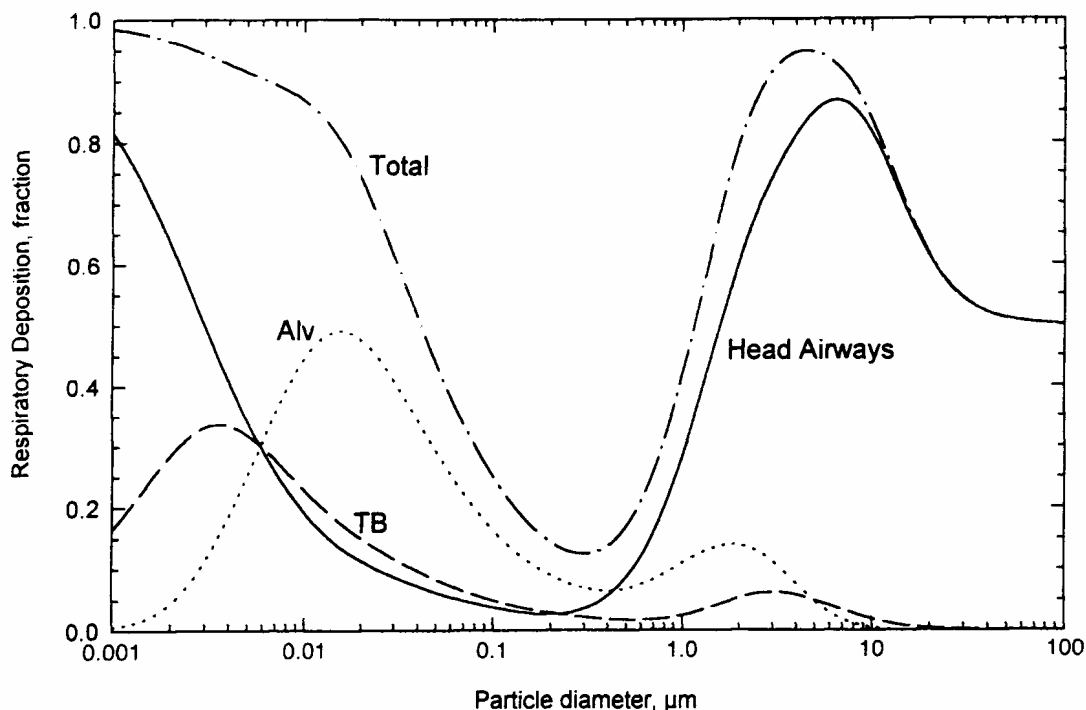

Figure 4: *Predicted total and regional deposition following light exercise (nose breathing) based on the International Commission on Radiological Protection (ICRP) deposition model. Average data for males and females combined. Deposition takes place in the alveoli (the deepest region in the lungs, where gas exchange takes place) (Alv), the tracheobronchial region (middle level, where the bronchus start to branch) (TB) and the head airways region (nasal cavity and throat) (from Hinds, 1999).*

2.3 Airborne Particles and Climate

Apart from health effects, the atmospheric aerosol has a significant impact on climate. Firstly, the particles scatter sunlight back into space, and they are also able to absorb it (the so-called direct effect, Haywood and Boucher, 2000). Secondly, since all cloud droplets are originally formed on aerosols, changes in aerosol number concentration and composition will change the cloud frequency and lifetime, as well as the size and chemical composition of the droplets, also altering the solar reflectivity (the indirect effect, Haywood and Boucher, 2000). The net cooling resulting from the direct and indirect effects of the anthropogenic aerosol may be of the same order of magnitude as the warming potential of greenhouse gases, as can be seen in Figure 5, although the uncertainty is very large.

A special type of aerosol particle that was studied in the present work and which may affect climate is that formed during so-called particle formation events in background environments. In the atmosphere there are many favourable conditions for the formation of nanometre-sized particles which can grow to detectable sizes and eventually participate in cloud formation (Pirjola et al., 2004), and many such events have been detected worldwide (review by Kulmala et al., 2004). One example of such an event in southern Sweden is

shown in Figure 6, where events occur on about 1/3 of all days. In Scandinavia, these particles usually grow by condensation of sulphuric acid and some other unknown compounds from the photo-oxidation of organic species in the boreal forest (Boy et al., 2005; Kulmala et al., 2004). In other, more polluted environments, events are also frequently observed (Laaksonen et al., 2005) and may be important for the production of cloud condensation nuclei (CCN). However, ammonia and sulphate should be more important for particle formation and growth (Smith et al., 2005 and Zhang et al., 2004) than in the boreal forest.

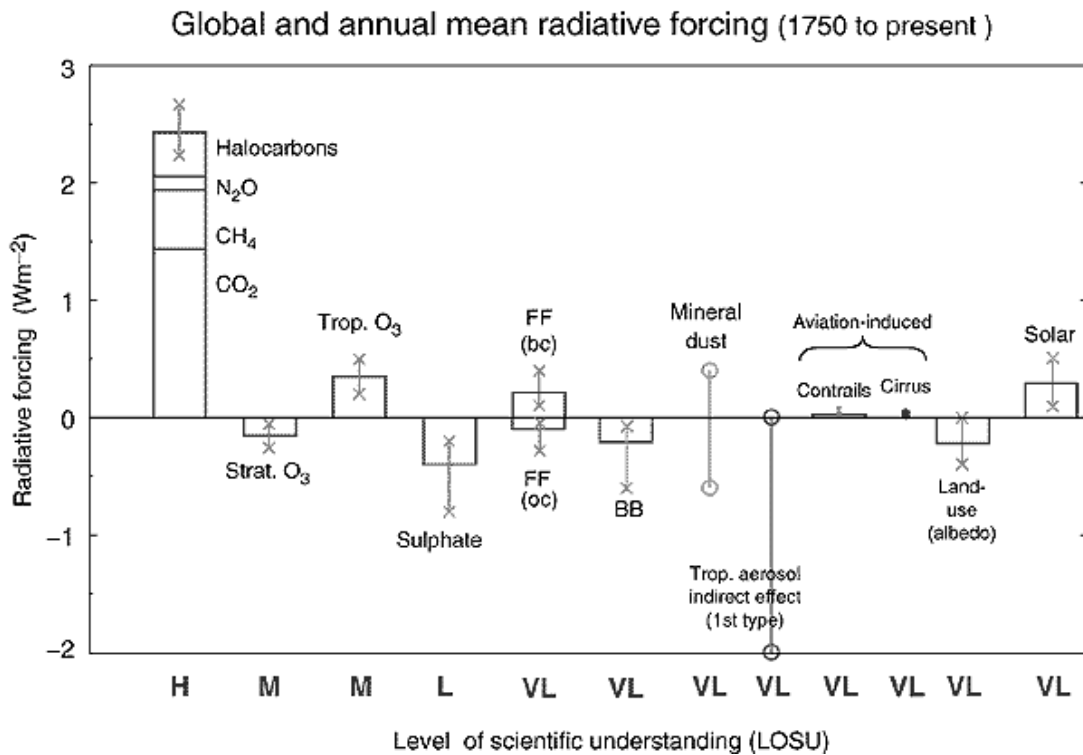

Figure 5: Estimates of globally and annually averaged anthropogenic radiative forcing due to changes in concentrations of greenhouse gases and aerosols, from pre-industrial times to the present time (IPCC, 2001). The aerosol forcing includes sulphate aerosols, fossil fuel combustion (FF), organic carbon (oc), black carbon (bc), mineral dust, the indirect effect and aviation-induced clouds. Trop. and Strat. are abbreviations of Tropospheric and Stratospheric respectively. Letters presented in the lower part of the diagram indicate the level of scientific certainty (H=high, M=medium, L=low and VL=very low).

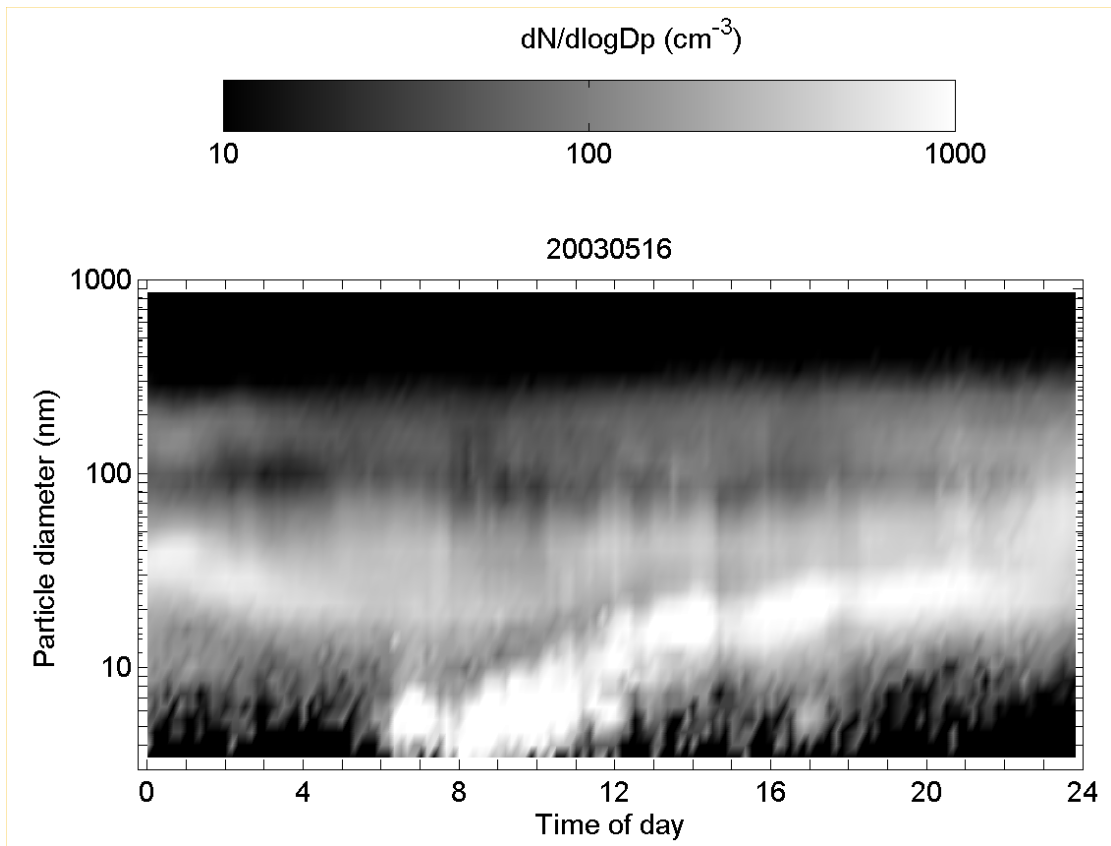

Figure 6: *Typical particle number size distribution for a particle formation event day in Vavibill, Sweden (56°N 01' N, 13° 98' E, 172 m above sea level) on May 16, 2003 (from Kristensson et al., 2005).*

3. Source Characterization Analysis

The methods used to characterize the sources and apportion the particle pollution to these sources are described below.

3.1 Emission Inventories

To be able to differentiate the various sources of air pollution at different sites, knowledge of the emissions from each of the sources is required. Since traffic and domestic wood combustion sources have not previously been well characterized, this was undertaken.

3.1.1 Domestic Wood Combustion Emission Inventory

Particle emissions from domestic wood combustion were measured and presented in Paper I. The measurements were performed on a wood stove, which is the most frequently used small-scale combustion device in Sweden.

The characterization implies several measurements on a commercial soapstone stove (Woodstock Fireview, USA, weight 220 kg, dimensions 0.72 × 0.66 × 0.51 m) burning birch logs, typically used in Swedish homes. The wood burning cycle was initiated by lighting split-wood (500 g) and a newspaper. A second wood load was inserted at 7 minutes (1.0 kg), a third wood load at 17 minutes (2.0 kg) and a fourth wood load at 45 minutes (2.0 kg). Flue gas samples were collected for 90 minutes, excluding the first minute of paper burning.

The passage of the flue gases through the instruments is depicted in Figure 7. The gases were first diluted with dry, compressed, particle-free air (RH<5%), and then passed through a counter-flow arrangement through the outer concentric tube enclosing the sample flow tube. This meant that the sampled flue gases were gradually cooled to near room temperature, while the dilution air was heated to a temperature close to that of the flue gases. The average dilution ratio (DR) was typically 20-30.

The air flow rate through the stove was calculated by injecting sulphur hexafluoride (SF₆) as a tracer into the flue pipe at a controlled flow rate (E, g h⁻¹) about 1 metre from the sampling point. The SF₆ concentration (C, g m⁻³) was measured with a MIRAN 1B2 IR spectrophotometer (Foxboro Instruments, Foxboro, MA, USA) and the total air flow rate (V, m³ h⁻¹) was then calculated as:

$$V=E/C . \tag{1}$$

The concentration expressed as the amount of species emitted per kg of fuel burned, could then be written as:

$$C \text{ (kg}^{-1}\text{)}=C \text{ (m}^{-3}\text{)} \cdot \text{DR} \cdot V \text{ } \tau/m_{\text{wood}} \tag{2}$$

where t is the sampling time and m_{wood} the mass of wood inserted.

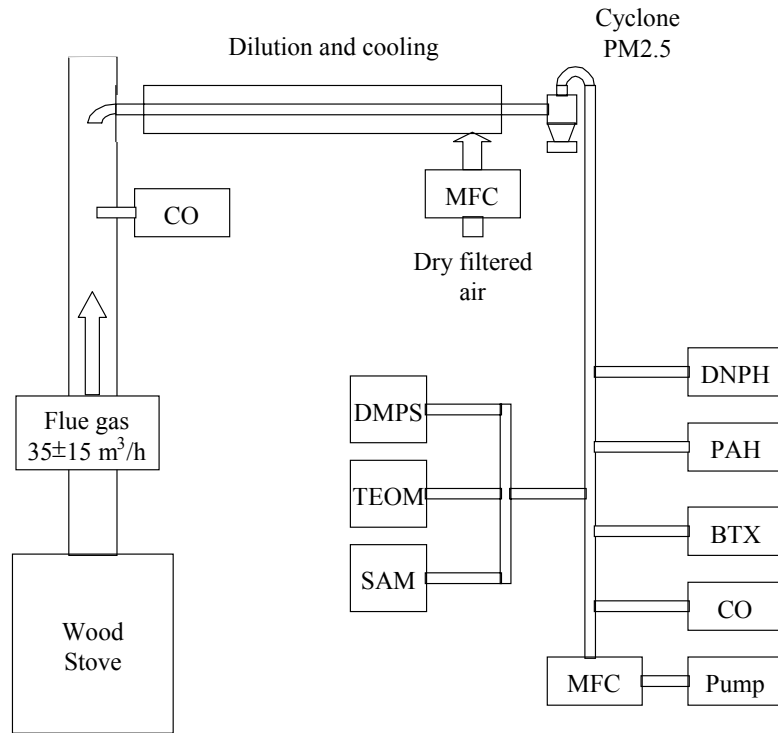

Figure 7: Schematic illustration of experimental set-up during the wood combustion emission inventory. MFC – Mass flow controller, DMPS – differential mobility particle sizer, TEOM – tapered element oscillating microbalance monitor, SAM – stationary aerosol monitor, DNPH - 2,4-dinitrophenylhydrazine, PAH – polycyclic aromatic hydrocarbons, BTX – benzene, toluene and xylenes, and CO – carbon monoxide.

Emission factors were calculated for PAH, PM2.5, PM0.9, the particle number size distribution, elements in aerosols heavier than aluminium, and finally a number of gaseous species.

3.1.2 Traffic Emission Inventory

The traffic emission measurements presented in Paper II, which included measurements of gases and PAH (polycyclic aromatic hydrocarbons) besides particles, were performed during the winter of 1998/1999 in a tunnel in Stockholm, Sweden called the Söderled tunnel. By conducting measurements at two sites in the tunnel, one 370 m from the entrance and the other 965 m from the entrance, it was possible to calculate the total exhaust emission from the number of vehicles passing through the tunnel per hour, per km, E_{tot} :

$$E_{\text{tot}} = \frac{\Delta C \cdot V}{D}. \quad (3)$$

Here, $D=0.595$ km is the distance between the two sites, ΔC the corresponding difference in species concentration and V the total air flow through the tunnel calculated from the wind speed, w using SF_6 as a tracer. V was $79.5w+15$ ($m^3 s^{-1}$). E , the average emission factor for the vehicles passing through the Söderled tunnel, expressed as the amount of species emitted per vehicle km driven, was simply derived from the total emission factor by dividing by the total number of vehicles (N). Speed dependent average emission factors were also calculated for different intervals, and ranged from 45 to 90 $km h^{-1}$.

To be able to differentiate the emission factors for each category of vehicles, heavy duty vehicles (HDV) and light duty vehicles (LDV), the total emission factor was rewritten as:

$$E_{tot} = E_{LD} \cdot NLD + E_{HD} \cdot NHD \quad (4)$$

where E_{HD} and E_{LD} are the emission factors for the two vehicle types. By rearranging the terms in Equation (4), the emission factor for HDV could be calculated with regression analysis using NHD/NLD as the independent variable and E_{tot}/NLD as the dependent variable:

$$\frac{E_{tot}}{NLD} = E_{HD} \cdot \frac{NHD}{NLD} + E_{LD} \quad (5)$$

However, Equation (6) proved to be much more suitable for the calculation of E_{LD} with NLD/NHD and E_{tot}/NHD as the independent and dependent variables, respectively:

$$\frac{E_{tot}}{NHD} = E_{HD} + E_{LD} \cdot \frac{NLD}{NHD} \quad (6)$$

The differentiation of emission factors according to vehicle type was possible for NO_x , carbonyls, and the particle number size distribution.

The regression analysis of E_{HD} and E_{LD} could be further divided into four discrete speed intervals for NO_x and the particle size distribution. However, these did not yield significantly better agreement with measured data than did the speed-independent emission factors, since the speed dependency is not strong. Therefore, an attempt was made to transform the speed-dependent emission factors into a continuous speed scale. The preliminary calculations with discrete speed intervals suggested that the speed dependency should have the form of a third-degree polynomial, i.e.

$$E_{HD} = a v^3 + b v^2 + c v + d \quad (7)$$

and

$$E_{LD} = e v^3 + f v^2 + g v + h . \quad (8)$$

A first estimate of the 8 parameters (a to f) was obtained by fitting the four emission factors calculated from the discrete speed intervals with a third-degree polynomial. The agreement with measured concentrations could then be improved by minimizing the expression:

$$\xi^2 = \frac{1}{n} \cdot \sum \left(\frac{C(965 \text{ m}) - C_m(965 \text{ m})}{\bar{C}} \right)^2 , \quad (9)$$

where $C(965 \text{ m})$ is calculated from Eqs. (3), (4), (7) and (8), $C_m(965 \text{ m})$ is the true measured concentration at 965 m, \bar{C} the average of the two, and n the number of measurements (~ 550 for the particle size distribution and ~ 1500 for NO_x).

This yielded emission factors for PAH, PM10, PM2.5, the coarse PM2.5 fraction, the exhaust PM2.5 fraction, organic and elemental carbon fractions of PM2.5, the particle number size distribution, elements in particles heavier than aluminium, and finally a number of gaseous species.

3.2 Source Apportionment Analysis

In order to calculate the contributions from different sources, source/ receptor modelling was used. Receptor modelling was used in the northern Swedish city of Lycksele to determine the contributions from domestic wood combustion, traffic, and background particles to the particle number size distribution in an urban area, where wood combustion is widely used during wintertime (Paper III). The contributions from long-distance-transported sources to PM2.5 and PM10 in Vavihill were calculated using metals as tracers (From the particle-induced X-ray emission analysis method, PIXE) (Paper V).

All source/receptor models are based on the assumption that the measured concentration of species i at the receptor point, $x_{i,j}$ (where j is the j^{th} measurement) can be expressed as a sum of contributions from the p different sources (Henry et al., 1984):

$$x_{i,j} \cong \sum_k^p a_{i,k} f_{k,j} \quad (10)$$

where $a_{i,k}$ is the source profile for source k , and $f_{k,j}$ is the contribution from source k to the j^{th} measurement, when the contribution is given in absolute amounts. Three different models were used for the studies presented in Papers III and V.

3.2.1 The APCA Method

In Paper V, the absolute principal component analysis (APCA) model was applied to PM data to obtain information on which sources influenced the background station Vavihill in southern Sweden, and a first approximation was made of the source profiles.

APCA begins with autoscaling of data, which means adjusting the $m \times n$ (m =number of species measured, n =number of data points) data matrix around its mean and dividing with the arithmetic standard deviation. Each measurement is in the m -space, where the first principal component (PC) line from the origin will define the direction in the m -dimensional measurement space along which most of the variance is explained. The second orthogonal PC line will explain most of the remaining variance, and so on, until a satisfactory proportion of the variance has been explained (equal to p if there are p significant sources). By applying singular value decomposition (SVD) to the data set, these orthogonal PC lines are produced, where:

$$Z(i,j)=B(i,k) \cdot G(k,j) \quad (11)$$

B is the score matrix, describing the contribution of each principal component (physical source) to the measurements, and G is the loading matrix corresponding to the source profile. In SVD, G is equally negative and positive, but orthogonal rotation of the PC axes (usually VARIMAX) modifies the loadings to give them a more physical meaning. Finally, the method of Swietlicki and others (1996) is used to transform B in the PC analysis back into source contributions with absolute values.

3.2.2 The COPREM Model

The second model applied in Paper V was the COPREM model (the constrained physical receptor model, Wählén, 2003). Unlike APCA it does not employ orthogonality and imposes constraints on the non-negativity of source contributions and profiles. Also it weighs each measurement error separately by iteratively minimizing the following expression:

$$\chi^2 = \sum_j^n \sum_i^m \frac{\left(x_{i,j} - \sum_k^p a_{i,k} f_{k,j} \right)^2}{\sigma_{i,j}^2} \quad (12)$$

where $\sigma_{i,j}$ is the measurement error. Thus, measurements with smaller errors will be given more weight, making the analysis more physical. COPREM also makes use of the source profiles and the number of sources inferred from the APCA analysis, thereby introducing more constraints into the method. An iterative

method is used, in which the minimization of χ^2 is performed by solving the equations for the local minima:

$$\frac{\partial \chi^2}{\partial f_{k,j}} = 0 \quad (13)$$

and

$$\frac{\partial \chi^2}{\partial a_{i,k}} = 0 \quad (14)$$

alternatively. Solving Eq. (13) corresponds to the situation where the source profile is exactly known, and the analysis strives to find the source strengths (see chemical mass balance, CMB models, Henry et al., 1984), while solving Eq. (14) corresponds to the situation where nothing is known about the source profile prior to the model run, as in the PC analysis. COPREM was used in Paper III, since source profiles were known beforehand.

3.2.3 The PMF Model

The third and final model that was used in Paper V was PMF (positive matrix factorization) (Paatero, 1997). PMF also uses constraints on the non-negativity of solutions and Eqs. (12) and (14) to obtain a source profile and source strength matrix when there is no previous knowledge of the source. The important advantages of PMF over COPREM are that it gives more robust solutions, is less sensitive to outliers and requires no knowledge of the sources beforehand, while COPREM provides more realistic source profiles if knowledge on the profiles is provided as input data.

3.3 New Particle Formation Characterization

Almost 2 years of particle number size distribution data were analyzed from the Vavihill station in southern Sweden (Paper VI). From the data set, new particle formation events were classified by type and frequency of occurrence, which gives the opportunity to quantify the contribution that they make to the aerosol loading in the atmosphere. In conjunction with the measurements of other properties of these formation events, it becomes possible to study the dynamics of secondary formation and to provide a tool for climate modellers predicting the climate effect of formation events. Since formation events occur only once each day around midday at Nordic latitudes, the days are often termed “event days”.

3.3.1 Classification of Events

Events are divided into five categories.

1. Non-events: There exists no doubt that no formation has occurred, or the formation is too small or intermittent to have any effect on the aerosol population.
2. Un-defined: It is not possible to determine whether the small particles come from events or not.
3. Class II: A definite event. The classification is based on one or more of the following criteria: formation not observed at the smallest sizes, too many interruptions in formation, impossible to perform physical characterization of the event, no growth by condensation of the event particles, not lasting more than about 3 hours.
4. Class Ib: An event in which it is possible to calculate the growth rate, although sometimes difficult. This type may include interruptions in the events, or other phenomena that distort the formation event.
5. Class Ia: A “perfect” nucleation, i.e., clear growth for at least 10 hours with no interruptions. Different methods of calculating the growth rate of nucleation mode aerosols (see below) give similar results.

This classification was developed by Dal Maso et al. (2005). Ideally, the classification should be performed by at least two independent researchers to ensure that it is objective. In this way events are classified as un-defined, if at least one person judges the day to be an un-defined day. The distinction between class Ia, Ib and II events is also rather straightforward, for example, a class Ib event is downgraded to a class II event, if it is impossible to calculate the growth rate of the event.

3.3.2 Physical Characterization of Events

The parameters used to characterize the events include the growth rate of the growing nucleation mode (GR, nm h⁻¹), the “apparent” formation rate of aerosols above 3 nm in diameter which is derived from the particle number size distribution (dN₃/dt, cm⁻³ s⁻¹), the formation rate of the freshly activated particles corrected for coagulation losses (J₁, cm⁻³ s⁻¹, assuming they are 1 nm in diameter), the vapour concentration of the vapours that are responsible for the growth of the formation aerosols (C_{vapour}, cm⁻³), the vapour production rate (Q, cm⁻³ s⁻¹), the condensation sink of vapours to the pre-existing larger aerosols (the aerosols that existed before the formation event), and finally the number concentration of nucleation mode aerosols at the end of the formation event day (N_{nucl}, cm⁻³) and their geometric mean diameter (GMD, nm). Most of the

calculations have been developed in a semi-automatic software environment presented by Dal Maso et al. (2005).

To be able to calculate the GR, the particle number size distribution spectrum is first fitted with a log-normal fitting method developed by Hussein et al. (2005) which gives the GMD of the different size modes. A straight line is then fitted to the GMD of the growing nucleation mode during the relevant time interval (until the end of the day, or until the growth is interrupted). The log-normal fitting also gives the final number concentration of nucleation mode aerosols at the end of the GR calculation period (N_{nucl}). An alternate method of calculating the GR is based on the fitting of a normal mode to each size bin during the whole nucleation period (the “channel method”, Laakso et al., 2002) (in contrast to the above method, where a complete spectrum is fitted on each occasion). The channel method is used only as a supplement to the first, and gives an indication of whether the first fit was good or not.

Following the GR calculations, an attempt is made to calculate dN_3/dt . For this calculation, the region where the particle number concentration is increasing with time following the start of the formation event is selected. Here, a straight line is fitted as a function of time to the particle number concentration of the nucleation mode, which is again obtained from the log-normal fitting.

The number size distribution is calculated for dry aerosols. However, the particles grow when exposed to ambient humidity. Since the condensation sink is larger for larger particles, this means that the sinks are underestimated when they are calculated for a dry particle size distribution. For this reason, these parameters are calculated at ambient humidity. Parameterization was performed based on the ambient humidity and hygroscopic growth factors in Hyytiälä, Finland. The parameterization was originally taken from Brazilian data (Zhou, 2001), but applied to Finnish situations (Laakso et al., 2004). The Finnish GF are probably not always applicable to GF in Sweden. However, it is better to do the GF correction, than to neglect it (Dal Maso et al., 2002). The growth factor for the size distribution then becomes:

$$\text{GF}=(1-\text{RH}/100)^{\gamma(d_p)}, \gamma=-3.11 \cdot 10^5 \cdot d_p/dp_0-0.0847 \quad (15)$$

where dp_0 is 1 nm diameter, and d_p the diameter of the aerosols in the size distribution. Figure 8 shows an example of this calculation, where the relative humidity (RH) is higher in the morning and evening than around midday. The GF is weighted according to a mixture of less hygroscopic and more hygroscopic particles, i.e. two separate growth modes were not used. Note that the GF corrected condensation sink was calculated based on a dry particle size distribution.

One of two ways is usually adopted to express the condensation sink, either as a number reflecting the surface area available for condensation (m^{-2}), or as a rate at which gases condense on the particles (s^{-1}). The second method requires a priori knowledge of the condensable vapours (often called CS), while the former

method (Kerminen et al., 2004) does not require any prior knowledge of what might condense on the particles (often called CS'). CS is later used to calculate Q , and CS' to calculate J_1 .

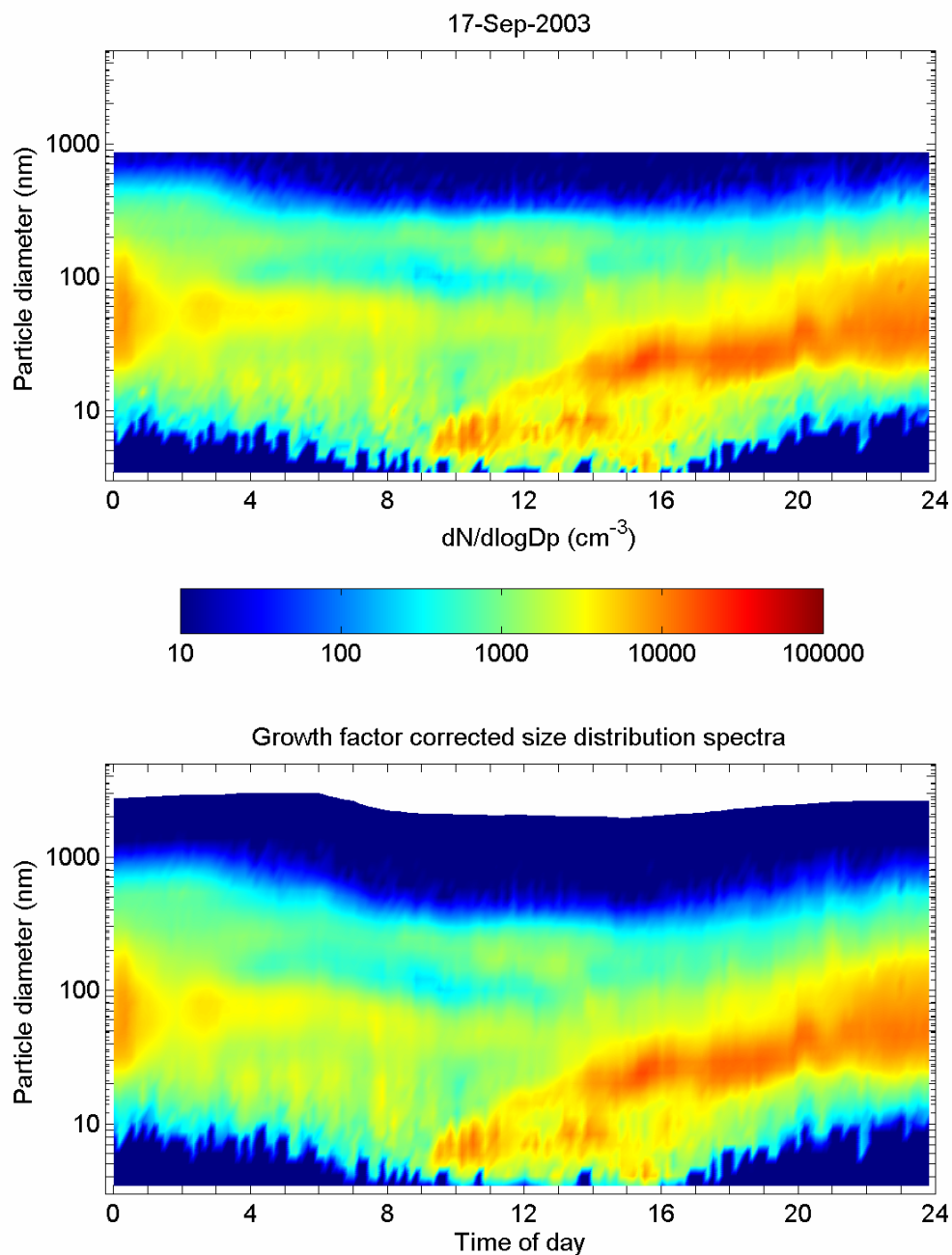

Figure 8: *GF-corrected particle number size distribution (Sep. 17, 2003) in the lower spectrum together with the dry spectrum in the upper part.*

To obtain CS', the air mean free path must be calculated (Hinds, 1999):

$$\lambda_{air} = \frac{1}{\sqrt{2}n\pi d_m^2} \quad (16)$$

where n is the concentration of molecules in the air, and $d_m=3.7 \cdot 10^{-10}$ m the collision diameter. For realistic atmospheric conditions, $\lambda_{air}=63$ nm. The calculations then continue with the Knudsen number,

$$Kn_i = 2\lambda_{air}/d_{p,i}, \quad (17)$$

where the index i refers to the discrete size bins of the size distribution measurements, and $d_{p,i}$ is the geometric mean diameter of this interval. Kn_i ranges from 37 to 0.15 (upon going from 3.4 nm to 850 nm diameter). The transitional correction factor is then calculated (β_{mi}).

$$\beta_{mi} = \frac{1 + Kn_i}{1 + (4/3\alpha + 0.337) \cdot Kn_i + 4/3\alpha \cdot Kn_i^2} \quad (18)$$

α is the accommodation coefficient, chosen as 1. β_{mi} ranges from 0.02 to 0.90. CS' is finally calculated from:

$$CS' = \frac{1}{2} \sum_i \beta_{m,i} d_i N_i \quad (\text{m}^{-2}) \quad (19)$$

where N_i is the number of particles per m^3 in each size interval prior to nucleation.

The calculation of CS requires certain knowledge on the condensing species. Sulphuric acid is known to contribute on average about 9% to the growth of the nucleation mode aerosol during formation events in the Finnish boreal forest (Boy et al., 2005). The properties of the other condensing gases are still unknown. Therefore, the condensation was calculated as if all the condensing gases were sulphuric acid. The air mean free path in Eq. (16) is then replaced with the vapour mean free path of sulphuric acid (Kulmala, 1998).

$$\lambda_{H_2SO_4} = 3 \cdot D \cdot \sqrt{\frac{\pi M_v}{8RT}} \quad (\text{m}) \quad (20)$$

$M_v=98.08$ g mol⁻¹ is the molecular mass of the condensing vapour, k is Boltzmann's constant ($1.38 \cdot 10^{-23}$ m² kg s⁻² K⁻¹), N_A is Avogadro's number ($6.022 \cdot 10^{23}$ mol⁻¹), T is the temperature (here chosen to be 283 K). The diffusion coefficient is given by Kulmala et al. (1998):

$$D = \frac{0.001 \cdot T^{1.75} \sqrt{\frac{1}{M_{air}} + \frac{1}{M_v}}}{p \cdot (d_{air}^{1/3} + d_{sulphuric\ acid}^{1/3})^2} \text{ (cm}^2 \text{ s}^{-1}) \quad (21)$$

where $M_{air}=28.965$ g/mol. The volumes of diffusivity: $d_{air}=19.7$ cm³ mol⁻¹, and $d_{sulphuric\ acid}=51.96$ cm³ mol⁻¹ were taken from Reid et al. (1987). This gives $D=0.0998$ cm² s⁻¹ for sulphuric acid. Under these assumptions, $\lambda_{sulphuric_acid}=121$ nm. The Knudsen number can now be calculated as above, but with the air mean free path replaced by the vapour mean free path of sulphuric acid:

$$CS = 2\pi D \sum_i \beta_{M,i} d_{p,i} N_i \text{ (s}^{-1}\text{)}. \quad (22)$$

In the molecular regime ($Kn \gg 1$, $d_p < 10$ nm diameter), the condensation sink is proportional to the second power of the diameter, and in the continuum regime ($Kn \ll 1$, $d_p > 1$ μm diameter), the condensation sink is proportional to the diameter. In the transitional regime, where most of the present particles are found, it is proportional to d_p^x , where x is somewhere between 1 and 2 (Kulmala et al., 2001).

For the calculation of the formation rate of activated particles (J_1), the following model by Kerminen and Kulmala (2002) was applied:

$$J_1 = \frac{dN_3}{dt} e^{\frac{\eta}{1} - \frac{\eta}{3}} \text{ (cm}^{-3} \text{ s}^{-1}\text{)} \quad (23)$$

where

$$\eta = \gamma CS' / GR \text{ (nm)} \quad (24)$$

$$\gamma = \gamma_0 \cdot (d_{mean} / 150 \text{ nm})^{0.048} \cdot (T / 293 \text{ K})^{-0.75} \approx \gamma_0 = 0.23 \text{ (nm}^2 \text{ m}^2 \text{ h}^{-1}\text{)} \quad (25)$$

d_{mean} is the mean diameter of the most abundant condensation sink mode, and dN_3/dt is the “apparent” nucleation rate. In Paper VI, γ_0 was used as an approximation of γ . Three assumptions were made for the calculation of J_1 :

- (1) The only important sink for the nuclei is their coagulation to larger pre-existing particles.
- (2) The nuclei grow by condensation at a constant rate.
- (3) The pre-existing population of larger particles remains unchanged during nucleus growth.

It is important to note that the growth rate of nuclei below 3 nm diameter is not known today, and this alone probably represents the largest uncertainty for the J_1 calculations.

Since the diffusion rate of molecules to the particles is known via knowledge of the growth rate of the nucleated particles and an a priori assumption about the diffusion coefficient, one can indirectly calculate the vapour concentration, C_{vapour} , required to explain the observed growth. A formula for this can be found in Dal Maso et al. (2002):

$$C_{vapour} = \frac{\rho}{\Delta t DM_x} \left[\frac{dp_2^2 - dp_1^2}{8} + \left(\frac{4}{3\alpha} - 0.623 \right) \frac{\lambda_v}{2} (dp_2 - dp_1) + 0.623 \lambda_v^2 \ln \left(\frac{2\lambda_v + dp_2}{2\lambda_v + dp_1} \right) \right] \text{ (mol m}^{-3}\text{)}. \quad (26)$$

If the assumption is also made that the rate of loss of the condensable vapours is in steady state with the production rate, the production rate, Q becomes:

$$Q = S = CS \cdot C_{vapour} \text{ (cm}^{-3} \text{ s}^{-1}\text{)}. \quad (27)$$

4. Instrumentation

The equipment and techniques utilized in the source characterization studies are briefly explained in the following.

4.1 TEOM

The tapered element oscillation microbalance (TEOM®, Series 1400a, Rupprecht and Patashnik Co., Albany, NY, USA) was used in real-time in several of the experiments to measure PM_{2.5} and PM₁₀ (Patashnik and Rupprecht, 1999). The operation of the TEOM is based on the change in eigenfrequency of an oscillating filter that is generated by the continuous accumulation of mass on the filter. The mass, *M*, measured every 2 seconds is calculated as:

$$M=K_0/f^2 \quad (28)$$

where *f* is the oscillation frequency. *K*₀ is the calibration constant, unique for each TEOM instrument, and is calculated with a pre-weighed filter cartridge. The values presented by the TEOM are running averages smoothed over many minutes. Smoothing is done exponentially, where the running average is weighted more by the values closer to the current time than further back in time.

4.2 ACPM

On-line measurements of the PM_{2.5} mass fraction of the organic and inorganic carbon (the latter is sometimes referred to as soot, black carbon or elemental carbon) was measured during the tunnel traffic emission inventory (Paper II) with the ambient carbon particulate monitor (ACPM®, Series 5400, Rupprecht & Patashnik Co., Albany, NY, USA) (Rupprecht et al., 1995). The instrument has two sampling lines, one where the particles are analysed for carbon mass and another where new subsequent collection of particles is initiated to save dead time. The collected particles are heated to an intermediate temperature (340°C) and the change in CO₂-concentration, detected by a non-dispersive infrared (NDIR) detector then indirectly gives the organic carbon mass. Similar analysis is then performed at a higher temperature (750°C) resulting in a measurement of the elemental carbon part. The lower cut-off diameter of the ACPM is 0.12 μm.

4.3 DMPS

The differential mobility particle sizer (DMPS), described in detail by Zhou (2001) was used to measure the particle number size distribution. The system consists of three main parts: the bipolar diffusion charger which establishes a well-defined charge on the particles, a differential mobility analyser (DMA)

where a specific mobility diameter is selected, and finally, a condensation particle counter (CPC) which counts the selected aerosol particles.

After passing the charger (the aerosol charge distribution is described in detail by Wiedensohler et al., 1988), the aerosol passes through the DMA, the heart of the DMPS. A schematic drawing of the DMA is included in Figure 9. The aerosol is drawn into the DMA through the aerosol sample slit at a flow rate Q_s . The air is transported with the laminar, clean, dry sheath flow (flow rate Q_{sh}) through the DMA and out via the excess flow (flow rate Q_{ex}). The charged particles will be deflected out of the sheath flow when passing through the DMA due to the voltage applied to the centre rod of the DMA. If the particles have the right electrical mobility they will be collected at the aerosol outlet slit (depicted as monodisperse aerosol flow Q_a in Figure 9). Otherwise they will be transported away by the excess flow or deposited on the DMA walls. If $Q_{ex}=Q_{sh}$, the following relation holds between the particle diameter and its electrical mobility, Z_p :

$$Z_p = \frac{neC_c}{3\pi\eta D_p} = \frac{Q_{sh} \ln(r_2/r_1)}{2\pi VL} \quad (29)$$

where n is the number of charges on the particle, e the elementary charge, C_c the Cunningham slip correction factor (Zhou, 2001), η the air viscosity, D_p the particle diameter, r_1 and r_2 the inner and outer diameters of the DMA respectively, V the applied voltage and finally, L the length of the inner rod. Hence, the aerosol mobility distribution can be measured by applying different voltages to the DMA. By making use of the inversion algorithm described by Zhou (2001), which includes corrections for multiple charges, CPC counting efficiencies, the shape of the transfer function, and the deposition in the inlet tubing, the aerosol number size distribution can be determined.

4.4 Elemental Composition Mass Estimation

During the wood combustion and traffic emission inventories (Papers I and II, respectively), the stationary aerosol monitor (SAM, Hansson and Nyman, 1985) was used to collect the PM_{2.5} and PM₁₀ fractions on filter strips consisting of Nuclepore polycarbonate porous membrane filters with a pore size of 0.4 μm . The time resolution of sampling was 10 minutes for the wood combustion inventory and 1 hour for the traffic inventory respectively. The particles in the characterization of the long-range-transported aerosol (Paper V) were passed through a Gent-type PM₁₀ inlet into a stacked filter unit (SFU) (Figure 10). This unit contains Nuclepore polycarbonate membrane filters with two different pore sizes in series (8 μm and 0.4 μm) to separate the coarse and fine PM₁₀ fractions from each other, with a time resolution of 24 hours.

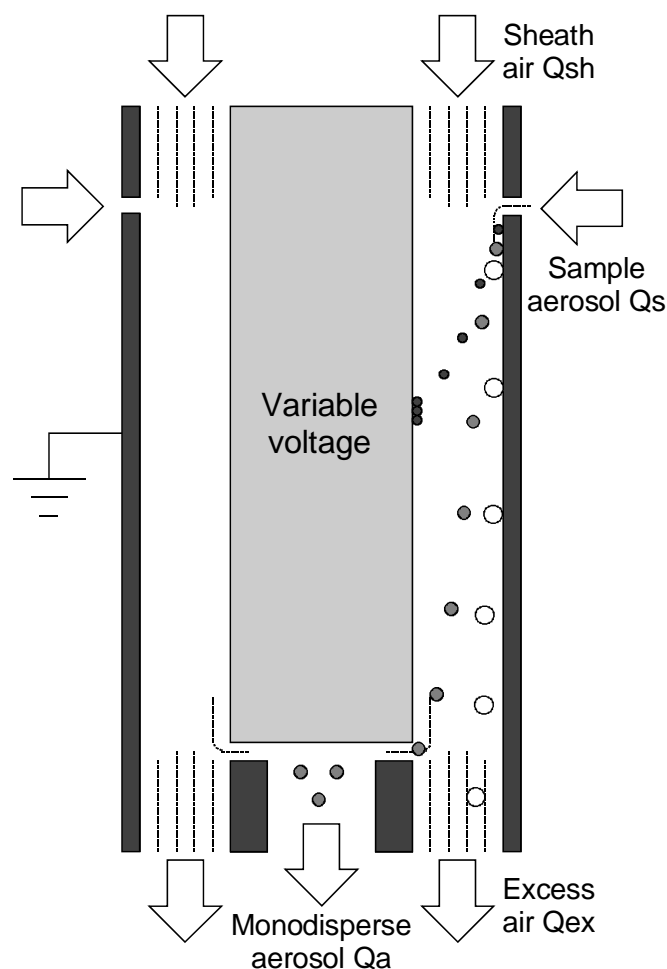

Figure 9: *The principles of a DMA.*

The filters were subsequently analysed using the PIXE method (particle-induced X-ray emission) (Johansson and Campbell, 1988) at the ion beam analytical facility of the Division of Nuclear Physics at Lund University. The PIXE method involves irradiating the filter samples with a proton beam. Due to the interaction of protons with the atoms collected on the filter material, X-rays with characteristic energies will be emitted, and a semiconductor detector detects and classifies the X-rays according to their energy. The yield of characteristic X-rays is then converted to absolute concentrations of elements from Al and heavier with detection limits of $\sim 0.05 \text{ ng m}^{-3}$.

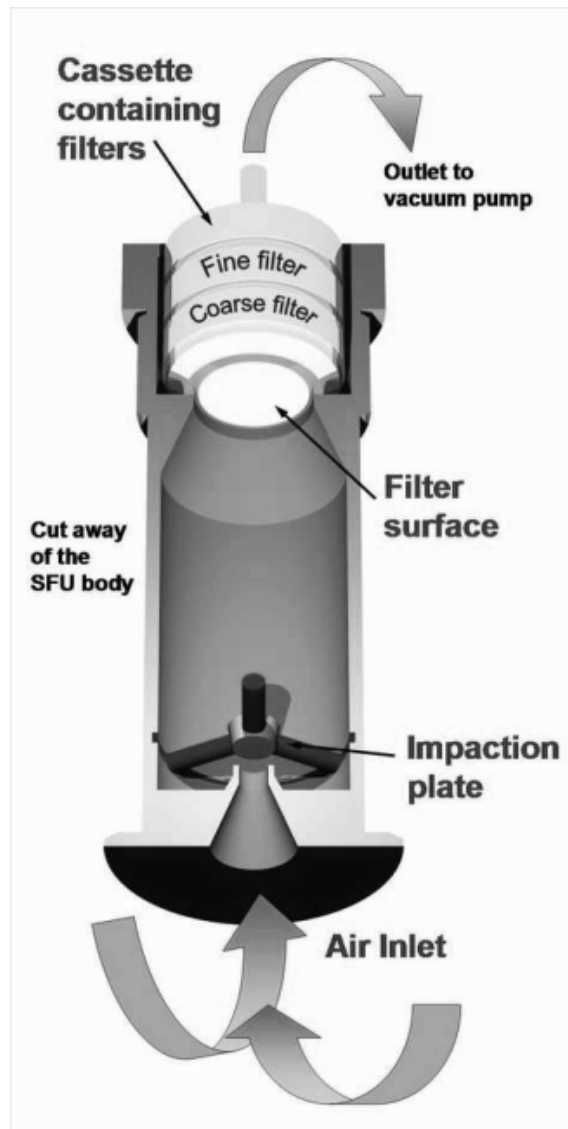

Figure 10: *Illustration of the sampling head with the 10 μm diameter impactor inlet and stacked filter unit (SFU) (adapted from Hopke et al., 1997, and ANSTO, 2003).*

5. Compilation of Source Studies in Sweden

5.1 Research Incentives in Sweden

In order to reduce the hazardous effects of particulate matter, air quality limits were applied to PM₁₀ in the EU and Sweden starting from January, 1 2005. The limits in Sweden are:

1. The daily mean concentration is not allowed to exceed $50 \mu\text{g m}^{-3}$ more than 35 times per year.
2. The yearly mean is not allowed to exceed $40 \mu\text{g m}^{-3}$.

The second limit value has barely been exceeded on a busy street, Hornsgatan, in Stockholm during the past 5 years (Johansson et al., 2005). However, of greater concern is the fact that PM₁₀ is higher than $50 \mu\text{g m}^{-3}$ between 69 and 101 times each year in the same street (Figure 11), hence the first air quality limit is clearly exceeded. Other streets in Sweden are not likely to be more polluted than this street, which sets the standards for other cities in Sweden. The trend is not decreasing, and therefore, this air quality limit must be under close supervision during the coming years.

Number of days each month

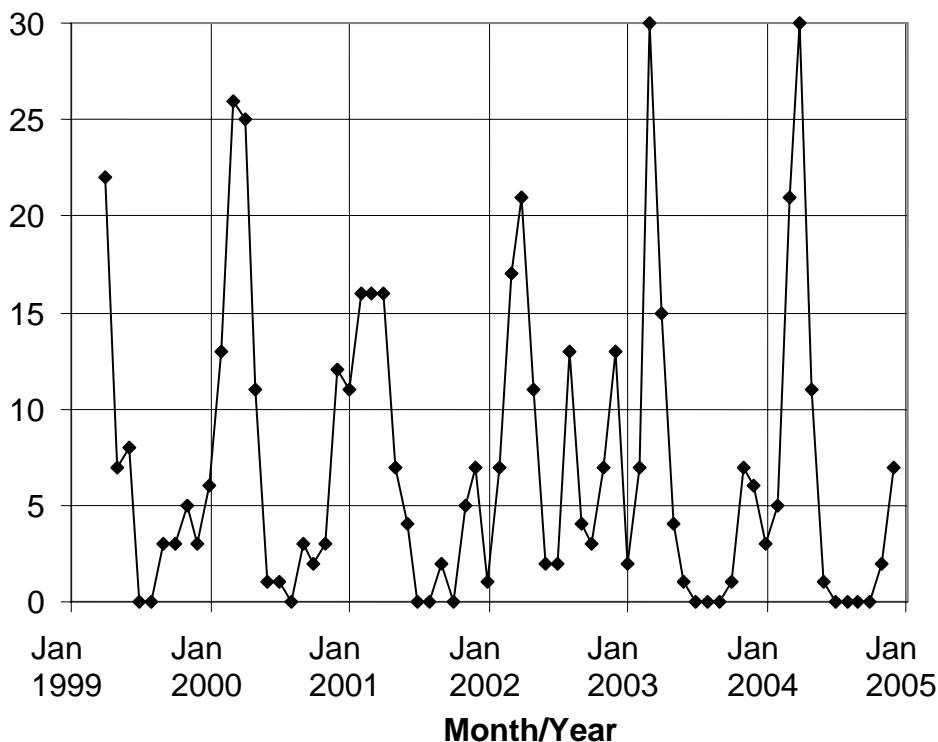

Figure 11: The number of days each month that $50 \mu\text{g m}^{-3}$ of PM₁₀ is exceeded in Hornsgatan, Stockholm (from Johansson et al., 2005).

High concentrations of PM₁₀ were discovered several years ago in the northern Swedish town of Lycksele when it was very cold during temperature inversion periods. The values in the town centre of Lycksele reached 30 µg m⁻³ on several occasions. The question was whether the high values were due to traffic or the extensive use of wood combustion by house owners.

The air quality limits should not be considered as values below which no health affects are observed, and it can be debated whether the PM₁₀ fraction is most harmful to humans, or if other parameters such as PM₁, or the number of ultrafine particles should be used for limits in the future (see e.g. Johansson et al., 2005 and Forsberg et al., 2005).

Nevertheless, PM₁₀ limits are the driving force for much of the research in Sweden. Researchers in Sweden try to pin-point the strongest sources of PM₁₀, so that political action can be taken to reduce PM₁₀. Since PM_{2.5} and the number of ultrafine particles are commonly used indicators of fine and combustion particles, respectively, researchers in Sweden also quantify the source contributions of these particles.

5.2 Urban Source Apportionment

Numerous studies have been made in two large campaign networks to elucidate the contribution from domestic wood combustion to PM₁₀, PM_{2.5} and ToN levels in Lycksele and Växjö (southern Swedish town). The work has proceeded furthest in Lycksele. In Stockholm, several studies have been performed to quantify the source contribution to PM₁₀, PM_{2.5} and ToN from traffic in several environments relevant to population exposure.

The source contribution estimates often follow the procedure depicted in Figure 12. Measurements in the exhaust plume, or close to the sources, are performed to estimate the emission per kg wood burned or vehicle km driven. This forms an emission database, which is used in dispersion modelling to calculate the concentrations at arbitrary locations in the urban area. Source/receptor models often provide a more reliable source contribution than a dispersion model at specific receptor points, where air quality measurements are performed. Therefore, they can be used to validate the dispersion model. If both models agree, reliable results can be expected from dispersion modelling at other locations than the receptor point. With the improved knowledge from model runs, new emission databases can be formed, and the source apportionment procedure can be repeated as needed, as shown in Figure 12.

5.2.1 Domestic Wood Combustion

Measurements were performed to calculate emission factors for a wood stove (belonging to the group of small-scale devices called “domestic burners”) in terms of PM_{2.5} and the particle number size distribution (Paper I). This allowed the estimation of the source contribution to the particle number size distribution in Lycksele with source/receptor modelling (Paper III) and PM_{2.5} in Lycksele

and Växjö (Johansson et al., 2004b, and Johansson et al., 2004c, respectively). Together with a collection of emission estimates from other domestic appliances (Johansson et al., 2004a; Pettersson, 2002; 2003), dispersion modelling could be performed for PM₁₀ and ToN in Lycksele (Johansson, 2003, and Gidhagen, 2004a, respectively).

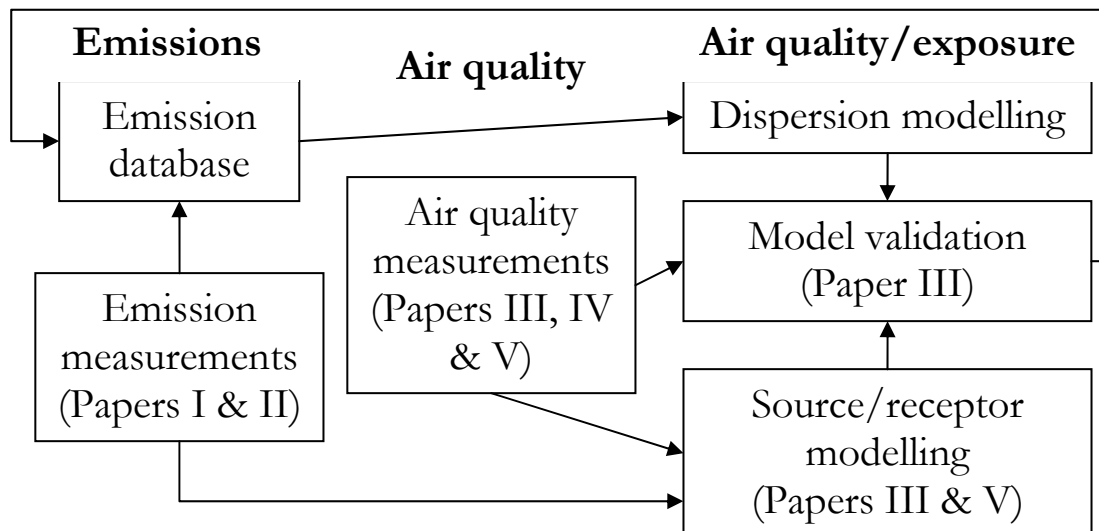

Figure 12: *Line of action for the source apportionment studies of PM₁₀, PM_{2.5} and the particle number size distribution or ToN. The boxes show the contributions from the different papers in the thesis to the work performed.*

The dispersion modelling results for PM₁₀ agree well with source/receptor modelling results for PM_{2.5} in the housing district of Forsdala, Lycksele. At several locations in another district, called Furuvik, dispersion modelling shows that the levels of PM₁₀ are higher than $50 \mu\text{g m}^{-3}$ more than 35 times per year, thus exceeding the air quality limit (Figure 13). On those occasions, wood combustion is the totally dominating contribution to PM₁₀.

The emission measurements presented in Paper I, by Boman et al. (2005), and by Johansson et al. (2004a) show that the number size distribution from domestic wood combustion is different from that of traffic (Paper II). Most of the particles from traffic are around 20 nm in diameter, while most of the wood particles are found between 20 and 200 nm diameter (see Figure 14). The difference between the two sources provides the opportunity to perform source/receptor modelling of the particle number size distribution (see Paper III).

The calculations show that the contribution to ToN from wood combustion is about 70% during cold winter days in Forsdala, Lycksele. The other important sources of particles come from traffic and long-distance transport. ToN can occasionally be almost as high as in the most traffic-polluted streets in Stockholm and Copenhagen during the rush hour ($\sim 20000 \text{ cm}^{-3}$). Dispersion modelling performed by Gidhagen et al. (2004a) shows good agreement for the combined source contribution of wood combustion and

background particles as seen in Figure 15, although the wood combustion contribution obtained from the dispersion modelling is slightly overestimated. The background and wood combustion sources could not be separated from each other. On the other hand, long-distance transported particles contribute only about $1000 \text{ particles cm}^{-3}$. According to Gidhagen's modelling, there are several districts in Lycksele that experience high levels of ToN similar to the situation with PM10.

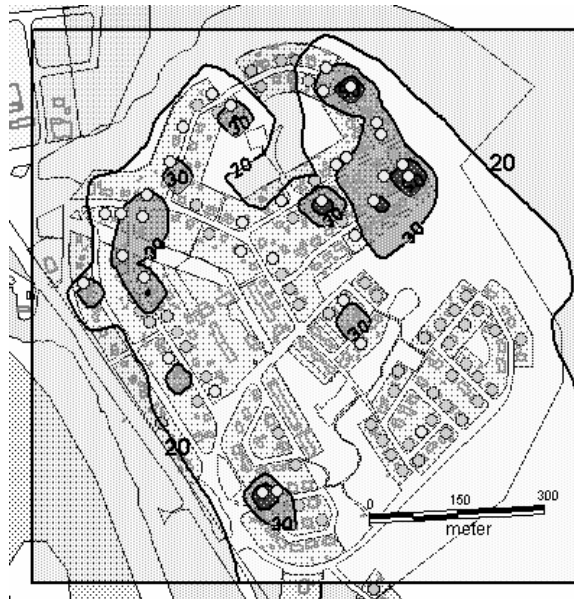

Figure 13: *The number of times the limit of $50 \mu\text{g m}^{-3}$ of diurnally averaged PM10 is exceeded during one year in the district of Furuwik in Lycksele (from Johansson et al., 2003). The paler and darker shaded circles indicate old non-environmentally approved and environmentally approved boilers, respectively. Local fireplaces are not included. The darkest shading represent areas where the air quality limit is exceeded.*

To summarize, a reliable knowledge base has been established that can attribute PM10, PM2.5 and ToN levels to their corresponding sources in Lycksele during wintertime. In particular, the results in Lycksele show that a reduction of the number of old conventional wood-log boilers without a heat storage tank could significantly reduce PM10 (Hansson et al., 2003). Domestic burners are the most common small scale appliances in Lycksele. However, they contribute only about 10% to the PM10 in Lycksele compared with the wood-log boilers (Johansson et al., 2003). The results from Lycksele can be generalized to several cities in northern Sweden, as shown by Modig and Forsberg (2004).

In southern Sweden, Växjö, the results are more inconclusive (Johansson et al., 2004d). Nevertheless, the conclusions that can be drawn from the measurements and modelling show that the contribution to PM2.5 from long-distance transport is higher than in Lycksele, whereas the contribution to PM2.5 from wood combustion is lower than in Lycksele. The population in Växjö prefers domestic burners to boilers due to the lower heating requirement, and

meteorology and topography do not favour trapping of pollutants as frequently as in Lycksele. There is thus no imminent risk of air quality limits being exceeded in the housing areas of Växjö.

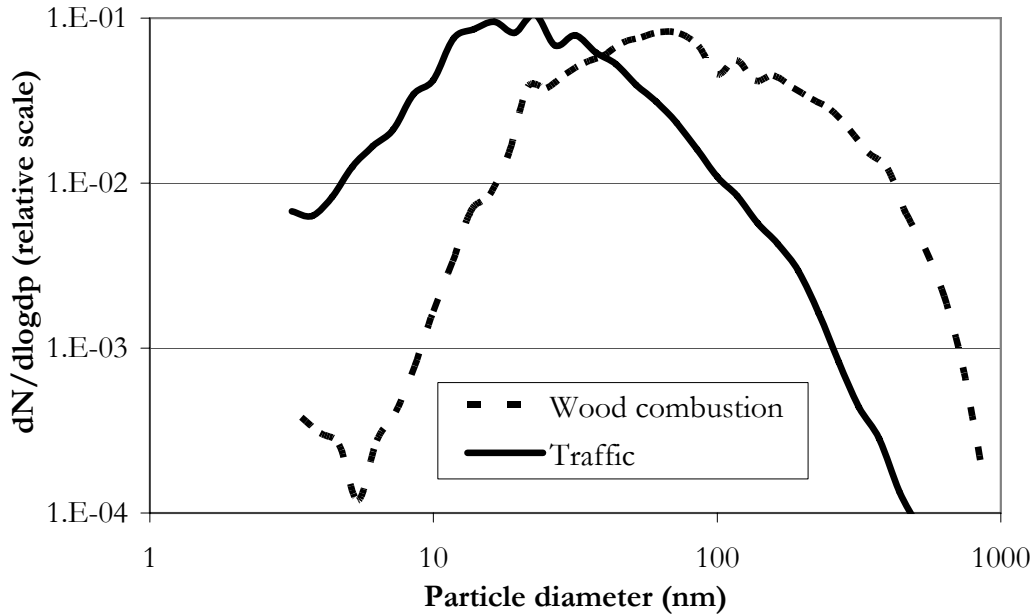

Figure 14: *The average size distribution from wood stove combustion and traffic exhaust (from Paper I and II respectively).*

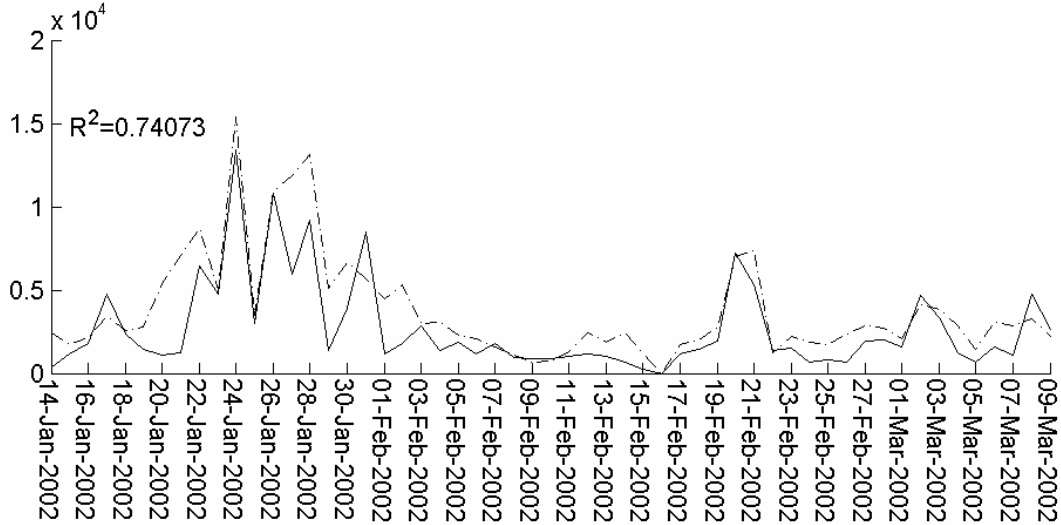

Figure 15: *Daily average contribution to the particle number concentration (cm^3) from both domestic wood combustion and long range transport during the entire measurement period in Forsdala, Lycksele. Source/receptor modelling results are shown with the continuous line and dispersion modelling results with a dashed-dotted line. The coefficient of determination (R^2) between the two modelling runs is given in the Figure (From Paper III).*

5.2.2 Traffic

Recently, several emission factor measurements have become available for PM, and the particle number size distribution and ToN in different road environments in Scandinavia, and for varying speeds (Paper II; Janhäll and Hallquist, 2005; Gidhagen et al., 2003; Gidhagen et al., 2004b; Gidhagen et al., 2004c; Ketzler et al., 2003; Areskoug et al., 2004; Johansson et al., 2005). Laboratory measurements of emission factors and the variety of emission estimates in outdoor air makes it possible to calculate the source contributions to PM and ToN from traffic in Sweden in the same way as the source apportionment of wood combustion particles in the previous chapter.

The characteristics of the emission factors from traffic in Scandinavia have been deduced from the work of Wåhlin et al. (2003), Gidhagen et al. (2004c), and from Paper II. Firstly, the emission factors per vehicle km driven of both PM and ToN are speed dependent as well as temperature dependent. In addition a differentiation between LDV and HDV for the exhaust emission (Paper II) showed that the HDV (6% of the traffic work on average in Sweden) contributed about 35% of the exhaust emissions, on average, for both ToN and PM_{0.9}. For the PM₁₀ and PM_{2.5} emissions it is more difficult to say how much the different kinds of vehicles contribute to the emission (Gustafsson, 2003a). Most of the PM₁₀ emission comes from re-suspended material and apart from the correlation with traffic intensity, it is also affected by the wetness of the road surface and vehicle speed (Paper II).

Intensive source/receptor studies in Stockholm (Johansson et al., 2005) and road simulator tests (Dahl et al., 2005) have shown that the greatest cause of high concentrations of PM₁₀ and the reason why air quality limits are exceeded, is the wear of asphalt. The contribution is highest during the spring, since the spring is often dry, and therefore re-suspension higher. In addition, cars are still running on studded tyres, which cause greater wear of the asphalt (Figure 16). Between 50 and 85% of the total PM₁₀ emission is due to the use of studded tyres (Johansson et al., 2005). The exhaust fraction of PM₁₀ in streets with heavy traffic is only of the order of 10% (see Paper II and Johansson et al., 2005).

Other important sources of PM₁₀ are sanding and salting of roads and brake wear (on roads with low speed limits and with many traffic lights, where braking is more frequent) (see Johansson et al., 2005; Sternbeck et al., 2004; Wåhlin and Palmgren, 2005). Sanding is also thought to cause more wear on asphalt and lead to higher emissions (Johansson et al., 2005). Dispersion modelling presented by Johansson et al. (2005) in which the exhaust and the re-suspended PM₁₀ fractions were separated shows that a wet surface does not prevent all PM₁₀ material. The particles become airborne as soon as the road surface dries up.

Regarding particle number concentration contributions, a unique study on urban background ToN in Stockholm, shows that the highest concentrations are

found close to motorways and roads with heavy traffic (Gidhagen et al., 2005). See Figure 17.

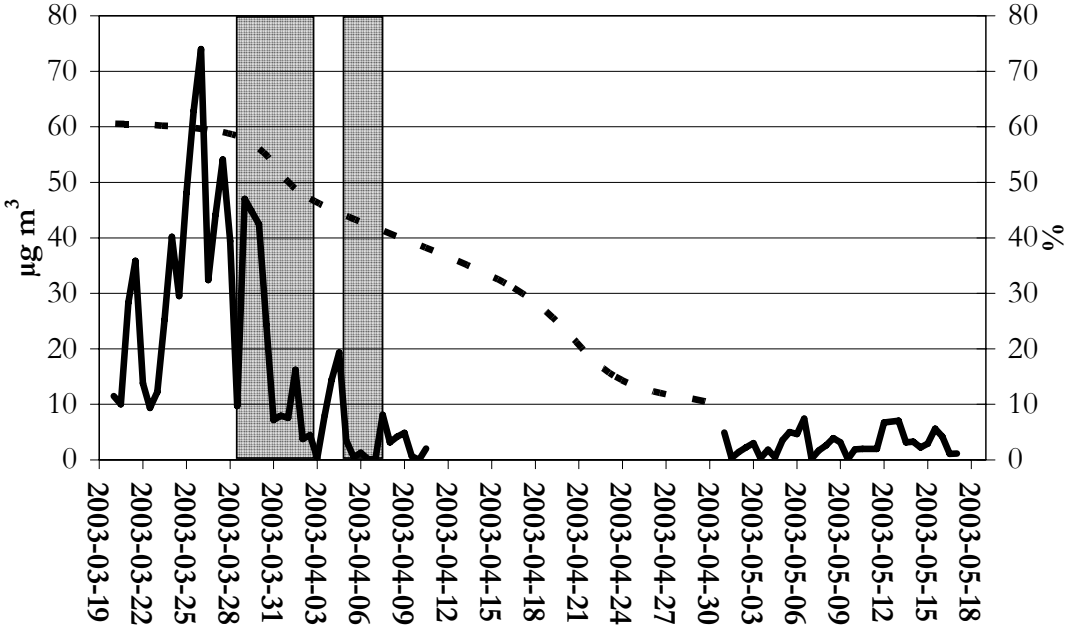

Figure 16: The fraction of cars using studded tyres (dashed line) and the re-suspended fraction of PM10 (continuous line) (from Johansson et al., 2005). The grey shaded areas show periods of rain.

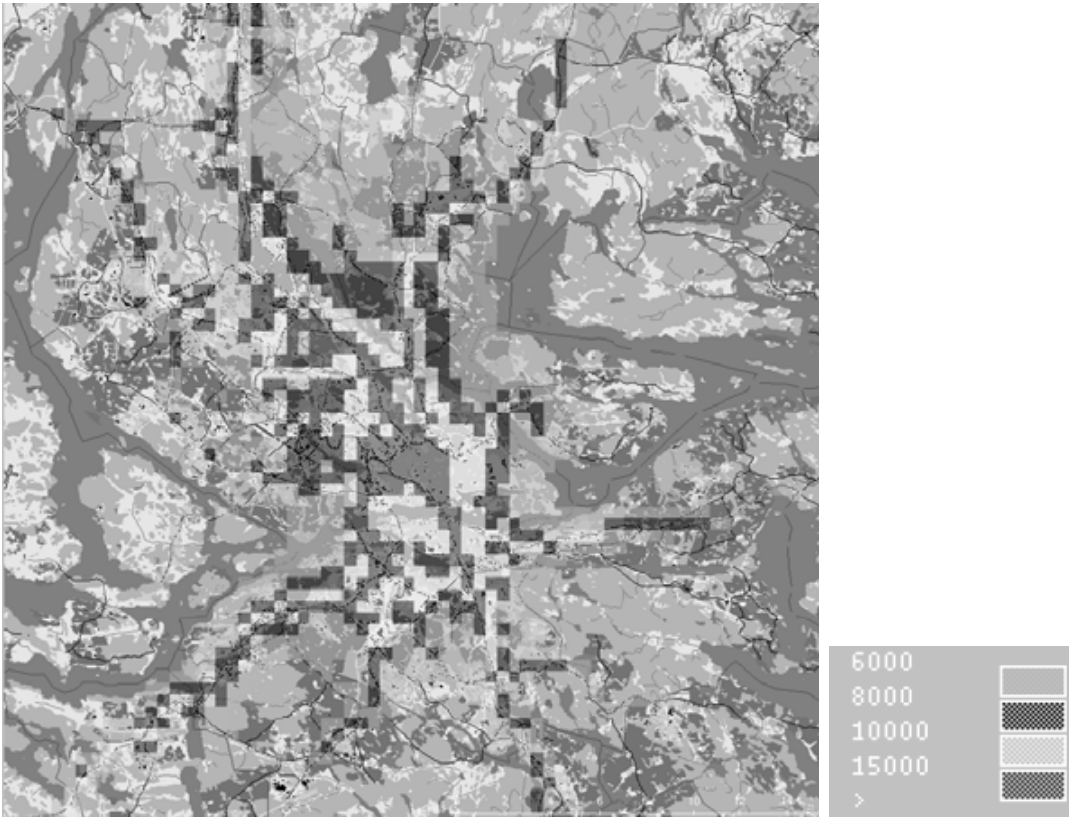

Figure 17: Average ToN (cm^3) calculated using dispersion modelling in the Stockholm urban background area, 13-17 April 2002 (Gidhagen et al., 2005).

5.3 Rural Source Characterization

As shown by Forsberg et al. (2005), PM_{2.5} and PM₁₀ background concentrations are much higher in southern than in northern Sweden. The average levels increase from about 7 $\mu\text{g m}^{-3}$ to 18 $\mu\text{g m}^{-3}$ upon going from northernmost to the southernmost Sweden. The reason for the difference is the vicinity in southern Sweden to large particle sources in continental Europe. The health risk associated with background particles is estimated to be greater in southern than in northern Sweden (Forsberg et al., 2005).

However, there are not only anthropogenic sources contributing to PM₁₀ and PM_{2.5} in Sweden. Paper V shows that nearly 20% of PM comes from the sea, and also nearly 20% from soil material in southernmost Sweden (Table 1). Part of the soil dust is likely to be related to anthropogenic activities, such as agriculture, or traffic in the south. The remaining part of the PM_{2.5} and PM₁₀ arises from oil and coal combustion, and from a sulphur related pollution source (Table 1).

Table 1: *Average source contributions to PM_{2.5} and PM₁₀ in Vavihill, Sweden using two different source/receptor models (COREM and PMF) (from Paper V). “Not attributed” denotes data that could not be attributed to any of the four selected sources.*

	Soil	Sea	Pollution Oil/Coal	Not attributed	
COPREM					
PM ₁₀	21.9%	15.8%	33.9%	24.0%	4.5%
PM _{2.5}	18.2%	14.5%	39.6%	23.4%	4.3%
PMF					
PM ₁₀	19.2%	22.3%	28.3%	23.2%	7.1%
PM _{2.5}	15.6%	20.5%	34.0%	23.0%	6.8%

The particle number concentrations vary with latitude in Scandinavia, similar to PM levels, i.e. ToN increases in the southerly direction. On a northerly–southerly longitude line, the yearly average ToN concentrations during 2003 are: Pallas, Finland, few hundred cm^{-3} (68°N), Hyytiälä, Finland, $\sim 2500 \text{ cm}^{-3}$ ($\sim 62^\circ\text{N}$), and Vavihill, Sweden, $\sim 3800 \text{ cm}^{-3}$ (56°N) (CREATE, 2005, and Adam Kristensson, unpublished data). However, not only the closeness to anthropogenic air masses gives rise to higher concentrations in southern Scandinavia. A higher frequency of formation events also plays a role in this connection (see Vehkamäki et al., 2004; Dal Maso et al., 2005; Paper VI). To complicate matters even further, the number concentration of particles in different sizes in Scandinavia also depends on air mass history, cloud processes, and aerosol dynamics, as shown by Tunved et al. (2004) and Tunved et al. (2005a).

Formation events occur during 36% of all analysed days in Vavihill. Paper VI shows that the formation rate of particles larger than 3 nm in diameter

observed by the instrumentation during formation events around midday is of the order of $1 \text{ cm}^{-3} \text{ s}^{-1}$, irrespective of the varying degree of pollution in the air mass.

However, the outcome for the nucleation mode particle number concentration by the end of the day, is different for polluted and clean air masses. Since polluted air contains more particles prior to the event than cleaner air, it will also provide a larger polydisperse coagulation sink for the nucleation mode aerosols. Consequently, the final number concentration of nucleation mode aerosols will be higher in the cleaner air ($\sim 3000 \text{ cm}^{-3}$) than in the more polluted air ($\sim 2000 \text{ cm}^{-3}$) at the end of the day. Also, the fraction of nucleation mode aerosol particles to ToN is almost a factor 2 higher for cleaner air. Furthermore, the frequency of events in cleaner air masses is higher than in more polluted ones (Figure 18). Air arriving from southerly and easterly directions is generally regarded as polluted. The above facts imply that formation event particles from polluted air masses should have less impact on the climate, since they are fewer. A closer inspection of the trajectory of polluted air masses reveals that the air has not persisted over the polluted areas more than two days in 22 out of 39 cases before arriving at Vavihill when type I events are observed. This means that air from areas that are in general regarded as polluted, in many cases, still has to be relatively clean to be able to contribute to events in southern Sweden.

In all, 35% of the formation events (7% of all days) produce particles in the nucleation mode that are larger than about 30 nm geometric mean diameter during the event day. This indicates that the nucleation mode aerosols could affect the climate if they were allowed to grow to even larger sizes on following days.

5.4 Future Prospects

5.4.1 Wood Combustion

Many of the old wood-log boilers without heat storage tanks will be replaced by newer, cleaner ones in the long term, and recently proposed legislation or grants may speed up this process (Korsfeldt et al., 2003). Hence, current PM10 air quality limits should not to be exceeded at least in the future. However, evaluation limits (maximum 35 diurnal average values of PM10 above $30 \mu\text{g m}^{-3}$) may be exceeded in the future, which requires immediate attention by local authorities. Alternatively, new, lower air quality limits may be proposed. In any case, wood-log boilers, and other types of domestic appliances may still pose health risks in the future and cause PM10 limits to be exceeded (see Boman et al., 2003 and e.g. Johansson, 2003).

Boman, (2005), Johansson et al. (2004a) and Wiinikka (2005) have shown that with the techniques already available today and with the right installation and operation of combustion devices, the emission of particles and other

compounds could be reduced by several orders of magnitude compared with older wood boilers and stoves. If such systems were to be used, no significant effects on the environment should be expected.

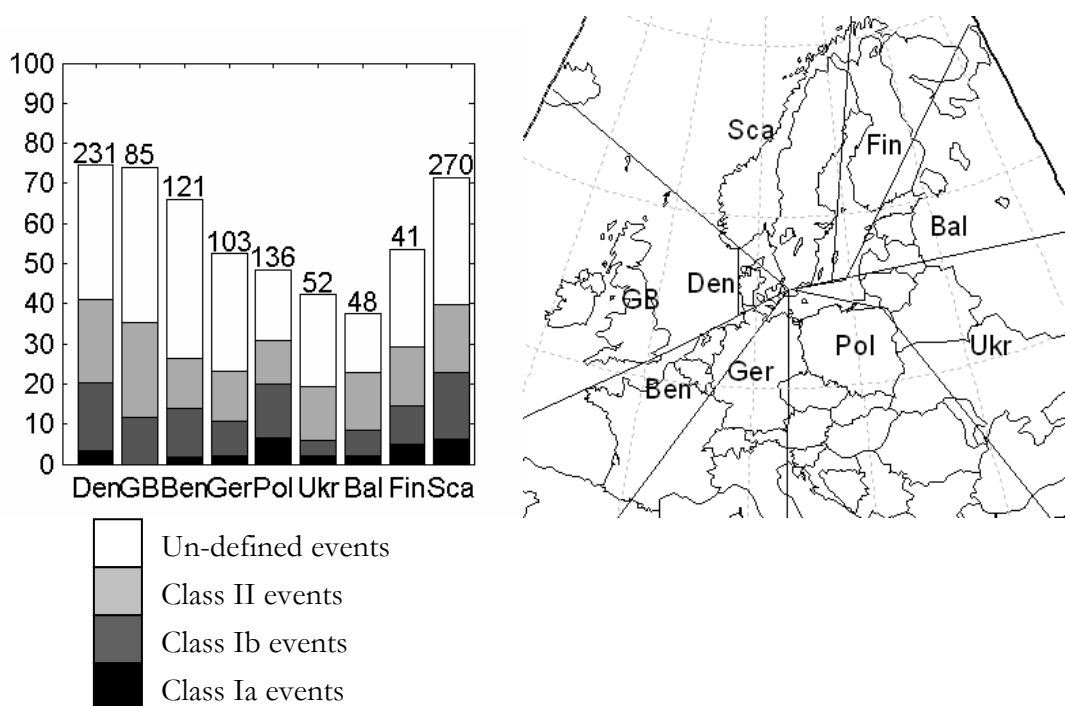

Figure 18: *The frequency (in percent) of formation events in Vavibill as a function of source region (left). On top of bars is denoted the number of times that the trajectories have passed the source region within two days before arriving at Vavibill. Sector classification of source regions (right). Vavibill is situated at the centre point where region border limits meet.*

It is still not known in detail which compounds in wood smoke are harmful to humans. If such information were to become available in future, data are available from Lycksele to indirectly calculate size-dependent lung deposition of aerosol particles with different hygroscopic properties (Swietlicki et al., 2003). In fact, lung deposition instrumentation has recently been developed to directly measure the size-resolved deposition in the lungs of human subjects (Löndahl et al., 2005). Several campaigns are taking place at the moment to measure the lung deposition in different environments where there are emissions from wood smoke and traffic exhaust.

A new dispersion model called VEDAIR is under development. Its goals are to estimate the PM10 levels in different Swedish municipalities where wood combustion is common and to attribute the levels to their respective sources when cities have problems associated with air quality or evaluation limits. The model will first be validated against measurements in Lycksele to test the spatial variability within a housing district. Furthermore, soot levels will be tested

against PM10 in Lycksele to develop a more cost-effective measurement method.

5.4.2 Traffic

Although the reasons for high PM10 concentrations in traffic environments are clearer today, it is not a straightforward task to reduce these emissions. A reduction in the use of studded tyres must be compared with the risk of more traffic accidents. Nevertheless, a reduction in the use of studded tyres has been tried in Norway, and it has led to much lower PM10 levels (Johansson et al., 2005). No accompanying increase in accidents was noted (Gustafsson et al., 2005). Cleaning of streets in Stockholm has not led to a significant decrease in PM10. Binding of road particles with “ICE-AWAY”, which contains calcium magnesium acetate has, on the other hand, proven that significant reductions of PM10 levels can be achieved (Johansson et al., 2005). A means of reducing traffic congestion in Stockholm has recently been approved; namely, the introduction of congestion charges. This will have positive effects on PM10 levels. Finally, changing road material, and driving at different speeds were tested in a road simulator, which showed that considerable reductions in road emission could be achieved (Gustafsson et al., 2005), and these methods might also be tested in Stockholm to reduce PM10 emissions (Johansson et al., 2005). The way in which PM10 emissions vary with type of vehicle (LDV or HDV) is also an important task to be investigated.

Another dispersion model network like VEDAIR, called SIMAIR has been started in Sweden, which will hopefully be able to elucidate the effects of different degrees of use of studded tyres. The PM10 model included in SIMAIR has already been compared with measurements performed on a motorway in Stockholm. The comparison showed good agreement in general, although, the model was not able to reproduce the large temporal variability of the measured emission factors (Swietlicki et al., 2004). Measurements in Malmö (southern Sweden) are being performed at the moment together with modelling in Halmstad (also southern Sweden). These results will be used to validate the results of SIMAIR for southern Swedish conditions. The use of studded tyres in southern Sweden is less frequent (Figure 19), and should lead to lower PM10 levels along and close to roads (see the German study by Lohmayer et al., 2001).

It should be remembered that the high PM10 concentrations discussed above are most problematic close to roads. Paper IV shows that complete removal of traffic in Copenhagen would not reduce PM10 concentrations in the urban background by more than a few percent, although at kerbside the reduction could be as high as 2/3 (Figure 20). In Copenhagen, the average contribution from long-distance transport is more important than in Stockholm. Conversely, a reduction in traffic exhaust would significantly reduce ToN in both the urban background, and at rural locations tens of km away from the

urban area (Paper IV, and Adam Kristensson, unpublished data). Especially nucleation and Aitken mode aerosols could be reduced.

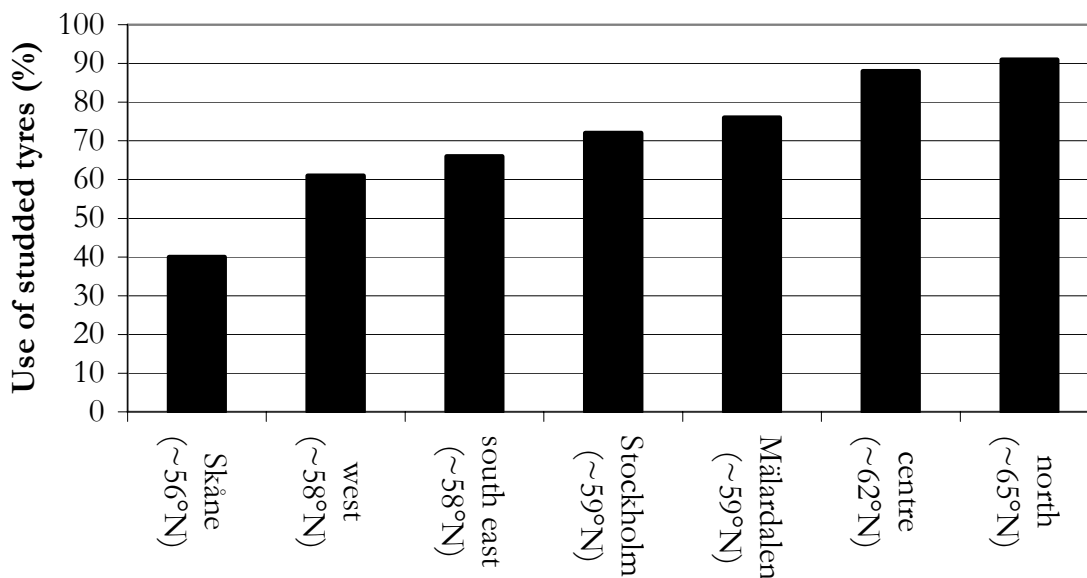

Figure 19: Degree of use of studded tyres in different parts of Sweden (from Johansson *et al.*, 2005).

This indicates that traffic from an urban area could have a significant effect on the particle number concentration on a small regional scale, which should be remembered when modelling ToN over Europe. However, nucleation events also contribute to these numbers, and therefore, this matter should be addressed in future work. When the wind is from the south or south-east, the Vavihill background station shows high levels of more aged accumulation mode aerosols (Adam Kristensson, unpublished data).

Although considerable effort has been made in Sweden to track down the sources of re-suspended particle mass and to reduce the emissions of these particles, it should be emphasized that there is as yet no conclusive evidence that mortality is linked with the re-suspended fraction of PM₁₀, although significant effects on pulmonary diseases have been observed in Stockholm (Forsberg and Segerstedt, 2004). It is believed that the fine fraction of PM₁₀ in urban areas may be the cause of increased death risk in Sweden (see Forsberg and Segerstedt, 2004; Le Tertre, 2002). Therefore, it is worthwhile to continue studying the effects of exhaust emissions as well.

A number of techniques are used today and others are in the planning stage to reduce the emission of exhaust, including fuel and technology developments, environmental labelling of cars (e.g. EURO V), legislation, increased price of fuel, etc. (see e.g. Åhman, 2003). The potential for emission reductions is very large. However, an increase in fuel consumption is currently being experienced in Sweden, due to the popularity of sport utility vehicles (SUV). Special taxes on these kinds of vehicles are being planned; otherwise SUV could significantly

disrupt the undertaking of the Government to reduce greenhouse gas emissions in Sweden.

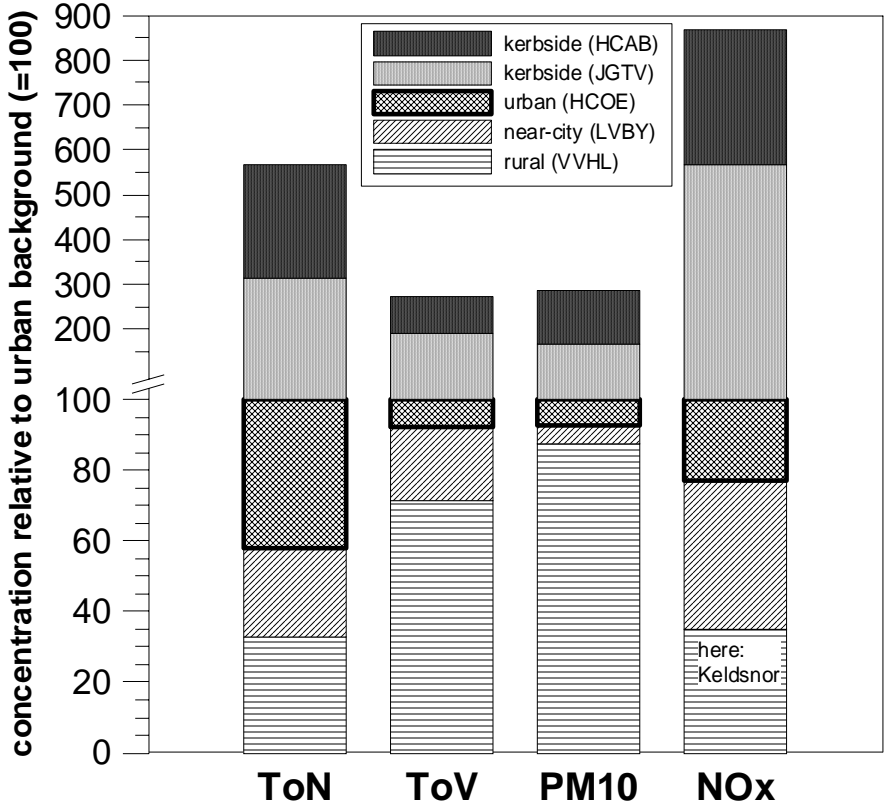

Figure 20: Comparison of average concentrations of total particle number (ToN), total particle volume (ToV), PM10 and NOx at rural (VVHL=Vavibill), near-city (outside Copenhagen) urban and kerbside stations relative to urban background levels (in Copenhagen). The concentration levels are cumulative so that only the difference between the level below appears as a specific pattern. The elevation of the urban background (HCOE) above the near-city level is shown by bold lines and represents the potential for urban emission reduction measures to decrease urban concentrations. Note that the scale of the vertical axis changes at 100. Since NOx was not measured at Vavibill, data from another rural station (Keldsnor) was used to represent background contributions (from Paper IV).

5.4.3 Long-Distance Transport

Improvements have recently been achieved in the modelling of PM10 and PM2.5 levels over Europe with the EMEP model (Tsyro, 2005). However, unresolved issues remain about the chemical composition of aerosols. Hopefully, chemical characterization such as those described in Paper V, and future chemical composition measurements in Scandinavia will contribute to a better understanding.

Significant improvements in the modelling of particle number concentrations over Scandinavia, including the representation of nucleation

events, have been made (Tunved et al., 2005b; Tunved et al., 2005c). However, the scenarios modelled are limited. More work is required to fully understand aerosol transformation during long-distance transport in other types of air masses, and for a variety of meteorological conditions. Work has already been started to map the aerosol number size distribution over the northern hemisphere including nucleation, and to calculate its effect on climate (Ken Carslaw, personal communication).

PM_{2.5} has commonly been used as a tracer for fine particulate matter, excluding contributions from coarse, wind-generated particles. However, studies in Sweden show that coarse particles unfortunately comprise a significant fraction of PM_{2.5} in two main environments. The first is background environments (Paper V), where about 40% of the long-distance-transported PM_{2.5} comes from soil dust and sea salt particles. The second is areas with heavy traffic. Paper II shows that most of the traffic-induced particles larger than 600 nm in diameter arise from re-suspension, and these comprise a dominant fraction of PM_{2.5} during dry spring periods, as shown above (Johansson et al., 2005). Therefore, using PM_{2.5} would seriously complicate the assessment of sources and the choice of abatement strategy in the future (Areskoug et al., 2004).

Only health impact assessments have been made so far to predict the effects on health of background PM in Scandinavia (Forsberg et al., 2005). Epidemiological studies are needed to confirm whether long-range-transported particles have adverse effects on health. To address this matter, an epidemiological study has been started in Stockholm (Christer Johansson, personal communication) which will focus on the effects on the health of the population during episodes of elevated levels of long-distance-transported particles. If this project provides statistically significant results it may have far-reaching effects on the research on background aerosols, independent of the outcomes of the study.

Acknowledgements

I wish to express my most sincere gratitude to my supervisor during my PhD studies at the Division of Nuclear Physics in Lund University, Professor Erik Swietlicki. He has been very kind to me and has helped me by guiding me in the right direction, and has given me very meaningful and exciting tasks during the years. At the same time he has always had faith in me, and allowed me to work independently, propose new ideas for projects and take charge of several measurement tasks, which has helped me to build up my own professional confidence, creativity and personal maturity.

I wish to extend my warmest gratitude to my colleagues at the Division of Nuclear Physics, who have helped me and made my time at the Division a truly enjoyable one.

I am also very grateful to my first two supervisors during my research career at the Department of Applied Environmental Sciences at Stockholm University (ITM). The first was, Professor Johan Ström, who introduced me to the exciting world of research, was patient with me and taught me how to write articles. My second supervisor and presently my co-supervisor, Dr Christer Johansson, has also been a very important person during my PhD studies, whom I found great pleasure in co-operating with. With his help I discovered the pleasures of experimental work. Before I leave ITM, I would like to thank all my former colleagues at the Institute for their co-operation and the pleasant working atmosphere.

Thank you also to my colleagues at the Division of Ergonomics and Aerosol Technology at the Lund Institute of Technology, and at the National Environmental Research Institute in Denmark. I would also like to thank colleagues at the University of Helsinki for inviting me there, for their co-operation, and at Copenhagen University for giving me a chance to continue my research in Copenhagen.

The following people who have helped me with the Vavihill station deserve special thanks: Jakob Löndahl, Torsten Nilsson, Anders Vestin, Hans Areskoug, Christer Nilsson, Andreas Maßling, Jingchuan Zhou, Roland Bengtsson, and Jenny Rissler.

Finally, I would like to thank my friends and family for their support, especially my wife Ania, who always encouraged me, and tried to make me think positively. Thanks Viktor, my son, for all the joy you bring to my life.

References

- Åhman, M., 2003. "Cars in Transition – An Assessment of Future Vehicle Technologies". Doctoral dissertation at Lund University, Environmental and Energy Systems Studies, Lund, Sweden, ISBN 91-88360-59-8.
- ANSTO, Australian Nuclear Science and Technology Organisation, 2003, <http://www.ansto.gov.au/nugeo/iba/images/posters/sfu.htm>.
- Areskoug, H., Johansson, C., Alesand, T., Hedberg, E., Ekengren, T., Vesely, V., Wideqvist, U., Hansson, H.-C., 2004. „Concentrations and sources of PM10 and PM2.5 in Sweden“. ITM-report no. 110, Stockholm, Sweden.
- Birmili, W., Wiedensohler, A., Heintzenberg, J., Lehmann, K., 2001. "Atmospheric particle number size distribution in central Europe: Statistical relations to air masses and meteorology". *J Geoph. Res.*, 106, 32005-320018.
- Boman, C., Forsberg, B., Järholm, B. G., 2003. "Adverse health effects from ambient air pollution in relation to residential wood combustion in modern society". *Scand. J. Work Environ. Health*, 29 (4), 251-260.
- Boman, C., Pettersson, E., Nordin, A., Westerholm, R., Boström, D., 2005. "Gaseous and particulate emissions from residential wood log and pellet stoves – experimental characterization and quantification". To be submitted.
- Boy, M., Kulmala, M., Ruuskanen, T. M., Pihlatie, M., Reissell, A., Aalto, P. P., Keronen, P., Dal Maso, M., Hellen, H., Hakola, H., Jansson, R., Hanke, M., Arnold, F., 2005. "Sulphuric acid closure and contribution to nucleation mode particle growth". *Atmos. Chem. Phys.*, 5, 863-878.
- Cahill, T. A., Eldered, R. A., Barone, J. B., Asbaugh, L. L., 1979. "Ambient aerosol sampling with Stacked Filter Units". Report no. FHWA-RD-78-178, U.S. Department of Transportation, Washington D. C., USA.
- Carslaw, K., School of Earth and Environment, University of Leeds, Leeds, United Kingdom, carslaw@env.leeds.ac.uk.
- CREATE, 2005. European data, <http://www.nilu.no/projects/ccc/create/>.
- Dahl, A., Gudmundsson, A., Swietlicki, E., Bohgard, M., Blomqvist, G., Gustafsson, M., "Emissions of coarse particle from traffic caused by studded winter tires", Proceedings of the European Aerosol Conference 2005, Gent, Belgium.
- Dal Maso, M., Kulmala, M., Lehtinen, K. E. J., Mäkelä, J. M., Aalto, P., O'Dowd, C. D., 2002. "Condensation and coagulation sinks and formation of nucleation mode particles in coastal and boreal forest boundary layers". *J. Geoph. Res.*, 107, NO. D19, 8097, 10.1029/ 2001JD001053.
- Dal Maso, M., Kulmala, M., Riipinen, I., Wagner, R., Hussein, T., Aalto, P. P., Lehtinen, K. E. J., 2005. "Formation and Growth of Fresh Atmospheric Aerosols: Eight Years of Aerosol Size Distribution Data from SMEAR II, Hyytiälä, Finland". Submitted to *Boreal Emv. Res.*
- Ekman, A. M. L., Rodhe, H., 2003. "Regional temperature response due to indirect sulfate aerosol forcing: impact of model resolution". *Climate Dynamics*, 21, 1-10.
- Forsberg, B., Segerstedt, B., Gidhagen, L., 2003. "Dagboksstudie med astmatiker, genomförd under mätkampanjen i Lycksele". Report to the Swedish Energy Agency, Project no. 12625-2, BHM (In Swedish).

- Forsberg, B., Segerstedt, B., 2004. "Vägdamm och grova partiklars effekter på befolkningens hälsa", Report, project AL90B 2002:8108, Swedish Road Administration, http://www.vv.se/filer/19220/2004_136.pdf (in Swedish).
- Forsberg, B., Hansson, H.-C., Johansson, C., Areskoug, H., Persson, K., Järholm, B., 2005. "Comparative Health Impact Assessment of Local and Regional Particulate Air Pollutants in Scandinavia". *Ambio*, 34, 11-19.
- Gidhagen, L., Johansson, C., Ström, J., Kristensson, A., Swietlicki, E., Pirjola, L., Hansson, H.-C., 2003. "Model simulation of ultrafine particles inside a road tunnel". *Atmos. Env.*, 37, 2023-2036.
- Gidhagen, L., 2004a. "Simulering av partikelantalskoncentrationer i Lycksele". Final report no. 21823-1 to the Swedish Energy Agency (in Swedish).
- Gidhagen, L., Johansson, C., Langner, J., Olivares, G., 2004b. "Simulation of NO_x and ultrafine particles in a street canyon in Stockholm, Sweden". *Atmos. Env.*, 38, 2029-2044.
- Gidhagen, L., Johansson, C., Omstedt, G., Langner, J., Olivares, G., 2004c. "Model Simulations of NO_x and Ultrafine Particles Close to a Swedish Highway". *Environ. Sci. Technol.*, 38, 6730-6740.
- Gidhagen, L., Johansson, C., Langner, J., Foltescu, V. L., 2005. "Urban scale modelling of particle number concentration in Stockholm". *Atmos. Env.*, 39, 1711-1725.
- Gustafsson, M., 2003a. "Emissioner av slitage- och resuspensionspartiklar i väg- och gatumiljö". Swedish National Road and Transport Research Institute, VTI report no. 944: 2003 (in Swedish).
- Gustafsson, M., Blomqvist, G., Gudmundsson, A., Dahl, A., Swietlicki, E., 2005. "Studies of wear particles using the VTI road simulator/particle generator", World Road Association, PIARC International Road Congress, Turin and Sestriere, Italy, 27-30 March, 2006.
- Hansson, H.-C., Nyman, S., 1985. "Microcomputer-controlled multisample soot photometer". *Env. Sci. Tech.*, 19, 1110-1115.
- Hansson, H.-C., 2003. "BHM – Preliminär slutrapport, Sammanfattning". <http://www.itm.su.se/bhm/rapporter/BHM%20sammanfattning%206.pdf>. Report to the Swedish Energy Agency (In Swedish).
- Haywood, J., Boucher, O., 2000. "Estimates of the direct and indirect radiative forcing due to Tropospheric aerosols: A review", *Reviews of Geophysics*, 38, 513-544.
- Heintzenberg, J., 1989. "Fine particles in the global troposphere. A review". *Tellus*, 41B, 149-160.
- Henry, R. C., Lewis, C. W., Hopke, P. K., Williamson, H. J., 1984. "Review of receptor model fundamentals". *Atmos. Env.*, 18, 1507-1515.
- Hinds, W. C., 1999. "Aerosol Technology: Properties, behavior, and measurement of airborne particles" (2nd edition). Wiley, New York.
- Hopke, P. K., Xie, Y., Raunemaa, T., Biegalski, S., Landsberger, S., Maenhaut, W., Artaxo, P., Cohen, D., 1997. "Technical Note. Characterization of the Gent Stacked Filter Unit PM10 Sampler". *Aerosol Sci. Tech.*, 27, 726-735.
- Hussein, T., Dal Maso, M., Petäjä, T., Kulmala, M., 2005. "A lognormal, multiconstraint fitting method for aerosol size distributions". Submitted to *Boreal Env. Res.*
- Ibald-Mulli, A., Wichmann, H. E., Kreyling, W., Peters, A., 2002. "Epidemiological evidence on health effects of ultrafine particles". *J. Aerosol Med.*, 15, 189-201.

- Intergovernmental Panel on Climate Change (IPCC), 2001. "Climate Change 2001: The Scientific Basis". <http://www.ipcc.ch>.
- Jacobsson, M. C., Hansson, H.-C., Noone, K. J., Charlson, R. J., 2000. "Organic atmospheric aerosols: Review and state of the science". *Reviews of Geoph.*, 38, 267-294.
- Janhäll, S., Hallquist, M., 2005. "A novel method for determination of size resolved, submicrometer traffic emission factors". To be submitted.
- Johansson, C., Department of Applied Environmental Science, Stockholm University, Stockholm, Sweden (christer.johansson@itm.su.se).
- Johansson, S. A. E., Campbell, J. L., 1988. "PIXE: A Novel Technique for Elemental Analysis". 1st edition., John Wiley and Sons Ltd., Chichester, Great Britain, Chapters 1-4 and 12.3.
- Johansson, C., 2003. "BHM – Preliminary final report to the Swedish Energy Agency from the Air Monitoring Cluster" (in Swedish).
- Johansson, L. S., Leckner, B., Gustavsson, L., Cooper, D., Tullin, C., Potter, A., 2004a. "Emission characteristics of modern and old-type residential boilers fired with wood logs and wood pellets". *Atmos. Env.*, 38, 4183-4195.
- Johansson, C., Hedberg, E., Olivares, G., Gidhagen, L., Karlsson, H., Wideqvist, U., Vesely, V., Swietlicki, E., Kristensson, A., Zhou, J., Rissler, J., Brohammer, P., Brorström-Lundén, E., Peterson, K., Remberger, M., Potter, A., Junedahl, E., Persson, K., Sjöberg, K., Sellin-Lindgren, E., Jacobsson, J., Tranefors, C., Andersson, L., Eltahir, E., Omstedt, G., Langner, J., Foltescu, V., Pettersson, M., Ahlinder, R., Sjövall, B., Norberg, B., Burman, L., 2004b. "Mätningar och beräkningar av vedeldningens påverkan på luftföroreningshalter. Del 1 – Lycksele", ITM-report no. 124, ITM, Stockholm, Sweden (in Swedish).
- Johansson, C., Hedberg, E., Olivares, G., Gidhagen, L., Karlsson, H., Wideqvist, U., Vesely, V., Swietlicki, E., Kristensson, A., Zhou, J., Rissler, J., Brohammer, P., Brorström-Lundén, E., Peterson, K., Remberger, M., Potter, A., Junedahl, E., Persson, K., Sjöberg, K., Sellin-Lindgren, E., Jacobsson, J., Tranefors, C., Andersson, L., Eltahir, E., Omstedt, G., Langner, J., Foltescu, V., Pettersson, M., Ahlinder, R., Sjövall, B., Norberg, B., Burman, L., 2004c. "Mätningar och beräkningar av vedeldningens påverkan på luftföroreningshalter. Del 2 – Växjö", ITM-report no. 125, ITM, Stockholm, Sweden (in Swedish).
- Johansson, C., Hansson, H.-C., Ström, J., Hedberg, E., Olivares, G., Karlsson, H., Wideqvist, U., Swietlicki, E., Nilsson, T., Kristensson, A., Brorström-Lundén, E., 2004d. "Den småskaliga vedeldningens betydelse för luftkvaliteten i Lycksele och Växjö", ITM-report no. 133, ITM, Stockholm, Sweden (in Swedish).
- Johansson, C., Norman, M., Omstedt, G., Swietlicki, E., 2005. "Partiklar i stadsmiljö – källor, halter och olika åtgärders effekt på halterna mätt som PM10". SLB report no. 4:2004, Stockholm, Sweden (in Swedish).
- Kerminen, V.- M., Kulmala, M., 2002. "Analytical formulae connecting the "real" and the "apparent" nucleation rate and the nuclei number concentration for atmospheric nucleation events". *Aer. Sci.*, 33, 609-622.
- Kerminen, V.- M., Anttila, T., Lehtinen, K. E. J., Kulmala, M., 2004. "Parameterization for Atmospheric New-Particle Formation: Application to a System Involving Sulfuric Acid and Condensable Water-Soluble Organic Vapors". *Aerosol Sci. Tech.*, 38, 1001-1008.

- Ketzel, M., Wählin, P., Berkowicz, R., Palmgren, F., 2003. "Particle and trace gas emission factors under urban driving conditions in Copenhagen based on street and roof-level observations". *Atmos. Env.*, 37, 2735-2749.
- Korsfeldt, T., Filipsson, E., Karlsson, G., 2003. "Småskalig vedeldning – Energimyndighetens analys och förslag till åtgärder". Report of the Swedish Energy Agency no. ER23:2003 (in Swedish).
- Kristensson, A., Dal Maso, M., Kerminen, V.-M., Swietlicki, E., 2005. "Characterization of new particle formation events at a background site in southern Sweden", Proceedings of the European Aerosol Conference 2005, Gent, Belgium.
- Kulmala, M., Toivonen, A., Mäkelä, J. M., Laaksonen, A., 1998. "Analysis of the growth of nucleation mode particles observed in Boreal forest". *Tellus*, 50B, 449-462.
- Kulmala, M., Dal Maso, M., Mäkelä, J. M., Pirjola, L., Väkevä, M., Aalto, P., Miikkulainen, P., Hämeri, K., O'Dowd, C. D., 2001. "On the formation, growth, and composition of nucleation mode particles". *Tellus*, 53B, 479-490.
- Kulmala, M., Vehkamäki, H., Petäjä, T., Dal Maso, M., Lauri, A., Kerminen, V.-M., Birmili, W., McMurry, P. H., 2004. "Formation and growth rates of ultrafine atmospheric particles: a review of observations", *Aerosol Sci.*, 35, 143-176.
- Laakso, L., Mäkelä, J. M., Pirjola, L., Kulmala, M., 2002. "Model studies on ion-induced nucleation in the atmosphere". *J Geoph. Res.*, 107, NO. D20, 4427, doi:10.1029/2002JD002140.
- Laakso, L., Petäjä, T., Lehtinen, K. E. J., Kulmala, M., Paatero, J., Hörrak, U., Tammet, H., Joutsensaari, J., 2004. "Ion production rate in a boreal forest based on ion, particle and radiation measurements". *Atmos. Chem. Phys.*, 4, 1933-1943.
- Laaksonen, A., Hamed, A., Joutsensaari, J., Hiltunen, L., Cavalli, F., Junkermann, W., Asmi, A., Fuzzi, S., Facchini, M. C., 2005. "Cloud condensation nucleus production from nucleation events at a highly polluted region", *Geoph. Res. Letters*, 32, L06812, doi:10.1029/2004 GL022092.
- Le Tertre, A., Medina, S., Samoli, E., Forsberg, B., Michelozzi, P., Boumghar, A., Vonk, J. M., Bellini, A., Atkinson, R., Ayres, J. G., Sunyer, J., Schwartz, J., Katsouyanni, K., 2002. "Short-term effects of particulate air pollution on cardiovascular diseases in eight European cities". *J. Epidemiol Community Health*, 56:773-779.
- Lohmayer, A., 2001. "Validerung von PM10-immissionsberechnungen im nachbereich von strassen und quantifizierung der feinstaubbildung von strassen. The report is available from www.Lohmeyer.de/Literatur/zusammenfassung_06_01.pdf.
- Löndahl, J., Maßling, A., Pagels, J., Swietlicki, E., 2005. "Respiratory deposition of ultrafine hydrophobic and hygroscopic particles during rest and exercise". BACCI-workshop, Kuopio, Finland, June, 2005.
- Medina, S., Placencia, A., Ballester, F., Mücke, H. G., Schwartz, J., 2004. "APHEIS: Public health impact of PM10 in 19 European studies". *J. Epidemiol Community Health*, 58:831–836. doi: 10.1136/jech.2003. 016386.
- Modig, B., Forsberg, B., 2004. "Halter av Bensen och PM10 I vedeldningsbelastade bostadsområden i Västerbotten och Norrbotten vintern 2003/2004". Final report no. 21623-1 to the Swedish Energy Agency (in Swedish).

- Paatero, P., 1997. "Least squares formulation of robust non-negative factor analysis". *Chemom. intel. lab. systems*, 37, 23-35.
- Pagels, J., 2005. "Fine and Ultrafine Particles from Combustion Sources". Doctoral dissertation at Lund University, Dept. Of Design Sciences, Lund, Sweden, ISBN 91-628-6457-2.
- Patashnik, H., Rupprecht, E. G., 1999. "Continuous PM10 Measurements Using the Tapered Element Oscillating Microbalance". *J. Air Waste Manag. Assoc.*, 41, 1079.
- Pettersson, M., 2002. "Emissionsdatabas för Lycksele". SLB report no. 4:2002 (in Swedish).
- Pettersson, M., 2003. "Emissionsdatabas för Lycksele och Växjö". SLB report no. 5:2003.Slutrappport P12629-1 (in Swedish).
- Pirjola, L., Lehtinen, K. E. J., Hansson, H.-C., Kulmala, M., 2004. "How important is nucleation in regional/global modelling?" *Geoph. Res. Letters*, 31, L12109, doi: 10.1029/2004GL019525.
- Pope, C. A. III, Dockery, D. W., 1999. "Air Pollution and Health. Epidemiology of Particle Effects", First Edition, 673-705. Academic Press, Great Britain.
- Reid, R. C., Prausnitz, J. M., Poling, B. E., 1987. "The properties of gases & liquids, 4th edition". McGraw-Hill.
- Rupprecht, E. G., Patashnik, H., Beeson, D. E., Green, R. N., Meyer, M. B., 1995. "A New Automated Monitor for the Measurement of Particulate Carbon in the Atmosphere". Presented at "Particulate Matter: Health and Regulatory Issues", Pittsburgh, PA, USA, April, 4-6.
- Segerstedt, B., Forsberg, B., 2002. "Partiklar I omgivningsluften och akuta fall av lungsjukdom i Lycksele". <http://www.itm.su.se/bhm/rappporter/RapportSot&Astma%20rev%20Final-B0.pdf> . Report to the Swedish Energy Agency, Project no. 12625-1, BHM (In Swedish).
- Smith, J. N., Moore, K. F., Eisele, F. L., Voisin, D., Ghimire, A. K., Sakurai, H., McMurry, P. H., 2005. "The chemical composition of atmospheric nanoparticles during nucleation events in Atlanta", submitted to *Journal of Geophysical Research – Atmospheres*.
- Sternbeck, J., Furusjö, E., Palm, A., 2004. "Vägtrafikens bidrag till PM10 och metaller vid tätorts- och landsvägskörning". Swedish Environmental Research Institute, IVL, report no. B 1598 (in Swedish).
- Swietlicki, E., Sanjiv, P., Hansson, H.-C. Edner, H., 1996. "Urban air pollution source apportionment using a combination of aerosol and gas monitoring technique". *Atmos. Env.*, 30, 2795-2809.
- Swietlicki, E., Kristensson, A., Zhou, J., Rissler, J., 2003. "Predicted size-resolved lung deposition of submicrometer aerosol particles from domestic wood combustion in a residential area". Proceedings of the NOSA 2003 Symposium, Copenhagen, Denmark.
- Swietlicki, E., Omstedt, G., Johansson, C., Nilsson, T., Gidhagen, L., Kristensson, A., 2005. "Measured and modelled PM10 emission factors from on-road traffic sources", Proceedings of the European Aerosol Conference 2005, Gent, Belgium.
- Tsyro, S. G., 2005. To what extent can aerosol water explain the discrepancy between model calculated and gravimetric PM10 and PM2.5"? *Atmos. Chem. Phys.*, 5, 515-532.

- Tunved, P., Ström, J., Hansson, H.-C., 2004. "An investigation of processes controlling the evolution of the boundary layer aerosol size distribution properties at the Swedish background station Aspöreten". *Atmos. Chem. Phys.*, 4, 2581-2592.
- Tunved, P., Nilsson, E. D., Hansson, H.-C., Ström, J., Kulmala, M., Aalto, P., Viisanen, Y., 2005a. "Aerosol characteristics of air masses in Northern Europe: influences of location, transport, sinks and sources". *J. Geophys. Res.*, 110, D07201.
- Tunved, P., Korhonen, H., Ström, J., Hansson, H.-C., Lehtinen, K. E. J., Kulmala, M., 2005b. "A pseudo-Lagrangian model study of the size distribution properties over Scandinavia: Transport from Aspöreten to Värriö". *Atmos. Chem. Phys. Disc.*, 4, 7757-7794.
- Tunved, P., Korhonen, H., Ström, J., Hansson, H.-C., Lehtinen, K. E. J., Kulmala, M., 2005c. "Is nucleation capable of explaining observed aerosol integral number increase during southerly transport over Scandinavia"? To be submitted.
- Vehkamäki, H., Dal Maso, M., Hussein, T., Flanagan, R., Hyvärinen, A., Lauros, J., Merikanto, J., Mönkkönen, P., Pihlatie, M., Salminen, K., Sogacheva, L., Thum, T., Ruuskanen, T. M., Keronen, P., Aalto, P. P., Hari, P., Lehtinen, K. E. J., Rannik, Ü., Kulmala, M., 2004. *Atmos. Chem. Phys.*, 4, 2015-2023.
- Wiedensohler, A., 1988. "An approximation of the bipolar charge-distribution for particles in the sub-micron size range". *J Aerosol Sci.*, 19 (3), 387-389.
- Wiinikka, H., 2005. "High Temperature Aerosol Formation and Emission Minimisation during Combustion of Wood Pellets". Doctoral dissertation at Luleå University of Technology, Dept. Of Applied Physics and Mechanical Engineering, Luleå, Sweden, ISSN 1402-1544.
- Wählin, P., 2003. "COPREM – A multivariate receptor model with a physical approach". *Atmos. Env.*, 37, 4861-4867.
- Wählin, P., Ketzler, M., Palmgren, F., 2003. "Dependence on meteorological conditions of traffic particle profiles measured in a street canyon in Copenhagen". Proceedings, 1st International Symposium on Incomplete Combustion, November 9 – 11, 2003, Kuopio, Finland.
- Wählin, P., Palmgren, F., 2005. "Source apportionment of locally generated PM in a busy road in Copenhagen". European Geosciences Union, General Assembly, Vienna, Austria, 24-29 April, 2005.
- Zanobetti, A., Schwartz, J., Samoli, E., Gryparis, A., Touloumi, G., Atkinson, R., Le Tertre, A., Bobros, J., Celko, M., Goren, A., Forsberg, B., Michelozzi, P., Rabczenko, D., Aranguiz Ruiz, E., Katsouyanni, K., 2002. "The Temporal Pattern of Mortality Responses to Air Pollution: A Multicity Assessment of Mortality Displacement". *Epidemiology*, 13, 87-93.
- Zhang, Q., Stanier, C. O., Canagaratna, M. R., Jayne, J. T., Worsnop, D. R., Pandis, S. N., Jimenez, J. L., 2004. "Insights into the Chemistry of New Particle Formation and Growth Events in Pittsburgh Based on Aerosol Mass Spectrometry", *Environ. Sci. Technol.*, 38, 4797-4809.
- Zhou, J., 2001. "Hygroscopic Properties of Atmospheric Aerosol Particles in Various Environments". Doctoral dissertation at Lund University, Dept. Of Nuclear Physics, Lund, Sweden, ISBN 91-7874-120-3.