



LUND UNIVERSITY

Spherical Machines: A Literature Review

Martinez, David

2005

[Link to publication](#)

Citation for published version (APA):

Martinez, D. (2005). *Spherical Machines: A Literature Review*. (TEIE; Vol. TEIE-7208). IEA.

Total number of authors:

1

General rights

Unless other specific re-use rights are stated the following general rights apply:

Copyright and moral rights for the publications made accessible in the public portal are retained by the authors and/or other copyright owners and it is a condition of accessing publications that users recognise and abide by the legal requirements associated with these rights.

- Users may download and print one copy of any publication from the public portal for the purpose of private study or research.
- You may not further distribute the material or use it for any profit-making activity or commercial gain
- You may freely distribute the URL identifying the publication in the public portal

Read more about Creative commons licenses: <https://creativecommons.org/licenses/>

Take down policy

If you believe that this document breaches copyright please contact us providing details, and we will remove access to the work immediately and investigate your claim.

LUND UNIVERSITY

PO Box 117
221 00 Lund
+46 46-222 00 00

Spherical machines: a literature review



David Martínez Muñoz

Department of Industrial Electrical Engineering and Automation
Lund University

Spherical machines: a literature review

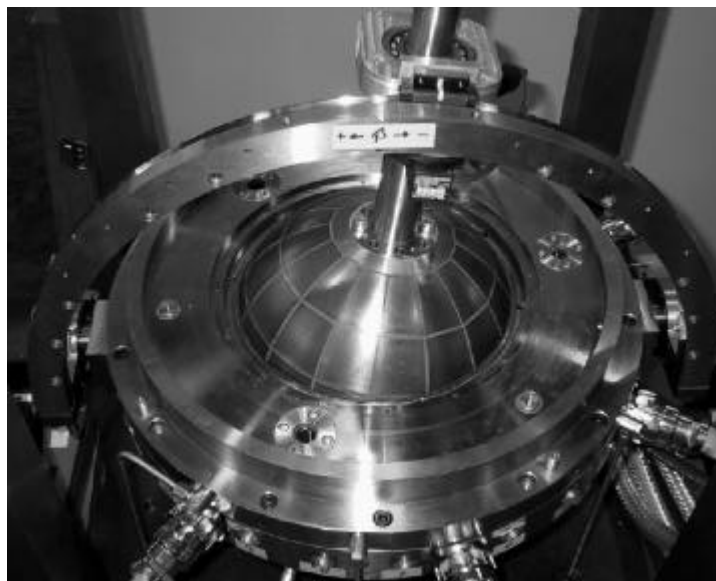

David Martínez Muñoz
Dept of Industrial Electrical Engineering and Automation,
Lund University, Sweden. 2005-03-01

This report contains a summary of the work with spherical electrical machines found in the specialised literature. Spherical actuators allow several degrees of freedom (DOF), which is particularly interesting in robotics. Complex movements are traditionally accomplished by combining several electrical machines with 1-DOF, ending up with an overweight actuator and accuracy problems due to tolerances. The research into multi-degree-of-freedom actuators has been ongoing for decades, the first designs dating from the late 1950's. However, competitive performance has not been achieved until power electronics and digital signal processors were incorporated in the controls, and therefore the literature reviewed in this report is mainly limited to the contributions done in the last decade. The report is mainly focused on the configurations presenting 3-DOF which have been successfully implemented in practice, although other potential topologies and 2-DOF systems are also reviewed.

Contents

Introduction	4
Permanent magnet machines	4
Induction machines	9
Reluctance machines	11
Other 2-DOF topologies	12
References	14

Introduction

Advances in robotics, office automation and intelligent flexible manufacturing and assembly systems have necessitated the development of precision actuation systems with multiple degrees of freedom (DOF). In general, however, motion with several DOF is currently realised almost exclusively by using a separate motor/actuator for each axis, which results in complicated transmission systems and relatively heavy structures. This inevitably compromises the dynamic performance, owing to the effects of inertia, backlash, nonlinear friction and elastic deformation of gears, for example. Actuators which are capable of controlled motion in two or more degrees of freedom can alleviate these problems, while being lighter and more efficient. A particular interesting configuration to perform these tasks is the spherical machine.

There are two main research groups that have worked with design of spherical electrical machines: one from the University of Aachen (Germany) and the other from the University of Sheffield (UK). Their machines consist of an inner spherical surface permanent magnet rotor included within a spherical stator with and without teeth. Only these two groups have succeeded in developing a prototype capable of moving with three DOF and relatively accurate position control, although the algorithms are complicated and require a considerable amount of power electronics. This, together with the high weight of the machines has been the main limiting factor for their commercial exploitation.

The latest contributions on spherical machines are pointing towards asynchronous motors rather than permanent magnets, and they have been developed in a couple of universities in Poland. However these concepts are already at a very early design stage, mainly focusing on simulations and how to achieve the movement of the rotor, while practical implementation and accurate controls are not yet reported. The purpose of this report is to provide an insight view of the different topologies found in the specialized literature regarding two and three degrees of freedom actuators suitable for robot applications.

Permanent Magnet Machines

RWTH Aachen

The research was financially supported by the Volkswagenstiftung. For investigations, a planar motor for motion in two dimensions was built as a test bench first. The experimental tests confirmed the results of the simulations and showed a maximum torque of more than 40 Nm and a high position accuracy. The planar motor has magnets arranged in lines and rows, which are mounted on a movable carriage. This carriage can move in x- and y- direction and can even turn around its z-axis. The motion is obtained by running current through the coils of the stator, which is mounted on a T-beam opposite to the magnets. The position accuracy with the planar motor was 5 micrometers.

The research on the spherical machine has been published in [1] and [2]. Pictures of the machine are shown in Fig. 1. The diameter of the inner sphere is 275 mm and the height of the pole shoes is 50 mm. The specified torque is 40 Nm in all positions. The rated speed is 12 rad/s. The gap between stator and rotor is approximately 40 micrometers. A high manufacturing accuracy is needed to build the elements of the inner and outer sphere. Oil inside the stator housing is used for the hydrostatic bearing and also for cooling purposes. The stator yoke is made of a soft magnetic powder composite with a relative permeability of 500, and it serves to reduce eddy current losses. In parked position or in case of a failure of the bearing system an additional mechanical brake is activated. The rotor consists of a sphere with 112 NdFeB permanent magnets, arranged in seven rows each having 16 magnets with alternating north and south orientation. The outer stator core

casing has 96 stator poles and windings. The rotor is supported by hydrostatic bearings built into the outer stator case. The working area is only limited by the opening angle of the case ($\pm 60^\circ$). The control hardware consists of three digital signal processor (DSP) boards, which offer 480 MFLOP computing power, memory for storing force characteristics, and a high number of input/output channels.

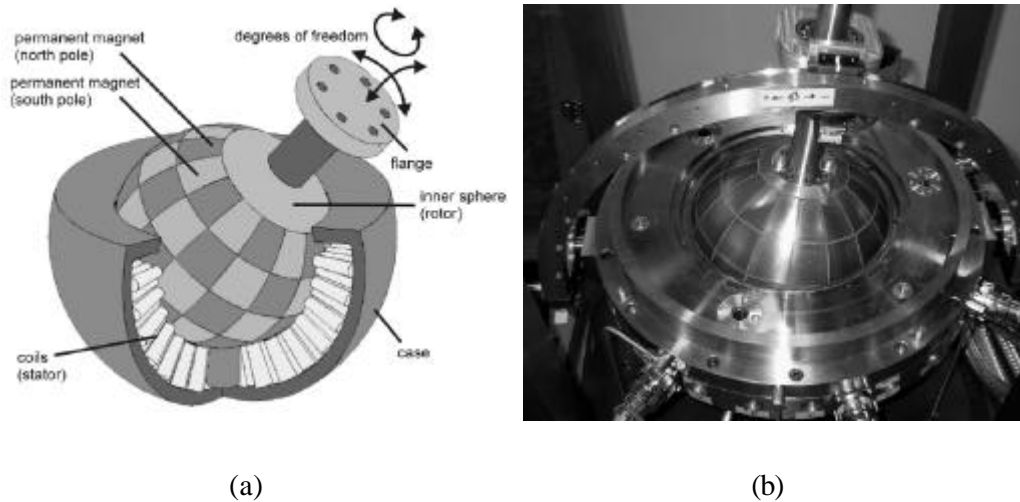

Fig. 1: (a) Principle of design; (b) Prototype and motor test bench.

The currents of the stator coils have to be controlled individually because the pole pitch can vary continuously during operation. This is due to the different sizes of the magnets and the variable tilt of the rotor. Consequently, 96 independent converter phase legs are needed. Each phase leg is controlled by a separate current regulator. In general, a positive or negative magnetic flux is needed to obtain the desired force produced by each coil. This is achieved by a positive or a negative current running through the stator windings, and a half-bridge converter was selected for each tooth. This has the advantage that only two switching elements are used per phase. This results in lower costs, higher reliability and ease of implementation compared to the full-bridge converter. The stator winding voltage is rated low for safety reasons (24 V). MOSFETs are used, given the low current and voltage requirements. They are ideal devices because they offer low losses, can be switched at frequencies above 20 kHz and require a simple gate driver. To avoid beat frequencies (giving high current ripple) a central clock was used to synchronize the PWM signals of all converter legs.

The force and associated torque produced by one stator winding can be represented by a partial vector. These characteristics are calculated in FEM and stored in look-up tables, since they are highly non-linear and cannot be described by simple equations. The total torque vector is the sum of the partial vectors and depends on all stator currents. Only the stator poles which are positioned above a permanent magnet boundary can produce significant torque. The poles which are located at the middle of a permanent magnet only produce radial forces. To calculate the local partial vector, the relative position of the magnets has to be used. Therefore, sensors are mounted on a special frame. The position control is realized by an outer control loop with position feedback. The 96 currents have to be calculated using only three independent variables of the command torque vector. There is an infinite number of combinations for the currents in the stator to achieve a certain movement. Three different methods were examined to solve this problem.

- a) *Vector search algorithm*: All partial vectors are sorted by magnitude and orientation. Subsequently, “the best” vectors are used to reach the final vector. The difficulties arise in the computing time and the difficulty in defining the correct definition of “the best” vector.
- b) *Vector approximation algorithm*: This algorithm minimizes the distance between each single force/torque vector and the final end vector, which is commanded by the outer control loop. The total calculation time is very short and is limited to 96 computation cycles.
- c) *Vector sorting algorithm*: This algorithm divides the single partial vectors into certain groups. The torque vectors produced by these groups are linearly combined to produce the desired torque vector. This technique was tested starting from three sectors (areas) but could be easily increased. The method results in a higher efficiency of the machine because only the most effective stator coils are used. On the other hand, it must be considered that with a higher number of areas (sectors) the calculation time for the control algorithm increases enormously.

The Vector Approximation and the Vector Sorting Algorithm were compared by simulation. In simulations, the Approximation Algorithm shows in some positions small deviations from the command signal. This is caused by the imprecise determination of the final vector with the single partial vectors. The result with the Sorting Algorithm is very accurate because it uses a linear combination. However, in the simulations with position control no difference can be detected on the position signals when using the two different algorithms. This means that the small torque deviations are filtered by the inertia or are regulated by the feedback signals. Another aspect is the efficiency and the peak stress of the machine. The Sorting Algorithm uses a high number of stator coils which means that the load is distributed over many stator coils. The Approximation Algorithm uses the same number of the stator pole windings in every control cycle. This means that the first stator coils in the sequence have to carry a high load while the others stay nearly unused.

The experiments showed that higher torque could be delivered than the minimum 40 Nm predicted in the simulations at all positions. The experiments also showed that a maximum deviation of 0.1° occurs. The main reason for this error is the fact that the exact determination of the force vectors is very difficult because mapping these forces using 3-D FEM calculations or measurements is time-consuming. Consequently, a precise feed-forward control was not realized. The most promising method is the sorting algorithm, which uses the motor very efficiently with no peak stress on single stator windings.

The present problem of the spherical motor in robot applications is the overweight of the motor. Therefore it is necessary to decrease the motor weight in the future work for practical robot applications. Another disadvantage is the complexity of the power electronics. It is not clear from the papers if the rotor is solid or hollow. Probably it is hollow, as the authors refer to a “sphere”, not a “ball”.

University of Sheffield

The group has developed a 3-DOF actuator (pan, tilt, rotational motion) [3], which carries a miniature video camera as its payload. The actuator has a four-pole spherical permanent magnet rotor, which is formed from two pairs of parallel magnetized quarter-spheres, and a single stator winding arrangement comprising four pairs of circular coils. A plot of the design and prototype is shown in Figure 2. The spherical rare-earth magnet rotor (NdFeB,

$B_r=1.25$ T, $\mu_r=1.07$) is housed within the spherical stator on a low friction surface coating. The stator coils are arranged so that three independently controllable torque components can be developed by energising the appropriate coil pairs. The stator can be either air-cored or iron-cored, by enclosing the windings with a spherical iron shell so as to increase the torque capability. When current is applied to the stator coils, the resulting torque will orientate the rotor so as to minimize the system potential energy. Thus, control of the rotor orientation is achieved by varying the coil currents. The specific force/torque capability of each axis of the actuator is similar to that of slotless/air-cored single-axis tubular linear motors. However, since it eliminates the need for a complex mechanical transmission system to realize the desired 3-DOF motion, the overall volumetric efficiency could be significantly higher.

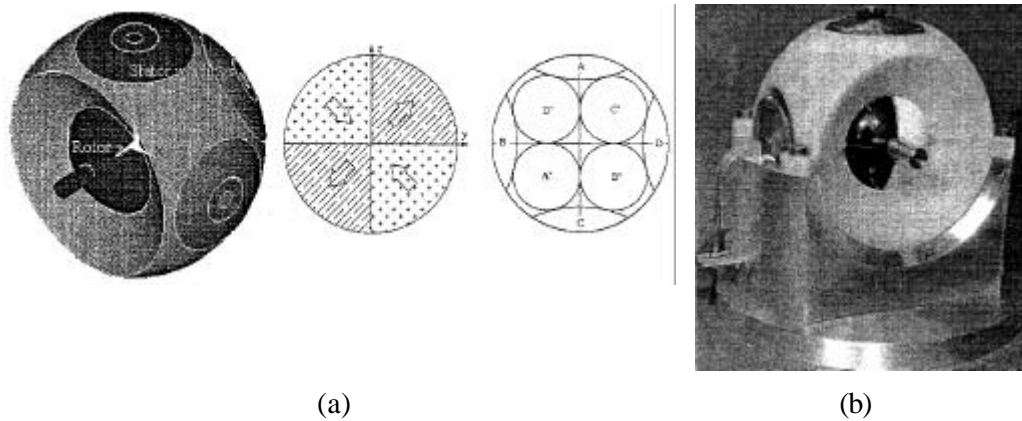

Fig. 2: (a) Principle of design; (b) Prototype and motor test bench.

The torque characteristic is expressed as a function of the ratio of the rotor radius to the outer radius of the stator windings, and from simulations it can be observed that there is a maximum around 0.75. For position control, a coordinate system is attached to the rotor, and Euler angles are defined between the rotating and stationary system. A rotational transformation matrix can then be built, which provides a unique mapping between an instantaneous rotor orientation and a set of Euler angles. For closed-loop control, it is necessary to have position feedback signals. The orientation of the rotor may be deduced by simply using six sensors.

A prototype was built and tested. Due to manufacturing tolerances both the rotor and the stator housing are not perfect spheres. This results in a significant amount of nonuniformly distributed stick-slip friction torque. The effect of the destabilising torque on the step and tracking responses are clearly visible. Nevertheless, the results demonstrate the operation of the spherical actuation system. However, the performance of the system can be improved significantly by exerting tight control on manufacturing tolerances or using an alternative bearing system, and air bearing, for example. An earlier 2-DOF version of the actuator above is presented in [4], allowing only pan and tilt.

In general, all the actuators analyzed so far have an aperture in the stator to allow access to the rotor so as to attach the external payload, and the effect of this aperture has been analyzed in [5]. The aperture modifies the magnetic field distribution, which in turn may degrade the performance of the actuator in three respects, since it may result in the following:

- a) an asymmetrical flux density distribution, which would affect the excitation torque versus rotor angular displacement characteristics;
- b) a reluctance torque component, due to the interaction of the permanent-magnet field and the asymmetrical stator iron geometry;
- c) asymmetry in the radial force distribution, and hence an “unbalanced magnetic pull”, which could impose a significant additional load on the bearing system.

The effect of the aperture was analyzed both with computational and experimental investigations. It was observed that the excitation torque characteristic is not modified to any great extent by the presence of the aperture. However, the presence of the aperture does introduce significant problems in terms of the resulting reluctance torque and unbalanced radial forces. Thus, while an iron-cored stator would increase the volumetric torque capability compared to an air-cored stator, it would also inevitably require a more complex rotor mechanical support arrangement, and thereby compromise one of the attractive features of spherical actuators, i.e. their relative simplicity.

Finally, another interesting area of research related to spherical actuators is Halbach permanent magnet machines [6]. Basically, the magnets present a changing magnetization, which provides a sinusoidal magnetic field. This is achieved using special magnetization devices for bonded isotropic or anisotropic ring magnets, or by assembling smaller pieces of magnets with different directions of magnetization. With the Halbach principle, rotor back-iron is not essential, since the return path is provided by the magnetization pattern. This reduces the rotor inertia. Furthermore, the sinusoidal field makes for negligible cogging torque and an essentially sinusoidal emf waveform, without recourse to conventional design features such as skewing of the stator/rotor, optimisation of the magnet pole-arc, distributed stator windings, etc. It is therefore appropriate for brushless AC motors, particularly those with slotless configuration. The main applications of Halbach magnetised machines are:

- a) High-speed motors/generators. For example in flywheel energy storage systems. This is due to their low iron loss.
- b) Servomotors. For example computer disks and electric power assisted steering. This is due to the low cogging torque and torque ripple.
- c) Linear machines. Such as material handling and semiconductor wafer stepping. Due to the low inertia and high airgap field and force capabilities, linear Halbach motors can achieve very high acceleration.
- d) Passive magnetic bearings/magnetic coupling. Actually Halbach machines are extensively been used for these applications.
- e) Spherical motors. In particular it is interesting the fact that no rotor back-iron is needed, which would alleviate the actual weight problems in spherical machines. Their lower torque ripple would also be an advantage for position control. With adequate magnetization techniques they could be more easily manufactured than conventional surface permanent magnet spherical machines.

Induction Machines

So far, the spherical machines analyzed are synchronous machines with a permanent magnet rotor. Traditionally, induction (asynchronous) spherical machines have not attracted commercial interests, probably due to the relatively complex stator core and winding arrangement and the inherently poor servo characteristics of induction motors. Nevertheless, it is worth presenting the latest work in spherical induction machines, which has been mainly developed at universities in Poland and Belgium.

The first topology has been presented in [7], and it is shown in Figure 3. The external surface of the rotor can be slotted (left picture) or smooth (right picture). In case of a smooth rotor, the winding is a thin, conducting layer of copper or other diamagnetic material. Rods made of diamagnetic, conducting materials, create a winding in case of slotted rotor. The rotor may be situated in the centre of the stator in such a way that distances between the rotor's surface and the stator are constant in the polar directions, or the rotor could even roll on the internal surface of the armature. The armature should have diametrically opposite pairs of coils. They are connected in series, so that when one of them acts as a North pole, the other acts as a South pole.

To cause rotation of the rotor around one of its polar axis, an armature should have additional elements, which can produce migration and rotation of the field around the polar axis. These elements can be additional armatures or modular magnetic circuits with double slot-tooth structure. The presented three-phase spherical induction motor has four symmetric situated modular exciters, with six slots each. The airgap radius is 50 mm and the outer stator radius 80 mm. The airgap is 0.4 mm.

Both topologies were evaluated by simulation using the Modeller in OPERA 3D. The shapes of the torque curves are quite similar for both constructions, and indicate that the starting torque grows with the rotor radius. However, the starting torque for the motor with smooth rotor is twice higher than for the motor with slotted rotor. It was observed that the starting torque depends very strongly on the thickness of the rotor copper layer. The largest starting torque is achieved for a very thin layer of copper (around 0.0005 m).

However, no experimental investigations were conducted. Also, no comments were made on the control system used to control the rotor position, which would be a disadvantage of this topology. This concept is on an early stage of investigation.

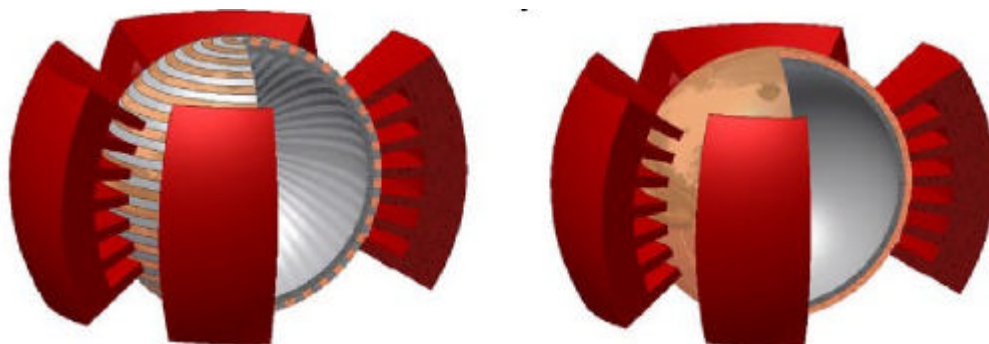

Fig. 3: Spherical induction motor (Poland).

An interesting idea has been cited in [8] about filling the gap of spherical machines with ferrofluids. A numerical model testing this idea is presented in [9]. The main purpose of ferrofluids in terms of electric effects is to fill air gaps in magnetic circuits in order to increase the permeability in the gap to reduce the magnetic resistance in the circuit. This leads to a decrease of the magnetising current and an increase of the efficiency. First

results from theoretical studies show that the magnetic resistance using a ferrofluid is reduced by about 10%, if the solid magnetic materials are taken into account. However, no experimental results have been reported.

Another topology of a 2-DOF spherical induction motor has been presented in [10], and the concept is shown in Figure 4. The stator consists of five separate inductors. There are four one-degree of freedom classic side-inductors and one two-degree of freedom (with crossed windings) inductor below the rotor. Such a configuration, combined with adequate alimentation of both systems of windings, provides the actuator with 2-DOF. In order to minimize the air-gap and avoid friction, aerostatic suspension of the rotor was used. The compressed air is delivered through the openings shown in Figure 4. A positive effect of such a solution is the cooling of the actuator. Three rotor structures were analyzed:

- a) massive rotor made of steel.
- b) two-layers rotor with inner steel layer and external copper layer.
- c) the two-layers-with-teeth rotor.

Analytical and finite element modeling proved that massive rotor's performances are much worse comparing to the rotor with an internal layer composed of iron and an external layer created of copper. However, for the rotor with teeth, not only the electromechanical conversion is better, but also the maximal torque produced is higher, around 20% more than option b) and 40% more than option a).

The distribution of the teeth in the rotor has to be as regular as possible in order to ensure torque isotropy. The most uniform distribution on a sphere is defined by the vertices of a regular icosahedron, i.e. formed of identical equilateral triangles, inscribed in this sphere. Additional vertices and face number were created by tessellation, which consists in adding new vertices in the center of each face of the considered solid. The vertices

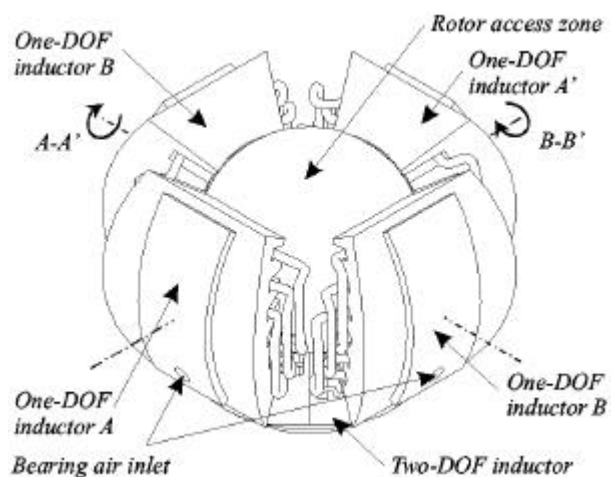

Fig. 4: Spherical induction motor (Belgium).

created like this are connected to the face vertices from which they result. Analyzing the number of teeth, some combinations were found given higher torque oscillations. Tessellation orders of six and higher avoid the combinations giving torque oscillations. Higher order tessellations also provides higher torque, but the manufacturing complexity and the rotor losses increase a great deal. Therefore it was concluded to keep the sixth order tessellation, and instead the width of the teeth was increased to increase the torque

response. The results and the topology are interesting but still, no mention of control strategies are provided to solve the low capability for position control in induction motors. Furthermore, the study is only theoretical with no confirmation by experimental results.

Reluctance Machines

The 3-DOF spherical motor presented in [13] operates on the principle of variable-reluctance (VR). The machine consists of two spheres as shown in Figure 7. These two spheres are concentric and are supported one on the other by bearing rollers in the gap. The stator poles are wound by coils and each coil can be energized individually. The ferromagnetic poles are strategically distributed on the stator surface. The rotor poles which have no coil are distributed on the rotor surface. Both the stator poles and the rotor poles are of circular shape. The measurement mechanism of the rotor orientation consists of two circular sliding guides one sliding block, and three encoders.

For simplicity in motion control, it is desired that the poles are evenly spaced on the stator and on the rotor following the pattern of regular polyhedrons. Each vertex of the polyhedron corresponds to the location of one pole. The regular polyhedrons are tetrahedron (4), octahedron (6), cube (8), icosahedron (12), and dodecahedron (20). The choice on the particular pattern influences the range of inclination. To provide 3-DOF motion, at least two independent torques which are not colinear acting on the rotor are required. Thus, it is necessary to have more stator poles than rotor poles. The mismatch is also necessary to avoid electro-magnetic singularities, when all the stator and rotor poles are fully overlapped.

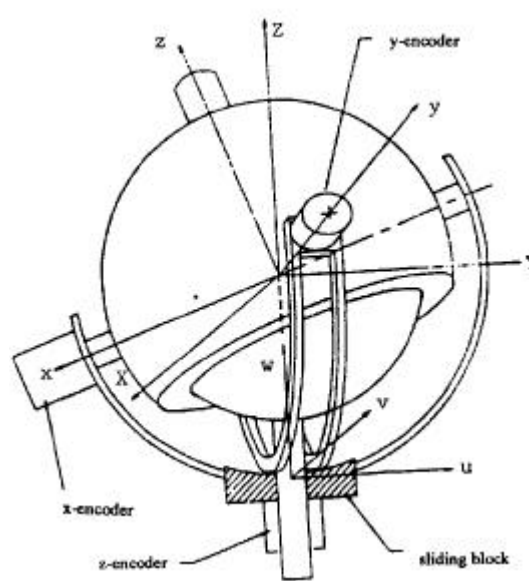

Fig. 7: Basic structure of the VR spherical motor.

Furthermore, each of the rotor poles must overlap at least three adjacent stator poles at any instant in order to actuate the rotor pole along any directions on the tangential surface of the stator. In addition, it is undesirable that any stator pole simultaneously overlaps with more than one rotor pole.

The paper presents a kinematic analysis of the spherical wrist actuator, and an exact relationship of the overlapping area in three dimensional space is derived analytically.

However, no experimental work is reported. In general, a VR motor has a relatively large range of motion, possesses isotropic properties in motion, and is relatively simple and compact in design. The trade-off however, is that a sophisticated control scheme is required.

An air bearing for this kind of machine was analyzed in [14]. The air bearing is essentially a regulator that tends to maintain the rotor at its equilibrium position. It is clean and has a cooling effect on interacting components, and does not interfere with the actuator electromagnetic system. The air bearing is characterized by three distinct flow regions; namely the restrictor, air pocket, and the annulus. Air enters the bearing from a pressure source, passes through the restrictor, flows through the annulus and then exhausts to the atmosphere. To maintain the rotor in equilibrium at the stator center, the air bearings are designed to direct their forces at the vertices of polyhedrons towards the stator center. Thus, once the bearing locations are specified, the directions of the bearing forces are considered known. Theoretically, the minimum number of simple point bearings required to achieve bi-directional position control of the spherical rotor in a three-dimensional space is four.

Another attractive approach to the air bearing concept, is to design a compound unit so that pressurized air passes through the center of the electromagnetic pole enabling it to also serve as a bearing. The advantages of a compound unit are twofold:

- a) The air-jet will provide cooling effect to the electromagnetic pole coil windings.
- b) The design will optimize the stator surface by maximizing the size of each bearing, thereby enhancing load-bearing capacity.

The detailed kinematics of air bearings are analytically described in the paper, and evaluated by simulation. The results indicate that the magnetic disturbance is adequately compensated by the air-bearing system since the force has little impact on the air bearing dynamics.

Other 2-DOF Topologies

Some other topologies have been found for 2-DOF actuators that are worth including in the survey. Sokolov et al. [11] presented an actuator for a laser light pointer mounted on the working head, see Figure 5. The spherical direct drive actuator consists on a constant magnet rotor fastened in gimbals and located between two pairs of crossed solenoids. The windings of each pair of solenoids are located in alignment and are connected in phase for a mechanical moment magnification enclosed on a magnet rotor. Such disposition of the windings allows, in the first approximation, to neglect their mutual influence and mutual induction. Position is measured by means of four Hall sensors, and a control system is used to excite the adequate coils depending on the position error.

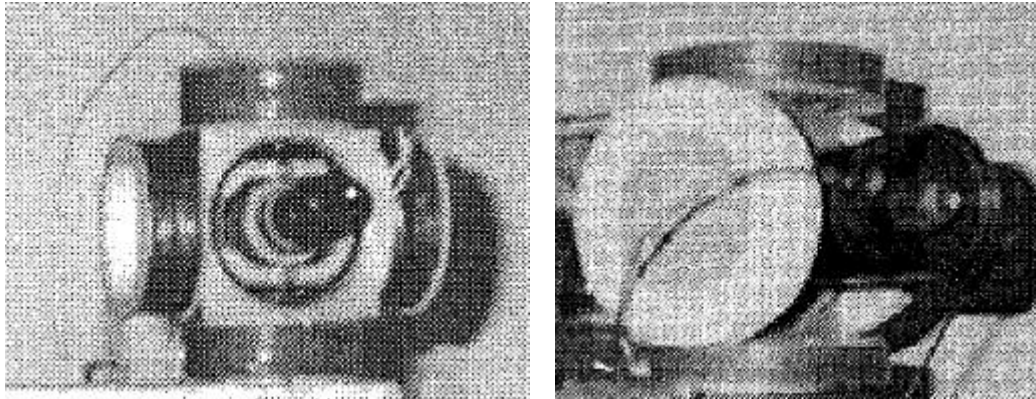

Fig. 5: Two views of Sokolov's machine.

A miniature spherical pointing motor was presented by Bederson et al. [12], suitable for applications in active vision. The principle is similar to the machine presented above [11]. The motor consists of three orthogonal motor windings in a permanent magnetic field, configured to move a small camera mounted on a gimbal, see Figure 6. It is an absolute positioning device and is run open-loop. The basic principle is to orient a permanent magnet to the magnetic field induced by three orthogonal motor windings by applying the appropriate ratio of currents to the three coils. Coils A and B control the tilting, while coils A and C control the panning. The position of the rotor can be calculated given the currents applied to the three coils. However, due to manufacturing tolerances, the calculated currents give only an approximation to the actual position of the motor. Therefore the motor had to be calibrated to associate motor positions with the related set of currents that move the motor to these positions. An open-loop controller was implemented successfully, but for higher performance a velocity or position sensor could be added to run the motor with a closed-loop control strategy. The prototype is 4x5x6 cm, weights 160 gr and is capable of actuating a 15 gram load. Its total workspace is approximately 60° . The position of the motor could be achieved in steps no smaller than 0.011° .

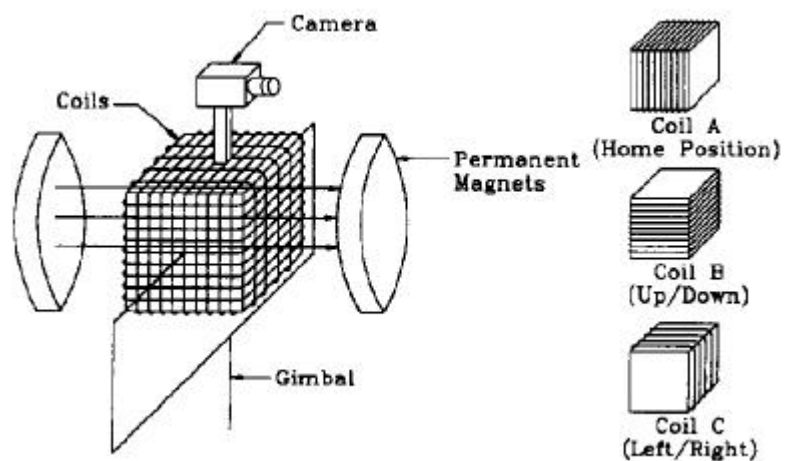

Fig. 6: Picture of Bederson's pointing motor principle.

References

- [1]. K. Kahlen, I. Voss, C. Priebe and R.W. De Doncker, "Torque control of a spherical machine with variable pole pitch", IEEE Trans. Power Electron., Vol. 19, No. 6, pp. 1628-1634, 2004.
- [2]. K. Kahlen and R.W. De Doncker, "Current regulators for multi-phase permanent magnet spherical machines", IEEE Industry Applications Conf. Rec., 2000, Vol. 3, pp. 2011-2016.
- [3]. W. Wang, J. Wang, G.W. Jewell and D. Howe, "Design and control of a novel spherical permanent magnet actuator with three degrees of freedom", IEEE Trans. Mechatronics., Vol. 8, No. 4, pp. 457-468, 2003.
- [4]. J. Wang, G.W. Jewell and D. Howe, "Analysis, design and control of a novel spherical permanent-magnet actuator", IEE Proc.- Electr. Power Appl., Vol. 145, No. 1, pp. 61-71, 1998.
- [5]. J. K. Mitchell, G. W. Jewell, J. Wang, C.M. Bingham and D. Howe, "Influence of an aperture on the performance of a two-degree-of-freedom iron-cored spherical permanent-magnet actuator", IEEE Trans. Magnetics. Vol. 38, No. 6, pp. 3650-3653, 2002.
- [6]. Z.Q. Zhu and D. Howe, "Halbach permanent magnet machines and applications: a review", IEE Proc.- Electr. Power Appl., Vol. 148, No. 4, pp. 299-308, 2001.
- [7]. G. Kaminski and A. Smak, "Induction motors with spherical rotor", ICEM'04 Conf. Proc., Sept. 2004, Cracow, Poland, 4 pp.
- [8]. D. Spalek and K. Waleczek, "Spherical induction motor with ferrofluids in gap", ICEM'04 Conf. Proc., Sept. 2004, Cracow, Poland, 6 pp.
- [9]. A. Nethe, T. Scholz, H.D. Stahlmann and M. Filtz, "Ferrofluids in electric motors – A numerical process model", IEEE Trans. Magnetics., Vol. 38, No. 2, pp. 1177-1180, 2002.
- [10]. G. Galary, B. Dehez and D. Grenier, "Finite element modeling of a two-degree of freedom spherical actuator", ICEM'04 Conf. Proc., Sept. 2004, Cracow, Poland, 6 pp.
- [11]. S.M. Sokolov, O.V. Trifonov and V.S. Yaroshevsky, "Research of spherical direct drive actuators control systems", IEEE Int. Conf. on Robotics & Automation, May 2001, Seoul, Korea, 6 pp.
- [12]. B.B. Bederson, R.S. Wallace and E.L. Schwartz, "A miniature pan-tilt actuator: the spherical pointing motor", IEEE Trans. Robotics & Automation, Vol. 10, No. 3, pp. 298-308, 1994.
- [13]. K.M. Lee and J. Pei, "Kinematic analysis of a three degree-of-freedom spherical wrist actuator", Fifth Int. Conf. On Advanced Robotics, Atlanta, USA pp. 72-77, 1991.
- [14]. D.E. Ezenekwe and K.M. Lee, "Design of air bearing system for fine motion application of multi-DOF spherical actuators", IEEE Int. Conf. on Advanced Intelligent Mechatronics, Sept. 1999, Atlanta, USA, 7 pp.