



LUND UNIVERSITY

The water-supply system in Roman Pompeii

Olsson, Richard

2015

[Link to publication](#)

Citation for published version (APA):

Olsson, R. (2015). *The water-supply system in Roman Pompeii*. [Licentiate Thesis, Classical archaeology and ancient history].

Total number of authors:

1

General rights

Unless other specific re-use rights are stated the following general rights apply:

Copyright and moral rights for the publications made accessible in the public portal are retained by the authors and/or other copyright owners and it is a condition of accessing publications that users recognise and abide by the legal requirements associated with these rights.

- Users may download and print one copy of any publication from the public portal for the purpose of private study or research.
- You may not further distribute the material or use it for any profit-making activity or commercial gain
- You may freely distribute the URL identifying the publication in the public portal

Read more about Creative commons licenses: <https://creativecommons.org/licenses/>

Take down policy

If you believe that this document breaches copyright please contact us providing details, and we will remove access to the work immediately and investigate your claim.

LUND UNIVERSITY

PO Box 117
221 00 Lund
+46 46-222 00 00



The water-supply system in Roman Pompeii

Richard Olsson



LUND UNIVERSITY
Department of Archaeology and Ancient History
Thesis for a licentiate degree

Lund University
Department of Archaeology and Ancient History
Thesis for a licentiate degree

The water-supply system in Roman Pompeii

Richard Olsson



LUND UNIVERSITY
Department of Archaeology and Ancient History
Thesis for a licentiate degree

Richard Olsson

Lund University
Department of Archaeology and Ancient History
Thesis for a licentiate degree

Copyright: Richard Olsson, Lund University
ISBN 978-91-87833-40-3

Printed in Sweden by Universitetsservice US-AB, Stockholm 2015.

English editing: Carole Gillis.

Distributed by The Department of Archaeology and Ancient History, Lund University.

Cover illustration: Water tower no. 1 and street fountain no. 19. Photo by the author.

Richard Olsson

Abstract

This study focusses on the urban infrastructure for water supply in Roman Pompeii. The water distribution network of lead pipes was constructed inside the city walls, at the time when the city was connected to an aqueduct. Life for the Pompeians changed considerably when aqueduct water started running continuously in street fountains all around the city. The study is based on previous research and on my own investigations and measurements on site in connection with the Swedish Pompeii Project.

The thesis presents a new interpretation of the main water system, in specific, the interconnection of the water towers. Three main water pipelines were connected from a distributor building, *Castellum Aquae*, located at the highest level in the city, and supplied water to the top containers on at least fourteen water towers. The main water system worked on the principle that water could flow down from the top container of one water tower to the next provided that this was located at a lower level.

Investigations and measurements of the vertical grooves on the sides of the water towers support my conclusion that two of the water towers were designed to supply water to two public baths. Three of the water towers were built with a groove for a connection to other water towers in the not yet excavated parts of the city.

The study also presents a small part of the water distribution for public and private use. The design of individual pipes from the top container of water towers to all street fountains, public baths, houses and workshops was based not only on the shortest distance between water tower and water user, but also on the head between the level of the top container and the level of the water user.

It is argued in the study that the planning of the water infrastructure was a complex procedure. The design engineer in antiquity had to consider changes in the operation of the system and changes in the demand from water users.

Keywords: Pompeii, Water supply, Water towers, Public baths, Street fountains.

Lund University
Department of Archaeology and Ancient History
Thesis for a licentiate degree

Richard Olsson

Contents

Acknowledgements

1. Introduction

- 1.1 The aim of the study
- 1.2 Definitions and methods
- 1.3 Previous research and its relation to this thesis
 - 1.3.1 On the aqueduct and the *Castellum Aquae*
 - 1.3.2 On water towers
 - 1.3.3 On the main water system
 - 1.3.4 On water supply for public use
 - 1.3.5 On water supply for private use
 - 1.3.6 On pipe dimensions

2. The main water system

- 2.1 The aqueduct and the *Castellum Aquae*
- 2.2 The water towers
 - 2.2.1 Technical assessment of the function of the water tower
 - 2.2.2 Location of the water towers
 - 2.2.3 Heights of the water towers
 - 2.2.4 Distance between the water towers
 - 2.2.5 Grooves in the water towers
 - 2.2.6 The top containers of the water towers
- 2.3 The three main water pipelines
 - 2.3.1 Description of water tower no. 1
 - 2.3.2 Description of water tower no. 7
 - 2.3.3 Description of water tower no. 12
 - 2.3.4 The beginnings of the three main water pipelines
 - 2.3.5 All other water towers in the main water pipelines
 - 2.3.6 The western water pipeline
 - 2.3.7 The central water pipeline
 - 2.3.8 The eastern water pipeline

3. Water supply for public use

- 3.1 Water supply to the street fountains
 - 3.1.1 Location and design of street fountains
 - 3.1.2 Water pressure in the distribution network
 - 3.1.3 Water supply to street fountains in the north-western part of the city
 - 3.1.4 Water supply to street fountains in the south-western part of the city

- 3.1.5 Water supply to street fountains in the central part of the city
- 3.1.6 Water supply to street fountains in the south-eastern part of the city
- 3.1.7 Water supply to street fountains in the north-eastern part of the city
- 3.2 Water supply to the public baths
 - 3.2.1 The Stabian Baths
 - 3.2.2 The Forum Baths
 - 3.2.3 The Suburban Baths
 - 3.2.4 The Sarno Baths
 - 3.2.5 The Central Baths

4. Water supply for private use

- 4.1 Water supply to houses
 - 4.1.1 Water supply from water tower no. 2
 - 4.1.2 Water supply to houses in *insula* V 1
 - 4.1.3 Water supply to houses in *insula* VI 14
 - 4.1.4 Water supply to houses in *insula* VII 3
 - 4.1.5 Water supply to houses in *insula* IX 4
 - 4.1.6 Water connections from water tower no. 2
- 4.2 Water supply to workshops
 - 4.2.1 Water supply from water tower no. 9
 - 4.2.2 Water connections from water tower no. 9

5. Discussion

- 5.1 Discussion on the planning procedure
- 5.2 Discussion on the water quantity
- 5.3 Discussion on the operation of the system

6. Summary and conclusions

Sammanfattning (Summary in Swedish)

Appendices

- App. 1 Tables
- App. 2 Catalogue of water towers
- App. 3 List of figures
- App. 4 Bibliography

Acknowledgements

After forty years in different management positions in Swedish industry, I retired and enrolled as a student at the Department of Archaeology and Ancient History at Stockholm University. During the last ten years of my professional career, I had conducted business in Egypt and other countries in the Middle East and acquired an interest in ancient history, among other things, visiting magnificent monuments created during antiquity.

I am very grateful to Professor Anne-Marie Leander Touati, who has been the main supervisor for my work on the Bachelor's and Master's theses. She encouraged me to participate in the field campaigns of the Swedish Pompeii Project in 2009 and 2012, which gave me first-hand experience of the ancient city. With her vast knowledge she has been a constant supporter of my work, always ready to correct any mistakes and to give guidance and new perspectives. After she was appointed Professor at the Department of Archaeology and Ancient History at Lund University, she encouraged me to carry on my education and get a licentiate degree at Lund and became my assistant supervisor.

Henrik Gerding is a Senior Lecturer in Archaeology and Ancient History at Lund University and has been my main supervisor during this work. I am very grateful to him for his constructive criticism and competent support throughout the development of my thesis. Indefatigable, he has read and commented upon all my ideas. He is to thank for all the contributions and discussion that made my thesis better. All mistakes are of course my own. I wish also to thank Carole Gillis for her editing my English.

I wish also to thank the staff of the Soprintendenza speciale per i beni archeologici di Pompei, Ercolano e Stabia, actually headed by professor Massimo Osanna, at the time of my study by professor Piero Giovanni Guzzo, and the personnel of the Direzione degli Scavi on site. I would also like to thank the personnel of the Swedish Institute in Rome for and all members of the Swedish Pompeii project for their support.

The inspiration I received from professors and colleagues at the higher seminar was invaluable, especially for giving me new insights when I needed them. I have had the privilege to be able to participate in the higher seminar of the Department of Archaeology and Ancient History in both Lund and Stockholm and I have benefitted from many discussions on different topics, for which I am deeply grateful. My different personal networks from my professional career and from my social contacts have always encouraged me and given great support. Most of all I would like to thank my wonderful family.

Richard Olsson
June, 2015

Richard Olsson

Lund University
Department of Archaeology and Ancient History
Thesis for a licentiate degree

Richard Olsson

1. Introduction

Water is essential for human life. When building cities, the availability of water is of great importance. This was also the case for the city of Pompeii. In the beginning Pompeii was supplied with water from wells and from rainfall that was collected and stored in cisterns. The Romans had great knowledge of hydraulics and constructed aqueducts to supply water to their cities. When Agrippa was responsible for the water supply to Rome from 33 BC until his death in AD 12, the system was developed and the number of aqueducts was increased from four to seven.¹ It seems probable that during the same period under Roman rule, the city of Pompeii was connected to an aqueduct from Serino built to supply a number of cities along the Bay of Naples with water.² The Serino aqueduct was a complex and costly project and it became the most important water resource for the city for more than a century. At the same time, an urban water infrastructure was built inside the city to distribute water to all water users. This was also a complex task as Pompeii was located at the foot of the Vesuvius volcano and the city sloped from north to south. The water distribution system had to be designed to reduce water pressure in the pipelines to a suitable level.

Obviously during such a long time as a hundred years, the water-supply system had to be repaired and modernized a number of times. Archaeological remains present in modern times can give us only an idea of how the system was working at the end of its lifetime, when Pompeii was buried in ashes from the volcano in AD 79. We know however that the water supply system had to be repaired after an earthquake that struck the city in AD 62 (or in AD 63).³ At that time, Pompeii was severely damaged, buildings were destroyed and there is good reason to believe that water pipelines were broken. This was probably also the case shortly before the eruption of Vesuvius in AD 79 because there were, as we shall see, ditches along the streets full of *lapilli* where water pipes were expected to be found.

1.1 The aim of the study

The aim of this thesis is to analyse and to give a description of the urban water infrastructure in Pompeii based on previous research and my own field investigations and measurements carried out on-site. In my work both on- and off-site, I am greatly indebted to the support of the Swedish Pompeii Project (documenting and studying insula V 1). My focus will be on the discussion concerning the distribution of water in lead pipes located in the streets. This will be somewhat hampered because when lead pipes were found in the streets, they were generally removed, and only a few pipes were found in scientifically conducted archaeological excavations, and even then in a fragmented state. I have measured the heights of the water towers and calculated the head (see definition below) as a way to discuss the interconnections between the towers. I have also calculated the head to public and private users. A hypothetical model of the urban water

¹ Frontin. *Aq.* 9.

² Hodge 1992, 282.

³ Wallace-Hadrill 2003.

infrastructure will be created and presented in three parts: the main water system, the water supply for public use and the water supply for private use.

Even though the aim of the present study is mainly of a technical nature, it is based on a basic categorisation of the water-supply system, in which technical properties can be shown to mirror societal order and priorities. Demonstrating the working of this tripartite system is an aim in itself. The three pillars of my study, presented below, deal with how water was led through the city and how it was distributed according to two different principles: a permanent flow to public users and an interruptible flow to (mainly) private users.

The main water system comprises the three main water pipelines going from the *Castellum Aquae* to the top containers of the water towers in the city. The top containers are parts of the main water system. The heights of the water towers and the design of the grooves in the towers will be shown to have had importance when designing the main water system. A new interpretation of the course of the three main water pipelines is presented. A possibility for the location of further water towers in the not yet excavated parts of the city is suggested. A technical description of the function of the main water system is also presented.

The water supply for public use comprises all distribution pipes going from the top containers of the water towers to the street fountains and the public baths. A plausible design of the pipe connections in the streets to most of the street fountains will be presented. The question of whether the existence of two public baths was already taken into consideration when designing the main water system with water towers in the city will be discussed. A new interpretation of the aqueduct water supply to these two public baths will be presented. The pipe connections to the three later public baths will also be taken up.

The water supply for private use comprises all distribution pipes going from the top containers of the water towers to the houses and workshops. The design of the pipes was aimed at maintaining a stable water pressure in the top containers, enabling a private water user to open or close his water supply without disturbing the water flow to another private water user. The design of the water supply for private use thus allowed a new user to be connected to a top container at any time.

This comprehensive presentation of the urban water infrastructure in Pompeii will be a new contribution to the knowledge of the use of water and will give a better understanding of the urban planning in Roman cities.

1.2 Definitions and methods

The terminology used in this thesis comprises some concepts that need to be carefully defined. The basic terms are the following:

Richard Olsson

The term water supply will be used to describe the water supplied to the city from an aqueduct and distributed throughout the city through pipelines to the different water users. The term will thus not comprise water that was collected from rainfall or water that was drawn from wells nor will it include all drainage removing water from the city.

The term Roman Pompeii limits the study in time and space. Pompeii is the city inside its walls and Roman is the time from the establishment of the city as a Roman colony in 80 BC until the eruption in AD 79. See Fig. 1.1 below.

The term system will comprise all building works, water pipes and other components necessary for establishing a full infrastructure for water supply in the city. The intention is to be explicit and by doing so clarify and contribute to the development of research terms. Within the term 'system' there will be a number of definitions that will be used.

I have introduced the term main water system for the three main water pipelines going from the *Castellum Aquae* to the top containers on all water towers in the city. The term will also include the top containers.

Castellum Aquae is a building still *in situ* close to the town wall at *Porta Vesuvio*, which is a town gate located in the north at the highest level in the city, where the incoming aqueduct is connected to the water supply system of the city. The building could be mistaken for a water cistern built to ensure the water supply, but it functioned merely as a distributor for the incoming water from the aqueduct to the three main water pipe lines.

The term water tower will be consistently used for the solid constructions built to hold up a water container. During the archaeological excavations fourteen such water towers have been found so far, and they are sometimes called water pillars or water citadels by other researchers. The water towers have a rectangular cross section and are constructed with a vertical indentation (see 'groove', below) on one, two or three sides going from the base of the water tower at street level up to the water container on the top. The water towers were designed to reduce the water pressure.

The term grooves will be used to describe the vertical indentations on the sides of the water towers. They were intended to house and protect main water pipelines taking water from street level up to the top container on one side of the water tower, and to house and protect other main water pipe lines on one or two of the other sides taking water away from the top container down to street level, mostly to the next water tower. Some grooves for other purpose are identified.

The term top container will be used for the rectangular leaden boxes open at the top. They were located on top of the water towers but now missing. They were designed for the purpose of water distribution to the public and private water users near-by.

Richard Olsson

The term head is defined as the difference in level between the water surface in the top containers of two interconnected water towers. The term is also used for a similar difference in level between the water surface in the top container of one water tower and the level of the opening of a water distribution point.

The term water storage tank will be used for large receivers built on top of the public baths.

The term water supply for public use I have reserved for all distribution pipes going from the top containers to all public water users in the city, i.e., the street fountains and the public baths.

The term water supply for private use will be used in the same way for all distribution pipes going from the top containers to all private water users in the city, the houses and the workshops. One pipe for each user was connected to the top container.

The description of the water infrastructure in Pompeii needs to consider a number of prerequisites regarding the functioning of the system. The main water system had to have been designed to guarantee that all top containers on the water towers were supplied with water, implying that only a small portion of the water in a certain top container could be supplied to users and a large portion of the water would pass through the top container to the next one. The water pressure in the system providing water to the street fountains should be constant to ensure a steady water flow. The public baths required a large but varying water supply and were thus designed to have a storage tank on top of the building. The water supply for private use to a house or a workshop should be independent of any opening or closing of a water valve in a neighbouring house or workshop.

The main water system will be studied from the premise that aqueduct water could be passed from the top container of one water tower up to the top container of the next water tower through the force of the atmospheric pressure, provided that the second top container was located at a level lower than the first one. The heights of all water towers as well as their locations in the city have been investigated to establish the reasonable, consecutive order in which the top containers received their water, and thereby to present the plausible direction of the three main water pipe lines. Further, all grooves in the water towers have been studied on the basis of a hypothesis that all grooves were designed for a purpose. Measurements of all water towers, the size of all the grooves, the orientation of the water towers and the grooves themselves are presented to establish which grooves were designed to house and protect the pipes in the main water system. It will also be suggested, that there were grooves meant to house and protect pipes intended to be connected to unknown water towers located in the parts of Pompeii that so far have not been excavated.

The water supply for public use will be studied for all street fountains and for public baths. It will be shown that there were grooves meant to house and protect water pipes intended to supply two public baths with aqueduct water. All water users were supplied with aqueduct water from the top
Richard Olsson

container of a water tower through a separate small pipe normally installed in the pavement or in the street. I will discuss the location and height for the top containers and for the water users and calculate the difference in height between top containers and water users. Together with the findings from some archaeological investigations in the pavements, it will be possible to make a plausible interpretation concerning the location of some of the distribution pipes in the distribution network. The water supply for private use will be discussed in the same manner: however, only water pipe connections in selected areas to some houses and workshops will be presented.

1.3 Previous research and its relation to this thesis

1.3.1 On the aqueduct and the *Castellum Aquae*

Roman Pompeii was supplied with water from an aqueduct reaching the city at the highest level at *Porta Vesuvio* and connected to the water infrastructure inside the city walls at the *Castellum Aquae*. This aqueduct was built from a city, Serino, supplying all cities along the Bay of Naples with water from a source some 96 km from Pompeii at a level a.s.l. (above sea level) of about 370 m.⁴ The water intake at the *Castellum Aquae* was about 43 m above sea level (+ 43 m).⁵ The inclination of the aqueduct was on average consequently 3.4 m per km or about 0.3 %. *Fig. 1.1* shows the *Castellum Aquae* at the *Porta Vesuvio* and the streets in the city.

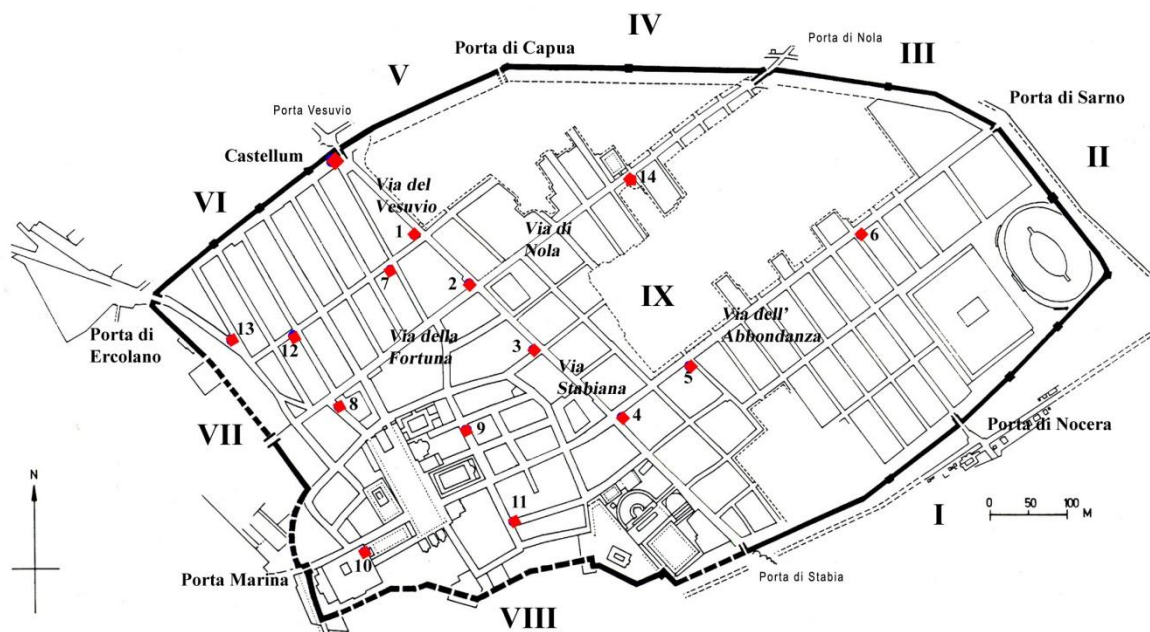

Figure 1.1. City plan of Pompeii with town gates, main streets and the numbers of the *insulae* (in roman numerals) in black and water towers in red. Drawing by author.

⁴ Eschebach 1996, 3 and n. 9, indicating oral information from A. Casale and M. Pagano.

⁵ The level above sea level (a.s.l.) will be indicated with a + and a figure.

The aqueduct and the water intake have been studied by Christoph Ohlig and presented in his doctoral thesis and in the article ‘Neue Fakten zur Wasserversorgung Pompejis’.⁶ Ohlig was of the opinion that Pompeii had two phases in the supply of aqueduct water: a first aqueduct, built in the days of Sulla and later, a second aqueduct, connected when the Serino aqueduct had a branch leading to the city. Ohlig made chemical analyses of the sinter from the walls of the aqueduct of Pompeii and several other aqueducts, and concluded that in the first phase the water could not have come from the Serino region, and that of the second phase seems to be a mixture of water from the Avella and the Serino region. In a review of Ohlig’s paper, Andrew Wilson generally supports his arguments and conclusions.⁷ Wilson remarked however that the Sullan date of an earlier aqueduct, although highly plausible, is still only a hypothesis. Later, Ohlig’s hypothesis has been questioned by Gemma Jansen,⁸ and rejected by Andrea Schmölder-Veit.⁹ The latter pointed out that no archaeological evidence has been found that confirms an aqueduct coming from Avella, the only other location at a high enough level to supply water to Pompeii. If there was an earlier aqueduct, the water supply system would have been affected when the second was connected.

Ohlig also discussed two branches of the aqueduct just outside the city walls at *Porta Vesuvio*, one branch going east and one going west.¹⁰ He was of the opinion that the branch going east was closed already during antiquity. It could have been a connection to a water channel entering the city at *Porta di Capua*. The branch going west was discussed by Liselotte Eschebach.¹¹ She considered this branch to be a connection to a water tower built inside VI 1, 6-8. 24-26, *Casa delle Vestali*. Rick Jones and Damian Robinson made an investigation of this house and presented a hypothesis that a new cistern was constructed in the house after the earthquake in AD 62.¹² In this thesis I am not going to discuss the branches of the aqueduct outside the city walls, but instead focus on the urban water infrastructure from the *Castellum Aquae* inside the city walls. Ohlig made a major contribution in describing the design, the construction and the function of the *Castellum Aquae* in his article ‘Anmerkungen zum Funktionsmodell des Castellum Aquae im antiken Pompeji’.¹³ He emphasised that this Roman building acted only as a regulator and a distributor. On the floor inside the *Castellum Aquae* there was a device to control the water flow to the three main water pipelines going out through the south façade. The responsible water engineer could easily give priority to one or two of the outgoing pipelines.

Jean-Pierre Adam and Pierre Varène studied the architectural design of the *Castellum Aquae*.¹⁴ The *Castellum Aquae* is a square building but has a circular cupola with a diameter of 5.8 m, built by the

⁶ Ohlig 2001 and 2002.

⁷ Wilson 2006.

⁸ Jansen 2007, 259-260.

⁹ Schmölder-Veit 2009, 120-121.

¹⁰ Ohlig 1996, 20.

¹¹ Eschebach 1996, 3.

¹² Jones & Robinson 2005, 705-706.

¹³ Ohlig 1996.

¹⁴ Adam & Varène 2008.

Romans in all probability during Augustan times. Adam and Varène argue that the southern façade has a symmetrical architectural design in three parts with Roman arches, something that was also typical for that period.

The *Castellum Aquae* in Pompeii had three outgoing main water pipelines. In his book on architecture Vitruvius described such a tripartite organisation of the main water system.¹⁵ He recommended one main water pipe line for the street fountains, a second main water pipeline for the public baths and a third main water pipeline for private use. The Vitruvian system was not used in Pompeii, however. It would have made it necessary to build three separate water pipelines parallelly all over the city. Instead, the three main water pipelines distributed water regionally to the eastern, central and western part of the city.

Inside the *Castellum Aquae* there was an arrangement on the floor to divide the incoming water from the aqueduct in three separate water flows. Trevor Hodge showed the distribution arrangement in his article ‘Anomalies in flow at the Pompeii Castellum’.¹⁶ He argued that the capacity of the three outgoing pipe lines was much larger than the water supply from the aqueduct, based on the cross-sections. He stated that the largest water pipe in the middle opening may have taken half of the water flow and that the water pipes in the other two openings took one third and one sixth respectively.

1.3.2 On water towers

The water towers in Pompeii have been discussed by many scholars. Hans Eschebach described the location of fourteen constructions, as shown in *Fig 1.2*.¹⁷ He classified nine of them as water towers, four as water pillars and one as a water citadel.¹⁸ I will use the locations as described by Eschebach, but the term water tower will be used for all fourteen structures given as nos. 1 to 14 which I have classified as water towers.

¹⁵ Vitr. *De Arch.* 8.6.2.

¹⁶ Hodge 1996.

¹⁷ Eschebach 1993.

¹⁸ Eschebach 1993.

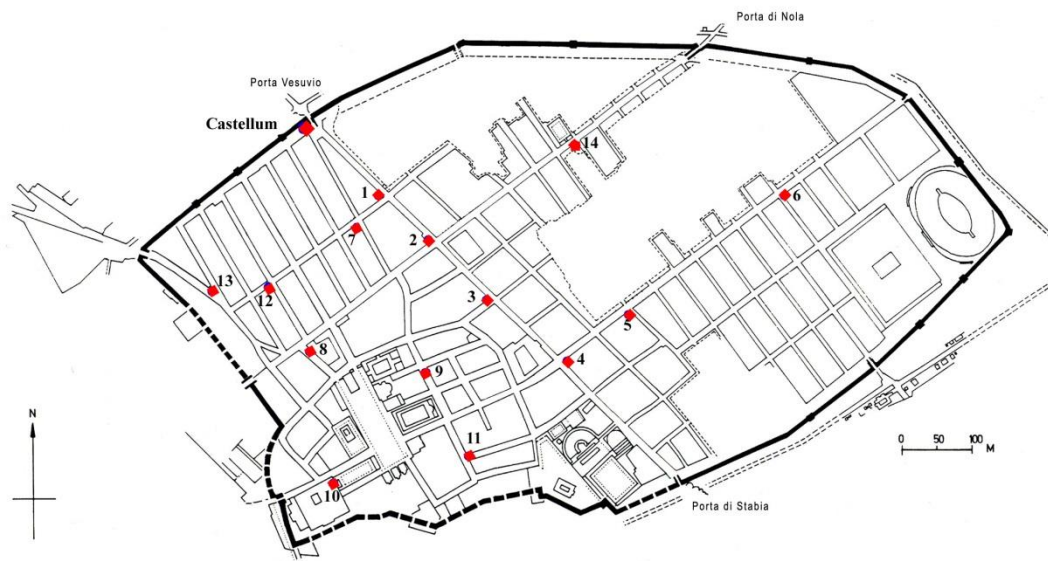

Figure 1.2. Location of the *Castellum Aquae* and the fourteen water towers. Drawing by author.

Jens Dybkjaer Larsen made a survey of eleven of the water towers presented in his article ‘The water towers of Pompeii’.¹⁹ Larsen did not agree with Eschebach concerning the number of water towers,²⁰ referring to Eschebach’s article ‘Gebrauchwasserversorgung Pompejis’ presented at a conference in Lyon in 1977 and published in 1983, but did not tell the reader why he is disagrees with Eschebach. Larsen measured the height of the eleven towers in his survey. He commented that the heights are not certain as it has to be assumed that the top of the towers may have been worn down. He pointed out, however, that the height of water tower no. 8 must be regarded as certain as this tower is attached to the building of the Forum Baths behind. The height of tower no. 6 is very uncertain as the tower was hit by a bomb during World War II. Larsen mentioned the grooves in the towers but did not present any measurements of them.

Thea Heres studied the construction of the water towers and presented her findings in an article called ‘The structures related to the water supply of Pompeii: building materials and chronology’.²¹ She discussed the damage caused by the earthquake in AD 62. She was of the opinion that a general reconstruction of the water-supply system had to be carried out after the earthquake. She concluded that of the fourteen in total, seven water towers were constructed after AD 62, among them water tower no. 2. Five of the water towers have preserved their original appearance untouched by the earthquake, among them water tower no. 1. Towers no. 3 and no. 4 also preserved masonry in their lower parts from before AD 62, whereas the upper parts date after AD 62. Assuming that Heres’ dating is correct, water tower no. 2 was entirely redesigned and reconstructed later than water tower

¹⁹ Dybkjaer Larsen 1982.

²⁰ Dybkjaer Larsen 1982, 65, n. 8.

²¹ Heres 1992, 42-61.

no. 1. In my opinion this could explain why the grooves are wider in water tower no. 2 than those in no. 1.

Jan Wiggers discussed the function of the towers in his article ‘The urban water supply of Pompeii’.²² Jehuda Peleg calculated the static water pressure that the towers create for the distribution network in his article ‘Der Zweck und der Betrieb der Wassertürme von Pompeji’.²³

1.3.3 On the main water system

The water system in Pompeii has been studied by many scholars. Archaeological information on all the buildings in the city was collected and put together by H. Eschebach. His work was completed after his death by his wife Liselotte Eschebach and published in the book *Gebäudeverzeichnis und Stadtplan der antiken Stadt Pompeji*.²⁴ In this book there is information on all the buildings in the city and also a map of the city indicating the topographical heights at all intersections. This information is used in this study to calculate the topographical height at street level for water towers and street fountains.

H. Eschebach presented an estimation of the total water use in the city in his article ‘Gebrauchwasserversorgung Pompejis’.²⁵ Espen Andersson gave estimated figures on the number of houses that were connected to the water supply and discussed the water consumption in Pompeii in his article ‘Urban water supply in Pompeii and the private water consumption’.²⁶ He was of the opinion that water supplied to fountains in houses for private use was important, and that water for public street fountains was of secondary importance.²⁷

Salvatore Nappo made archaeological excavations of the pavements between 1992 and 1994 in connection with the installation of a modern water-pipe system.²⁸ These new public works facilitated an overview of the system from antiquity and allowed scholars to formulate a new hypothesis about the situation of the water-supply system just before the eruption of Vesuvius in AD 79. Nappo described ditches along the streets full of *lapilli* where he had expected to find water pipes, as shown in *Fig. 1.3*. He noticed some pipe fragments but observed also that parts of the system were in the process of being repaired, possibly due to damage shortly before the time of the eruption. I will use Nappo’s findings to establish possible locations for the water pipes in the distribution network.

²² Wiggers 1996.

²³ Peleg 1996.

²⁴ Eschebach 1993.

²⁵ Eschebach 1983.

²⁶ Andersson 1994.

²⁷ Andersson 1994, 31.

²⁸ Nappo 1996.

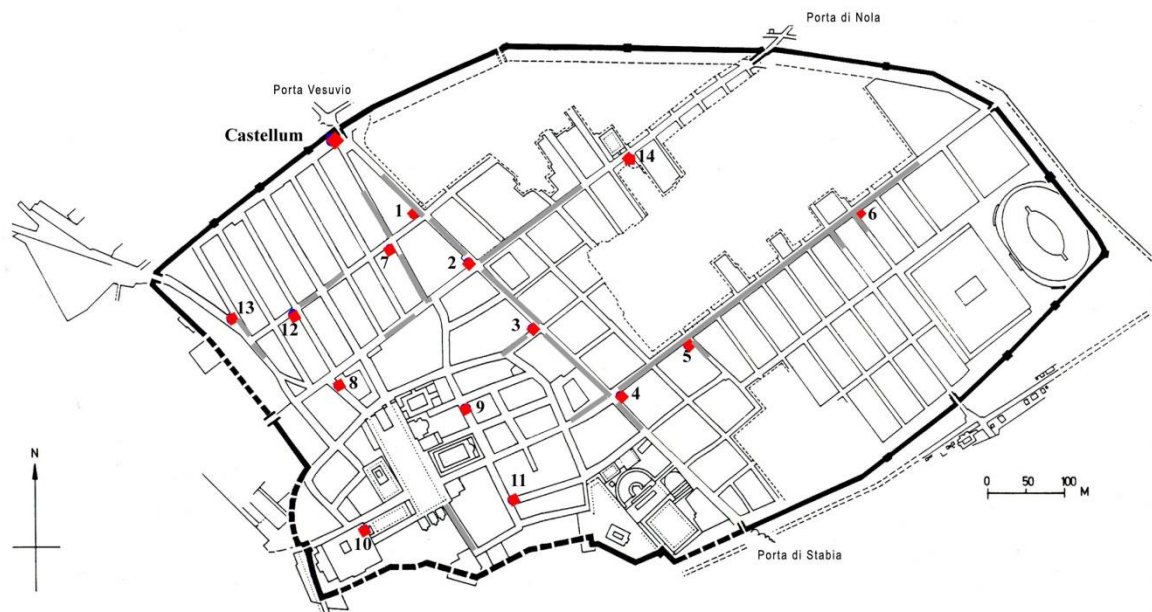

Figure 1.3. Location of ditches along the streets. The 14 water towers are marked in red, the ditches in grey. Drawing by author.

Gemma Jansen discussed the main water system in her doctoral thesis *Water in de Romeinse stad. Pompeji, Herculaneum, Ostia*.²⁹ L. Eschebach described the operation of the water supply from the Serino aqueduct in her article 'Wasserwirtschaft in Pompeji'.³⁰ Water was distributed from the *Castellum Aquae* through three main water pipe lines, as discussed before. She refers to Maiuri, who found lead pipe fragments from two of the main water pipe lines.³¹ One pipe fragment was found in the western pavement of *Via del Vesuvio/Via Stabiana*, and another pipe fragment was found in *Vicolo dei Vettii*. There is no archaeological evidence substantiating the location of the third main water line, but L. Eschebach is of the opinion that it could have been located in the eastern pavement of *Via del Vesuvio/Via Stabiana*, based on the location of water tower no. 4 on the eastern side on the corner of *Via Stabiana* and *Via dell'Abbondanza*. This hypothesis seems unlikely, partly because the water pressure at water tower no. 4 would have been too high, and partly also because the balance of the water flow in the three water pipelines with such a difference in water pressure would have been disturbed.

Schmölder-Veit presented a reconstruction of the urban water-supply infrastructure in the city. She was of the opinion that the three main water pipelines could be reconstructed based on the vertical grooves in the water towers.³² Her reconstruction is shown in *Fig. 1.4*.³³

²⁹ Jansen 2002.

³⁰ Eschebach 1996.

³¹ Maiuri 1931, 555, 562, Abb. 4.

³² Schmölder-Veit 2009, 124.

Richard Olsson

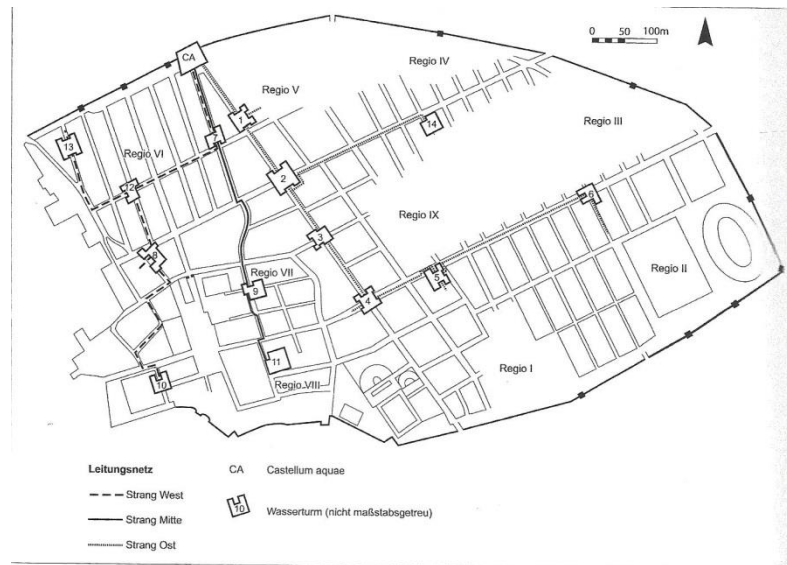

Figure 1.4. Reconstruction of the main water pipelines. From Schmölder-Veit 2009, 122, Pl. 13. With the kind permission of Andrea Schmölder-Veit.

The three lines supplied water to different parts of the city. She suggested that the eastern water pipe line was installed in the western pavement of *Via Stabiana*, where a lead pipe fragment 17 x 23 cm has been found.³⁴ According to her hypothesis this pipeline supplied water to water towers 1, 2, 3, 4, 5, 6 and 14. According to her, the central water pipeline was laid under the eastern pavement of *Vicolo dei Vettii* and supplied water to water towers nos. 7, 9 and 11. She was also of the opinion that the western pipe line was installed along the *Vicolo dei Vettii*, leading to water tower 7 and then further to towers nos. 12, 13, 8 and 10. This interpretation will be scrutinised below and partly confirmed but also partly corrected.

1.3.4 On water supply for public use

a) The street fountains

In his *Gebäudeverzeichnis*, H. Eschebach presented in detail the street fountains in the city, indicating their location, material and motif of the relief stone.³⁵ Based on this information I have presented the location of forty-two street fountains in *Fig. 1.5*.³⁶ Three of the street fountains (nos. 11, 30 and 38) were constructed without a water basin. Two more fountains were built in connection with a monument, no. 15 in front of the Arch of Caligula and no. 25 in the Arch at the Forum. Two street fountains were totally different, no. 35 at the Triangular Forum and no. 36 in the Gladiator Barracks. All the rest of the forty-two street fountains were constructed with four standing stones arranged to form a water basin.

³³ Schmölder-Veit 2009, 122 Pl. 13. The reconstruction indicates the grooves in the water towers, but tower no. 3 should be turned 90 degrees counter-clockwise.

³⁴ Schmölder-Veit 2009, 122.

³⁵ Eschebach 1983, 90 and Tafel 2.

³⁶ Eschebach 1983, 104, Tafel 2.

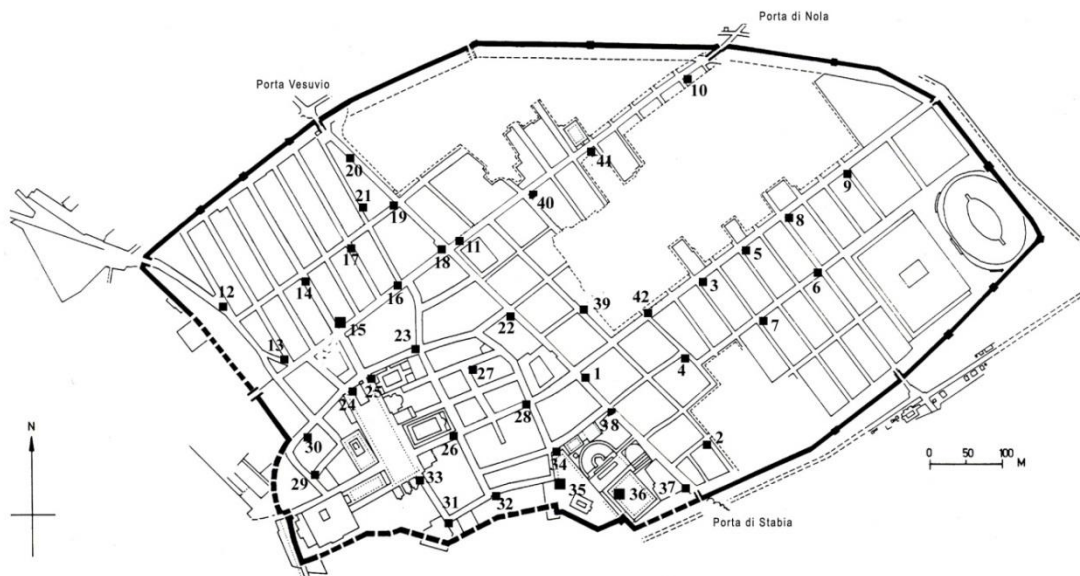

Figure 1.5. Location of street fountains. Drawing by author.

Yastami Nishida measured the size of the water basins and discussed the construction design of 35 street fountains.³⁷ He categorised the 35 street fountains he investigated according to their design, and defined eight different types. Schmölder-Veit elaborated on the observations made by Eschebach and discussed the number of street fountains in different parts of the city. She also commented on the difference in size and capacity of the fountain basins and describes the construction design of the street fountains.³⁸ Kurt Wallat studied the buildings along the eastern side of the Forum and gave detailed information on the street fountain no. 26 on the *Via dell'Abbondanza*.³⁹ Jean-Pierre Adam made a major presentation on Roman construction design and also presented in detail his observations on the street fountains.⁴⁰ David Newsome studied the buildings and the streets around *insula VII 15* in the centre of the city. He discussed street fountain no. 29 standing in the corner of *Vicolo del Gallo* and *Vicolo del Gigante*, halfway blocking the entrance to *Vicolo del Gallo*.⁴¹

b) The public baths

Archaeological investigations have found remains of five public baths in Pompeii. Two of these were first supplied with water from deep wells, the Stabian Baths established long before the Roman period and the Forum Baths built after the city became a Roman colony in 80 BC. Two public baths were built after the Serino aqueduct was connected to the city: the Suburban Baths

³⁷ Nishida 1991, 91-102.

³⁸ Schmölder-Veit 2009, 128-129.

³⁹ Wallat 1997, 104-105.

⁴⁰ Adam 1984, 278-280.

⁴¹ Newsome 2009.

developed during the Julio-Claudian period and the Sarno Baths constructed in the Claudian era. The Central Baths were still under construction at the time of the eruption of Vesuvius in AD 79.

Garrett Fagan studied the development of the phenomenon of bathing in the Roman world.⁴² He discussed not only the five public baths in Pompeii but also two baths built by private individuals, as seen in *Fig 1.6*. In the eastern part of the city on the premises of Julia Felix, a private bath was constructed around the corner of the amphitheatre called *Balneum Venerium et Nongentum*. At the other end of the city, a private bath was located near the theatre called The Palaestra Baths. These two private baths will not be discussed in this thesis.

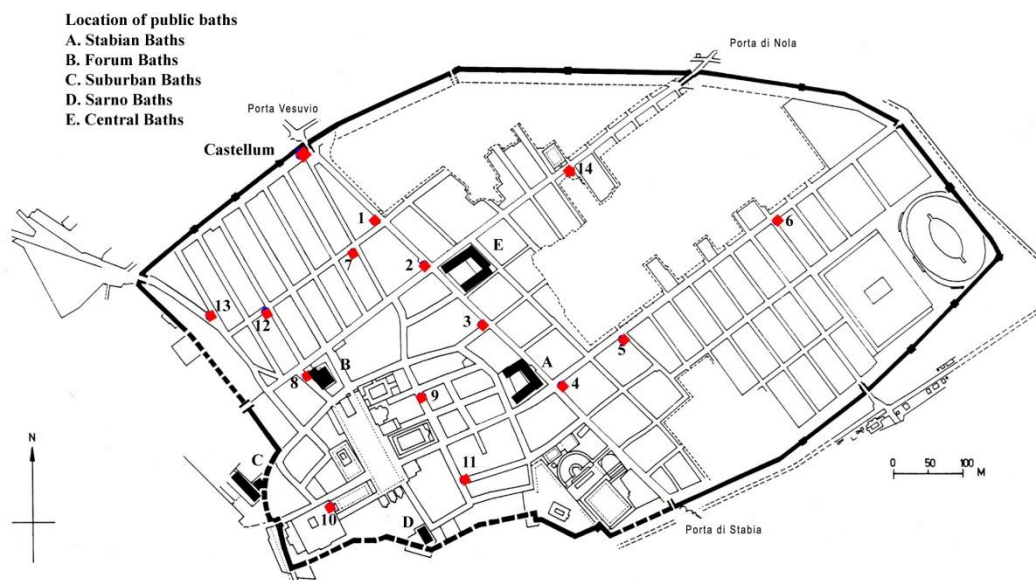

Figure 1.6. Location of public baths. The water towers are indicated in red, the baths in black. Drawing by author.

Inge Nielsen made a major investigation on the architecture and cultural history of Roman public baths and presented the development of baths, dividing it into several stages.⁴³ She described the vital importance of the water supply and commented that Roman baths normally had an elevated water storage tank. I will elaborate on her findings in the discussion of water supply to the public baths in Pompeii.

The building complex of the Stabian Baths was studied and described in detail by H. Eschebach in *Die Stabianer Thermen in Pompeji*.⁴⁴ He also investigated the archaeological finds of pipes in the buildings. A water-lifting device was described by Rudolf Pemp in his doctoral thesis *Drei*

⁴² Fagan 1999, 56-68.

⁴³ Nielsen 1990.

⁴⁴ Eschebach 1979.

Wasserhebwerke Pompejis and compared with two other baths supplied with water from a deep well.⁴⁵ The tread-wheel was situated on the west side of the well and the water storage tank on top of the building, on the east side. The capacity of the water storage tank was 38,000 litres. Eschebach was of the opinion that the water supply to the Stabian Baths came through a direct branch pipe from a main water pipeline in *Via Stabiana*. This suggestion will be discussed below and a new interpretation will be presented.

The Forum Baths were designed and built in a layout similar to the Stabian Baths and have been described by Ann Olga Koloski-Ostrow in her article ‘The city baths of Pompeii and Herculaneum’.⁴⁶ The Forum Baths were constructed shortly after the city was made a Roman colony in 80 BC but later enlarged with a women’s bath, probably in the Augustan period when aqueduct water was supplied.⁴⁷ The water-lifting device has been described in detail by John Peter Olesen in *Greek and Roman water-lifting devices. The history of a technology*.⁴⁸ The exact location was given by Thorkild Schiöler in his *Roman and Islamic water-lifting devices*, mentioning the covered well “...23 meters to the right of the entrance and 17 meters into the ruins at right-angles to the street.”⁴⁹ Rudolf Pemp investigated in detail the traces from the water-lifting device in the Forum Baths.⁵⁰ According to Pemp, there must have been a water-storage tank at the top of the building, large enough to receive water from the deep well and to supply water to the different rooms in the Forum Baths.

The Suburban Baths were constructed during the Julio-Claudian period after the aqueduct was connected to the city. Koloski-Ostrow suggested that the construction was made during Emperor Tiberius’ reign early in the first century AD.⁵¹ The water-management system in the Suburban Baths was investigated and presented by Hubertus Manderscheid in his article ‘Greek and Roman Baths’.⁵² He assumed that the Suburban Baths were connected to the city’s water-supply system. There was a large water-storage tank just outside the south-east side of the baths receiving aqueduct water and supplying water to all the facilities. Manderscheid was of the opinion that the water consumption in the Suburban Baths was intensive.

The Sarno Baths were constructed during the Claudian time about AD 50 but were not in operation at the time of the Vesuvius eruption in AD 79. Koloski-Ostrow suggested that the Sarno Baths were in the process of being renovated due to damage acquired in the earthquake in AD 62.⁵³ She did not however discuss a water-supply system.

⁴⁵ Pemp 1939 and 1940.

⁴⁶ Koloski-Ostrow 2007, 231-233.

⁴⁷ Fagan 1999, 58-59.

⁴⁸ Olesen 1984.

⁴⁹ Schiöler 1973, 150.

⁵⁰ Pemp 1940, 30-31.

⁵¹ Koloski-Ostrow 2007, 241-242.

⁵² Manderscheid 2000, 524-529.

⁵³ Koloski-Ostrow 2007, 240.

The Central Baths were under construction at the time of the eruption in AD 79. Nathalie de Haan and Kurt Wallat studied the Central Baths and commented upon the planned use of water.⁵⁴ de Haan & Wallat suggested that the planned water consumption would have been considerable.⁵⁵ Within the service quarters of the Central Baths, they found some unfinished construction work usually interpreted as the base for a sundial, but which possibly could have been a water tower. This possibility will be discussed below.

My investigations on the heights of water towers and of the water-storage tanks for public baths enable me to present a new interpretation of the water-supply system for the Stabian Baths and the Forum Baths.

1.3.5 On water supply for private use

a) The houses

Water was supplied to some houses when the aqueduct was connected to the city. H. Eschebach mentioned that at least 63 houses had a water connection.⁵⁶ Jansen counted up to 91 houses that were supplied from the aqueduct system in her article 'Water pipe systems in the houses of Pompeii'.⁵⁷ In another article, 'Die Verteilung des Leitungswassers in den Häusern Pompejis' she listed 24 houses where archaeological investigations using a metal detector have discovered water pipes, distributors and closing valves.⁵⁸ Nathalie de Haan studied private baths in the city and presented a list of 30 houses with private baths in 'Die Wasserversorgung der Privatbäder in Pompeji'.⁵⁹ She is of the opinion that most private baths were constructed after the connection of the Serino aqueduct to the city as mentioned in her article 'Pompeian private baths and the use of water'.⁶⁰ In her doctoral thesis *Römische Privatbäder. Entwicklung, Struktur und sozialer Status*, de Haan presented houses in Pompeii with private baths.⁶¹

Houses were supplied with water through a separate small pipe connected to its own distribution system inside the house.⁶² Such distribution systems have been studied in the Swedish Pompeii Project. Arja Karivieri and Renée Forsell traced the water lines within the double atrium house of *Caecilius Iucundus* in their article 'The House of Caecilius Iucundus, V 1, 22-26. A preliminary report'.⁶³ Anne-Marie Leander Touati presented a plan of all water lines and drains known in *insula* V 1 in 2009 (Fig. 14) and discussed the juridical and social implications that may be concluded from a study of them in her article 'Water, well-being and social complexity in insula V 1. A

⁵⁴ de Haan & Wallat 2006.

⁵⁵ de Haan & Wallat 2006, 420.

⁵⁶ Eschebach 1983, Tafel 5.

⁵⁷ Jansen 2001.

⁵⁸ Jansen 1996.

⁵⁹ de Haan 1996.

⁶⁰ de Haan 2001.

⁶¹ de Haan 2010.

⁶² Some houses had a water tank on the roof with a water pipe to an individual fountain inside the house without being connected to the water-supply system. See Dessalle 2006.

⁶³ Karivieri & Forsell 2007.

Pompeian city block revisited'.⁶⁴ Thomas Staub discussed the ingoing water lines of the *Casa del Torello di Bronzo* and of the function of its complex water system, distribution boxes, valves and the possibilities to partially close certain lines within the house at will in his doctoral thesis *The Casa del Torello di Bronzo (VI, 7) in Pompeii*.⁶⁵ His work has been of fundamental importance for my study of water supply for private use.

Balázs Kapossy presented a list of 60 fountain sculptures from Pompeii located in 30 private houses in his study *Brunnenfiguren der hellenistischen und römischen Zeit*.⁶⁶ The fountain sculptures were probably supplied by water with a suitable water pressure, not too high and not too low.

b) The workshops

It is reasonable to assume that aqueduct water was also supplied directly or indirectly to workshops requiring much water. In a city plan, H. Eschebach indicated 46 such workshops and marked in which *insula* these workshops were located and in which part of the *insula*. His indications make it possible for other scholars to identify which workshops he meant were water-supplied.

Miko Flohr discussed the work, economy and environment in the fulling workshops in Pompeii in his book *The world of the fullo: Work, economy and society in the Roman Italy*.⁶⁷ He stated that the laundries equipped with rinsing facilities obtained water through lead pipes connected to the urban water supply.

1.3.6 On pipe dimensions

Henning Fahlbusch studied the Roman standard for water-pipe dimensions, mentioning that Vitruvius described such a standard for lead-pipe dimensions.⁶⁸ In his ten books on architecture, Vitruvius gave a Roman standard for water pipes, with eight standard sizes based on the circumference of the pipe in *digiti* (1 *digitus* = 1.85 cm).⁶⁹ The lead pipes were manufactured from a flat piece of metal, bent around a cylinder and soldered together along the long side of the bent pipe, thus giving the pipe a pear-shaped section. The size of the pipe was given by the width of the flat piece of lead prior to manufacturing. The size given in *digiti* thus corresponded to the circumference of the pipe or somewhat less. This Roman standard for water-pipe dimensions is presented in *Table 5*. Fahlbusch calculated the diameter and area for circular pipes based on the circumference mentioned by Vitruvius. His calculations are also presented in *Table 5*. It is possible that the Vitruvian dimensions were used when the water-supply system in Pompeii was designed and built. Later another system for pipe dimensions was introduced by Agrippa and confirmed in 11 BC by Augustus. The system has been described by Frontinus and had 25 standard sizes.⁷⁰ It is possible

⁶⁴ Leander Touati 2009.

⁶⁵ Staub 2013.

⁶⁶ Kapossy 1969.

⁶⁷ Flohr 2013.

⁶⁸ Fahlbusch 1989, 139-144.

⁶⁹ Vitr. *De Arch.* 8.6.4.

⁷⁰ Frontin. *Aq.* 39-63.

that this new system with many more dimensions was used in Pompeii when the water-supply system was redesigned and repaired.

Archaeological reports from Pompeii do not show any particular interest in pipe dimensions. Some scholars indicate the dimensions of a pipe fragment with two different diameters in cm, others only with one figure and others again in Roman standard without mentioning which Roman standard.

Ohlig mentioned that the inside dimension of one of the main water pipe lines found in the *Via del Vesuvio/Via Stabiana* close to water tower no. 1 was 22 x 16.8 cm.⁷¹ Schmölder-Veit indicated the dimension of 17 x 23 cm for the same pipe fragment.⁷² With reference to Fahlbusch I would call this pipe fragment a *tricenaria* in Roman standard.

Nappo estimated a pipe fragment with probably a Roman standard called *vicenaria* in the western pavement of *Via del Vesuvio/Via Stabiana* south of *Vico di Mercurio*.⁷³ He also gives pipe dimensions in other parts of the city, calling them *denaria* or *octonaria*.

Forsell estimated the diameter of the water-inlet pipe to *Casa di Caecilius Iucundus* to about 0.05 m.⁷⁴ This might be the larger dimension of the pear-shaped pipe: with reference again to Fahlbusch, I would call this pipe *octonaria* in Roman standard.

Thomas Staub measured the water-inlet pipe to *Casa del Torello di Bronzo* as being about 0.048 x 0.082 m.⁷⁵ This might have been the Roman standard dimension called *denaria*.

Pipe fragments found in the streets will be discussed further below. Any future discussion on water-pipe dimensions in Pompeii would benefit from having dimensions given with two different outside measurements of the pear-shaped pipe and when possible also with two inside measurements. The water pipe could then be related to the Roman standard as presented by Fahlbusch.

⁷¹ Ohlig 1996, 21.

⁷² Schmölder-Veit 2009, 122.

⁷³ Nappo 1996, 39.

⁷⁴ Renée Forsell, personal information, dimension estimated to be 0.05 m.

⁷⁵ Staub 2013, 93.

2. The main water system

The purpose of the aqueduct was to bring water of good quality to the city. The function of the urban water infrastructure was to distribute aqueduct water in correct quantities and water pressure to each public and private user. The purpose of the main water system was to supply water to the top containers of all the water towers in the city. From there the water was distributed for public use to street fountains and to public baths with a continuous water flow, described below in chapter 3, and for private use in houses and workshops with a non-continuous water flow, described below in chapter 4.

The total water quantity for all water users along one of the main water pipe lines had to pass through the top container of the first water tower in the line before going to the water towers 'downstream'. The water inflow in each top container must have been larger than the water outflow in the main water pipe line between it and the following water tower to make it possible to keep the top container filled with water. A top container full of water was a pre-requisite for having sufficient water pressure for the water users. To make the main water system function with stability, it is reasonable that the water quantity passing through the top containers on the first water towers in each of the three main water pipelines must have been much larger than the water quantity being used by the water users supplied from each particular tower. This would also indicate that water would have flowed out of the system after the last water tower in all three main water pipe lines.

The relevant issues to be investigated to be able to present the main water system in the water-supply infrastructure in Pompeii are the following:

- Location of the water towers in the city,
- Topographical heights of the water towers, i.e., the height above sea level at the summit of the top container of the water tower, to show the probable water-pipe connection in the three main water pipelines,
- Grooves of the water towers and the direction of the grooves to discuss the reason why they were made and to discuss the interconnection of the towers and
- Size of the top containers of the water towers.

2.1 The aqueduct and the *Castellum Aquae*

Water was supplied to Roman Pompeii from an aqueduct reaching the city at its highest level at *Porta Vesuvio* and was connected to the urban water infrastructure inside the city walls at the *Castellum Aquae*. This building acted as a regulator and a distributor and had at floor level a device to divide the water flow to the three main water pipelines passing through the south façade at street level as discussed above in 1.3.1.

One matter for discussion could be why the design engineer in Pompeii chose to make a tri-partite construction for the water supply to the main water pipelines. When looking at the city map as Richard Olsson

shown in *Fig. 2.1*, it would have been natural to divide the water supply in two main water pipelines, one going down the *Via del Vesuvio* and the other going down the *Vicolo dei Vettii*. Yet the design engineer decided to use three major lines. Vitruvius' ten books on architecture were written about the same time that planning was going on for a new urban water-supply system to Pompeii from the Serino aqueduct. This could of course have influenced the design engineer, but I have already ruled it out above: as I discussed above, if the tri-partite construction was made in order to divide the water between street fountains, public baths and private users, it would have been necessary to build three separate, parallel water pipelines all over the city. The only other *Castellum* excavated from the Roman period is the *Castellum* in Nimes where there were ten main water pipelines. In my opinion, the design engineer for the urban water-supply system in Pompeii chose to make a third major pipeline to provide water to the north-western part of the city in *Regio VI*, located at a very high level (*Fig. 2.1*).



Figure 2.1. North-west part of the city. Drawing by author.

H. Eschebach gave the topographical level + 42.6 m on the street in front of the *Castellum Aquae*.⁷⁶ This level will be used as the level of two of the three main water pipelines when entering the city. The middle pipeline emerges slightly above street level at + 43.0 m, as seen in *Fig. 2.2*.

⁷⁶ H. Eschebach 1993, city map.
Richard Olsson



Figure 2.2. South façade of *Castellum Aquae* with indications of levels for the three openings. The middle one slightly above and the left and right ones are on the same level. Photo and indication of levels by author.

It is not possible to assess with certainty which one of the three main pipelines was going in which direction of the city. The openings in the south façade of *Castellum Aquae* are not equal in size: Hodge measured the central opening and found it had an external diameter of 30 cm, while the two side ones have an external diameter of 25 cm.⁷⁷ I have got the same measurements, diameter 30 cm for the middle one and 25 cm for the other two. As mentioned above, Hodge pointed out that the distribution arrangement inside the *Castellum Aquae* divided the incoming water from the aqueduct in three separate flows, so that most of the water supplied from the aqueduct was distributed to the city through the water pipeline emerging from the middle opening.⁷⁸ I will argue that more than half of the water demand came from water users in the eastern part of the town, and that it was this line, henceforth labelled as “the eastern water pipeline”, that was coming through the middle opening to continue down in the western pavement of *Via Vesuvio/Via Stabiana*. The middle opening of the *Castellum Aquae* was thus at the higher level + 43.0 m to make it possible for the eastern pipeline to cross over the central pipeline coming from the left opening (as seen in the direction of the water flow) of the *Castellum Aquae* at + 42.6 m. This line will henceforth be labelled as the “central water pipeline”, because, as we will see, it was supplying water to the centre of the town to water users living on its forum axis. The third water pipeline coming from the right opening (as seen in the direction of the water flow) will be labelled as the “western water pipe line”.

⁷⁷ Hodge 1992, 282.

⁷⁸ Hodge 1996, 14.

2.2 The water towers

2.2.1 Technical assessment of the function of the water tower

The city of Pompeii is located on the southern slope of the Mount Vesuvius volcano and has a large difference in height between the northern and the southern parts of the city. H. Eschebach indicated the highest level in the city, at *Porta Vesuvio*, to be + 42.6 m and the lowest level at *Porta Stabia* to be + 8.8 m.⁷⁹ The Romans used their knowledge of siphon technology to cope with this difference. The three main water pipelines distributed aqueduct water from the *Castellum Aquae* to the top containers of the water towers. The top containers were open at the top. The atmospheric pressure on the water surface in the top container of one water tower pressed water through a pipe up to the top container of the following water tower provided that the water surface of this second container was located at a lower level than that in the first water container. In this way the main water system consisted of a number of connection pipes from one top container to the next in consecutive order and aqueduct water would fill up all the top containers in the system. This technical principle is illustrated in *Fig. 2.3* showing the water-pipe connections at water towers nos.1 and 2.

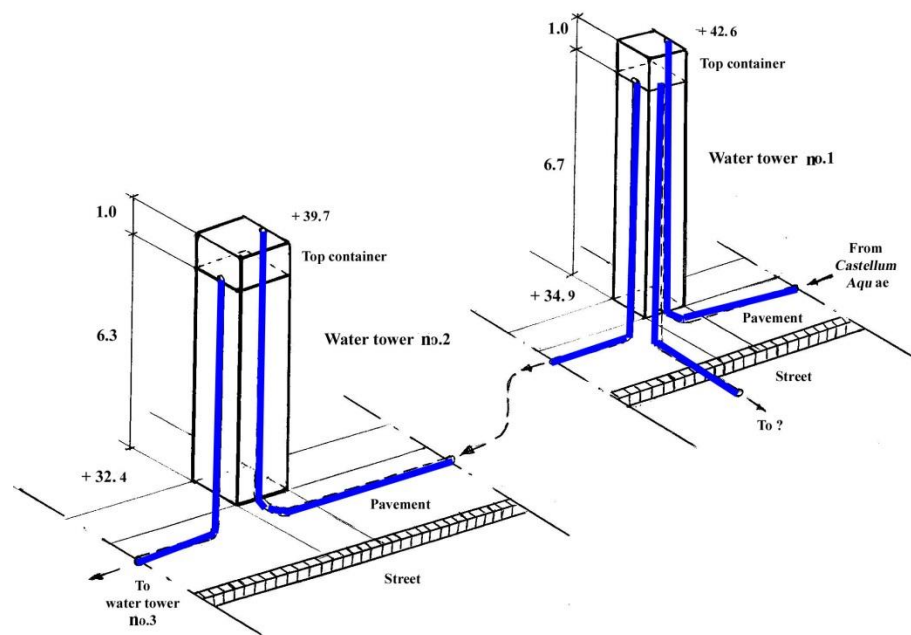

Figure 2.3. Water-pipe connections at water tower no. 1 and no. 2. Drawing by author.

Aqueduct water was distributed to water tower no. 1 in a pipe shown to the right in *Fig. 2.3* coming from the middle opening of the *Castellum Aquae*. The atmospheric pressure on the water surface in the *Castellum Aquae* at the level of + 43.0 m would press water up to the top container of water tower no. 1 at + 42.6 m. Another connection pipe was installed from the top container of tower no. 1 to the top container of tower no. 2. The atmospheric pressure on the water surface of the top container of tower no. 1 at + 42.6 m would press water up to the top container of tower no. 2 at + 39.7 m. All the top containers of the water towers were joined in the same way by connection pipes

⁷⁹ H. Eschebach 1993, city plan.
Richard Olsson

according to this principle. The head is defined as the difference in level between the top containers of two water towers: thus, the head between tower 1 and tower 2 was 2.9 m. It has been estimated that the water pipes could not withstand a water pressure higher than a head of about 6-8 m.⁸⁰

The water towers with their top containers had a double function. First, they were designed to gradually reduce the water pressure in the system, but they also had a second function, to act as distributors to water users situated in the vicinity of the towers. The head of the top container created sufficient pressure to supply street fountains, public baths, houses and workshops with aqueduct water. Every water user was connected to a top container by an individual pipe. The different water users had different demands on the water: public users were supplied with a constant flow of water, as no archaeological evidence of closing valves has been found. Public baths had a large demand for water, and were normally equipped with a large storage tank with an overflow. Private users normally had water supplied, with one or several distributors inside the house and closing valves to indoor fountains. When these closing valves were shut off, the quantity of water passing through the top container in the main water system changed to compensate for the lesser amount of water being used.

2.2.2 Location of the water towers

H. Eschebach described the location of the fourteen structures I have considered as water towers, shown in my drawing in *Fig. 2.4*.⁸¹ Four of these towers are freestanding along *Via del Vesuvio/Via Stabiana*. The other ten towers stand in connection with buildings.

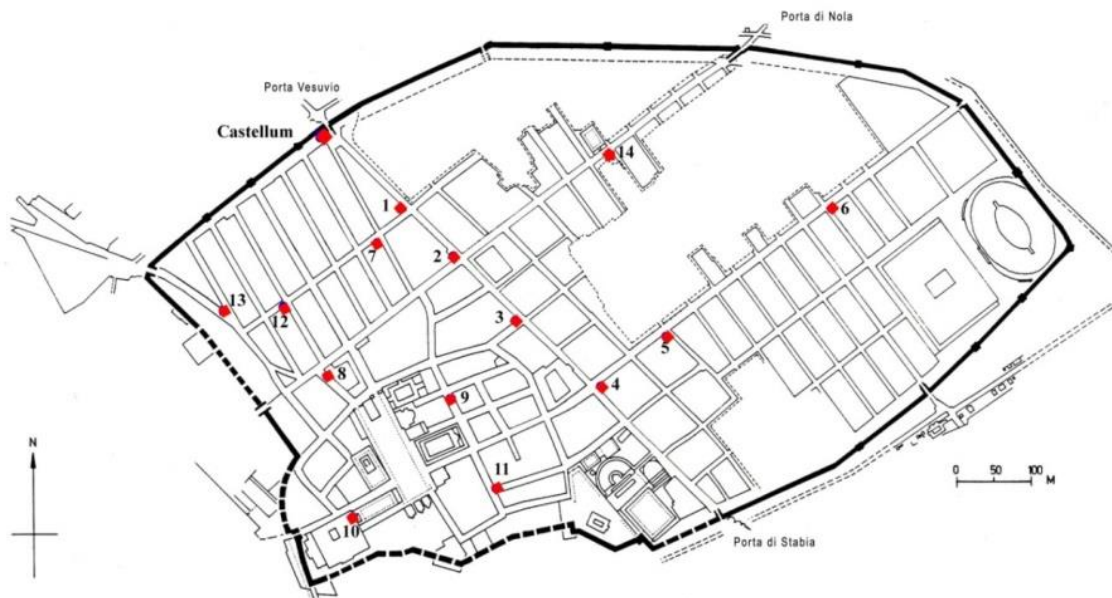

Figure 2.4. Location of the fourteen water towers. Drawing by author.

⁸⁰ Dybkjaer Larsen 1982, 41.

⁸¹ H. Eschebach 1993.

2.2.3 Heights of the water towers

Jens Dybkjaer Larsen made a survey of eleven of the water towers, as mentioned above. He measured the height of the eleven towers but also commented that the measurements were uncertain. By studying the masonry of walls behind the water towers, Larsen determined that the original water towers, no. 7 and no. 10, were higher than the present measured height. Larsen did not describe his measurement method, however. His measurements are listed in *Table 1*.⁸² Because of the uncertainty around Larsen's measurements, I will use my own measurements in the discussion below except for water towers no. 7 and no. 10, where I will use the heights determined by Larsen from the masonry on walls behind the towers.

The levels at street level are taken from H. Eschebach's town plan, measured in front of the location for each water tower. For water towers nos. 5, 6 and 8, an average of two figures are used as Eschebach did not give a value directly in front of the water tower. The levels at the base of the water tower for nos. 1, 2, 3, 5 and 6 are adjusted by 0.20 m above the street level as these water towers are standing on the pavement. In my field investigations all fourteen water towers were measured and studied in detail. The height of the towers was measured with a laser device on a tripod, first horizontally to the tower, then at an angle to the top and last at an angle to the base; these measurements were then trigonometrically calculated by the device to give one measured value. Three such values from three different positions were taken for each tower and the mean values and the standard variations were calculated to give the measured value of the height in the study report. My measurements of all fourteen water towers are presented in *Table 1*. Instead of using the average value as the measured height in my further discussions, one could argue that the highest measured value should have been used, as the top of the water towers are worn and the surface is no longer flat. This is especially relevant regarding my measurements of water towers nos. 2, 3, 6 and 9, where the standard variation is large. I have chosen to use the average value, as all measurements in any case must be regarded as approximate.

The fourteen water towers in Pompeii are massive construction works with great stability, designed to bear the heavy load from a lead water container. As mentioned before, four of the towers, nos. 1, 2, 3 and 4, are freestanding, while the remaining ten towers are all constructed in connection with a building. Heres studied the construction and the chronology of the water towers.⁸³ She concluded that five of the water towers seem to date entirely from before the earthquake in AD 62 (or 63), towers nos. 1, 9, 12, 13 and 14, although she remarks that no. 12 was damaged and thoroughly restored in the early nineteenth century.⁸⁴ The lower parts of water towers no. 3 and no. 4 also date from before the earthquake but she believes that the other seven were constructed after the earthquake. Tower no. 6 was hit by a bomb in World War II and has also been restored.

⁸² Dybkjaer Larsen 1982, 51.

⁸³ Heres 1992, 58.

⁸⁴ Heres 1992, 56.

2.2.4 Distance between the water towers

H. Eschebach made a city map.⁸⁵ From this map I have measured approximate distances between all the water towers as presented in *Table 2*. Based on the difference in base level of the water towers, I have calculated the inclination of the pipeline between the towers, also shown in *Table 2*. Normally the inclination at street level is about two to three percent. Only the first section from the *Castellum Aquae* to water towers nos. 1 and 7 is very steep. The main pipeline between water towers nos. 4 and 5 has a negative inclination, but this is compensated for by the fact that water tower no. 4 is much higher than tower no. 5.

2.2.5 Grooves in the water towers

All the water towers have grooves from the base to the top on one, two or three sides but of different sizes. The function of the grooves in all probability was to house and protect the main water pipelines. One such main pipeline took aqueduct water up to the top container on one side of the tower. Another main pipeline in another groove took water down to street level and up to the top container in the next tower. All the grooves in all the towers have been measured. The measurements are presented in *Table 3*. It is interesting to note the lack of standardisation. The depths of the grooves vary from shallow (only 12/13 cm) to medium (15/17/18 cm) to deep (20/25 cm), up to very deep grooves (27/28/30 cm): of course, all figures should be regarded as approximate. The varying depths of the grooves were made to accommodate pipes of different sizes. It is remarkable that the grooves in water tower no. 1 are of only medium depths while those in tower no. 2 are deeper, although due to the levels of the towers, the main water pipeline should have reached tower no. 1 before tower no. 2. As mentioned above, Heres concluded that many water towers were rebuilt after the earthquake in AD 62 or 63. She is of the opinion that water tower no. 1 was constructed before the earthquake but that all of water tower no. 2 dates from after the earthquake. During this redesign and new construction, water tower no. 2 may have been enlarged and given deeper grooves.

It would be reasonable to believe that all the grooves were made for a reason and they were all used to protect the pipes. Some grooves were obviously constructed for the main water pipelines in the main water system, but there are other grooves for some other purpose. The different grooves on every tower will be discussed below and an explanation for most of the grooves there will be presented.

2.2.6 The top containers of the water towers

All water towers had top containers made of lead. Only one such top container was found on site but it was later lost. It has however been described in an old excavation report including also a picture that is copied here in *Fig. 2.5*.⁸⁶ From the report it could be noted that the top container was found on water tower no. 6 and had a horizontal cross-section of 0.65 x 0.65 m with a height of 0.56

⁸⁵ H. Eschebach 1993, city map.

⁸⁶ Spinnazzola 1917, 255-256.

m, somewhat smaller than the cross-section of the tower itself. No other top containers have been found.

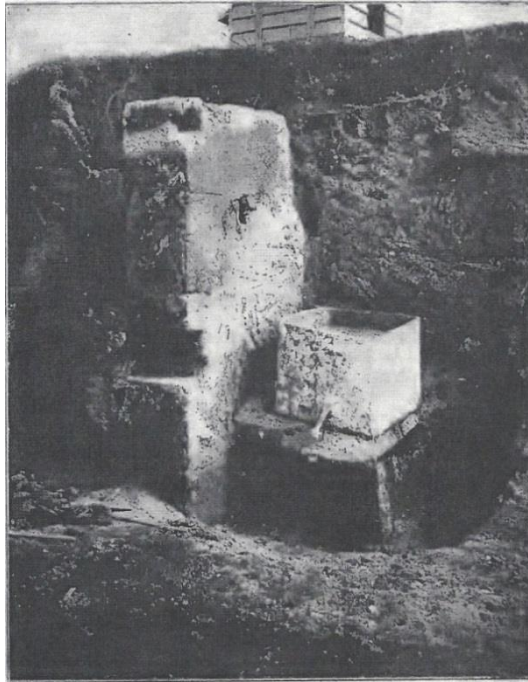

Figure 2.5. Top container of water tower no. 6. Photo from Spinnazzola 1917, 255.

The container of water tower no. 6 was made of 9-mm-thick lead and had two water connections soldered close to the bottom on the front side towards *Via dell'Abbondanza* and one water connection on the opposite side towards the small alley called *Vicolo di Octavius Quartio*. In my discussion I will argue that there might have been more than these three connections. The inflow pipeline from water tower no. 5 could have been bent over the top edge of the top container of water tower no. 6.

The containers were intended to hold water: thus, they could not have had a base larger than the cross-section of the water tower as lead is a soft metal and needed total support for its base. All the towers differed in size and it is thus reasonable to believe that the base of the top container was smaller than the tower it rested on. To have sufficient stability the height of the container must have been smaller than its width. My estimation of the cross-sections and the heights of the top containers are presented in *Table 4* and in the catalogue at the end of the paper. The estimated capacity of the top containers has been calculated and listed in the catalogue.

The top containers were a part of the water-distribution system and were intended to function as distributors to water users located in the vicinity of the tower in question. In my opinion the water inflow to the top container came through a pipe bent over the top edge of the container. All water-outflow pipes to water users were connected close to the bottom of the top container. A top container full of water created sufficient pressure in the pipes connected to each user to ensure a flow of water. If a top container was running low on water, the pressure would disappear and the

Richard Olsson

distribution function would cease. The head of water from the top container to the water user corresponded to the difference in height between the tower and the user. The principle of the top container acting as a part of the distribution chain is illustrated in *Fig. 2.6*, showing the water-pipe connections of the top container of water tower no. 2. The number of pipe connections is not known. Water had spilled over from the top of the container down the sides of the water tower, however, creating thick lime deposits. There are traces in these deposits of where the pipe connections were once installed. On water tower no. 2, *Fig. 2.6*, I have counted traces of six connections on the eastern side, labelled A-F, two labelled G and H, on the western side and also two, called J and K, on the southern side. There are no indications of lime deposits and water-pipe connections on the northern side of water tower no. 2. Thus, in total there were at least ten water-pipe connections from the top container of tower no. 2 to different users near-by. Pipe connections from top water containers to users will be discussed below.

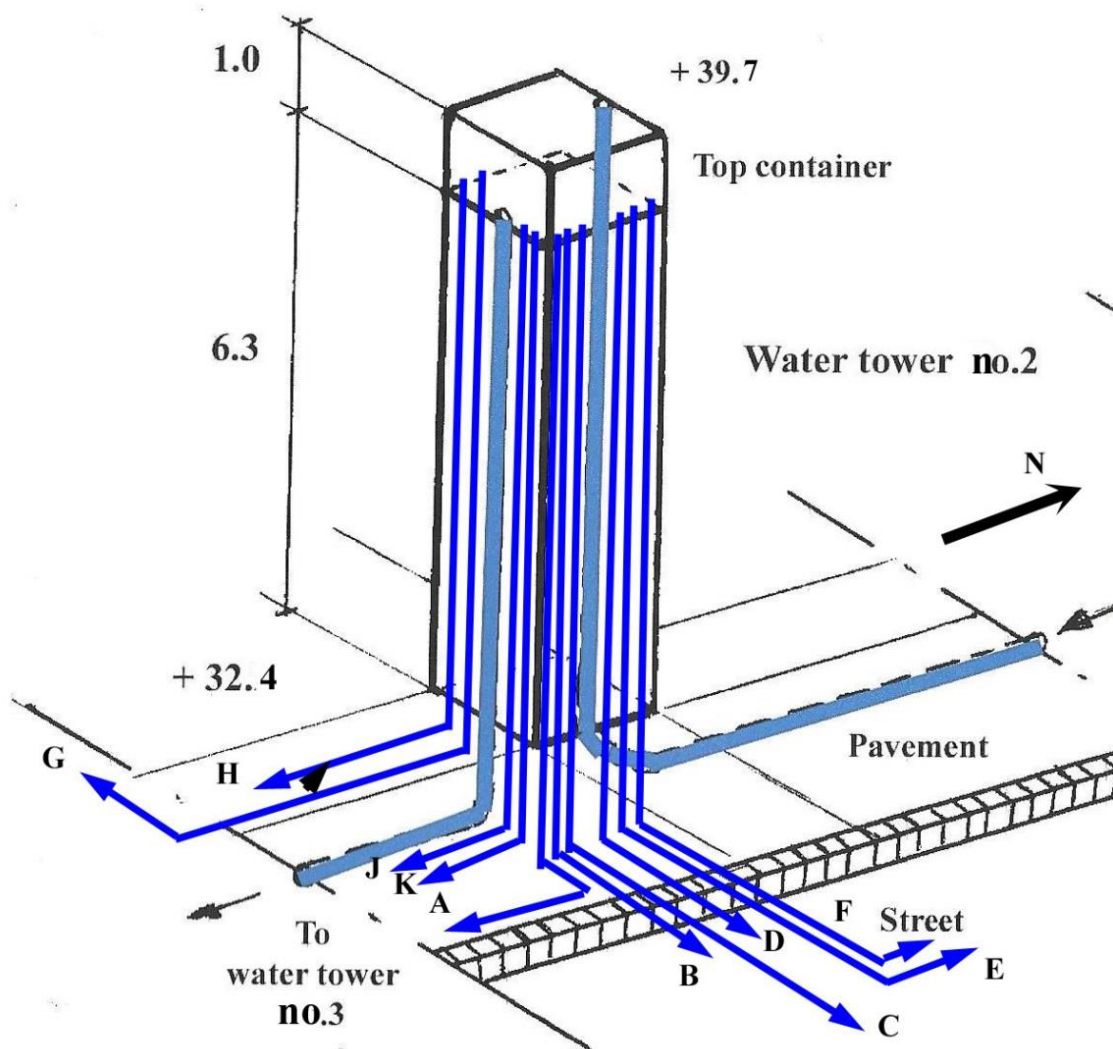

Figure 2.6. Pipe connections to users from top container of water tower no. 2. Drawing by author.

2.3 The three main water pipelines

The water towers had different heights and were located at different levels in the city. The aqueduct water was pressed from one top container to the next provided that each new container was located at a lower level than the one before it in the chain. This technical principle could give an indication of the location of the three main water pipelines. The aqueduct water was distributed in Pompeii from the *Castellum Aquae* through three main water pipelines located at + 42.6 / + 43.0 m as indicated above. The measurements of the heights of all water towers and the calculations of the level at the top container of all towers are presented in Table 1. Water tower no. 1 with its top container at level + 42.6 m, water tower no. 7 with its top container at maximum level + 41.9 m and water tower no. 12 with its top container at level + 42.3 m must have been the first tower in each of the three main water pipelines because they are higher than all other top containers.

As mentioned above, L. Eschebach discussed the possible location of the three main pipelines.⁸⁷ Referring to Maiuri, she mentioned that pipe fragments were found from two of the main water pipelines.⁸⁸ One main pipeline was located in the western pavement of *Via del Vesuvio/Via Stabiana* coming from the *Castellum Aquae*. The pipe fragment had the typical pear shape with inner dimensions of 22 x 16.8 cm, according to Ohlig.⁸⁹ She also said (again referring to Maiuri) that another pipe fragment found in *Vicolo dei Vettii*, however without giving the dimension. There is no archaeological evidence for the location of the third main pipeline, but Eschebach believes that it could have been installed in the eastern pavement of *Via del Vesuvio/Via Stabiana*. I will offer a different opinion below.

Schmölder-Veit also discussed the three main water pipelines mentioned above. She suggests that the eastern pipeline was installed in the western pavement of *Via Stabiana* and the central one, in the eastern pavement of *Vicolo dei Vettii*, as Eschebach does. Her hypothesis that the western water pipeline was installed along the *Vicolo dei Vettii* will be scrutinised below and partly confirmed but also partly corrected.

In the western pavement of *Via del Vesuvio/Via Stabiana* south of *Vico di Mercurio*, Nappo found a 3.6-m-long water pipe with a large dimension, estimated by him to be the size called *vicenaria*.⁹⁰ In my opinion this pipe must have been a fragment of the main water pipeline between water towers no. 1 and 2 in the main water system.

2.3.1 Description of water tower no. 1

The top container of water tower no. 1 had a level at the top of + 42.6 m, a little lower than the *Castellum Aquae* at + 42.6 / 43.0 m. It is located on the western pavement of *Via del Vesuvio/Via Stabiana* in an open area outside VI 16, 4, and was freestanding. The tower has three grooves: one

⁸⁷ Eschebach 1996, 5.

⁸⁸ Maiuri 1931, 562-564.

⁸⁹ Ohlig 1996, 21.

⁹⁰ Nappo 1996, 39.

Richard Olsson

of them in the northern side, to receive aqueduct water from the *Castellum Aquae* through a pipe to the top container; a second groove in the southern side with a pipe taking water from the top container of tower no. 1 down to street level to be distributed to the top container of the next water tower, presumably to water tower no. 2; a third groove on the eastern side. It is reasonable to believe that this groove also had a main water pipe taking water down from the top container of tower no. 1. If so, it is possible that there could have been a pipe in *Vicolo delle Nozze d'Argento* leading to the top container of another water tower in the part of *Regio V* or *Regio IV* that has not yet been excavated.

2.3.2 Description of water tower no. 7

The top container of water tower no. 7 has a calculated level at the top of + 41.0 m, based on the measured height of the tower in my field investigations 4.4 m. As mentioned above, this measurement does not correspond to the original height. In his investigations Dybkjaer Larsen tried to establish a better figure by studying the masonry on the wall behind the tower and determined that the height of the tower must have been at least 5.3 m.⁹¹ With this value the level at the top would have been + 41.9 m, a little lower than the *Castellum Aquae* at + 42.6 m. I will use Dybkjaer Larsen's estimate for my arguments about the water pipelines. The tower is located in the southwestern corner of the intersection of *Vicolo di Mercurio* and *Vicolo dei Vettii* with its western side connected to the eastern wall of the building at VI 13, 16. The tower has two grooves, one larger one on the northern side and one smaller one on the southern side. The aqueduct water was distributed from the *Castellum Aquae* in a pipe leading up in a groove in the northern side to fill the top container of the tower. In the groove in the southern side of the tower, another pipe distributed water to the top container of the next tower, most probably water tower no. 9.

Schmölder-Veit assumed that the third main water pipeline coming from the *Castellum Aquae* was also connected to the top container of water tower no. 7 and that a third pipe in the larger groove on the northern side of the tower distributed water to tower no. 12.⁹² However, the top container of water tower no. 12 had a higher level at the top, + 42.3 m. It is more reasonable to believe that the third main water pipeline passed by water tower no. 7, going directly to water tower no. 12 and that the larger groove on the northern side of tower no. 7 was intended to give space for water pipes going to different users. On the northern wall of building VI 13 in *Vicolo di Mercurio* close to water tower no. 7, there are water pipes obviously coming from the tower, still visible *in situ* located on the wall but not in the groove of the water tower.

2.3.3 Description of water tower no. 12

The most interesting water tower is perhaps no. 12. It has been rebuilt in modern times, and therefore the original size of the tower is obviously uncertain. Based on my measurements I have estimated that the water level at the top of water tower no. 12 was + 42.3 m, very close to the level of + 42.6 m at *Castellum Aquae* but low enough to have water piped in directly from there. It is

⁹¹ Dybkjaer Larsen 1982, 51.

⁹² Schmölder-Veit 2009, 122.

located in connection with the building VI 6, 11 in *Vicolo di Mercurio* and at the corner of *Vicolo della Fullonica*. Water tower no. 12 is quite low, only 1.6 m, but it stands with its base at a level of + 39.9 m, higher than any other water tower in the city. The tower is built with two grooves, one larger one on the eastern side and one smaller one on the western side. A pipe in the larger groove on the eastern side received aqueduct water from the *Castellum Aquae*. In this larger groove on the eastern side, there might have been room for two pipes as shown in the catalogue in Appendix 2. A second pipe in the same large groove on the eastern side took water down from the top container to street level and continued down the *Vicolo della Fullonica* to the top container of the next water tower no. 8. Just like Schmölder-Veit, I believe that a third pipe in the small groove on the western side distributed water to the top container of water tower no. 13.

2.3.4 The beginnings of the three main water pipelines

The first water towers in each of the three main water pipelines were water tower no. 1 at level + 42.6, no. 7 at level + 41.9 and no. 12 at level + 42.3 m, respectively, as shown in *Fig. 2.7*. These are also the towers closest to the *Castellum Aquae*. The main water system would have worked best if the three towers directly connected to the *Castellum Aquae* had had about the same height.

Although no pipe fragment has been found from the third main water pipe, I hypothesise that it would have been located in the western pavement of *Vicolo dei Vettii*, turning in to *Vicolo di Mercurio*, passing by tower no. 7 without being connected and going further in *Vicolo di Mercurio* in the direction of and supplying water to the top container of tower no. 12.

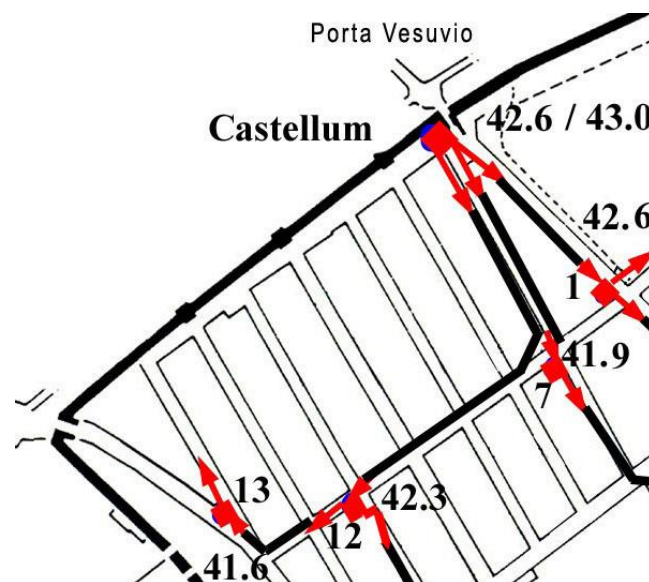

Figure 2.7. The beginning of the three water pipelines. Drawing by author.

2.3.5 All other water towers in the main water pipelines

The beginning of the three pipelines has been demonstrated above: I will now describe all the other towers in the main pipelines on the basis of their location and their height. The estimated level of the top container of every water tower is presented in *Table 1* and the measured sizes of the grooves

are shown in *Table 3*. The levels will be used to explain the interconnection of all the excavated water towers in the city and the measurements of the grooves will be used to indicate the location of the pipelines. The orientation of the grooves in each water tower is indicated in *Fig. 2.8* with red arrows. It is probable that these orientations indicate the directions of the main water pipelines. Only water tower no. 12 has a groove where I suggest that one incoming and one outgoing pipe are placed in the same groove. The three main water pipelines will be called the western, the central and the eastern water pipeline.

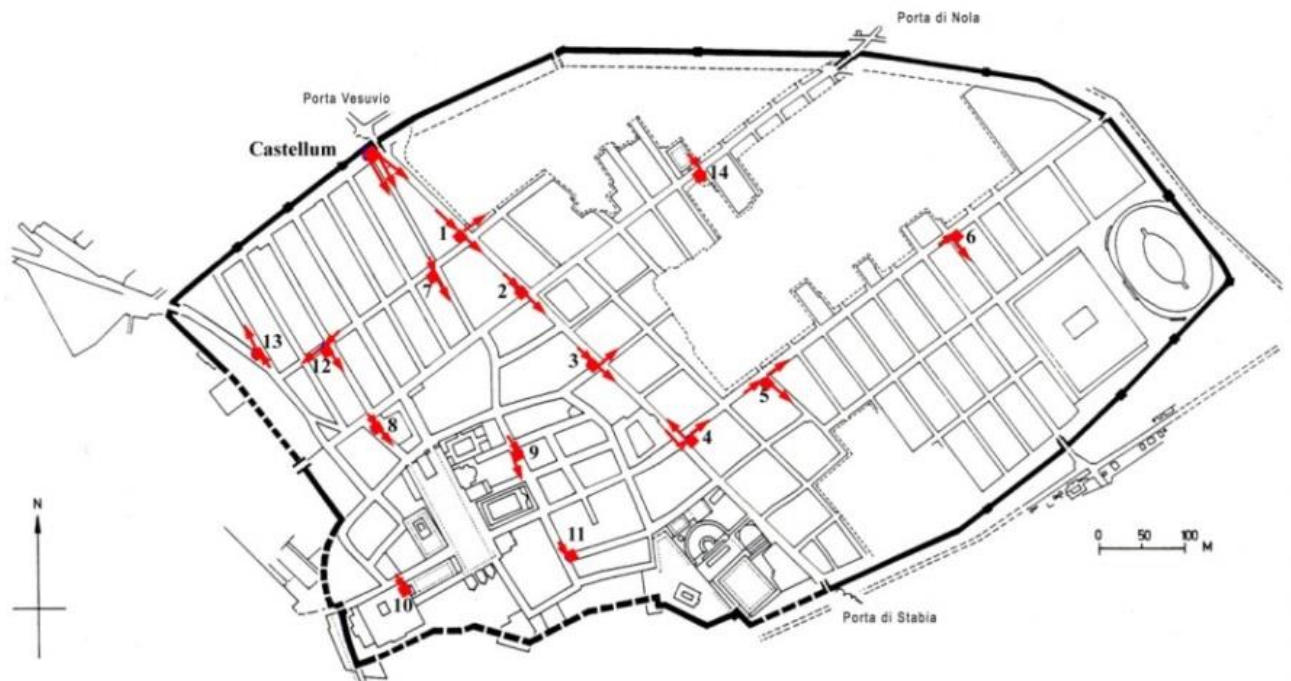

Figure 2.8. The direction of the grooves in the water towers marked with red arrows. Drawing by author.

2.3.6 The western water pipeline

The western main water pipe line from the *Castellum Aquae* went to water tower no. 12 to divide the supply of water to both tower no. 13 and tower no. 8, from where it continued to tower no. 10, as shown in *Fig. 2.9*. The top container of the water tower no. 12 had an estimated level of + 42.3 m as indicated in *Table 1*. Tower no. 13 had its top container at + 41.6 m and the top container of tower no. 8 was at a level of + 41.7 m. Tower no. 10 has its base at a much lower level and had an estimated level at the top of + 37.0 m.

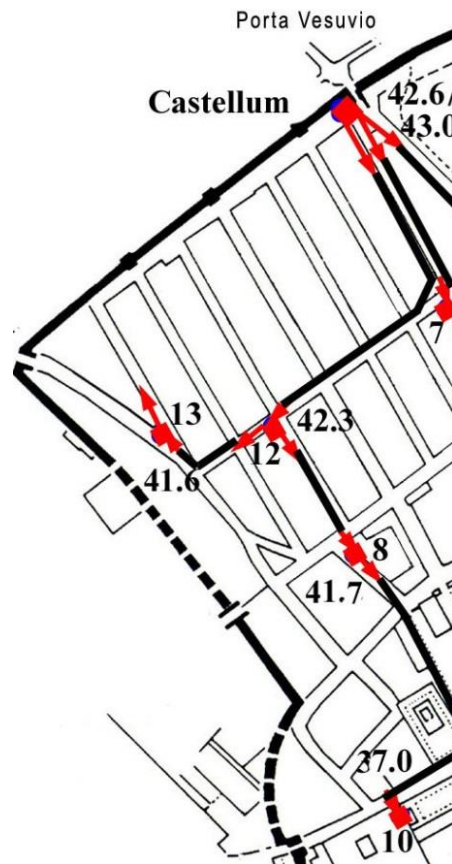

Figure 2.9. The western water pipeline. Drawing by author.

The north-western part of the city is situated at a very high level. From the low water tower no. 12 standing with its base at + 39.9 m, one main water pipeline went in a western direction in *Vicolo Mercurio*, turning north in *Via Consulare* to water tower no. 13, which has its base at almost the same level 39.8 m, as at no. 12. Another main water pipeline went down *Vicolo della Fullonica* under *Via delle Terme* and down in *Vicolo delle Terme* to tower no. 8.

The western water pipeline had four towers. Water tower no. 12 has been described above. no. 13 seems to be the smallest water tower in the city with a measured height of only 0.8 m. The tower stands with the western side at VI 1, 19 in connection with the masonry wall of a deep water well. The tower has two grooves, one at the southern side for a water pipe coming from the previous tower no. 12 and another groove at the northern side possibly for a pipe going to the north in *Vicolo di Narciso* to the house called *Casa delle Vestali*, which was supplied with water. When the aqueduct did not work satisfactorily, the house installed a storage tank in the house.⁹³

The eastern side of water tower no. 8 is located in connection with VII 5, 8, the back side of the Forum Baths. To be able to supply the Forum Baths with enough water, this particular top container could very well have been larger than the cross-section of the tower. The Forum Baths have a large

⁹³ Jones & Robinson 2005, 697-702.
Richard Olsson

opening above the top level of the water tower. The top container could have been placed partly on the tower and partly into the opening in the wall, extending into the Baths. The tower had a groove on the northern side for the inlet pipe coming from tower no. 12 and one groove on the southern side for the outlet pipe going to the next tower, no. 10. The tower also had a wide but not so deep groove on the western side, to house and protect some six small water pipes for distributing water to users. To supply water from tower no. 12 both to tower no. 13 and to tower no. 8, it would have been necessary that the top containers of the latter two towers had about the same level at the top. The estimated levels for tower 8 (+41.7) and for tower 13 (+41.6) are shown in *Table 1*.

Water tower no. 10 is located behind the *Basilica* at VIII 1, 2. The supply pipe coming from tower no. 8 could in my opinion have been laid under the western part of the *Forum* and along *Via Marina* to the back of the *Basilica*. Schmölder-Veit suggested a different hypothesis, that the pipe was installed in *Vicolo dei Soprastanti* and along *Vicolo del Gallo* and *Vicolo del Gigante* and laid under *Via Marina* to the *Basilica*.⁹⁴ Tower no. 10 has only one visible groove on the northern side for a supply pipe from the previous tower no. 8 going up to the top container.

2.3.7 The central water pipeline

The second main water pipeline coming from the *Castellum Aquae* went first to the top container of water tower no. 7 in the larger groove on the northern side. This groove possibly also had space for pipes that distributed water to users. In the smaller groove on the southern side, there was space for a water pipe going to the next tower, no. 9, and then further to tower no. 11, as shown in *Fig. 2.10*. The levels of the top containers of the three towers were estimated to + 41.9 m, + 39.2 m and + 34.7 m, respectively as indicated in *Table 1*.

⁹⁴ Schmölder-Veit 2009, 122.

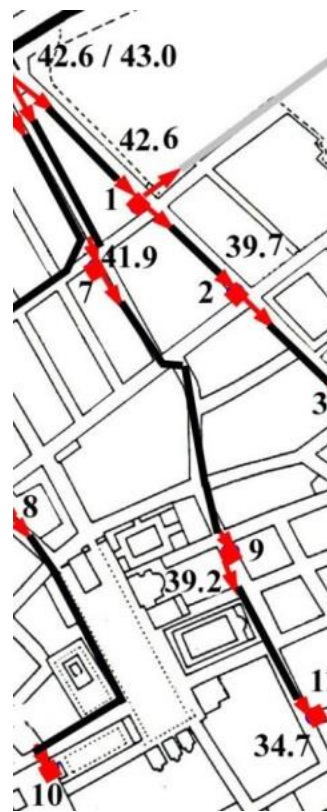

Figure 2.10. The central water pipeline. Drawing by author.

Water tower no. 9 is tall, with a measured height of 6.0 m, and stands in *Vicolo di Eumachia* at the corner of *Vicolo del Balcone Pensile* with the southern side of the tower in connection with the building at VII 10, 7. The tower has only two grooves, one at the northern side with space for a lead pipe coming from the previous tower no. 7 and one on the western side for a water pipe going under *Vicolo di Eumachia* to the next tower, no. 11. The supply pipe from tower no. 9 would have passed under the main street *Via dell'Abbondanza* and continued down *Vicolo del 12 Dei* to the corner of *Vicolo delle Pareti Rosse* and on to the next water tower no. 11, at VIII 5, 3. This tower has only one groove on the western side for the inlet water pipe coming from the previous tower, no. 9, and going up to the top container.

2.3.8 The eastern water pipeline

The eastern water pipeline distributed water from the *Castellum Aquae* to the top container of water tower no. 1 at +42.6 m, from where it continued further in two directions. One pipeline possibly went east to an unknown tower in the not yet excavated parts of the city in *Regio V* or in *Regio IV* and then possibly further to the top container of tower no. 14 at +36.3 m. The other pipeline, going south, continued to the top container of tower no. 2 at +39.7 m and continued from tower no. 2 south to tower no. 3 with the top container at +36.2 m. Tower no. 3 also had a groove on the eastern side with a possible connection to an unknown tower in *Regio IX*. From water tower no. 3, the pipeline continued south to tower no. 4 with the top container at +32.1 m, on to the top

container of tower no. 5 at + 29.7 m with a connection south to an unknown tower in *Regio I*, and finally to the top container of water tower no. 6 at + 26.5 m, as seen in *Fig. 2.11*.

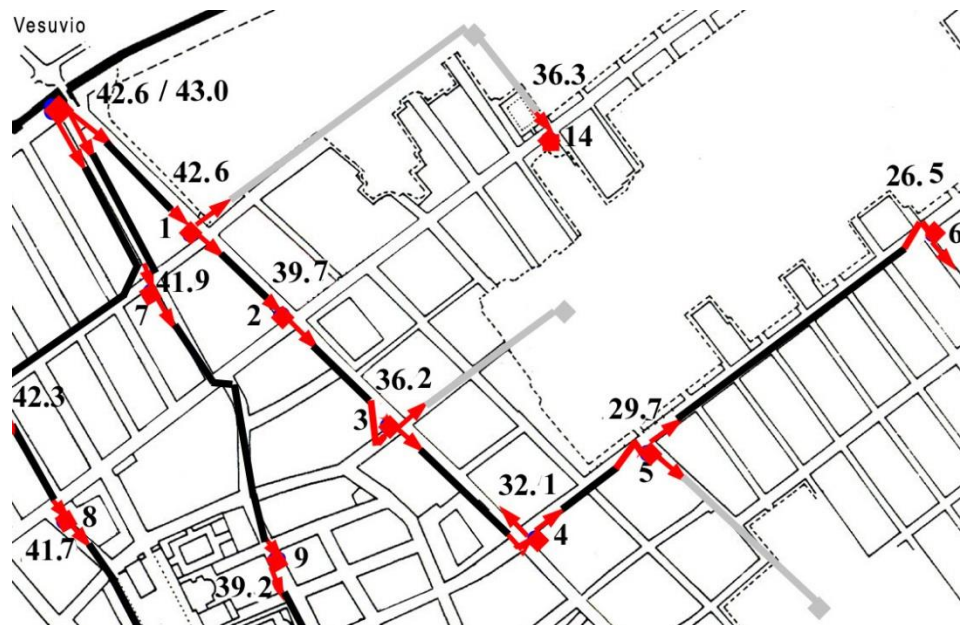

Figure 2.11. The eastern water pipeline. Drawing by author.

Water tower no. 1 has been described above with its three grooves, one on the northern side for the pipe from the *Castellum Aquae*, one on the southern side for the pipe to the next tower and a third groove on the eastern side, possibly for a pipe going to a further water tower in *Regio V* or *IV* which have not yet been excavated. It is possible that this unknown tower had a connection to tower no. 14. Water tower no. 14 is one of the smallest towers in the city with a cross-section of only 0.75 x 0.75 m, and is located on the south side of *Via di Nola* at IX 10, 2, built in connection with two buildings, one on each side. The tower has only one visible groove on the northern side taking water up to the top container from the unknown tower in the unexcavated part of the city in *Regio V* or *IV*. Schmölder-Veit presented a different hypothesis.⁹⁵ She suggested that the southern groove in water tower no. 2 could also have had space for a second, smaller lead pipe going to water tower no. 14. I am of the opinion that water tower no. 14 was supplied via an unknown water tower from water tower no. 1, because this tower has a groove on the eastern side, whereas tower no. 2 does not have one.

Water tower no. 2 in the eastern water pipe line is located at VI 14, 17 on the western pavement of *Via del Vesuvio/Via Stabiana*. This is the largest water tower in the city, measuring 1.50 m x 1.50 m. Water tower no. 2 has only two grooves, one at the northern side to take water in a pipe from the previous tower, no. 1, up to the top container, and one on the southern side for a pipe to take water down to the street level and to the top container of the next tower, no. 3.

⁹⁵ Schmölder-Veit 2009, 124.

Water tower no. 3 is tall, with a measured height of 6.6 m and is located at VII 2, 1 on the western pavement of *Via Stabiana*. The tower has three grooves but none on the northern side. The western groove was intended to give space for a pipe coming from tower no. 2 up to the top basin, because the tower stands close to the street on the eastern side of the western pavement. The groove on the southern side was intended for the connection from the top container down to street level and on to the top container of the next tower, no. 4. Tower no. 3 finally had a groove on the eastern side with space for a pipe taking water from the top container to a possible but not yet excavated water tower in *Regio IX*.

Water tower no. 4 is located at I 4, 15 in the south-eastern corner of *Via Stabiana* and *Via dell'Abbondanza*, with half of the tower on the street and half on the eastern pavement. It is one of the larger towers, measuring 1.20 x 1.20 m, and has three grooves, of which the western is the largest. The incoming water from tower no. 3 went under the street, crossing to this western groove and up to the top container. The two other grooves, on the northern and the eastern sides of the tower, have the same, somewhat smaller size. In my opinion the eastern groove had a pipe going to the top container of the next tower no. 5. The groove on the northern side contained a pipe that might have gone back north under *Via Stabiana* to supply the Stabian Baths with water. The water supply to the public baths will be discussed below.

Water tower no. 5 is located on *Via dell'Abbondanza* at the intersection with *Vicolo di Paquius Proculus* at I 6, 1, with the west side of the tower connected to a building. The tower has three grooves, one at the northern side for a pipe coming from the previous tower, no. 4, one at the eastern side for a pipe going to the next tower, no. 6, and a third groove on the southern side, possibly for a connection to an unknown water tower in the not yet excavated part of *Regio I*.

Water tower no. 6 is the last water tower on the eastern water pipeline and it is located far away on *Via dell'Abbondanza* where it crosses *Vicolo di Octavius Quartio* at II 2, 1. It was reconstructed after a bomb hit it in 1943.⁹⁶ It stands on the lowest point of the water system with its base at + 22.9 m, almost twenty metres lower than the inlet to the system from the *Castellum Aquae* at *Porta Vesuvio*. The top container of water tower no. 6 had a level at + 26.5 m. The tower has one small groove on each of three sides, the northern, the western and the southern, as the tower stands with the eastern side attached to a building. The northern groove would have had space for a pipe coming from the top container of the previous water tower, no. 5. The groove on the southern side possibly had a pipe going down the small street *Vicolo di Octavius Quartio* to the pool in the *Palestra Grande* at the level + 18.7 m. The groove on the western side of water tower no. 6 still has a fragment of a pipe *in situ* with a measured diameter of 0.04 m. This pipe seems to be going to the other side of *Vicolo di Octavius Quartio* where there is a water pipe fragment of the same size with an ancient valve located inside a modern concrete construction under a modern steel grating. The reason for this valve is not known. Archaeological excavations, as described by Nappo, have

⁹⁶ Heres 1992, 51.
Richard Olsson

exposed a deep ditch in the southern pavement of *Via dell'Abbondanza* full with *lapilli* all the way from *Via di Stabiana* to water tower no. 6.⁹⁷ A hypothesis suggested by Nappo is that a separate pipe distributed water to the pool in *Palestra Grande* all the way from water tower no. 4 and that the ancient valve at the corner of *Vicolo di Octavius Quartio* was a regulating valve.⁹⁸ This seems unlikely as the head from the top container of water tower no. 4 at + 32.1 m to the valve at + 23.1 m would have been 9.0 m, too great a pressure for the pipe. Such a separate pipe would also have disturbed the water supply to water towers no. 5 and no. 6 when the regulating valve was open.

⁹⁷ Nappo 1996, 42.

⁹⁸ Nappo 1996, 43.

3. Water supply for public use

The distribution network supplied water for public use from the containers on top of the water towers to the street fountains and the public baths. The various water users had different demands for water. The street fountains were supplied with a constant flow of water: we assume this as no archaeological evidence for closing valves to the street fountains has been found to date. Public baths normally had large storage tanks and a great demand for water and were thus supplied with a continuous water flow. When the water was not used, the street fountains and the public baths had an overflow.

The relevant issues to be investigated in order to understand the system of water supply for public use are the following:

- Location of the public water recipients in the city in relation to the water towers, in order to discuss the hypothetical route that the water followed to each one assuming that it took the shortest distance from the tower to the user,
- Topographical heights for the water intake for the street fountains to show the probable water-supply connection, based on the hypothesis that the head from water tower to water user was less than 8 m,
- Topographical heights for the storage tanks in two public baths to show the probable pipe connections for supplying water ,
- Size of the public baths, to demonstrate the large quantities of water required for the different rooms for cold, warm and hot baths distributed through the complicated water-pipe network inside the baths and
- Archaeological finds of water-pipe fragments in the pavements.

To present the probable water supply to the street fountains, first the location of each street fountain in relation to the closest water tower will be listed, secondly the head from tower to street fountain will be calculated to establish a possible connection from a tower to each street fountain and thirdly the archaeological situation in streets and pavements will be considered. The probable water supply to the public baths will be discussed in a similar way.

3.1 Water supply to the street fountains

3.1.1 Location and design of street fountains

The street fountains are stone constructions comprising in most cases four orthostats at right angles, forming a rectangle and thereby creating a water basin. On top of one of the side stones was a smaller stone, sometimes with a relief, with an opening through which aqueduct water was led into the basin. On the top of one the other side stones, an overflow let the water out onto the street when the basin was full. In addition, at the bottom on one of the side stones, an outlet was made to allow the basin to be emptied for regular cleaning.

Richard Olsson

The street fountains in Pompeii have been discussed by many scholars. H. Eschebach presented in detail the 42 street fountains found in the city, indicating their location.⁹⁹ Together with T. Schäfer, he described the material and the iconography used on the relief stone; they also numbered the street fountains from no. 1 to no. 42.¹⁰⁰ There were 35 normal street fountains with a basin, 3 fountains without a basin and 4 fountains of special design. The locations of the 42 street fountains in my study in relation to the water towers are presented in *Fig. 3.1*.



Figure 3.1. Location of street fountains and water towers. The towers are numbered 1-14 and are indicated in red, while the fountains are in black and numbered 1-42. Drawing by author.

In the publication *Gebäudeverzeichnis und Stadtplan der antiken Stadt Pompeji* Eschebach listed all the 35 normal street fountains.¹⁰¹ The 35 street fountains were located in street corners in all parts of the city, in some cases on the pavement and in others partly on the street blocking or preventing traffic. Aqueduct water flowed from the top container of a water tower near-by to each street fountain through a separate water pipe to the opening in the relief stone on top of one of the side. Water flowed continuously into the water basins, supplying the people in Pompeii, who carried it back to the houses or workshops for consumption. If the consumption was less than the water supplied, the overflow allowed excess water to flow out and downhill, cleansing the streets. Three examples of normal street fountains are shown in *Fig. 3.2 a, b and c*.

⁹⁹ H. Eschebach 1983, 90 and Tafel 2.

¹⁰⁰ Eschebach & Schäfer 1983, 11-40.

¹⁰¹ H. Eschebach 1993, 490-491.



Figure 3.2 a, b and c. Street fountains nos. 20, 21 and 27 with basins. Photos by author. The overflow outlet is clearly seen in 3.2 b, as is the outlet for cleansing at the bottom.

There were three street fountains in the city constructed without a water basin, nos. 11, 30 and 38.¹⁰² H. Eschebach categorised them as “drinking fountains” (*Laufbrunnen für Trinkwasser*), suggesting that these three fountains were for special use. Schmölder-Veit described them after their form, calling them “*Stockbrunnen*”,¹⁰³ without giving any explanation as to why the three fountains were without basins.

Thomas Staub made an interesting observation: a pipe from the southern of the two distribution boxes in the kitchen of *Casa del Torello di Bronzo* goes under the floor towards the street fountain without a basin no. 11.¹⁰⁴ His observation indicates that the street fountain was not supplied with aqueduct water directly from a water tower, but indirectly through a pipe controlled by the owner of the house. Perhaps even the other two basinless fountains should be discussed in connection with activities in an adjacent house. The three street fountains without a basin are shown in *Fig. 3.3 a, b and c*.



Figure 3.3 a, b and c. Street fountains nos. 11, 30 and 38 without basins. Photos by author.

Four street fountains had special designs and should not be seen as true street fountains or be compared with the normal ones. They are included here among H. Eschebach’s 42 street fountains. Street fountain no. 15 was located at the base of the Arch of Caligula on *Via Mercurio* at VI 10, 10: it was perhaps not intended for water collection by the people. The Arch of Caligula was constructed with two large pillars connected on top. It has been suggested that the connection contained a water storage tank. If this was the case, the container could not have been supplied with

¹⁰² H. Eschebach 1993, 122, 345 and 393.

¹⁰³ Schmölder-Veit 2009, 127.

¹⁰⁴ Staub 2013, 94.

aqueduct water as the Arch of Caligula stands on a street level of + 35.7 m and has an approximate height of more than 7 m, and thus could not be supplied from the Castellum Aquae at + 42.6 m, as the water could not have flowed up to the top of the container. Street fountain no. 25 was built in the arch at the north-east corner of the Forum, probably for decorative purpose and for its beauty (Fig. 3.4 a). Street fountain no. 35 was standing in the Triangular Forum, an open place for cult and tranquillity (Fig. 3.4 b). Street fountain No. 36 was a drinking fountain in the theatre district known later as the Gladiator Barracks. The fountain was placed in the soldiers' camp but had probably belonged to a private building. It was removed in 1810.¹⁰⁵



Figure 3.4 a and b. Street fountains nos. 25 and 35 with special design. Photos by author.

In my field investigations all the street fountains were studied in detail. The size of the street fountains has been measured and the capacity of each basin calculated and presented in *Table 6*. All the street fountains are different in size – there does not seem to have been any standardisation. The different sizes of the basins of the normal street fountains could be grouped into four categories: ten small-sized basins with a capacity of ca 400 litres (S), four medium-sized basins with a capacity of ca 600 litres (M), nineteen large-sized basins with a capacity of ca 800 litres (L) and three extra-large-sized basins with a capacity of ca 1200 litres (XL). The size category for each basin is indicated in *Table 6*. The capacities for basinless street fountains and for specially designed street fountains have not been calculated.

3.1.2 Water pressure in the distribution network

According to Dybkjaer Larsen, the water pipes could not be subjected to pressure higher than a head of 6–8 m without damaging the pipe.¹⁰⁶ He refers to Fritz Kretschmer, who investigated Roman water valves and concluded that the water pressure in the system had to be reduced to 0.6 kg/cm² in order to not damage the valve.¹⁰⁷ Although there are no closing valves by the street fountains, I have chosen to consider the head of 8 m as a limit for the water pressure in the distribution network.

¹⁰⁵ See Mazois, F., 1824, *Les Ruines de Pompei: Seconde Partie*. Paris: Firmin Didot. (p. 37 Plate III, Fig. II).

¹⁰⁶ Dybkjaer Larsen 1982, 41.

¹⁰⁷ Kretschmer 1960, 61.

Each street fountain was supplied with water through a separate pipe connection from the top container of a near-by water tower. The level for the edge of the basin of all street fountains has been calculated and is presented in *Table 6*: this calculation is based on the street level in front of the street fountain, following H. Eschebach. For the normal street fountains, I added the height of the basin plus 0.2 m up to the level of the mouth of the street fountain pipe, called the level of the pipe opening. For basinless street fountains, I added 0.3 m to the street level and for the specially designed street fountains, I considered the pipe opening to be 1.0 m above the street level. The head for the pipe connection is the difference in level between the top container of the water tower and the pipe opening of the street fountain. The head and the distance to a water tower indicate which tower each fountain was most likely to have been connected to. The head also determined the quantity of water pouring into the basin of the fountain. The head must have been large enough to ensure a steady flow of water but small enough to avoid the risk of damaging the water pipe. The water flow from top container of a water tower to a street fountain is mathematically a function of the square root of the head. Comparing the water flow to different fountains supplied from the same top container, the one with a head twice that of the head of another one would have had approximately 40% more flowing water.

Below, I present a hypothetical model of a part of the water supply destined for street fountains and public baths based on three factors, first the distance from water towers to the public users, then the head for a possible pipe connection and finally the information from archaeological investigations of the pavements of the streets made by Salvatore Nappo.

3.1.3 Water supply to street fountains in the north-western part of the city

In the north-western part of the city there are nine street fountains: nos. 11, 12, 14, 16, 17, 18, 19, 20 and 21. Nappo investigated the western pavement of *Via del Vesuvio / Via Stabiana* where he has found a ditch full of *lapilli* along *insula* VI 16 and all the way down to the Stabian Baths (see *Fig.3.5 a*).¹⁰⁸ This ditch could have contained the main water pipeline to water tower no. 1 but also pipes going to street fountains nos. 19 and 20. If these two street fountains were supplied with water from tower no. 1, the head, as shown in *Table 7*, would have been 7.0 m to street fountain no. 19 and only 1.7 m to street fountain no. 20. Water tower no. 2, being close, probably supplied water to street fountains nos. 11 and 18 with a head of 7.2 m and 6.6 m. The observation made by Thomas Staub that street fountain no. 11 was supplied with water from tower no. 2 but via a pipe coming from a distributor in a house, will be discussed below.

Nappo investigated pavements in *Vico dei Vettii* also, and describes a ditch from *Vicolo di Mercurio* in a north-west direction ending at street fountain no. 21.¹⁰⁹ The ditch continues south to the southern pavement of *Via della Fortuna* where it turns west but not east.¹¹⁰ This ditch probably contained the main water pipeline from water tower no. 7 to water tower no. 9 but also water pipes

¹⁰⁸ Nappo 1996, 37.

¹⁰⁹ Nappo 1996, 39.

¹¹⁰ Nappo 1996, 39.

to consumers. My opinion is that street fountains nos. 16 and 21 were connected to water tower no. 7. The calculated head was 7.7 m to fountain no. 16 and only 1.0 m to fountain no. 21, as shown in *Table 7*. Street fountains nos. 14 and 17 are located on *Vicolo di Mercurio* but there are no indications of water pipes in the pavements: however, close to tower no. 7 there are two large and five small pipes on the wall of VI 13 going east. Street fountain no. 17, located close to tower no. 7, was reasonably supplied from that tower with a head of 3.8 m. Street fountain no. 14 could have been supplied either from water tower no. 7 or no. 12. It is my opinion that street fountain no. 14 was also supplied from water tower no. 7, with a head of 4.9 m based on the pipes on the wall of VI 13 going east. In the eastern pavement of *Via Consulare*, Nappo found a ditch north of *Vicolo di Mercurio*,¹¹¹ possibly for the main pipeline between water towers nos. 12 and 13. Street fountain no. 12 could have had a pipe connection from tower no. 13 with a head of only 0.9 m or from water tower no. 12 with a head of 1.6 m. My guess is that fountain no. 12 was connected to tower no. 13, being so close. The ditch in *Via Consulare* continued to the south of *Vicolo di Mercurio*, probably for water pipes for private use.

In the north-western part of the city it is plausible that

- water tower no. 1 had pipe connections to street fountains nos. 19 and 20.
- water tower no. 2 had pipe connections to street fountain no. 18 and indirectly to 11.
- water tower no. 7 had pipe connections to street fountains nos. 14, 16, 17 and 21.
- water tower no. 12 was not connected to any street fountain and
- water tower no. 13 had a pipe connection to street fountain no. 12.

All the plausible pipe connections mentioned here are shown in *Fig. 3.5 a and b*.

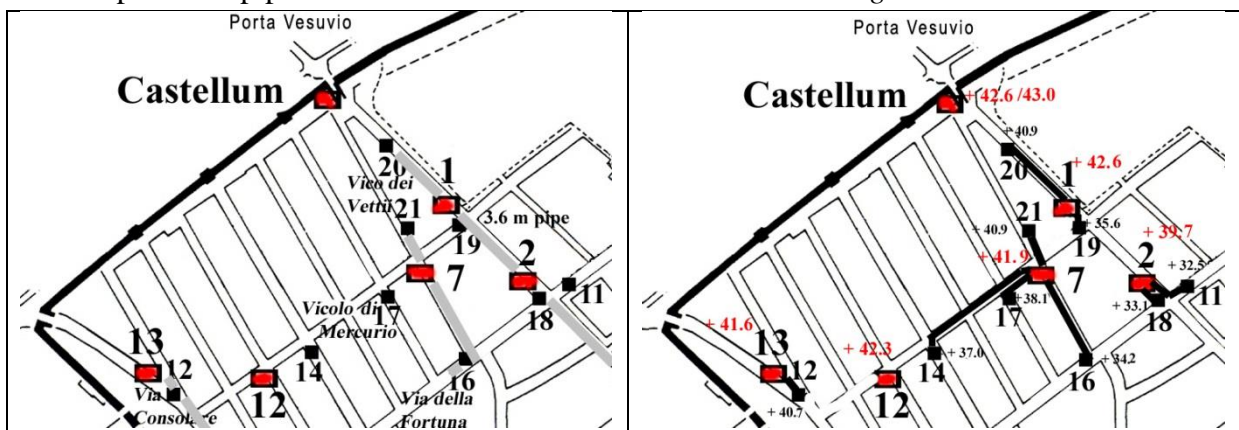

Figure 3.5 a. Street fountains and excavation ditches in the north-western part of the city. The red rectangles represent the water towers, the black ones, the street fountains. The grey street markings indicate ditches full of *lapilli*. Drawing by author.

Figure 3.5 b. Street fountains with plausible pipe connections in the north-western part of the city, indicating the heights of the towers in red and of fountains in black. Drawing by author.

¹¹¹ Nappo 1996, 42.
 Richard Olsson

3.1.4 Water supply to street fountains in the south-western part of the city

In the south-western part of the city, there are eleven street fountains: nos. 13, 15, 24, 25, 26, 27, 29, 30, 31, 32 and 33. Nappo investigated the pavements of the streets around the Forum Baths and found no traces of water pipes in *Via del Foro*, in the south pavement of *Via delle Terme* or in *Vico di Modesto*.¹¹² In the north pavement of *Via delle Terme* there is however a ditch beginning outside VI 6, 3 and ending outside VI 6, 1.¹¹³ This could be an indication that street fountain no. 13 had a pipe connection to water tower no. 8 with a head of 3.0 m. Street fountain no. 15 at the base of the Arch of Caligula would have had a head of 5.0 m if it too was supplied from water tower no. 8. Nappo did not mention any investigations in *Vico delle Terme* but the location and the levels make it plausible that street fountains nos. 24 and 25 were also connected to water tower no. 8 with a head of 4.6 m and 3.8 m, respectively. Street fountain no. 30 was constructed without a water basin but if it had been connected to a water tower, it is possible that it had a pipe connection to the closest tower, no. 8, with a head of 7.5 m.

Nappo also described one ditch full with *lapilli* in the south-western part of the city located along the western pavement of *Via delle Scuole* all the way to street fountain No. 31.¹¹⁴ One interpretation is that both street fountains nos. 31 and 33 had pipe connections from water tower no. 10, with a head of 3.0 m and 2.9 m, respectively. Pipe connections to these two street fountains from the closest water tower no. 11 have been excluded because the head would have been too low, only 0.7 m and 0.6 m, respectively. Probably fountain no. 29 was also connected to tower no. 10, being the closest and with a head of 2.3 m, and not to tower no. 8, which would have had too large a head. Nappo's investigations have not shown pipe connections close to water towers nos. 9 and 11. Possibly street fountain no. 27 could have been supplied from tower no. 9, being the closest and if so, having a head of 7.8 m. Water tower no. 11 could have supplied water to fountains nos. 26 and 32, with a head of 4.3 m and 1.5 m, respectively.

In the south-western part of the city it is plausible that

- water tower no. 8 had pipe connections to street fountains nos. 13, 15, 24 and 25 and possibly also no. 30
- water tower no. 9 possibly had pipe connections to street fountain no. 27
- water tower no. 10 had pipe connections to street fountains nos. 31 and 33 and possibly also no. 29 and
- water tower no. 11 possibly had pipe connections to street fountains nos. 26 and 32.

All plausible pipe connections mentioned here are shown in *Fig. 3.6 a and b*.

¹¹² Nappo 1996, 41.

¹¹³ Nappo 1996, 42.

¹¹⁴ Nappo 1996, 44.

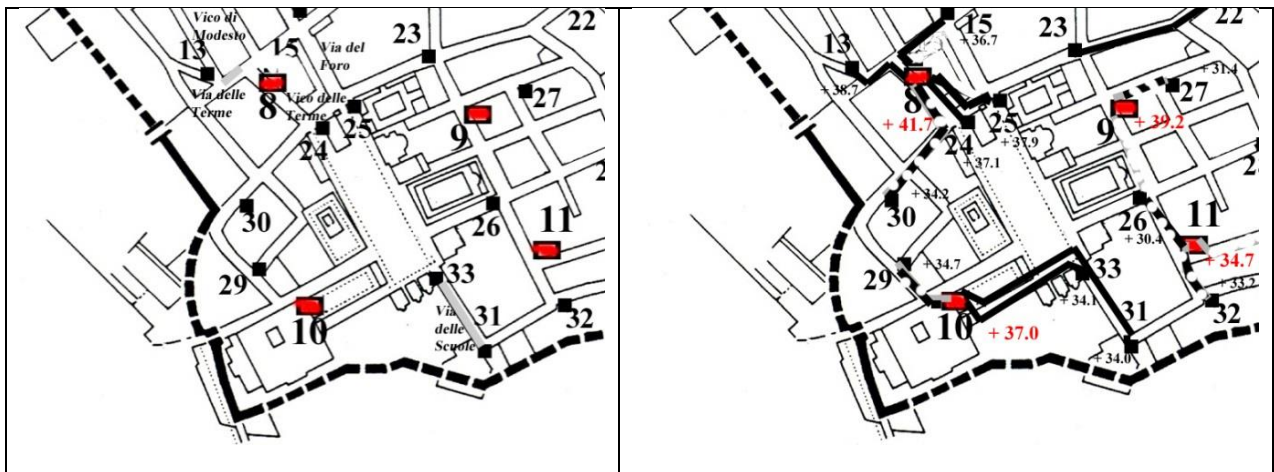

Figure 3.6 a. Street fountains and excavation ditches in the south-western part of the city. The red rectangles represent the water towers, the black ones, the street fountains. The grey street markings indicate ditches with *lapilli*. Drawing by author.

Figure 3.6 b. Street fountains with plausible pipe connections in the south-western part of the city, showing the heights of the towers in red and of fountains in black. Drawings by author.

3.1.5 Water supply to street fountains in the central part of the city

In the central part of the city there are seven street fountains: nos. 1, 22, 23, 28, 34, 35 and 39. The situation in the pavements close to water tower no. 3 was described by Nappo as rather complex.¹¹⁵ He studied the northern pavement in *Via degli Augustali* and found two pipes going west for a length of about 9 metres, with different dimensions. The larger one, of the size he called *denaria*, was found in a ditch full with *lapilli* continuing in the northern pavement all the way to street fountain no. 23. The other, smaller pipe, called *octonaria*, could have supplied water to a private user. It is plausible that street fountains no. 22 with a head of 6.2 m and no. 23 with a head of 2.2 m were connected to water tower no. 3.

Nappo also investigated the pavements of *Via dell'Abbondanza* and found a ditch full of *lapilli* along the southern pavement of *Via dell'Abbondanza* all the way from *Porta di Sarno* to *Via Stabiana*, where it turns south in the eastern pavement and ends between *insula* I 4 and I 3. It is reasonable to think that tower no. 4 supplied water to street fountain no. 1, located close to the tower and having a head of 6.2 m. He also found a pipe of the *denaria* size in the northern pavement going to fountain no. 28.¹¹⁶ Thus it is probable that water tower no. 4 also supplied water to fountain no. 28, with a head of 6.1 m. It is possible that even the two street fountains nos. 34 and 35 were supplied from tower no. 4, having heads of 7.1 m and 7.0 m, respectively. Street fountains nos. 28, 34 and 35 could not have been connected to the closest water tower, no. 11, because the head would have been 8.7 m, 9.7 m and 9.6 m, respectively, much above the limit of 8 m. which, as discussed earlier, could cause damage to the pipes. Fountain no. 39 could have been supplied with

¹¹⁵ Nappo 1996, 41.

¹¹⁶ Nappo 1996, 42.

Richard Olsson

water from tower no. 3, having a head of 6.2 m or from tower no. 4 with a head of only 2.1 m, but not from tower no. 5 as the head then would have been negative. If there was an unknown water tower in *Regio IX*, as suggested above, fountain no. 39 could have been supplied from there. This is all, of course, speculative.

In the central part of the city it is plausible that

- water tower no. 3 had pipe connections to street fountains nos. 22 and 23 and
- water tower no. 4 had pipe connections to street fountains nos. 1 and 28 and possibly also to street fountains nos. 34 and 35.

Street fountain no. 39 was possibly connected to an unknown water tower.

All plausible pipe connections mentioned here are shown in *Fig. 3.7 a and b*.

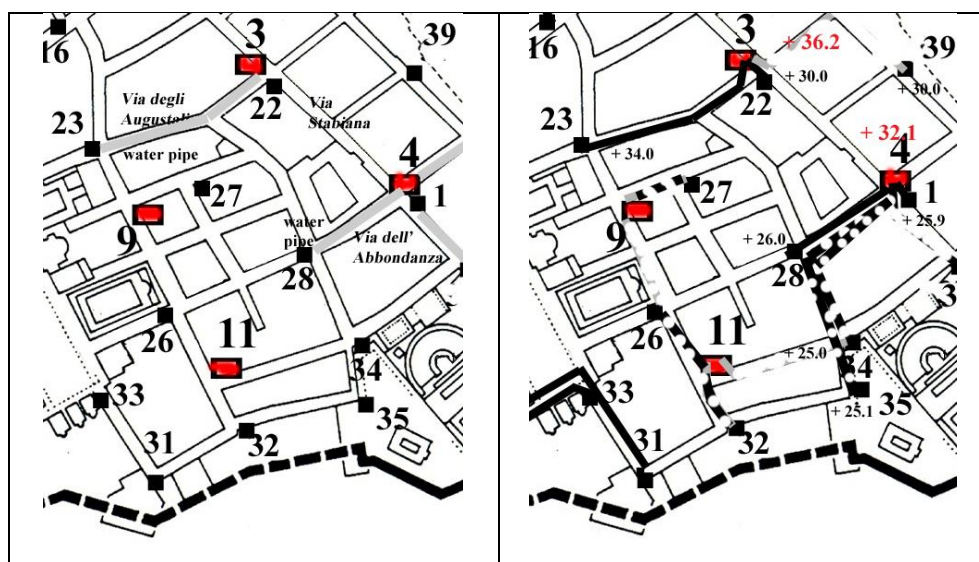

Figure 3.7 a. Street fountains and excavation ditches in the central part of the city. The red rectangles represent the water towers, the black ones, the street fountains. The grey street markings indicate ditches with *lapilli*. Drawing by author.

Figure 3.7 b. Street fountains with plausible pipe connections in the central part of the city showing the heights of the towers in red and of fountains in black. Drawing by author.

3.1.6 Water supply to street fountains in the south-eastern part of the city

In the south-eastern part of the city there are twelve street fountains: nos. 2, 3, 4, 5, 6, 7, 8, 9, 36, 37, 38 and 42. Nappo described a ditch going south from water tower no. 5 along the street between *insula I 6* and *I 7*.¹¹⁷ This indicates that street fountain no. 4 was connected to water tower no. 5 with a head of 6.3 m. Also fountain no. 3 with a head of 4.2 m and no. 42 with a head of 3.2 m were probably connected to tower no. 5. Nappo's archaeological investigations of the southern pavement of *Via dell'Abbondanza* show no indication of water installations by *insula II 4* and *II 5* close to *Porta di Sarno* and there are no street fountains in this part of the city. However there is a pipe of

¹¹⁷ Nappo 1996, 42.
 Richard Olsson

the size he called *denaria* going from street fountain no. 9 towards water tower no. 6. Another *denaria* pipe goes west, probably to fountain no. 8. The ditch continues to the west towards fountain no. 5 with a branch to the south in *Via di Nocera* towards street fountain no. 6. It is reasonable to assume that fountains no. 9 with a head of 3.1 m, no. 8 with a head of 2.9 m and no. 6 with a head of 4.9 m were all supplied with water from tower no. 6. It is possible that even street fountain no. 5 with a head of 1.9 m could have been connected to tower no. 6 as it is the closest. The distance to water tower No. 5 was longer, but it is also a possibility that the water might have been supplied from there with a head of 5.1 m. It has been discussed above that the top container of water tower No. 6 had only three visible water connections.

The part of Pompeii close to *Porta di Stabia* is located at a very low level. There are five street fountains in this part of the city: nos. 2, 7, 36, 37 and 38. Street fountain no. 38 was basinless and could not have been connected to the closest water tower, no. 4, because the head would have been very much above 8 m (11.3 m). Fountains no. 7 at + 21.4 m and no. 38 at + 20.8 m could both have been supplied from tower no. 5 but the head would have been slightly over 8 m (8.3 m and 8.9 m respectively). Street fountains nos. 2, 36 and 37 are located at a very low level in the city, at + 15.8 m, + 15.1 m and + 10.8 m respectively, and could not have been supplied with water from tower no. 4, which stands at the eastern pavement of *Via Stabiana* at *Via d'Abbondanza*. The level of the top container of tower no. 4 was + 32.1 m, making the head much above the crucial value of 8 m. The existence of these five street fountains at this very low part of the city could be an indication of the possible existence of one or even two unknown water towers in the not yet excavated part of *Regio I*.

In the south-eastern part of the city, it is plausible that

- water tower no. 5 had pipe connections to street fountains nos. 3, 4, 5 and 42 and
- water tower no. 6 had pipe connections to street fountains nos. 6, 8 and 9.

Street fountains nos. 7 and 38 were possibly connected to an unknown water tower and fountains nos. 2, 36 and 37 to another unknown water tower.

All plausible pipe connections mentioned here are shown in *Fig. 3.8 a and b*.

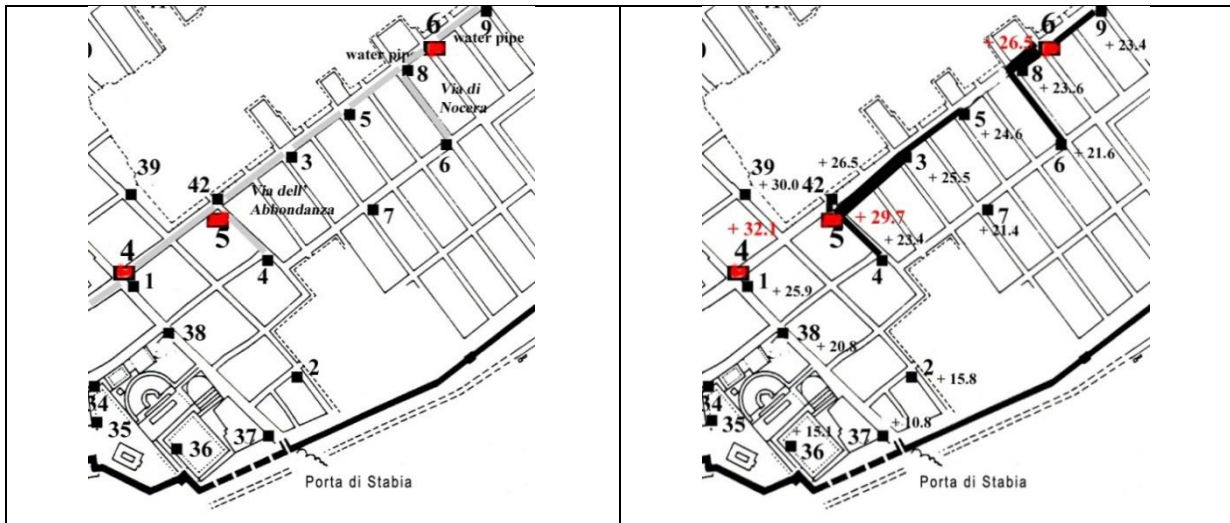

Figure 3.8 a. Street fountains and excavation ditches in the south-eastern part of the city. The red rectangles represent the water towers, the black ones, the street fountains. The grey street markings indicate ditches with *lapilli*. Drawing by author.

Figure 3.8 b. Street fountains with plausible pipe connections in the south-eastern part of the city showing the heights of the towers in red and of fountains in black. Drawing by author.

3.1.7 Water supply to the street fountains in the north-eastern part of the city

In the north-eastern part of the city there are three street fountains: nos. 10, 40 and 41. There are no traces of water pipes in the eastern part of *Via di Nola* but it is reasonable that street fountains nos. 40 and 41 were connected to water tower no. 14 with a head of 3.3 m and 4.3 m, respectively. Fountain no. 10 would have had a head of 8.9 m, above the estimated maximum limit if supplied from water tower no. 14.

In the north-eastern part of the city it is plausible that

- water tower no. 14 had pipe connections to street fountains nos. 40 and 41 and possibly also to fountain no. 10.

All plausible pipe connections mentioned here are shown in *Fig. 3.9*.

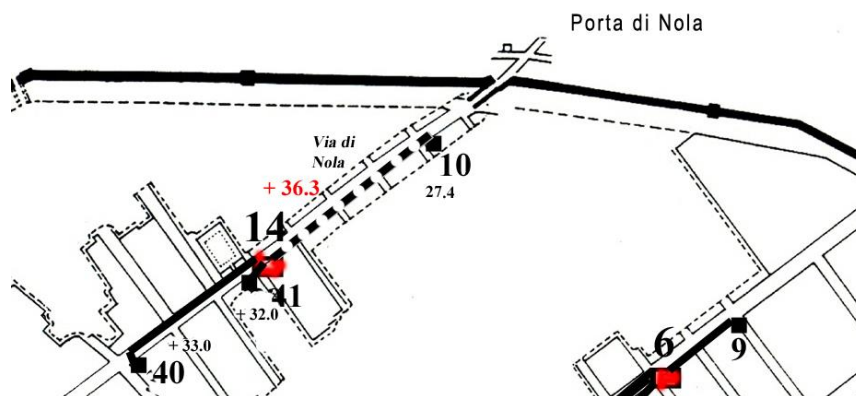

Figure 3.9. Plausible pipe connections to street fountains in the north-eastern part of the city.

Drawing by author.

Richard Olsson

3.2 Water supply to the public baths

3.2.1. The Stabian Baths

A constant, adequate water supply was of vital importance to Roman baths. The need for water was great, but varied much during the day. Water supply to boilers and baths could be opened and closed by valves in the water pipes. Roman baths therefore normally had an elevated water storage tank to secure that a sufficient quantity of water was always available when needed. Such a water-filled storage tank needed a strong construction underneath it to bear the heavy weight of the water tank.

Location and size

The Stabian Baths are located in the southern part of *insula* VII 1, at the corner of *Via Stabiana* and *Via dell'Abbondanza*. The building site is large, about 2400 square metres, and slopes towards the south. The Baths were originally built long before the city became a Roman colony and rebuilt and modernised in a number of phases during antiquity. The building complex that was the Stabian Baths was studied and described in detail by H. Eschebach.¹¹⁸ The main entrance to the men's baths is from *Via dell'Abbondanza* at VII 1, 8 leading in to an open outdoor area (A) with a large pool (B) with two side pools (C). To the right are the men's dressing room (D) and cold (E), warm (F) and hot baths (G). In the north-east corner is the main entrance to the women's baths from *Via Stabiana* at VII 1, 17, leading to the women's dressing room (H) and cold (I), warm (J) and hot baths (K). The boiler room (L) is located in between to serve both the men's and the women's baths.

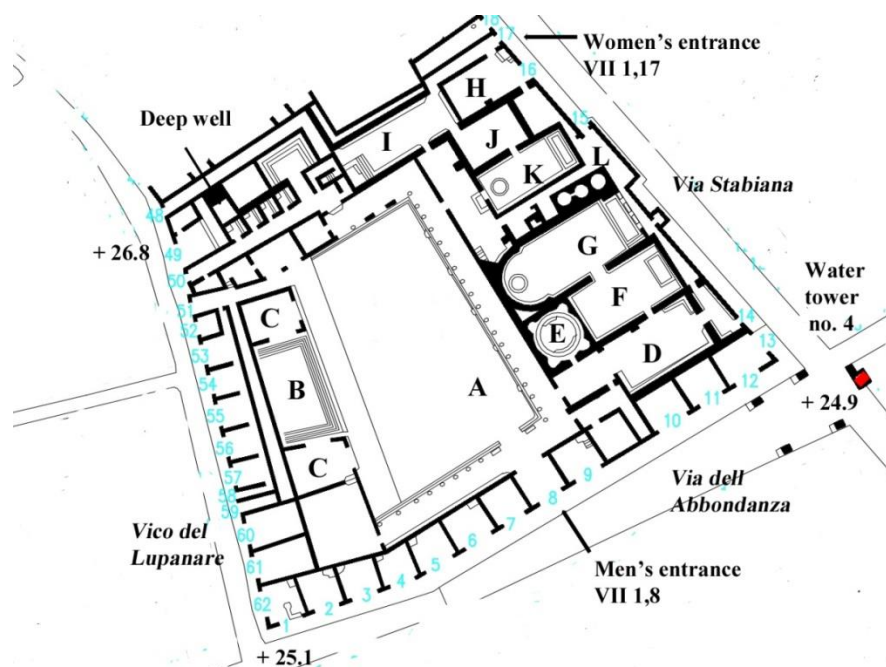

Figure 3.10. The Stabian Baths. Drawing with additions by author.

¹¹⁸ Eschebach 1979.
Richard Olsson

Water supply from a deep well

In the beginning, the water for the Stabian Baths was supplied from a deep well, located in the north-western corner of the site. It was equipped with a 5.50-m-high tread-wheel operated from above and a water-lifting device, which took water from the well up to a large storage tank on top of the building. According to H. Eschebach, the storage tank was 3.80 x 11.25 m with a height of 0.90 m and located 2.60 m above floor level.¹¹⁹ The capacity of the storage tank was estimated to 38,000 litres.

The approximate level of the storage tank can be based on street levels given by Eschebach.¹²⁰ The corner of *Via dell'Abbondanza* and *Vico del Lupanare* is located at + 25.1 m. The slope to the north along *Vico del Lupanare* up to the entrance at VII 1, 49 outside the room for the water-lifting device and the well has a rise of about 1.7 m,¹²¹ with the street level at the entrance consequently at + 26.8 m. As mentioned, the water storage tank was located 2.60 m above floor level and had a height of 0.90 m. Thus the water level in the water storage tank of the Stabian Baths can be calculated at approximately + 30.3 m. Later when the water was supplied from the aqueduct they needed more water, and the height of the storage tank was increased to 1.46 m¹²² and the capacity, to 62,000 litres, giving a water level in the water storage tank of approximately + 30.8 m.

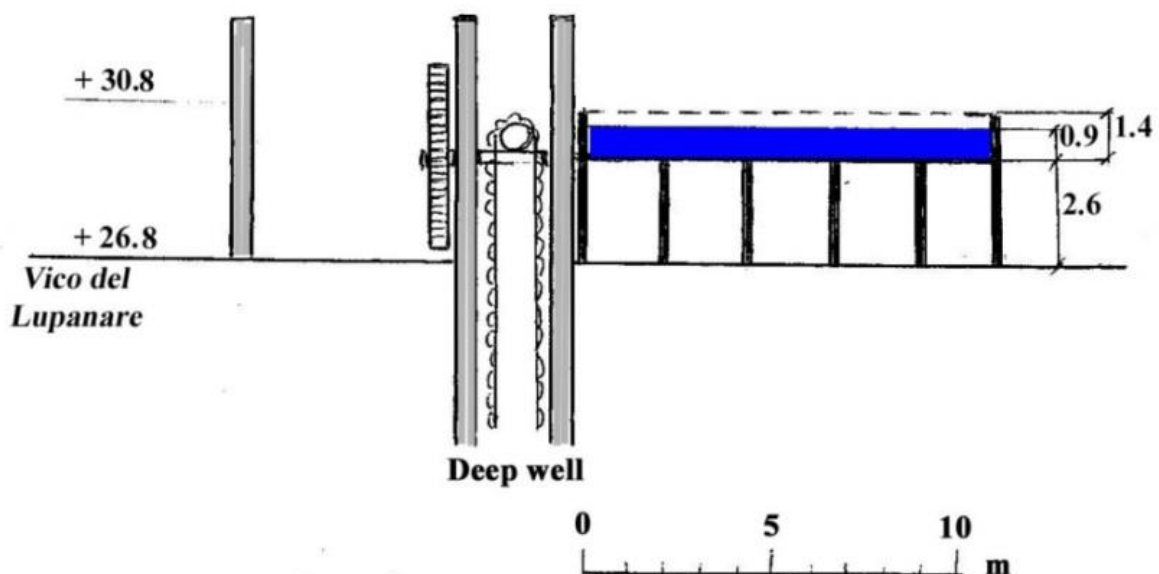

Figure 3.11. Level of water storage tank in Stabian Baths. Drawing by author.

It is not known whether the deep well was used after the time when the storage tank was connected to the aqueduct system. The tread-wheel and the water-lifting device must then have been taken out of operation as the lifting device no longer reached to the level of the increased height of the top of

¹¹⁹ H. Eschebach 1979, 31-34 and figure 12a.

¹²⁰ H. Eschebach 1993, city map

¹²¹ H. Eschebach 1979, Tafel 2.

¹²² H. Eschebach 1979, 34.

the storage tank (Fig.3.11). It would of course have been possible to rebuild the lifting device to a higher level, but it would have been complicated and does not seem plausible. The water in the deep well could thus no longer be supplied to the Baths, but the well remained open. It is not known whether the water was used for other purposes, whether the shaft was used to take care of the water overflow from the storage tank or whether the well went out of use.

Water supply from the aqueduct

The Stabian Baths already existed when the aqueduct was constructed and therefore the supply of water to the baths could have been taken into consideration when designing the new aqueduct main water system. The Stabian Baths had a large water storage tank on top of the building and had a large need for water, shown by the fact that the height of the storage tank was raised at the time of the connection to the aqueduct.¹²³ In my opinion, the Stabian Baths were supplied with water through a separate, large lead pipe installed in a separate groove in a water tower, distributing water directly to the enlarged water storage tank.

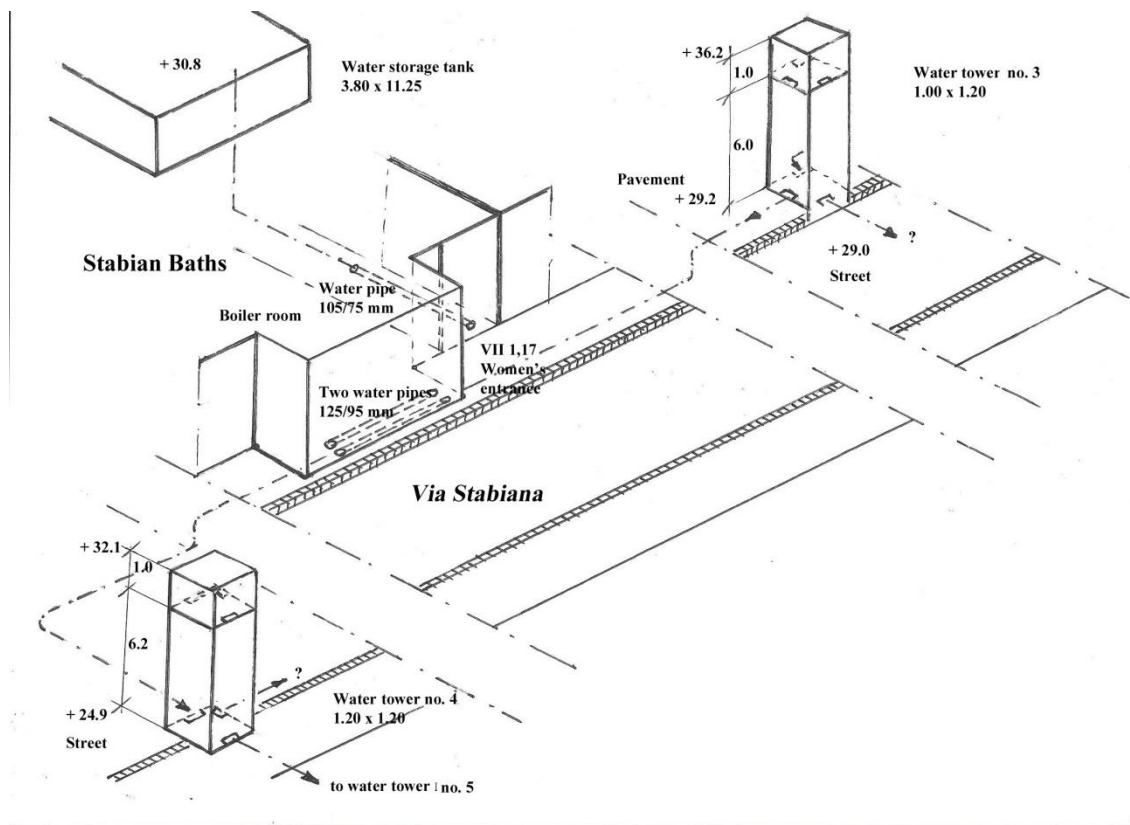

Figure 3.12. Stabian Baths – Storage tank and closest water towers. Drawing by author.

As seen in Fig. 3.12, water was supplied to the Stabian Baths from the top container of a water tower. The atmospheric pressure on the water surface in the tower container pressed water through a

¹²³ Eschebach 1979, 34.
Richard Olsson

separate lead pipe up to the large water storage tank on the top of the Stabian Baths. This water could have come to the Baths either from water tower no. 3, located on the western pavement of *Via Stabiana* in the north corner of *Via degli Augustali*, or from water tower no. 4, located on the eastern pavement of *Via Stabiana* in the south corner of *Via dell'Abbondanza*.

Two possible water towers

Water tower no. 3 is tall and stands on the western pavement of *Via Stabiana* in the north corner of *Via degli Augustali* in an open area at VII 2, 1. It has three grooves, one on the western side for a pipe coming from water tower no. 2, one on the southern side for a pipe to take water to the next water tower, no. 4 and one on the eastern side with an unknown purpose. This last groove could have been for a pipe in one of the following three directions: north to supply water to the Central Baths later to be located in *insula IX 4*. This seems unlikely as the lower part of water tower no. 3 was built before AD 62, when the planning for the Central Baths had probably not yet started. A second possibility is that the pipe followed the street south to supply water to the Stabian Baths and connected to the water pipe found in the women's entrance at VII 1, 17. Such a solution would have influenced the balance of the main water system and supplied a lesser quantity of water to water tower no. 4, with a top container at a higher level than the storage tank on the Stabian Baths. The third and most probable possibility in my opinion is that this groove was made for a pipe to a possible, not yet excavated water tower in *Regio IX*, even if Nappo did not find any archaeological traces from pipes in *Via Augustali* east of *Via Stabiana*, as discussed above. It is still possible that a groove on the eastern side of water tower no. 3 was intended to house a pipe going east. Water tower no. 4 is located on the eastern pavement of *Via Stabiana* where it crosses *Via dell'Abbondanza* and also has three grooves. The large groove on the western side was made for the water connection coming from tower no. 3 and the groove on the eastern side was intended for a pipe to bring water to tower no. 5 further down on *Via dell'Abbondanza*. The third groove on the north side could in my opinion have been designed to accommodate a pipe supplying water to the Stabian Baths. The level of the water in the top container of tower no. 3 was + 36.2 m and that of tower no. 4 was + 32.1 m. As indicated above, the water level of the storage tank of the Stabian Baths was + 30.8 m as shown in *Fig. 3.12*.

Archaeological finds of lead pipes

When studying the Stabian Baths, H. Eschebach indicated that two large, parallel pipes, 95/125 mm, were located in the western pavement of *Via Stabiana* inside the extension of the Stabian Baths built on the pavement.¹²⁴ I agree with Eschebach that the two pipes were part of the main water pipeline, which was located in the western pavement of *Via Stabiana* between water towers nos. 3 and 4. The two parallel pipes were possibly installed in the pavement before the Stabian Baths got new boilers and needed to extend onto a major part of the pavement. Eschebach also mentioned a smaller pipe, 75/105 mm, located in the women's entrance to the Stabian Baths at VII 1,17.

¹²⁴ H. Eschebach 1979, 36 and Tafel 29.

Discussion

The connection from the main water system to the pipe found in the women's entrance is not known but the design of pipes in the pavement just outside VII 1, 17 will be discussed below. There could be several possible explanations, as shown in *Fig. 3.13*.

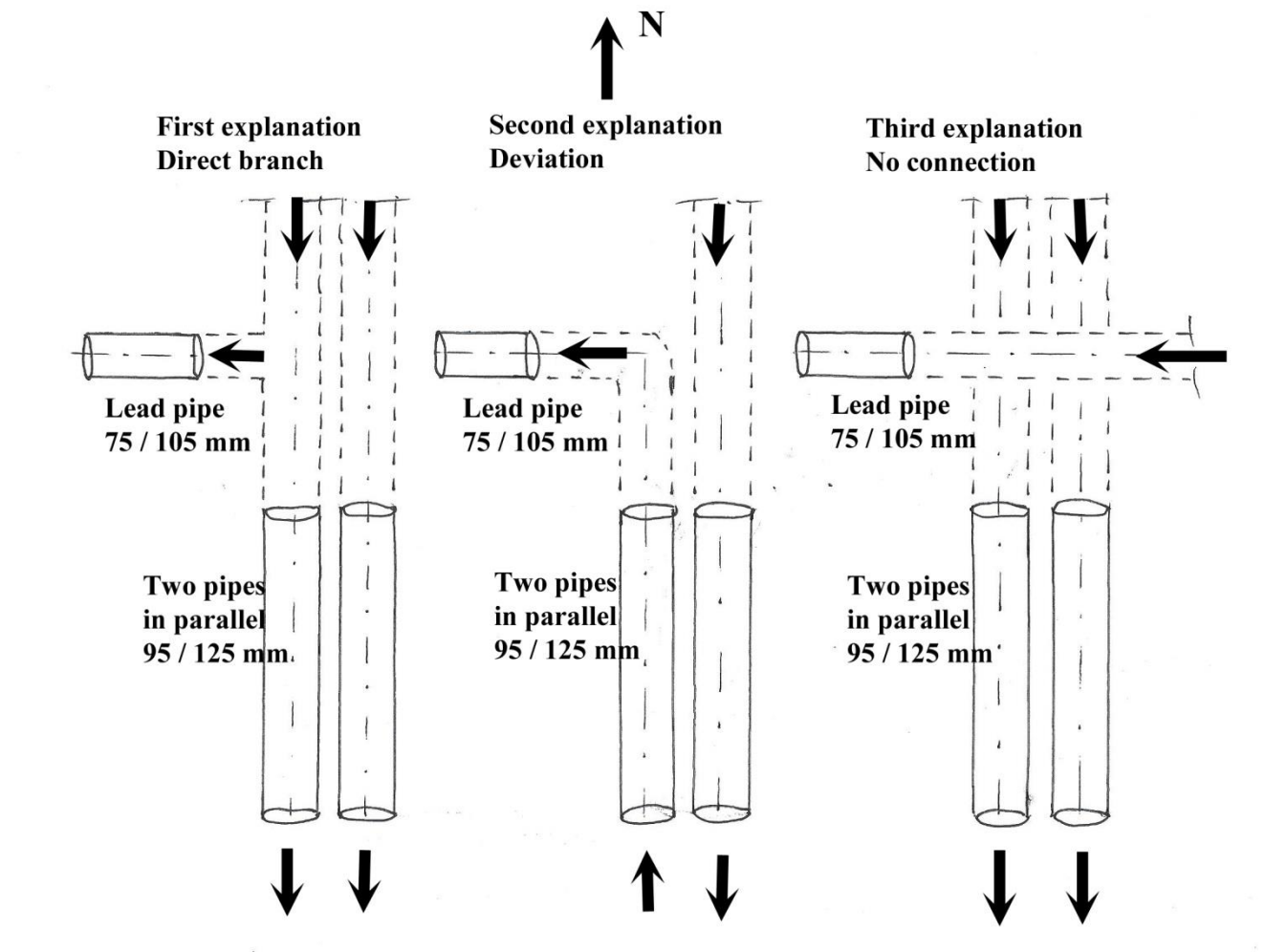

Figure 3.13. Stabian Baths – possible water-supply connections. Drawing by author.

The first explanation is given by Eschebach. He suggests that the pipe in the women's entrance could have been a direct branch from the main water pipeline in the street going to the storage tank on top of the Stabian Baths. I find this explanation inadequate, as the level of the top storage tank is much lower than the level of the top container on water tower no. 4 and a direct branch from tower no. 3 would have influenced the balance of the main water system. Most water would have been supplied to the storage tank and only a smaller quantity to tower no. 4.

A second explanation is that one of the two parallel pipes was going south to supply water to tower no. 4, and that the other was going north to supply the Stabian Baths from tower no. 4. It is difficult

Richard Olsson

to understand however why the size of the lead pipe going north should have been reduced when turning into the women's entrance.

A third and in my opinion the most likely explanation is that there were two parallel pipes all the way from tower no. 3 supplying water to the top container of tower no. 4. The design engineer in antiquity could have chosen to install two smaller-sized, parallel pipes of 95 x 125 mm instead of selecting one larger pipe, in order to reduce the risk for water leakage. It is plausible that the water supply to the Stabian Baths after the construction of the aqueduct system came from water tower no. 4 in a separate pipe going down in the north groove of the tower, up north along *Via Stabiana*, through the women's entrance and then turning west in the direction of the water storage tank on top of the building.

The distribution of water inside the Stabian Baths to the different rooms was documented by Eschebach.¹²⁵ This water distribution system remained basically unchanged when the baths were connected to the aqueduct.

3.2.2 The Forum Baths

Location and size

The layout for the Forum Baths was designed and built similarly to the Stabian Baths: they have recently been described with all their special features by Koloski-Ostrow.¹²⁶ The Forum Baths are located in *insula VII 5*, on a building site which is only half the size of the Stabian Baths, about 1200 square metres. The Forum Baths were constructed shortly after the city was made a Roman colony in 80 BC but were enlarged later by adding a women's bath, probably in the Augustan period when aqueduct water was supplied.¹²⁷ The Forum Baths had two main entrances from the *Via delle Terme*: at VII 5, 2, to the men's baths and at VII 5, 8, to the women's baths. There were two back entrances to the men's baths: at VII 5, 24 and at VII 5, 12. The men's baths had a dressing room (D) and cold (E), warm (F) and hot baths (G). The women's baths also had a dressing room (H) and cold (I), warm (J) and hot baths (K). The boiler room (L) was located in between to serve both baths with cold, warm and hot water with a separate entrance at VII 5, 7 and a back entrance to the working area at VII 5, 10. When the Forum Baths were enlarged by adding the women's baths, the north-west corner of the building was strengthened and part of the southern pavement of *Via delle Terme* was used for the extension.

¹²⁵H. Eschebach 1979, Tafel 29.

¹²⁶Koloski-Ostrow 2007, 231-233.

¹²⁷Fagan 1999, 58-59.

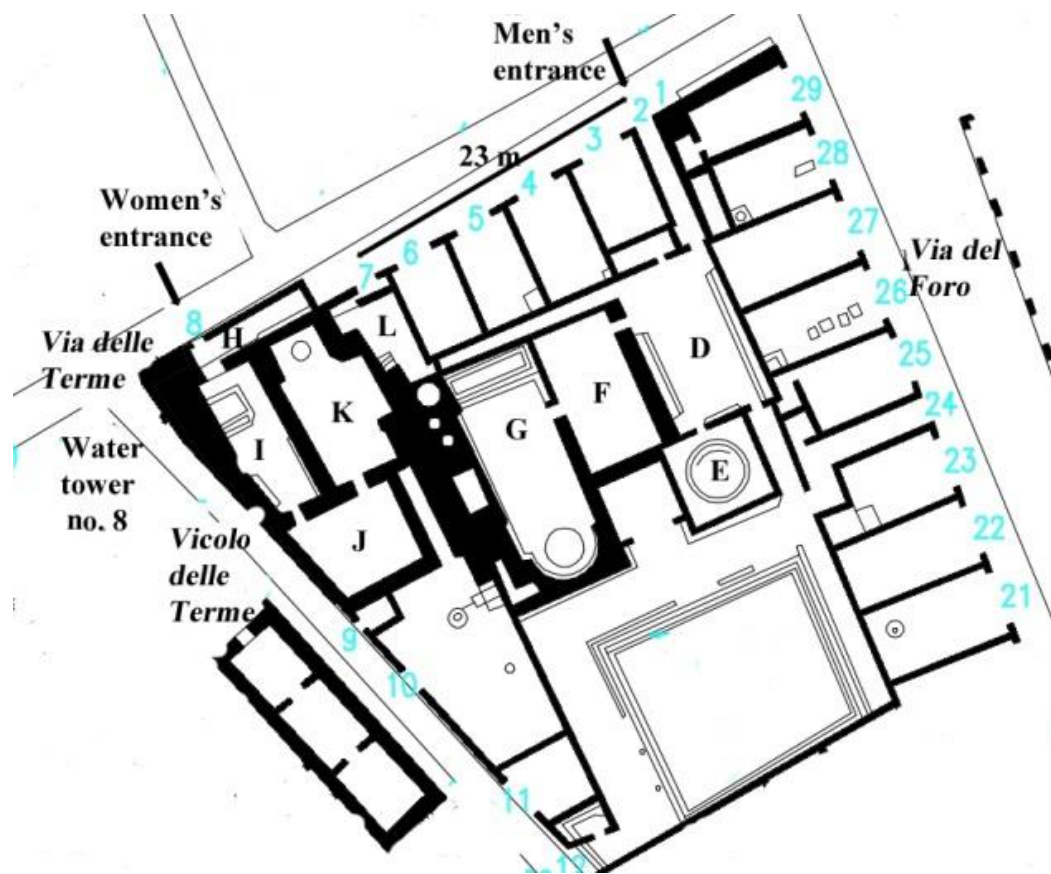

Figure 3.14. The Forum Baths. Drawing with additions by author.

Water supply from deep well

Initially, the Forum Baths were supplied with water from a deep well located behind the boilers in the north-western corner of the building. The well was equipped with a tread-wheel lifting-device with small buckets on a chain: it was presented by Rudolf Pemp in his doctoral thesis,¹²⁸ and described in detail by John Peter Olesen.¹²⁹ The exact location of the covered well was given by Thorkild Schiöler in describing the distance from the main entrance of the men's baths at VII 5, 2 along the *Via delle Terme* towards the boiler room, saying, "...23 meters to the right of the entrance and 17 meters into the ruins at right-angles to the street."¹³⁰

Pemp suggests that there must have been a water-storage tank at the top of the building, large enough to receive water from the deep well.¹³¹ There is no archaeological evidence for a water-storage tank on the top of the Forum Baths, but with the water-lifting device described by Pemp, it would have been necessary to have a storage tank to collect the water before it was distributed to different rooms in the baths.

¹²⁸ Pemp 1939 and 1940.

¹²⁹ Olesen 1984.

¹³⁰ Schiöler 1973, 150.

¹³¹ Pemp 1940, 30-31.

Richard Olsson

From the storage tank, water was supplied to the different rooms in the Forum Baths in a way similar to that in the Stabian Baths.

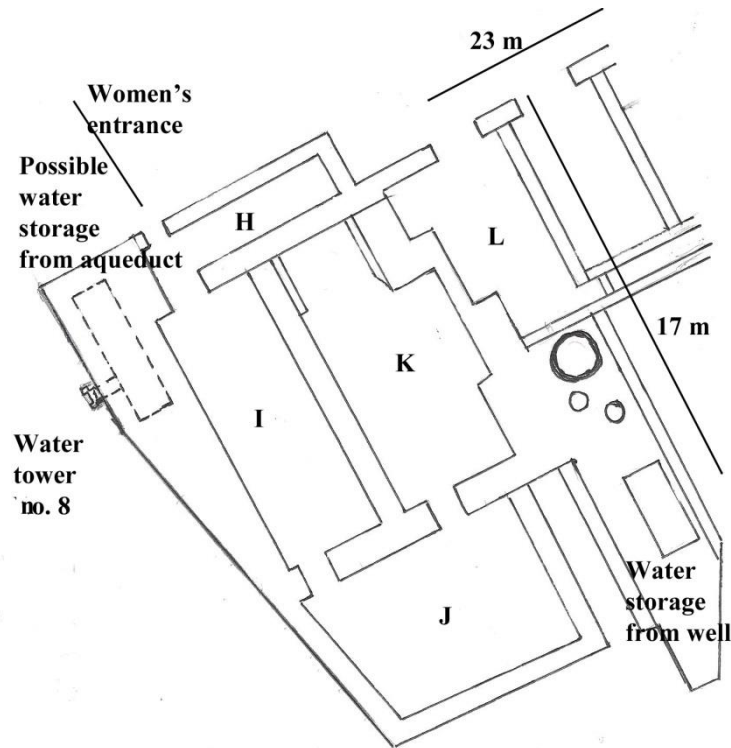

Figure 3.15. North-west corner of the Forum Baths with hypothetical water-storage tank from the well. Drawing by author.

Water supply from the aqueduct

When planning the aqueduct-water infrastructure, water tower No. 8 was built in *Vicolo delle Terme* on the west side of the Forum Baths, about 5 m from the street corner. Tower No. 8 has three grooves, one on the northern side with space for an incoming water pipe from tower No. 12, one on the southern side for an outgoing water pipe to tower No. 10 and one large groove on the western side for a number of distribution pipes to consumers. On top of the water tower, there was a water container that could have been built partly on the tower and partly extending into the Baths, possibly connected to a water-storage tank on top of the building. There is no archaeological proof of such a tank on the top of the Forum Baths, but it would have been necessary to have a storage tank in order to collect the water before it was distributed to the baths. A storage tank filled with water would have needed to stand on a strong construction to bear the heavy load on top. Just such a sturdy construction was built in the north-west corner of the Forum Baths when the extension was made for the women's baths (when aqueduct water was supplied) (see *Fig. 3.14*). The top container of the water tower could have been connected to a storage tank inside the Forum baths building, estimated by me to have been 6.4 x 2.0 m with a height of 1.2 m. and a capacity of about 15,000 litres.

Richard Olsson

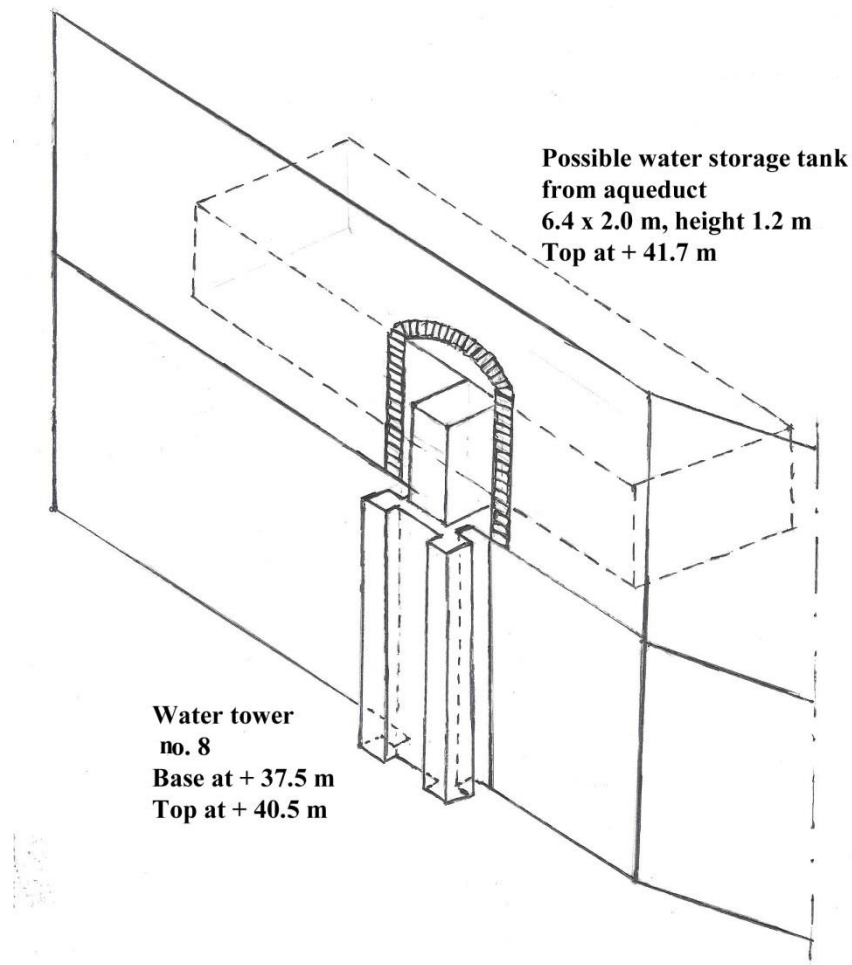

Figure 3.16. North-west corner of the Forum Baths with a hypothetical water-storage tank from the aqueduct. Drawing by author.

On the other side of *Vicolo delle Terme* opposite the Forum Baths, there is a large cistern. The water storage capacity of the cistern was over 400,000 litres but its purpose is not known.

3.2.3 The Suburban Baths

Location and size

The Suburban Baths were built after the construction of the aqueduct and the water supply could not have been considered when designing the primary water-supply system with the water towers, so there were no grooves for pipes designated for the baths in the original towers. The aqueduct water was supplied instead in the same way as for all other users: through a separate lead pipe in the secondary water system from the top container of one of the towers.

The Suburban Baths are located outside *Porta Marina*, where stairs lead down to the main entrance into the baths from the terrace. These baths were constructed during the Julio-Claudian period after the aqueduct was connected to the city. Koloski-Ostrow suggests that the construction was made

Richard Olsson

during Emperor Tiberius' reign early in the first century AD.¹³² The water-management system in the Suburban Baths was investigated and presented by Mandersheid.¹³³ The Baths occupy a site which is only half the size of the Forum Baths or about 600 square metres with a large terrace towards the sea. The Suburban Baths had only one set of baths, with an entrance leading to an open area at the terrace (A) and a corridor to the right leading to a dressing room (D) and cold (E), warm (F) and hot baths (G). It had a side pool (C) and an indoor pool (B). The boiler room (L) was located in direct connection to the warm and hot baths.

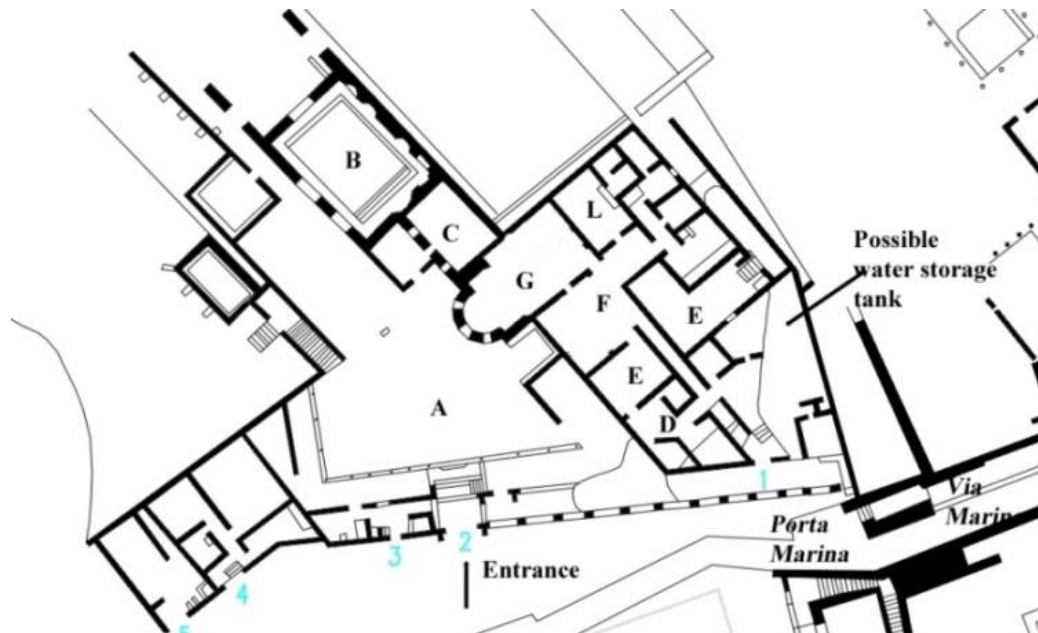

Figure 3.17. The Suburban Baths. Drawing with additions by author.

Water supply from the aqueduct

Water tower No. 10, located behind the *Basilica* at VIII 1,2, is the nearest water tower to the Suburban Baths. It is possible that the Suburban Baths were supplied with aqueduct water through a separate pipe going from the top container of tower No. 10 at + 37.0, along *Vico dei Soprastanti* to the corner of *Vico del Gallo*. The intersection is located at + 33.6 m. The pipe continued south and down to the Suburban Baths located at a much lower level.

Mandersheid, assuming that the Suburban Baths were connected to the city's water-supply system, documented in detail the water distribution to the different rooms in the baths.¹³⁴ There was a large water-storage tank just outside the south-east side of the baths receiving aqueduct water and supplying water to all the facilities. Mandersheid did not give any information about the size of the storage tank, but with three sections, each with a length of about 4 m and a width of more than 1 m, the storage tank could have had a capacity of more than 10,000 litres. Mandersheid was of the opinion that the water consumption at the Suburban Baths was intensive. There is a beautiful water

¹³² Koloski-Ostrow 2007, 241-242.

¹³³ Mandersheid 2000, 524-529.

¹³⁴ Mandersheid 2000, 524-529.

inlet in the cold bath that the visitor could admire already when entering the bath. Water comes out of a spout from a fountain at a level high above the head of the visitor and flows down a water stair into a large cold bath where the visitor can cool off from the hot temperature in the city.

3.2.4 The Sarno Baths

Location and size

The Sarno Baths were also built after the construction of the aqueduct and consequently supplied with water through a separate pipe in the secondary water system from the top of one of the towers, possibly water tower No. 10 as it is closest to the baths.

The Sarno Baths were located in the south of the city at VIII 2, 17 and had a main entrance at the street level directly from *Via delle Scuole*. The Baths were constructed during the Claudian period about AD 50 and were not in operation at the time of Vesuvius' eruption in AD 79. Koloski-Ostrow suggests that the Sarno Baths had to be renovated due to damage incurred from the earthquake in AD 62.¹³⁵ The baths were located four levels below street level in a large building and had a dressing room (D) and cold (E), warm (F) and hot baths (G). The boiler room (L) was located by the rooms for warm and hot baths. The baths had no open area, however, no pool and no separate bath for women. In connection with the baths there were seven rooms. The total area of the baths was less than 100 square metres.

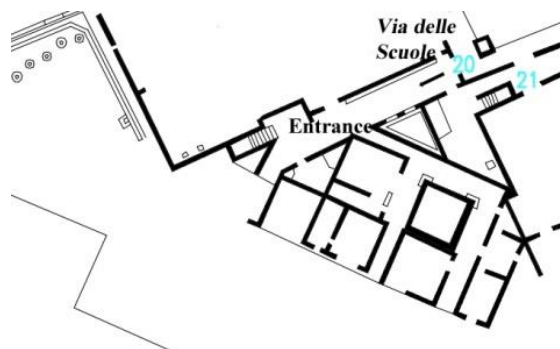

Figure 3.18. The Sarno Baths at street level. Drawing with additions by author.

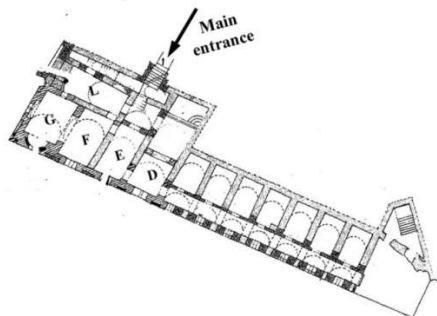

Figure 3.19. The Sarno Baths at bath level, four levels below street level. Drawing with additions by author.

¹³⁵ Koloski-Ostrow 2007, 240.
Richard Olsson

Water supply from the aqueduct

It is possible that the water supply to the Sarno Baths also came through a separate pipe from water tower no. 10 along *Via Championne* and down *Via delle Scuole*, where the street at the end corner is located at + 33.3 meter. There is no indication of a storage tank in the Sarno Baths. Nappo noticed in his investigations of the excavations of the pavements in the city that there was a ditch full with *lapilli* all along the western pavement of *Via delle Scuole* down to the street fountain no. 31 at the end of the street at VIII 2, 20.¹³⁶

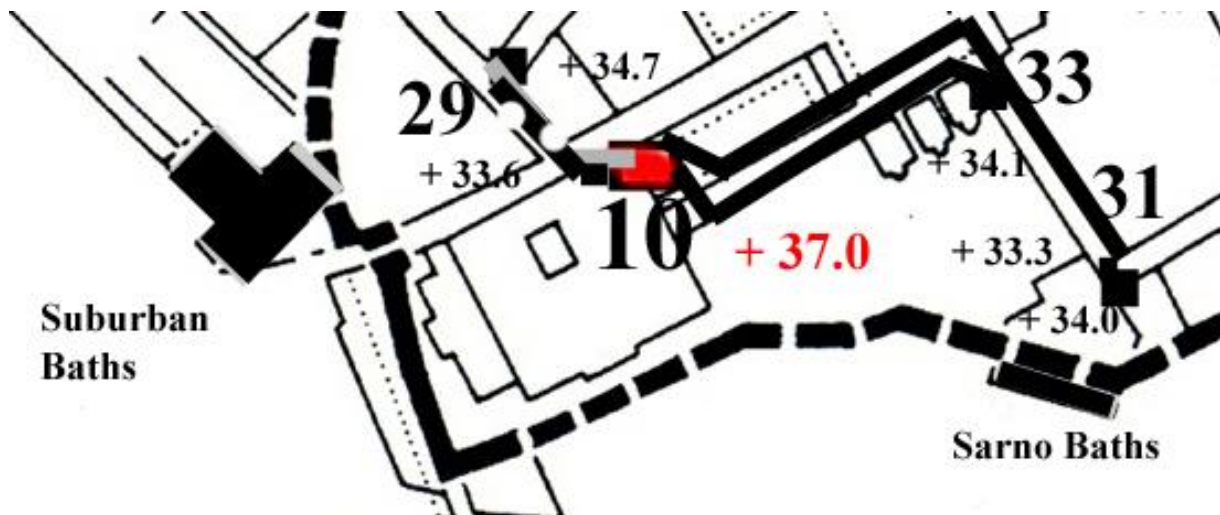

Figure 3.20. Possible location of pipe connections to the Suburban Baths and the Sarno Baths. Water tower no.10 in red. Drawing with additions by author.

3.2.5 The Central Baths

Location and size

The Central Baths were under construction at the time of Vesuvius' eruption in AD 79. The baths were located in *insula IX 4* and were designed with the latest technology but did not have separate baths for women. The building site was very large, almost 3600 square metres. There is no evidence of any water connections to the planned Central Baths but the construction of this new and modern bath building could not have started without planning and designing the water supply. Nappo investigated the southern pavement of *Via di Nola* and found two lead pipes outside *insula IX 4*.¹³⁷ Both pipes turn north under the street towards the northern pavement, so Nappo was certain that they could not have been intended to supply water to the Central Baths.

¹³⁶ Nappo 1996, 44.

¹³⁷ Nappo 1996, 41 and figure 4.

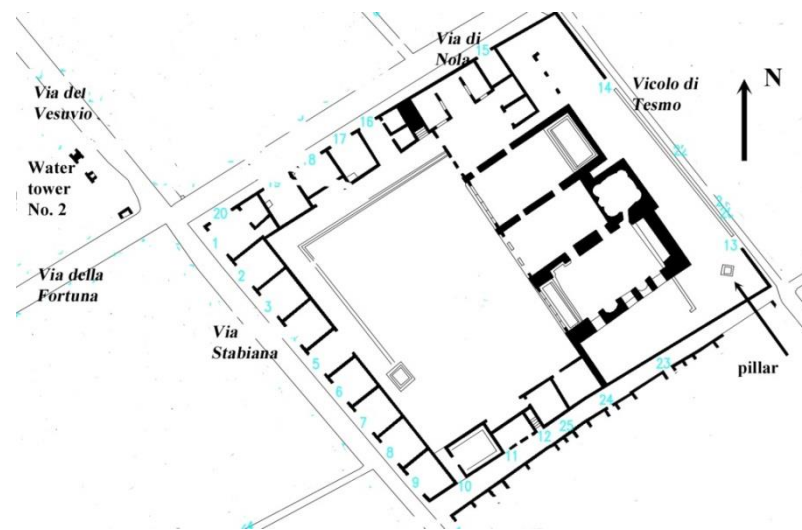

Figure 3.21. The Central Baths. Drawing with additions by author.

de Haan and Wallat presented a documentation of the planned water-supply system for the Central Baths.¹³⁸ They focussed on the estimated use of water for cold and warm baths, for pools and boilers and for various *labra*. The water capacity of the pools in the *Frigidarium* is calculated to 22,700 litres and the two pools in the *Caldarium* to 6800 and 5400 litres, respectively. Therefore the water consumption of the Central Baths would have been great had they been completed, and it must be assumed that they were intended to be connected to the aqueduct water-supply system. This is also the opinion of de Haan and Wallat.¹³⁹

There is no archaeological indication of a water-storage tank on the building site, but in my opinion a large tank would have been necessary. de Haan and Wallat discuss a pillar located in the south-east corner of the service area of the Central Baths with the four sides oriented obliquely in the room with one side to the south. The pillar was interpreted by Johannes Overbeck and August Mau as the base of a sundial.¹⁴⁰ If this was the case, it could be asked why a sundial would be located in the service area. de Haan and Wallat wonder instead whether it could have been the start of a water tower.¹⁴¹ The pillar has a cross-section of 1x1 m and is built similarly to the water towers in the city. In my opinion this suggestion does not seem likely. A new water tower inside the Central Baths would then have had to be interconnected with the other water towers in the main water system. A redesign of the system would have been necessary. In any case there must have been plans for installing a large water-storage tank at a high level on top of the building with a connection from the main water system, perhaps from water tower no. 3.

¹³⁸ de Haan & Wallat 2006, 417-422.

¹³⁹ de Haan & Wallat 2006, 420.

¹⁴⁰ Overbeck & Mau 1884, 238.

¹⁴¹ de Haan & Wallat 2006, 422.

4. Water supply for private use

The distribution network supplied water for private consumption from the containers on top of the water towers to houses and workshops. Houses often had a water supply with distributors and closing valves to individual fountains inside the house. When in operation the distribution network could supply some users with full capacity, whereas other consumers could close the valves and receive no water. The main water system thus had to operate with a water quantity passing through the top containers that was continuously changing over time.

Frontinus described the procedure of how a person in Rome had to make a personal request to acquire water to be supplied to a private house.¹⁴² The delivery of water was officially granted and a fee was charged.

The relevant issues to be studied in presenting the water supply for private use are the following:

- Location of the private water consumers in the city in relation to the water towers, to discuss the possible water supply to each private user based on the assumption that the water supply should take the shortest possible distance from the tower to the user, but at the same time guarantee a water pressure high enough to make fountains in the house function while at the same time being low enough not to damage the pipe,
- Archaeological finds of water pipe fragments, distributors, closing valves and fountain sculptures in houses and
- Archaeological reports on water distribution system inside houses.

The number of private users is not known. Houses and workshops in all parts of the city were connected to the water supply. The distribution network was comprehensive and complex. I have chosen not to try to present a full description of the pipe connections to all private users. Instead I will focus on pipe connections from water tower no. 2, most of them going to houses, and on pipe connections from water tower no. 9, probably supplying a number of workshops with aqueduct water.

4.1 Water supply to houses

After the aqueduct was connected to the city, water was supplied to some houses through a separate pipe from the top container of a water tower and had an individual distribution system inside the house with distributors and closing valves. Many houses had fountains that required a certain water pressure to work satisfactorily, and aqueduct water was sometimes also supplied to kitchens and to private baths.

¹⁴² Frontin. *Aq* 105.
Richard Olsson

The number of houses which were connected to the water-supply system is not known. In a city plan, H. Eschebach indicated 63 houses which to his knowledge were connected.¹⁴³ In his plan he marked in which *insula* and in which part of the *insula* these houses and workshops were located to make it possible to identify the house. I have modified his plan to include only houses in Fig. 4.1.

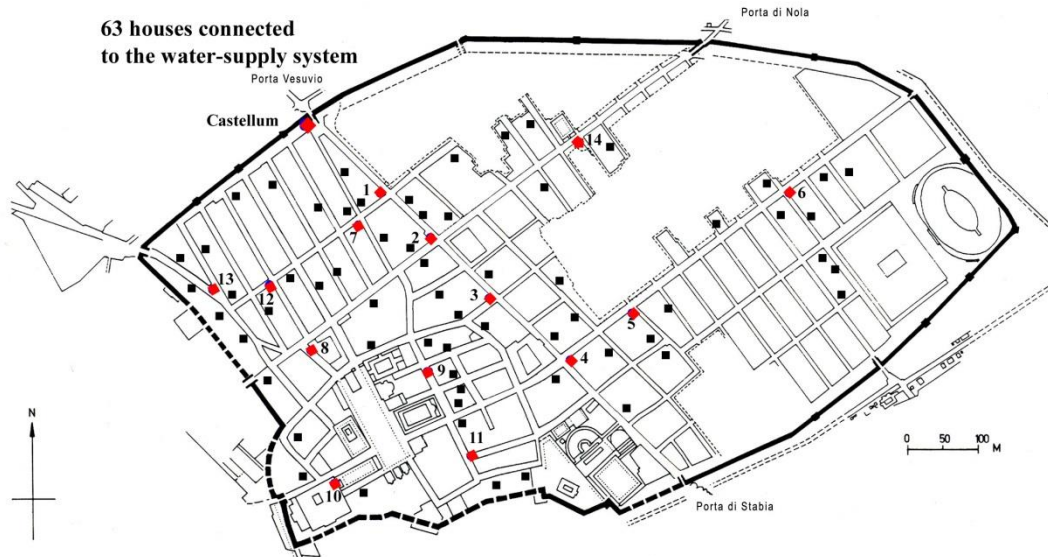

Figure 4.1. 63 houses connected to the water-supply system. Houses in black and water towers in red. Modified from H. Eschebach.

In a later presentation in 2001, Jansen identified and listed 91 houses supplied with aqueduct water.¹⁴⁴ In her figure she included some workshops. In a separate article published the same year, she reconstructed the distribution system in seven houses.¹⁴⁵ She concluded that the water-pipe connection to a house usually began at a water tower and continued in the pavement to the entrance of the house, continuing through distributors and closing valves to fountains in *atriums* and *peristyles* and in some cases to kitchens and baths. In an earlier work in 1996 she had listed 24 houses where archaeological investigations had identified water pipes, distributors and closing valves.¹⁴⁶

Balázs Kapossy studied fountain sculptures and in *Brunnenfiguren der hellenistischen und römischen Zeit* presented 60 spouting fountain sculptures from Pompeii located in 30 houses.¹⁴⁷ During my field investigations I visited the *Museo Archeologico Nazionale di Napoli* and studied the original archaeological reports on these fountain sculptures. The reports are in Italian, handwritten and only partly digitalised. All finds are registered with a date and a catalogue number.

¹⁴³ Eschebach 1983, Tafel 5.

¹⁴⁴ Jansen 2001, Footnote 204.

¹⁴⁵ Jansen 2001, 37.

¹⁴⁶ Jansen 1996.

¹⁴⁷ Kapossy 1969.

My investigation is based on H. Eschebach's list, with 63 houses supposed to have been connected to the distribution network. I have compared his list with the houses named by Jansen in her study and with the houses with fountain sculptures as studied by Kapossy. A fountain sculpture in a house is of course not evidence that the house was connected to the distribution network, but it is an indication of water in the house and has been used in relation to the lists compiled by Eschebach and Jansen. In my investigation I have visited all the houses in Pompeii that are supposed to have had a supply of water. In *Table 7* I listed 32 houses confirmed by all three sources to have been connected to the water system.

In *insula I 3*, for instance, Eschebach listed one private house and three workshops. In the same *insula*, Jansen named one house I 3, 3.4.31, *Casa di Epidius Fortunatus*, which is a house with a small workshop and a private bath. In the same *insula*, Kapossy mentioned another house I 3, 29 *Casa del Innulus*, where a fountain sculpture of a dog had been found.¹⁴⁸ The situation concerning water connection in *insula I 3* is in my opinion unclear and therefore no house from *insula I 3* has been included in *Table 7*.

In the next *insula*, I 4, Eschebach listed one house and one workshop. Jensen named three houses with supposed water connections in this *insula*, I 4, 5.6.25.28 *Casa del Citarista*, I 4, 9.10, a small atrium house with no name and I 4, 20.21, a small shop. Jansen also discovered a distributor and a closing valve in the first of these three houses. Kapossy described a number of fountain sculptures in the same *insula*: in *Casa del Citarista*, copies of two sculptures are shown in *Fig. 4.2*. In my opinion it is confirmed that the private house I 4, 5.6.25.28 *Casa del Citarista* must have had a connection to the water-supply system and I have included the house in *Table 7*.



Figure 4.2. Copies of fountain sculptures in *Casa del Citarista*. Snake (Cat. 4898) and Boar with two dogs (Cat. 4899). Photos by author.

¹⁴⁸ *Museo Archeologico Nazionale di Napoli*, Catalogue number 120359, “Un cane curicato, alquanto rollo nel naso e nella bocca, il quale ha un fore che serviva per getto di aqua. Marmo 200 mm”, found in 1873-03-01.

Richard Olsson

The location of the water towers are known and presented above. It is reasonable that houses were connected to the top container of the closest water tower, provided that the water pressure was great enough but not too great to provide the fountains in the house with a suitable flow, as discussed above. There are however only a few houses that are so well archaeologically investigated that an individual distribution system inside the house has been presented. Therefore the discussion on the water supply to houses will be focussed on pipe connections to private users from only one of the water towers.

4.1.1 Water supply from water tower no. 2

I have chosen to present the distribution network from water tower no. 2. The tower is located at VI 14, 17 on the western pavement of *Via del Vesuvio / Via Stabiana* and has lime deposits on the east, south and west side but not on the north side. From the lime deposits I have estimated that there were ten pipe connections from the top container of water tower no. 2 to different users near-by as shown in *Fig. 2.4* above. It seems as if one of the water connections was larger than the others. Water tower no. 2 is located in between four blocks in the city and has *insula* V 1, *insula* VI 14, *insula* VII 3 and *insula* IX 4 on different sides as shown in *Fig. 4.3*.



Figure 4.3. Water tower no. 2 close to users in V 1, VI 14, VII 3 and IX 4. Drawing by author.

4.1.2 Water supply to houses in *insula* V 1.

H. Eschebach indicated three houses and one workshop connected to the aqueduct water system in *insula* V 1.¹⁴⁹ In the same *insula* Jansen listed three houses by name and also in her other investigation indicated water pipes, distributors and closing valves in two of the houses: in *Casa di Caecilius Iucundus*, V 1, 23.25-27.10 and in *Casa del Torello di Bronzo*, V 1. 7. In the same *insula* Kapossy presented a fountain sculpture in one of the three houses, in *Casa del Torello di Bronzo*, V 1, 7.¹⁵⁰ The three houses are listed in *Table 7*. The Swedish Pompeii Project has conducted archaeological investigations in *insula* V I and presented among other things the water distribution systems inside the three houses. The water connections to the three houses will be discussed below, from north to south, as shown in *Fig. 4.4*.

¹⁴⁹ H. Eschebach 1983, Tafel 5.

¹⁵⁰ *Museo Archeologico Nazionale di Napoli*, Catalogue number 4890. "Torello con bella patina verde. A tergo e nella bocca é forato onde servire per getto d'acqua."

Richard Olsson

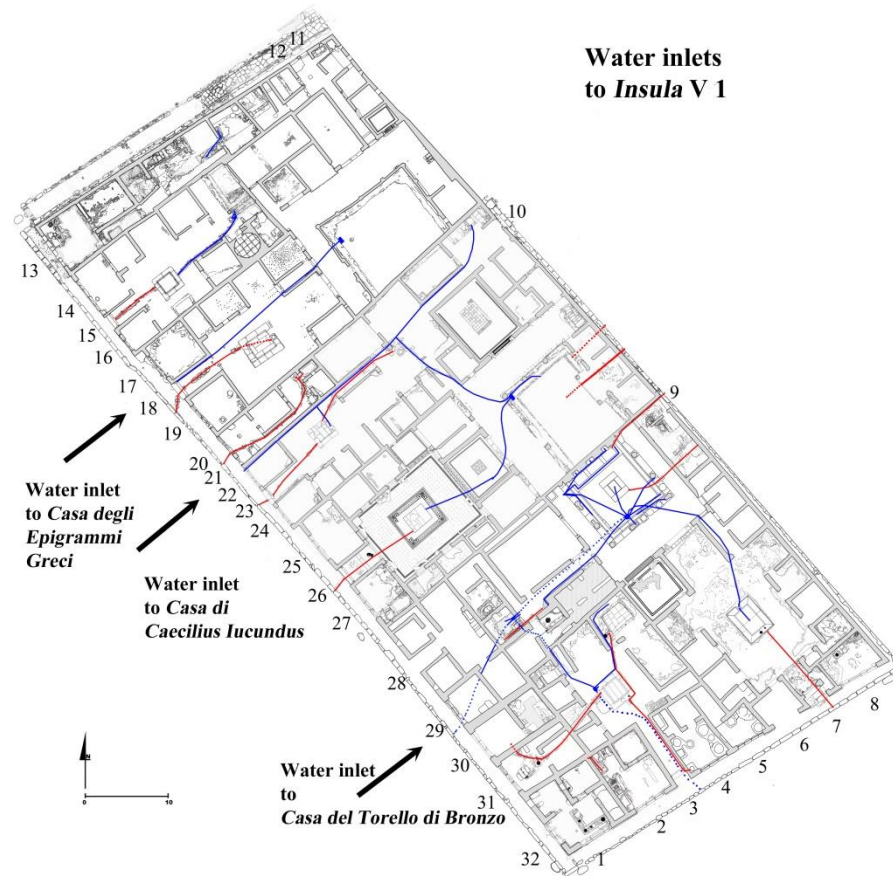

Figure 4.4. Water inlets (and drains) to *insula* V 1. Drawing by Henrik Boman & Ezequiel Pinto Guillaume with additions by the author. Courtesy of the Swedish Pompeii Project.

Margareta Staub Gierow presented archaeological investigations of *Casa degli Epigrammi Greci*, V 1, 18.11-12.¹⁵¹ She documented a pipe still partly preserved in the corridor between the *peristyle* and the *atrium*. The water pipe came in to the house through the *fauces* at V 1, 18 as shown in Fig. 4.4. The water system in the house was also investigated by Jansen with a metal detector.¹⁵² She found traces of water pipes in the house. The water inlet came from *Via del Vesuvio / Via Stabiana* to the *atrium* and the *peristyle* through the *fauces* at V 1, 18. Aqueduct water could have been supplied from water tower no. 1 or from no. 2. From tower no. 1 the head can be calculated as the head of the tower 7.7 m (the top at + 42.6 m and the base at 34.9 m) plus the head of the pipe in the street 1.2 m, totally 8.9 m, as the pressure in the pipe increases when sloping down from the foot of the tower towards the entrance of the house. From tower no. 2 the head can be calculated in the same way as 7.3 m (the top at 39.7 m and the base at 32.4 m) minus the head of the pipe in the street 1.3 m, totally 6.0 m, as the pressure in the pipe decreases when sloping upwards towards the house. It is my opinion that the aqueduct water came from water tower no. 2 because the head from water tower no. 1 would have been too high.

¹⁵¹ Staub Gierow 2008, 98.

¹⁵² Jansen 1996, 48 and footnote 2.

Karivieri and Forsell reported on the water installations in *Casa di Caecilius Iucundus*, V 1, 23.25-27.10.¹⁵³ The water most probably came from the top container of water tower No. 2 and was brought into the north house through a pipe with a diameter estimated at 0.05 m along the north wall of *taberna* 22, as shown in *Fig. 4.4*.¹⁵⁴

In his doctoral thesis Staub presented an extensive documentation of the complex water distribution system in *Casa del Torello di Bronzo*, V 1, 7.¹⁵⁵ Aqueduct water was probably supplied from water tower No. 2 in a pipe measuring 0.048 x 0.082 m.¹⁵⁶ This could well match the larger pipe connection (called C) as indicated by the wider imprint in the lime deposits on the east side of tower No. 2, as will be discussed below. The inlet water pipe to *Casa del Torello di Bronzo*, V 1, 7 came in from the west under the floor of *Taberna* V 1, 29 and under the floor in the neighbouring house, *Casa di Tofelanus Valens*, V 1, 28, as shown in *Fig. 4.4*. Water was distributed to different areas of the house: Staub documented five distribution boxes. An observation of special interest made by him is that a pipe from the southern of the two boxes in the first distributor in the kitchen of *Casa del Torello di Bronzo*, could have been used to supply the street fountain without a basin No. 11 on *Via di Nola* in front of V 1, 3.¹⁵⁷ The pipe turns downwards at a ninety-degree angle and according to Staub, its possible destination was the street fountain. Staub is of the opinion that this privately financed street fountain was for the benefit of the workshops with their great water consumption -- a laundry at V 1, 2 and a dye shop at V 1, 4-5. If this is correct, the street fountain was supplied with aqueduct water not directly from water tower No. 2 but indirectly through a water pipe controlled by the owner of *Casa del Torello di Bronzo*.

4.1.3 Water supply to houses in *insula* VI 14.

H. Eschebach indicated two houses and one workshop connected to the aqueduct water system in *insula* VI 14. The workshop was probably the large laundry, VI 14, 21.22, *Fullonica del Vesonius Primus*, which had a great need for water and will be discussed below. Kapossy mentioned that a fountain sculpture of a hare has been found in the laundry in the same *insula* but did not present the catalogue number. Jansen identified two houses with water pipes, distributors and closing valves, one on the west side of *Via del Vesuvio / Via Stabiana* with the entrance at VI 14, 18-20 *Casa di Orfeo*, and one with its entrance from *Vicolo dei Vettii* at VI 14, 43 *Casa degli Scienziati*. My investigations confirm that these two houses were supplied with water and are thus listed in *Table 7*. I suggest that the first house was supplied with water from water tower no. 2, but that the second house was connected to water tower no. 7, as shown in *Fig. 4.8*. In her list of houses Jansen also mentioned a third house VI 14, 28-32 *Casa di Manius Salarius Crocus*. This house might have been

¹⁵³ Karivieri & Forsell 2007.

¹⁵⁴ Renée Forsell, personal communication, dimension estimated to be 0.05 m.

¹⁵⁵ Staub 2013, 88-103.

¹⁵⁶ Staub 2013, 93.

¹⁵⁷ Staub 2013, 94.

supplied from water tower no. 1 as it is the closest. I have refrained from including this house in my *Table 7*.

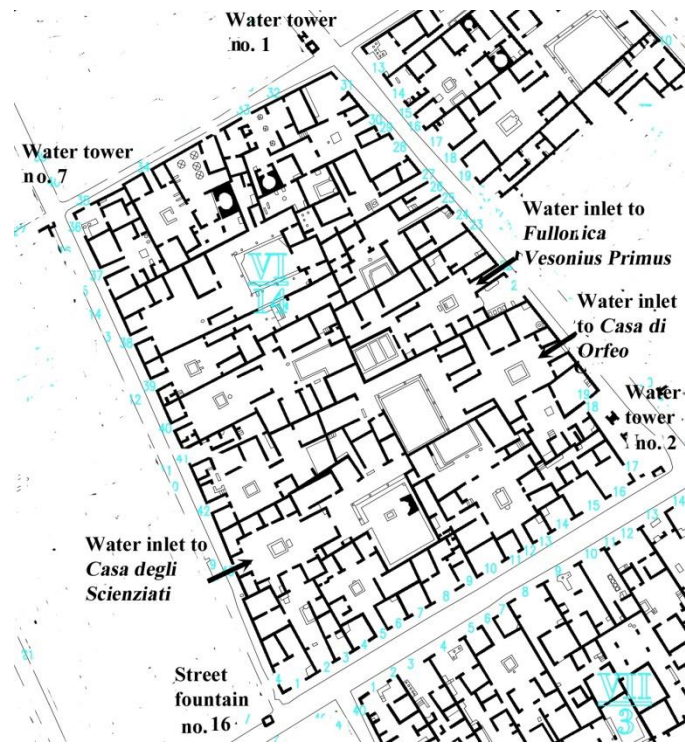

Figure 4.5. Water inlets to *insula* VI 14. Drawing with additions by author.

4.1.4 Water supply to houses in *insula* VII 3

H. Eschebach indicated that one house and one workshop were connected to the water-supply system in *insula* VII 3. Jansen also listed and named one house and one workshop in the same *insula*. The house, *Casa di C. Memmius*, VII 3, 1-3.38-40, is located at the corner of *Via della Fortuna* and *Vicolo Storto* and possibly connected to water tower no. 2 or o. 7. The workshop is a small laundry, VII 3, 24.25, located on *Vico del Panettiere* and could have been supplied from water tower no. 2 or no. 3. Kapossy does not mention any fountain sculptures found in this *insula*.



Figure 4.6. Water inlets to *insula* VII 3. Drawing with additions by author.

4.1.5 Water supply to houses in *insula* IX 4

Neither Eschebach nor Jansen listed any water connections to *insula* IX 4 from *Via di Nola*. The Central Baths were under construction in this block at the time of Vesuvius' eruption, as mentioned above. Nappo found two pipes in the southern pavement of *Via di Nola* outside the planned Central Baths.¹⁵⁸ These two pipes seem to come from the northern pavement, possibly from water tower No. 2, and continue to the east to supply water to unidentified consumers perhaps further to the east at *Via di Nola*.

4.1.6 Water connections from water tower no. 2

I have presented the water supply to houses for a small part of the city close to water tower no. 2. As mentioned above, I have estimated from the lime deposits that there were ten water connections from the top container of this tower to different users near-by. One of the water connections (called C) seems to have been larger than the others. A plausible design for these connections is of course speculative but is shown in *Fig. 4.7* and has been identified as follows:

- A water supply to unknown destination in pipe found in *Via di Nola*
- B water supply to unknown destination in pipe found in *Via di Nola*
- C water supply to *Casa del Torello di Bronzo*, V 1, 7
- D water supply to *Casa di Caecilius Iucundus*, V 1, 23.25-27.10

¹⁵⁸ Nappo 1996, 41.
 Richard Olsson

- E water supply to *Casa degli Epigrammi Greci*, V 1, 11.12.18
- F water supply to the workshop *Fullonica del Vesonius Primus*, VI 14, 22
- G water supply to *Casa di C. Memmius*, VII 3, 1-3.38-40
- H water supply to *Casa di Orfeo*, VI 14, 18-20
- J water supply to street fountain no. 18
- K water supply to street fountain no. 11 in case it was supplied directly

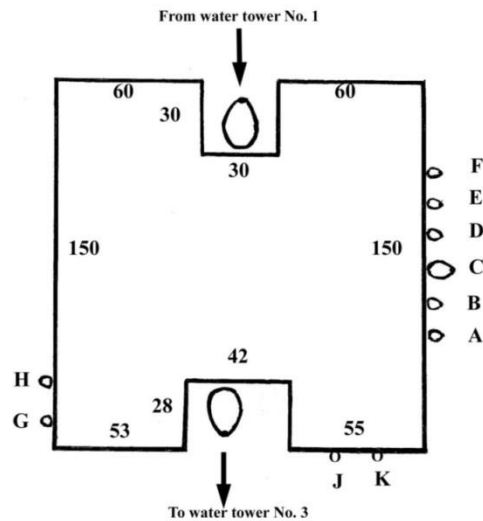

Figure 4.7. Water connections from water tower no. 2. Drawing by author.

I have discussed only the pipe connections to houses from water tower No. 2. The number of connections has been estimated based on the lime deposits on three of the four sides of the tower, although there might have been a larger number of pipe connections. Further, the destinations of the water pipes are only speculative: however, my study method could be used for all the water towers in the city, if we only knew which houses were connected to the water-supply system.

4.2 Water supply to workshops

Water was supplied to some workshops after the aqueduct was connected to the city. The number of workshops connected is not known. H. Eschebach indicated in the city plan 46 workshops such as laundries, dyehouses and tanneries, which had high water consumption, as indicated above in *Fig 4.1*. The tanneries will not be discussed in this thesis. In his book *Gebäudeverzeichnis und Stadtplan der antiken Stadt Pompeji* he listed 21 of these workshops such as *fullonicae*, laundries.¹⁵⁹ In her list Jansen mentioned only a few of these workshops, and in her investigation of water pipes, distributors and closing valves, no traces were identified in workshops or laundries.¹⁶⁰ Kapossy

¹⁵⁹ H. Eschebach 1993, 484.

¹⁶⁰ Jansen 1996, 47-50.

presented only one fountain sculpture in a laundry, as noted above, which is a reasonable interpretation as fountain sculptures were not a common decoration in workshops.¹⁶¹

In Eschebach's list, four houses with built-in facilities for a laundry in a minor part of the house, a so-called "house with an *oficina lanifricaria*" (VII 3, 24.25; VII, 10, 5.8.13; VII 12, 17-21; VII 12, 30-32) are not included. Eschebach may have listed these four as "houses" connected to the water-supply system instead of "workshops". He has however indicated all four as "houses with an *oficina lanifricaria*" in his *Gebäudeverzeichnis*. In my investigation, I have added these four houses to my list of investigated workshops as shown in *Table 8*. To the list of workshops with large requirements of water, three dyehouses (V I, 4.5; VII 14, 5.17-19; VIII 4, 1.53) should also be included. In total my list of investigated workshops contains 28 laundries and dyehouses.

In a modified plan taken from Eschebach, I have shown Eschebach's 46 workshops requiring large water consumption and indicated which 21 of these that were *fullonicae*, indicated with an "F", presented here in *Fig. 4.8*. Four of the laundries were not shown in Eschebach's original plan, although he listed them in his later published *Gebäudeverzeichnis*. I have indicated six of the laundries with an "F?" as they were questioned already by Eschebach. In the plan I have added four "houses with an *oficina lanifricaria*", indicated with an "OL", and also three dyehouses, indicated by "DH". Most of the laundries are located in clusters in three areas in the city, in the north around water tower no. 1, in the south-east around water tower no. 4 and in the central part of the city around water tower no. 9.

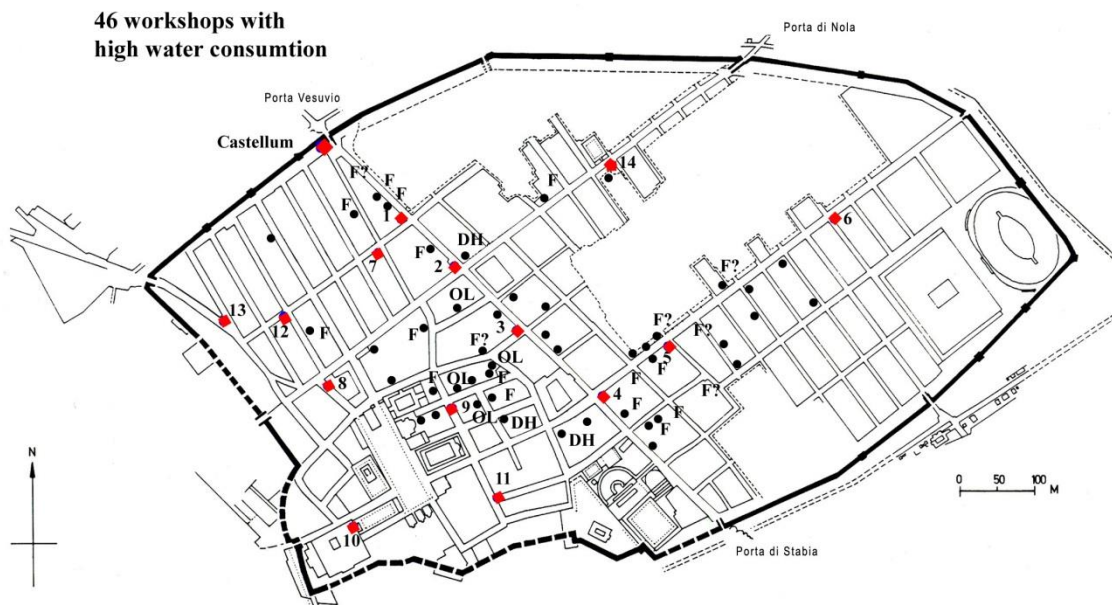

Figure 4.8. Forty-six workshops with large water requirements . Modified from Eschebach.

¹⁶¹ Kapossy 1969.
Richard Olsson

Flohr investigated water management in Roman laundries.¹⁶² He emphasised that not much archaeological evidence remains: thus, the process cannot really be traced. However he distinguishes two types of installations. The first had fulling stalls, *saltus fullonici*, where textiles were treated by workers trampling them. In the other type of installation, the textiles were scrubbed on a working bench with soap and rinsed in fresh water. Both types can be found in Pompeii and both used a lot of water.

In an article “Reconsidering the atrium house: Domestic fullonicae at Pompeii”, Flohr described three laundries originally built as domestic houses, but later, perhaps after the earthquake, rebuilt into combined residential and commercial houses.¹⁶³ He studied these three laundries, *Fullonica Stephanus* at I 6,7, *Fullonica del L. Veranius Hypsaeus* at VI 8, 2.20.21 and *Fullonica di Vesonius Primus* at VI 14, 21.22. He commented that the availability of piped water made a reconstruction of the houses easier. In the last-mentioned laundry, a new fountain in the *impluvium* was fed by a branch of the water pipe supplying water to the rinsing basins, according to Flohr.¹⁶⁴

In his book *The world of the fullo: Work, economy and society in Roman Italy*, Flohr presented an analysis of the work in Roman laundries.¹⁶⁵ The design of the water system was a priority when building the rinsing basins. Flohr is of the opinion, but has not given any evidence, that all workshops with rinsing facilities were filled with aqueduct water through lead pipes connected to the urban water infrastructure.¹⁶⁶ One laundry, *Fullonica del Mustius & Ovia* at VI 15, 3 was fed from a cistern in the house. The rinsing basins in *Fullonica di Vesonius Primus* at VI 14, 21.22 had an overflow between the basins but not to the drain.¹⁶⁷ This is an indication that there was no continuous supply of water to the laundry, in Flohr’s opinion. .

4.2.1 Water supply from water tower no. 9

To discuss the water pipe connections from one of the water towers in the city, I have chosen to present the water supply to laundries from water tower no. 9, located at VII 10, 7 on the corner of *Via di Eumachia* and *Vicolo del Balcone Pensile* in the central part of the city. There are lime deposits on the east side of the water tower but not on the other sides. From the lime deposits, I have estimated that there were six pipe connections from the top container going east in *Vicolo del Balcone Pensile*, as shown in *Fig. 4.9*.

¹⁶² Flohr 2006.

¹⁶³ Flohr 2011.

¹⁶⁴ Flohr 2011, 100.

¹⁶⁵ Flohr 2013.

¹⁶⁶ Flohr 2013, 137.

¹⁶⁷ Flohr 2013, 139.

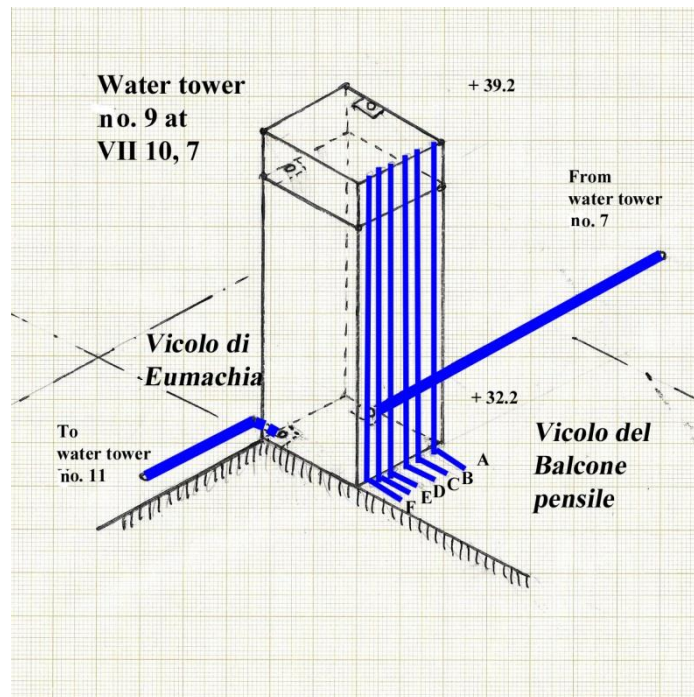

Figure 4.9. Pipe connections to users from the top container of water tower no. 9. Drawing by author.

Water tower no. 9 in the central part of the city is located in the middle of a cluster of laundries around *insula* VII 10 called “house with an *oficina lanificaria*”, VII 10, 5.8.13 (indicated as OL), *insula* VII 11 with unnamed *oficina lanificaria* VII 11, 2.3.4.5 (indicated as F), and *insula* VII 12 with *Casa di Narcisso* with an *oficina lanificaria* VII 12, 17.21 (indicated as OL), *Casa del Camillo* VII 12, 22-25 (indicated as F) and the “house with an *oficina lanificaria*” VII 12, 30-32 (indicated as OL), as shown in *Fig. 4.10*. All these five laundries were located along the same street *Via del Balcone pensile* and close to the water tower no. 9.

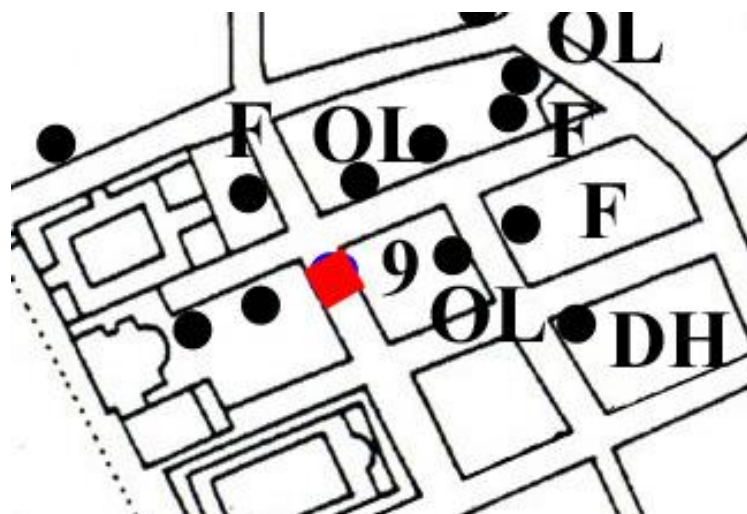

Figure 4.10. Location of water tower no. 9 with a cluster of laundries. Red square is water tower no. 9. Drawing by author.

Richard Olsson

It is possible, although speculative, that all these laundries were supplied with water from the same water tower, no. 9, as shown in *Fig. 4.11*.



Figure 4.11. Water inlets to five laundries on *Via del Balcone pensile*. Laundries in grey. Drawing with additions by author.

4.2.2 Water connections from water tower no. 9

A plausible design for the connections from water tower no. 9 going east is shown in *Fig. 4.12* and has been identified as follows:

- A water supply to “house with an *oficina lanifricaria*” VII 10, 5.8.13
- B water supply to street fountain no. 27
- C water supply to unnamed *Oficina lanifricaria* VII 11, 2.3.4.5
- D water supply to *Casa di Narcisso* with an *oficina lanifricaria* VII 12, 17.21
- E water supply to *Casa del Camillo* VII 12, 22-25
- F water supply to “house with an *oficina lanifricaria*” VII 12, 30-32

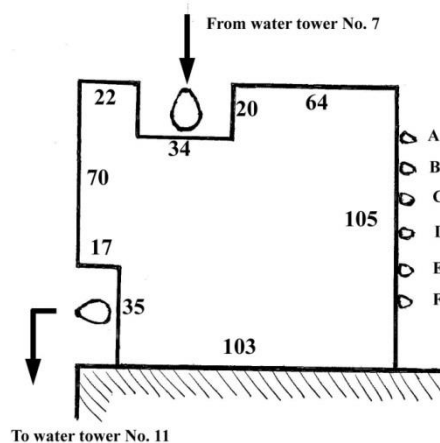

Figure 4.12. Water connections from water tower no. 9. Drawing by author.

Six pipe connections on the eastern side of water tower no. 9 have been indicated based on the lime deposits on this side of the tower. Although speculative, they can indicate water-pipe connections to five laundries along *Via del Balcone* and to street fountain no. 27, located in the same street. In the

Richard Olsson

modified plan from H. Eschebach as shown in *Fig. 4.13*, there are however more workshops possibly connected to the water-supply system. We do not know whether there were more pipe connections on the other sides of the water tower as we have not found any lime deposits on these sides.

5. Discussion

This thesis has presented a reconstruction of the urban water infrastructure in Pompeii. The main water system has been described in some detail. The water supply for public use to street fountains and public baths has been explained, whereas the water supply for private use to houses and workshops only has been discussed in part and with examples. The same description method could be used to give a full description of the pipe connections to all houses connected to the water system. A further discussion of laundries, industrial activities and other workshops with a large demand for water and need of the drainage system of the city would allow us to better understand the complexity of the water-supply system and to get a full picture of water in Pompeii. This study leads to further discussion on a number of matters: three such aspects are taken up below.

5.1 Discussion on the planning procedure

The planning of the urban water infrastructure must have started soon after the decision to connect an aqueduct to the city. The design and the construction of the water-supply system was a complex task and must have taken a considerable time. The water intake should be placed at the highest level in the city in a building designed to function as a distributor. The fairly steep slope of the city had to be taken into consideration in the planning. It must have been possible to measure the topographical levels of the city in antiquity. With the knowledge that the difference in height from north to south was more than 30 m and understanding possibly from experience that the pressure had to be reduced to 6–8 m, the design engineer must have planned to build water towers at four or five levels sloping downwards through the city. The water towers should be located in intersections to facilitate distribution in all directions and should be connected to the *Castellum Aquae* by main pipelines. There were two streets which were especially suited for the installation of these lines: one main water pipeline in *Via Vesuvio / Via Stabiana* and another in *Vicolo dei Vettii*. It is not known why Pompeii had yet a third pipeline. I would argue that this line was needed to supply water to the north-western part of the city.

The next step in the complex planning procedure was most likely to make a survey of the potential water users. The water supply for public use to street fountains in all parts of the city and to the public baths was the most important. Water supply to some private consumers was considered from the beginning, as seen from the grooves in the water towers. After the connection of an aqueduct to the city, the number of private users increased over time. The general design of the water-supply system with containers on top of the water towers creating steady water pressure to the users made it possible to connect a new private user at any time. The water engineer had merely to climb up the water tower to the top container and solder a new water pipe close to the bottom. His only consideration was the risk that the top container could run out of water. When too many new private users were connected, it was necessary to redesign the main water system.

5.2 Discussion on the water quantity

The water to Pompeii was supplied through an aqueduct that was a branch from the Serino aqueduct supplying several cities along the Bay of Naples. It is not known whether there was a device at the inlet of the branch to regulate the water quantity to the city of Pompeii. It is assumed that the total water quantity entering the city was constant.

The total amount of aqueduct water supplied to the city of Pompeii is not known, but many scholars have made attempts to estimate it. H. Eschebach calculated the total water supply to the city to 75 l/s based on the water inlet area of the aqueduct, 0.25 x 0.30 m, and a water velocity of 1.0 m/s.¹⁶⁸ Even if the inlet area is correct, the water velocity must be considered an estimate as is the total water supply. Ohlig discussed the water demands of the city and based his estimation on a water consumption of 200 – 400 l per person and day for a population of about 8000 people, giving a calculated total water quantity of 20–40 l/s.¹⁶⁹ This value must also be considered as approximate.

The *Castellum Aquae* acted as a regulator inside the city, and had an arrangement on the floor that could direct the incoming water from the aqueduct to the three main pipelines. The sum of these three water flows was always equal to the total water quantity arriving from the aqueduct, however: the flow of water could be altered for each of the three main water lines, but the total amount of water could not be changed or stopped from flowing.

Hodge studied the *Castellum Aquae* and discussed the function of the regulator. The water from the aqueduct would have spread out very shallowly to a uniform depth of about 2 cm, but due to the difference in width of the openings, the middle opening would have taken almost half of the water, the other two less than a third each. With gates in place in the openings, the water could be regulated, so that about half of the water supply went to the middle water pipe line, called the eastern main water pipe line, about one-third to the right-hand one, called the western main water pipe line, and about one-sixth to the left-hand one, called the central main water pipe line, as mentioned above.¹⁷⁰

Hodge also discussed the relative capacity of the aqueduct and of the three main pipelines on the basis of the cross-sections.¹⁷¹ He calculated the cross-section of the aqueduct as 25 x 25 cm or 625 cm², a little smaller than Eschebach's estimation. He calculated the size of the openings in the south façade of the *Castellum Aquae* at 30 cm and 25 cm, respectively, and he assumed that the largest pipes possible were installed to go through the openings: thus, circular pipes 1.5 cm thick with an inner diameter of 27 cm and 22 cm, respectively. The relative capacity of the three openings was thus estimated by Hodge to 380 + 573 + 380 cm², a total cross-section of 1333 cm². Hodge

¹⁶⁸ Eschebach 1983, 101.

¹⁶⁹ Ohlig 1996, 22.

¹⁷⁰ Hodge 1996, 15.

¹⁷¹ Hodge 1996, 14.

concludes that the capacity of the three main pipes together was more than twice what the aqueduct could supply.

I would argue that discussing the relative capacity based on circular pipes is to simplify the matter. It is well known that pipes in antiquity were produced with a pear-shaped cross-section, and that the pipe taking water from the *Castellum Aquae* to water tower no. 1 according to Ohlig had a diameter of 16.8 x 22 cm, by me called the Roman standard dimension *tricenaria*.¹⁷² Eschebach gave a dimension of 17 x 23 cm for the same pipe fragment, as shown to the left in *Fig. 5.1*.¹⁷³ Fahlbusch showed a pear-shaped pipe fragment from a museum seen to the top right in *Fig. 5.1*.¹⁷⁴

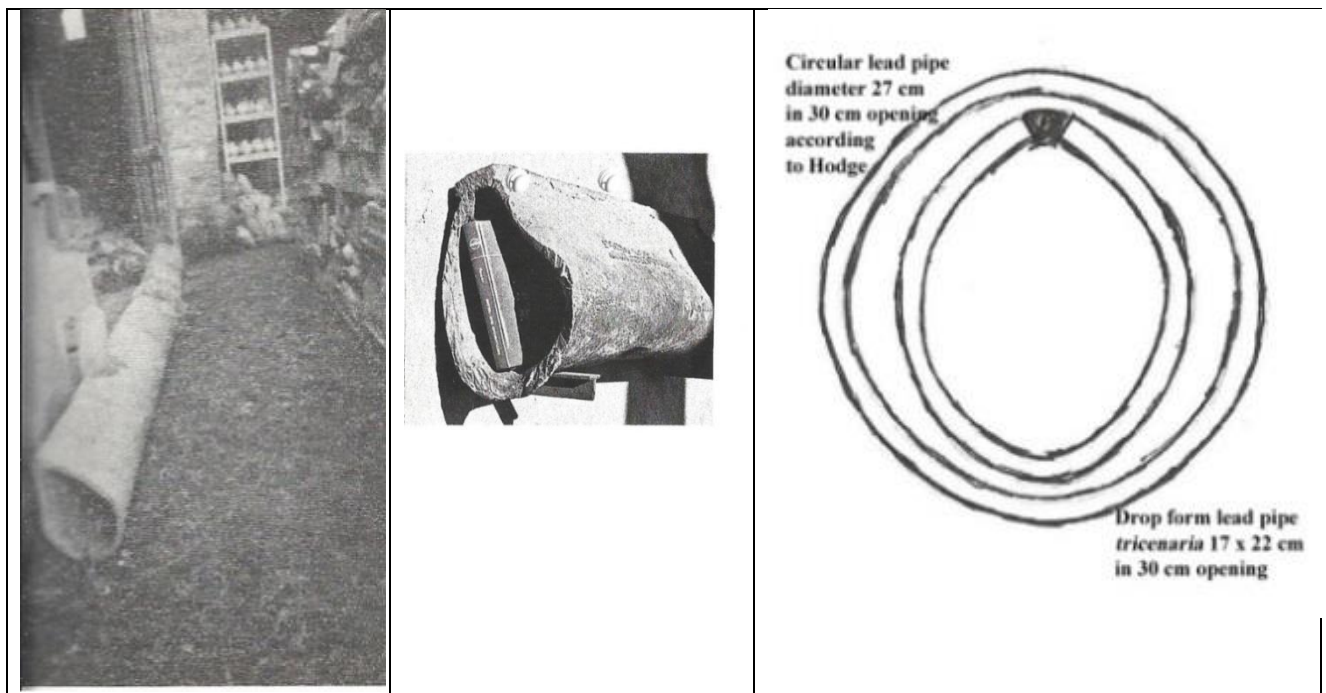

Figure 5.1. Main water pipe fragment (left). A pear-shaped pipe fragment (centre). A pear-shaped pipe at its opening, according to author (right).

Assuming that the pipes going through the openings of *Castellum Aquae* were pear-shaped and had the dimensions called *tricenaria* and *vicenaria*, respectively, as shown to the right in *Fig.5.1*, a calculation shows that the three main pipes together had a relative capacity of $140 + 260 + 140 \text{ cm}^2$, a total cross section of 540 cm^2 . It is not my intention to make another estimation of the total water quantity supplied to the city. However it is evident that the complex system was designed with a certain over-capacity to function satisfactorily. Such an over-capacity resulted in a steady overflow of water at many points in the system.

¹⁷² Ohlig 1996, 21.

¹⁷³ Eschebach 1983, 119.

¹⁷⁴ Fahlbusch 1989, 140.

5.3 Discussion on the operation of the system

The total quantity of water from the aqueduct was constant, but the amount of water being used could of course change over time. The water for public use was supplied by a constant water flow. The water for private use could however change from one moment to the next, because houses were often equipped with distributors and closing valves to individual fountains inside the house. The workshops could also regulate their water usage.

The operation of the system had to take into consideration that the water quantity needed in the city changed over time. I will discuss only two operation scenarios: the first operational scenario is when all public and private water users were consuming their full amount of water: this would mean that all closing valves in houses and workshops were open and water was continuously flowing in all street fountains and public baths. The water-supply system was operating at full capacity. The main water system had to guarantee that the top containers of all water towers and the storage tanks of two public baths were full, in order to provide stable water pressure to the water users even in this full-capacity scenario.

The second operational scenario is when most of the closing valves in houses and workshops were closed, but at the same time the water was flowing continuously in the street fountains and to the public baths. The water-supply system would thus be operating with reduced water consumption, but still with the full water quantity arriving from the aqueduct. The system operated in this scenario with overflow: that is, excess water in the system would have to flow out over the edge of the top containers on the water towers and at the end of the three main water pipelines after water towers Nos. 6, 10, 11 and 13. How this overflow was arranged is not known.

To illustrate, I have made a principal layout of the main water system as presented in *Fig. 5.2*. Water levels at the base of the water towers are shown. The water towers are located at different levels. The water had to pass through a top container to fill up the next. Most of the incoming water to every water tower had to pass through the top container of the tower: only a minor part would have been used there, however, while the rest went on to the next tower.

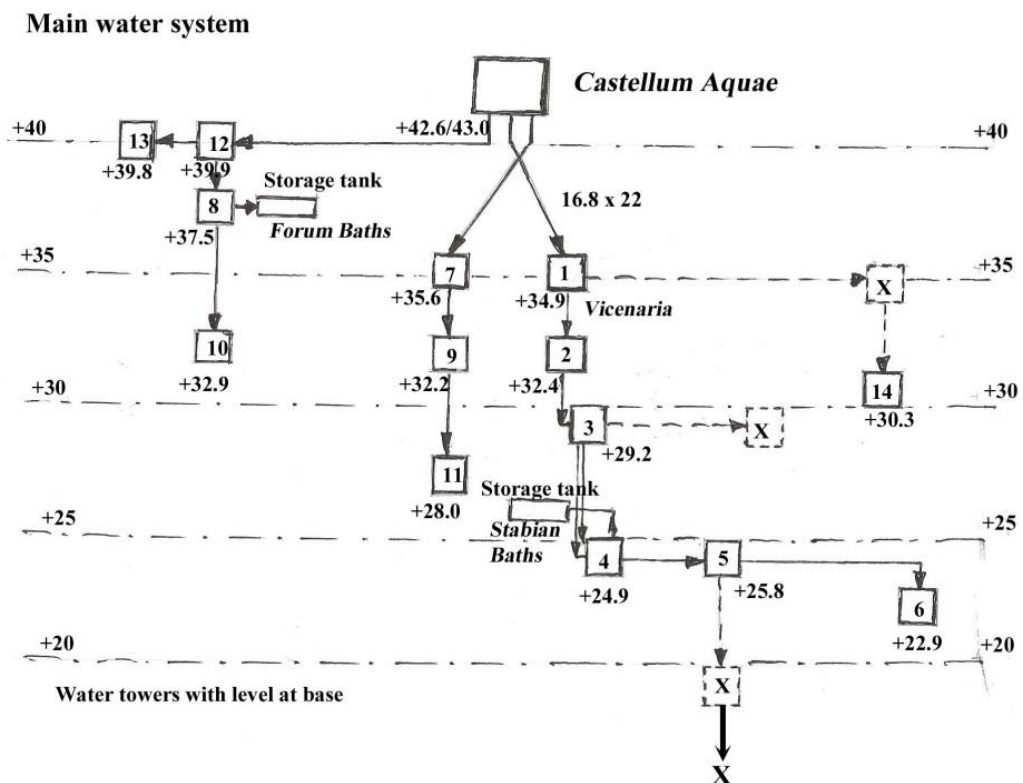

Figure 5.2. Principal layout of the main water system. Drawing by author.

If the total water quantity supplied to the city was 75 l/s as estimated by H. Eschebach, and if half of the total water quantity was flowing in the eastern (middle) main water pipe line as calculated by Hodge, then about 38 l/s was flowing from the *Castellum Aquae* to water tower no. 1. The top container of the tower would in theory have been filled in less than a minute. Some of the incoming water went from the top container of water tower no. 1 to two street fountains and four water users close to the tower, while some continued to an unknown tower and further to tower no. 14. Only a small portion of the incoming water in tower no. 1 was used for local consumers, perhaps 6 - 8 l/s. This figure is of course arbitrary. The rest of the incoming water to water tower no. 1, about 30 - 32 l/s, would then have been gone further to supply the next water tower, tower no. 2. The top container of this tower would then also have been filled in less than a minute. Most of the water in every water tower would pass through the top container and only a small part would be used by public and private water users. When the system was operating at reduced capacity, the overflow of water increased.

6. Summary and conclusions

A reconstruction of the urban water infrastructure

The urban water infrastructure in Pompeii has been discussed above. The design, construction and location of the water towers have been presented. The heights of the water towers, the distance between them, the grooves and the sizes of the top containers have been measured, calculated and tabled. My investigations have yielded a new interpretation of the main water system concerning the interconnection of the water towers in the three main water pipe lines as presented in *Fig. 6.1*. The location of the water towers and the orientation of the grooves, combined with the maximum level at the top, led to my conclusions on the interconnections. The main water system must have been designed in its entirety on one single occasion and could have been enlarged by an extra water tower only if the system was redesigned.

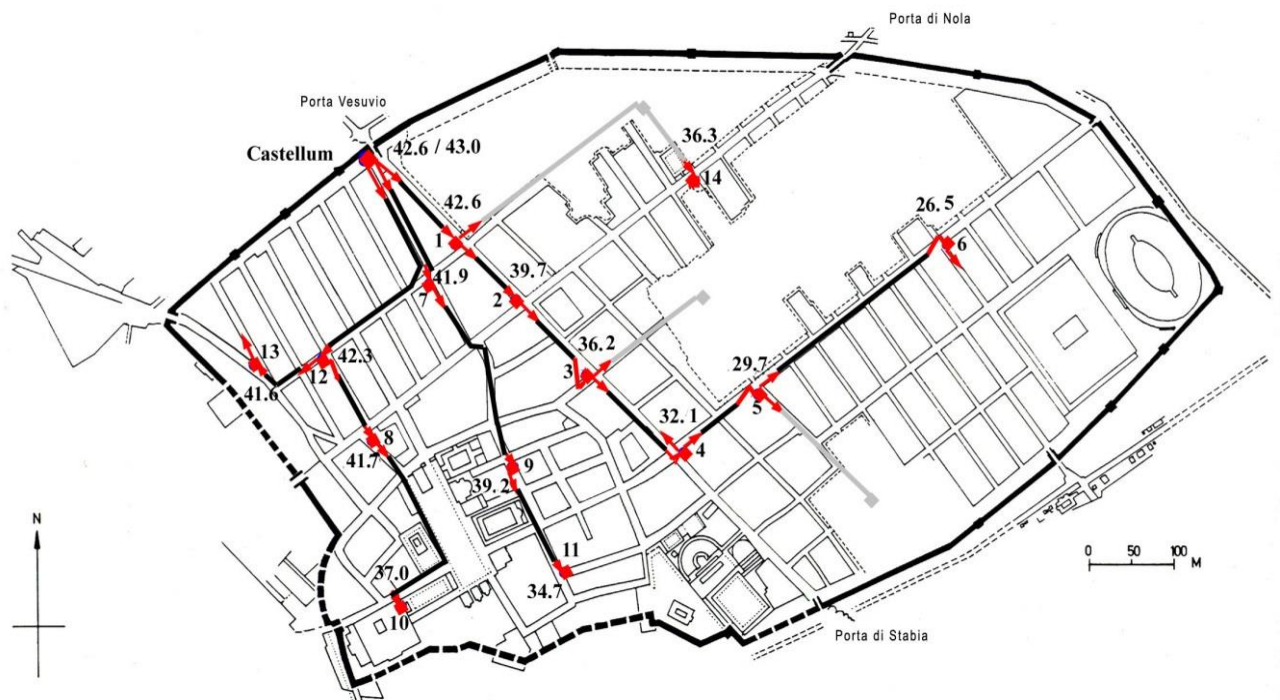

Figure 6.1: The main water system with the levels of top containers on the water towers and the suggested position of the main water pipelines and of possible other water towers (in grey) in the as yet unexcavated parts of the city. Drawing by author.

It could be argued that the measured heights of the water towers are uncertain. In any case the topographical level of the three openings in the *Castellum Aquae* + 42.6 / + 43.0 must be considered as certain, and consequently the levels of the three first water towers, No. 1 at + 42.6, No. 7 at + 41.9 and No. 12 at + 42.3, could not have been much higher. Also the levels of the water towers No. 8 at + 41.7 and No. 13 at + 41.6 are very likely to be correct.

The grooves of the water towers were designed to contain the main water pipelines going up to the top container and down to the street level and connecting to the next tower. Most of the grooves served this function with only a few exceptions. Three of the water towers were built with a groove that might have been designed for the connection to further water towers in the as yet unexcavated parts of the city, in *Fig. 6.1* marked in grey. All the further water towers were connected into the eastern water pipeline. Two of the water towers were also designed to supply water to two public baths in the city. Most of the aqueduct water went to the eastern pipe line. The middle opening in the *Castellum Aquae* contained the first part of this eastern pipeline, which had to cross over the central pipeline before entering the city and was thus located at a higher level.

My reconstruction of the urban water infrastructure as shown in *Fig. 6.1* is a system with three main water pipelines, based on the principle that aqueduct water could be pressed from the top container of one water tower to the next provided that this latter one was located at a lower level. The western main water pipeline first went to the top container of water tower no. 12 and then to no. 13 as well as no. 8 and further to no. 10. The central main water pipeline with the pipe fragment found in *Vicolo dei Vettii* connected the top containers of water tower no. 7, on to no. 9 and finally to no. 11. The eastern main water pipeline with the pipe fragment found in *Via del Vesuvio / Via Stabiana* must have connected the top containers of water towers no. 1 to no. 14 via an unknown tower, as well as to nos. 2, 3, 4, 5 and 6, with possible towers in *Regio V or IV* from tower no. 1, in *Regio IX* from tower no. 3 and in *Regio I* from tower no. 5. I have also concluded that the eastern main water pipeline was designed to supply water to the Stabian Baths via tower no. 4 which has a separate groove probably for this purpose, and that the western main pipeline supplied water to the Forum Baths, as tower no. 8 was constructed in direct contact with the western wall of the Baths and hypothetically had a water storage tank on top of the baths. These two baths were taken into consideration when the main water system was designed.

The water supply for public use was designed to supply water for public use from the top containers of the water towers to the street fountains and to the public baths; the water supply for private use was designed in the same way to supply water for private use to the houses and the workshops. The water-supply system was designed based not only on the shortest distance between water tower and water user, but also on the head between the level of the top container and the level of the water user. The head had to be large enough to make fountains function and low enough not to damage the pipes.

Five of the street fountains were located close to *Porta di Stabia* at a very low level in the city and could not have been supplied from any of the known water towers. The head would have been much above the critical value of 8 m. The existence of these five street fountains could well be an indication of one or even two unknown water towers in *Regio I*.

The water supply for public use from the water towers to the street fountains has been analysed based on the location of the fountains, the archaeological excavations of the pavements, the levels of water towers and fountains and the head of water to each fountain. This analysis has resulted in a plausible overall design of the pipe connections to most of the street fountains shown in *Fig. 6.2*.



Figure 6.2. Plausible overall design of water-supply system to street fountains. Probable pipe connections to street fountains marked by solid lines and plausible connections, by dotted lines. Water towers in red. Drawing by author.

The three other public baths were also supplied from the water supply for public use. The Suburban Baths and the Sarno Baths were probably supplied with aqueduct water through separate pipes from the top container of water tower No. 10. The Suburban Baths also had a large water storage tank working as a distributor to the different rooms in the baths. No such storage tank has been identified for the Sarno Baths. The Central Baths were still under construction at the time of the eruption: there is no trace of water connections. These Baths could not have been planned without designing a water supply for them and would have been equipped with a storage tank and supplied from the water-supply system.

Aqueduct water was also supplied to the houses and the workshops from the water supply for private use. I have studied all the houses supposed to have been connected to aqueduct water and have listed 32 houses which I believe were connected since fountain sculptures, pipes, and distributors and/or closing valves were found in archaeological excavations in the houses. I have also studied 28 workshops, laundries and dyehouses for the same reason. I have presented the possible pipes going from water tower no. 2 to houses and from water tower no. 9 to laundries as illustrations of the complexity of the water system.

The urban water infrastructure was a complex system. Almost 3000 m of lead pipes had to be manufactured and installed to create the interconnections between at least fourteen water towers in the three main water pipe lines. Another about 5000 m of lead pipes was laid in the pavements of the streets to connect public and private users to the top containers of the water towers. Forty-two street fountains and five public baths were supplied with a continuous flow of aqueduct water and more than one hundred private users, houses and workshops, were supplied with a changing amount of water according to their individual requirements. During the work with my thesis I have been impressed by the competence of Roman water engineers who with their knowledge and experience designed and operated complex infrastructure systems.

Sammanfattning

(Summary in Swedish)

Denna studie har fokuserat på den urbana vatteninfrastrukturen i den romerska staden Pompeji. Efter det att en akvedukt anslutits till staden byggdes ett kommunalt system för vattenförsörjning både till offentliga och privata användare. Livskvaliteten förbättrades för stadens invånare när vatten började rinna kontinuerligt i ett stort antal nybyggda gatufontäner. Undersökningen baseras på tidigare forskning och författarens egna observationer och mätningar på plats i staden i anslutning till det svenska Pompejiprojektet.

Avhandlingen presenterar en ny tolkning av hur de tre huvudvattenledningarna knöt samman vattentornen i staden. Pompeji ligger på sluttningen av vulkanen Vesuvius. Akvedukten anslöt i stadens högsta punkt till en fördelningsbyggnad, som distribuerade vatten till tankar på toppen av minst fjorton vattentorn. Dessa vattentankar var öppna på toppen. Systemet bygger på principen, att vatten kan tryckas upp av det atmosfäriska trycket från en sådan tank på toppen av ett vattentorn till tanken på nästa vattentorn, förutsatt att den senare låg på en lägre nivå än den förra.

Vattentornen har vertikala ursparingar på en, två eller tre av sidorna på de firsidiga tornen. Dessa var utförda för att installera och skydda huvudvattenledningarna. En sådan kom från föregående vattentorn och var förlagd i en ursparing på tornets ena sida och gick upp till tanken på toppen. På motsvarande sätt gick huvudvattenledningar i ursparingar från tanken på toppen ner till gatunivå på tornets andra sidor för anslutning till nästa vattentorn. Genom uppmätning av vattentornens höjder, deras placering i den sluttande staden, ursparingarnas storlek och riktning har jag dragit slutsatser om huvudvattenledningarnas sträckning i staden. Två av vattentornen var konstruerade för att föra vatten till de två offentliga bad, som redan fanns i staden när akvedukten anslöts. Jag har också presenterat en hypotes om att tre av vattentornen hade ursparingar, som var avsedda för installation av vattenrör till troliga vattentorn i de ännu ej utgrävda delarna av staden.

Avhandlingen presenterar delar av vattendistributionen från vattentornens toptankar till offentliga och privata användare. Varje användare hade en individuell vattenledning från ett närbeläget vattentorn. Gatufontäner och bad hade kontinuerligt rinnande vatten. Privata användare i hus och verkstäder hade individuella distributionsnät inne i husen, ofta försedda med vattenfördelare och avstängningsventiler till sina fontäner. De hade därigenom ett varierande vattenbehov. De individuella vattenledningarna från vattentornens toptankar till användarna var konstruerade inte enbart baserat på det kortaste avståndet mellan de två. Fallhöjden mellan torn och användare bestämde vattentrycket, som måste vara tillräckligt högt för att systemets fontäner skulle fungera men samtidigt tillräckligt lågt för att inte skada vattenledningen.

Under arbetet med avhandlingen har jag imponerats av kompetensen hos dåtidens vatteningenjörer och hur de med kunskaper och erfarenheter hade förmåga att konstruera, bygga och driva komplexa infrastruktursystem.

Appendix 1: Tables

Table 1: The heights of the water towers

| Water tower no. | Location | Level at street | Level at base | Meas. height by D-L | Meas. height by author | Variation in meas. height | Est. height of top container | Est. water level at the top |
|-----------------|----------|-----------------|---------------|---------------------|------------------------|---------------------------|------------------------------|-----------------------------|
| 1 | VI 16,4 | + 34.7 | + 34.9 | 6.20 | 6.67 | 0.16 | 1.0 | + 42.6 |
| 2 | VI 14,17 | + 32.2 | + 32.4 | 6.35 | 6.34 | 0.34 | 1.0 | + 39.7 |
| 3 | VII 2,1 | + 29.0 | + 29.2 | 6.05 | 5.96 | 0.45 | 1.0 | + 36.2 |
| 4 | I 4,15 | + 24.9 | + 24.9 | 6.60 | 6.15 | 0.16 | 1.0 | + 32.1 |
| 5 | I 6,1 | + 25.6 | + 25.8 | 4.20 | 3.33 | 0.07 | 0.8 | + 29.7 |
| 6 | II 2,1 | + 22.7 | + 22.9 | 2.74 | 3.03 | 0.34 | 0.6 | + 26.5 |
| 7 | VI 13,16 | + 35.6 | + 35.6 | 5.33 (4.90) | (4.37) | 0.09 | 1.0 | + 41.9 |
| 8 | VII 5,8 | + 37.5 | + 37.5 | 3.00 | 2.83 | 0.09 | 1.2 | + 41.7 |
| 9 | VII 10,7 | + 32.2 | + 32.2 | 6.30 | 6.02 | 0.34 | 1.0 | + 39.2 |
| 10 | VIII 1,2 | + 32.9 | + 32.9 | 3.54 (3.06) | (3.15) | 0.04 | 0.6 | + 37.0 |
| 11 | VIII 5,3 | + 28.0 | + 28.0 | 5.73 | 5.69 | 0.06 | 1.0 | + 34.7 |
| 12 | VI 6,11 | + 39.9 | + 39.9 | - | 1.63 | 0.14 | 0.8 | + 42.3 |
| 13 | VI 1,19 | + 39.8 | + 39.8 | - | 0.80 | 0.00 | 1.0 | + 41.6 |
| 14 | IX 10,2 | + 30.3 | + 30.3 | - | 5.37 | 0.16 | 0.6 | + 36.3 |

Table 1: The heights of the water towers

Comments to Table 1:

- Location as presented by Hans Eschebach in his *Gebäudeverzeichnis*
- Level at street as given by Hans Eschebach in his City Map from 1993.
- Level at base plus 0.2 m if standing on the pavement.
- Measured height by Jens Dybkjaer Larsen in his survey from 1982. Towers nos. 7 and 10 estimated by evidence on masonry wall behind them. Actual values in brackets.
- Measured height by author taken in 2009. Average of three measurements.
- Height of top container estimated by author from 2009.
- Estimated water level at the top as the sum of level at base + measured height + estimated height of top basin.
- Estimated levels are uncertain, especially for towers nos. 6, 10 and 12.

Table 2: Distance between the water towers

Eastern pipeline:

| From water tower no. | Level at base m a.s.l. | To water tower no. | Level at base m a.s.l. | Measured distance, in metres | Inclination average |
|-----------------------------|-------------------------------|---------------------------|-------------------------------|-------------------------------------|----------------------------|
| Castellum | 42.6/43.0 | 1 | 34.9 | 140 | 5.6 % |
| 1 | 34.9 | 2 | 32.4 | 90 | 2.8 % |
| 2 | 32.4 | 3 | 29.2 | 140 | 2.3 % |
| 3 | 29.2 | 4 | 24.9 | 130 | 3.2 % |
| 4 | 24.9 | 5 | 25.8 | 130 | -0.2 % |
| 5 | 25.8 | 6 | 22.9 | 240 | 0.1 % |
| 1 | 34.9 | 14 | 30.3 | 350 | 1.3 % |

Central pipeline:

| From water tower no. | Level at base m a.s.l. | To water tower no. | Level at base m a.s.l. | Measured distance, in metres | Inclination average |
|-----------------------------|-------------------------------|---------------------------|-------------------------------|-------------------------------------|----------------------------|
| Castellum | 42.6 | 7 | 35.6 | 150 | 4.7 % |
| 7 | 35.6 | 9 | 32.2 | 240 | 1.4 % |
| 9 | 32.2 | 11 | 28.0 | 140 | 3.0 % |

Western pipeline:

| From water tower no. | Level at base m a.s.l. | To water tower no. | Level at base m a.s.l. | Measured distance, in metres | Inclination average |
|-----------------------------|-------------------------------|---------------------------|-------------------------------|-------------------------------------|----------------------------|
| Castellum | 42.6 | 12 | 39.9 | 300 | 0.9 % |
| 12 | 39.9 | 8 | 37.5 | 110 | 2.5 % |
| 8 | 37.5 | 10 | 32.9 | 250 | 1.7 % |
| 12 | 39.9 | 13 | 39.8 | 120 | 0.1 % |

Table 2: Distance between the water towers

Table 3: The grooves of the water towers

| Water tower no. | Cross-section | Groove north | Groove east | Groove south | Groove west |
|-----------------|---------------|--------------|-------------|--------------|-------------|
| 1 | 1.23 x 1.20 | 27 x 17 | 14 x 12 | 27 x 18 | - |
| 2 | 1.50 x 1.50 | 30 x 30 | - | 42 x 28 | - |
| 3 | 1.00 x 1.20 | - | 32 x 17 | 36 x 17 | 50 x 20 |
| 4 | 1.20 x 1.20 | 30 x 13 | 30 x 13 | - | 35 x 18 |
| 5 | 1.05 x 0.95 | 27 x 27 | 15 x 17 | 25 x 25 | Wall |
| 6 | 0.85 x 1.05 | 15 x 15 | Wall | 15 x 15 | 15 x 15 |
| 7 | 1.05 x 1.15 | 65 x 30 | - | 20 x 20 | Wall |
| 8 | 0.60 x 1.20 | 35 x 25 | Wall | 35 x 25 | 55 x 13 |
| 9 | 1.20 x 1.05 | 34 x 20 | - | Wall | 35 x 17 |
| 10 | 0.55 x 0.60 | 15 x 15 | Wall | ? | - |
| 11 | 1.10 x 1.15 | Wall | - | - | 35 x 20 |
| 12 | 0.90 x 0.95 | - | 60 x 20 | Wall | 23 x 15 |
| 13 | 1.05 x 1.20 | 40 x 15 | - | 40 x 15 | Wall |
| 14 | 0.75 x 0.75 | 15 x 13 | Wall | ? | Wall |

Table 3: The grooves of the water towers

Comments to Table 3:

The depths of the grooves vary and can protect pipes of different dimensions.

- 5 small grooves with depths of 12/13 cm suitable for 10 *digiti* pipes (*denaria*)
- 14 medium grooves with depths of 15/17/18 cm suitable for 15 *digiti* pipes (*quingulum denum*)
- 8 deep grooves with depths of 20/25 cm suitable for 20 *digiti* pipes (*vicenaria*)
- 4 very deep grooves with depths of 27/28/30 cm suitable for 30 *digiti* pipes (*tricenaria*).

Table 4: The top containers of the water towers

| Water tower no. | Cross-section of tower, in m | Estimated Height, in m | Estimated capacity, in litres |
|------------------------|-------------------------------------|-------------------------------|--------------------------------------|
| 1 | 1.23 x 1.20 | 1.0 | 1400 l |
| 2 | 1.50 x 1.50 | 1.0 | 2200 l |
| 3 | 1.00 x 1.20 | 1.0 | 1200 l |
| 4 | 1.20 x 1.20 | 1.0 | 1400 l |
| 5 | 1.05 x 0.95 | 0.8 | 1000 l |
| 6 | 0.65 x 0.65 | 0.56 | 230 l |
| 7 | 1.05 x 1.15 | 1.0 | 1200 l |
| 8 | 0.60 x 1.20 | 1.2 | 900 l + tank |
| 9 | 1.20 x 1.05 | 1.0 | 1200 l |
| 10 | 0.55 x 0.60 | 0.6 | 200 l |
| 11 | 1.10 x 1.15 | 1.0 | 1200 l |
| 12 | 0.90 x 0.95 | 0.8 | 700 l |
| 13 | 1.05 x 1.20 | 1.0 | 1000 l |
| 14 | 0.75 x 0.75 | 0.6 | 300 l |

Table 4: The top containers of the water towers

Comments to Table 4:

The height and the capacity for each top container are estimated by the author

- The total maximum capacity of the top containers together is 14,130 l.
- The estimated capacity of top containers in the western pipe line is 2800 l.
- The estimated capacity of the top containers in the central pipe line is 3600 l.
- The estimated capacity of the top containers in the eastern pipe line is 7730 l

The total estimated capacity of the top containers in each main water pipeline could give an indication of which pipeline was supplied with the most aqueduct water .

Table 5: Standard for water-pipe dimensions

Vitruvius presented standard dimensions for lead water pipes.¹⁷⁵ He gave figures for the width of lead plates before the plates were rolled to form pipes (in *digitus*, where 1 *digitus* = 1.85 cm). He also gave the weight (in *pondus*, where 1 *pondus* = 0.45 kg) for a 10-foot plate (where 1 foot = 29.6 cm).

| Size in <i>digiti</i> | Name | circumference in cm | Weight in pounds |
|-----------------------|-----------------------|---------------------|------------------|
| 5 | <i>quinaria</i> | 9.25 | 60 |
| 8 | <i>octonaria</i> | 14.8 | 100 |
| 10 | <i>denaria</i> | 18.5 | 120 |
| 15 | <i>quinum denum</i> | 27.75 | 180 |
| 40 | <i>quadragenaria</i> | 74.0 | 480 |
| 50 | <i>quinguagenaria</i> | 92.5 | 600 |
| 80 | <i>octogenaria</i> | 148.0 | 960 |
| 100 | <i>centenaria</i> | 185.0 | 1200 |

The standard (weights) as presented by Vitruvius shows that in his opinion the lead plates all had the same thickness (about 1 cm) irrespective of the size of the pipe. Such thick lead pipes have never been found in archaeological excavations, however.

Fahlbusch, referring to Vitruvius' standard, calculated the inner diameter and circumference based on the size in *digiti* and also added two sizes not mentioned.¹⁷⁶ He refrained from giving the circumference of the pipe dimension in pear-shaped form.

| Size in <i>digiti</i> | Name | Circumference in cm | Ideal inner diameter in cm | Ideal area cm ² |
|-----------------------|-----------------------|---------------------|----------------------------|----------------------------|
| 5 | <i>quinaria</i> | 9.25 | 2.94 | 6.81 |
| 8 | <i>octonaria</i> | 14.8 | 4.71 | 17.43 |
| 10 | <i>denaria</i> | 18.5 | 5.89 | 27.24 |
| 15 | <i>quinum denum</i> | 27.75 | 8.83 | 61.28 |
| 20 | <i>vicenaria</i> | 37.0 | 11.78 | 108.93 |
| 30 | <i>tricenaria</i> | 55.5 | 17.67 | 245.11 |
| 40 | <i>quadragenaria</i> | 74.0 | 23.55 | 435.75 |
| 50 | <i>quinguagenaria</i> | 92.5 | 29.44 | 680.86 |
| 80 | <i>octogenarian</i> | 148.0 | 47.11 | 1743.08 |
| 100 | <i>centenaria</i> | 185.0 | 58.89 | 2723.45 |

Fahlbusch has also presented a later Roman standard for circular pipes introduced by Agrippa and established by Augustus.¹⁷⁷ This later standard was discussed by Frontinus.¹⁷⁸ I have chosen not to discuss this later standard for the water supply in Pompeii.

¹⁷⁵ Vitr. *De Arch.*, 8.6.4.

¹⁷⁶ Fahlbusch 1989, 139.

¹⁷⁷ Fahlbusch 1989, 140-141.

¹⁷⁸ Frontin. *Aq.* 39-63.

Table 6. Street fountains 1-21

| Number | Location | Size (LxWxH) | Capacity | Size | Level of street a.s.l. | Level of fountain basin a.s.l. | Level of pipe opening a.s.l. | Current level of water tower a.s.l. | Head |
|--------|---------------------|-------------------|----------|------|------------------------------|---|---------------------------------------|--|------|
| 1 | I 4, 15 | 120 x 150 x 76 | 1360 | XL | + 24.9 | + 25.7 | + 25.9 | 4 (+ 32.1) | 6.2 |
| 2 | I 5, 2 | 60 x 100 x 75 | 450 | S | + 14.8 | + 15.6 | + 15.8 | Unknown tower | - |
| 3 | I 9, 1 | 90 x 130 x 70 | 820 | L | + 24.6 | + 25.3 | + 25.5 | 5 (+ 29.7) | 4.2 |
| 4 | I 10, 1 | 70 x 95 x 70 | 460 | S | + 22.5 | + 23.2 | + 23.4 | 5 (+ 29.7) | 6.3 |
| 5 | I 12, 2 | 90 x 130 x 67 | 780 | L | + 23.7 | + 24.4 | + 24.6 | 5 (+ 29.7) | 5.1 |
| 6 | I 13, 10 | 70 x 110 x 55 | 420 | S | + 20.8 | + 21.4 | + 21.6 | 6 (+ 26.5) | 4.9 |
| 7 | I 16, 4 | 80 x 80 x 67 | 420 | S | + 20.5 | + 21.2 | + 21.4 | Unknown tower | - |
| 8 | II 1, 2 | 90 x 120 x 70 | 750 | L | + 22.7 | + 23.4 | + 23.6 | 6 (+ 26.5) | 2.9 |
| 9 | II 3, 5 | 85 x 125 x 70 | 740 | L | + 22.5 | + 23.2 | + 23.4 | 6 (+ 26.5) | 3.1 |
| 10 | III 11, 1 | 85 x 95 x 77 | 620 | M | + 26.4 | + 27.2 | + 27.4 | Possibly 14 (+ 36.3) | 8.9 |
| 11 | V 1, 3 | No basin | 0 | - | + 32.2 | - | + 32.5 | 2 (+ 39.7) | 7.2 |
| 12 | VI 1, 19 | 90 x 125 x 70 | 780 | L | + 39.8 | + 40.5 | + 40.7 | 13 (+ 41.6) | 0.9 |
| 13 | VI 3, 20 | 105 x 120 x 70 | 880 | L | + 37.8 | + 38.5 | + 38.7 | 8 (+ 41.7) | 3.0 |
| 14 | VI 8, 24 | 90 x 120 x 78 | 840 | L | + 36.0 | + 36.8 | + 37.0 | 7 (+ 41.9) | 4.9 |
| 15 | Arch of Caligula | | - | - | + 35.7 | | + 36.7 | 8 (+41.7) | 5.0 |
| 16 | VI 13, 7 | 95 x 125 x 67 | 790 | L | + 33.3 | + 34.0 | + 34.2 | 7 (+ 41.9) | 7.7 |
| 17 | VI 13, 17 | 80 x 110 x 70 | 610 | M | + 37.2 | + 37.9 | + 38.1 | 7 (+ 41.9) | 3.8 |
| 18 | VI 14, 17 | 94 x 120 x 67 | 750 | L | + 32.2 | + 32.9 | + 33.1 | 2 (+ 39.7) | 6.6 |
| 19 | VI 16, 4 | 94 x 128 x 67 | 800 | L | + 34.7 | + 35.4 | + 35.6 | 1 (+ 42.6) | 7.0 |
| 20 | VI 16, 19 | 99 x 125 x 68 | 840 | L | + 40.0 | + 40.7 | + 40.9 | 1 (+ 42.6) | 1.7 |
| 21 | VI 16, 28 | 74 x 90 x 67 | 440 | S | + 40.0 | + 40.7 | + 40.9 | 7 (+ 41.9) | 1.0 |

Table 6. Street fountains 22-42

| Number | Location | Size (LxWxH) | Capacity | Size | Level of street a.s.l. | Level of fountain basin a.s.l. | Level of pipe opening a.s.l. | Current level of water tower a.s.l. | Head |
|--------|-----------------------|-----------------|----------|------|------------------------------|---|---------------------------------------|--|------|
| 22 | VII 1, 32 | 94 x 120 x 76 | 850 | L | + 29.0 | + 29.8 | + 30.0 | 3 (+ 36.2) | 6.2 |
| 23 | VII 4, 32 | 80 x 120 x 70 | 340 | S | + 33.1 | + 33.8 | + 34.0 | 3 (+ 36.2) | 2.2 |
| 24 | VII 7, 26 | 75 x 95 x 48 | 340 | S | + 36.4 | + 36.9 | + 37.1 | 8 (+ 41.7) | 4.6 |
| 25 | Arch at Forum | | - | - | + 36.4 | + 36.9 | + 37.9 | 8 (+ 41.7) | 3.8 |
| 26 | VII 9, 67 | 105 x 150 x 70 | 1100 | XL | + 29.5 | + 30.2 | + 30.4 | Possibly 11 (+ 34.7) | 4.3 |
| 27 | VII 11, 5 | 85 x 120 x 75 | 760 | L | + 30.4 | + 31.2 | + 31.4 | 9 (+ 39.2) | 7.8 |
| 28 | VII 14, 13 | 95 x 125 x 67 | 720 | L | + 25.1 | + 25.8 | + 26.0 | 4 (+ 32.1) | 6.1 |
| 29 | VII 15, 1 | 90 x 90 x 90 | 720 | L | + 33.6 | + 34.5 | + 34.7 | Possibly 10 (+ 37.0) | 2.3 |
| 30 | VII 15, 12 | No basin | 0 | - | + 33.9 | - | + 34.2 | Possibly 8 (+ 41.7) | 7.5 |
| 31 | VIII 2, 20 | 90 x 100 x 45 | 400 | S | + 33.3 | + 33.8 | + 34.0 | 10 (+ 37.0) | 3.0 |
| 32 | VIII 2, 29 | 75 x 90 x 60 | 400 | S | + 32.4 | + 33.0 | + 32.2 | Possibly 11 (+ 34.7) | 1.5 |
| 33 | VIII 2, 11 | 100 x 120 x 70 | 840 | L | + 32.2 | + 33.9 | + 34.1 | 10 (+ 37.0) | 2.9 |
| 34 | VIII 7, 30 | 95 x 120 x 67 | 760 | L | + 24.1 | + 24.8 | + 25.0 | Possibly 4 (+ 32.1) | 7.1 |
| 35 | Triangular Forum | | - | - | + 24.1 | - | + 25.1 | Possibly 4 (32.1) | 7.0 |
| 36 | Gladiator Barracks | | - | - | + 14.1 | - | + 15.1 | Unknown tower | - |
| 37 | VIII 7, 1 | 85 x 100 x 60 | 510 | M | + 10.0 | + 10.6 | + 10.8 | Unknown tower | - |
| 38 | VIII 7, 25 | No basin | 0 | - | + 20.5 | - | + 20.8 | Unknown tower | - |
| 39 | IX 7, 17 | 65 x 100 x 70 | 520 | M | + 29.1 | + 29.8 | + 30.0 | Unknown tower | - |
| 40 | IX 8, 1 | 95 x 125 x 76 | 900 | L | + 32.0 | + 32.8 | + 33.0 | 14 (+ 36.3) | 3.3 |
| 41 | IX 10, 2 | 90 x 140 x 90 | 1130 | XL | + 30.9 | + 31.8 | + 32.0 | 14 (+ 36.3) | 4.3 |
| 42 | IX 11, 1 | 90 x 125 x 67 | 750 | L | + 25.6 | + 26.3 | + 26.5 | 5 (+ 29.7) | 3.2 |

Table 7. Houses with water supply investigated by author in Regio I - VI

| Location | Name | Archaeological finds of fountain sculptures acc to Kapossy | Archaeological finds of pipe acc. to Jansen |
|------------------|----------------------------|---|---|
| I 4, 5.6.25.28 | Casa del Citarista | Leaping lion (Cat. 4897) Snake (Cat. 4898) Boar with two dogs (Cat. 4899) Dog (Cat 4900) Dog (Cat 4901) | Distributor Closing valve |
| I 7, 10-12.19 | Casa dell'Efebo | Pomona (Cat. 144276) | Pipe, System |
| II 2, 1-6 | Casa di Octavius Quatro | | |
| II 4, 2-12 | Preadia di Julia Felix | | Pipe |
| III 2, 1 | Casa di Trebius Valens | | Pipe |
| V 1, 3. 6-9 | Casa del Torello di Bronzo | Bull in bronze (Cat. 4890) | Pipe |
| V 1, 11.12.18 | Casa degli Epigrammi Greci | | Pipe |
| V 1, 22.25-27.10 | Casa di Caecilius Iucundus | | Distributor, System Closing valve |
| V 2, i | Casa delle Nozze d'Argento | Pigeon (Cat. 124357) | Distributor Closing valve |
| VI 2, 4 | Casa di Sallustio | Sphinx (Cat. 69789) | |
| VI 8, 22 | Casa del Fontana Grande | Eros with dolphin (Cat. 111701) | |
| VI 8, 23 | Casa del Fontana Piccolo | Eros with duck (Cat. 5000) Boy fishing (Cat. ?) | |
| VI 9, 5 | Casa del Centauro | Apollo with lyre (Cat. ?) | |
| VI 12, 17 | Casa del Fauno | Faun (Cat. ?) | |
| VI 14. 18-20 | Casa di Orfeo | | Distributor Closing valve |
| VI 14, 43 | Casa degli Scenziati | | Distributor Closing valve |
| VI 15, 1.27 | Casa dei Vettii | Priapus (Cat. ?) Dionysus (Cat. ?) Satyr (Cat. ?) Boys with duck (Cat. ?) | Closing valve |
| VI 16, 6.7.38 | Casa degli Amorini dorati | | Pipe |

Table 7. Houses with water supply investigated by author in Regio VII - IX

| Location | Name | Archaeological finds of fountain sculptures acc to Kapossy | Archaeological finds of pipe acc. to Jansen |
|------------------------|--------------------------|---|---|
| VII 1, 25.46.47 | Domus Siricus | | Pipe |
| VII 2, 16 | Casa di Gavius Rufus | Satyr with dog (Cat. ?) | Distributor |
| VII 2, 45 | Casa dell'Orso | | Pipe, System |
| VII 3, 1-3.38-40 | Casa del C. Memmius | | |
| VII 4, 56 | Casa della Fontana | Silenus with tube (Cat. 6341) | |
| VII 12, 28 | Casa del Balcone pensile | Boy (Cat. ?) | System |
| VIII 2, 21 | Casa del Aelius Mgnus | Pigeon (Cat. 120268) | |
| VIII 4, 4 | Casa del Holconius Rufus | Boy with pigeon (Cat. ?) | |
| VIII 4, 14-16.22.23.30 | Domus Cornelia | | Distributor, System |
| VIII 5, 28 | Casa delle Calce | Frog (Cat. 120042) | |
| IX 1, 20.30 | Casa dei Diadumeni | | System |
| IX 3, 5.24 | Casa di Marcus Lucretius | Faun (Cat. ?) Silenus (Cat. ?) Dolphin (Cat. ?) Ibis (Cat. ?) Duck (Cat. ?) Cow (Cat. ?) Deer (Cat. ?) Hare (Cat. ?) | Distributor Closing valve |
| IX 7, 20 | Casa della Fontana | Amorin holding dolphin (Cat. 111701) Amorin holding Pan (Cat. 114595) Silenus holding wineskin (Cat. 120362) | |
| IX 8, 3-6 | Casa del Centenario | Satyr (Cat. 111495) | |
| IX 14, 2.4 | Casa dei Obellii Firmi | | System |

Table 8. Workshops with water supply investigated by author

Eschebach recorded 46 workshops with large water requirements, from which he described 21 as laundries, 10 with a name and 11 without. In my field investigations I have added four houses with built-in facilities for a laundry in a minor part of the house, so-called “house with an *oficina lanificaria*”, and also three dyehouses. In total I have studied 28 laundries and dyehouses on site. Six of these were already questioned by Eschebach. Three large laundries were investigated in detail by Flohr.

| Location | Name of laundry | <i>Saltus fullonici</i> | Comment |
|-----------------|---|-------------------------|--|
| I 3, 15 | Workshop – Sestius Venustus | 0 | |
| I 3, 18 | <i>Oficina lanificaria</i> –Sestius Venustus | 0 | |
| I 4, 7 | Fullonica del Maeniarus & Passaratus | 2 | |
| I 4, 26 | Fullonica del Dionysius | 2 | |
| I 6, 7 | Fullonica del Stephanus | 5 | Investigated by Miko Flohr |
| I 10, 6 | Small fullonica without name | ? | Eschebach: Fullonica ? |
| I 11, 1 | Small fullonica without name | ? | Eschebach: Fullonica ? - Thermopolium |
| V I, 4.5 | Dyehouse and laundry | - | Dye house added by author |
| V 3, 1.2 | Small fullonica without name | 2 | |
| VI 8, 2.20.21 | Fullonica del L. Veranius Hypsaesus | 4 | Investigated by Miko Flohr |
| VI 14, 21.22 | Fullonica di Vesonius Primus | 7 | Investigated by Miko Flohr |
| VI 15, 3 | Fullonica del Mustius & Ovia | 2 | |
| VI 16, 3.4 | Fullonica di Maurius Salarius Crocus | 3 | |
| VI 16.6 | Small fullonica without name | ? | |
| VI 16, 27 | Small fullonica without name | ? | Eschebach: Fullonica ? - Wineshop |
| VII 2, 41 | Fullonica del Maceiro | | Eschebach: Fullonica ? - Wineshop |
| VII 3, 24.25 | “House with an <i>oficina lanificaria</i> ” | ? | House added by author |
| VII 4, 39 | Small fullonica without name | ? | |
| VII 9, 44 | Small fullonica without name | ? | |
| VII 10, 5.8.13 | “House with an <i>oficina lanificaria</i> ” | 0 | House added by author |
| VII 11, 2.3.4.5 | <i>Oficina lanificaria</i> without name | 0 | |
| VII 12, 17.21 | Casa di Narcisso with an <i>oficina lanificaria</i> | 0 | House added by author |
| VII 12, 22-25 | Casa del Camillo | 0 | |
| VII 12, 30-32 | “House with an <i>oficina lanificaria</i> ” | 0 | House added by author |
| VII 14, 5.17-19 | <i>Oficina pigmenteria</i> | - | Dyehouse added by author |
| VIII 4, 1.53 | Casa del Cambio with an <i>oficina tinctoria</i> | - | Dyehouse added by author |
| IX 11, 6 | Small fullonica without name | ? | Eschebach: Fullonica ? |
| IX 13, 4-6 | Casa del fullo M. Fabius Ululitremulus | - | Eschebach: Fullonica ? – House for fullo |

Appendix 2: Catalogue of water towers. (Photos by author)

Water tower no. 1.

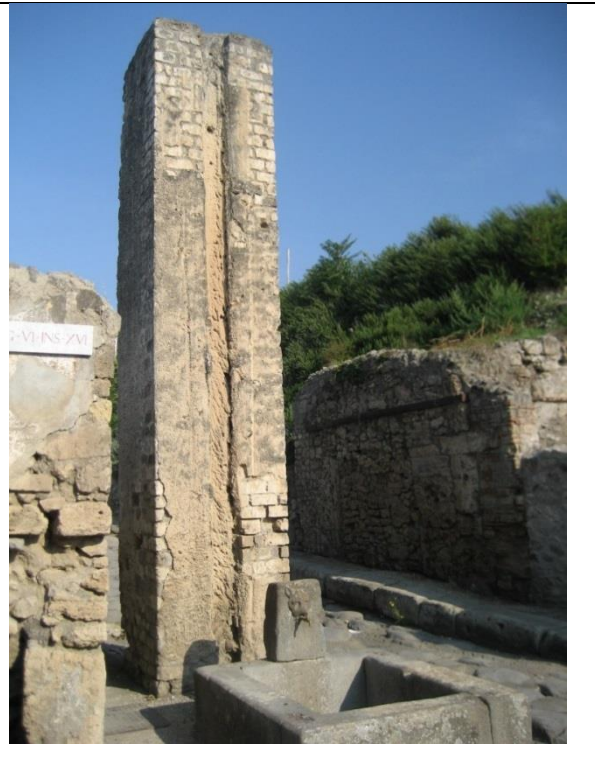
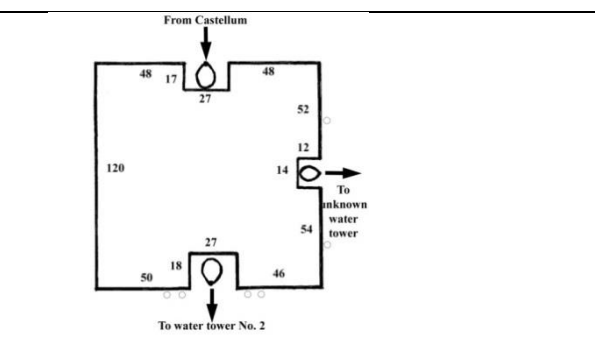
| | |
|---|---|
|  | <p>Location: VI 16,4 on the western pavement of <i>Via Vesuvio / Via Stabiana</i></p> <p>Level at street + 34.7 m</p> <p>Level at base + 34.9 m</p> <p>Measured height:</p> <ul style="list-style-type: none"> by Dybkjaer Larsen 6.20 m by author 6.67 m <p>Estimated height of top container 1.0 m</p> <p>Estimated water level at the top of the tower + 42.6 m</p> <p>Estimated capacity of top container 1400 l</p> <p>Distance from <i>Castellum</i> 140 m</p> <p>Inclination of pipe 5.6 %</p> |
|  | <p>Cross-section: 123x120 cm</p> <p>Grooves:</p> <ul style="list-style-type: none"> - north: 27x17 cm - east: 14x12 cm - south: 27x18 cm - west: none |

Water tower no. 2.

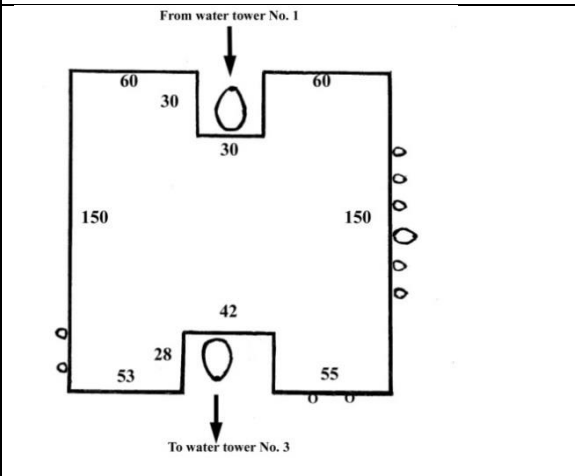
| | |
|--|---|
|  | <p>Location: VI 14,17 on the western pavement of <i>Via Vesuvio / Via Stabiana</i></p> <p>Level at street + 32.2 m Level at base + 32.4 m</p> <p>Measured height:</p> <p>by Dybkjaer Larsen 6.35 m by author 6.34 m</p> <p>Estimated height of top container 1.0 m</p> <p>Estimated water level at the top of the tower + 39.7 m</p> <p>Estimated capacity of top container 2200 l</p> <p>Distance from tower no. 1 90 m</p> <p>Inclination of pipe 2.8 %</p> |
|  <p>The diagram shows a cross-section of a 150x150 cm tower. It features two circular openings: one at the top (30x30 cm) labeled 'From water tower No. 1' and one at the bottom (42x28 cm) labeled 'To water tower No. 3'. The tower has a central vertical shaft. Dimensions for the top section are 60 cm (width), 30 cm (radius), and 30 cm (height). Dimensions for the bottom section are 42 cm (width), 28 cm (radius), and 53 cm (width). The main body of the tower is 150 cm wide and 150 cm high. There are also small circles on the right side of the tower.</p> | <p>Cross-section:: 150x150 cm</p> <p>Grooves:</p> <ul style="list-style-type: none"> - north: 30x30 cm - east: none - south: 42x28 cm - west: none |

Water tower no. 3.

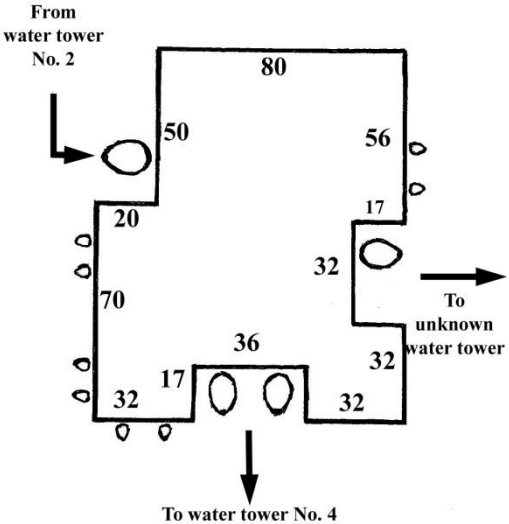
| | |
|--|---|
|  | <p>Location: VII 2,1 on the western pavement of <i>Via Stabiana</i> Level at street + 29.0 m Level at base + 29.2 m Measured height: by Dybkjaer Larsen 6.05 m by author 5.96 m Estimated height of top container 1.0 m Estimated water level at the top of the tower + 36.2 m Estimated capacity of top container 1200 l Distance from tower no. 2 140 m Inclination of pipe 2.3 %</p> |
|  | <p>Cross-section: 100x120 cm Grooves: - north: none - east: 32x17 cm - south: 36x17 cm - west: 50x20 cm</p> |

Water tower no. 4.

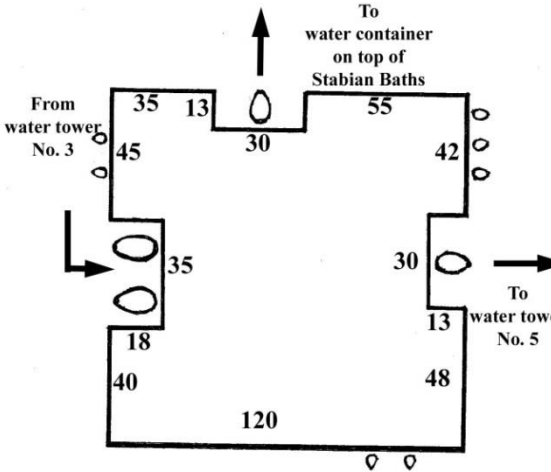
| | |
|--|--|
|  | <p>Location: I 4,15 on the corner of <i>Via Stabiana</i> and <i>Via dell'Abbondanza</i> Level at street + 24.9 m Level at base + 24.9 m Measured height: by Dybkjaer Larsen 6.60 m by author 6.15 m Estimated height of top container 1.0 m Estimated water level at the top of the tower + 32.1 m Estimated capacity of top container 1400 l Distance from tower no. 3 130 m Inclination of pipe 3.2%</p> |
|  <p>The plan shows a rectangular structure with a total width of 120 cm and a total height of 48 cm. It features several openings: a 30x13 cm opening on the north side, a 30x13 cm opening on the east side, and a 35x18 cm opening on the west side. The structure is connected to 'water tower No. 3' on the left and 'water tower No. 5' on the right. An arrow points upwards from the top of the structure to a 'water container on top of Stabian Baths'.</p> | <p>Cross-section: 120x120 cm Grooves: - north: 30x13 cm - east: 30x13 cm - south: none - west: 35x18 cm</p> |

Water tower no. 5.

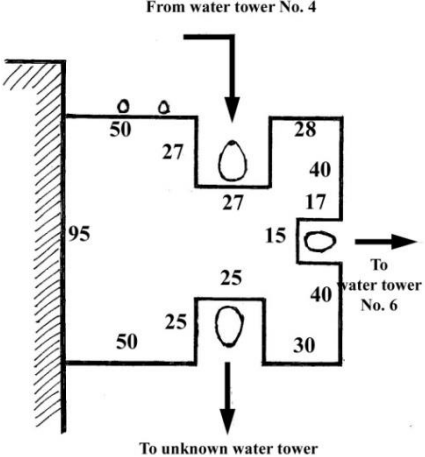
| | |
|---|--|
|  | <p>Location: I 6,1 on <i>Via dell'Abbondanza</i> at <i>Vicolo di Paquius Proculus</i></p> <p>Level at street + 25.6 m Level at base + 25.8 m</p> <p>Measured height: by Dybkjaer Larsen 4.20 m by author 3.33 m</p> <p>Estimated height of top container 0.8 m Estimated water level at the top of the tower + 29.7 m Estimated capacity of top container 1000 l Distance from tower no. 4 130 m Inclination of pipe -0.2 %</p> |
|  | <p>Cross-section: 105x95 cm</p> <p>Grooves:</p> <ul style="list-style-type: none"> - north: 27x27 cm - east: 15x17 cm - south: 25x25 cm - west: wall |

Water tower no. 6.

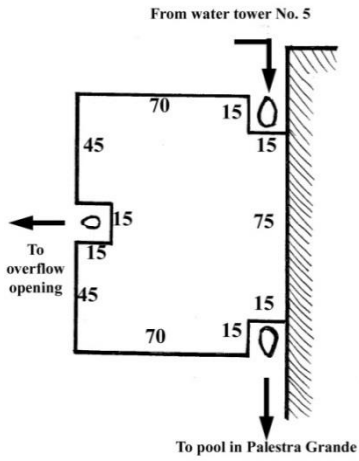
| | |
|--|---|
|  | <p>Location: II 2,1 on <i>Viadell'Abbondanza</i> at <i>Vicolo di Octavius Quartio</i> Level at street + 22.7 m Level at base + 22.9 m Measured height: by Dybkjaer Larsen 2.74 m by author 3.03 m Height of top container 0.56 m Estimated water level at the top of the tower + 26.5 m Estimated capacity of top container 300 l Distance from tower no. 5 240 m Inclination of pipe 0.1 %</p> |
|  | <p>Cross-section of water tower: 85x105 cm Top container: 65x65 cm Grooves: - north: 15x15 cm - east: wall - south: 15x15 cm - west: 15x15 cm</p> |

Water tower no. 7.

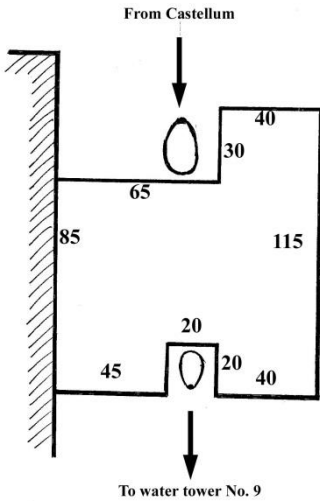
| | |
|--|---|
|  | <p>Location: VI 13,16 on <i>Vicolo di Mercurio</i> and <i>Vicolo dei Vettii</i> Level at street + 35.6 m Level at base + 35.6 m Measured height: by Dybkjaer Larsen 5.33 m by author (4.37 m) Estimated height of top container 1.0 m Estimated water level at the top of the tower + 41.9 m Estimated capacity of top container 1200 l Distance from <i>Castellum</i> 150 m Inclination of pipe 4.7 %</p> |
|  | <p>Cross-section: 105x115 cm Grooves: - north: 65x30 cm - east: none - south: 20x20 cm - west: wall</p> |

Water tower no. 8.

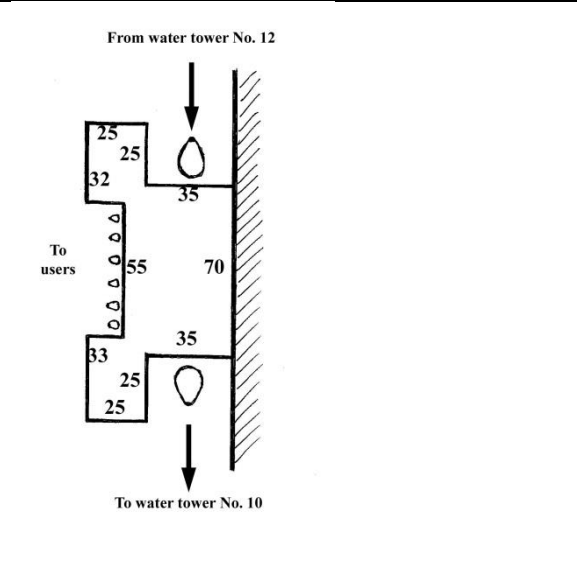
| | |
|---|---|
|  | <p>Location: VII 5,8 on the back side of the Forum Baths</p> <p>Level at street + 37.5 m</p> <p>Level at base + 37.5 m</p> <p>Measured height:</p> <ul style="list-style-type: none"> by Dybkjaer Larsen 3.00 m by author 2.83 m <p>Estimated height of top container 1.2 m</p> <p>Estimated water level at the top of the tower + 41.7 m</p> <p>Estimated capacity of top container 900 l + tank in the Forum Baths</p> <p>Distance from tower no. 12 110 m</p> <p>Inclination of pipe 2.5 %</p> |
|  | <p>Cross-section: 60x120 cm</p> <p>Grooves:</p> <ul style="list-style-type: none"> - north: 35x25 cm - east: wall - south: 35x25 cm - west: 55x13 cm |

Water tower no. 9.

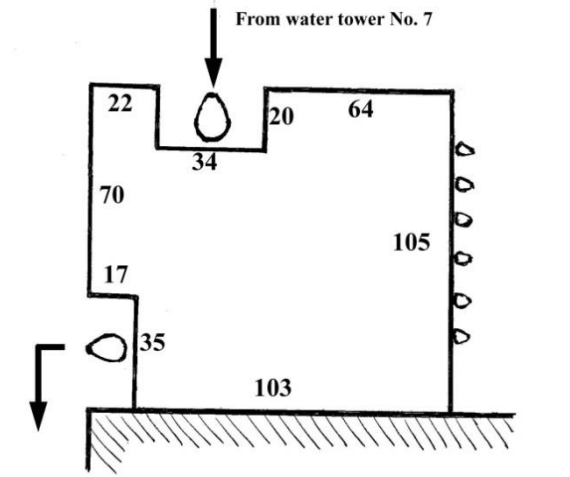
| | |
|--|--|
|  | <p>Location: VII 10,7 on <i>Via di Eumachia</i> at <i>Vicolo del Balcone Pensile</i></p> <p>Level at street + 32.2 m Level at base + 32.2 m</p> <p>Measured height: by Dybkjaer Larsen 6.30 m by author 6.02 m</p> <p>Estimated height of top container 1.0 m Estimated water level at the top of the tower + 39.2 m Estimated capacity of top container 1200 l Distance from tower no. 7 240 m Inclination of pipe 1.4 %</p> |
|  | <p>Cross-section: 120x105 cm</p> <p>Grooves:</p> <ul style="list-style-type: none"> - north: 34x20 cm - east: none - south: wall - west: 35x17 cm |

Water tower no. 10.

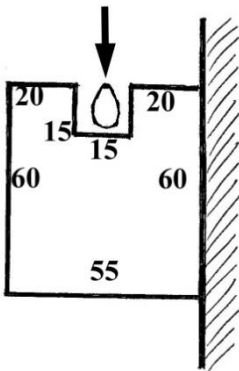
| | |
|---|--|
|  | <p>Location: VIII 1,2 behind the <i>Basilica</i></p> <p>Level at street + 32.9 m</p> <p>Level at base + 32.9 m</p> <p>Measured height:</p> <ul style="list-style-type: none"> by Dybkjaer Larsen 3.54 m by author (3.15 m) <p>Estimated height of top container 0.6 m</p> <p>Estimated water level at the top of the tower + 37.0 m</p> <p>Estimated capacity of top container 200 l</p> <p>Distance from tower no. 8 250 m</p> <p>Inclination of pipe 1.7 %</p> |
| <p>From water tower No. 8</p>  | <p>Cross-section: 55x60 cm</p> <p>Grooves:</p> <ul style="list-style-type: none"> - north: 15x15 cm - east: wall - south: ? - west: none |

Water tower no. 11.

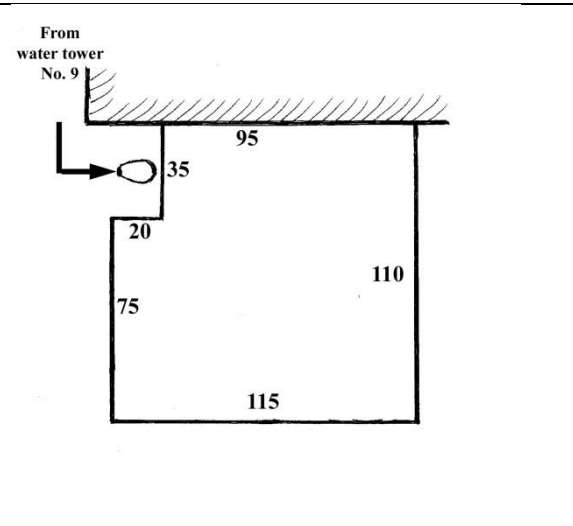
| | |
|--|---|
|  | <p>Location: VIII 5,3 on <i>Vicolo dei 12</i> at the corner of <i>Vicolo delle Pareti Rosse</i></p> <p>Level at street + 28.0 m</p> <p>Level at base + 28.0 m</p> <p>Measured height:</p> <p>by Dybkjaer Larsen 5.73 m</p> <p>by author 5.69 m</p> <p>Estimated height of top container 1.0 m</p> <p>Estimated water level at the top of the tower + 34.7 m</p> <p>Estimated capacity of top container 1200 l</p> <p>Distance from tower no. 9 140 m</p> <p>Inclination of pipe 3.0 %</p> |
|  | <p>Cross-section: 110x115 cm</p> <p>Grooves:</p> <ul style="list-style-type: none"> - north: wall - east: none - south: none - west: 35x20 cm |

Water tower no. 12.

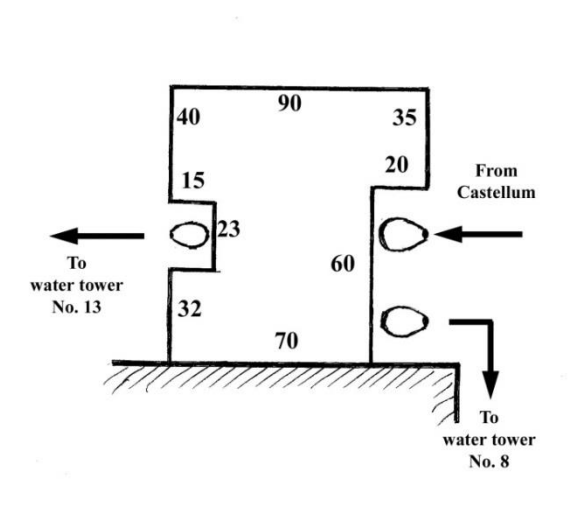
| | |
|--|--|
|  | <p>Location: VI 6,11 on <i>Vicolo di Mercurio</i> at <i>Vicolo della Fullonica</i> Level at street + 39.9 m Level at base + 39.9 m Measured height: by Dybkjaer Larsen - by author 1.63 m Estimated height of top container 0.8 m Estimated water level at the top of the tower + 42.3 m Estimated capacity of top container 700 l Distance from <i>Castellum</i> 300 m Inclination of pipe 0.9 %</p> |
|  | <p>Cross-section: 90x95 cm Grooves: - north: none - east: 60x20 cm - south: wall - west: 23x15 cm</p> |

Water tower no. 13.

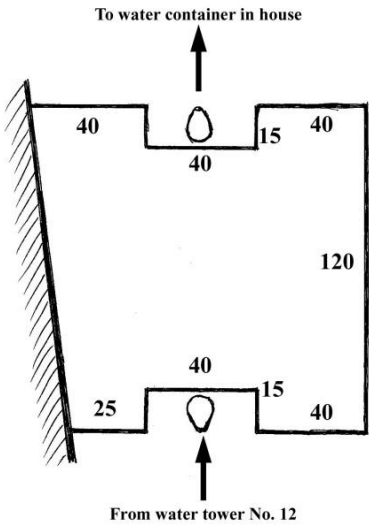
| | |
|---|--|
|  | <p>Location: VI 1,19 in connection with a deep well from antiquity Level at street + 39.8 m Level at base + 39.8 m Measured height: by Dybkjaer Larsen - by author 0.80 m Estimated height of top container 1.0 m Estimated water level at the top of the tower + 41.6 m Estimated capacity of top container 1000 l Distance from tower no. 12 120 m Inclination of pipe 0.1 %</p> |
|  | <p>Cross-section: 105x120 cm Grooves: - north: 40x15 cm - east: none - south: 40x15 cm - west: wall</p> |

Water tower no. 14.

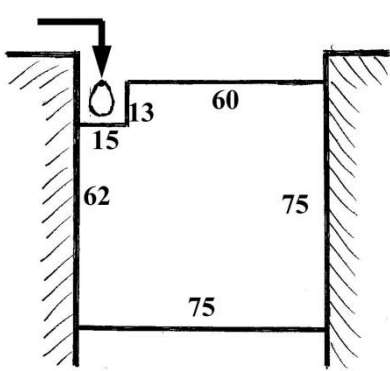
| | |
|---|---|
|  | <p>Location: IX 10,2 on the south side of <i>Via di Nola</i> between two buildings</p> <p>Level at street + 30.3 m</p> <p>Level at base + 30.3 m</p> <p>Measured height:</p> <ul style="list-style-type: none"> by Dybkjaer Larsen - by author 5.37 m <p>Estimated height of top container 0.6 m</p> <p>Estimated water level at the top of the tower + 36.3 m</p> <p>Estimated capacity of top container 300 l</p> <p>Distance from tower No. 1 350 m</p> <p>Inclination of pipe 1.3 %</p> |
| <p>From unknown water tower</p>  | <p>Cross-section: 75x75 cm</p> <p>Grooves:</p> <ul style="list-style-type: none"> - north: 15x13 cm - east: wall - south: ? - west: wall |

Appendix 3. List of Figures

1. Introduction

Figure 1.1 City plan of Pompeii with town gates, main streets and numbers of *insulae* in black and water towers in red. Drawing by author.

Figure 1.2. Location of *Castellum Aquae* and the fourteen water towers. Drawing by author.

Figure 1.3. Location of ditches along the streets. The 14 water towers are marked in red, the ditches in grey. Drawing by author.

Figure 1.4. Reconstruction of the main water pipelines. From Schmölder-Veit 2009, 122, Pl. 13. With the kind permission of Andrea Schmölder-Veit.

Figure 1.5. Location of street fountains. Drawing by author.

Figure 1.6. Location of public baths. The water towers are indicated in red, the baths in black. Drawing by author.

2. The main water system

Figure 2.1. North-west part of the city. Drawing by author.

Figure 2.2. South façade of *Castellum Aquae* with indications of levels for the three openings. The middle one slightly above and the left and right ones are on the same level. Photo and indication of levels by author.

Figure 2.3: Water-pipe connections at water tower No. 1 and No. 2. Drawing by author.

Figure 2.4. Location of fourteen water towers. Drawing by author.

Figure 2.5. Top container of water tower No. 6. Photo from Spinnazzola 1917, 255.

Figure 2.6: Pipe connections to users from top container of water tower No. 2. Drawing by author.

Figure 2.7: The beginning of the three water pipelines. Drawing by author.

Figure 2.8: The direction of the grooves in the water towers marked with red arrows. Drawing by author.

Figure 2.9: The western water pipe line. Drawing by author.

Figure 2.10: The central water pipe line. Drawing by author.

Figure 2.11: The eastern water pipe line. Drawing by author.

3. Water supply for public use

Figure 3.1. Location of street fountains and water towers. The towers are numbered 1-14 and in red, while the fountains are in black and numbered 1-42. Drawing by author.

Figure 3.2 a, b and c. Street fountains nos. 20, 21 and 27 with basins. Photos by author. The overflow outlet is clearly seen in 3.2 b, as is the outlet for cleansing at the bottom.

Figure 3.3 a, b and c. Street fountains nos. 11, 30 and 38 without basins. Photos by author.

Figure 3.4 a and b. Street fountains nos. 25 and 35 of special design. Photos by author.

Figure 3.5 a. Street fountains and excavation ditches in the north-western part of the city. The red rectangles represent the water towers, the black ones, the street fountains. The grey street markings indicate ditches full of *lapilli*. Drawing by author.

Figure 3.5 b. Street fountains with plausible pipe connections in the north-western part of the city indicating the heights of the towers in red and of fountains in black.. Drawing by author.

Figure 3.6 a. Street fountains and excavation ditches in the south-western part of the city. The red rectangles represent the water towers, the black ones, the street fountains. The grey street markings indicate ditches with *lapilli*. Drawing by author.

Figure 3.6 b. Street fountains with plausible pipe connections in the south-western part of the city showing the heights of the towers in red and of fountains in black.. Drawing by author.

Figure 3.7 a. Street fountains and excavation ditches in the central part of the city. The red rectangles represent the water towers, the black ones, the street fountains. The grey street markings indicate ditches with *lapilli*. Drawing by author.

Figure 3.7 b. Street fountains with plausible pipe connections in the central part of the city showing the heights of the towers in red and of fountains in black. Drawing by author.

Figure 3.8 a. Street fountains and excavation ditches in the south-eastern part of the city. The red rectangles represent the water towers, the black ones, the street fountains. The grey street markings indicate ditches with *lapilli*. Drawing by author.

Figure 3.8 b. Street fountains with plausible pipe connections in the south-eastern part of the city showing the heights of the towers in red and of fountains in black.. Drawing by author.

Figure 3.9. Plausible pipe connections to street fountains in the north-eastern part of the city. Drawing by author.

Figure 3.10. The Stabian Baths. Drawing with additions by author.

- Figure 3.11. Level of water storage tank in Stabian Baths. Drawing by author.
Figure 3.12. Stabian Baths – Storage tank and closest water towers. Drawing by author.
Figure 3.13. Stabian Baths – possible water-supply connections. Drawing by author.
Figure 3.14. The Forum Baths. Drawing with additions by author.
Figure 3.15. North-west corner of Forum Baths with hypothetical water storage-tank from well. Drawing by author.
Figure 3.16. North-west corner of Forum Baths with hypothetical water-storage tank from aqueduct. Drawing by author.
Figure 3.17. The Suburban Baths. Drawing with additions by author.
Figure 3.18. The Sarno Baths at street level. Drawing with additions by author.
Figure 3.19. The Sarno Baths at bath level, four levels downstairs. Drawing with additions by author.
Figure 3.20. Possible location of pipe connections to the Suburban Baths and the Sarno Baths. Water tower no. 10 in red. Drawing with additions by author.
Figure 3.21. The Central Baths. Drawing with additions by author.

4. Water supply for private use

- Figure 4.1. 63 houses connected to the water-supply system. Houses in black and water towers in red. Modified from H. Eschebach.
Figure 4.2. Copies of fountain sculptures in *Casa del Citarista*. Snake (Cat. 4898) and Boar with two dogs (Cat. 4899). Photos by author.
Figure 4.3. Water tower No. 2 close to users in V 1, VI 14, VII 3 and IX 4. Drawing by author.
Figure 4.4. Water inlets (and drains) to *insula* V 1. Drawing by Henrik Boman & Ezequiel Pinto Guillaume with additions by the author. Courtesy of the Swedish Pompeii Project.
Figure 4.5. Water inlets to *insula* VI 14. Drawing with additions by author.
Figure 4.6. Water inlets to *insula* VII 3. Drawing with additions by author.
Figure 4.7. Water connections from water tower No. 2. Drawing by author.
Figure 4.8. Forty-six workshops with large requirement of water. Modified from Eschebach.
Figure 4.9. Pipe connections to users from top container of water tower no. 9. Drawing by author.
Figure 4.10. Location of water tower no. 9 with a cluster of laundries. Red square is water tower no. 9. Drawing by author.
Figure 4.11. Water inlets to five laundries on *Via del Balcone pensile*. Laundries in grey. Drawing with additions by author.
Figure 4.12. Water connections from water tower no. 9. Drawing by author.

5. Discussion

Figure 5.1. Main water pipe fragment (left). A pear-shaped pipe fragment (centre). A pear-shaped pipe in opening according to author (right).

Figure 5.2. Principal layout of the main water system. Drawing by author.

6. Summary and conclusions

A reconstruction of the urban water infrastructure

Figure 6.1: The main water system with levels of top containers on the water towers and suggested position of main water pipelines and of possible other water towers (in grey) in the as yet unexcavated parts of the city. Drawing by author.

Figure 6.2. Plausible overall design of water supply system to street fountains. Probable pipe connections to street fountains marked by solid lines and plausible connections by dotted lines. Water towers in red. Drawing by author.

Appendix 4. Bibliography

Translations of ancient authors:

Frontin. *Aq.* Frontinus, Sextus Julius, *De aquae ductu urbis Romae*, translated to German, *Wasserversorgung im antiken Rom*, ed. by The Frontinus Society, München 1989

Vitr. *De Arch.* Vitruvius, *De architectura*, translated to Swedish, *Om arkitektur, tio böcker*, by Birgitta Dahlgren, Stockholm 1989.

Bibliography:

Adam 1984 Adam, Jean-Pierre, *La construction romaine. Matériaux et techniques*, Paris 1984.

Adam & Varène 2008 Adam, Jean-Pierre and Varène, Pierre, “La castellum aquae de Pompéi. Étude architecturale”, *Revue Archéologique* 2008-1, 37-72.

Andersson 1994 Andersson, Espen, “Urban water supply in Pompeii and the private water consumption” in *Actas XIV Congreso internacional de arqueología clásica*, ed. by X. Dupré Raventos, Tarragona 1993, 29-31.

Dessalle 2006 Desalle, Hélène, “Castella private: water towers and tanks in Roman dwellings” in *Cura Aquarum in Ephesus. Proceedings of the 12th international congress on the history of water management and hydraulic engineering in the Mediterranean Region. Ephesus/Selcuk, October 2-10, 2004*, ed. by G. Wiplinger, Leuven 2006, 363-370.

Dybkjaer Larsen 1982 Dybkjaer Larsen, Jens, “The water towers of Pompeii” in *Analecta Romana* 11, Köpenhamn 1982, 41-67.

H. Eschebach 1979 Eschebach, Hans, *Die Stabianer Thermen in Pompeji*, Berlin 1979.

H. Eschebach 1983 Eschebach, Hans, “Gebrauchswasserversorgung Pompejis” in *Journées d'études sur les aqueducs romains*, ed. by J.-P. Boucher, Paris 1983.

Richard Olsson

- H. Eschebach 1993 Eschebach, Hans, *Gebäudeverzeichnis und Stadtplan der antiken Stadt Pompeji*, published by Liselotte Eschebach, Köln, 1993.
- L. Eschebach 1996 Eschebach, Liselotte, “Wasserwirtschaft in Pompeji”, in *Cura Aquarum in Campania 1994*, ed. by Nathalie de Haan & Gemma Jansen, Leiden 1996, 1-12.
- H. Eschebach & Schäfer 1983 Eschebach, Hans & Schäfer, Thomas, “Die öffentlichen Laufbrunnen Pompejis. Katalog und Beschreibung”, in *Pompeii, Herculaneum, Stabiae I*, Pompeii 1983.
- Fagan 1999 Fagan, Garrett G., *Bathing in public in the Roman world*, Michigan 1999.
- Fahlbusch 1989 Fahlbusch, Henning, “Über Abflussmessung und Standardisierung bei den Wasserversorgungsanlagen Roms”, in *Frontinus Wasserversorgung im antiken Rom*, 129 – 144, ed. by The Frontinus Society, München 1989.
- Flohr 2006 Flohr, Miko, “Organizing the workshop. Water management in Roman *fullonicae*” in *Cura Aquarum in Ephesus. Proceedings of the 12th international congress on the history of water management and hydraulic engineering in the Mediterranean Region. Ephesus/Selcuk, October 2-10, 2004*, ed. by G. Wiplinger, Leuven 2006, 193-200.
- Flohr 2011 Flohr, Miko, “Reconsidering the atrium house; Domestic *fullonicae* at Pompeii”, in *Pompeii: art, industry and infrastructure*, ed. by Eric Poehler, Miko Flohr and Kevin Cole, Oxford 2011, 88-102.
- Flohr 2013 Flohr, Miko, *The world of the fullo: Work, economy and society in Roman Italy*, Oxford 2013.
- de Haan & Jansen 1996 de Haan, Nathalie & Jansen, Gemma, *Cura Aquarum in Campania*, Proceedings of the Ninth International Congress on the History of Water Management and Hydraulic Engineering in the Mediterranean Region, Leiden 1996.
- de Haan 1996 de Haan, Nathalie, “Die Wasserversorgung der Privatbäder in Pompeji”, in *Cura Aquarum in Campania 1994*, ed. by Nathalie de Haan & Gemma Jansen, Leiden 1996, 59-65.
- Richard Olsson

- de Haan 2001 de Haan, Nathalie, "Pompeian private baths and the use of water", in *Water Use and Hydraulics in the Roman City*, ed. by A. Koloski-Ostrow, Boston 2001, 41-49.
- de Haan 2010 de Haan, Nathalie, *Römische Privatbäder. Entwicklung, Struktur und sozialer Status*, Frankfurt 2010.
- de Haan & Wallat 2006 de Haan, Nathalie & Wallat, Kurt, 'The water supply of the Central Baths in Pompeii', in *Cura Aquarum in Ephesus. Proceedings of the 12th international congress on the history of water management and hydraulic engineering in the Mediterranean Region. Ephesus/Selcuk, October 2-10, 2004*, ed. by G. Wiplinger, Leuven 2006, 417-422.
- Heres 1992 Heres, Thea L., "The structures related to the water supply of Pompeii: building materials and chronology" in *Mededelingen 51-52*, Roma 1992-1993, 42-61.
- Hodge 1992 Hodge, Trevor, *Roman Aqueducts & Water Supply*, London 1992.
- Hodge 1996 Hodge, Trevor, "Anomalies in Flow at the Pompeji Castellum", in *Cura Aquarum in Campania 1994*, ed. by Nathalie de Haan & Gemma Jansen, Leiden 1996, 13-18.
- Jansen 1996 Jansen, Gemma, "Die Verteilung des Leitungswassers in den Häusern Pompejis", in *Cura Aquarum in Campania 1994*, ed. by Nathalie de Haan & Gemma Jansen, Leiden 1996, 47-50.
- Jansen 2001 Jansen, Gemma, "Water pipe systems in the Houses of Pompeji", in *Water Use and Hydraulics in the Roman City*, ed. by A. Koloski-Ostrow, Boston 2001, 27-40.
- Jansen 2002 Jansen, Gemma, *Water in de Romeinse stad. Pompeji, Herculaneum, Ostia*, Leuven 2002.
- Jansen 2007 Jansen, Gemma, "The water system" in *The world of Pompeii*, ed. by John J. Dobbins and Pedar W. Foss, New York 2007, 257-266.
- Jones & Robinson 2005 Jones, Rick and Robinson, Damian, "Water, Wealth and Social Status at Pompeii. The House of the Vestals in the First Century", *AJA*, 109, 2005, 695-710.
- Kapossy 1969 Kapossy, Balázs, *Brunnenfiguren der hellenistischen und römischen Zeit*, Zürich 1969.
- Richard Olsson

- Karivieri & Forsell 2007 Karivieri, Arja and Renée Forsell, *The House of Caecilius Iucundus, V 1, 22-27, Preliminary report* in *Opuscula Romana*, 2006-2007.
- Koloski-Ostrow 2007 Koloski-Ostrow, Ann Olga, "The city baths of Pompeii and Herculaneum" in *The world of Pompeii*, ed. by John J. Dobbins and Pedar W. Foss, New York 2007, 224-256.
- Kretzschmer 1960 Kretzschmer, Fritz, "Römische Wasserhähne" in *Jahrbuch der Schweizerischen Gesellschaft für Urgeschichte* 48, Zürich 1960.
- Leander Touati 2009 Leander Touati, Anne-Marie, "Water, well-being and social complexity in insula V 1. A Pompeian city block revisited", *Opuscula* 2010-3, Stockholm 2009, 105-161.
- Maiuri 1931 Maiuri, Amedeo, "Pozzi e condutture", in *Notizie degli Scavi*, Milano 1931, 546-576.
- Manderscheid 2000 Manderscheid, Hubertus, "Greek and Roman Baths" in *Handbook of water technology*, ed. by Örjan Wikander, Leiden 2000, 524-525.
- Nappo 1996 Nappo, Salvatore Ciro, "L'impianto idrico a Pompei nel 79 d.C. Nuovi dati", in *Cura Aquarum in Campania 1994*, ed. by Nathalie de Haan & Gemma Jansen, Leiden 1996, 37-45.
- Newsome 2009 Newsome, David J., "Traffic, space and legal change around the Casa del Marinario at Pompeii (VII 15, 1-2)" in *BABESCH* 84 (2009), 121-142.
- Nielsen 1990 Nielsen, Inge, *Thermae et Balnea. The architecture and cultural history of Roman public baths*, Aarhus 1990.
- Nishida 1991 Nishida, Y., "Measuring structures of Pompeii" in *Opuscula Pompeiana 1 (1991)*, 71-102.
- Ohlig 1996 Ohlig, Christoph, "Anmerkungen zum Funktionsmodell des Castellum Aquae im antiken Pompeji" in *Cura Aquarum in Campania 1994*, ed. by Nathalie de Haan & Gemma Jansen, Leiden 1996, 19-27.

- Ohlig 2001 Ohlig, Christoph, *De Aquis Pompeiorum. Das Castellum Aquae in Pompeji. Herkunft, Zuleitung and Verteilung des Wassers*, Nijmegen 2001.
- Ohlig 2002 Ohlig, Christoph, "Neue Fakten zur Wasserversorgung Pompejis" in *Nuove Ricerche Archeologiche a Pompei ed Ercolano*, ed. by Pietro Giovanni Guzzo & Maria Paola Guidobaldi, Neapel 2002, 278-294.
- Olesen 1984 Olesen, John Peter, *Greek and Roman Water-lifting Devices. The History of a Technology*, Toronto 1984.
- Olesen 1996 Olesen, John Peter, "Water-lifting devices at Herculaneum and Pompeii in the context of Roman Technology" in *Cura Aquarum in Campania 1994*, ed. by Nathalie de Haan & Gemma Jansen, Leiden 1996, 67-77.
- Overbeck & Mau 1884 Overbeck, J. & Mau, A., *Pompeii in seinen Gebäuden, Alterthürmen und Kunstwerken*, Leipzig 1884.
- Peleg 1996 Peleg, Jehuda, "Der Zweck und der Betrieb der Wassertürme vom Pompeji", in *Cura Aquarum in Campania 1994*, ed. by Nathalie de Haan & Gemma Jansen, Leiden 1996, 33-36.
- Pemp 1939 Pemp, Rudolf, *Drei Wasserhebewerke Pompejis*, Würzburg 1939.
- Pemp 1940 Pemp, Rudolf, *Drei Wasserhebewerke Pompejis*, Würzburg 1940.
- Schiöler 1973 Schiöler, Torkild, *Roman and Islamic Water-lifting Devices*, Odense 1973.
- Schmölder-Veit 2009 Schmölder-Veit, Andrea, *Brunnen in den Städten des westlichen Römischen Reiches, Palilia 19*, Wiesbaden 2009.
- Spinnazzola 1917 Spinnazzola, Vittorio, "Continuazione degli scavi in via dell'Abbondanza" in *Notizie degli Scavi*, Milano 1917, 247-264.
- Staub 2013 Staub, Thomas, *The Casa del Torello di Bronzo (V 1,7) in Pompeii*, Stockholm 2013.
- Staub Gierow 2008 Staub Gierow, Margareta, "Some results from the last year's field work in *Casa degli Epigrammi Greci (V I, 18.11-12)*" in *Nuove*
- Richard Olsson

ricerche archeologiche nell'area Vesuviana, ed. by Pietro Giovanni Guzzo och Maria Paola Guidobaldi, Rome 2008, 93-108.

- Wallat 1997 Wallat, Kurt, *Die Ostseite des Forums von Pompeji*, Frankfurt am Main 1997.
- Wiggers 1996 Wiggers, Jan, "The urban water supply system of Pompeji", in *Cura Aquarum in Campania 1994*, ed. by Nathalie de Haan & Gemma Jansen, Leiden 1996, 29-32.
- Wilson 2006 Wilson, Andrew, "Water for the Pompeians", *JRA* (19), 2006, 501-507.