



LUND UNIVERSITY

Small scale experiments and theoretical aspects of flame extinguishment with water mist

Andersson, Petra; Arvidson, Magnus; Holmstedt, Göran

1996

[Link to publication](#)

Citation for published version (APA):

Andersson, P., Arvidson, M., & Holmstedt, G. (1996). *Small scale experiments and theoretical aspects of flame extinguishment with water mist*. (LUTVDG/TVBB--3080--SE; Vol. 3080). [Publisher information missing].

Total number of authors:

3

General rights

Unless other specific re-use rights are stated the following general rights apply:

Copyright and moral rights for the publications made accessible in the public portal are retained by the authors and/or other copyright owners and it is a condition of accessing publications that users recognise and abide by the legal requirements associated with these rights.

- Users may download and print one copy of any publication from the public portal for the purpose of private study or research.
- You may not further distribute the material or use it for any profit-making activity or commercial gain
- You may freely distribute the URL identifying the publication in the public portal

Read more about Creative commons licenses: <https://creativecommons.org/licenses/>

Take down policy

If you believe that this document breaches copyright please contact us providing details, and we will remove access to the work immediately and investigate your claim.

LUND UNIVERSITY

PO Box 117
221 00 Lund
+46 46-222 00 00



Report 3080

Small scale experiments and theoretical aspects of flame extinguishment with water mist

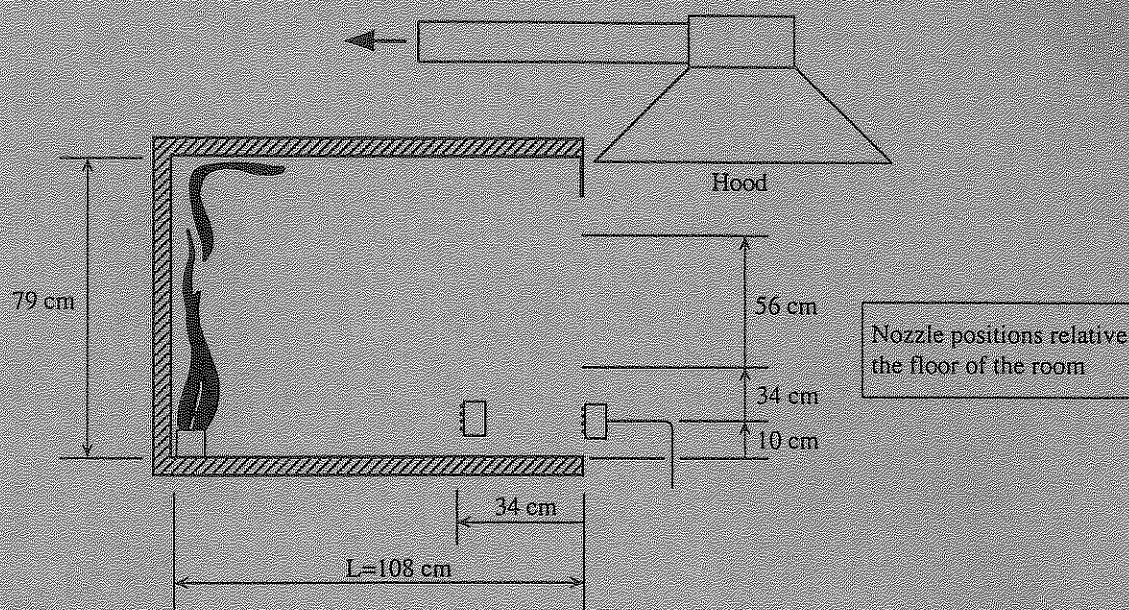

Petra Andersson
Magnus Arvidson*
Göran Holmstedt

* Swedish National Testing and Research Institute (SP), Department of Fire Technology

Research financed by the Swedish Fire Research Board (BRANDFORSK)

Lund, May 1996

ISSN 1102-8246

ISRN LUTVDG/TVBB--3080--SE

Keywords: water, water mist, extinction, experiments

Report financed by Brandforsk project No. 621-921, 610-922

© Copyright Institutionen för brandteknik
Lunds tekniska högskola, Lunds universitet, Lund 1996

Omslag: Magnus Arvidson

Layout: Maria Andersen

Illustrationer/Diagram: Petra Andersson, Magnus Arvidson, Göran Holmstedt et al

Department of Fire Safety Engineering · Lund Institute of Technology · Lund University

Adress/Address	Telefon/Telephone	Telefax	E-post/E-mail
Box 118 /John Ericssons väg 1 S-221 00 LUND	046 - 222 73 60 +46 46 222 73 60	046 - 222 46 12 +46 46 222 46 12	Petra.Andersson@brand.lth.se

Abstract

Small scale experiments and theoretical aspects of flame extinguishment with water mist

The present study focuses on extinction of flames with water mist where surface cooling effects are neglected i.e. water mist as a total flooding system where the direct spray cannot reach and cool all burning items in the protected volume.

The study includes a survey of the production and properties of water mist such as different types of nozzles and means to describe droplet size distribution. Properties of jets and sprays are discussed as well as water droplet movement, fall and evaporation.

Three different series of experiments were conducted with different hydraulic atomising nozzles. In the first series, droplet size distribution and water spray distribution measurements for the nozzles were conducted. The measurements showed that the droplet size distribution ranged from a Sauter Mean Diameter of approximately 35 - 85 μm , all dependent on the water pressure and the configuration of nozzles. The measurements show that considerably larger droplets are formed when individual nozzles are placed together. This can be explained by a coalescence effect when droplets from the sprays of the nozzles collide.

The second series of experiments were done using a tubular propane gas burner where water and propane were mixed prior to reaching the burner outlet. Based on the tests, the specific amount of extinguishing medium required (Required Extinguishing Medium Portion, $\text{REMP} = \dot{m}_e / \dot{m}_g$ i.e. the ratio of the agent quantity to fuel quantity consumed) is given as a quantitative measure of the efficiency of the agent. The lower the REMP value, the more efficient the agent. The water pressure ranged between 40 and 80 bar which provided for droplet sizes with a Sauter Mean Diameter in the order of 35 μm . The results show that the amount of water needed for extinguishment by weight is between 1,2 - 2,2 times the amount of propane gas. The decrease in droplet sizes decreased the amount of water needed. Another observation was that the heat release rate of the fire is not affected until extinction occurs. A REMP-value of 1,2 - 2,2 corresponds to a water content of 100 - 200 g/m^3 protected volume which is in agreement with theoretical values.

Finally, a series of tests were conducted in a 1/3 scale room using a propane gas fire. Parameters such as location of the fire, the location of the nozzle, water flow rate and the size of the room opening were varied. In these tests the water content needed was in close agreement with the values obtained from the REMP experiments and the theoretical values. These tests also highlighted the problem of delivering the droplets to the fire. To achieve "total flooding" in an actual situation, nozzles covering the complete protected compartment, with additional nozzles under obstructions would be needed. To make droplets follow the air flows inside a room and behave more like a gaseous total flooding agent, requires droplets of a size in the order of 1 - 20 μm .

Key words: Water, Water Mist, Extinction, Experiments

Table of Contents

	Abstract	1
	Small scale experiments and theoretical aspects of flame extinguishment with water mist	1
	Table of Contents	3
	Nomenclature	5
1	Introduction	9
1.1	Pool fires	10
1.2	Gas turbines	10
1.3	Enclosed spaces	10
1.4	Electrical equipment	11
1.5	Cabins and engine rooms on board ships	11
1.6	Conclusions	11
2	Water mist - production and properties	13
2.1	Different types of nozzles	13
2.2	Droplet sizes and their description	13
2.3	Properties of jets	16
2.4	Properties of sprays	17
2.4.1	Drag forces	19
2.4.2	Throw of sprays	20
2.4.3	Droplets falling in air	21
2.4.4	Evaporation	21
2.4.5	Droplets falling and evaporating	25
2.4.6	Density of water mist - air mixtures	26
3	Extinction of fires with water mist	29
3.1	Theory of extinction of hydrocarbon flames	29
4	Experiments	31
4.1	Droplet size and water distribution measurements	31
4.2	REMP experiments	34
4.2.1	Results from the REMP experiments	36
4.3	1/3 scale room tests	39
4.3.1	Experimental set-up	39
4.3.2	Test procedure	41
4.3.3	Test results and observations from the 1/3 scale room tests	41
4.3.4	Water content in the region of the flame	43
5	Discussion and suggestions for future work	45
	References	47
	Appendix A	
	Appendix B	
	Appendix C	
	Appendix D	

Nomenclature

A_d	Area of droplet exposed to drag forces, m^2
A_o	Orifice area, m^2
B	Mass transport number
b_D	Normalised mass fraction
b_T	Non-dimensional temperature
C_{iw}	Molar heat capacity of liquid water, J/mole
C_{gw}	Molar heat capacity of water vapour, J/mole
C_{gp}	Molar heat capacity of combustion products, J/mole
C_{eN_2}	Molar heat capacity of nitrogen, J/mole
C_d	Drag coefficient
C_g	Specific heat of gas, J/kg/K
C_l	Specific heat of liquid water, J/kg/K
C_o	Coefficient of discharge of nozzle
C_1	Constant
C_2	Constant
D_F	Diffusion coefficient
D_i	Droplet diameter, m
D_o	Initial droplet diameter, m
$D_{v0.5}$	Volume Mean Diameter, see also VMD
d_o	Orifice diameter, m or mm
F_d	Forces on the droplet, N
g	Acceleration due to gravity, m/s^2
G	Gravitational force, N
H	Pressure at nozzle, meter water
h	Heat transfer coefficient, $J/K/m^2/s$
h	The maximum height, m
K_g	Thermal conductivity of gas phase at the wall, $J/s/m/K$
L	Latent heat of vapourisation of water, J/kg

l	Distance from nozzle, m
l_0	Distance from nozzle where droplets starts to fall out, m
M_d	Mass of droplet, kg
\dot{m}	Mass flow rate, kg/s
Nu	Nusselt number
P	Pressure, Pa
Pr	Prandtl number
Q	Heat, J/kg
\dot{Q}	Volume flow rate, m ³ /s
R	Radius of droplet, m
R_n	Reaction force of nozzle, N
r	Radius of spray, m
Re	Reynolds number
SMD	Sauter Mean Diameter
T	Temperature
T_d	Droplet temperature, K
T_g	Gas temperature, K
T_R	Temperature inside droplet, K
T_r	Adjusted reference temperature, K
T_w	Droplet wall temperature, K
T_∞	Temperature far away from droplet, K
t	Time
\dot{V}	Volume flow rate, m ³ /s
v_a	Velocity of spray, m/s
v_c	Velocity of combustion products, m/s
v_{dot}	Water droplets total velocity relatively the gas flow, m/s
v_h	Water droplets horizontal velocity relatively the gas flow, m/s
v_n	Mean velocity after the nozzle, m/s

v_r	The velocity in the pipe (or hose) before the nozzle, m/s
v_v	Water droplets vertical velocity relatively the gas flow, m/s
v_y	Water droplets velocity in y direction in fixed coordinate system, m/s
v_x	Water droplets velocity in x direction in fixed coordinate system, m/s
v_z	Water droplets velocity in z direction in fixed coordinate system, m/s
VMD	Volume Mean Diameter
\dot{W}''	Mass flow rate per surface area out of droplet, kg/s/m ²
X_e	Mole fraction of water mist
X_f	Mole fraction of fuel
X_p	Mole fraction of combustion products
X_{N_2}	Mole fraction of nitrogen
X_{di}	Mole fraction of dissociation
x_i	number of droplets
Y	Mass fraction, kg/kg
Y_R	Mass fraction inside droplet
Y_∞	Mass fraction far away from the droplet
Y_w	Mass fraction at wall
α	Angle between droplets trajectory and horizontal plane
α_g	Thermal diffusivity, m ² /s
β	Angle between droplets trajectory and gas flow in the horizontal plane
ΔH_c	Heat of combustion, J/mole
ΔH_{di}	Heat of dissociation, J/mole
ρ	Density of spray, kg/m ³
ρ_d	Density of droplet, kg/m ³
ρ_g	Density of gas (=air), kg/m ³
ρ_s	Density of saturated steam, kg/m ³
μ	Dynamic viscosity

ν Viscosity, m^2/s

Θ Cone angle

Θ_j Angle of broadening of a turbulent jet

1 Introduction

Recent experimental and theoretical work on extinction of fires with fine water sprays indicate that water mist may have a wider application as an extinguishing agent than previously anticipated [1]. The phase out of Halon demands finding alternative means of active fire protection. This report focuses on the application of water mist as an active fire protection system in rooms i.e. total flooding system.

An immediate problem is the definition of mist. Lefebvre [2] uses the nomenclature given in figure 1 as a classification of different drop sizes and NFPA [3] proposes a nomenclature according to figure 2.

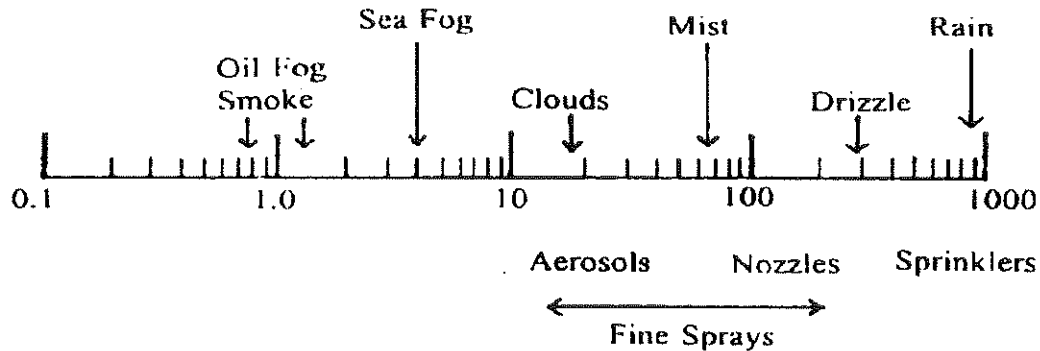

Figure 1 Examples of water divided in droplets of different diameters in μm [1].

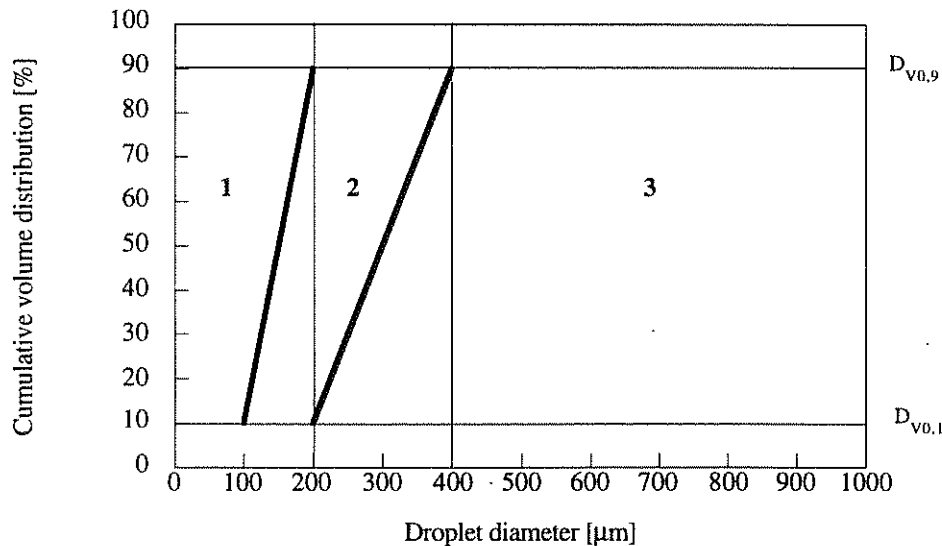

Figure 2 The definition and the division into different classes of water mist according to NFPA 750 [3].

In NFPA 750 the mist is divided into three classes; class 1, the cumulative distribution curve lies entirely to the left of a line connecting $Dv_{0.1} = 100 \mu\text{m}$ and $Dv_{0.9} = 200 \mu\text{m}$; class 2, a portion of the cumulative percent volume distribution curve lies beyond the limits of a class 1 spray, but entirely to the left of a line connecting $Dv_{0.1} = 200 \mu\text{m}$ and $Dv_{0.9} = 400 \mu\text{m}$; class 3, the $Dv_{0.9}$ is greater than $400 \mu\text{m}$ or for which any portion of the curve extends to the right of the class 2 cut-off line, but the $Dv_{0.99}$ is less than $1000 \mu\text{m}$.

The relationship between drop size distribution and extinguishing capacity of a water mist is complex. In general, class 1 and class 2 sprays are more efficient to extinguish flames (gas phase cooling) and class 3 sprays acts mainly by cooling the fuel surface. However, the drop size distribution of a spray does not uniquely define its suitability for a given application. Another important parameter is the distribution of the water mist, which is influenced by the momentum and the location of the spray, room geometry, obstructions in the room, fire induced flows, gravity differences, etc.

Recently, several experiments using fine spray systems against different fire scenarios have been published and a review is given in [1].

1.1 Pool fires

Mawhinney [4] studied extinction of liquid pool fires using a twin-fluid nozzle. The position of the nozzle relative to the flames was changed and the room had some obstructions which reduced the capacity to extinguish the fire. Martilla [5] studied extinction of a hidden liquid pool fire using a Marioff Hi-fog nozzle. Cousins [6] and Spring et al [7] studied extinction of pool fires in aeroplane cabins where only a limited number of nozzles close to the fire were activated. Leonard et al [8] showed in experiments with fires in containers on ships that fine mist cannot always prevent large scale fire spread.

1.2 Gas turbines

Gameiro [1] has studied extinction of pool and spray fires in the enclosure of a gas turbine with twin-fluid nozzles. Wighus et al [9] carried out tests in a full scale 70 m^3 model of a turbine hood using volume mean diameters between 166 and $219 \mu\text{m}$. Recently, Factory Mutual Research Corporation (FMRC) approved a water mist system for gas turbine protection.

1.3 Enclosed spaces

Martilla [5] has studied fires in computer rooms and in enclosed spaces resembling ticket booths, paint rooms and transformer rooms using the Marioff Hi-fog system and Cousins studied [6] extinction of wood fires in a 1 m^3 box. Tuomisaari [10] has carried out tests in a container using volume mean diameters between $100 - 200$ and $200 - 400 \mu\text{m}$.

1.4 Electrical equipment

Martilla [5] has also studied the Hi-fog system against fires involving electrical switchgear and Spring et al [7] have tested six twin-fluid nozzles variously positioned against fires in telecommunication switchgear cabinets and high-voltage power transformers (with both AC and DC voltage). Simpson [11] has presented a fully integrated water mist fire suppression system for telecommunications and other electronics cabinets. Recently, Factory Mutual Research Corporation (FMRC) approved a water mist system for the protection of some scenarios involving electronic equipment.

1.5 Cabins and engine rooms on board ships

In a research work at the Swedish National Testing and Research Institute [12] different spray and pool fires were suppressed by different water mist systems in an engine room type of scenario. In total more than 200 tests have been performed. Arvidson [13] has studied full scale fire tests with different mist nozzles in a 12 m² cabin. Their tests highlight the importance of the water distribution patterns, drop sizes and nozzle locations.

Recently, the International Maritime Organisation (IMO) published guidelines and test procedures for the installation of water mist systems in cabins/corridors and public spaces as well as engine rooms on board ships [14, 15].

1.6 Conclusions

As pointed out by Jones and Nolan [1] few coherent experimental programmes have been initiated for direct study of the extinguishing effectiveness of sprays of various qualities for a given fire scenario. The complex relationship between extinguishing capacity and drop size distribution, spray location, spray momentum, room geometry, obstructions in the room and fire induced flows makes it very difficult to make general design rules for water mist systems.

The present study is focused on extinction of flames with water mist where surface cooling effects are neglected e.g. water mist as a total flooding system where the direct spray cannot reach and cool all burning items in the protected volume. Special efforts have been made to give some answers to the following questions:

- What is the inerting concentration of water mist expressed as g/m³ protected volume and how does it change with drop size distribution? What is the extinguishing concentration of water mist against diffusion flames expressed as g/m³ protected volume and how does it change with drop size distribution?
- How do obstructions placed in the path of a spray reduce the sprays capacity to extinguish a fire? What influence has the drop size distribution and the spray momentum?
- Is it possible for finer elements in the spray to become entrained in the circulation patterns established by the fire gases? What influence has the drop size distribution and the spray momentum?
- Which major factors determine the transport of droplets to all parts of the room where burning takes place?

2 Water mist - production and properties

In the 1930's it was found that greater efficiencies in water application could be achieved if the hose streams that fire fighters used were changed to nozzles which broke the stream up into a wide spray or sprinkler-type pattern. This is attributed to the better heat absorption characteristics if the water is divided into droplets with a larger total area, exposed to the heat from a fire. However, a solid stream (or jet) would provide better range and penetration characteristics [16].

2.1 Different types of nozzles

There are many different ways to atomise water into small droplets, the ones common for fire suppression [17] are:

- Hydraulic atomising nozzles
- Pneumatic atomising nozzles
- Impingement atomising nozzles

The different approaches have of course advantages and disadvantages.

Hydraulic atomising nozzles generally require high pressures and small orifice sizes to be able to produce small water droplets. This is associated with specialised pumping equipment and distribution piping. The small orifice sizes make these nozzles very sensitive to clogging. In a swirl type nozzle, water under pressure is forced through an opening normally tangent to a whirl chamber. In the whirl chamber a decreasing diameter results in an increasing velocity. The water exits the nozzle with a horizontal velocity due to the rotational energy and vertical velocity due to the mass flow of the liquid stream [16]. Swirl nozzles normally give a hollow cone spray pattern. It is common to "fill" this hollow cone by placing an extra opening in the centre of the swirl plate [18].

Pneumatic atomising (or air-atomising) nozzles generally produce the smallest droplets. Air or other gases (N_2 is commonly used) are used to atomise the water. The orifice sizes are not as small as hydraulic atomising nozzles and work with low to moderate water and air pressures. However, the piping installation requires both water and air supply to each nozzle and if large areas are intended to be covered, the total air demand can be very high. Another name for these types of nozzles are dual fluid or twin fluid nozzles. Reduced water flow rate, increased air flow and air pressure contributes to smaller droplet sizes with this type of nozzle [19].

Impingement atomising nozzles use a deflector, either a single probe, plate or a specially shaped spiral, in front of the orifice. The water strikes the deflector and breaks up into a spray. This type of nozzle generally produces coarser sprays than the two other types described above. The type of nozzle is however very robust and the orifice size is not generally as small compared to hydraulic atomising nozzles.

2.2 Droplet sizes and their description

There are many terms currently used in the description of droplet sizes in water sprays. Care must therefore be exercised when comparing data on droplet sizes for a given spray, as the numerical value will differ all dependent on which convention has been chosen. Some common expressions [1, 19] used to describe an average droplet diameter are:

Arithmetic Mean. The arithmetic mean is a simple weighted average based on the diameters of all the individual droplets in the spray sample. The arithmetic mean can be expressed as:

$$\text{Arithmetic mean} = \frac{\sum x_i \cdot D_i}{\sum x_i} \quad (1)$$

Where x_i is the number of droplets having the diameter D_i .

Surface Mean. The surface mean is the diameter of a droplet whose surface area, if multiplied by the total number of droplets, will equal the total surface of all the droplets in the spray sample. The surface mean can be expressed as:

$$\text{Surface mean} = \left(\frac{\sum x_i \cdot D_i^2}{\sum x_i} \right)^{1/2} \quad (2)$$

Volume Mean. The volume mean is the diameter of a droplet whose volume, if multiplied by the number of droplets, will equal the total volume of the sample. The volume mean is often quoted VMD or $D_{v0.5}$ and can be expressed as:

$$\text{VMD} = \left(\frac{\sum x_i \cdot D_i^3}{\sum x_i} \right)^{1/3} \quad (3)$$

Sauter Mean Diameter. The Sauter mean, also more correctly called "volume-surface mean" is the diameter of a droplet whose ratio of volume to surface area is equal to that of the entire spray sample. The Sauter mean is often quoted D_{32} or SMD and can be expressed as:

$$\text{SMD} = \frac{\sum x_i \cdot D_i \cdot D_i^2}{\sum x_i \cdot D_i^2} \quad (4)$$

A complete plot of the droplet sizes is a better expression than the single values described above. It is possible for two sprays having, for example, the same volume mean diameter, to have widely differing ranges of droplet sizes.

The Rosin-Rammler empirical distribution [20] function is often used to describe the droplet size distribution. The function is given by the following equation:

$$P_v(D) = \frac{1,386 \cdot D}{D_v^2} \cdot e^{-0,693 \cdot D^2 / D_v^2} \quad (5)$$

$$\int_0^D P_v(D) dD = 1 - e^{-0,693 \cdot D^2 / D_v^2} \quad (6)$$

Where $P_v(D)$ is the probability frequency function for a droplet with the diameter D .

The figures below show both the measured and the predicted droplet size distribution and the cumulative distribution for the nozzle used in the test series described in Chapter 4.2.

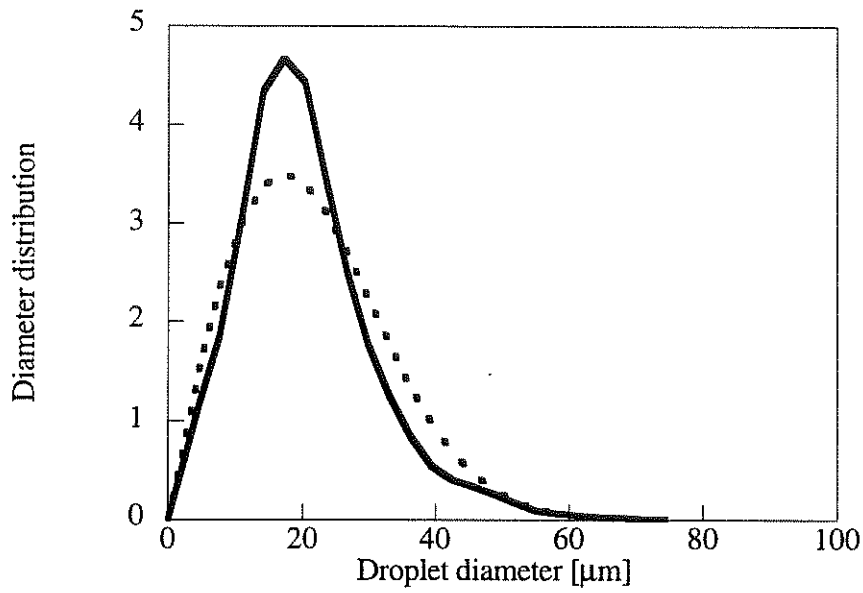

Figure 3 The droplet size distribution for the Lechler 212.085 nozzle at 80 bar and the predicted distribution using the Rosin-Rammler function (dotted line).

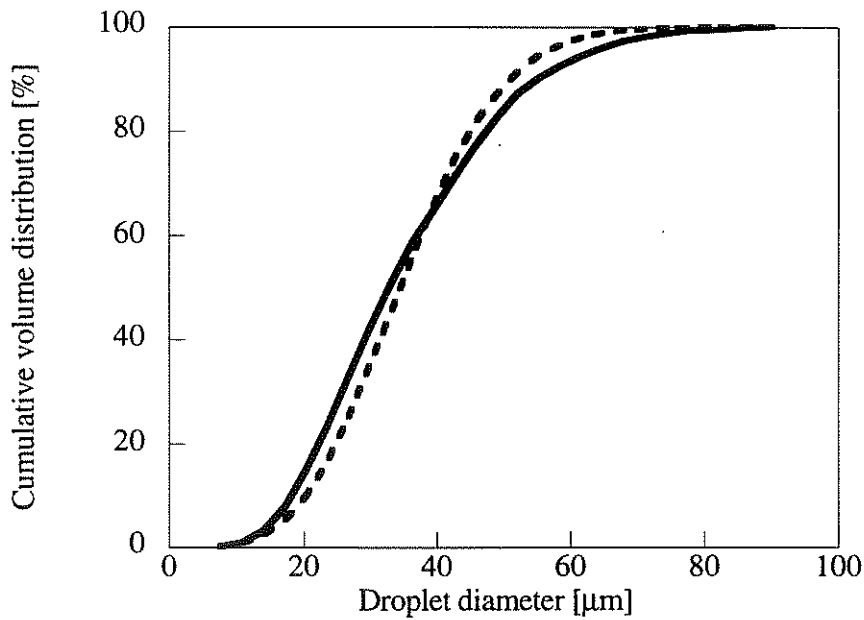

Figure 4 The cumulative droplet size distribution the Lechler 212.085 nozzle at 80 bar and the predicted distribution using the Rosin-Rammler function (dotted line).

For a given type of nozzle, the mean droplet size depends on the nozzle orifice diameter, the pressure and the spray pattern. Research by Factory Mutual [21, 18] indicates that the VMD is inversely proportional to the 1/3 power of pressure and directly proportional to the 2/3 power of the orifice diameter:

$$\text{VMD} \propto \frac{d_0^{2/3}}{P^{1/3}} \quad (7)$$

Where

d_0 = orifice diameter
 P = water pressure

However, the droplet size is also dependent on the spray pattern. An increase of the spray angle will contribute to smaller droplets, a decrease to larger [19, 18]. The explanation is due to coalescence of droplets as coarse droplets catch up and impinge upon small droplets as the density of the spray increases. The coalescence of droplets is also the reason [17] why the droplet size distribution measured very close to a nozzle is much finer than when measured at a longer distance from the nozzle. Interaction of a spray from one nozzle with the spray from another nozzle also results in agglomeration of droplets, when nozzles are installed in a system.

2.3 Properties of jets

The mean velocity, v_n , at a nozzle can be approximated [18] using the formula:

$$v_n = \sqrt{\frac{2\Delta P}{\rho} + v_r^2} \quad (8)$$

Where

v_n = the mean velocity after the nozzle, m/s
 ΔP = pressure drop across the nozzle, Pa
 ρ = the density of the liquid, kg/m³
 v_r = the velocity in the pipe (or hose) before the nozzle, m/s

Usually $v_r^2 \ll v_n^2$ and the formula can be approximated with:

$$v_n \approx \sqrt{\frac{2\Delta P}{\rho}} \quad (9)$$

The volume flow rate from a hydraulic nozzle can be determined using the following formula:

$$\dot{V} = C_o \cdot A_o \cdot \sqrt{\frac{2\Delta P}{\rho}} \quad (10)$$

Where

\dot{V} = the volume flow rate, m³/s
 C_o = coefficient of discharge of nozzle
 A_o = orifice area, m²

The mass flow, \dot{m} , can be calculated using the formula $\dot{m} = \rho \cdot \dot{Q}$ and the maximum reaction force, R_n , with the formula:

$$R_n = \dot{m} \cdot v_n = \rho \cdot \dot{V} \cdot v_n = C_o \cdot A_o \cdot 2\Delta P \quad (11)$$

Where

R_n = the reaction force, N
 \dot{m} = the mass flow rate, kg/s
 g = acceleration due to gravity, m/s²

The theoretical [18] maximum height a vertical jet can reach is given by the expression:

$$h = \frac{v_n^2}{2g} = \frac{\Delta P}{\rho \cdot g} \quad (12)$$

Where

h = maximum height, m

The maximum height in practice is however lower and can be approximated using the equation:

$$h = \frac{2}{3} \left(H - 0,113 \cdot \frac{H^2}{d_o} \right) \quad (13)$$

Where

H = nozzle pressure given as meter water
 d_o = orifice diameter, mm

The height is very dependent on whether the flow stays as a jet or breaks up in a spray.

2.4 Properties of sprays

The reaction forces of a spray are much less than the reaction forces of a corresponding jet of the same flow rate at the same pressure. This is due to the fact that in a spray parts of the liquid receives a velocity perpendicular to the spray direction. Thus the forward momentum is much less and the spray drops are quickly retarded due to drag forces so that they can be considered as droplets carried by a moving air stream. The expected airflow pattern around a spray is shown in figure 5, and in figure 6 an example of a spray pattern is shown [22]. Please note the early break up point.

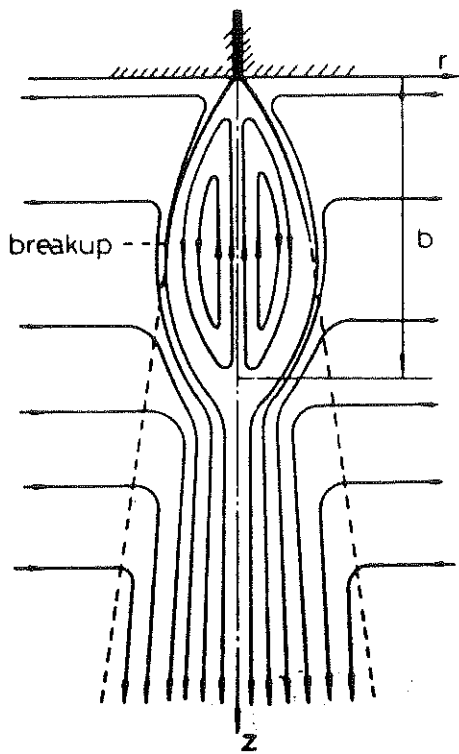

Figure 5 The expected air flow pattern around a water spray.

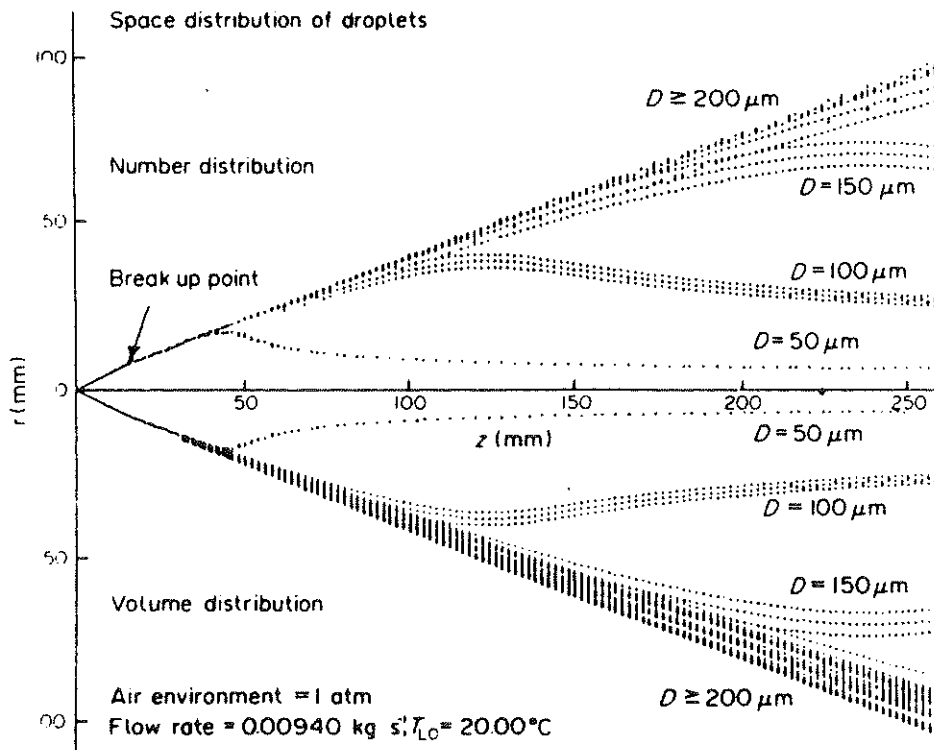

Figure 6 Example of a water spray pattern.

2.4.1 Drag forces

When a droplet travels through a flow of gas, the velocity will change due to gravitational and drag forces on the droplet. Assuming that the gravitational forces are directed in the negative z-direction and that the gas flows in the x-direction, the changes of velocities in the x, y and z directions are described by [23]:

$$\begin{aligned} \frac{dv_h}{dt} &= \frac{-F_d \cdot \cos \alpha}{M_d} \\ \frac{dv_v}{dt} &= g \frac{(\rho_d - \rho_g)}{\rho_d} - \frac{F_d \cdot \sin \alpha}{M_d} \end{aligned} \quad (14)$$

where V_h is the horizontal velocity relative to the gas velocity V_g and V_v is the vertical velocity relative to V_g , F_d is the force on the droplet, α is the angle between the droplets trajectory and the horizontal plane, M_d is the mass of the droplet, ρ_d is the density of the droplet, ρ_g is the density of the gas and g is the acceleration due to gravity. The force on the droplet is given by:

$$F_d \equiv \frac{1}{2} \rho_g v_{\text{dtot}}^2 C_d A_d \quad (15)$$

where V_{dtot} is the velocity of the droplet relative the gas and C_d is the drag coefficient. By introducing the angle β which is the angle between the droplet trajectory and the gas flow and using the definitions:

$$\begin{aligned} \cos \alpha &\equiv \frac{v_h}{v_{\text{dtot}}} \\ \sin \alpha &\equiv \frac{v_v}{v_{\text{dtot}}} \end{aligned} \quad (16)$$

and assuming that the droplet is spherical the equations can be rearranged into

$$\begin{aligned} \frac{dv_x}{dt} &= -\frac{3\rho_g C_d v_{\text{dtot}} v_h}{4\pi\rho_d D} \cos \beta \\ \frac{dv_y}{dt} &= -\frac{3\rho_g C_d v_{\text{dtot}} v_h}{4\pi\rho_d D} \sin \beta \\ \frac{dv_z}{dt} &= \frac{dv_v}{dt} \end{aligned} \quad (17)$$

where D is the diameter of the droplet and the total relative velocity is given by

$$v_{\text{dtot}} = \sqrt{(v_x - v_g)^2 + v_y^2 + v_z^2} \quad (18)$$

The drag coefficient C_d is given by

$$C_d = \frac{24}{\text{Re}} + 0.1935 \cdot \text{Re}^{0.3695} \quad (19)$$

where Re is the Reynolds number, that is the ratio between the inertia forces and the viscous forces, given by definition:

$$Re \equiv D \cdot v_{d\text{tot}} / \nu \quad (20)$$

which is calculated using an appropriate mixture viscosity ν calculated at an adjusted reference temperature T_r for taking the effects of the two phase mixture into account

$$T_r = T_d + (T_g - T_d) / 3 \quad (21)$$

2.4.2 Throw of sprays

At a certain distance from the nozzle the velocity of the droplets and the entrained air is so low that the droplets start to fall out. That distance can either be calculated using the above equations or by using a somewhat simpler approach looking at the conservation of momentum of the spray. Assume that the spray is circular with a radius r and velocity v_a , the mass flow through the nozzle is \dot{m} and the velocity in the nozzle is v . Then by conservation of momentum [18]:

$$\pi \cdot r^2 \cdot \rho \cdot v a^2 = \dot{m} \cdot v \quad (22)$$

but v is proportional to the square root of the pressure P and thus

$$v a \propto \sqrt{\dot{m} \cdot P^{0.5}} / r \quad (23)$$

However r is a function of the cone angle Θ and the distance l from the nozzle

$$r = l \cdot \tan((\Theta / 2 + \Theta_j / 2) / 2) \quad (24)$$

where Θ_j is the angle of broadening of a turbulent jet (approximately 11°) with Θ greater than 45° . Thus the radius can be approximated as

$$r = l \cdot \tan(\Theta / 4) \quad (25)$$

combining the equation for the velocity and for the radius gives us an expression for the distance there droplets fall out l_0

$$l_0 \propto \frac{\sqrt{\dot{m} \cdot P^{0.5}}}{\tan(\Theta / 4)} \quad (26)$$

2.4.3 Droplets falling in air

Water droplets fall in air due to the gravitational force G

$$G = m \cdot g = g \cdot \rho \cdot \pi \cdot D^3 / 6 \quad (27)$$

where m is the mass of the droplet, ρ is the density of the droplet and D the diameter. When falling they are slowed down by the frictional forces given by equation (15). Therefore the droplet reaches a certain falling velocity when the gravitational force equals the frictional force. This falling velocity v , at room temperature, can be approximated as [20]:

$$\begin{aligned} v &= 31 \cdot D^2 & 0 < D < 0.1 \text{ mm} \\ v &= 4 \cdot D & 0.1 < D < 1 \text{ mm} \\ v &\approx 4.6 \cdot \sqrt{D} & 1 < D < 4 \text{ mm} \end{aligned} \quad (28)$$

where D is in mm and v in m/s.

2.4.4 Evaporation

Water droplets moving through a hot gas will evaporate. The evaporation depends on the temperature, humidity and transport properties of the gas. Also the diameter, temperature and transport properties of the droplet has great influence on the evaporation process. In the model for evaporation of droplets described below no radiation is taken into account [24]. First of all we conclude that the heat Q required to transfer a unit mass into the free stream can be expressed as:

$$Q \equiv L + C_l(T_w - T_R) \quad (29)$$

Here L is the Latent heat of vaporisation, C_l is the specific heat of water, T_w is the droplet wall temperature and T_R is the temperature inside the droplet. Looking at the energy balance over the droplet-gas interface gives the following equation:

$$\dot{W}_w'' Q = K_g \left. \frac{dT}{dr} \right|_w \quad (30)$$

where \dot{W}_w'' is the mass flow rate per surface area out of the droplet, K_g is the thermal conductivity of the gas phase at the wall, using the definition of thermal diffusivity $\alpha_g = K_g / \rho_g / C_g$ we get:

$$\dot{W} = \rho_g \alpha_g \left. \frac{d}{dr} \left(\frac{C_g T}{Q} \right) \right|_w \quad (31)$$

where C_g is the specific heat of the gas. By introducing the non-dimensional temperature as:

$$b_T \equiv \frac{C_g (T - T_\infty)}{Q} \quad (32)$$

equation 31 transforms to:

$$\dot{W}_w'' = \rho_g \alpha_g \left. \frac{db_T}{dr} \right|_w \quad (33)$$

If we look at the mass conservation at the wall we get:

$$\begin{aligned} \dot{W}_w'' Y_R &= \dot{W}_w'' Y_w + (-\rho_g D_F \left. \frac{dY}{dr} \right|_w) \\ \dot{W}_w'' &= \rho_g D_F \left. \frac{d}{dr} \left(\frac{Y}{Y_w - Y_R} \right) \right|_w \end{aligned} \quad (34)$$

by defining the normalised mass fraction as:

$$b_D \equiv \left(\frac{Y - Y_\infty}{Y_w - Y_R} \right) \quad (35)$$

equation 34 reduces to:

$$\dot{W}_w'' = \rho_g D_F \left. \frac{db_D}{dr} \right|_w \quad (36)$$

Writing the conservation equations for energy and mass in spherical co-ordinates,

$$\frac{d}{dr} (K_g 4\pi r^2 \frac{dT}{dr}) - \frac{d}{dr} ([\dot{W}_w'' 4\pi r^2] C_g T) = 0 \quad (37)$$

$$\frac{d}{dr} (\rho_g D_F 4\pi r^2 \frac{dY}{dr}) - \frac{d}{dr} ([\dot{W}_w'' 4\pi r^2] Y) = 0$$

dividing the energy equation with Q and the mass equation with $(Y_w - Y_R)$ gives us

$$\rho_g \alpha_g \frac{d}{dr} (r^2 \frac{db_T}{dr}) - [\dot{W}_w'' R^2] \frac{db_T}{dr} = 0 \quad (38)$$

$$\rho_g D_F \frac{d}{dr} (r^2 \frac{db_D}{dr}) - [\dot{W}_w'' R^2] \frac{db_D}{dr} = 0$$

the boundary conditions are given by equations (34) and (36) and in the stream $b_T = b_D = 0$. By assuming that the Lewis number equals one i.e. $\alpha_g = D_F$ the equations are easily solved.

$$\dot{W}_w'' = \frac{\rho_g \alpha_g}{R} \ln(b_\infty - b_w + 1) \quad (39)$$

The heat flux across a boundary layer is expressed in the following equation:

$$q \equiv h(T_\infty - T_w) \equiv K_g (T_\infty - T_w) / R \quad (40)$$

Using this in equation (39) and defining the mass transport number B as $b_{\infty} - b_w$ we get:

$$\dot{W}_w = \frac{h}{C_g} \ln(B+1) \quad (41)$$

when the surrounding gas temperature is much larger than the boiling temperature the B number equals B_T :

$$B_T \approx \frac{C_g(T_{\infty} - T_B)}{L + C_l(T_B - T_R)} \quad (42)$$

and when the surrounding gas temperature is much smaller than the boiling temperature B equals B_D

$$B_D \approx \frac{Y_{\infty} - Y(T_{\infty})}{Y(T_{\infty}) - Y_R} \quad (43)$$

For small droplets and natural convection the lifetime of the droplet is derived as

$$t_{life} = \frac{\rho_l D_0^2}{8\rho_g \alpha_g \ln(B+1)} \quad (44)$$

The heat transfer coefficient for a solid sphere can be expressed as:

$$\frac{hD}{K_g} \equiv Nu = \frac{1}{1 + 0.4\beta/L} \cdot (2.0 + 0.6\left(\frac{c\mu}{K_g}\right)^{0.33} \left(\frac{VD\rho_s}{\mu}\right)^{0.5}) = 2 + 0.6 \cdot Pr^{0.33} \cdot Re^{0.5} \quad (45)$$

where D is the droplet diameter, β is the enthalpy increase per unit mass of vapour between surface temperature and surrounding gas/flame temperature (negligible), λ is the latent heat of vaporisation, c is specific heat at constant pressure, μ is the viscosity of the saturated steam, V is the droplet velocity relative to the gas and ρ_s is the density of the saturated steam. For small droplets (<0,1 mm) the velocity is so low that the Nusselt number ($=hD/K_g$) equals 2. For large droplets the forced convection is the dominating factor and the Nusselt number can be approximated as

$$Nu = 0.6 \cdot Pr^{0.33} \cdot Re^{0.5} \quad (46)$$

Now the Prandtl number Pr is a constant so that the Nusselt number becomes:

$$Nu = C_1 \cdot \sqrt{v \cdot D} \quad (47)$$

$$C_1 = 0.6 \cdot Pr^{0.33} \cdot \sqrt{\rho/\mu}$$

If we assume that all heat going into the droplet is used to evaporate the water we get the following differential equation:

$$\dot{q} = -\frac{L \cdot \rho}{A} \cdot \frac{dVol}{dt} = -\frac{L \cdot \rho}{4\pi(D/2)^2} \cdot 4\pi \cdot (D/2)^2 \cdot \frac{1}{2} \frac{dD}{dt} \quad (48)$$

rearranging (48) gives us the change in diameter

$$\frac{dD}{dt} = -\frac{2h}{L\rho} \Delta T \quad (49)$$

For the small droplets (<0,1 mm) we obtain

$$\begin{aligned} \frac{dD}{dt} &= -\frac{4K_g \Delta T}{L\rho D} \\ DdD &= \frac{-4K_g \Delta T}{L\rho} dt \end{aligned} \quad (50)$$

integrating from diameter D_0 at time $t=0$ to diameter D at time t gives:

$$\begin{aligned} \int_{D_0}^D DdD &= -\frac{4K_g \Delta T}{L\rho} \int_0^t dt \Rightarrow \\ D^2 &= D_0^2 - \frac{8K_g \Delta T}{L\rho} t \end{aligned} \quad (51)$$

The time it takes to completely evaporate the droplet is given by:

$$t_{\text{life}} = \frac{D_0^2 L\rho}{8K_g \Delta T} \quad (52)$$

This expression can also be obtained from equation (44) by using of Taylor series expansion.

For the larger droplets (>0,5 mm) we get:

$$\frac{dD}{dt} = -\frac{2K_g}{L\rho D} \cdot C_1 \sqrt{vD} \cdot \Delta T \quad (53)$$

For droplets in the range 0,1 - 1 mm the velocity is $4 \cdot 10^3 \cdot D$ why equation 53 becomes

$$\frac{dD}{dt} = \frac{-2K_g \Delta T}{L\rho D} \cdot C_1 \sqrt{4000 \cdot D \cdot D} = \frac{-2K_g C_2 \Delta T}{L\rho} \quad (54)$$

$$C_2 = 2C_1 \cdot \sqrt{1000}$$

and the diameter as a function of time becomes

$$D = D_0 - \frac{2K_g C_2 \Delta T}{L\rho} t \quad (55)$$

and the lifetime

$$t_{\text{life}} = \frac{D_0 L\rho}{2K_g \Delta T C_2} \quad (56)$$

Table 1 shows some typical lifetimes of droplets, assuming that K_g equals 0,1 over the temperature interval and that C_1 equals 120.

Table 1 Typical lifetimes of droplets of different sizes at different temperatures.

T_g [°C]	D_0 [μm]					
	1	10	50	100	500	1000
400	9,4 μs	0,94 ms	24 ms	94 ms	2,5 s	5,0 s
600	5,6 μs	0,56 ms	14 ms	56 ms	1,5 s	3,0 s
800	4,0 μs	0,40 ms	10 ms	40 ms	1,1 s	2,1 s
1000	3,1 μs	0,31 ms	7,8 ms	31 ms	0,8 s	1,7 s

2.4.5 Droplets falling and evaporating

In a fire scenario droplets often are moving down through an upward plume, thus the distance the droplet moves relative to a fix co-ordinate system is given by

$$\frac{dx}{dt} = v - v_c \quad (57)$$

where x is the distance travelled, v is the droplet velocity and v_c the velocity of the combustion products.

For small droplets <0,1 mm using equations (51) and (28) and putting them into equation (57) and integrating gives

$$x = \int_0^t 31 \cdot 10^6 \cdot \left(D_0^2 - \frac{8K_g \Delta T}{L\rho} t \right) - v_c dt \quad (58)$$

$$x = 31 \cdot 10^6 \cdot \left(D_0^2 t - \frac{8K_g \Delta T}{L\rho} \cdot \frac{t^2}{2} \right) - v_c t$$

Setting v_c to 0 gives the maximum distance travelled by the droplet, X_{fall} , by using the expression for t_{life} from equation (44)

$$x_{\text{fall}} = 31 \cdot 10^6 / 2 \cdot \frac{D_0^4 L \rho}{8 K_g \Delta T} \quad (59)$$

For larger droplets (>0,5 mm) we get using equations (28) and (55)

$$x = \int_0^t (4000(D_0 - \frac{2K_g C_2 \Delta T}{L\rho} t) - v_c) dt \quad (60)$$

$$x = 4000(D_0 t - \frac{2K_g C_2 \Delta T}{L\rho} \cdot \frac{t^2}{2}) - v_c t$$

assuming $v_c=0$ and putting equation (56) into (60) gives the maximum distance

$$X_{\text{fall}} = 2000 \cdot \frac{D_0^2 L \rho}{2 K_g \Delta T C_2} \quad (61)$$

In table 2 some typical falling distances are given.

Table 2 Typical falling distances for droplets of different sizes at different temperatures

T_g [°C]	D_0 [μm]					
	1	10	50	100	500	1000
400	0,15 nm	1,5 μm	0,91 mm	15 mm	2,5 m	9,9 m
600	88 pm	0,88 μm	0,55 mm	8,7 mm	1,5 m	6,0 m
800	63 pm	0,63 μm	0,39 mm	6,3 mm	1,1 m	4,3 m
1000	49 pm	0,49 μm	0,30 mm	4,9 mm	0,8 m	3,3 m

2.4.6 Density of water mist - air mixtures

When water mist is distributed in the air, the density of the mixture will depend on the amount of water in gas and liquid phase. Since water in vapour phase is lighter than air and water in liquid phase is denser, the air mixture can be either lighter or denser than air dependent on how much water is evaporated and how much is mist. In figure 7, the density difference between dry air and water saturated air at the same temperature (solid line) and the density difference between dry air at 20°C and water saturated air (dotted line) are given as a function of temperature. In order to get a water/air mixture with neutral density this difference must be compensated for with water mist.

For droplets in the range 0,1 - 1 mm the velocity is $4 \cdot 10^3 \cdot D$ why equation 53 becomes

$$\frac{dD}{dt} = \frac{-2K_g \Delta T}{L\rho D} \cdot C_1 \sqrt{4000 \cdot D \cdot D} = \frac{-2K_g C_2 \Delta T}{L\rho} \quad (54)$$

$$C_2 = 2C_1 \cdot \sqrt{1000}$$

and the diameter as a function of time becomes

$$D = D_0 - \frac{2K_g C_2 \Delta T}{L\rho} t \quad (55)$$

and the lifetime

$$t_{life} = \frac{D_0 L\rho}{2K_g \Delta T C_2} \quad (56)$$

Table 1 shows some typical lifetimes of droplets, assuming that K_g equals 0,1 over the temperature interval and that C_1 equals 120

Table 1 Typical lifetimes of droplets of different sizes at different temperatures.

T_g [°C]	D_0 [μm]					
	1	10	50	100	500	1000
400	9,4 μs	0,94 ms	24 ms	94 ms	2,5 s	5,0 s
600	5,6 μs	0,56 ms	14 ms	56 ms	1,5 s	3,0 s
800	4,0 μs	0,40 ms	10 ms	40 ms	1,1 s	2,1 s
1000	3,1 μs	0,31 ms	7,8 ms	31 ms	0,8 s	1,7 s

2.4.5 Droplets falling and evaporating

In a fire scenario droplets often are moving down through an upward plume, thus the distance the droplet moves relative to a fix co-ordinate system is given by

$$\frac{dx}{dt} = v - v_c \quad (57)$$

where x is the distance travelled, v is the droplet velocity and v_c the velocity of the combustion products.

For small droplets <0,1 mm using equations (51) and (28) and putting them into equation (57) and integrating gives

$$x = \int_0^t 0,31 \cdot 10^6 \cdot \left(D_0^2 - \frac{8K_g \Delta T}{L\rho} t \right) - v_c dt \quad (58)$$

$$x = 0,31 \cdot 10^6 \cdot \left(D_0^2 t - \frac{8K_g \Delta T}{L\rho} \cdot \frac{t^2}{2} \right) - v_c t$$

Setting v_c to 0 gives the maximum distance travelled by the droplet, X_{fall} , by using the expression for t_{life} from equation (44)

$$x_{\text{fall}} = 0.31 \cdot 10^6 / 2 \cdot \frac{D_0^4 L \rho}{8 K_g \Delta T} \quad (59)$$

For larger droplets (>0,5 mm) we get using equations (28) and (55)

$$x = \int_0^t (4000(D_0 - \frac{2K_g C_2 \Delta T}{L \rho} t) - v_c) dt \quad (60)$$

$$x = 4000(D_0 t - \frac{2K_g C_2 \Delta T}{L \rho} \cdot \frac{t^2}{2}) - v_c t$$

assuming $v_c=0$ and putting equation (56) into (60) gives the maximum distance

$$X_{\text{fall}} = 2000 \cdot \frac{D_0^2 L \rho}{2 K_g \Delta T C_2} \quad (61)$$

In table 2 some typical falling distances are given.

Table 2 Typical falling distances for droplets of different sizes at different temperatures

T_g [°C]	D_0 [μm]					
	1	10	50	100	500	1000
400	1,5 pm	15 nm	9,1 μm	146 μm	2,5 m	9,9 m
600	0,88 pm	9 nm	5,5 μm	87 μm	1,5 m	6,0 m
800	0,63 pm	6 nm	3,9 μm	63 μm	1,1 m	4,3 m
1000	0,49 pm	5 nm	3,0 μm	49 μm	0,8 m	3,3 m

2.4.6 Density of water mist - air mixtures

When water mist is distributed in the air, the density of the mixture will depend on the amount of water in gas and liquid phase. Since water in vapour phase is lighter than air and water in liquid phase is denser, the air mixture can be either lighter or denser than air dependent on how much water is evaporated and how much is mist. In figure 7, the density difference between dry air and water saturated air at the same temperature (solid line) and the density difference between dry air at 20°C and water saturated air (dotted line) are given as a function of temperature. In order to get a water/air mixture with neutral density this difference must be compensated for with water mist.

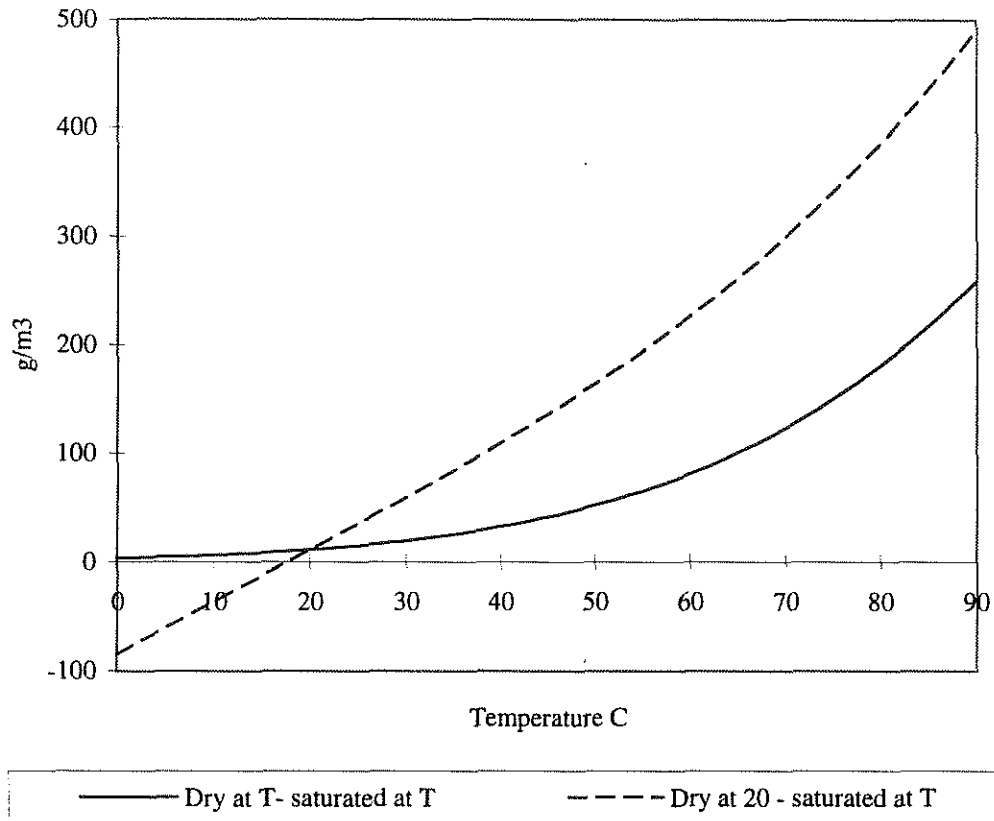

Figure 7 Density difference between dry air at 20°C and water saturated air (dotted line) and the density difference between dry air at 20°C and water saturated air (dotted line) given as a function of temperature.

3 Extinction of fires with water mist

Extinction of a fire occurs when the combustion process is brought to certain limits of combustion by some agent. At the limit, the rate of reactions is reduced below a certain minimum rate needed to sustain the process. This is usually dictated by heat loss phenomena but it may also be governed by loss of active radicals. In general the thermal load needed to extinguish a diffusion flame (total flooding scenario) is less than that needed for extinction of a premixed flame due to greater heat losses from the diffusion flame. However, when the flame is large i.e. greater than a few meters in diameter, experience indicates that the thermal load needed is approximately the same as required for a premixed flame. The diffusion flame may be considered as a narrow zone where the fuel and air mix to produce mixtures within the flammability limits.

There are two extreme possibilities for a water spray to extinguish a fire; either by extinction of the flame or by cooling the fuel surface. In the experiments described below, the fuel is already gaseous and fed by a tube into the combustion volume. There is no energy feedback from the flames which affects the fuel flow, i.e. direct cooling of the surface by water or radiation blocking effects are not considered in the experiments. This scenario corresponds approximately to a situation where the water droplets from the spray nozzle cannot directly impinge and wet or cool the fuel surface.

The most common methodology for measuring the efficiency of different extinguishing agents against diffusion flames is to use a laboratory cup burner. However, the results from cup burner tests depend on many variables and the results are in most cases difficult to translate to real fire situations. It was anticipated that the introduction of the gas burner test would overcome these problems as the scale easily could be increased and quantitative results could be achieved. The method was originally developed by NBS for studying [25] water spray extinction on large jet flames. Later the method has been developed to a Nordtest method, NTFIRE 044 [26] to study extinction of buoyant flames.

3.1 Theory of extinction of hydrocarbon flames

Flame extinguishing mechanisms are effectively explained by thermal quenching concepts and a flame heat balance [18, 27]. The form of heat balance used for quantitative calculations of extinction concentrations applied to water mist is given by (the equation only considers direct cooling of the flame by water mist):

$$X_e(L + \int_{T_0}^{373} C_{lw} dT + \int_{373}^{1550} C_{gw} dT) = X_f \Delta H_c - \sum X_p \int_{T_0}^{1550} C_{gp} dT - X_{N_2} \int_{T_0}^{1550} C_{gN_2} dT - \sum X_{di} \Delta H_{di} \quad (62)$$

Here X represents the mole fraction of, e = water mist, f = fuel, p = combustion products, N₂ = nitrogen and di = dissociation. C represents the molar heat capacity for lw = liquid water, gw = water vapour, gp = combustion products and gN₂ = nitrogen, respectively. ΔH_c = heat of combustion and ΔH_{di} = heat of dissociation and L is the latent heat of vaporisation of water. The left side of the equation includes all the heat sinks contributed by the extinguishing water. The right hand side represents the theoretical excess heat which must be removed from the same adiabatic flame to reduce its temperature to a limit below which the flame cannot propagate usually in the order of 40% of X_f ΔH_c. The equation is based on the assumption that the temperature of diffusion flames is adiabatic and that the fuel and oxygen diffuse into the flames at stoichiometric rates. Radiation and other heat losses are neglected.

These effects are accounted for by increasing the adiabatic flame temperature at the limit to fit the experiments. Considering water mist as an extinguishing agent which evaporates completely, approximately 50% of the heat sink effect comes from evaporation of water and 50% from heating the gaseous water vapour. With this formula assuming a limit adiabatic flame temperature of 1550 K, the inerting concentration of water mist for premixed stoichiometric propane-air mixtures can be calculated to be approximately 280 g per cubic meter room volume. Usually, there is a difference between the demand of extinguishing media for diffusion flames compared to premixed flames by a factor of two i.e. a diffusion flame would require about 140 - 170 g water mist per cubic meter room volume. If instead water vapour of 100 K is used, the water demand is approximately doubled. The figures given above are under the assumption that the water mist is completely evaporated and that the vapour is heated to the adiabatic flame temperature.

As a summary, the major factors which determine the ability of a water spray to extinguish a diffusion flame are:

- abstraction of heat per unit volume (pure thermal phenomenon)
- the transport of droplets to all parts of the room where the burning is taking place

Both factors are to a large extent depending on the spray properties, especially on the drop size distribution and its ability to distribute and maintain a high water content in the whole volume of the fire room.

4 Experiments

Three different types of experiments were conducted and in all the experiments the Lechler nozzle 212.085 was used. Firstly, the droplet size and water distribution was measured using different pressures and different nozzle configurations in a nozzle body. In the second series of experiments, tubular burner tests were conducted to determine the efficiency of water mist and in the third series of experiments, a propane fire in a 1/3 scale room was used.

4.1 Droplet size and water distribution measurements

For the experimental work, a nozzle denoted 212.085, manufactured by Lechler International GmbH was used. The narrowest cross section of the nozzle is 0,25 mm. In the first test series, where REMP values were determined, a single nozzle was used. For the second test series, which was conducted in a 1/3 scale room, either 8 or 12 nozzles of the 212.085 type were combined in a multiple nozzle body. The nozzle body is shown in figure 8.

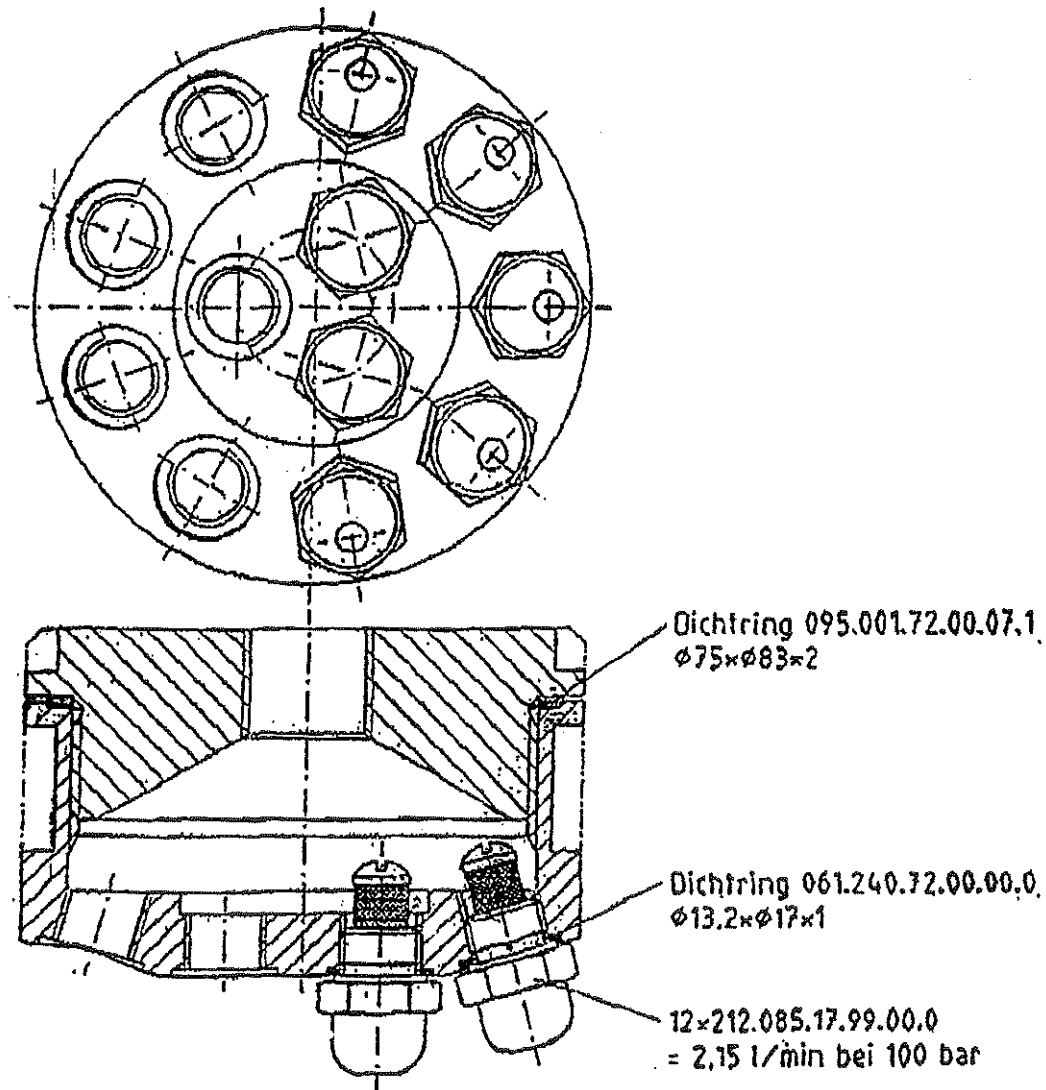

Figure 8 The nozzle body used in the 1/3 scale room experiments

The droplet size distribution was measured by Lechler using an Aerometrics Laser-Phase-Doppler-Analyser, both for the single nozzle and for the multiple nozzle configuration. The accuracy of the equipment is approximately $\pm 10\%$ for the Sauter Mean Diameter. The measurements were conducted with the nozzles directed downward, at different pressures and at different positions in the spray. For the single nozzle, the measurements were conducted in a point on the centric axis of the spray at a distance of 250 mm from the tip, at 40, 60 and 80 bar, respectively. For the multiple nozzle configuration, most of the measurements were done a point on the centric axis of the spray at a distance of 1000 mm from the tips of the nozzles. Additionally, two measurements were made at 1000 mm distance and at 75 and 150 mm from the centreline. Three measurements were also conducted in a point 600 mm from the tips of the nozzles.

The spray angle was measured at about 50 mm from the orifice of the nozzles, before the spray collapses.

The results are summarised table 3 below.

Table 3 Spray angle, flow rates and droplet sizes at different pressures for the nozzles used in the experiments.

Nozzle	Spray angle [°]	Measurement point [mm]	Pressure [bar]	Flow rate [L/min]	Sauter Mean Diameter [µm]	D _{V10} [µm]	D _{V50} [µm]	D _{V90} [µm]
212.085	80	-/-/250	40	0,12	35,08	20,96	37,02	59,72
212.085	N/M	-/-/250	60	0,15	33,32	19,61	34,74	60,90
212.085	75°	-/-/250	80	0,17	31,13	18,20	32,85	55,17
212.085 x 8	105°*	-/-/250	60	1,18	73,57	40,80	86,79	139,39
212.085 x 8	105°*	-/75/1000	60	1,18	71,33	38,36	86,61	147,16
212.085 x 8	105°*	-/150/1000	60	1,18	73,85	40,27	92,08	142,72
212.085 x 12	110°	-/-/1000	20	0,98	86,22	48,23	105,30	160,39
212.085 x 12	N/M	-/-/1000	40	1,43	82,54	46,20	97,95	158,03
212.085 x 12	105°*	-/-/1000	60	1,77	81,03	45,20	98,00	154,71
212.085 x 12	105°*	-/75/1000	60	1,77	82,75	46,52	104,80	156,40
212.085 x 12	105°*	-/150/1000	60	1,77	83,84	47,01	107,87	164,58
212.085 x 12	110°	-/-/600	20	0,98	72,67	40,45	87,29	140,39
212.085 x 12	N/M	-/-/600	40	1,43	67,96	37,21	80,11	138,51
212.085 x 12	105°*	-/-/600	60	1,77	66,02	37,30	78,54	121,18

*) Measured at 80 bar
N/M Not Measured

Some conclusions can be made from the measurements:

- As expected, a general observation is that the droplet sizes decrease with increased pressure, for a given nozzle or nozzle configuration.
- Combining the 212.085 nozzle in a multiple nozzle body resulted in considerably larger droplets compared to the individual nozzle. This can be explained by the coalescence effect, when droplets tends to collide and form larger droplets. However, it should be realised that the measurements where made at a longer distance from the nozzle tips for the multiple nozzle body configuration, which has accentuated this effect. The tendency that the droplet size is increased at distances further away from the nozzle can be seen when comparing the data, at the same pressure as measurements were conducted both at 1000 mm and 600 mm distance.

- The measurement made with 8 pcs of 212.085 nozzles at 60 bar, at different angles from the centreline of the spray, indicates that the variation in droplet size at the different positions not is significant.
- All the results would fall into the Class 1 category according to NFPA 750 [3].

A full set of the graphs with the droplet size distribution is provided in Appendix A.

In addition to the droplet size measurements, Lechler also measured the vertical water distribution at different pressures. The tests were conducted with the individual nozzle located 0,25 m and the multiple nozzle body 1,0 m above a transversal and a longitudinal row of tubes ($\phi=16$ mm) where the water was collected. See figure 9 below.

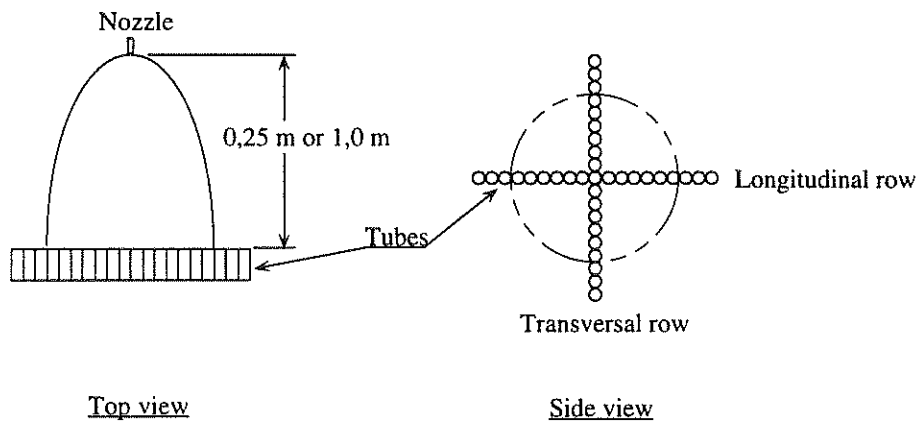

Figure 9 Principle sketch of the vertical water distribution measurements.

The results are presented as the deviation from the mean value and presented in Appendix B.

The horizontal distribution for the 12 pcs multiple nozzle configuration was also measured. The measurements were made with the nozzle in horizontal position 1,4 and 1,0 m respectively above floor level using different pressures. The water was collected in cups ($\phi=80$ mm) placed every 0,5 m. The set-up is shown in figure 10 below.

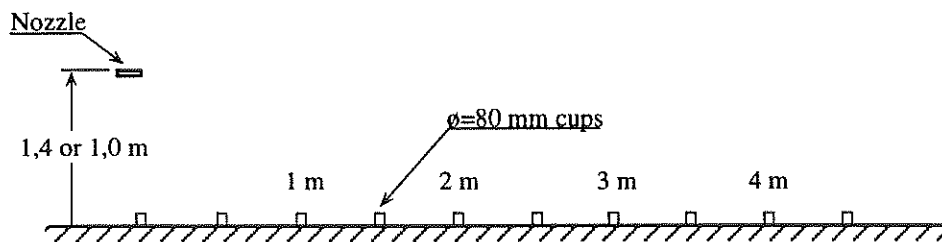

Figure 10 Principle sketch of the horizontal distribution measurements.

The results from the measurements are shown in the table below.

Table 4 Horizontal distribution for the multiple nozzle body with 12 pcs of nozzles.

Height [m] and pressure [bar]		Water distribution [g/min] at horizontal distance [m] from the nozzle									
		0	0,5	1,0	1,5	2,0	2,5	3,0	3,5	4,0	4,5
1,0	20 bar	0,6	1,3	2,5	3,3	2,2	1,0	0,4	0,1	0,08	0,05
1,0	40 bar	1,8	0,3	0,7	2,0	2,2	1,3	0,8	0,5	0,3	0,2
1,0	60 bar	0,3	0,2	0,7	1,6	2,2	1,9	1,3	0,8	0,4	0,3
1,0	80 bar	0,07	0,3	0,7	1,6	2,5	2,6	2,0	1,3	0,7	0,4
1,4	20 bar	1,2	2,0	2,5	4,3	2,4	1,4	0,5	0,2	0,1	0,07
1,4	40 bar	3,5	1,5	2,4	3,4	3,0	2,4	1,5	0,8	0,4	0,2
1,4	60 bar	4,5	0,5	1,3	2,1	2,5	2,3	1,7	1,1	0,8	0,5
1,4	80 bar	1,1	0,4	0,7	1,3	1,9	2,5	1,9	1,3	0,8	0,4

Based on these tests a rough estimate of the mean velocity in the spray was made. This was done by estimating the distance where the main part of the spray hits the floor and assuming that it follows a ballistic curve neglecting drag forces. The results are given below. Within brackets, the mean velocity obtained when the same calculations were performed based on the conservation of momentum and the measured spray area one meter from the nozzle given in Appendix B.

- 20 bar, 3,0 m/s (2,6 m/s, 1,6 m/s with 8 pcs of nozzles)
- 40 bar, 3,6 m/s
- 60 bar, 4,4 m/s
- 80 bar, 5,0 m/s (5,5 m/s)

4.2 REMP experiments

The specific amount of extinguishing medium required (Required Extinguishing Medium Portion, $REMP = \dot{m}_e / \dot{m}_g$ i.e. the ratio of the agent quantity to fuel quantity consumed) is given as a quantitative measure of the efficiency of the agent. The lower the REMP value, the more efficient the agent [26].

In a REMP test, the extinguishing media and the fuel should be premixed and flow out of the burner at low Froude number. However, it is difficult to produce small water droplets without any momentum. Therefore, when using a water spray, the Froude number will become rather high and the flame will be slightly premixed since air is entrained into the spray.

To determine the REMP value for water in the form of small droplets, testing was carried out using a tubular burner where propane gas and water were mixed prior to reaching the burner outlet, as shown in figure 12. As mentioned earlier, one individual nozzle, denoted 212.085, manufactured by Lechler International GmbH was used. The nozzle was placed in the burner so that the water did not hit the edge of the burner but still most of the water was included in the flame. The mass flow rate of water, \dot{m}_e , was measured for each water pressure used after each test by collecting the water and weighing it. The propane flow, \dot{m}_g , was measured and controlled using a gas flow meter.

During the tests, the quantity of propane was decreased until flame extinction occurred. An important aspect is that the burner operates at a low Froude number, i.e. where gravitational forces dominate the flame behaviour. The rate of heat release (RHR) was measured using oxygen consumption calorimetry. The production rates of CO and CO₂ were measured during each test. The measurement were made by extracting combustion gases from the hood as shown in figure 11.

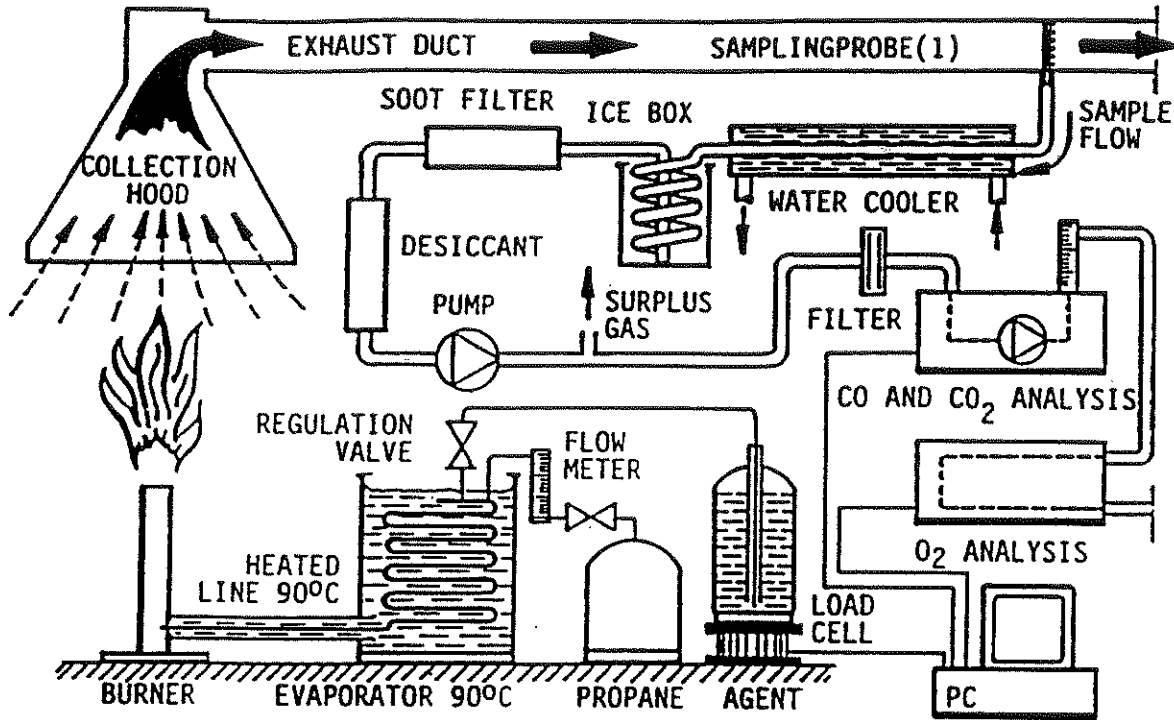

Figure 11 Principle sketch of the experimental set-up for the REMP experiments

The test procedure was as follows. First the water pressure was adjusted to the required value, the tests were performed at 40, 60 and 80 bar respectively. The water was then turned off and the gas was ignited. A one minute preburn was allowed to provide for a stabilised flame, before the water was turned on. After an additional one minute period, the gas flow was reduced in steps, equal to about 0,05 g/s, every minute until extinction occurred.

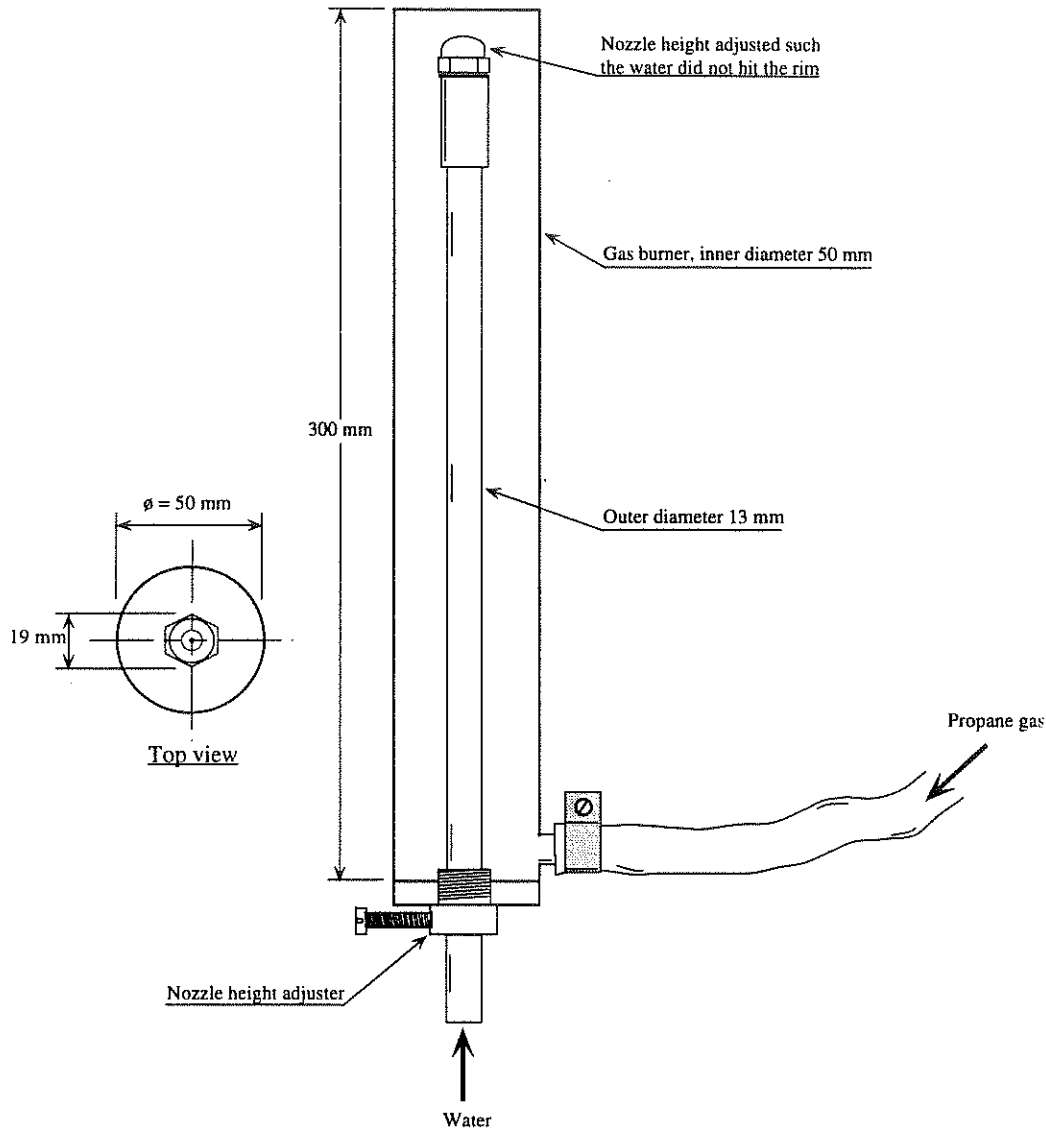

Figure 12 Detail of the tubular gas burner and the position of the water nozzle used in the REMP experiments

4.2.1 Results from the REMP experiments

Two test series were performed. In the first series the RHR and combustion gases were not measured, only the water and propane mass flow rate. In the second test series the RHR was measured.

In table 5, the results of the two test series are presented. One important factor when conducting REMP experiments is the Froude number, that is the ratio between inertial forces and gravitational forces given by equation (63).

$$Fr = \frac{v^2}{gD} \quad (63)$$

Here v is the velocity, g the acceleration due to gravity and D the diameter of the outlet. However, in these experiments, there is not a well defined Froude number since the water and the gas have different velocities and outlet diameters. Therefore, a Froude number was calculated by assuming that the momentum of the gas and water in the outlet was equal to the momentum of the water spray.

$$v = \frac{\dot{m}_e \cdot v_e}{\dot{m}_e + \dot{m}_g} = \frac{\dot{m}_e^2 \cdot 4}{\pi \cdot D^2 (\dot{m}_e + \dot{m}_g)} \quad (64)$$

Table 5 Results from the two test series (I and II) where the REMP value was determined for different water pressures (mass flow rates)

Pressure [bar]	Water mass flow rate [g/s]		Propane gas mass flow rate [g/s]		Time to extinction [s]		REMP-value		Froude ^{1/2}	
	I	II	I	II	I	II	I	II	I	II
40	1,6	1,53	0,62	0,80	1	14	2,6	1,9	34	29
40	1,6	1,53	0,85	0,70	10	10	1,9	2,2	30	31
40	1,6	1,53	0,85	0,65	1	8	1,9	2,5	30	31
40	1,6	-	(0,5)	-	N/E	-	(3,2)	-	(35)	-
40	1,6	-	(0,5)	-	N/E	-	(3,2)	-	(35)	-
60	1,9	1,83	1,10	1,20	15	5	1,7	1,5	35	32
60	1,9	1,83	0,95	1,30	5	22	2,0	1,4	37	31
60	1,9	1,83	1,05	1,30	20	38	1,8	1,4	36	31
60	1,9	1,83	0,95	1,30	15	18	2,0	1,4	37	31
60	1,9	1,83	0,85	1,30	20	8	2,2	1,4	38	31
80	2,2	2,05	1,40	1,72	20	0	1,5	1,2	39	33
80	2,2	2,05	1,40	1,87	20	0	1,5	1,1	39	31
80	2,2	2,05	1,00	1,72	10	18	2,1	1,2	44	32
80	2,2	2,05	1,50	1,87	23	0	1,5	1,1	38	31
80	2,2	2,05	1,50	1,87	30	0	1,5	1,1	38	31
80	-	2,05	-	1,42	-	40	-	1,4	-	35
80	-	2,05	-	1,6	-	17	-	1,3	-	35

N/E Not Extinguished

- No test conducted

In figure 13 the REMP value is given as a function of the Sauter mean diameter of the water spray. In this figure it is seen that the REMP-value decreases with the decreasing droplet size. In figure 14 the REMP value as a function of the square root of the Froude number is given. From this figure it is observed that the Froude numbers are rather high, in excess of 400, which is the limit where the REMP value is affected by the momentum of the water spray [25].

The REMP-value obtained in the test series can be compared to other extinguishing medias. Halons has a REMP-value of approximately 4 - 5 and dry powders approximately 1 - 4.

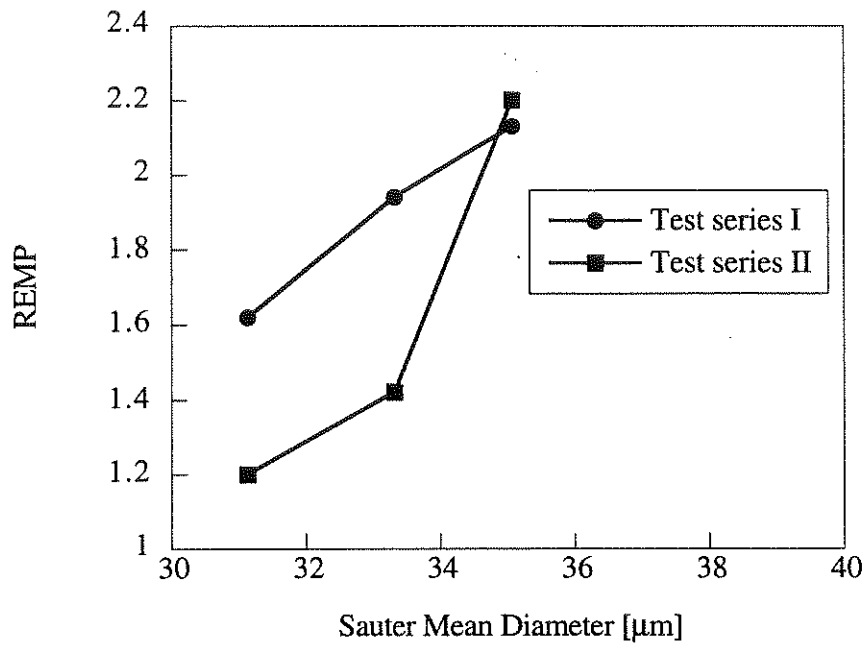

Figure 13 The REMP value as a function of the Sauter mean diameter.

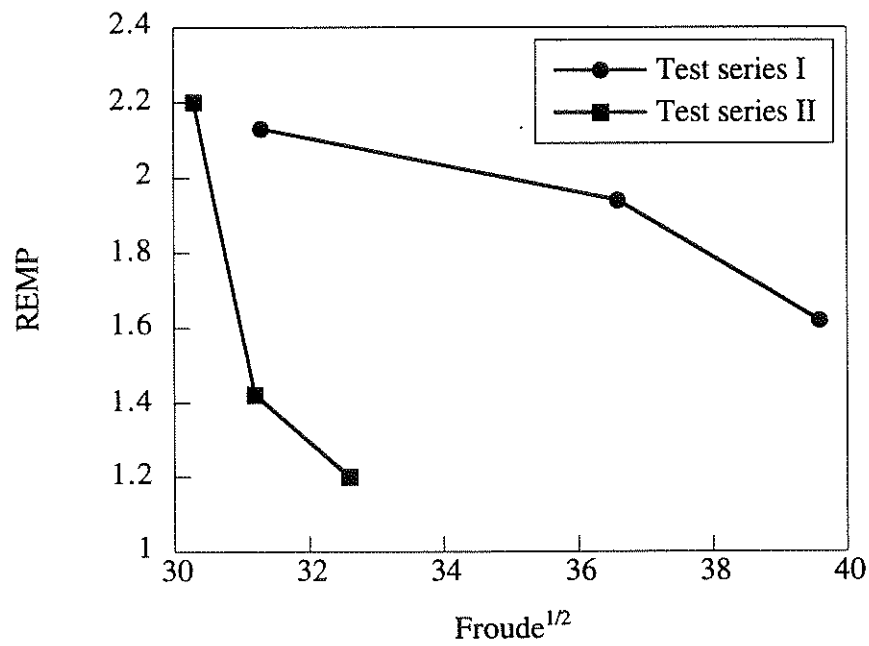

Figure 14 The REMP value as a function of the square root of the Froude number.

The theoretical water content needed for inerting a stoichiometric propane-air mixture is 280 g/m^3 (see chapter 3). This corresponds to a REMP value of 3,5. By comparing the ratio between 3,5 and the experimental REMP values it is possible to estimate the water content needed for extinction of diffusion flames. The results are given in table 6. These results should be compared to the values given for other extinguishants e.g. $140 - 170 \text{ g/m}^3$ (see chapter 3).

Table 6 Calculated water content (g/m^3) for the REMP experiments

Pressure [bar]	Water content [g/m^3]
40	165 g/m^3
60	149 g/m^3
80	126 g/m^3

In Appendix C, RHR graphs from the second series is presented. The dotted line in these figures is a reference curve achieved by conducting the experiments without adding water. As seen from the results, the application of water does not affect the fire until extinction occurs. For some of the tests, the production of CO and CO_2 is presented. No CO was formed without water, some CO was formed close to extinction when water was used.

4.3 1/3 scale room tests

To study the influence of air flows on extinguishment in a room, tests were carried out in a 1/3 scale room. The tests were conducted using either 8 or 12 single 212.085 nozzles combined in a multiple nozzle body. During the tests, the location of the multiple nozzle body and the fire was varied. In addition, the ventilation opening to the room was changed. During the tests RHR, CO and CO_2 production rates were measured as in the REMP experiments.

4.3.1 Experimental set-up

The test room is shown in figure 15. The room is constructed from bricks with an internal liner of stainless steel, having a depth of 108 cm, a width of 76 cm and a height of 79 cm. The front wall has an opening with a width of 45 cm and a height of 67 cm.

As fire source, a quadratic sandfilled gas burner (propane) was used. The gas burner was placed in the rear left hand corner or at the rear wall as shown in figure 15.

The tests were conducted using either 8 or 12 single nozzles of the 212.085 nozzles combined in a multiple nozzle body. A sketch of the nozzle body is shown in figure 8. The nozzle body was placed either at the rim of the opening of the room or 34 cm into the room. It was placed at three different heights 10, 34 and 56 cm above the floor, respectively. The lowest of the positions was chosen with respect to the spray pattern, to prevent water from hitting the floor.

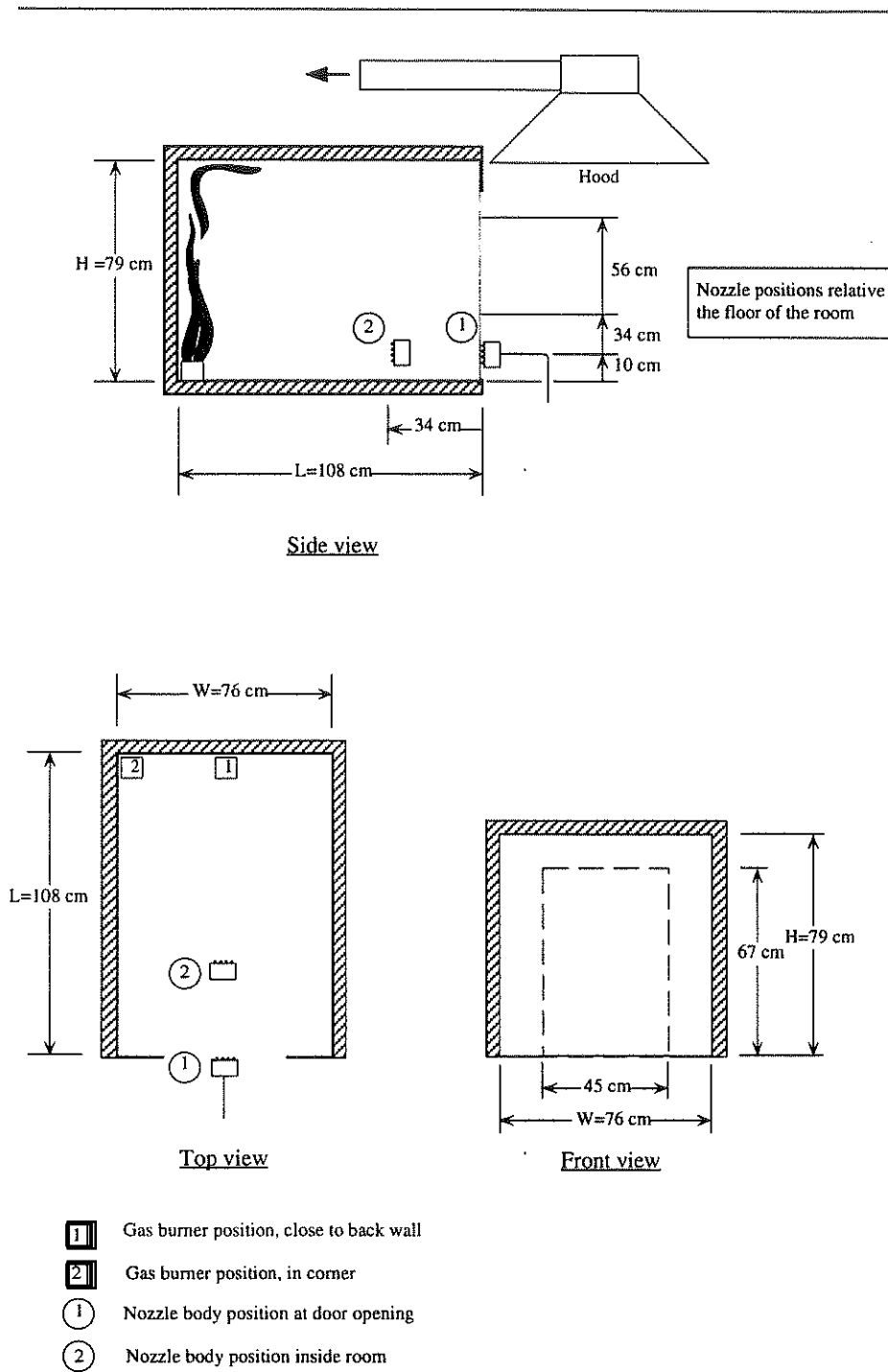

Figure 15 Principle sketch of the 1/3-scale room.

4.3.2 Test procedure

The test procedure was similar to the REMP experiments. The propane flow was measured and controlled using a gas flow meter. The gas was ignited and after a three minute preburn time the water was turned on. After an additional one minute period the gas flow to the burner was lowered one step. Thereafter the gas flow was lowered one step every minute until extinction occurred. During the tests the RHR, CO and CO₂ was measured. For reference purposes the test procedure was repeated without the use of water. The initial Rate of Heat Release was approximately 50 kW, depending on the propane flow rate.

The water pressure was kept constant at either 20, 40, 60 or 80 bar throughout the tests. Twenty-four different tests were conducted for each water pressure level where the location of the gas burner (in the corner or at the wall), the location of the nozzle body (two positions at three different heights) and the number of nozzles (8 or 12) in the nozzle body were varied. The mass flow rate of water was measured for each nominal water pressure used after each test by collecting the water and weighing it.

A couple of tests were conducted where the opening to the room was varied by screening the opening with a 20 cm high steel plate positioned at different heights.

4.3.3 Test results and observations from the 1/3 scale room tests

Tables 7 and 8 summarise the results from the tests. The results are presented as the Rate of Heat Release where extinction was achieved. In many cases the fire was more or less extinguished immediately and should be considered as "overkill". These cases are indicated with an asterisk in the tables.

Table 7 Rate of Heat Release in kW when extinction occurred in the 1/3 scale room tests. The nozzle body was located at the opening (position 1)

Pressure [bar]	Position of gas burner	Height of nozzle body above the floor [cm]					
		+10 cm		+34 cm		+56 cm	
		12 pcs	8 pcs	12 pcs	8 pcs	12 pcs	8 pcs
20 bar	In corner	N/E	-	45	N/E	40	37
	At wall	24	15	45*	43	43*	44
40 bar	In corner	41	40	42*	44	43*	43*
	At wall	45*	40	43*	44	44*	45*
60 bar	In corner	42*	45*	42*	47*	38*	45*
	At wall	42*	46*	42*	47*	38*	45*

N/E Not Extinguished

- No test conducted

* Extinction occurred immediately

Table 8 Rate of Heat Release in kW when extinction occurred in the 1/3 scale room tests. The nozzle body was located 34 cm in from the opening (position 2)

Pressure [bar]	Position of gas burner	Height of nozzle body above the floor [cm]					
		+10 cm		+34 cm		+56 cm	
		12 pcs	8 pcs	12 pcs	8 pcs	12 pcs	8 pcs
20 bar	In corner	N/E	-	45	17	44	11
	At wall	38*	44	40	28	43	47
40 bar	In corner	40	45	43*	45	43*	34
	At wall	48*	43	44*	45*	43	47
60 bar	In corner	38	45*	41*	46*	41	45
	At wall	45*	46*	45*	46*	42*	45

N/E Not Extinguished

- No test conducted

* Extinction occurred immediately

Some observations were made from the tests:

- The fire was always easiest to extinguish when the nozzle body was located at a higher position. In addition, a higher pressure provided for faster extinguishment compared to a lower pressure.
- When the nozzle body was located in the lower position, the most easy fire to extinguish was when the gas burner was located at the rear wall and the nozzle body was in the middle of the room. The most difficult fire to extinguish was the one in the corner, when the nozzle body was in the middle of the room.
- When the nozzle body was at a middle height a different situation arose. For the 20 bar case the easiest condition was having the burner at the wall and the nozzle body positioned at the opening. The most difficult case was the one with the burner in the corner and the nozzle body at the opening. In the 40 bar case the easiest condition was with the burner at the wall and the nozzle body in the middle. With the nozzle body at the opening it is more difficult to achieve extinguishment. The same thing goes probably for the 60 bar case, but no significant difference is shown in time to extinction.
- When the nozzle body was in the smoke layer, the tendency was that it is much easier to extinguish the fire. For the 20 and 40 bar case it was easiest to extinguish the fire with the burner at the wall and the nozzle in the opening. It was most difficult in the corner-middle case. For the 60 bar case no significant differences between the cases were observed.
- All tests were performed twice but almost no difference in time to extinguishment was observed. The tests were also conducted using 80 bar pressure and 12 pieces of nozzles. In these cases the fire was extinguished immediately.
- The observations described above leads to the conclusion that the main transport mechanism in the room is the spray momentum and not the air entrainment into the fire.
- No changes in RHR were observed until extinction occurred. No changes in CO/CO₂ production with or without water was observed.
- A couple of tests were made with a smaller opening to the room by screening the opening with a steel plate. In all these tests the fire was extinguished immediately. After extinction, hot unburned gases flowed out and ignited outside the room.

4.3.4 Water content in the region of the flame

By looking at the vertical water distribution in Appendix 2 and considering that the flame width is about 10 cm at the bottom of the room, 15 cm at midheight and 25 cm at the ceiling, it is possible to estimate the water content (g/m^3) in the air in the region of the flame. By assuming an ordinary throw trajectory, it is possible to estimate the velocity in the water spray based on the results from horizontal distribution tests. Thus a velocity of 3,0 m/s was obtained for the 20 bar case, 3,6 m/s for the 40 bar case, 4,4 m/s for the 60 bar case and 5,0 m/s for the 80 bar case. Considering the tests with the nozzle body 10 cm above the floor, the water flow over an area of 10 cm diameter is estimated to 1,8 times the mean water flow for all water pressures from Appendix 2. The mean water flow per area is calculated as the water flow rate in L/min (or g/s), measured by collecting and weighing, divided by the spray area obtained from Appendix 2. For the 20, 40, 60 and 80 bar cases the following results were obtained by assuming that the spray area is circular with a diameter of 30 cm.

$$\frac{837 \cdot 1.8}{\pi \cdot 0.15^2 \cdot 60 \cdot 3} = 118 g / m^3$$

$$\frac{1165 \cdot 1.8}{\pi \cdot 0.15^2 \cdot 60 \cdot 3.6} = 137 g / m^3$$

$$\frac{1415 \cdot 1.8}{\pi \cdot 0.15^2 \cdot 60 \cdot 4.4} = 136 g / m^3$$

$$\frac{1634 \cdot 1.8}{\pi \cdot 0.15^2 \cdot 60 \cdot 5} = 139 g / m^3$$

With the nozzle body 34 cm above the floor, the water content is 1,5 times the average and with the nozzle body 56 cm above the floor, 1,1 times the average for 80 and 60 bar and 1,2 times the average for 40 and 20 bar. Thus the same calculations can be performed for these cases and for the tests where only 8 nozzles were used in the body. The results are given in table 9.

Table 9 Estimated water content (g/m^3) in the region of the flame for the 1/3 scale room tests.

Pressure [bar]	Height of nozzle body above the floor [cm]					
	+10 cm		+34 cm		+56 cm	
	12 pcs	8 pcs	12 pcs	8 pcs	12 pcs	8 pcs
20	118*	114	98	95	76	74
40	137*	108	114*	92*	88	69
60	136*	112*	113*	62*	83*	69
80	139	-	115	-	85	-

*) Immediate extinguishment

- No test conducted

These values for water content are lower compared to the values obtained from the REMP experiments. One explanation for this is that the droplet size velocity probably is overestimated since the velocity slows down due to the wall in front of the spray. In addition, low values occur when the nozzle body was placed in the smoke gas layer. This is probably due to the fact that smoke gases were forced in to the flame by the water spray.

For the cases where the gas burner was placed in the corner the above argument is a too simplistic approach. Instead, the deflection of the water due to the air flow needs to be considered. In figure 16 the trajectories of droplets of different sizes moving in an air stream that bends off are given. The trajectories are obtained by assuming that 0,2 m from the wall, the droplets and the air stream both are moving perpendicular towards the wall with 4,0 m/s. However, since there is a wall the air stream is supposed to bend off with a circular curve with 0,2 m radius. The droplets are then subject to drag forces according to equation (14) - (21). As seen in figure 16 it is only droplets that are smaller than 20 μm that are able to follow the air stream, the rest will hit the wall.

From the droplet size measurements it is obvious that only about 1% by mass of the droplets are in that size region. Therefore, the extinguishment, when the gas burner was located in the corner, probably was due to stretch of flame from the momentum of the spray. Also, when the nozzles was mounted in a higher position, the flame could partly be hit directly from the spray since the flame was slightly wider higher up. There is probably also a considerable effect from the smoke re-circulation when the nozzles were mounted in a higher position.

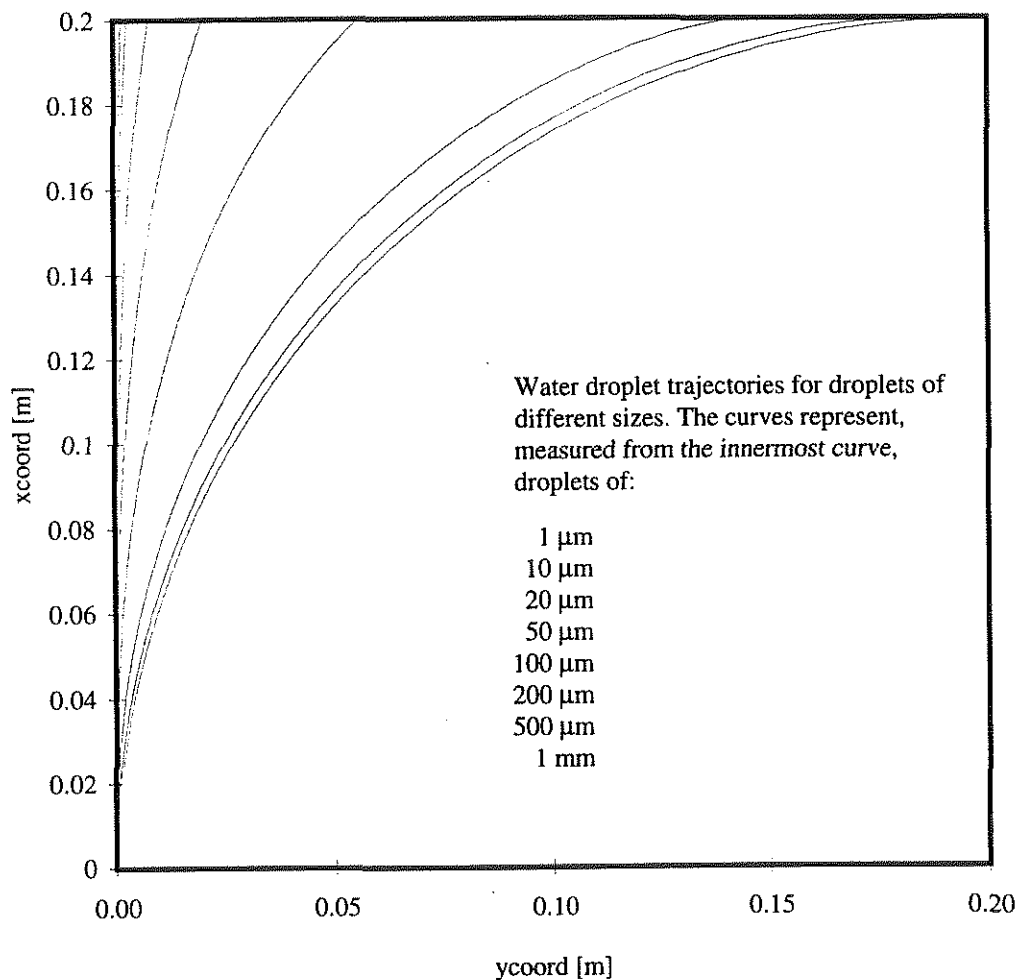

Figure 16 Trajectories for droplets of different sizes at an air flow of 4 m/s.

5 Discussion and suggestions for future work

The present study focused on extinction of flames with water mist where surface cooling effects were neglected i.e. water mist as a total flooding system where the direct spray cannot reach and cool all burning items in the protected volume. Special efforts have been made to give some answers to the following questions:

- What is the inerting concentration of water mist expressed as g/m^3 protected volume and how does it change with drop size distribution? What is the extinguishing concentration of water mist against diffusion flames expressed as g/m^3 protected volume and how does it change with drop size distribution?
- How does obstructions placed in the path of a spray reduce the sprays capacity to extinguish a fire? What influence has the drop size distribution and the spray momentum?
- Is it possible for finer elements in the spray to become entrained in the circulation patterns established by the fire gases? What influence has the drop size distribution and the spray momentum?
- Which major factors determine the transport of droplets to all parts of the room where burning takes place?

Three different series of experiments were conducted with different hydraulic atomising nozzles. In the first series, droplet size distribution and water spray distribution measurements for the nozzles were conducted. The measurements showed that the droplet size distribution ranged from a Sauter Mean Diameter of approximately 35 - 85 μm , all dependent on the water pressure and the configuration of nozzles. The measurements show that considerably larger droplets are formed when individual nozzles were placed together. This can be explained by a coalescence effect when droplets from the sprays of the nozzles collide.

The second series of experiments were made using a tubular propane gas burner where water and propane were mixed prior to reaching the burner outlet. Based on the tests, the specific amount of extinguishing medium required (Required Extinguishing Medium Portion, $\text{REMP} = \dot{m}_e / \dot{m}_g$ i.e. the ratio of the agent quantity to fuel quantity consumed) is given as a quantitative measure of the efficiency of the agent. The lower the REMP value, the more efficient the agent. The water pressure ranged between 40 and 80 bar which provided for droplet sizes with a Sauter Mean Diameter in the order of 35 μm .

Finally, a series of tests were conducted in a 1/3 scale room using a propane gas fire. Parameters such as location of the fire, the location of the nozzle, water flow rate and the size of the room opening were varied.

The two fire test series indicate that water in the form of very small water droplets ("water mist") might be an excellent extinguishant. In practice, however, problems of delivering the water to the fire arise.

- The results from the REMP (Required Extinguishing Media Portion) experiments conducted indicate that water mist is 2 - 3 times as effective as halon by weight. The water content needed for extinguishing diffusion flames are in the order of 125 - 165 g/m^3 , the lower value for smaller droplets. These values are in reasonable agreement with the values obtained considering that the theoretical inerting concentration for water mist is 280 g/m^3 and that for other extinguishing agents the extinction concentration against diffusion flames are about 40 - 60% of the inerting concentration, which in this case would be 140 - 170 g/m^3 .

In the 1/3 scale room the values obtained for the extinction of propane diffusion flame were within 100 - 200 g/m³. The rather low values can be explained by an underestimation of the water content and the fact that the flame is affected by smoke that re-circulated in the room and the great stretch of the flame caused by the spray momentum. In all fire tests the water content needed for extinction was decreased with smaller droplets. In all the tests no heat release reduction was observed until extinction occurred. In the REMP series an increase in CO-production was observed close to extinction but no such effect was observed in the 1/3 scale room.

- Calculations show, that with spray and gas velocities in the order of 2 - 5 m/s and an obstruction placed in the path of a spray, the droplets must be in the droplet size range of 1 - 20 µm in diameter in order to follow the airflow around the obstruction, otherwise the droplet will impinge on the obstruction.
- In order for the finer elements of a spray to become entrained in the circulation pattern established by fire gases and not entrained by spray momentum, the droplets must be below 10 - 20 µm otherwise they will fall down due to gravitational forces, i.e. no build-up of water concentration with larger droplets will occur in the air.
- In order to distribute water mist to all parts of a room, as a gaseous total flooding system works, it is essential to have a spray with a large momentum and small droplets. If the momentum of the spray is small then it cannot reach far away from the nozzle since other distribution mechanisms are very slow processes. If the droplets are larger than 10 - 20 µm they will impinge on obstructions and walls or fall out to the floor due to gravity forces and wet the surrounding surfaces. This can be desirable if there is a coupling between the surface and the fire i.e. a fire on a wall, but when it comes to liquid or gaseous fires this has limited effects on the fire.

As a conclusion, achieving total flooding with water mist it is essential that nozzles cover the complete protected compartment, with nozzles under and behind obstructions. These demands make it difficult to establish rules for dimensioning and take scaling effects into account.

For future investigations, alternative methods to produce and distribute water mist, with small droplets in the whole compartment including obstructions, such as the systems that uses superheated water should be evaluated. In addition, measurement techniques for determining the water and vapour content in air in g/m³ need to be developed.

References

- [1] Jones, A. and Nolan, P. F., "Discussion on the use of fine water sprays or mists for fire suppression", *J. of Loss Prev. Process Ind.*, Volume 8, Number 1, 1995, pp. 17 -22
- [2] Lefebvre, A.H., in "Atomization and sprays", Hemisphere Publishing, London, 1989, chapter 3
- [3] "Standard on Water Mist Fire Protection Systems", NFPA 750, National Fire Protection Association, 1 Batterymarch Park, Quincy, MA, USA, Draft 1995
- [4] Mawhinney, Jack, R., "Characteristics of Water Mists for Fire Suppression in Enclosures", *Proceedings of the Halon Alternatives Technical Working Conference*, Albuquerque, May 11 - 13, 1993, pp 291 - 302
- [5] Martilla. Paul, K. "Water Mist in Total Flooding Applications", *Proceedings of the Halon Alternatives Technical Working Conference*, Albuquerque, May 11 - 13, 1993, pp 309 - 316
- [6] Cousins, C.S., "Recent Work on Fire Control Using Fine Water Sprays at the Fire Research Station", *Proceedings of the 1st International Conference on Fire Suppression Research*, Stockholm, 1992, pp 229 - 244
- [7] Spring, D.J. et al., "New Applications of Aqueous Agents for Fire Suppression", *Proceedings of the Halon Alternatives Technical Working Conference*, Albuquerque, May 11 - 13, 1993, pp 303 - 308
- [8] Leonard, J.T., et al., "Post-Flashover Fires in Simulated Shipboard Compartments: Phase 2- Cooling of Fire Compartment Boundaries", *Memorandum Report No SAND-83-8234*, Naval Research Laboratory, Washington DC, USA, 19 September, 1991
- [9] Wighus, R. et al., " Full Scale Water Mist Experiments", *Proceedings of the International Conference on Water Mist Fire Suppression Systems*, Borås, Sweden, November 4 - 5, 1993
- [10] Tuomisaari, Maarit, "Suppression of Compartment Fires with a small Amount of Water", *Proceedings of the International Conference on Water Mist Fire Suppression Systems*, Borås, Sweden, November 4 - 5, 1993
- [11] Simpson, Terence, "A fully Integrated Water Mist Suppression System for Telecommunications and Other Electronic Cabinets", *Proceedings of the International Conference on Water Mist Fire Suppression Systems*, Borås, Sweden, November 4 - 5, 1993
- [12] Ryderman, Anders, "Developments of Standards and Test Methods for Water Mist Systems", *Proceedings of the International Conference on Water Mist Fire Suppression Systems*, Borås, Sweden, November 4 - 5, 1993

- [13] Arvidson, Magnus, "The efficiency of different Water Mist Systems in a Ship Cabin", Proceedings of the International Conference on Water Mist Fire Suppression Systems, Borås, Sweden, November 4 - 5, 1993
- [14] Resolution A.800(19), "Revised Guidelines for approval of Sprinkler Systems Equivalent to that Referred to in SOLAS Regulation II/2/12", December 14, 1995
- [15] MSC/Circ. 668, "Alternative Arrangements for Halon Fire-Extinguishing Systems in Machinery Spaces and Pump-rooms", December 30, 1994
- [16] Fleming, Russell P. "Water-based Fire Suppression Systems", not yet published
- [17] Mawhinney, Jack, R. "Engineering Criteria For Water Mist Suppression Systems", Water Mist Fire Suppression Workshop, March 1 - 2, 1993: Proceedings, NIST, 1993
- [18] Rasbash, Lecture notes, University of Edinburgh
- [19] "Industrial Spray Nozzles and Accessories", Lechler International GmbH, Catalogue 02.90
- [20] Holmstedt, Lecture Notes, Department of Fire Safety Engineering, Lund University, Lund, 1996
- [21] Fleming, Russell P. "Automatic Sprinkler System Calculations", The SFPE Handbook of Fire Protection Engineering, 2nd Edition, 1995
- [22] Holmstedt, Göran, Persson, Henry and Ryderman, Anders. "SLÄCKMEDEL OCH SLÄCKVERKAN, Kunskapsläge och Forskningsbehov", SP-RAPP 1984:35 ISSN 0280-2503
- [23] Gardiner, A.J. "The mathematical modelling of the interaction between sprinkler sprays and the thermally buoyant layers of gases from fires"; Thesis, 1988
- [24] Kanury, Murty A., "Introduction to Combustion Phenomena", Gordon and Breach Science Publishers, 1975
- [25] Holmstedt, G., Persson, H. and Säwenmark, G., "Extinguishing of gas diffusion flames with powders and halons at various Froude numbers", SP Report 1986:24, Swedish National Testing and Research Institute, Borås, 1986 (In Swedish).
- [26] NT FIRE 044, Fire protection: Fire extinguishing media - Powder. Approved 1991-11, 10 pages
- [27] Ewing, Curtis, T., Beyler, Craig L. and Carhart, Homer W., "Extinguishment of class B flames by thermal mechanisms; Principles underlying a comprehensive theory; Prediction of flame extinguishing effectiveness.", J. of Fire Prot. Engr., 6(1), 1994, pp 23 - 54

Appendix A

Droplet size distribution measurements

On the following pages the droplet size distribution of the nozzles used is presented. The measurements were conducted by Lechler GmbH using an Aerometrics Laser-Phase-Doppler-Analyser, both for the single nozzle and for the multiple nozzle configuration. The accuracy of the equipment is approximately $\pm 10\%$ for the Sauter Mean Diameter. The measurements were made with the nozzles directed downward, at different pressures and at different positions in the spray. For the single nozzle, the measurements were conducted at a point on the central axis of the spray at a distance of 250 mm from the tip, at 40, 60 and 80 bar, respectively. For the multiple nozzle configuration, most of the measurements were made at a point on the central axis of the spray at a distance of 1000 mm from the tips of the nozzles. Additionally, two measurements were made at 1000 mm distance and at 75 and 150 mm from the centreline. Three measurements were also conducted at a point 600 mm from the tips of the nozzles.



Lehler GmbH & Co. KG
Präzisionsdüsen . Anlagenbau
Höhenstraße 24 . Postfach 1709
D - 70707 Fellbach / Germany
Telefon (07 11) 58 53 - 01
Telefax (07 11) 58 53 - 418
Teletex 7 111 378

Droplet Size Analysis

Product Number : 212.085
Date of Measurement : 22 NOV 1994 Mes.Point\mm\x/y/z : -/-/250
Liquid - Pressure : 40.0 bar Gas - Pressure : 0.00 bar
Liquid - Flow : 0.120 l/min Gas - Flow : 0.00 m³/h i.N.
Medium : Wasser Gas\Liquid - Rat : 0.00
Remark : -- Test 4; single nozzle --

Results of Droplet Size Analysis

Number of Droplets = 40593
Arithmetic Mean Value = 25.62 μm
Standard Deviation = 41.48 %
Area Mean Diameter = 27.73 μm
Volume Mean Diameter = 29.99 μm
Sauter Mean Diameter = 35.08 μm

D(NUM) 10% = 12.73 μm
D(NUM) 50% = 21.88 μm
D(NUM) 90% = 38.34 μm

D(VOL) 10% = 20.96 μm
D(VOL) 50% = 37.02 μm
D(VOL) 90% = 59.72 μm



Lehler GmbH & Co. KG
 Präzisionsdüsen . Anlagenbau
 Höhenstraße 24 . Postfach 1709
 D - 70707 Fellbach / Germany
 Telefon (07 11) 58 53 - 01
 Telefax (07 11) 58 53 - 418
 Teletex 7 111 378

Droplet Size Analysis

Product Number : 212.085

Date of Measurement : 22 NOV 1994

Mes.Point\mm\x/y/z : -/-/250

Liquid - Pressure : 40.0 bar

Gas - Pressure : 0.00 bar

Liquid - Flow : 0.120 l/min

Gas - Flow : 0.00 m³/h i.N.

Medium : Wasser

Gas\Liquid - Rat : 0.00

Remark : -- Test 4; single nozzle --

Sauter Mean Diameter : 35.08 µm

Arithm. Mean Value : 25.62 µm

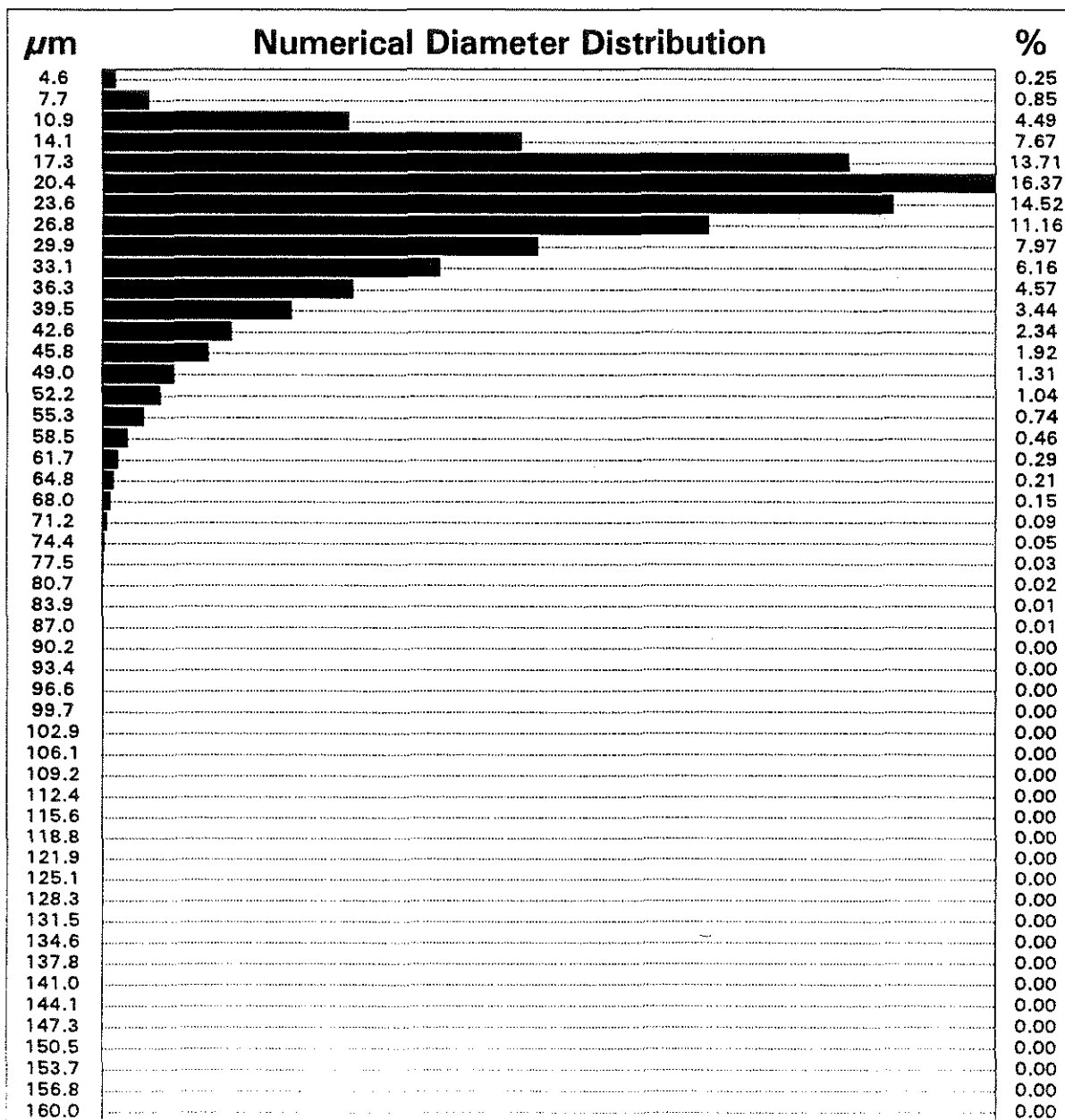

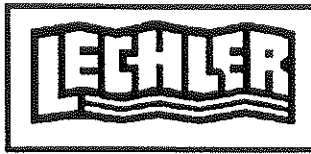

Lechler GmbH & Co. KG
 Präzisionsdüsen . Anlagenbau
 Höhenstraße 24 . Postfach 1709
 D - 70707 Fellbach / Germany
 Telefon (07 11) 58 53 - 01
 Telefax (07 11) 58 53 - 418
 Teletex 7 111 378

Droplet Size Analysis

Product Number : 212.085

Date of Measurement : 22 NOV 1994

Mes.Point\mm\x/y/z : -/-/250

Liquid - Pressure : 40.0 bar

Gas - Pressure : 0.00 bar

Liquid - Flow : 0.120 l/min

Gas - Flow : 0.00 m³/h i.N.

Medium : Wasser

Gas\Liquid - Rat : 0.00

Remark : -- Test 4; single nozzle --

Sauter Mean Diameter: 35.08 μ m

Arithm. Mean Value : 25.62 μ m

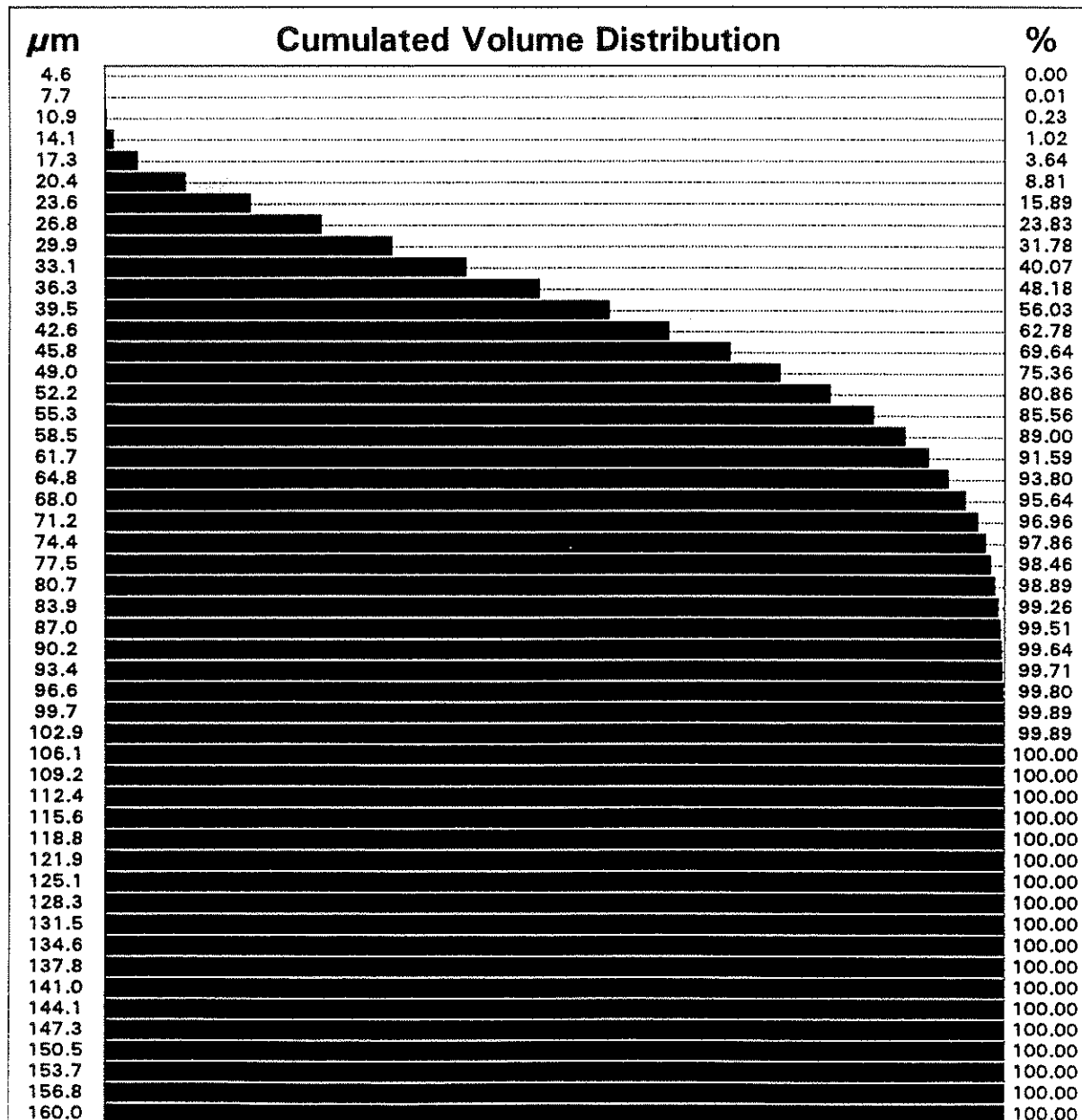

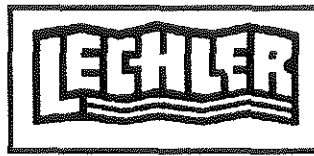

Lechler GmbH & Co. KG
Präzisionsdüsen . Anlagenbau
Höhenstraße 24 . Postfach 1709
D - 70707 Fellbach / Germany
Telefon (07 11) 58 53 - 01
Telefax (07 11) 58 53 - 418
Teletex 7 111 378

Droplet Size Analysis

Product Number : 212.085
Date of Measurement : 22 NOV 1994 Mes.Point\mm\x/y/z : -/-/250
Liquid - Pressure : 60.0 bar Gas - Pressure : 0.00 bar
Liquid - Flow : 0.148 l/min Gas - Flow : 0.00 m³/h i.N.
Medium : Wasser Gas\Liquid - Rat : 0.00
Remark : -- Test 5; single nozzle --

Results of Droplet Size Analysis

Number of Droplets = 44799
Arithmetic Mean Value = 23.42 μm
Standard Deviation = 44.30 %
Area Mean Diameter = 25.61 μm
Volume Mean Diameter = 27.96 μm
Sauter Mean Diameter = 33.32 μm

D(NUM) 10% = 10.89 μm

D(NUM) 50% = 20.02 μm

D(NUM) 90% = 34.95 μm

D(VOL) 10% = 19.61 μm

D(VOL) 50% = 34.74 μm

D(VOL) 90% = 60.90 μm

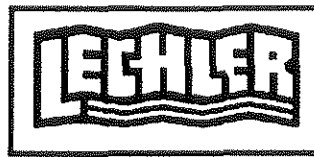

Lechler GmbH & Co. KG
 Präzisionsdüsen . Anlagenbau
 Höhenstraße 24 . Postfach 1709
 D - 70707 Fellbach / Germany
 Telefon (07 11) 58 53 - 01
 Telefax (07 11) 58 53 - 418
 Teletex 7 111 378

Droplet Size Analysis

Product Number : 212.085

Date of Measurement : 22 NOV 1994

Mes.Point\mm\x/y/z : -/-/250

Liquid - Pressure : 60.0 bar

Gas - Pressure : 0.00 bar

Liquid - Flow : 0.148 l/min

Gas - Flow : 0.00 m³/h i.N.

Medium : Wasser

Gas\Liquid - Rat : 0.00

Remark : -- Test 5; single nozzle --

Sauter Mean Diameter: 33.32 μm

Arithm. Mean Value : 23.42 μm

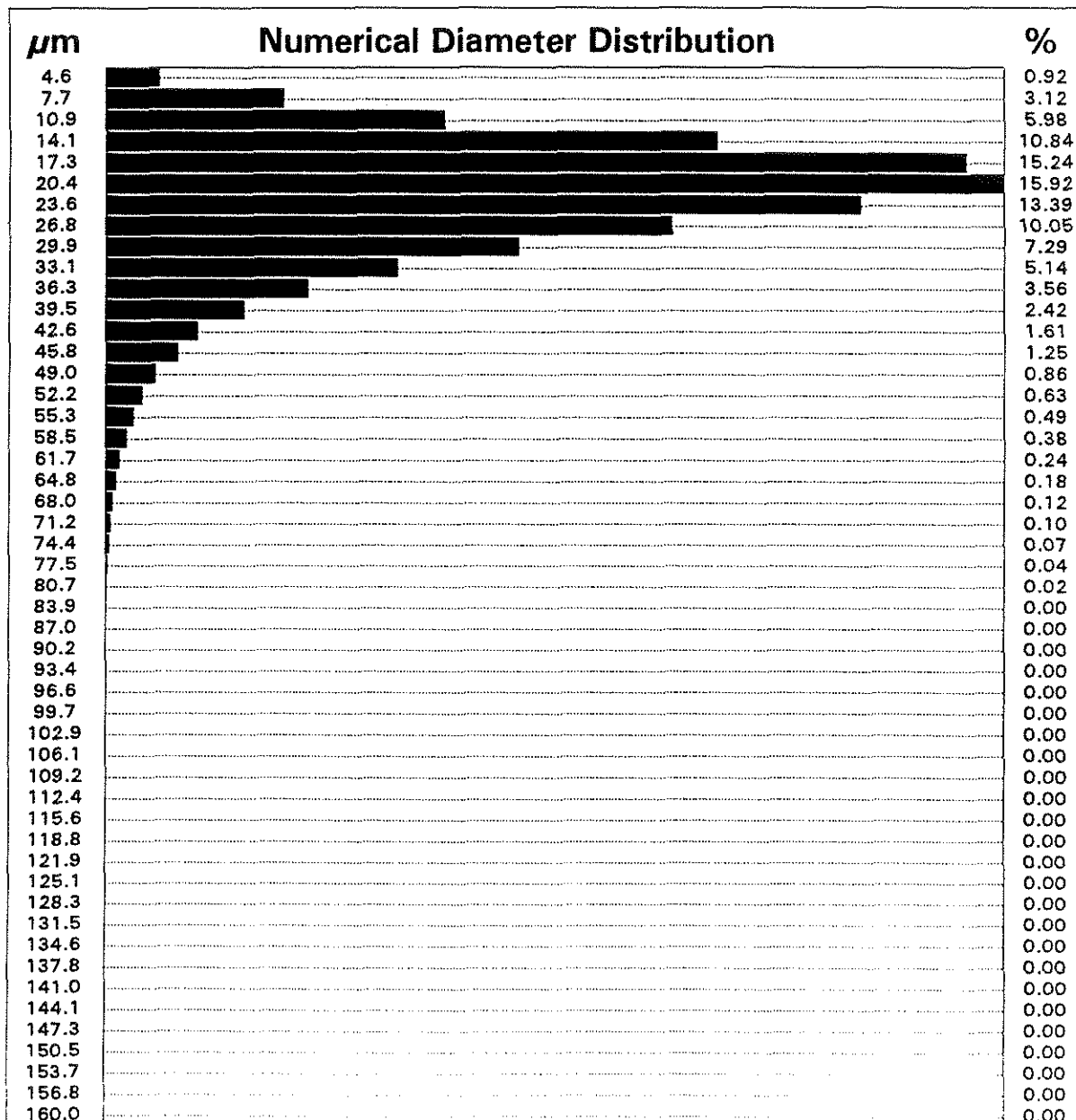



Lehler GmbH & Co. KG
 Präzisionsdüsen . Anlagenbau
 Höhenstraße 24 . Postfach 1709
 D - 70707 Fellbach / Germany
 Telefon (07 11) 58 53 - 01
 Telefax (07 11) 58 53 - 418
 Teletex 7 111 378

Droplet Size Analysis

Product Number : 212.085

Date of Measurement : 22 NOV 1994

Mes.Point\mm\x/y/z : -/-/250

Liquid - Pressure : 60.0 bar

Gas - Pressure : 0.00 bar

Liquid - Flow : 0.148 l/min

Gas - Flow : 0.00 m³/h i.N.

Medium : Wasser

Gas\Liquid - Rat : 0.00

Remark : -- Test 5; single nozzle --

Sauter Mean Diameter: 33.32 μm

Arithm. Mean Value : 23.42 μm

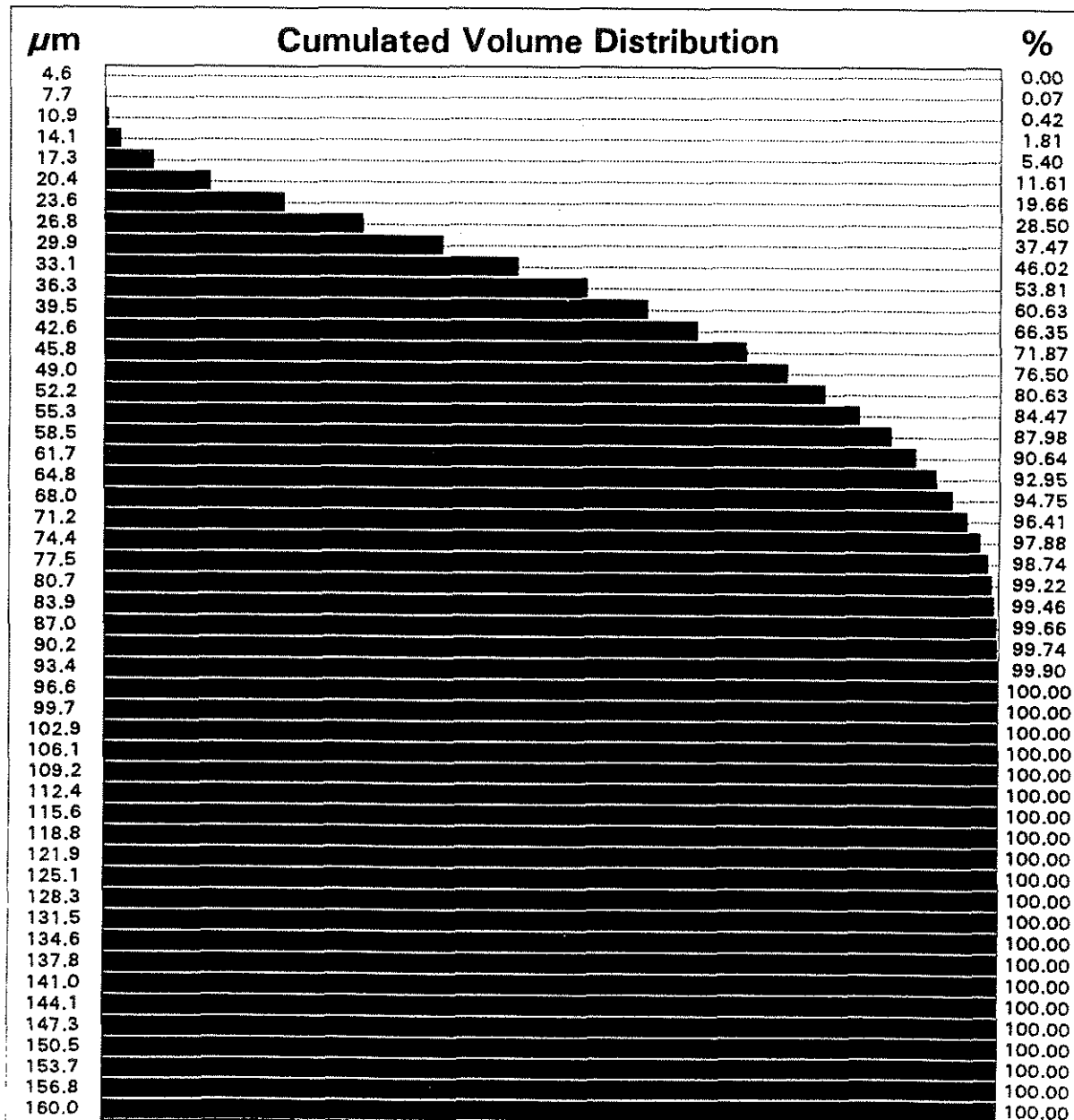

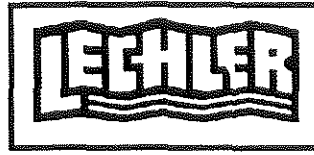

Lechler GmbH & Co. KG
Präzisionsdüsen . Anlagenbau
Höhenstraße 24 . Postfach 1709
D - 70707 Fellbach / Germany
Telefon (07 11) 58 53 - 01
Telefax (07 11) 58 53 - 418
Teletex 7 111 378

Droplet Size Analysis

Product Number : 212.085
Date of Measurement : 22 NOV 1994 Mes.Point\mm\x/y/z : -/-/250
Liquid - Pressure : 80.0 bar Gas - Pressure : 0.00 bar
Liquid - Flow : 0.175 l/min Gas - Flow : 0.00 m³/h i.N.
Medium : Wasser Gas\Liquid - Rat : 0.00
Remark : -- Test 6; single nozzle --

Results of Droplet Size Analysis

Number of Droplets = 33738
Arithmetic Mean Value = 20.82 μm
Standard Deviation = 48.98 %
Area Mean Diameter = 23.18 μm
Volume Mean Diameter = 25.58 μm
Sauter Mean Diameter = 31.13 μm

D(NUM) 10% = 7.91 μm

D(NUM) 50% = 17.69 μm

D(NUM) 90% = 32.36 μm

D(VOL) 10% = 18.20 μm

D(VOL) 50% = 32.85 μm

D(VOL) 90% = 55.17 μm

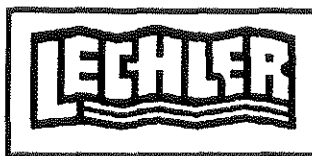

Lechler GmbH & Co. KG
 Präzisionsdüsen . Anlagenbau
 Höhenstraße 24 . Postfach 1709
 D - 70707 Fellbach / Germany
 Telefon (07 11) 58 53 - 01
 Telefax (07 11) 58 53 - 418
 Teletex 7 111 378

Droplet Size Analysis

Product Number : 212.085
 Date of Measurement : 22 NOV 1994 Mes.Point\mm\x/y/z : -/-/250
 Liquid - Pressure : 80.0 bar Gas - Pressure : 0.00 bar
 Liquid - Flow : 0.175 l/min Gas - Flow : 0.00 m³/h i.N.
 Medium : Wasser Gas\Liquid - Rat : 0.00
 Remark : -- Test 6; single nozzle --
 Sauter Mean Diameter: 31.13 μm Arithm. Mean Value : 20.82 μm

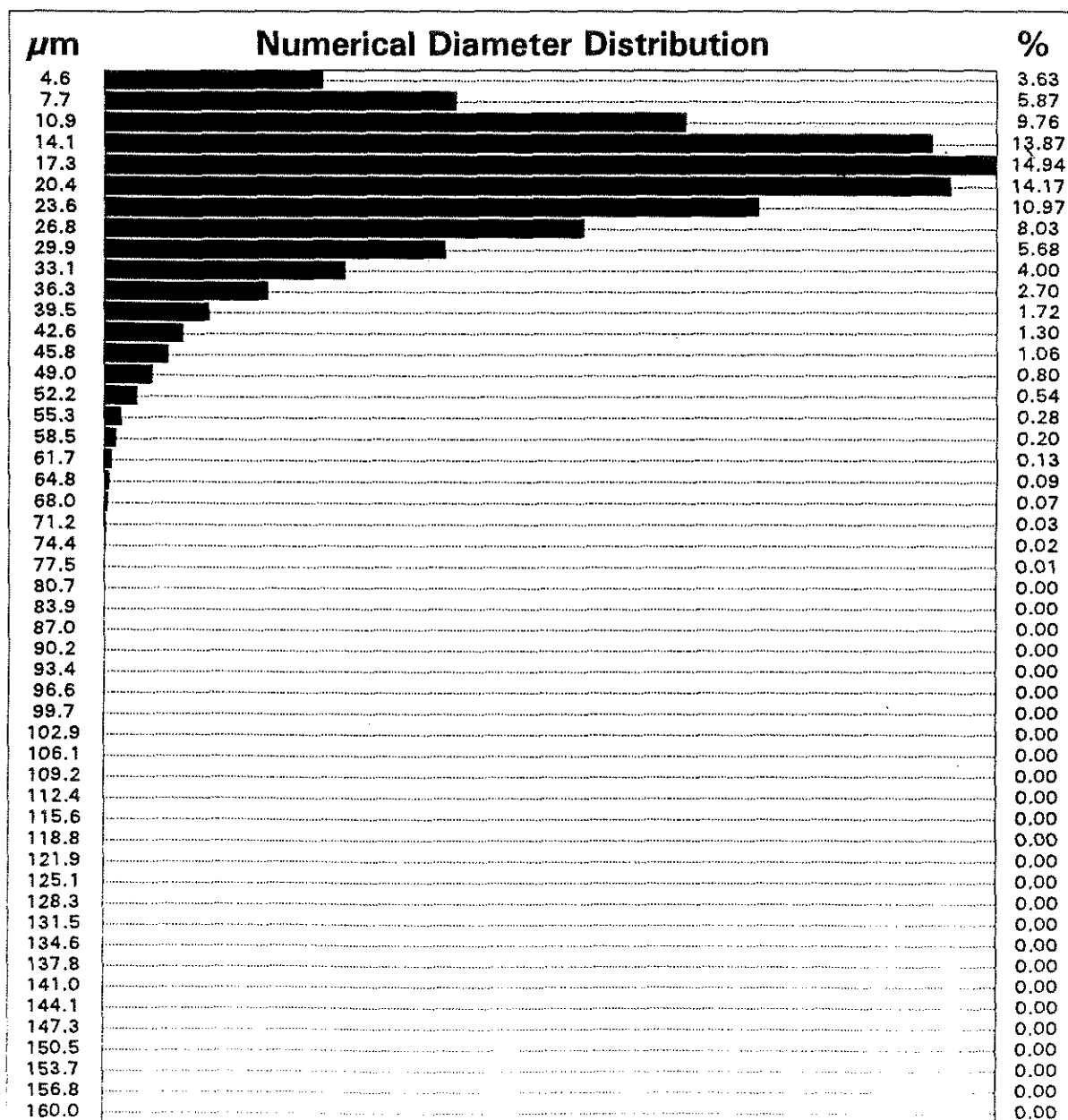



Lechler GmbH & Co. KG
 Präzisionsdüsen . Anlagenbau
 Höhenstraße 24 . Postfach 1709
 D - 70707 Fellbach / Germany
 Telefon (07 11) 58 53 - 01
 Telefax (07 11) 58 53 - 418
 Teletex 7 111 378

Droplet Size Analysis

Product Number : 212.085

Date of Measurement : 22 NOV 1994

Mes.Point\mm\x/y/z : -/-/250

Liquid - Pressure : 80.0 bar

Gas - Pressure : 0.00 bar

Liquid - Flow : 0.175 l/min

Gas - Flow : 0.00 m³/h i.N.

Medium : Wasser

Gas\Liquid - Rat : 0.00

Remark : -- Test 6; single nozzle --

Sauter Mean Diameter: 31.13 μm

Arithm. Mean Value : 20.82 μm

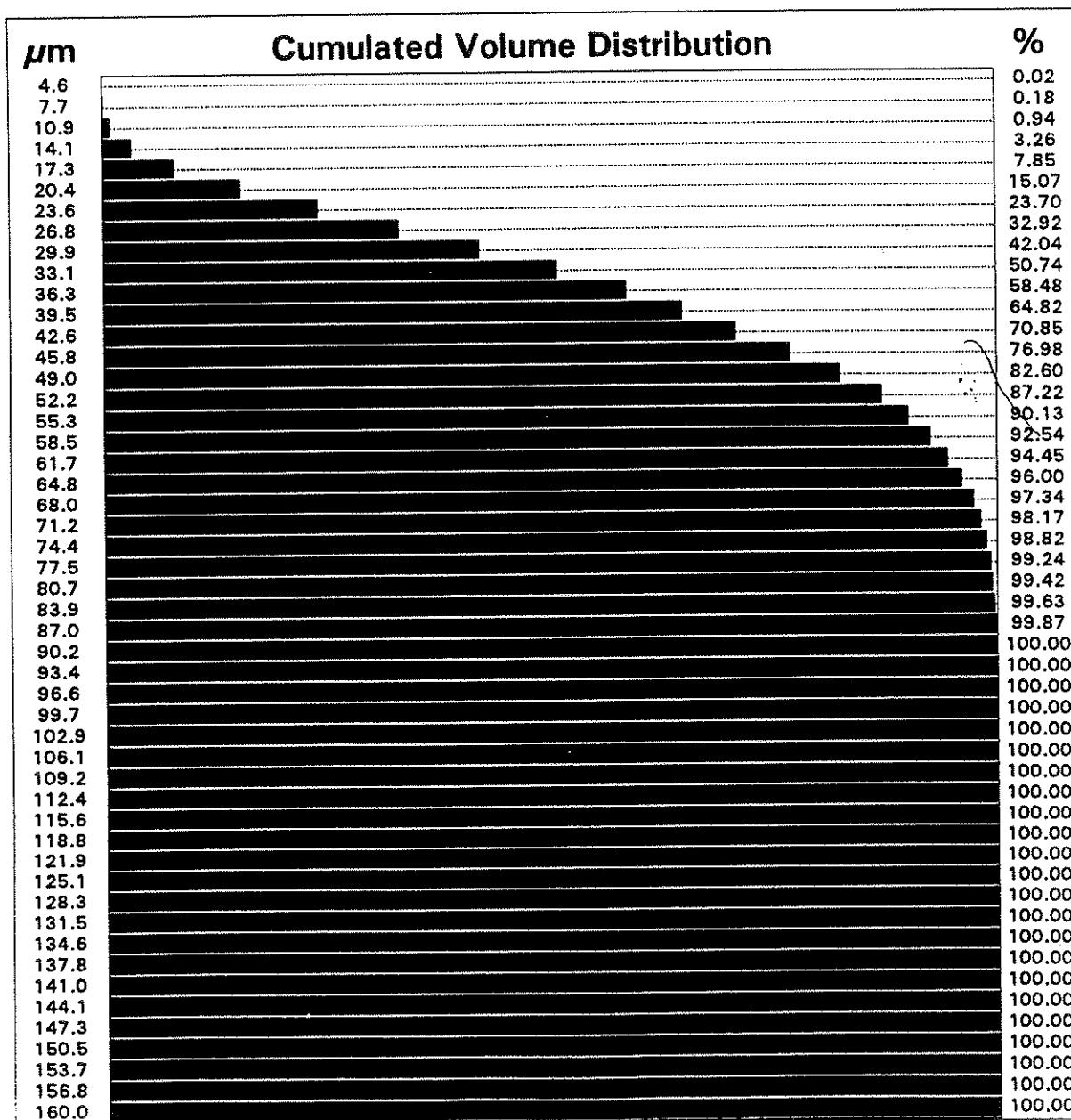

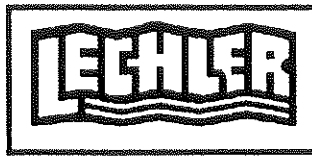

Lehler GmbH & Co. KG
Präzisionsdüsen . Anlagenbau
Höhenstraße 24 . Postfach 1709
D - 70707 Fellbach / Germany
Telefon (07 11) 58 53 - 01
Telefax (07 11) 58 53 - 418
Teletex 7 111 378

Droplet Size Analysis

Product Number : 212.085 X 8
Date of Measurement : 22 NOV 1994 Mes.Point\mm\x/y/z : 0/0/250
Liquid - Pressure : 60.0 bar Gas - Pressure : 0.00 bar
Liquid - Flow : 1.18 l/min Gas - Flow : 0.00 m³/h i.N.
Medium : Wasser Gas\Liquid - Rat : 0.00
Remark : -- Test 7; body with 8 nozzles 212.085 --

Results of Droplet Size Analysis

Number of Droplets = 53880
Arithmetic Mean Value = 42.52 μm
Standard Deviation = 57.04 %
Area Mean Diameter = 48.95 μm
Volume Mean Diameter = 56.07 μm
Sauter Mean Diameter = 73.57 μm

D(NUM) 10% = 18.13 μm
D(NUM) 50% = 33.44 μm
D(NUM) 90% = 73.49 μm

D(VOL) 10% = 40.80 μm
D(VOL) 50% = 86.79 μm
D(VOL) 90% = 139.39 μm

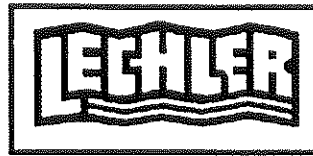

Lechler GmbH & Co. KG
 Präzisionsdüsen . Anlagenbau
 Höhenstraße 24 . Postfach 1709
 D - 70707 Fellbach / Germany
 Telefon (07 11) 58 53 - 01
 Telefax (07 11) 58 53 - 418
 Teletex 7 111 378

Droplet Size Analysis

Product Number : 212.085 X 8

Date of Measurement : 22 NOV 1994

Mes.Point\mm\x/y/z : 0/0/250

Liquid - Pressure : 60.0 bar

Gas - Pressure : 0.00 bar

Liquid - Flow : 1.18 l/min

Gas - Flow : 0.00 m³/h i.N.

Medium : Wasser

Gas\Liquid - Rat : 0.00

Remark : -- Test 7; body with 8 nozzles 212.085 --

Sauter Mean Diameter: 73.57 μm

Arithm. Mean Value : 42.52 μm

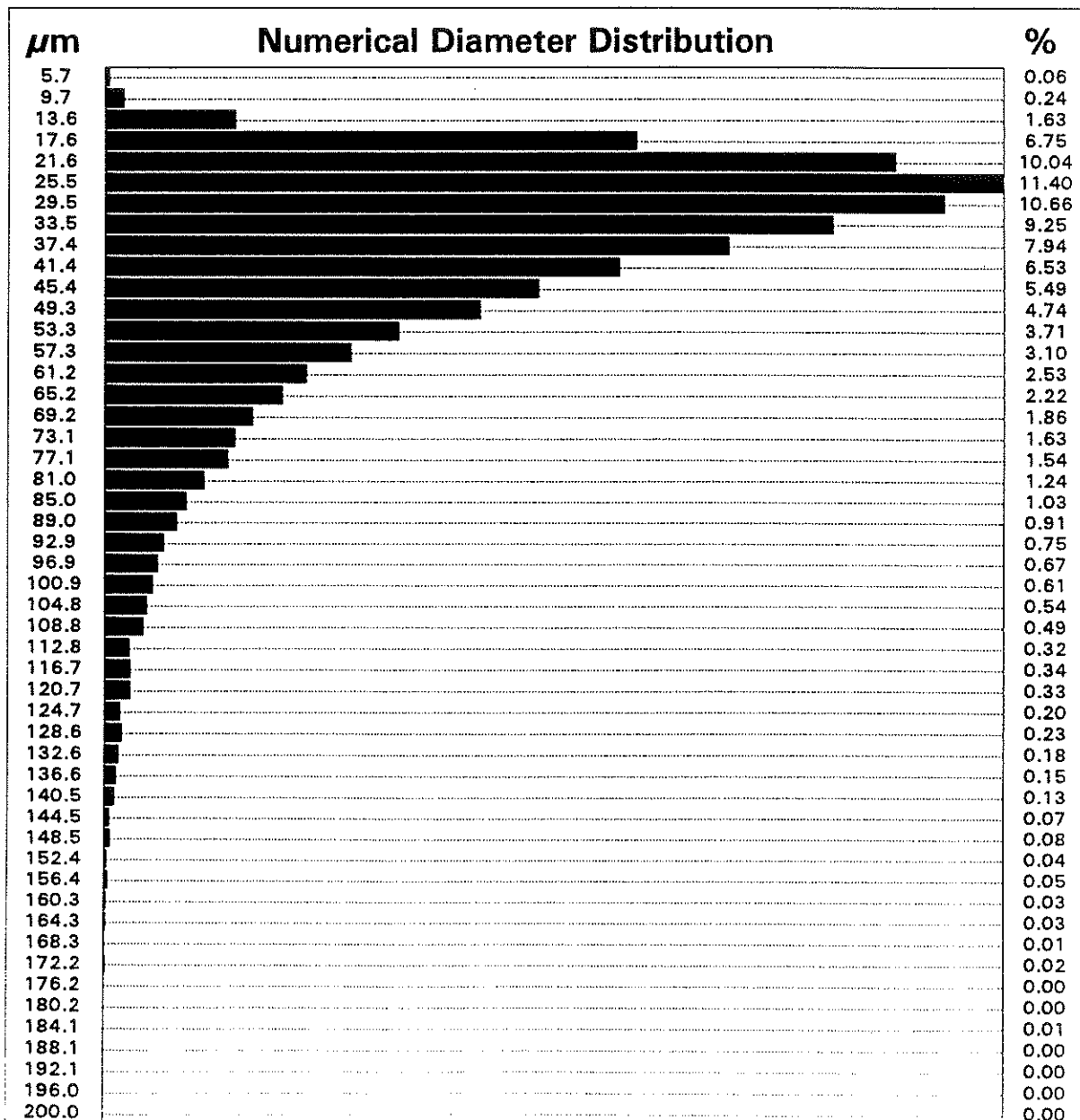

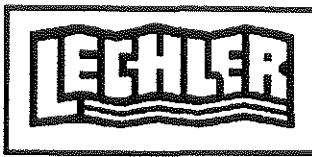

Lechler GmbH & Co. KG
 Präzisionsdüsen . Anlagenbau
 Höhenstraße 24 . Postfach 1709
 D - 70707 Fellbach / Germany
 Telefon (07 11) 58 53 - 01
 Telefax (07 11) 58 53 - 418
 Teletex 7 111 378

Droplet Size Analysis

Product Number : 212.085 X 8
 Date of Measurement : 22 NOV 1994 Mes.Point\mm\x/y/z : 0/0/250
 Liquid - Pressure : 60.0 bar Gas - Pressure : 0.00 bar
 Liquid - Flow : 1.18 l/min Gas - Flow : 0.00 m³/h i.N.
 Medium : Wasser Gas\Liquid - Rat : 0.00
 Remark : -- Test 7; body with 8 nozzles 212.085 --
 Sauter Mean Diameter: 73.57 μ m Arithm. Mean Value : 42.52 μ m

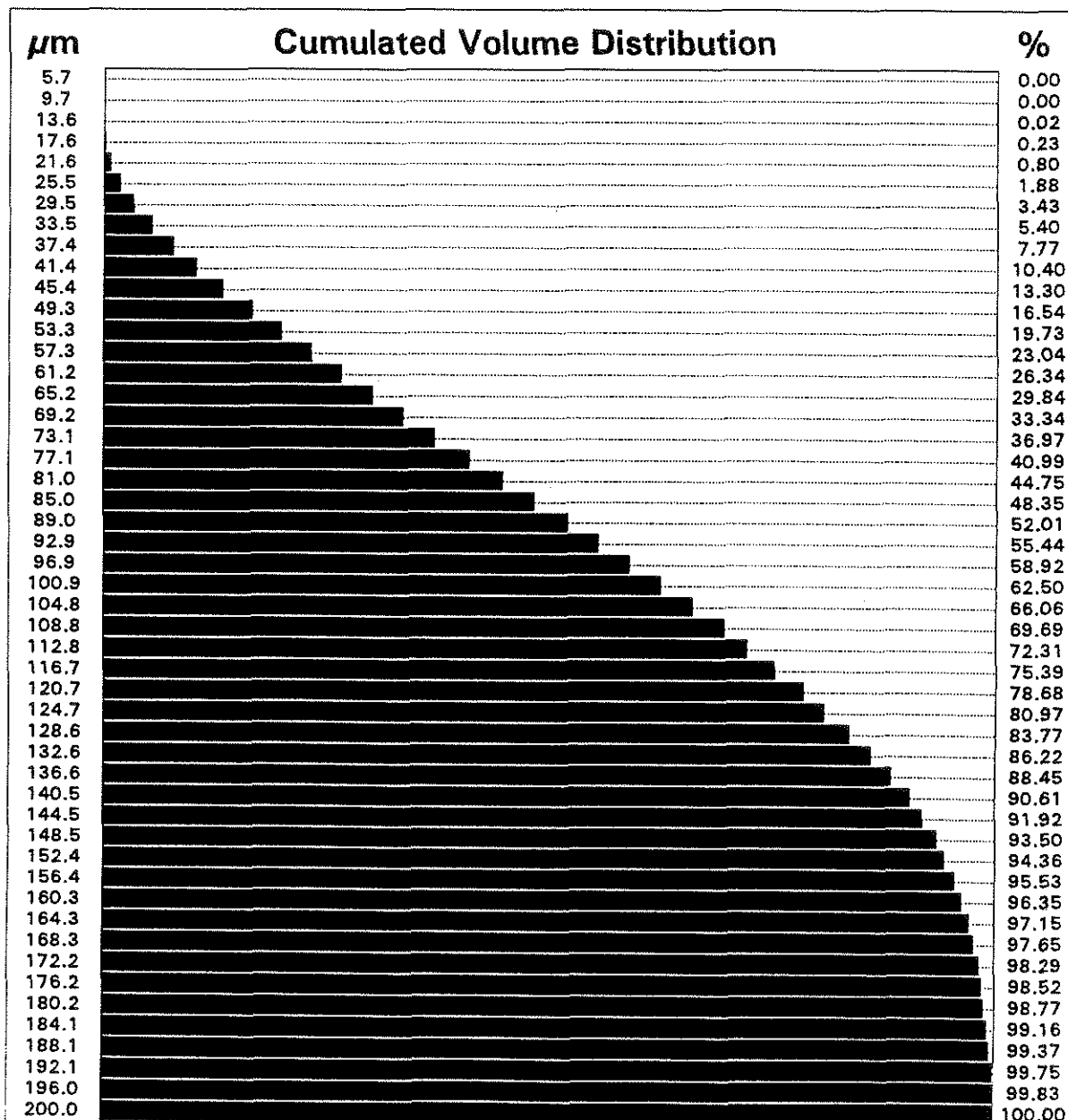

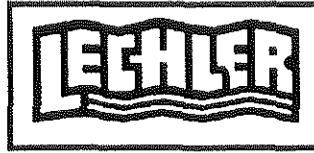

Lechler GmbH & Co. KG
Präzisionsdüsen . Anlagenbau
Höhenstraße 24 . Postfach 1709
D - 70707 Fellbach / Germany
Telefon (07 11) 58 53 - 01
Telefax (07 11) 58 53 - 418
Teletex 7 111 378

Droplet Size Analysis

Product Number : 212.085 X 8
Date of Measurement : 22 NOV 1994 Mes.Point\mm\x/y/z : -/75/1000
Liquid - Pressure : 60.0 bar Gas - Pressure : 0.00 bar
Liquid - Flow : 1.18 l/min Gas - Flow : 0.00 m³/h i.N.
Medium : Wasser Gas\Liquid - Rat : 0.00
Remark : -- Test 8; body with 8 nozzles 212.085 --

Results of Droplet Size Analysis

Number of Droplets = 58554
Arithmetic Mean Value = 36.93 μm
Standard Deviation = 63.24 %
Area Mean Diameter = 43.70 μm
Volume Mean Diameter = 51.45 μm
Sauter Mean Diameter = 71.33 μm

D(NUM) 10% = 14.79 μm
D(NUM) 50% = 27.55 μm
D(NUM) 90% = 65.13 μm

D(VOL) 10% = 38.36 μm
D(VOL) 50% = 86.61 μm
D(VOL) 90% = 147.16 μm



Lechler GmbH & Co. KG
 Präzisionsdüsen . Anlagenbau
 Höhenstraße 24 . Postfach 1709
 D - 70707 Fellbach / Germany
 Telefon (07 11) 58 53 - 01
 Telefax (07 11) 58 53 - 418
 Teletex 7 111 378

Droplet Size Analysis

Product Number : 212.085 X 8
 Date of Measurement : 22 NOV 1994 Mes.Point\mm\x/y/z : -/75/1000
 Liquid - Pressure : 60.0 bar Gas - Pressure : 0.00 bar
 Liquid - Flow : 1.18 l/min Gas - Flow : 0.00 m³/h i.N.
 Medium : Wasser Gas\Liquid - Rat : 0.00
 Remark : -- Test 8; body with 8 nozzles 212.085 --
 Sauter Mean Diameter: 71.33 μ m Arithm. Mean Value : 36.93 μ m

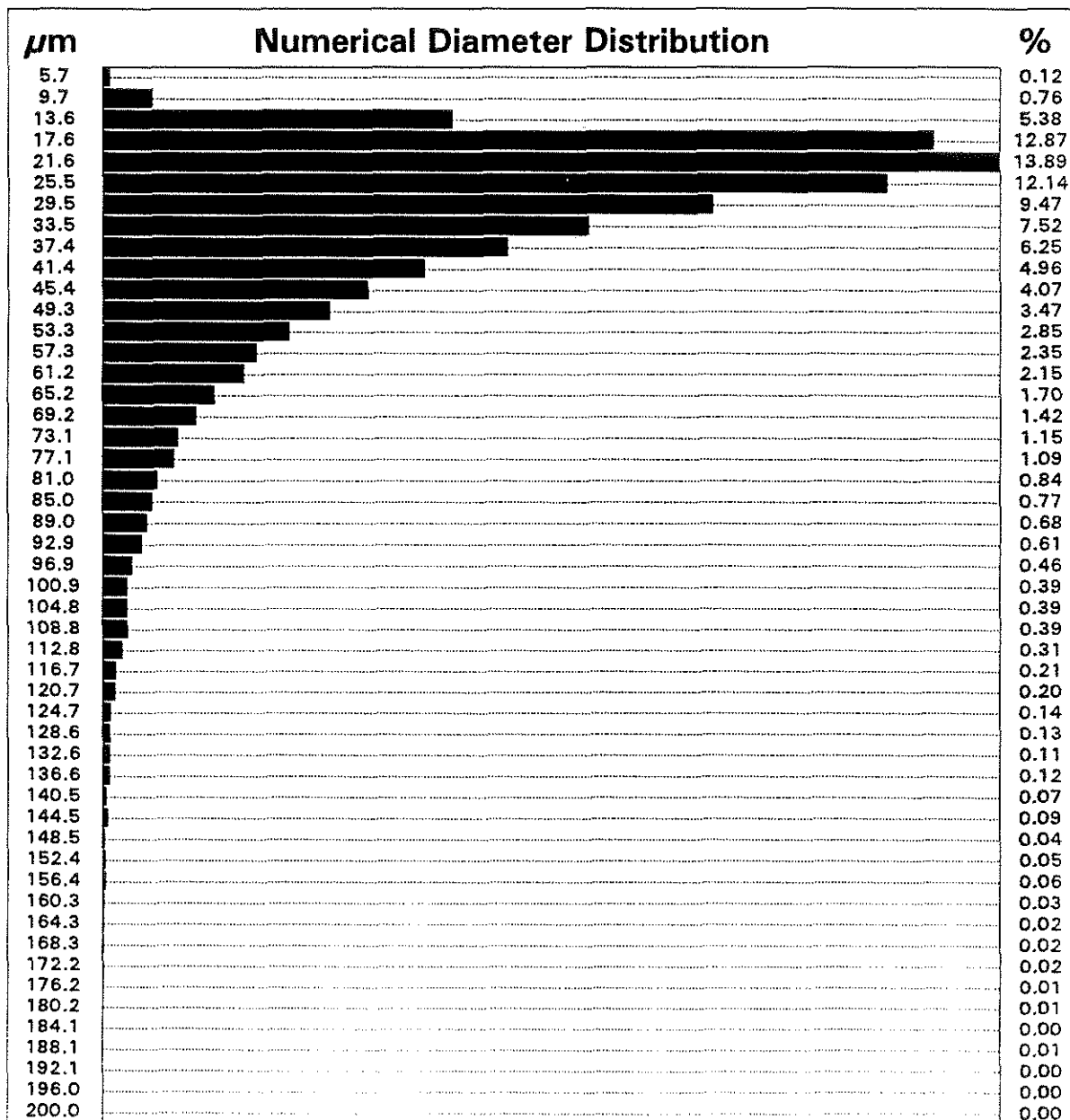



Lehler GmbH & Co. KG
 Präzisionsdüsen . Anlagenbau
 Höhenstraße 24 . Postfach 1709
 D - 70707 Fellbach / Germany
 Telefon (07 11) 58 53 - 01
 Telefax (07 11) 58 53 - 418
 Teletex 7 111 378

Droplet Size Analysis

Product Number : 212.085 X 8

Date of Measurement : 22 NOV 1994

Mes.Point\mm\x/y/z : -/75/1000

Liquid - Pressure : 60.0 bar

Gas - Pressure : 0.00 bar

Liquid - Flow : 1.18 l/min

Gas - Flow : 0.00 m³/h i.N.

Medium : Wasser

Gas\Liquid - Rat : 0.00

Remark : -- Test 8; body with 8 nozzles 212.085 --

Sauter Mean Diameter : 71.33 μ m

Arithm. Mean Value : 36.93 μ m

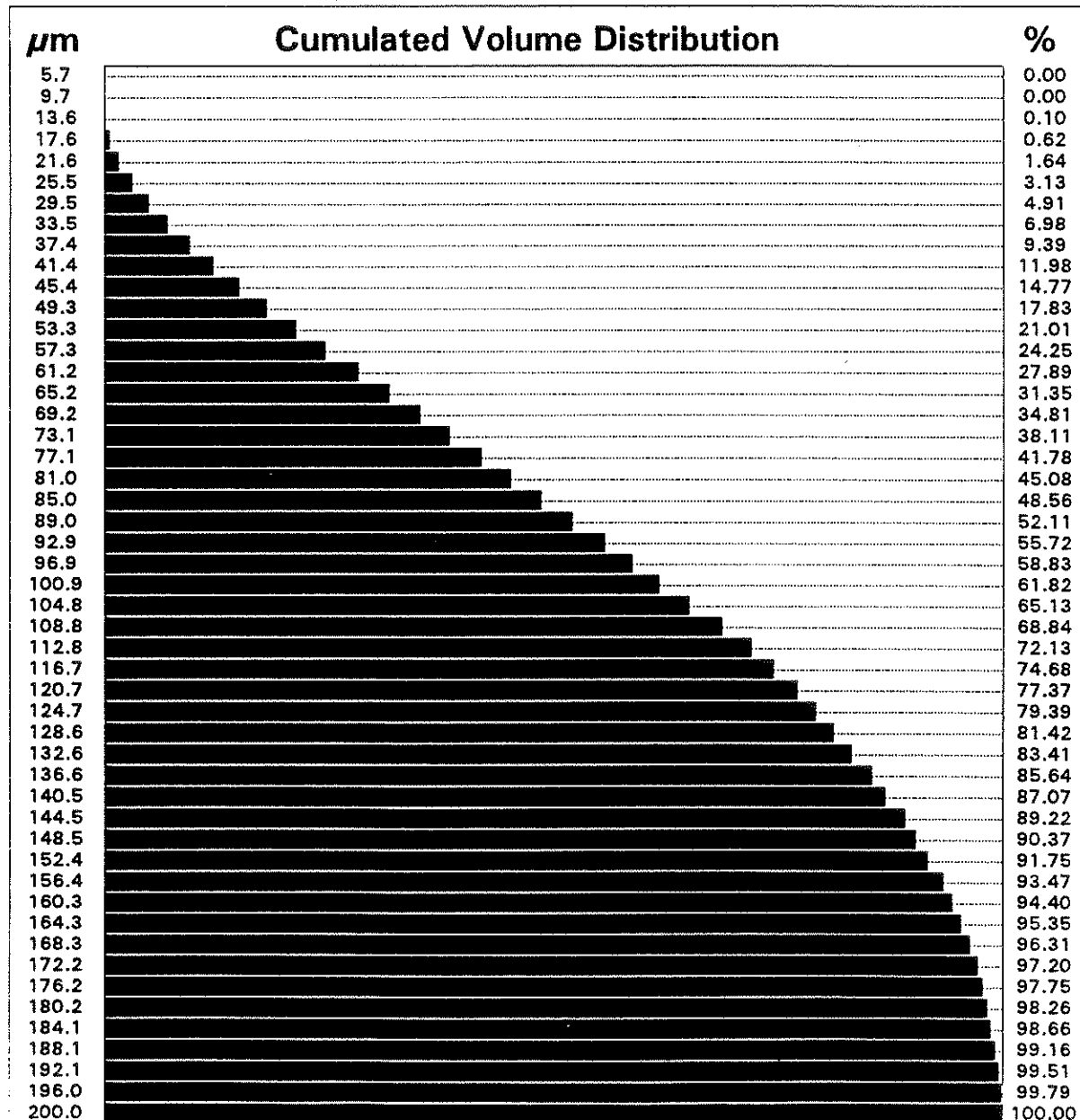

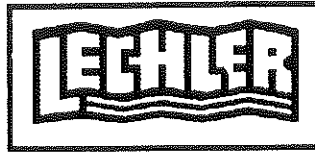

Lehler GmbH & Co. KG
Präzisionsdüsen . Anlagenbau
Höhenstraße 24 . Postfach 1709
D - 70707 Fellbach / Germany
Telefon (07 11) 58 53 - 01
Telefax (07 11) 58 53 - 418
Teletex 7 111 378

Droplet Size Analysis

Product Number : 212.085 X 8
Date of Measurement : 22 NOV 1994 Mes.Point\mm\x/y/z : -/150/1000
Liquid - Pressure : 60.0 bar Gas - Pressure : 0.00 bar
Liquid - Flow : 1.18 l/min Gas - Flow : 0.00 m³/h i.N.
Medium : Wasser Gas\Liquid - Rat : 0.00
Remark : -- Test 9; body with 8 nozzles 212.085 --

Results of Droplet Size Analysis

Number of Droplets = 43869
Arithmetic Mean Value = 34.64 μm
Standard Deviation = 70.54 %
Area Mean Diameter = 42.39 μm
Volume Mean Diameter = 51.01 μm
Sauter Mean Diameter = 73.85 μm

D(NUM) 10% = 12.18 μm
D(NUM) 50% = 24.37 μm
D(NUM) 90% = 65.08 μm

D(VOL) 10% = 40.27 μm
D(VOL) 50% = 92.08 μm
D(VOL) 90% = 142.72 μm



Lehler GmbH & Co. KG
 Präzisionsdüsen . Anlagenbau
 Höhenstraße 24 . Postfach 1705
 D - 70707 Fellbach / Germany
 Telefon (07 11) 58 53 - 01
 Telefax (07 11) 58 53 - 418
 Teletex 7 111 378

Droplet Size Analysis

Product Number : 212.085 X 8
 Date of Measurement : 22 NOV 1994 Mes.Point\mm\x/y/z : -/150/1000
 Liquid - Pressure : 60.0 bar Gas - Pressure : 0.00 bar
 Liquid - Flow : 1.18 l/min Gas - Flow : 0.00 m³/h i.N.
 Medium : Wasser Gas\Liquid - Rat : 0.00
 Remark : -- Test 9; body with 8 nozzles 212.085 --
 Sauter Mean Diameter : 73.85 µm Arithm. Mean Value : 34.64 µm

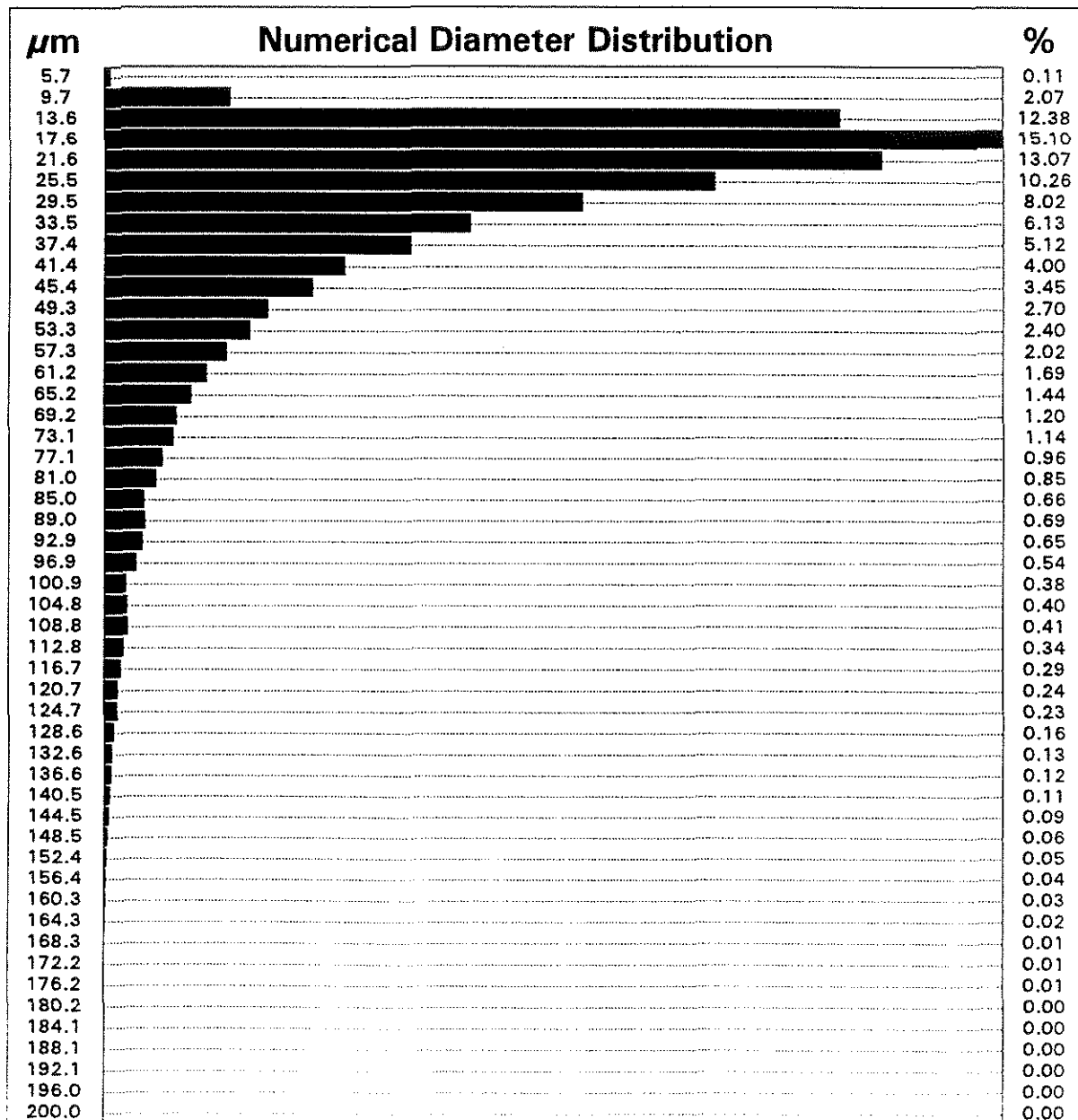

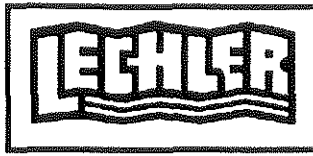

Lechler GmbH & Co. KG
 Präzisionsdüsen . Anlagenbau
 Höhenstraße 24 . Postfach 1709
 D - 70707 Fellbach / Germany
 Telefon (07 11) 58 53 - 01
 Telefax (07 11) 58 53 - 418
 Teletex 7 111 378

Droplet Size Analysis

Product Number : 212.085 X 8
 Date of Measurement : 22 NOV 1994 Mes.Point\mm\x/y/z : -/150/1000
 Liquid - Pressure : 60.0 bar Gas - Pressure : 0.00 bar
 Liquid - Flow : 1.18 l/min Gas - Flow : 0.00 m³/h i.N.
 Medium : Wasser Gas\Liquid - Rat : 0.00
 Remark : -- Test 9; body with 8 nozzles 212.085 --
 Sauter Mean Diameter : 73.85 μ m Arithm. Mean Value : 34.64 μ m

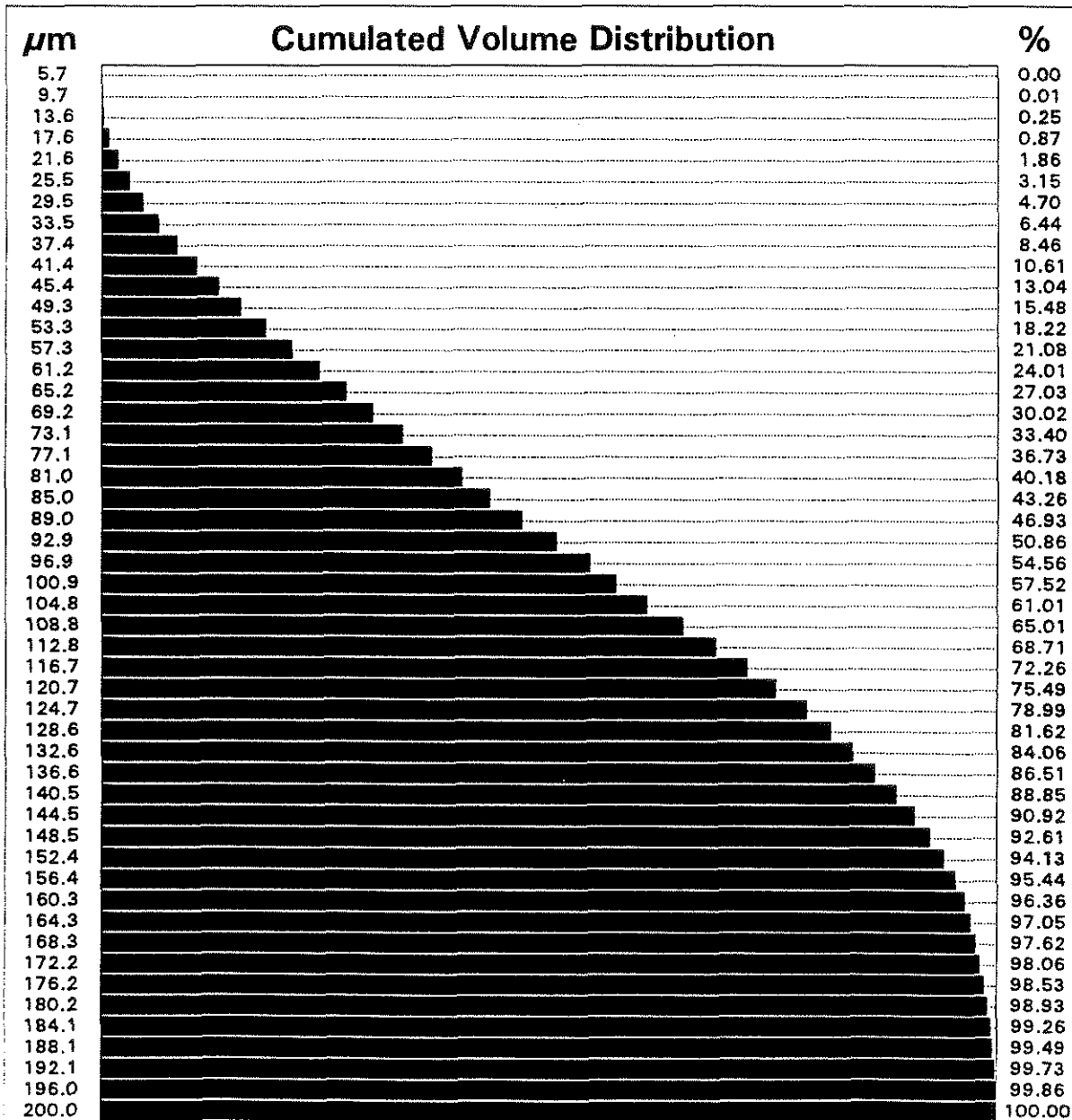



Lechler GmbH & Co. KG
Präzisionsdüsen . Anlagenbau
Höhenstraße 24 . Postfach 1709
D - 70707 Fellbach / Germany
Telefon (07 11) 58 53 - 01
Telefax (07 11) 58 53 - 418
Teletex 7 111 378

Droplet Size Analysis

Product Number : 212.085 X 12
Date of Measurement : 23 NOV 1994 Mes.Point\mm\x/y/z : -/-/1000
Liquid - Pressure : 20.0 bar Gas - Pressure : 0.00 bar
Liquid - Flow : 0.980 l/min Gas - Flow : 0.00 m³/h i.N.
Medium : Wasser Gas\Liquid - Rat : 0.00
Remark : -- Test 10; body with 12 nozzles 212.085 --

Results of Droplet Size Analysis

Number of Droplets = 36564
Arithmetic Mean Value = 45.03 μm
Standard Deviation = 64.30 %
Area Mean Diameter = 53.53 μm
Volume Mean Diameter = 62.75 μm
Sauter Mean Diameter = 86.22 μm

D(NUM) 10% = 17.82 μm
D(NUM) 50% = 33.35 μm
D(NUM) 90% = 83.45 μm

D(VOL) 10% = 48.23 μm
D(VOL) 50% = 105.30 μm
D(VOL) 90% = 160.39 μm

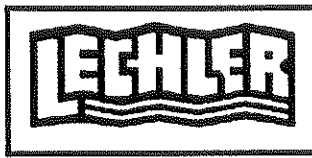

Lechler GmbH & Co. KG
 Präzisionsdüsen . Anlagenbau
 Höhenstraße 24 . Postfach 1709
 D - 70707 Fellbach / Germany
 Telefon (07 11) 58 53 - 01
 Telefax (07 11) 58 53 - 418
 Teletex 7 111 378

Droplet Size Analysis

Product Number : 212.085 X 12

Date of Measurement : 23 NOV 1994

Mes.Point\mm\x/y/z : -/-/1000

Liquid - Pressure : 20.0 bar

Gas - Pressure : 0.00 bar

Liquid - Flow : 0.980 l/min

Gas - Flow : 0.00 m³/h i.N.

Medium : Wasser

Gas\Liquid - Rat : 0.00

Remark : -- Test 10; body with 12 nozzles 212.085 --

Sauter Mean Diameter: 86.22 μm

Arithm. Mean Value : 45.03 μm

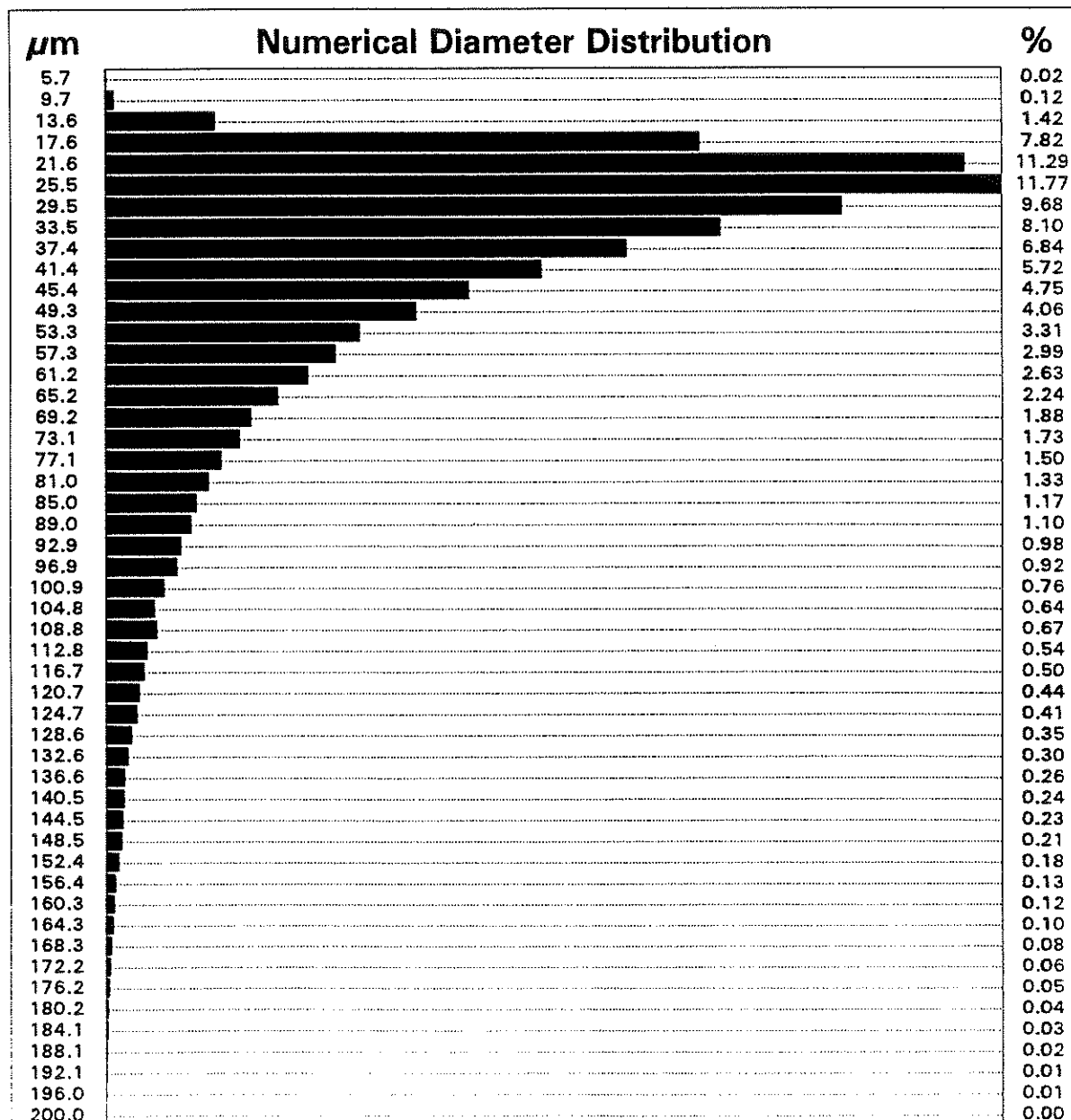



Lechler GmbH & Co. KG
 Präzisionsdüsen . Anlagenbau
 Höhenstraße 24 . Postfach 1709
 D - 70707 Fellbach / Germany
 Telefon (07 11) 58 53 - 01
 Telefax (07 11) 58 53 - 418
 Teletex 7 111 378

Droplet Size Analysis

Product Number : 212.085 X 12

Date of Measurement : 23 NOV 1994

Mes.Point\mm\x/y/z : -/-/1000

Liquid - Pressure : 20.0 bar

Gas - Pressure : 0.00 bar

Liquid - Flow : 0.980 l/min

Gas - Flow : 0.00 m³/h i.N.

Medium : Wasser

Gas\Liquid - Rat : 0.00

Remark : -- Test 10; body with 12 nozzles 212.085 --

Sauter Mean Diameter: 86.22 μm

Arithm. Mean Value : 45.03 μm

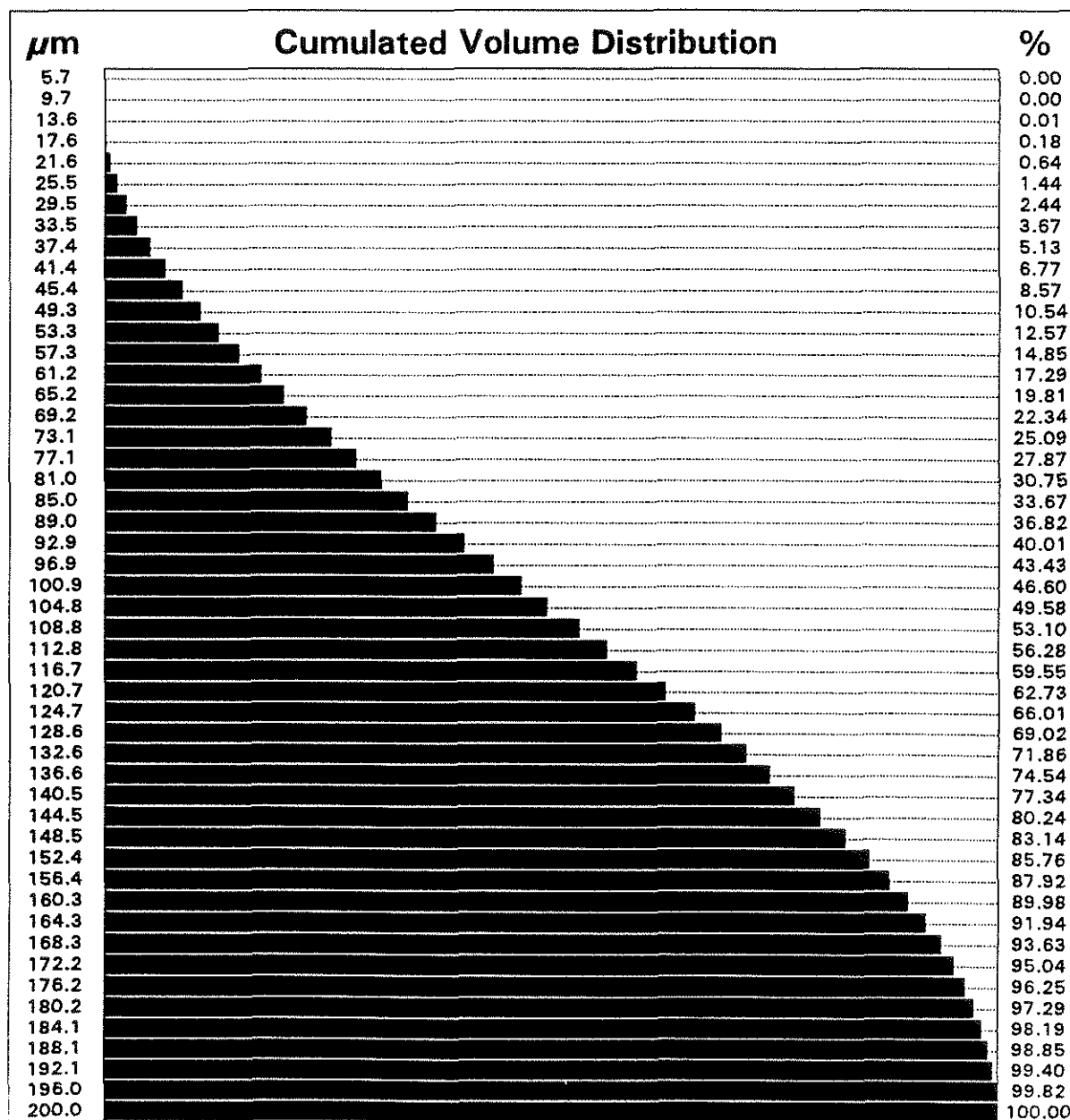

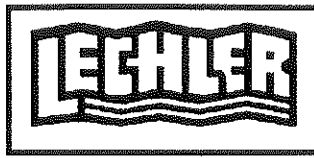

Lechler GmbH & Co. KG
Präzisionsdüsen . Anlagenbau
Höhenstraße 24 . Postfach 1709
D - 70707 Fellbach / Germany
Telefon (07 11) 58 53 - 01
Telefax (07 11) 58 53 - 418
Teletex 7 111 378

Droplet Size Analysis

Product Number : 212.085 X 12
Date of Measurement : 23 NOV 1994 Mes.Point\mm\x/y/z : -/-/1000
Liquid - Pressure : 40.0 bar Gas - Pressure : 0.00 bar
Liquid - Flow : 1.43 l/min Gas - Flow : 0.00 m³/h i.N.
Medium : Wasser Gas\Liquid - Rat : 0.00
Remark : -- Test 11; body with 12 nozzles 212.085 --

Results of Droplet Size Analysis

Number of Droplets = 35607
Arithmetic Mean Value = 46.26 μm
Standard Deviation = 59.34 %
Area Mean Diameter = 53.80 μm
Volume Mean Diameter = 62.05 μm
Sauter Mean Diameter = 82.54 μm

D(NUM) 10% = 19.11 μm

D(NUM) 50% = 35.87 μm

D(NUM) 90% = 81.55 μm

D(VOL) 10% = 46.20 μm

D(VOL) 50% = 97.95 μm

D(VOL) 90% = 158.03 μm

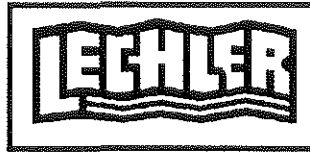

Lehler GmbH & Co. KG
 Präzisionsdüsen . Anlagenbau
 Höhenstraße 24 . Postfach 1709
 D - 70707 Fellbach / Germany
 Telefon (07 11) 58 53 - 01
 Telefax (07 11) 58 53 - 418
 Teletex 7 111 378

Droplet Size Analysis

Product Number : 212.085 X 12

Date of Measurement : 23 NOV 1994

Mes.Point\mm\x/y/z : -/-/1000

Liquid - Pressure : 40.0 bar

Gas - Pressure : 0.00 bar

Liquid - Flow : 1.43 l/min

Gas - Flow : 0.00 m³/h i.N.

Medium : Wasser

Gas\Liquid - Rat : 0.00

Remark : -- Test 11; body with 12 nozzles 212.085 --

Sauter Mean Diameter: 82.54 μm

Arithm. Mean Value : 46.26 μm

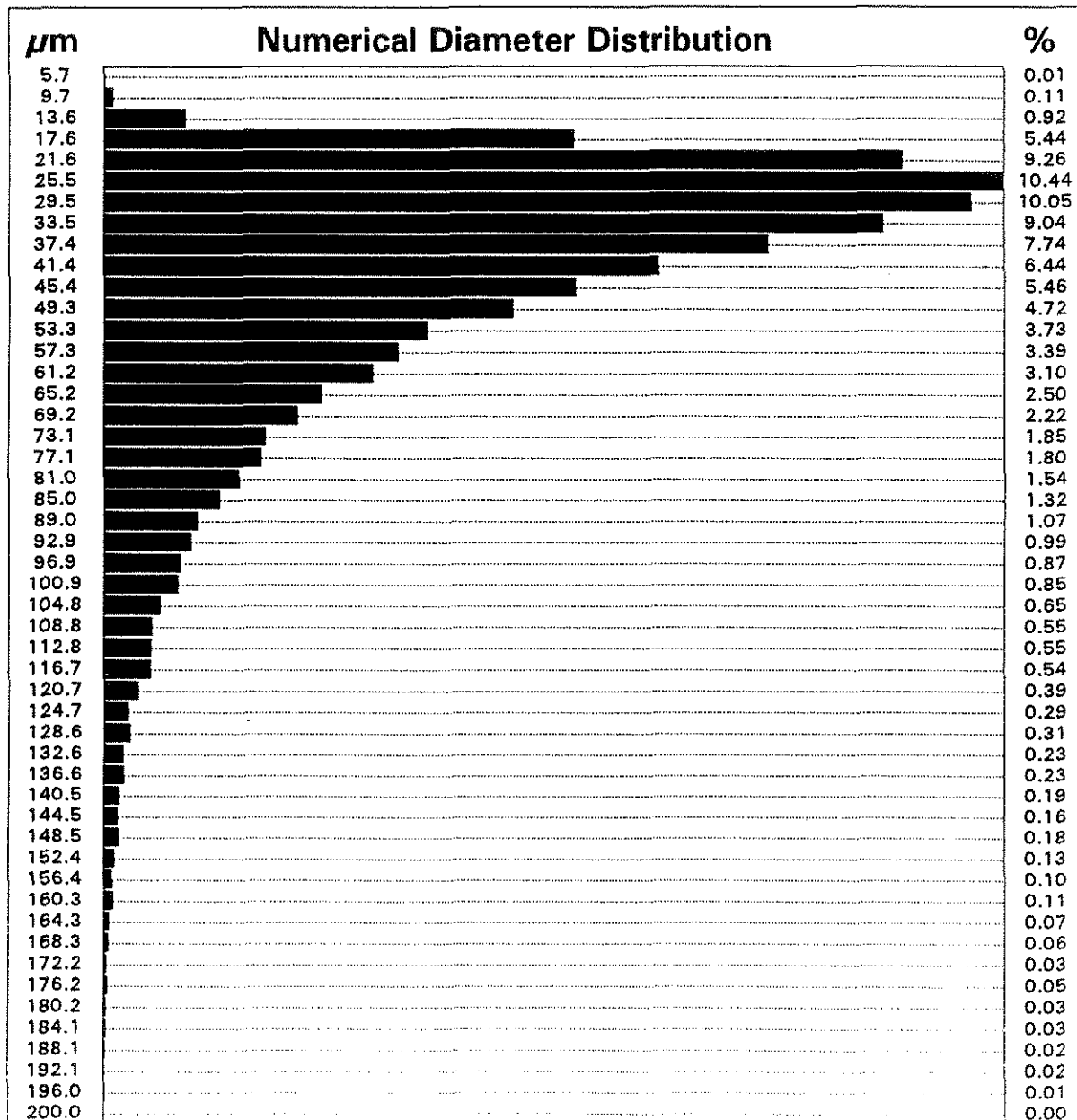

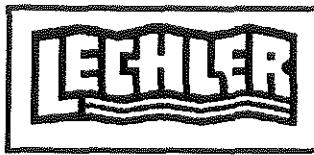

Lechler GmbH & Co. KG
 Präzisionsdüsen . Anlagenbau
 Höhenstraße 24 . Postfach 1709
 D - 70707 Fellbach / Germany
 Telefon (07 11) 58 53 - 01
 Telefax (07 11) 58 53 - 418
 Teletex 7 111 378

Droplet Size Analysis

Product Number : 212.085 X 12

Date of Measurement : 23 NOV 1994

Mes.Point\mm\x/y/z : -/-/1000

Liquid - Pressure : 40.0 bar

Gas - Pressure : 0.00 bar

Liquid - Flow : 1.43 l/min

Gas - Flow : 0.00 m³/h i.N.

Medium : Wasser

Gas\Liquid - Rat : 0.00

Remark : -- Test 11; body with 12 nozzles 212.085 --

Sauter Mean Diameter: 82.54 μm

Arithm. Mean Value : 46.26 μm

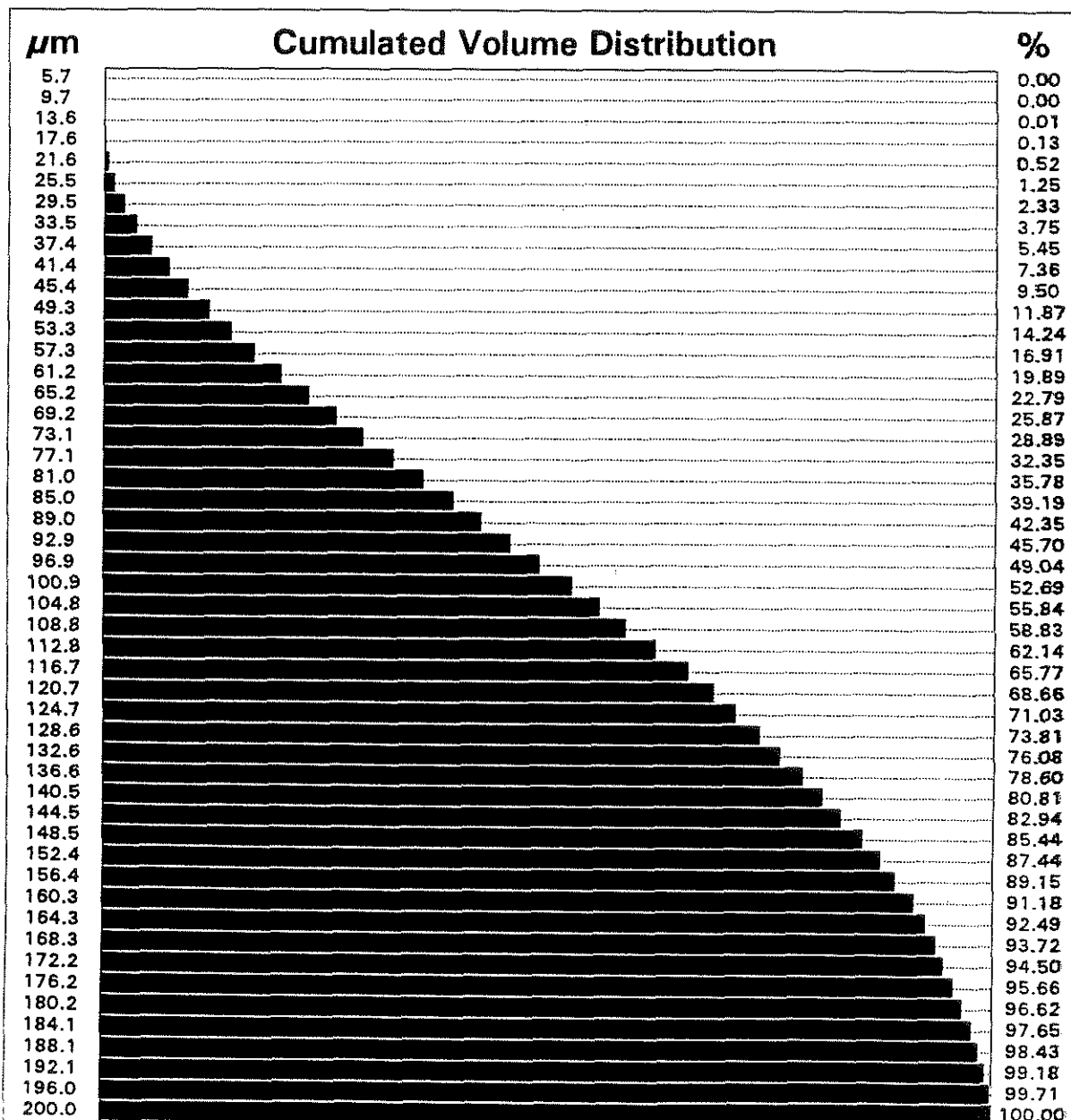

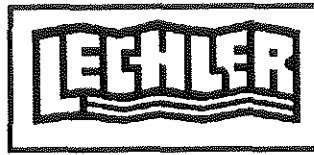

Lechler GmbH & Co. KG
Präzisionsdüsen . Anlagenbau
Höhenstraße 24 . Postfach 1709
D - 70707 Fellbach / Germany
Telefon (07 11) 58 53 - 01
Telefax (07 11) 58 53 - 418
Teletex 7 111 378

Droplet Size Analysis

Product Number : 212.085 X 12
Date of Measurement : 23 NOV 1994 Mes.Point\mm\x/y/z : -/-/1000
Liquid - Pressure : 60.0 bar Gas - Pressure : 0.00 bar
Liquid - Flow : 1.77 l/min Gas - Flow : 0.00 m³/h i.N.
Medium : Wasser Gas\Liquid - Rat : 0.00
Remark : -- Test 12; body with 12 nozzles 212.085 --

Results of Droplet Size Analysis

Number of Droplets = 35086
Arithmetic Mean Value = 42.41 μm
Standard Deviation = 64.12 %
Area Mean Diameter = 50.38 μm
Volume Mean Diameter = 59.02 μm
Sauter Mean Diameter = 81.03 μm

D(NUM) 10% = 16.12 μm
D(NUM) 50% = 31.64 μm
D(NUM) 90% = 77.68 μm

D(VOL) 10% = 45.20 μm
D(VOL) 50% = 98.00 μm
D(VOL) 90% = 154.71 μm

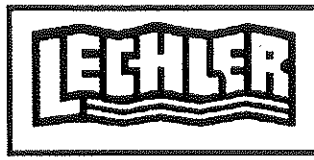

Lechler GmbH & Co. KG
 Präzisionsdüsen . Anlagenbau
 Höhenstraße 24 . Postfach 1709
 D - 70707 Fellbach / Germany
 Telefon (07 11) 58 53 - 01
 Telefax (07 11) 58 53 - 418
 Teletex 7 111 378

Droplet Size Analysis

Product Number : 212.085 X 12

Date of Measurement : 23 NOV 1994

Mes.Point\mm\x/y/z : -/-/1000

Liquid - Pressure : 60.0 bar

Gas - Pressure : 0.00 bar

Liquid - Flow : 1.77 l/min

Gas - Flow : 0.00 m³/h i.N.

Medium : Wasser

Gas\Liquid - Rat : 0.00

Remark : -- Test 12; body with 12 nozzles 212.085 --

Sauter Mean Diameter: 81.03 μm

Arithm. Mean Value : 42.41 μm

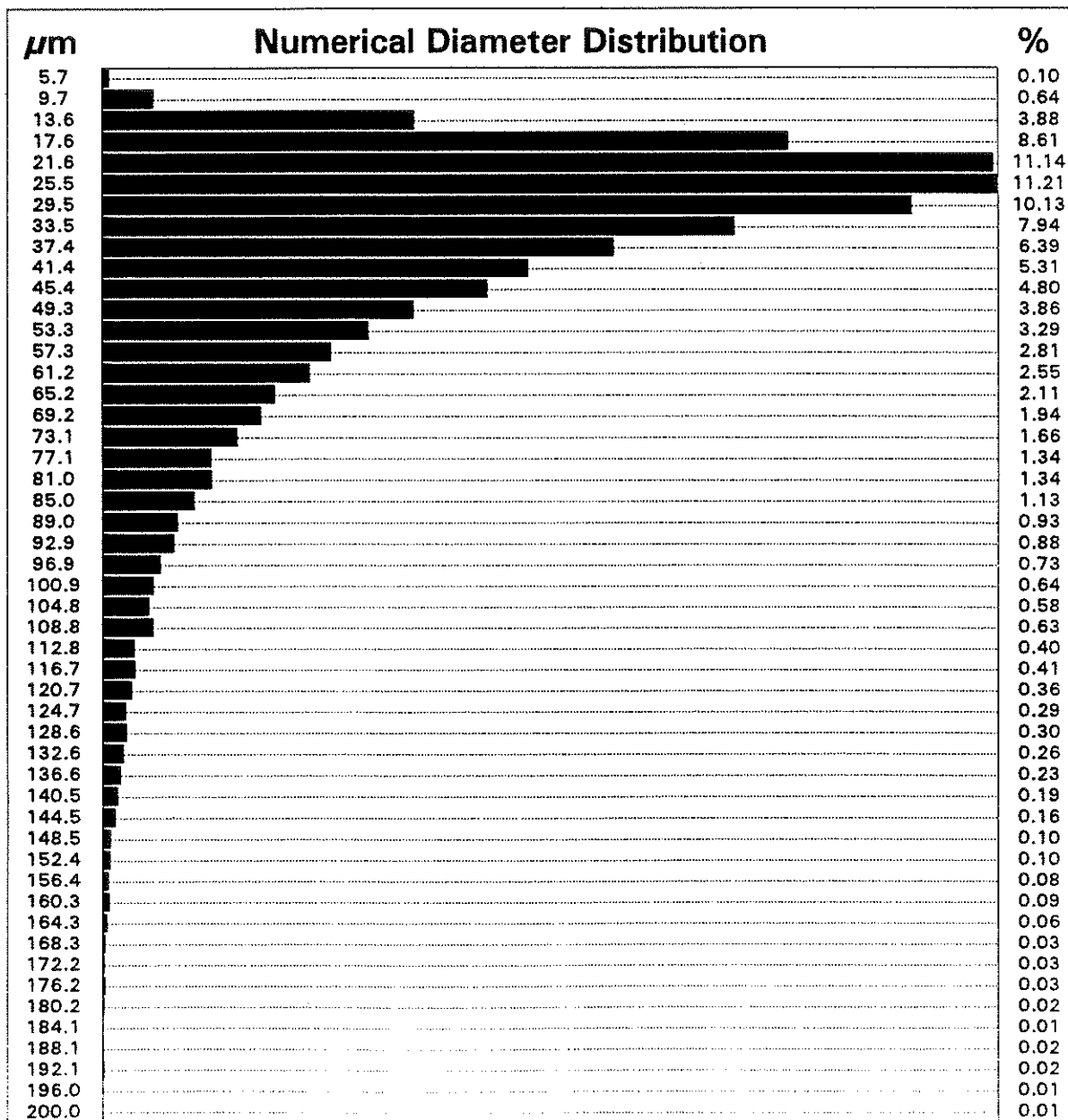

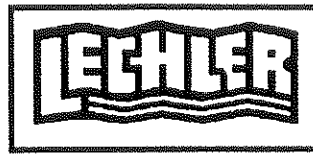

Lechler GmbH & Co. KG
 Präzisionsdüsen · Anlagenbau
 Höhenstraße 24 · Postfach 1709
 D - 70707 Fellbach / Germany
 Telefon (07 11) 58 53 - 01
 Telefax (07 11) 58 53 - 418
 Teletex 7 111 378

Droplet Size Analysis

Product Number : 212.085 X 12

Date of Measurement : 23 NOV 1994

Mes.Point\mm\x/y/z : -/-/1000

Liquid - Pressure : 60.0 bar

Gas - Pressure : 0.00 bar

Liquid - Flow : 1.77 l/min

Gas - Flow : 0.00 m³/h i.N.

Medium : Wasser

Gas\Liquid - Rat : 0.00

Remark : -- Test 12; body with 12 nozzles 212.085 --

Sauter Mean Diameter: 81.03 μ m

Arithm. Mean Value : 42.41 μ m

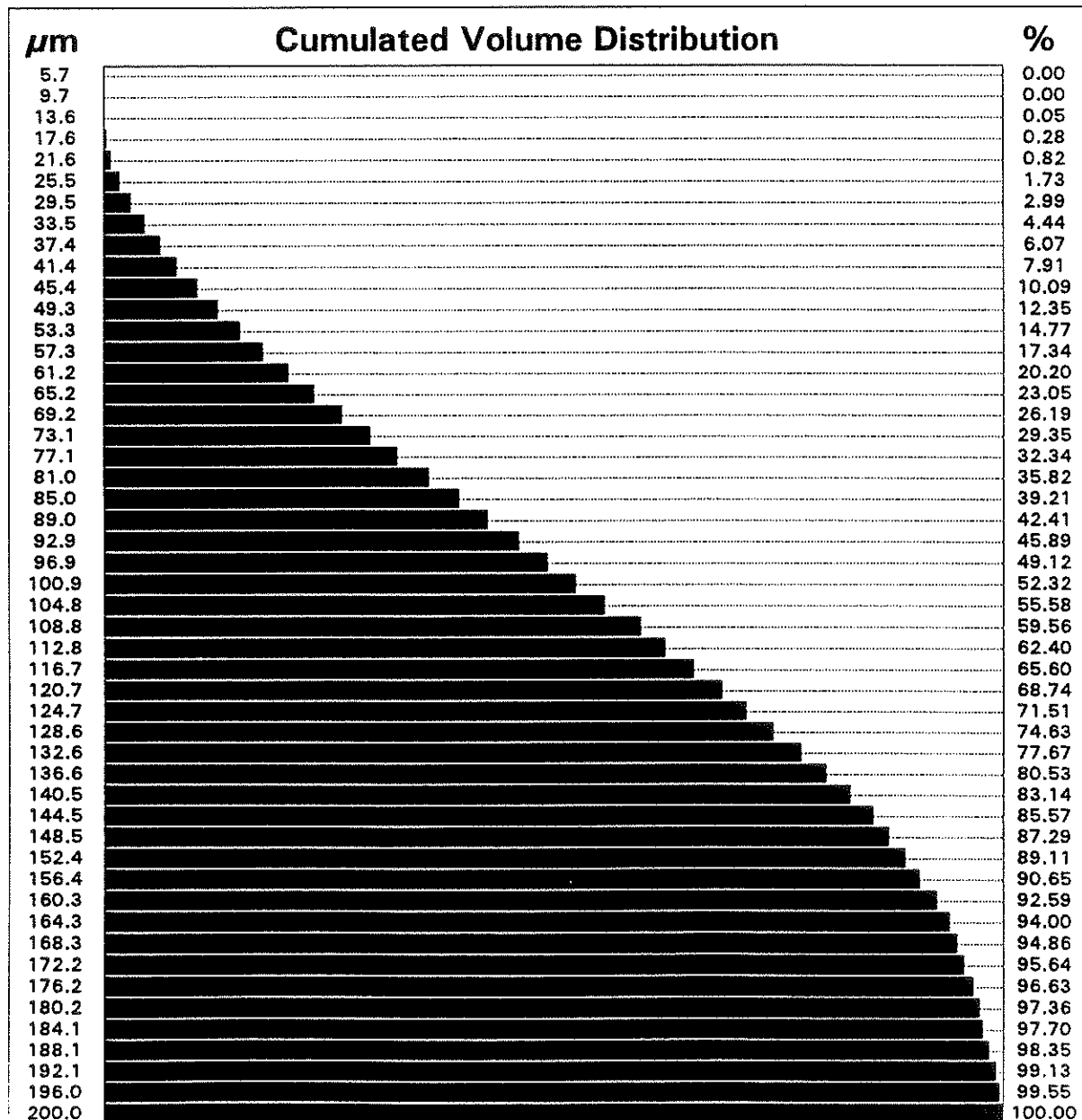



Lechler GmbH & Co. KG
Präzisionsdüsen . Anlagenbau
Höhenstraße 24 . Postfach 1709
D - 70707 Fellbach / Germany
Telefon (07 11) 58 53 - 01
Telefax (07 11) 58 53 - 418
Teletex 7 111 378

Droplet Size Analysis

Product Number : 212.085 X 12
Date of Measurement : 23 NOV 1994 Mes.Point\mm\x/y/z : -/75/1000
Liquid - Pressure : 60.0 bar Gas - Pressure : 0.00 bar
Liquid - Flow : 1.77 l/min Gas - Flow : 0.00 m³/h i.N.
Medium : Wasser Gas\Liquid - Rat : 0.00
Remark : -- Test 13; body with 12 nozzles 212.085 --

Results of Droplet Size Analysis

Number of Droplets = 37330
Arithmetic Mean Value = 33.02 μm
Standard Deviation = 82.27 %
Area Mean Diameter = 42.76 μm
Volume Mean Diameter = 53.29 μm
Sauter Mean Diameter = 82.75 μm

D(NUM) 10% = 9.55 μm

D(NUM) 50% = 21.26 μm

D(NUM) 90% = 67.40 μm

D(VOL) 10% = 46.52 μm

D(VOL) 50% = 104.80 μm

D(VOL) 90% = 156.40 μm

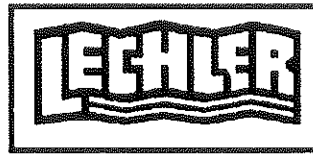

Lechler GmbH & Co. KG
 Präzisionsdüsen · Anlagenbau
 Höhenstraße 24 · Postfach 1700
 D - 70707 Fellbach / Germany
 Telefon (07 11) 58 53 - 01
 Telefax (07 11) 58 53 - 418
 Teletex 7 111 378

Droplet Size Analysis

Product Number : 212.085 X 12

Date of Measurement : 23 NOV 1994

Mes.Point\mm\x/y/z : -/75/1000

Liquid - Pressure : 60.0 bar

Gas - Pressure : 0.00 bar

Liquid - Flow : 1.77 l/min

Gas - Flow : 0.00 m³/h i.N.

Medium : Wasser

Gas\Liquid - Rat : 0.00

Remark : -- Test 13; body with 12 nozzles 212.085 --

Sauter Mean Diameter : 82.75 μm

Arithm. Mean Value : 33.02 μm

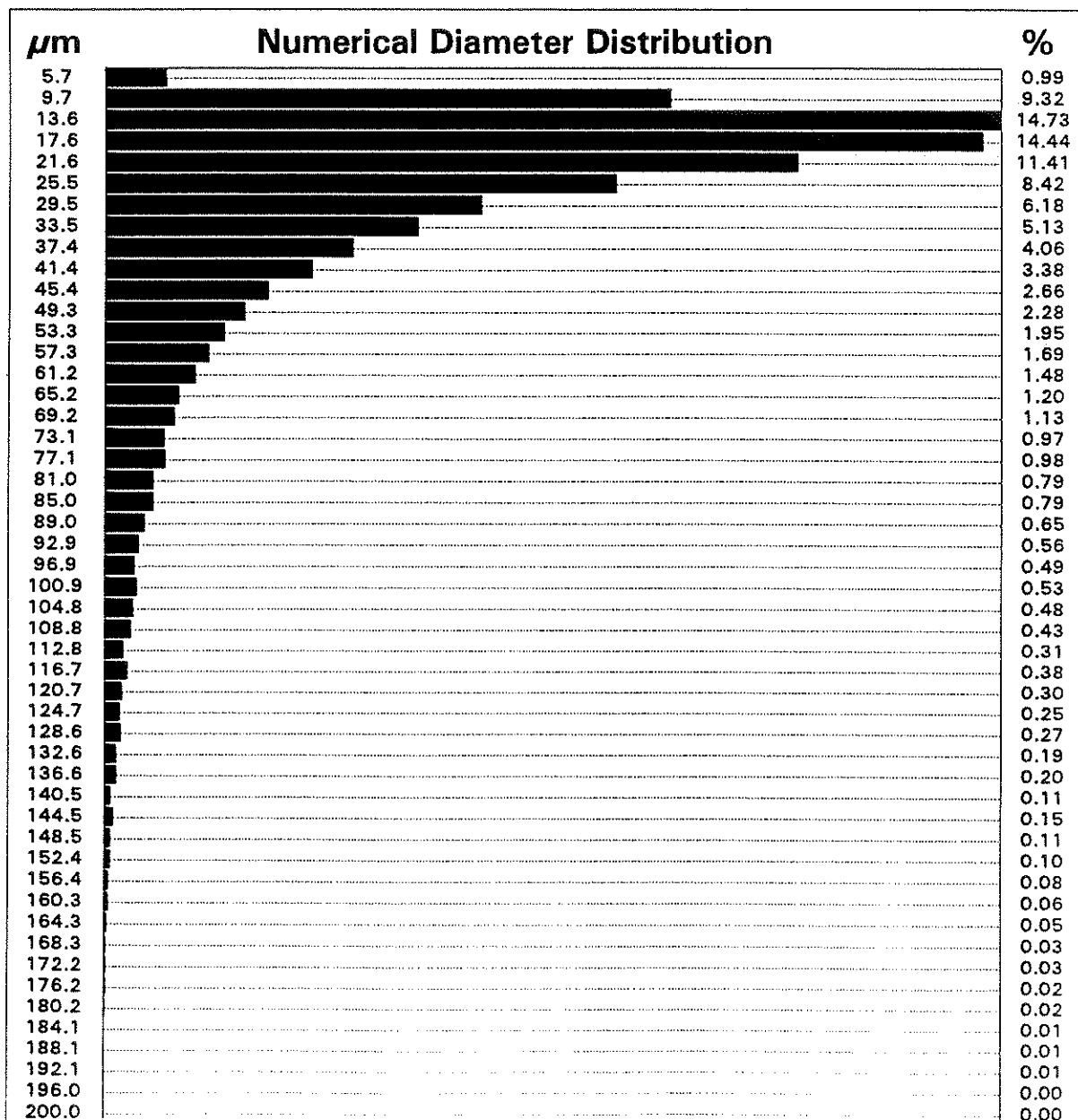

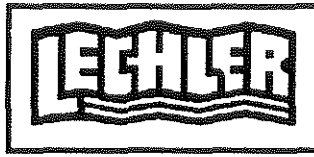

Lehler GmbH & Co. KG
 Präzisionsdüsen . Anlagenbau
 Höhenstraße 24 . Postfach 1709
 D - 70707 Fellbach / Germany
 Telefon (07 11) 58 53 - 01
 Telefax (07 11) 58 53 - 418
 Teletex 7 111 378

Droplet Size Analysis

Product Number : 212.085 X 12

Date of Measurement : 23 NOV 1994

Mes.Point\mm\x/y/z : -/75/1000

Liquid - Pressure : 60.0 bar

Gas - Pressure : 0.00 bar

Liquid - Flow : 1.77 l/min

Gas - Flow : 0.00 m³/h i.N.

Medium : Wasser

Gas\Liquid - Rat : 0.00

Remark : -- Test 13; body with 12 nozzles 212.085 --

Sauter Mean Diameter: 82.75 μ m

Arithm. Mean Value : 33.02 μ m

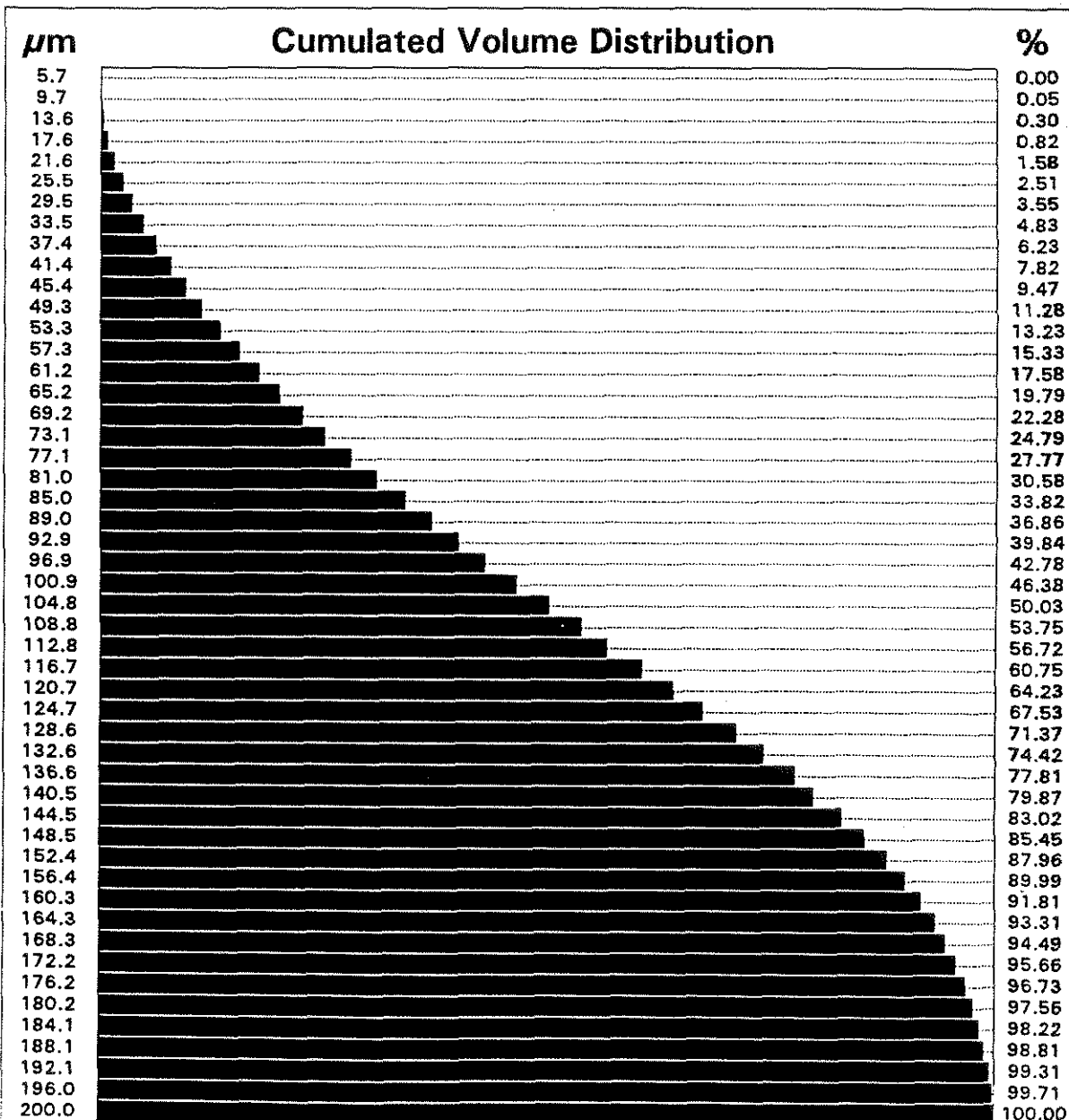

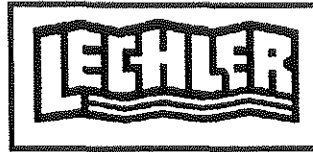

Lechler GmbH & Co. KG
Präzisionsdüsen . Anlagenbau
Höhenstraße 24 . Postfach 1709
D - 70707 Fellbach / Germany
Telefon (07 11) 58 53 - 01
Telefax (07 11) 58 53 - 418
Teletex 7 111 378

Droplet Size Analysis

Product Number : 212.085 X 12
Date of Measurement : 23 NOV 1994 Mes.Point\mm\x/y/z : -/150/1000
Liquid - Pressure : 60.0 bar Gas - Pressure : 0.00 bar
Liquid - Flow : 1.77 l/min Gas - Flow : 0.00 m³/h i.N.
Medium : Wasser Gas\Liquid - Rat : 0.00
Remark : -- Test 14; body with 12 nozzles 212.085 --

Results of Droplet Size Analysis

Number of Droplets = 40738
Arithmetic Mean Value = 29.03 μm
Standard Deviation = 91.25 %
Area Mean Diameter = 39.30 μm
Volume Mean Diameter = 50.59 μm
Sauter Mean Diameter = 83.84 μm

D(NUM) 10% = 7.16 μm
D(NUM) 50% = 17.42 μm
D(NUM) 90% = 60.12 μm

D(VOL) 10% = 47.01 μm
D(VOL) 50% = 107.87 μm
D(VOL) 90% = 164.58 μm



Lechler GmbH & Co. KG
 Präzisionsdüsen · Anlagenbau
 Höhenstraße 24 · Postfach 1709
 D - 70707 Fellbach / Germany
 Telefon (07 11) 58 53 - 01
 Telefax (07 11) 58 53 - 418
 Teletex 7 111 378

Droplet Size Analysis

Product Number : 212.085 X 12

Date of Measurement : 23 NOV 1994

Mes.Point\mm\x/y/z : -/150/1000

Liquid - Pressure : 60.0 bar

Gas - Pressure : 0.00 bar

Liquid - Flow : 1.77 l/min

Gas - Flow : 0.00 m³/h i.N.

Medium : Wasser

Gas\Liquid - Rat : 0.00

Remark : -- Test 14; body with 12 nozzles 212.085 --

Sauter Mean Diameter : 83.84 μm

Arithm. Mean Value : 29.03 μm

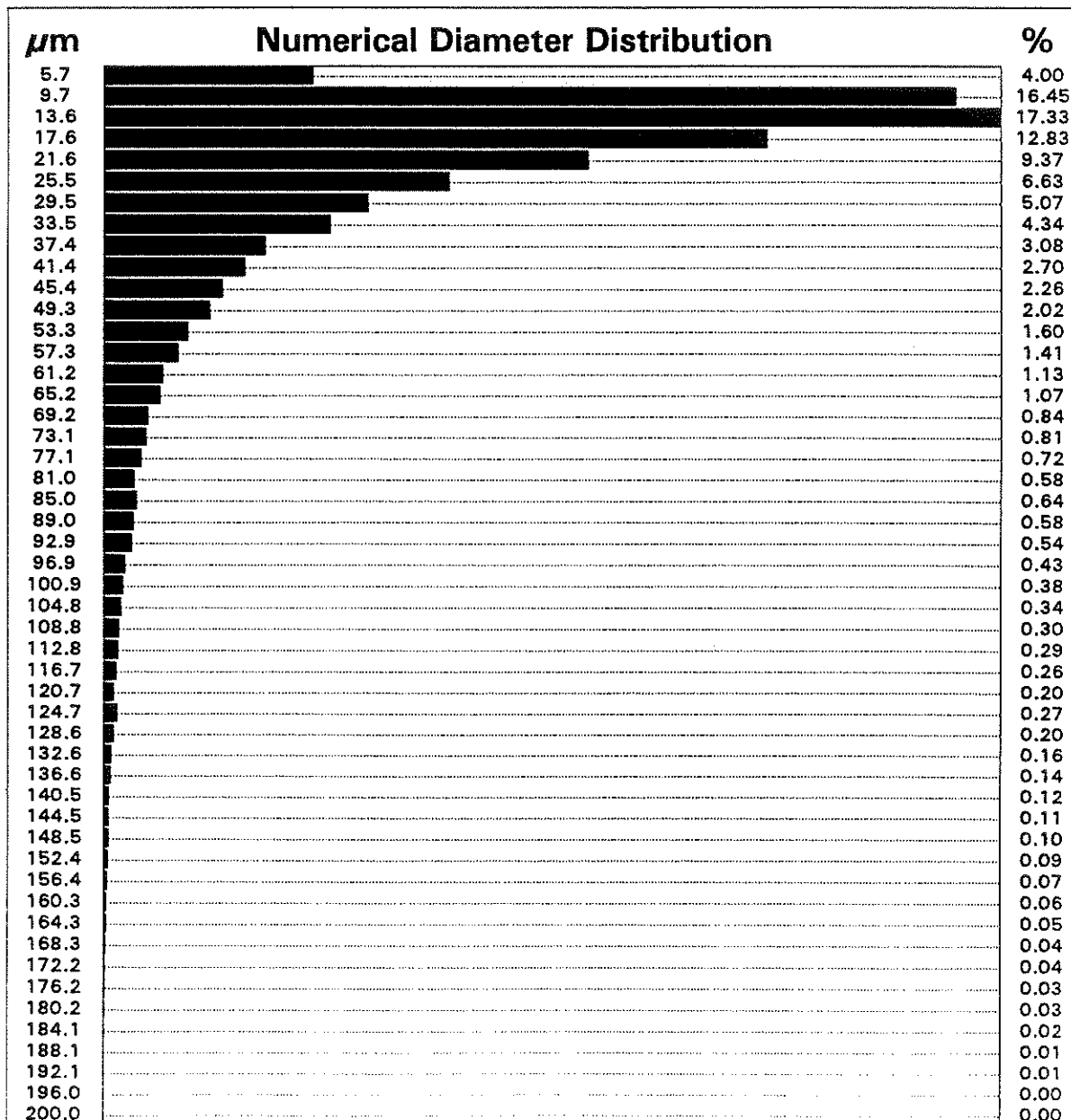



Lechler GmbH & Co. KG
 Präzisionsdüsen . Anlagenbau
 Höhenstraße 24 . Postfach 1709
 D - 70707 Fellbach / Germany
 Telefon (07 11) 58 53 - 01
 Telefax (07 11) 58 53 - 418
 Teletex 7 111 378

Droplet Size Analysis

Product Number : 212.085 X 12

Date of Measurement : 23 NOV 1994

Mes.Point\mm\x/y/z : -/150/1000

Liquid - Pressure : 60.0 bar

Gas - Pressure : 0.00 bar

Liquid - Flow : 1.77 l/min

Gas - Flow : 0.00 m³/h i.N.

Medium : Wasser

Gas\Liquid - Rat : 0.00

Remark : -- Test 14; body with 12 nozzles 212.085 --

Sauter Mean Diameter: 83.84 μ m

Arithm. Mean Value : 29.03 μ m

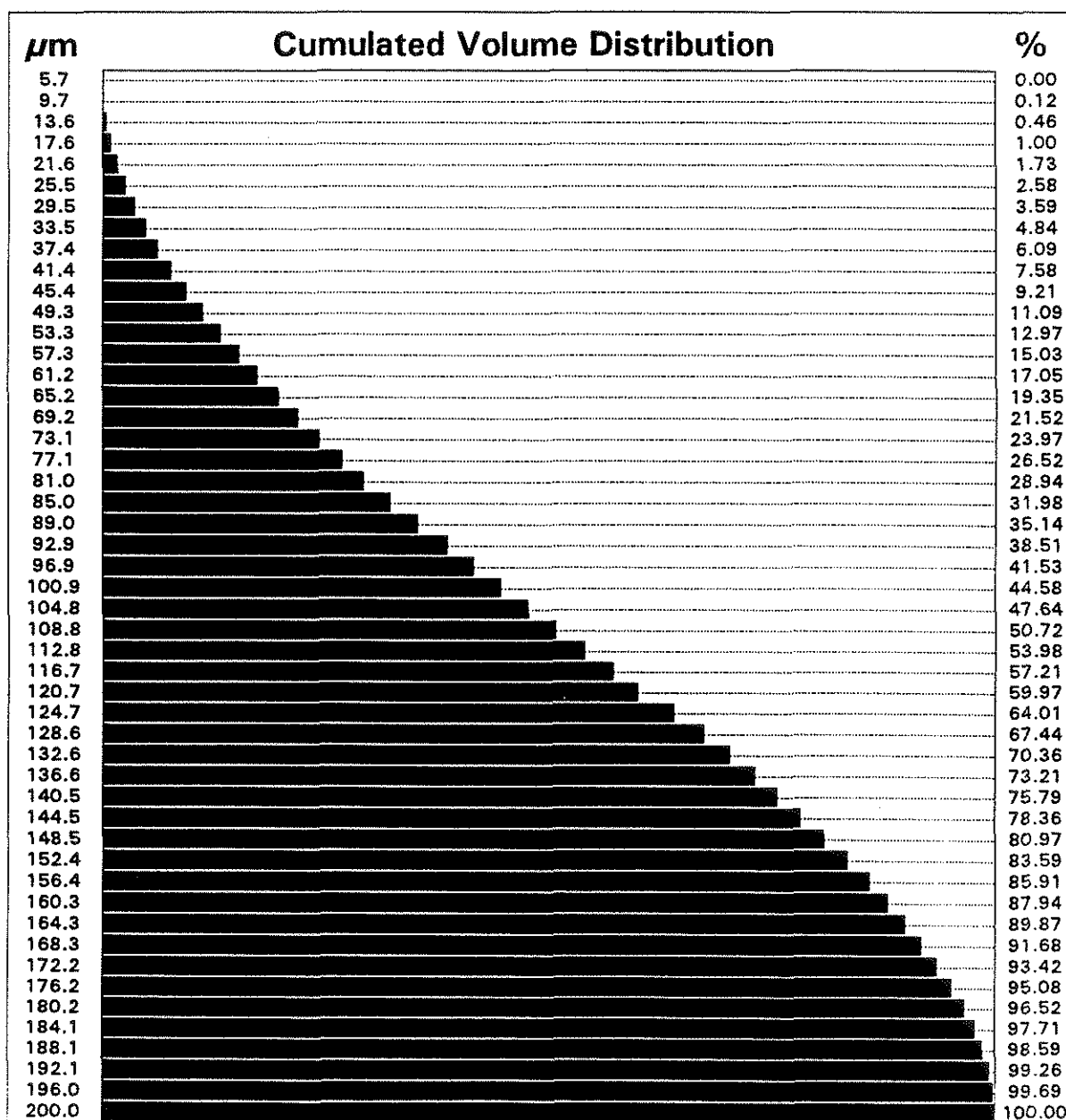

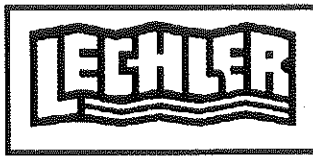

Lechler GmbH & Co. KG
Präzisionsdüsen . Anlagenbau
Höhenstraße 24 . Postfach 1709
D - 70707 Fellbach / Germany
Telefon (07 11) 58 53 - 01
Telefax (07 11) 58 53 - 418
Teletex 7 111 378

Droplet Size Analysis

Product Number : 212.085 X 12
Date of Measurement : 23 NOV 1994 Mes.Point\mm\x/y/z : -/0/600
Liquid - Pressure : 20.0 bar Gas - Pressure : 0.00 bar
Liquid - Flow : 0.980 l/min Gas - Flow : 0.00 m³/h i.N.
Medium : Wasser Gas\Liquid - Rat : 0.00
Remark : -- Test 15; body with 12 nozzles 212.085 --

Results of Droplet Size Analysis

Number of Droplets = 36104
Arithmetic Mean Value = 36.90 μm
Standard Deviation = 66.64 %
Area Mean Diameter = 44.34 μm
Volume Mean Diameter = 52.28 μm
Sauter Mean Diameter = 72.67 μm

D(NUM) 10% = 12.22 μm

D(NUM) 50% = 27.58 μm

D(NUM) 90% = 68.44 μm

D(VOL) 10% = 40.45 μm

D(VOL) 50% = 87.29 μm

D(VOL) 90% = 140.39 μm



Lechler GmbH & Co. KG
 Präzisionsdüsen . Anlagenbau
 Höhenstraße 24 . Postfach 1709
 D - 70707 Fellbach / Germany
 Telefon (07 11) 58 53 - 01
 Telefax (07 11) 58 53 - 418
 Teletex 7 111 378

Droplet Size Analysis

Product Number : 212.085 X 12

Date of Measurement : 23 NOV 1994

Mes.Point\mm\x/y/z : -/0/600

Liquid - Pressure : 20.0 bar

Gas - Pressure : 0.00 bar

Liquid - Flow : 0.980 l/min

Gas - Flow : 0.00 m³/h i.N.

Medium : Wasser

Gas\Liquid - Rat : 0.00

Remark : -- Test 15; body with 12 nozzles 212.085 --

Sauter Mean Diameter: 72.67 μm

Arithm. Mean Value : 36.90 μm

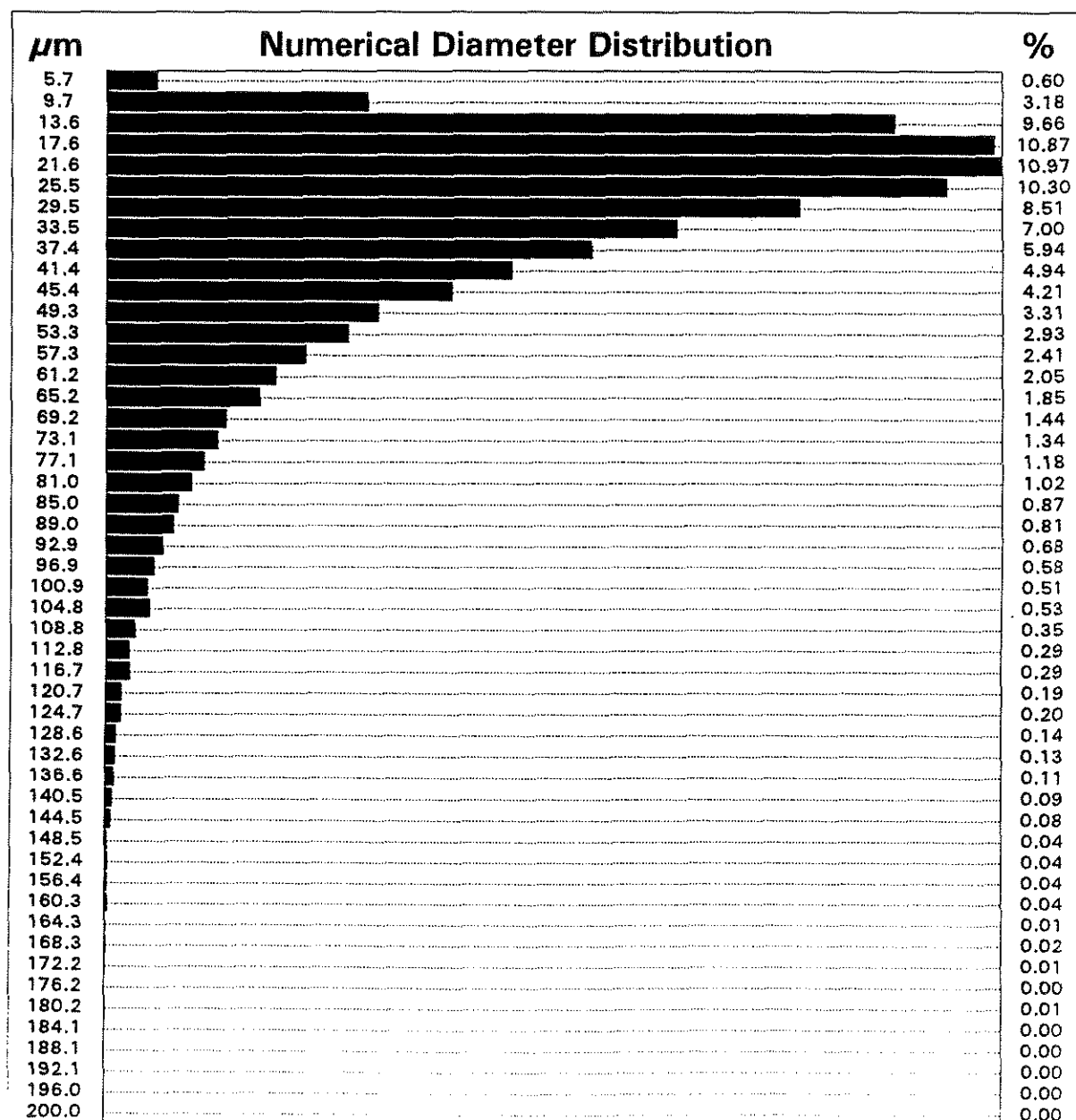

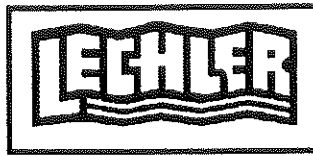

Lechler GmbH & Co. KG
 Präzisionsdüsen . Anlagenbau
 Höhenstraße 24 . Postfach 1709
 D - 70707 Fellbach / Germany
 Telefon (07 11) 58 53 - 01
 Telefax (07 11) 58 53 - 418
 Teletex 7 111 378

Droplet Size Analysis

Product Number : 212.085 X 12
 Date of Measurement : 23 NOV 1994 Mes.Point\mm\x/y/z : -/0/600
 Liquid - Pressure : 20.0 bar Gas - Pressure : 0.00 bar
 Liquid - Flow : 0.980 l/min Gas - Flow : 0.00 m³/h i.N.
 Medium : Wasser Gas\Liquid - Rat : 0.00
 Remark : -- Test 15; body with 12 nozzles 212.085 --
 Sauter Mean Diameter: 72.67 μm Arithm. Mean Value : 36.90 μm

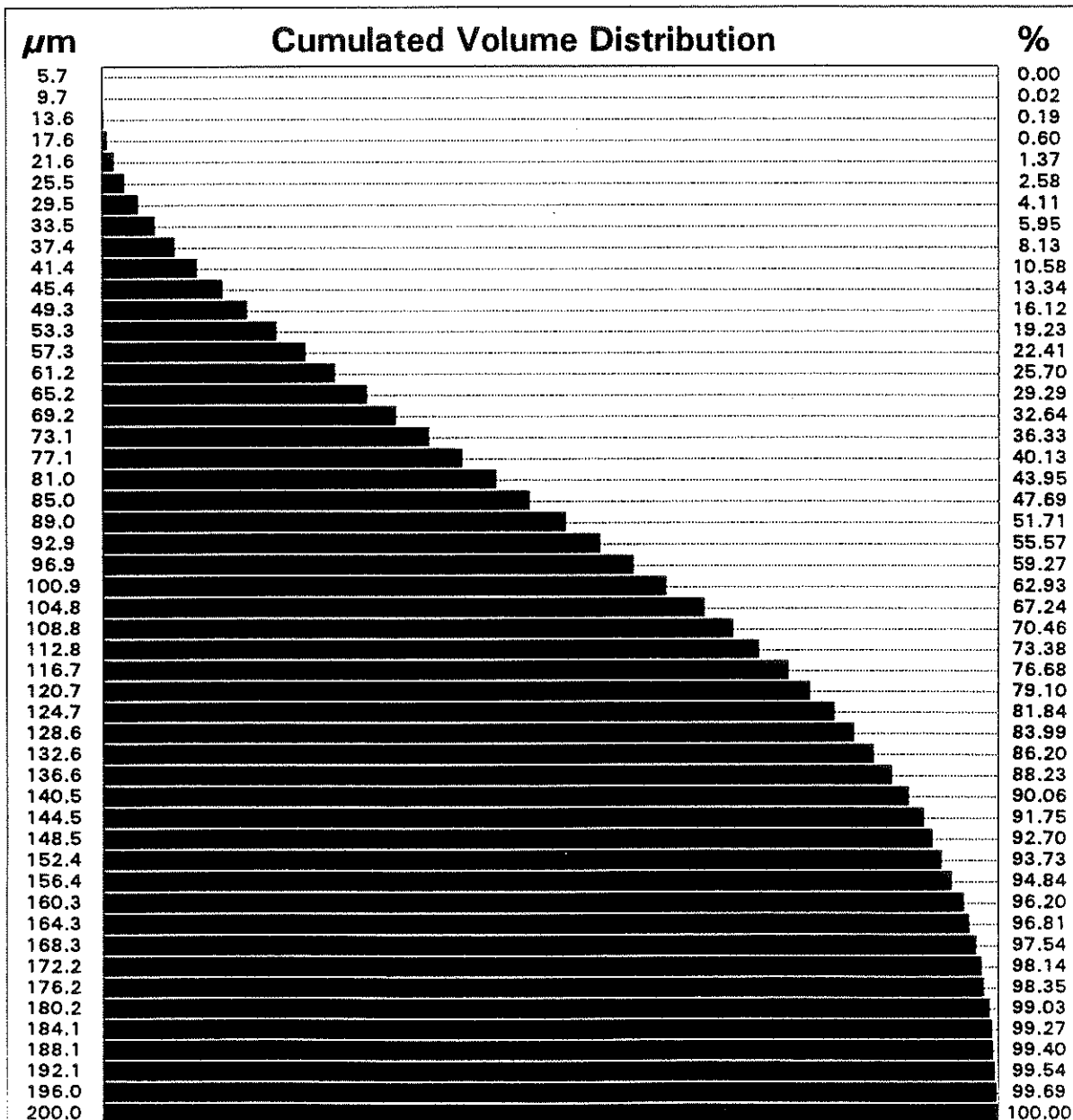



Lehler GmbH & Co. KG
Präzisionsdüsen . Anlagenbau
Höhenstraße 24 . Postfach 1705
D - 70707 Fellbach / Germany
Telefon (07 11) 58 53 - 01
Telefax (07 11) 58 53 - 418
Teletex 7 111 378

Droplet Size Analysis

Product Number : 212.085 X 12
Date of Measurement : 23 NOV 1994 Mes.Point\mm\x/y/z : -/0/600
Liquid - Pressure : 40.0 bar Gas - Pressure : 0.00 bar
Liquid - Flow : 1.43 l/min Gas - Flow : 0.00 m³/h i.N.
Medium : Wasser Gas\Liquid - Rat : 0.00
Remark : -- Test 16; body with 12 nozzles 212.085 --

Results of Droplet Size Analysis

Number of Droplets = 34458
Arithmetic Mean Value = 36.82 μm
Standard Deviation = 61.53 %
Area Mean Diameter = 43.23 μm
Volume Mean Diameter = 50.27 μm
Sauter Mean Diameter = 67.96 μm

D(NUM) 10% = 13.48 μm
D(NUM) 50% = 28.82 μm
D(NUM) 90% = 64.79 μm

D(VOL) 10% = 37.21 μm
D(VOL) 50% = 80.11 μm
D(VOL) 90% = 138.51 μm

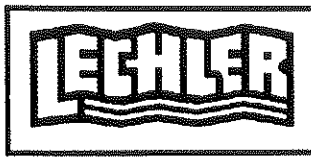

Lechler GmbH & Co. KG
 Präzisionsdüsen . Anlagenbau
 Höhenstraße 24 . Postfach 1709
 D - 70707 Fellbach / Germany
 Telefon (07 11) 58 53 - 01
 Telefax (07 11) 58 53 - 418
 Teletex 7 111 378

Droplet Size Analysis

Product Number : 212.085 X 12
 Date of Measurement : 23 NOV 1994 Mes.Point\mm\x/y/z : -/0/600
 Liquid - Pressure : 40.0 bar Gas - Pressure : 0.00 bar
 Liquid - Flow : 1.43 l/min Gas - Flow : 0.00 m³/h i.N.
 Medium : Wasser Gas\Liquid - Rat : 0.00
 Remark : -- Test 16; body with 12 nozzles 212.085 --
 Sauter Mean Diameter: 67.96 μ m Arithm. Mean Value : 36.82 μ m

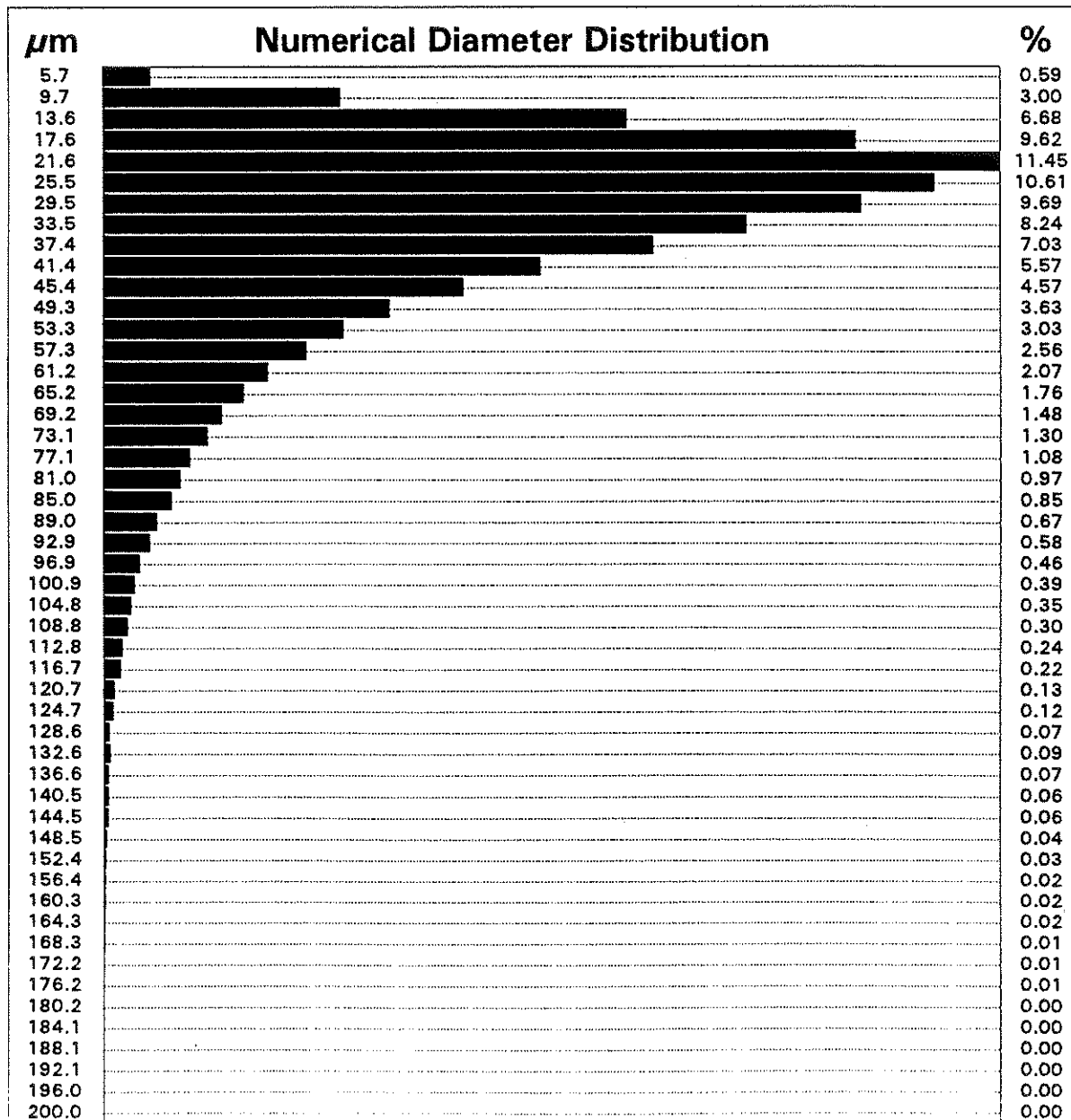

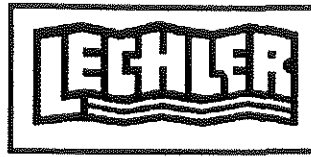

Lechler GmbH & Co. KG
 Präzisionsdüsen · Anlagenbau
 Höhenstraße 24 · Postfach 1709
 D - 70707 Fellbach / Germany
 Telefon (07 11) 58 53 - 01
 Telefax (07 11) 58 53 - 418
 Teletex 7 111 378

Droplet Size Analysis

Product Number : 212.085 X 12
 Date of Measurement : 23 NOV 1994 Mes.Point\mm\x/y/z : -/0/600
 Liquid - Pressure : 40.0 bar Gas - Pressure : 0.00 bar
 Liquid - Flow : 1.43 l/min Gas - Flow : 0.00 m³/h i.N.
 Medium : Wasser Gas\Liquid - Rat : 0.00
 Remark : -- Test 16; body with 12 nozzles 212.085 --
 Sauter Mean Diameter: 67.96 μm Arithm. Mean Value : 36.82 μm

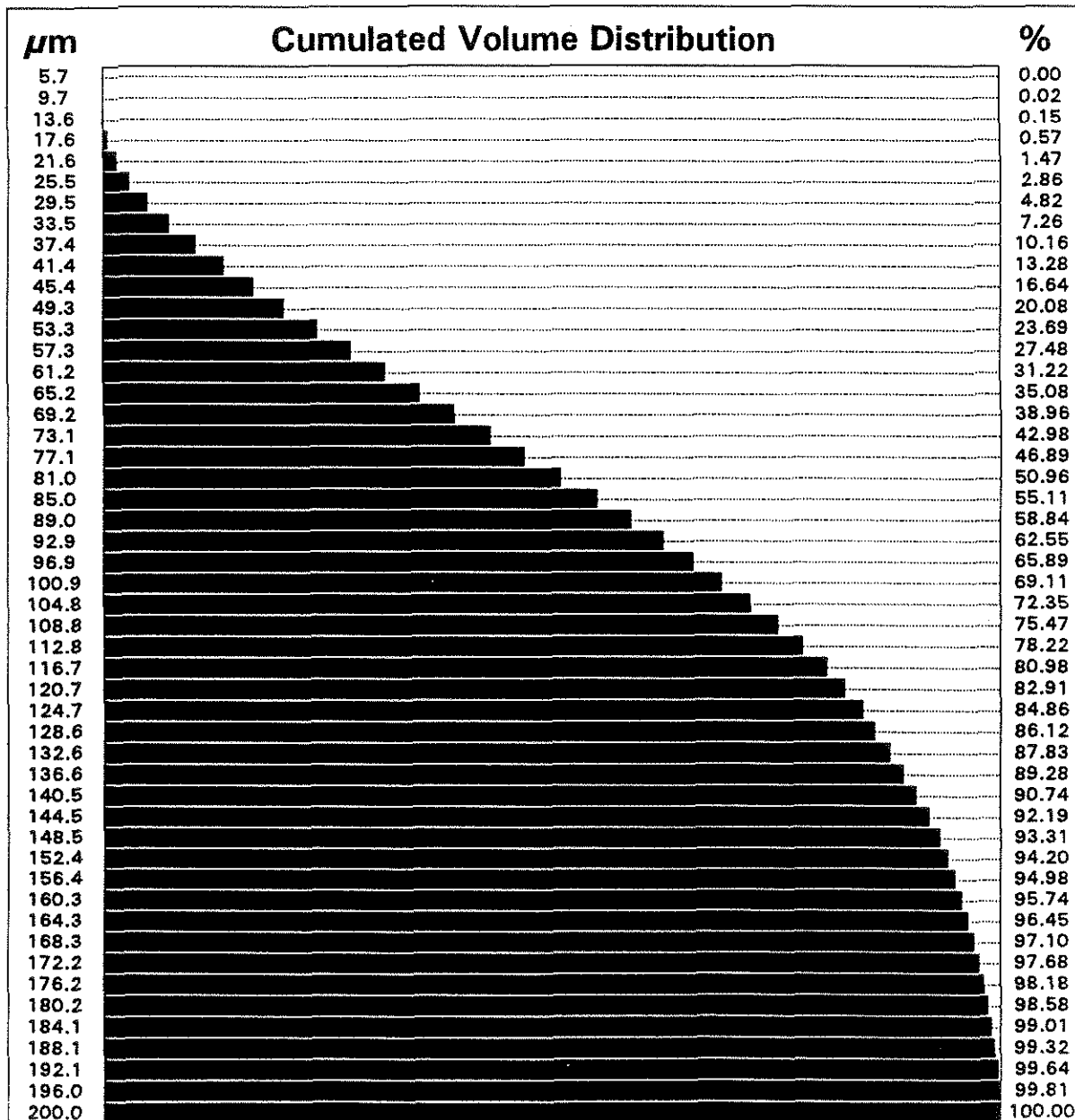

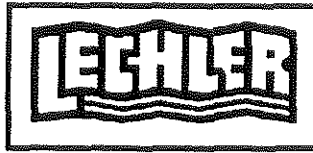

Lechler GmbH & Co. KG
Präzisionsdüsen . Anlagenbau
Höhenstraße 24 . Postfach 1709
D - 70707 Fellbach / Germany
Telefon (07 11) 58 53 - 01
Telefax (07 11) 58 53 - 418
Teletex 7 111 378

Droplet Size Analysis

Product Number : 212.085 X 12
Date of Measurement : 23 NOV 1994 Mes.Point\mm\x/y/z : -/0/600
Liquid - Pressure : 60.0 bar Gas - Pressure : 0.00 bar
Liquid - Flow : 1.77 l/min Gas - Flow : 0.00 m³/h i.N.
Medium : Wasser Gas\Liquid - Rat : 0.00
Remark : -- Test 17; body with 12 nozzles 212.085 --

Results of Droplet Size Analysis

Number of Droplets = 33925
Arithmetic Mean Value = 34.28 μm
Standard Deviation = 66.31 %
Area Mean Diameter = 41.13 μm
Volume Mean Diameter = 48.16 μm
Sauter Mean Diameter = 66.02 μm

D(NUM) 10% = 10.43 μm
D(NUM) 50% = 25.74 μm
D(NUM) 90% = 63.87 μm

D(VOL) 10% = 37.30 μm
D(VOL) 50% = 78.54 μm
D(VOL) 90% = 121.18 μm



Lechler GmbH & Co. KG
 Präzisionsdüsen · Anlagenbau
 Höhenstraße 24 · Postfach 1709
 D - 70707 Fellbach / Germany
 Telefon (07 11) 58 53 - 01
 Telefax (07 11) 58 53 - 418
 Teletex 7 111 378

Droplet Size Analysis

Product Number : 212.085 X 12

Date of Measurement : 23 NOV 1994

Mes.Point\mm\x/y/z : -/0/600

Liquid - Pressure : 60.0 bar

Gas - Pressure : 0.00 bar

Liquid - Flow : 1.77 l/min

Gas - Flow : 0.00 m³/h i.N.

Medium : Wasser

Gas\Liquid - Rat : 0.00

Remark : -- Test 17; body with 12 nozzles 212.085 --

Sauter Mean Diameter: 66.02 μm

Arithm. Mean Value : 34.28 μm

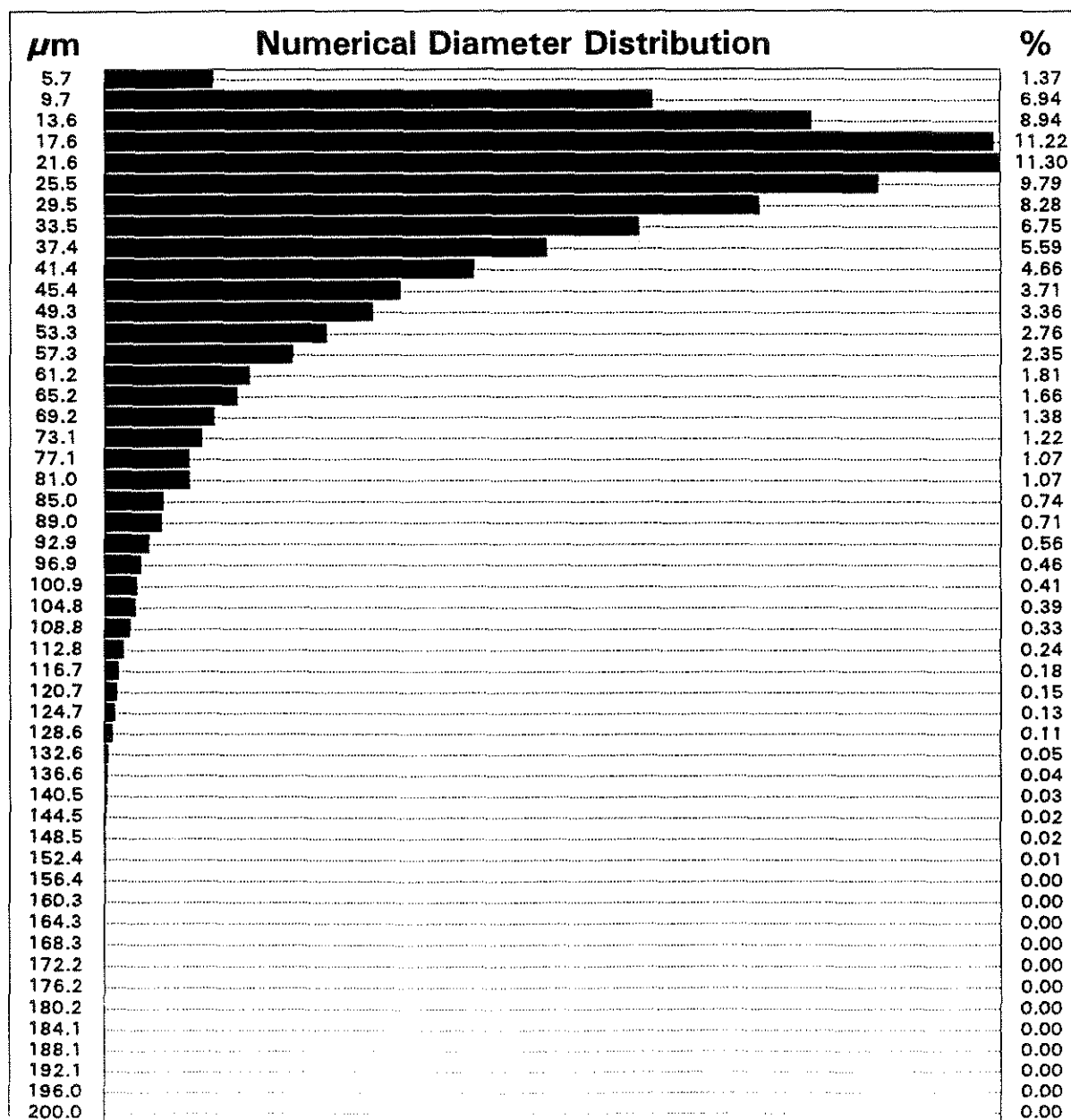



Lehler GmbH & Co. KG
 Präzisionsdüsen . Anlagenbau
 Höhenstraße 24 . Postfach 1709
 D - 70707 Fellbach / Germany
 Telefon (07 11) 58 53 - 01
 Telefax (07 11) 58 53 - 418
 Teletex 7 111 378

Droplet Size Analysis

Product Number : 212.085 X 12

Date of Measurement : 23 NOV 1994

Mes.Point\mm\x/y/z : -/0/600

Liquid - Pressure : 60.0 bar

Gas - Pressure : 0.00 bar

Liquid - Flow : 1.77 l/min

Gas - Flow : 0.00 m³/h i.N.

Medium : Wasser

Gas\Liquid - Rat : 0.00

Remark : -- Test 17; body with 12 nozzles 212.085 --

Sauter Mean Diameter: 66.02 μm

Arithm. Mean Value : 34.28 μm

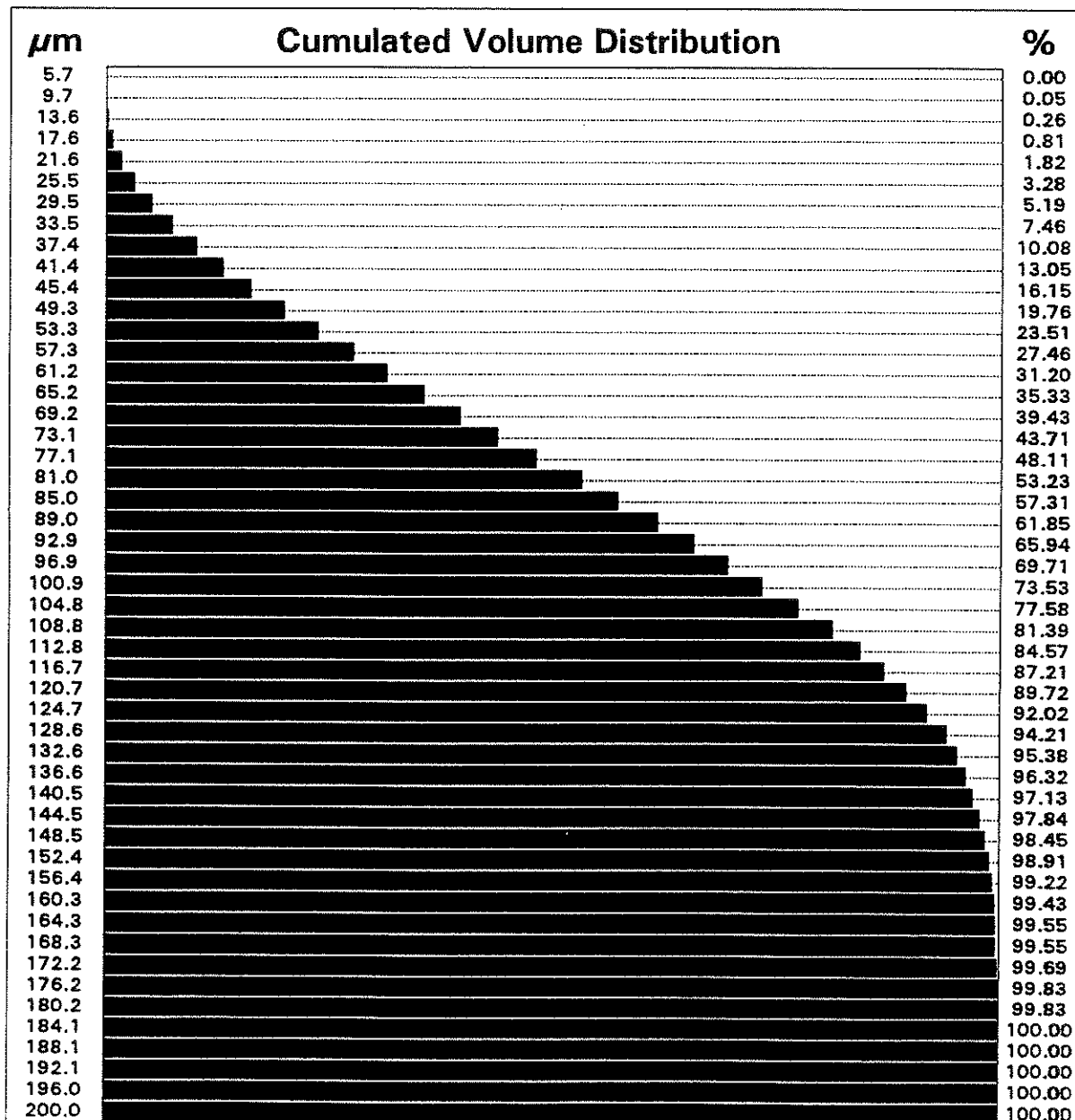

Appendix B

Vertical water distribution measurements

On the following pages the vertical water distribution of the nozzles used is presented. The tests were conducted with the individual nozzle located 0,25 m and the multiple nozzle body 1,0 m above a transversal and a longitudinal row of tubes ($\phi=16$ mm) where the water was collected. See figure B-1 below.

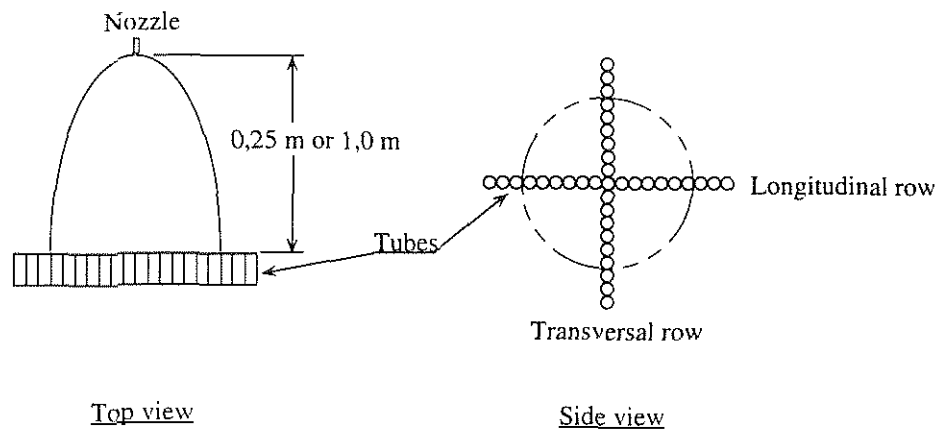

Figure B-1 Principle sketch of the vertical water distribution measurements.

The results are presented as the deviation from the mean value.

FLÜSSIGKEITSVERTEILUNG

ERZ.-Nr.: 212.085
Datum: 22-11-1994

EINZELMESSUNG

Wasserdruck	:	40	bar	Spritzhoehe	:	250	mm
Volmuenstrom	:	.12	l/min	Strahlbreite	:	112	mm
Luftdruck	:	0	bar	Meßstellenabstand:		16	mm
Luftvolumenstrom:		0	m ³ /h i. N.	Variationskoeffizient:		60	%

Bemerkung: Test 3 - a -> 0 degree

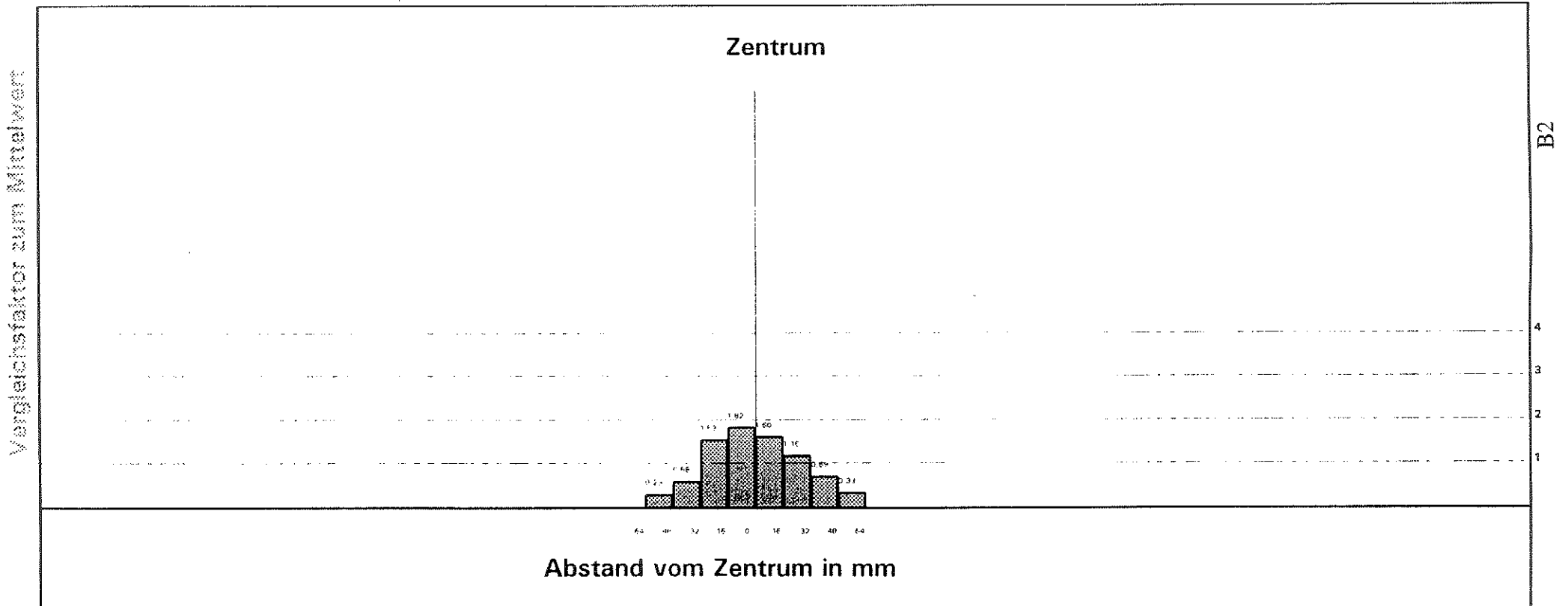

FLÜSSIGKEITSVERTEILUNG

ERZ.-Nr.: 212.085
Datum: 22-11-1994

EINZELMESSUNG

Wasserdruck	:	40	bar	Spritzhoehe	:	250	mm
Volmumenstrom	:	.12	l/min	Strahlbreite	:	112	mm
Luftdruck	:	0	bar	Meßstellenabstand	:	16	mm
Luftvolumenstrom	:	0	m ³ /h i. N.	Variationskoeffizient	:	59	%

Bemerkung: Test 3 - b -> 90 degree

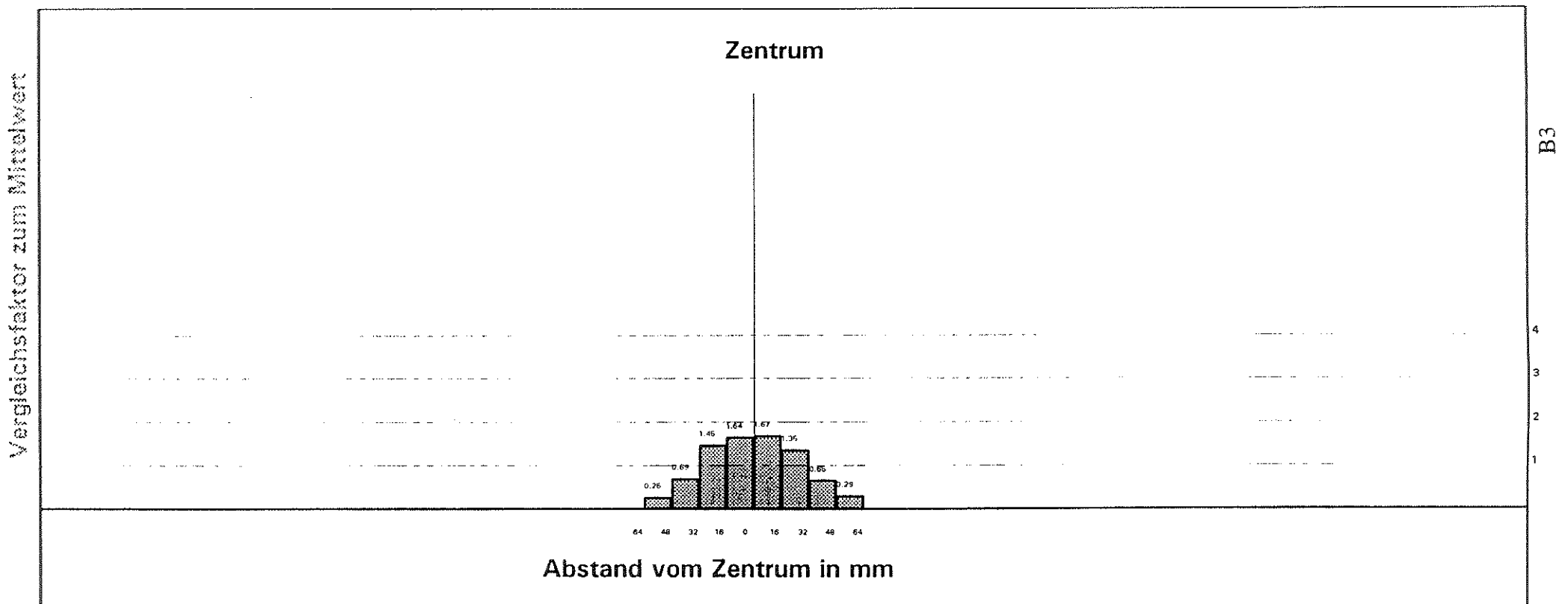

FLÜSSIGKEITSVERTEILUNG

ERZ.-Nr.:212.085
Datum:22-11-1994

EINZELMESSUNG

Wasserdruck	:	80	bar	Spritzhoehe	:	250	mm
Volmumenstrom	:	.17	l/min	Strahlbreite	:	80	mm
Luftdruck	:	0	bar	Meßstellenabstand:	:	16	mm
Luftvolumenstrom:	:	0	m ³ /h i. N.	Variationskoeffizient:	:	78	%

Bemerkung: Test 4 - a -> 0 degree

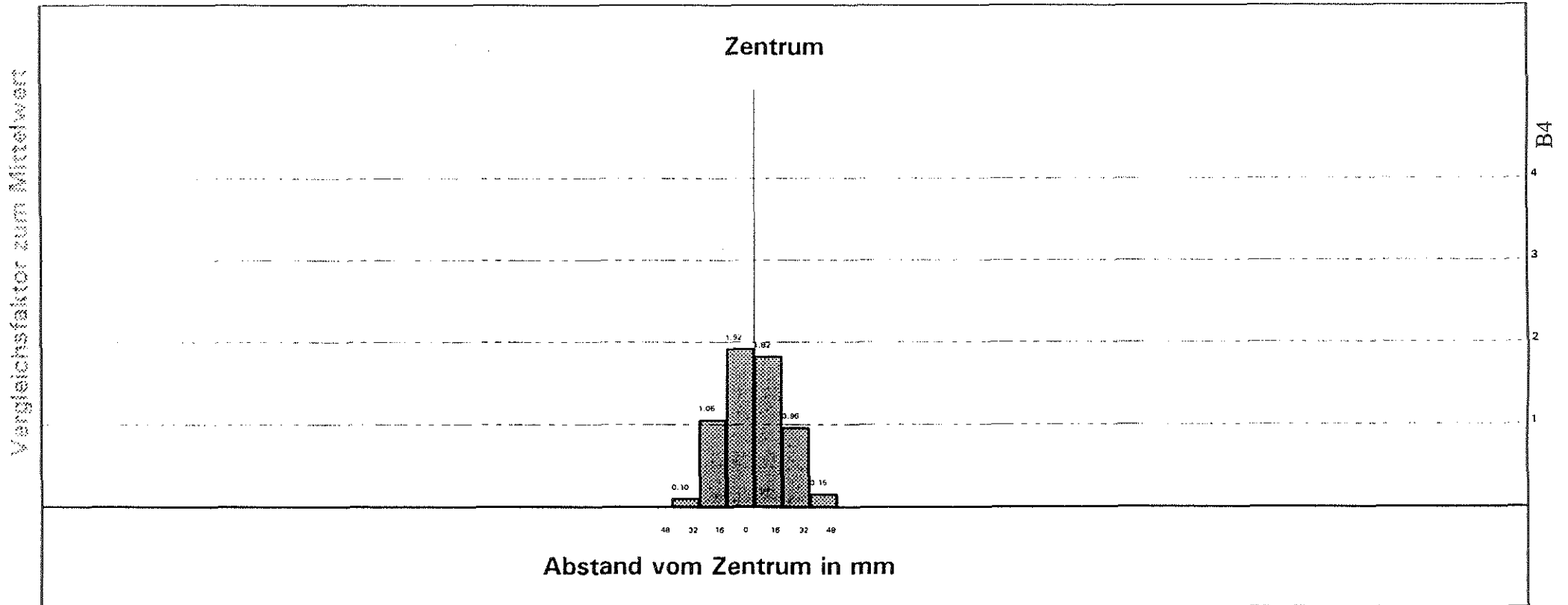

FLÜSSIGKEITSVERTEILUNG

ERZ.-Nr.: 212.085
Datum: 22-11-1994

EINZELMESSUNG

Wasserdruck	:	80	bar	Spritzhoehe	:	250	mm
Volmumenstrom	:	.17	l/min	Strahlbreite	:	80	mm
Luftdruck	:	0	bar	Meßstellenabstand	:	16	mm
Luftvolumenstrom	:	0	m ³ /h i. N.	Variationskoeffizient	:	79	%

Bemerkung: Test 4 - b -> 90 degree

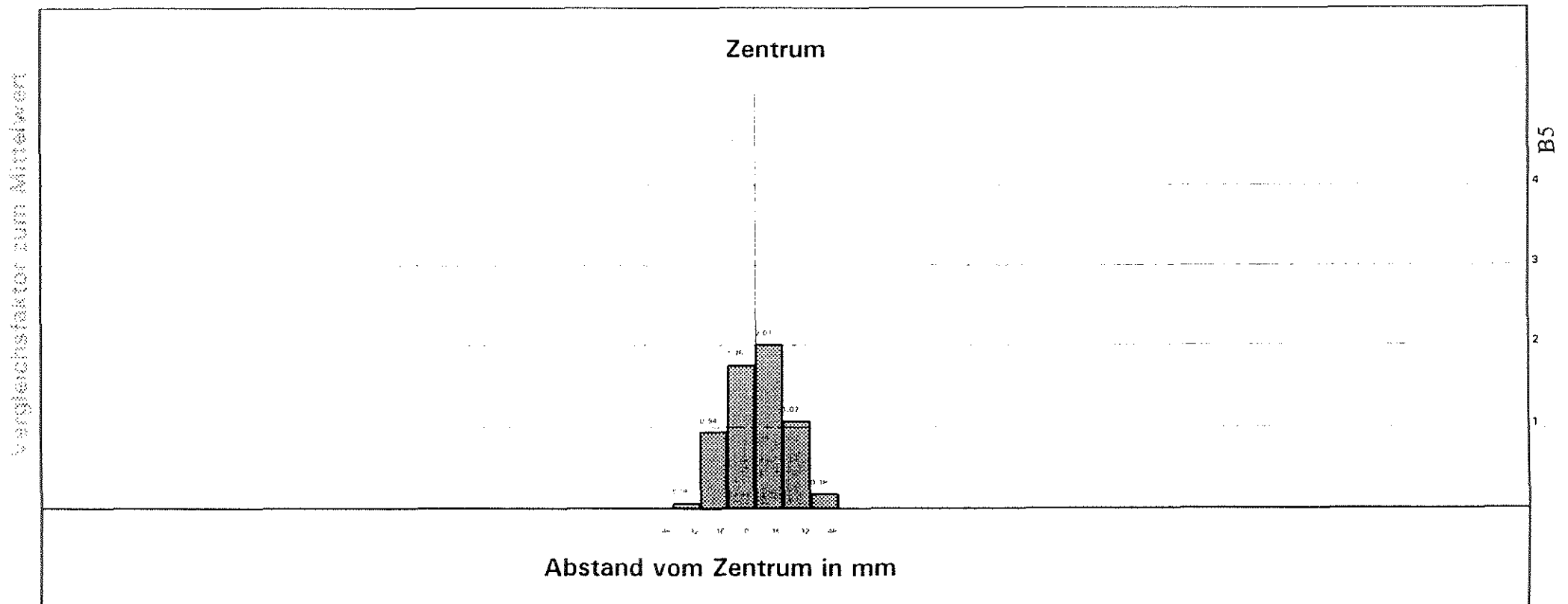

FLÜSSIGKEITSVERTEILUNG

ERZ.-Nr.: 212.085 X 8
Datum: 22-11-1994

EINZELMESSUNG

Wasserdruck	:	20	bar	Spritzhoehe	:	1000	mm
Volmuenstrom	:	.66	l/min	Strahlbreite	:	464	mm
Luftdruck	:	0	bar	Meßstellenabstand:	:	16	mm
Luftvolumenstrom:	:	0	m ³ /h i. N.	Variationskoeffizient:	:	58	%

Bemerkung: Test 5 - a -> 0 degree; 8 Dsen im Dsenkopf

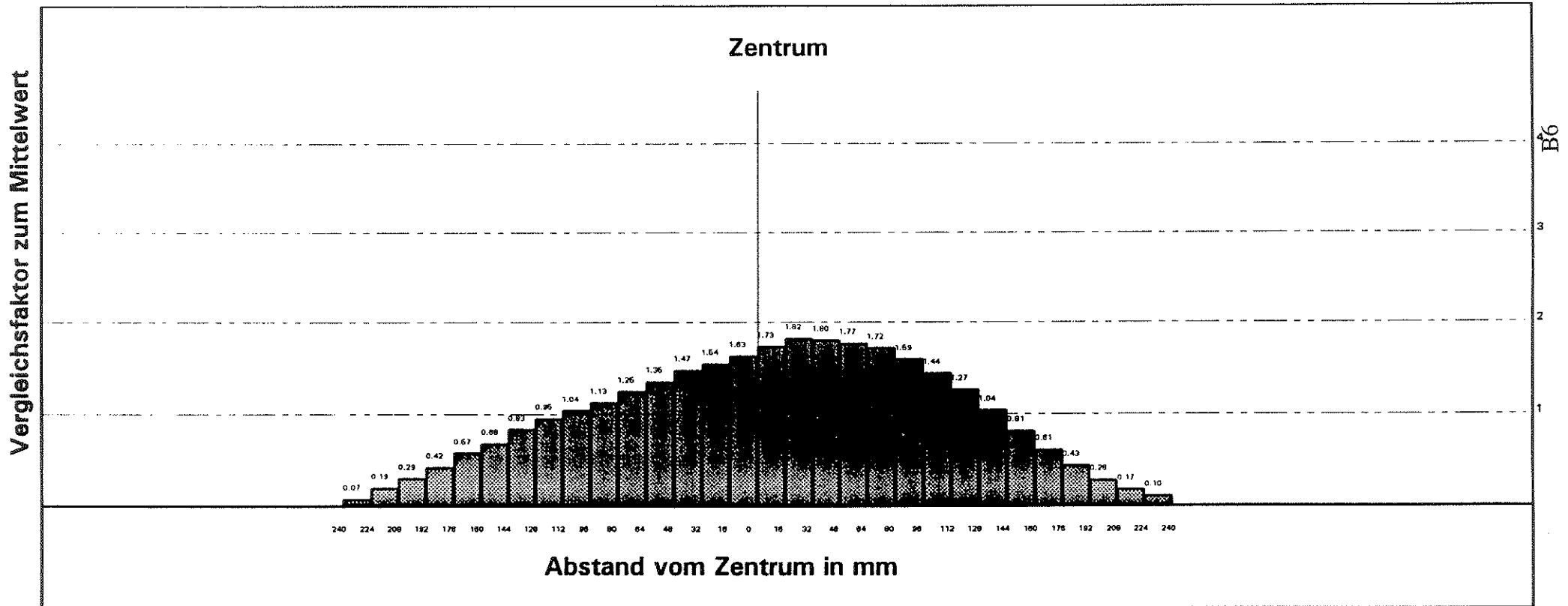

FLÜSSIGKEITSVERTEILUNG

ERZ.-Nr.: 212.085 X 8
Datum: 22-11-1994

EINZELMESSUNG

Wasserdruck	:	20	bar	Spritzhoehe	:	1000	mm
Volmumenstrom	:	.66	l/min	Strahlbreite	:	288	mm
Luftdruck	:	0	bar	Meßstellenabstand	:	16	mm
Luftvolumenstrom	:	0	m ³ /h i. N.	Variationskoeffizient	:	69	%

Bemerkung: Test 5 - b -> 90 degree; 8 Dsen im Dsenkopf

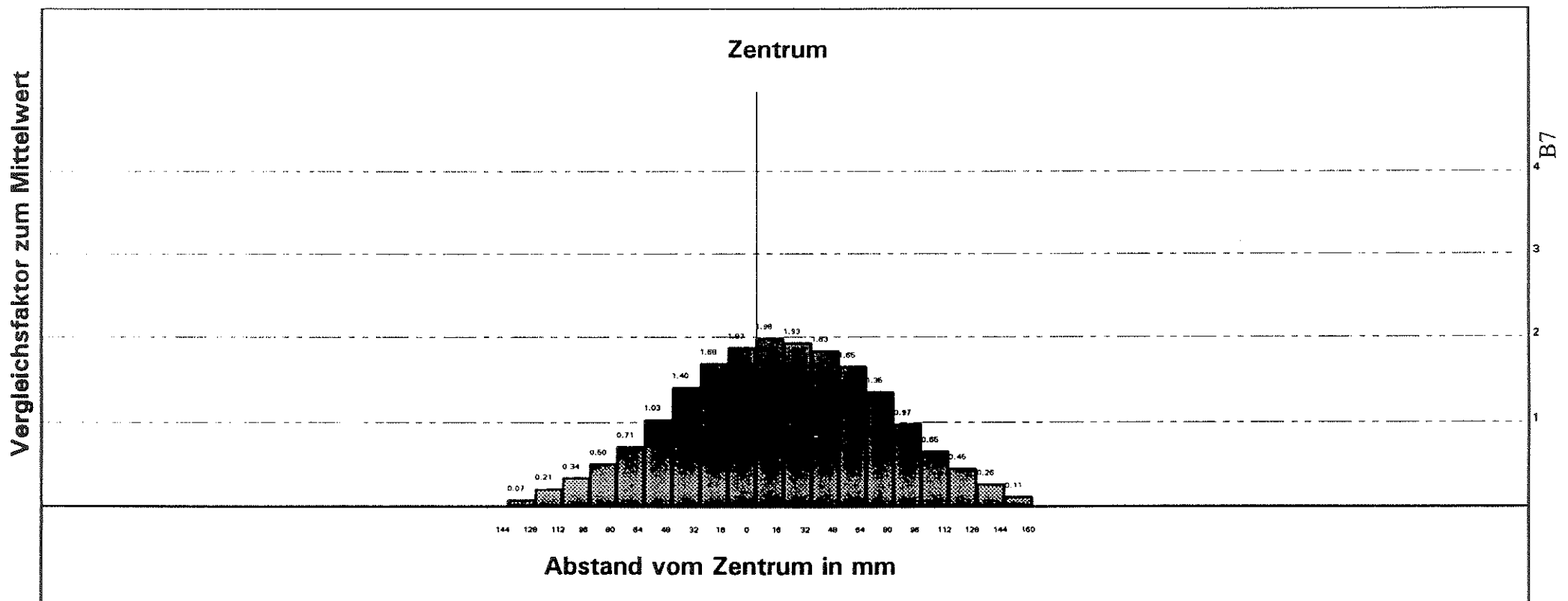

FLÜSSIGKEITSVERTEILUNG

ERZ.-Nr.: 212.085 X 8
 Datum: 22-11-1994

EINZELMESSUNG

Wasserdruck	:	80	bar	Spritzhoehe	:	1000	mm
Volmumenstrom	:	1.4	l/min	Strahlbreite	:	416	mm
Luftdruck	:	0	bar	Meßstellenabstand	:	16	mm
Luftvolumenstrom	:	0	m ³ /h i. N.	Variationskoeffizient	:	59	%

Bemerkung: Test 6 - a -> 0 degree; 8 Dsen im Dsenkopf

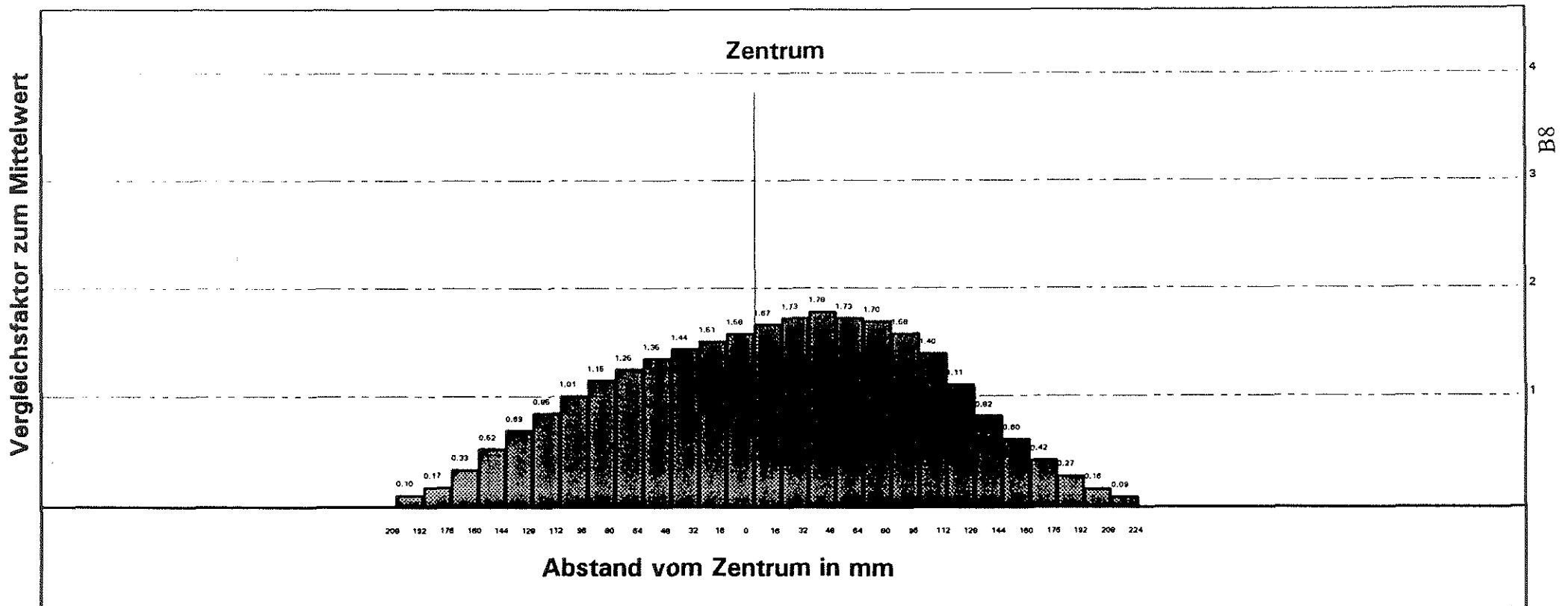

FLÜSSIGKEITSVERTEILUNG

ERZ.-Nr.: 212.085 X 8
Datum: 22-11-1994

EINZELMESSUNG

Wasserdruck	:	80	bar	Spritzhoehe	:	1000	mm
Volmuenstrom	:	1.4	l/min	Strahlbreite	:	272	mm
Luftdruck	:	0	bar	Meßstellenabstand	:	16	mm
Luftvolumenstrom	:	0	m ³ /h i. N.	Variationskoeffizient	:	70	%

Bemerkung: Test 6 - b -> 90 degree; 8 Dsen im Dsenkopf

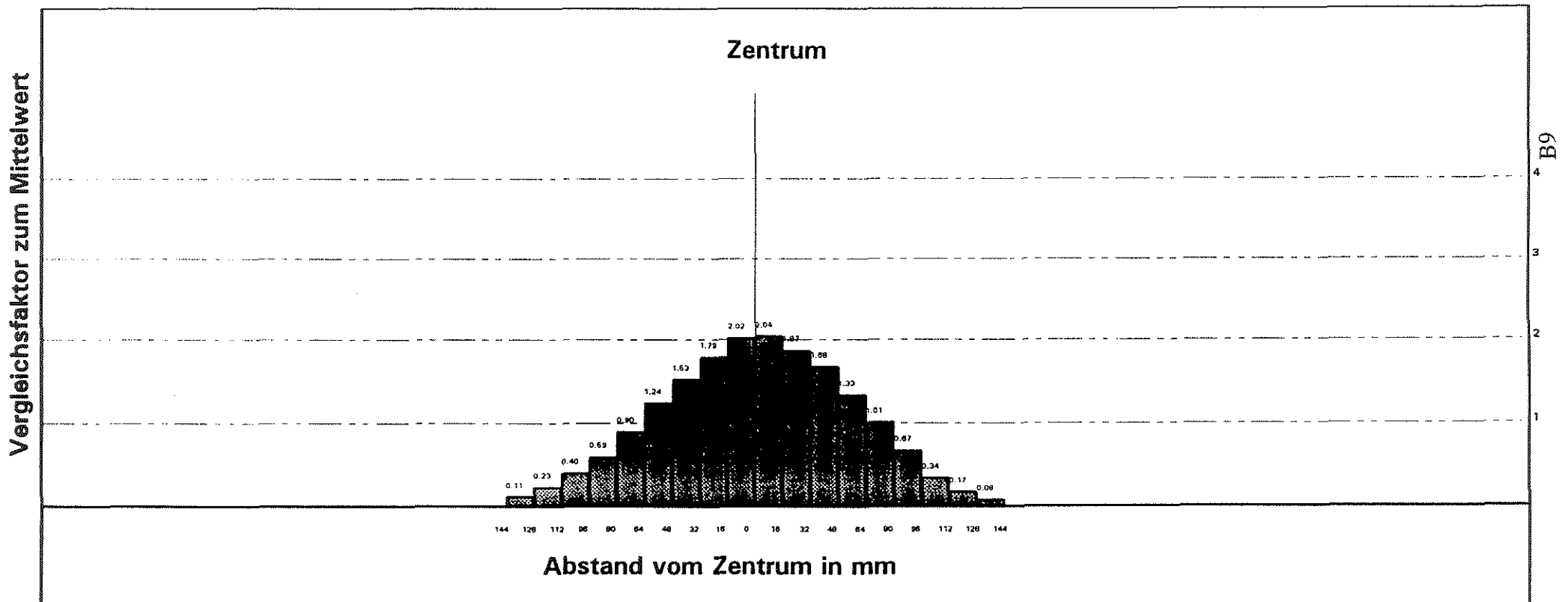

FLÜSSIGKEITSVERTEILUNG

ERZ.-Nr.: 212.085 X 12
 Datum: 23-11-1994

EINZELMESSUNG

Wasserdruck	: 20 bar	Spritzhoehe	: 1000 mm
Volmumenstrom	: .98 l/min	Strahlbreite	: 480 mm
Luftdruck	: 0 bar	Meßstellenabstand	: 16 mm
Luftvolumenstrom	: 0 m ³ /h i. N.	Variationskoeffizient	: 61 %

Bemerkung: Test 7 - a -> 0 degree; 12 Dsen im Dsenkopf

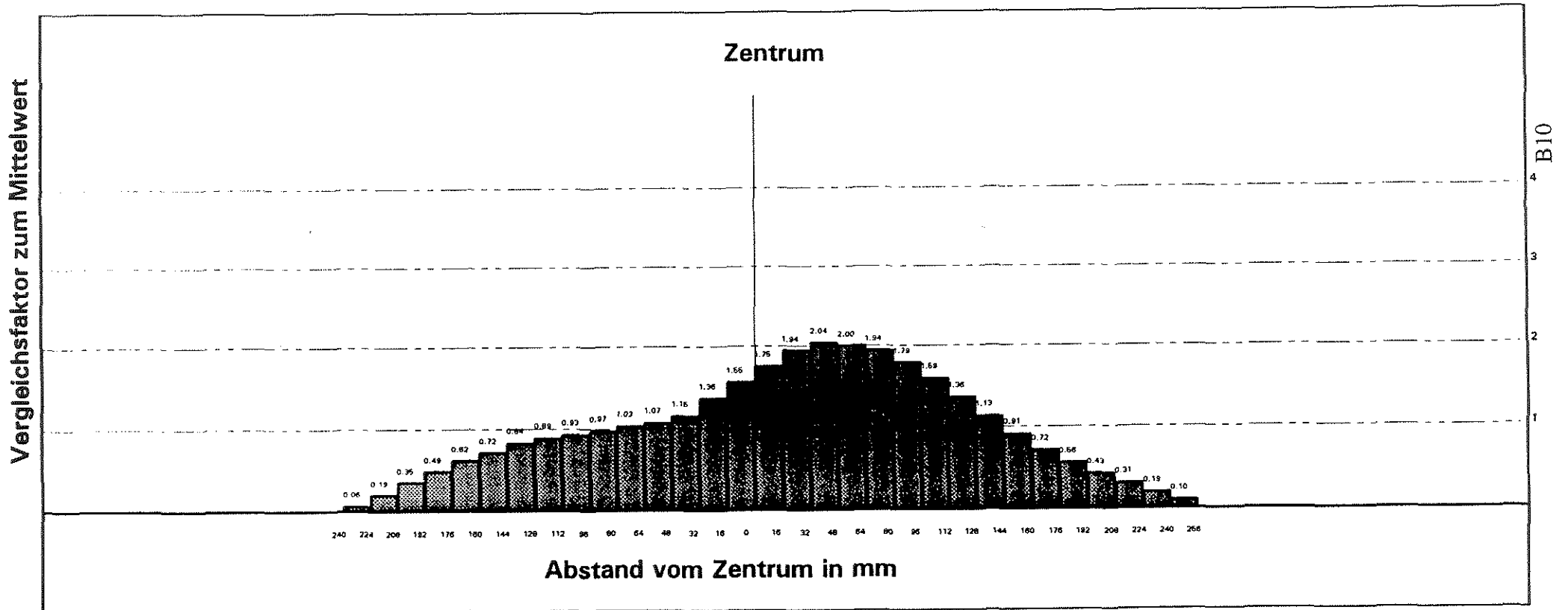

FLÜSSIGKEITSVERTEILUNG

ERZ.-Nr.: 212.085 X 12
Datum: 23-11-1994

EINZELMESSUNG

Wasserdruck	:	20	bar	Spritzhoehe	:	1000	mm
Volmumenstrom	:	.98	l/min	Strahlbreite	:	288	mm
Luftdruck	:	0	bar	Meßstellenabstand:	:	16	mm
Luftvolumenstrom:	:	0	m ³ /h i. N.	Variationskoeffizient:	:	67	%

Bemerkung: Test 7 - b -> 90 degree; 12 Dsen im Dsenkopf

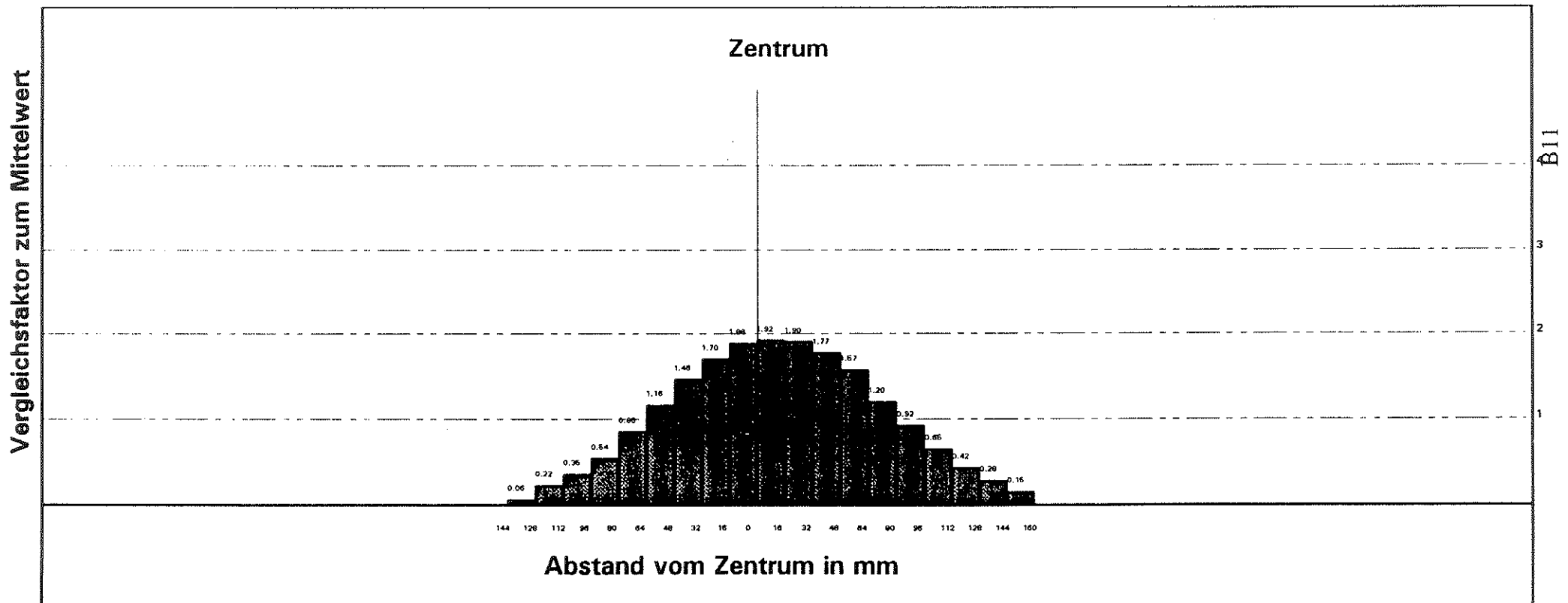

FLÜSSIGKEITSVERTEILUNG

ERZ.-Nr.: 212.085 X 12
 Datum: 23-11-1994

EINZELMESSUNG

Wasserdruck	: 80 bar	Spritzhoehe	: 1000 mm
Volmumenstrom	: 2.05 l/min	Strahlbreite	: 432 mm
Luftdruck	: 0 bar	Meßstellenabstand	: 16 mm
Luftvolumenstrom	: 0 m ³ /h i. N.	Variationskoeffizient	: 55 %

Bemerkung: Test 8 - a -> 0 degree; 12 Dsen im Dsenkopf

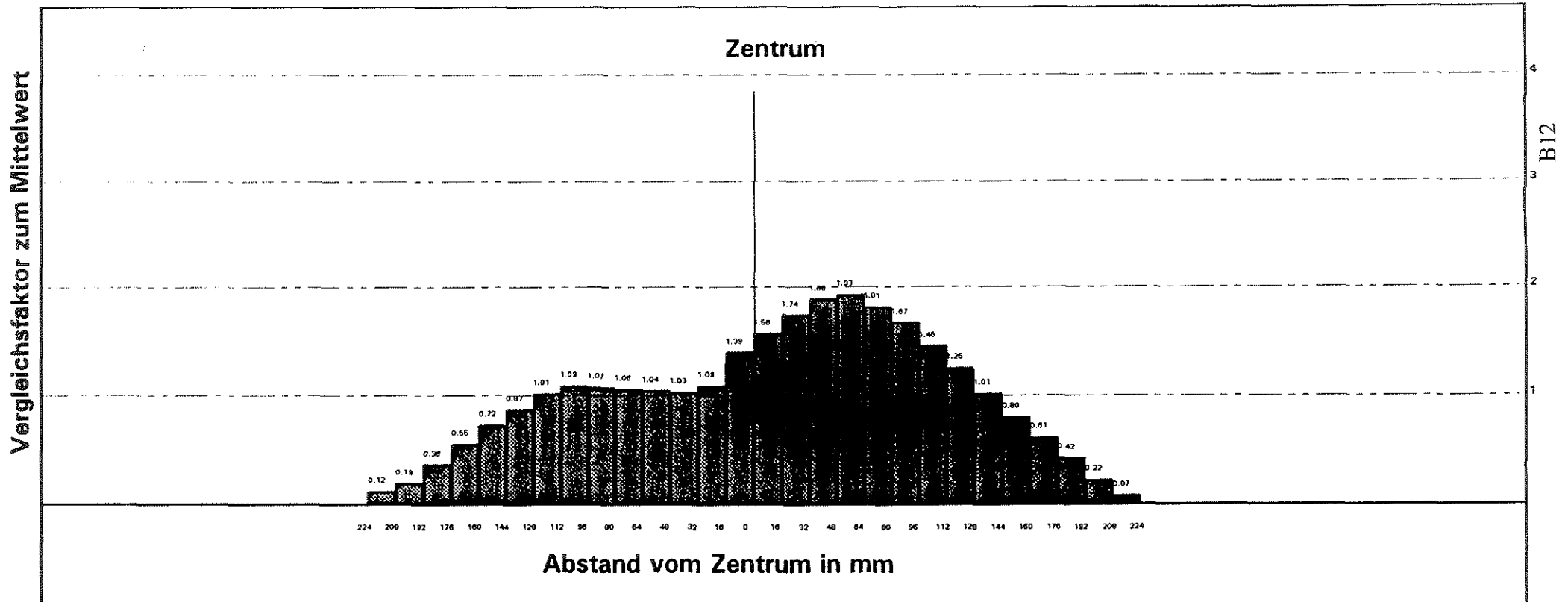

FLÜSSIGKEITSVERTEILUNG

ERZ.-Nr.: 212.085 X 12
 Datum: 23-11-1994

EINZELMESSUNG

Wasserdruck	:	80	bar	Spritzhoehe	:	1000	mm
Volmuenstrom	:	2.05	l/min	Strahlbreite	:	272	mm
Luftdruck	:	0	bar	Meßstellenabstand	:	16	mm
Luftvolumenstrom	:	0	m ³ /h i. N.	Variationskoeffizient	:	70	%

Bemerkung: Test 8 - b -> 90 degree; 12 Dsen im Dsenkopf

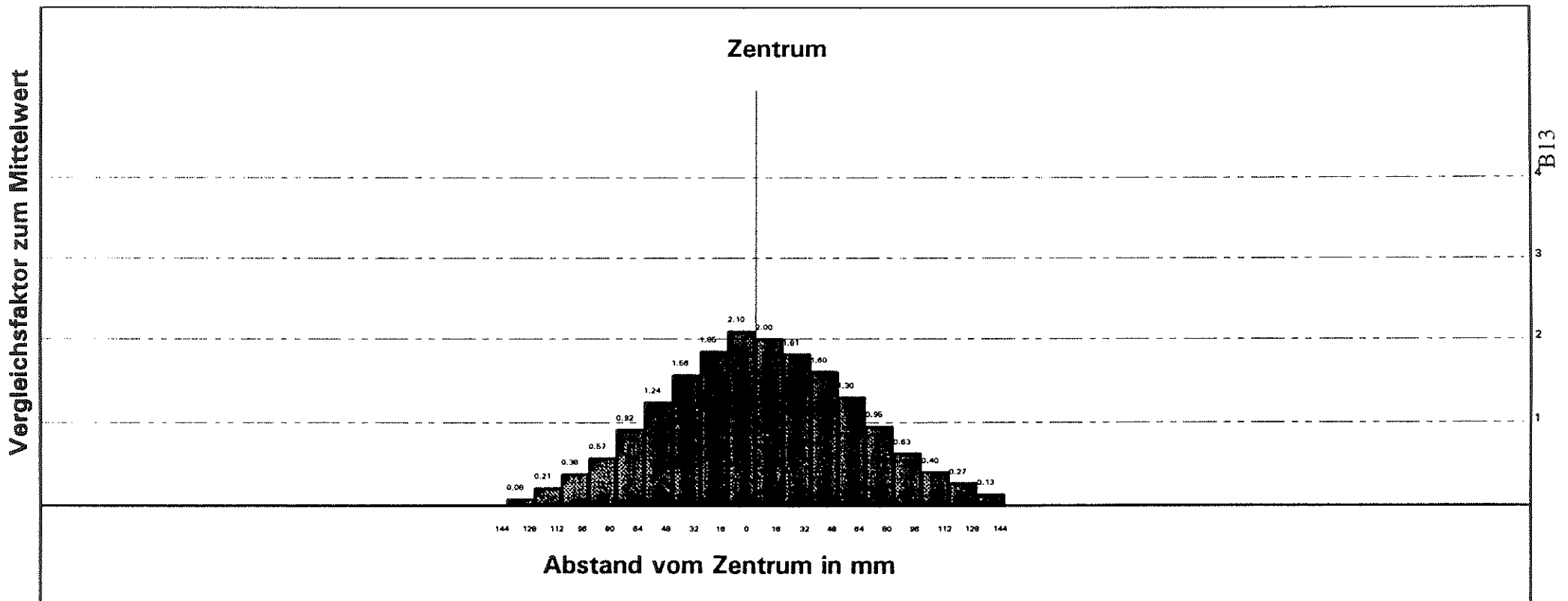

Appendix C

Rate of Heat Release, CO and CO₂ graphs from the REMP experiments

In the following graphs the Rate of Heat Release (RHR) in kW as a function of time for the REMP experiments are given. Water pressures of 40, 60 and 80 bar respectively were used. The dotted lines are the Rate of Heat Release without adding water. In some cases the CO production in ppm is presented as well, no CO production rate was observed without water. The CO₂ production is also presented for some cases, the dotted lines are the CO₂ production rate without adding water.

RHR 40 bar, 1

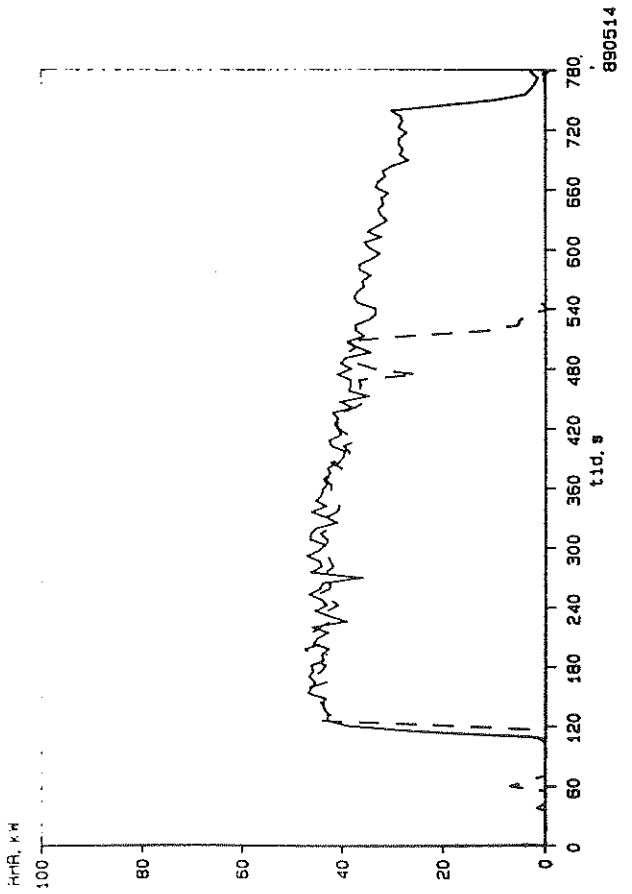

RHR 40 bar, 2

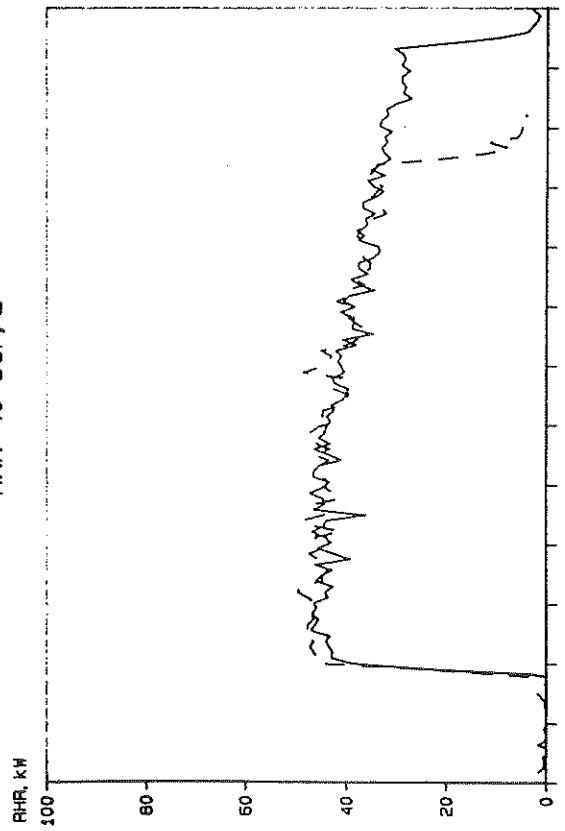

CO 40 bar, 2

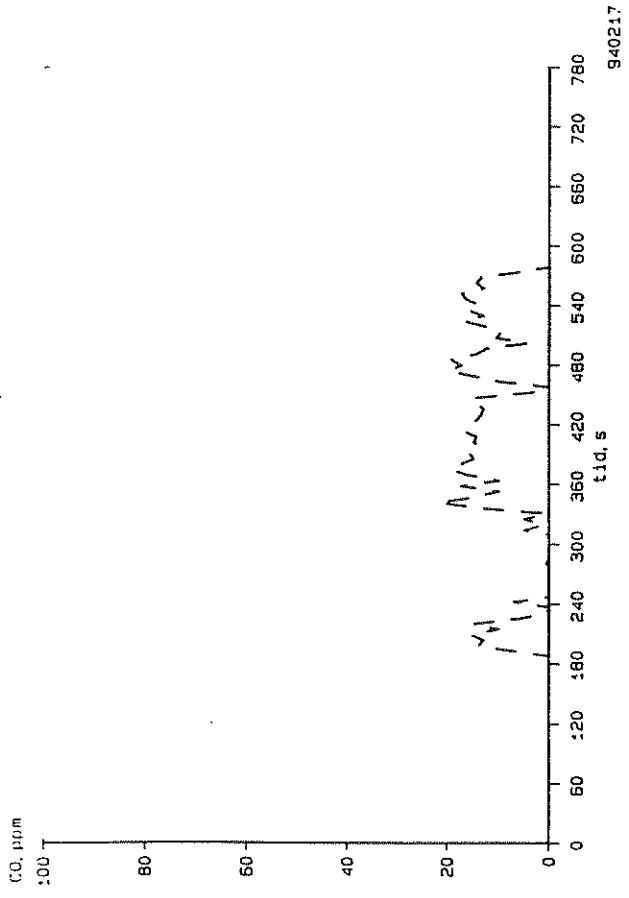

CO2 40 bar, 1

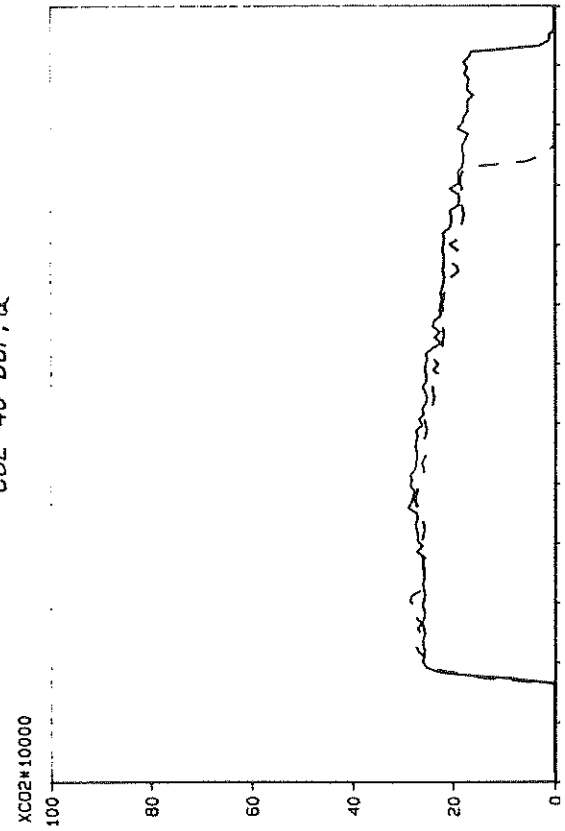

CO2 40 bar, 3

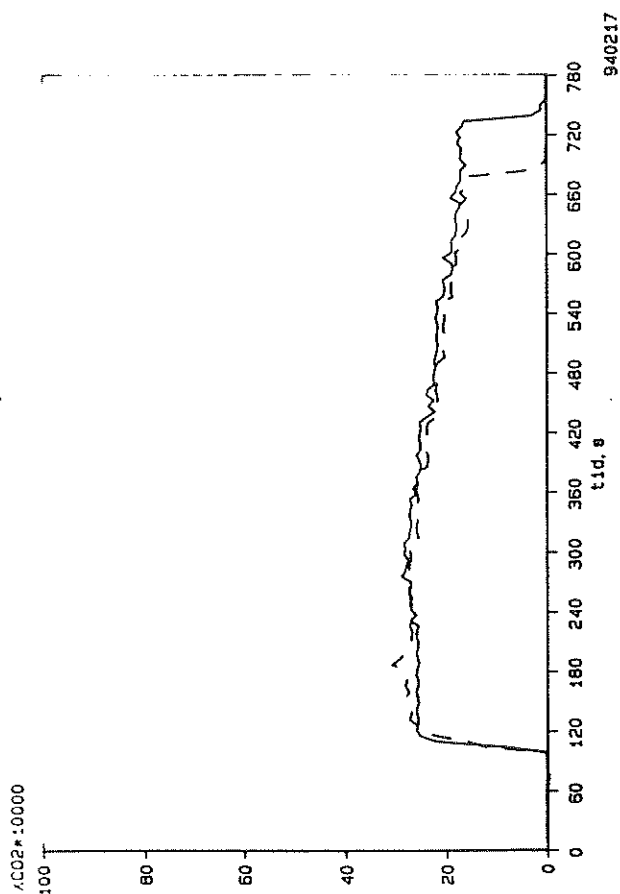

940217

RHR, kW

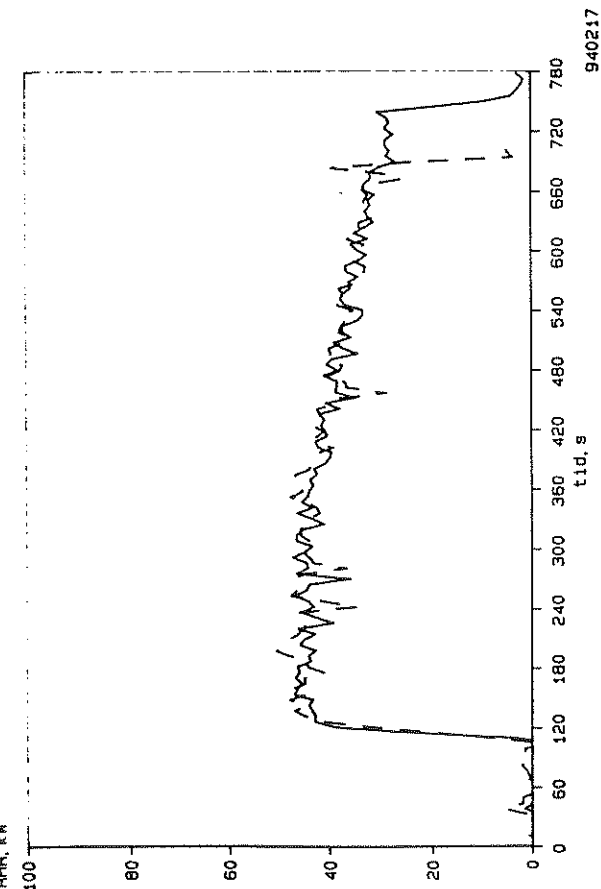

940217

CO 40 bar, 3

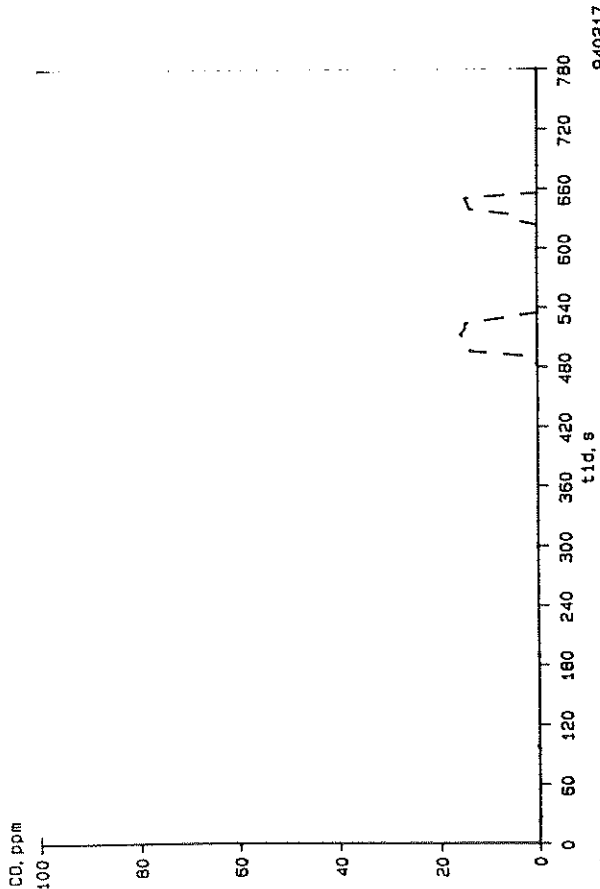

940217

RHR 60 bar, 1

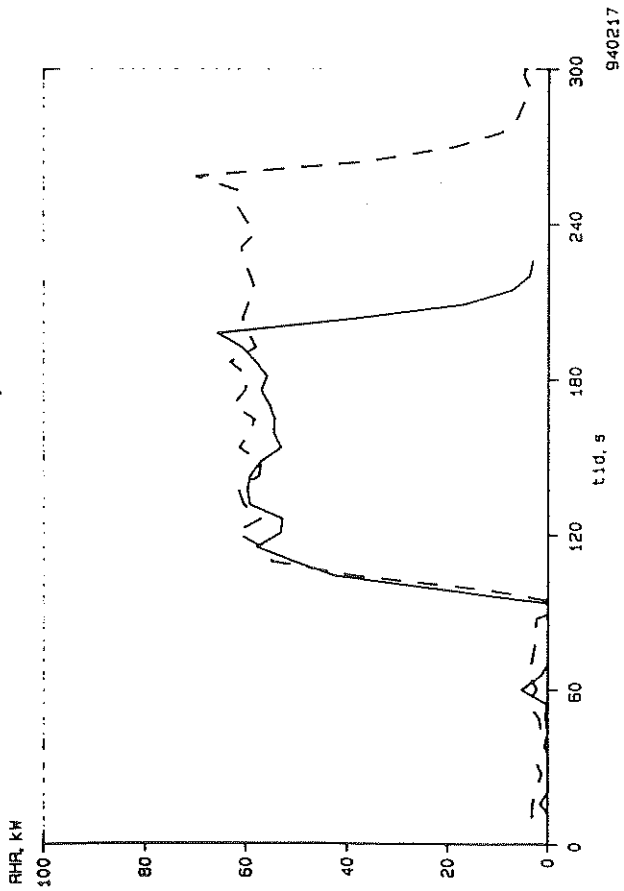

CO 60 bar, 1

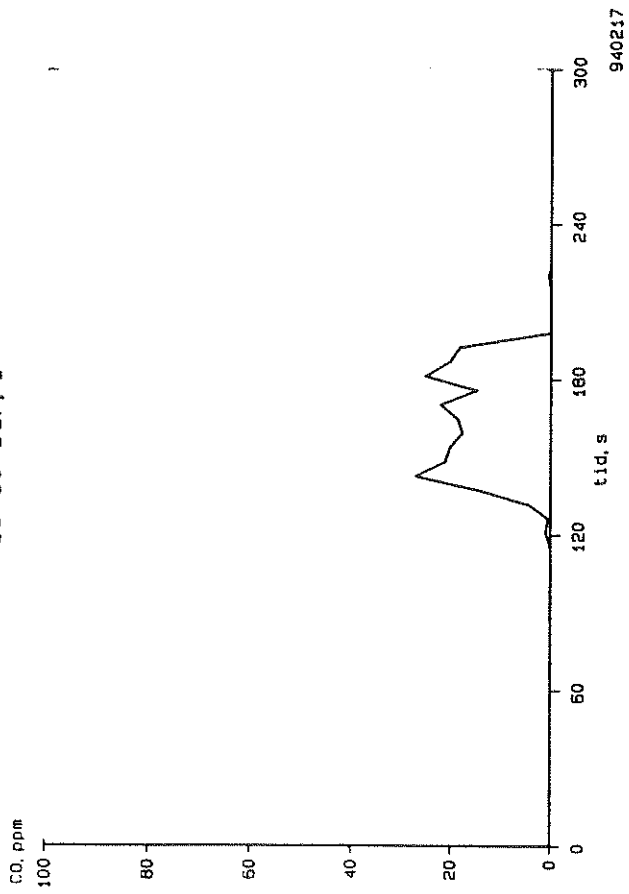

CO2 60 bar, 1

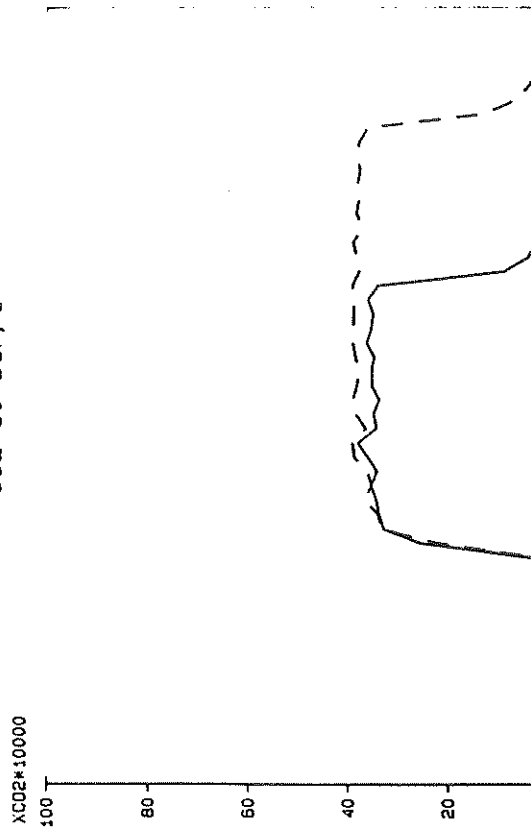

AHR 60 bar, 2

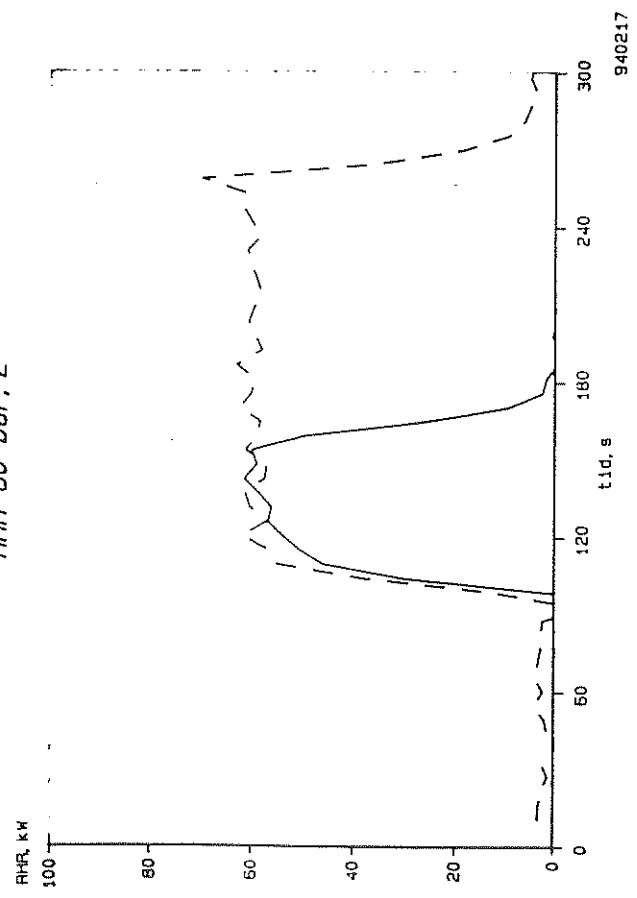

AHR 60 bar, 3

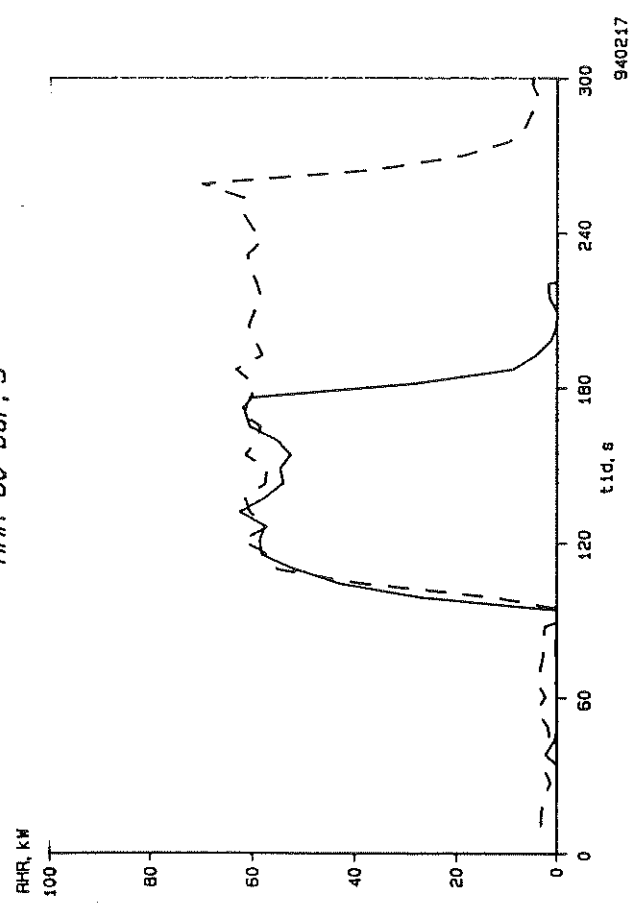

5

CO 60 bar, 3

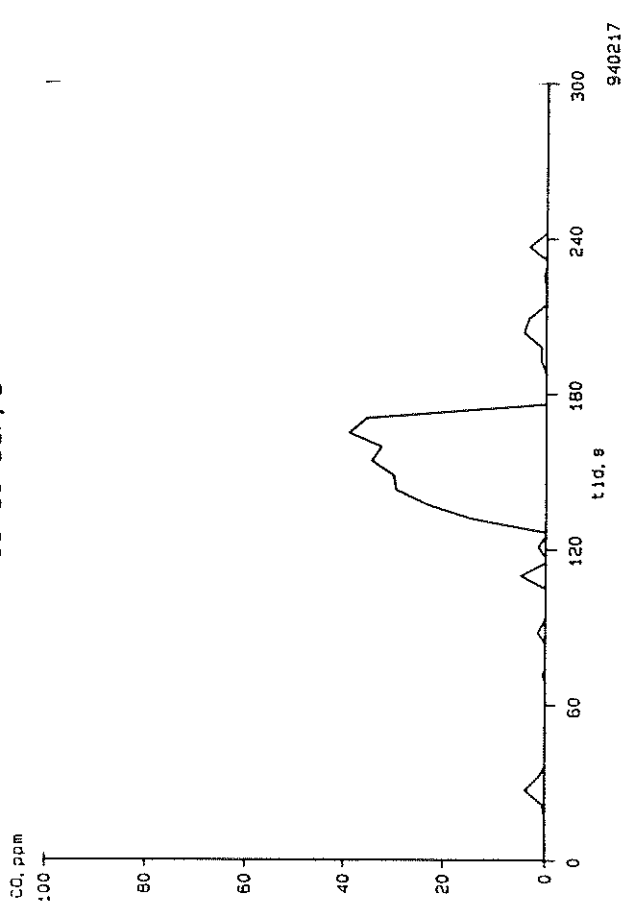

RHR 60 bar, 5

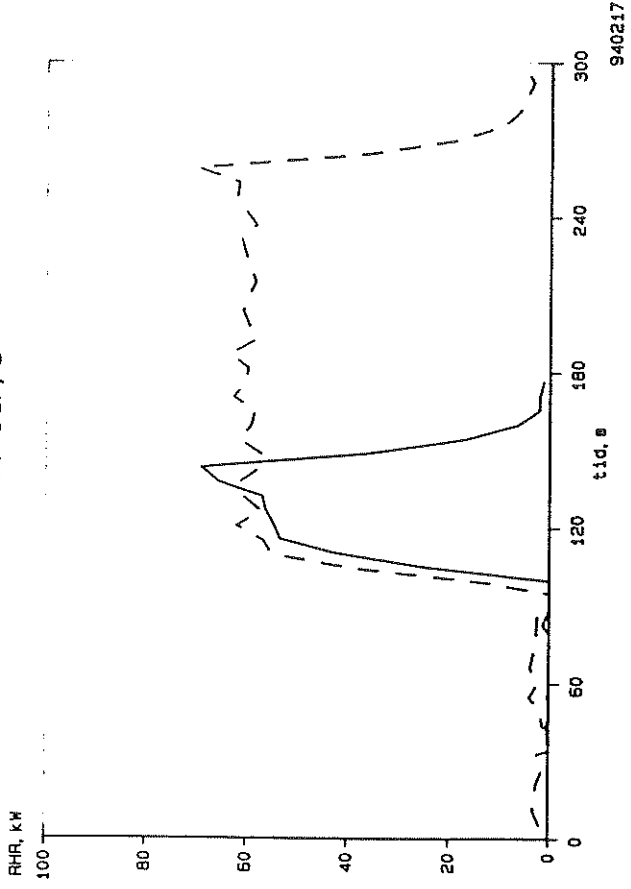

CO 60 bar, 5

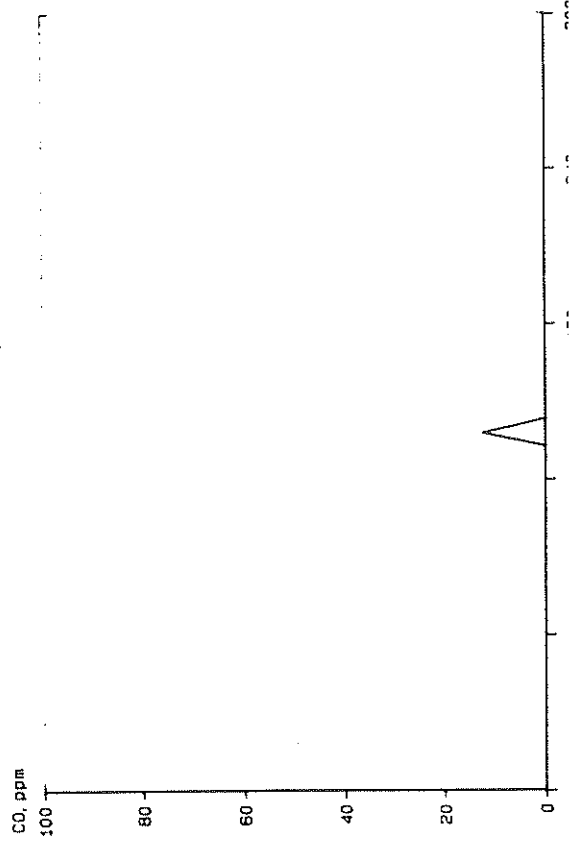

RHR 60 bar, 4

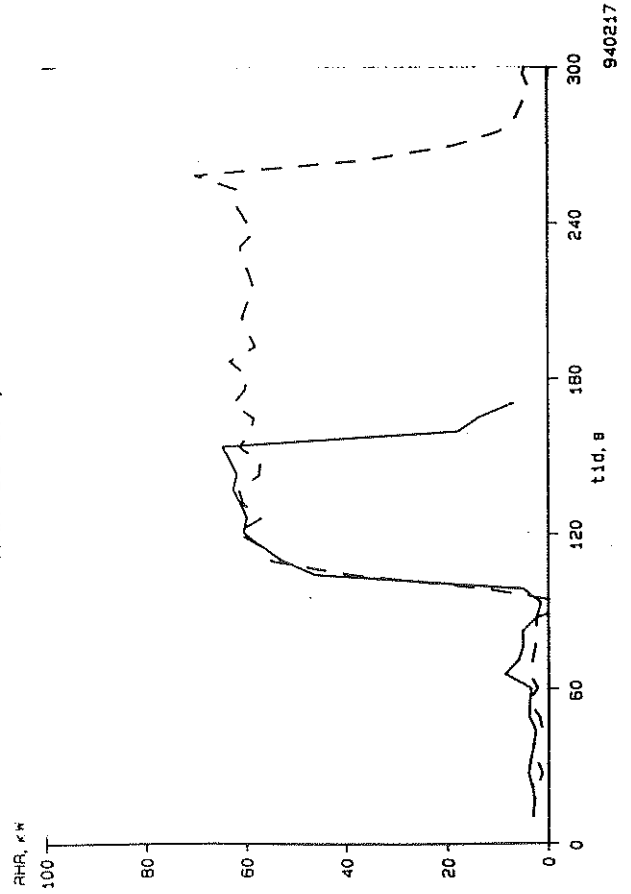

CO 60 bar, 4

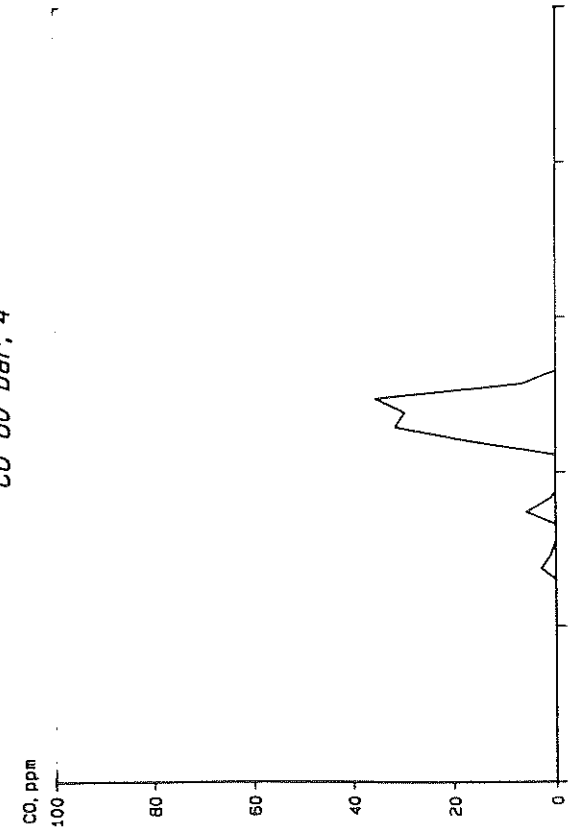

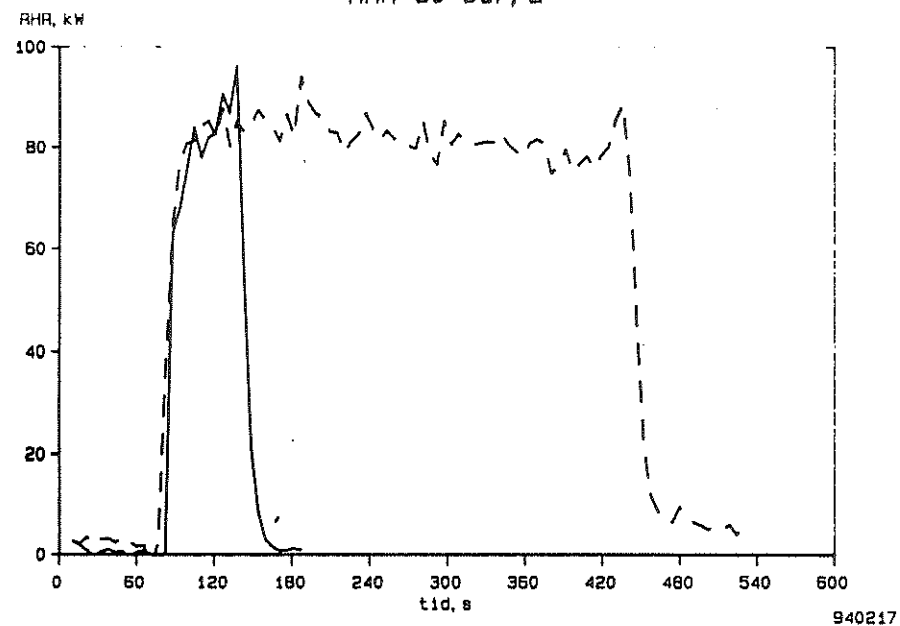
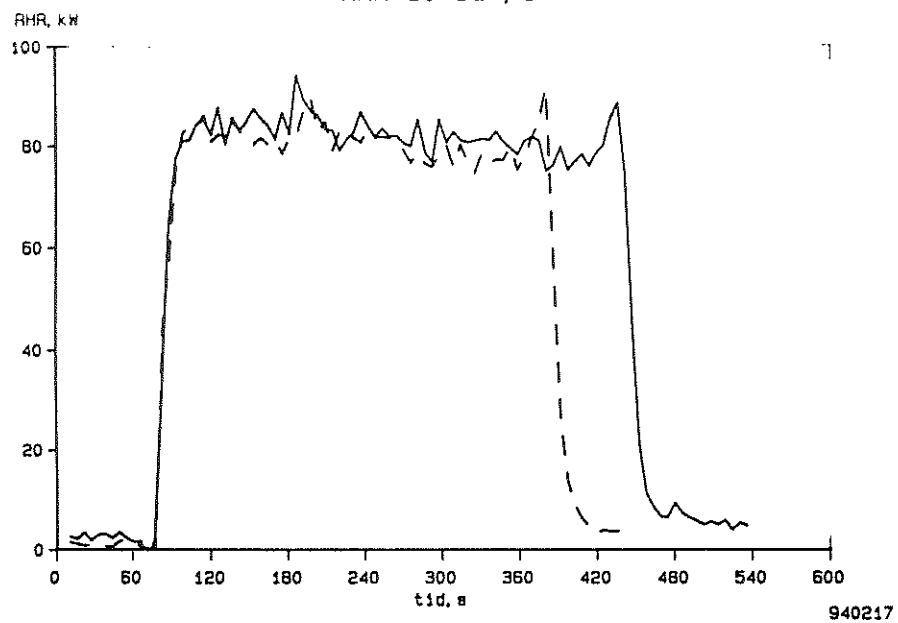

C7

CO 80 bar, 1

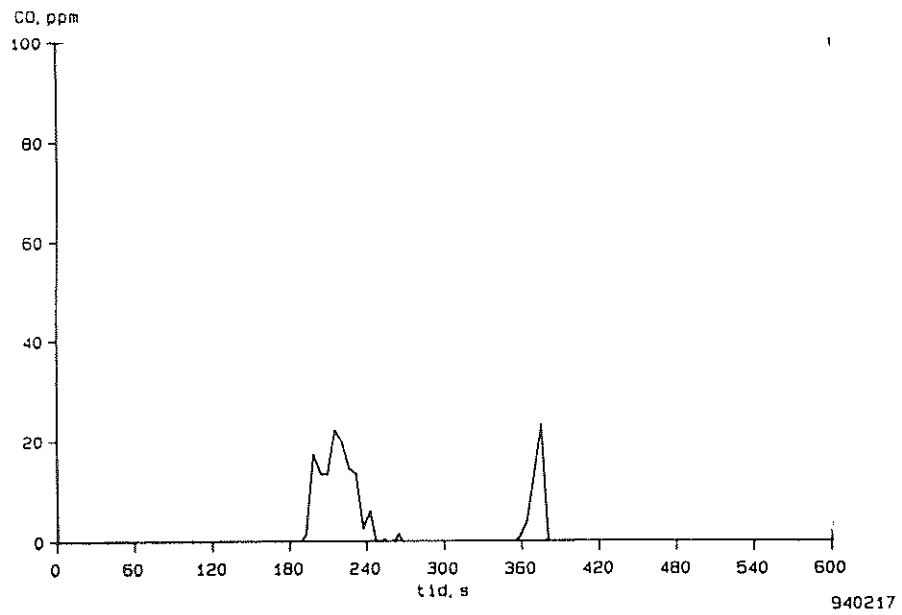

RHR 80 bar, 3

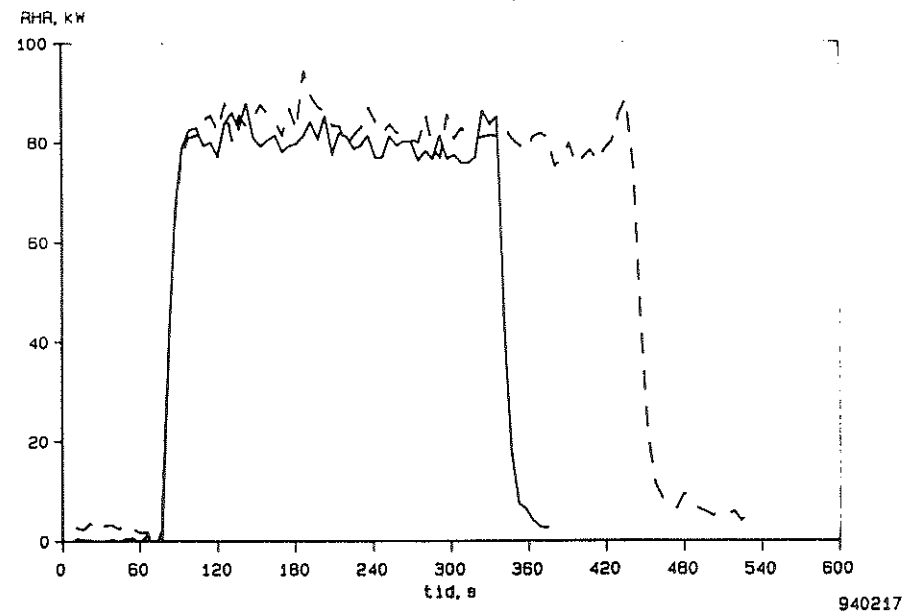

RHR 80 bar, 5

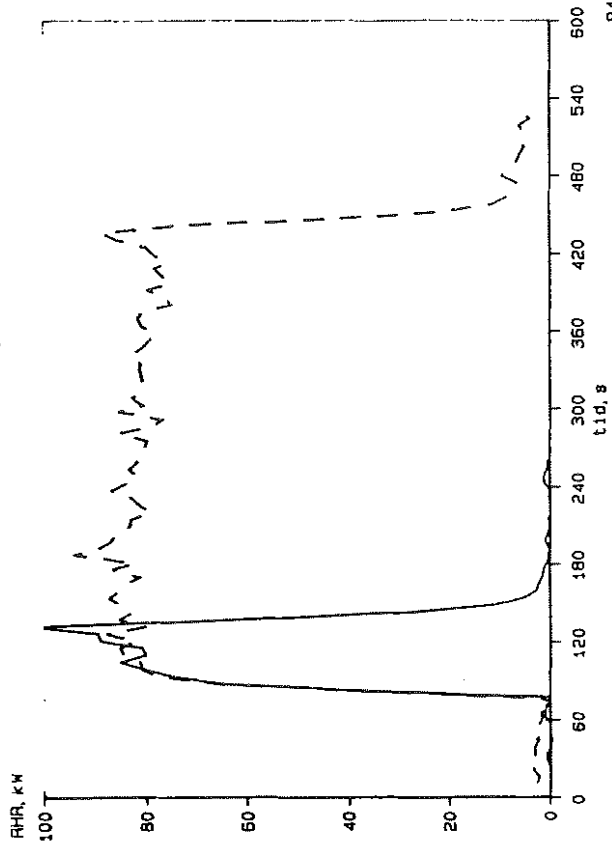

940217

RHR 80 bar, 21

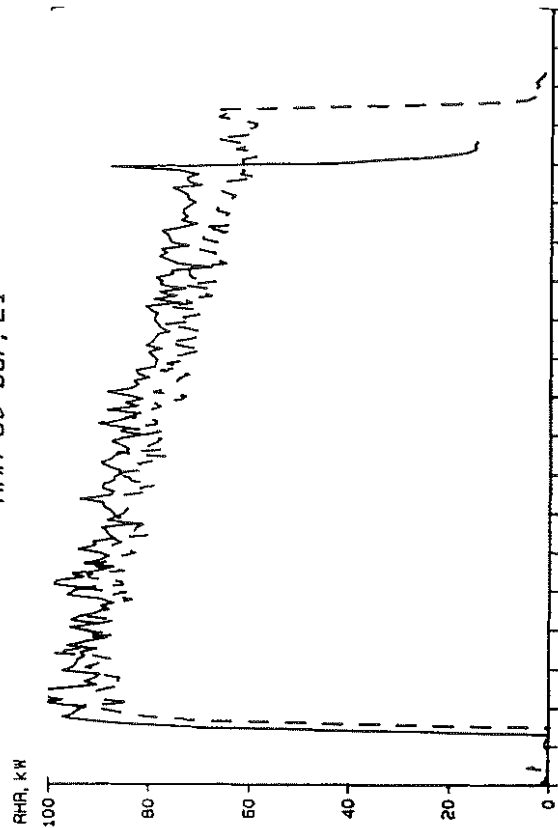

RHR 80 bar, 4

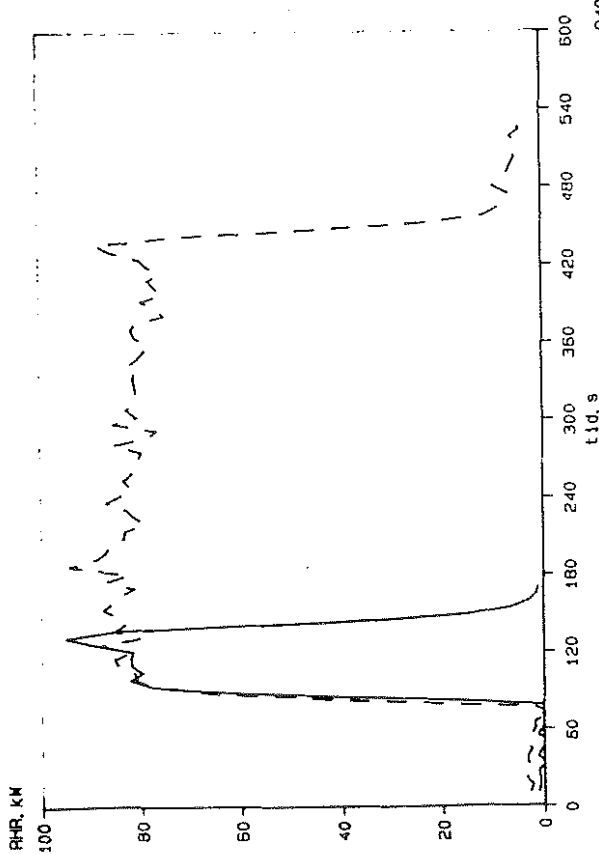

940217

RHR 80 bar, 22

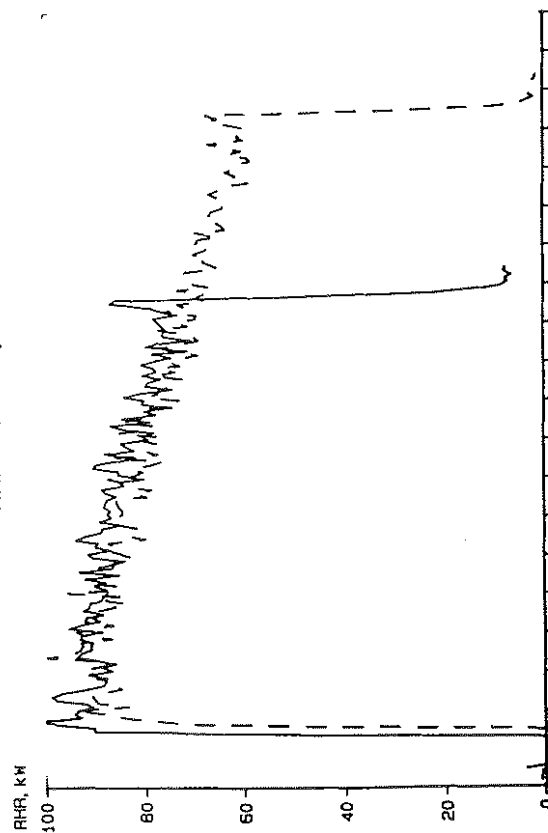

Appendix D

Rate of Heat Release, CO and CO₂ graphs from the 1/3 scale experiments

In the following graphs the Rate of Heat Release (RHR) in kW as a function of time from the 1/3 scale tests are presented. In some cases the CO and/or CO₂ production is shown as well. The dotted lines are the Rate of Heat Release/CO/CO₂ without adding water. The diagrams are presented in the same order as presented in the tables below going from left to right. At the end the diagrams from the 80 bar cases are presented, all these tests resulted in an immediate extinction.

Table D-1 Rate of Heat Release in kW when extinction occurred in the 1/3 scale room tests. The nozzle body was located at the opening (position 1)

Pressure [bar]	Position of gas burner	Height of nozzle body above the floor [cm]					
		+10 cm		+34 cm		+56 cm	
		12 pcs	8 pcs	12 pcs	8 pcs	12 pcs	8 pcs
20 bar	In corner	N/E	-	45	N/E	40	37
	At wall	24	15	45*	43	43*	44
40 bar	In corner	41	40	42*	44	43*	43*
	At wall	45*	40	43*	44	44*	45*
60 bar	In corner	42*	45*	42*	47*	38*	45*
	At wall	42*	46*	42*	47*	38*	45*

N/E Not Extinguished

- No test conducted

* Extinction occurred immediately

Table D-2 Rate of Heat Release in kW when extinction occurred in the 1/3 scale room tests. The nozzle body was located 34 cm in from the opening (position 2)

Pressure [bar]	Position of gas burner	Height of nozzle body above the floor [cm]					
		+10 cm		+34 cm		+56 cm	
		12 pcs	8 pcs	12 pcs	8 pcs	12 pcs	8 pcs
20 bar	In corner	N/E	-	45	17	44	11
	At wall	38*	44	40	28	43	47
40 bar	In corner	40	45	43*	45	43*	34
	At wall	48*	43	44*	45*	43	47
60 bar	In corner	38	45*	41*	46*	41	45
	At wall	45*	46*	45*	46*	42*	45

N/E Not Extinguished

- No test conducted

* Extinction occurred immediately

RHR
20b123co

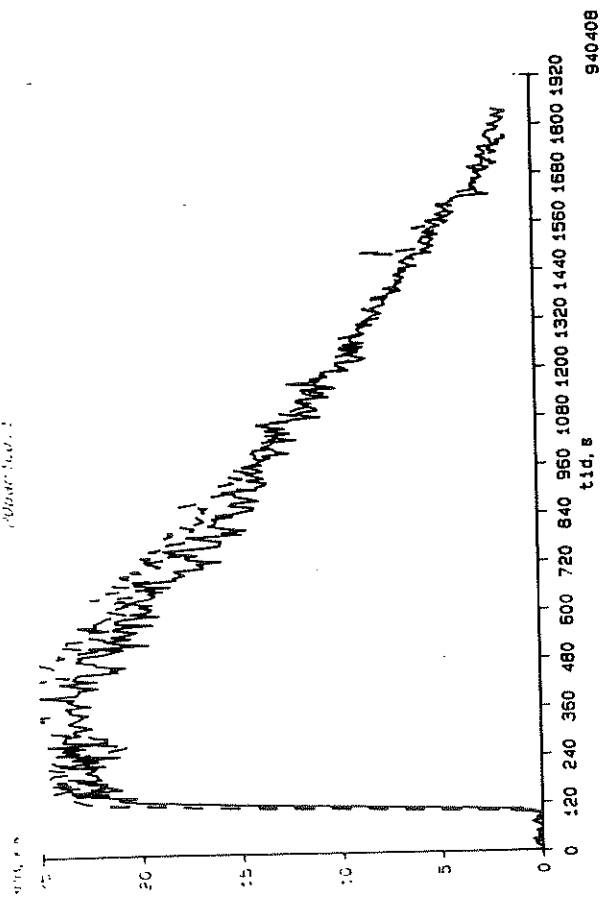

RHR
20b123co

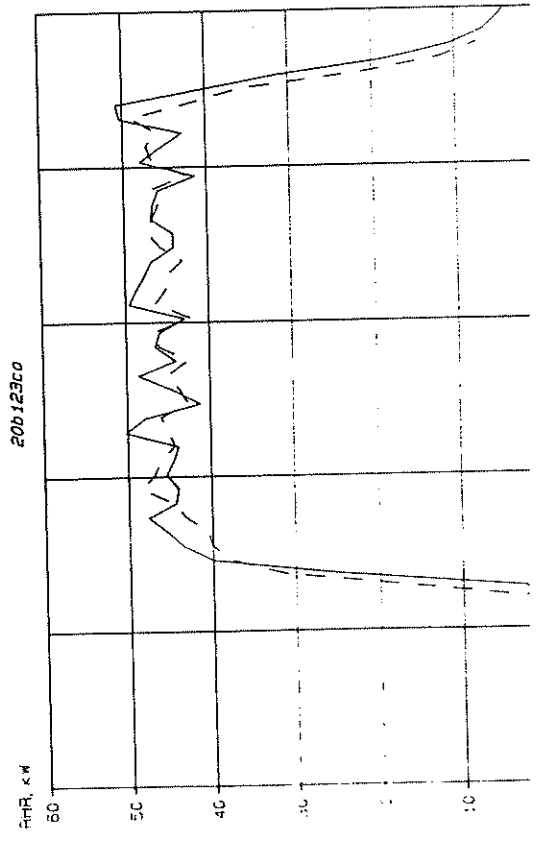

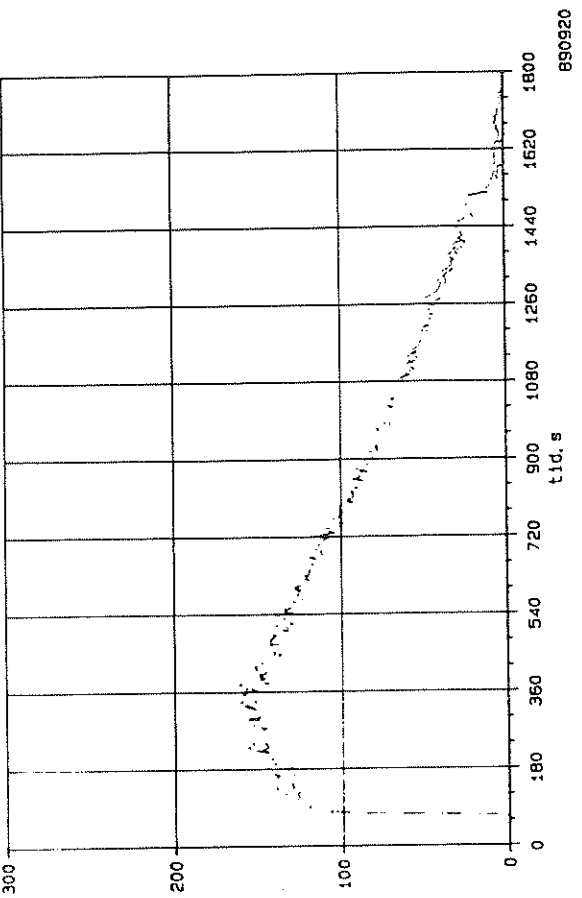

D3

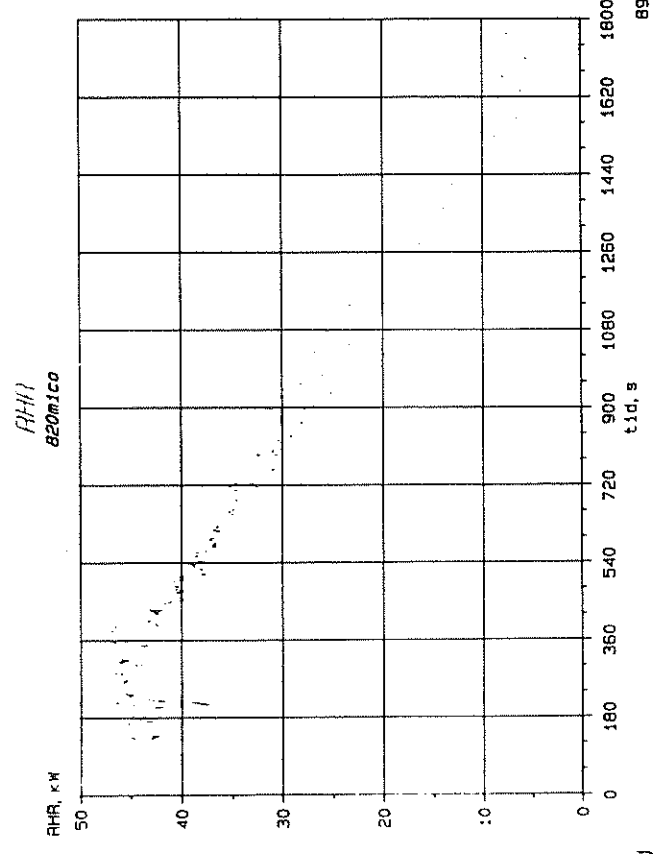

CO

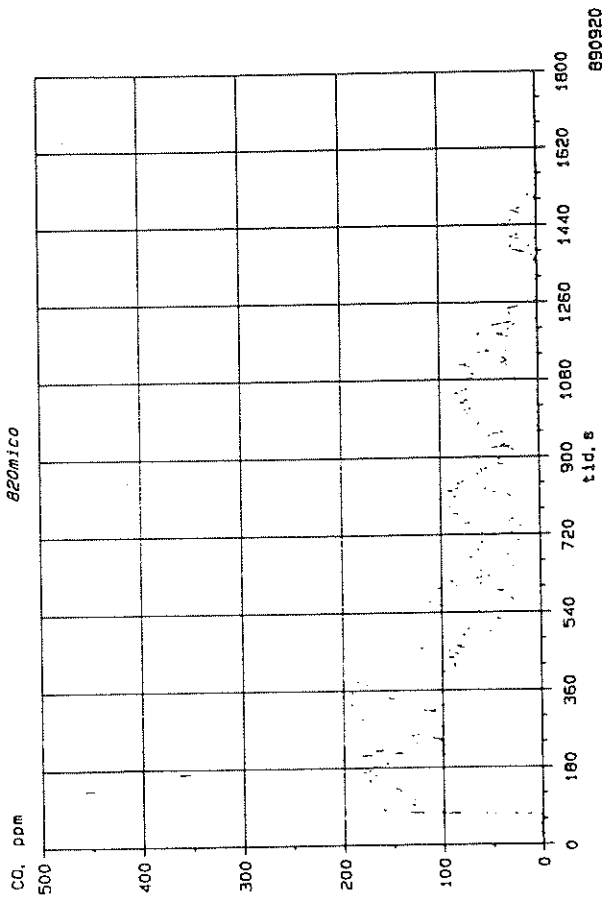

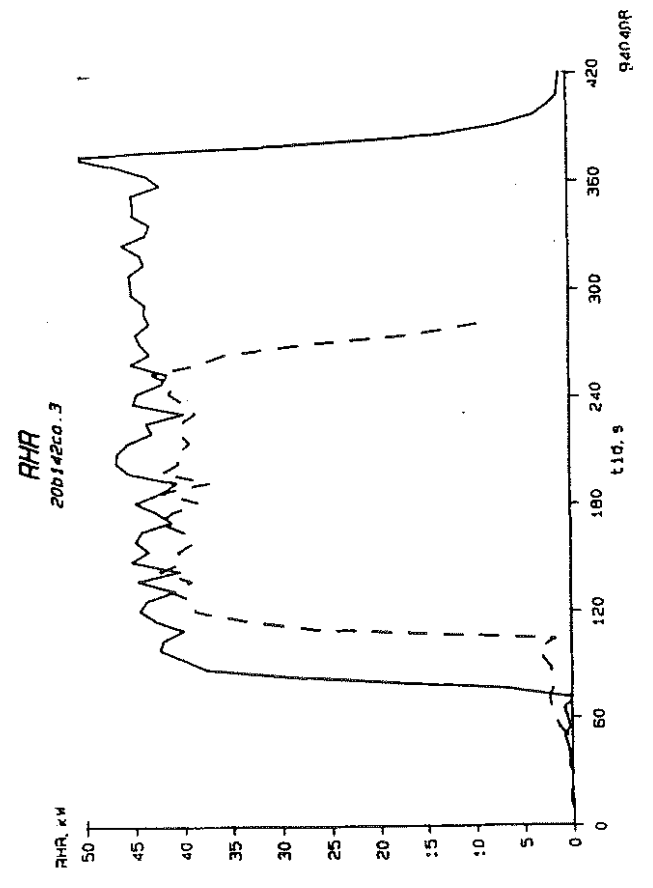
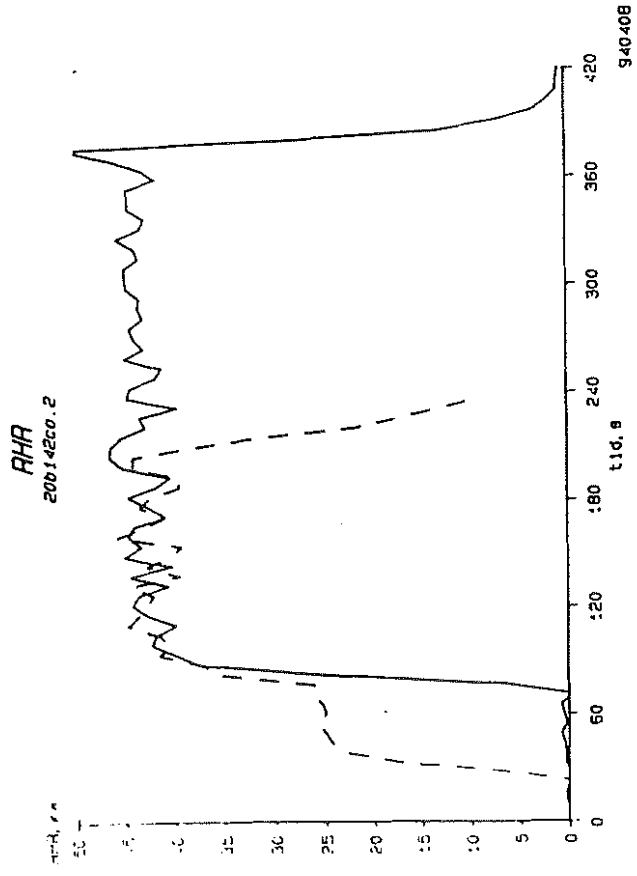

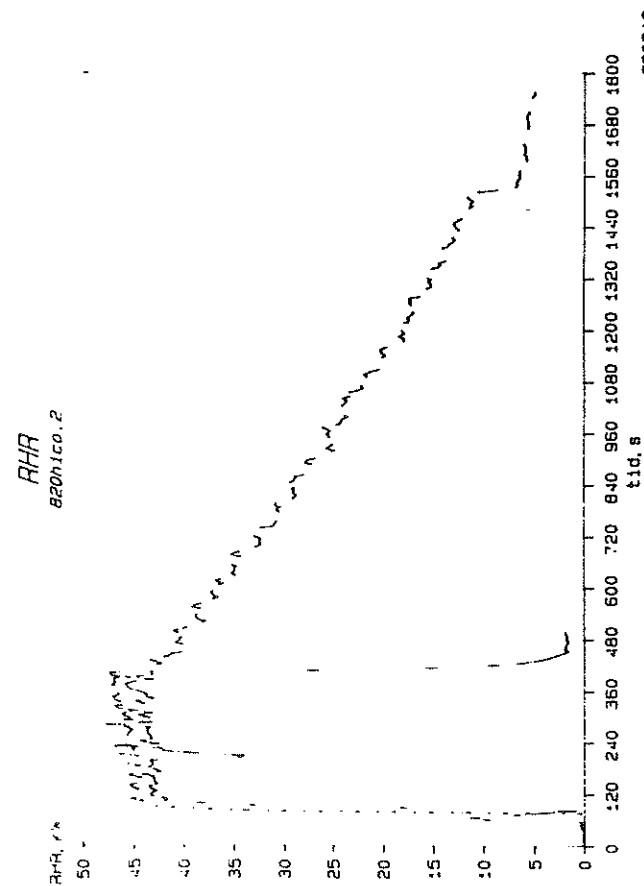
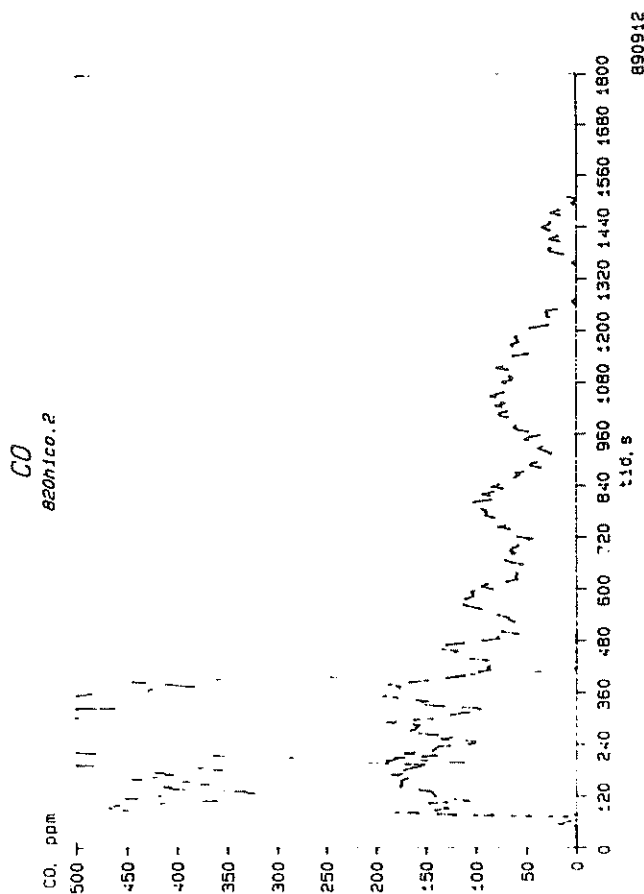
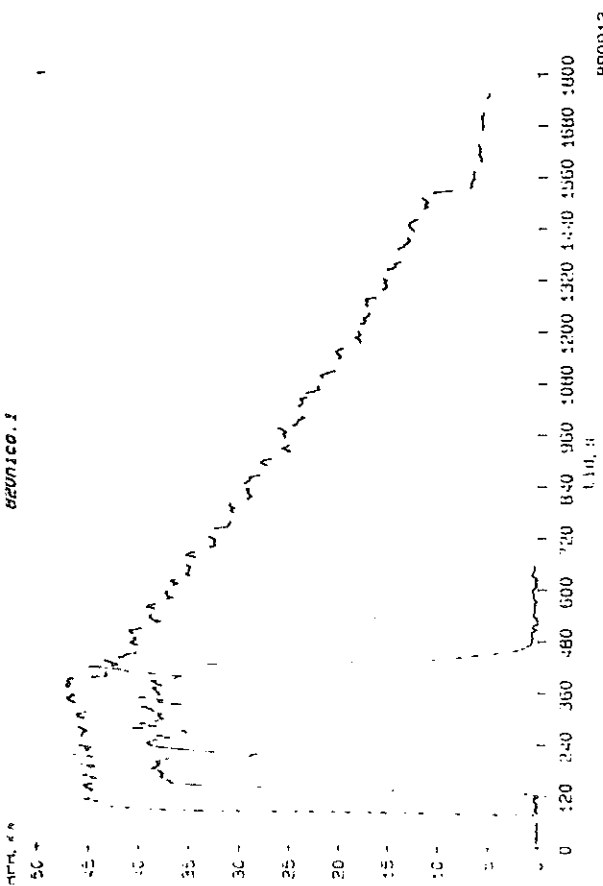
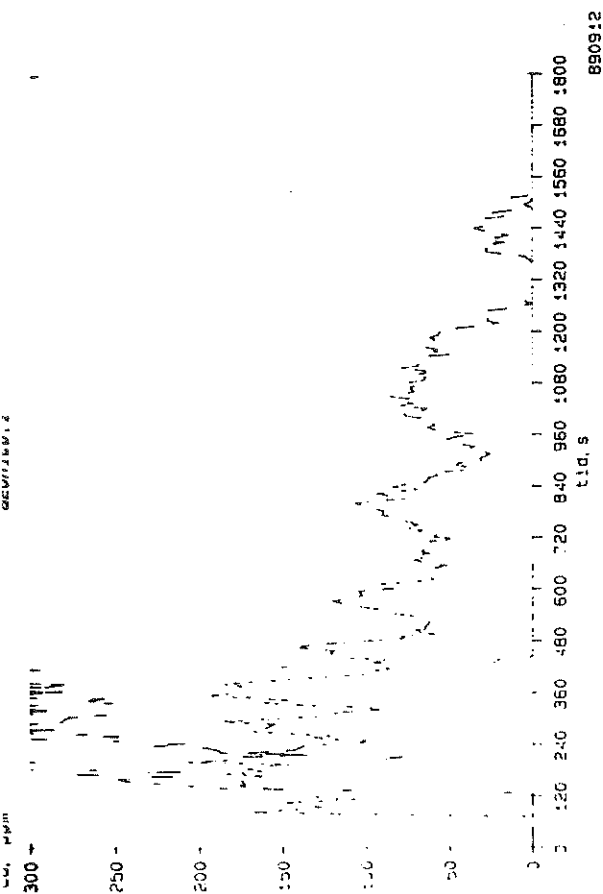

C02
820Hico.2

155-1111
300 -

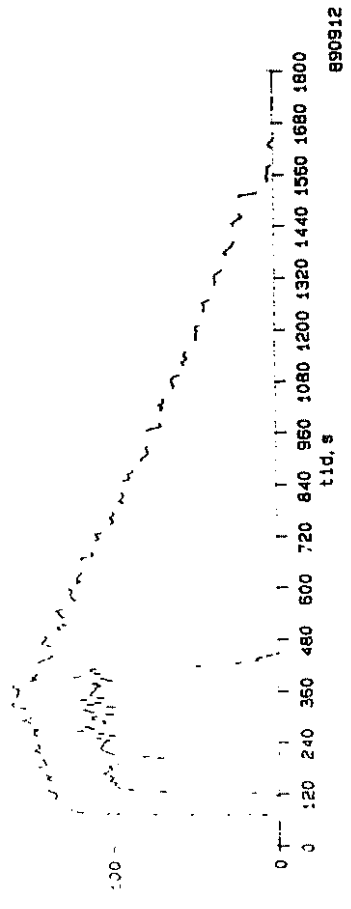

D6

C02
820Hico.2

XCO2#1000
300 -

200 -

100 -

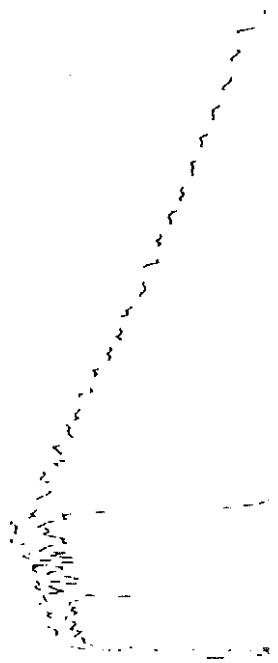

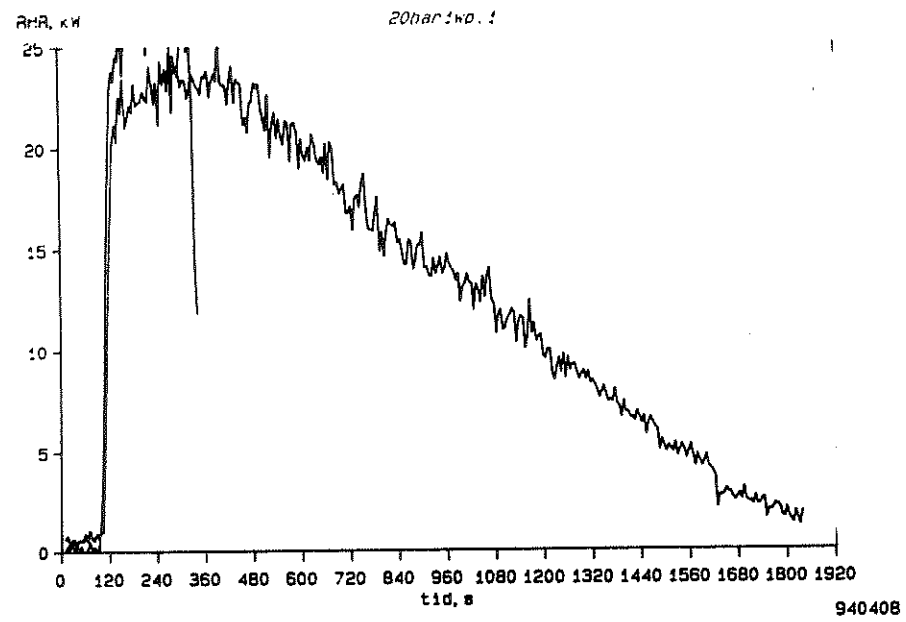

D7

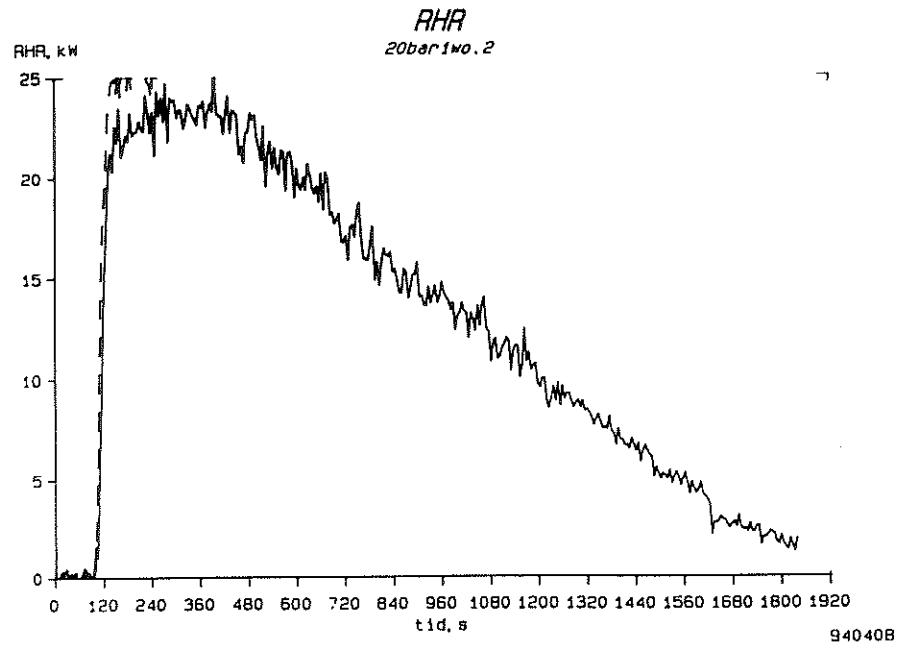

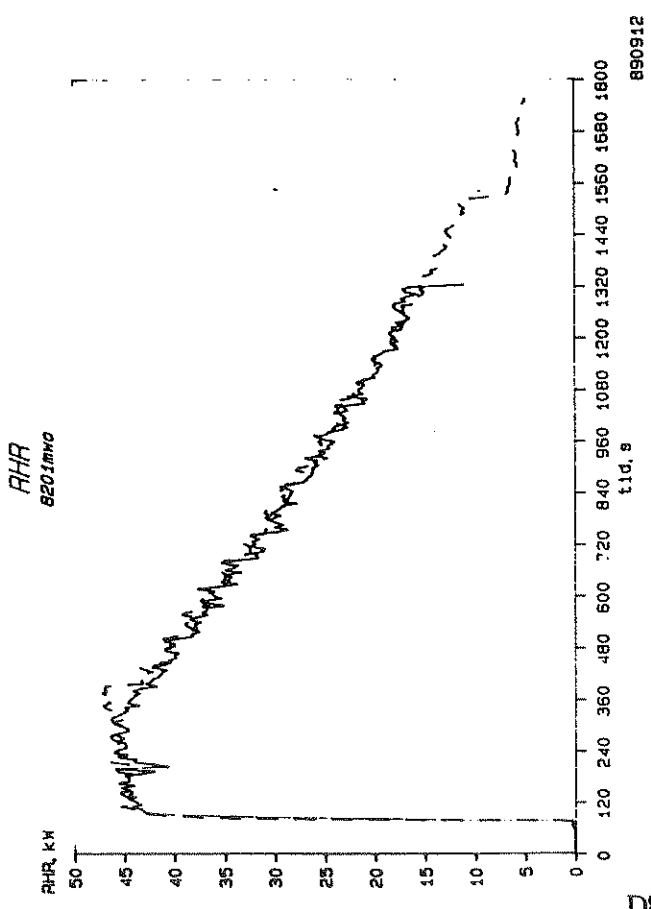
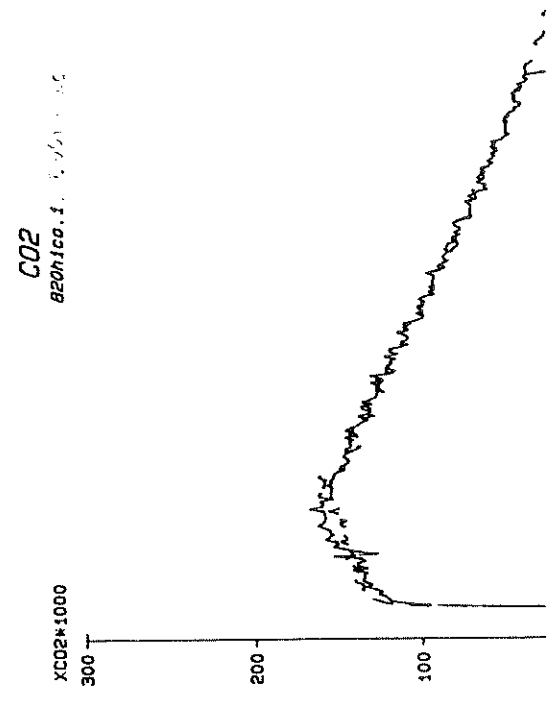
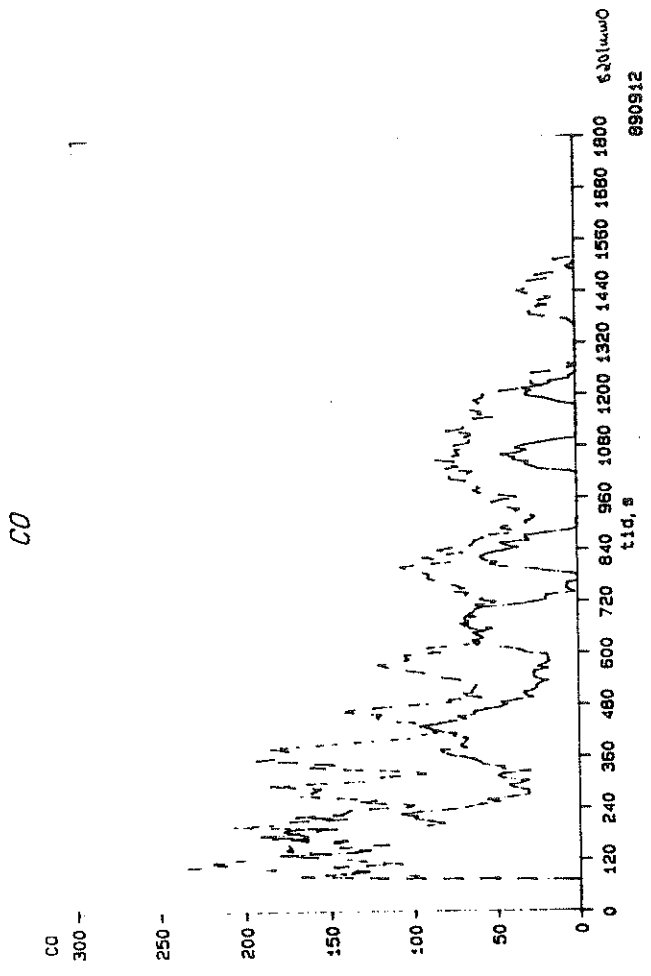

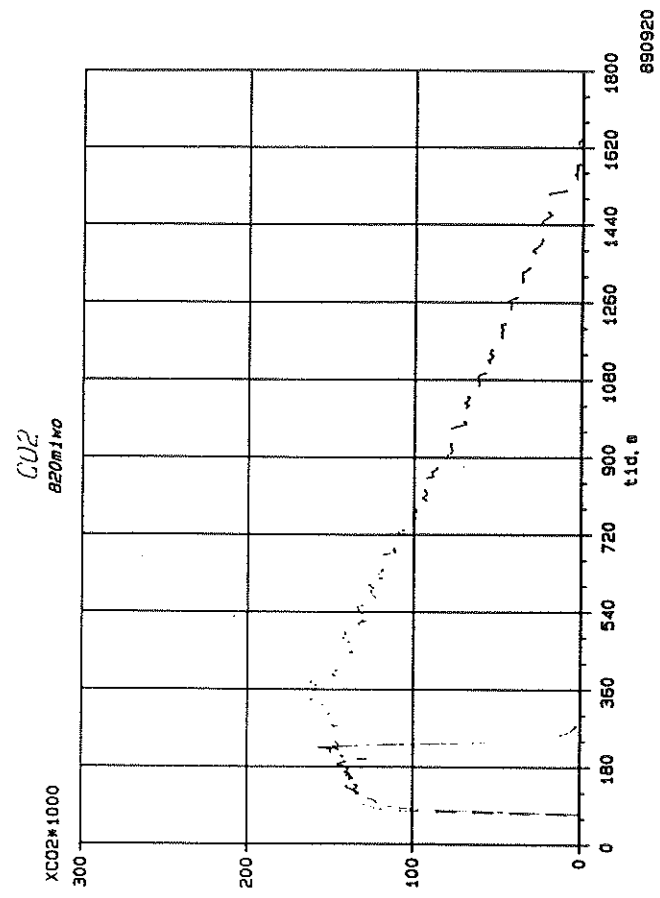
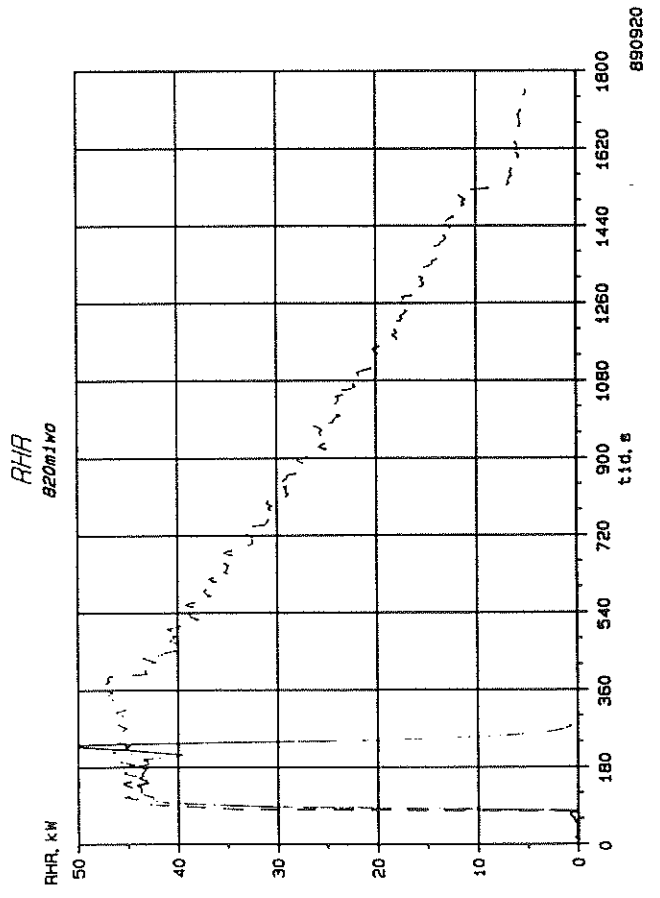
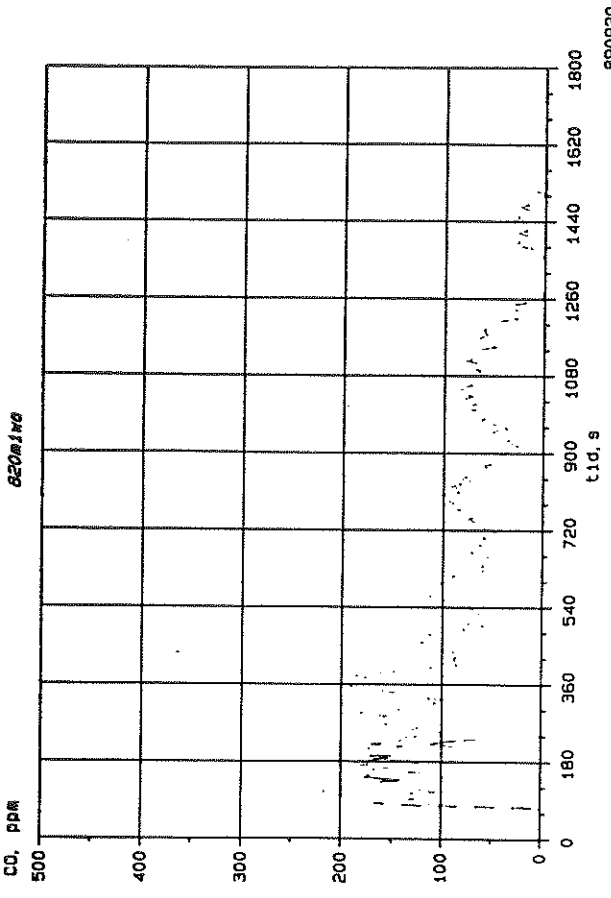
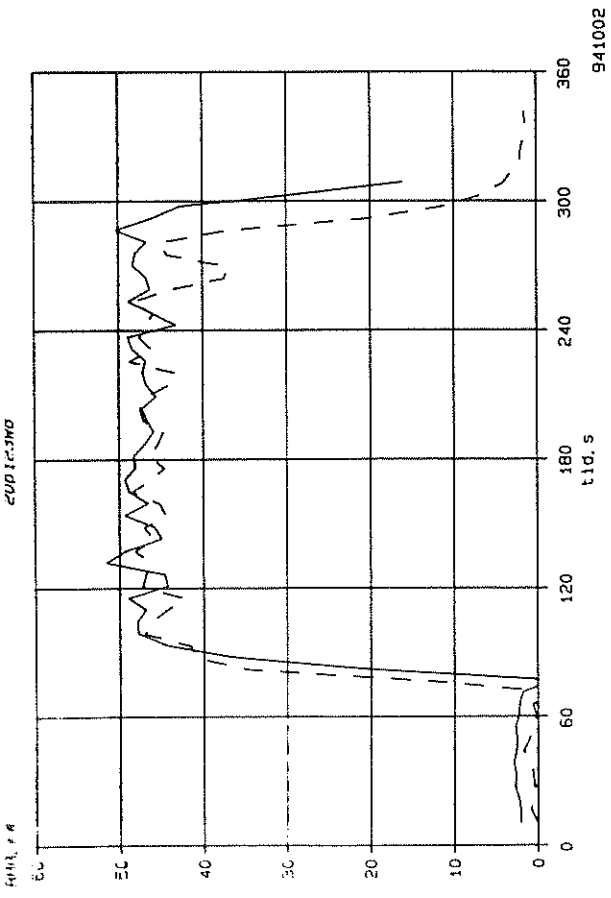

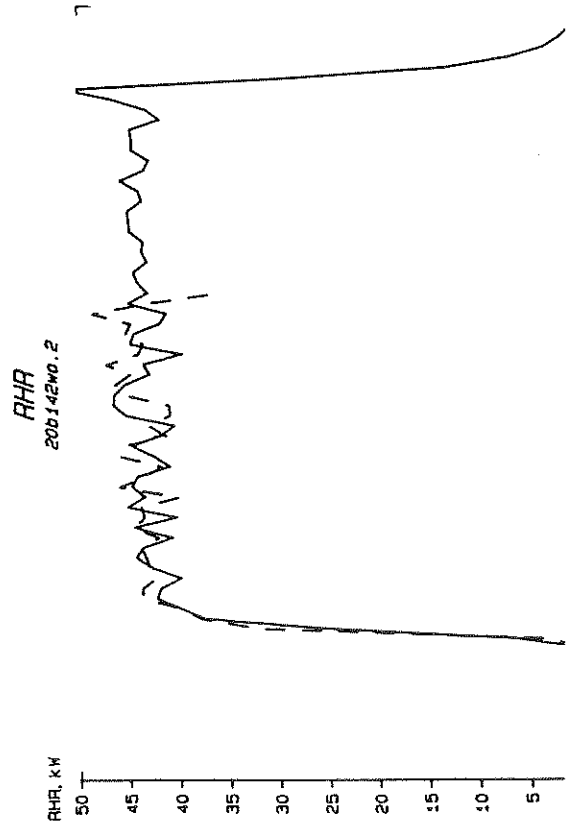
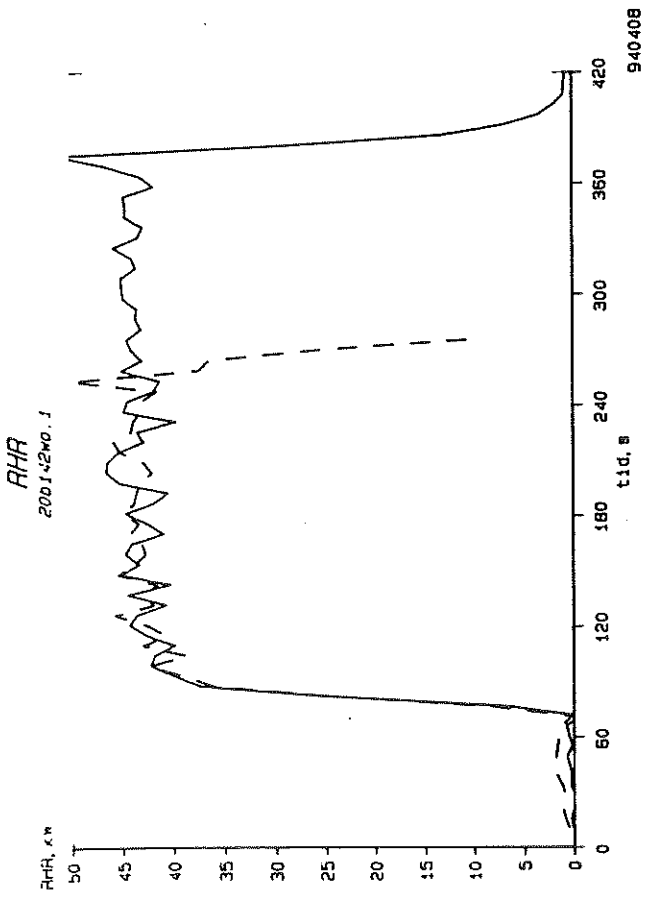

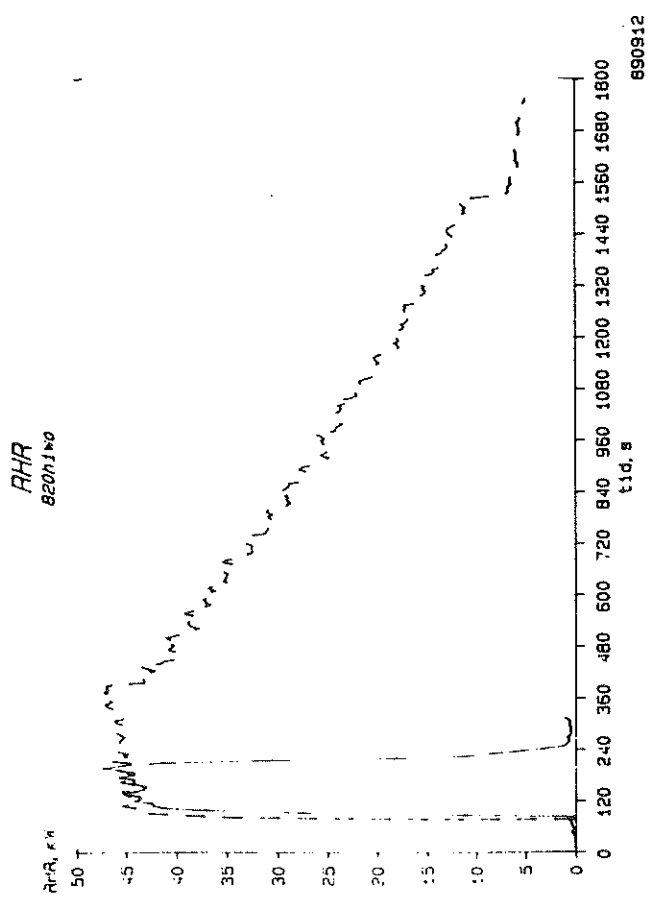
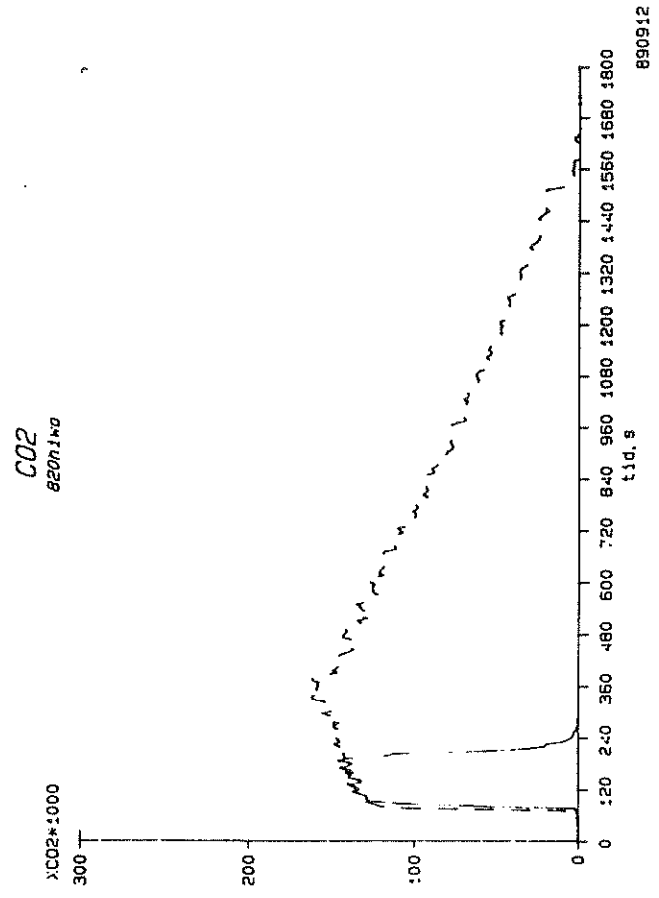
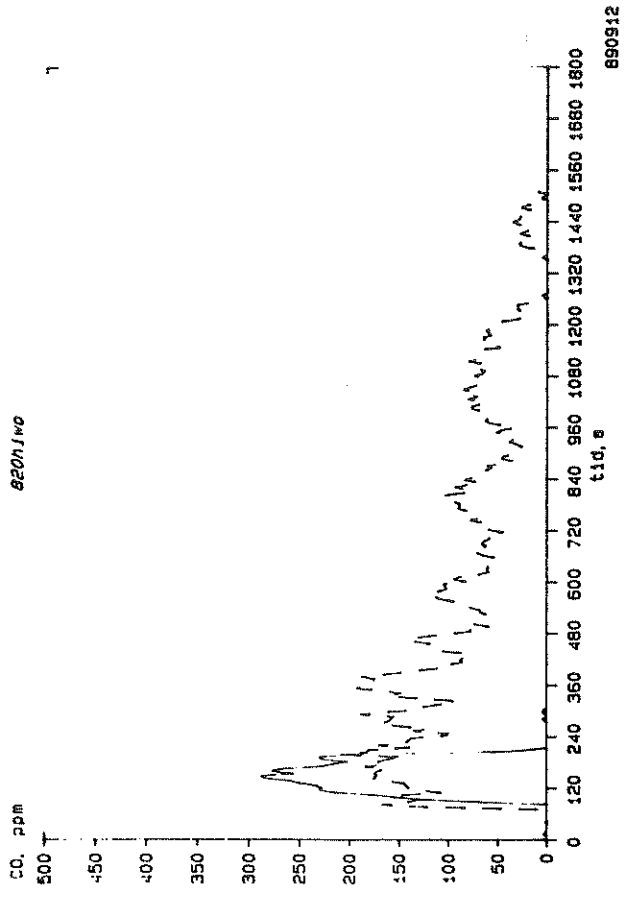

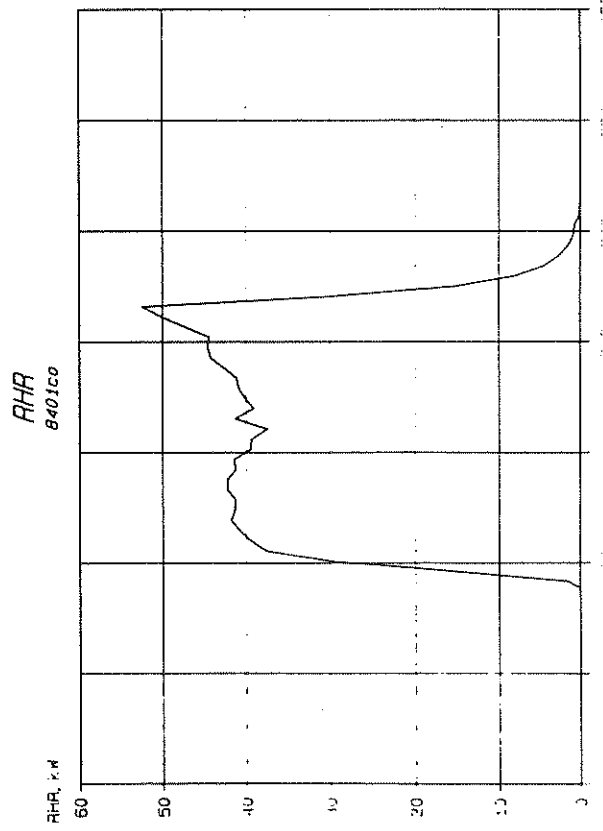
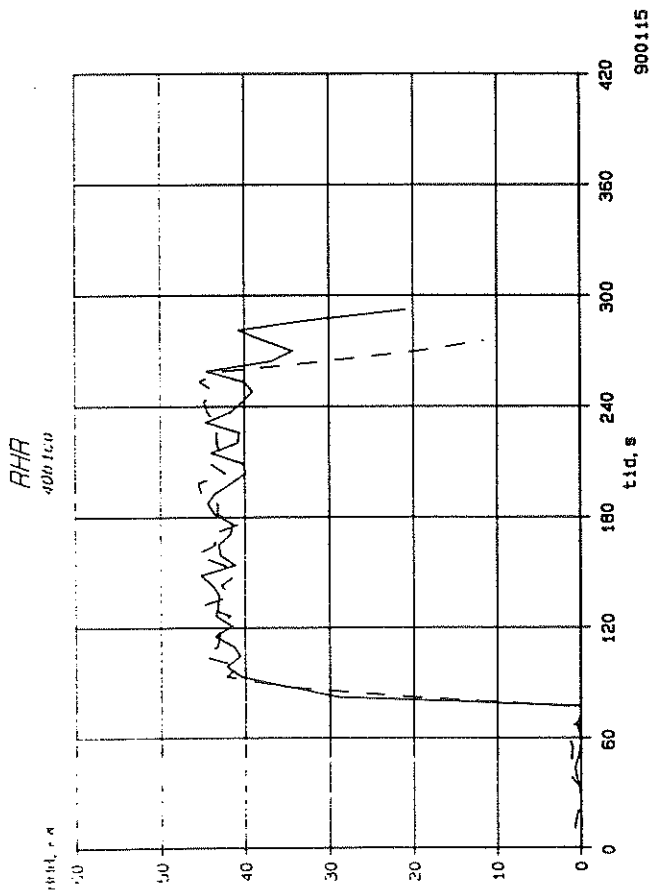

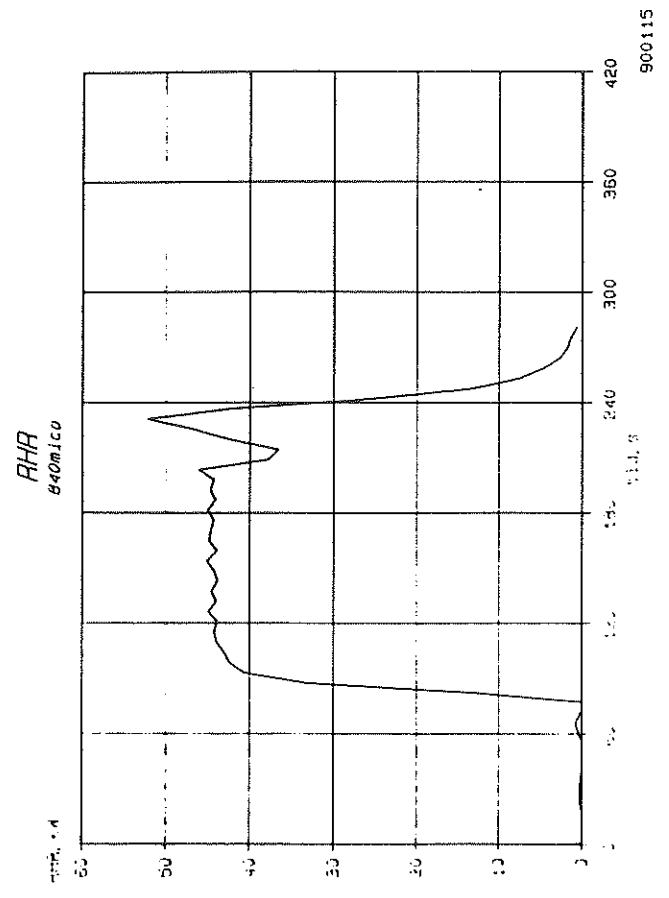
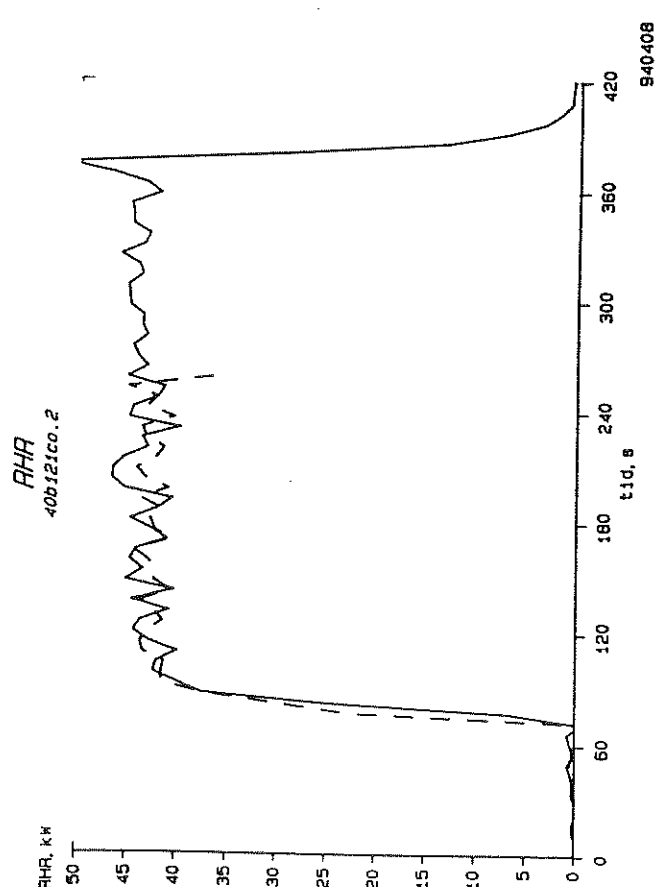
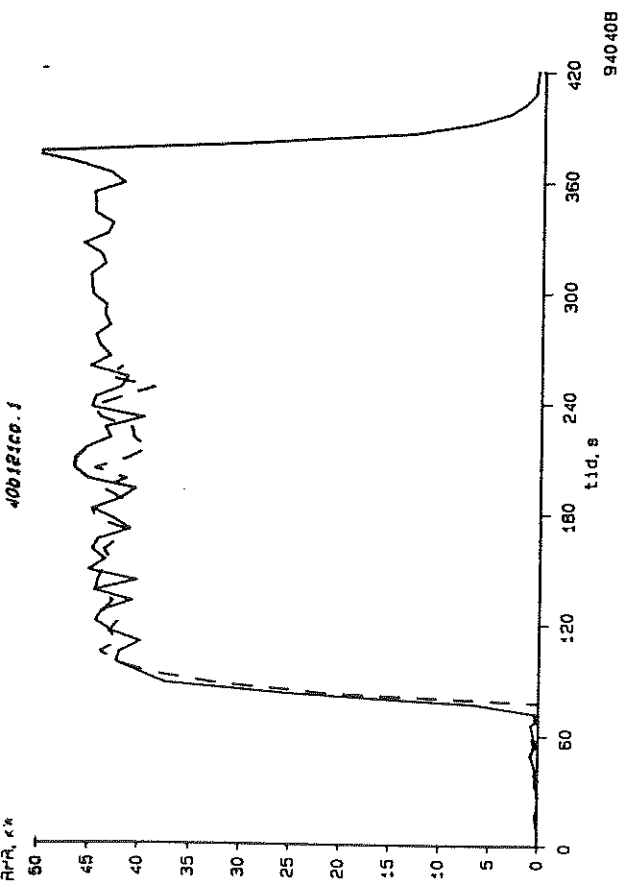

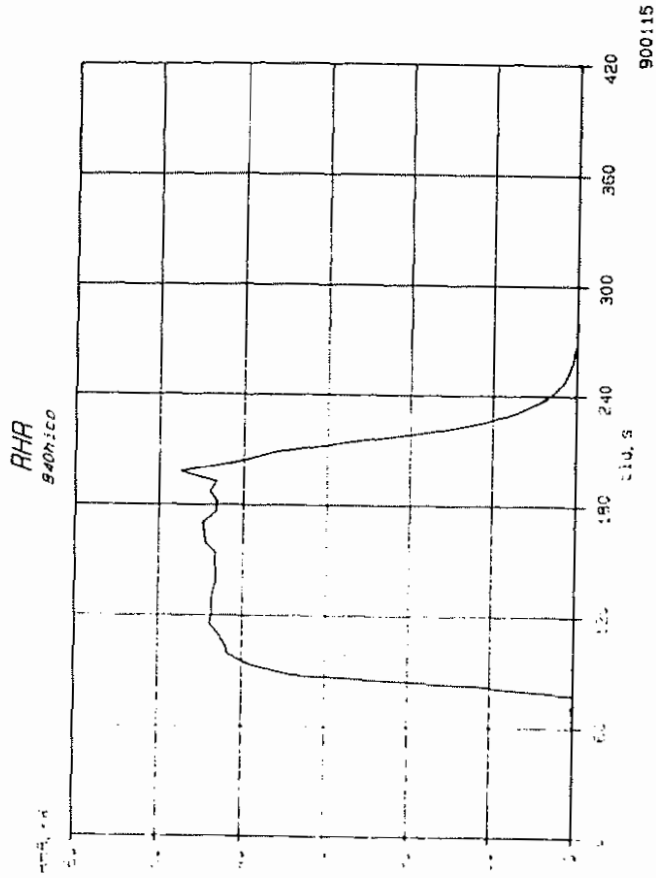
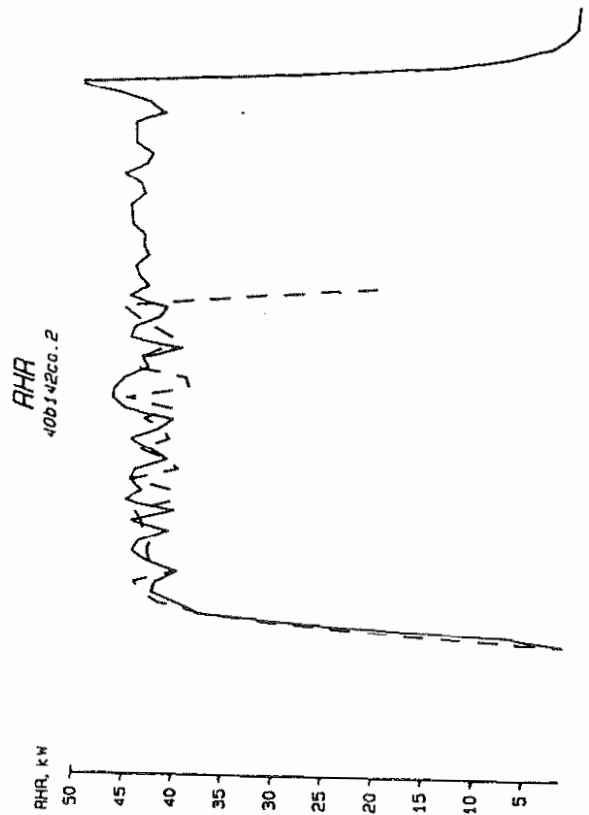
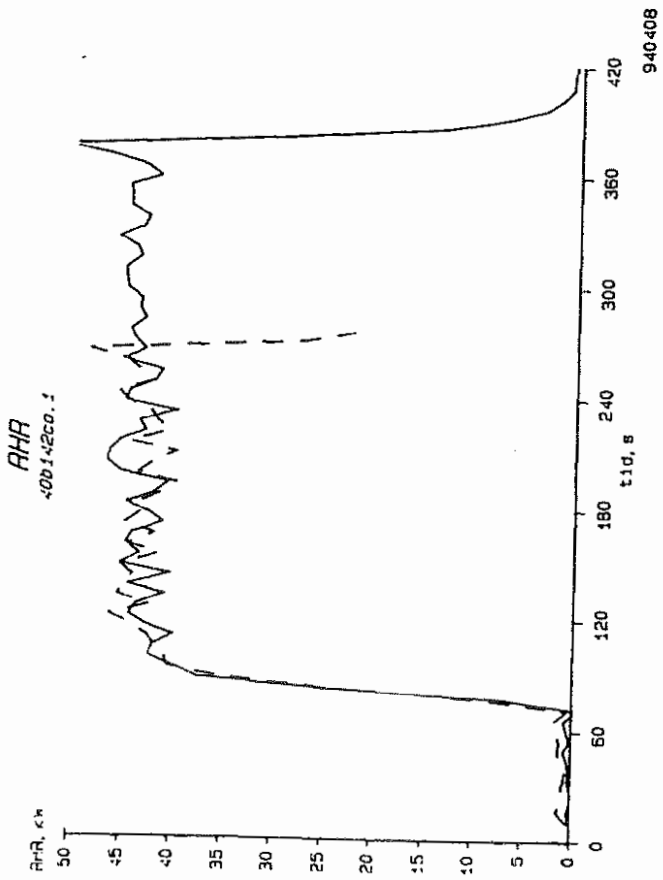

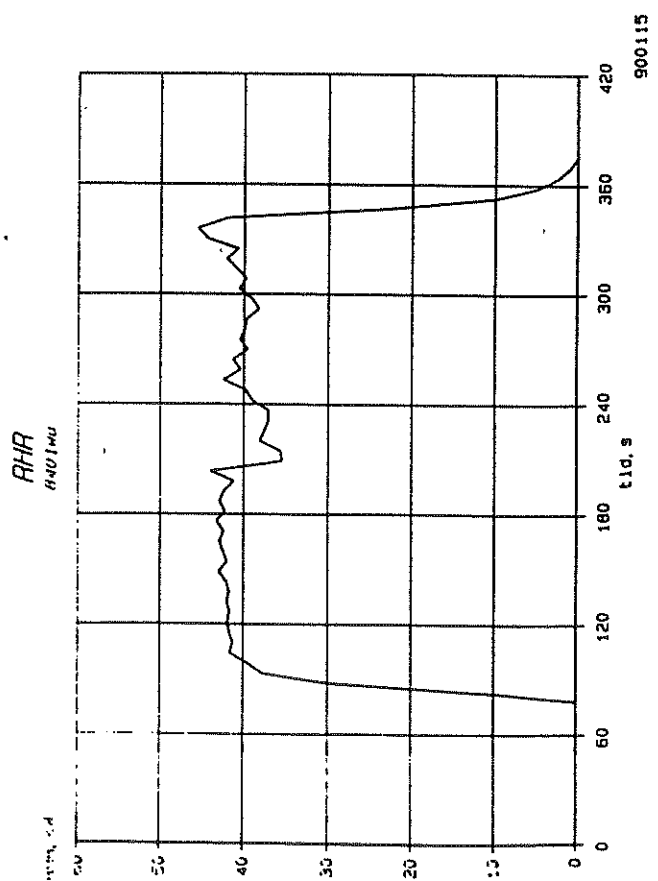
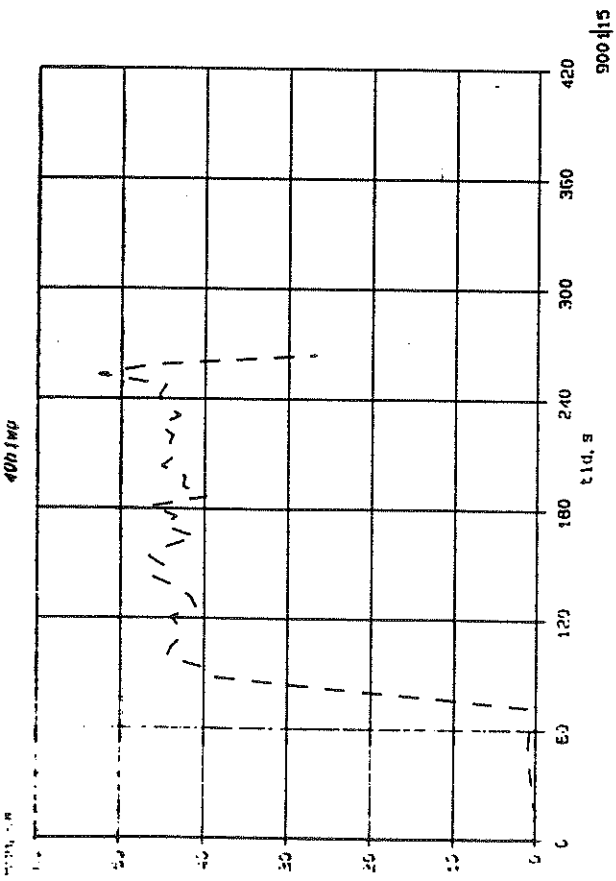

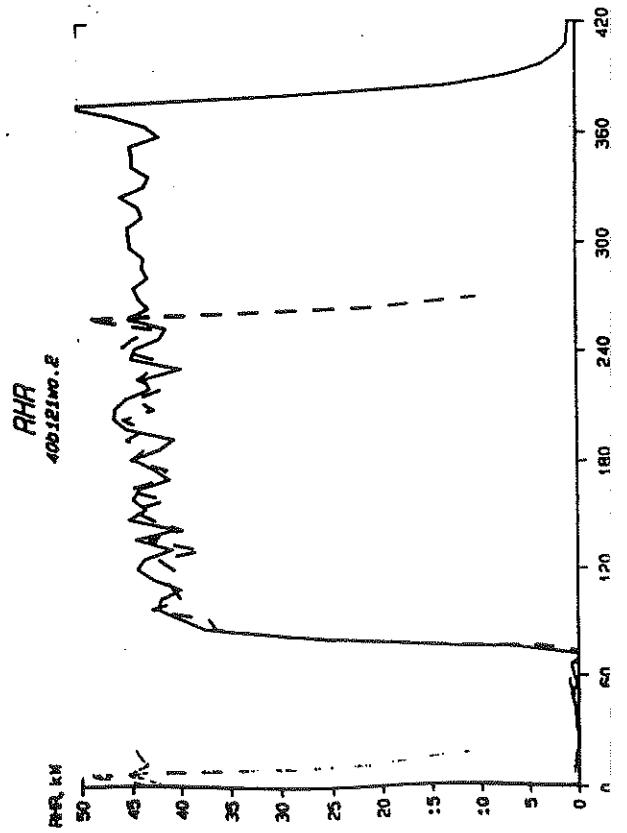
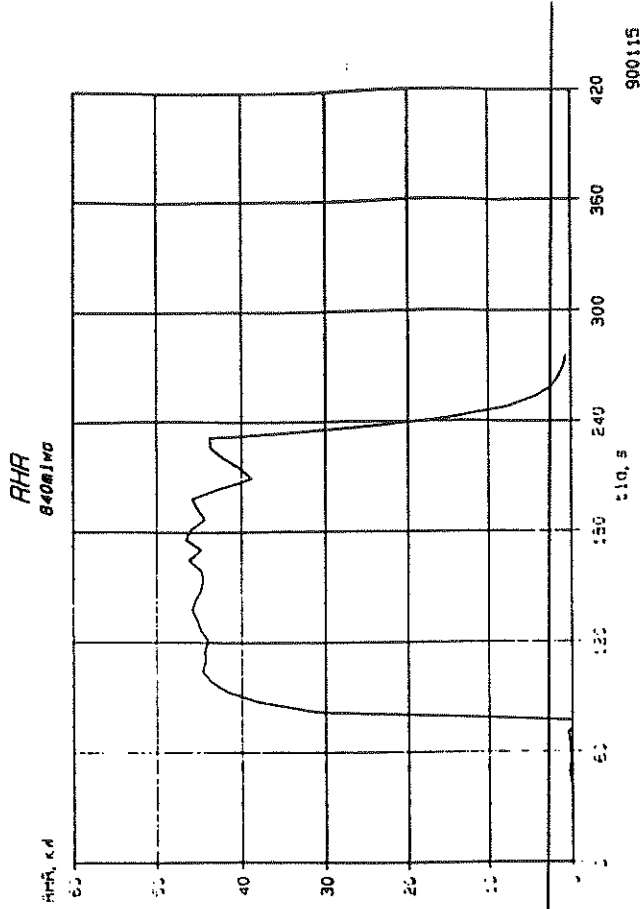
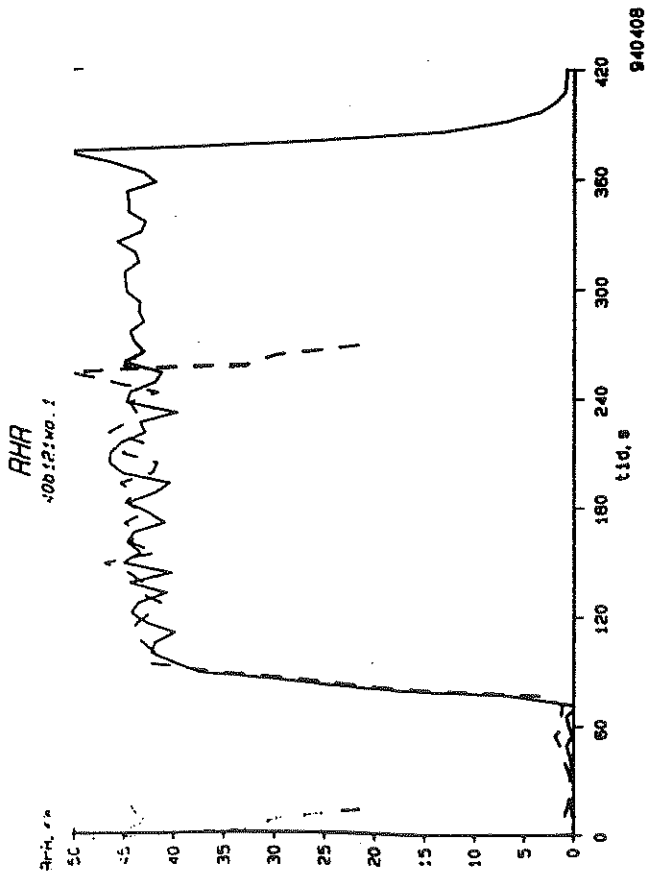

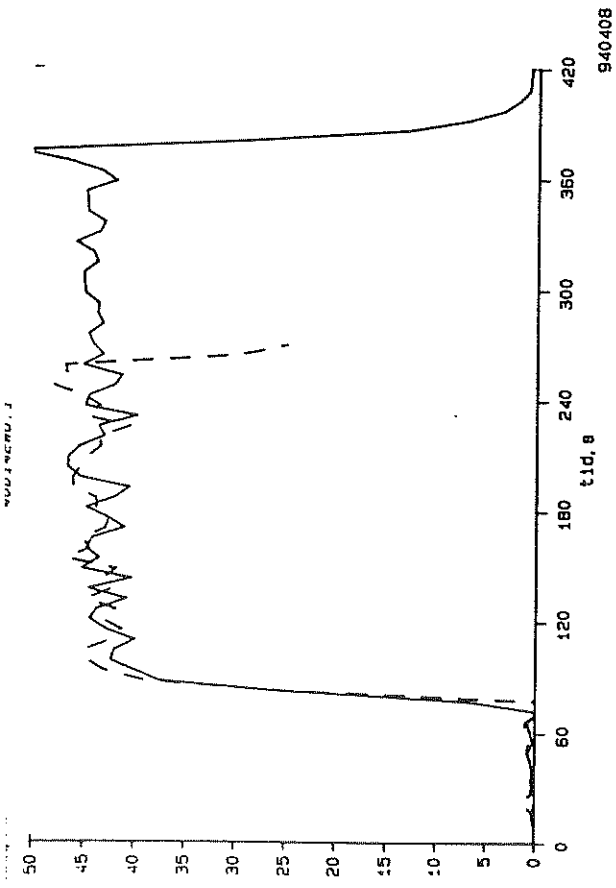

RHR
400142NO.2

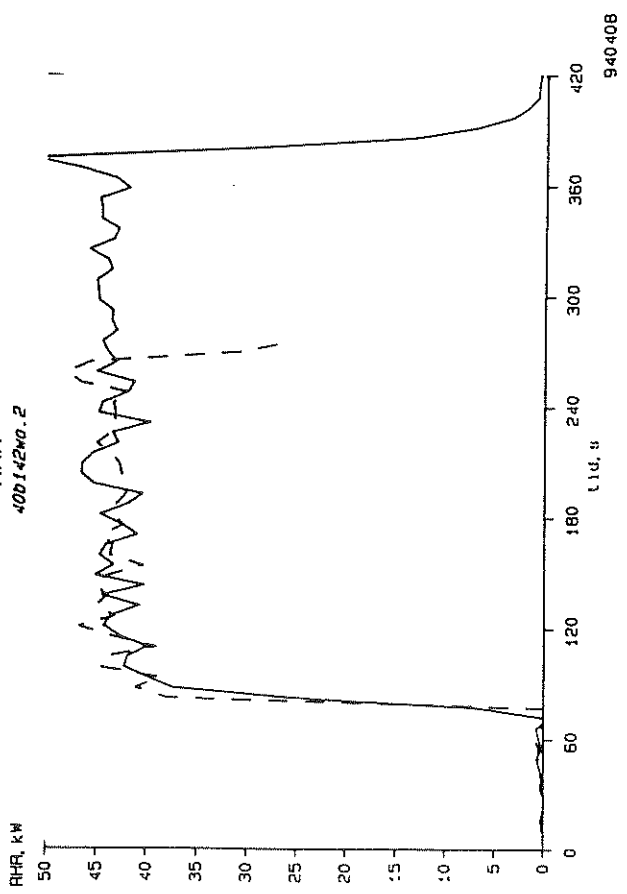

RHR
840h1W0

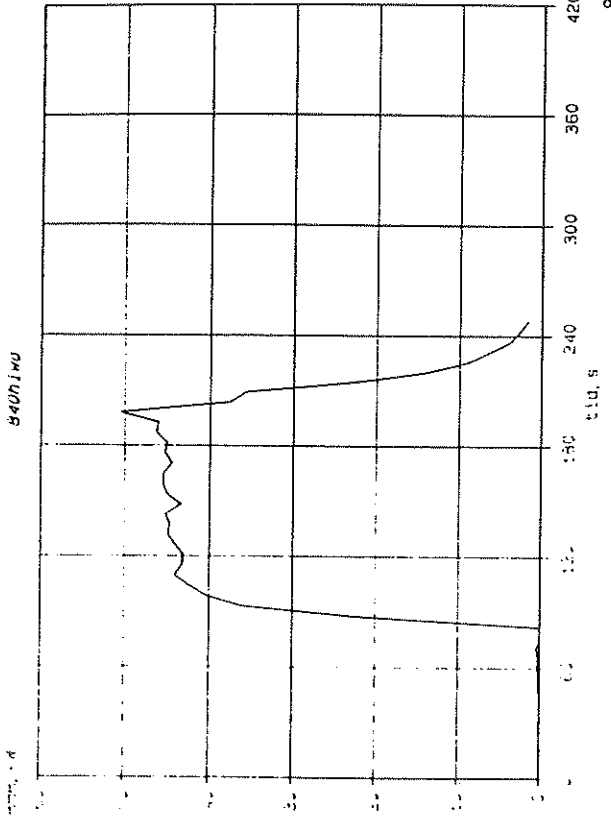

RHR
60b120co

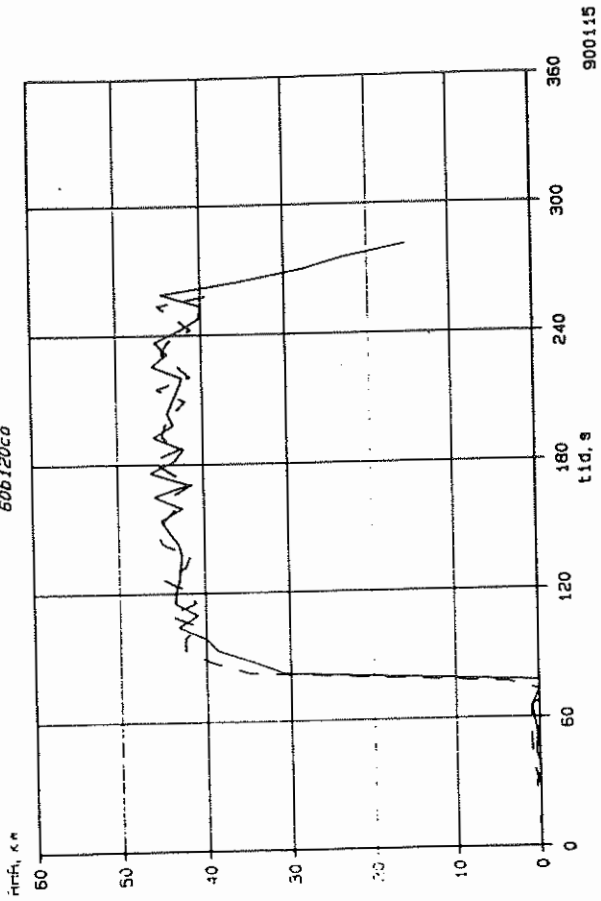

RHR
860m1co

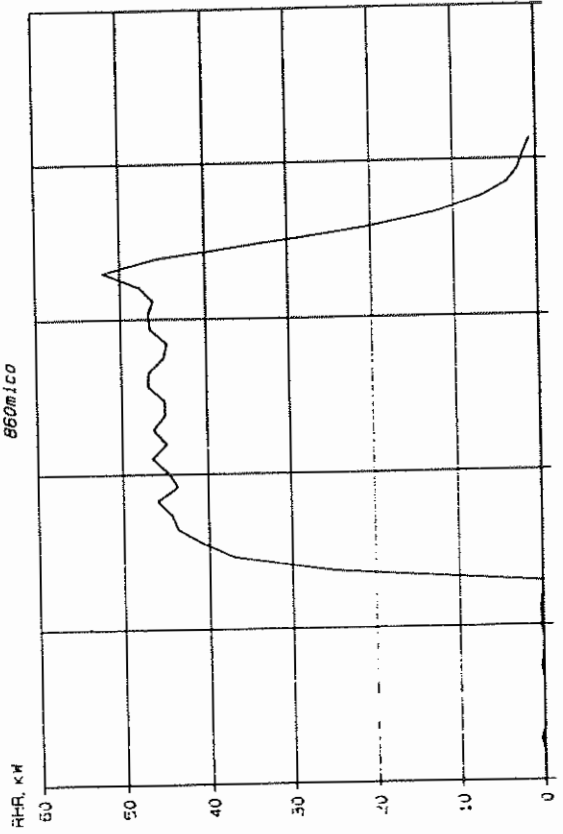

RHR
60b1co

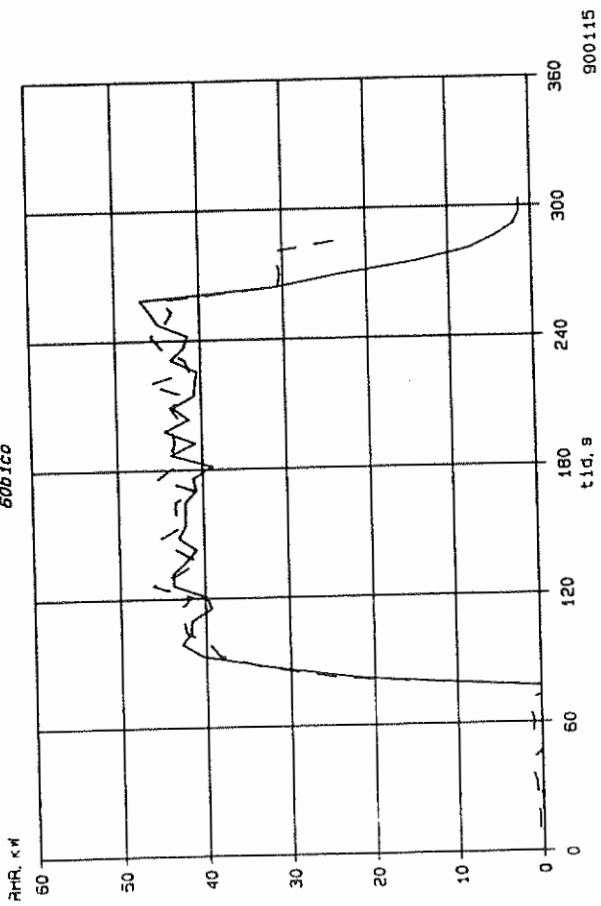

RHR
8601mco

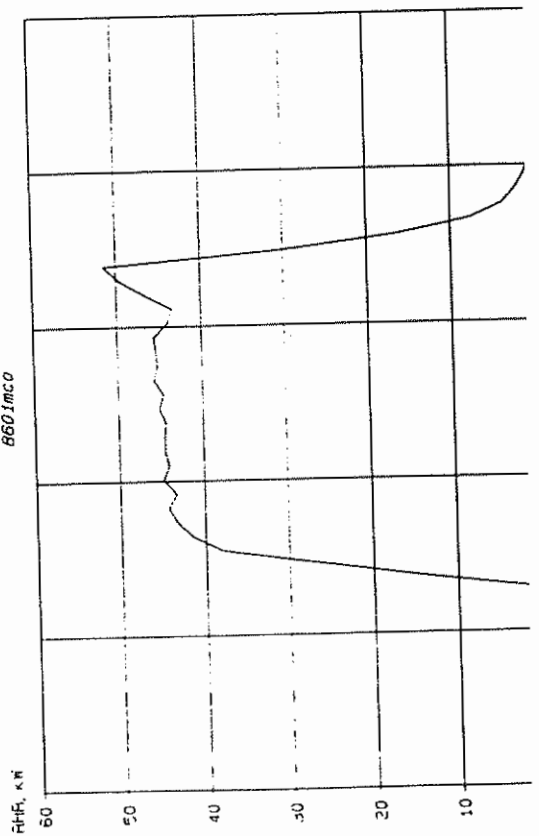

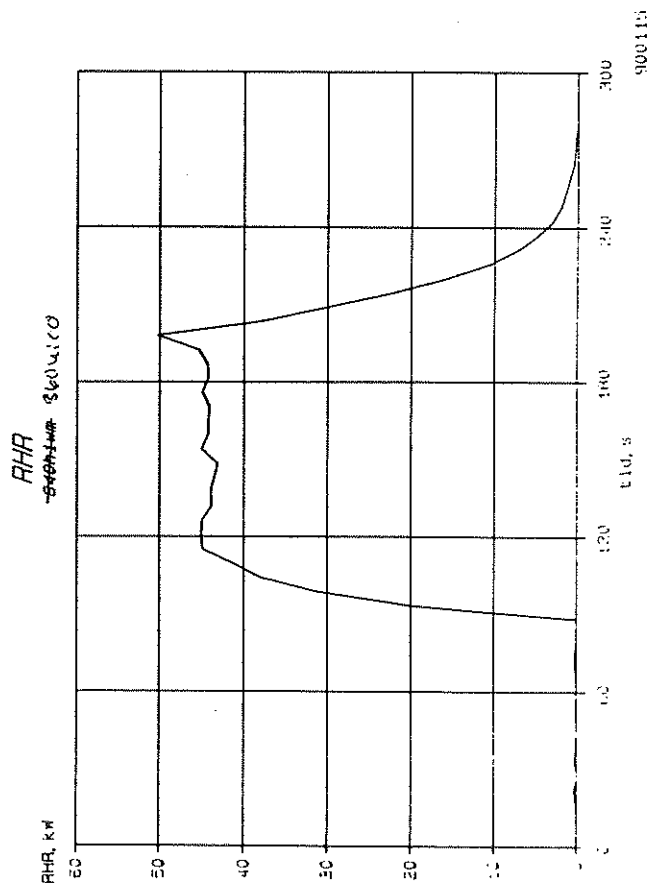
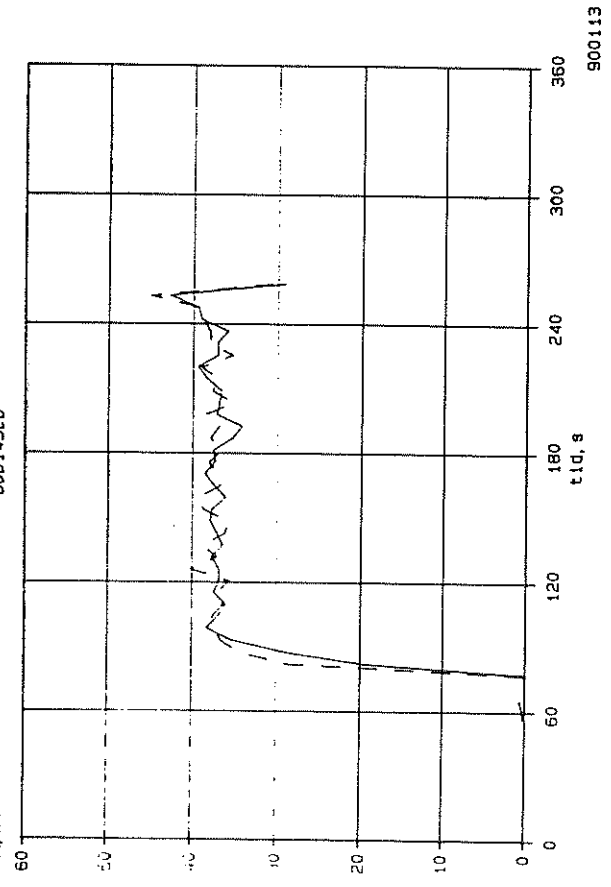

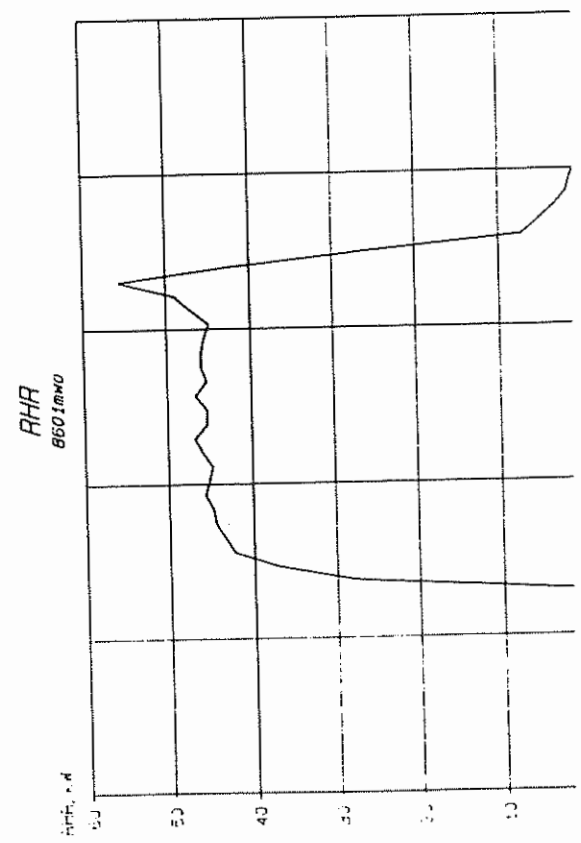
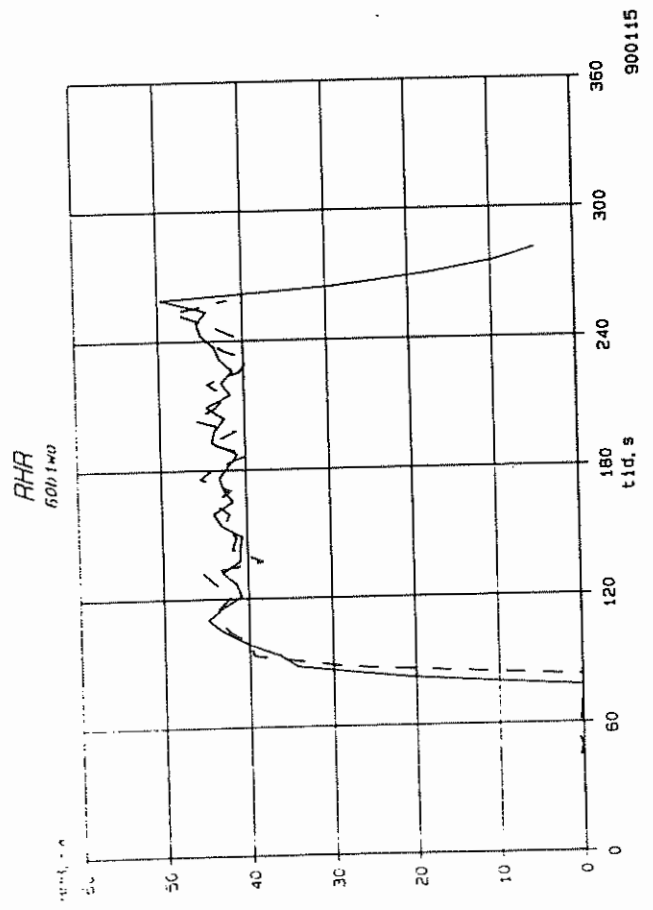
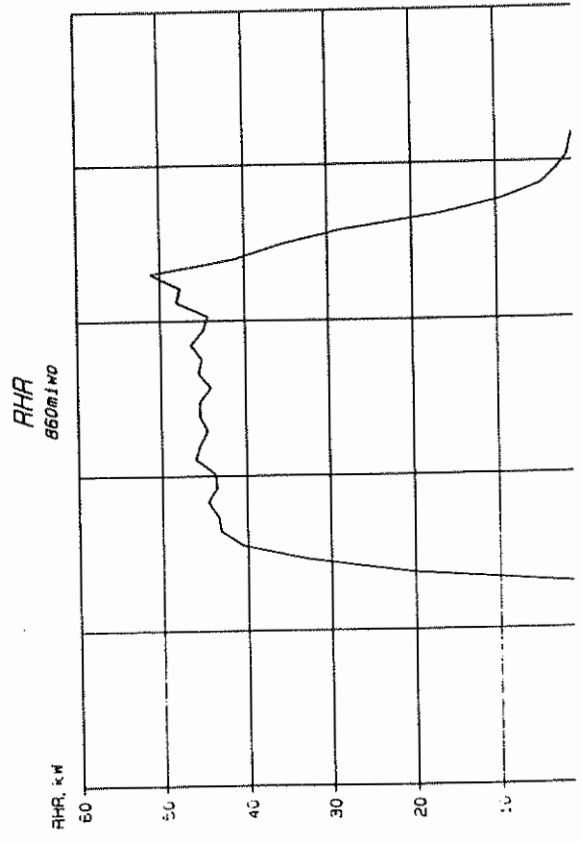
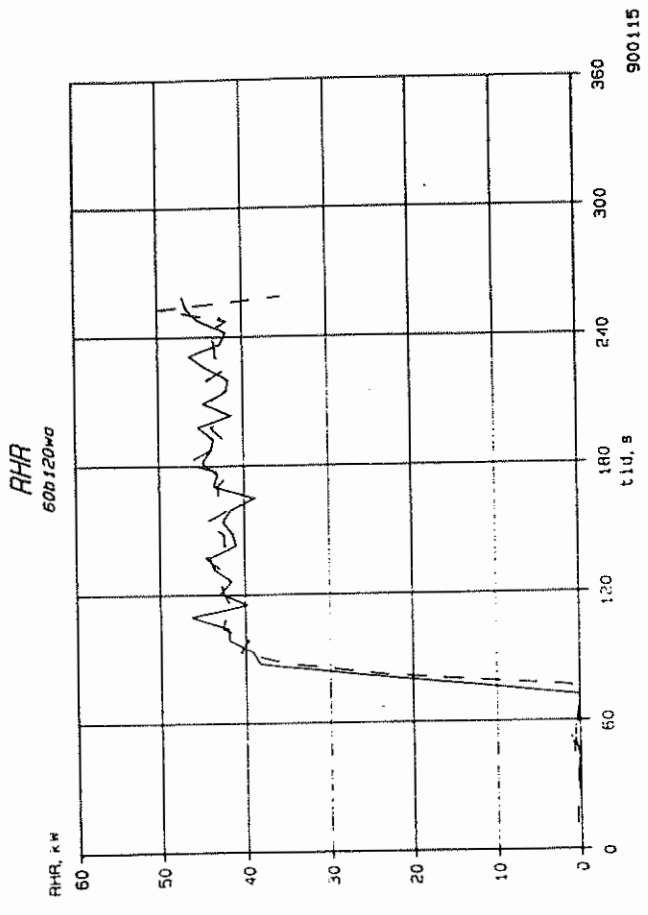

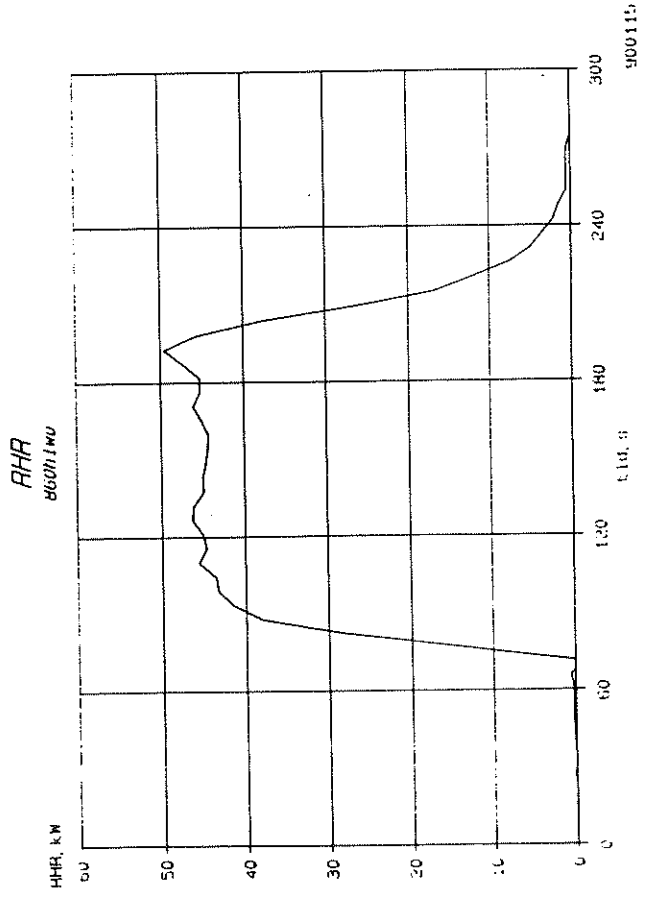
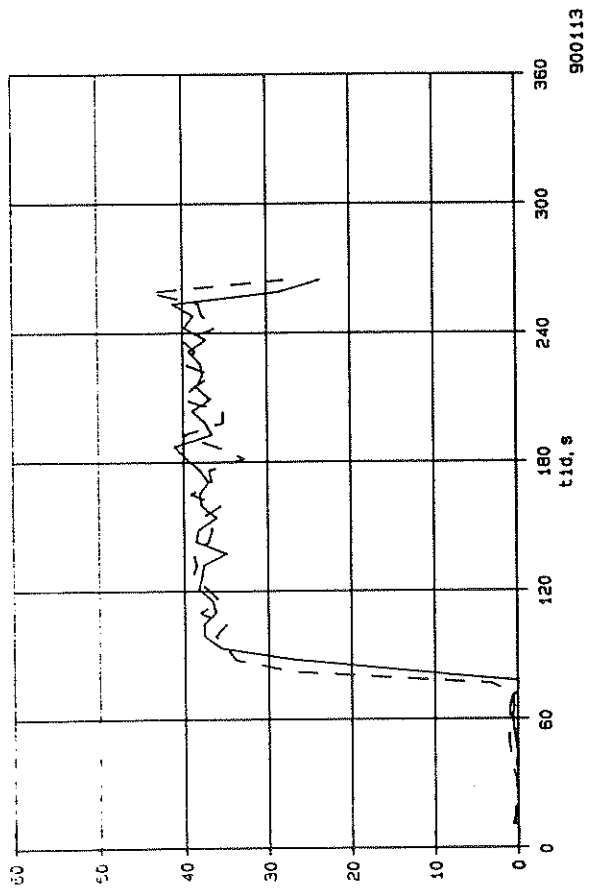

RHR 7

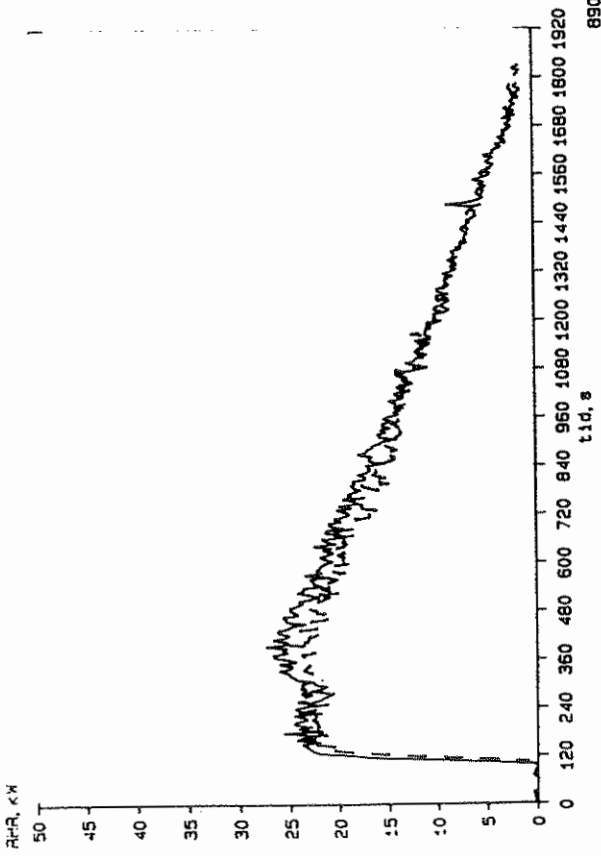

RHR
20b123cm

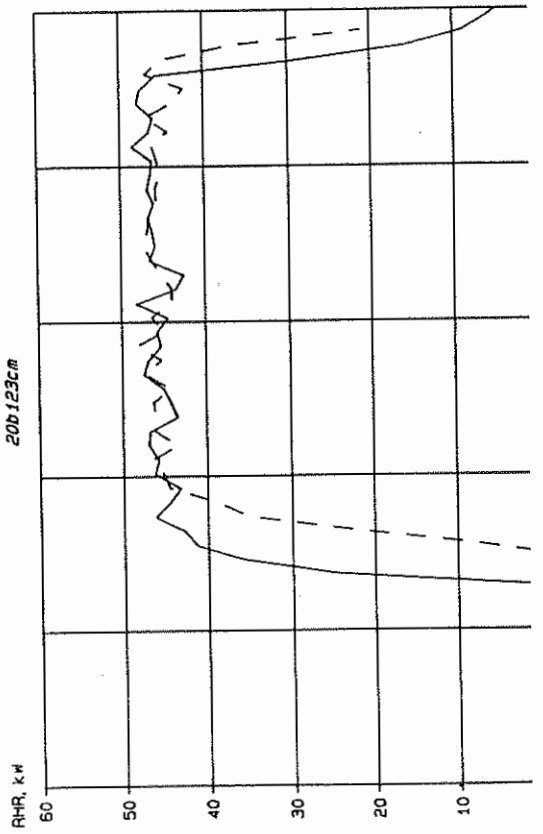

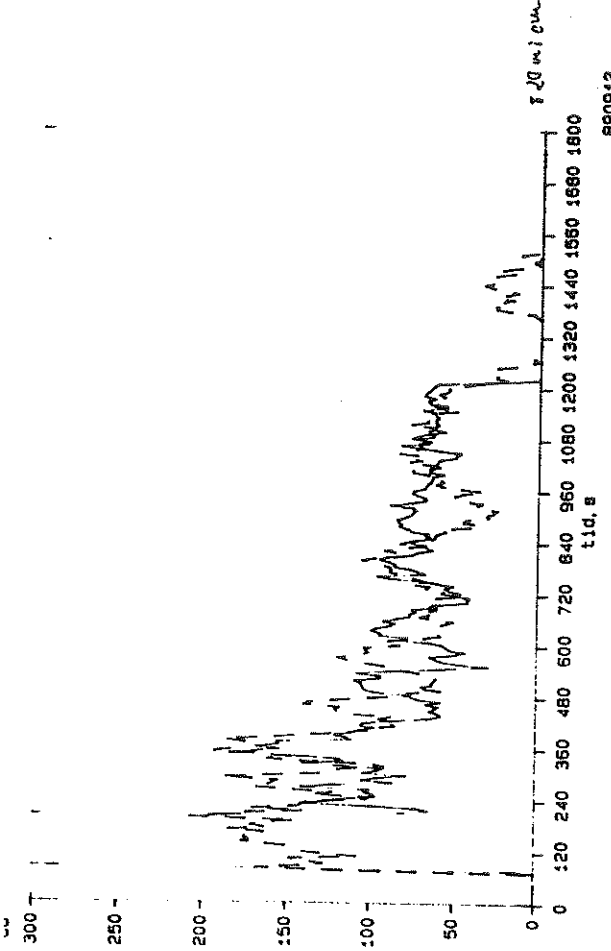

890912

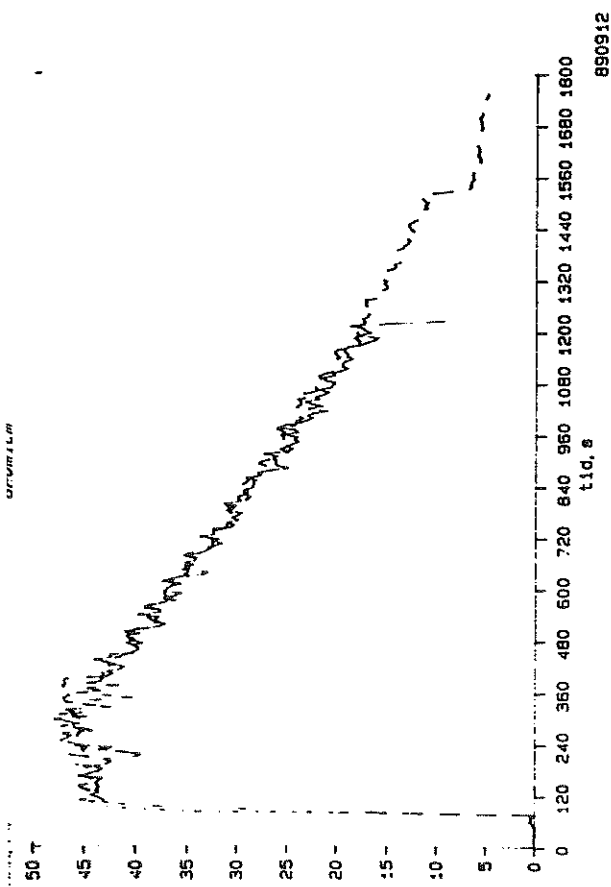

890912

CO2
820m/cm

X:CO2#:000
500

400 -

300 -

200 -

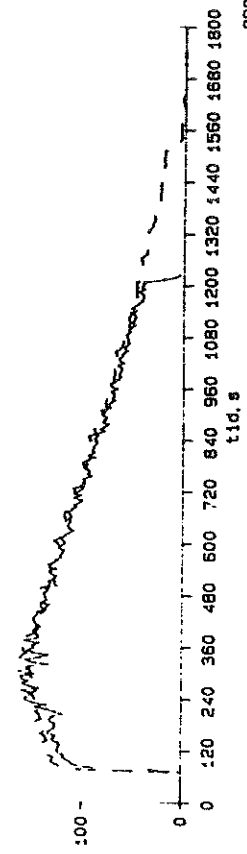

890912

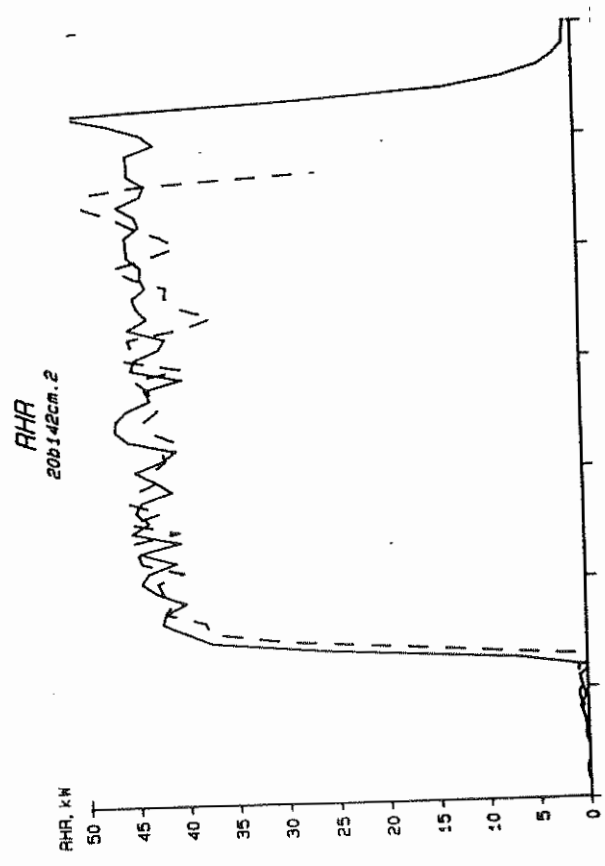
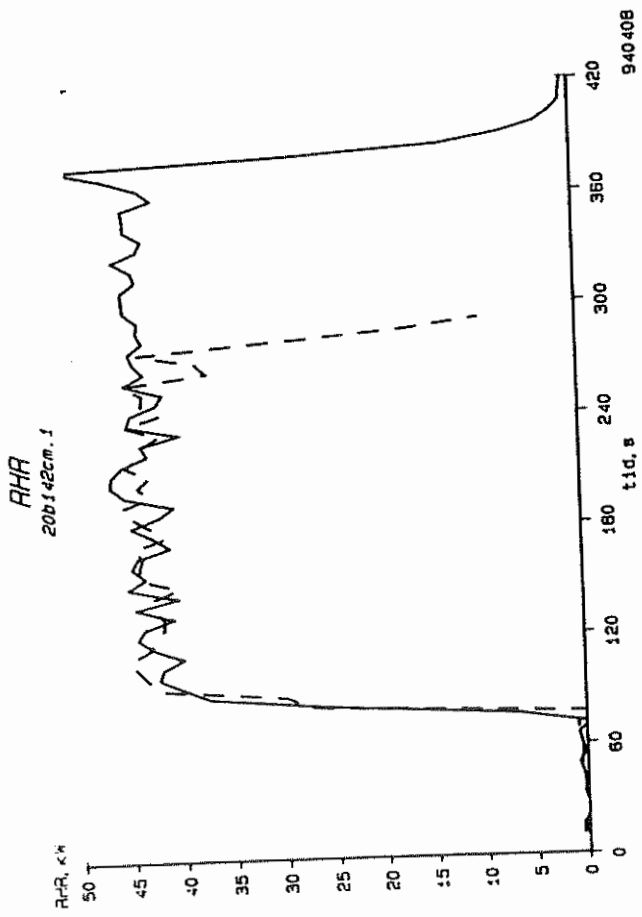

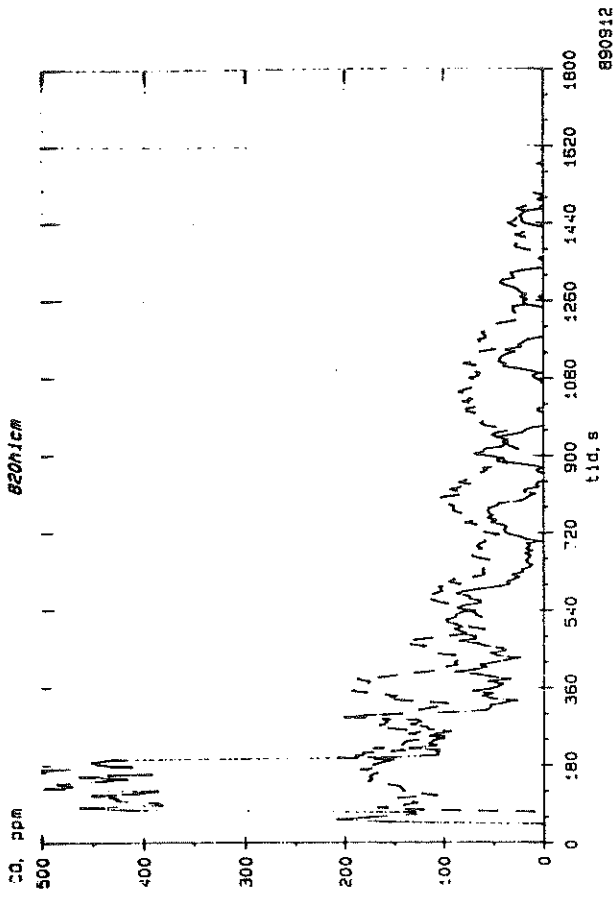
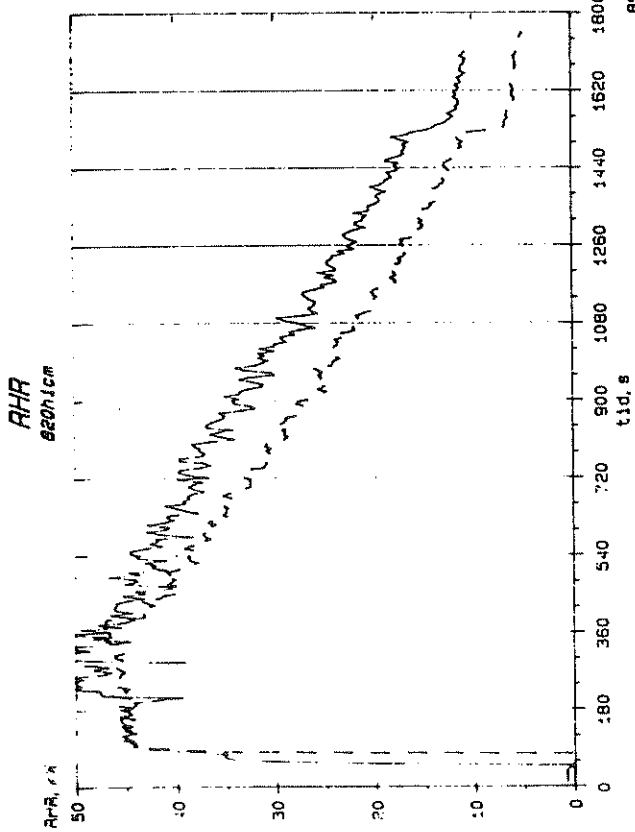

CO2
820mic

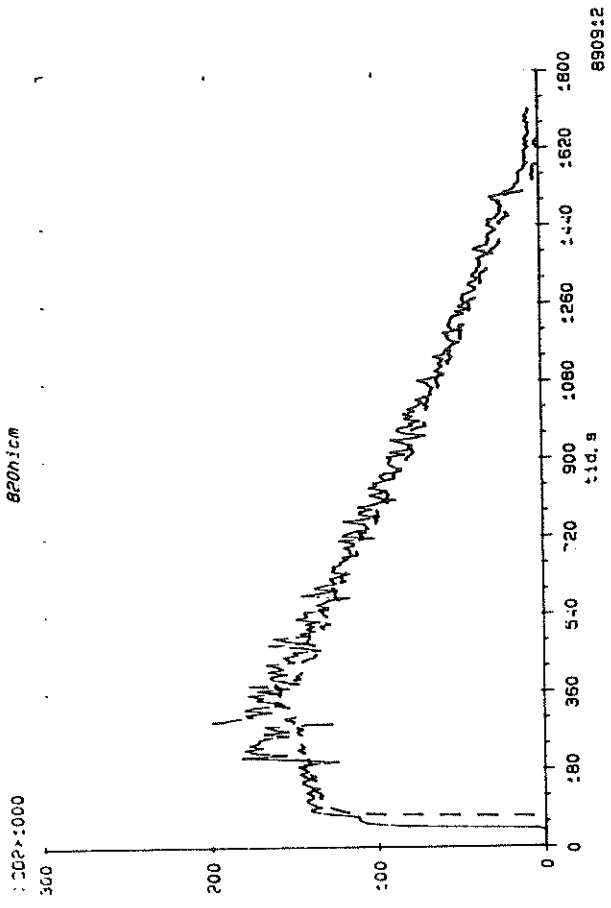

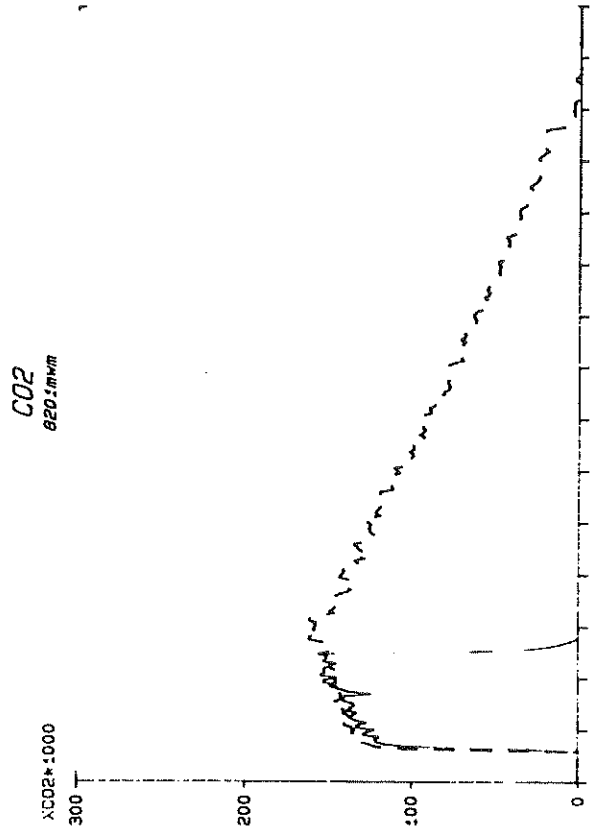
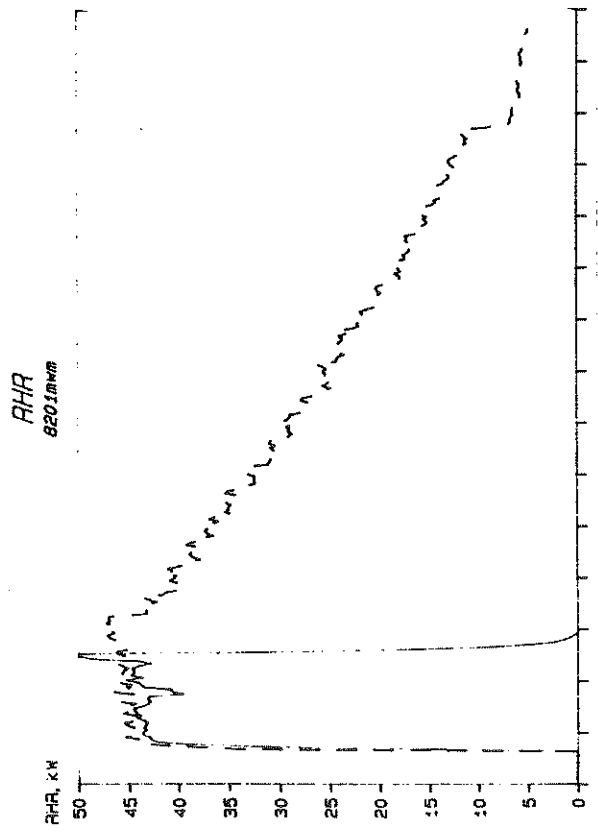
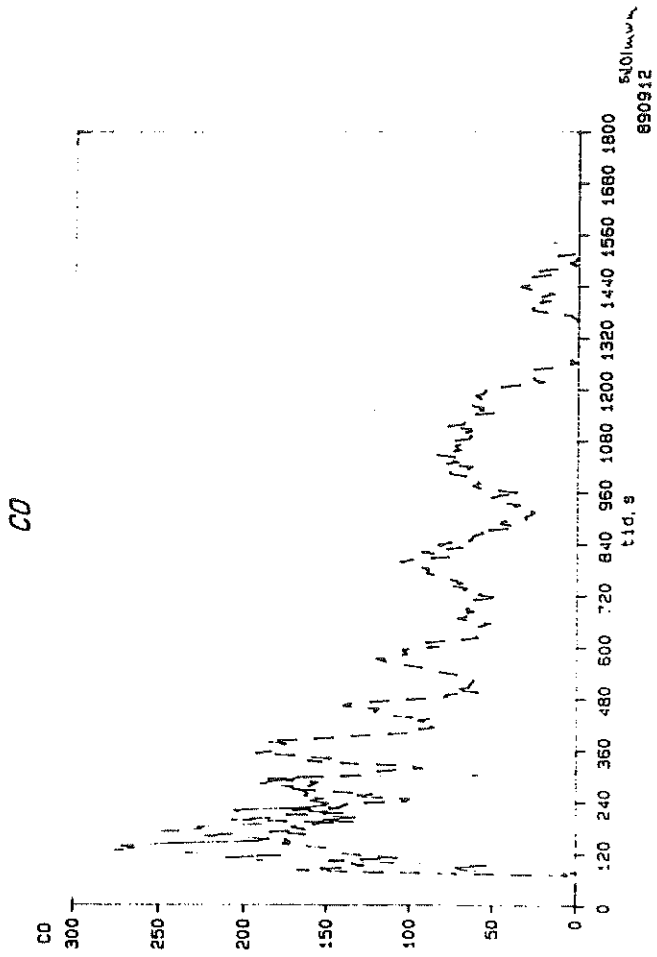
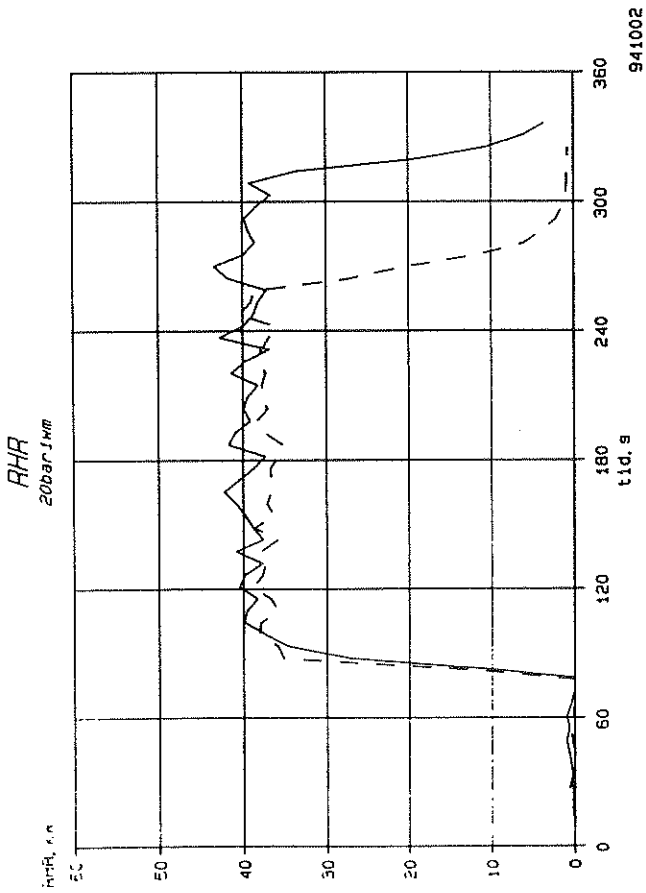

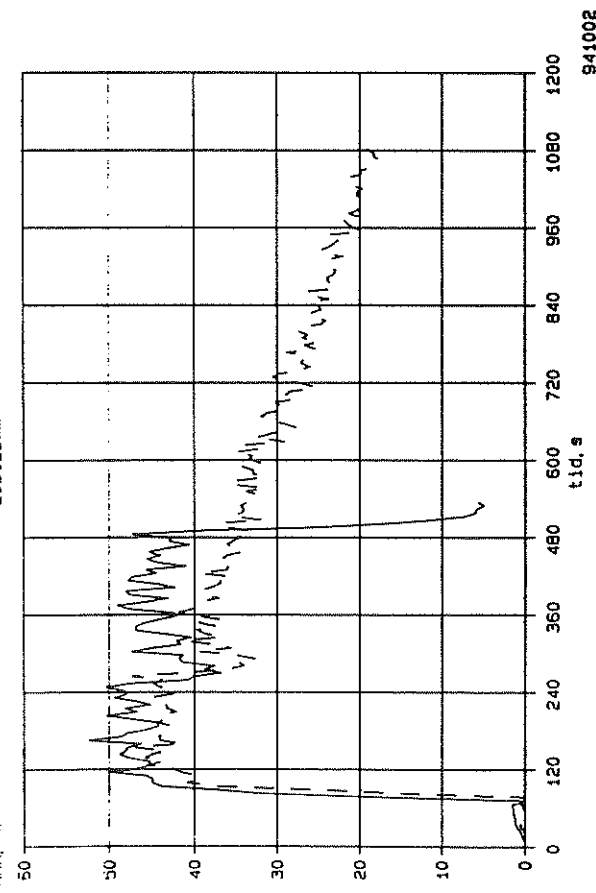

D27

RHR
620m.1mm

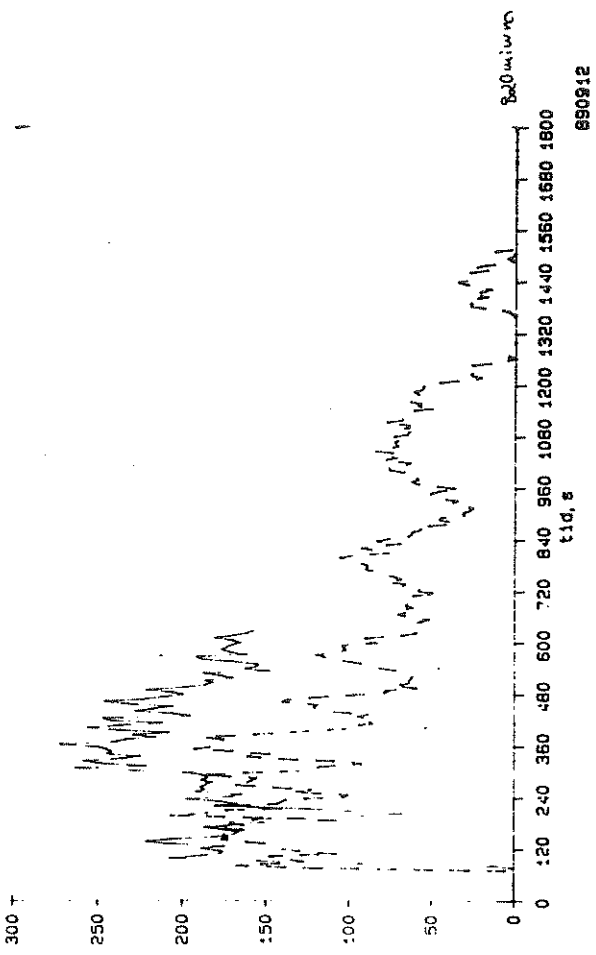
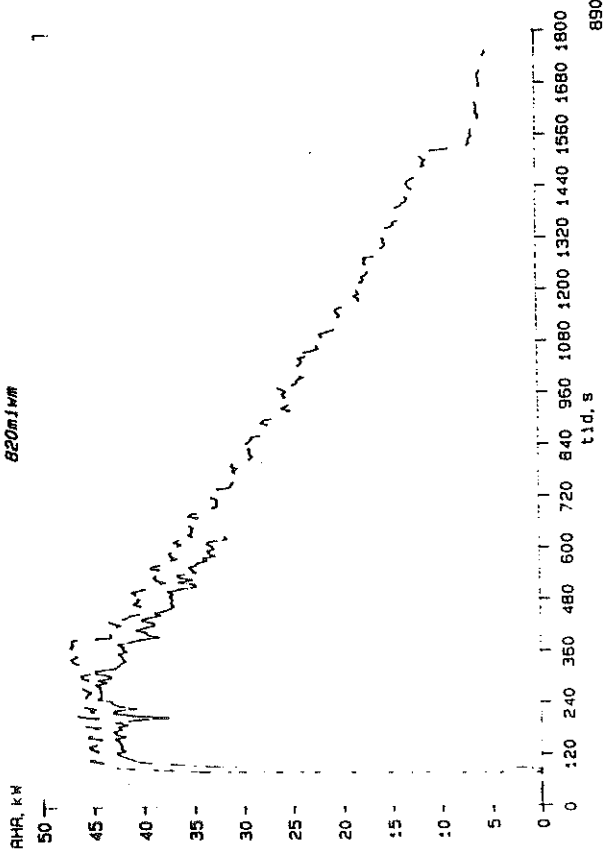

CO2
620m.1mm

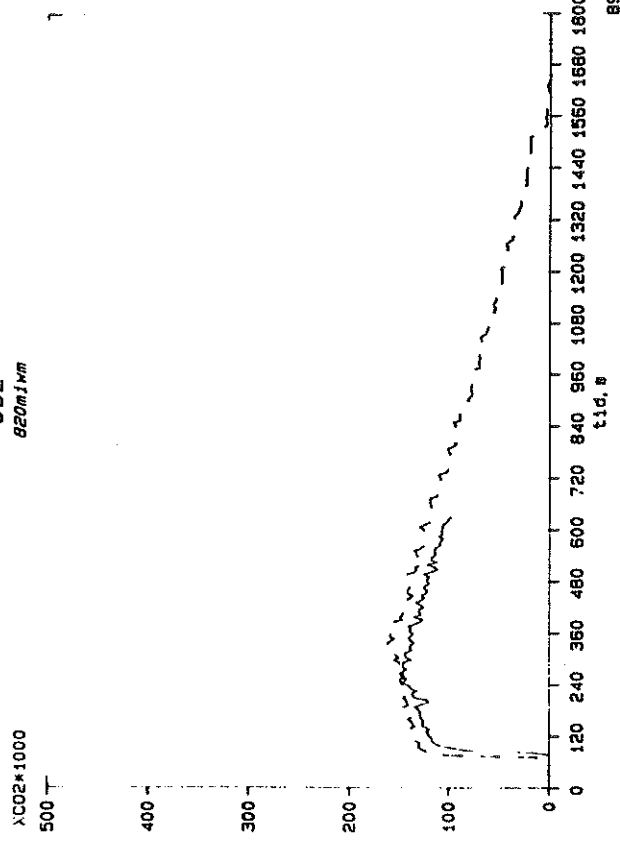

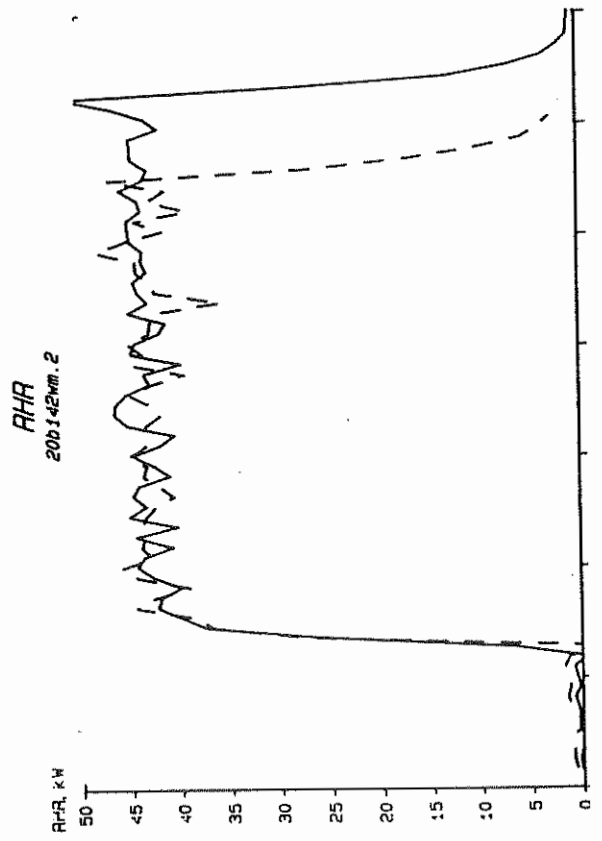
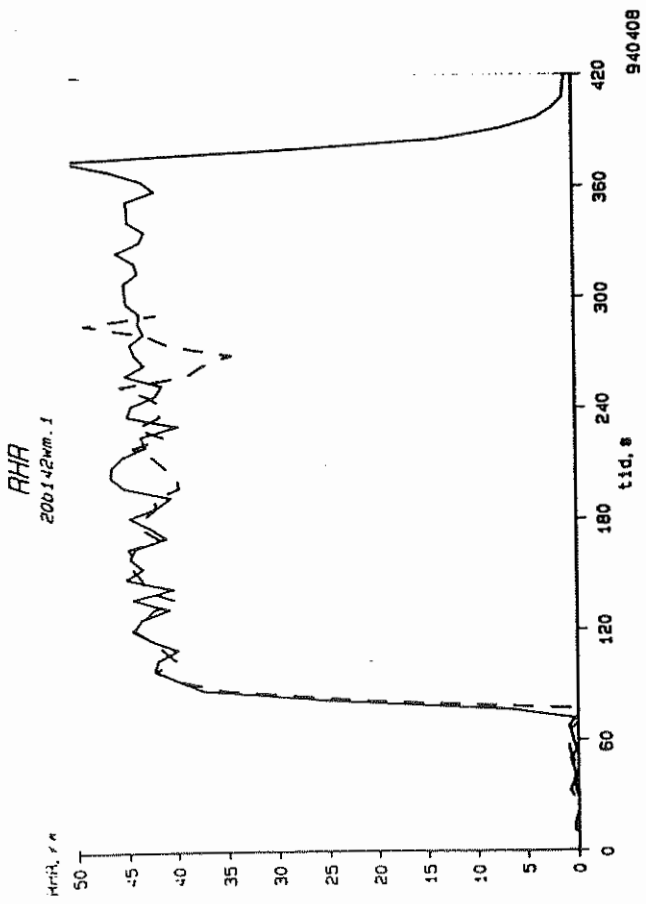

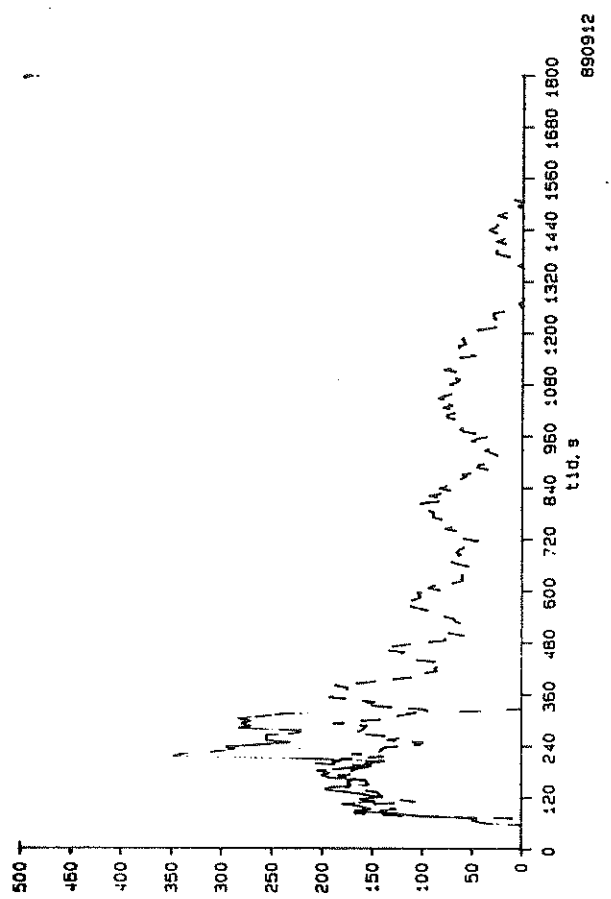
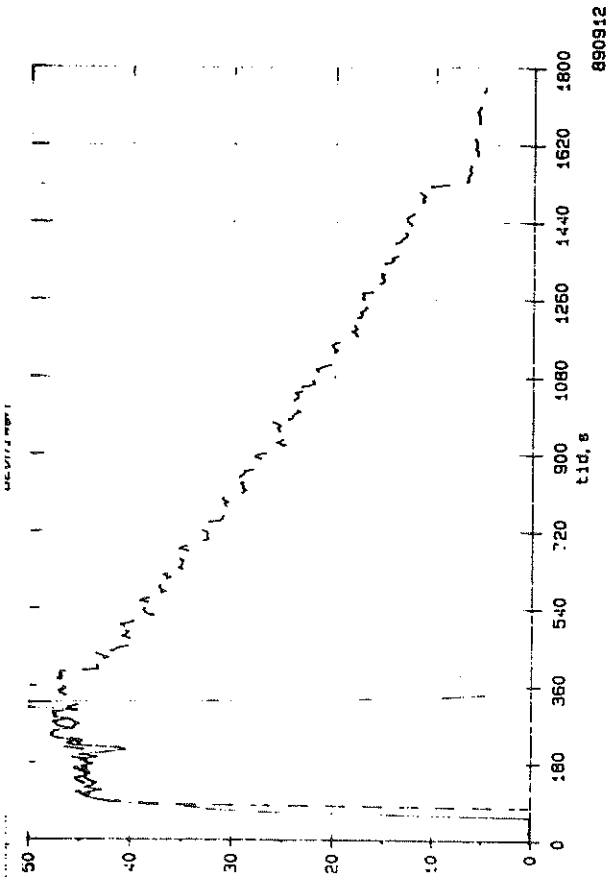

D29

CO2
820nm

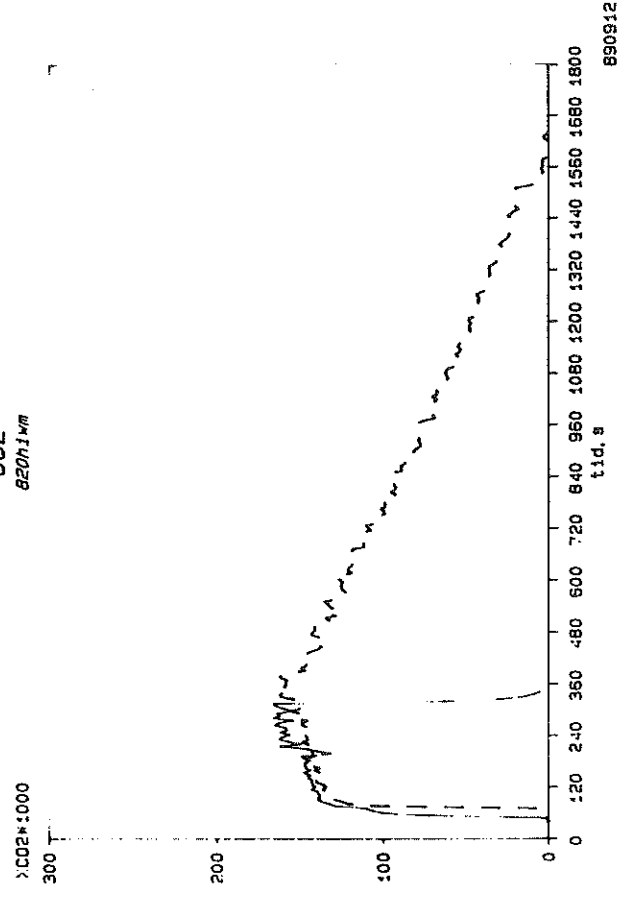

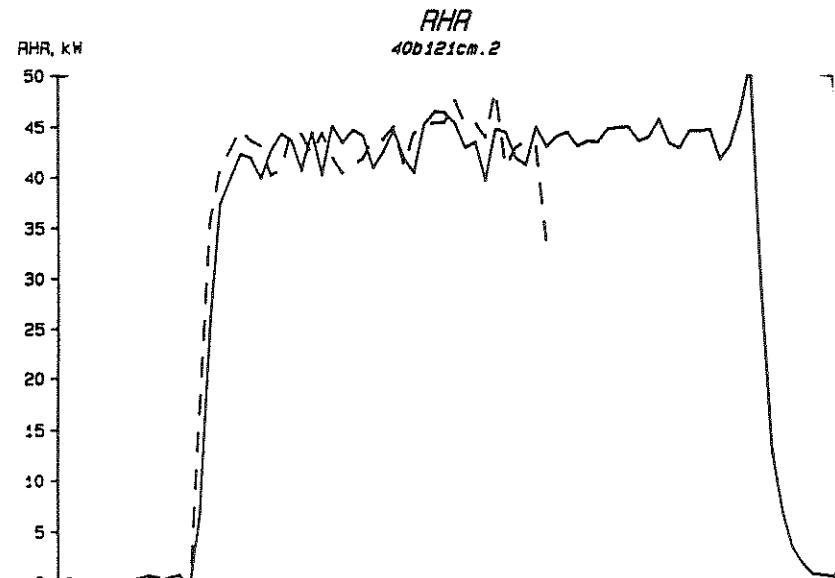
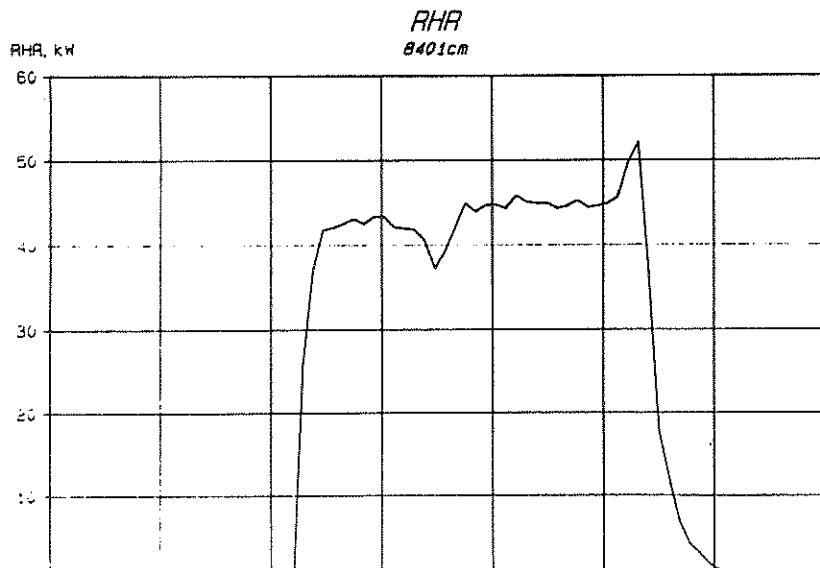
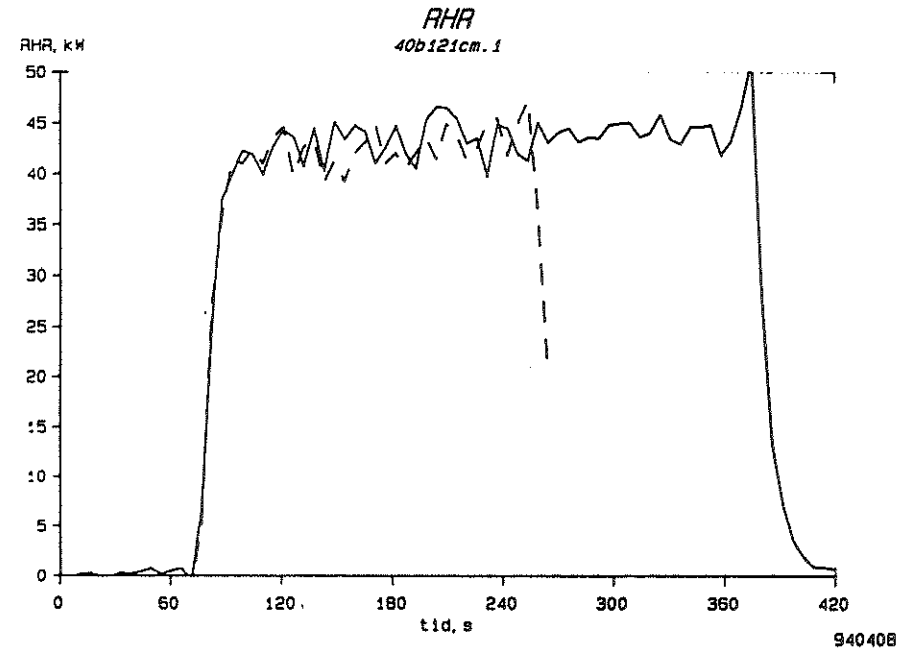
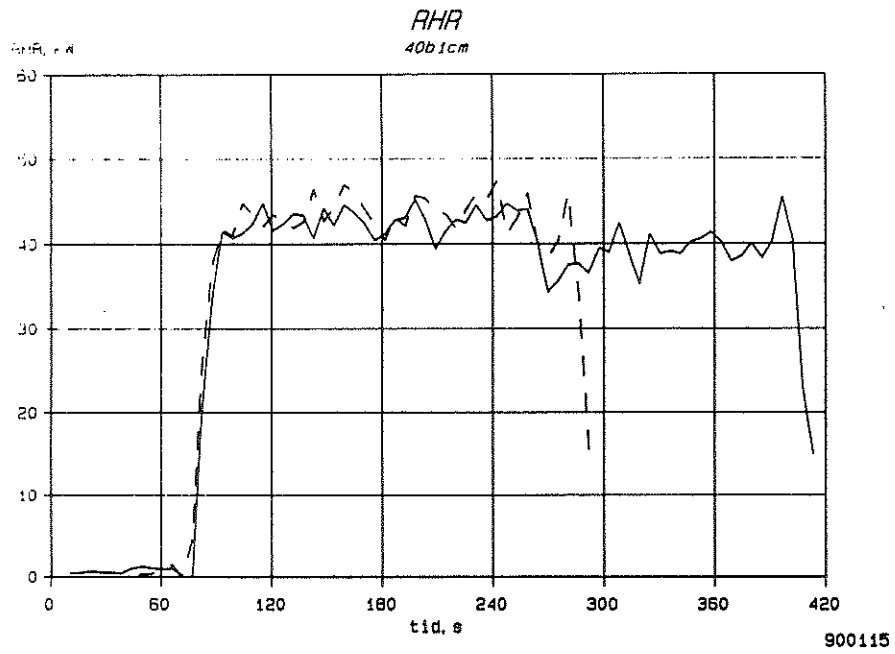

D30

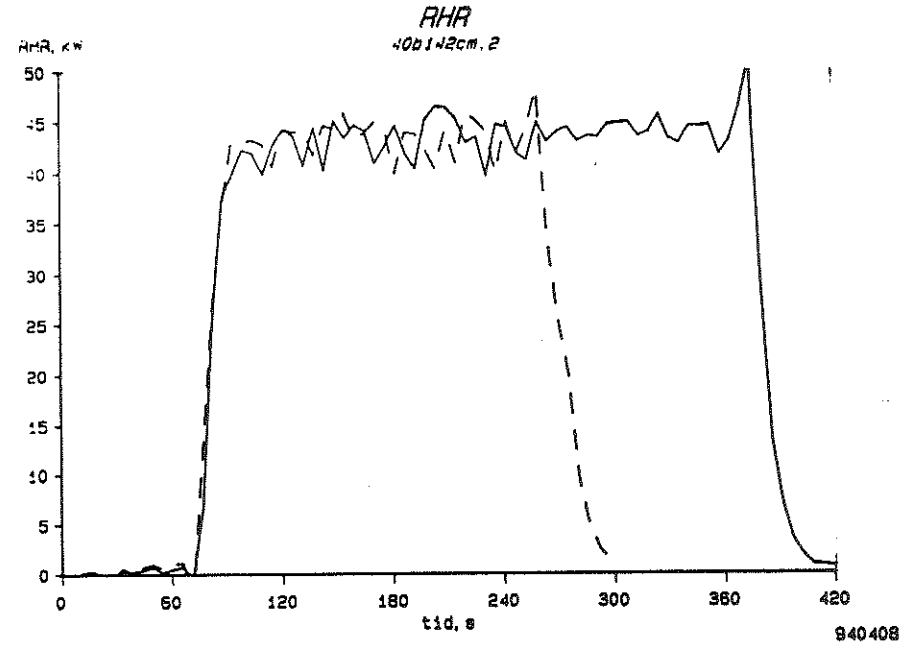
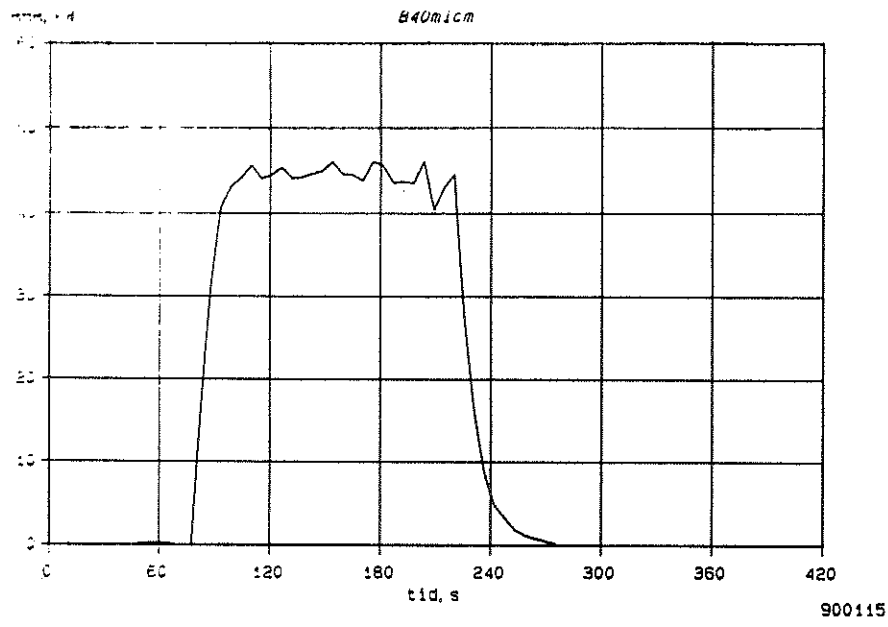

D31

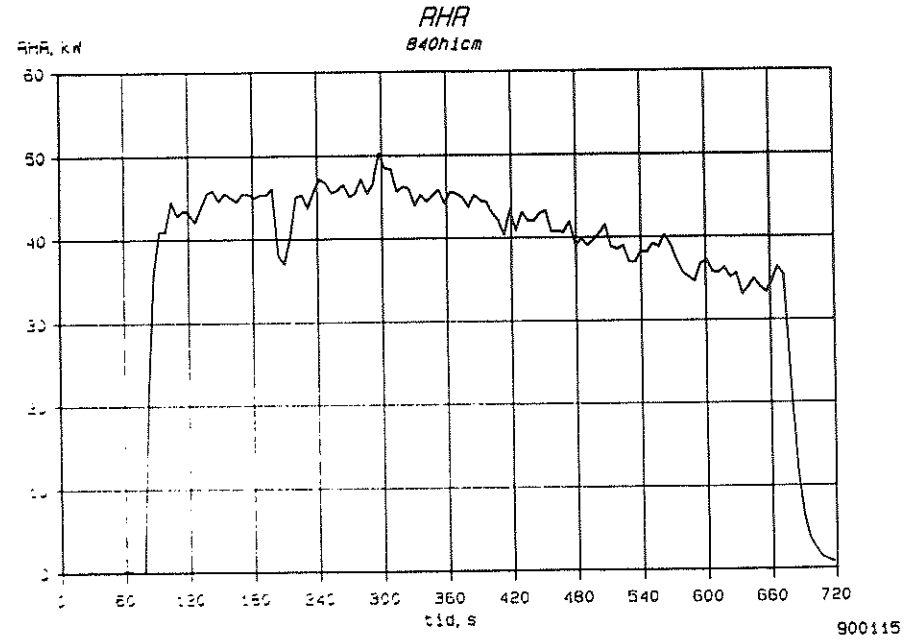
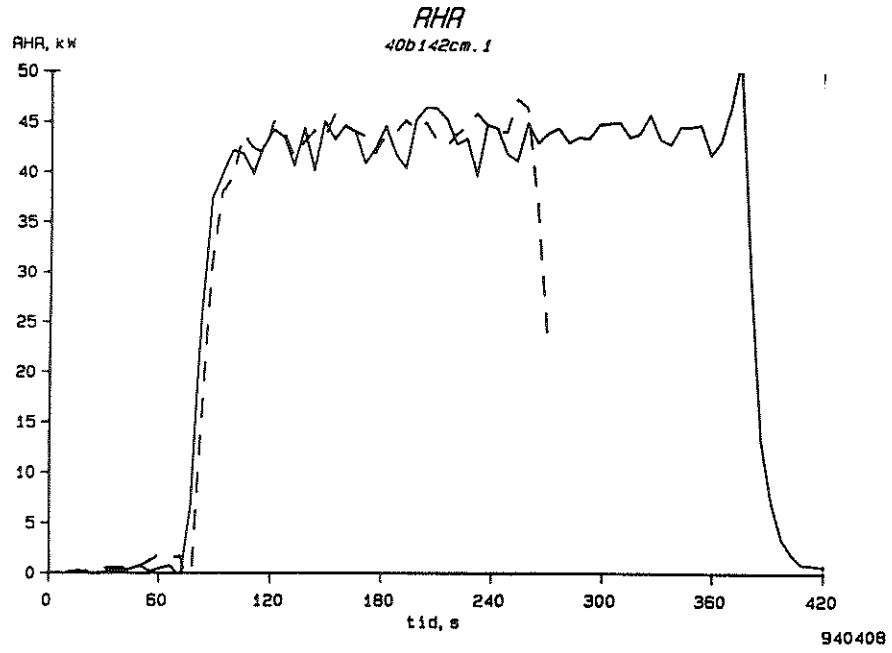

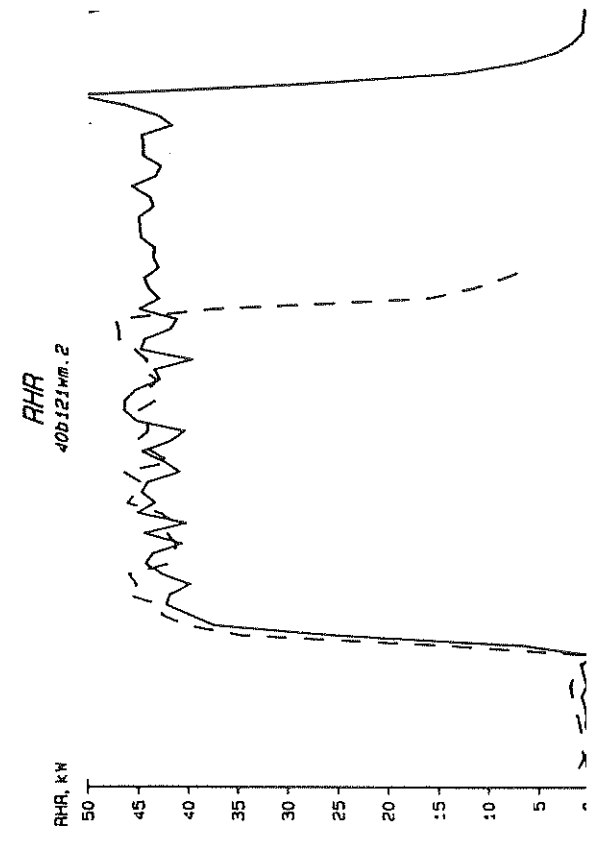
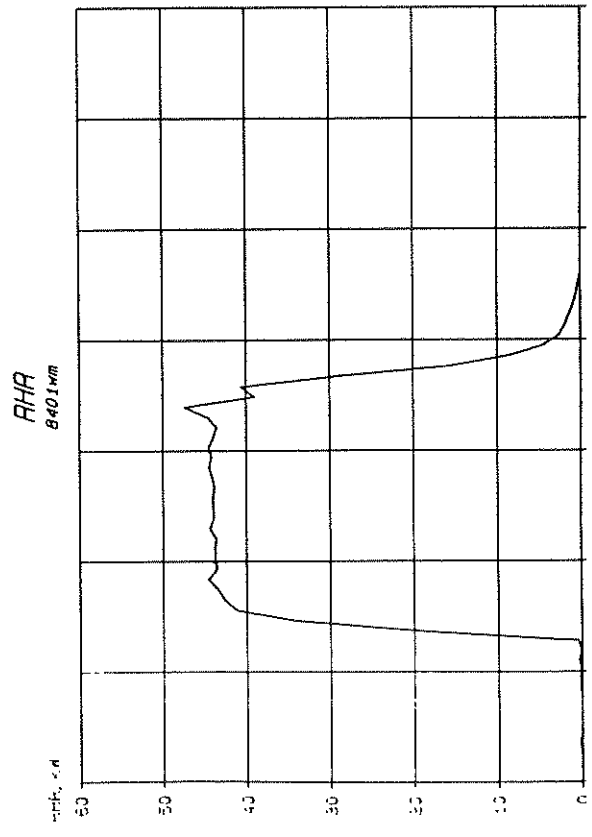
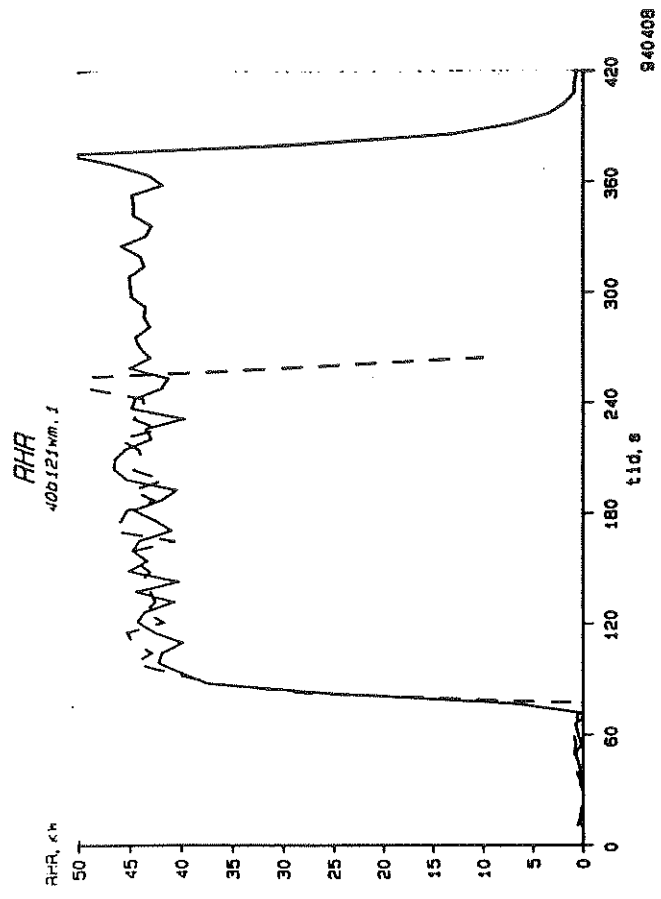
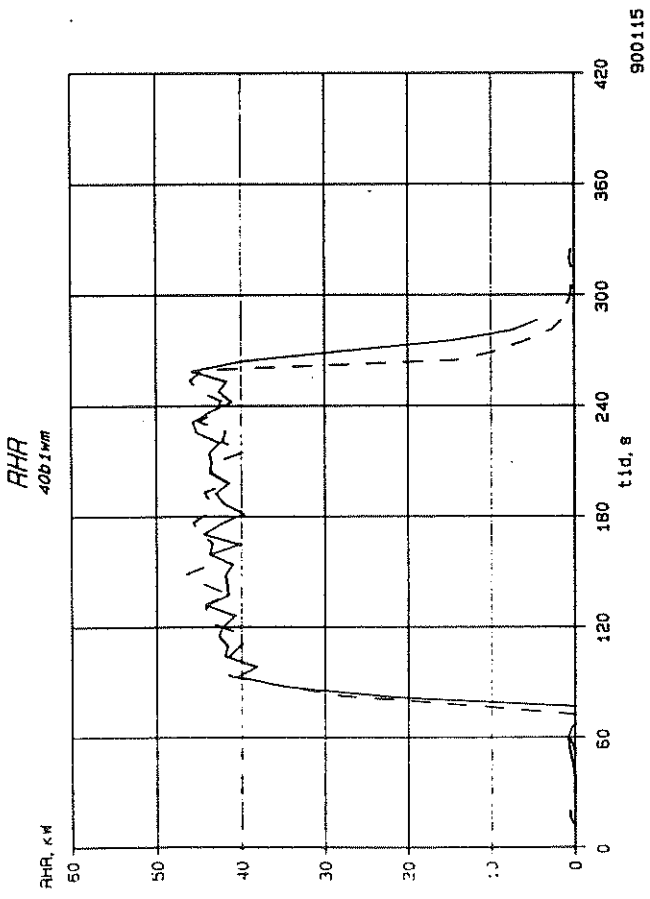

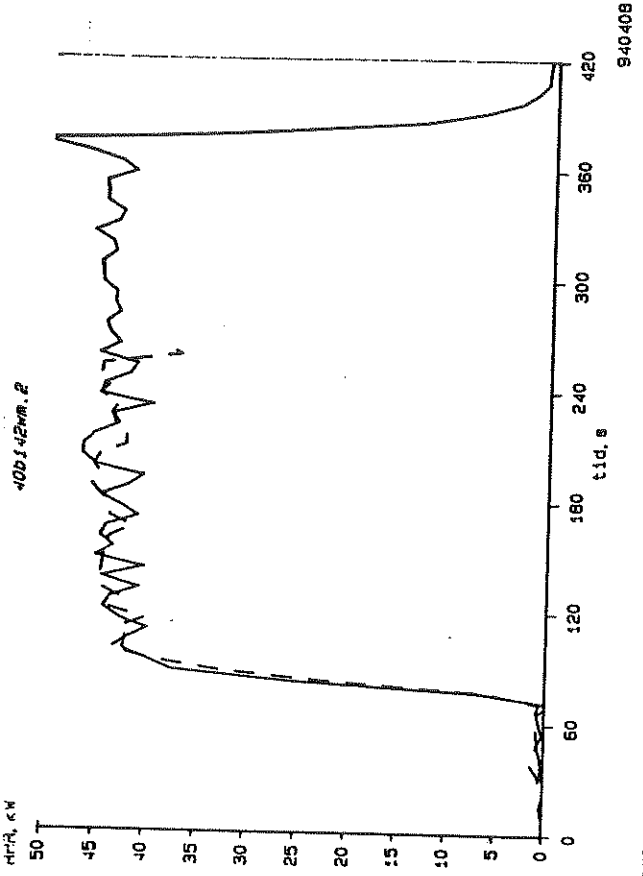
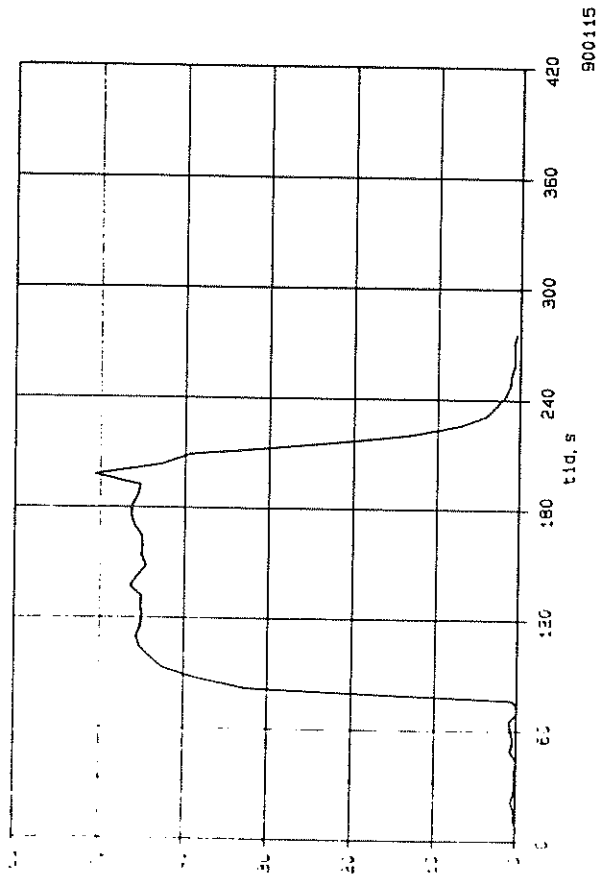

D33

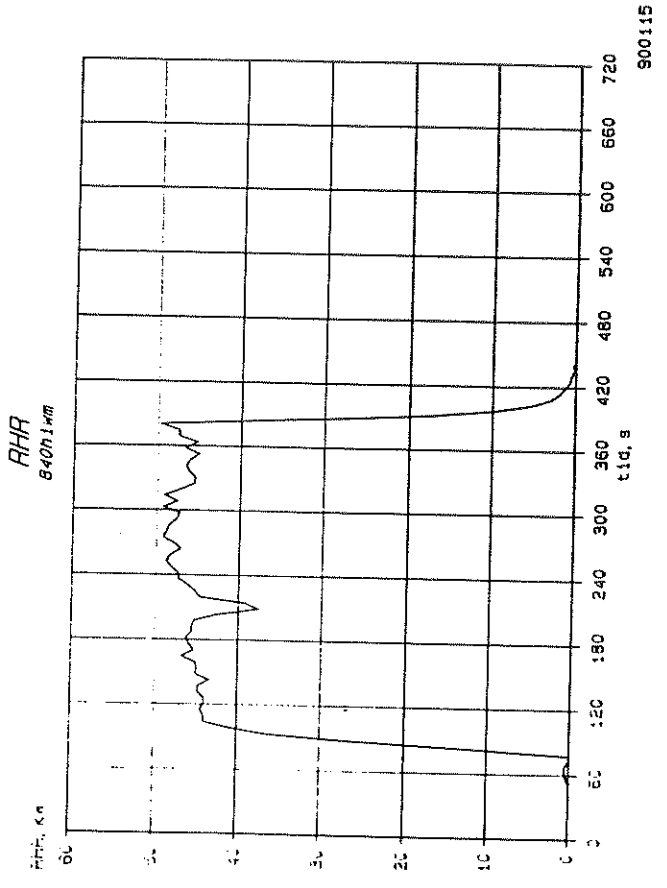
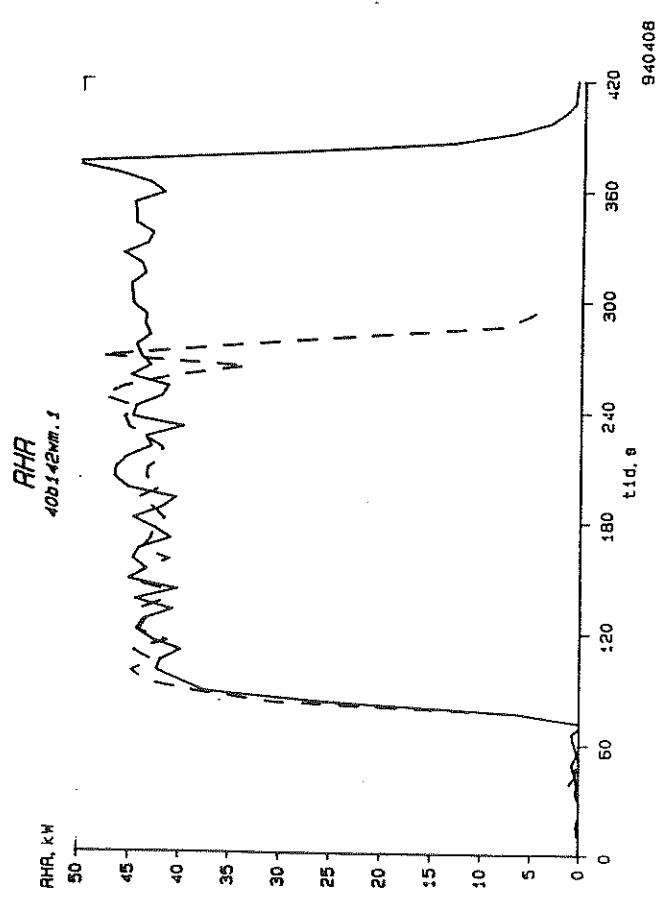

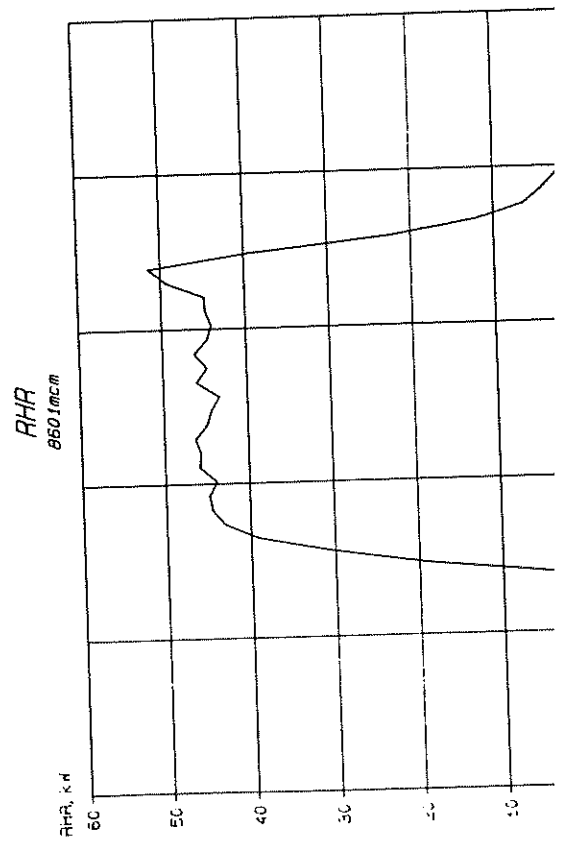
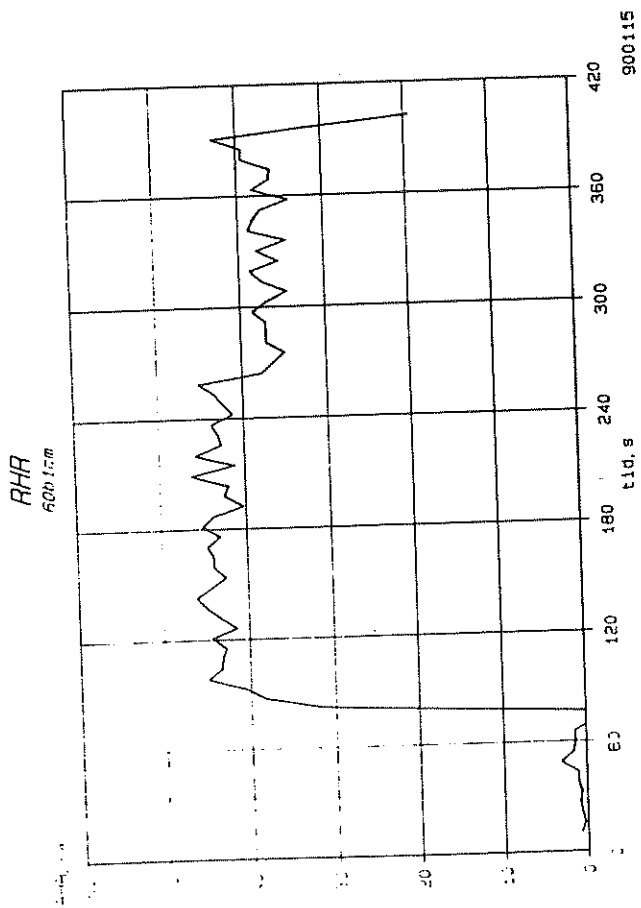
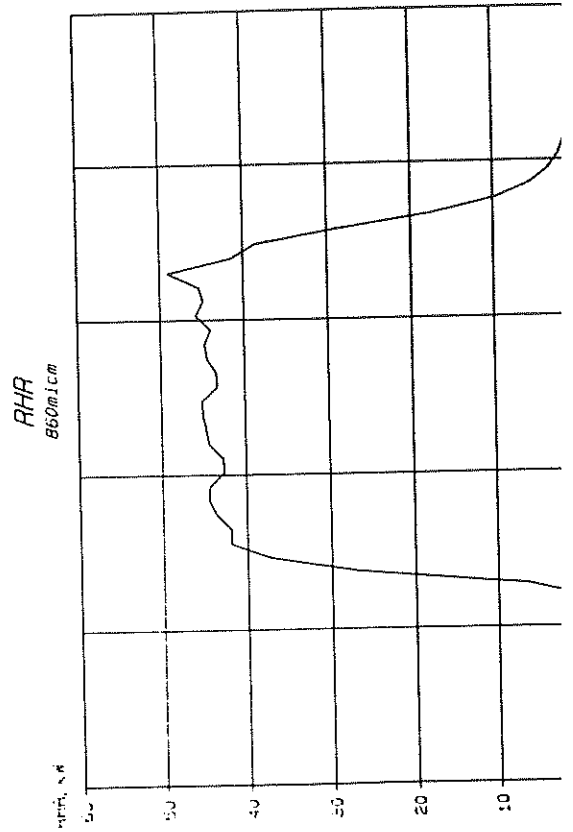
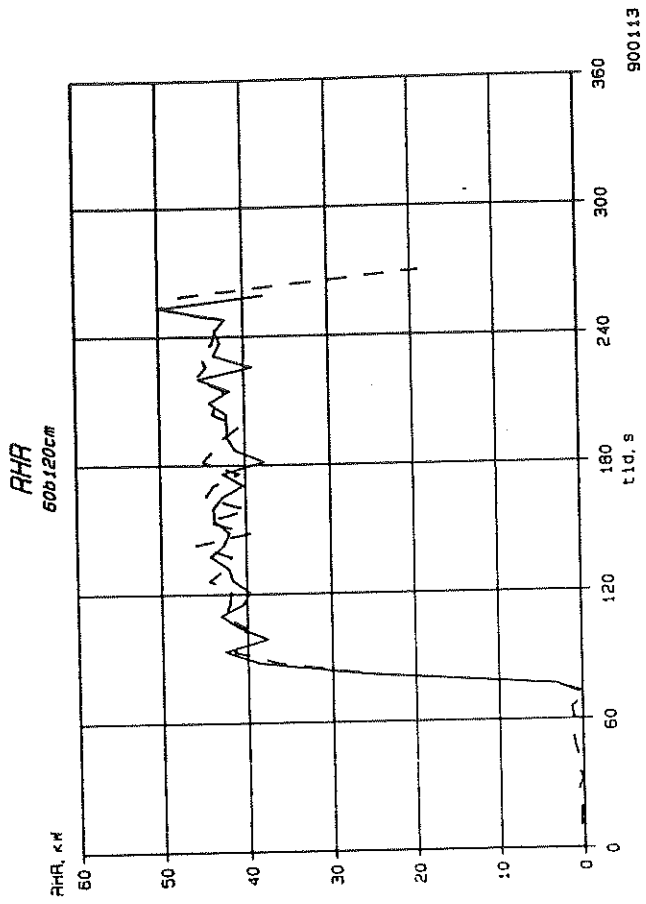

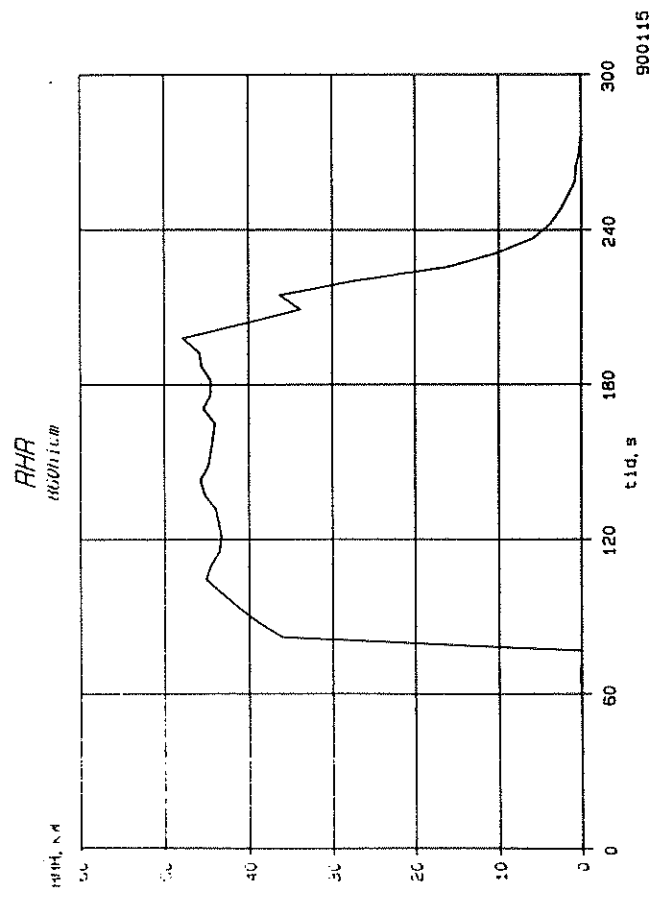
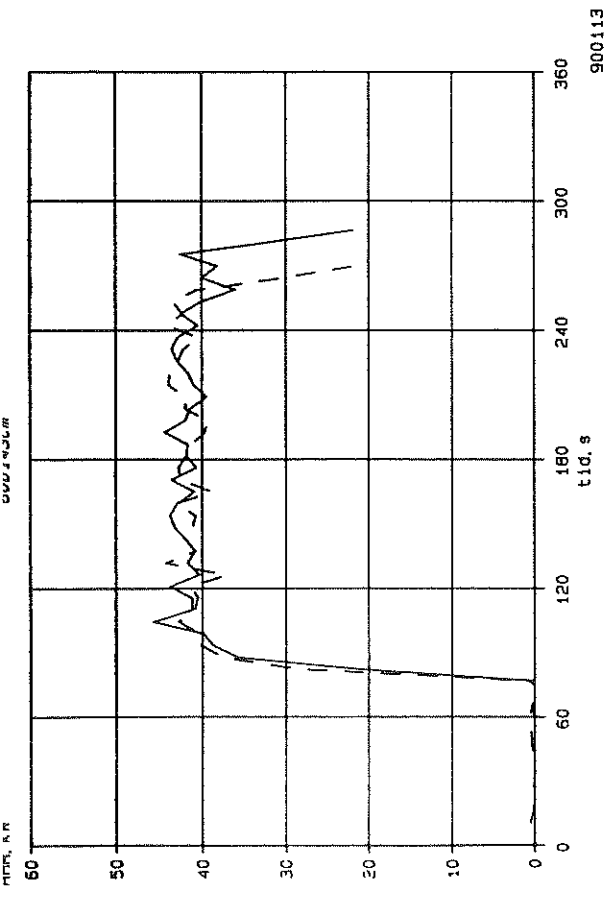

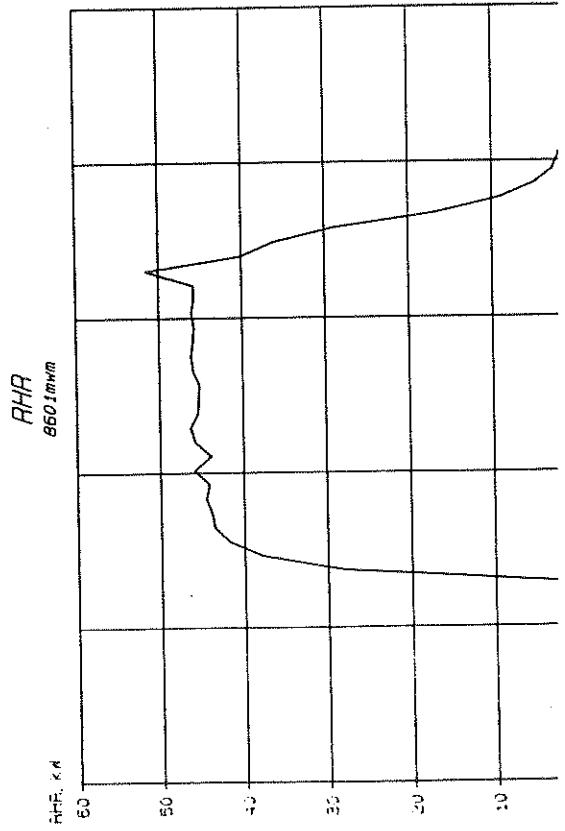
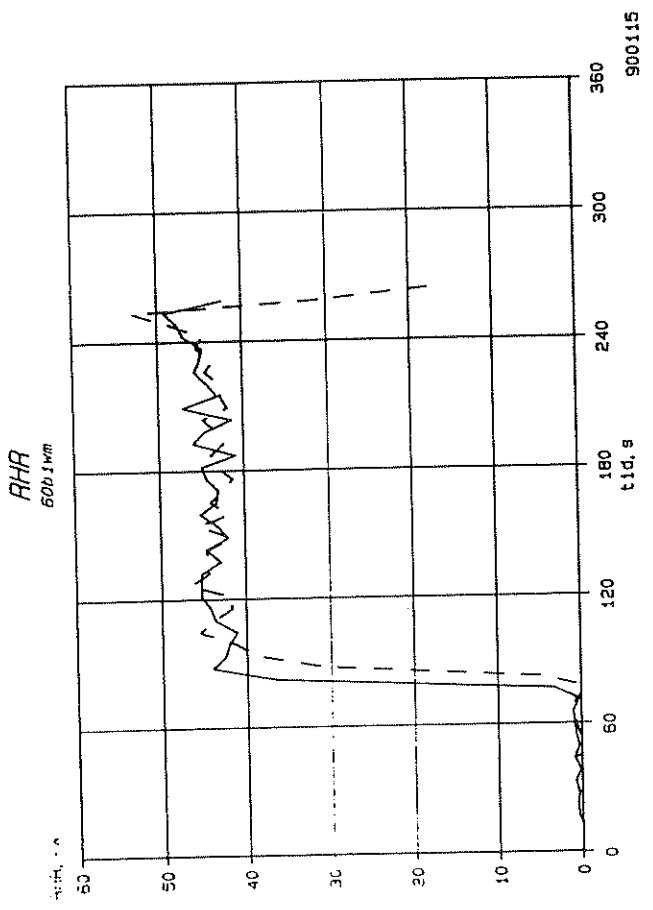
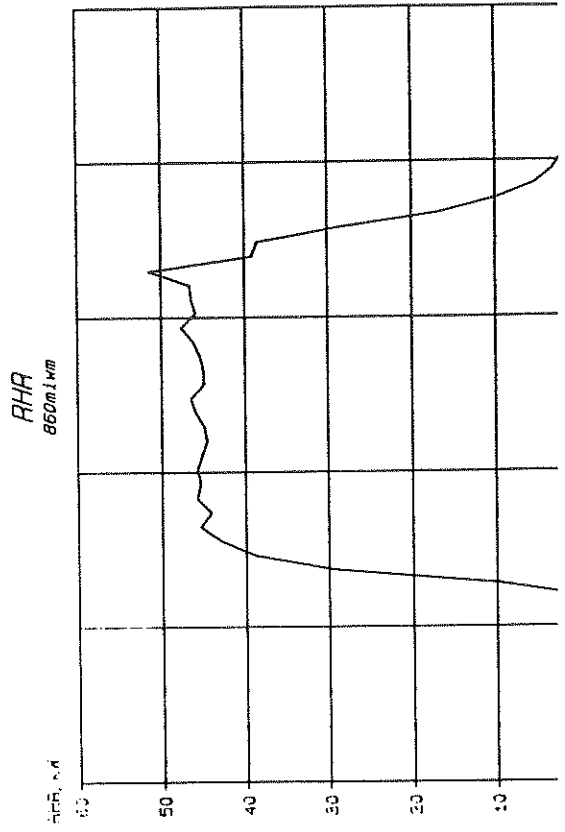
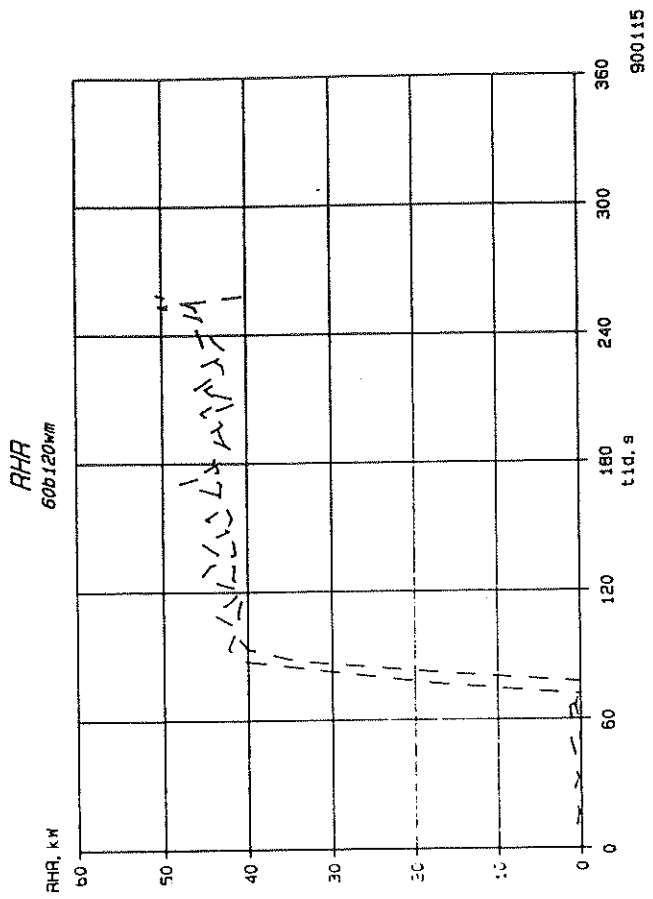

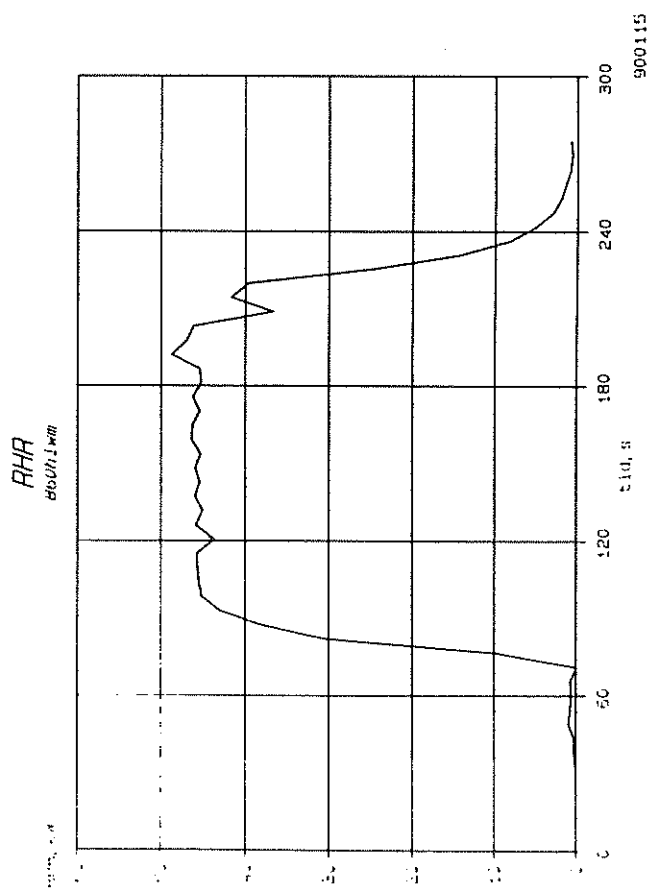
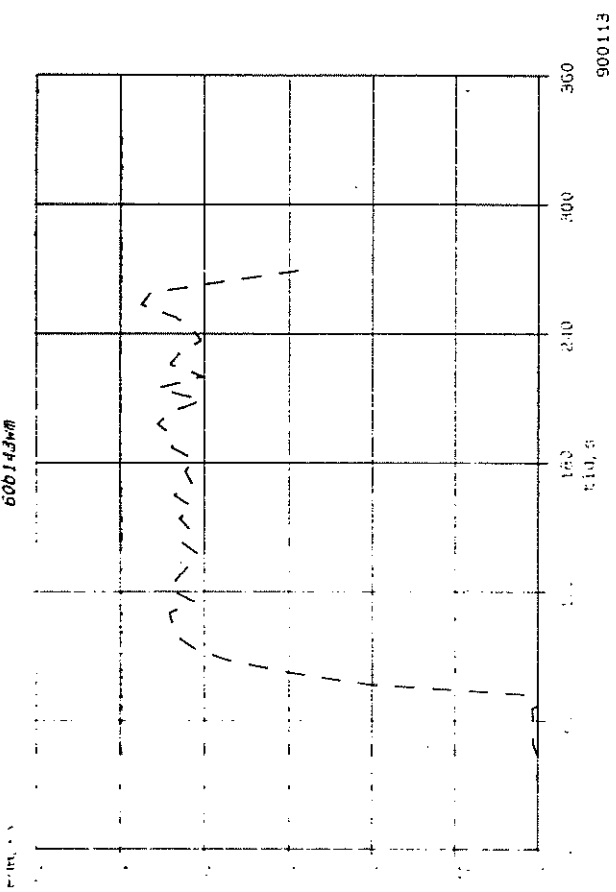

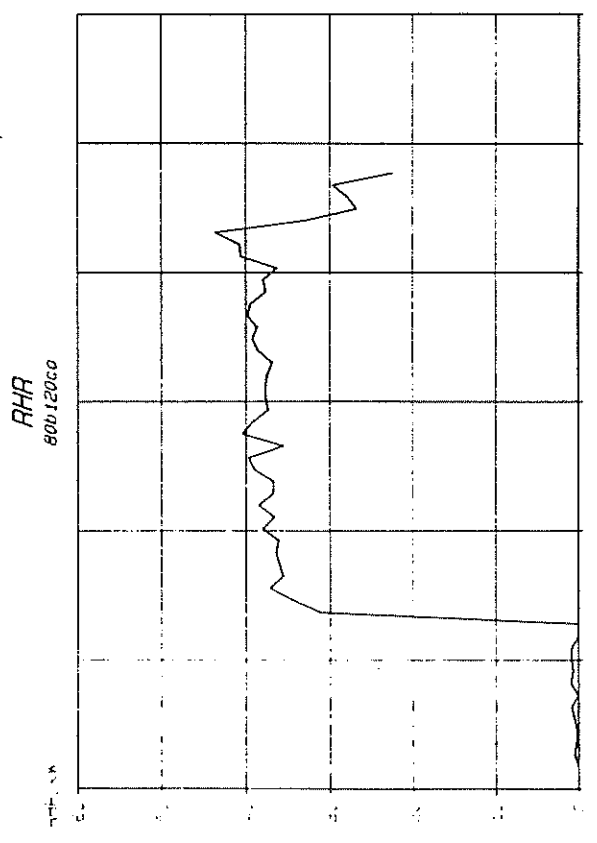
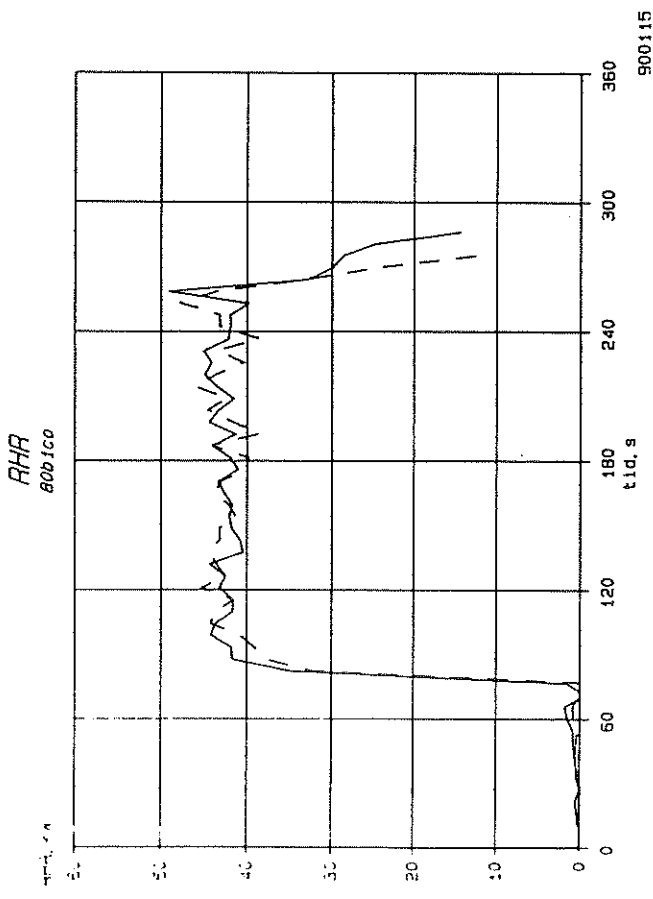
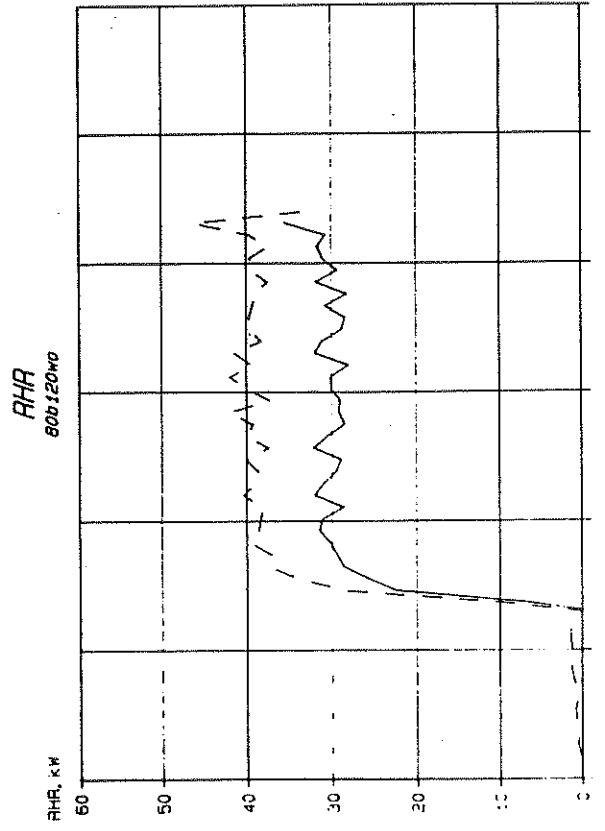
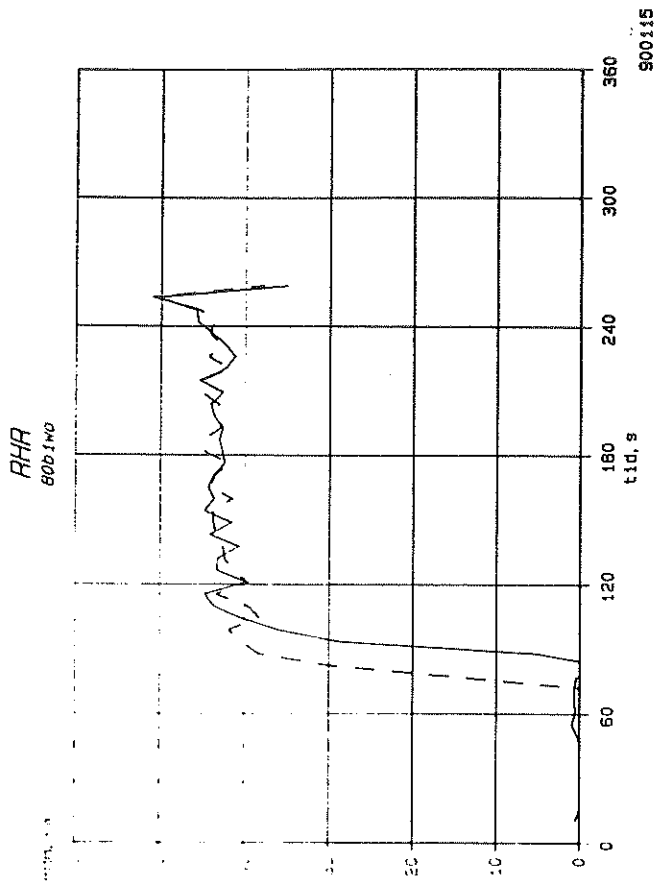

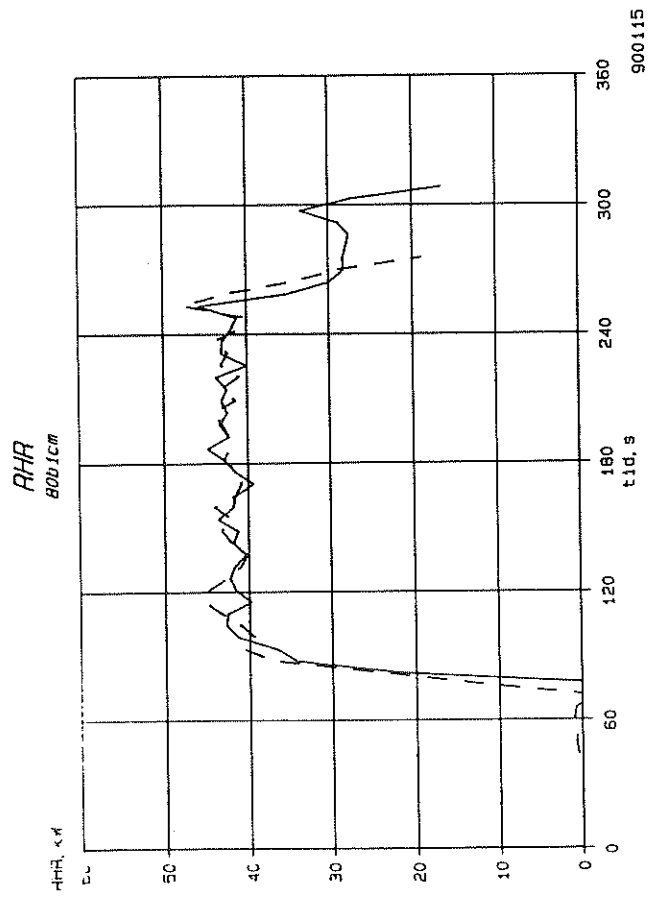
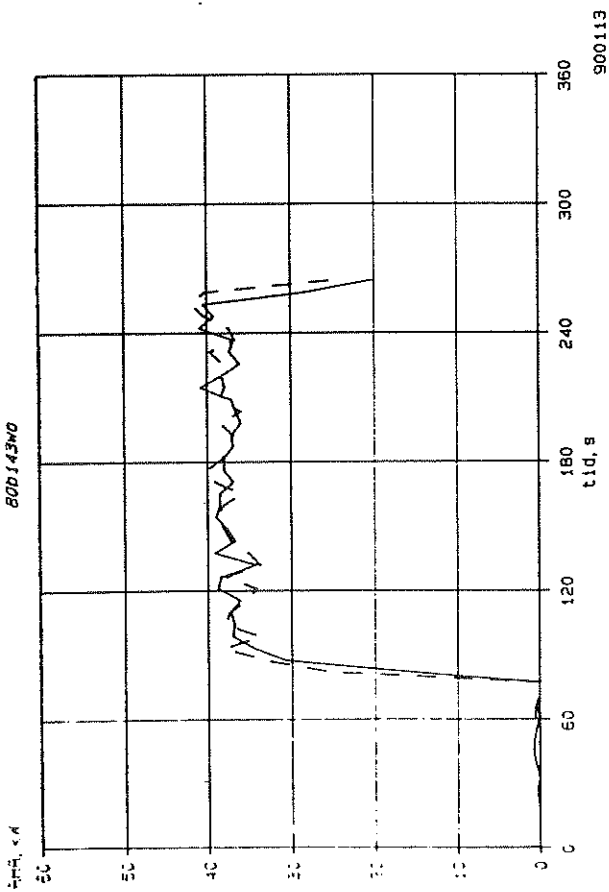
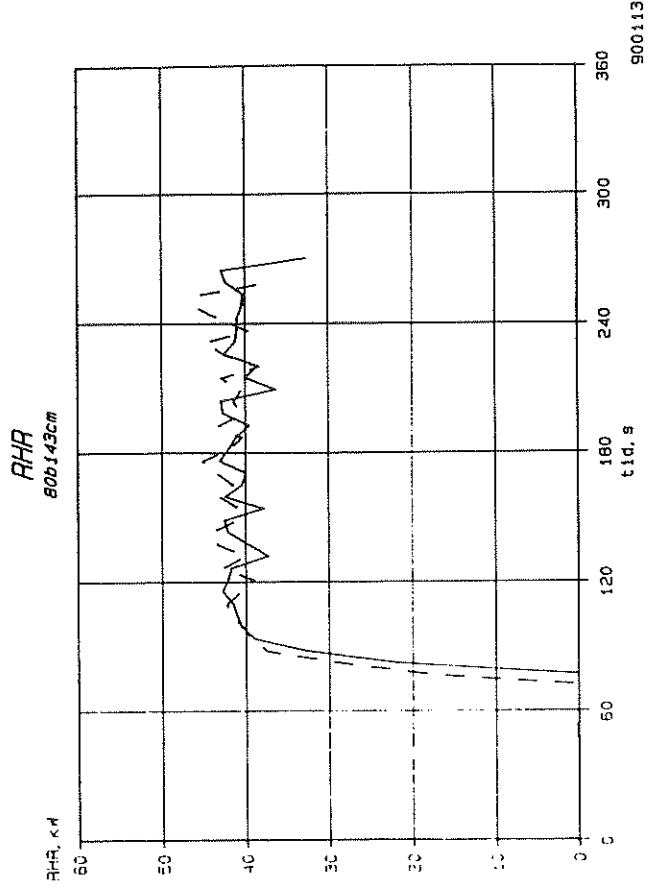
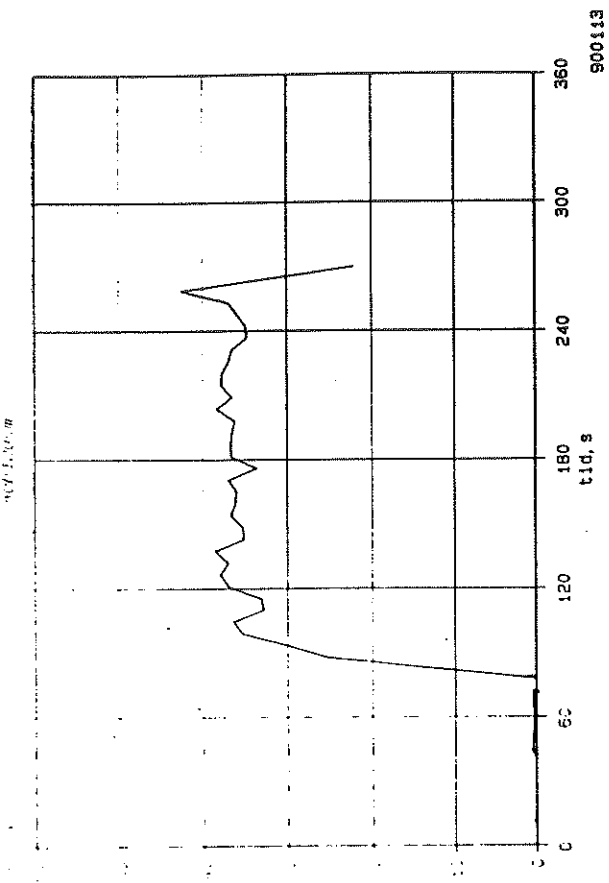

RHR
80b 1mm

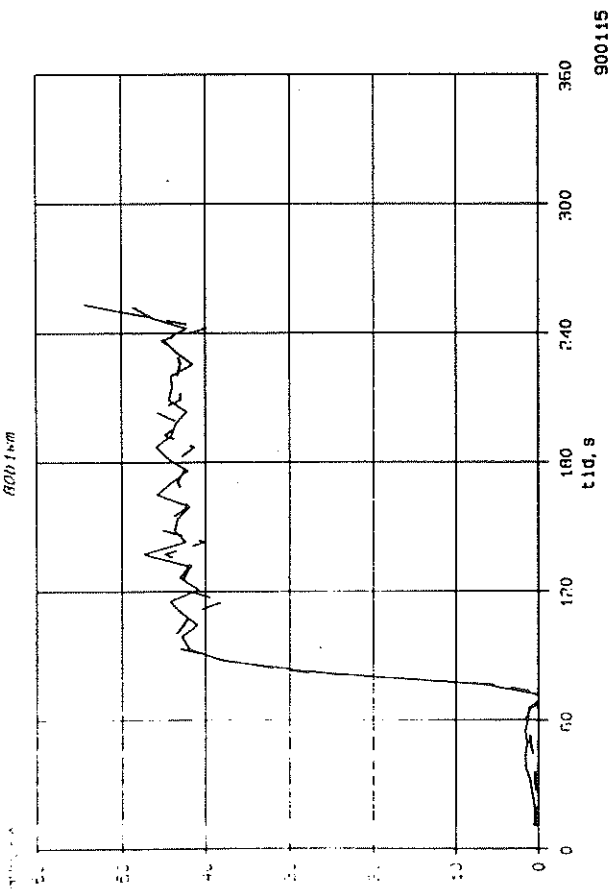

900115

RHR
80b 1.43mm

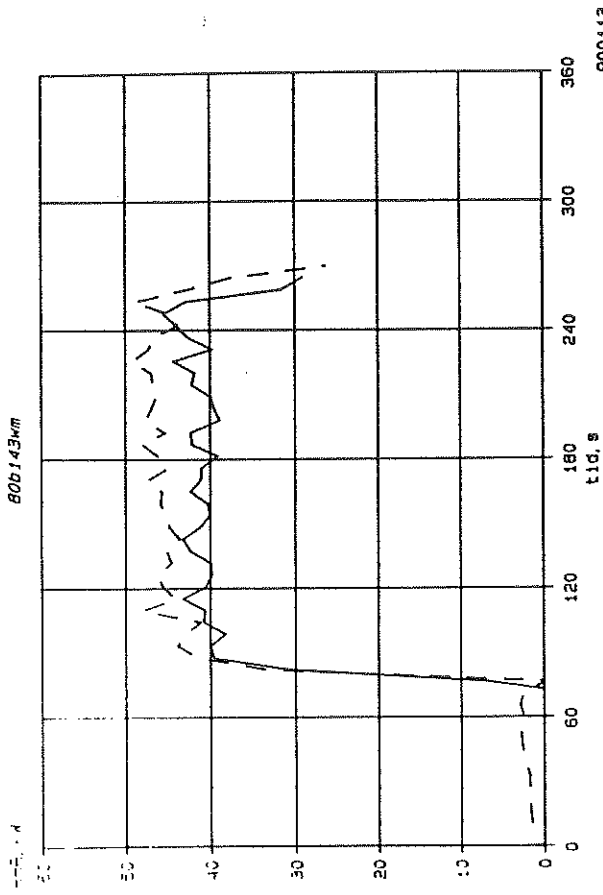

900113

RHR
80b 120mm

