



LUND UNIVERSITY

Continuity for Centuries

A Ceremonial Building and its Context at Uppåkra, Southern Sweden

Larsson, Lars

2004

Document Version:

Publisher's PDF, also known as Version of record

[Link to publication](#)

Citation for published version (APA):

Larsson, L. (Ed.) (2004). *Continuity for Centuries: A Ceremonial Building and its Context at Uppåkra, Southern Sweden*. (Acta Archaeologica Lundensia. Series in 8°; Vol. 48). Almqvist & Wiksell International.

Total number of authors:

1

General rights

Unless other specific re-use rights are stated the following general rights apply:

Copyright and moral rights for the publications made accessible in the public portal are retained by the authors and/or other copyright owners and it is a condition of accessing publications that users recognise and abide by the legal requirements associated with these rights.

- Users may download and print one copy of any publication from the public portal for the purpose of private study or research.
- You may not further distribute the material or use it for any profit-making activity or commercial gain
- You may freely distribute the URL identifying the publication in the public portal

Read more about Creative commons licenses: <https://creativecommons.org/licenses/>

Take down policy

If you believe that this document breaches copyright please contact us providing details, and we will remove access to the work immediately and investigate your claim.

LUND UNIVERSITY

PO Box 117
221 00 Lund
+46 46-222 00 00

ACTA ARCHAEOLOGICA LUNDENSIA
SERIES IN 8°, No. 48

Continuity for Centuries

A ceremonial building and its context
at Uppåkra, southern Sweden

EDITED BY:
LARS LARSSON

UPPÅKRASTUDIER 10

Published with grants from the Bank of Sweden Tercentenary Foundation

The following information can be found in the printed version:

The cover picture shows the glass bowl from the deposition in the house with a part of the house stratigraphy as a background

© The Department of Archaeology and Ancient History

Layout: Ottosson Media

Printed by Grahns Tryckeri AB, Lund 2004.

Distribution: Almqvist & Wiksell International, Box 7634, S-103 94 STOCKHOLM

ISBN 91-22-02107-8

ISSN 0065-0994

CONTENTS

PREFACE

Lars Larsson & Karl-Magnus Lenntorp

The Enigmatic House 3

Birgitta Hårdh

The Metal Beaker with Embossed Foil Bands 49

Lena Grandin

How and where was the beaker from Uppåkra made?
Some indications from chemical analyses. 93

Berta Stjernquist

A Magnificent Glass Bowl from Uppåkra 103

Berta Stjernquist

A Glass Beaker with Cut Decoration, Found at Uppåkra 153

Margrethe Watt

The Gold-Figure Foils (“Guldgubbar”) from Uppåkra 167

Bertil Helgesson

Tributes to be Spoken of Sacrifice and Warriors at Uppåkra 223

The Enigmatic House

Lars Larsson & Karl-Magnus Lenntorp

Abstract

During removal of the topsoil a remarkable house was found at the central place of Uppåkra, southernmost Sweden. Remains of a small, high timbered house were found with deep wall trenches, two pairs of large roof-supporting posts and large poles in all four gables. The excavation documented a sequence of almost identical houses in altogether seven stages. A forerunner and a successor were also present, showing somewhat different shapes in relation to the sequence of houses.

Not only the structure but also the finds were remarkable. In an early stage of excavation a deposition of a beaker of bronze and silver with gold foil decoration and a glass bowl was found. A large number of finds of special character were made including more than hundred gold-foil figures, small gold objects, glass sherds and a ring handle. Not only the houses but the area around them display an extremely large number of deposited weapons.

The house sequence with an overdimensioned support of posts and walls and its contents makes it unique. It is compared to a variety of houses with somewhat similar shape and combination of finds interpreted as buildings of ritual or ceremonial importance. These comparisons include small cultic buildings as well as halls.

The enigmatic house is viewed as a building of extraordinary height in relation to its size, founded during the Roman Iron Age and rebuilt until the early Viking Age. Through the centuries the building became a core representative of a solidly established social order. The shape of the building went out of fashion and might even have been viewed as ancient but it continued to be used.

Lars Larsson & Karl-Magnus Lenntorp, Department of Archaeology and Ancient History, University of Lund, Sandgatan 1, SE-223 50 Lund

Introduction

The majority of the work forming the basis of this article was conducted during the years 2001–2004. The excavation of the unique house remains began in 2001 with the examination of sections of large roof-supporting post-holes and a spectacular cache. The well-preserved remains and the finds warranted further excavation (Fig. 1). The expectation was that this would illuminate and deepen our understanding of ceremonies and structures for ceremonial purposes during the

Iron Age. In the following years the work proceeded, and in 2004 the excavation of the house was completed.

The chosen excavation area is situated south of Uppåkra parish church (Fig. 2). The area was chosen for several reasons. Part of the area was on a ridge that today is highest elevation within the settlement. Another circumstance was the occupation layers up to 2 metres thick on the site and the close proximity to the church, which dates back to at



Fig. 1. Aerial photograph of the remains of the high timbered house. The photo was taken from east during summer 2001. The remains of the house are seen in the central view of the photo. Parts of the western post-hole pairs are under excavation. Photo by Perry Norräng.

least the 12th century. The site also contained four known burial mounds, two preserved and two destroyed (Fig. 2). The abundance of detector finds gathered indicated the existence of magnificent finds within the area. There was also a fairly large amount of glass sherds present. Several circumstances thus indicated that the site had contained a manor for the leading family at the site (Larsson 2002).

Examining a complex sequence of occupation layers like this one leaves many questions unanswered and allows, in general, for several possible interpretations. In this examination there are a number of issues that should constantly be re-examined. The most obvious of these is whether the alteration of one floor surface and a new fireplace also involved a new building. In the present examination the youngest structures were so ex-

tensive that the foundation erased almost all traces of older structures. The problem then arises of whether it is possible to conclude that older structures on the site resembled the youngest ones. In order to describe the development of the structure, the creation of a new floor surface and a new fireplace has been interpreted as a new house, despite the fact that the element of the structure has not been validated. Several of the preserved floor surfaces were damaged by younger truncations, and it is not possible to define exactly how many floor surfaces actually were in use on the site since at least one surface had been destroyed by agriculture. The excavation area has been cultivated for more than a thousand years.

From the start in 2000 and onwards all occupation layers and structures at Uppåkra



Fig. 2. Map of the excavation area during the field campaigns 2001–2004 (grey). The house remains are marked black. The parish church from the 19th century is seen in the centre. The two existing grave mounds Storehög (A) and Lillehög (B) and two destroyed mounds (C and D) are marked on the map.

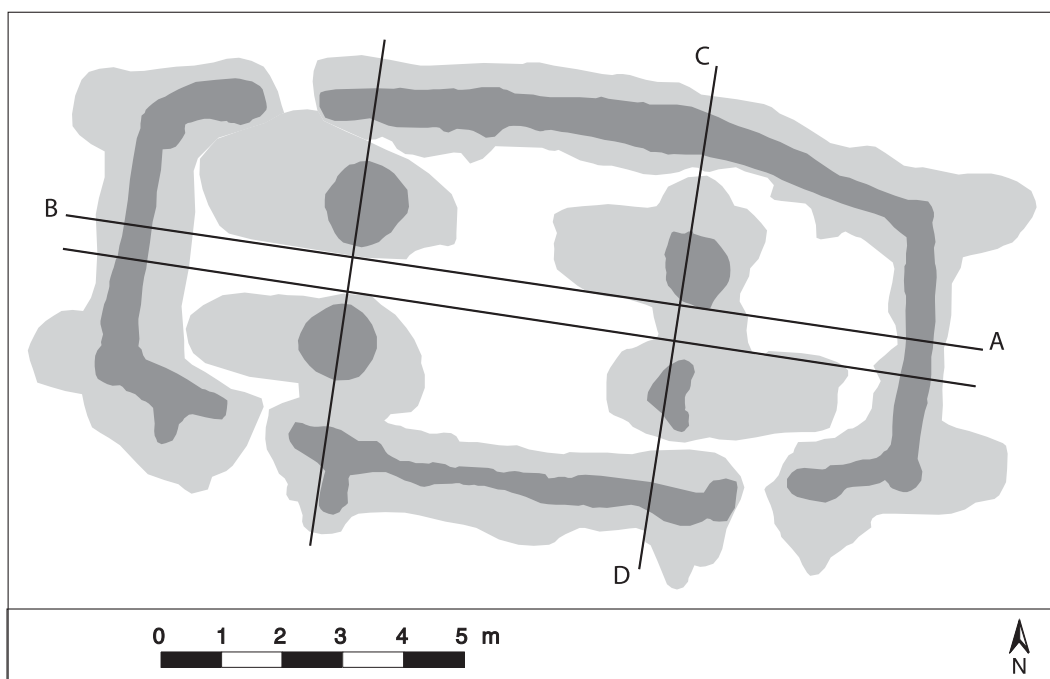

Fig. 3. The youngest stave house, house 2, had all elements such as post-holes and wall trenches well preserved, but there were no floor horizons or fireplaces preserved. Black represents the standing timber construction and grey represents the cuttings for wall trench and post-holes. The figure also illustrates where sections were documented in profiles and the letters A–D refer to sections illustrated in Fig. 8.

were examined by the single context methodology (Larsson 1996). The occupation layers in connection with the house remains were sieved without exception. All contexts were documented with digital techniques and all information was collected and processed in Intrasis (Intrasis.com). Early in the excavation, three section banks that affected the house remains were saved, one longitudinal and two transversal (Fig. 3).

The high timbered house

The house remains were so well preserved that the plan could be established already in connection with the initial clearance of the intact surface (Fig. 1). It later turned out that further structural details could be distinguished. The house had straight gables

and slightly bowed walls 13,5 metres long and 6 metres wide, and four large post-holes placed in pairs had supported the roof. The post fillings were clearly visible against the yellow clay of the floor surface. The house had three entrances, one facing north and two facing south. In the centre of the house were the remains of a fireplace. Obviously it was a distinctive structure.

A yard with an exceptional abundance of finds surrounded the house. The surface was littered with an accumulation of fire-cracked stones and a considerable amount of artefacts.

The excavation of the cleared remains was initiated with the help of a metal detector scan. In the floor surface south of the fireplace was a rare cache find consisting of metal beaker and a glass bowl (Hårdh this volume; Stjernquist this volume). From what could be gathered,

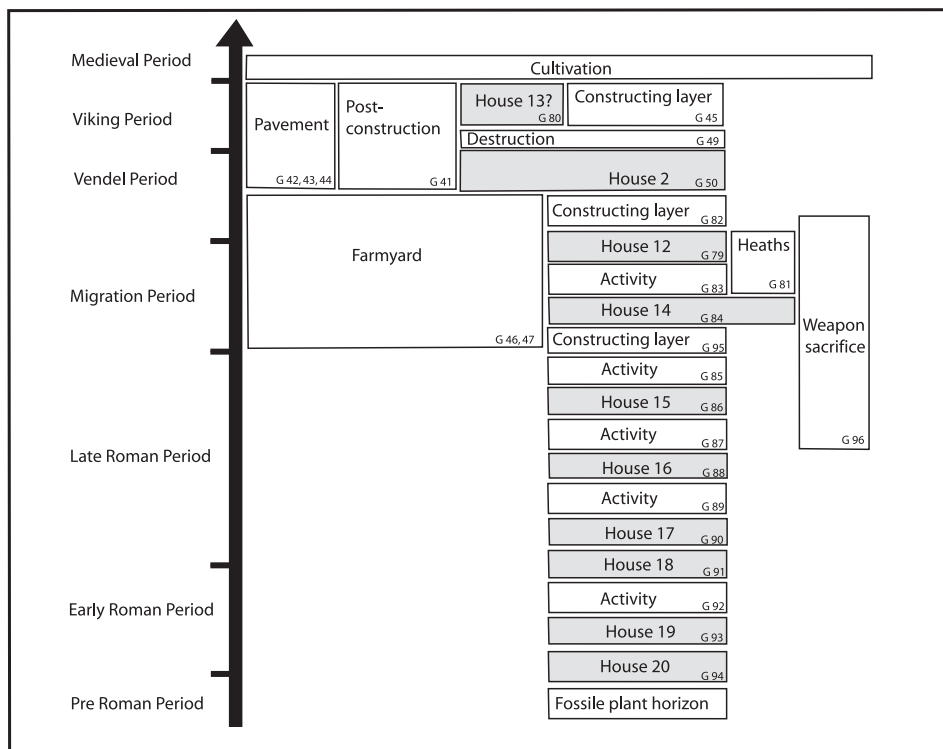

Fig. 4. An approximate diagram of constructions and activities at the high timbered house and in the surroundings during a time sequence from Pre-Roman period to the Middle Ages.

the items had been deposited while the house was in use, since the floor clay had been dug up, placed and levelled after the deposition.

The field excavation in 2001 focused on the large trench in the north while limited effort was devoted to the above-mentioned house remains in the south. Even during the stripping of the top soil, the colouring from the posts had been shown to be considerable in relation to the size of the house. In combination with the rare cache find this indicated that these house remains differed from other settlement remains. To properly plan the following year's excavation, further information about the house and its possible predecessors on the site was needed. We expected to obtain a measure of the dimension of the roof-carrying posts and walls by examining parts of the post-holes and parts of the wall trench. We also expected

to gain insight into the stratigraphic sequences below the cleared house by studying the sides of the post-holes.

The excavation was then limited to smaller parts of the western pairs of post-holes and two small stretches of the wall trench. Despite the limited effort the yield from the field excavation was considerable.

Apart from the previously mentioned cache find, a large iron ring with a still existing staple and a damaged cranium from a cow were among the objects found in the north-western post-hole (see Fig. 5). No less than seven gold-foil figures were found in the post-hole fillings and in the wall trenches. Outside the south-west entrance further excavation also came upon, among other things, a small drop of molten gold, a crucible fragment with traces of gold and a pair



Fig. 5. The post-hole in north-west direction during the excavation. The darkened soil in the centre of the photograph illustrates where the post once stood. The finds of a cow skull and a iron ring can also be seen in the photo. Photo by Jonas Paulsson.

of spearheads. In this phase of the excavation it was also evident from the stratigraphy of the post-hole edges that the house remains consisted of several generations of a distinctive structure on the same site that had been in use for an unusually long period of time.

The process of deconstructing the floor and the wall structure took much longer than first anticipated. During the field campaign in 2002 large parts of the wall trenches, three of the four corner post-holes and the central part of the floor around the fireplaces were excavated. In 2003 the work continued and the filling in the remaining post-holes and wall trenches was excavated. A fragmented part of an older wall trench at the south-west entrance was documented. The excavation of the

house remains was fully completed in 2004. During the last year the floor layers located close to the gables and three older sequences of wall trenches were documented.

The reasons why the excavation was extended to four field campaigns were: (1) The excavation involved large quantities of occupation soil that was examined by trowel and finally water-sieved. The water sieving turned out to be especially time-consuming because of the high content of clay. 2) The excavation also required a considerable effort to document over 300 layers, features and cuts.

A clear pattern of settlement evolves. The finds also give a rich and illuminating insight into the peculiar ceremonies and conceptual world of the Iron Age.



Fig. 6. The south-west post-hole during the 2002 excavation campaign. The eastern half of the post-hole is finished. Photo by Linda Pettersson.

Results of the excavation

It was apparent that the surface contained the remains of three different house remnants that had all been erected in stave construction. There were earth layers showing that the continuity of settlement had been broken and the house had been taken apart. There were also indications of a succeeding building, which had been erected by a different technique (see house 13).

House 2

The youngest stave house (house 2) was damaged by soil scarification. The remains consisted of a structure with trenches and post-holes and two hearths. Subsequently there were no fireplaces and floor layers preserved. This can probably be explained by the fact that the house appeared in the surface of the intact

occupation layers and the floor surface and fireplace had most likely been ploughed off in recent times. The structure consisted of pits for eight sturdy posts and wall trenches. Four of the posts were placed in the respective corners of the structure and the remaining four posts were inner pairs of roof bearers. The dimensions of the post-holes were certainly impressive: around 4 x 2 metres in area and at least 1.7 metres deep (see section Figs. 6 and 8). In three of the inner post-holes, stone constructions stabilizing the bearing structure were found. In three of the post-holes there were ten or so large stones measuring around 0.4 x 0.6 metres and in some cases weighing more than 60 kg. In the fourth post-hole, localized in the south-west, no stone construction was found. In the filling layer, however, occasional small stones were found. The existing stone features and layers indicating the placing of



Fig. 7. The southern part of the wall trench during the excavation in 2002. The photo is taken from the west. To the left are the remaining clay floor horizons and to the right are the sooty yard layers. Note the trench form that indicates the entrance in south-west. Photo by Linda Pettersson.

the posts showed that the posts probably had a diameter of at least 0.7 metres. The corner post-holes had the same dimension as the inner post-holes, but the stone constructions were not as large, consisting of a number of smaller stones. The wall trenches for the gable sections were straight and about 1 metre deep.

The long side of the house had slightly convex trenches, also around 1 metre deep. The primary filling layers in the trenches consisted of the earlier floor sections and yard layers. These had been redeposited on a number of occasions. In the bottom of the trenches were obvious depressions from the construc-

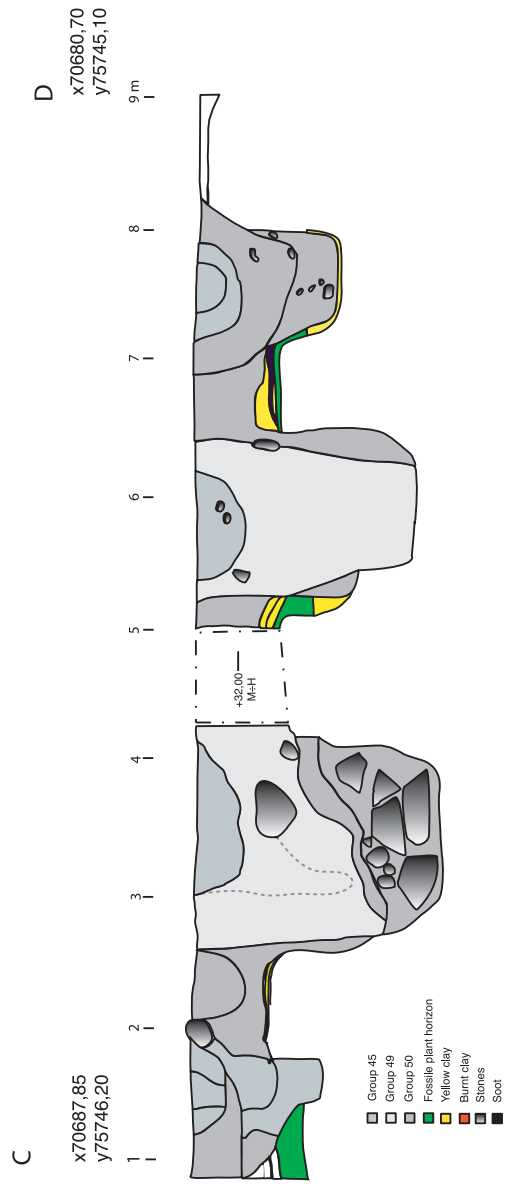
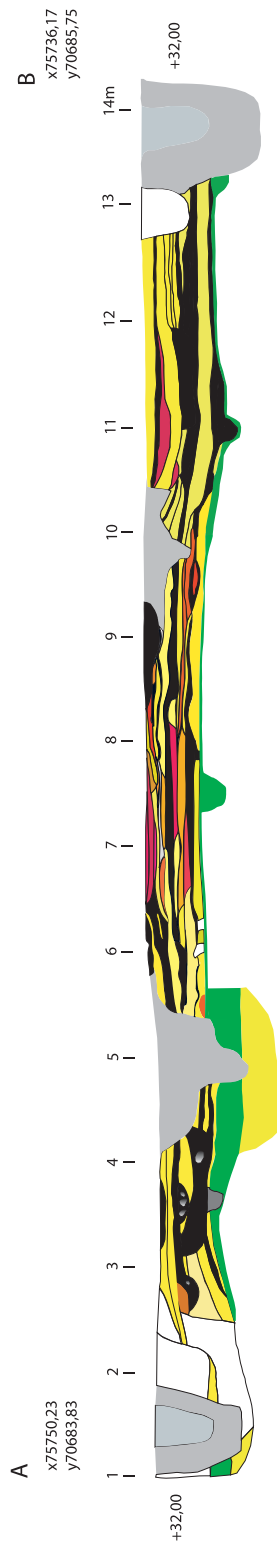

Fig. 8. Documented sections from the excavated house. Above a section from east to west that crosses the central parts of the house. Below is a cross-section from north to south through the eastern post pairs and parts of the wall trenches.



Fig. 9. A view from north-east of the complex stratigraphical situation in the section bank running east–west. At least seven generations of a high timbered house were documented and a forerunner and a successor had also left their traces in the section. The large stones that are seen originate from the post-holes (to the right). The central section bank was removed and the excavation was completed during the field campaign of 2004. Photo by Bengt Almgren.

tion of the walls. The depressions were circular or semicircular and showed that the wall had been constructed of tightly placed logs that were either whole or split in half. It could thus be concluded that the walls had been built in stave technique. The wall trenches ran up to the three entrances where they terminated. At the entrance sections the trench had been deepened and the abundance of stone constructions and clearly marked doorposts indicated that the doors had been of considerable height. Judging by the depth of the trenches and the roof-supporting post-holes, it seems that this must once have been an impressive building on the site (Fig. 7).

The finds in the filling layers were particularly rich. Those which could be dated

reflected the difficulties with the long continuity of the site. The finds span a long time. There were artefacts and potsherds dating from the Pre-Roman Iron Period up to the Viking Age. Among the artefacts there were three fibulae, two of bronze and one of iron. One bronze fibula could be dated to the end of the third century (no. 2997) and the other bronze fibula (no. 3475) could be placed in the period fourth–fifth centuries (Lenntorp & Piltz-Williams 2002). The third fibula, made of iron, has not yet been dated. Five sherds of glass were also found. It was also in this context that the majority of the gold-foil figures were discovered. The fact that several gold-foil figures were found close to the bottom of the post-holes, almost 1.5 metres from the upper part of the

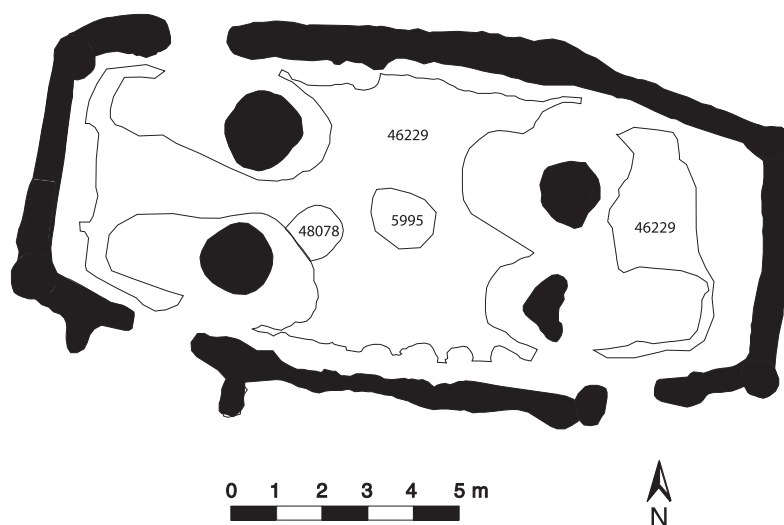

Fig. 10. The clay floor of house 14 was well preserved (46229). In the centre of the house there is a fireplace (5995) with an ember pit (48078). Part of the original wall trench was preserved in the eastern gable. The black silhouette represents the best-preserved construction of the later house 2.

structure, indicated that several gold-foil figures had been placed there during the erection of the posts or had been in previous use and ended up in the find location during one of the many re-pits. The finds that were dated to the foundation layers of house 2 included a rather large amount of pottery dating the construction of the house to the Vendel Period and Viking Age but there were also redeposited ceramics (Fig.12). The destruction of house 2 probably occurred during the early Viking Age.

Forerunners

The clay floor fragments that were initially interpreted as a floor surface could be divided into two different floor horizons (houses 14 and 12). On the floor surface there were also small sections of added earth, which probably had been used in levelling (group 82). The levelling was most likely done in the construction of house 2. The filling included two gold-foil figures, burnt grain and pot-sherds

dating to Vendel Period–Viking Age. There were redeposited potsherds as well (Fig. 12). The latest floor surface (house 12) was only preserved in small fragments and no fireplace could be connected to the house. It is difficult to define the time when the house was in use. There were no dated finds in the floor layer. Considering the stratigraphic sequences, the floor layer ought to originate from around the end of Migration Period and the beginning of the Vendel Period.

Below the fragmentarily preserved clay floor of house 12 a very well-preserved floor was found (house 14, see Fig. 10). On the floor surface and especially around the centrally placed fireplace, a sooty activity layer had accumulated during the time the house was used. Just south of the fireplace was the above-mentioned cache of a metal beaker and a glass bowl. These had been deposited during the time the house was in use or immediately thereafter. Close to the fireplace there was also a pit containing an abundance of charcoal.



Fig 11. Above: A ceramic vessel that was deposited beneath the clay floor of house 19. Scale 1:3. Below: A Viking age comb deposited in the final phase of the high-timbered house. Scale 1:2. Photo by Bengt Almgren

The pit had probably been used to hold glowing embers. A piece of cinder found in the clay floor indicated the possibility that metal had been processed in the house. The finds in the floor clay and activity layer showed that the house had been in use from the Roman Iron Age to the Migration Period. The stratigraphy also showed that the time when the house was in use was in the latter part of the above period, i.e. the Migration Period.

So far it had turned out that there were fragments of at least three different houses, instead of only one as the first interpretation had maintained. The continuity had been broken when the latest stave house was torn down. The dismantling of the house could be distinguished in two separate stages. An initial stage was when the standing timber structure was torn down. There were no

remnants of wood or other traces to indicate that the wood had been left standing to rot. In the process of dismantling the walls and posts, parts of the primary filling layers in the structure were redeposited. It was in these layers that many of the above-mentioned finds belonged, the iron ring, the fragmented cranium of a cow and several gold-foil figures. The iron ring has been interpreted as a door ring (Ödman 2003). It cannot have been located there when the house was in use. The cranium could have been in place during the time of usage, but considering its fragility it seems likely that it was disposed in connection with the demolition (Fig. 5). A reasonable explanation seems to be that the ring was mounted on one of the doors and when the house was demolished the ring, probably with the skull, was deposited in the post-hole. The cavities left by the timber structure were levelled with filling layers covered with soot. Especially where the corner posts had been placed these sooty fillings contained quite large quantities of fire-cracked stones. There was also a surprisingly large amount of iron nails (a total of 51). The nails were predominantly found in the fillings that were placed in the cavities where the wall had been. In the northern wall-trench 28 nails were found, of which 19 were concentrated in a cache close to the bottom of the layer. In the southern wall trench eight nails were scattered. The number of nails is surprisingly large since bearing structures in prehistoric houses were generally erected without using nails. Obviously several iron nails had ended up in the wall trench after the dismantling of the house. The accumulation of 19 iron nails indicates that the nails were intentionally deposited as a part of the ground levelling act after the demolition of the house.

A hypothesis is that the soot in the filling layers could have come about as the wooden

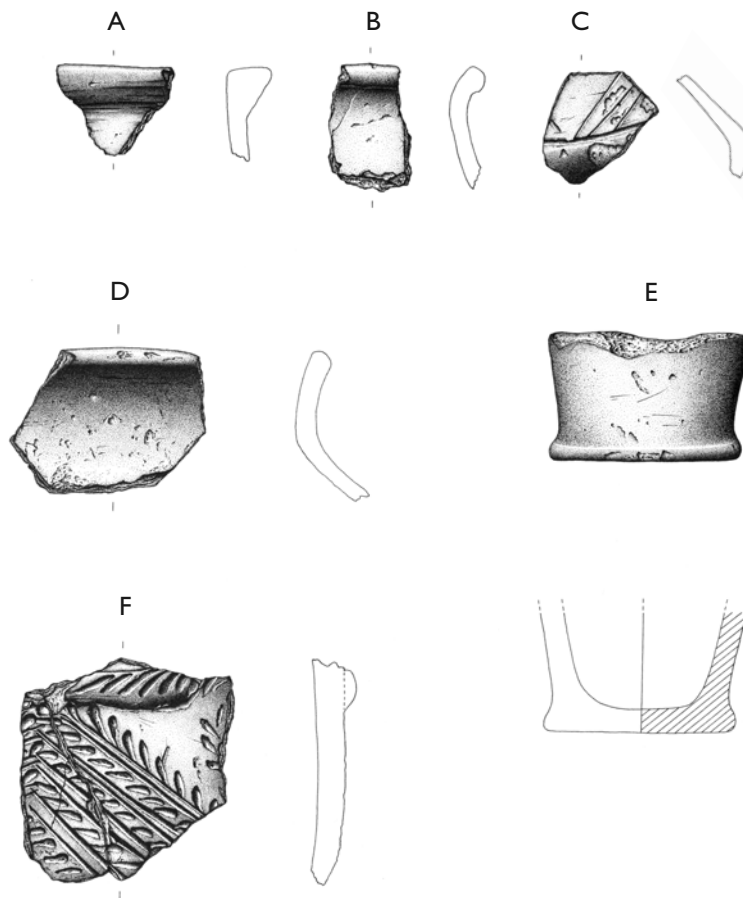

Fig 12. Pottery-sherds from the house sequence. A - C are ceramics from group 93 (A and B dated to Roman period, C to Roman-Migration period). D is related to group 86. E - F are examples of redeposited ceramics from groups 50 and 82 (E dated to Pre/Early Roman period and F dated to early Roman period). Fnr A:5015, B:5371, C:4859, D:3775 E:6667 and F:5198. Scale 1:2. Drawings by Björn Nilsson.

material from the dismantled house was burnt. The dismantling and the levelling act indicated that the demolition had occurred under supervised conditions and had been thorough. The find of an Arabic dirhem, coined by Caliph al Mansur between AD 771 and 755 in the Madinat al Salem, and two Viking Age comb fragments in the layers dated the episode (Fig. 11). It probably occurred at the beginning of the Viking Age, considering the year the coin was minted.

When the upper floor layers had been excavated, five more or less well-preserved floor layers were revealed. This implies that probably eight generations with the same basic concept and tradition had been built with extremely small changes. Thanks to a relatively large amount of finds from floor layers and activity layers, the origin of the site-bound structure can be dated to the Late Roman Iron Age. The structure that could be validated for house 2 was most likely representative

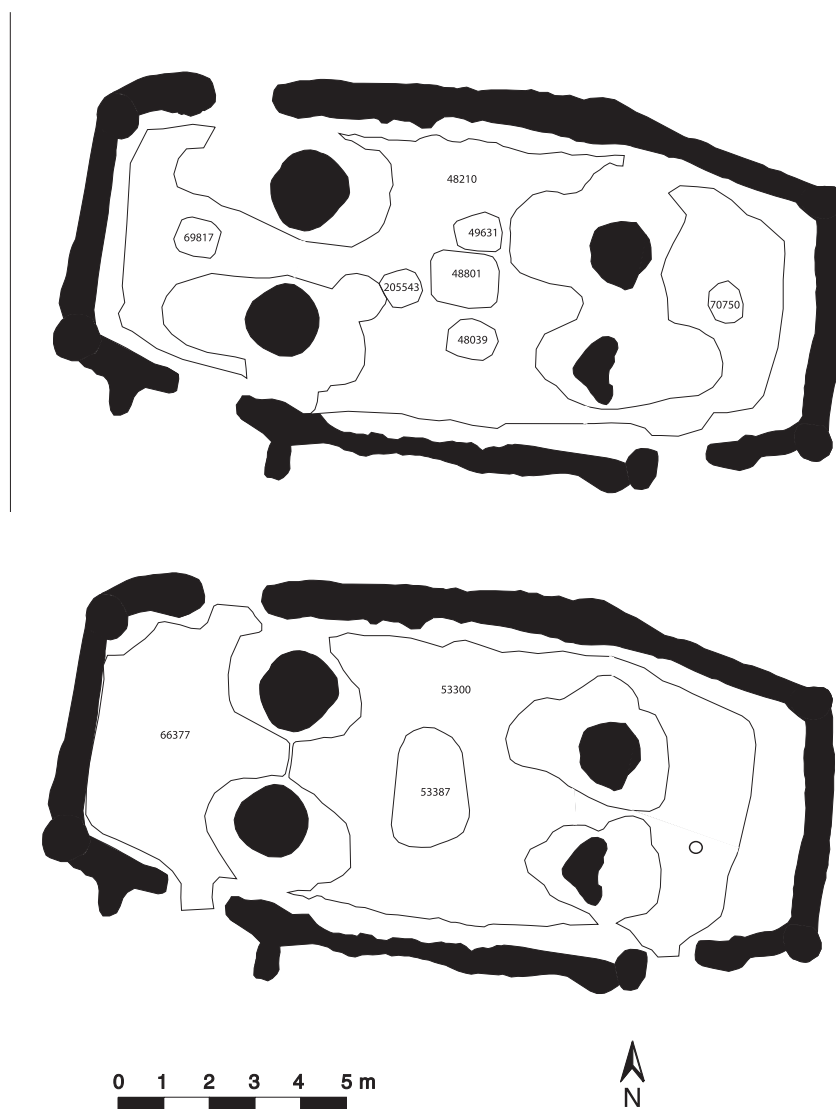

Fig. 13. House 15 (above) was the fifth generation that was built in the stave technique. A clay floor covered the entire area inside the house and in the centre there was a fireplace (48801). The fireplace was flanked by three ember pits (49631, 48039 and 205543). Further ember pits were localized to the east and west (69817 and 70750).

House 19 (below) is the oldest house built in the stave technique. The house was probably built in the third century. In the centre of the house there was a fireplace, and three-quarters of the inside had a clay floor. The western quarter had a pavement. There was also a hearth. Part of the wall trench in the eastern gable and small parts of the northern long side were preserved. The find spot of an almost intact ceramic vessel under the clay floor is marked with a circle.

of its predecessors. This was indicated, among other things, by similar floor layers, with the same spatial distribution and perhaps most strongly by the central placing of the fireplaces. The structure consisted of wall trenches with strengthened corners and holes for roof-supporting posts. The latest house was equipped with three entrance sections. It could be stated with certainty that they existed from the very beginning because no older trenches could be found crossing through an entrance section. The entrance sections were constructed in the same way, although they differed in their exteriors. The south-west entrance had two enlargements that probably showed the existence of a smaller entrance hall. An older variant of one of the enlargements was found in an older phase, most likely house 15. This confirmed the presence of an entrance hall as a traditional element. The two other entrances were located in the building itself. Two pairs of inside posts, anchored with stone packing, carried the roof. Considering the design of the remaining elements of the structure it is clear that the house was built in stave technique. The house had a length of 13.5 metres with convex long sides and straight gables, 4.5 metres wide. The floor surface most likely measured up to 75 square metres. The basic concept of the house had probably been decided right from the beginning and was retained that way with an astonishing degree of exactitude for several generations. It was only in the south-west corner and in the eastern gables that minor parts of the wall trench diverged somewhat from its successors.

Under the floor layers of house 14 was found a predecessor, which was a very well-preserved surface of clay with a fireplace located in a central position (house 15, Fig. 13). Around the fireplace five ember pits had

been dug. It could not be decided whether the pits had been used one by one or at the same time, but most likely they were used successively. Around the fireplace was a layer of soot. It contained, amongst other things, two fragments of glass (find nos. 3456; 3466) and two fibulae of bronze. One of these could be dated to Roman Iron Age (find 3966) and the other to younger Roman Iron Age (find 3675). The layer of soot also contained a molten drop in bronze (find 3478). It showed that the people living there had possibly engaged in metal handicraft. The finds connected with house 15 indicate that the building was erected during the Late Roman Iron Age, most probably at the end of the period.

The following two clay-floor sequences (house 16 and 17) were restored in fragments. The fragmentation was probably a result of levelling acts in later building stages. Despite this, minor parts of the original wall trench belonging to house 16 were preserved in the east.

House 18 had a much better preserved floor surface, wholly comparable with the preservation degree of house 15. The house had exactly the same spatial configuration as its successor and it also had a fireplace in the centre. Close to the fireplace an ember pit was found. Compared to house 15, which had an easily recognizable activity area, a continuous layer of soot was missing. The floor surface was covered in patches with conserved lenses of soot. Just north-west of the fireplace, in a soot lens a complete storage vessel was found, albeit crushed on the floor (find 5548). The vessel was of an ordinary Iron Age type and could not be dated more exactly. The finds from the house which could be dated and which come from the activity layer and clay floor showed that house 18 was established during Late Roman Iron Age and Migration

Period, most likely in use during the former period.

The floor layer of the oldest stave house (house 19, Fig. 13) had been constructed on the original plant horizon. The clay floor was very thick compared to the above-mentioned one, besides which it had a higher lime content. Somewhat surprisingly, the clay floor did not cover the whole floor of the house. At the same level as the western pair of roof-supporting posts the clay floor changed to an area of pebbles more or less covered with soot. Finds in this soot layer included several fragments of crucibles. Under the centrally placed fireplace a squared depression had been made in the fossil plant horizon. The depression was completely filled with floor clay, which made the surface flat and at the same level as the floor where the fireplace was located. The heavy filling of clay possibly functioned as a source of warm air for the fireplace. Immediately west of the fireplace, a second, somewhat smaller, fireplace had been built. On the clay floor a sooty activity layer had been formed, group 92. The soot was thickest close to the fireplace and was obviously caused by the activities taking place there.

The floor clay belonging to house 19 contained, in particular, one amber bead shaped like a charm that could be dated back to the Late Roman Iron Age. The pottery is dated to the period from the Early Roman Iron Age to the Migration Period (Fig. 12). It is likely that the house (19) was established some time during the Late Roman Iron Age, taking into account the amber bead and the pottery. Finds of smaller amounts (290 grams) of metal slag, both in the floor and in the activity layer, and the above-mentioned fragment of a crucible from the pavement indicated that some metal handicraft had taken place inside the house.

Near the eastern gable there was an almost intact vessel, which had been placed in a small pit (see Figs 11 and 13). The vessel was clearly covered by the clay floor. However, it is likely that the vessel was deposited when house 19 was in use or under construction, because in the area covering the pit, the clay floor layer displayed marks suggesting secondary repair. This is consistent with the pit having been made into the clay floor and then covered over.

The houses – some assumptions

The structure found in the surface was the same from house 19 up to house 2 (Fig. 4). The design with a clay floor and a centrally located fireplace showed that the structure of the buildings had more or less been unchanged over a very long period of time. Supporting factors are the extent of the clay floor and the location of the fireplaces in the centre. The clay floors could often be determined by the outer limits of the structure. Occasionally it was found that the clay floor had a smaller extent. In most situations this could be explained by other factors than the ground plan, as in the case of house 19. The clay floor was delimited to the west and gave way to a pavement, which could also be regarded as a floor surface. That was also the case for floors 12, 16 and 17, whose limitations could most likely be explained as damage caused during the building phase or during some necessary repair.

It is difficult to determine the continuity of the stave construction. The foundation of house 2 effectively destroyed most of the older structures. However, there were a few exceptions, three different stages of the wall trenches were preserved in the eastern gable, belonging to houses 12, 16 and 19. This could be seen in fig. 8. The preservation of

parts of older wall-trenches was caused by a minor dislocation of later houses. A preserved part of an older trench was also found from the corner post to the strengthened part at the entrance in the south-west. This clearly proved that the (basic) structure could be confirmed in the older periods as well, even from the original house 19. It could be safely concluded that the depth not could have been the same for the oldest building as for the latest structure because the remnants were built upon the surface. Therefore the post-holes belonging to the oldest house could not have been deeper than around 1.2 metres.

The location of the fireplaces in all the houses showed, without any exceptions, that they had been in a central position between the two roof-supporting pairs of posts. The fireplaces were obviously open and they were not made with any great care. There was no stone packing, for example, and there is no evidence that the fireplace was elevated above the floor surface. The reason for this could possibly be that parts of the fireplace had been levelled out in connection with new construction.

In many cases several hearths pits flanked the fireplaces. These differed from other hearth pits at the settlement and from those at other Iron Age settlements in that these most commonly contain large amounts of fire-cracked stone. Unlike ordinary pits, the hearth pits in the house were filled with a sooty layer of humus. In the bottom of these was found homogeneous layer of charcoal without any fire-cracked stone. Their location could possibly have something to do with their proximity to the fireplace, which suggests that they functioned as reservoirs of live coal, like the ember vessels of later times. In other words, they could be regarded as ember pits. The construction indicated that live coal from one fire could be covered and

saved in the pit for use at a later moment to light another fire. The existence of separate or even up to five different pits in the same floor surface, together with the fact that this was the case for the whole sequence of houses, could mean that this was a tenacious tradition. In one of the younger houses (house 12) there were two hearths flanking the central fireplace. They were located in the centre line of the house. The hearths were constructed in the traditional way: a small pit filled with soot, charcoal and fire-cracked stones. Several of the fire-cracked stones were fragments of millstones. In this case it was obvious that these particularly hearths indicated a new tradition. No similar hearths had been found in the previous houses. Outside and especially south and east of the house, a number of similar hearths have been documented (Lennertorp & Lindell 2001).

A long-house

When the oldest floor layer had been removed, remains of another house could be documented (house 20). It was a traditional long-house, the remnants of which consisted of four filled post-holes (Fig. 14). Three of the post-holes were more or less badly damaged by later structures. Luckily, one post-hole was intact so that the level of its foundations could be determined. It was dug down from the fossil plant horizon and its form was oval, measuring 1.00 x 0.60 in the top level, and the depth was 0.80 metres. The stratigraphy showed that the post dimension had been about 0.90 x 0.30 metres in diameter. It was a rather large post compared with those in similar Early Iron Age houses (Larsson 1995). The placement of the post-holes indicated that they originated as roof bearers in a long-house. Two post-holes constituted a pair of

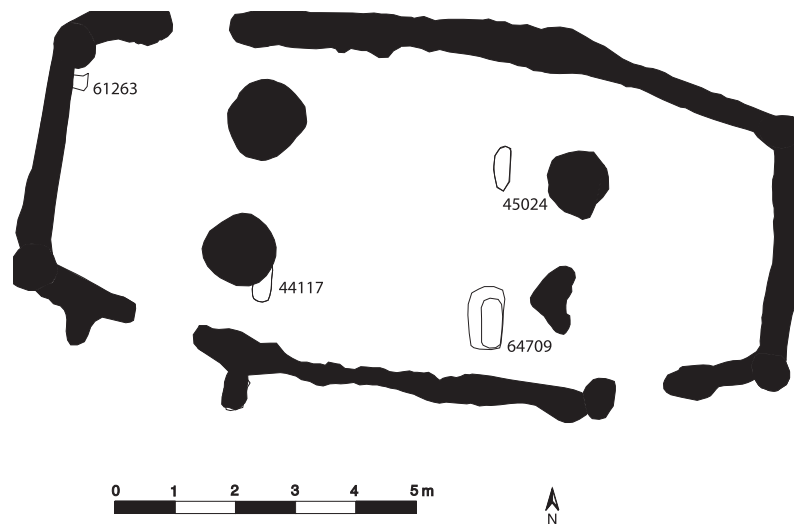

Fig. 14. Underneath the oldest preserved clay floors of house 19 there were post-holes that did not fit the tradition of this house and its predecessors. Obviously this indicates a forerunner with a different building tradition. A total of four post-holes are connected to a forerunner, house 20, but only one of these had the original cut level preserved (64709).

roof supports and the other two indicate another two pairs. They were placed at intervals of 2.40 metres. The total of three pairs of roof posts indicate that the length of the house was at least eight metres. It was not possible to tell whether the house had any fireplace or was built of timber or clay.

There were no dated finds from the post-holes that could determine exactly when the long-house was in use. The stratigraphy showed that it was older than the first stave house, obviously a forerunner. The dating of the long-house was based only on stratigraphy, which made it not later than around AD 300. The house was probably in use during the Early Roman Iron Age. No other instances of activities were found between the long-house and its successors. However, artefacts found in later filling layers and dated to the Pre-Roman Iron Period could perhaps have originated in the time of the long-house.

Apart from the long-house there was a

large pit in the excavation area. The exact position was below the north-east corner post belonging to the stave house. The pit extended at least 2 metres down from the original plant horizon and its function is still unknown because it has not been investigated in detail.

The successors of the stave house and an enclosure

The continuity of the place did not stop when the stave house was torn down in the ninth century. Some traces of a younger house could be found (house 13, see Fig. 15). These remnants of settlement, however, were not easy to interpret. In excavation surface a number of pits become visible, filled with the same type of layer. The pits were around 0.3 metres in diameter and 0.2 to 0.3 metres deep. The character of the filled layers was a



Fig. 15. In the surface of the preserved occupation layers there were traces of a younger construction, group 80. This was interpreted as remains of a small building built on a sill of stones, house 13. House 13 were flanked to the north and south by post-holes that were interpreted as an enclosure, group 41, dark grey spots. The light grey colour represents the cuts for house 2. There are several similarities between the two houses but in terms of the building tradition house 13 represents a new order.

mixture of yellow clay and humus. On the other hand, it is doubtful whether the objects in these two groups belonged to one and the same structure. From a stratigraphic point of view it is very possible, and their internal similarities point in this direction. The type of structure is still unclear, however. It is not likely that the houses were comparable to those that had occupied the place earlier, because of the small depth and size of the pits. They are probably not traces of post-holes but of stones. One suggestion could be that one group of pits was the remains of a building which had been raised on a stone sill (house 13). The

length of the house is hard to determine but the width was most certainly around 4.5 metres. The other pits could perhaps be remnants of an enclosure. The enclosure could also, as one option, have belonged to the stave house (house 2). This is corroborated by the fact that the enclosure was located to conform to the convex long sides of the house and that the pits in the south were seemingly well adjusted to the entrances of the house in the south-west and in north. It is at least obvious that the place once again had been used for settlement after the last stave house had been demolished. However, the building style had changed.

Finds of special character

Among the finds from the house sequence, some groups of artefacts have a character or a distribution that might be of special interest in order to understand the function.

Gold-foil figures

As is evident from fig. 16, gold-foil figures are found in all parts of the house. In fig. 16 the position of the figures has been projected on the floor of the second last house (house 12), which does not do justice to the distribution. With the exception of two, all were found in the fill.

The two exceptions derive from a securely established layer. They were found in a levelling layer, group 82, related to activities in connection with the erection of house 2, one in the north-western part and one in the north-eastern part. However, this does not mean that they can be regarded as a well-dated sequence, as the levelling layer might have been taken from disturbed soil. It just gives a *post terminus quem*.

Although no figures could be linked to any floor level, the find positions are of some interest as it means that figures were not allowed to be deposited on a floor, only in a fill.

The strange position of two gold-foil figures in the levelling layer group 82 might be viewed as somewhat puzzling. As an explanation one might refer to the designation *hofsmold* or “temple soil”. In some Icelandic sources, *Vatnzdæla saga*, *Eyrbyggja saga* and *Landnámabók*, temple soil is mentioned as something one took along when leaving Iceland (Lidén 1969:19). This act can be explained as soil extracted as a concrete requirement for cult remains. In relation to the re-erection of a house, certain rules were followed regard-

ing what kind of soil could be used for levelling. The soil might have been taken from the fill of the wall trenches or posts. The levelling layer in the sequences of the houses usually contains a large number of artefacts.

The gold-foil figures from Uppåkra now constitute the second largest collection in Scandinavia (Watt, this volume). The number of finds and their relation to a well preserved house structure aroused the expectation of new knowledge that might allow a deeper understanding of their use. Recognizing foil figures during excavation with a trowel turned out be rather difficult. Most of the figures were found during water sieving of the soil. This means that the exact location is known for just a few examples. With the excavation method practised at Uppåkra the relation of the figures to specific layers is more certainly documented.

Despite the distribution within the entire house, certain concentrations are evident. The filling of three posts contained four figures each. This is in stark contrast to the fourth north-western post with a much higher number of finds. In the wall trench just east of the entrance to the north a small concentration of figures was found.

Yet another concentration is related to the east gable, especially connected to the central part and both gable corners.

Within the filling of the north-western posts, two obvious concentrations are evident – one related to the central part of the post-hole and the other to a small area just to the east. From an examination of the depth of the figures in the fill it is evident that the central concentration is related to figures found at a level of about one metre, while the figures in the eastern concentration are found at a considerable variation in depth.

The concentrations might be the result of conscious depositions of gold-foil figures on

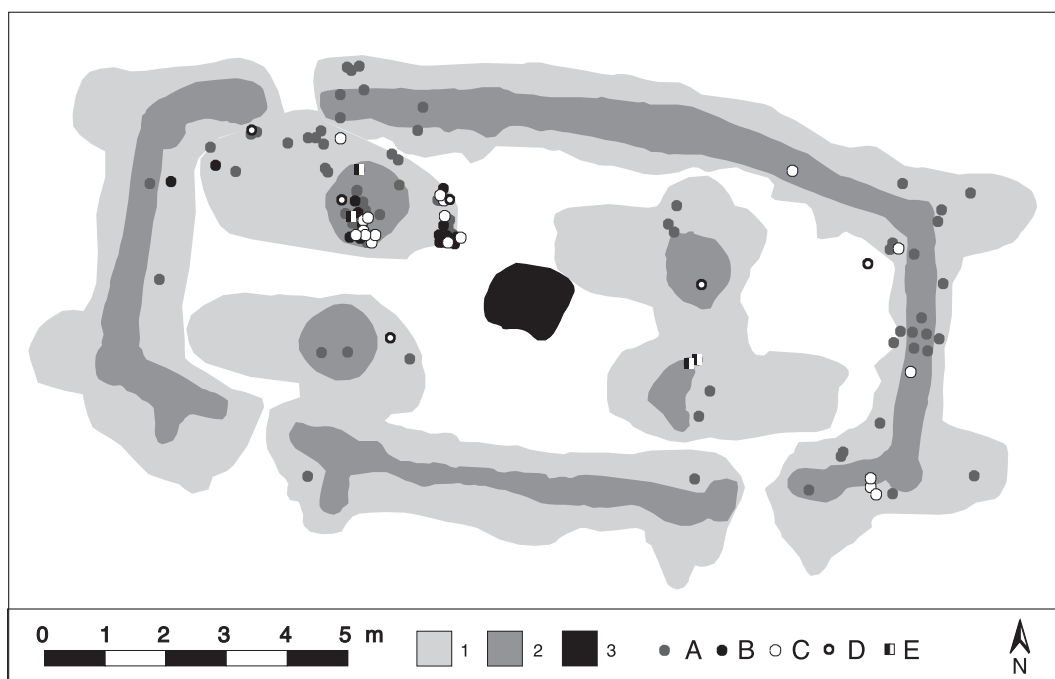

Fig. 16. The distribution of the gold-foil figures (A) in the house sequence. Gold-foil figures manufactured from the same die are specially marked. B and C: male figures from two different dies, D: female figures from the same die and E: male-female pairs.

two or more occasions. Another explanation is that the figures were fastened to the post. When the posts were replaced during rebuilding of the house, the figures were removed and allowed to fall down into the hole created by the post removal. One of these explanations or a combination of both may be the explanation for the distribution of figures in other parts of the house. Besides the post in north-west, posts at the corners of the eastern gable and some posts just east of the entrance in the north-west could have been deliberately chosen for the purpose of deposition or the posts to which figures were fastened.

Concerning different motifs on the figures and their distribution, there are few exceptions to the distribution picture. The number of figures classified as females (Watt, this volume) is smaller than the males, and their distribution merely accentuates that of the total number.

The number of figures depicting male-female pairs is small. However, the distribution differs as two of the total of four are found in the filling of the hole for the south-eastern roof-supporting post (Fig. 16:E).

Regarding figures made from the same dies, the examples presented by Watt in this volume, such as male (Watt, this volume: Fig. 7) (Fig. 16:B), and female motifs (Watt, this volume: Fig. 22) (Fig. 16:D), all have a noticeable concentration in the post-hole in the north-west. Just one male die-group (Watt, this volume: Fig. 11) shows a distribution in contrast to the others as it is spread throughout the house (Fig. 16:C).

Glass vessels

A glass bowl, presented in a separate article (Stjernquist b, this volume), was found to the

south of a fireplace below the floor of house 12. Besides this a number of sherds of bowls and beaker were found. At least four sherds belong to a beaker presented in a special article (Stjernquist a, this volume). In addition there are a number of glass sherds, most of them in a very fragmentary state. Judging by the shape, colour and decoration the material originates from a total of about 10 vessels.

The sherds are found in all parts of the house, located in the filling of roof-supporting posts as well as the wall trenches. Finds were made in floor levels. The distribution of sherds from the same beaker indicates a considerable spread (Stjernquist a, this volume: Fig. 1). Despite that, a certain concentration can be recognized in the south-eastern part of the house (Fig. 17).

Depositions below house floors

Alongside other finds considered to be of ritual or ceremonial importance, the beaker and the grass bowl (Hårdh, this volume; Stjernquist b, this volume), were intentionally deposited. The deposition was made below the floor of house 12 (Fig. 17), regarded as the second youngest in the sequence. That the floor level above the deposition has been smoothed is proof that the pit for the deposition was not dug from a higher level. Such a deposition of some exceptional objects might be regarded as the final activity when abandoning a house with a specific function – a kind of epilogue offering. However, there was yet one more example of the house sequence. Interpreting the deposition as caused by external danger can hardly be considered convincing.

The deposition might be linked to the role or perception of the objects having become obsolete or considerably changed. However, they were still regarded as objects of special

value. In order to avoid being contaminated by mixture with other artefacts of a more secular character, they were removed from the physical reality and simultaneously rooted to the mental construction by being deposited within the house. It is thus reasonable to comprehend the deposition in connection with the abandoning of house 12 and the erection of house 2.

The vessel found below the floor of house 19 was probably intact when deposited. It was empty but might have served as a kind of dedicatory offering. The vessel has a rounded belly, short and straight neck and a somewhat thickened and faceted rim (Fig. 11). These elements date the vessel to an early part of the Roman Iron Age (Vifot 1936:Fig. 15; Liversage 1980:87 pp.).

Gold objects and raw material of gold

A number of small artefacts of gold were found. They include objects such as a pendant (Fig. 18:A), a socket (Fig. 18:B) and a capsule filled with granulated decoration (Fig. 18:C).

The loop of the pendant has a shape similar to those found on bracteates. Similar pendants from Gotland have been dated to the seventh century (Nerman 1969–75: Taf. 115:1010, Taf. 180:1489–1492).

There is a small peg on the bottom of the capsule indicating that it was fastened to a larger object of high quality. Similarities can be seen to small separate decorations in between the torsos on the collars from the Migration Period, as shown by the find from Möre (Holmqvist 1980).

Fragments of objects made of foil of different thickness are included in the gold find category (Fig. 18:G–J), along with finds of raw gold such as twisted thread (Fig. 18:

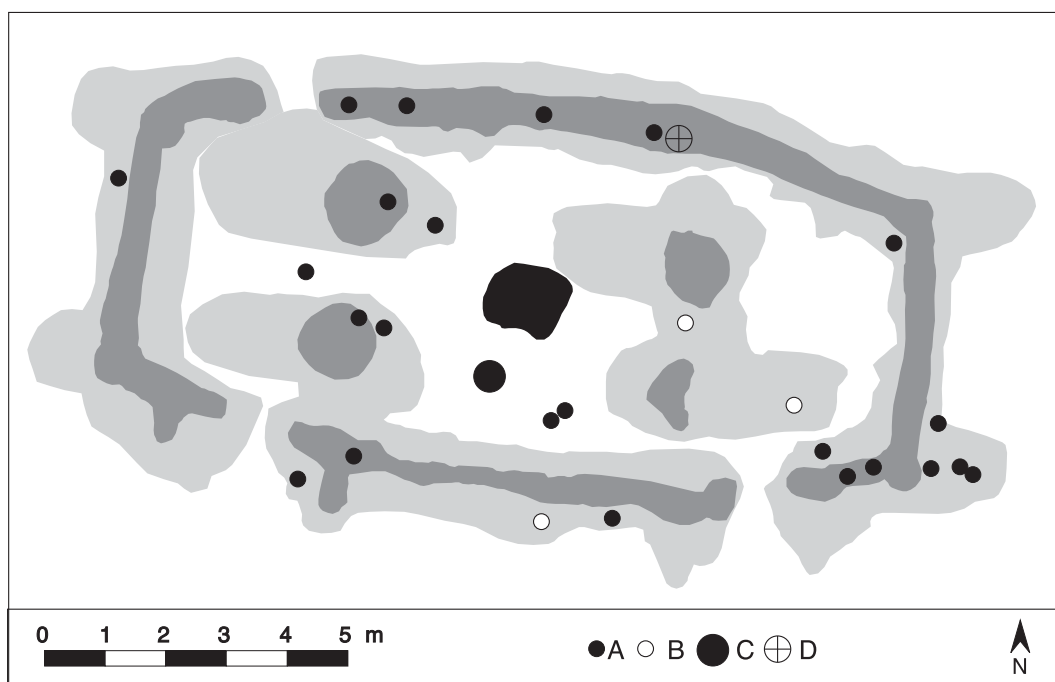

Fig. 17. The distribution of glass sherds (A), sherds from the same beaker (B) and the position of the deposited glass bowl (C). The position of a concentration of iron nails is also recorded (D).

E-F) and fragments of small bars (Fig. 18: D). Among the foil fragments, long and narrow sheets might be waste from the cutting of foil figures. In a few cases the sheets have a Y-shaped end. These can possibly be regarded as very stylized figure similar to the depictions of humans in wood from the Iron Age (Capelle 1995) (Fig. 18:H-I). In one case a strip of thicker foil exhibits traces of decoration imprinted on one side, with similarities to the kind of ornamentation common on bracteates (Fig. 18:K).

That the gold-foil strips are not only waste from figure manufacture is manifested by their distribution. The majority are found in the filling of the same post-holes and close to the east gable, like most of the foil figures (Fig. 19). The strips might thereby be regarded as some kind of substitute for figures. The same distribution also applies to the fragments of

gold bars. That manufacture of gold objects was performed close to the house is proved by fragments of crucibles with remains of gold grains found just south of the house.

Ring handles

Besides gold objects, other finds were made in the filling for the north-western roof-supporting post. These include a door ring handle made of iron. The ring has a diameter of 147 mm and is fashioned with four forged knobs located regularly around the ring. (Ödman 2003) (Fig. 20:A). A staple was fixed to the ring so that the ring easily could run through the eye of the staple.

Yet another iron ring handle was found at Uppåkra during metal detector survey. This has a diameter of 23 cm and has four knobs attached to the ring (Fig. 20:B). The staple

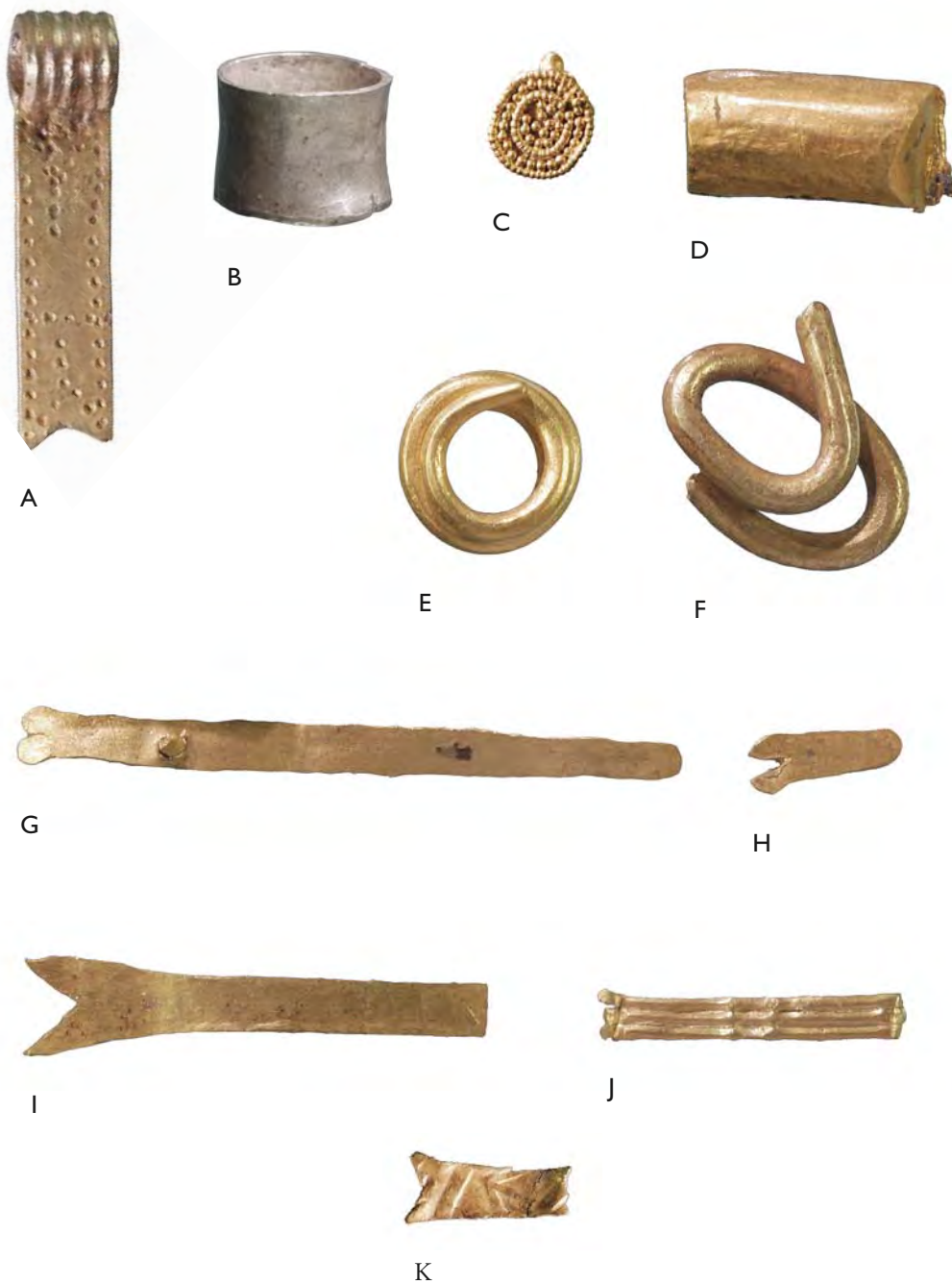

Fig. 18. Gold objects from the house sequense. A: pendant (fnr 6411), B: socket (fnr 2503), C: capsule filled with granulated decoration (fnr 6663), D: part of a gold bar (fnr 3429), E–F: parts of gold thread (fnr 2980 and 3455), G–J: gold foil sheets (fnr 200, 201, 7282 and 6413) , and K: fragment of a gold foil object with decoration (fnr 867). Scale 3:1. Photo by Bengt Almgren.

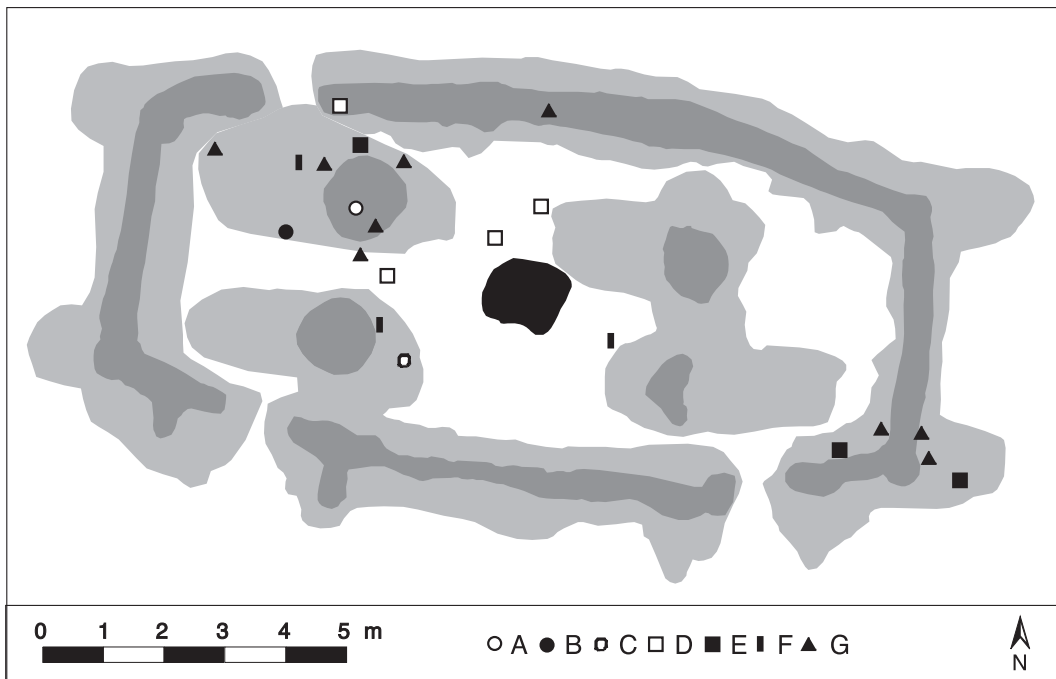

Fig. 19. The distribution of the gold objects. A: pendant, B: capsule, C: socket, D: Y-shaped foils, E: bar, F: wire and G: gold-foil pieces.

is also preserved. It has been interpreted as a handle for a door to the Romanesque predecessor of the present church.

Knobs are common on the ring handles of Romanesque doors but they are usually no more than three, symbolizing the Holy Trinity, and they are placed close together. The regularly located knobs are suggested to represent a pre-Christian symbolism, such as four gods (Ödman 2003:95)

The ring handle from the house is equal in size to the church door handles of later date (Karlsson 1988). The detector find is the largest example in southern Sweden. One important aspect is that it was found in the topsoil just about ten metres from the house in question.

It was natural to regard the large ring handle as a later intrusion in the prehistoric settlement as long as no other prehistoric ring

handles were found. However, the similarities between the two ring handles, the differences from later ring handles and their close location are indications that not only the post-hole find but also the topsoil find belonged to the house. One must be aware that finds in the uppermost part of the post-hole fillings might have been removed by ploughing and spread within some distance of the original location. Fragments of the same object found by metal detector surveys and by excavation in other parts of the settlement show similar distributions (Paulsson 1999:48).

One interesting feature is that the shape of the staple on the ring handle from the post-hole filling indicates a door thickness of about 65 mm. This can be compared to the thickness of Romanesque church doors that varies between 40 and 60 mm (Ödman 2003: 94). The door to which the ring handle was



Fig. 20. Ring handles. A: ring handle found in the north-western post hole and B: ring handle found in the topsoil about ten metres from the house sequence. Scale 1:2.

attached was thicker than any known medieval church door from Scania!

The door handle is a symbolically charged object. The ring as such was a sign of power and wealth as well as a symbol of gods (Vierck

1981:78). There might be a mixture of traditions, for example, in the use of torques as well as influences from the Roman Empire. Neck rings appear on wooden statues considered to depict gods (Capelle 1995:45 pp.)

as well as representations of figures from the aristocracy or from mythology (Watt, this volume). Rings with knobs are depicted on bracteates, some held by humans (Vierck 1981: Abb. 7. 1a and Taf. 2.1.1). The holding of rings indicates a function beyond that of a decorative attribute for nobles. Such gestures may hint at a relation between earthly and supernatural forces, as when people swore oaths by holding a ring. Even if humans and objects in some instances might be depicted in different sizes on bracteates, the sizes of the rings and humans coincide with the ring handles in question. The oath ring is an attribute connected with the god Ull (Näsström 2001: 127). The ring is thereby of political, religious and legal importance.

Ring handles of church doors were used when swearing oaths (Grimm 1881). A written source from Iceland mentions that ring handles were transferred from the old pagan main building to the church (Rafnsson 1983:3).

Nails

Nails are a category of finds that should not provoke much interest in a find situation such as a house. The structure was probably built without much support of nails, but nails might have been used indoors for wooden objects of different kinds. The reason for treating the distribution of nails among the category of finds is the noticeable concentration of nails that was recognized at the middle part of the northern wall trench. A total of 19 nails were found within a small area in both vertical and horizontal terms (Fig. 17). The number of nails is somewhat uncertain due to corrosion. Some of the nails were deformed from being used. The position of the nails denotes an intentional deposition in one of the small pits formed by the removal of the posts

of the wall belonging to house 2 – the final stage of the house sequence.

Concerning the deposition of nails, one can refer to statements about *reginnaglar*, i.e. the nails of the gods, which were hammered into the high-seat pillars (Simek 1984:262). Thus the location of nails might indicate the position of the high-seat close to the northern wall, as also mentioned in Norse written sources (Ström 1985:93; Bertell 2003:124).

Special structures of the house

In evaluating the arrangements and functions of the house, certain elements related to the house sequences will be examined.

Roof-supporting posts and corner posts

Large roof-supporting posts inside the house and posts in each corner are parts of the structure that attract interest. As described in the section on house 2, the roof-supporting posts were placed in holes with a depth of at least 1.7 m and, judging by the stone lining, the posts had a diameter of about 0.7 m. The depth and the size of the posts are remarkable especially considering the size of the house.

In order to support the roof of a long and wide house, big posts and deep post-holes are necessary. However, the post-holes rarely exceed a depth of one metre. Extremely large and deep post-holes were documented at the excavation of the main building of the central farm at Tissø, western Zealand (Jørgensen 1998:234). The depth and diameter of the holes was about three metres. One has to take in consideration that the length of the house was 48 metres and just five pairs of posts supported the superstructure. This can be compared to the main building at Lejre of the same size but with eleven pairs of roof-

supporting posts (Christensen 1997:53). This might mean that the posts in the house at Tissø had to be of extraordinary dimensions in order to support even a roof of ordinary size, even more if the superstructure was larger than usual (Jørgensen 2002:231).

The best parallel to the house in Uppåkra is found in the main building of a farm at Bulbogård, the northernmost concentration of houses at the large settlement at Tissø (Jørgensen 1998:Fig. 1). All four corners of a 40-metre-long house with several pairs of roof-supporting posts end in large posts the size of the inner ones. The house is dated to about AD 600 (personal information from Lars Jørgensen, National Museum, Copenhagen).

By relating the depth of the posts to the height, the substructure can be calculated. Adding the topsoil, the last house in the sequence had post-holes with a depth of about two metres. With the addition of stone lining the posts might have reached five to six metres above the floor. Thereby the maximum height of the posts was about eight metres.

If the same relation of depth and post-length is projected on the oldest house, one obtains a somewhat smaller height at above five metres above the floor. In both cases the height is much larger than that of ordinary Iron Age houses.

Entrances

During the excavation of the house sequences a special problem was to ascertain whether three entrances identified in the last sequence – house 2 – existed in earlier houses (Fig. 3). A change in the location as well as the number of entrances would be rather easy to recognize by the diverging formation of all the wall trenches. But this was not identified.

The location and shape of three wall trenches seem to be the same during all sequences.

In most Iron Age houses the main entrance is located in the middle of the house, sometimes combined with other entrances. The house at Uppåkra differs from ordinary structures in the location of the entrances. As in most houses, there are opposite entrances to the north and the south but they are located in the western part of the house. Judging by the structural details related to the entrances, the south-western one seems to be the most important, at least when viewed from the outside. Traces of solid posts mark a small vestibule or a projecting structure protecting the door or making people approaching the house more aware of this entrance. This does not mean that the other entrances were of less importance than activities or ceremonies performed inside the house. The main concentration of gold objects and the ring handle in the area close to the entrance at the north-west accentuates the proximity to an area of the house that was considered important for its ceremonial function. It seems natural to associate the location of the ring handle with the northern entrance.

Fireplaces

A common feature throughout the house sequence is the centrally located fireplaces. The shape is round to oval with a size between 1.3 and 2.0 m. The fireplaces cover a relatively restricted area compared to the large hearths found in some main buildings during, e.g., the Early Iron Age (Björhem & Säfstad 1993:316 pp.; Larsson 2003a:Fig. 7). There is a marked discrepancy between the care invested in the house construction and the lack of interest in the arrangement of fireplaces. Judging by the spread of ash and

soot, not much effort was made to delimit the fireplaces. Several square metres around the fireplace are covered in soot. However, it should be noticed that areas affected by fire are connected to the fireplace and are not the remains of burnt houses.

In the oldest house sequence, house 19, two fireplaces located along the central axis are documented (Fig. 13). Ember pits on both sides of the fireplace are identified in house 15 (Fig. 12). This might indicate a slight change in the function of the house. Perhaps certain activities previously performed outside the house were moved inside. A number of fireplaces dating to earlier settlement are found around the structure.

In the layer of soot belonging to houses 12, 14, 15 and 19 slag, drops of molten metal, crucibles and a blast furnace nozzle have been found as important manifestations that casting with copper alloys was performed. In some house horizons, ember pits are found close to the fireplaces. Metal casting might very well be linked to these features.

Stone pavement

In the earliest house sequence, house 19, a stone pavement covered the western part of the floor as far as the first roof-supporting posts. Yet another difference was noted – the clay pavement was thicker than in other floor horizons, and made of stiffer clay. The entire floor thus differs from the rest of floor sequences. No finds were made that might explain this difference, which is perhaps functional.

Cult house or hall

Already in the planning of the excavation, hopes were raised of finding houses with a function in the social and ritual sphere. With the

special finds and structural elements as well as the sequence of houses, interest was devoted to two kinds of features: one with a central ritual character, a cult house, and a building with a more distinct social function, a hall

Cult houses

During the Neolithic as well as the Bronze Age buildings and features of special shape have been identified as being used entirely or partly for ritual purposes (Andersen 1997; Svensson 2002; Victor 2002). The buildings from the late Bronze Age with a similar use are few and do not display a similar unity in formation (Kaliff 1997:54 pp.; Björhem & Säfvestad 1993:110 pp.).

It is not until Viking Age that buildings with a specific ritual function seem to appear. Adam of Bremen's description of the temple at Uppsala does not provide any direct clue as to its shape (1984:SKL 138). The post-holes found beneath the stone church at Uppsala have been interpreted as the remains of a rectangular temple building (Lindquist 1923), alternatively as scaffolding used for the erection of churches or remains of a royal hall (Nordahl 1996:56 pp.; Nielsen 1997).

During the excavation of a stone church at Mære, northern Trøndelag, Norway, posts from an older church were documented (Lidén 1969). Below these features a trench and posts for an even older structure were revealed. In four nearby post-holes and in the immediate neighbourhood altogether 19 gold-foil figures were found. The post-holes were interpreted as belonging to a high-seat structure within a pre-Christian building. Comparisons were made between the post-holes and the description of the temple at Uppsala, and the post-holes were thought to have had some link to the erected wooden figures of the gods (Olsen

1969:26). The same explanation has been presented concerning the four inner posts of the building at Uppåkra (Ödman 2003: 95). The inner posts of the house sequence at Uppåkra might not have supported the roof. The holes could instead have supported four wooden figures of gods.

As to the latter reference, parallels are drawn to Saxo's description of the wooden figure of a god in the 12th-century temple of Arkona, the central site of the west Slavonic tribes. Much effort was required to cut down the figure in order to remove it from the temple.

In this context we can refer to the description of the temple at Arkona. The outer wall was covered with carvings and a single entrance led into the structure where the roof was supported by four posts (Saxo 1924:49 p.).

During the excavation of a farmstead dated to the Viking Age at Borg, Östergötland, a small house measuring 7.5 x 6 m was identified (Nielsen 1997:381 pp.). The house was divided into two rooms with a passage in the centre of the house. At the end of the passage opposite the entrance, a stone foundation was documented. Two amulet rings of iron were found. A paved yard outside the entrance consisted of rounded as well as fire-cracked stones. On the paved yard 98 amulet rings and a large quantity of bones were found. The large proportion of skulls and jaws suggest that the animal bones were not ordinary food refuse but remains of sacrificial meals.

At Sanda in central Sweden a solid rectangular stone structure was found in between the Viking Age farm and its cemetery (Åqvist 1996:111). The special shape of the structure and the finds of pottery and miniature sickles constitute the basis for an interpretation of the features as a *harg*, a term for a place of ritual importance in Norse religion (Olsen 1966:75 pp.).

Some smaller buildings close to the large halls at Lejre and Tissø, Zealand (Christensen 1991; Jørgensen 2002) have been interpreted as structures of ritual importance (Jørgensen 1998:242 pp.). In three out of four stages of development of the central farm at Tissø palisade enclosures were situated in connection with the south-western part of the main building. They enclosed some small structures considered to have been used as cult houses (Jørgensen 1998:Figs. 2–5). They are all less than ten metres in length but seem to represent a variety of building styles with a square, rectangular and a more or less circular shape (Jørgensen 1998:Fig. 10). Some include centrally oriented roof-supporting posts while others are marked by posts in the wall or wall trenches. From the sixth century until the early tenth century ritual activities are supposed to have taken place within the enclosure (Jørgensen 2002:234).

A similar relation between a main building and an enclosed area has been documented at Järrestad, south-eastern Scania, dating to the eighth century (Söderberg 2003a:289 pp., 2003b:Fig. 6). However, the building is shaped like an ordinary house and not a small house of special design (Söderberg 2003b: 130 p.). The special position of the house is indicated by a number of entrances and a post-hole deposition of a hammerhead and a socket axe of iron.

Hall buildings

There is great conceptual confusion about halls. Too often houses of large size are identified without further ado as halls. However, Herschend has determined five criteria for halls (Herschend 1993:182 p.): (1) They belong to a big farm. (2) Originally they consisted of one room with a minimum of

posts. (3) They are singled out by their position on the farm. (4) The hearth was not used for cooking or for handicraft. (5) The objects found in the house are different from those found in the dwelling part of the main house on the farm. There are other elements accentuating the specific character of a hall such as entrances over and above the standard plan, a pronounced location and monumental graves in the neighbourhood.

Herschend envisages different stages of hall architecture directly related to changes of political and ritual importance. During a late part of the Roman Iron Age he identifies some embryonic halls such as house 16 at Vallhagar and house VII at Rönnerum, both on the island of Öland (Herschend 1993:184 p.). Similar early halls are found in Jutland, such as Nørre Snede and Dankirke (Fig. 21). These are rather small buildings with a maximum length of twenty metres when the main buildings of contemporary farms are thirty to forty metres in length (Hvass 1988:70).

The hall as such appears when rituals and ceremonies related to the local leaders become activities included in a wider regional community. Thus the need emerges for a building where the representatives of aristocratic groups could meet, displaying their position of power by e.g. constructing a high-seat. The location of entrances and exits in relation to the high-seat is involved in specific rules and customs. The function of openings and their location in the building are not only a matter for the power relations between the living but of utmost importance in connection with visitors from an imaginary world.

During a later part of the Iron Age, the hall was integrated into large buildings as a specific part of the house. This is well illustrated by the two large buildings at Borg, Lofoten, northern Norway, dated to the Migration Period/early

Merovingian Period and Viking Age respectively (Herschend & Mikkelsen 2003; Johansen & Munch 2003). In both a specific hall-room has been identified (Herschend & Mikkelsen 2003:Fig. 6A.19). Within the later, 83-metre-long structure the hall encompasses a room measuring 14 x 8 m – not much larger than the size of the house at Uppåkra.

The function of the hall

Even in the embryonic halls a division into a private and an official sphere is identified. These halls do not include a specific entrance room. This might mean that a special entrance procedure before the guests were allowed into the hall took place outdoors (Herschend 1998:37).

According to Herschend's criterion 5 the halls are connected to items of specific character such as gold objects and glass vessels. In the building Foundation Ia, at Helgö, central Sweden, with three pairs of roof-supporting posts, fragments of glass vessels are concentrated in the middle northern post-hole with a diagonal spread to the south-westernmost post. However, the gold-foil figures (Lamm 2004) were found close to the northern post of the central pair (Herschend 1995:Fig. 3). A considerable number of glass vessels were found during the excavation of house 6 at Dejbjerg, Jutland, dated to the fifth and sixth centuries. (Hansen 1996:224). This building can be followed during a sequence of three stages ending with destruction by fire. It was in the filling of the youngest house that the glass vessels were found. The sherds appear in the eastern part of the building with a concentration in the north-eastern post-hole (Hansen 1996:Fig. 6).

The largest collection of gold-foil figures was found at Sorte Muld with about 2,300

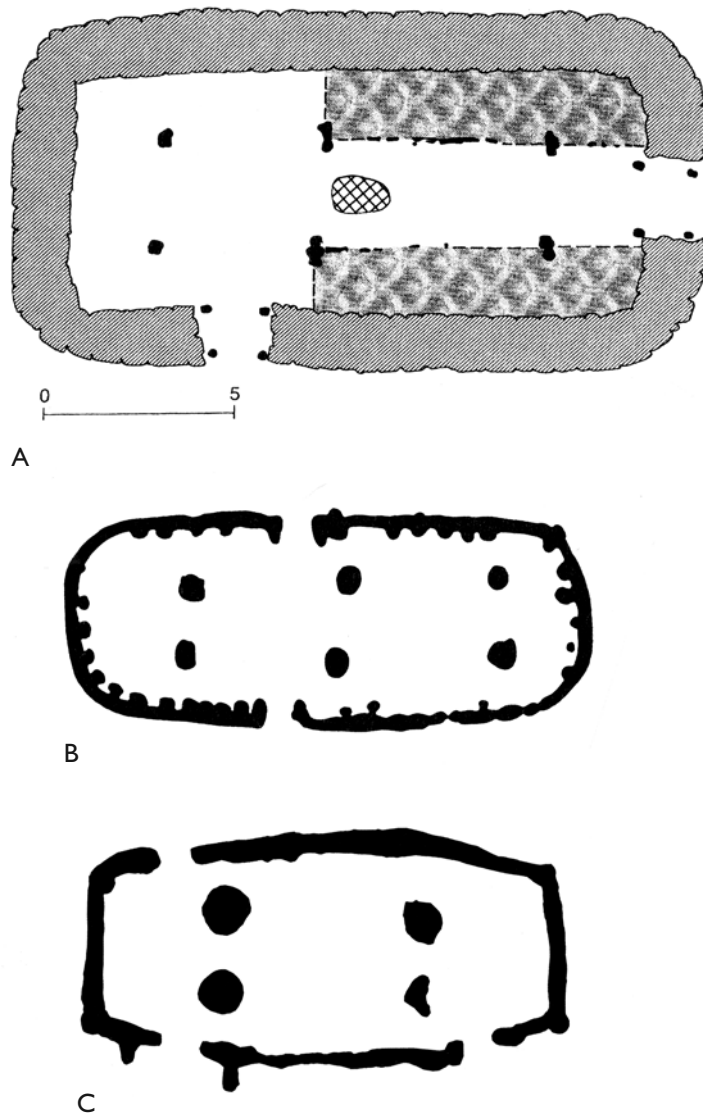

Fig. 21. Embryonic halls. A: house 16 at Vallhagar, Öland, B: house 2 at Dankirke, Jutland and C: Uppåkra. A–B from Herschend 1993.

finds (Watt 1991:94 pp.). This collection could not be linked to any particular feature. The formerly second largest collection with 102 figures was found at the trade centre of Lundeborg on the eastern coast of Funen (Thomsen *et al.* 1993:87 pp.). With one exception, all were found within a very limited area in the central part of the site. About

thirty figures were recognized within an area equal to the size of a fist.

Excavation of the Slöinge site in southern Halland revealed two closely related buildings – Houses II and III – of about the same size – 30 x 8.5 m (Lundqvist 1996:13 pp., 2003:62 pp.). In Houses II and III gold-foil figures as well as fragment of glass vessels and

raw garnets were found within a small number of post-holes in the central part of the structure. Long and narrow gold-foil sheets regarded as waste from the manufacture of gold-foil figures were found (Lundqvist 2000:52). Judging by the find distribution, objects of specific status were deposited at the north-western post of a centrally located room with a multifunctional use. Of a total 56 figures, most were found in the filling of post-holes or close by. In House III a cache of 35 gold-foil figures was found in the upper part of the north-western post-hole. The post-holes are not large, with a depth of about 0.6 m (Lundqvist 1996:Fig. 8). Glass sherds as well as glass beads give a dating to the seventh century (Lundqvist 2000:47). Dendrochronological analyses of posts provide a date to the interval 710–720 for a building phase of House III. This might mean that the earliest phase is initiated during the seventh century but the sequence of houses continues until the first half of the ninth century. The figures represent single humans as well as pairs, the latter being the dominant type.

At Toftegård on Zealand a gold-foil figure was found in a post-hole of a building with a length of about forty metres (Törnberg 1998:227). Six additional figures were found in the topsoil. Six of the figures show pairs.

In the hall-room at Borg, northern Norway, the high-status finds including gold-foil figures and sherds of glass beakers were found in the north-eastern post-hole (Holand 2003; Munch 2003:Fig. 9H.13).

Finds such as those presented above are regarded as markers of the location of the high-seat. If one look into the distribution it is not possible to find a regular location of the high-seat. In the house at Uppåkra the high-seat must have been located close to the

northern wall not far from the north-western post (Fig. 23).

A high timbered building

When scrutinizing the house at Uppåkra details of the construction are most evident in some parts but very uncertain in others. The construction of the later houses meant that most details of older ones were destroyed.

That the house had solid corner posts can only be explained in terms of a need to strengthen the structure. Such a need would not have existed if the house had been constructed as an ordinary building measuring 13 x 6.5 m. However, if the house had extremely high walls and roof, the corner posts would have been a detail of the utmost importance. That the long sides of house were somewhat bowed facilitated the erection of a high building (Herschend 1998:43) (Fig. 22).

In the poem *Beowulf* (1995) the hall of the Danish king Hrothgar has a central role. It described mentioned as one of the largest of its kind (l. 78), adorned with horns (l. 704). However, it is frequently described as high (e.g., ll. 82, 114, 713) and its inner height was impressive (l. 983). The door was equipped with wrought iron bands (l. 721). It is also mentioned that king Hrothgar's high hall was held together outdoors and indoors by iron bands (Herschend 1997:50). This was probably necessary in order to stabilize a tall structure. Perhaps the chain mentioned by Adam of Bremen (1984:252) in his description of the temple at Uppsala had the same purpose. At Uppåkra the architectural solution to secure a tall building was not iron bands but solid posts in all corners to which the walls as well as the roof could be fixed.

Other poems or sagas, such as *Völuspá* and *Grimnismál*, present tall wooden buildings

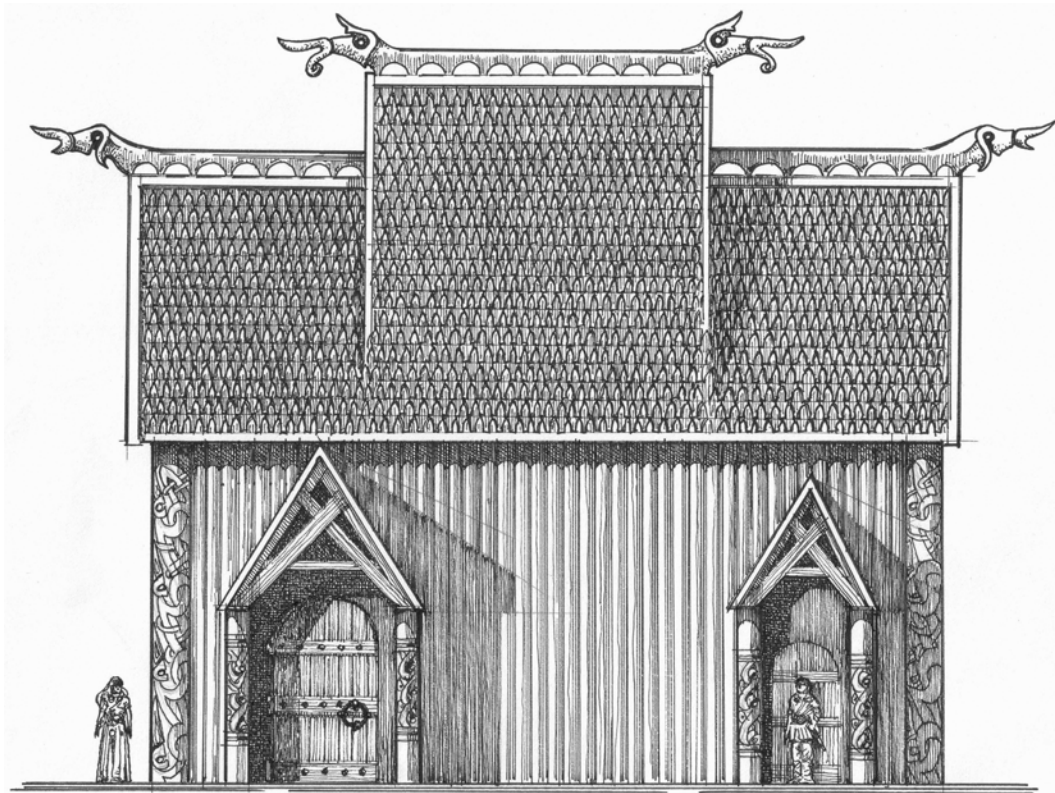

Fig. 22. A tentative reconstruction of house 2 at Uppåkra. Drawing by Loïc Lecareux.

referred to as *harg* (Olsen 1966:106). Olsen sees the development of the *harg* from an elevated platform to an elevated building. However, the building does not need to be of any considerable size as it was used for protecting cultic images and offerings to the gods.

Based upon the plan of the oldest church at Urnæs, Norway, Olsen identifies a structure diverging from later two-aisled churches and instead regards it as a tradition continuing from the tall *harg* of the pre-Christian age (Olsen 1966:213 pp.). This original church included solid posts in all four corners and four inner roof-supporting posts. However, the lack of comparisons among the large number of late prehistoric houses caused Olsen to doubt his own model of the *harg* structure (Olsen 1985:127). Whether the early

Norwegian stave churches originate from a regional, prehistoric building tradition or are a structure of continental origin, based on the specific requirements and ideal of Christianity, is a question studied by several scholars (Christie 1970; Hauglid 1979; Qvale 1993; Anker 1997:184 pp.; Jensenus 2001:105 pp.). The arguments seem to be in favour of the latter interpretation mainly because of the lack of prehistoric parallels from Scandinavia.

Whether the house at Uppåkra should be regarded as a cult house or a hall might be a question of words and their meaning. From a holistic perspective it is rather a question of whether there are any real differences between these two hypothetical structures. As an example of the mixture of these concepts, one can comment on building I at Helgö,

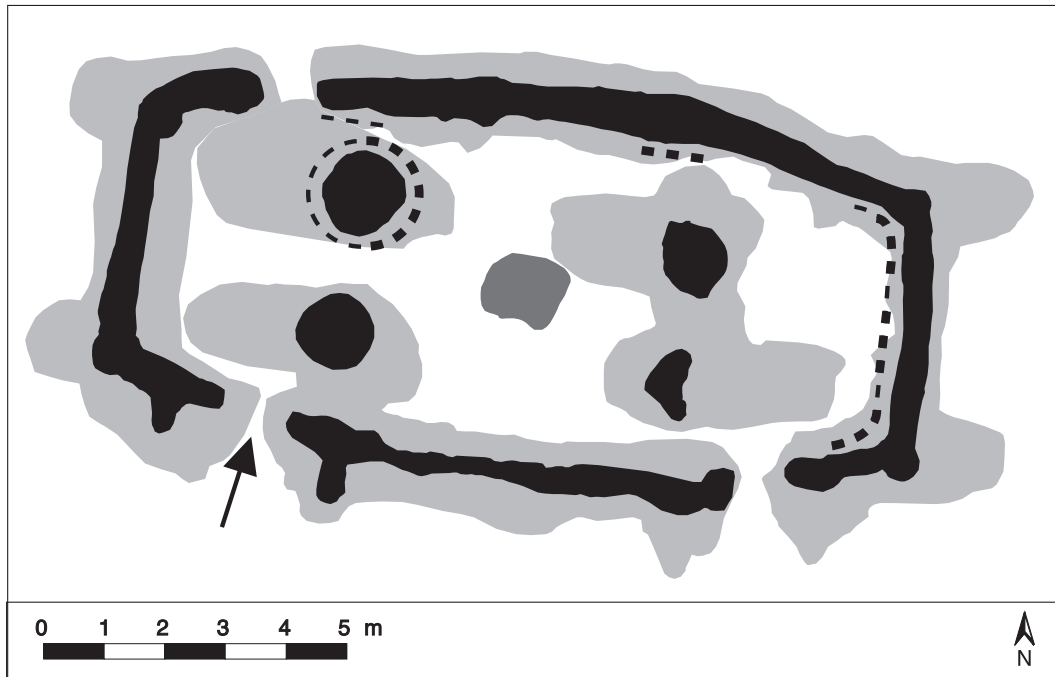

Fig. 23. Areas of ritual use within the house marked by dashed lines and arrow.

central Sweden, which has been regarded as a hall. With the finds of specific Christian connections, the same house has been interpreted as filling a new function as a church in an incipient mission (Holmqvist 1980:60; Hyenstrand 1988:70 p.). The hall which was suited for pre-Christian ceremonies and rituals could be transformed into a church without any major architectural changes.

Large timbered buildings and their duration

Regardless of whether or not a connection exists between the house at Uppåkra and later wooden churches, the latter can be used in order to study constructional aspects. The stave churches in Lund are somewhat later but they might be linked to a building tradition, showing at least some similarities.

The stave church in Drotten block has a basic structure with some similarities to the house at Uppåkra, although the former was twice as large. An important advantage is that most of the wood below the former surface was preserved. The inner posts had a diameter of 0.5–0.6 m (Mårtensson 1976:117 pp.). The wall trenches for the church at Drotten had a width of 0.9–1.0 m and a depth of 0.7–0.8 m. The split trunks had an average width of about 0.5 m. A study of the posts shows that some inner posts as well as staves in the wall were replaced. An interesting observation is that struts were used so that posts could be replaced without affecting the roof structure. The height of the wall staves is calculated at 3–3.5 m above the surface. The posts and the staves were cut from oaks growing in an open landscape where a rather short trunk and a wide crown made it difficult to obtain long and straight poles. The posts had a height of about 5 m.

Concerning the time of use for the different house sequences at Uppåkra, the church at Drotten provides some important information. It was erected in 1051 and was demolished before 1100 (Mårtensson 1976:123 p.). Despite the short time of use, posts as well as staves were replaced at least once about 25 years after construction. Posts cut about fifty years before the building work were also used (Bartholin 1976:158). The time of use for one of the other wooden churches in Lund, St Stephen's, is estimated at about sixty years (Mårtensson 1981:25).

When the churches were abandoned after a very short time of use, it was not just because of the need for thorough renovation caused by the decaying of wood. The most important reason might be that the church was replaced by a new one in stone or because it had to be moved to a new site because of a redistribution of land.

The finds from different layers in the sequence of houses at Uppåkra provide a variety of objects with a dating span from the late part of the Pre-Roman Iron Age to the early Viking Age. Based on pottery, the earliest representative of the house sequence, house 19, can be dated from the Early Roman Iron Age to the Migration Age. A radiocarbon dating corroborated an early dating with the value 2080 ± 45 BP (Ua-22073). With an interval of two sigma, the calibrated date is 210 BC–AD 30. At least four house levels might be dated to the Late Roman Iron Age and the Migration Period. Three house levels belong to the interval Late Migration Period–Viking Age. A radiocarbon dating from a fireplace (group 81, Fig. 4) probably linked to house 14, the earliest of the later sequence, provided a dating of 1575 ± 45 BP (Ua-22072) and the calibrated interval of AD 400–600 which is regarded as somewhat late. More datings are needed to es-

tablish the house sequences securely. However, the early dating of house 19 is remarkable.

Based upon the dating of finds, five houses were erected within a period of about 400 years, while the remaining building covered a time span of about 300 years. This indicates a somewhat shorter life for the earlier buildings, with an average of 80 years compared to about 100 years for the later house levels. This observation is in good agreement with the formation of the occupation layers of the site, with a higher accumulation rate during the Early Iron Age and much slower during the Late Iron Age (Larsson 2003b:20). The rather short time of existence for the different houses could hardly be caused by natural decomposition of the building material. The need for a replacement must have been a social one.

The neighbourhood

The house at Uppåkra was situated on the edge of a plateau (Fig. 24) within the central part of the site covering about 40 hectares (Larsson 2002: Figs 2 and 3). About a hundred metres to the north the highest part of the site was located. This part is partially excavated and presents remains of a long settlement continuity comprising houses from the Roman Iron Age to the Viking Age (Lenntorp & Piltz Williams 2002). Finds and features allowed the identification of activities connected to an ordinary settlement.

Finds made during metal detector survey within the central part of the site clearly show a mixture of objects, which means that no clear division into settlements from different parts of the Iron Age can be made. However, within certain areas it is possible to assign a majority of finds to a specific period. One such area is the location of the house where a considerable number of objects are dated

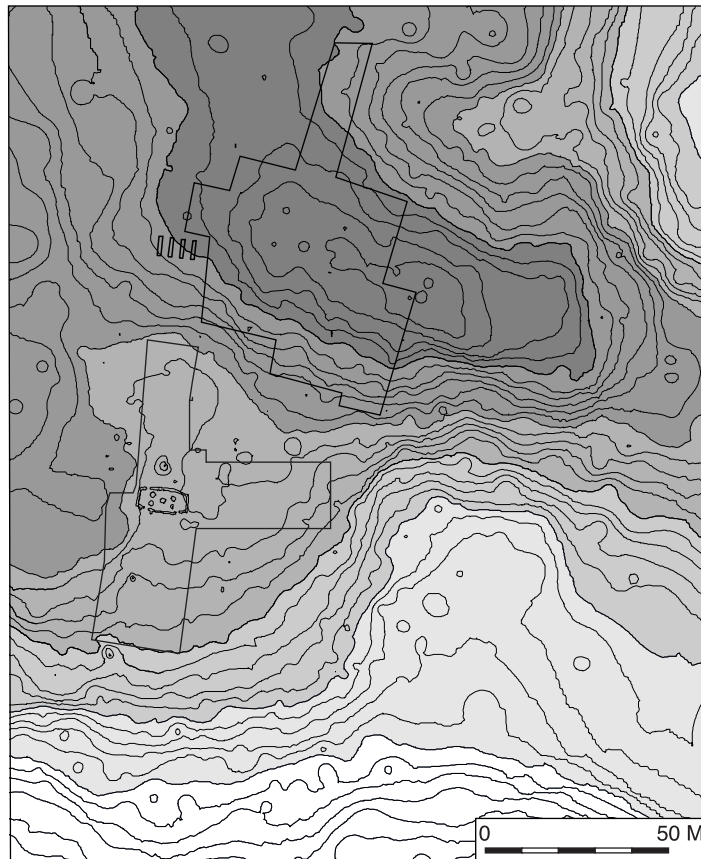

Fig. 24. The topographic situation in the neighbourhood of the house sequence. The isarithmic division is 0.1 m.

to the Roman Iron Age and the Migration Period (Calitta 2000).

The area around the house is characterized by many special features, all together forming a special milieu. About a hundred metres to the west of the house an old road connecting the western part of Scania runs through the site at a distance of about hundred metres west of the house (Fig. 2). This road is dated to the Iron Age or even earlier (Eriksson 2001; Samuelsson 2001).

To the west and north of the cult house, there have been at least four burial mounds, two of which are still visible (Lenntorp & Piltz-Williams 2002:46) (Fig. 2). According to a written source from the 18th century, an-

other mound was located within the churchyard (Larsson 1998:106). Mounds of this kind were often constructed during the Early Bronze Age, but they might be of Iron Age origin as well. One mound has been partly excavated, and the occupation layers dated to Iron Age close to the mound were very thin or non-existent (Lindell 2001:4 pp.). These mounds were obviously respected by the Iron Age citizens of Uppåkra and it is most likely that they played an important role in the social and religious life of the community. Close to the mounds a couple of graves have been found dating to the Roman Iron Age and the Early Middle Ages (Vifot 1936; Stjernquist 1996; Anglert & Jansson 2001).

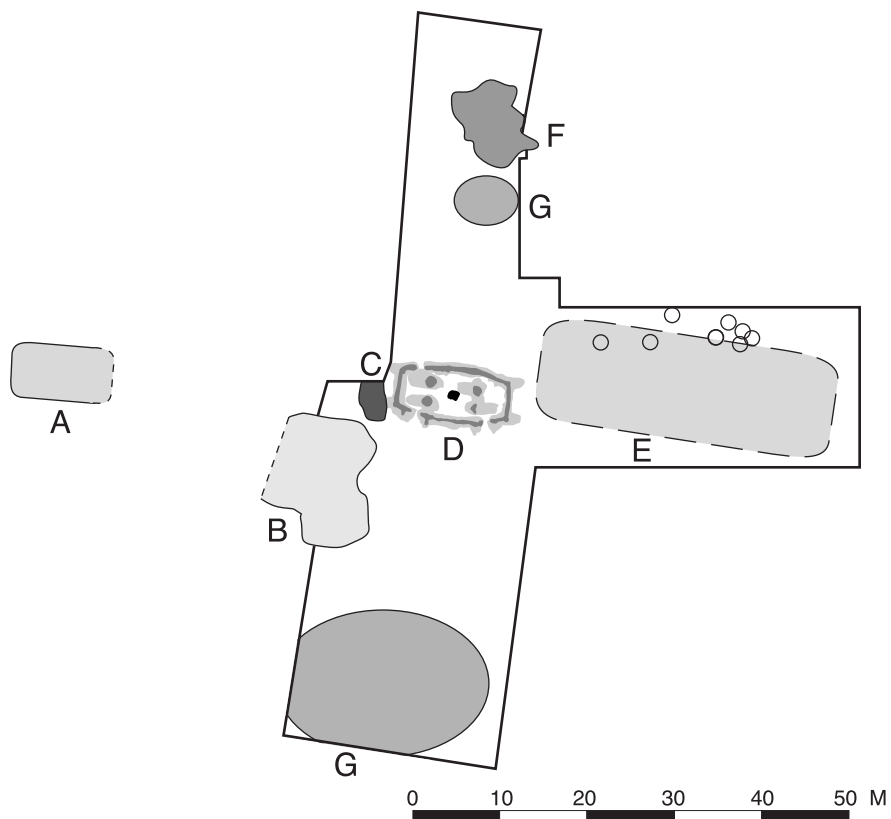

Fig. 25. Features in the neighbourhood of the house sequence. A: house partly excavated in 1934, B: stone paving, C: concentration of fire-cracked stones and bones, D: the house sequence, E: area with several long-houses, F: concentrations of weapons and G: sparse distribution of weapons. The circles mark pits with intact and fragmentary quern stones.

About 40 m to the west of the house in question another house was excavated in 1934, with additional trenches dug in 1999 (Vifot 1936; Lindell 2001:8) (Fig. 25:A). The walls are built of wattle-and-daub and there is a stone pavement outside, of which a remarkable number are quern stones. From the house there is a large accumulation of burnt grain (Regnell 2001:114 pp.). This house is dated to around AD 400 (Vifot 1936) and it was destroyed by fire without being rebuilt. Between the house in question and the house from the transition from Roman Iron Age to

the Migration Period there was one 40 square metre large pavement (Fig. 25:B) A half a dozen millstone fragments were used in the pavement. A Thor's hammer amulet made of iron was found in the pavement during the excavation in 1999 (Lindell 1999).

A small number of finds suggest that the paved layer might be dated to the Vendel Period or the Viking Age (Lindell 1999:25).

A special feature was located just west of the house gable (Fig. 25:C). It has a length of at least 5 m and contained fire-cracked stones and animal bones.

To the north as well as to the south of the house, depositions of weapons were made (Helgesson, this volume) (Fig. 25:F and G). Despite a shallow depression in the surface to the north of the sequences of houses, it is obvious that the weapons were not deposited in a wet environment or even a moistly soil. During the excavation in the early summer of 2004 when the trench to the north was widened, it became quite noticeable that the concentration of weapons (Fig. 25:F) was deposited on small rise formed by a scattered layer of stones.

Even if the best parallels for deposition of weapons are found among depositions in bogs such as the Danish sites Illerup and Vimose (Ilkjær 1990) there are obvious differences. The depositions in Uppåkra include a more limited variation of weapons than in the bogs. That references are made to bog finds is due to the excellent preservation in bogs of metals as well as artefacts of organic material. We lack similar depositions on dry ground. It might be a historic reality that this kind of deposition was not arranged on land. However, if similar depositions were made on dry ground we would have troubles in identification due to poor preservation.

Depositions of spearheads are present on dry ground in southern Scandinavia (Nerman 1942, Hagberg 1967:70 pp.; Henriksen 1991:11 p.; Nicklasson 1997:236 p.). Among these, finds dated to the Early and Late Iron Age are present.

At the same time as the house was identified, the topsoil was removed from an area to the east of the house. At a distance of less than five metres a mosaic of different features such as fireplaces, fragments of clay floors, pits and post-holes was identified immediately below the topsoil, covering an area of 35 x 15 m (Fig. 25:E). A small excavation in the

easternmost part of this area identified several post-holes from at least two houses, but the number might be as high as five.

Of special interest is a row of pits with a fill of quern stones, both fragments and intact examples (Fig. 25). The pits are shallow and despite the horizontal position of most features the shape of the pits shows that they were not used as stone lining. A number of intact quern stones have also been found within the area to the south of the house as well as within the features connected to the burnt house to the west.

The large number of quern stones marks an intentional use. Quern stones had a symbolic meaning, such as the mill Grotti, grinding gold as well as peace and good fortune, war and disaster (Hultkrantz 1991:41; Zachrisson 2004:361 pp.). The quern stone was a symbol of a world-pillar.

The location of the house at the edge of the plateau might have been deliberately intended to provide a monumental setting. To the south a gentle slope ends in an area that was not a true wetland but too wet during the winter for permanent settlement; it is marked by the absence of occupation layers. About two hundred metres further to the south the surface rises again with another concentration of occupation layers as well as numerous detector finds (Larsson 2002:Fig. 8). The house had a remarkable position, visible over a large area from the south-west to the south-east.

Ritual and social continuity

The continuity of rituals from prehistory to the early medieval period has been intensively discussed, not least based upon the remains of buildings (Olsen 1966; Lidén 1969; André 2002). No such direct continuity is evident at Uppåkra. The building remains identified

preceding the last example of the house sequence, house 2, differ from the earlier plan, which means that less consideration was taken of the previous use of the area.

No Viking Age finds of ritual or symbolic importance have been made within the immediate neighbourhood of the house, either during excavation or by metal detector survey.

An early medieval church is indicated by graves partly destroyed by the digging of a foundation for the Romanesque stone church about two hundred metres to the north of the house (Anglert & Jansson 2001). Buildings from the Viking Age used for ritual and ceremonial activities are still missing. Direct continuity is not evident but a continuity of buildings of ritual and ceremonial importance within the large site is most plausible.

The importance of the hall as a centre for marking political dominance as well as a focus for political upheavals has been emphasized (Herschend 1995, 2003; Nordberg 2003). By its existence it manifested the leading role of an individual or a family. The rituals performed within the hall functioned as activities of reproduction in order to guarantee the existing social order. However, changes within the hierarchy could result in the destruction of an old hall by fire. New leaders built new halls and manifested changes, but within the basic framework of the social hierarchy (Herschend 2003).

The high timbered house and its finds might in its total constitute a kenning for the hall of Odin at Valhalla and the concentration of the cosmology of Norse mythology. Valhalla is thought to be as high as three high-seats were located one above the other (*Snorres Edda*:32). In the hall spears were used as rafters and shield covered the entire hall (Nordberg 2003:199 pp.). The mixture of spearheads of different age in the deposi-

tions just outside the hall in Uppåkra indicated that spears were stored for generations, most suitably in the hall. Parts of shields are the second most numerous group of finds in the depositions and might also originate from the hall.

Most of the gold-foil figures are found right beside heavy roof-supporting posts. The find situation might suggest, as at Uppåkra, that the figures were fastened to posts. There is nothing on the figures to show how they could have been attached to the pole, but the slight weight in relation to the size of the surface would have made it easy to use a fixative such as honey or fat.

Trees, with the ash Yggdrasil as the centre of the earth, are important in Norse mythology and the cosmological landscape (Andrén 2004). In Snorri's *Edda* the tree Glasir is located just outside Valhalla (1997:140). This tree is characterized by its golden leaves or needles and is regarded as the most beautiful tree among the Æsir and Vanir. The leaves of Glasir are a kenning for gold (*Snorres Edda* 1997:162).

The posts of the house might represent the trees in the neighbourhood. A special post covered with gold-foil figures could have been interpreted as a mental correspondence to Glasir at Valhalla.

Just as at other sites, the house at Uppåkra was rebuilt several times. However, only minor changes to the original plan were made and no traces of destruction by fire have been proved.

The Uppåkra site differs from most south Scandinavian central places by its considerable continuity from the late part of the Pre-Roman Iron Age until the late Viking Age. Some sites might have had the same time of existence and a similar or even more important position than Uppåkra for some centuries. But none has comparable finds and

features manifesting such an important role as Uppåkra as a political, economic and ritual centre during most of the Iron Age.

Tissø and Lejre have small houses probably used for ritual purposes and larger buildings more for ceremonial use. The monumental buildings at Tissø comprised an eastern part rich in finds and a western part with much fewer artefacts. Because of this difference the eastern part has been interpreted as the public area and the western part as the private living area. Other houses on the farm were used for different activities closely linked to the public manifestation. The farm did not function as an independent production unit and few finds were made inside the enclosure. Numerous finds outside the enclosure attest to a variety of handicrafts. The waste represented seasonal activities connected to a market place, as evidenced by weights and hacksilver. Therefore, the main farm at Tissø is considered to have been used seasonally (Jørgensen 2002:238). It was one of the large farms owned by the king. Lejre, on the other hand, is interpreted as a residential site because of the mounds and other burial monuments that indicate the permanent use of the site. In this social system the mounds and the thick occupation layers at Uppåkra are elements that showing the duration and importance of the site, which should be regarded as a permanent residence.

The sequence of houses at Uppåkra might mirror the long and seemingly unchanged continuity of importance that is proved for the site. Unchanged by the dramatic events of centuries, Uppåkra stands out as a strikingly unaffected central place. The initial building from the Roman Iron Age was rebuilt on at least seven occasions but not burnt down. Through the centuries the building became a core representative of a solidly established so-

cial order. The shape of the building went out of fashion and might even have been viewed as ancient, almost atavistic. The small inner area was quite sufficient as a place for meeting within the social order of the Early Iron Age. It was suitable for a group of about twenty persons. However, during the Late Iron Age the limited size might have been an obstacle when the representatives of the power sphere of interest to the leaders of the Uppåkra site were assembled. As is evident, e.g. from Borg in northern Norway, the area for ceremonies and rituals might not have been much larger during the Late Iron Age than during the Early Iron Age. However, it was then a room directly connected to a larger building where many more persons could be housed and fed. Despite the logistic problems, the house at Uppåkra continued to be used and protected. Just like the site *per se* (Larsson 2003b:20) the house became a testimony to the long and stable continuity of a secular and sacred order for at least half a millennium. During the early Viking Age it had irrevocably become too old-fashioned to function as a building of central importance for the leaders at Uppåkra. Probably some of the elements connected to the building no longer functioned in a changing symbolic system. This might already be indicated by the deposition of the glass bowl and the bronze beaker when house 12 was replaced. They were of a considerable age when deposited, used by generations, but had finally lost their importance as attributes in ceremonies. According to the observations made during the excavation, the last house in the sequence, house 2, was dismantled in an orderly manner. But the area was not kept unused for any length of time. Another building was erected.

The question is how the proceeding and the succeeding building of the house should

be regarded. The forerunner – house 20 – is built without wall trenches and a certain divergence concerning the position of the three post-holes, most probably for roof-supporting poles, and the orientation of the building. However, the relation of the post-holes, has similarities to those of the house sequences. The shape and the size of the holes and the colouring of the post in the third hole show that the post was large and elongated. They must have been shaped by cleaving of trunks with a diameter of at least 0.9 m, a most rare dimension in house building from the Early Iron Age. House 20 might have had a special function as a dwelling for the elite within the newly established settlement.

Despite a different building technique, the latest recorded house – house 13 – is similar in orientation and most probably size to the latest house of the sequence – house 2. The long walls and at least one gable touch the inner side of the wall trench for house 2. It is most likely that house 13 was intentionally built on the site of the house sequence.

The similarities of the oldest house on the site as well as the latest to the sequence of houses might indicate that not only the location but also the function should be linked to the other houses in the sequence.

References

- Adam av Bremen (1984). *Historien om Hamburgstiftet och dess biskopar*. Översatt av Emanuel Svenberg. Stockholm.
- Andersen, N. H. 1997. *The Sarup Enclosures*. Jutland Archaeological Society Publications XXXIII:1.
- Andrén, A. 2002. Platsens betydelse. Norrön ritual och kultplatskontinuitet. Jennbert, K., Andrén, A. & Raudvere, C. (eds.), *Plats och praxis. Studier av nordisk förkristen ritual*, 299–342. Vågar till Midgård 2.
- 2004. I skuggan av Yggdrasil. Trädet mellan idé och realitet i nordisk tradition. Andrén, A., Jennbert, K. & Raudvere, C. (eds.), *Ordning och kaos. Studier av nordisk förkristen kosmologi*, 389–430. Vågar till Midgård 4.
- Anglert, M. & Jansson, P. 2001. Kyrkplatsen i Uppåkra – undersökningarna 1997–1999. Larsson, L. (ed.), *Uppåkra. Centrum i analys och rapport*, 23–40. Uppåkrastudier 4. Acta Archaeologica Lundensia, Series in 8°, No. 36.
- Anker, P. 1997. *Stavkirkene deres egenart og historie*. Oslo.
- Bartholin, T. S. 1976. Dendrokronologiske og vedanatometiske undersøgelser af træfundene. Mårtensson, A. W. (ed.), *Uppgrävt förflutet för PKbanken i Lund. En investering i arkeologi*, 145–169. Archaeologica Lundensia VII.
- Beowulf. 1995. Edited by M. Alexander. London.
- Bertell, M. 2003. *Tor och den nordiska åskan*. Föreläsningar kring världaxeln. Stockholm.
- Björhem, N. & Säfvestad, U. 1993. *Fosie IV. Bebyggelse under brons- och järnålder*. Malmöfynd 6.
- Calitta, M. 2000. *Relationen mellan ploglager och kulturlager i Uppåkra*. Seminar paper. Institute of Archaeology, University of Lund. Lund.
- Capelle, T. 1995. *Anthropomorphe Holzidole in Mittel- und Nordeuropa*. Scripta Minora 1995–1996:1.
- Christensen, T. 1991. *Lejre – syn og sagn*. Roskilde.
- 1997. Hallen i Lejre. Callmer, J. & Rosengren, E. (eds.), “... Gick Grendel att söka det höga huset...”. *Arkeologiska källor till aristokratiska miljöer i Skandinavien under yngre järnålder*, 47–54. Hallands Läns museers Skrifter 9.
- Christie, H. 1970. *Stavkirkene i bygningshistorisk sammenheng*. Fyrirlestrar. Minningarsjóðs Ásu Guðmundsdóttur Wright. Reykjavík.
- Ekhoff, E. 1916. *Svenska stavkyrkor*. Stockholm.
- Eriksson, M. 2001. En väg till Uppåkra. Larsson, L. (ed.), *Uppåkra. Centrum i analys och rapport*, 167–176. Uppåkrastudier 4. Acta Archaeologica Lundensia, Series in 8°, No. 36.
- Grimm, J. 1881. *Deutsche rechtaltertümer*. Band 1–3. Göttingen.
- Hagberg, U. E. 1967. *The Archaeology of Skedemosse*, II. Stockholm.
- Hahnloser, H. R. 1959. Urkunden zur Bedeutung des Türnings. *Festschrift für Erich Meyer zum*

- sechzigsten Geburtstag, 29. Oktober 1957. *Studien zu Werken in den Sammlungen des Museums für Kunst und Gewerbe Hamburg*. Hamburg.
- Hansen, T. D. 1996. Et jernalderhus med drikkeglas i Dejbjerg, Vestjylland. *Kuml* 1993–94: 211–237.
- Hauglid, R. 1979. Features of the origin and development of the stave churches in Norway. *Acta Archaeologica* 49 (1978), 37–60.
- Helgesson, this volume. Helgesson, B. Tributes to be Spoken of. Sacrifice and Warriors at Uppåkra.
- Henriksen, M. B. 1991. Våben mellem grave. *Skalk* 1991, nr. 6, 9–11.
- Herschend, F. 1993. The Origin of the Hall in Southern Scandinavia. *Tor* 25, 175–199.
- 1995. Hus i Helgö. *Fornvännen* 1995, no. 4, 221–228.
- 1997. *Livet i hallen*. Occasional Papers in Archaeology 14.
- 1998. *The idea of the good in Late Iron Age society*. Occasional Papers in Archaeology 15.
- 2003. Mossoffer på torran skånsk husgrund. *Artefact*. <http://wl.403.telia.com/~u40305830>.
- Herschend, F. & Mikkelsen, D. K. 2003. The Main Building at Borg. Munch, G. S., Johansen, O. S. & Roesdahl, E. (eds.), *Borg in Lofoten. A chieftain's farm in North Norway*, 41–76. Arkeologisk skriftserie 1. Bøstad.
- Holand, I. 2003. Glass vessels. Munch, G. S., Johansen, O. S. & Roesdahl, E. (eds.), 2003. *Borg in Lofoten. A chieftain's farm in North Norway*, 213–229. Arkeologisk skriftserie 1. Bøstad.
- Holmqvist, W. 1980. *Vikingar på Helgö och Birka*. Stockholm.
- Hultkrantz, Å. 1991. *Vem är vem i nordisk mytologi. Gestalter och äventyr i Eddans gudavärld*. Stockholm.
- Hvass, S. 1988. Jernalderens bebyggelse. Mortensen, P. & Rasmussen, B. M. (eds.), *Jernalderens stammesamfun*, 53–92. *Fra Stamme til Stat* I. Jysk Arkæologisk Selskabs Skrifter XXII.
- Hyenstrand, Å. 1988. Helgö, Birka and the church of St Gaubert. Lundström, A. (ed.), *Thirteen studies on Helgö*, 64–71. Statens Historiska Museum Studies 7.
- Hårdh, B. 2001. Offerplatser och samhällsstrukturen. Hårdh, B. (eds.), *Uppåkra. Centrum och sammanhang*, 71–86. Uppåkrastudier 3. Acta Archaeologica Lundensia, Series in 8°, No. 34.
- Hårdh, this volume. Hårdh, B. The Metal Beaker with Embossed Foil Bands.
- Ilkjær, J. 1990. *Illerup Ådal. 1. Die Lanzen und Speere. Textband*. Jutland Archaeological Society Publications XXV:1.
- www.Intrasis.com
- Jensenus, J. H. 2001. *Trekirkene før stavkirkene. En undersøkelse av planlegging og design av kirker før ca. år 1100*. Context avhandlingar 6. Oslo.
- Johansen, O. S. & Munch, G. S. 2003. ¹⁴C-dates. Munch, G. S., Johansen, O. S. & Roesdahl, E. (eds.), *Borg in Lofoten. A chieftain's farm in North Norway*, 33–40. Arkeologisk skriftserie 1. Bøstad.
- Jørgensen, L. 1998. En storgård fra vikingetid ved Tissø, Sjælland – en foreløbig præsentation. Larsson, L. & Hårdh, B. (eds.), *Centrala platser, centrala frågor. Samhällsstrukturen under Järnåldern*, 233–248. Uppåkrastudier 1. Acta Archaeologica Lundensia, Series in 8°, No. 28.
- 2002. Kongsgård – kultsted – marked. Overvejelser omkring Tissøkompleksets struktur og funktion. Jennbert, K., Andren, A. & Raudvere, C. (eds.), *Plats och praxis. Studier av nordisk förkristen ritual*, 215–247. Vågar till Midgård 2.
- Kaliff, A. 1997. *Grav och kultplats. Eskatologiska föreställningar under yngre bronsålder och äldre järnålder i Östergötland*. Aun 24.
- Karlsson, L. 1988. *Medieval Ironwork in Sweden I–II*. Uddevalla.
- Lamm J. P. 2004. Figural gold foils found in Sweden: a study based on the discoveries from Helgö. Clarke, H. & Lamm, K. (eds.), *Exotic and Sacral Finds from Helgö*, 41–142. Excavations at Helgö XVI.
- Larsson, L. 1998. Gjort och ogjort i Uppåkra. Larsson, L. & Hårdh, B. (eds.), *Centrala platser, centrala frågor. Samhällsstrukturen under Järnåldern*, 95–112. Uppåkrastudier 1. Acta Archaeologica Lundensia, Series in 8°, No. 28.

- 2002. Uppåkra – Research on a Central Place. Recent Excavations and Results. Hårdh, B. & Larsson, L. (eds.), *Central Places in the Migration and Merovingian Periods. Papers from the 52nd Sachsensymposium Lund, August 2001*, 19–30. Uppåkrastudier 6. Acta Archaeologica Lundensia Series in 8°, No. 39.
- 2003a. Dybäck during the Iron Age. An area with centralising functions in southernmost Scania in local and regional perspectives. Hårdh, B. (ed.), *Fler fynd i centrum. Materialstudier i och kring Uppåkra*, 41–80. Uppåkrastudier 9. Lund. Acta Archaeologica Lundensia Series in 8°, No. 45.
- 2003b. The Uppåkra Project. Preconditions, Performance and Prospects. Larsson, L. & Hårdh, B. (eds.), *Centrality – Regionality*. The social structure of southern Sweden during the Iron Age, 27–66. Uppåkrastudier 7. Acta Archaeologica Lundensia, Series in 8°, No. 40.
- Larsson, M. 1995. Förhistoriska och tidigmedeltida hus i södra Sverige. Göthberg, H., Kyhlberg, O. & Vinberg, A. (eds.), *Hus & Gård*. Hus & Gård i det förurbana samhället, 23–64. Riksantikvarieämbetet Arkeologiska undersökningar Skrifter 14.
- Larsson, S. 1996. *Att arbeta med stratigrafi i Lund – konsekvenser för vår syn på den medeltida staden*. Meta 1996:4, 26–34.
- Lenntorp, K.-M. & Lindell, M. 2001. *Rapport. Arkeologisk. Förundersökning Stora Uppåkra 8:3, Fornlämning 5, Uppåkra socken, Staffanstorps kommun, Skåne Län*. Uppåkra 2001. Lund.
- Lenntorp, K.-M. & Piltz-Williams, B. 2002. *Rapport. Arkeologisk Förundersökning Stora Uppåkra 8:3, Fornlämning 5, Uppåkra socken, Staffanstorps kommun, Skåne län*. Uppåkra 2002. Lund.
- Lindell, M. 1999. *Rapport. Uppåkra, fornlämning 5, 99:2*. LUHM 31 125. Lund.
- 2001. Utgrävningar i Uppåkra – en översiktlig beskrivning av de inledande utgrävningarna utförda under åren 1996–1998. . Larsson, L. (ed.), *Uppåkra. Centrum i analys och rapport*, 3–22. Uppåkrastudier 4. Acta Archaeologica Lundensia, Series in 8°, No. 36.
- Lidén, H.-E. 1969. From Pagan Sanctuary to Christian Church. The Excavation of Mære Church in Trøndelag. *Norwegian Archaeological Review* 1969:2, 3–32.
- Liversage, D. 1980. *Material and Interpretation*. The Archaeology of Sjælland in the Early Iron Age. Copenhagen.
- Lundqvist, L. 1996. Slöinge – en stormansgård från järnåldern. Lundqvist, L., Lindeblad, K., Nielsen, A-L. & Ersgård, L. (eds.), *Slöinge och Borg. Stormansgårdar i öst och väst*, 9–52. Riksantikvarieämbetet Arkeologiska undersökningar Skrifter 18.
- 2000. *Järnålderns centra – exempel från Halland och Västergötland*. Gotarc Serie C. Arkeologiska Skrifter 35..
- 2003. *Slöinge 1992–1996. Undersökningar av en boplatz från yngre järnålder*. Gotarc Serie C. Arkeologiska Skrifter No 42.
- Malmberg, S. 2003. *Dazzling Dining. Banquets as an Expression of Imperial Legitimacy*. Uppsala
- Mårtensson, A. W. 1976. Gravar och kyrkor. Mårtensson, A. W. (ed.), *Uppgrävt förflutet för PKbanken i Lund. En investering i arkeologi*, 87–134. Acta Archaeologica Lundensia VII.
- 1981. *S:t Stefan i Lund. Ett monument ur tiden*. Gamla Lund, föreningen för bevarande av stadens minnen årsskrift 62. Lund.
- Nerman, B. 1942. En fornsvensk fågelkult. *Fornvännen* 1942, 385–389.
- 1969–1975. *Die Vendelzeit Gotlands*. I–II. Stockholm.
- Nicklasson, P. 1997. *Svärdet ljuger inte*. Vapenfynd från äldre järnålder på Sveriges fastland. Acta Archaeologica Lundensia Series in 4°, No. 22.
- Nielsen, A-L. 1997. Pagan Cult and Votive Acts at Borg. An Expression of the Central Significance of the Farmstead in the Late Iron Age. Andersson, H., Carelli, P. & Ersgård, L. (eds.), *Visions of the Past. Trends and Traditions in the Swedish Medieval Archaeology*, 373–392. Lund Studies in Medieval Archaeology 19.
- Nordahl, L. 1996. *...templum quod Ubsola dicitur ... i arkeologisk belysning*. Aun 22.
- Nordberg, A. 2003. *Krigarna i Odins sal. Dödsföreställningar och krigarkult i fornnordisk religion*. Stockholm.
- Näsström, B.-M. 2002. *Blot. Tro och offer i det förkristna Norden*. Stockholm.

- Olsen, O. 1966. Hørg, hov og kirke. Historiske og arkæologiske vikingetidsstudier. *Aarbøger for nordisk oldkyndighed og historie* 1965, 1–307.
- 1969. Comments. *Norwegian Archaeological Review* 1969, vol. 2, 27–27.
- 1985. Hørg, hov og kirke – 30 år efter. Lidén, H.-E. (ed.), *Møtet mellom hedendom og kristendom i Norge*. Oslo.
- Paulsson, J. 1999. Metalldetektering och Uppåkra. Att förhålla sig till detektormaterial. Hårdh, B. (ed.), *Fynden i centrum. Keramik, glas och metall från Uppåkra*, 41–58. Uppåkrastudier 2. Acta Archaeologica Lundensia, Series in 8°, No. 30.
- Qvale, W. 1993. Stavkirkeproblemet i forskningshistorisk belysning. *Kunst og kultur* 1993, no. 2.
- Rafnsson, S. 1983. *Frásögur um Fornaldarleifar 1817–1823*. Reykjavík.
- Regnell, M. 2001. Gård, åker och äng – den centrala platsens triviala bas. Larsson, L. (ed.), *Uppåkra. Centrum i analys och rapport*, 113–122. Uppåkrastudier 4. Acta Archaeologica Lundensia, Series in 8°, No. 36.
- Samuelsson, B.-Å. 2001. Kan gravar spegla vägars ålder och betydelse? Ett exempel från Söderslätt i Skåne. Larsson, L. (ed.), *Uppåkra. Centrum i Analys och rapport*, 177–184. Uppåkrastudier 4. Acta Archaeologica Lundensia, Series in 8°, No. 36.
- Saxo Grammaticus Danmarks Riges Krønike*. Utg. Gruntvig, N. E. S. 1924. København.
- Siemek, R. 1984. *Dictionary of Northern Mythology*. Cambridge.
- Snorres Edda*. (1997). Översatt av Karl G. Johansson och Mats Malm. Stockholm.
- Stjernquist, B. 1996. Uppåkra, a Central Place in Skåne during the Iron Age. *Lund Archaeological Review* 1995, 89–120.
- Stjernquist a, this volume. Stjernquist, B. A Magnificent Glass Bowl from Uppåkra.
- Stjernquist b, this volume. Stjernquist, B. A Glass Beaker with Cut Decoration, Found at Uppåkra.
- Ström, F. 1985. *Nordisk hedendom. Tro och sed i förkristen tid*. Göteborg.
- Svensson, M. 2002. Palisaded Enclosures – The Second Generation of Enclosed Sites in the Neolithic of Northern Europe. Gibson, A. (ed.), *Behind Wooden Walls: Neolithic Palisaded Enclosures in Europe*, 28–58 BAR International Series 1013.
- Söderberg, B. 2003a. Integrating Power. Some Aspects of a Magnate's Farm and Presumed Central Place in Järrestad, South-East Scania. Larsson, L. & Hårdh, B. (eds.), *Centrality – Regionality. The Social Structure of Southern Sweden during the Iron Age*, 283–310. Uppåkrastudier 7. Acta Archaeologica Lundensia, Series in 8°, No. 40.
- 2003b. Järnålderns Järrestad. Bebyggelse, kronolog, tolkningsperspektiv. Söderberg, B. (ed.), *Järrestad. Huvudgård i centralbygda*, 109–174. Riksantikvarieämbetet Arkeologiska undersökningar Skrifter 51.
- Thomsen, P. O., Blæsild, B., Hardt, N. & Michaelson K. K. 1993. *Lundeborg – en handelsplats fra jernalderen*. Skrifter fra Svendborg & Omegns Museum 32.
- Tornbjerg, S. Å. 1998. Toftegård – en fundrig gård fra sen jernalder og vikingetid. Larsson, L & Hårdh, B. (eds.), *Centrala platser, centrala frågor. Samhällsstrukturen under Järnåldern*, 217–232. Uppåkrastudier 1. Acta Archaeologica Lundensia, Series in 8°, No. 28.
- Victor, H. 2002. *Med graven som granne*. Om bronsålderns kultus. Aun 30.
- Vierck, H. 1981. *Imitatio imperii und interpretatio Germania* vor der Wikingerzeit. Zeitler, R. (ed.), *Les Pays du Nord et Byzance* (Scandinavie et Byzance), 64–113. Actes du colloque nordique et international de byzantinologie tenu à Upsal 20–22 avril 1979. Uppsala.
- Vifot, B.-M. 1936. Järnåldersboplatsen vid Uppåkra. *Meddelanden från Lunds universitets historiska museum* 1936, 97–141.
- Watt, M. 1991. Sorte Muld. Høvdingesæde og kultcentrum fra Bornholms yngre jernalder. Mortensen, P. & Rasmussen, B.M. (eds). *Fra Stamme til Stat i Danmark* 2. Høvdingesamfund og Kongemagt, 89-106. Jysk Arkæologisk Selskabs Skrifter XXII:2.
- Watt, this volume. Watt, M. The Gold-Figure Foils (“Guldgubbar”) from Uppåkra.
- Zachrisson, T. 2004. Det heliga på Helgö och dess kosmiska referenser. Andrén, A., Jennbert, K.

- & Raudvere, C. (eds.), *Ordning mot kaos. Studier av nordisk förkristen kosmologi*, 243–287. Vägar till Midgård 4.
- Åqvist., C. 1996. Hall och harg. Det rituella rummet. Engdahl, K. & Kaliff, A. (eds.), *Religion från stenålder till medeltid*, 105–120. Riksantikvarieämbetet Arkeologiska undersökningar Skrifter 19.
- Ödman, A. 2003. Tankar kring två ringhandtag från Uppåkra. Hårdh, B. (ed.), *Fler fynd i centrum. Materialstudier i och kring Uppåkra*, 89–96. Uppåkrastudier 9. Lund. Acta Archaeologica Lundensia Series in 8°, No. 45.

The Metal Beaker with Embossed Foil Bands

Birgitta Hårdh

Abstract

The metal beaker that was found in the house is a unique object. The shape arouses associations with late antique glasses. The beaker is covered with embossed gold bands with figure representations carried out in early Style I. The bands were probably produced around 500 AD. The body of the beaker might be contemporaneous or possibly also older, with the bands as a later addition. The beaker is connected to drinking vessels, usually horns or glasses decorated with similar bands. Various elements in the decoration of the bands also correspond closely to gold bracteates and relief brooches originating in South Scandinavia, first and foremost Zealand and Scania. It is thus probable that the beaker was manufactured in South Scandinavia, perhaps in a workshop in Uppåkra. Style I is thought by several scholars to have been developed in South Scandinavia. With the discovery of the South Scandinavian central places during the last few decades, we now have the context where the style emerged.

Birgitta Hårdh, Department of Archaeology and Ancient History, Lund University, Sandgatan 1, SE-223 50 LUND.

The metal beaker that was deposited in the house close to the fireplace together with a glass bowl is a unique object. The well-documented find circumstances, and the fact that it was discovered as part of a deposition within a house at a settlement site, give it an exceptional position. Moreover, the beaker is a unique object without proper parallels but with plentiful associations with objects and ornamentation from the Migration Period. It will undoubtedly become important in future discussions about art, style and technical development in the Migration Period. It is, not least through its context, an important find for further discussions about ritualistic phenomena, ideologies of power and iconography. The direct connection to Uppåkra is also important as it elucidates the part that

central places played in artistic development, in this case of Style I.

Haseloff and others frequently emphasize South Scandinavia as a region of innovation regarding metal craft and stylistic development. Especially Style I has been regarded by a number of scholars as originating in South Scandinavia. On the other hand, it has often been emphasized that the grave rituals in Denmark and South Sweden, with generally very scanty grave goods, obstruct the analysis of stylistic development in what has been seen as the core region of the style (Haseloff 1981). Since the monumental *Die germanische Tierornamentik der Völkerwanderungszeit. Studien zu Salin's Stil I* by Haseloff appeared in 1981, the situation in South Scandinavia has changed fundamentally through the recently dis-



Fig. 1a. The Uppåkra beaker. Photo: Bengt Almgren, LUHM, Lund. Height 165 mm.



Fig. 1b. The Uppåkra beaker seen from the opposite side. Photo: Bengt Almgren, LUHM, Lund. Height 165 mm.

covered central places with abundant testimonies of metal craft. At Uppåkra finds which can be connected to metal handicraft, including those with a dating to the Migration Period, are numerous. The record from Gudme, for example, also indicates art handicraft of the highest quality with a large concentration of ornaments in gold cloisonné, which were probably locally produced in part. Thrane maintains that the question of locally produced gold handicraft of high quality will be increasingly interesting with the abundant new finds appearing at South Scandinavian central places (Thrane 1994:109 pp.). The connection between the development of Style I and the art of cloisonné has also been emphasized by Arrhenius (Arrhenius 1985:118). An important group of finds in this respect is the big Migration Period hack-silver hoards from Zealand, Lolland and Jutland, which together with continental late antique silver vessels, ingots etc. also contain fragments of locally produced silver ornaments. According to Voss this group shows that the hoards were collected within the regions where they have been found. The hoards also give an insight into the local workmanship and also how the silver was handled, fragmented and, according to Voss, the use as means of payment (Voss 1955).

The finds from recent years' research at Uppåkra bring renewed interest to the question of craft, art and innovation centres in South Scandinavia. Investigations of metallurgy in Uppåkra have shown that Uppåkra in all probability had permanent workshops and that metallurgical technique was at a high level at least from the Migration Period onwards (Kresten *et al.* 2001:5). Finds of patrices for gold-foil figures (Watt 1999) and garnets also indicate high-quality handicraft on the site during the Migration Period and later.

Migration Period Uppåkra appears through a great number of spectacular finds as a distinguished centre in the highest possible category (Hårdh 2002, 2003 pp.). The beaker should thus be considered together with other prestigious objects from the site.

The beaker from Uppåkra

The beaker dealt with in this article was discovered during excavation of the so-called cult house in the summer of 2001. The beaker (Fig. 1) is made of copper with additions of silver and gold. The body made of copper is conical with straight sides, wide mouth and narrowing towards the foot. It is made of tin plate which has been bent to a cone and soldered together with a vertical seam along the whole side, clearly visible on the inside of the beaker. The foot, with a base of a round plate and an inward-curved stem with round transition, is of silver (Fig. 2). Around the beaker run six horizontal embossed gold bands with figures and a seventh band, close to the foot, with vertical grooves and a thin bead line of embossed foil. The picture foils show human and animal figures (Fig. 3, Fig. 4, Fig.5). Eight narrow, profiled silver bands are placed along the mouth of the beaker, between each embossed foil band and at the transition to



Fig. 2. The foot of the beaker. Photo: Bengt Almgren, LUHM, Lund.



Fig. 3. Embossed foil from the Uppåkra beaker. Photo: Bengt Almgren, LUHM, Lund. Length 58 mm.



Fig. 4. Embossed foil from the Uppåkra beaker. Photo: Bengt Almgren, LUHM, Lund. Length 49 mm.



Fig. 5. The gold foil with grooves. Photo: Bengt Almgren, LUHM, Lund.

the foot (Fig. 6). The silver band close to the mouth has a profile different from the other seven. The mouth rim is bent outward and the upper surface was covered with a flat, narrow silver band with two incised lengthwise grooves (Fig. 7). The height of the beaker is approx. 165 mm. It is slightly deformed, flattened from the side, and the size of the mouth is in the present shape 109 x 71 mm. The circumference at the mouth is 265 mm, measured at the silver band on the top of the rim. The foot is 17 mm high and consists of several

parts: a tubular stem, curved inward at the middle, which is soldered to an arched round plate. This is strengthened with a flat round bottom plate soldered to the arched plate with the help of a ring of thin silver tin plate. The bottom plate has a diameter of 39.5 mm.

The embossed figure bands are decorated in Style I. They have beaded lines along the long sides and are divided into rectangular picture panels where two representations alternate, one with anthropomorphic and zoomorphic motifs and one with only



Fig. 6. Profiled silver bands, detail. Photo: Bengt Almgren, LUHM, Lund.



Fig. 7. The rim of the beaker. Photo: Bengt Almgren, LUHM, Lund.

zoomorphous motifs. The first panel (Fig. 3) shows two human faces in profile on each side together with animal representations. The other (Fig. 4) shows two *en-face* animal faces with a striated animal body between. The picture panels are separated by narrow transverse borders. The same motifs are regu-

larly repeated and the bands were apparently embossed over a long patrix with both picture panels on it. The rectangular panels with anthropomorphous and zoomorphous motifs are 58 mm long and the panels with only zoomorphous motifs are 49 mm. The bands seem to have been embossed as long bands

which were then cut into appropriate lengths. The embossed bands must have been glued or soldered on to the beaker; apart from one single rivet there are no traces of rivets on the bands. At certain places the embossed gold bands cover the edges of the profiled silver bands, so it is obvious that the embossed bands were added last.

The picture panels are arranged on the six bands in the following way, from the mouth of the beaker down to the foot (A=anthropomorphous and zoomorphous motifs, Z=only zoomorphous motifs):

Band 1: Z, A, Z, A, Z. Thus two panels with only zoomorphous motif meet at one place.

Band 2: A, Z, A, Z, A. The last picture panel is cut at the middle, which means that one and a half picture panels of the type with anthropomorphous and zoomorphous motifs together meet.

Band 3: A, Z, A, Z, A. The last picture panel is cut so that only a head remains.

Band 4: A, Z, A, Z. The foil is damaged at the last picture panel so it is uncertain whether it has been cut or not.

Band 5: A, Z, A, Z. The last picture panel is probably cut so that only half of it remains.

Band 6: Z, Z, A. The embossed foil is damaged but there was probably also a part of a third Z motif panel here.

The embossed figure bands are 15 mm wide and the profiled silver bands 4.5 mm. In the uppermost silver band there is a rivet hole, so it was obviously fastened with a rivet.

The narrow profiled silver bands (Fig. 6) have parallels in the hoard from Høstentorp, Zealand (Voss 1955: Fig. 20). The embossed foil with grooves and beaded border (Fig. 5) also has parallels in Høstentorp (Voss 1955: Fig. 21). Technically as well as in picture representation, the embossed figure bands



Fig. 8. Figure foil found close to the beaker. Photo: Bengt Almgren, LUHM, Lund. Length 16 mm.

are closely connected to a whole group of Migration Period embossed foils, which will be treated in detail below.

In the soil, close to the beaker, a small fragment of an embossed gold foil was found (Fig. 8). Notwithstanding its fragmentary condition, a human face with an eye, nose and mouth is clearly visible. In front of the face is a beaded border. There are traces of solder on the back of the foil. However, this foil was embossed on a different patina from the rest of the figure foils. Moreover, there does not seem to be space enough for this foil on the beaker so it is unclear whether it belongs here. This will be discussed further below.



Fig. 9. Metal beakers with embossed foil bands from Himlingøje, Zealand. Photo: National Museum, Copenhagen. Height 11.0 and 11.5 cm.

Drinking vessels with embossed figure foils

A group of silver beakers with embossed figure bands of gilded silver beneath the rim might be seen as forerunners of our beaker. The group consists of five beakers, dated to the Late Roman Age, C1b, all from east Zealand. The beakers are manifestly similar in workmanship and clearly show the contacts between the Zealandic localities of Himlingøje, Valløby and Nordrup. The figure foil bands on the beakers from Himlingøje have the richest decoration in the group (Fig. 9). It consists of a picture frieze with men with ring swords and various types of birds and quadrupeds, some of which have been interpreted as horses and ibexes. Werner refers to them as hunting friezes (Werner 1941:46 p.). The beakers from Valløby and Nordrup have embossed bands with a simpler decoration, a frieze with backward-looking quadrupeds (Werner

1941: Taf. 20–22; Lund Hansen 1995: Fig. 4:6, Taf. 2). The manufacture shows a highly developed handicraft irrespective of whether the objects were made by local masters or by foreign specialists. There are very few pictorial representations from the Early Roman Iron Age in Scandinavia. The changes have been seen as a result of the impact of Roman culture when, during the 3rd century, a pictorial world and a language of symbols through Roman inspiration appears fully developed in South Scandinavia (Roth 1979:50 p.; Lund Hansen 1995:237, and works cited there). Links with the Roman border provinces were strong and regular, with imports of decorated objects which must have been used as models for the Zealand beakers, for example. Around and after 300 this import ceases (Werner 1941:69).

The local connection of the beakers is obvious, among other things from the fact that their shape is based on local pottery types.

Werner believes that the five Zealand beakers derive from a workshop with clear connections to the embossed foil decorations from the Thorsberg find. According to him, the Scandinavian origin of the embossed figure friezes has never been questioned (Werner 1941:47 p.). The inspiration from the Zealand figure foils comes from *terra sigillata* vessels with pictorial representations, painted glass vessels and not least from Hemmoor buckets with figure friezes beneath the rim (Werner 1941:56 pp.) The Zealand silver beakers have been found in graves, in two cases as pairs (Lund Hansen 1995:377). They are clearly connected to aristocratic drinking customs.

From the early Migration Period and later there are several examples of horns, wood vessels and glass beakers with embossed figure foil bands beneath the rim. Well known among drinking vessels with embossed bands are the two aurochs horns from mound 1 in Sutton Hoo, East Anglia, and the six maple wood bottles with related mountings from the same grave. The two big aurochs horns, like the wooden bottles, were decorated with rectangular, gilded silver mountings and immediately beneath them elongated triangular mountings. The rectangular as well as the triangular mountings are decorated with embossed animal ornaments. One and the same patris was used for the rectangular foils and another for all the triangular foils. In the same way one patris was used for all the rectangular foils and one for the triangular ones on the wooden bottles. Thus, the two horns were decorated as a pair and the six bottles as a set (Bruce-Mitford 1972:33, Figs. 6, 11, 12, Pl. 19). In this connection it is interesting to notice that also from mound 2 in Sutton Hoo there are silver mountings from two drinking horns, embossed on the same patris as those from mound 1. These horns too are regarded

as having been aurochs horns (Bruce-Mitford 1975 Vol. I: 117 p.). The Sutton Hoo graves were built in the decades around 600 and the drinking vessels with embossed figure foils are apparently younger than the Uppåkra beaker. Bruce-Mitford maintains further that wooden cups with gilded silver mountings are not unusual in Anglo-Saxon graves (Bruce-Mitford 1972:33).

Drinking horns with gilded silver mountings are also known from a grave in Taplow, Buckinghamshire. This is the richest Anglo-Saxon grave after Sutton Hoo. There are four horns from Taplow, two big ones and two small ones. The two bigger horns with figure mountings in the Helmet Style, equivalent to Scandinavian Style I, are especially interesting in this connection. The two horns have embossed bands along the rims and beneath them triangular mountings pointing down. In each triangular panel there is a human figure with a face in profile, framed by a U-shaped element, interpreted as a helmet. Two arms, each ending with a hand with fingers and an expanded thumb, are clearly visible. One hand is raised in front of the face and around each wrist are distinct triple arm rings (Fig. 10). Kendrick demonstrated that this is an emperor representation, going back to pictures on imperial medals but here showing a further development within English 6th century art. The two smaller horns are decorated in the Ribbon Style, which is closely connected to Scandinavian Vendel Style A or Style II (Åberg 1926:10 p., Figs. 1–9; Kendrick 1938:76 p., Fig. 14:viii; Holmqvist 1951:56; Speak 1980:18). Kendrick also emphasizes that the wealth of splendid objects in Kent to a large extent is due to local handicraft (Kendrick 1938:18).

Beakers with embossed figure foils are also known from continental Europe. In a richly



Fig. 10. Mountings from the drinking horns from Taplow – helmet style. Photo: British Museum.

furnished grave from Soest, Westphalia, with, among other things, a gold disk brooch, gold foil pendants and beads, remains of two wooden beakers with silver foil mountings were also found. The foils are 18 mm wide embossed bands of gilded silver with animal decoration. There is one band along the rim and similar bands are also arranged vertically on the beakers. The bands were fixed by grooved strips, fastened on the beaker with rivets. In the grave there was also a coin struck for Justinian, 541–553 AD (Werner 1935:93, Taf. 20:9). Wood and glass beakers with embossed foils have also been found east of the Baltic and are then referred to as imports from the west (Gaerte 1929: Abb. 240, 290).

A special group is made up of glass beakers with mountings in precious metal, usually gold. Straume lists 15 glasses of this type, 12 Norwegian items and three Swedish. She suggests that glasses with decorated foils generally are repaired. The repairs were done in two different ways. In the first case an irregularly shaped foil, corresponding in shape to the missing shard in the glass, was attached to the rim of the glass with rivets. In order to strengthen the repair a rim mounting was then bent around the edge. In the second case, shards from the side of a glass were joined by small riveted mountings. The repairs were done so that the metal foils were fastened to the beaker with rivets after small



Fig. 11. The glass with embossed foil from Snartemo, Vest-Agder, Norway.
Photo: E. I. Johansen, UKM. Height 15.3 cm.

holes had been drilled in the glass. In some cases there are no rivet holes, so here apparently some kind of glue was used to attach the foils to the glass. Six repaired glass beakers have metal mountings decorated in Style I. Apart from a beaker from an inexpertly excavated grave all repaired glass beakers have

been found in graves dated to the Migration Period, D1 and D2 (Straume 1987:48 p., Taf. 42, 58, 61, 86).

The beaker from Snartemo is a good example of this (Fig. 11). It was broken into three pieces and was mended at five places with metal foils. It is a glass beaker with cut

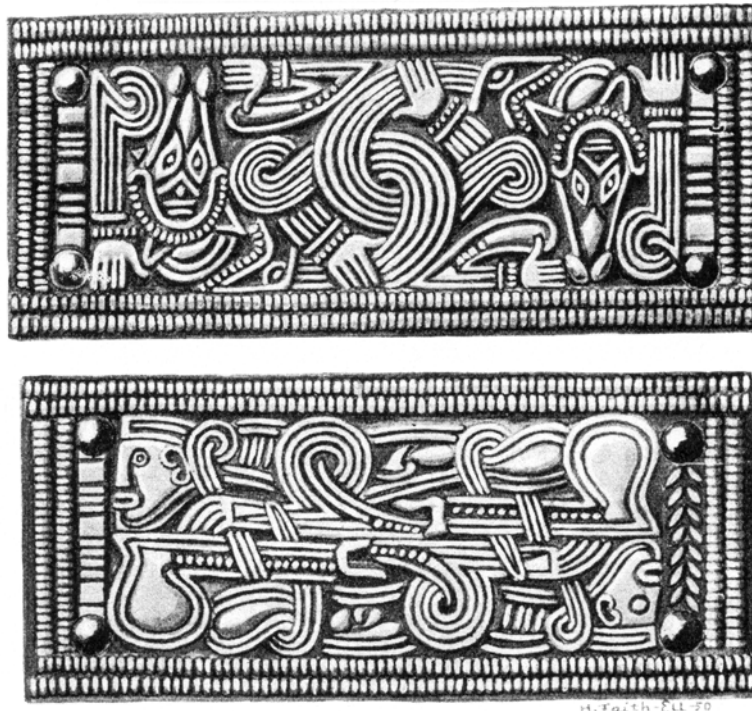

Fig. 12. The mountings from Söderby Karl, after Holmqvist 1951, Fig. 5. Size 6x2.5, 5x2.5 cm.

and polished facets, wide mouth and narrowing sharply towards the foot, which is small and round. Apart from the foils on the sides of the beaker it also has rim mountings in the shape of embossed figure foil bands in silver. The band is divided into rectangular panels with two representations which are repeated alternating, a hunched human being and an animal representation (Hougen 1935:28 pp.; Straume 1987:49; Fig. 17).

Glasses with metal mountings are also known from England and continental Europe. Bruce-Mitford mentions, for example, horn-shaped glasses with mountings from Rainham, Essex, together with other similar glasses from the Frankish area and from Italy (exhibited at the British Museum, Bruce-Mitford 1972:90, note 25).

Close parallels to the Uppåkra beaker in time as well as in manufacture show two drink-

ing horns from Söderby Karl, Uppland (Fig. 12). Rim mountings and end mountings are preserved from the two horns, together with fragments of chains and some further metal elements. Each rim mounting consists of a foil tube widest in diameter at the rim and gradually narrowing, following the shape of the horns. On the outer side the tube is strengthened with three parallel strips of copper alloy running around the tube and transverse strips, which divide each rim mounting into eight rectangular panels. The strips are covered with smooth silver foil. In each of the eight panels gilded copper alloy foils with embossed decoration are fastened with a rivet in the four corners of each foil. Beneath the lowest strip there is a row of closely attached rivets, which fastened the rim mounting to the horn. The rivets are surrounded by embossed beaded borders and rosettes. The figure foils

have a diagonal symmetric composition in two varieties. The upper foils, closest to the rim, show band-shaped animals with faces in profile and human hands. The lower foils show stylized quadrupeds with human faces. In both cases the figure panel is surrounded by beaded borders (Holmqvist 1951:33 pp.). Holmqvist suggests that the anthropomorphic elements in Style I derive from late Roman influences, which were rapidly dying out during the 5th century. He dates the horns from Söderby Karl to the 5th century (Holmqvist 1951: 59 p.).

The practice of furnishing drinking vessels with bands or mountings with figure-decorated embossed foils thus connects a whole group of wood beakers, horns and glasses, together with a group of metal beakers which, however, are considerably older than the rest of the vessels. In this group the Uppåkra beaker is unique, being a beaker entirely of metal and with a dating to the Migration Period. The shape also differs manifestly from the group of older metal beakers from Zealand, instead showing a connection to late antique glass beakers. Also special for the Uppåkra beaker is the large number of embossed foil bands. Other drinking vessels have one or at most two parallel bands at the rim whereas the Uppåkra beaker is covered with bands.

The drinking vessels described here derive from graves, in all cases where find circumstances are known, and it is not uncommon that they appear as pairs. It is generally stated that the two vessels were made in close connection to one another, and in several cases it has also been stated that the pair of vessels shows connections to local handicraft.

The shape of the beaker

Thus, there are numerous drinking vessels of various types with bands of embossed figure foil along the rim. However, the Uppåkra beaker is unique, being a tall metal beaker with wide mouth, straight sides and a small foot. The best parallels to the shape of the Uppåkra beaker are to be found among glass beakers. Migration Period glasses of so-called Snartemo type are high and slender with a wide mouth and a small round foot. The difference is that the glasses have a slightly curved profile whereas the sides of the Uppåkra beaker are straight. The feet of the glasses have no stem but consist of a round disc immediately under the bottom of the glass beaker (Hougen 1935: Pl. VIII:11; Näsman 1984:66 pp.). A good parallel to the Uppåkra beaker is also a glass with polished facets from Sojvide, Sjonhem parish, Gotland (Fig. 13). This is a beaker in milk white glass with facets all over the surface and of almost the same size as the Uppåkra beaker. Shape and proportions correspond closely and this glass also has a small round foot but without a stem (SHM 4687; Almgren & Nerman 1914: Taf. 18:277). The shape of the Uppåkra beaker may also be compared to glasses with cut and polished facets of Straume's types VIII and IX (Straume 1987:38 pp.). Both these types are conical beakers with straight sides, wide mouth and a small round foot. The above-mentioned glass with embossed foils from Snartemo grave V belongs to Straume's type VIII (Hougen 1935:V:1; Straume 1987: 98, Taf. 10, 61:2–3; Fig. 9). Interesting in this connection is also a glass from Tu, Klepp in Rogaland, with wide mouth and a small round foot, made of green glass and with blue overlay (Straume's type VIII). In technical respects this glass shows similarities to the



Fig. 13. The glass from Sojvide, Sjonhem, Gotland. Photo: ATA. Height 18 cm.

glass bowl that was deposited together with the metal beaker treated in this article (for the glass bowl see further Stjernquist's article in this volume). The glass from Tu, Klepp, has an inscription in Greek (Straume 1987:100 p.). A glass with the same shape and the same Greek inscription, although not in overlay technique, was found in a grave in Stilling Århus (Straume 1987:38, no. 91).

Straume puts the glasses of types VIII and IX at the transition from the Late Roman Iron Age to the Migration Period, phases C3–D1 (Straume 1987:40). Näsman calls the group conical foot-beakers and refers them chronologically to period VI, Migration Period, but with traditions from period V, Late Roman Iron Age (Näsman 1984:61). Näsman also discusses the repaired glasses. They have been found in graves dated to period VI and are seen by several scholars as antiquities already at their deposition. However, Näsman maintains, in connection with Arrhenius as well as Straume, that the glasses were not necessarily especially old when deposited. Cut and polished glasses were, according to Näsman, produced in Eastern Europe far into period VI. He also emphasizes that, rarity and sentimental value, among other things, might explain why these glasses were repaired. The concentration of repaired glasses is, according to Näsman, to be explained by burial customs (Näsman 1984:22 p. with references).

The Sojvide beaker, according to Lund Hansen, belongs to Eggers' type 185. This type is also represented by two items in one of the graves from Juellinge, Lolland. The Juellinge grave, as well as the Sojvide grave are dated by Lund Hansen to period B (Lund Hansen 1987:402, 448). If the shape of the Uppåkra beaker may be connected to glasses of type E 185, it thus shows traditions from the Early Roman Iron Age. According

to Almgren and Nerman, the Sojvide glass should be dated to period IV but was found in a grave dated to period V (Almgren & Nerman 1914:42).

Thus, the Uppåkra beaker can be referred to as a metal beaker made in a shape that connects it to glasses dated to Late Roman Iron Age–Migration Period but with older traditions regarding its shape.

The embossed foil bands

The Uppåkra beaker thus possesses six figure-decorated embossed foil bands which run parallel and cover almost the entire beaker. There are two figure panels which are repeated alternately, the first with two human beings and two animal representations and the second with two animal representations. Obviously, a long patirix with both representations were used to make the embossed foils. It is also clear that the bands were made in lengths and cut into appropriate pieces, sometimes in the middle of a representation. This is a typical way of manufacturing embossed foils which is characteristic of the entire group of drinking vessels with bands along the rims.

Both figure panels have a diagonal symmetrical composition. The first rectangular panel (Fig. 3, Fig. 14) shows two male heads in the opposite corners, face in profile and the nose pressed against the border. The faces have oval eyes marked with double outline, a triangular nose and a small curved mouth. The nose and mouth are cut by the border of the foil band. The hair is upright and marked with lines. Each figure has an arm with four fingers. Around the wrist is a rounded element, possibly an arm ring. Along each long side of the panels there are also two human legs, each with a foot.



Fig. 14. Embossed foil band from Uppåkra. Drawing B. Nilsson.



Fig. 15. Embossed foil band from Uppåkra, interpretation by the author.

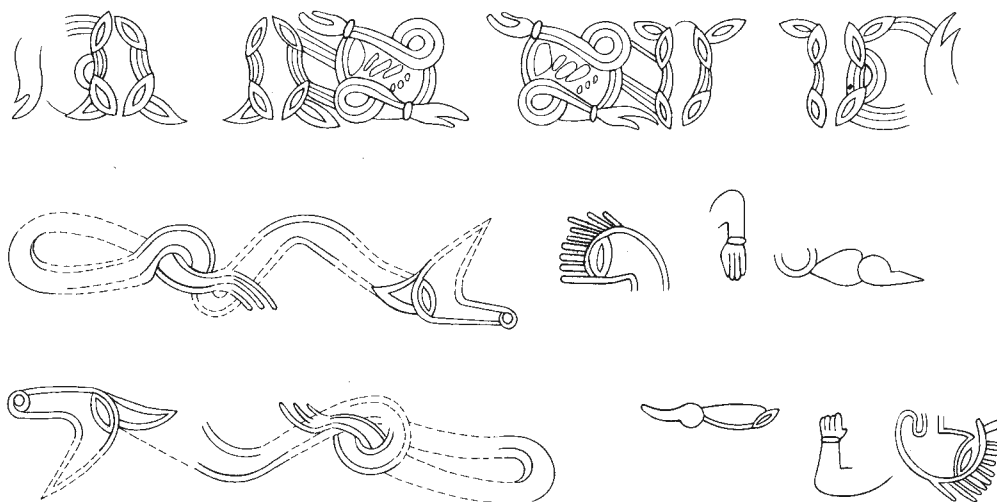

Fig. 16. Embossed foil band from Uppåkra, interpretation by the author.

Behind each human head there is an animal head in profile with a gaping mouth. The lower jaw, according to this interpretation, is concealed behind the human head. The animal has an oval eye of the same type as the human being and a round nostril. One animal head has a pointed ear; on the other head the ear is reduced to a small triangle. The central part of the panel shows two intertwined elements. I interpret this as the serpent-like bodies of the

two animals wound around each other (Fig. 15, Fig. 16). The tail of each animal is twisted around the neck of the opposite human being so that a loop of the serpent-like animal's body also passes into the next rectangular panel, with entirely zoomorphous decoration. The human hands seize the outermost part of the animal bodies. This interpretation with the two serpent-like animals and the human hands seizing a part of the serpent body has

a clear parallel in the representation on the Söderby Karl mountings.

The decoration of the second panel consists entirely of zoomorphous elements (Fig. 4, Fig. 14). Easiest to identify are two animal's heads seen *en-face* with oval eyes, similar to the eyes on the first panel. Further, the animals have oval nostrils and two pointed ears. One animal head is oriented upwards and the other downwards if the band is held horizontally. Between the heads there is an element of a striated animal body with rounded parts, evidently hips, one above and one below the body. From one of the hips a distinct leg protrudes, marked with a line and ending in a small paw with long toes. At the transition between leg and foot there is a small element which looks like an arm ring. The other hip element also has a paw with toes, although the leg is not so distinct here, one outline line missing, but here too there is an arm-ring-shaped element at the transition between leg and paw. The legs are situated along the long sides of the panel, close to the beaded border with the paw close to a nostril at each animal's head. The animal body is connected to both heads through two parallel, in one case triple lines. This gives an almost identical picture if one turns the band 180 degrees. Thus, we have two heads with a common body. On each short side of the panel there are further animal elements, a leg with a paw. Around these legs is a loop, which probably should be seen as part of the presentation of the first figure panel, as a part of the serpent body that is twisted around the human figure. Between the legs on the short sides and the *en-face* heads there are bands of double or triple parallel lines. The interpretation suggested here is that these are neck parts of the *en-face* heads, which in this way each are part of two different animal repre-

sentations. The animal body in the middle of the panel is thus common to the two *en-face* heads which, for their part, each also belong to another neck element (Fig. 15, Fig. 16). The big *en-face* animal heads also have clear parallels in the mountings from Söderby Karl where the faces also are placed in opposite directions (cf. Fig. 12).

The embossed foils on the horns from Söderby Karl thus show several similarities to the Uppåkra foils in representation and composition. Common features are a diagonal symmetrical composition and the mixture of animal and human representations. On the Söderby Karl horns four rectangular mountings have been attached by rivets along the rim and four in a row below the first row. One patrix was used for the upper mountings at the rim and another for the mountings of the second row. The panels of the upper row show two band-shaped animals with their bodies linked to one another. The animals consist of a head with open mouth and a band-shaped lengthy striped body ending in a human hand that grips around its own body. On each side of this central representation there is a big *en-face* animal head with oval eyes, big nostrils and pointed ears. The panel further shows two animal legs each ending in a human hand and two extra arms each with a hand. The panel is surrounded by a double beaded border. The lower mountings show two stylized quadrupeds, diagonal symmetrically placed and with human faces. These panels are likewise surrounded by double beaded borders (Holmqvist 1951:37, Figs. 3–5; Haseloff 1981).

In a goldsmith's grave in Vestlye, Time, Rogaland, there was, among the rich furnishing, a late Roman glass beaker with an embossed figure in gold foil along the rim (Fig. 17). The representation shows two deeply

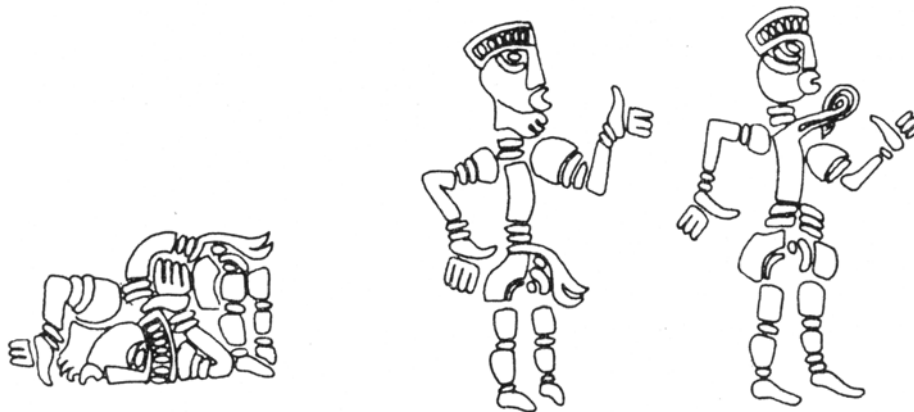
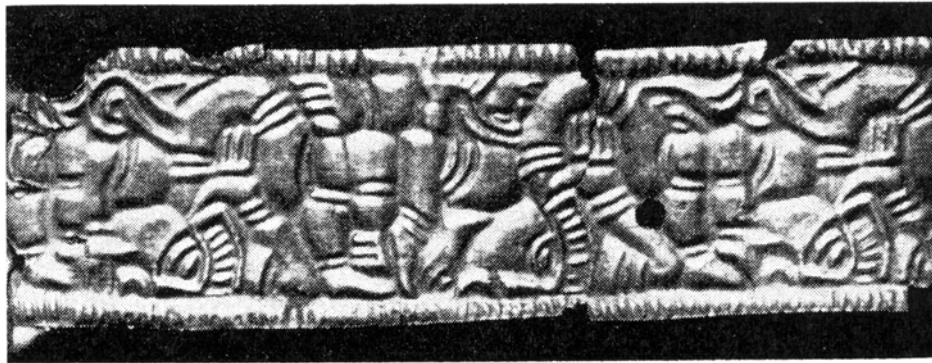

Fig. 17. The embossed foil band from Vestlye, Time, after Bakka 1962.

crouched male figures. They are very similar though differing from one another in details. Both of them have big faces in profile, one with a beard, the other without. Both figures are depicted with two arms and hands with an extended thumb. The bodies are bent to a U-shape and one leg with a foot is visible on each figure (Bakka 1963; Hougen 1967: Fig. 76; Haseloff 1970:29 f., Taf. 8–10). The figures on the Vestlye band are intertwined into an endless chain. If my interpretation of the Uppåkra representation is correct, i.e. that the body of the serpent makes a loop into the panel with zoomorphous figures and intertwines with them, then the Uppåkra foils also show figures linked to one another in an endless chain.

From Rimestad, Nærbo, Rogaland, another glass beaker with an embossed figure in gold foil beneath the rim is known. In this case the representation shows four mixed figures with animal bodies and human heads. One of these animal-human figures also possesses a distinct human hand with extended thumb (Hougen 1935: Pl. X:1, 3; Haseloff 1970:31, Taf. 12; Haseloff 1981:123, Abb. 73:2; Straume 1987: Taf. 58). The band from Rimestad differs from Vestlye as the representation is interrupted at certain intervals, probably due to the length of the patrix.

The grave Snartemo V contained, as mentioned above, a glass beaker with embossed figure foil bands. The embossed foil (Fig. 18, Fig. 19), which is only partially preserved,



Fig. 18. The embossed foil band from Snartemo, Vest-Agder, Norway. Photo: UKM, Oslo. Width 1.3 cm.

shows two regularly alternating figure panels. One shows two animals, both with their heads on the short sides of the panel. One figure is placed along the diagonal of the panel with its single leg in the opposite corner. The second animal twines its front leg around the first figure while the back leg is bent upward and kicks against the long side of the panel. In the empty space in one corner there is an isolated animal head. The second panel shows a sitting human figure with long hair and a hand raised in front of the face. The figure is so deeply crouched that the thigh runs parallel to the stomach (Hougen 1935: 38, Pl. V:2; Straume 1987: Taf. 61). Thus, here are two representations, within demarcated rectangular panels, which are repeated, a zoomorphous and an anthropomorphous representation. The embossed foil on a glass beaker from Kvassheim, Eigersund, Vest-Agder, shows rectangular figure panels where one and the same zoomorphous representation is repeated (Hougen 1935: Pl. IX:5–6; Straume 1987: Taf. 42:1).

Some connected, well-known, embossed figure foils are those from the sword from Snartemo grave V (Hougen 1935: Pl. 1.2; Vierk 1967: Abb. 6:4, 5). Four square foils, two on each side of the handle, show symmetrically arranged figure representations. The “front side” of the handle has two square



Fig. 19. The embossed foil band, detail, from Snartemo, Vest-Agder, Norway. Photo: UKM, Oslo.

foils with animals and human beings in a diagonally symmetric composition. On the “back side” of the handle one foil shows two male figures, both with long hair intertwined in one another, while the other foil shows a human being and an animal in what Vierk has interpreted as a battle scene. The interesting thing here is that the two male figures have been placed upside-down. Thus they are intended to be seen from the perspective of the one who carries the sword.

The embossed figure foils numbered here show in various ways connections to the foil bands on the Uppåkra beaker:

- A diagonal symmetric composition (Söderby Karl, the Snartemo sword, Rimestad)
- Rectangular panels with alternating representation (the Snartemo glass)

- Endless chain of repeated representations (Vestlye)
- Beaded border (Söderby Karl, Vestlye, Kvasseheim, Rimestad, and some gold-foil figures, see further below)
- Animal head *en-face* (Söderby Karl)
- Serpent with wide-open mouth (Söderby Karl)
- Arm rings (Söderby Karl, Snartemo, Taplow)
- Intertwined figures (Snartemo sword (human figures), Uppåkra (serpents))

Holmqvist maintains that there are several correspondences between the embossed foils from Söderby Karl and those from Snartemo. He emphasizes especially the diagonal symmetrical composition, which he says is unusual during the style epoch treated here (Holmqvist 1951:46). The anthropomorphic elements are also a peculiarity which puts them into a special category within Style I. So, the Uppåkra beaker must also belong to this exclusive group.

The representations, human beings and animals

From the figures on the embossed foil bands the human heads together with an arm, a hand and an arm ring are easiest to identify. The faces are pressed against the border of the foil and it is appropriate to consider whether it may be two half faces, or rather two sides of the same face, that are depicted. In that case the representation would be something similar to the two face halves on a relief brooch from Zealand (Salin 1904: Abb. 472; Haseloff 1981: Taf. 25), which Alenstam interprets as two parts of an *en-face* face (Alenstam 1949: Fig. 8:12–13). Moreover,

the faces that Alenstam reproduces show similarities to the Uppåkra faces regarding mouth, nose and eyes.

The best parallels to the figures on the embossed foils from Uppåkra are to be found on relief brooches and on some gold bracteates. A gilded silver relief brooch from Kirchheim, Nürtingen, Württemberg (Haseloff 1981; 289 pp.; Haseloff 1981: Taf. 39) has two human figures on the rectangular head plate, which have several traits common with the Uppåkra figures (Fig. 20). The faces are seen in profile and the hair is depicted as lines straight out from the heads. Each figure has a big hand with a rounded marking, perhaps an arm ring.

The Kirchheim brooch was found in a rich woman's grave in an Alemannic cemetery but



Fig. 20. Detail from the Kirchheim brooch, after Haseloff 1981.

according to Haseloff there is no doubt that it originates from South Scandinavia. He characterizes it as one of the most beautiful South Scandinavian Style I brooches and declares that it is of the utmost importance for assessing the first appearance of Style I on the continent. It also sheds new light on Style I on the continent. The human figures on the Kirchheim brooch belong stylistically to the best expressions for Style I and are directly connected to Scandinavian representations.

Important elements here are the upright hair, the dot eyes together with the marked nose. Haseloff maintains that the closest parallels to the Kirchheim faces are to be found on gold bracteates of Type B (Haseloff 1981:288 pp.).

Also, gold bracteates have some representations which can be compared to the Uppåkra foils. A group of bracteates from the same stamp, the so-called Söderby bracteates, make a good parallel to the human head from Uppåkra (Mackeprang 1952: Pl. 3:3). Here we find the same upright standing hair, the triangular nose and the oval eyes. The legs of the figure on the Söderby bracteates, as well as the legs of an animal figure on the same bracteate stamp, are executed in the same way as the winding elements on the Uppåkra foils. Haseloff mentions a number of similar examples on bracteates from Funen, Zealand and Scania. The human heads of the bracteate from Scania also have upright-standing hair. Haseloff maintains that there cannot be any doubt that the Kirchheim brooch belongs to the core area of the distribution of the B-bracteates, i.e. Jutland, the Danish islands and Scania (Haseloff 1981:318 p.).

The winding elements on the Uppåkra foils, here interpreted as animal bodies, have evident parallels on some wood carvings from some Danish bog offerings. In the Nydam bog find, Nydam III, as well as in Kragehul, some well-preserved lance shafts of wood have been found. The shafts are decorated with winding serpents whose bodies are marked with double outlines (Engelhardt 1867: Pl. II:9; Vang Pedersen 1988: Figs. 29–31). A sword scabbard of wood found in Nydam bog in 1997 also has a decoration of intertwined serpents with bodies with double outlines. Their big heads with wide-open mouths have one or two pointed ears, thus corresponding closely to the serpents on the

Uppåkra foils (Nyhedsbrev 1997:46). Similar intertwined serpents are to be seen on a gold bracteate from Lyngby, Randers (Mackeprang 1952: Pl. 3:10 a), and on the first gold horn found at Gallehus, the long one (Brøndsted 1966:322 ff.). In 1996 a silver pendant with a decoration of two gilded and stamp-decorated serpents was found in Uppåkra (Fig. 21). Again, we encounter serpents in a couple, partly intertwined. In this case the heads are seen from above and show manifest similarities to an animal head of wood from the Vimose bog find (Engelhardt 1869: Fig. 10; Hårdh 1999, Fig. 2).



Fig. 21. Pendant with serpent representation from Uppåkra, U1266. Photo: Bengt Almgren, LUHM, Lund. Width 4.5 cm.

Heads in profile in combination with a raised hand with a spread thumb are a common motif in anthropomorphous representations of the Migration Period and are referred to by Holmqvist as the Emperor gesture (Holmqvist 1951:50). This interpretation is not appropriate here; the arm is not raised and the hand lacks a spread thumb. As for

the arm rings, Holmqvist points out that they appear in a number of representations in the anthropomorphous style. They constitute a special feature, often following anthropomorphous representations; for instance, there are several bracteates with distinctly marked arm rings around the wrists (Holmqvist 1951: 52 p.). Elements resembling arm rings are also to be seen in connection with apparent animal paws, for example on the paws on the Uppåkra foils. Usually, human hands in Migration Period art are represented with a spread thumb. This element is repeatedly found on gold bracteates and relief brooches as well as on other objects like the mountings from Söderby Karl. The Uppåkra foils show human hands with four fingers but no thumbs. Human hands with four fingers but no thumbs have a parallel for example on the equal-armed relief brooch from Ekeby, Malsta (Magnus 2001a:286). The distinctly pronounced thumb is seen by Capelle as indicating humanness (Capelle 2004).

The serpent-like animals seen in profile with wide-open mouths on the Söderby Karl mountings also have human hands. The animal head in profile with gaping mouth also appears on relief brooches. The two heads that protrude from the upper part of the foot on the big relief brooch from Gummersmark, Zealand, are a very close parallel to the animal heads on the Uppåkra foils (Fig. 22). Common here are the narrow nose, the round nostril, the oval eye with double outline and the pointed ear (cf. Haseloff 1981: Taf. 23). Similar heads are also to be seen on the relief brooch from Vedstrup, Zealand (Haseloff 1981: Taf. 26; Fig. 23).

The representation in the second figure panel on the Uppåkra beaker is absolutely zoomorphous. It consists, as mentioned, of two *en-face* faces, in opposite directions. The

elongated faces have oval eyes, big nostrils and small oval ears. The oval eyes have double outlines like the animals on the first figure panel. The embossed foils on the Söderby Karl horns also have elongated *en-face* faces with big nostrils which resemble the faces on the Uppåkra beaker. Two silver mountings from Øvsthus, Fjellberg, Hordaland, are other good parallels to these animal faces (Straume 1987: Taf. 112:1–2). There are also clear parallels to these animal faces on some relief brooches, among them the above-mentioned one from Gummersmark, which also has heads in profile (Haseloff 1981: Taf. 23, 25, 26), the brooch from Lunde, Lista, Norway (Haseloff 1981. Taf. 6, 7) and on the brooch from grave 41 in Bifrons, Kent, England (Haseloff 1981: Taf. 20, Abb. 25, 57:3). All these examples have animal heads with elongated faces, distinct nostrils and pointed ears. All, except the faces on the Bifrons brooch, have oval eyes. Especially the head on the Lundby brooch has great similarities to the *en-face* faces on the Uppåkra foils. The face on the Lunde brooch, with oval eyes, triangular forehead and a strip that runs along the eyes and continues along the middle axis of the face, has evident similarities to the heads of the above-mentioned silver pendant from Uppåkra. Similar characteristics are shown by the plastic heads at the foot and head plate of the chip-carve decorated relief brooch from Grönby (Fig. 27). An elongated animal head seen from above or *en-face* with marked eyes and big nostrils is a recurrent element on relief brooches, especially at the foot, and on cruciform brooches, in this case in a more stylized execution. The head plate of the Lunde brooch is further filled by two serpent figures with wide-open mouths, oval eyes and pointed ears. Their open mouths enclose a human face or a mask.



Fig. 23. The relief brooch from Vedstrup, Zealand. Photo: National Museum, Copenhagen. Length 13.9 cm.

Between the two *en-face* faces in the second figure panel from Uppåkra there is, as mentioned, a transversely striped animal body with rounded hips and legs ending in a small paw with long toes and, as a matter of fact an arm ring at the transition from leg to paw.

Broad, striped animal bodies are current in Style I. The position of the body, with one leg along the stomach and one along the back, shows clear correspondence to the representation of the animals on the above-mentioned relief brooch from Vedstrup, Zealand (Haseloff 1981: Abb. 97 C, 98, 107; Fig.



Fig. 22. The relief brooch from Gummersmark, Zealand. Photo: S.-A. Tornbjerg, Køge Museum. Length 15.9 cm.

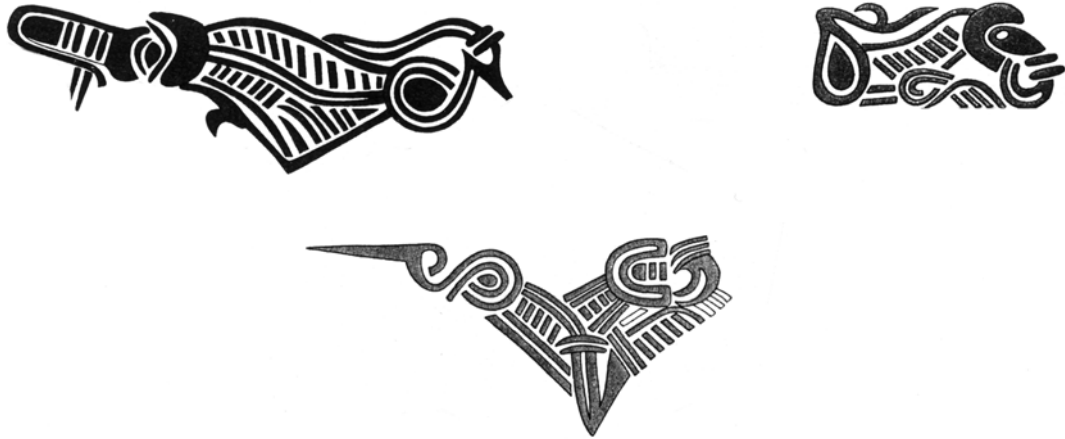

Fig. 24. Animal figures on the Vedstrup brooch, Zealand, after Haseloff 1981, Abb. 98,107, 108.

23, Fig. 24). Similar animal representations are also to be seen on some gold bracteates of type C (Hauck 1992: Abb. 14). The transversely striated body also shows some similarities to animal representations for example on the Bifrons 41 brooch.

Thus, details in the representations on the Uppåkra foils can in several respects be connected to similar representations on gold bracteates and relief brooches. It is also obvious that there is a South Scandinavian connection. In many instances parallels have been drawn to Zealandic relief brooches.

The embossed figure foils on the Uppåkra beaker and the embossed foils from Söderby Karl are executed in the same technique as gold-foil figures. The beaded border that surrounds the figure representations on the foils from Uppåkra as well as Söderby Karl is also typical of several gold-foil figures. However, the embossed bands and mountings show another world of representations than the gold-foil figures do. The gold-foil figures are usually depicted as realistically human representations whereas the embossed foils on beakers have hard-to-interpret representations

with fantasy animals and metamorphosis, which is also typical of relief brooches.

The pictures – interpretation

Much has been written about interpretation of the iconography in Migration Period art, and the opinions of the possibilities of interpretation are very diverse. Haseloff is utterly unwilling to make any interpretations of decoration at all: “Trotzdem muß man ernsthaft die Frage stellen, ob dem Künstler überhaupt eine bestimmte Absicht im Sinne einer bildhaften Darstellung eines historischen oder sagenhaftes Ereignisses bei der Komposition dieses Motiv vorgeschwebt hat”. On the other hand, it is appropriate to ask, according to Haseloff, why a figure, in this case the man on one of the Grönby brooches (Fig. 27), is twisted in the way he is. The extreme bending and intertwining of bodies and limbs, which to us looks unnatural, must have been intentional and thus had a meaning (Haseloff 1970:31).

Roth is of the opinion that Haseloff’s work is the terminal point in a research tradition

aiming to elaborate solid systematics, to register, classify, describe and clarify evolutionary links. He maintains further that the efforts at interpretations so far have mainly concerned the gold bracteates, as they combine picture and script. The bracteates also often show distinct scenes such as Odin with the ravens, Thor with the goats or Tyr with the Fenris wolf. It is important to consider, according to Roth, that the representations on the gold bracteates already in their first embossing probably are founded on a long oral tradition. To translate this into pictorial representations was not possible until they were confronted with the classical pictorial world which resulted in *interpretatio Germanica* (Roth 1986: 9 p.; cf. Werner 1966).

Roth stresses the importance of picture and motif being considered in context. On what type of object is the representation applied and what function did the object have? Is there a connection to a female or male sphere? Is the picture placed on an amulet or on an everyday object? Does the picture occur on a simple object or on one which has the character of a sign of dignity, a special sword, a belt or a ring? Why is such a large part of the pictorial representations connected to the female sphere (Roth 1986:18)?

Migration Period pictorial representations may be divided according to three principles. The gold-foil figures show generally realistic representations of human beings, often of distinguished persons, aristocrats or perhaps gods. Some figures carry a ring around the neck and have their feet pointing downwards, perhaps showing hanged persons. In this case it is easy to see associations with representations of Odin. A well-dressed woman with a beaker in hand is possibly a Valkyria or the noble housewife in the role of the Valkyria. The loving couple has sometimes been inter-

preted as gods, sometimes simply as symbols of a fertility cult. In all these cases there is of course the possibility that the giver of the offer, the templum money, depicted himself/herself in a way to arouse associations with religious ideas.

The second theme is the representations on the gold bracteates. Especially on the B-bracteates there are often several figures arranged in a way that might show scenes which have sometimes been interpreted as mythological representations, known from written sources. The bracteates have been seen as amulets with, among others, healing motifs (e.g. Hauck 1992). The sequence of bracteates from A to D also shows a gradual development away from realistic to increasingly symbolic representations (cf. Haseloff 1970:35).

The third theme is found on scabbard rim mountings, relief brooches and embossed foils of various types. In this case it is a world of imagination difficult to interpret with fragmented animal representations, figures combining anthropomorphous and zoomorphous elements, and combining parts of human beings and animals in an ambiguous way.

On the rectangular head plate of the Gummersmark brooch there are two small human figures, in their execution closely resembling gold-foil figures. This representation is unique on a relief brooch but is also an example that crossing of themes and categories of objects is possible.

A point of departure for the understanding of the iconography is the observation that themes and motifs are connected to certain categories of objects. Obviously there are also rules for how a motif can be represented. For instance, Siv Kristoffersen has pointed out that broken symmetry is a frequent trait on relief brooches, while this does not seem

to be the case on sword scabbard rim mountings (Kristoffersen 1995:7).

Vierk and others maintain that the relief brooches and the gold bracteates had the function of amulets (Vierk 1967:135; Magnus 2001a:282). The same motifs often occur on both types of objects, and in South Scandinavia gold bracteates and relief brooches are often deposited together as hoards while in Norway and England both types of objects have been found in women's graves (Magnus 2001a:282 with refs.). Haseloff writes about a picture topos with healing and fortune-bringing character and exemplifies with gold bracteates, the Grönby brooches, the embossed foils from Vestlye and the gold foil cross from Cividale (Haseloff 1970:36).

To be able to discuss an interpretation of the representations on the figure foils from Uppåkra, it is necessary to consider the parts it consists of: human heads in profile, hands with four fingers but no thumbs, serpents with wide-open mouths over the human heads, the intertwined animals which surround the human beings, the horse heads *en-face*, representations in pairs, two humans, two serpents, two horses, transformations and animal figures that grow into one another.

A characteristic trait of the Uppåkra foils is the diagonal symmetrical composition of pairs, humans, serpents and horses. Human figures in pairs are not unusual in Migration Period representations and have been interpreted as a pair of gods, a mythological pair of heroes or a representation of blood or weapon brotherhood. In connection with a presentation of a strap mounting from Veszvény, Werner treats the motif with two male faces turned away from one another in a symmetrical composition and calls it, after the sword mounting from Snartemo V, the Snartemo motif. This representation

is further to be seen in various forms on relief brooches and mountings from Scandinavia, Hungary, England and France. Werner mentioned the mountings from Söderby Karl as an example of diagonal symmetrical composition together with a representation of the exchangeability between human and animal limbs (Werner 1962:98 pp.; also Vierk 1967:118, note 63). Vierk maintains that in representation of pairs of humans the two men are usually apparently united (in the case of Snartemo through the hair plaits). This is a well-known motif which is widely distributed in Scandinavia, England and on the continent (map in Vierk 1967: Abb. 9). A composition repeated several times, not least on relief brooches, is a pair of men linked together with a pair of serpents. Vierk gives some examples of the combination of men and serpents, "Wurmkampfmotiv", and mentions the Grönby brooch and a couple of examples from England. He does not give any interpretations here but suggests that the human pair, as expressed in Snartemo, might derive from ideas about serpents acting in pairs that have been transformed into a human pair (Vierk 1967:118, Abb. 5; Fig. 25). As for the Grönby brooch and others, the question is of course again whether two men and two animals are depicted or if it is one and the same representation that is repeated and reverted.

The serpent pair is a well-known motif, not least as heads with wide-open mouths protruding at both sides of the foot of relief brooches. That the heads with gaping mouths on relief brooches actually are serpents is obvious, according to Vierk, who compares the heads with the full-length figures on the relief brooch from Lunde, Vest Agder (Haseloff 1981: Taf. 6:2) and the bracteate from Vå, Scania (Fig. 26). Vierk maintains the dua-



Fig. 25. Embossed foil with human pair from Snartemo, Vest-Agder, Norway. Photo: L. Smesstad, UKM, Oslo. 2.8x2.8 cm.



Fig. 26. Gold bracteate from Vå, Scania. Photo: ATA, Stockholm. Diam. 3.5 cm.

listic character in Germanic mythology, with the serpent as a dangerous monster and at the same time a protective being. The representation of paired serpents on sword scabbard mountings, on “Pferdestirnanhänger” and on bracteates shows the connection to amulets, thus indicating the protective aspect of the serpents (Vierk 1967:114 ff.; see further Johansen 1997:63 pp.; Vierk uses the term *Worm*, which can be translated as “dragon serpent”, see e.g. Johansen 1997). Vierk mentioned a number of examples of how especially serpents with two heads and a common body should be interpreted as protective. As a well-known example he cites the two-headed serpent extended over the helmet from Sutton Hoo and the similar motif on the gold bracteate from Vå (Vierk 1967:121 pp., Abb. 6). A later representation of the same motif is found on the S-shaped brooches from the Merovingian period, which are frequent not least in Uppåkra (40 items by 8 August 2002; Rundkvist 2003).

Representations of a human being together with a serpent, or serpents, are quite abundant on relief brooches and have been

discussed frequently, and the interpretations suggested are highly diverse because of the ambiguous signification of the serpents. Alenstam and Magnus see the animal as a monster. Alenstam interprets the bent and twisting animal and man on the Grönby brooch as a struggle, possibly an illustration of the Beowulf epic (Alenstam 1949:214). Vierk agrees with this interpretation and puts forward other examples that, according to him, strengthen Alenstam’s interpretation as a struggle representation. He also emphasizes a related struggle scene on the Snartemo sword (Vierk 1967:121). On the other hand, Vierk sees the animal heads with wide-open mouths over the human figures on the Grönby brooch, as well as other representations of the same kind, as protecting, “in ihre sympatische Wirksamkeit einbezogen” (Vierk 1967:105). However, according to the interpretation of the Grönby brooch, Haseloff has another opinion. He thinks that, as the man clasps his own body and the animal bites its own tail, it could hardly be a struggle motif. Haseloff sees an intertwined animal close to an intertwined human figure and believes

that we cannot come further (Haseloff 1970: 28). An interpretation of the big serpent is of course that it represents the Midgard serpent. In an attempt to interpret the iconography on the relief brooch from Ekeby, Malsta in Uppland, Magnus stresses that the decoration gives a conventional impression of violence and chaos with monsters that attack humans as well as each other. Gaping jaws with rows of long teeth are a conspicuous feature. There is a whole group of relief brooches which show a human being in the mouth of a zoomorphous head. Brooches with this motif are known from Denmark, Norway and Germany. Possibly this is to be seen as a Ragnarok representation (Magnus 2001a:286 p.).

The figure foils from Uppåkra show the human head in the mouth of the animal. The lower jaw is concealed by the human head and the hand of the human being grips around the tail of a serpent, but not of the one that keeps its mouth open over his head. This gives the impression of an engulfing representation, the body of the serpent twisted around the neck of the men gives the impression of strangulation. Along the sides of the figure panels there are two human legs with a foot each, which might be compared to the representation on certain relief brooches with separate limbs, the Ekeby brooch, for example. Perhaps it is also conspicuous that the human hand is depicted with four fingers but without the spread thumb, which otherwise is a characteristic feature. The isolated arms on the Ekeby brooch show the same trait, four fingers and also a bulge on the wrist, possibly representing an arm ring, but no thumb (Magnus 2001a:286). The question is how important it is whether the hand is shown with a thumb or not. The thumb is thought to indicate humanity in contrast to the paws of animals (Capelle 2004). The iconography

on the Ekeby brooch with separate limbs and hands without thumbs in combination with monsters was interpreted by Magnus as a Ragnarok representation. A fundamentally different interpretation is given by Arrhenius (2001:307). She thinks it is a representation of the sacred marriage, ultimately with reference to the Osiris myth. The spread limbs of Osiris are collected by Isis (Freyja) and he comes to life again with a kiss (Arrhenius 2001:307). So, both interpretations refer to someone in distress and the thumbless hand might be an indication of this. If this is correct, the Uppåkra beaker could also show humans under attack from monsters. On the other hand, Vierk sees the animals with gaping mouths over the human body on the Grönby brooch as protective beings, again showing the possibility to interpret the iconography in diametrically different ways.

Karl Hauck and Alexandra Pesch have emphasized the back-bent legs of the human figures, which can be compared to representations on a number of B-bracteates, e.g. IK 61, 104, 176, 195 and others. The iconography on the bracteates is interpreted here as the contrast between the strong/good (Odin?), coming from above and defeating the evil powers, which come from beneath (Hauck & Pesch, letter of 26 September 2002).

The second picture panel on the Uppåkra foils, with entirely zoomorphous representations, is even more difficult to understand than the first one. An obvious feature is the image of two elongated *en-face* faces with oval eyes, big nostrils and pointed ears. They are also arranged in opposite directions. As mentioned above, they have parallels on relief brooches. Representations in Style I typically show *en-face* faces composed of two faces in profile. As for the Uppåkra faces, it is obvious that they are divided lengthwise by an empty

space. As a matter of fact the only place on the whole figure foil where the pattern is open, where there is empty space from one long side of the band to the other, is actually through these faces. It is possible to see two faces in profile, combined to make one *en-face* face. Vierk mentions some examples of the same manner of representation on the relief brooches from Gummersmark and Bifrons (Vierk 1967:137, Abb. 8). The Gummersmark example is especially interesting in this respect, as the face here is divided lengthwise by a strip (Fig. 22). The Uppåkra heads are just as clear examples as those referred to by Vierk and can be seen in the same way. The composition within this picture panel is moreover a good example of transformations. The centrally placed animal body seems, through the neck outlines, to be able to connect to both *en-face* faces at the same time because lines from the *en-face* faces towards the short sides of the panels could also be interpreted as neck lines. On each of the short sides of the panels there are also animal legs with paws. The representation might be seen as an expression of a principle of duality of a kind well known in ethnology, described by Lévi-Strauss (Vierk 1967:138 with references). Siv Kristoffersen has demonstrated that this principle of decoration, especially connected to rim mountings of sword scabbards, “split representation” as she calls the principle of representation, following Lévi-Strauss (Kristoffersen 1995:10, Figs. 8, 9, 11). It is not clear how these objects, made of gold foil and decorated with filigree and granulation, actually were used. They are not worn as would have been expected if they had been mounted on scabbards. They have never been found on swords and have so far not been found in graves but in contexts interpreted as hoards or votive finds (Kristoffersen 1995:2

f.). The connection between “split representation” and the sword scabbards might be connected to its ritual significance (Kristoffersen 1995:11). With reference to Lévi-Strauss, Kristoffersen says that the animal is divided and spread out over the surface. The entire animal is depicted from different perspectives because the picture does not represent the animal but actually is the animal. This agrees with the discussion above about the human profile faces and the diagonal symmetrical composition. Also separate limbs from animals and humans can be seen in this way.

An evident example of this type of representation is seen on the sword scabbard from Åmdal, Lista, Norway, analysed by Holmqvist. The mounting is made of gold with decoration in filigree and granulation. In the middle there is a facial mask with bulging cheeks. If we draw a line vertically over the face we will instead get two human faces in profile, rubbing their noses against each other. From the faces the necks of two complete animal figures protrude. On each side, finally, there is a small human figure with profile faces and an arm with a hand and a thumb (Holmqvist 1977:36 p., Fig. 41).

Kristoffersen has also registered a difference between the decoration of the sword scabbards and the decoration on the relief brooches, as the symmetrical composition is often broken on the relief brooches whereas this never seems to be the case with the sword scabbards. The broken symmetry is shown in details, that for example, one animal has ears and the opposite animal does not (Kristoffersen 1995:8 p.). In this respect again the representations on the figure foils are closer to the representations on the relief brooches, even if we might have expected the opposite as the representations of the figure foils, such as the scabbard mountings, occur on regu-

larly rectangular surfaces. The profile animal heads on the Uppåkra foils, for example, have differently executed ears. A thoroughly accomplished “split representation”, according to Kristoffersen, does not occur on objects which were worn by women, and these are the majority of objects with animal decoration (Kristoffersen 1995:15).

A zoological identification of the animals depicted in Style I is of course hazardous. A quadruped might change into a serpent-like creature, a serpent can have ears, as in Uppåkra, or possess one or a couple of legs. Anatomical details are depicted decoratively rather than naturally. The *en-face* faces from Uppåkra, with their elongated shape, pointed ears and big nostrils, are however most likely representations of horses.

Pairwise representation, human being–animal (horse), characterizes the figure foils from Uppåkra. The linking together of the two motifs gives an endless sequence. Haseloff (1970) emphasizes movement in this type of representation, and it is not far-fetched to apprehend the representation on the Uppåkra foils as an eternal movement. The motifs, paired humans, *en-face* faces and animals with wide open mouths are all found on the Gummersmark brooch. All elements on the Uppåkra foils are also to be seen on the mountings from Söderby Karl. A relief brooch from Bifrons, grave 63, shows a quadruped, horse and human being in a representation related to the embossed foils from Söderby Karl as well as those from Uppåkra (Roth 1986: Abb. 9).

Both Haseloff and Roth maintain that the representations on gold bracteates as well as on relief brooches should be seen as pictures with a healing character, bringing fortune, auspicious signs or meanings (Haseloff 1970: 36; Roth 1986:12). The themes on the bracteates go back to conceptions which probably

already existed for a long time as oral traditions (Roth 1986:10).

If we go back to the three different thematic representations mentioned above, we can state that in both content and structure the Uppåkra foils, like other embossed figure foils, show the closest relation to the relief brooches and to a certain extent to the gold bracteates. Relief brooches and gold bracteates have been seen as healing and protecting objects. Both belong to the female sphere and the representations have largely been connected to ideas about Odin.

Dating

There are many problems concerning the dating of the hoard in the house. The context, the house in itself and other finds such as the gold-foil figures, give an average chronological frame, although very wide as the house seems to have existed for several centuries. But even if we can state during what phase the beaker and the glass bowl were deposited, this is still of limited help. The objects might have been old at deposition and they are also not necessarily contemporaneous. Regarding richly furnished graves it has often been stated that especially prestigious objects, weapons, beakers or brooches were old when deposited (e.g. Hougen 1935:26; Kristoffersen 1997:13).

First and foremost we must consider the possibility that the beaker was not manufactured on one single occasion. It is quite possible that the metal beaker was only later given the embossed foil bands, possibly also with the profiled silver strips. The small piece of embossed foil with a human face, which did not fit into the foils on the beaker, might derive from an earlier decoration of the beaker. A further complication is the dating of

the embossed figure foil bands. A prerequisite for them is patrices of some kind. Patrices, especially if they are cast in metal, may have been used for a long time, been transmitted over vast areas and not least been modified (cf. Werner 1970). Details could have been added or removed when an old patrix emerged again with the aid of e.g. wax model and moulds. (Cf. also Shepherd's critical comments on the possibility of dating objects from this period at all; he maintains that it is *de facto* impossible to obtain an absolute dating for Migration Period objects. An element of relative dating might be accepted for individual sites, according to Shepherd, but these cannot be transferred beyond the limits which the material itself sets, 1998:12 pp., 24.)

For dating of the beaker itself there is hardly anything more than analogies in shape and decoration to be used. The shape of the beaker is connected to the late antique glasses dated to period IV–V or possibly VI, Roman Iron Age–Migration Period (Näsman 1984 and above). The Uppåkra beaker is made of metal and with a shape that resembles the glasses. This gives an indication but is not sufficient for a more accurate dating.

The profiled silver strips have close parallels among the hack silver in the Høstentorp hoard. However, their shape is rather simple and thus difficult to use for dating purposes. Similar strips are also known from much later contexts, for example, in Viking Age silver hoards. The correspondence to the strips in the Høstentorp hoard show that details on the beaker can be linked in a South Scandinavian context and does not contradict a dating to the Migration Period.

The embossed foils are decorated in Style I and various elements show connections to elements on relief brooches in Style I. Bakka discusses the brooches from Gummersmark,

Bifrons grave 41, Vedstrup and others and states a connection between them. He divides early Style I objects into two chronological groups, with the animal head in wood from Vimose and the relief brooches from Gummersmark and Tveitane viewed as somewhat older than the relief brooches from Engers, Vedstrup and Bifrons 41 (Bakka 1958:39). The so-called Kent master immigrated, according to Bakka, to England around 500, which gives a chronological basis for, among other things, the brooch from Bifrons (Bakka 1958:57). In several respects the embossed foils from Uppåkra show connections to both groups.

Haseloff divides Style I into four phases, A–D. The first phase, A, is characterized by animal figures with rounded bodies and a typical shape of the head, known as Vimose heads after the wooden head mentioned above. In phase A figures composed of humans and animals also occur (Haseloff 1981:707). Solid animal figures are also characteristic, and the fact that the animals usually are depicted complete, with head, neck, body and legs (Haseloff 1981:175). Among other things, Haseloff assigns the relief brooches from Gummersmark and Bifrons 41, together with the embossed foils from the glass beaker from Snartemo V and the embossed foils from Rimestad and Söderby Karl, to phase A. He sees the Gummersmark brooch as the classical expression of phase A. Phase B likewise has crawling quadrupeds but these have, instead of a rounded, plastic body, a flat body, striped between the outline lines. Haseloff refers the relief brooches from Grönby and Vedstrup, together with the Kirchheim brooch and others, to phase B (Haseloff 1981:175 pp.). Geographically phase B with its striped animal bodies seems to show a concentration in the Baltic area (Haseloff 1981:

707). Phase A, according to Haseloff, is the common ground from which the following phases of Style I have developed. This is also the only phase that follows directly after the Nydam Style. In phase B the animals show the same compact shapes as in phase A. A new feature is that the bodies of the animals, still depicted with outlines, are now filled with raised stripes (Haseloff 1981:180).

According to the classification by Haseloff, the Uppåkra foils should be referred to an early part of the Migration Period with traits related to phase A as well as to phase B. The execution of the striped animal body and double outlines and the animal heads, the heads in profile as well as those *en-face* makes it appropriate to put them in the same horizon of time as the brooches from Grönby and Vedstrup. The representations on the foils also have parallels on objects assigned by Haseloff to phase A, especially the Gummersmark brooch and the mountings from Söderby Karl.

The difficulty in obtaining an absolute dating of early Style I and connected objects is well illustrated by the Gummersmark brooch, dated by Montelius to the beginning or middle of the 5th century, by B. Almgren to the 5th century, by Salin to the end of the 5th century, by Åberg to the early 6th century and by Mackeprang to the 6th century (Voss 1955:179).

Bakka refers to Nissen Meyer's division of the relief brooches into six stages. The Gummersmark and Grönby brooches belong here to stage 3, whereas Vedstrup is referred to stage 4. Bakka also puts the Bifrons 41 brooch in stage 4. Nissen Meyer dates stage 3 to the end of the 5th century and around 500 and stage 4 to early 6th century (Bakka 1958:60). with cited literature). The brooch from Bifrons grave 41 was very worn when it was

laid in the grave. The interment is thought to have been made in the middle of the 6th century and the brooch should be considerably older (Bakka 1958:69). Haseloff dates it to 500–520 (Haseloff 1981:173).

Haseloff refers the Kirchheim brooch to his phase B. The interment from Kirchheim, according to Haseloff, should have been made around 600 (Haseloff 1981:325). Through its "Zangenfries" (the border of triangles with circles at the peak), the relief brooch has an obvious South Scandinavian connection. The decoration is related to Scandinavian bracteate art and animal decoration and, according to Haseloff, is one of the foremost expressions of the Scandinavian goldsmith's art from the first half of the 6th century. He suggests that it might have been made on Zealand (Haseloff 1981:302 pp.). The brooch is one of the oldest objects in the grave and should, according to Haseloff, be dated no later than to the first half of the 6th century. It was thus about half a century old when deposited in the grave. Haseloff maintains that the deposition of old Scandinavian brooches as late as around 600 shows that they were highly appreciated, especially in the Alemannic area. It seems that animal decoration, together with the closely connected bracteate decoration, was valued as a talisman or amulet because of its magic-religious content, even though the lady in the Kirchheim grave was a Christian, as the gold-foil cross obviously testifies (Haseloff 1981:325).

Phase A is thus, according to Haseloff, the introduction to Style I. It replaces the Nydam Style, thereby being the beginning of a Germanic art which had liberated itself from the Roman heritage. Haseloff thinks that this process might have taken place about 475 and that early Style I was developed during the last decades of the 5th century (Haseloff

1981:172). He also thinks that phases A and B run more or less parallel and together constitute early Style I. The execution of the animals in the later phases, C and D, is clearly different from that of the early style, with band-shaped animals and a more dissolved decoration. The various elements on the Uppåkra foils correspond mainly to phases A and B. There is a certain tendency towards a dissolved decoration that is difficult to interpret, which possibly points forward towards younger Style I. Stylistically the Uppåkra foils belong to the early Style I but have a younger character than e.g. the mountings from Söderby Karl.

Thus, the shape of the beaker shows traditions which are older than the style of the embossed figure foils. But as we do not have any accurate parallels to the beaker we do not know anything about the time of manufacture of metal beakers in shapes connected to late antique glasses. The embossed foils belong stylistically within the older part of Style I, somewhere in the late 5th century or around 500 AD, if we accept Haseloff's dating. However, we must consider the possibility that the figure foils are a later addition to an older beaker.

The background to the development in South Scandinavia

Style I represents the first independent Scandinavian achievement that has liberated itself from late antique models. Haseloff has convincingly demonstrated that the development of Style I, with a background in the Nydam Style, is clearly connected to South Scandinavia (Haseloff 1981:706, 1986:86). Roth

maintains that the development of an independent figure art proceeded in similar ways in South Scandinavia and in the Slovakian–Hungarian area. That the development of the first figure art took place precisely in these regions is explained by Roth as showing that these areas were not immediate neighbours of the Roman-Germanic conflicts, but were exposed to influences from the Provincial Roman area and probably also had contacts with artists and, for example, also access to stamps, patrices etc. from the former Roman provinces (Roth 1979:45 pp.).

Joachim Werner maintains that the external conditions were especially favourable in South Scandinavia. He emphasizes the connection between the early runic script and the pictorial art. Runic inscriptions on metal objects, dated before 300, occur in South Scandinavia from Scania to Jutland whereas the area with Germanic pictorial art in the 3rd century was considerably larger, from Estonia and Norway to Silesia and Slovakia. On the other hand, Werner points out, the core area with the technically and qualitatively most important works is not so extensive but restricted to the same South Scandinavian region between Himlingøje (Zealand) and Thorsbjerg (Schleswig) from which also the runic inscriptions originate. Conclusive here was close contact with the Roman world, a favourable position in long-distance trade, the self-consciousness of the local nobility and not least the creative ability of local artists and runic masters. Werner emphasizes that the process towards the independent style was prolonged. It lasted two hundred years until the successors of the Hoby chief themselves were able to create pictures and started to use script. The development of an indigenous epigraphic script is an obvious parallel to the development of an indigenous

pictorial art. The development of picture and script was thus an expression of one and the same changing mental concept. Werner looks at it as some kind of emancipation process. Pictures and script give a personal meaning to the individual, as healing images on ornaments and weapons or as magic inscriptions to protect the owner and his weapons. Thus, they worked as a visible expression of the individual's personality and as a personal relation to the protecting divinity. This step was taken earliest, Werner maintains, in the South Scandinavian region (Werner 1966:34 pp.).

If we assume that style carries meaning, a change of style and especially the development of a new style must have a central signification concerning social and political changes, as Hedeager maintains (1999:223). She thinks that the early Nordic iconography must have had an organizing role in the establishment of the new Germanic realms and worked as an active part in political legitimation. The stylistic expression is highly involved in the social strategies that shape relations and ideologies. Control of style is thus a part of the control of the social reproduction, in the legitimation of power and thus a part of the cosmology of society (Hedeager 1995: 225 pp.). Siv Kristoffersen maintains that Style I develops in a period characterized by sociopolitical changes and with the emergence of a more complex type of society. The development of the style expresses a demand to create an independent Germanic expression and was probably a part of an identity-creating process. So, the style may have played an important part in social and political strategies, e.g. to regularize the relations of power between various groupings (Kristoffersen 1992:40 p.; 1997:202 pp., 241 pp.).

Within Style I local variation has since long been recognized. Bakka emphasizes that

the creative activity expressed in Style I has two centres: southern Norway and Denmark. His examples from the Danish centre are relief brooches like those from Gummersmark and Vedstrup, which show close mutual relations. The Danish centre moreover has close relations to southern England; the Kent master, the creator of objects such as the Bifrons 41 brooch belonged to the same group of artists as the one who made the Vedstrup brooch. Maybe they also knew each other (Bakka 1958:42, 55).

Glass beakers repaired with embossed foils in Style I show a marked concentration in south-western Norway. A close analysis of the foils also shows a connection between those glasses (Straume 1987:50; cf. Näsman 1984 on the concentration of glasses in Norway).

From the decoration Straume divides the foils from glass beakers into two groups. The first one comprises the foils from the beakers from Rimestad, Snartemo and Vestly. They share the representation of crouched humans and animals and hands with spread thumbs. The mountings from Rimestad and Snartemo are most closely related, in figure representations as well as in the beaded border that encloses the figure panel. Already Hougen noticed the relation between these foils and the middle part of the sword grip from the Snartemo V grave. They might derive from the same workshop. The band-shaped animal friezes from Solberg also show agreement with Snartemo and Rimestad.

To the second group Straume assigns the mountings from Kvasshem and Haugestad with animal figures without anthropomorphic details. The composition and striped details correspond to pieces of work in early Style I. Common for both groups are the division into figure panels, the animal friezes and the beaded border decoration. Gold or

silver were used in both cases. Probably both groups originate from related workshops, which is also indicated by the distribution of the items. Hougen suggests a local goldsmith tradition in south-western Norway, and that those figure foils were produced in a workshop in the region (Hougen 1935:34 pp., 51 pp.). It is conclusive, as Straume points out, that the Vestly foils obviously were found in a goldsmith's grave (Straume 1987:52).

The Scandinavian style arrived on the continent by various routes. The Rhine estuary region was a transmission area and the Rhine served as a communication link. It was in the Rhine estuary region that Style I was accepted and further developed by Frankish goldsmiths. Also the Alemannes in south-west Germany obviously played an important part in this process. Besides the Rhine area there was also a centre in Thuringia shown in a concentration of Scandinavian brooches and bracteates. The communication links might have gone via the Elbe and Saale (Haseloff 1970:37). Haseloff discusses where the Kirchheim brooch was produced. He is of the opinion that it was made in the core area of the B-bracteates, that is, in South Scandinavia, Jutland, the Danish islands and Scania. The "Zangenmuster" shows a concentration in Zealand. However, Haseloff maintains, the region suffers from a scarcity in finds which makes it difficult to discuss the origin (Haseloff 1981:319). The abundance of finds in South Scandinavia is rapidly changing now, however, through new finds, mainly from settlement sites and central places. The find contexts are new and show on the one hand depositions at settlements and on the other hand residue from metal handicraft.

Several of the so-called central places in South Scandinavia emerge in Late Roman Iron Age. The central places indicate a new

type of societal organization and larger social and political units than earlier (Helgesson 2002:143). For Scania Helgesson outlines five central areas, with Uppåkra appearing as the most prominent place with a more complex settlement structure in the neighbouring region than what is seen in the rest of Scania (Helgesson 2002:156). Kristoffersen discusses the difference in the distribution pattern between the Nydam Style and Style I. The Nydam Style is homogeneous and widely distributed whereas Style I, mainly the relief brooches, show quite a different pattern of production with obvious local variations. She also thinks that the Nydam Style functioned as a more general marking of position and regulation of the relations of power in political centres. The style represents a Scandinavian expression related to continental expressions, which were also common for a higher social class. Style I worked within a power political context where, in connection with the development of larger political units, it was a part of the distribution of power through political relations. This is expressed in the considerably more obvious local variations within Style I (Kristoffersen 1997:47 p., 241). Probably it also shows something of the organization and the movements of artists and craftsmen (cf. Lund Hansen 1970:93). Carnap-Bornheim sees the Migration Period goldsmith as highly mobile but at the same time also dependent on access to valuable raw material. This probably promoted a close relation between the goldsmith and his employer (Carnap-Bornheim 2001:276). The emergence of the central places in South Scandinavia gave demand as well as possibilities for more permanently working craftsmen and more permanent workshops.

The beaker, context and interpretation

We thus have a creative development in the artistic field in the Migration Period in South Scandinavia, mainly expressed in the creation of Style I. The Grönby brooches (Fig. 27) could have been made at one and the same place and at the same time, perhaps by the same person. The two brooches together show a strong mixture of old and new, of provincial and foreign (Alenstam 1949:220). Bakka writes about “The South Scandinavian school of the Grönby brooches” (Bakka 1958: 48).

The two Grönby brooches have several connections to the Uppåkra beaker and to other contemporary objects from Uppåkra. The plain foot brooch from Grönby, with its representations of animals and humans, has motifs in common with the beaker. The brooch with roof-shaped foot from Grönby, with its plastic animal heads, shows a connection to the serpent-decorated pendant from Uppåkra. The relief brooch from Uppåkra, found in 1999, is very closely connected to the brooch with roof-shaped foot from Grönby, but, according to Magnus, it was scarcely hardly produced in the same workshop or by the same craftsmen. Both, however, belong to an early group of relief brooches from Scania, with strong ties to Denmark (Magnus 2001b: 176 p.). Around the rectangular head plate the Uppåkra brooch has closely placed triangles crested by a circle. This motif is above all known from the mausoleum of Theoderic the Great at Ravenna, but occurs also, as mentioned above, on a number of relief brooches (Haseloff 1981:301 pp.; Magnus 2001b:176). The Theoderic motif connects the Zealandic brooches from Vedstrup and Gummersmark with the Uppåkra brooch. From the distribution it is obvious that the ornament has its

centre in South Scandinavia with a concentration in Zealand (Haseloff 1981:305).

The beaker can in several ways be inserted into a South Scandinavian context. The pictures on the figure foils may be connected to representations on relief brooches and gold bracteates. A large share of them have been found in South Scandinavia, especially in Zealand and Scania. Details such as the grooved foils and the profiled silver strips have parallels in the Zealandic Høstentorp hoard. The embossed foils of the beaker are executed in the same technique as gold-foil figures. That gold-foil figures were made in Uppåkra is beyond doubt, as patrices for making them have been found there. Thus the representations, as well as some technical elements, connect the beaker to the region. There is no doubt that all the technique required to make the beaker existed locally. So, the beaker might have been made in the region and if so, in all likelihood in Uppåkra. As mentioned above, embossed figure foils seem to have been produced regionally, for example in East Zealand, in south-west Norway and East Anglia.

An appropriate question is whether the beaker was made on a single occasion or if the embossed figure foils especially are a later addition. The shape shows associations, as mentioned above, with late antique glasses, above all conical foot beakers, dated by Näsman to period VI. The embossed figure foils belong to the same group of decorated objects which Haseloff refers to his phases A and B of Style I. Shape and decoration may thus be contemporaneous, although we cannot rule out the possibility that the embossed foils were added later and do not belong to the original design. They appear now and then somewhat “pasted” as they partly cover the edges of the silver strips. It could of course also be the case that



Fig. 27. Relief brooches from Grönby, Scania. Photo: Bengt Almgren, LUHM. 11 and cm. 11.8 cm.

the craftsman had only one special patrix, which gave a certain width to the embossed foil band. Perhaps the fragment of embossed foil, with a face representation that did not correspond to the figure foil band on the beaker actually belonged to an earlier decoration of the beaker or parts of it. The tradition of making drinking vessels in metal is known since the Late Roman Iron Age in Zealand.

Uppåkra in the 5th–6th centuries appears as an extremely distinguished centre with finds like gold bracteates, gold-foil figures and patrices for making these, continental garnet brooches, glass, ornaments and weapons of

the highest quality together with local ornament production (Hårdh 2002). Places where gold bracteates and gold-foil figures occur are usually in a favourable location for communications, they played a highly important part in pre-urban long-distance trade, they were connected to political power and religious centres and, together with theophoric place-names, as parts of a sacred topography (Hauck 1992: 231). Analysis of metal handicraft has shown beyond doubt an advanced and experimenting craft with a start not later than the Migration Period (Kresten *et al.* 2001). One gold bracteate from Uppåkra belongs to a small

group of related representations which are concentrated in south-western Scania (Axboe 2001:174). The technique as well as the social environment thus was available as a context for the manufacture of the beaker. The house where it was found, with its manifold ritual elements, give the ideological frame for this unique object.

Steuer discussed the possibility of tracing the retinue and its leader, “Gefolgschaftsführer”, through the archaeological record. He viewed the ring swords as symbols of loyalty and weapon fellowship, above all manifested by the two connected rings on the sword pommel. The two rings are sometimes also associated with other objects such as shields or drinking horns (Steuer 1992:208). As a predecessor of the ring swords he mentions the gold-grip spatha, “Goldgriffspatha”, from the late 5th century. This is usually seen, he maintains, as a sign of rank for the highest levels in society. To the same group of objects he assigns gold rings, drinking horn mountings and ornament discs for shields (Steuer 1992:211 p.). Among the detector finds from Uppåkra, there is actually a fragment of a sword handle decorated with garnet and gold, a part of a “Goldgriffspatha” (U28726, Fig. 28). It is a fragment of a German “Goldgriffspatha” of the type Flohenheim-Gültingen (identification by B. Arrhenius, see further Arrhenius 1985).

The decoration on the beaker shows, as previously stated, connections with representations on gold bracteates and above all on relief brooches. The relief brooches belong to the female sphere. Kristoffersen maintains that Style I appears on objects to a large degree connected to women. She therefore thinks that Style I was linked especially to women and to a special group of women (Kristoffersen 1992:41). The picture that is



Fig. 28. Fragment of a “Goldgriffspatha”, Uppåkra, U28726. Photo: Bengt Almgren, LUHM, Lund. Length 2.9 cm.

evoked by Norwegian relief brooches shows a wealthy woman belonging to a warrior aristocracy with broad contacts, open to outside influences and with great mobility over large areas. The graves are often connected to big farms or manorial farms. The grave furnishing could indicate that the woman supervised the resources of the farm, executed or administered textile handicraft and probably also had religious functions (Kristoffersen 1992:53; 1997:194 pp.).

The gold bracteates in Scandinavia have been found in deposits but on the continent and in England they belong to women’s graves. The gold bracteates indicate various functions for precious metals in the Late Roman–Early Mediaeval society, social status, political power and symbolic meaning. Their role as amulets has been pointed out several times. Gaimster sees them as an expression of social relations directly associated with women. She maintains that this idea is a challenge to the traditional apprehension of a society founded on warrior ideology. Probably the bracteates indicate a strong female position and an important political role as representative of the family and as individuals with wealth and power (Gaimster 2001:152).

The beaker as a phenomenon is depicted several times in connection with so-called Valkyria representations, i.e. a picture showing



Fig. 29. Gold-foil figure from Uppåkra. Photo: Bengt Almgren, LUHM, Lund. Length 1 cm.

a nobly dressed woman with a beaker or a drinking horn in her hand. The motif is well known, for example, on gold-foil figures, also from Uppåkra (Watt 1999, Fig. 2; Fig. 29). Enright emphasizes, based on written and archaeological source material, that “the noble wife” who serves the drink to the retinue in the hall incarnates authority in home and hall. He characterizes the structure of power in the Migration Period as a warrior aristocracy carried by men with power, whereas the symbols of power to a high degree are sustained and organized by women. They created stability and legitimized the power structure (Enright 1996:53). It is interesting in this respect that the representation of a woman with a drinking horn occurs on the longer gold horn from Gallehus together with intertwined serpent pairs. The twin representation, two warriors with sword and shield, occurs on the shorter horn from Gallehus (Brøndsted 1966: 324). Beakers and other drinking vessels often appear as pairs, in a number of male graves, Snartemo, Högom, Taplow, Sutton Hoo and others, from central Scandinavia and England, which also might show other customs of deposition than in South Scandinavia. Steuer sees the graves with the dead as host at a banquet as an expression of a *Gefolgschaftsführer* (Steuer 1992:212 pp.). Steinsland states, in connection with an analysis of

representations on gold-foil figures, that the pre-Christian society apparently stressed the interplay between male and female powers as the fundamental element of life. In the alliances and interaction between male and female power lies the key for understanding the pre-Christian mythology and ideology (Steinsland 1990:86).

The rich collection of pictures is a fascinating and challenging element. They arouse associations with the representations on bracteates and relief brooches, seen by some scholars as healing and curative forces, as amulets. Horses, ravens and serpents have often been connected with Odin (Davidson 1993:77, Fig. 9; Hauck 1977:502 pp., 1980: 35 pp.). The destroyed weapons, mainly lances, which have been found north and south of the Uppåkra ceremony house, strengthen this association. Odin was apparently first and foremost a god for aristocratic warriors, like the Roman god Mercury a protector of kings and warriors. The importance of Odin was also strengthened as the king became the central figure in society (Davidson 1993:787, 100). Several Germanic princely families also claimed a divine origin, usually from Odin (Axboe 1994:155).

Conclusions

The Uppåkra beaker is a spectacular find. It is unique and the pictorial world on it fires the imagination. The new find is also important in various respects. So, it is appropriate to consider the role Uppåkra and other central places played in the development of Style I, especially in the Scania–Zealand region.

It is especially valuable that the beaker was found in a manifest context, which makes it possible to discuss its function in a more qualitative way. The beaker as such might be

connected to Valkyria representations, especially as it derives from a context where gold-foil figures were also found. Thus it is tied to organized cult, ceremonies and royal and religious centres. Its decoration of precious metals, gold and silver, is logical in this respect. The representations on the figure foils – the dragon serpents and the engulfing motif, the diagonal symmetry, the pairwise representation and the element of transformation – contain the code for the interpretation of the iconography and the find as a whole.

The development of Style I and the development of the South Scandinavian central places are two interlinked phenomena. With the discovery of the central places we now have the context where the development of the style took place and the context where the demand as well as the prerequisites for the new style existed. Uppåkra is an obvious expression of these events.

Acknowledgements

I wish to express my sincere thanks to Morten Axboe and Torsten Capelle, with whom I have discussed the interpretation of the figure foils and who opened my eyes to several elements, although we might not agree on all details.

References

- Åberg, N. 1926. *The Anglo-Saxons in England during the early centuries after the invasion*. Uppsala.
- Alenstam, B. 1949. Zwei Reliefsplatten aus Grönby, Skåne. *Meddelanden från Lunds Universitets Historiska Museum*, 69–113.
- Almgren, O. & Nerman, B. 1914. *Die ältere Eisenzeit Gotlands*. Erstes Heft. Kungl. Vitterhets Historie och Antikvitets Akademien. Stockholm.
- Arrhenius, B. 1985. *Merovingian Garnet Jewellery, Emergence and Social Implications*. Kungl. Vitterhets Historie och Antikvitets Akademien. Stockholm.
- 2001. Beliefs behind the use of polychrome jewellery in the Germanic area. Magnus, B. (ed.), *Roman Gold and the Development of Early Germanic Kingdoms*, 297–310. Kungl. Vitterhets. Historie och Antikvitets Akademien. Konferenser 51. Stockholm.
- Axboe, M. 1994. Goldbrakteaten und Dänenkönige. Keller, H. & Staubach, N. (eds.), *Iconologia Sacra. Mythos, Bildkunst und Dichtung in der Religions- und Sozialgeschichte Alteuropas. Festschrift für Karl Hauck zum 75. Geburtstag*. 144–155. Berlin.
- 2001. En C-brakteat fra Uppåkra. Hårdh B. (ed.), *Uppåkra. Centrum och sammanhang*, 169–175. Uppåkrastudier 3. Lund.
- Bakka, E. 1958. On the beginning of Salin's Style I in England. *Universitetet i Bergen Årbok* 1958, 4–83.
- 1963. Gullpressblekket fra Vestly. *Fra Haug og Heidni. Tidsskrift for Rogalands arkeologiske forening* 1963, no. 1, 207–213.
- Brøndsted, J. 1966. *Danmarks Oldtid* III. Copenhagen.
- Bruce-Mitford, R. 1972. *The Sutton Hoo Ship-Burial. A Handbook*. 2nd ed. London.
- 1975. *The Sutton Hoo Ship-Burial*. Vol. 1. London.
- Capelle, T. 2004. *Die verborgenen Menschen in der germanischen Ornamentkunst des frühen Mittelalters*. Scripta Minora, 2001–2002:1. Lund.
- Carnap-Bornheim, C. v. 2001. The social position of the Germanic goldsmith A.D. 0–500. Magnus, B. (ed.), *Roman Gold and the Development of Early Germanic Kingdoms*, 263–278. Kungl. Vitterhets. Historie och Antikvitets Akademien. Konferenser 51. Stockholm.
- Davidson, H. E. 1993. *The Lost Beliefs of Northern Europe*. London.
- Engelhardt, C. 1867. *Kragehul Mosefund*. Fynske mosefund. I. Copenhagen.
- 1969. *Vimose Fundet*. Fynske Mosefund II. Copenhagen.
- Enright, M. 1996. *Lady with a Mead Cup. Ritual, Prophecy and Lordship in the European Warband from La Tène to the Viking Age*. Dublin.

- Gaerte, W. 1929. *Urgeschichte Ostpreussens*. Königsberg.
- Gaimster, M. 1998. *Vendel period gold bracteates on Gotland. On the significance of Germanic art*. Lund.
- Hårdh, B. 1999. Offerfynd på Uppåkraboplatsen? Hårdh, B. (ed.), *Fynd i centrum. Keramik, glas och metall från Uppåkra*, 127–134. Uppåkrastudier 2. Lund.
- 2002. Uppåkra in the Migration and Merovingian Periods, Hårdh, B. & Larsson, L. (eds.), *Central Places from the Migration and Merovingian Periods. Papers from the 52nd Sachsen Symposium in Lund*, 41–54. Uppåkrastudier 6. Lund.
- 2003. Uppåkra i folkvandringstiden. Hårdh, B. (ed.), *Fler fynd i centrum. Materialstudier i och kring Uppåkra*, 41–80. Uppåkrastudier 9. Lund.
- Haseloff, G. 1970. Goldbrakteaten – Goldblattkreuze. *Neue Ausgrabungen und Forschungen in Niedersachsen* 5, 24–39.
- 1981. *Die germanische Tierornamentik der Völkerwanderungszeit. Studien zu Salin's Stil I*. Vols. I–III. Berlin, New York.
- 1986. *Bild und Motiv im Nydamstil und Stil I. Zum Problem der Deutung frühmittelalterlicher Bildinhalte*. Sigmaringen.
- Hauck, K. 1977. Zur ikonologie der Goldbrakteaten XIV. *Frühmittelalterliche Studien* 11.
- 1980. Gott als Arzt: Eine exemplarische Skizze mit Text- und Bilderzeugnissen aus drei verschiedene Religionen zu Phänomenen und Gebäuden der Heilung. Meier, C. & Ruberg, U. (eds.), *Text und Bild. Aspekte des Zusammenwirkens zweier Künste in Mittelalter und früher Neuzeit*. 19–61. Wiesbaden.
- 1992. Der religions- und sozialgeschichtlichen Quellenwert der völkerwanderungszeitlichen Goldbrakteaten. Beck, H. (ed.), *Ergänzungsbande zum Reallexikon der germanischen Altertumskunde*, 229–269.
- Hedeager, L. 1995. Myter og materiell kultur: Den nordiske oprindelsemyte i det tidlige kristne Europa. *Tor* 28, 217–234.
- 1999. Skandinavisk dyreornamentik. Symbolsk repræsentation af en førkristen kronologi. Fuglestedt, I, Gansum, T. & Opedal, A. (eds.), *Et hus med mange rom: vennebok til Bjørn Myhre på 60-årsdagen*, 219–237. AmS rapport 11. Stavanger.
- Helgesson, B. 2002. *Järnålderns Skåne. Sambälle, centra och regioner*. Uppåkrastudier 5. Lund.
- Holmqvist, W. 1951. Dryckeshornen från Söderby Karl. *Fornvännen*, 33–65.
- 1977. *Vår tidiga konst*. Stockholm.
- Hougen, B. 1935. Snartemofunnene. Studier i folkevandringstidens ornamentik og tekstilhistorie. *Norske Oldfunn* VII. Oslo.
- 1967. *The Migration Style of Norway*. 2nd ed. Oslo.
- Johansen, B. 1997. *Ormalur. Aspekter av tillvaro och landskap*. Stockholm Studies in Archaeology 14. Stockholm.
- Kendrick, T.D. 1938. *Anglo-Saxon Art to A.D. 900*. London.
- Kresten, P., Hjärthner-Holdar, E. & Harryson, H. 2001. Metallurgin i Uppåkra: Icke-järnmetaller under tusen år. *Analysrapport* 10. Riksantikvarieämbetet. Avdelningen för arkeologiska undersökningar. Uppsala.
- Kristoffersen S. 1992. Den germanske dyrestilen og kvinnegravar med relieffspenner. *K.A.N.* nos 13–14. 40–57.
- 1995. Transformations in Migration Period Animal Art. *Norwegian Archaeological Review* 28, No. 1, 1–17.
- 1997. *Dyreornamentikkens sociale tilhørighet og maktpolitiske sammenheng. Nydamstil og Stil I i Sør- og Sørvestnorge*. Bergen.
- Lund Hansen, U. 1970. Kvarmløsefundet – en analyse af Sösdalastilen og dens forudsætninger. *Aarbøger for Nordisk Oldkyndighed og Historie* 1969, 63–102.
- 1987. *Römischer Import im Norden. Warenaustausch zwischen dem Römischen Reich und dem freien Germanien*. Copenhagen.
- 1995. *Himlingøje – Seeland – Europa. Ein Gräberfeld der jüngeren römischen Kaiserzeit auf Seeland, seine Bedeutung und internationalen Beziehungen*. Copenhagen.
- Mackeprang, M. 1952. *De nordiske guldbrakteater*. Jysk Arkæologisk Selskabs Skrifter II. Aarhus.
- Magnus, B. 2001 a. The enigmatic brooches. Magnus B. (ed.), *Roman Gold and the Development of the Early Germanic Kingdoms*, 279–296.

- Kungl. Vitterhets Historie och Antikvitetsakademien. Konferenser 51. Stockholm.
- 2001 b. Relieffspenner fra Uppåkra og andre funnsteder i Skåne. Hårdh B. (ed.), *Uppåkra. Centrum och sammanhang*, 175–186. Uppåkrastudier 3. Lund.
- Näsman, U. 1984. *Glas och handel i senromersk tid och folkvandringstid. En studie i glas från Eketorp II, Öland, Sverige*. Uppsala.
- Nyhedsbrev, Marinarkæologisk fra Roskilde*. No. 9. December 1997.
- Roth, H. 1979. *Kunst der Völkerwanderungszeit*. Propyläen Kunstgeschichte. Suppl. Bd. IV.
- 1986. Einführung in die Problematik, Rückblick und Ausblick. Reitzenstein, D. v. (ed.), *Zum Problem der Deutung frühmittelalterlicher Bildinhalte*, 9–24. Sigmaringen.
- Rundkvist, M. 2003. Snake brooches of south Scandinavia. Hårdh, B. (ed.), *Fler fynd i centrum. Materialstudier i och kring Uppåkra*, 97–121. Uppåkrastudier 9. Lund.
- Salin, B. 1904. *Die altgermanische Thierornamentik*. Stockholm.
- Shepherd, C. 1998. *A Study of the Relation between Style I Art and Socio-Political Change in Early Medieval Europe*. BAR International Series 745. Oxford.
- Speak, G. 1980. *Anglo-Saxon Animal Art and its Germanic Background*. Oxford.
- Steinsland, G. 1990. De nordiske gullblekk med parmotiv og norrøn fyrsteideologi. *Collegium medievale* 3 1990/1, 73–94.
- Steuer, H. 1992. *Interpretationsmöglichkeiten archäologischer Quellen zum Gefolgschaftsproblem. Beiträge zum Verständnis der Germania des Tacitus II*. Abhandlungen der Akademie der Wissenschaften in Göttingen, 203–257. Göttingen.
- Straume, E. 1987. *Gläser mit Facettenschliff aus skandinavischen Gräbern des 4. und 5. Jahrhunderts n. Chr.* Oslo.
- Thrane, H. 1994. Goldene Schwertteile der Völkerwanderungszeit auf Fünen, Dänemark.
- Keller, H. & Staubach, N. (eds.), *Iconologia Sacra. Mythos, Bildkunst und Dichtung in der Religions- und Sozialgeschichte Alteuropas. Festschrift für Karl Hauck zum 75. Geburtstag*. Berlin.
- Vang Petersen, P. 1988. Nydam III – et våbenoffer fra ældre germansk jernalder. *Aarbøger for Nordisk Oldkyndighed og Historie* 1987, 105–137.
- Vierck, H. 1967. Ein Relieffibelpaar aus Norden-dorf in Bayerisch Schwaben. Zur Ikonographie des germanischen Tierstils I. *Bayerische Vorgeschichtsblätter* 32, 104–143.
- Voss, O. 1955. The Høstentorp Silver Hoard and its Period. *Acta Archaeologica* XXV 1954, 171–219.
- Watt, M. 1999. Guldgubber og patricer til guld-gubber fra Uppåkra. Hårdh, B. (ed.), *Fynden i centrum. Keramik, glas och metall från Uppåkra*, 177–190. Uppåkrastudier 2. Lund.
- Werner, J. 1935. *Münzdatierte austrasische Grabfunde*. Römisch-Germanische Kommission. Berlin.
- 1941. *Die beiden Zierscheiben des thorsberger Moorfundes. Ein Beitrag zur frühgermanischen Kunst- und Religionsgeschichte*. Berlin.
- 1962. *Die Langobarden in Pannonien*. Bayrische Akademie der Wissenschaften. Munich.
- 1966. *Das Aufkommen von Bild und Schrift in Nordeuropa*. Bayrische Akademie der Wissenschaften. München. Heft 4. Munich..
- 1970. Zur Verbreitung frühgeschichtlicher Metallarbeiten (Werkstatt – Wanderhandwerk – Handel – Familienbildung). *Early Medieval Studies* 1, 65–81.
- Unpublished reference: Hauck, K. & Pesch, A. Letter from 26 September 2002.

How and where was the beaker from Uppåkra made? Some indications from chemical analyses.

Lena Grandin

Abstract

The decorated beaker from Uppåkra is made of copper (alloy), coated with alternating embossed foil bands of gold, and profiled silver rings. Detailed chemical analyses of samples from the respective material categories have been compared with previous analytical results of artefacts and waste material from the complex metal workshop at the site. The chemical composition of the copper samples, silver rings or soldering alloys show little or no resemblance to previously analysed metal artefacts. The gold foils present various chemical proportions but similar distributions are common in the previously analysed artefacts as well. As far as is known today, it was possible to produce the embossed gold foils at Uppåkra but indications for the production of the other components of the beaker have not been identified previously in terms of chemical compositions. However, the technical skill previously identified among the craftsmen clearly emphasizes sufficient knowledge also for making artefacts as the beaker.

Lena Grandin, National Heritage Board, Geoarchaeological Laboratory (RAÄ UV GAL), Portalgatan 2A, SE-754 23 Uppsala

Introduction

The decorated beaker found by the Uppåkra excavations has been studied from many points of view. Some of the interesting questions concern the material and how and where the beaker was made. At the same site, a complex metal workshop has been identified and studied. Previous analytical studies (Kresten *et al* 2000, 2001a, 2001b) have shown a variety of materials and the high technical skill of the craftsmen who produced those items. Analytical work has been performed on some selected samples from the beaker in order to obtain detailed information about the composition of the various materials and to be able to distinguish the material quality of the

various components and the working techniques applied to make the final product. One of the major aims is to find out whether the beaker can be related to the work with other non-ferrous metals at Uppåkra.

Materials and methods

The beaker is made of a body of copper alloy(s), coated with alternating bands of gold and silver. Seven different samples (indicated on the sketches of the beaker in fig. 1) covering a variety of materials were selected for analysis by Hasse Hansen, Department of Archaeology and Ancient History, Lund

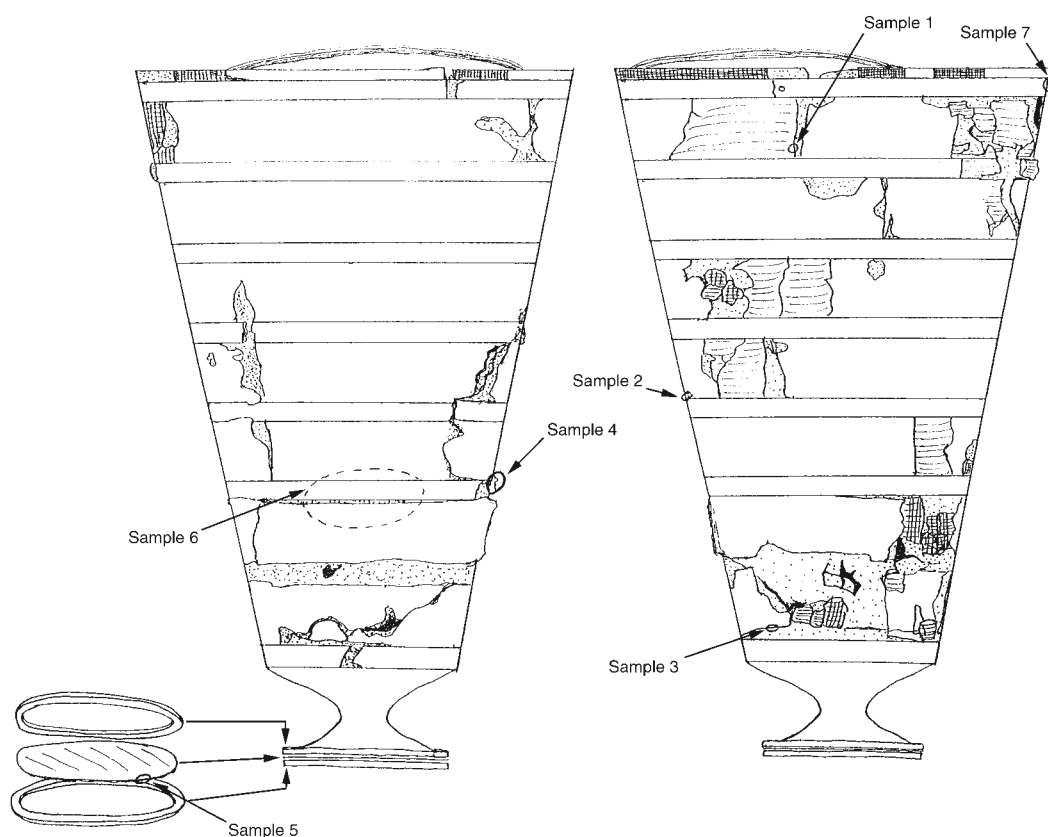

Fig. 1. A sketch of the beaker indicating the sampling sites. See also Hårdh 2004: Fig 1a-b. Sample 6 is from the interior of the body of the beaker, the other samples from the surface. The thin profiled bands are of silver, the broader embossed foil bands are made of gold.

University. Sample 1, according to the descriptions, is from the embossed foil band of gold at the mouth of the beaker. Sample 2 is from a similar type of band from the central part of the beaker. Sample 3, from the lower parts, is also from an embossed foil band, but with different ornaments than the upper ones. Samples 4 and 7 are from two separate profiled silver bands. Sample 5, from the foot, is of copper (alloy). Similar material is present in sample 6 from the interior of the beaker. Already when taken some of the samples were observed to contain several components such as gold, silver and soldering alloys.

The samples are only a few millimetres across. They were all mounted in resin and

polished to a plane surface, to enable the analysis. The orientation of the samples was also essential since it was important to polish a cross-section that included the body, the coating bands, and, if present, the soldering alloys. Metallographic analyses were performed to study the microstructure of the samples in order to distinguish various production and working techniques. Chemical analyses were carried out to reveal the chemical composition of each constituent, and whether there are variations or similarities between seemingly similar parts of the beaker.

The electron microprobe technique has been used for the chemical analyses. The technique enables quantitative chemical data on

most elements heavier than oxygen, and with detection limits usually at a fraction of one weight percent. Spot analyses yield chemical compositions of all phases present as small as 3–5 micrometres in size. Analytical routines specially designed for gold, silver and copper alloys were applied. The routines include major elements as well as minor and trace elements that are chemically and geochemically associated with the major elements in question. If phases, or areas, are too small for quantitative analyses, they can be analysed qualitatively. The analyses were made at the Department of Earth Sciences, Uppsala University, on a Cameca SX50, run by Hans Harryson. At the same time, images of the analysed areas were obtained. These images represent the back-scattered electrons and show the mean atomic weight at each point, and result in brighter colours for heavy elements, such as gold or lead, and darker colours for lighter elements, such as copper. The micrographs can be obtained at various magnifications, and are very useful in revealing minor variations in composition and can therefore be a guide to exactly where to make the analysis.

The results obtained have also been compared with metal finds from the specialized metal work at the site, previously analysed with the same method. Those finds include metal waste, bars, ingots, and various artefacts such as rings, fibulae, needles, and weights. Results from the previous studies have been presented in detail in analytical reports (Kresten *et al.* 2000, 2001a) and in summary in an earlier volume of *Uppåkrastudier* (Kresten *et al.* 2001b). A great variation in materials could be distinguished, including gold, silver, several copper alloys and soldering alloys. In addition a number of processes and techniques for working with these types of materials were identified. The latter

is of special interest regarding the beaker and whether soldering techniques were used or not, and whether it can be related to the previously analysed finds.

The beaker

The detailed results of the composition of the various components of the beaker are presented in an analytical report (Grandin 2003). In the current presentation, only a summary and an interpretation will be included. Among the gold samples only samples 2 and 3 contained well-defined layers of gold. In sample 1, silver constituted the dominating layer, and only a small concentration enriched in gold could be detected. The samples with surface layers (the profiled bands) of silver also contained layers of more or less corroded phases containing copper and tin.

Copper alloys

Of the three-layered foot, only the central part was included in the sample. In the cross-section, no contacts with coating layers have been observed. The foot (sample 5) is relatively intact and is composed of a fairly homogeneous copper-rich alloy. The matrix, a texturally homogeneous phase (Fig. 2) is mainly copper with minor concentrations of tin (approx. 1%). Silver and iron are present only in trace amounts. No other elements that could be characteristic indicators of a geochemical origin or process have been detected. In fig. 2, the presence and distribution of lead droplets in the matrix also is noted. The microstructure of the foot indicates that it was hot-worked. The previously analysed finds from Uppåkra were either copper with no traces of tin or alloys with higher concentrations of tin and/or zinc, and with different

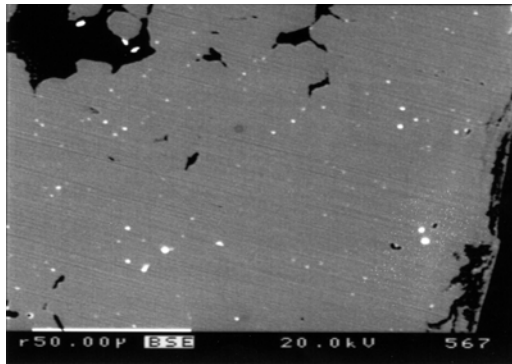

Fig. 2. Sample 5. Detail of cross-section of the foot of the beaker. This consists mainly of one homogeneous phase (grey) of copper with approx. 1% tin. Additionally, tiny lead droplets (bright) are distributed in the matrix. Back-scattered electron image, magnification according to scale bar at lower left.

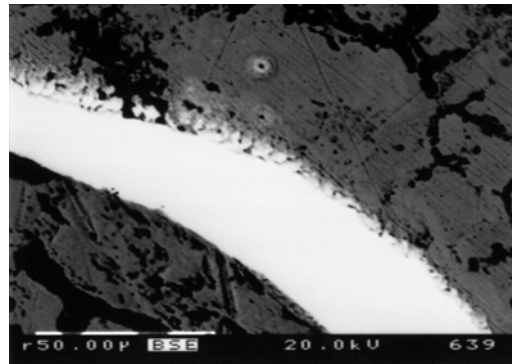

Fig. 3. Sample 2. Detail of a gold layer, some ten micrometres wide, in diffuse contact with the area in the upper part of the micrograph that consists of silver. Back-scattered electron image, magnification according to scale bar at lower left.

distributions and/or concentrations of lead droplets. Only a single sample in the previously analysed material presents a similar composition with low tin concentration.

The body of the beaker (sample 6) is far less well preserved. The cross-section is layered with a central part that is a strongly corroded copper-containing phase with trace amounts of lead and it was not possible to see traces of working techniques. The central layer is coated with thin zones of less corroded phases, and is also dominated by copper with concentrations of phases rich in tin and lead. This sample, lacking tin, differs from the other samples from the beaker where copper or copper alloys have been analysed. The high degree of corrosion of the sample also makes it difficult to compare with previously analysed finds. However, the composition seems to be fairly common and could therefore theoretically be related to various finds and, hence, various geochemical origins.

Gold

Samples 2 and 3 from the embossed foil bands both contain gold but are somewhat complex in composition. Sample 2 is composed of several layers (Fig. 3). The outermost layer is gold with a content of silver (approx. 6%) and copper (0.3–0.4%). This layer is in contact with a layer dominated by silver. The contact zone is diffuse and heterogeneous in a few micrometres. The layer dominated by silver is inwards succeeded by a mixture of phases, one dominated by silver, and one by tin. The latter also contain copper and lead. Probably the body (corroded) of the beaker is not included in the sample, but only the coating and the soldering alloys.

Gold is the major phase also in sample 3, with varying proportions between the alloying elements. Generally silver is present in approx. 9–10% and copper in approx. 0.7–0.9%, that is, in somewhat higher concentrations than in sample 2. A surface layer in sample 3, a few micrometres thick, is depleted in gold and enriched in silver (maximum

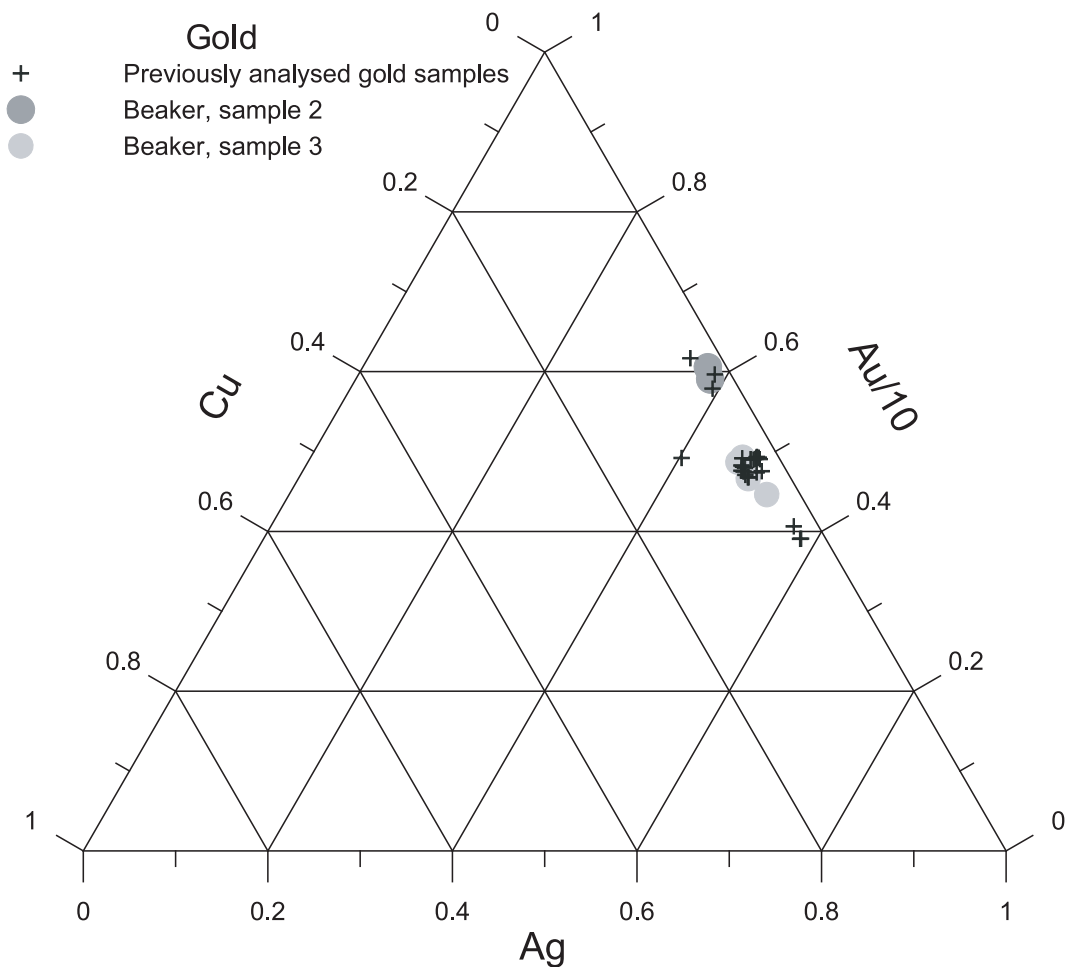

Fig. 4. Ternary diagram showing the distribution of gold, silver and copper in the two gold samples from the beaker. Previously analysed gold finds from Uppåkra are also included in the diagram. The two samples from the beaker can be distinguished by different proportions between the three elements. In both cases, corresponding finds from the previous analyses (Kresten *et al.* 2001a) are present.

67%). In the same cross-section, fragments of corroded material that is rich in tin and lead, and with a surface layer of material rich in silver, are also detected. These fragments may constitute soldering alloys but the body itself is not preserved in this sample.

In both samples 2 and 3, gold is “alloyed”, but not deliberately, with silver and copper, and the proportions can distinguish the two samples (Fig. 4). Among the previously analysed gold finds as artefacts, gilding material

and bars (Kresten *et al.* 2001a) the same two compositions were common (Fig. 4). As an example, the composition in sample 2 is similar to the gilding of a brass mounting. The alloying proportions in sample 3 are more in accordance with that of a metal bar.

Silver

Samples 4 and 7 are from the profiled silver bands (Fig. 1). In sample 4, silver constitutes

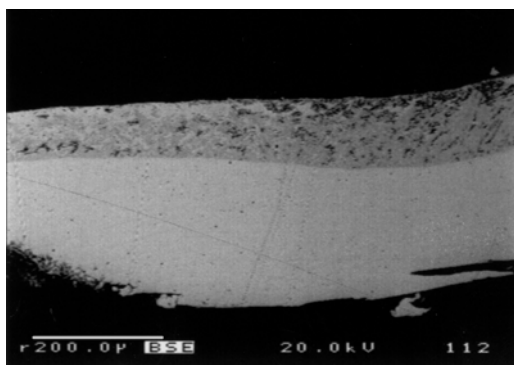

Fig. 5. Sample 4. The lower part of the micrograph shows the silver layer, the upper (black) part a partly corroded copper alloy. A zone of approximately 50–100 micrometres width is a transition zone containing mainly silver and copper in various proportions. In the upper part (not detectable in the micrograph) also a tin-rich zone with content of copper and lead is present. Back-scattered electron image, magnification according to scale bar at lower left.

a layer, approximately 200 micrometres thick (Fig. 5) applied to a copper-rich material. The layer also contains minor concentrations of gold (1.3–1.5%) and copper (0.8–1.0%). A rim, approximately 50 micrometres thick, in contact with the copper-rich material contains several phases with various proportions between the elements – copper (3–10%), gold (1–2%) and lead (a maximum of 1.4%). On the other side of the contact zone, a rim is made of a phase rich in tin with various concentrations of copper (6–11%), lead (5–10%) and rarely a few weight percent of silver. The body is extensively corroded but contains mainly copper. Other elements are present only in trace amounts.

Sample 7 presents a similar feature with an outer layer of silver applied to extensively corroded copper, and with a mixed contact zone in between (Figs. 6). The silver layer also contains gold (approx. 5%) and copper (approx. 4%). The contact zone is thinner than

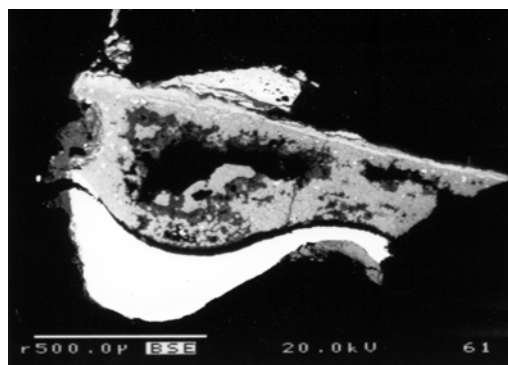

Fig. 6. Sample 7. An overview of a core of mainly corroded copper alloy (various grey colours) coated with silver (bright, in the lower part of the micrograph) with a small content of gold and copper. Back-scattered electron image, magnification according to scale bar at lower left.

in sample 4 but contains several phases with various proportions between the elements: silver (81–90%), gold (2.9–4.2%), copper (4.5–9.9%) and lead (0.9–2.0%).

In the complex sample 1, several layers of silver were distinguished. One layer, some ten micrometres thick, is silver. In contact with this is a slightly thicker layer of silver with other compositions. This layer also contains gold (1.2–2.1%) and copper (1.0–2.0%). A transition zone of several sub-layers delimits the silver layer from the beaker framework. As in most samples, the framework is extensively corroded but is probably copper, possibly with minor lead content. The transition zone closest to the silver layer contains a mixture of silver, gold and copper (and lead), and closest to the copper framework it is constituted by a heterogeneous alloy dominated by tin. Lead and copper are present in lower concentrations.

In fig. 7, the proportions between silver, gold and copper illustrate the compositions of the silver samples. The figure presents the variation in proportions between the three

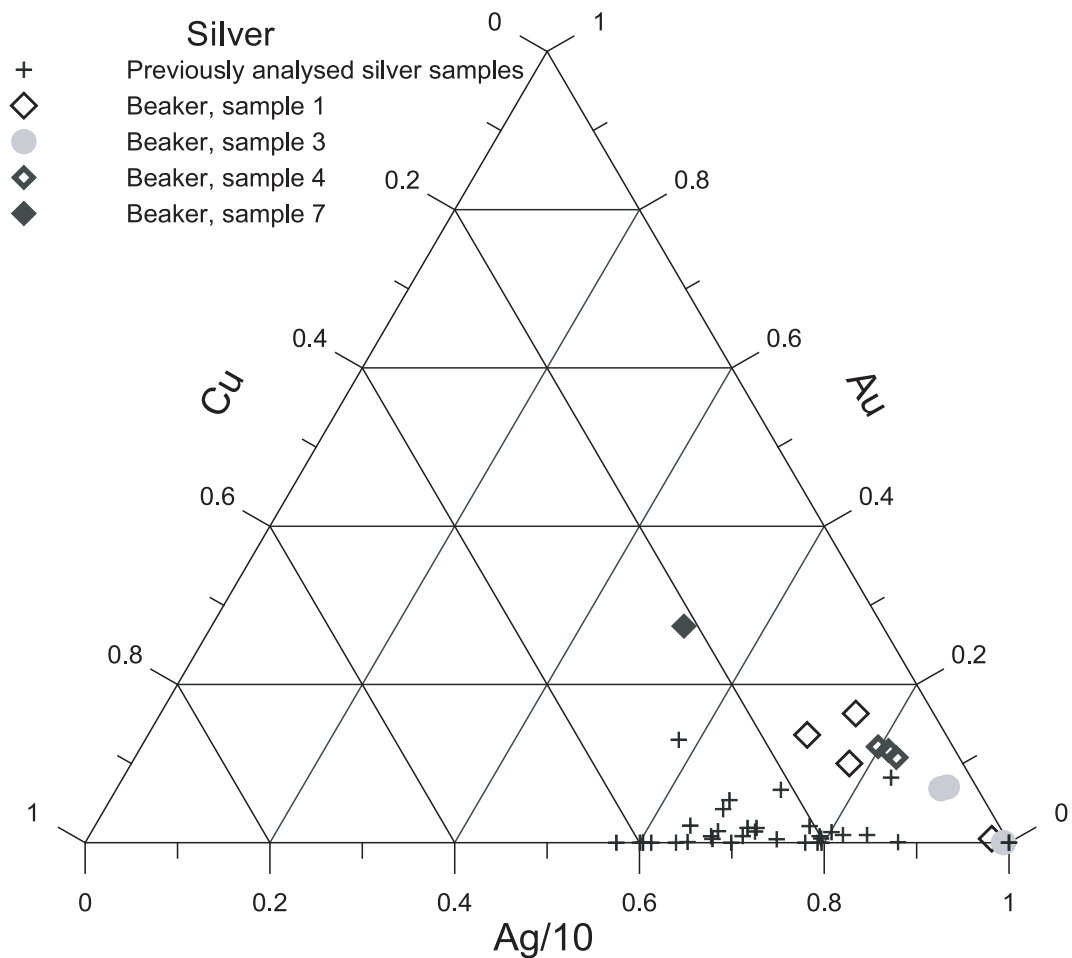

Fig. 7. Ternary diagram showing the distribution of gold, silver and copper in the silver samples from the beaker. Previously analysed silver finds from Uppåkra are also included in the diagram. There is a variation in proportions between the three elements in the samples from the beaker. However, a common feature compared to the previously analysed finds is the higher concentration of gold. The previously analysed finds (Kresten *et al.* 2001a) mostly lack gold or have a lower gold concentration.

samples. Previously analysed silver finds from Uppåkra (Kresten *et al.* 2001a) are also included. Most of those can be distinguished from the silver analyses of the beaker, mainly by clearly lower gold concentrations. The beaker samples are almost always more complex in composition. That is, there are no apparent relations between the beaker samples and the majority of the previously analysed finds.

Soldering alloys

The major components of the beaker are described above, and also how those could be related to the material previously studied. What is left to define is how the components were combined to give the final beaker, what working techniques and soldering materials were used and whether these can be traced to the workshop at the site.

In several samples, including the gold and silver samples, the corroded remains of a copper alloys, with low concentrations of tin and/or lead were detected. In between the copper alloy and silver, a transition zone with complex composition and with several phases is common.

Although the complex components in between the layers of silver and copper (Figs. 5 and 7) vary in composition, they have a shared purpose. They are all part of contact zones where soldering alloys have been applied to attach the coating metal in the bands to the body of the beaker. The alloys have also reacted with the metals/alloys on both sides at the increased temperatures, which has partly resulted in complex textures and compositions. Alloys representing higher (hard solders) as well as lower (soft solders) melting temperatures were used. The hard solders are based on copper and silver, and the soft solders on tin and lead.

In the previously analysed finds from Uppåkra, a number of different soldering alloys were identified, both in artefacts and as raw material (Kresten *et al.* 2001a), and with applications similar to that of the beaker. The soldering alloys in the beaker are generally complex in composition, with three or four metals in concentrations of several weight percent, partly also due to diffusion between the main metals or alloys as discussed above. The previously analysed soldering alloys are less complex. If these discrepancies are considered and proportions of the soldering alloys are compared instead, there are still differences between the solders in the beaker and those previously analysed. These are demonstrated, for example, by similar proportions between silver and copper, but the presence of tin in the beaker is distinguished from an absence of tin in the other finds.

The soldering alloys discussed so far are related to joining silver with copper and copper alloys. The gold bands were applied without these solders. Some alternatives, apart from mechanical applications, are organic binders that will not react with the metals and will hence not be detected in the chemical analyses performed. Some gold samples are also complex in terms of gold applied to silver, which in turn is attached to copper. In such a case, a thin transition zone that is affected by increased temperatures enhancing the joining of the metals defines the gold-silver contact.

Concluding remarks

The two embossed foil bands from the beaker with two different decorations also present various composition. Both can be related to previously analysed gold samples from the same site, artefacts as well as raw material. These compositions, however, are not unique for Uppåkra, and a number of sources of gold are possible. The profiled silver bands in the analysed samples present various compositional proportions, dissimilar from the previously analysed silver finds. Regarding copper and copper alloys, with only low concentrations of tin and lead, these are similar to only a few of the previously analysed samples, but absence of characteristic trace elements allows for several possibilities for their origin. The embossed bands may have been applied using organic binders and/or mechanical techniques. The attachment of silver has left more pronounced chemical indications in the samples as soldering alloys. These are of various compositions but do not correspond to earlier results.

The gold samples of the beaker show most resemblance with previously analysed finds. The copper-based material has a composition

in accordance with only a few of the numerous finds analysed earlier. The silver bands show no correspondence and the soldering alloys differ from other finds in the proportions of their components. This means that there are no simple explanations suggesting that the beaker was made locally. However, gold and copper of similar composition were available. Also the technical knowledge of using soldering alloys has previously been documented, although the corresponding material is not known as yet from the metal workshop in Uppåkra.

References

- Grandin, L. 2003. Bägaren från Uppåkra. Arkeo-
metallurgiska analyser. LUHM 31251, Upp-
åkra sn, Skåne. *Geoarkeologiskt Laboratorium,*
Analysrapport 9-2003. Uppsala.
- Kresten, P., Hjärthner-Holdar, E. & Harryson, H.
2000. Metallhantering i Uppåkra. Råämnen
och halvfabrikat (Interimsrapport). LUHM
31000, Uppåkra sn, Skåne. *Geoarkeologiskt*
Laboratorium, Analysrapport 15-2000. Upp-
sala.
- 2001a. Metallurgin i Uppåkra: Icke-järnmetaller
under tusen år, LUHM 31000, Uppåkra sn,
Skåne. *Geoarkeologiskt Laboratorium, Analys-*
rapport 10-2001. Uppsala.
- 2001b. Metallurgin i Uppåkra: Smältor och
halvfabrikat. Hårdh, B. (ed.), Uppåkra. *Cent-*
rum i analys och rapport. Uppåkrastudier 4.
Acta Archaeologica Lundensia, Series in 8°,
No. 36. Lund.

A Magnificent Glass Bowl from Uppåkra

Berta Stjernquist

Abstract

During the excavation of the Iron Age settlement at Uppåkra in 2001 a remarkable glass bowl was found in a house construction which was used and rebuilt from the Roman Iron Age to the Viking Period. The many wealthy finds indicate that the house had a special character: a ceremonial building (Larsson & Lenntorp in this volume). The glass bowl was revealed a few centimetres below the surface of the floor where it was placed together with a fine metal beaker (Hårdh in this volume).

The preservation of the bowl was a very difficult job; it was damaged because of the pressure of the soil. It has a rim diameter of about 165 mm and a height of 97 mm. It consists of two layers of glass: a clear underlayer and a cobalt blue overlay, which is cut so that bands form a rosette with petals which encircle the body. Below the rim is a blue ribbon and on the base two circular blue bands.

As the bowl has no parallels the dating relies above all on the combination with the metal beaker decorated with gold foil. The dating is thus defined at about 500 AD. The method of analysis is to look through and discuss groups of glass vessels with the same characteristic traits as the bowl, that is, on the one hand glasses decorated in overlay technique and vessels of the same type as these, and on the other hand vessels of glass and metal with rosette and petal decoration. These groups are mapped and discussed intensively. The investigation turns from Scandinavia to the continent and as far away as the surroundings of the Black Sea, the eastern Mediterranean areas and Sassanian districts, with their workshops for glass production, and to Egypt where flower decoration with lotus design had a symbolic signification. The transfer of the glass bowl from a probable production place in the south-eastern areas is discussed.

The chemical analysis by Maria Lang is published in the Appendix. The report declares that the composition is typical of the Roman glasses made in the Cologne area during the first four centuries of the Christian era. It shows that the manufacture of glasses and the composition of glass was rather similar to the Roman frontier in the west and in the south-east. Trace elements to distinguish between them technically are obviously lacking.

Berta Stjernquist, Department of Archaeology and Ancient History, University of Lund, Sandgatan 1, SE-223 50 Lund

Site and find-spot

A large number of excavations of Iron Age settlement sites and cemeteries all over Scania is the background to the recent studies of the political landscape and hypothesized regions. In the network of important sites Uppåkra has a special position because of its large and

deep occupation layers and rich finds which were recognized in 1934. After preliminary excavations at that time, new investigations started in 1996 in connection with the project *The Social Structure of Southern Sweden during the Iron Age* (Stjernquist 1996; Hårdh

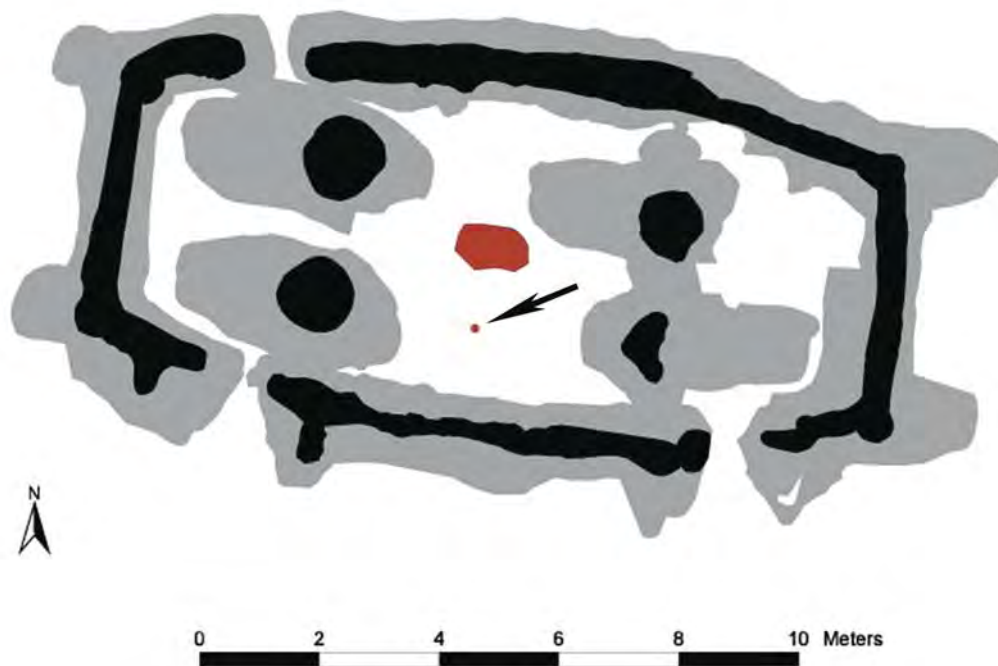

Fig. 1. Uppåkra. The foundation of the house where the glass bowl was found. Drawing by Birgitta Piltz-Williams and Karl-Magnus Lenntorp.

2000; Larsson 2001a–b; 2002). The result up till now of these investigations is a huge body of find material and a conception of the structure of the settlement with remains of house foundations, published in the series *Uppåkrastudier*.

During the investigation in 2001 a remarkable glass bowl was found in a house foundation (Fig. 1). This foundation was situated approximately 150 m to the south of the church in a trench opened that year.

The house foundation was marked by a yellowish clay floor surrounded by a wall trench with traces of corner posts. It had three entrances. The length of the house was 13 m, the breadth 4.5–6.5 m. In the middle was a hearth surrounded by four large posts. The posts have been repaired several times, which shows that the house was used and rebuilt during a very long time, from the Roman Iron Age to the Viking Period. The

house level where the bowl was found was documented during the excavation as number 14, which is the late Migration Period. The house, which was designated number 8 in the series of reconstructions was, however, used even after that time (Lenntorp & Piltz-Williams 2002). The large posts and many wealthy finds, for instance gold-foil figures (*guldgubbar*), indicate that the house had a special character: a ceremonial house or a residence (Larsson & Lenntorp, this volume; Watt, this volume).

A survey of the floor by metal detector gave a response at a point to the south of the hearth. Decorated pieces of metal and fragments of glass were revealed a few centimetres below the surface of the floor. Because of the fragmentary state of the objects a section of soil with the finds in it was removed and transported to the laboratory at the Institute for careful excavation (Fig. 2).

The preservation

The excavation of the soil in the laboratory revealed two objects, namely a bronze and silver beaker decorated with bands of impressed gold foil and a glass bowl. They had been placed close together in a hollow dug into the clay floor. The beaker was kept in a

recumbent position. The glass bowl was placed upside down (Figs. 3–6). It was pressed against the beaker, probably because of the weight of the soil and the pressure on the floor when the surface was restored. During the preservation the beaker was taken away first. It is published by Birgitta Hårdh (this volume).



Fig. 2. A section of soil with the bowl and the beaker visible. Photo Bengt Almgren.



Fig. 3. The glass bowl during the preservation. The base with the wall visible. Photo Bengt Almgren.



Fig. 4. The glass bowl during the preservation. The base and parts of the wall. Photo Bengt Almgren.



Fig. 5. The glass bowl during the preservation. The base of the bowl with the two bands of blue overlay glass. Photo Bengt Almgren.



Fig. 6. The glass bowl during the preservation. The wall with blue overlay decoration. Photo Bengt Almgren.

The whole bowl was *in situ* but damaged because of the pressure to which it had been exposed. The base and the wall of the bowl were excavated, cleaned and treated to make them firm. It was possible to take up parts of it successively after treatment and to put the pieces together. The preservation was a great and very difficult job skilfully undertaken by the curator Hasse Hansen over several months (Fig. 7).

Description of the bowl

The glass bowl has a rim diameter of approx. 165 mm, a base diameter of approx. 48 mm and a height of approx. 97 mm. The dimensions are difficult to estimate exactly. It consists of two layers of glass. The underlayer is clear with a tint of yellow-green, the overlay is cobalt blue. The overlay is cut so that patterns



Fig. 7. Curator Hasse Hansen working during the preservation. Photo Bengt Almgren.



Fig. 8. The blue ribbon on the bowl, with cut ornament. Enlarged. Photo Bengt Almgren.

are formed. The thickness of the layers varies: the colourless layer approx. 4–6 mm, the blue layer approx. 2–3 mm.

The rim is sloped a little. Below a colourless edge of 15 mm at the rim there is a blue ribbon, 8–10 mm broad, which is divided into rectangles, length 20 mm, by double grooves. The rectangles have cut ovals, length 15 mm, breadth 6 mm (Fig. 8). The blue ornament of the wall appears below this ribbon as 12 bows formed by 5–8 mm broad bands. They form a rosette with petals, 6–10 mm from one another, which encircle the vessel body, starting 10 mm from the base. The traces of the cutting tool there are very clear. The blue bands of the ornament are followed by lines, 1–2 mm broad, which seem to be traces of a tool used for drawing and cutting the pattern (Fig. 9).

The base is light with two circular bands of the blue overlay glass: one at the edge, 10 mm broad, and the other in the middle, 10 mm broad, forming a 28 mm broad disc (Figs. 3–5, 12). The disc, together with the inner blue circle, is the base on which the bowl is supported. Half of the band of this blue circle is sloped a little. The outer blue band of the base is located slightly higher up, approx. 10 mm, than the inner one, with the consequence that the bowl cannot rest on it. It forms the transition to the body. Accordingly, the base is a little bowl-shaped (Fig. 31).

When the inner band of the base is cut in the blue overlay the change-over to the central disc of light glass is not distinct. The blue gets thinner as a transition. The bows of blue overlay on the body have the same thinning out, approximately 18–20 mm. The transition to the light glass is not distinct but gradual (Fig. 10).

The bowl (Figs. 11–12) has a smooth surface on the inside with very light traces of cutting below the rim.

The chemical analysis performed by research engineer Maria Lang is published as Appendix (see this and the discussion of the result below).

Problems

The bowl seems to be unique among the known glass material (Figs. 11–12). Accordingly, the analysis is very complicated. The problems concern the dating of the bowl, the type of vessel, the manufacture, probable origin and distribution routes and the function at the site.

The bowl was found lying close together with the beaker. The two pieces were used at the settlement at the same time. That is why the dating of the bowl is dependent on the dating of the beaker, analysed stylistically by Birgitta Hårdh (this volume). The chronology is based on Hansen 1987 and 1993.

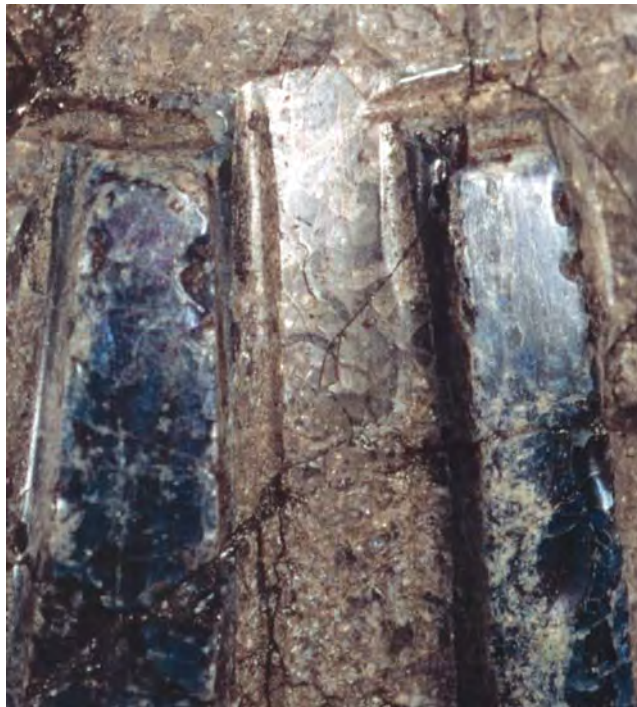

Fig. 9. Traces of wheeled lines at the overlay decoration. Enlarged. Photo Bengt Almgren.



Fig. 10. The transition from the blue to the light glass. Enlarged. Photo Bengt Almgren.



Fig. 11. The bowl after the preservation. 4:5. Photo Bengt Almgren.

The task is to find glass vessels with similar characteristic features and their probable origin. The background and affinity of the object will in this way be elucidated. The task is further to consider the possibilities which have existed to move the vessel from a production place to Scandinavia and to the Uppåkra settlement. The problem of manufacture will be illuminated by scientific analyses (see below).

The function of glass vessels as parts of drinking sets during the Iron Age is well known by means of graves, pictures and written material. This bowl has a special position as found deposited in a house together with a magnificent beaker of metal. The problem concerns its function and also the reason for its deposition.

The dating

As the glass bowl has no parallels the dating relies above all on the find combination with the beaker decorated with gold foil. The two pieces were used at the settlement at the same time. The background and connections of the beaker, based on the decoration and the shape, have been analysed in detail by Birgitta Hårdh (this volume). The dating is thus defined as A/B of Style I according to Hasehoff, that is, approximately 500 AD, a dating which is valid for the bowl as well. As mentioned above the level where the bowl was found was number 14, which is the Migration Period (Lenntorp & Piltz-Williams 2002). This fits in very well with the stylistic dating. That means probably that the bowl was made in the 5th century.



Fig. 12. The base of the bowl after the preservation. Enlarged. Photo Bengt Almgren.

Method of analysis

As there are no parallels to the bowl in the known corpus of glass vessels, the method of analysis must be to look through and discuss groups with the same characteristic traits as the bowl. This means comparative material in two respects: technical and decorative. Thus, the analyses concern glass vessels from the Roman Iron Age and the Migration Period produced in the same technological way as the bowl and glass vessels of a type similar to these vessels. They concern furthermore vessels with decoration similar to the bowl.

Thus, the groups enclose on the one hand glass vessels decorated in overlay technique and cut vessels of the same type as the vessels with overlay, and on the other hand vessels

of glass and metal with rosette and petal decoration. A survey of these groups and their settings may expose complexes with the necessary conditions for their production and, accordingly, give an indication of their origin. The origin of the bowl might be found in these complexes.

This investigation concerns glass objects from the point of view of the material and its changes during the Late Roman Iron Age and the Migration Period (the fourth to the sixth centuries). With Scandinavian material as a basis Näsman as well as Straume have treated large groups of glass vessels from these periods. The continental find material and its prerequisites are discussed intensively. In addition there is a large body of literature with different starting points published by other scho-

lars. The theoretical discussion of the material and the research findings in the literature will be used and supplemented in this paper.

An important part of the investigation is further a number of scientific analyses carried out by specialists. The research engineer Maria Lang at the Glass Research Institute, Växjö, is responsible for these analyses. The result is published here as an appendix, see Appendix and discussion below.

The technical aspect. Objects of similar manufacture

Types of special interest. Bowls and beakers

Various forms of glass bowls were in use in the Roman Iron Age and the Migration Period and are found as imports in the Nordic countries. They are part of the material intensively discussed by Lund Hansen (Hansen 1987) and for the Late Roman and Migration Periods by Näsman (1984) and Straume (1987).

It is well known that the fabrication of glass vessels changed successively from the Late Roman to the Migration Period. The workshops moved from towns to rural districts where a supply of fuel was easily available (e.g. Rademacher 1942; Janssen 1983). This is a tendency but we are very little acquainted with the manufacture, although remains of workshops are known from districts along the Roman frontiers and adjacent areas in the west as well as the east (Näsman 1984:17; Straume 1987:54 pp.; Steppuhn 1998: 106 pp.). The fabrication is influenced by Roman tradition but also affected by tendencies of other glass-producing areas in the east. The conditions are complicated by the fact that glassworkers moved a great deal between employers.

The Roman tradition in the Migration Period has been emphasized even concerning

bowls. Harden has introduced a main group named “Roman survivals” in his papers concerning glass vessels in England and Ireland (Harden 1956). Evison has made use of this term in the treatment of glass vessels in the Migration Period. She has listed bowls of simple forms (Evison 2000: Fig. II.1–11). There are plain bowls but also bowls with some decoration, such as indents and Christian symbols. Many are mould-blown, which is a tradition from the Roman Age. She speaks about differences in relation to the continental series. The similarities are, however, striking in many cases. Parallels can be found in the western part of the continent as in the Rhine area. The large body of glass vessels from Ursula Koch’s excavation of *Der runde Berg bei Urach* can be discussed in this connection (Koch 1987; cf. 1996). The very interesting series of bowls with indents can be dated from the end of the 4th century and from the 5th century. This type of conical bowl, interesting for the analysis of the bowl from Uppåkra, is richly exemplified by Isings (form 117) (Isings 1957; cf. Haberey 1942). A fine copy, found in grave 1248 of the cemetery at Krefeld-Gellep, may also be mentioned (Pirling 1960).

Bowls and beakers with cut decoration are common, in the Late Roman Iron Age and the Migration Period, in Scandinavia as well as on the continent (Näsman 1984; Straume 1987). Several types with cutting are of special interest for the analysis of the bowl from Uppåkra and will be discussed below. Some vessels with applied trailing in the form of medallions or bows are also interesting (for instance Koch 1968) as well as vessels with flower decoration.

As the overlay decoration characterizes the Uppåkra bowl in a special way, the treatment will start with this decoration. The known glass finds will be catalogued and analysed.

Glass vessels with overlay

Special categories of glass vessels with overlay from the Roman Period have been recorded on the continent, those known as cameo glass and the *vasa diatreta*.

The cameo glasses are magnificent products from the beginning of the period, including the well-known Portland vase. The blue glass is blown in a form with white glass and cut so that the decoration appears as white figures. The technique is principally of the same kind as that used later (Kisa 1908 II:569 pp.; Harden 1988:59 pp.). The Solberg vessel found in Norway belongs to the cameo glasses (Ekholm 1957). A piece of a jug published by Fremersdorf (1967: Taf. 4) has colourless glass with blue overlay cut with figures in the same technique as some Scandinavian vessels (cf. Näsman 1984:65).

The *diatreta* glass vessels are another category of glasses with overlay. Many of them have an inscription in Greek letters (Haberer 1961; Doppelfeld 1960; 1966; Näsman 1984:65 p.). These magnificent glass vessels are manufactured with great skill. They have two or three layers of coloured glass and have been cut so that deep openwork is left over the inner glass layer. They can be dated to the third and fourth centuries, which is the same time as the early vessels, the beaker from Himlingøje for instance, with overlay of the complex documented from late Roman times to the Migration Period. They are distributed from Cologne to Italy and Greece (Doppelfeld 1960, Fig. 1). There is also one vessel from the fine grave from Czéke-Cejkov (Rau 1972: No. 85). Arrhenius has discussed the manufacture with reference to antique writers and stressed that the cutting wheel was used in the same way as it was used for cutting garnets in Sassanian gem art (Arrhenius 1973:38 pp., 1985:55 pp.). The glassworkers travelled

and visited several workshops. The technique was distributed in that way.

Glass vessels with overlay from the Late Roman Age and the Migration Period have been listed by Ekholm, Näsman and Straume with Scandinavian finds as a basis. In 1957 and in 1965 Ekholm presented summaries with datings starting with the well-known find from Solberg. Similar summaries can be found in other papers published by Ekholm which treat vessels of oriental origin, some reprinted in 1974 (see Näsman 1984). The body of finds has, however, grown since then. In her work about the large body of glass finds from the Roman Iron Age, Lund Hansen has briefly discussed the finds with overlay (Hansen 1987:161). Näsman (1984: 63 p.) and Straume (1987:45), however, have published the most complete lists of such glass vessels. These collections will be used here as a starting point. The find lists will be discussed, uncertain finds omitted and new finds added. The Swedish finds will be carefully studied (Fig. 13).

Sweden

1. *Uppåkra*, Uppåkra Parish. LUHM 31251: 1523. The bowl is ID 201 623 described above (Figs. 11-12).
2. *Hallbjens-Bjärges*, Lau Parish, Gotland. SHM 13085. Inhumation, man. One sherd, colourless with green overlay and cut lines (Fig. 14). C3. Straume 1987: 109, No. 62.
3. *Eketorp fort*, Gräsgård Parish, Öland. Sherd of a pale green conical vessel with dark blue overlay, 1.7 mm thick, cut ovals. Found in house Ä. Näsman 1984:63.
4. *Triberga fort*, Hulterstad Parish, Öland. Sherd of light-green glass with emerald-green overlay, thick, with parts of two cut ovals. Found in 2002 by excavation in a

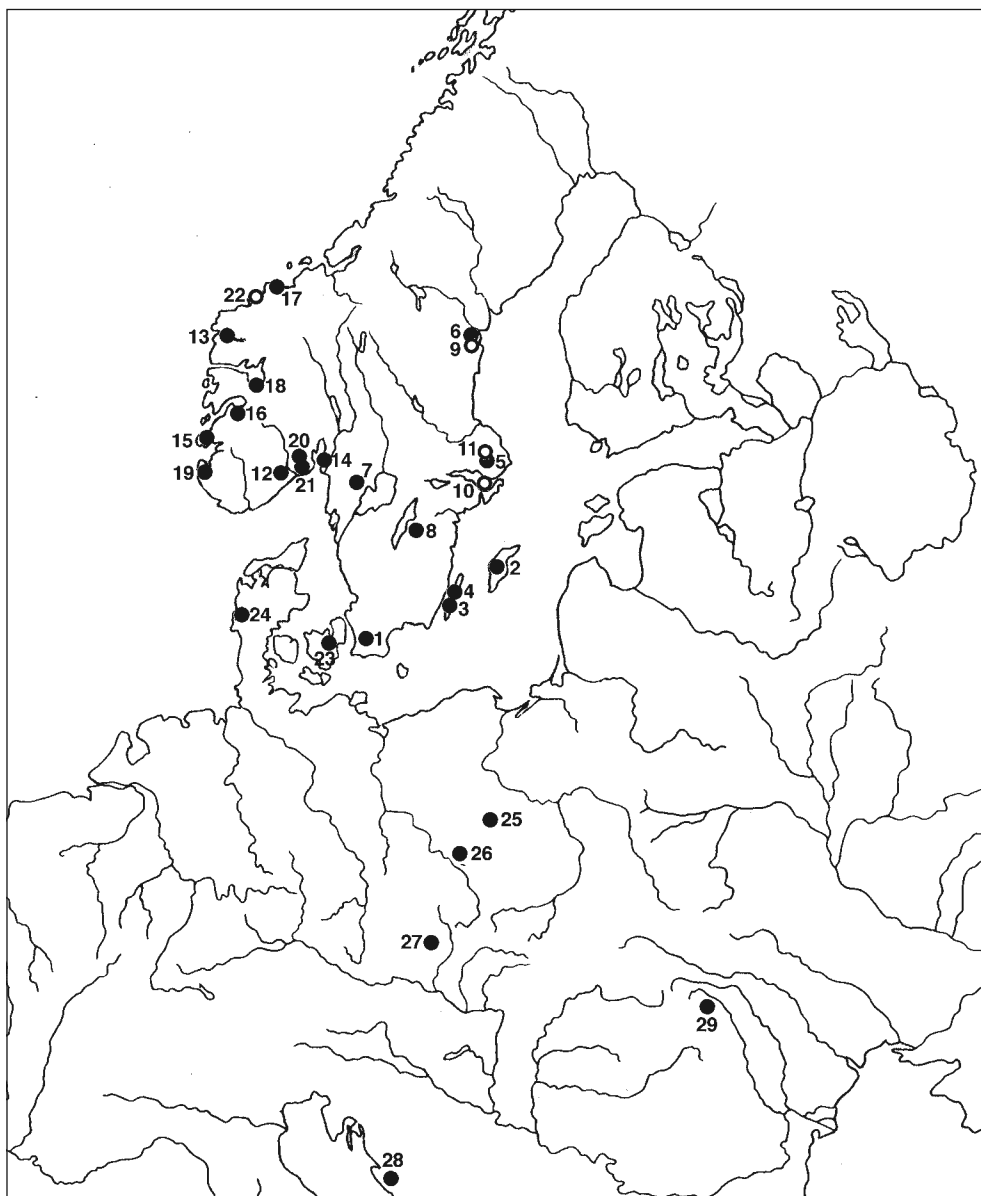

Fig. 13. Map showing the locations of overlay decoration discussed in the paper (after Straume 1987 with changes). Ring: uncertain find.

house foundation. Information from Ulf Näsman.

5. *Ottarshögen, Vendel Parish*. SHM 15847. Colourless or pale yellow-green glass with dark blue overlay (Fig. 15). Eleven pieces are melted, two not melted have a pronounced cut which forms broad facets.

The broad facets indicate a cut-glass beaker. The pale glass is 5–6 mm in the cut, the blue glass 2–3 mm but cut down. The melted pieces have the blue overlay visible in 6–10 mm broad and approx. 3 mm thick strings. Lindqvist 1936:167 p. with fig. 81. Cf. Straume 1987:112, No. 72.

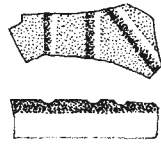

Fig. 14. The sherd from Hallbjens-Bjärages (after Straume 1987). 1:1.

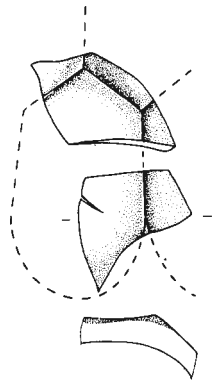

Fig. 15. Sherds from the Ottar Mound (after Straume 1987). 1:1.

6. *Skottssund, Njurunda Parish*. SHM 25337:6. Inhumation. Many small sherds, colourless or pale yellow-green, approx. 6 mm thick, some with blue and some with green overlay, 1–2.5 mm. Approx. 10 sherds with unpolished lines in the surface of the overlay. Traces of cut (Fig. 16). D1. Selinge 1977: 257 pp., 1985:125 pp. and Fig. 9; Straume 1987:113, No. 73 and Pl. 95.
7. *Ullerön, Dals-Eds Parish*. SHM 24059. Grave. Seven pieces, three of which are melted. Two pieces of blue glass. Two small pieces of colourless or pale yellow glass with approx. 1 mm blue overlay. Näsman 1984:63.
8. *Abbetorp, Väderstad Parish, Östergötland*. A pale green sherd with blue overlay and traces of cut (facets). Found near a large stone together with two other sherds of the same vessel, other glass sherds and other finds. The dating is probably the Migration Pe-

riod. The site is interpreted as a cult place. Petersson 2001; Österström 2001:30 and fig. p. 31.

Uncertain finds:

9. *Västland, Skön Parish*. SHM 17062. Grave. Pieces of melted glass, pale green with blue streaks, overlay not visible. Seven pieces with cut ovals. A sherd of blue-green glass and a sherd with a blue rim. The collection seems to be mixed with sherds from more than one grave. Selinge 1977: 262 pp.; Näsman 1984:63.
10. *Lovö, Lovö parish*. SHM 29401:12. Grave. Melted pieces of glass, probably yellow and blue colours, listed by Straume as overlay but it is uncertain. D1. Straume 1987:112, No. 70.
11. *Old Uppsala. The East Mound*. Only parts of the grave finds are collected. Melted glass, pale green and blue. Overlay uncertain. Lindqvist 1936:176.

Norway

12. *Espedalen, Gjerpen*. C 23240. Inhumation, woman. Pale green sherds with blue overlay. C3. Straume 1987:78, No. 7.
13. *Evebø, Gloppen*. B 4590. Inhumation, man. Pale green sherds with blue overlay. D1–D2. Straume 1987:79, No. 8.
14. *Haugen, Borge, Østfold*. C 26633. Cremation. Fragments, pale green with blue overlay. C2–C3. Straume 1987:87, No. 20.
15. *Mæle, Haus, Hordaland*. B 6981. Inhumation, woman. Colourless fragments with blue overlay. C2–C3. Straume 1987: 92, No. 29.
16. *Opedal, Ullensvang, Hordaland*. B 6409. Inhumation, woman. Pale green fragments with blue overlay. D1–D2. Straume 1987: 94, No. 32.

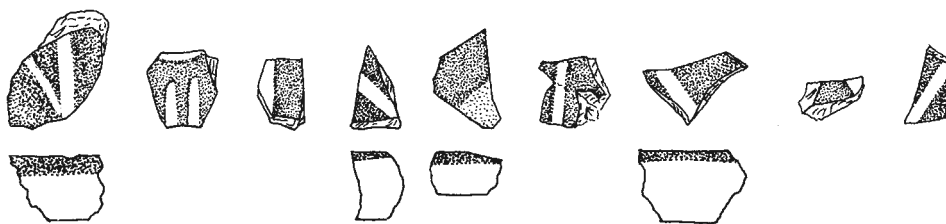

Fig. 16. Sherds with overlay decoration. Finds from Skottsund. Drawing by B. Händel. 1:1. ATA.

17. *Sandnes*, Bolsøy. Møre og Romsdal. T 14277; 14499; 16592. Cremation. Colourless fragments with blue overlay. D2. Straume 1987:97, No. 37.
18. *Skaim*, Aurland, Sogn og Fjordane. B 11694. Inhumation, woman. Pale yellow-green fragments with blue overlay. D2. Straume 1987:97, No. 38.
19. *Tu*, Klepp, Rogaland. S 1494 (Fig. 17). Inhumation? Beaker, some parts lacking. Pale green sherds with blue overlay. Cut medallions and Greek inscription. Dating uncertain. Straume 1987:100, No. 44.
20. *Tveitane*, Brunlanes, Vestfold. C 10102-10107. Grave, woman. Pale green sherd with blue overlay. C3. Straume 1987:101, No. 45.
21. *Valby*, Tjølling. Inhumation, woman. C 16445-16456. Pale green fragments with blue overlay. C3. Straume 1987:102, No. 47.

Uncertain find:

22. *Haram*, Sunnmøre. Straume 1987:86, No. 19.

Denmark

23. *Himlingøje*, Zealand. NM C 30626. Beaker (Fig. 18). A stray find from 1948. Yellow glass with green overlay. Cut decoration. Straume 1987:117, No. 80. C3-D1. Hansen 1987:161 and 413; 1995:150 and 152, Fig. 4:20. C1b or C2.
24. *Dankirke*, Jutland. Sherd, colourless glass

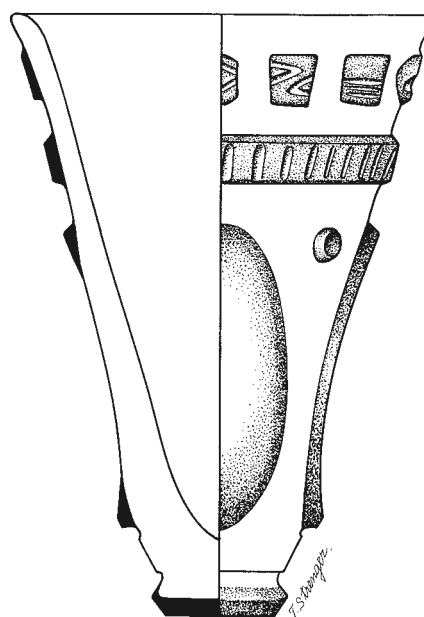

Fig. 17. Glass vessel from Tu, Klepp (after Straume 1987).1:2.

with blue overlay. Hansen 1983; Näsman 1984:63. Unpublished.

Poland

25. *Piwonice*, Dep. de Poznan. House foundation. Footed beaker with cut medallions. Yellow-green glass with blue overlay (Fig. 19). D1. Dabrowski 1959; cf. Werner 1959; Straume 1987:125, No. 112.
26. *Zakrzów, Oleśnica* (Sackrau). Grave 1, inhumation. Yellow-green sherds with blue overlay. Late C2. Rau 1972, No. 16; Straume 1987:125, No. 118.

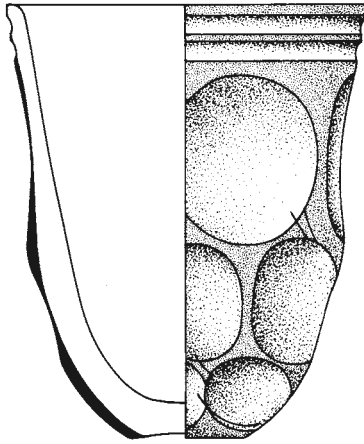

Fig. 18. Glass vessel from Himlingøje (after Straume 1987). 1:2.

Moravia

27. *Žuráň*, Podolí, Brno. Cremation 2. Yellow-green sherds with blue overlay. D1. Poulik 1950, Fig. 86; Werner 1959; Straume 1987:127, No. 151. Approx. 450 AD.

Dalmatia

28. *Salona* (Solín). Bowl with cut circular figures with grooves between them. Colourless glass with purple coloured overlay and a green rim. Saldern 1964, Fig. 10; Näsman 1984:65; Straume 1987:46.

Romania

29. *Tocileni*, Jud. Botosani. Fragments of a beaker with Greek inscription and a ribbon with vertical lines below the rim. Colourless glass with blue overlay cut with Greek letters remaining (Fig. 20:1). Dating is late 4th or 5th century. Gomolka-Fuchs 1999:137, 139 and Fig. 7:1.

Five of the eight finds from Sweden have blue overlay (the bowl from Uppåkra included)

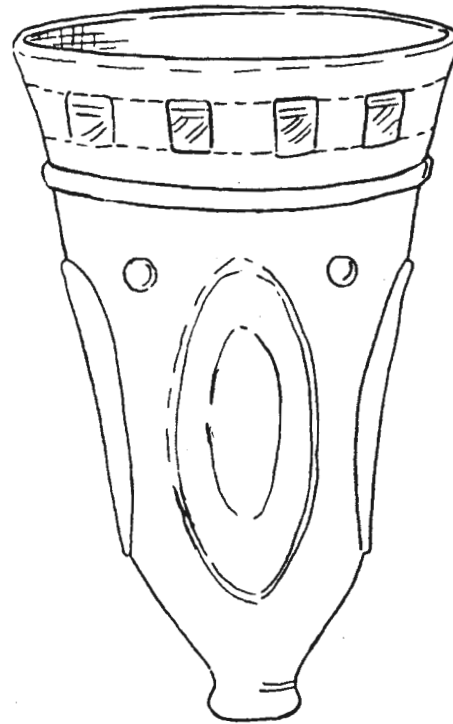

Fig. 19. Glass vessel from Piwonice (after Werner 1959). 1:2.

while two have green overlay. The eighth find, Skottsund, has blue as well as green overlay; unsure whether it is one or two vessels. Straume has registered the Skottsund sherds with overlay as two beakers with blue and green overlay. Näsman has only mentioned that the sherds have blue as well as green overlay. The bottom colour (sometimes difficult to discern) for all is colourless or light coloured in yellow-green, green or amber.

The ten finds from Norway all have blue overlay. The bottom colour is colourless for two finds and pale yellow or yellow-green for the rest, eight finds. One of the finds from Denmark, Himlingøje, has yellow glass and green overlay and the other blue overlay (Straume 1987:44 pp.; Hansen 1995:150).

To sum up: seventeen of the Scandinavian finds have blue overlay while three or possi-

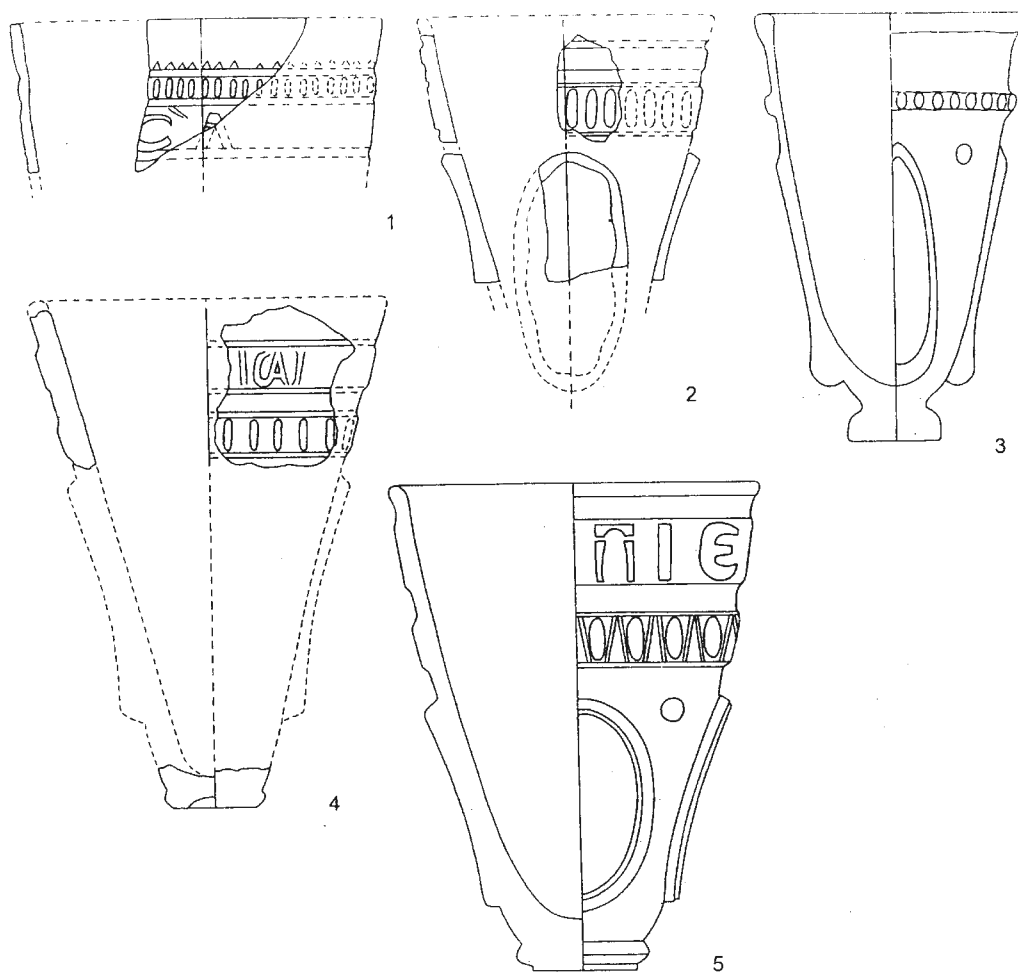

Fig. 20. Drawing of glass vessels from Romania. 1. Tocileni; 2. Miorcani; 3. Independenta; 4. Birlad, Valea Seaca; 5. Barcea. (After Gomolka-Fuchs 1999 but reduced in size.)

bly four have green (cf. Straume's interpretation 1987). The sherds from Skottsund with blue as well as green overlay are included and interpreted as one beaker. The blue overlay dominates the few continental finds. Only the special vessel from Salona has a more highly coloured fashion with purple and green. This standardization has, however, very little to say about the origin of the vessels. Most of them could have come from the same workshop but we know very little about it. Other characteristic traits must be considered as well.

The dating of the glasses with overlay has been discussed by Näsman (1984:64) and by Straume (1987:45 p.) They are both of the opinion that the finds with these vessels start in Late Roman Iron Age and continue at least until the end of the Migration Period. An early find in the series seems to be the Himlingøje glass, which is dated by Lund Hansen to C1b or early C2 (Hansen 1987, 261; 1995:150) and by Straume to C3 or D1. The find from Zakrzów is late C2. The latest find seems to be the partly melted glass from Ottershögen dated by a coin to approximately

500 AD or the beginning of the 6th century. It will be noticed that the find from Old Uppsala is omitted here as uncertain. The finds from the continent fit in with this datings as do the new finds which are added, Abbetorp, Triberga and Uppåkra.

With these datings the complex of glasses with overlay decoration from the Migration Period has chronological contact in the late Roman Iron Age with *diatreta* vessels with overlay. As it starts in the middle of the Roman Iron Age it is not much later than the cameo vessels and other objects with overlay decoration from the Early Roman Iron Age. There might be some technical tradition linking them.

Thus, the finds with overlay decoration are numerous in Scandinavia but very few in central and south-eastern Europe. This distribution might be an erroneous picture due to special circumstances. The finds have been better taken charge of in Scandinavia and are as a whole better known there than in the parts outside Scandinavia where overlay finds could be expected, especially in the south-eastern areas where vessels with cut decoration are common (Näsman 1984:65 p.). The find from Tocileni confirms this. It is, however, possible to draw the conclusion that glasses with overlay decoration were fairly rare.

The technique for the manufacture seems to be the same everywhere but the colours vary. Examination is, however, difficult since several finds are from cremations and melted. There are, for instance, very few finds where the thickness of the overlay can be studied. On the bowl from Uppåkra it is approx. 2–3 mm. This is about the same as on the beaker from Tu where the overlay is registered as approx. 2–4 mm.

It has been noticed above that the blue strings of the overlay are followed by lines,

1–2 mm broad. These lines are very clear and characteristic and may be traces of a cutting tool which was stiff. It could not easily shape curved lines. When it rounded the bows of the design it sometimes did so with lines put together at right angles. The lines are at the same time very smooth, as if made mechanically.

It is obvious that the lines were made by a bow-powered cutting wheel, as this was used for cutting garnets in the gem art of Roman times and earlier. It is known that the cutting wheel played an important part in work on glass too. It was used for making tesserae and also for engraving pictures. Before cutting, a sketch of the picture was drawn by a tool, probably a wheel of copper. There are antique descriptions but they are insufficient (Röder 1965; Arrhenius 1985:55 pp.). This method of making sketches and cutting is mentioned by von Saldern (von Saldern 1963:7; cf. Harden 1969).

The manufacture of the bowl with the overlay and cut decoration demanded great skill. When it had received the two layers of glass by blowing, the light and the blue, the glassblower or his assistant had to outline the design in preparation for the cutting. The hypothesis is that this outline was made with the help of the cutting wheel. The cutting continued with the blue glass between the lines, leaving behind the overlay decoration (Charlston 1964; Goldstein *et al.* 1982; Harden 1988:53 pp.). It may be noticed that the borderlines between the overlay decoration and the pale bottom glass are sometimes marked by a gradual thinning out of the blue strings. This is very clear at the bows and at the blue base-rings. The disc is partly blue, coloured by a thin layer of glass.

Glass vessel types with overlay and vessels of the same types but without overlay

As there is no parallel to the bowl from Uppåkra the method is to discuss other types of vessels from the Late Roman Age or the Migration Period which are sometimes embellished with the overlay technique. There might be a connection between them and the bowl, not only in technique but also in production and origin. The connection between glasses decorated with overlay and with cut motifs has been stressed by Näsman (1984).

Thus, it is important to be able to decide the types of glasses which are decorated with overlay. Many of these finds are, however, small pieces or melted sherds which are difficult to classify with regard to type of vessels. The known vessel types with overlay are cylindrical beakers with cut ovals and conical beakers, with or without foot, cut with ovals, facets or medallions. Beakers with ovals or medallions formed by applied trailing are also important because of the similar design which may indicate the same origin. Medallions may be round or oval. The term medallion means, however, in this connection an elliptical design with the length larger than the breadth.

There are several sherds with overlay and traces of cut which may have been a round design, ovals, medallions or facets or a combination of these motifs. The shape of fragmentary vessels is sometimes difficult to decide. The glass from Eketorp with overlay decoration (Eketorp 7) has, however, been classified as conical (Näsman 1984:63). The vessel from Abbetorp is classified as conical as well. There are many other variants regarding the shape of vessel with cut ovals which is demonstrated by Straume (1987: Pls. 2–5).

Cylindrical beakers with cut ovals

These beakers are represented by the well-known find from Himlingøje which is published by Straume in her large work on cut-glass vessels (1987) (Fig. 18). Lund Hansen has discussed the Himlingøje glass and dated it to C1b or C2, while Straume mentions a dating to C3–D1. It is a cylindrical beaker with cut ovals. The vessel from Himlingøje as well as a beaker from Borrby and another from Rådal belong to Type I series B variant 3 (Straume 1987:30). The proportions, the thick glass wall, the design with ovals and the technique are similar, although the Himlingøje glass is unique with the overlay decoration. Näsman mentions that the sherd from Triberga fort is very similar to the Himlingøje vessel.

Straume is of the opinion that the vessels with cut ovals were made in south-eastern Europe, like many others glasses with cut decoration. She mentions parallels from the Sîntana de Mureş-Černjachov complex. Lund Hansen's conclusion is also south-eastern Europe. It is probably appropriate to follow Straume's classification where the types are presented. She has discerned a small group including three vessels, mentioned above, with characteristic traits which seem to indicate production in south-eastern Europe. Himlingøje with overlay as well as Borrby and Rådal without overlay decoration belong to this group (Straume 1987:62; cf. Rau 1972:56 p.).

Näsman designates the cylindrical beakers with cut ovals as Eketorp 3 vessels. The number of objects is, however, very large with great variation, as is obvious from Straume's lists as well. Concerning the production centres, Näsman calls attention to different opinions presented by scholars, for instance Rau, who has considered new finds and the discussions about them. Rau is of the opinion that the

production was localized in areas north-west of the Black Sea where the workshops were taken over by Germanic peoples (Rau 1972, 1974; Ščukin 1975; cf. Gomolka-Fuchs 1999). A decision about origin is, however, difficult because of the great variations in the material. We have to reckon with production at several places (Näsman 1984:64 pp.).

Conical beakers with cut ovals or facets

Many of the beakers with cut ovals or facets have been classified as conical similar to the types Eketorp 5–7. These beakers are principally included in Straume's type VII. Several of them have overlay decoration, such as Espedalen, Mæle, Eketorp, Abbetorp and Dankirke. Many of them are fragmentary. Their origin is probably south-eastern Europe where many types of glass vessels with cut decoration were manufactured in production centres working in the Syrian-Egyptian tradition (Straume 1987).

Conical beakers with cut medallions

Conical beakers with cut medallions are of special interest for the discussion of the origin of the glass bowl from Uppåkra (Näsman 1984:61 pp.). Some vessels with rather large ovals similar to medallions also belong to this class. The design with medallions or large ovals has some similarities to the flower decoration on the Uppåkra bowl. These categories are also of interest for problems concerning the origin of the overlay decoration as a whole. Some of them have overlay which indicates that this type of decoration was used in the region where they were manufactured. It will, however, be emphasized that the material is not homogeneous. The vessels may, for instance, have or lack a foot.

Straume has classified these vessels as type VIII (Straume 1987:38 p.). The dating

is C3 or D1. The typical vessels of this category have foot. There are, however, variants without a marked foot. Furthermore, some are fragmentary which involves uncertainty regarding the shape. Three fine vessels of this type have been found in Scandinavia, one in Norway (Tu) (Fig. 17) and two in Denmark (Stilling and Vorning). The fragmentary vessels from Enebø and Lunde (Straume No. 27) have traces of medallions, and Enebø, type VIII variant, has overlay decoration as well. They are all described by Straume. Fragments of three finds from Sweden (Nos. 62, 64, 73) are mentioned by Straume in connection with type VIII. No. 64 from Helgö, reconstructed by Holmqvist, seems to be typical with traces of Greek letters (Holmqvist 1964; cf. Lundström 1981). The classification of Nos. 62 and 73 (Hallbjens-Bjerges and Skottsund) is, however, uncertain (cf. Näsman 1984:61 p.).

The beaker from Tu is highly interesting for the problem concerning the bowl (Straume 1987, Pls. 9 and 111:6) (Fig. 17). It is conical with a foot. The glass is green with blue overlay. The design is four oval medallions on the body and between them four nubs. There is an inscription in Greek letters (Straume 1987:39) and a ribbon with vertical lines running below the rim. The medallions are cut down in the overlay. The inscription, the ribbon and the nubs between the medallions are left when the overlay of the upper part is cut away.

The beaker from Stilling is conical with a foot. The glass is green. The design is four oval medallions on the body and between them four nubs. There is an inscription in Greek letters (Straume 1987:121 and 39) and a ribbon with vertical lines or furrows running below the rim. The cut is of high quality. The grave is dated to C3/D1. The third vessel of this group found at Vorning is similar

but smaller. The glass is nearly colourless. It is conical with a low foot. The decoration is four medallions, smaller than the medallions on the other two glasses of the group. There is also an inscription and a ribbon with vertical lines below the rim (Straume 1987:123 and 39).

The glass vessels decorated with medallions have been described in detail because of their affinity with the bowl from Uppåkra. The cut is of high quality, the decoration petal-like on the body and horizontal below the rim. One of them, the fine vessel from Tu, has dark blue overlay like the fragmentary beaker from Enebø. The quality of the glass is, however, not similar, even if the affinities between the vessels point towards the same workshop or at least the same production centre. The inscription in Greek letters is important for conclusions concerning the origin in spite of the well-known fact that the glassblowers moved over large areas working at different workshops. Some other finds from Scandinavia are mentioned as vessels with medallions (Lunde, Slusegård). They are, however, fragmentary and perhaps not typical and will not be discussed here (Näsman 1984:62; Straume 1987: Pl. 9:27, 64)

From sites on the continent there are some vessels with medallions, consequently belonging to type VIII. The beaker from Piwonice (Fig. 19) is highly interesting because of the overlay decoration and traces of an inscription in Greek letters below the rim. The glass is yellow-green and the overlay blue. It was very fragmentary but is reconstructed (Werner 1959; Dąbrowski 1959: Pl. 13). The drawings show a beaker with foot similar to the vessels from Tu and especially to the one from Stilling which lacks the overlay, however. The dating, first half of the 5th century, is based on objects from the house founda-

tion where it was found. In spite of its poor condition, the beaker is very important for the discussion of overlay decoration because of its similarity to the Scandinavian finds and its find context. As one of the very few overlay vessels from the continent it is also important for conclusions concerning problems of distribution. The same can be said about the fragmentary vessel with cut medallions from Žuráň, grave 2, important also for the dating of the glass vessels with overlay. The overlay of the sherds has several ornamental patterns which are difficult to interpret (Poulik 1950: Pl. 86; Zeman 1961).

Some conical beakers from Romania, belonging to the Sîntana de Mureş-Černjachov culture, newly presented by Gomolka-Fuchs, are highly interesting for the discussion concerning the glass vessels with overlay decoration (1999) (Fig. 20). Among the many conical vessels with facet decoration from the area there are one whole and 12 fragments of vessels with cut medallions of which a group of four beakers have Greek inscriptions. One of them, from Barcea, is the whole one with Greek letters and an ornamental ribbon below the mouth (Gomolka-Fuchs 1999: Fig. 7:5). It is decorated with large medallions and with nubs between them. It has a foot. The other three, from Tocileni, Miorcani and Birlad, might have been foot beakers but they are fragmentary. The preserved parts show, however, the same type of beakers with Greek inscription. One of them (Miorcani) has traces of cut? medallions as well. The vessel from Tocileni is of special interest because of the blue overlay decoration (Fig. 20:1) similar to that of the beakers from Tu in Norway and Piwonice in Poland. This new find from Romania confirms the assumption that vessels with overlay decoration were made at production centres in the south-eastern areas of Europe

where cutting of glass continued from the Late Roman Age through the Migration Period.

Other glass vessels with cut medallions are known from Moldavia, namely, Malaeşti with Greek inscription (Rikman 1972, Fig. 4.3; Kropotkin 1970: Fig. 75,8; Rau 1972: No. 71), Novye Stynkausy (Rikman 1972: Fig. 4.1) and probably Chuča. Malaeşti is a pale yellow, conical glass vessel which was found in an inhumation together with pottery vessels. Vessels cut with rather large ovals are now and then assigned to the category with medallions (Näsman 1984:61 p.), although the decoration differs in detail. It is valid for the vessels from Enebø and the continental one from Pécs (Fülep 1977). Komarov from a settlement with glass production in Ukraine can also be mentioned. The decoration of the sherds is, however, unclear (Kropotkin 1970: Fig. 72,1–13; Rau 1972: No. 72; Näsman 1984:61 p.; Straume 1987:39).

Some of these continental finds are difficult to assess because of their bad condition and the difficulty of checking them, as they are available only in distant areas and brief publications. The impression of the pictures is that some vessels from the Black Sea region differ from the Scandinavian and continental ones. There seem, however, to be many vessels with Greek inscription in the south-eastern part of Europe which is highly important for the study of the distribution of the medallion beakers and their origin.

In connection with the cut vessels with medallion decoration, another group of medallion beakers will be discussed because of their affinities to the cut vessels. They have medallion decoration as well, but the ornament is marked by applied self-coloured trailing. Their affinity with the facet beakers has been stressed by several scholars (Werner 1959:423; Näsman 1984:86). They have

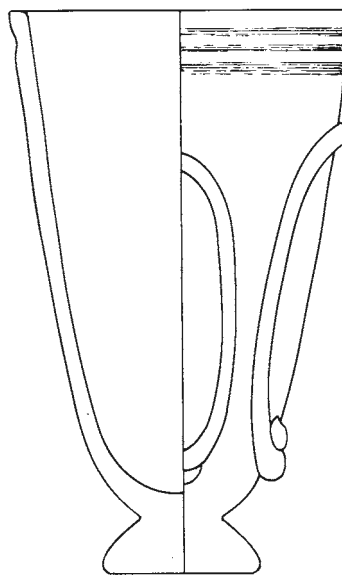

Fig. 21. Glass vessel from Salthammer (after Straume 1987). 1:2.

roughly the same distribution and dating as the cut ones. One of this type was found at Salthammer in Norway (Straume 1987:97 and Pl. 59:1) (Fig. 21). It is a conical beaker with a foot, of colourless glass, decorated with three large medallions in trailing. The dating is late C2 or C3.

The continental finds of this type of vessels are known from Kostelec na Hané in Moravia, from Barabás (Kosino) in Hungary and from Independenta and Izvoare in Romania (Näsman 1984:86). The addition of known glass vessels with cut medallions indicates, however, that the vessels with the same design in applied trailing might be more numerous than the published and discussed ones, not least in the Black Sea region. The vessels with trailing, perhaps easier to manufacture, seem to be copies of vessels with cut medallions. It is, however, possible that one and the same design was made in different techniques.

The vessel from Kostelec na Hané (Werner 1959; Zeman 1961: Fig. 81; Tejral 1975: Fig.

12,16) was recorded in a cremation (grave 421) and can be dated to the 4th century. The footed beaker from Barabás (formerly Kosino), in Budapest Museum is made of yellow-green glass with four medallions in applied self-coloured trailing and with nubs between them in the same way as several of the cut beakers. It was found in a woman's grave with a rich context which has been discussed by Werner (1959). He proposes a rather late dating, second half of the 5th century (cf. Kovrig 1979).

The beakers from Independenta and Izvoare grave 8, both from cemeteries in Muntenia, belong to the complex of vessels with applied trailing found in the same areas as the beakers with cut medallions. The vessel from Independenta is similar to the Scandinavian finds with medallions in trailing and nubs (Mitrea & Preda 1966:183 pp. and Figs. 134, 267). The beaker from Izvoare has a small foot, a wide body with medallions in trailing but no nubs (Mitrea 1972, Fig. 11a; Rau 1975 p. and Pl. 5:2). The dating of the continental finds is discussed by Näsman (1984: 86) and Ščukin (1976 with diagram). They are estimated to be C3–D. This is in accordance with the dating by Rau of the beaker from Izvoare to the 5th century.

The beakers with medallions in applied trailing are found in the late Sîntana de Mureş-Černjachov culture from Ukraine and Moldavia to Romania and the Danube district. It appears that these beakers show small variations but that the design is the same as a whole. The conclusion might be that they were manufactured at different workshops, perhaps small ones, in the area. There could be more vessels of the same type which are not mentioned here.

Näsman considers the possibility that the vessels with cut medallions were made in the

earlier southern Russia and the ones with applied trailing in Muntenia (1984:86 and Map 6). It is not possible, however, to obtain a complete grasp of the find material in these distant areas with a restricted number of accessible publications. The region extends along the north-western and northern surroundings of the Black Sea from Romania, with Muntenia and Moldavia, via the Republic of Moldavia to southern Ukraine and perhaps to southern Russia. It is a region where glass vessels might have been manufactured at many local workshops. As a matter of fact, there are many workshops in these districts. Rau has recorded about ten (1972:179 f., Fig. 72).

In connections with the glass vessels with medallions in applied trailing a magnificent vessel from a grave at Wiepenkathen has been mentioned (Böhme 1974:142 p. and Fig. C). It is a beaker made of thick yellow-green glass with a network of tremendous trails in dark blue and yellow-green. The dating is approximately 400 AD or the 5th century. Böhme supposes that it is associated with the material in the Black Sea areas and perhaps was made there. With its two colours it has some feeling of overlay decoration even if the manufacture is different. It is in any case interesting as evidence of contacts with the Black Sea region.

Discussion

The analyses based on the technical aspect have treated glass vessels with overlay decoration. They are made in a way similar to the manufacture of the bowl. As the vessels with overlay are found within some types of cut vessels, the investigations have concentrated on these types. They are distributed from Scandinavia to the south-eastern parts of Europe. Some vessels are found in Central Europe but in the northern and north-western surroundings of the Black Sea these glass ves-

sels with cut decoration have a long tradition with influences from the early glass-producing areas in Syria and Alexandria and from the Achaemenian and Sassanian districts (von Saldern 1963:1 pp.; Pinder-Wilson 1963; cf. Näsman 1984:51 with references).

The glass-producing areas at the Black Sea were also influenced by Greco-Roman culture. Many workshops are documented within the Sintana de Mureş-Černjachov culture and they continued after its cessation approximately 400 AD. Greek was spoken in these districts, important for the conception of the glass vessels with Greek inscription even if it is a well-known fact that the glass-makers moved around. The newly published finds with Greek letters and with overlay decoration from Romania speak for these areas as a district producing the vessels (Gomolka-Fuchs 1999).

The technique with overlay decoration is, as mentioned, known on the continent during the Roman Iron Age. The tradition of this technique might, however, be in the south-eastern parts of Europe where the cutting of glass vessels with great skill continued from the Roman Iron Age into the Migration Period. The glass vessel with overlay from Tocileni is important in this connection. Tejral mentions in 1975 that there are many vessels with overlay decoration in the region of the Černjachov Culture. Näsman, however, criticizes this statement as being without evidence. It is not possible to distinguish in the known material a connection without interruption over a long time, but the technique appears now and then within the eastern Mediterranean areas. Overlay decoration is known, for instance, in glass production in Egypt and in the Islamic manufacture in Iraq and Persia. The date of the Islamic material might be from the 8th and 9th centuries AD,

but the chronology is rather unsure (Lamm 1930; *Glass from the Ancient World* 1957; von Saldern 1968:52).

The design. Objects with similar decoration

The ornamental ribbon around the bowl

The glass bowl from Uppåkra has an ornamental ribbon below the edge running around the vessel. It is decorated with horizontal cut ovals divided by double vertical furrows (Fig. 8). This ornament is uncommon and seems to be unique on glass vessels. Cut horizontal ovals without furrows exist but they are not very common on the glass vessels with cut ornaments. A glass bowl from Haagerup in Denmark has a row of such ovals below the rim, as does another kept in the Galerie für Antike Kunst Zürich. Besides other cut ornament, this has a row of horizontal ovals below the rim (Fremersdorf 1967: Pl. 79 and 173). The last one is supposed to be Sassanian. Fremersdorf (1967) presents some other glass vessels with this type of ornament.

The ornament with ovals and vertical furrows is, however, found on a metal object from Uppåkra, an eyebrow of a helmet. This is made of bronze, gilt and inlaid with silver wires and niello in close-set vertical lines between two ribbons with the same ornament as on the glass bowl, namely horizontal ovals divided by two vertical lines. The ribbons are placed at the over-edge and the under-edge of the eyebrow. The ornament has a geometric character which is common in carved decoration. It has at the same time a Classical aspect. The fact that the two objects, one in metal and the other in glass, have the same decoration is highly interesting. The problem is,

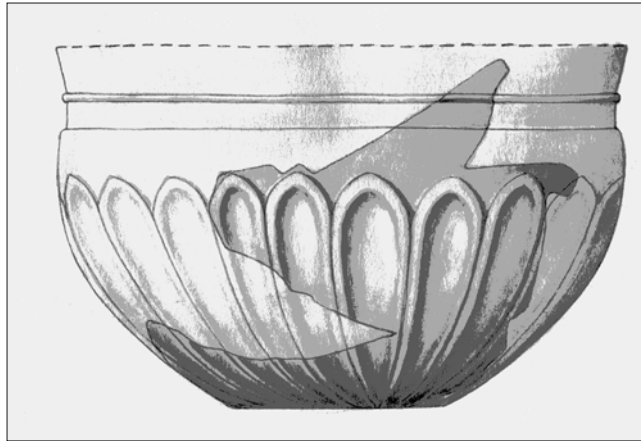

Fig. 22. Glass vessel from Bodummark. Drawing by Allan Fridell. Department of Archaeology and Ancient History, Uppsala. 1:2.

however, where the eyebrow was made. The motif might have been used at different places even if it is complicated to present it.

In the production of silver objects from the Migration Period there is an ornament with oval bosses divided by some kind of marking such as a square or points. This ornament looks rather similar to the ribbon on the bowl. It is found, for instance, on objects in the Hesselager find and also on silver in the Mildenhall treasure. It can be characterized as an ornament influenced by Roman tradition.

Glass vessels with flower decoration

Another category of glasses with connections to the bowl is vessels with the same or similar design. The body is decorated with bows proceeding from the base and enclosing the bowl. They are similar to petals forming a rosette around the body. Thus, the decoration is different from the ornament on the glass bowls from the beginning of the Roman Iron Age with ribs, known as pillar-moulded bowls. The design has instead a flower-like appearance. There is a relation between the

rosette and the lotus ornament. In Egypt the lotus motif seen from above was formed like a rosette (Wilson 1994). There are some comparative objects with lotus and rosette motifs which will be discussed.

Two fragmentary glass bowls from Bodummark (Fig. 22) and Vrangstrup in Jutland, Denmark, have flower-like decoration. The glass bowl from Bodummark, Rise, Aabenraa Amt, consists of uncoloured sherds. They were found in a grave dated by several objects, for instance a sword, ladle and strainer and spurs to B2/C1a (Ekholm 1957; Hansen 1987:107 p. and 230, Fig. 44). It is called a lotus bowl because of the decoration with petals running from the base and surrounding the body like a rosette. The other lotus bowl was found in Vrangstrup grave 3, Granslev, Viborg Amt (Hansen 1987:428). It is fragmentary. The grave is dated to C2 by many fine objects for instance a neck-ring of gold, fibula, pottery vessels.

As a parallel to the two lotus bowls from Denmark a vessel from the wealthy grave at Hassleben has been mentioned. This is a bowl of colourless glass decorated with cut flutings

placed closely side by side (Schulz 1933: Pl. 20:1; Ekholm 1957). The decoration, however, is not very similar to the lotus bowls. It is dated by the grave to approximately 300 AD and might have been made in Cologne. Two glass bowls kept in the Trier Museum, published by Fremersdorf (Fremersdorf 1967: Pls. 63 and 65), have petal-like design with parallels in the material from Dura-Europos (Clairmont 1963). Another glass vessel with similar design is in Museum Bonn (Follmann-Schulz 1992:38, 20).

A bowl of thick colourless glass, found in the Rhineland and kept in Museum Bonn, has a cut ornamentation with a rosette proceeding from the base which is decorated with a Medusa head (Haberey 1957–1958; Follmann-Schulz 1992). The rosette is similar to the design of the Uppåkra bowl. Another bowl with the same motif is in the Metropolitan Museum, New York (Kisa 1908:579, Fig. 254). These bowls are dated to the 3rd or 4th centuries.

Another highly interesting bowl of approximately the same date comes from grave 533 at Krefeld-Gellep, dated by a Roman coin from 298 AD. It is made of colourless very thin glass and decorated with a series of lotus-like petals or leaves which proceed from the base surrounding the body. Between the petals is a mussel shell and on the base a flower. The ornament is partly cut (Pirling 1968: Pl. 47, 13) (Fig. 23). The glass material has been analysed (Wedepohl *et al.* 1997).

Some glass bowls with applied trailing will also be mentioned because of the design. Below the horizontal trails petal-like tongues proceed from the base of the bowl and form a rosette around the body. These bowls are found in the same areas as the conical beakers with applied trailing, that is, England, France and parts of Germany. There are 20, in round

numbers, in the Rhine area but they are uncommon east of the Rhine and have in fact very little in common with vessels with cut decoration, even if bowls with applied trailing could have imitated bowls with cutting (Koch 1968:114 pp. and Pl. 97; Näsman 1984:79). There are also pottery vessels probably imitating the glass vessels with cutting (Goethert-Polascheck 1977).

The two bowls from Denmark are characterized by a rosette-like design cut around the body of the vessel. The rosette ornament exists on many types of vessels, even if the details of the design vary with the petals placed closely side by side or with regular intervals at the upper part of the flower. The most interesting example in this connection is the flower decoration on glass and on metal vessels. Ekholm has searched for the background to the lotus bowls in such material from earlier times. He cites as an example a bowl of silver from Palestine which was excavated by Flinders Petrie in 1938 in a grave from approximately 850 BC (Ekholm 1958: Fig. 3) decorated with petals which surround the bowl from the base. It is, in fact, very striking as a parallel to the bowl from Bodummark even if it is impossible to see a connection. Ekholm was of the opinion that this design existed in the tradition for a very long time. There are other examples of bowls with lotus flowers, also in glass, which are important for the discussion of the flower ornament on the Uppåkra bowl.

The glass vessels with flower decoration discussed here are from the Roman Iron Age. Their ornamentation seems, however, to be influenced by an old tradition with origin in the Hellenistic time and earlier. This can be exemplified further.

A large complex of cut-glass vessels in the eastern Mediterranean areas illustrates glass production from the 8th century BC in late

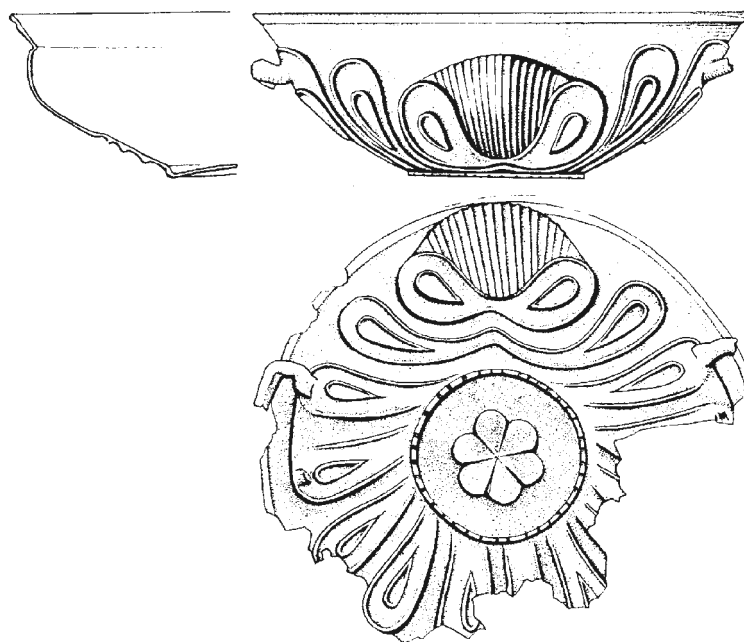

Fig. 23. Glass vessel from Krefeld-Gellep (after Pirling 1968). Rim diameter 13 cm.

Achaemenian and early Hellenistic times. It was followed by the cut vessels in Early Roman time manufactured with great skill and later by the well-known magnificent *diatreta* vessels. It is difficult to discern any continuity in the known material but the tradition appears now and then (von Saldern 1963). The early production gave glass vessels with flower decoration which are highly interesting for conclusions concerning the design of the Uppåkra bowl and similar vessels presented here. Some examples will be mentioned.

An omphalos bowl from Gordion of nearly colourless glass has 32 raised petals radiating from the base to the rim. The bowl is said to have been manufactured in a mould or by the lost wax process and then ground with the help of a cutting tool (von Saldern 1959: 25). The dating is the 8th century BC. A shallow bowl at the British Museum has a raised leaf rosette with sixteen petals. It was formed

and then cut and ground. It was given to the museum but is said to be from Mesopotamia and dated to the 7th century or later (von Saldern 1959: Fig. 11). The dating is, however, very tentative. Parallels can be found in the Römisch-Germanisches Museum, Cologne and in the Corning Museum of Glass (von Saldern 1963:8 and Pl. I, Figs. 1–2). The bowl in the Corning Museum of Glass is of colourless glass with a slight greenish tinge. It is cast, lathe-cut and polished. It is from western Asia, probably Iran, and belongs to the Achaemenid Period, 500–400 BC (Fig. 24).

An Achaemenian glass bowl from Georgia belonging to the same group of vessels with flower decoration was found during excavation at Saikhe between the years 1982 and 1990. It is rather deep and decorated with thirty-two lotus petals. It was mould-made and then treated by cutting. A radiocarbon dating of the chestnuts found in the same lay-



Fig. 24. Glass bowl with lotus ornament. Rim diameter: 17.5 cm. Photo from the Corning Museum of Glass.

er has given the 6th century BC (Makharadze & Saginashvili 1999). Other glass vessels with flower decoration presented by von Saldern are later, dated to Hellenistic times. Some belonging to the so-called “finned” bowls are said to come from Canosa. There are also similar bowls with rosette design in private or other collections and in the British Museum.

A glass bowl from Dakhowskaya by Majkop on the Black Sea in the Adigej administrative region has a decoration similar to the lotus bowl from Bodummark discussed above (Fig. 25). It is of pale green glass and decorated with vertical bows similar to petals placed closely side by side running from the base and surrounding the body like a rosette. The dimension is about the same as the Uppåkra bowl. According to Kropotkin, this bowl was made in Syria in the last century BC or the first AD (Kropotkin 1970:27 and 101, Pls. 73:4 and 74:7). The motif has some similarity to the fluting ornaments found on bowls of metal.

Von Saldern sketches the lines from the early glass, made at least partly in western Persia, on the Syrian coast and later in Alexandria, to the highly qualified cut glass of Roman production (Harden 1934; 1936; 1949; von Saldern 1959, 1963:44 p.). It may be mentioned that the very long tradition can be traced also in the production of gold glass. This very fine type of glass vessels is known in the early production for instance at Gordion, is found in Roman times and later at several places, including Scandinavia (von Saldern 1959:45 pp.; Harden 1969:63 pp.; Stjernquist 1999a with references).

Comparative objects of metal

There is an isolated piece of metal from the late Roman Iron Age which gives the impression of similarity to the decoration of the bowl. It is a bowl of bronze found in grave III at Harpelev and dated to the 4th century AD (Fig. 26). It is published and discussed by Lund Hansen (1977: Fig. 10). She had no

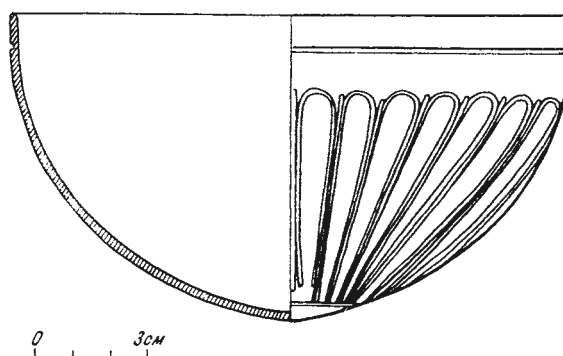

Fig. 25. Glass bowl from Dakhowskaya by Majkop (after Kropotkin 1970).1:2.

parallels, however, and the origin is not clear. The similarity is the shaping of the base, the fluted body and the edge with double furrows. It seems to be influenced by a design similar to that of the glass bowl from Uppåkra (Hansen 1977:106). The most interesting metal vessels are, however, found far away.

The large number of glass vessels with flower decoration found in the eastern Mediterranean areas and dated to the last millennium BC have been discussed by several scholars. There seems to be a current opinion of a relation between these glass vessels and vessels of metal, especially silver vessels, that is to say that the decoration of the glass vessels is influenced by design in metal. Ekholm, for instance, believes that the Bodummark vessel has some such early model and that the design depends on a surviving tradition (Ekholm 1958:17 pp.). There is a similarity even if it is difficult to discern a connection. The background is the large complex of metal bowls with fluted decoration which is characterized as some kind of lotus ornament. It can be studied in the large production of Hellenistic silver objects which includes many early trends and also in Greek and Roman art handicraft.

In the eastern Mediterranean area many metal bowls can be mentioned (Strong

1966). A silver bowl from Rhodes with lotus ornament is dated to *c.* 650 BC. Many fine objects with fluted decoration or leaf ornament might come from workshops in Egypt with influences from Persian metal handicraft. Rostovtzeff reproduces a silver bowl with lotus ornament found in Egypt, now in the Cairo Museum (1941: Pl.XLVII:4), and another found in Persia in a hoard from the 4th century (1941: Pl. LX:2). Strong refers to a characteristic group of bowls decorated with leaves, lotus and bosses, found in Egypt in 1917 and now in the Metropolitan Museum of Art. The large Thracian hoard from Rogozen in Bulgaria with 165 silver vessels decorated with Classical motifs, flutings and lotus dated from approximately the fifth to the fourth centuries can also be mentioned (Rogozen 1988). It is very difficult, however, to get a general view of the material and to treat it critically.

Silver vessels with similar decoration appear now and then also in the centuries AD. Very interesting objects are a set of two silver beakers found in 1947 in grave 3 at Łęg. Piekarski in Poland, dated to Eggers' period B (*Inventaria Archaeologica, Pologne* 1960: IV 26, 5–6; Wielowiejski 1989; Künzl 2002: Pl. 17,3) (Fig. 27). They are decorated with

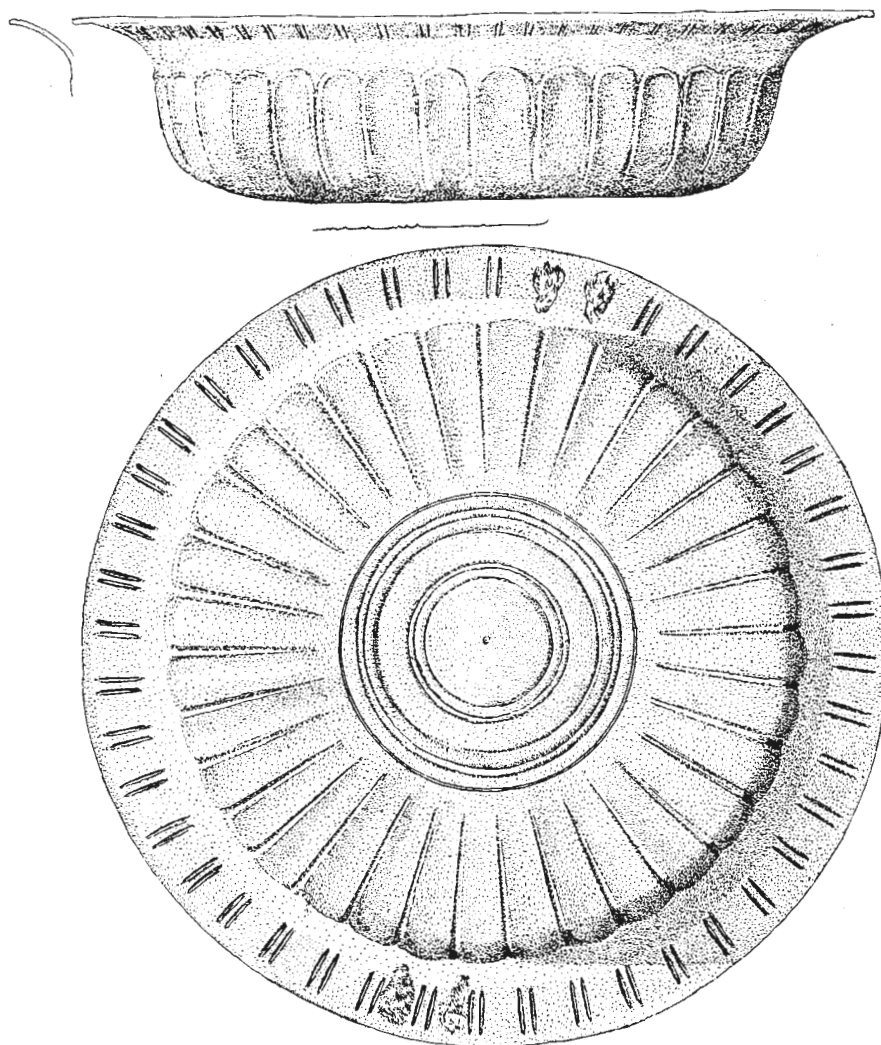

Fig. 26. Metal vessel from Harpelev (after Lund Hansen 1977). The loose handles are not reproduced here. Diameter: 42 cm.

petal-like tongues in relief running from the base and surrounding the body of the beaker like a rosette, a decoration similar to the lotus ornament of the glass bowls from Bodummark and Dakhowskaya. The silver beakers are assumed to be Germanic art handicraft copying the shape of a Roman vessel (Künzl 2002:340, Note 79). They were stolen from the museum in Poznan (see pictures of reconstructions in Wielowiejski 1989 and Künzl 2002).

Furthermore, the famous Sutton Hoo find contains, for instance, a series of silver bowls where the fluted decoration and the flower design have a prominent position. There are sixteen items of imported silver. Twelve of these are bowls. The large fluted bowl is decorated with leaf-shaped pattern proceeding from the base. Several parallels have been found in silver hoards from the fifth or sixth centuries such as Mildenhall, Tarprain Law and Kaiseraugst (Strong 1966; Bruce-Mitford

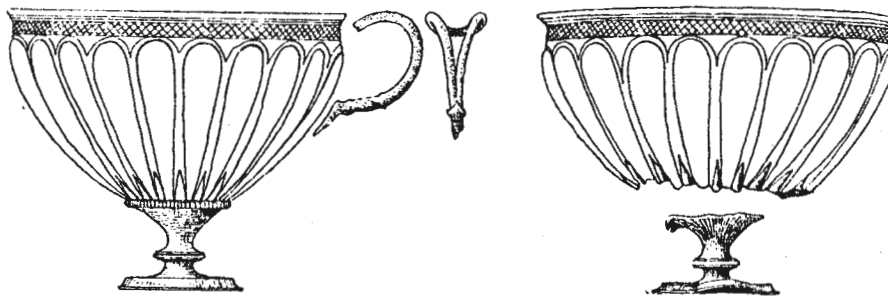

Fig. 27. Silver beakers from Łęg. Piekarski (after *Inu. Arch. Pologne* 1960).1:2.

1983). A set of ten bowls with chased cross-shaped ornaments are highly interesting in this connection because of the rosette pattern at the centre of the roundels. The eight lobes of the rosette on eight bowls are divided from each other by radial borders. The patterns on the bowls Nos. 80, 86 and 81 are very fine (Bruce-Mitford 1983: Figs. 77, 78, 79, 80, 81, 82, 87, 88, 89). The centre of the rosette is a small roundel (Fig. 28).

The Sutton Hoo silver is supposed to have been imported from Constantinople or from some other place in the eastern Mediterranean areas. The Anastasius dish bears Byzantine Imperial control stamps and the set of ten bowls has characteristics which indicate an eastern localization (Bruce-Mitford 1983:162 p.). At an exhibition in 1977 the Sutton Hoo silver was compared with pieces of antique silver including Sassanian silver. The eastern influences on the Sutton Hoo bowls were thus elucidated. The connections with an early tradition of handicraft are, however, not clear.

The decoration and its symbolic signification

The ornament of the glass bowl from Uppåkra has been characterized as a flower or rosette ornament (Fig. 29). It has been compared with fluted decoration influenced by a tradition of plant patterns with the lotus design as an important element.

The lotus ornament was a holy pattern in Egypt in ancient times and later in different parts of Asia. There are many variants: closed or open flowers, with or without stems and leaves. In Egypt it was a symbol of sun and life associated with Horus, the god of the sun. The flower opens and closes with the sun. It was at the same time a symbol of fertility. In this quality it was associated with the goddess Isis. The Egyptian lotus had two forms: *Nymphaea lotus*, the white one, with curved outline of the open flower-head and rounded petals, and *Nymphaea caerulea* with pointed and narrow petals. Both forms are found as ornaments (Wilson 1994:101).

This plant motif of ancient Egypt was adopted in western Asia in the second millennium BC and spread to eastern parts such as Assyria, India, China and Japan as an ornament in handicraft and building. It was a sacred symbol in Buddhism. The lotus ornament also spread to Greece and has influenced other parts of Europe (Lewis & Darley 1986; Wilson 1994; *The Dictionary of Art* 1996).

It is quite clear that objects with lotus ornament came to Europe and that the design influenced handicraft there. As a flower ornament it can be circular with the elements radiating from its centre forming a rosette motif. It is a hypothesis that the design of the bowl from Uppåkra had a background in



Fig. 28. Sutton Hoo Ship-Burial. Bowl Inv. No. 80 with rosette ornament (after Bruce-Mitford 1983, Fig. 77). Enlarged. Acknowledgement to the Trustees of the British Museum.

that pattern. Whether the symbolic value was included is, however, an open question, but it is not impossible.

Discussion

The decoration has been regarded in this paper as an element modelled by many influences. An analysis of this kind might illustrate the connections and elucidate the question

of origin and production. There are, however, many uncertainties and source-critical problems. One difficulty is the fact that the stylistic formation is complex. Models might have existed but different elements could have changed and been mixed. Another difficulty is due to the very wide distribution of the material discussed. The connections are probably not direct but through a series of gradual stages. The hypothesis is, however,

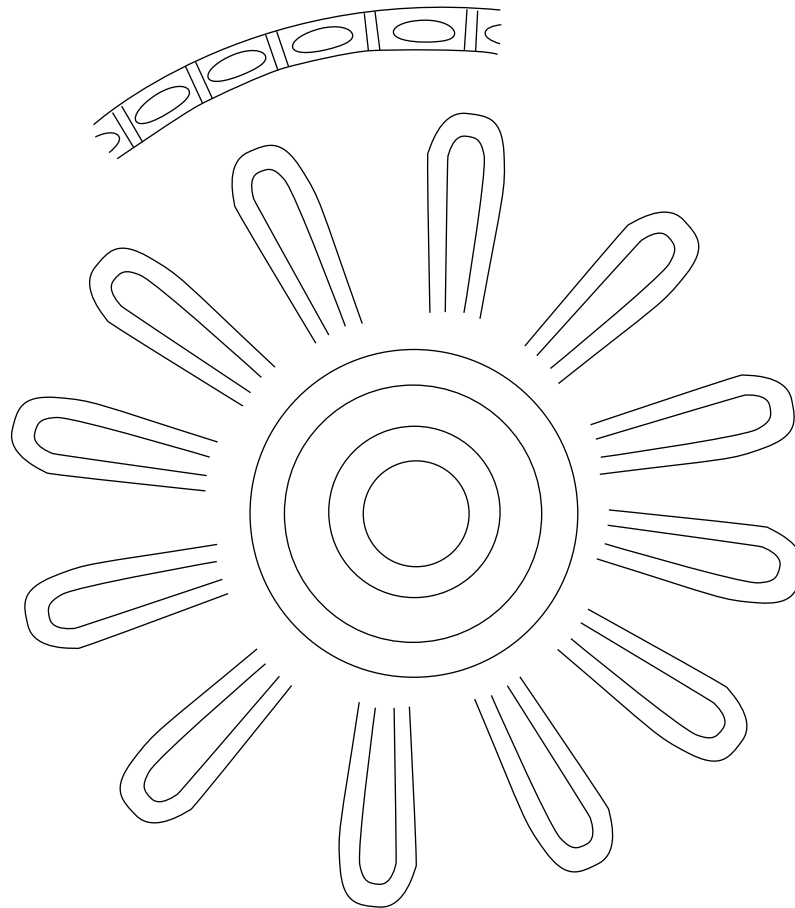

Fig. 29. The ornament of the glass bowl from Uppåkra folded out as a rosette. Drawing by Berta Stjernquist. 1:2.

that the art handicraft was dominated by a style tradition which can be recognized, even if this tradition was influenced by many unknown components.

The ribbon below the rim of the bowl has been interpreted as traces of a Classical tradition with a geometric shape. The occurrence, shaping and connections of the rosette pattern have been discussed. The vegetable design, especially the lotus pattern, is the most obvious element which has been traced and demonstrated by research. The region where this element existed in handicraft products over a very long time is the eastern Medi-

terranean areas: the Black Sea area, Persia, Egypt (Pope 1938; Rostovtzeff 1922; 1941; von Saldern 1959; Kropotkin 1970: Pls. 73: 4, 74:7). It was probably distributed in different directions. The connections, however, are not clear.

Probable complex of origin

As the bowl is unique in the sense that there are no parallels among the known glass vessels, the problems of its manufacture and origin are especially complicated. The find of this magnificent piece is a reminder of the

incompleteness of our knowledge of prehistoric material. The large amount of detector finds from Uppåkra shows the richness of the settlement. We are, however, aware of the fact that the retrieved material is only part of what once existed. Glass sherds of different kinds indicate that imported glass vessels were common (Stjernquist 1999).

There is no evidence of glass production in Scandinavia at that time, although it has been discussed for some special types (Näsman 1984:34 pp.; Straume 1987:54 pp., cf. Arrhenius 1973). Glass manufacture demanded resources of raw material including emery or a substitute for it, and not least technically competent glassmakers and an organization. Although it is known that glassmakers moved around we cannot reckon with high-qualified production of glass vessels in Scandinavia in the Iron Age. The origin of the glass bowl must be sought in regions in the west and in the east where cut-glass vessels of high quality were produced not only in Roman times but also in the 5th century, when the bowl might have been made.

To shed light on the problem of the origin, the analysis has discussed groups with the same characteristic traits as the bowl, namely comparative material from two angles: technical and decorative. Furthermore, the scientific analysis will elucidate the problem of origin.

The technical aspect has emphasized the overlay decoration and the groups of vessels which are characterized by overlay and cut decoration. The overlay decoration is found in Scandinavia and in some cases on the continent with sporadic finds in Poland, Moravia, Dalmatia and Romania. The vessels with cut decoration of ovals and medallions are found in the same areas. The flower decoration with lotus and rosette design has a very

long tradition starting with the manufacture in Egypt. The spread of these patterns is demonstrated in Asia and parts of Europe, with the lands around the Black Sea appearing to be an important region. The high skill and large production of cut vessels are found in the same areas where many workshops from Roman times and the subsequent centuries are known (Ščukin 1975; Sorokina 1978). It seems clear that these traditions influenced the bowl from Uppåkra. It is not possible to prove it, but the hypothesis is that the origin is in that region, perhaps in Romania, Ukraine, south Russia or in the area south-east of the Black Sea. The evidence points in that direction.

It is characteristic that the ornamentation has a very long tradition. There may sometimes be a vacuum when other motifs were preferred but many kinds of decoration such as the gold glass return later (cf. Stjernquist 1999a).

The chemical analysis by Maria Lang is published in the Appendix. Pieces of the clear and of the blue glass from the bowl were analysed as well as pieces of a glass beaker of clear glass with green tint and cut ovals found in the same house as the bowl. This glass with cut ovals is published in another paper in this volume.

All three glasses have the same type of composition. It is soda glass mainly consisting of SiO_2 and Na_2O . They are very much in the same range as 19 analysed Roman glasses found in Norway with which they are compared (Christie, Brenna & Straume 1979). The low content of potash and magnesia indicates that natron is likely to have been the sodium source. The report declares that this composition is typical of the Roman glasses made in the Cologne area during the first four centuries of the Christian era. This

result is confirmed by the analyses of the late Roman glass bowl from grave 533 at Krefeld-Gellep, discussed above, and of some other late Roman glasses from the same cemetery (Wedepohl *et al.* 1997).

The 19 glasses from Norway which have been analysed are not all from the Roman Period. Some of them are dated to the Late Roman Age and others to the Merovingian Period with Roman tradition surviving. Several of these glasses were probably made in the south-eastern parts of Europe (Straume 1987). The stylistic analyses of the glass bowl from Uppåkra made in this paper indicate that it originated in the same areas. The interesting result is that the manufacture of glasses and the composition of glass was rather similar on the Roman frontier in the west and in the south-east. Natron was available. Trace elements to distinguish between them technically are obviously lacking. Analyses discussed by Newton in a paper mentioned in the report point in the same direction.

Hypothesis concerning the route of the vessel to Uppåkra

The distribution of glass from the production sites to the find places in Scandinavia has been discussed by scholars in many papers. Some of them, published in recent years, have the Scandinavian material as starting point (Näsman 1984:91 pp.; Hansen 1987, 1995; Straume 1987). These papers summarize and analyse the different opinions. The bowl from Uppåkra, however, has augmented the discussion with new aspects which refine and emphasize some opinions and open for new ones.

As the find place is at a great distance from the production site, the distribution is

a difficult problem. It has one theoretical and one practical aspect. The theoretical one has been analysed by the author in two papers (Stjernquist 1967, 1985). There are three possibilities of transfer: long-distance, gradual long-distance and local. Long-distance transfer means that the products go from the production area past other settlements directly to a remote area. They do not stop on the way. The variant of the long-distance transfer, namely gradual transfer, means that the products were brought to a remote area but the transfer is mediated by the inhabitants, for luxury objects by the elite, from settlement to settlement on the way. This model concerns prehistoric societies which have a system of exchange of goods instead of a market economy. It is applicable to the distribution of glass vessels.

This model refers to courses of events from a general point of view. The background is, however, activities carried out by individuals based on economic and other conditions. The transfer of the fragile glass vessels involved many difficulties. We know very little about the practical realization of the transfer, even if there is some information.

Capelle, who has studied the packing and transfer of goods, not least fragile goods, emphasizes that the glass vessels might have caused difficult problems. Packaging in wooden crates and containers, as known from Pompeii for terra sigillata, is a model for long-distance transfer of all fragile objects (Capelle 1988 with references). The waterways with different kinds of boats were certainly used (Eckholdt 1980; Ellmers 1984) and supplemented with sleighs during the winter. We can accept the idea that the thick glass of many vessels found in Scandinavia depends on planned long-distance transfer, at least partly.

There are some written sources treating the transfer of goods during the Iron Age. With the available material as a starting point Kunow has discussed the roads, the organization and the goods for the Early Iron Age (Kunow 1980) and Verhulst for the Late Iron Age (Verhulst 1970; cf. Schwärzel 1983). The information is, however, rather scarce and concerns only some parts of Europe. The social and political conditions are not similar everywhere. The written sources indicate that the transfer from the Mediterranean areas to Scandinavia was affected by different systems: on the one hand market economy or some kind of monetary economy, and on the other exchange of goods and luxury at a high level.

The Germanic people, which dominated large parts of the continent in the Late Roman Age, and after the breakdown of the Roman Empire, distributed luxuries such as glass objects through a network of exchange at a high level, an instrument of power. Näsman has presented five phases of exchange and trade from the Late Roman Age to the Middle Ages, that is, from exchange to market economy (1990:110 pp.). Conditions in the Alemannic area, discussed by Steuer and presented as a model, may be mentioned as an example of the trading activities of a Germanic people (Christlein 1978; Steuer 1997: Fig. 444). The king or duke took part in a network of trade and had craftsmen working. He might have mediated goods in a gradual trade. On the local level the products were distributed to the elites as payment for their duty as escort. Other Germanic people might have had a similar social structure. The transfer was probably a combination of trade and exchange.

A prerequisite for the transfer is favourable social and economic circumstances. The connections to the south-eastern parts

of Europe are, however, especially difficult to trace because of the great migrations in these areas. The problems have been intensively treated (Näsman 1984, 1990; Straume 1987; Hansen 1987, 1995; Kiss 2001). The result is that the contact lines in north–south directions were open even after the cessation of the Sântana de Mureş-Černjachov culture in the Black Sea area and the appearance of the Huns at the end of the 4th century. They might have functioned in the 5th century, the probable time for the distribution of the bowl from Uppåkra, in spite of the immigration of the Slavs (cf. Horedt 1979, 1999; Wolfram & Daim 1980; Gomolka-Fuchs, ed., 1999). This is evident from the distribution of the glass vessels with cut decoration originating in the Black Sea areas (Näsman 1990:95, Fig. 3, 1998: Fig. 2).

Another factor of importance for conclusions concerning the contact lines is the gold imports to Scandinavia in the Late Roman Age and the Migration Period which has been discussed very much. The *solidi* and other gold objects originating in south-eastern Europe were mediated or brought through personal contacts to Scandinavia and are partly found in hoards (Näsman 1984:119 p., 1998; Kylberg 1986 with references). The opinion is that lots of *solidi* were melted down and used for the production of luxury objects. The contact lines were open in spite of many difficulties. The hypothesis is that the bowl at that time came to the north from the production areas in the south, with many influences converging from different sources.

There are rather few written sources speaking about the conditions of the Germanic peoples living between the southern coast of the Baltic Sea and Pannonia in the Migration Period. The written sources which exist are, however, important. For instance, they

give some information about the Thuringian people living in the middle of Europe in the fifth and sixth centuries with a tradition from late Roman times (Schmidt 1987). They had contact with the Ostrogoths as well as with the Huns father to the south. The archaeological record also shows contact at a high level between southern Scandinavia, including the Uppåkra settlement, and the ruling tribes in the middle of Europe, not least the Thuringians (Näsman 1984, 1998; Wood 1998; Hårdh 2003). These tribes in the middle of the continent might have been a bridge for exchange and distribution of wealthy and luxury objects.

Function

The glass bowl was found together with a beaker of metal. Beakers of different kinds are used as drinking vessels in modern time and it is well documented that the use was the same also in prehistoric times (Enright 1996). Bowls could, however, be used in different ways: as drinking vessels or for arrangement or storage. The probable function of the magnificent glass bowl at the settlement will be illustrated.

Vessels for food and drink are found in graves and at settlements (Stjernquist 1999a with references). It is possible to study the combination of vessels in drinking sets which include vessels of metal, glass and pottery. Some examples will be mentioned. The graves from the Roman Iron Age in Jutland are known for large sets of pottery vessels of different shapes, bowls, dishes and beakers. A magnificent set of a similar kind is the well-known Hoby find with two Roman silver beakers with figure decoration (Hansen 1987). Werner has treated the sets of two beakers, very common in the graves from the

Roman Iron Age. They might be drinking sets for two kinds of beverage (Werner 1950). It could, however, be beakers for two individuals. Steuer has treated the drinking sets as status objects (1982:243 pp., 1992:214). Drinking sets in very wealthy graves like the princely grave from Hochdorf include a large vessel and many drinking horns intended for a group of guests (Krausse 1996; Bieg 2002; cf. Stjernquist 1999b; Ingemark 2003).

The function of the bowls in sets with beakers and bowls can be discussed. The question is whether the bowl was intended for drinking or for other arrangement with pieces of food. The pictures on the mosaics at Ravenna are highly interesting for the interpretation of the function of the bowl. A mosaic in the church San Apollinare Nuovo from the 6th century AD shows a picture of the three Magi presenting gifts (Fig. 30). Two of the vessels which they are carrying are bowls with a decoration of fluted ornaments. These ornaments look similar to the decoration of the Uppåkra bowl (Nordström 1953; Sfinx 1979:4). The vessels were used for gifts such as gold and incense. A similar bowl is represented in a publication from a symposium treating the commerce in perfume or incense with the far Orient using bowls as storage vessels (Avancini 1997).

The pictures of the three Magi present them and their attributes through the history of art in a design characteristic of the time. Therefore, the vessels with fluted decoration are highly interesting as an expression of an oriental style (Kehler 1909; Vezin 1950). The pictures illustrate at the same time the function of a vessel used for representation.

Three high-quality glass vessels were found in grave 6 at Valsgårde, namely: a blue and a green beaker and a glass bowl (Arwidsson 1942). The three vessels might be a drinking set. The grave is dated to the 7th century



Fig. 30. The three Magi presenting gifts in bowls with rosette decoration. San Apollinare Nuovo, Ravenna (after Sfinx 1979).

which is only approximately one century later than the bowl from Uppåkra.

Bowls as well as beakers were used as drinking vessels in Classical antiquity. Ingemark has recently discussed the Roman drinking customs which influenced the Germanic peoples (2003:225 pp.). Bowls as drinking vessels are further rather common on the Greek red-figure vases (Bieg 2002:139 p.). There is also literary evidence that glass vessels were used for drinking. This can be found in Aristophanes' *Acharnians* and concerns the year 425 BC. It speaks about Greek ambassadors who visited the Persian court and drank from goblets (*ekpomata*) of glass and gold (Trowbridge 1930:154, 151; von Saldern 1959: 41; Fossing 1941:54; Harden 1969). With reference to the literary information von Saldern presents a bowl with gold foil and flower decoration. It seems probable that the bowl from Uppåkra was used as a drinking vessel.

Holand in her paper in 2001 has treated drinking vessels and drinking customs in the first millennium AD starting with the vessel assemblages from a large Iron Age house at Borg in Norway. She treats not only the imported glass vessels but also bronze-bound

wooden buckets and pottery vessels, that is, many vessels which differ from the beakers. With reference to customs in later times she emphasizes that the drinking vessels were tools for religious rituals and ceremonies connected with fertility and continuity (2001:107). She puts forward the opinion that the vessels and the ceremonies were links between the living and the dead. The drinking customs played a great role in the offering ceremonies.

The role of the drinking ceremonies in religious activities has frequently been emphasized by scholars and can also be demonstrated (Behm-Blancke 1979). The large halls of the settlements or parts of them are interpreted as places where various ceremonies were performed. It is probable that the house at Uppåkra was of the same kind (Larsson & Lenntorp in this volume). It might have been a house for local ceremonies and also a house where foreign visitors were received and invited to drink with the local elite (Dietler 1990). The beaker and the bowl were used in that connection. The drinking was an expression of hospitality, it had a ritual and symbolic significance and a social value. Ingemark has discussed intensively the drinking vessels as

symbols of power and the drinking as a means of demonstrating wealth, generosity and knowledge (Ingemark 2003:225 pp.).

Drinking played a major role in different ceremonies, including ritual ones. However, it is not probable that the wealthy vessels from Uppåkra were offered to the gods when they were put under the floor of the house. They were obviously put there without damage, which speaks against the offering hypothesis. The floor of a house has long been a common hiding place in times of misfortune and impending disaster (cf. e.g. Randsborg 2002). It is, however, important to reckon with different possibilities of interpretation (Larsson & Lenntorp in this volume; Helgeson in this volume). The problem is complicated and calls for a close analysis. Aspects and definition of the concept “cult place” and offering finds have since long been discussed intensively (Bradley 1990; Stjernquist 1997 with references).

Conclusions

The glass bowl which was found during the excavation in 2001 together with a bronze and silver beaker is remarkable because of the blue overlay decoration over a light-coloured glass layer (Fig. 31). The overlay is cut to form petals which encircle the vessel body like a rosette and a horizontal string with cut ovals below the rim. The combination with the fine beaker gives a dating to approximately 500 AD.

The bowl seems to be unique among the known glass objects. Accordingly, the analysis is very complicated and concerns the dating of the bowl, the type of vessel, the manufacture, probable origin, the function and the distribution. The method of analysis is to discuss groups of vessel with the same

characteristic traits as the bowl. This means comparative material from two aspects: technical and decorative. The technical aspect comprises vessels with overlay decoration and vessels of the same types as the ones with overlay, namely glasses with cut motifs such as ovals and medallions and similar with trailing. The decorative aspect comprises vessels with flower and rosette ornamentation.

The vessels with overlay are encountered in large numbers in Scandinavia in finds dating from the Late Roman Iron Age and the Migration Period with connections backwards to the cameo technique and the *diatereta* glasses. They have cut decoration with ovals and medallions. Some of them also have inscriptions with Greek letters, like the fine beaker from Tu in Norway and a newly found fragmentary vessel from Romania. They are scarce on the continent but the known examples are distributed from Poland to the Black Sea regions where the Greek language was spoken over large areas. The glass vessels with cut decoration, which are numerous, show the same distribution picture as well as some glasses with cut medallions imitated in trailing.

The hypothesis is that the decoration on the bowl has connections with the petals and rosette design which is rather common on glass vessels found in different areas. Two fragmentary bowls from Denmark have this ornamentation called lotus design. This decoration has a background in Egyptian craftsmanship and spread into the Black Sea area as early as the Hellenistic period and perhaps earlier, and it had a symbolic signification. Several glass vessels with lotus motifs are manufactured in these regions which were a centre for the cut technique. The same ornamentation influenced metal craft, producing silver dishes and bowls with fluted and rosette

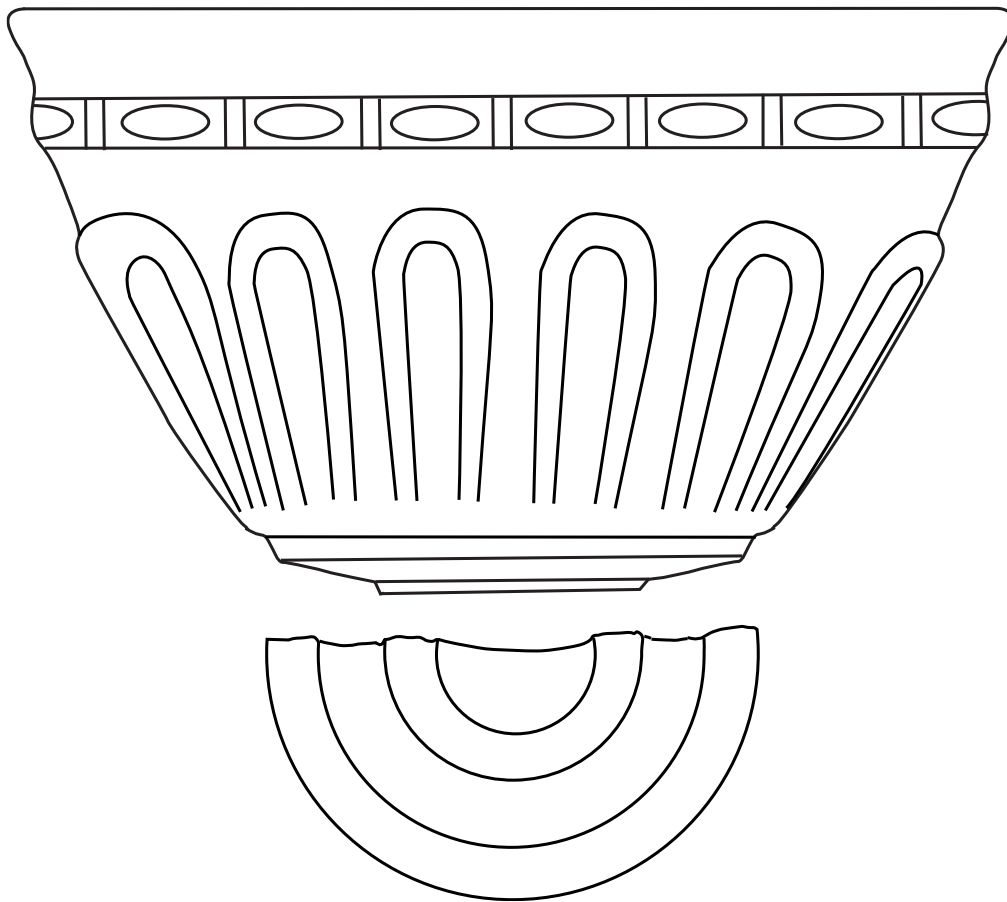

Fig. 31. The glass bowl reconstructed. Drawing by Berta Stjernquist. 4:5.

decoration over a very long time, also in the centuries AD. It is found on the silver beakers from a grave at Łęg. Piekarski from Eggers' period B and also on the bowls of the Sutton Hoo find which are supposed to be imports from Constantinople or from another place in the eastern Mediterranean areas. There are many other traces of this ornamentation on objects not only in the east but also in the western parts of Europe, as exemplified in this paper.

The function of the bowl has been discussed. It is documented that beakers and bowls were used by the elites as drinking vessels at ceremonies on a high level. These ceremonies

were instruments for producing friendship and contact with the local elite and with visiting chieftains. They were significant of power, expressed in wealth, generosity and knowledge. We may assume that drinking was also included in ritual ceremonies. The drinking vessels must have been magnificent, showing the high status of the host. The bronze and silver beaker and the glass bowl with overlay decoration met this requirement. They might have been a sign of rank. Desire for power was a characteristic feature in the mentality of the elites at that time, and friendship was an instrument to attain it. Their position at a power centre was, however, exposed. It was

necessary to make preparations when danger was impending. It is the hypothesis that apprehension about attack and not religious devotion caused the bowl to be put in the hiding place under the floor, as has been done with valuables over a very long time.

The characteristic features of the bowl seem to point to south-eastern Europe and the adjoining parts of western Asia. The areas on the Black Sea with their workshops for glass production in the Sassanian districts and around the sea have the prerequisites for the origin of the vessel, with a very long tradition of cutting and with skilful glassmakers working at many places. The influences of different kinds came from the Greco-Roman culture, from the Germanic tribes and from other peoples in the east where plant ornaments such as the lotus design were common. The surroundings of the Black Sea were a melting pot with many components. Communications there, expanded in Hellenistic and Roman times, promoted the contact.

The distribution of glass vessels from the production sites to the find places in Scandinavia has been intensively discussed by scholars in many papers. There is a theoretical and a practical aspect. The theoretical aspect considers different possibilities of transfer: long-distance, gradual long-distance and local. It is probable that the transfer over long distances was mediated by the inhabitants or by the elite at settlements between the production site and the find places. It must be emphasized, however, that the transfer from south-eastern Europe and adjoining parts of western Asia to Scandinavia must have passed through areas with different economic systems. The Germanic people that dominated large parts of the continent in the Late Roman Age and in the Migration Period distributed luxuries such as glass objects through a network of exchange

at a high level. The Alemannic and especially the Thuringian tribes might have played a great role.

Connections were probably difficult because of the great migrations in the south-eastern parts of Europe. The contact lines and the cultural relations were, however, open and maintained even after the cessation of the Sîntana de Mureş-Černjachov culture, the appearance of the Huns at the end of the 4th century, and the immigration of the Slavs. They might have functioned in the 5th century, the probable time of the transfer of the bowl to Scandinavia. This is evident from the distribution of glass vessels with cut decoration originating in the Black Sea region and from the great inflow of gold, especially *solidi*, into the Baltic Sea area. The hypothesis is that the magnificent bowl at that time came, perhaps gradually through exchange, to the north from the production centre in the south-eastern parts of Europe or adjoining parts of western Asia.

Acknowledgements

I wish to express my sincere gratitude to the curator Hasse Hansen who has done the difficult preservation work with great skill and helped with the documentation of the bowl. Warm thanks to Birgitta Hårdh and Lars Larsson who read the manuscript and made many important comments. Many thanks also to Bengt Almgren for the photography, to Sir David M. Wilson, Karl-Magnus Lenntorp, Birgitta Piltz-Williams, Bo Gräslund and Renate Pirling for information and help with the illustrations. Warm thanks to Eldrid Straume for placing the illustrations of her dissertation entirely at my disposal. I am very grateful to Ulf Näsman and to Maria Petersson for information on new finds of glass sherds with overlay. Warm thanks also to the Trustees of British Museum, the Corning Museum of Glass and to the Römisch-Germanisches Kommission, Deutsches Archäolo-

gisches Institut, for illustrations. I am very grateful to Rolf Petré, Kent Andersson, Gunnel Holmér, to the editorial staff of the *Sfinx* and the staff at LUHM for helpfulness. I am also very grateful to Anna Hagen-Thorn for help with Russian text. Thanks are finally due to the staff of the Library of the Academy of Letters History and Antiquity, Stockholm, and to Ann Tobin at the Library of the Department for their great help, to Maria Lang for important work and information, and to Alan Crozier for revising my English.

References

- Arrhenius, B. 1973. Kring två slipade glasbägare. *Göteborgs arkeologiska museum Årstryck 1972–73*.
- 1985. *Merovingian Garnet Jewellery*. Kungl. Vitterhets Historie och Antikvitets Akademien Stockholm. Göteborg.
- Arwidsson, G. 1942. *Valsgärde 6*. Uppsala.
- Avancini, A. (ed.) 1997. *Profumi d'Arabia. Atti del Convegno*. Roma.
- Behm-Blancke, G. 1979. Trankgaben und Trinkzeremonien im Totenkult der Völkerwanderungszeit. *Alt-Thüringen* 16. Weimar.
- Bieg, G. 2002. *Hochdorf V. Der Bronzekessel aus dem späthallstattzeitlichen Fürstengrab von Eberdingen-Hochdorf (Kr. Ludwigsburg). Griechische Stabdreifüsse und Bronzekessel der archaischen Zeit mit figürlichem Schmuck*. Stuttgart.
- Bierbrauer, V. 1980. Zur chronologischen, soziologischen und regionalen Gliederung des ostgermanischen Fundstoffs des 5. Jahrhunderts in Südosteuropa. In Wolfram & Daim 1980.
- 1999. Die ethnische Interpretation der Sintana de Mureş-Černjachov-kultur. In Gomolka-Fuchs (ed.) 1999.
- Böhme, H. W. 1974. *Germanische Grabfunde des 4. bis 5. Jahrhunderts zwischen unterer Elbe und Loire*. Münchener Beiträge zur Vor- und Frühgeschichte 19. München.
- Bradley, R. 1990. *The Passage of Arms. An archaeological analysis of prehistoric hoards and votive deposits*. Cambridge.
- Bruce-Mitford, R. 1983. *The Sutton Hoo Ship-Burial. Late Roman and Byzantine silver, hanging bowls, drinking vessels, cauldrons and other containers, textiles, the lyre, pottery bottle and other items*. Vol. 3. Cambridge.
- Capelle, T. 1988. Glastransporte. Hårdh, B., Larsson, L., Olausson, D. Petré, R. (eds.), *Trade and Exchange in Prehistory. Studies in Honour of Berta Stjernquist*. Acta Archaeologica Lundensia 8:16. Lund.
- Charlston, R. J. 1964. Wheelengraving and cutting, some early equipment. *Journal of Glass Studies* 4. Corning.
- Christie, O. H. J., Brenna, J. A. & Straume, E. 1979. Multivariate Classification of Roman Glasses found in Norway. *Archaeometry* 21, 2.
- Christlein, R. 1978. *Die Alamannen. Archäologie eines lebendigen Volkes*. Stuttgart /Alen.
- Clairmont, C. W. 1963. *The Glass Vessels. The Excavations at Dura – Europos. Final Report IV, Part V*. New Haven.
- Dąbrowski, K. 1959. Piwonice. *Inventaria Archaeologica. Pologne 2*. Bonn.
- Dietler, M. 1990. Driven by drink. The role of drinking in the political economy and the case of Early Iron Age France. *Journal of Anthropological Archaeology* 9, No. 4. Duluth.
- Doppelfeld, O. 1960. Das neue Kölner Diatretglas. *Germania* 38. Frankfurt.
- 1966. *Römisches und fränkisches Glas in Köln*. Cologne.
- Eckholdt, M. 1980. Schifffahrt auf kleinen Flüssen Mitteleuropas in Römerzeit und Mittelalter. *Schriften des Deutschen Schifffahrtsmuseums* 14.
- Ekholm, G. 1957. Orientalische Gläser in Skandinavien während der Kaiser- und frühen Merowingerzeit. *Acta Archaeologica* 27, 1956 (1957). Reprinted 1974.
- 1958. De ribbade glasskälarnas ursprung. *Fornvännen* 53, 1959.
- 1965. *Als orientalsch angenommene Gläser Skandinaviens aus dem ersten bis aus dem sechsten Jahrhundert n. Chr.* Antikvariskt Arkiv 26. Kungl Vitterhets Historie och Antikvitets Akademien. Stockholm. Reprinted 1974.
- Ellmers, D. 1984. Frühmittelalterliche Handels-schifffahrt in Mittel- und Nordeuropa. *Offa-Bücher* 28.
- Enright, M.J. 1996. *Lady with a mead cup. Ritual, prophecy and lordship in the European warband from La Tene to the Viking Age*. Dublin.

- Evison, V. 2000. Glass Vessels in England AD 400–1100. In Price, J. (ed.) 2000.
- Follmann-Schulz, A.-B. 1988. *Die römischen Gläser aus Bonn*. Beihefte der Bonner Jahrbücher 46. Cologne.
- 1992. *Die römischen Gläser im Rheinischen Landesmuseum Bonn*. Cologne.
- Fossing, P. 1940. *Glass vessels before glass-blowing*. Copenhagen.
- Fremersdorf, F. 1967. *Die römischen Gläser mit Schliff, Bemalung und Goldauflage aus Köln*. Die Denkmäler des römischen Köln 8. Cologne.
- Fülep, F. 1977. *Roman cemeteries on the territory of Pécs (Sopiana)*. Fontes Archaeologici Hungariae. Budapest.
- Germanisches Nationalmuseum Nürnberg: *Germanen, Hunnen und Awaren / Schätze der Völkerwanderungszeit*. Ausstellungskatalog Germanisches Nationalmuseum Nürnberg und Museum für Vor- und Frühgeschichte Frankfurt am Main 1987–1988. Nürnberg 1987.
- Glass from the Ancient World*, The Ray Winfield Smith Collection, The Corning Museum of Glass. Corning, New York. 1957.
- Goethert-Polascheck, K. 1977. *Katalog der römischen Gläser des Rheinischen Landesmuseums Trier*. Trierer Grabfunden und Forschungen 9. Mainz.
- Goldstein, S.M., Rakow, L.S., Rakow, J.K. 1982. *Cameo Glass. Masterpieces from 2000 Years of Glassmaking*. Corning.
- Gomolka-Fuchs, G. (ed.) 1999. *Die Sîntana de Mureş-Černjachov-Kultur. Akten des Internationalen Kolloquiums in Caputh vom 20. bis 24. Oktober 1995*. Kolloquien zur Vor- und Frühgeschichte, Band 2. Römisch-Germanische Kommission, Eurasien-Abteilung, Bonn.
- 1999. Gläser der Sîntana de Mureş-Černjachov-Kultur aus Rumänien und der Republik Moldavien. In Gomolka-Fuchs (ed.) 1999.
- Haberey, W. 1942. Spätantike Gläser aus Gräbern von Mayen. *Bonner Jahrbücher* 147.
- 1957–1958. Der Werkstoff Glas im Altertum. *Glastechnische Berichte. Zeitschrift für Glaskunde* B. 30, 31. Frankfurt a.M.
- 1961. Dickwandige Schliffbecker und Diatrete. *Kölner Jahrbuch für Vor- und Frühgeschichte* 5, 1960/61.
- Hansen, U. Lund. 1977. Das Gräberfeld bei Harpelev, Seeland. Studien zur jüngeren römischen Kaiserzeit in der seeländischer Inselgruppe. *Acta archaeologica* 47, 1976.
- 1983. Dankirke. Gläser. In *Hoops. Realexikon der Germanischen Altertumskunde* 5.
- 1987. *Römischer Import im Norden. Warenaustausch zwischen dem Römischen Reich und dem Freien Germanien*. Nordiske Fortidsminder B: 10. København.
- 1993. The Iron Age and the Viking Period. Hvass, S. & Storgaard, B. (eds.), *Digging into the Past. 25 Years of Archaeology in Denmark*. Aarhus.
- 1995. *Himlingøje – Seeland – Europe*. Nordiske Fortidsminder B:13 København.
- Harden, D. B. 1934. Glass from Kish. Excavations at Kish and Baghuthiat 1933. *Iraq* 1.
- 1936. *Roman Glass from Karanis*. University of Michigan. Ann Arbor.
- 1949. Tomb-Groups of Glass of Roman Date from Syria and Palestina. *Iraq* 11.
- 1956. Glass Vessels in Britain and Ireland, A.D. 400–1000. Dark-Age Britain: Harden, B.D. (ed.), *Studies presented to E. T. Leeds*. London.
- 1969. Ancient Glass I: Pre-Roman. *The Archaeological Journal* 125, 1968. London.
- 1970. Ancient Glass II. Roman Glass. *The Archaeological Journal* 126, 1969. London.
- 1988. *Glas der Caesaren*. The Corning Museum of Glass, The British Museum, Römisch-Germanisches Museum der Stadt Köln. Olivetti Mailand.
- Hårdh, B. 2000. Uppåkra – a centre in south Sweden in the 1st millennium AD. *Antiquity* 74.
- 2003. Uppåkra i folkvandringstiden. *Uppåkrastudier* 9. Acta Archaeologica Lundensia 8: 45. Lund.
- Harhoiu, R. 1980. Das norddonauländische Gebiet im 5. Jahrhundert und seine Beziehungen zum spätrömischen Kaiserreich. In Wolfram & Daim 1980.
- Holand, I. 2001. *Sustaining Life. Vessel import to Norway in the first millennium AD*. AmS Skrifter 17. Stavanger.
- Holmqvist, W. 1964. Glass. In Summaries concerning Glass and Pottery from the Central Building Complex. Holmqvist, W. & Arrhenius, B. (eds.), *Excavations at Helgö* II. Stockholm.

- Horedt, K. 1979. Der Ostgermanen im Karpatenbecken und an der unteren Donau. Roth, H. (ed.), *Kunst der Völkerwanderungszeit. Propyläen Kunstgeschichte Supplementband IV*. Frankfurt/Main.
- 1980. Wandervölker und Romanen im 5. bis 6. Jahrhundert in Siebenbürgen. In Wolfram & Daim 1980.
- 1999. Das Ende der Sintana de Mureș-Černjachov-Kultur und die Phase der hunnischen Expansion. In Gomilka-Fuchs (ed.) 1999.
- Ingemark, D. 2003. *Glass, alcohol and power in Roman Iron Age Scotland. A study of the Roman vessel glass from non-Roman/native sites in north Northumberland and Scotland*. Department of Archaeology and Ancient History. Lund University.
- Inventaria Archaeologica. Pologne*. Fascicule IV: Pl. 26. Lodz 1960.
- Isings, C. 1957. *Roman Glass from dated finds*. Archaeologia Traiectina. Groningen.
- Janssen, W. 1983. Gewerbliche Produktion des Mittelalters als Wirtschaftsfaktor im ländlichen Raum. Jankuhn, H. (ed.), *Das Handwerk in vor- und frühgeschichtlicher Zeit II*. Göttingen.
- Kehrer, H. 1908–09. *Die heiligen drei Könige in Literatur und Kunst I–II*. Leipzig.
- Kisa, A. 1908. *Das Glas im Altertüme I–III*. Leipzig.
- Kiss, A. 2001. Die völkerwanderungszeitlichen und frühmittelalterlichen Schatzfunde im Karpatenbecken. Magnus, B. (ed.), *Roman Gold and the Development of the Early Germanic Kingdoms*. Kungl. Vitterhets Historie och Antikvitets Akademien Konferens 51. Stockholm.
- Koch, U. 1968. *Die Grabfunde der Merowingerzeit aus dem Donautal um Regensburg*. Germanische Denkmäler der Völkerwanderungszeit A 10. Berlin.
- 1987. *Der runde Berg bei Urach. VI. Die Glas und Edelsteinfunde aus den Plangrabunden 1967–1983*. 1–2. Heidelberg.
- 1996. Glas – Luxus der Wohlhabenden. *Die Franken. Wegbereiter Europas*. Ausstellung Reiss-Museum Mannheim. Katalog – Handbuch. Mainz 1996.
- Kovrig, I. 1979. Die Ostgermanen im Donauraum. Roth, H. (ed.) *Kunst der Völkerwanderungszeit. Propyläen Kunstgeschichte Supplementband IV*. Frankfurt a.M./Berlin/Vienna.
- Krause, D. 1996. *Hochdorf III. Das Trink- und Speisesevice aus dem späthallstattzeitlichen Fürstengrab von Eberdingen-Hochdorf (Kr. Ludwigsburg)*. Stuttgart. Rev.: Stjernquist 1999b, *Fornvännen* 1999:38 pp.
- Kropotkin, V. V. 1970. *Rimskie importnye izdelija v vostočnoj Evrope (II v. do n.e. – V v.n.e.)*. Arkheologija SSSR D 1–27. Moskva.
- Kunow, J. 1980. *Negotiator et Vectura. Händler und Transport im freien Germanien*. Kleine Schriften aus dem vorgeschichtlichen Seminar Marburg 6. Marburg.
- Künzl, S. 2002. Römische Silberbecher bei den Germanen: Der Schalengriff. Peška, J. & Tejral, J. (eds.), *Das Germanische Königsgrab von Mušov in Mähren 2*. Römisch-germanisches Zentralmuseum. Mainz.
- Kylberg, O. 1986. Late Roman and Byzantine Solidi. An archaeological analysis of coins and hoards. *Excavations at Helgö X*. Stockholm.
- La Baume, P. 1974. Römisches Glas des östlichen Mittelmeerraumes und des Rheinlandes. *Archäologisches Korrespondenzblatt* 1974 No. 4.
- Lamm, C.J. 1930. *Mittelalterliche Gläser und Steinschnittarbeiten aus dem Nahen Osten*. Berlin.
- Larsson, L. 2001a. Uppåkra, an Iron Age site with a long duration. Internal and external perspectives. *Kingdoms and Regionality. Transactions from the 49th Sachsensymposium 1998 in Uppsala*. Theses and Papers in Archaeology B:6. Stockholm.
- 2001b. A building for ritual use at Uppåkra, southernmost Sweden. *Antiquity* 75.
- 2002. Uppåkra – Research on a Central Place. Recent Excavations and Results. Hårdh, B. & Larsson, L. (eds.), *Central Places in the Migration and Merovingian Periods. Papers from the 52nd Sachsensymposium Lund, August 2001*. Uppåkrastudier 6. Acta Archaeologica Lundensia 8:39. Lund.
- Lenntorp, K.-M. & Lindell, M. *Rapport. Arkeologisk Förundersökning Lilla Uppåkra 4:1 och 8:1, Fornlämning nr 5, Uppåkra socken, Staffanstorps kommun, Skåne Län*. Uppåkra 2000. Lund.

- *Rapport. Arkeologisk. Förundersökning Stora Uppåkra 8:3, Fornlämning 5, Uppåkra socken, Staffanstorps kommun, Skåne Län*. Uppåkra 2001. Lund.
- Lenntorp, K.-M. & Piltz-Williams, B. *Rapport. Arkeologisk Förundersökning Stora Uppåkra 8: 3, Fornlämning 5, Uppåkra socken, Staffanstorps kommun, Skåne län*. Uppåkra 2002. Lund.
- Lewis, P. & Darley, G. 1986. *Dictionary of Ornament*. London.
- Lindqvist, S. 1936. *Uppsala högar och Ottarshögen*. Kungl. Vitterhets Historie och Antikvitets Akademien. Stockholm.
- Lundström, A. 1973. Glas från Västsverige. *Göteborgs Arkeologiska museum Årstryck 1972–73*.
- 1981. Survey of the glass from Helgö. Glass – Iron – Clay. *Excavation at Helgö VII*. Kungl. Vitterhets Historie och Antikvitets Akademien, Stockholm.
- Makharadze, G. & Saginashvili, M. 1999. An Achaemenian Glass Bowl from Sairkhe, Georgia. *Journal of Glass Studies* 41. Corning, New York.
- Mitrea, B. 1972. Die Goten an der unteren Donau – einige Probleme im III.–IV Jahrhundert. *Studia Gotica. Antikvariska Serien* 25. Kungl. Vitterhets Historie och Antikvitets Akademien, Stockholm.
- Mitrea, B. & Preda, C. 1966. *Necropole din secolul al IV lea e.n. in Muntenia*. Biblioteca de Arheologie 10. Bucuresti 1966.
- Näsman, U. 1984. *Glas och handel i senromersk tid och folkvandringstid. En studie kring glas från Eketorp-II, Öland, Sverige*. Uppsala.
- 1986. Vendel Period Glass from Eketorp-II, Öland, Sweden. *Acta archaeologica* 55, 1984 (1986).
- 1990. Om fjärrhandel i Sydskandinavien yngre järnålder. Handeln med glas under germansk järnålder och vikingatid. *Hikuin* 16. Højbjerg.
- 1998. The Justinianic era of south Scandinavia: an archaeological view. Hodges, R. & Bowden, W (eds.), *The Sixth Century. Production, Distribution and Demand*. The Transformation of the Roman World Vol. 3. Leiden.
- Nordström, C.-O. 1953. *Ravennastudien. Ideen-geschichtliche und ikonographische Untersuchungen über die Mosaiken von Ravenna*. Stockholm.
- Österström, K. 2001. En skärva av glas. *ÖstgötaFynd*. Riksantikvarieämbetet. Avdelningen för arkeologiska undersökningar UV Öst. Linköping.
- Petersson, M. 2001. Boskapsskötsel och ojämlikhet. *Hemmet – trakten – världen*. Meddelanden från Östergötlands Länsmuseum 2001.
- Petru, S. 1976. Rimsko steklo slovenije (Römisches Glas in Slovenien), *Arheološki vestnik* 25, 1974. Ljubliana 1976.
- Pinder-Wilson, R. H. 1964. Cut-glass vessels from Persia and Mesopotamia. *The British Museum Quarterly* 27, 1963–1964. London.
- Pinder-Wilson, R. H. 1968. Pre-Islamic, Persian and Mesopotamian, Islamic, and Chinese glass. In Harden, D. B., Painter, K. S., Pinder-Wilson, R. H. & Hugh Tait. 1968. *Masterpieces of glass*. London.
- Pirling, R. 1960. Neue Funde des 4. und frühen 5. Jahrhunderts aus Krefeld-Gellep. *Germania* 3
- 1968. Eine römische Glasschale aus Krefeld-Gellep. *Journal of Glass Studies* 10, 1968. Cf. Wedepohl, Pirling & Hartmann 1997.
- Pope, A.U. 1938. *A Survey of Persian Art from Pre-historic Times to the Present*. Vol. 1. London.
- Poulik, J. 1950. *Jižni Morava země dávných slavonů*. Brno.
- Price, J. (ed.) 2000. Glass in Britain and Ireland AD 350–1100. *British Museum. Occasional Paper* 127. London.
- Rademacher, F. 1942. Fränkische Gläser aus dem Rheinland. *Bonner Jahrbücher* 147.
- Randsborg, K. 2002. To bury in the ground. *Drik – og du vil leve skønt. Festskrift til Ulla Lund Hansen på 60-årsdagen 18. august 2002*. Publications from The National Museum. Studies in Archaeology & History 7. Copenhagen.
- Rau, G. 1972. Körpergräber mit Glasbeigaben des 4. nachchristlichen Jahrhunderts im Oder-Weichsel-Raum *Acta Praehistorica et Archaeologica* 3.
- 1974. Zur Provenienzfrage spätantiker Gläser. *Archäologisches Korrespondenzblatt* 1974 No. 4.
- 1975. Spätantike Glasfunde im Karpatenraum. *Zeitschrift für Ostforschung* 24:2.
- Rikman, E. A. 1972. Vopros datirovki importnykh veschej v pamjatnikakh plemen chernjakhovskoj kultury Dnestrovsko-Pruskogo

- mezdurechja. Sur le problème relatif à la datation des objets importés sur les monuments de la culture Tcherniakhovienne de l'interfluve du Dniester et du Prut. *Sovjetskaja arkheologija* 1972 No.4.
- Röder, J. 1965. Oberflächenforschungen an römischen Bergkristallarbeiten. *Bonner Jahrbücher* 165.
- Rogozen 1988: *Der Thrakische Silberschatz aus Rogozen Bulgarien*. Katalog. Ausstellung in Bonn, Mainz, Freiburg, München und Hamburg 1988.
- Rostovtzeff, M. 1922. *Iranians and Greeks in South Russia*. Oxford.
- 1941. *The Social and Economic History of the Hellenistic World*. Oxford.
- Roth, H. 1979 (ed.). *Kunst der Völkerwanderungszeit. Propyläen Kunstgeschichte Supplementband IV*. Frankfurt/Main/Berlin /Vienna.
- Saldern, A. von 1959. Glass Finds at Gordion. *Journal of Glass Studies* I. Corning.
- 1963. Achaemenid and Sassanian cut glass. *Ars Orientalis* 5.
- 1964. Ancient Glass in Split. *Journal of Glass Studies* 6.
- 1968. Sassanidische und islamische Gläser in Düsseldorf und Hamburg. *Jahrbuch der Hamburger Kunstsammlungen* 13.
- Schmidt, B. 1987. *Das Königreich der Thüringer und seine Provinzen*. In Germanisches Nationalmuseum Nürnberg.
- Schulz, W. 1933. *Das Fürstengrab von Hassleben*. Römisch-Germanische Forschungen 7. Berlin. Leipzig.
- Schwärzel, D. 1983. *Handel und Verkehr des Merowingerverreiches nach den schriftlichen Quellen*. Kleine Schriften aus dem vorgeschichtlichen Seminar Marburg 14. Marburg.
- Ščukin, M. B. 1975. Das Problem der Černjachov-Kultur in der sowjetischen archäologischen Forschung. *Zeitschrift für Archäologie* 9.
- 1976. O nachal'noj date chernjakhovskoj kul'tury. Summary: About the Initial Date of the Cherniakhov Culture. *Prace archeologiczne* 22.
- Selinge, K.-G. 1977. Järnålderns bondekultur i Västernorrland. Baudou, E. & Selinge, K.-G. (ed.), *Västernorrlands Förhistoria*. Motala.
- 1985. Skottssund. An Early Iron Age Grave in Medelpad. In *Honorem Evert Baudou. Archaeology and Environment* 4. Umeå.
- Sorokina, N.P. 1978. Facettenschliffgläser des 2.–3. Jhd. u. Z. aus dem Schwartzeergebiet. *Annales du 7e Congrès International d'Étude Historique du Verre. Berlin-Leipzig, 15–21 août 1977*. Liège.
- Steenberg, E. & Simmingsköld, B. *Glas*. 1958.
- Stappuhn, P. 1998. *Die Glasfunde von Haithabu*. Schietzel, K. (ed.), *Berichte über die Ausgrabungen in Haithabu Bericht* 32. Neumünster.
- Steuer, H. 1982. *Frühgeschichtliche Sozialstrukturen in Mitteleuropa. Eine Analyse der Auswertungsmethoden des archäologischen Quellenmaterials*. Abh. Akad. Wiss. Göttingen, Phil.-Hist. Kl. Dritte Folge 128. Göttingen.
- 1992. Interpretationsmöglichkeiten archäologischer Quellen zum Gefolgschaftsproblem. Neumann, G. & Seemann, H. (ed.), *Beiträge zum Verständnis der Germania des Tacitus*, II. Göttingen.
- 1997. Handel und Fernbeziehungen. Tausch, Raub und Geschenk. *Die Alamannen*. Ausstellungskatalog, herausgegeben vom Archäologischen Landesmuseum Baden-Württemberg.
- Stjernquist, B. 1967. *Models of Commercial Diffusion in Prehistoric Times*. Scripta Minora Regiae Societatis Humaniorum Litterarum Lundensis 1965–66:2. Lund.
- 1985. Methodische Überlegungen zum Nachweis von Handel aufgrund archäologischer Quellen. *Untersuchungen zu Handel und Verkehr der vor- und frühgeschichtlichen Zeit in Mittel- und Nordeuropa*. Abhandlungen der Akademie der Wissenschaften in Göttingen. Phil.-Hist. Klasse. Dritte Folge 143. Göttingen.
- 1986. Glass from the settlement of Gårdlösa. *Papers of the Archaeological Institute University of Lund* 1985–1986
- 1996. Uppåkra, a Central Place in Skåne during the Iron Age. *Lund Archaeological Review* 1, 1995.
- 1997. *The Röekillorna Spring. Spring-cults in Scandinavian Prehistory*. Acta Regiae Societatis Humaniorum Litterarum Lundensis LXXXII. Lund.
- 1999a. Glass from Uppåkra: A Preliminary Study of Finds and Problems. Hårdh, B. (ed.),

- Fynden i Centrum. Keramik, Glas och Metall från Uppåkra*. Uppåkrastudier 2. Acta Archaeologica Lundensia 8:30. Lund.
- 1999b. Cf. Krausse 1996.
- Straume, E. 1987. *Gläser mit Facettenschliff aus skandinavischen Gräbern des 4. und 5. Jahrhunderts n. Chr.* Oslo.
- Strong, D.E. 1966. *Greek and Roman Gold and Silver Plate*. London.
- Szydłowski, J. 1980. Zur Anwesenheit der Westslawen an der mittleren Donau im ausgehenden 5. und 6. Jahrhundert. In Wolfram & Daim 1980.
- Tejral, J. 1975. *Die Probleme der späten römischen Kaiserzeit in Mähren*. Studie archeologického ústavu Československé akademie věd v Brně 1974/2. Prague.
- Trowbridge, M.L. 1930. *Philological Studies in Ancient Glass*. Studies in language and literature 13. University of Illinois. Urbana.
- Verhulst, A. 1970. Der Handel im Merowingerreich: Gesamtdarstellung nach schriftlichen Quellen. *Early Medieval Studies 2. Antikvariskt arkiv 39*. Kungl. Vitterhets Historie och Antikvitets Akademien. Stockholm.
- Veziņ, G. 1950. *L'Adoration et le cycle des Mages dans l'art chrétien primitif. Étude des influences orientales et grecques sur l'art chrétien*. Paris.
- Voss, O. 1951. Der Hesselagerfund. Ein Schatzfund des 5. Jahrhunderts aus Fünen. *Acta Archaeologica 22*.
- Wedepohl, K.H., Pirling, R. & Hartmann, G. 1997. Römische und fränkische Gläser aus dem Gräberfeld von Krefeld-Gellep. *Bonner Jahrbücher 197*. Cologne.
- Werner, J. 1950. Römische Trinkgefäße in germanischen Gräbern der Kaiserzeit. Kirchner, H. (ed.), *Ur- und Frühgeschichte als historische Wissenschaft. Festschrift zum 60. Geburtstag von Ernst Wahle*. Heidelberg.
- 1959. Studien zu Grabfunden des V. Jahrhunderts aus der Slowakien und der Karpaten-ukraine. *Slovenská archeológia 7:2*.
- Wielowiejski, J. 1989. Die römerzeitliche Silbergefäße in Polen. Importe und Nachahmungen. *Bericht der Römisch-Germanische Kommission 70*.
- Wilson, E. 1994. *8000 Years of ornament. An illustrated handbook of motifs*. London.
- Wolfram, H. & Daim, F. (Hrsg.) 1980. *Die Völker an der mittleren und unteren Donau im fünften und sechsten Jahrhundert*. Vienna.
- Wood, I. 1998. The Frontiers of Western Europe: development east of the Rhine in the sixth century. Hodges, R. & Bowden, W. (eds.), *The Sixth Century: Production, Distribution and Demand*. The Transformation of the Roman World Vol. 3. Leiden.
- Zeman, J. 1961. *Severní Morava v mladší době římské*. Monumenta Archaeologica 9. Praha.

Abbreviations

- ATA Antikvarisk-topografiska arkivet, Stockholm.
- B Historisk Museum Universitetet i Bergen.
- C Universitetets Oldsaksamling Universitetet i Oslo.
- NM Nationalmuseet, København.
- S Arkeologisk Museum, Stavanger.
- SHM Statens Historiska Museum, Stockholm.
- T Universitetet i Trondheim, Museet, Arkeologisk avdeling.

Appendix

Chemical Analysis of Iron Age Glass

Maria Lang

The Glass Research Institute, Box 3093, SE-350 33 Växjö

Background

At the excavation of the Iron Age settlement of Uppåkra a unique glass bowl was found. The bowl is made of clear glass with a tint of yellow/green with blue glass overlay. Fragments of blue and clear glass were picked out for chemical analysis. At the same time a small piece from a beaker of clear glass with cut oval ornaments was analysed.

Analyses

The glasses were analysed by energy dispersive X-ray spectroscopy (EDX) in a scanning electron microscope (SEM). Prior to the analyses the samples were prepared by grinding and

polishing. A thin conducting layer of carbon was evaporated on the surface in order to avoid charging in the SEM.

From blue and clear glass three pieces of each were prepared. The initial analyses showed that there was no great difference between the pieces, so the fully quantitative analyses were done on one fragment of each colour. Each result is the mean of analyses in 10 individual spots per sample. The amount of each element was measured and calculated as oxides by stoichiometry. Two different glass references were used for standardization.

% weight	Measurement uncertainty	Glass bowl		Glass with cut ovals, clear	Comparison with Roman glasses**
		Clear glass	Blue overlay		
Na ₂ O	0.5	20.0	18.8	17.0	16.1–19.4
MgO	0.2	0.8	0.7	0.9	0.5–1.2
Al ₂ O ₃	0.2	1.9	2.0	2.4	1.5–2.8
SiO ₂	1	68.2	70.1	67.8	64.5–71.8
Cl*	0.4*	1.6	1.6	1.3	–
SO ₃	0.1	< 0.15	< 0.15	0.2	–
K ₂ O	0.1	0.29	0.59	0.58	0.27–0.58
CaO	0.2	6.0	5.2	7.9	5.9–8.8
MnO	0.1	1.1	< 0.15	1.2	0–2.2
Fe ₂ O ₃	0.1	0.5	1.3	1.0	0.2–1.2
CoO	0.1	< 0.1	0.3	< 0.1	–
Total		100.4	100.6	100.3	

* For chloride we have no glass reference, thus the higher uncertainty. ** Found in Norway.

Comments

The three glasses have the same type of composition: soda glass mainly consisting of SiO_2 and Na_2O . The compositions are very much in the same range as 19 analysed Roman glasses found in Norway (Christie & Brenna 1979).

Ancient soda glass was melted essentially of sand (SiO_2) and a source for sodium (Na_2O). The sand often contains impurities of Al_2O_3 and Fe_2O_3 . The sodium source often contains K_2O , Al_2O_3 , CaO , MgO , Cl and Fe_2O_3 , explaining the presence of these elements.

Two important sources for sodium are plant ash and natron. However, it has been found (Caley 1962) that soda glasses made of plant ash contain higher amounts of potash (K_2O) and magnesia (MgO) than those made of natron. The table shows typical values:

	Typical content in glass (weight%)	
Soda source	MgO	K_2O
Natron	0.6–2	0.4
Plant ash	2–5	2

This indicates that in this case natron is likely to have been the sodium source.

This low magnesia and low potash type composition is typical of the Roman glasses made in the Cologne area during the first

four centuries of the Christian era (Newton 1980).

The cobalt oxide was obviously added to give the blue colour of the overlay.

Iron oxides in glass give a tint of colour, ranging from yellow/brown to green. The exact colour depends not only on the amount of iron but also on the atmospheric conditions above the melt. Reducing conditions give more of a blue tint in the green, whereas oxidizing conditions give more brown or yellow glass.

It is often discussed whether decolorizing agents were used to make the glass more colourless. Adding manganese to the glass can compensate for a green iron colour. It is interesting that in this case the two clear glasses contain about one percent of MnO whereas in the blue glass it is below the detection limit. This indicates that MnO may have been added to decolorize the glass.

References

- Caley, E. R. 1962. Analyses of ancient glasses 1790–1957. *Corning Museum of Glass, Monographs* I.
- Christie, O. H. J. & Brenna J. A. 1979. Multivariate classification of Roman glasses found in Norway. *Archaeometry* 21, 2, 223–241.
- Newton, R. G. 1980. Recent views on ancient glasses. *Glass Technology* 2.1, 4.

A Glass Beaker with Cut Decoration, Found at Uppåkra

Berta Stjernquist

Abstract

A rather well-preserved house foundation was excavated at Uppåkra during the years 2001 to 2004. Wealthy finds such as gold-foil figures and glasses indicate a ceremonial building (Larsson & Lenntorp this volume; Hårdh this volume; Stjernquist this volume). A large piece of a glass with cut decoration, two sherds with cut ovals of this vessel, a small sherd of the same fabric, and a fourth sherd with traces of a cut oval were found in and near the structure. The sherds were found in mixed layers with remains from different periods of the Iron Age.

The vessel is fragmentary and the height uncertain. It is reconstructed as a cylindrical beaker with a diameter of about 80 mm with a decoration of three rows of cut ovals. The height might have been about 100 mm. The reconstruction and the dating are tested stylistically against similar bowls and beakers found in Scandinavia and on the continent. The result is that it is a beaker produced and used as a drinking vessel in the 4th century. The origin is discussed against the background of the knowledge of the production and distribution of related beakers. The hypothesis is that it was produced in the south-eastern parts of the continent. The chemical analysis cannot contribute to the problem of origin. The composition is typical of Roman glasses but it seems to be similar in the west and in the south-east.

Berta Stjernquist, Department of Archaeology and Ancient History, Lund University, Sandgatan 1, SE-223 50 Lund.

Site and find-spot

During the years 2001 to 2004 the investigations at the settlement at Uppåkra included excavation of structures situated to the south of the church. A rather well-preserved house foundation was uncovered in a trench opened in 2001 (Fig. 1). This foundation was very interesting, with many wealthy finds such as gold-foil figures and glass vessels which indicate a ceremonial building (Larsson 2001a–b; Hårdh 2001; Stjernquist this volume). It was excavated very carefully. Several reconstructions of the house were documented. These alterations as well as the find material show that the building was used during a very long

time from the Roman Iron Age to the Viking Period. The upper part of the structure was damaged through agricultural work but the continuity could be demonstrated by details of the structure which could be studied in the remains. The level where the fine glass bowl and the decorated metal beaker were found was documented during the excavation as no. 14, a floor which is estimated as belonging to the eighth house probably from the late Migration Period (Lenntorp & Lindell 2001; Lenntorp & Piltz-Williams 2002). A piece of a glass vessel and two sherds with cut decoration and a small sherd without decoration

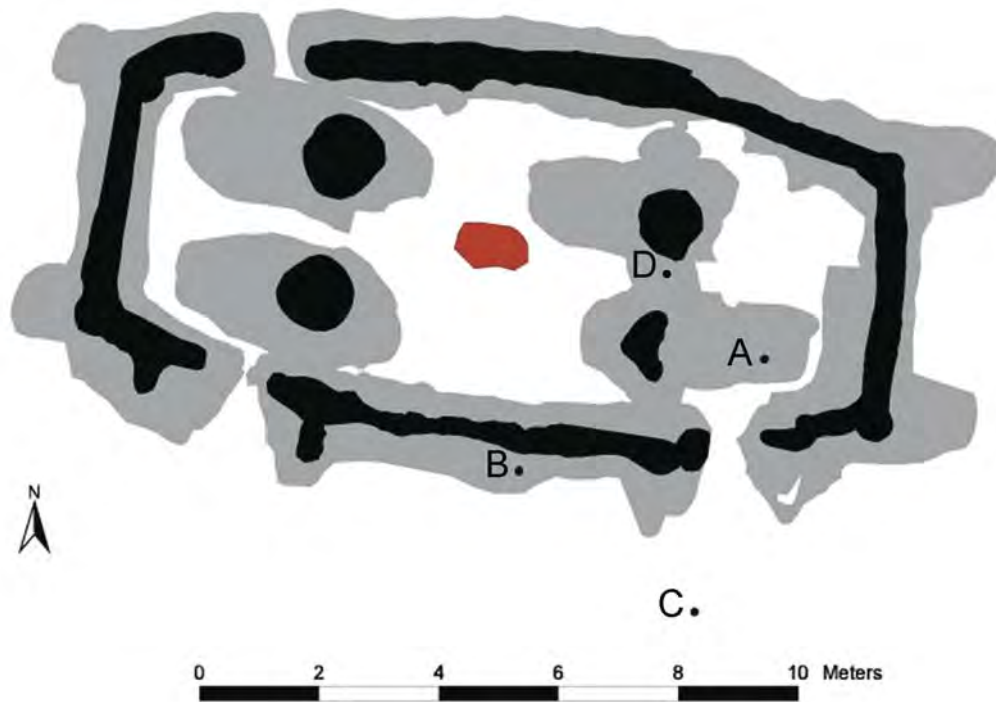

Fig. 1. The house where the sherds of the beaker were found. A, C and D find-spots of the sherds. Drawing by Birgitta Pilts-Williams and Karl-Magnus Lenntorp.

but of the same fabric were found in the same structure but at other levels (Figs. 2–4). They belong to a glass beaker. A fourth sherd (Fig. 6) seems to be of another fabric.

Description of the beaker. Reconstruction

A piece of a glass vessel, ID 203143, find No. 3022, was found in the filling of the south-eastern post-hole of the building (Fig. 1A). It is 60 mm high and 40 mm broad (Fig. 2). The size is, however, approximate because of the difficulty of measuring the bent surface of the piece exactly. The thickness of the glass is 5 mm at the base, 7 mm at the bend and 4 mm higher up (Fig. 4). Part of a cut round facet is at the base. Higher up the wall

where the glass is 5 mm thick, two cut ovals and traces of a third one are placed in a row 4–6 mm from each other. They indicate that there was a series of ovals around the beaker. A double horizontal line is visible just below the ovals. It might have run around the vessel; the surface, however, is worn which gives difficulties in discerning it. The glass is clear with a green tint.

A sherd, ID 203174, find no. 3053, about 26 x 15 mm, has parts of two cut ovals, 6 mm from each other (Figs. 3 and 4). They are of the same size as the ovals on the large piece of the vessel (15 x 13 mm). The sherd seems to belong to it. As the glass of this sherd is only 2.5–3 mm thick it might be localized in a second row of ovals higher up on the beaker. A very slight bend indicates the place along the wall. One of the ovals must belong to a



Fig. 2. The large sherd (find no. 3022). 1:1. Photo Bengt Almgren.



Fig. 3. The sherds find nos. 3053 and 2712. 1:1. Photo Bengt Almgren.

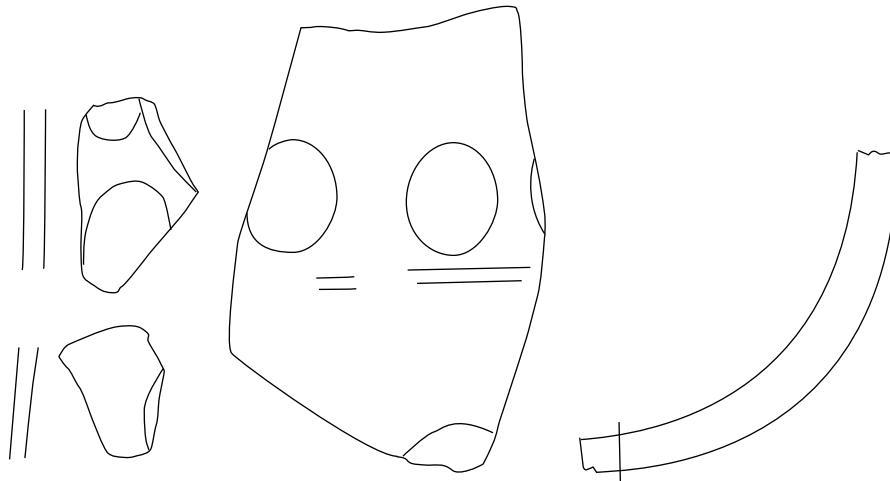

Fig. 4. The sherds (find nos. 3022, 3053, 2712). 1:1. Drawings by Berta Stjernquist.

third row. The ovals have visible traces of cutting running along the vessel. They were not polished. Traces of grinding round the vessel, visible between the two ovals, might be some kind of after-treatment. The glass is clear with a very light green tint. This sherd was found in the filling of the southern wall trench (Fig. 1B). The filling in the post-hole and in the wall trench had remains from different periods of the Iron Age and could not be dated more closely.

A third sherd with traces of a cut oval, ID 202831, find no. 2712 (Figs. 3 and 4), indicating that it belongs to the beaker, was found in the south-eastern part of a floor later than the so-called house 2, which was a construction from the Vendel–Viking Age (Fig. 1C). The layer was probably mixed with earlier material. The sherd is approximately 2–2.5 mm thick and might, in view of the thickness, belong to the third row of ovals. The glass is clear with a light green tint. Finally,

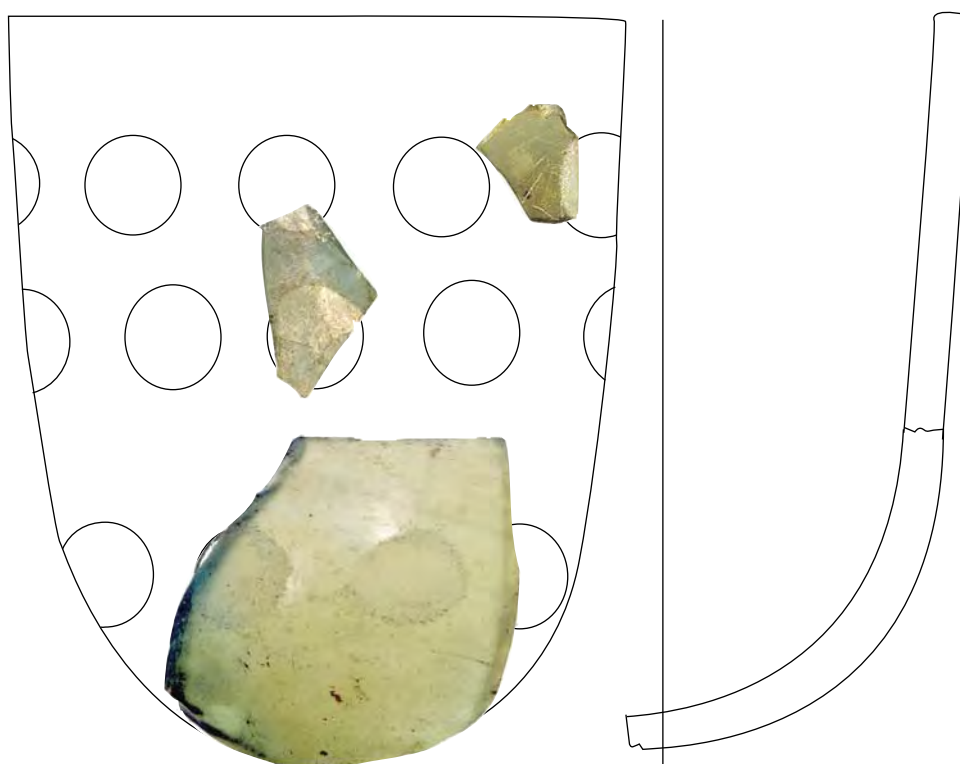

Fig. 5. Reconstruction of the beaker. 1:1. Drawing by Berta Stjernquist.

a very small sherd, ID 202826, find no. 2707, might belong to the same vessel.

All sherds are found by visual inspection to be clear with a green tint which might be the result of impurity in the glass. In the chemical analysis of the large sherd of the beaker the glass is identified as clear (cf. M. Lang in B. Stjernquist, *A Magnificent Glass Bowl from Uppåkra*, this volume). Colour as a classification element has been discussed by many scholars (cf. Stjernquist 1986:151 p.; Straume 1987:24 f.; Ingemark 2003:25 p.). The Munsell Colour Chart has sometimes been used. The prevalent opinion, however, is that it is impossible to get an objective description. That is why a traditional verbal description will be used here.

The pieces of glass which have been described above indicate a glass vessel which can be reconstructed as a cylindrical beaker with

a diameter of approximately 80 mm (Fig. 5). The small pieces are placed on the wall higher up with regard to the thickness of the glass. It appears from this that the vessel was decorated with three rows of cut ovals on the wall. There is a cut round facet on the base. As mentioned above, there is a horizontal double line below the first row of ovals. There might have been another double line below the second row as well but this is uncertain. Pieces of the rim are not preserved but the proportions speak for a height of approximately 100 mm. The large number of glass bowls or beakers with cut ovals have been used as models for the reconstruction (Rau 1972, 1974; Näsman 1984; Straume 1987;).

A fourth sherd with traces of a cut oval, ID 20 74 79, find no. 7278 (Fig. 6) was found in 2004 in the filling of a post-hole

in the eastern profile (Fig. 1 D). It is 12 x 25 mm and 3 mm thick. The fabric is characterized by numerous larger and smaller round bubbles, which distinguish it from the other sherds with cut. The glass is clear with a green tint but the surface is iridescent. This sherd has a different fabric than that of the reconstructed vessel and thus probably belongs to a second vessel.



Fig. 6. The sherd find no. 7278. 1:1. Drawing Berta Stjernquist. Photo Bengt Almgren.

Discussion of the reconstruction

The reconstruction of the beaker (Fig. 5) must be uncertain because of the small parts preserved (the large sherd no. 3022 and the small sherds nos. 3053 and 2712). It is therefore important to present the work with it gradually. The large sherd and the two small sherds have similar fabric and the same type of decoration. In spite of that, a possibility could be that we are dealing with more than one vessel. The similarity and the find-places near each other, however, have decided the assumption that they belong to the same vessel.

The large sherd shows that the object is a beaker or a bowl. The diameter of the vessel and the space between the rows of cut ovals was estimated with the help of this sherd. Parts of it are bent and form the bottom of the vessel. Because of the plain part of it over the first row of ovals, the second row must be more than 17 mm higher up on the wall of

the vessel. Sherd no 3053 with traces of two ovals is placed where the thickness of the glass can be estimated to be the same as the thickness of this small sherd. This sherd is very slightly bent along the vessel, showing that the two cuts might belong to two rows placed over each other with a space of about 5 mm. The result is that the small part of an oval on this sherd must belong to a third row of ovals. The visible traces of cutting on the ovals are along the vessel. The thickness, 2–2.5 mm, of the third sherd (no. 2712) indicates that it might belong to this row, so it is now placed there. It will be emphasized that the exact places of the two small sherds are unknown, as is the height of the beaker. A very slight difference in colour between the large sherd and the two small ones is due to the difference in thickness. The fabric of the fourth sherd (Fig. 6) is different. Therefore, it is not fitted into the reconstruction.

Problems. Method of analysis

The problems concern the dating of the vessel, the type and relations and the origin.

The large piece of the vessel as well as the smaller sherds have been found in mixed layers of the house foundation with a dating to the Iron Age in general. Thus, the find conditions cannot contribute to a more exact dating. The dating is based on stylistic and comparative analyses.

The vessel is fragmentary, which means that details of the shaping are uncertain and results in problems concerning the type. To ascertain the probable appearance it is necessary to discuss and make comparisons with glass vessels of similar shape. As mentioned above, the hypothesis is that the vessel is a cylindrical beaker with a diameter of 80 mm and a height of approximately 100 mm. But

it could perhaps be a bowl with the same diameter, the height of which must be lower. The hypothesis will be tested. The first question is whether it is a beaker or a bowl.

A large number of beakers and bowls have been published and analysed by several scholars. Above all the papers by Näsman (1984) and Straume (1987) will be used as well as Hansen (1987), which discuss the Scandinavian finds in relation to the material found on the continent. As a complement there are papers concerning special research projects such as Rau (1972, 1974) and Stjernquist (1986, 1999).

As a complement to the stylistic and comparative analyses a chemical analysis of the glass has been performed (cf. below).

Comparative material

Introduction

Glass vessels with cut decoration in the shape of a round or oval design are very common in northern Europe as well as in the south-eastern parts of the continent (Näsman 1984: 49 pp.; Straume 1987; Rau 1974). There are many different types. The relevant comparative material for the vessel from Uppåkra is found among variants of bowls and beakers. The vessel is characterized by the cut, by the decoration with a double line and by the thick wall. The bowls are interesting because of the decoration with a combination of cuts and double lines.

Bowls

The first category mentioned is the bowls. The decoration of these vessels is sometimes rather sparse. Because of their limited height, they have only a few rows of cutting. They have also the double horizontal line in com-

bination with cut ornamentation. Thus, some bowls will be discussed.

A bowl from Varpelev, Zealand. Cylindrical, red. Height 67–68 mm, diameter 23 mm. The base is even. At the rim two lines and below that one row with round and another with oval facets. Thickness of the glass: 6 mm (base) and 3 mm (rim). Dating C3–D1. Straume 1987, No. 95:2, Pls. 12 and 106:2.

A bowl from Kobbeå, Bornholm. Cylindrical. Height 77 mm, diameter 84 mm. The base is even. At the rim two lines and below that two rows of oval facets. Thickness 2 mm. Dating C2–C3. Straume 1987, No. 84, Pls. 12 and 99:1.

A bowl from Vrangstrup, Jutland. Cylindrical. Height approximately 100 mm, diameter 112 mm. The base is even. At the rim and at the transition to the base two lines and between them two rows of ovals and a system of lines. Thickness 2–3 mm. Dating C2–C3. Straume 1987, No. 97, Pls. 12 and 102:11.

A bowl from Skørtingen, Zealand. Cylindrical. Height 106 mm, diameter 112 mm. The base is even. The decoration is rows of ovals with horizontal double lines between them. Thickness 2–3 mm. Dating late C2. Straume 1987, No. 90, Pls. 12 and 103:8.

A bowl from Ytter Restad, Sweden (Fig. 7). Cylindrical. Height 88 mm, diameter 118 mm. The decoration is two rows of round facets and between them and below the rim horizontal double lines. Dating late C3–D1. Straume 1987, No. 78, Pl. 98:3.

Lund Hansen has treated these glass bowls and some continental parallels (1987:100 pp.). One group is characterized by the thin glass and a decoration consisting of round or oval cut, sometimes combined with double lines. The dating seems to be C2–C3. The other group has thick glass. These vessels are light



Fig. 7. The glass bowl from Ytter Restad. 3:4. Photo GAM.

green and in exceptional cases red (Varpelev, Sachrau). The dating is about the same as the first group but some might be as late as D1.

These bowls are not good parallels to the glass from Uppåkra. The glass of the body is rather thin. There are double lines on some of them but the combination of lines and ovals is not very similar. It should be mentioned that there are double lines also on some of the beakers with quite a different decoration, such as Bremnes (No. 2) and Gjerla (No. 15: 1) (Straume 1987, Pl. 6). The bowl from Ytter Restad seems to be the best parallel with the sparse cut and the combination of cuts and the double line (Arrhenius 1973:38 p.; Straume Pl. 98:3). The shape, however, is not very similar and the glass is not thick. The same concerns the bowl from Kobbeå with sparse

oval cuts in combination with double lines. These two bowls have a decoration similar to the Uppåkra glass. The difference is the shape, the thickness of the glass and the even base without a round cut. The last element is important. Most of the beakers similar to the Uppåkra glass have a base with a round cut.

Beakers

The other category, the beakers, is relevant as comparative material. The preserved parts of the vessel from Uppåkra can be reconstructed as a beaker with the sherds and their size as a starting point (Fig. 5). The result is a vessel which is similar to the fragmentary beaker from Eketorp published by Näsman 1984: 40. There are, however, some differences. The

sherds from Uppåkra show a round cut as a base and then three rows of light oval cuts. The first one which is visible on the large sherd approximately 30 mm above the base is followed by a double horizontal line. The place of the second and third rows is determined with regard to the thickness of the glass. The large piece shows that the first space must be at least 15 mm which is probable because of the thinner sherds. There are differences between the two reconstructions, Uppåkra and Eketorp, in the shape of the cuts and in the space between them. Another difference might be the thickness of the glass. The glass of the beaker from Uppåkra is rather thick at its base and lower part. It is not clear whether the Eketorp vessel had a base thicker than the exposed sherd of the wall.

There are other parallels among the beakers found in northern Europe. Some of them will be discussed here.

A glass beaker from Hundstad, Norway (Fig. 8). Cylindrical, height 89 mm, diameter 85 mm. Base with a round facet. Wall with three rows of round facets. Thickness 2–3 mm. Dating late C2. Straume 1987, No. 24, Pls. 2; 39:1; Straume 1998, Pls. 8 A-B.

A glass beaker from Forestad Mosse, Scania. Cylindrical, height 98 mm, diameter 79 mm. Base with a round facet. Wall with one row of round facets and three rows of oval. Thickness: rim 3 mm, base 4 mm. Lacks dating. Straume 1987, No. 61, Pls. 3, 108:6; 112:5.

A glass beaker from Sætrang, Norway. Cylindrical, height 114 mm, diameter 69 mm. Base with a round facet. Wall with one row of round facets and three rows with ovals. Dating C 3. Straume 1987, No. 41, Pls. 2; 108:1.

A glass beaker from Håland, Norway. Cylindrical, height 104 mm, diameter 78 mm.



Fig. 8. The glass beaker from Hundstad. 3:4. Photo Universitetets kulturhistoriske museer, Oslo.

Wall with one row of round facets and three rows of oval. Thickness: rim 3 mm, base 6 mm. Dating C3–D1. Straume 1987, No. 25, Pls. 3; 43:1. Cf. Rau 1974: Fig. 1.

A glass beaker from Merløsegård, Zealand. Cylindrical, height 105 mm, diameter 68–70 mm. Base with a round facet. Wall with one row of round facets and three rows with oval. Thickness 3 mm. Lacks dating. Straume 1987, No. 86, Pls. 2; 108:2.

A glass beaker from Vallstenarum, Gotland (Fig. 9). Cylindrical, height 131 mm, diameter 98 mm. Base with a round facet. Wall with one row of round facets and three rows of oval. Thickness: rim 3 mm, base 5 mm. Dating late C2. Almgren-Nerman 1923: grave 277 and Pl. 30:452; Straume 1987, No. 76, Pls. 2; 96:1.

These beakers are characterized by the cylindrical shape and three or four rows of facets on the wall. Most of them have a round facet on the base. The thickness of the base varies from 3 to 6 mm. The dating is late C2 to D1. The beaker from Hundstad is very interesting



Fig. 9. The glass beaker from Vallstenarum. Height 13.1 cm. Photo SHM.

in comparison with the Uppåkra vessel because of the spread of the cut decoration.

Some of these beakers are a little higher than the Uppåkra beaker which is reconstructed as 100 mm. It is of course possible that it was a little higher.

The Uppåkra vessel, as we have seen, is characterized by the thick wall. The wall of the beakers discussed above is not so thick even if the base of the vessel from Håland is 6 mm. Thus, beakers with a very thick wall must be tested as parallels.

Beakers with a thick wall are classified as type 1 B by Straume (1987: Pls. 3 and 4). The cut decoration is rather close. The thickness of the wall varies. They are cylindrical but sometimes very slightly conical. This slightly conical shape occurs in a fragmentary vessel found at Føyna, Norway. The height is 94 mm and the diameter 65 mm. The base is

even. The wall is decorated with one row of round facets and two rows of oval facets. The base is 8 mm thick, the wall thinner and thinner until 4 mm at the rim. Dating D 1? Straume 1987, No. 12, Pls. 3; 23. Another beaker of similar type is from Vestly, Norway. It is fragmentary but can be restored. Height is 97 mm, diameter 67 mm. The wall is decorated with one row of round and three rows of oval facets. At the base there is one row of small horizontal cuts as well. The thickness is 8 to 4 mm, which is the same as the beaker from Føyna. Dating D2. Straume 1987, No. 50, Pls. 4; 73:25; 109:4. Finally, a beaker from Rådal, Norway, with two rows of ovals will be mentioned because of the very thick wall. It is not very similar to the Uppåkra glass, however. The cutting of the decoration is very deep and the cuts very close. It is classified by Straume as belonging to the same group as

the beaker from Himlingøje. Straume 1987, No. 152 and Pl. 4.

These beakers (Eggers' type 230) are variants of the Kowalk type. The occurrence and dating are discussed by Rau (1972, 1975a–b), Lund Hansen (1987:88 p. and map 76) and Näsman (1984:50 pp. and map 3) as well as by Straume (1987, map 2). On the continent they appear in large numbers in Poland and in south-eastern Europe on the Black Sea. Rau emphasizes their abundant occurrence in the Pontic region (Rau 1972:131, 1974; cf. Ščukin 1976). There are, however, as a whole several variants in decoration, size and shape, some with rather sparse ornamentation, for instance the beaker from Žurovka 10.

Discussion

The result of the comparison with the known bowls and beakers is many vessels of similar shape and decoration. It is not possible, however, to find a very good parallel to the Uppåkra vessel with the same combination of shape, thickness and decoration. One difficulty is that the height of the vessel is unknown. It is, however, probable that the vessel was a not very high beaker decorated with lines and cuts. The round cut on the base is an element that speaks for a beaker because of the frequency of this detail on beakers of that size. The dating of closely related glass vessels has been discussed by Näsman (1984:50 p. with ref.; cf. Rau 1972; Ščukin 1976). The shape, thickness and decoration indicate a dating of the Uppåkra beaker to the 4th century. It should be mentioned that the chronology used in this paper is based on discussions in Hansen 1987 and 1993.

Research on the glass vessels with cut decoration has resulted in a very large corpus with many main types and variants (see Fremersdorf 1967; Isings 1957; Follmann-

Schultz 1988; Näsman 1984; Straume 1987). It is evident that the production concentrated upon series which were adequate and in demand. There might have been models. However, there has been no investigation of the extent to which they were defined as types. Variations on a small scale concerning size and shape might be due to the handi-craft-based production. The decoration on the glass vessels indicates that there have been many variations which are unknown in the material accessible for the present. The Uppåkra beaker might belong to one such unknown variant. It should be emphasized that there are many fragments with cut decoration (round or oval design) showing that there were many more vessels than those known at present (cf. for instance Andersson 2001).

The beaker was used as a drinking vessel, probably at a high level in society. Several investigations indicate the role of drinking vessels in various ceremonies. They functioned as symbols of power, for instance when foreign visitors were received and invited to drink with the local elite (Enright 1996; Holland 2001; Ingemark 2003). The beaker was probably used in the 4th century, like the fine glass bowl from Uppåkra in the Migration Period (Stjernquist in this volume).

Probable complex of origin and the route to Uppåkra

The discussion concerning the origin of the glass vessels with cut decoration has for quite a long time reckoned with two alternatives, namely the glass-producing areas in the west (Doppelfeld 1966; Fremersdorf 1967; Sorokina 1978) or in the east (Ekholm 1965). The questions have, however, become more

complicated as the amount of material has grown and research has facilitated a survey. The problems concerning the production of the cylindrical beakers with cut decoration of the type Eketorp 3 have been discussed intensively by Näsman (1984:51 pp.; 1998) with reference to different opinions about glass-making and glassworking in the 4th century. This involves information about glass vessels and glassworks in the Pontic area where the late Roman tradition lived on and the Sîntana de Mureş-Černjachov cultures had their expansion (Kropotkin 1970; Rau 1972, 1974; Gomolka-Fuchs 1999). In the light of the large number of thick vessels with cut decoration in the south-eastern areas, Näsman has suggested that these glass vessels were produced in Muntenia/Moldavia and Ukraine. The facts indicate that the Uppåkra beaker was made in that region, a westerly branch of the glass-producing districts on the Black Sea (cf. Straume 1987:54 pp.).

A chemical analysis of the beaker with cut ovals was performed together with the analyses of the glass bowl by Maria Lang, Chemical Analysis of Iron Age Glass, published as Appendix in Berta Stjernquist, *A Magnificent Glass Bowl from Uppåkra* (this volume). The result is that the glasses have the same type of composition. It is soda glass mainly consisting of SiO₂ and Na₂O. They are very much in the same range as 19 analysed Roman glasses found in Norway with which they are compared (Christie, Brenna & Straume 1979; cf. Stjernquist 1986). The low content of potash and magnesia indicates that natron is likely to have been the sodium source. The report declares that this composition is typical of the Roman glasses made in the Cologne area during the first four centuries of the Christian era. The interesting result is that the manufacture of glasses and the composition of glass

were rather similar on the Roman frontier in the west and in the south-east. Trace elements to distinguish between them technically are obviously lacking. Thus, the chemical analysis cannot elucidate more closely the question where the beaker was made.

Another problem concerns the route of the beaker from the production place to Scandinavia. The problem of distribution of glass vessels has been discussed by the author in the paper about the glass bowl (this volume) where the theoretical as well as the practical process has been elucidated. This concerns models for long-distance, gradual long-distance or local transfer of fragmentary material (Stjernquist 1985; Capelle 1988; Steuer 1997). The hypothesis is that the bowl and the beaker originated in the same areas, namely the south-eastern parts of the continent. The process of transfer might have been the same with exchange at a high level. Connections for the transmission of glasses between this region and Scandinavia were even easier in the 4th century than in the Migration Period, as is well documented (Näsman 1984, 1990, 1998; Kunow 1980; Verhulst 1970; Schwärzel 1983; Wolfram & Daim 1980; Wood 1998; cf. also Kokowski 2001 concerning the influences).

Conclusions

During the investigations at Uppåkra a rather well-preserved house foundation was uncovered in the area to the south of the church. It was excavated in the years 2001 to 2004. Many wealthy objects were found such as gold-foil figures, a beaker of bronze decorated with gilt silver foil and very fine glass vessels which indicate a ceremonial building. A piece of a glass and two sherds with cut decoration belong to the vessel discussed in this paper. It

is reconstructed as a cylindrical beaker with a diameter of approximately 80 mm, with a round cut on the base and with three rows of oval cuts on the wall. The glass is thick, measuring at the base approximately 5–7 mm. The rim is not preserved but the proportions indicate a height of 100 mm.

The problems concern the dating of the glass, the type and relations and the origin. The dating and the type are estimated stylistically. Related bowls and beakers in Scandinavia and on the continent are discussed and compared in detail. The vessel is thereby identified as a variant of the beakers named “Kowalk type” and the dating determined to the late Roman Period, the 4th century. The origin is discussed against the background of the knowledge of the production and distribution of related beakers (Stjernquist in this volume). The result is a hypothesis that the production area is the south-eastern parts of the continent. The process of transfer is the same as for the magnificent bowl discussed by the author in the paper mentioned above (this volume).

The chemical analysis shows a composition similar to other glasses made in Roman regions in the west and in the south-east. Trace elements to distinguish between them are, however, lacking. Thus, this analysis cannot contribute very much to the problem of origin.

Acknowledgements

Warm thanks to Birgitta Hårdh, Lars Larsson and Rolf Petré who read the manuscript and made many important comments. Thanks also to Hasse Hansen for the preservation of the beaker, to Bengt Almgren for the photographic work, to Karl-Magnus Lenntorp and Birgitta Piltz-Williams for information and help with the illustrations and to Margrethe Watt for discussion on

the reconstruction. Warm thanks also to Eldrid Straume for discussions and for help with the illustrations. Thanks are finally due to the staff at LUHM for helpfulness, to the staff of the Library of the Academy of Letters History and Antiquity, Stockholm, and to Ann Tobin at the Library of the Department for great help, to Maria Lang for important work and to Alan Crozier for the revising of my English.

References

- Almgren, O. & Nerman, B. 1923. *Die ältere Eisenzeit Gotlands*. Stockholm.
- Andersson, K. 2001. Romerska kärl i Uppland och Västmanland. *Fornvännen* 96. Stockholm.
- Arrhenius, B. 1973. Kring två slipade glasbägare. *Göteborgs arkeologiska museum Årstryck* 1972–73. Göteborg.
- Capelle, T. 1988. Glastransporte. Hårdh, B., Larsson, L., Olausson, D., Petré, R. (eds.), *Trade and exchange in Prehistory. Studies in Honour of Berta Stjernquist*. Acta Archaeologica Lundensia 8:16. Lund.
- Christie, O. H. J., Brenna, J. A. & Straume, E. 1979. Multivariate Classification of Roman Glasses found in Norway. *Archaeometry* 21,2.
- Doppelfeld, O. 1966. *Römisches und fränkisches Glas in Köln*. Cologne.
- Ekholm G. 1965. Als orientalisches angenommene Gläser Skandinaviens aus dem ersten bis aus dem sechsten Jahrhundert n.Chr. *Antikvariskt Arkiv* 26. Kungl. Vitterhets Historie och Antikvitets Akademien. Stockholm.
- Enright, M. J. 1996. *Lady with a mead cup. Ritual, prophecy and lordship in the European warband from La Tène to the Viking Age*. Dublin.
- Follmann-Schultz A.-B. 1988. *Die römischen Gläser im Rheinischen Landesmuseum Bonn. Katalog*. Bonner Jahrbücher Beiheft 46. Cologne.
- Fremersdorf, F. 1967. *Die römischen Gläser mit Schliff, Bemalung und Goldauflage aus Köln*. Die Denkmäler des römischen Köln 8. Cologne.
- Gomolka-Fuchs, G. 1999. Gläser der Sîntana de Mureş-Černjachov-Kultur aus Rumänien und der Republik Moldavien. Gomolka-Fuchs, G. (ed.), *Die Sîntana de Mureş-Černjachov-Kultur. Akten des Internationalen Kolloquiums*

- in Caputh vom 20. bis 24. Oktober 1995*. Römisch-Germanische Kommission. Eurasien-Abteilung, Bonn.
- Hansen, U. Lund. 1987. *Römischer Import im Norden. Warenaustausch zwischen dem Römischen Reich und dem Freien Germanien*. Nordiske Fortidsminder B 10. København.
- 1993. The Iron Age and the Viking Period. Hvass, S. & Storgaard, B. (eds.), *Digging into the Past. 25 Years of Archaeology in Denmark*. Aarhus.
- Hårdh, B. 2001. Unter Götter und Königen – das religiöse und politische Zentrum Uppåkra. Arrhenius, B. (ed.), *Kingdoms and Regionality. Transactions from the 49th Sachsensymposium 1998 in Uppsala*. Stockholm.
- 2004. This volume.
- Holand, I. 2001. *Sustaining Life. Vessel import to Norway in the first millennium AD*. AmS Skrifter 17. Stavanger.
- Ingemark, D. 2003. *Glass, alcohol and power in Roman Iron Age Scotland. A study of the Roman vessel glass from non-Roman/native sites in north Northumberland and Scotland*. Department of Archaeology and Ancient History, Lund University.
- Isings, C. 1957. *Roman glass from dated finds*. Archaeologia Traiectina. Groningen.
- Kokowski, A. 2001. Die Einflüsse der Goldschmiedekunst der Hunnen und Ostrogoten auf die skandinavischen Goldschmiede. Magnus, B. (ed.), *Roman Gold and the Development of the Early Germanic Kingdoms*. Kungl. Vitterhets Historie och Antikvitets Akademien Konferenser 51. Stockholm.
- Kropotkin, V.V. 1970. *Rimskie importnye izdelija v vostochnoj Evrope (II v. do n.e. – V v.n.e.* Arkeologija SSSR D 1–27. Moskva.
- Kunow, J. 1980. *Negotiator et Vectura. Händler und Transport im freien Germanien*. Kleine Schriften aus dem vorgeschichtlichen Seminar Marburg 6. Marburg.
- Lang, M. 2004. Chemical Analysis of Iron Age Glass. Appendix in Stjernquist, B. A Magnificent Glass Bowl from Uppåkra. This volume.
- Larsson, L. 2001a. Uppåkra, an Iron Age site with a long duration: internal and external perspectives. Arrhenius, B. (ed.), *Kingdoms and Regionality. Transactions from the 49th Sachsensymposium 1998 in Uppsala*. Stockholm.
- 2001b. A building for ritual use at Uppåkra, southernmost Sweden. *Antiquity* 75.
- Larsson, L. & Lenntorp, K.-M. 2004. This volume.
- Lenntorp, K.-M. & Lindell, M. *Rapport. Arkeologisk Förundersökning Stora Uppåkra 8:3, Fornlämning 5, Uppåkra socken, Staffanstorps kommun, Skåne Län*. Uppåkra 2001. Lund.
- Lenntorp, K.-M. & Piltz-Williams, B. *Rapport. Arkeologisk Förundersökning Stora Uppåkra 8:3, Fornlämning 5, Uppåkra socken, Staffanstorps kommun, Skåne Län*. Uppåkra 2002.
- Näsman, U. 1984. *Glas och handel i senromersk tid och folkvandringstid. En studie kring glas från Eketorp II, Öland*. Uppsala.
- 1990. *Om fjärrhandel i Sydskandinaviens yngre järnålder. Handeln med glas under germansk järnålder och vikingatid*. Hikuin 16. Højbjerg.
- 1998. The Justinianic era of south Scandinavia: An archaeological view. Hodges, R. & Bowden, W. (eds.), *The Sixth Century. Production, Distribution and Demand*. The Transformation of the Roman World vol. 3. Leiden.
- Rau, G. 1972. Körpergräber mit Glasbeigaben des 4. nachchristlichen Jahrhunderts im Oder-Weichsel Gebiet. *Acta Praehistorica et Archaeologica* 3.
- 1973. Facettschliffgläser und die Chronologie der Spätkaizerzeit. *Archäologisches Korrespondenzblatt* 1973 No. 3.
- 1974. Zur Provenienzfrage spätantiker Gläser. *Archäologisches Korrespondenzblatt* 1974 No. 4.
- 1975a. Spätantike Glasfunde im Karpatenraum. *Zeitschrift für Ostforschung* 24 No. 2.
- 1975b. Spätkaizerzeitliche Glasbecher vom Typ Sackrau II aus der Moldau. *Archäologisches Korrespondenzblatt* 1975 No. 2.
- Schwärzel, D. 1983. *Handel und Verkehr des Merowingerverreiches nach den schriftlichen Quellen*. Kleine Schriften aus dem vorgeschichtlichen Seminar Marburg 14. Marburg.
- Ščukin, M. B. 1976. O nachal'noj date chernjakhovskoj kul'tury. (About the Initial Date of the Cherniakhov Culture). *Prace archeologiczne* 22.
- Sorokina, N. P. 1978. Facettenschliffgläser des 2.–3. Jhd u.Z. aus dem Schwarzmeergebiet.

- Annales du 7e Congrès International d'Étude Historique du Verre. Berlin-Leipzig, 15–21 août 1977.* Liège.
- Steuer, H. 1997. Handel und Fernbeziehungen. Tausch, Raub und Geschenk. *Die Alamannen*. Ausstellungskatalog, herausgegeben vom Archäologischen Landesmuseum Baden-Württemberg.
- Stjernquist, B. 1985. Methodische Überlegungen zum Nachweis von Handel aufgrund archäologischer Quellen. *Untersuchungen zu Handel und Verkehr der vor- und frühgeschichtlichen Zeit in Mittel- und Nordeuropa*. Abhandlungen der Akademie der Wissenschaften in Göttingen. Phil.-Hist. Klasse. Dritte Folge 143. Göttingen.
- 1986. Glass from the settlement of Gårdlösa. *Papers of the Archaeological Institute University of Lund 1985–1986*. Lund.
- 1999. Glass from Uppåkra: A Preliminary Study of Finds and Problems. Hårdh, B. (ed.), *Fynd i centrum. Keramik, Glass och Metall från Uppåkra*. Uppåkrastudier 2. Acta Archaeologica Lundensia 8:30. Lund.
- 2004. A Magnificent Glass Bowl from Uppåkra. *Uppåkrastudier* 10. This volume.
- Straume, E. 1987. *Gläser mit Facettenschliff aus skandinavischen Gräbern des 4. und 5. Jahrhunderts n. Chr.* Oslo.
- 1998. Fibeln der römischen Kaiserzeit aus Norwegen – der Stand der Forschung. *100 Jahre Fibelformen nach Oscar Almgren. Internationale Arbeitstagung 25.–28. Mai 1997 in Kleinmachnow, Land Brandenburg*. Forschungen zur Archäologie im Land Brandenburg 5. Wünsdorf 1998.
- Verhulst, A. 1970. Der Handel im Merowingerreich: Gesamtdarstellung nach schriftlichen Quellen. *Early Medieval Studies 2. Antikvariskt arkiv* 39. Kungl. Vitterhets Historie och Antikvitets Akademien. Stockholm.
- Wolfram, H. & Daim, F. (Hrsg.) 1980. *Die Völker an der mittleren und unteren Donau im fünften und sechsten Jahrhundert*. Vienna.
- Wood, I. 1998. The Frontiers of the Western Europe: development east of the Rhine in the sixth century. Hodges, R. & Bowden, W. (eds.) *The Sixth Century: Production, Distribution and Demand*. The Transformation of the Roman World Vol. 3. Leiden.

Abbreviations

ATA	Antikvarisk-topografiska arkivet, Stockholm
GAM	Göteborgs Stadsmuseum, Arkeologiska avdelningen
LUHM	Lunds Universitets Historiska Museum
SHM	Statens Historiska Museum, Stockholm

The Gold-Figure Foils (“Guldgubbar”) from Uppåkra

Margrethe Watt

Abstract

The paper presents the recent finds of gold-foil figures from Uppåkra (House 2). The article gives a short summary of the find context and contains a detailed description of the 115 embossed figures, five patrices (dies) and seven individually made figures, grouped by motif.

The second part of the paper is dedicated to the discussion of various iconographic aspects, including the physical appearance of the figures, hairstyle and dress. A section on gesture and posture includes a discussion of the prophetic gesture (also known as “the seer’s thumb”) exhibited by two figures. It also points to the possible gesture of betrothal shown by one of the male-female pairs. The attributes, mostly associated with single male figures, are dominated by a staff/sceptre, club and different types of neck rings. The possibilities of identifying named gods (or persons) is reviewed against the background of particular gestures and attributes.

The problem of dating the gold foils is discussed in the light of some recent finds. The archaeological context points to an early date of deposition of the Uppåkra gold foils to the Migration/Merovingian Period transition or shortly after.

The overall impression of the Uppåkra figure foils is that they are strikingly similar to figures from Bornholm, and in several cases made from identical dies.

Margrethe Watt, Dyssegårdsvej 71B, DK-2870 Dyssegård, Denmark

Introduction

Gold figure foils or *guldgubbar* were among the first archaeological finds to be described and discussed in detail (Sperling 1700; von Melle 1725). In spite of this they are – at least from a formal point of view – a poorly defined group. The term *guldgubbe* which has become generally accepted, was first coined by N. J. Sjöborg in 1791, and simply means a “lille old man of gold”. Subsequent works on gold figure foils by A. Nordén (1938), M. Mackeprang (1943) and M. Watt (1992, 1999b) have established the term as referring to small figures of men or women (single or

couples) or occasionally animals embossed, cut out or scratched on gold foil. The terminology will be discussed further in Watt (forthcoming).

Since the 1980s the number of figure foils has grown in leaps and bounds from a handful to now exceeding 2900 pieces. Excavations combining modern techniques with systematic field reconnaissance have significantly increased the number of localities with figure foils (Fig. 1). The vast majority of foils appeared as a result of an emergency excavation and subsequent field reconnaissance



Fig. 1. Localities with gold figure foils (*guldgubbar*). With few exceptions they originate from settlement sites.

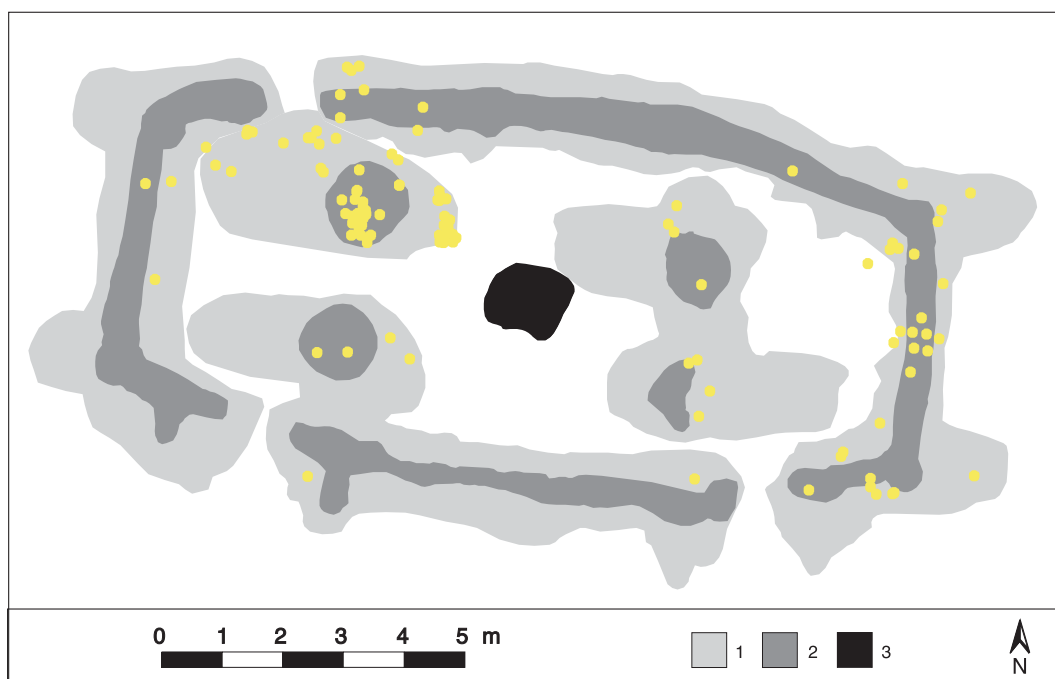

Fig. 2. Distribution of figure foils associated with House 2. The figures were found in the fill of post holes and wall trenches associated with the building phase of the house (group 50).

within the settlement complex of Sorte Muld on Bornholm (Watt 1991, 1999b, Watt forthcoming).

The archaeological context

The latest and so far second largest find of figure foils was discovered in connection with the investigation of a building complex in the central part of the Uppåkra settlement complex (Larsson, 2002; Larsson & Lenntorp, this volume).

The first two figure foils, as well as two dies (patrices) for making figure foils, were recovered from the topsoil as a result of surface and detector reconnaissance at Uppåkra in 1997 and 1998 (Larsson & Hårdh 1998; Watt 1999a). The remaining 120 figure foils and additional three patrices were found in 2001–2004 during the excavation of a

substantial house structure (Fig. 2) (Larsson 2002; Hårdh 2002, 42; Larsson & Lenntorp, this volume) (1).

Two of the figure foils (including one of the die-identical pieces fig. 15) lay in the fill associated with the levelling of the site prior to the building of House 2. Their stratigraphic and find context tie the deposition of these figures to the time around or shortly after the Migration/Merovingian Period transition (Larsson & Lenntorp, this volume). No figure foils were found in contexts earlier than this phase.

By far the largest number of figure foils come from the fill of the large post holes and wall trenches of House 2, which was constructed during the early part of the Merovingian Age (Vendeltid) (Larsson & Lenntorp, this volume). Many of the gold foils, including the die-identical pieces shown below as fig.

7 and fig. 22 come from the fill of the same large post hole in the north-west corner of the house (Fig. 2). Several figures appeared in the wall trenches.

A number of figure foils (including Figs. 12a, 14b, 17d–e, 24e and 27a) come from layers associated with the demolition of House 2, which took place during the Merovingian Period. Further pieces had been incorporated in layers belonging to a later levelling of the area (late Merovingian or Early Viking Age?).

Finally a couple of figures were found near a sacrificial weapon depot to the north of the house (the single figure 8d and the double figure 28c). The find context of these figures shows no direct link between the gold foils and the deposition of the weapons, of which the majority are dated to the Migration Period (Helgesson, this volume).

The Uppåkra figure foils

The number of figure foils from Uppåkra now totals 122 to which may be added four complete bronze dies (patrices) as well as a worn fragment of a fifth. In order to distinguish individual dies and figures they are referred to by their find number (fnr). The more than 430 figure types (dies) from Sorte Muld, which constitutes the bulk of the relevant comparative material, are referred to by a running die number (e.g. Sorte Muld 180).

The 115 embossed figure foils and 5 bronze dies from Uppåkra represent at least 58 different dies. While the majority of figures occur in one copy only, thirteen of the foils are represented by between two and fifteen die-identical pieces. Seven figures are made individually. The majority (including all those cut out individually) depict single figures. Six gold foils show a pair (male and

female), two of which appear to have been made with the same die.

Nearly all the figure foils from Uppåkra are complete and most of them well preserved. Some have been slightly crumpled, but – in contrast to the figure foils from Sorte Muld – very few appear to have been deliberately folded.

The figure foils from Uppåkra vary considerably in size from 9 to 26 mm in height, the largest being the patrix fig. 20 and one of the at least seven figures cut out individually (Fig. 30a). Individual figures have not been weighed, but based on a general similarity to the figures from Sorte Muld and Helgö an average weight of 0.1–0.15 grammes would be a fair estimate of the weight for the embossed figures and a little more for those made individually (Gullman 2004; Watt forthcoming).

Most of the embossed figures from Uppåkra are made to a high technical standard with a good finish. Several of the finest of the stamped figures from Uppåkra are made on dies or patrices with an unusually high relief, a trait which sets them apart from many figures from other localities.

The figure fnr 2053 (Fig. 11, bottom right), shows that the gold foil slipped sideways across the patrix during the manufacturing process, leaving a double imprint on the lower half of the figure. Other examples of double pressing have been recorded from Sorte Muld, Svintuna (Bodaviken) and Helgö (Watt forthcoming; Lamm 2004:113). Another figure (Fig. 5a) is embossed on thin gold foil with a fine honeycomb pattern of the type normally used as underlay in garnet jewellery. Even this peculiarity has a parallel on Sorte Muld.

So far none of the figures from Uppåkra have been analysed for gold content, but the colour as well as the lustre suggest that the majority are made of almost pure gold or at

least from an alloy with a high gold content. A small number are speckled with brownish stains, probably caused by the break down of the silver or copper components in the alloy. A similar spread in gold quality has been documented for other Swedish gold foils (Lamm 2004:115 p).

Description of the figures

The figures were all studied under the microscope, and although in most cases they are only shown from the front, the descriptions are based on information gleaned from both the front and back. The distinction between “front” and “back” is clearly demonstrated by one of the figures from Uppåkra where the excess gold foil, instead of being cut away, has been folded round to the back side (Figs. 17a–b). Several other figures from both Sorte Muld, Bornholm and Bolmsö, Småland, have (or have had) a backing and suspension loop of gold or bronze covering the back or “patrix-side” of the figure (Lamm 2004; Watt forthcoming).

As far as possible the figures are grouped according to sex and general motif: single figures (male, female (including one patrix), figures of uncertain sex) and pairs (male and female together). Within these groups the figures are arranged to allow for easy comparison of common features: dress, gesture, attributes etc. The cut-out figures are described as a group at the end. The figure foils and the two dies (patrices) found in 1997–98 have been published earlier (Watt 1999a) and are not described in this article, but are included in the discussion. Two complete dies found in 2003 are described in the sections “Single male figures” and “Single female figures”. A further fragment of a die, presumably representing the upper arch-shaped portion, is too

worn to allow even a guess as to the motif (Hårdh 2003:Fig. 10).

Single male figures (Figs. 3–18)

One of the finest gold-foil figures from Uppåkra is also the only known specimen from this die (Fig. 3a). It shows a man embossed on relatively thick rectangular gold sheet with a high lustre. The figure is depicted with the head and feet in profile and the body shown *en face*. The facial features are clear with a large bulging eye, a V-shaped mouth and narrow strands of hair flowing down over the shoulder.

The right hand holds a short pointed sword. The grip and triangular sword pommel seems attached to a narrow band ending in what looks like a loop behind the figure. The asymmetric sword blade suggests that the sword (drawn from its sheath?) may be a single edged seax. The left arm is bent upwards in front of the figure. Although the hand is largely hidden and some of the details obliterated in connection with the attachment of the narrow gold collar at shoulder level, the marks of the die on the back suggest that the fingers are pointing upwards with the thumb close to or below the chin. Several similar figures from Sorte Muld are seen to hold a beaker in the raised hand, but a careful examination of the back reveals no trace of this attribute. The meaning of the gesture is discussed below (see “Gesture and posture”).

The figure is dressed in a long caftan with a fine overall pattern and trimmed with broad ribbed borders and cuffs. Stylistically the details of this caftan are almost identical to those depicted on one of the plates from the Sutton Hoo helmet (Fig. 3d). A neck ring in the shape of a slightly irregular gold strip is placed across the neck and shoulder region

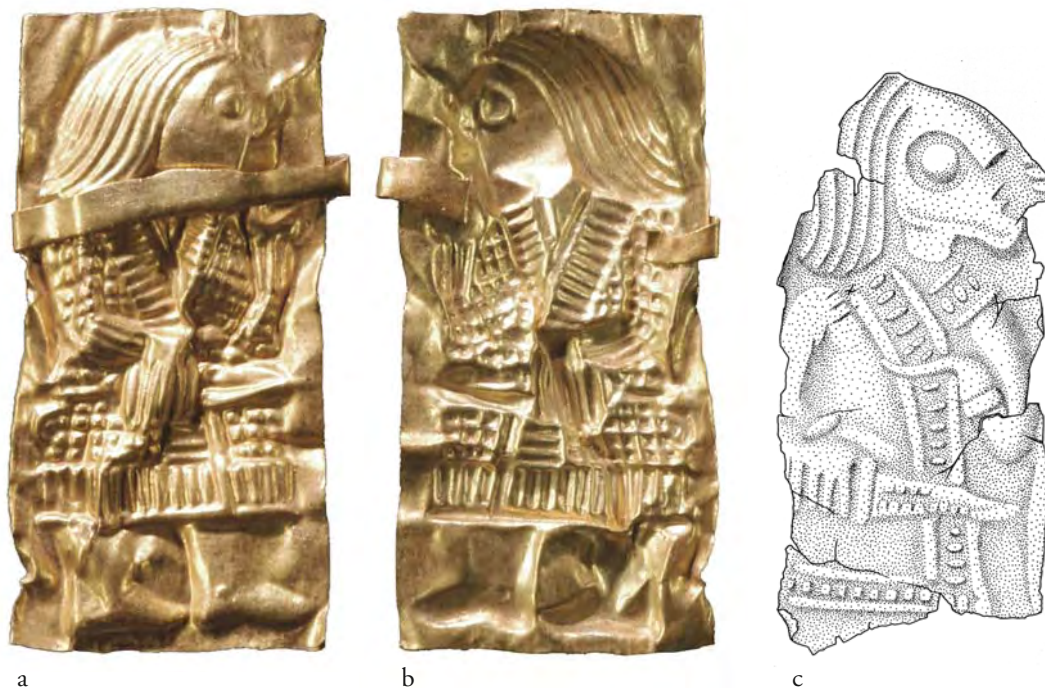

Fig. 3. a–b: Caftan-clad figure (fnr 6360, front (a) and back (b)); c: Sword-carrying gold foil figure from Sorte Muld (die 185). Photo: B. Almgren, LUHM; drawing: E. Koch (scale 4:1); d: Caftan-clad figure from a helmet plate from Sutton Hoo (after Bruce-Mitford 1978).

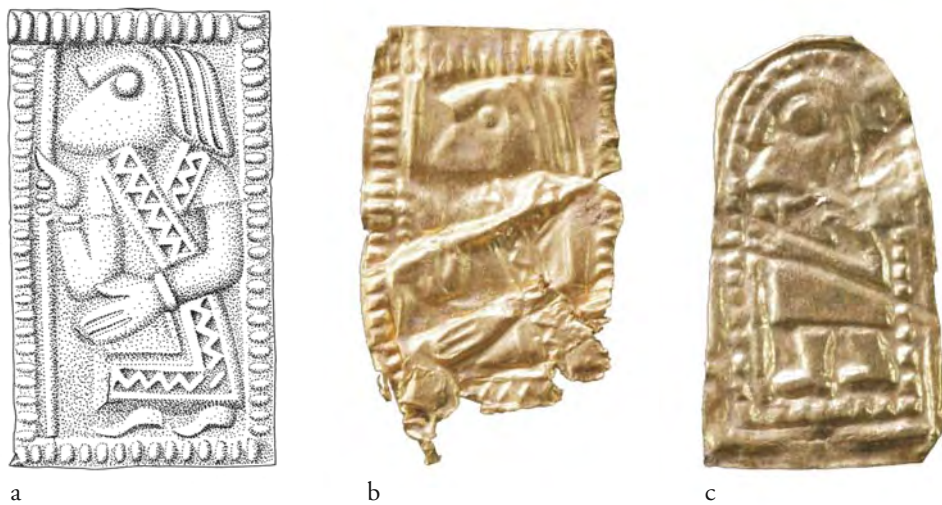

Fig. 4. The slightly damaged figure fnr 6407 (b) from Uppåkra is die-identical with Sorte Muld 3 (a). The figure fnr 6332 (c), surrounded by an arch-shaped frame, is unique to Uppåkra. Photo: B. Almgren, LUHM; drawing: E. Koch (4:1).

and the ends folded round onto the back in the same manner as on fig. 14a.

The figure is similar to the slightly fragmented Sorte Muld 185, which is the only other figure foil holding a single edged sword (Fig. 3c).

The somewhat buckled, incomplete piece fig. 4b shows a male figure in semi-profile (the feet are missing), surrounded by a beaded rectangular frame. The figure, which is die-identical with Sorte Muld 3 (Fig. 4a), is dressed in a long caftan trimmed with broad zigzag bands along the edges. The ring-like cuffs suggest that the caftan had long sleeves. In his right hand the figure holds a long narrow staff, while the left hand is placed in front of the abdomen.

The die Sorte Muld 3 represents what is considered to be the primary figure in a die-chain (see below: “Die-copying and die-families”). Like all fourteen die-identical specimens from Sorte Muld the single representative from Uppåkra is made of fine gold alloy.

Fig. 4c shows a figure standing in profile, surrounded by a beaded arch-shaped frame.

A smooth rim seen outside the beaded frame marks the edge of the likewise arch-shaped die. The head is disproportionately large with a big round eye. The nose and strands of hair at the back form a continuous band across the top of the head. The left arm is bent in a sharp angle and the hand is shown holding a narrow shoulder-length staff. The figure is dressed in a medium length plain garment (tunic).

The figure is so far unique to Uppåkra, but is iconographically and stylistically related to some common figure-types from Sorte Muld.

Fig. 5a and the large fragments figs. 5b–c represent two different but very similar dies. Although a close study of the die markings shows that both dies are unique to Uppåkra, they clearly belong to an extended “family” of interdependent dies well represented at Sorte Muld (Figs. 5d–f) (Watt forthcoming). The figures within this family are all shown standing in semi-profile facing the right. They are dressed in long caftans trimmed with a wide striped border. Well preserved figures are seen holding a club-like staff in one hand and lifting a cup or beaker in the other.



Fig. 5. Uppåkra fnr 2058 (a) and two die-identical fragments 6353 (b) and 6356 (c) are all closely related to a large family of figures including the dies 178, 179 and 339 from Sorte Muld (d–f). Note the colour difference reflecting the quality of the gold alloy and also the original honeycomb pattern of the foil used for fnr 2058 (a). Photo: B. Almgren, LUHM (4:1). Drawings: E. Koch (d–e), M. Watt (f) (4:1).

Fig. 5a (fnr 2058) is made of high quality gold foil with traces of a honeycomb pattern which was probably smoothed out during the embossing process. The other two figures are made of a much paler and more brittle gold-silver alloy.

Fig. 6a shows a 2.4 cm high arch-shaped bronze patrix, found by metal detector reconnaissance in 2003. The surface is strongly corroded and covered by a brownish-black coating blurring the details of the motif. The male figure is shown in semi profile, dressed in a long



Fig. 6. The bronze patrices from Uppåkra (fnr 38435) (a) and Smørenge, Bornholm (b) belong to the same extended family as the gold foils on fig. 5. Although both patrices are corroded, they appear to differ only in details of the hair and the pattern of the dress border. Photo: B. Almgren (a), Bornholms Museum (b) (4:1).

caftan with a broad border, holding a short thick staff or club in his right hand and lifting a cup or beaker(?) in his left. The figure type bears a close resemblance – not just to the gold foils in fig. 5 – but also to an almost identical patrix, found recently on the extensive settlement site at Smørenge, Bornholm (Fig. 6b). No gold foils have been identified as products of the Uppåkra-patrix, while a somewhat crumpled gold foil from Sorte Muld and a fragment from a settlement site at Møllegård, Bornholm, both appear to match the Smørenge-patrix (Watt 1992:Taf. XIX).

The 15 figures shown in fig. 7 comprise the largest number of die-identical figures from Uppåkra. Most of them are complete,

and nearly all appear to be made from the same pale gold-silver alloy.

The somewhat coarse figure is shown in profile facing right. The head is disproportionately large with a small eye, pointed nose, large V-shaped (open?) mouth and a few strands of shoulder-length hair at the back. The horizontal arm holding a long staff divides the head from the rest of the short body and slightly bent legs. There is no indication of whether the figure is dressed. All the pieces made with this die are finished off in the same manner by any excess gold foil being cut away in a broad arch around the head.

Although the figures from this particular die are so far only represented at Uppåkra,



Fig. 7. The largest number of die-identical figures from Uppåkra is 15 (fnr 4141, 4145–50, 4186, 6322, 6408, 6415, 6417, 6421 and 6426–27 (fnr 6322 not shown)). Nearly all the figures are made from the same debased gold. Photo: B. Almgren, LUHM (2:1).

stylistically they match a large group of simple staff-carrying figures from Sorte Muld (Watt forthcoming).

The small gold foils shown as figs. 8b–d belong to a group of simple staff-carrying figures common at Sorte Muld. All three have long hair and are dressed in knee-length tunics framed by a plain border. The smallest of the figures (Fig. 8b), which has been found in three die-identical copies at Uppåkra (only one shown), seems to match Sorte Muld 89 (Fig. 8a).

Fig. 8c is unique to Uppåkra and exists in two pieces, which appear to be made from slightly different alloys (only one shown). The long club-like staff carried by this figure seems considerably wider at the base than at the top end. The slightly damaged figure (8d) is very similar to the other two and also unique to Uppåkra.

The six die-identical pieces fig. 9 depict a male person standing in a frontal posture, but

with the feet and upturned head shown in profile. The figure holds a long staff obliquely in front of the body. A horizontal line below the hands indicates that the figure wears a knee-length garment.

The figures are die-identical to a further eight figures from Sorte Muld (die 47), which belong to a family of interdependent dies otherwise restricted to Bornholm (Fig. 9 left).

The Uppåkra figures – like those from Sorte Muld – all appear to be made of good-quality gold foil, though with slight variations in colour. The excess gold foil is neatly cut away along or slightly inside the edge of the arch-shaped die. The similarity in gold quality, as well as the sharpness of detail and general finish, suggest that the die-identical figures from both Uppåkra and Sorte Muld may belong to the same “batch”, made while the die was still fresh.

One of the finest gold foils from Uppåkra, fnr 6339, depicts a male figure standing *en*



Fig. 8. The figure Uppåkra fnr 6188 (b) seems to be die-identical with Sorte Muld 89 (a). Fnr 3426 (c) and 3883 (d) belong to the same stylistic group. Photo: B. Almgren, LUHM; drawing: E. Koch (4:1).



Fig. 9. The six figures fnr 3838, 3882, 4140, 6325, 6326 and 6330 (photographs) are all made with the same die as Sorte Muld 47. The middle figure in the bottom row is photographed from the back. The figures on the left show two other members of the same die-family: Sorte Muld 50 (top) and 49 (bottom). Photo: B. Almgren, LUHM; drawings: E. Koch (4:1).



Fig. 10. The caftan-clad figures from Uppåkra with a staff or sceptre attribute, fnr 6339 (a) and 3425 (b), belong to the same die-family as five figures from Sorte Muld (c, e–h). The figure fnr 4144 (d) is closely related to the group of die-identical figures shown on fig. 11. Photo: B. Almgren, LUHM; drawings: E. Koch (4:1).

face, but with the feet turned sideways (Fig. 10a). The bald head is excessively large with clear facial features but no hair. The figure holds a long sturdy staff in one hand while the other arm hangs down along the side of the body. The figure is dressed in a medium-length caftan with ribbed borders and a belt around the waist. The figure is made of thick, high quality gold foil on a die with an exceptionally high relief.

The figure exists in only one copy, but belongs to an extended family which also in-

cludes the figure figs. 10b–c as well as several dies from Sorte Muld (Figs. 10c, e–h). The Uppåkra figure may be regarded as a “prototype” from which Sorte Muld 106, 107 and 111 were copied. Some of the family members from Sorte Muld are rather crude with stylized caftans.

The smaller fig. 10b is shown in a posture similar to the one described above. Horizontal lines across the top of the head are interpreted as hair. The figure is dressed in a short stylized caftan. The long, ornate staff seen



Fig. 11. Eight die-identical caftan-clad figures (fnr 299, 2053, 3427, 3571, 3909, 6186, 6324 and 6429). The fuzzy, apparently three-legged specimen in the bottom row (right) is caused by the lower part of the gold foil sliding sideways during the pressing process. Photo: B. Almgren, LUHM (4:1).

beside the figure is decorated with circles or discs along its full length. The decorated staff is unique both within this family-group and among staff attributes in general (see below: “Attributes”). This figure is represented by just one specimen at Uppåkra, but is die-identical with a further nine pieces of Sorte Muld 109 (Fig. 10c).

The figure 10d is shown in frontal posture with the arms down the sides and the feet turned sideways. The facial features are clear with a brim of hair forming a semicircle round the upper part of the head. Both thumbs on the mitten-like hands are turned inwards towards the body. The figure is dres-

sed in a caftan which differs from the normal rendering of this garment, as the oblique edge is offset at the belt, possibly in an attempt to emphasise this characteristic feature.

The figure is made of good-quality gold on a patrix with high relief. Although it is the only known representative of this die it is – both iconographically and stylistically – closely related to the products of the die shown in fig. 11 together with which it forms a small family unique to Uppåkra.

The eight figures shown in fig. 11 all appear to have been made with the same die, but vary slightly in appearance and finish. The apparent variation is considered to be



Fig. 12. The four male figures fnr 62 (a), 3572 (b), 1912 (c) and 6328 (d) are all unique to Uppåkra. Photo: B. Almgren, LUHM (4:1).

due to differences in the thickness and purity of the gold, but can also be caused by wear and subsequent modification of the patrix, as is seen on several dies from Sorte Muld show (Watt forthcoming). The eight figures are all complete and made in the high relief typical of several Uppåkra dies. Slight differences in colour and finish indicate that the gold foil used in the manufacture is of varying quality and suggest that the figures may belong to different “batches”.

The figure is depicted standing in a frontal posture, but with the feet turned sideways. The large broad face has clear features, and the cap-like hair is drawn with oblique lines. The arms are sturdy and the fingers on the large hands are shown with the thumbs clearly pointing the same way (left), indicating that the palm of one hand is turned forwards while the other is turned backwards. This gesture is unique among the figure foils, but whether it carries a different meaning than those shown on the closely related fig. 10d or fig. 12 is uncertain. The figure is clad in a medium-length caftan with a plain border and cuffs held together with a belt around the waist.

Fig. 12a shows a stylized figure with the head and feet in profile and the body *en face*. The nose and shoulder-length hair form a continuous band across the top of the head. The prominent underhung chin is a characteristic feature of many gold-foil figures (Fig. 13). The arms hang straight down along the sides with mitten-like hands and inward-turned thumbs. The figure is dressed in a long garment with a double border at the bottom and a broad double belt round the waist. The hairstyle, dress and posture suggest that the figure is to be perceived as male.

The figure is slightly fragmented but originally carefully made of good-quality gold. The die is unique to Uppåkra and the figure only occurs in the one specimen.

Fig. 12b depicts a male figure with the head and torso shown in a frontal posture, the arms hanging down the sides of the body while the slightly bent legs and feet are turned sideways. The head is round with clearly marked facial features but no hair. The arms end in large hands, each with four long fingers of which the thumbs are turned outward. On the chest two nipples are placed close together,

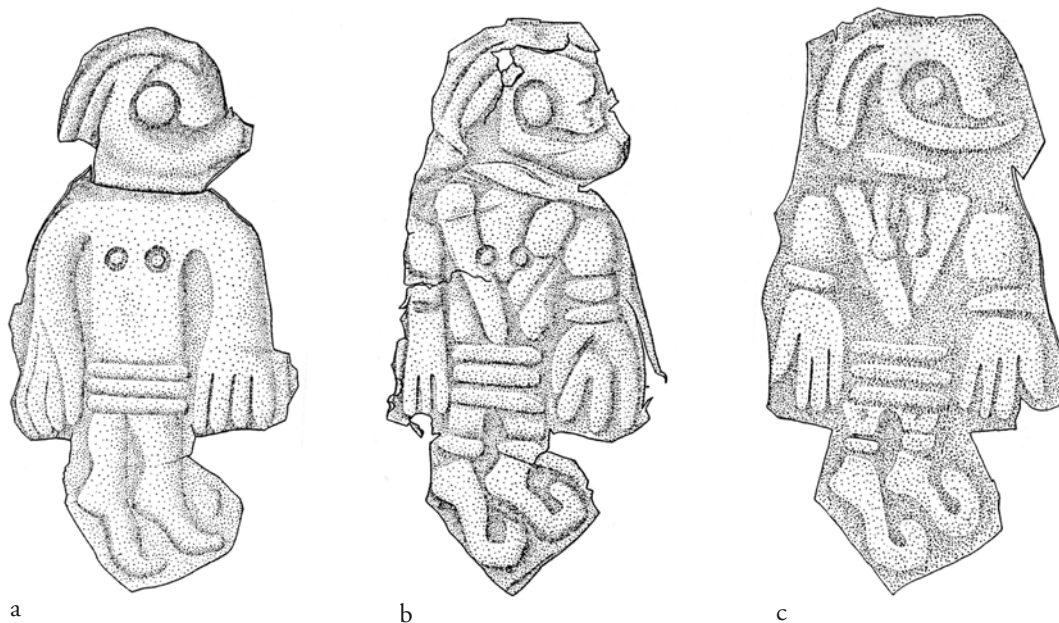

Fig. 13. Three members of an extended die-family from Sorte Muld related to fig. 12b. The figure Sorte Muld 303 (b) is – apart from a broad belt – perceived as naked, while 302 (a) and 301 (c) seem to be clad in stylised caftans. Drawings: E. Koch (4:1).

one slightly higher than the other. The nipples indicate that at least the upper part of the torso should be perceived as naked. The broad belt consisting of three parallel lines may, in this case, be regarded as an attribute rather than part of a garment.

The figure is made of good-quality gold and is the only known representative of this die. However, it seems related to a number of figures from Bornholm including the close knit die-family of figures which appears in versions both with and without clothes (Fig. 13).

Fig. 12c is one of the finest gold-foil figures from Uppåkra. It is shown standing in a symmetric *en face* posture with outward-turned feet. The arms and large hands display a conspicuous gesture with the hands placed in front of the abdomen with the thumbs pointing inwards and the other fingers turned outwards. The facial features are clear and the long hair parted in the middle and rolled up

in a way that is almost unique to this die. The figure is dressed in a medium-length tunic with a broad-ribbed border at the bottom. Although the figure lacks unambiguous sex-specific traits, the combination of hairstyle, short dress and gesture suggest that it should be perceived as male.

Judging from the colour and lustre, the figure is made of very fine gold. The details of the die and the technical finish bear the marks of a highly skilled craftsman. So far the figure is the sole representative of this die, and although it shares certain traits with a pair of die-identical figures from Bolmsö (Fig. 33a), it cannot be attached to any existing die-family.

Fig. 12d is shown standing in semi-profile with the large head and feet turned sideways and flowing, shoulder-length hair. The eye is marked by a depression similar to the two dimples on the lower part of the face, one of which possibly indicates the ear. The mar-



Fig. 14. The figures fnr 2785 (a, with an added “neck ring”) and 2494 (b) are die-identical. The stylised fnr 300 (c–d) is shown from both front and back. Photo: B. Almgren, LUHM (4:1).

kings on the back of the gold foil clearly show that the dimples are intentional (i.e. part of the die). A narrow band round the neck may be interpreted as a neck ring. The arms are placed asymmetrically in front of the abdomen with the large hands and fingers pointing downwards and the thumbs inwards in a gesture very similar to that of fig. 12c. The horizontal band below the fingertips indicates that the figure is dressed, but the garment is otherwise without detail. A combination of traits, including hairstyle and gesture, suggest that the figure should be perceived as male. The figure is the only representative of this die which cannot be related to any other established die-family. It is made of fine gold and pressed in high relief.

The two die-identical, somewhat stylised figures figs. 14a–b are shown in a frontal pose with the arms along the sides and the feet turned outwards. The head is large, round and bald with clear facial features. The hands and fingers, marked by horizontal grooves, are turned inwards in front of the belly. A border made with double lines indicates that the figure is dressed in a medium length garment.

One of the figures (Fig. 14a) is equipped with a loose “collar” or neck ring made of a slightly irregular gold strip. The collar reaches from shoulder to shoulder and is held in place by the ends being folded round to the back. This later addition may be a remnant from the trimming of excess gold foil and – judging from the colour and thickness of the gold foil – maybe even cut from the straight edge of the same figure. The short dress, gesture and gold collar-attribute suggest that the figure should be perceived as male.

So far the figures from this die have only been found at Uppåkra and have no immediate relatives within existing die-families. Both figures are made of the same good quality gold foil and are pressed on a patrix with very high relief.

The somewhat schematic figure 14c–d shows a person with head and torso in a frontal posture, but with the legs and feet in side view. The head is excessively large with coarse facial features including a wide moustache. Two small rectangular panels across the upper part of the body are probably arms, while a faint horizontal line below (at “knee level”)



Fig. 15. The six die-identical figures (fnr. 6406, 2296, 2772, 3881, 6184 and 6665) are made on a patrix (die) with high relief and afterwards neatly cut along the outline. The enlarged figure is a repeat of the one at the top left corner. Photo: B. Almgren, LUHM. The large figure on the right is on the scale 4:1, others 2:1.

indicates that the figure is wearing some kind of garment.

The figure is embossed on a strip of fairly good-quality gold foil, though some brown specks on the surface suggest that the gold content is below average. Compared to many other figures from Uppåkra fnr 300 is fairly coarse both in its design and technical execution. It is the only representative of this die, but stylistically it bears a certain similarity to some members of the die-family shown in fig. 10.

The six die-identical figures shown in fig. 15 and the fragment fig. 16b represent two very similar dies, the former unique to Uppåkra, the latter probably die-identical with Sorte Muld 282 (Fig. 16c). Both are depicted with the large head and feet in profile, while the torso is shown in a frontal posture. One hand (with an upward turned thumb) rests on the chest while the right arm is tightly bent with the hand under the protruding

chin. The legs are crossed over in a “dancing” posture. The difference between the two dies figs. 15 and 16b–c are seen most clearly in details such as the number and shape of the hair strands. The figures are perceived as naked and carry no attributes.

The six die-identical figures are all made of high quality gold, using a die with the high relief typical for Uppåkra. Any excessive gold foil is carefully cut away, either following the contours of the figure or forming an arch above the head. The fragment tentatively ascribed to the die Sorte Muld 282 is also made of good quality gold, but is quite buckled. In contrast the specimens from Sorte Muld are made of a range of different alloys, mostly with a high silver content and nearly all revealing a rather sloppy finish. The die Sorte Muld 282 may either be a copy of the Uppåkra version or both may derive from a common prototype.

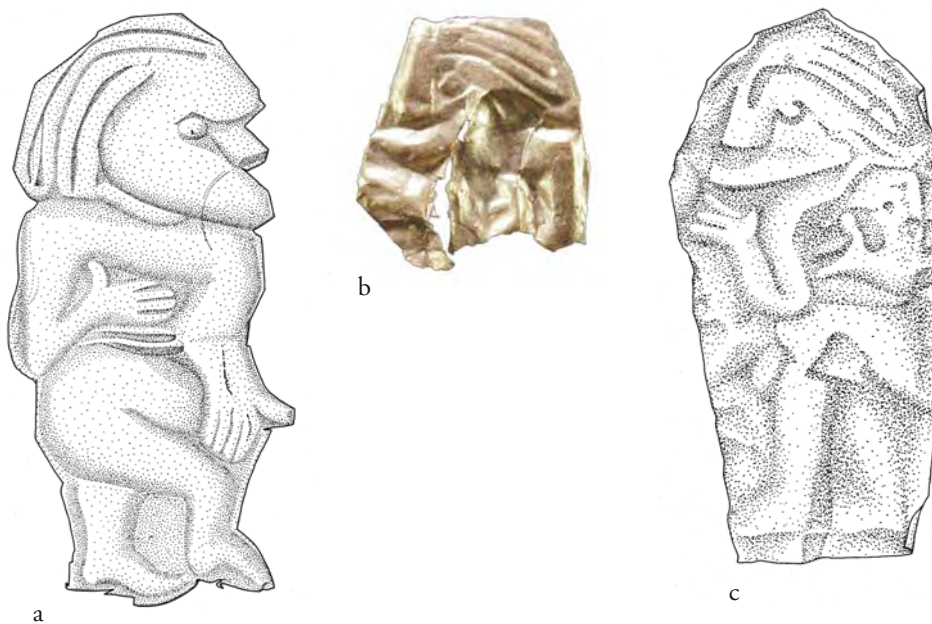

Fig. 16. The fragment fnr 6358 (b) from Uppåkra is die-identical with a figure from Sorte Muld (die 282) (c) and also stylistically related to three figures believed to have been found at Ravlunda in eastern Skåne (a: National Museum, Copenhagen). Photo: B. Almgren, LUHM; drawings: E. Koch (4:1).

A figure, also from Skåne, is an almost mirror image of the two from Uppåkra and Sorte Muld, depicting a naked person in a similar posture, but with a variation on the gesture (Fig. 16a). At least two out of the three figures of this type are believed to have been found at Ravlunda in eastern Skåne, and the third, kept in the National Museum in Copenhagen, is most likely also from Skåne (Lamm 2004:62 p, 97 p). Like the pieces on fig. 15, the Ravlunda figures are also pressed on a high relief patric. In all three specimens of the die, fig. 16a, the gold foil is carefully cut away following the contours of the figures.

Fig. 17 shows two very similar, apparently naked figures in semi-frontal posture with the legs crossed over in the same manner as seen on figs. 15–16.

The head of fnr 6664 (Figs. 17a–b) is shown from the side with a clearly marked nose and crew-cut hairstyle but no eye. The

left arm is bent upwards with the mitten-like hand placed in front of the face and the long, curved thumb placed in the open mouth. The other hand holds a short staff. A horizontal band between the head and shoulder is interpreted as a neck ring.

This die is represented by only one specimen from Uppåkra, but is die-identical with Sorte Muld 281 (Fig. 17c). Both copies are made of good quality gold. On the Uppåkra figure the excess gold foil along the edges is neatly folded round to the back (Fig. 17b).

The gold foil shown as figs. 17d–e is similar to the one described above, but is coarsely shaped and anatomically distorted. The lower part of the figure is buckled and has been folded so that the details of the legs are partly obliterated. Die-marks on the back side (Fig. 17e) show that the legs are crossed over in the same way as on figs. 17a–c. The facial features are coarse and much of the



Fig. 17. Fnr 6664 (a: front, b: back) from Uppåkra is die-identical with Sorte Muld 281 (c). The line seen running across the Uppåkra figure marks a flaw in the gold foil. The die fnr 2754 is considered to be an imitation of a–c (d: front, e: back, f: is an interpretation of d). Photos: B. Almgren, LUHM; drawings: E. Koch (c) and M. Watt (f) (4:1).

head is covered by the crew-cut hair marked by deep radiating grooves. Both arms are attached on the same side of the torso. One is bent upwards with the hand in front of the face and the thumb pushed into the mouth.

The other arm is stretched forward with the large hand holding a short staff. A beaded or ribbed band around the neck is interpreted as neck ring or collar, corresponding to the plain collar on figs. 17a–c.

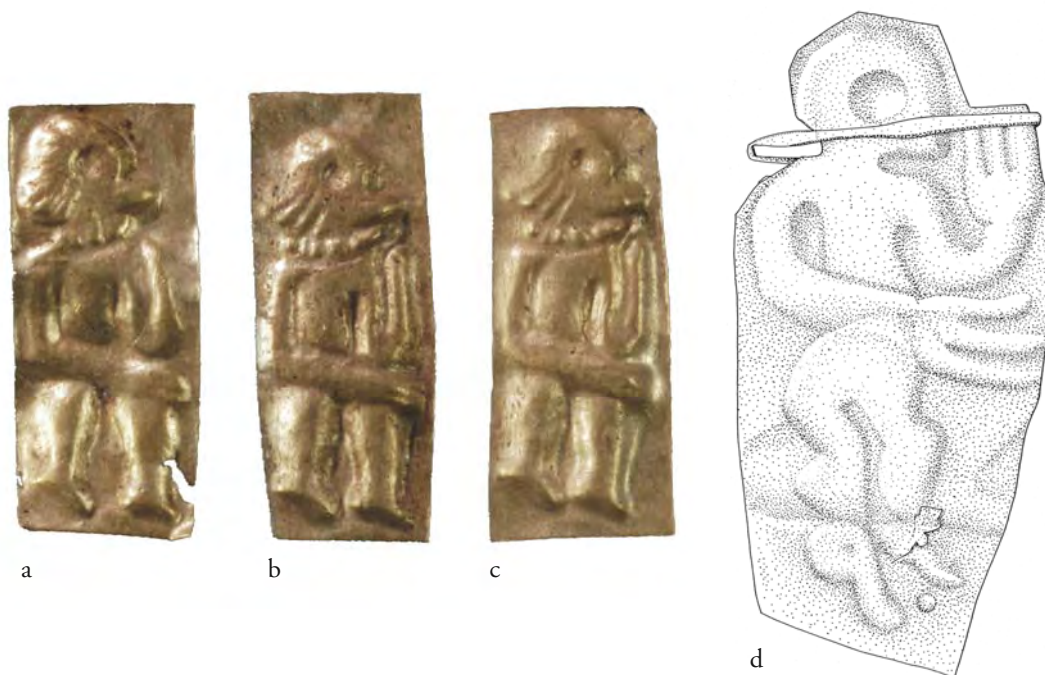

Fig. 18. The three die-identical figures, fnr 302, 2495 and 6410 from Uppåkra are closely related to a figure from Sorte Muld (die 280) (d) with a loose neck ring made of a thin gold strip. Photos: B. Alm-gren, LUHM; drawing: E. Koch (4:1).

The only specimen from this die is unique to Uppåkra. It is made of good quality gold foil which has been trimmed closely along the contours of the figure.

The figure is best described as a slightly clumsy copy of figs. 17a–b and Sorte Muld 281. Both belong to the same extended family as fig. 18. The significance of the gesture as a symbol of prophecy or foresight is discussed in the chapter on iconography (gesture).

The three die-identical pieces fig. 18 show a figure in semi-profile with a short body and sturdy legs. The head is very stylised, dominated by a deep-set eye and a strongly protruding chin. The hair is an unusual combination of a “crew-cut” at the top of the head and some strands of longer hair below. The left arm (with no hand) is bent up towards the chin and the right (with clearly marked fingers) stretched forward. The figure is per-

ceived as naked, but wears a beaded “necklace” similar to that on figs. 17d–f.

All three figures are made of relatively thick and – judging from the small brown and black specks on the surface – somewhat debased gold foil. Although fig. 18a appears slightly different to the other two, the marks from the patrix on the back show that all three figures are in fact die-identical. The closest parallel is a figure from Sorte Muld (die 280) where the raised hand ends in three upward pointing fingers (Fig. 18d), but they are also related to the two figure types above (Fig. 17).

In addition to the male figures described above a further two fragmented figures holding a staff are also considered to represent males (Figs. 27a–b). None of the fragments can be identified as the products of existing dies.

Fig. 27a consists of several small fragments of a pale, brittle, gold-silver alloy, which make



Fig. 19. The large female figure fnr 2188 (a) belongs to the same family as a figure represented both at Sorte Muld (die 264) and in the find described by Jacob von Melle in 1724 (b). Photo: B. Almgren, LUHM; drawing: E. Koch (4:1).

up a large proportion of the figure. Much of the head and – presumably – one leg are missing. The posture shown by the remaining front leg, which is lifted with the knee bent, has parallels on a number of double figures from Lundeborg (Thomsen 1993:91). The figure is dressed in a one-piece garment with a striped pattern.

Of the fragmented fig. 27b only the lower half is preserved with a knee-length dress and a sturdy pair of legs shown in profile. The large hand holds a staff. The colour of the fragment suggests that the gold is debased.

Single female figures (Figs. 19–23)

Single female figures are represented by nine or ten different dies, including two bronze

patrices, one of which has been described earlier (Watt 1999a).

The largest and most detailed of the female figures from Uppåkra is shown in profile and framed by a ribbed arch-shaped border (Fig. 19a). The stylized head is characterized by a large round eye, a protruding chin and some strands of hair of uneven length at the back. The shortest hair strand may be regarded as a feeble imitation of the characteristic female “bun” with some longer strands flowing down the back. One hand, appearing from under the cloak, holds a slender drinking horn. The figure is dressed in a long garment edged with an ornate border under which the small feet are seen in profile. The back and upper part of the dress is covered by a cloak with square corners and edged with a double

lined border. A circular ornament in the form of a “bull’s eye” may symbolize that the cloak is made of patterned cloth. The cloak is held together under the chin by a large fibula. The asymmetric shape of the fibula suggests that it may be either square-headed or of button-on-bow type. A necklace consisting of one (or two?) rows of beads covers the upper part of the chest. A band around the wrist of the hand holding the drinking horn may be interpreted as an arm ring, but by comparison to a similar figure from Bornholm (Fig. 19b), may equally well be regarded as a cuff of a long-sleeved dress.

The figure is made of relatively thick gold foil with brown corrosion specks suggesting that the gold content of the alloy is below average. The figure fnr 2188 from Uppåkra is the only known specimen from this die. It is, however, very similar to a figure represented by at least two specimens from Bornholm, including Sorte Muld (die 264; Fig. 19b). Although the two dies differ in many small details they are no doubt interdependent, possibly inspired by a common prototype.

The 2.6 cm long bronze patrix, fig. 20, is somewhat corroded, but still sufficiently well preserved for the motif to be deciphered: a female figure is depicted standing in profile holding what, from the shape and likeness to figures such as fig. 19, is assumed to be a drinking vessel (horn?). The details of the face and hair are badly corroded, but the eye, nose and mouth are distinguishable. The long hair seems shaped like a sausage below a round bun or knot. A row of three circles across the neck and shoulders is interpreted as a large fibula by analogy with similar figures (cf. Fig. 19a), but could also be regarded as a bead necklace. A group of oblique lines mark a sleeveless cloak or cape covering the upper part and back of the body. Below the cloak



Fig. 20. Bronze patrix from Uppåkra with a female figure holding what is assumed to be a drinking horn (fnr 4469). Photo: B. Almgren, LUHM (4:1).

the woman is dressed in a long frock or skirt with a broad chequered border, below which the large feet can be distinguished.

The die represented by this patrix is unique to Uppåkra, but although the figure cannot be attached to an established die-family the motif is well known both among figure foils and other find categories (Watt 1999a, Watt forthcoming).

The simplified female figure fig. 21a and the series of 11 die-identical pieces (Fig. 22) are very similar in appearance. Both are shown standing in profile with stylized facial features, a big round eye and a single strand of very long hair twisted in a simple loop at the back of the head. Arms or hands are not shown, but the legs and feet are seen in profile. Both figures are dressed in a simple,



Fig. 21. Three stylized female figures from Uppåkra: fnr 4136 (a), 1913 (b), 3663 (c) and sexually “neutral” figures from Uppåkra: fnr 7267–68, 7274 (e–f) and Sorte Muld (d, g). The figures c–g belong to the same extended die-family. Photo: B. Almgren, LUHM; drawing: E. Koch (4:1).

medium length, patterned garment with no details and no jewellery or attributes.

Both fig. 21a and the 11 die-identical figures on fig. 22 are made of the same type of pale gold foil. Both dies are unique to Uppåkra, but similar, very simple, female figures are well known from other localities.

The slightly fragmented fig. 21b shows a stylised female figure in profile. The large head has clear facial features and the hair strands seem collected in a fat pigtail. Like in many other female figures the hands are not shown. The figure is dressed in what may be assumed to be a long, possibly pleated frock



Fig. 22. Eleven die-identical female figures from Uppåkra fnr 2504, 4139, 4142, 4143, 4185, 6418–19, 6423–25 and 6428. Photo: B. Almgren, LUHM (2:1).

represented by the vertical stripes in the front (below the chin). A large part of the pleated garment is covered by a cloak held together with a circular brooch. The length of the dress and the shape of the feet cannot be determined as some of the lower part of the figure is missing. It is made of thin but good quality gold foil. The die is unique to Uppåkra and has no very close parallels.

Fig. 21c also shows a female figure standing in profile. The facial features include a nose and round eye. The long hair is tied in a tight knot seen as a slight bulge in the vertical band at the back of the neck. The figure is dressed in what is interpreted as a long pleated frock with a belt placed high on the body.

Double markings of the outline of the figure show that the gold foil shifted fractionally during the pressing process, so that a second eye and pigtail is seen as a faint 'echo'. The gold quality is fair with a slightly mat surface.

The die fig. 21c is unique to Uppåkra, but belongs to a family which include the fragmented pieces figs. 21e–f and also has several members on Sorte Muld, two of which are shown as figs. 21d and 21g. Fig. 21c from Uppåkra is interesting – but also confusing – because it

combines the characteristic high-belted dress with the typical female hairstyle, while the related dies from Bornholm and Uppåkra (Figs. 21d–g) all show figures with an almost equally typical "male" hairstyle (cf. also Fig. 25). Since the pleated dress occurs as a basic garment on many indisputably female figures (though normally partly hidden by a cloak), a reasonable conclusion would be that the group of figures in question should be perceived as female. However, it underlines the problem of pointing to reliable sex indicators, as also illustrated by double figures such as fig. 28d.

Fig. 23a shows a small female figure depicted in side view with a large head and armless body. The hair is coiled round in a loop with a pigtail hanging down the back. The upper part of the body is covered by an obliquely striped cloak below which an ankle-length checkered frock or skirt. Below the dress the crudely drawn feet are placed in perspective, one foot above the other. The die, which is unique to Uppåkra, is represented by three pieces (only one shown), all made of a pale gold-silver alloy. Similar female figures are found on Bornholm and also represented at Slöinge, Halland (Lamm 2004:86 (e.g. Slöinge, 350)).



Fig. 23. Three female figures from Uppåkra. The figure a (fnr 7266) is the better preserved of three die-identical specimens. The two figures b (fnr 99:2) and c (fnr 6343) are considered to be die-identical in spite of the difference in size. The shorter figure (c) appears to have been made after the patrix was damaged or worn and subsequently altered. Photo: B. Almgren, LUHM (4:1).

The two female figures figs. 23b–c are puzzlingly alike, although one is clearly shorter than the other. A close examination of the die marks on the back side reveals that the head and upper part of the body are identical, but appear to differ from the belt down. The fact that both figures are equipped with a pair of feet below the dress prove that the shorter figure is not just fragmented. The most likely explanation for this discrepancy seems to be that the patrix for some reason had become damaged and subsequently was shortened and partly reworked, including a new pair of feet. The fact that the die marks on the shorter figure appear less sharp than on the longer figure speaks in favour of this explanation. Although the “skirt” of the short figure appears pleated, faint traces of the chequered pattern on the back are still visible under a microscope.

The figures are depicted in profile. The highly stylised face with its strongly protruding

chin and hair bun on top gives it a “Mickey Mouse” like appearance. Both figures wear a two-piece garment consisting of a long chequered (or pleated) skirt. The upper part of the body is covered by a short obliquely striped shoulder cape or cloak. A narrow band around the neck may be interpreted either as a neck ring or – more likely – a neck band (as part of the dress). Weak marks on the back of the carefully cut-out flap protruding from the front of the body indicate that the figures are holding something in the hand. Judging from other female figures a fair guess would be a drinking horn, but the details of the hand and supposed attribute are largely obliterated.

The figures are both made of relatively thin but good-quality gold foil. The characteristic shape of the face with the strongly protruding chin has parallels on many figures from Sorte Muld both female and male (cf. Figs. 12a and 13).



Fig. 24. Figures with sexually conflicting traits from Uppåkra and Eketorp, Öland. a: Eketorp-B, Öland, b: fnr 3667 (with legs missing), c–d: fnr 3704 and 3445 (die-identical), e: fnr 1783 with typical “male” hairstyle and “female” dress. Photo: B. Almgren, LUHM; drawing: B. Händel (after Lamm 2004) (all 4:1).

Single figures of uncertain sex (Figs. 21 e–f, 24–26)

At least fourteen figures from Uppåkra, representing eleven different dies, lack unambiguous sexual characteristics. The figure fig. 24b and the two die-identical pieces figs. 24c–d are depicted standing in profile with no arms or hands, but with substantial legs and feet. The facial features are clearly marked and very similar in style. The hair consists of 3–4 hair strands hanging down over the shoulders. All three wear garments with a fur-like pattern arranged in bands divided by zig-zag lines. Combination analyses have shown that fur-like garments of this type are sexually neutral while the shoulder-length hair is normally, but not exclusively, associated with male figures (Watt forthcoming).

All three figures are made from good quality gold foil with a high lustre. The similarities in design, workmanship and finish are striking, suggesting that the figures from

the two dies emanate from the same hand. Though both are unique to Uppåkra, the stylistic resemblance in both facial features and dress-type to the figures from Eketorp is noticeable (Fig. 24a).

The figure fig. 24e is depicted in a slightly stooping posture with no arms or hands and a disproportionately large head. The facial features are coarse with multiple strands of shoulder-length hair. The figure is dressed in a fur-patterned cloak continuing downwards in a series of oblique lines, leaving only a small unpatterned triangle at the bottom. The narrow vertical panel on the front is considered to be part of the dress. While the hairstyle and relatively short dress suggest that the figure could be perceived as male, the short fur-patterned cloak, normally associated with female figures, casts doubt on the sexual affiliation. Whether the small dots below the chin are intended to represent beads or a brooch is uncertain.



Fig. 25. Figures from Uppåkra with sexually neutral traits. a: fnr 6204, b: 3662, c: 3668 and d: 2984. The figures b and c are die-identical with figures from Sorte Muld (dies 44 and 135). Photo: B. Almgren, LUHM (4:1).

Technically fig. 24e stands apart from the majority of gold foils from Uppåkra by being pressed on a very flat die which gives it the appearance of a contour drawing. This technique is also used in several figures from Bornholm (Watt forthcoming).

The group of figures in fig. 25 is of simple design with coarse features. They are all depicted standing in profile with large heads but no arms or hands. All have shoulder-length – or even longer – hair.

Figs. 25a–b are dressed in short, vertically striped or pleated tunics with the belt placed high on the body of the same type as seen in figs. 21 c–g. A line along the right hand side of fig. 25a marks the edge of the die. This figure is made of mat and brittle foil of a colour and rigidity which suggest a low gold content. Fig. 25b is die-identical with Sorte Muld 44.

Fig. 25c (Fnr 3668) is represented by one complete figure and one fragment (the fragment not shown). The dress is similar to figs. 21c–d and 25a–b, but with an overall fur-like pattern arranged in triangles of oblique lines. Both pieces from this die are made of thin foil

which – judging from the colour – has a gold content below average for Uppåkra. Fig. 25c is die-identical to Sorte Muld 135, and also similar to the figures Eketorp A and B and Slöinge no. 3001 (Lundqvist 1996:Fig. 9b; Lamm 2004:98 pp).

The figure fig. 25d is highly stylised as well as being slightly buckled, which makes the deciphering of certain details difficult. The figure is shown in profile with a large head, coarsely drawn facial features and unusually long and voluminous hair. The dress seems to include a short “skirt” with oblique stripes below a narrow belt. The details of the upper part of the body are unclear. Faint markings on the back side suggest that the thin angular line across the chest may represent an arm with the hand placed below the large nose, i.e. a gesture similar to that shown in figs. 15–16. The legs are shown in profile with slightly bent knees and the feet pointing obliquely downwards.

The figure is unique to Uppåkra and has no immediate parallels. The colour and lustre of the gold foil differs noticeably on the two sides, the front being darker and less shiny than



Fig. 26. Simple, sexually indeterminate figures from Uppåkra. a: fnr 6366, b: 3675, c: 3424, d: 2264. Photo: B. Almgren, LUHM (4:1).

the back. Similar colour differences have been observed on runs of die-identical figures from Sorte Muld (e.g. die 4, Watt forthcoming).

All four figures in fig. 25, as well as those already discussed and shown as figs. 21d–g, exhibit a combination of dominantly – but not exclusively – male traits (hairstyle, short garment) which is, at least occasionally, associated with female figures (Fig. 21c), but apparently also worn by men.

All four figures shown in fig. 26 are of very simple design with highly stylised facial features, shoulder-length “male” hair, and no arms or hands. A close examination of the die marks on the back side suggest that figs. 26b and 26c may be die-identical. All the figures are dressed, figs. 26a–c in short plain “tunics” and fig. 26d in a longer garment with a coarse fur-like pattern. Three small oblique lines on the shoulder of fig. 26d could be interpreted as a woman’s “cape” or cloak, but may also simply be part of the pattern. Although the overall impression is that figs. 26a–c may be male and fig. 26d possible female, all four figures lack unambiguous sexual characteristics.

With the exception of fig. 26a the above-mentioned figures appear to be made of

good-quality gold. Although they are all unique to Uppåkra, simplified representations of this kind are very common in Sorte Muld and also occur alongside the otherwise dominant double figures from Slöinge (e.g. Lamm 2004:86 pp; Watt forthcoming).

Fragments of single figures (Fig. 27)

Of the five fragments shown on fig. 27 two are mentioned above as probably male figures carrying a staff (Figs. 27a–b). The short dress of fig. 27c is typical of male figures, but not exclusive. The fragment fig. 27d represents the upper right hand corner of a figure including some strands of hair and part of one arm. The die-marks on the fragment fig. 27e cannot be deciphered.

The fragments figs. 27a–c represent independent dies. Fig. 27d bears a general resemblance to common figure types from Sorte Muld (cf. Figs. 4a–b). Judging from the colour of the metal all the fragments are of substandard brittle gold-silver alloy.

In addition to the fragments shown on fig. 27 a small number of nondescript pieces of embossed gold foil have been registered.



Fig. 27. Fragments of gold foil figures from Uppåkra. a: fnr 298, b: 6414, c: 306, d: 6412, e: 3661. Judging from the colour and stiffness of the foil these fragments are made of debased gold. Photo: B. Almgren, LUHM (4:1).

Double figures (male-female pairs) (Figs. 28–29)

Six of the gold foils from Uppåkra show two figures facing each other, representing five different dies (Fig. 28). One of them (Fig. 28a) has been identified as a member of a die-family represented in the Danish finds from Toftegården, Sjælland and Lundeborg, Fyn (Figs. 29a–b) (Watt 1999a:180).

The damaged and slightly buckled fig. 28b shows the contours of two stout figures in profile with the armless bodies almost touching. Apart from the outline of the chin the man's face (on the left) is almost obliterated. His body is bell shaped and covered in a medium-length garment with a pattern of oblique stripes, below which a pair of spindly legs are seen in profile. The woman's face is dominated by a large round eye. Faint traces of a knot or bun are seen at the back of the head, from which a pigtail in the shape of a narrow band, seems to almost reach the ground. The woman is dressed in a long, vertically striped or pleated frock partly covered by an obliquely patterned cloak or shawl. Faint traces of a pair of feet are seen below the dress.

This figure foil is unique to Uppåkra, and although it cannot be related to any established family, it has many features in common both with the simple armless pair fig. 28d and with several figures from Slöinge (Lundqvist 1996:Fig. 9a–b).

The small foil fig. 28c depicts two very clearly drawn figures, a man and a woman, in full profile facing each other (Fig. 28c). Both have highly stylized facial features. The hair of the woman (on the left) is tied in a cap-like bun from which a long, thin pigtail hangs down the back. Her right arm is bent forwards with distended fingers. She is dressed in a long frock with a small train and an apparently sleeveless jacket or cloak which may be perceived as open at the front. Both garments are chequered and edged with a plain border.

The man has unusually long hair and is dressed in a short patterned tunic with a plain border similar to the woman's dress. His left arm is bent forward with the hand in front of the waist with upturned thumb and palm. A collar-like band around the man's neck is interpreted as a neck ring, while the thinner band across the woman's neck is regarded as



Fig. 28. Double figures (male-female pairs) make up less than 5% of all gold foils from Uppåkra. a: fnr 4158 (cf. Figs. 29a–b), b: 6420, c: 5768, d: 6185, e–f: 6512–13 (cf. Fig. 30c). Photo: B. Almgren, LUHM (4:1).

part of the edging on the cloak. A faint curved line between the man's and the woman's garments appears to be part of the basic motif, but could be regarded as a flaw in the die. The significance of this detail is unknown, as it does not appear in any other motif.

The pair is unique to Uppåkra, and although many details, including the gesture, are known from other figure foils, it does not belong to any established family. It is made of high-quality, lustrous gold foil with the excess neatly cut away round the outer contour of the figures.

The figure foil, fig. 28d, shows two persons facing each other in full profile. The

armless bodies and highly stylized faces and protruding chins are almost touching. The woman's hair (on the left) is arranged in a cap-like bun with a long band-shaped pigtail reaching from the neck to the lower edge of her dress. Her long frock is vertically striped or pleated, and the upper part of the body covered by a cloak or shawl with a curved front border. The man's hair appears to be short (shoulder-length?). His dress is similar to the woman's but without the cloak.

This pair is worked in low relief on a fairly pale gold foil (gold-silver alloy?) with a slightly flaky surface structure. The figure is the only one known from this die, and although

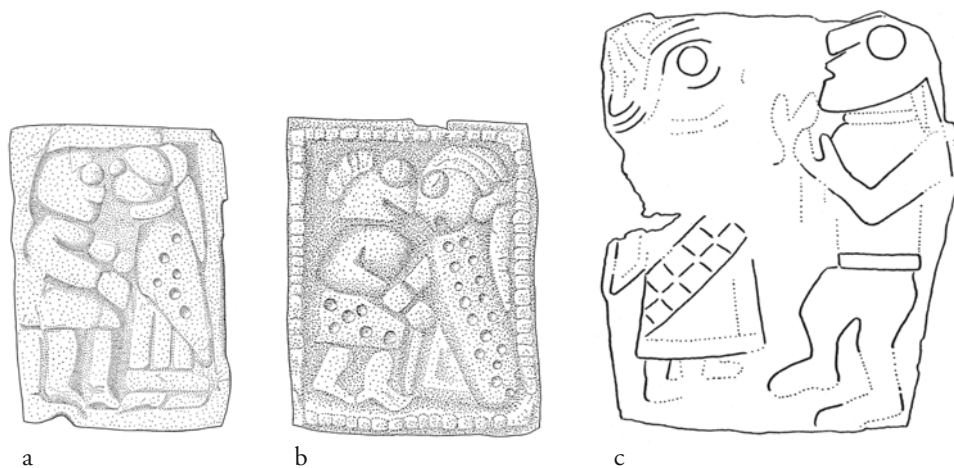

Fig. 29. A family of double figures from Lundeborg, Fyn (a) and Toftegården, Sjælland (b), appear to be die-identical with the damaged fig. 28a. c: Reconstruction of the die figs. 28e–f, based on a combination of observations from the front and back of both figures. The continuous lines mark the clearly visible details while the dotted lines indicate very faint or conjectured details. Drawing: Eva Koch (a: after Thomsen 1993; b: after Tornbjerg 1998); M. Watt (c) (4:1).

it appears to belong to no established family, there is a general stylistic similarity to fig. 28b and the above-mentioned simple figures from Slöinge.

The two crumpled but otherwise almost complete pairs figs. 28e–f are judged to be die-identical, although secondary damage make the figures appear slightly different. A reconstruction of the motif, based on combined observations from the front and back sides of both foils is shown as fig. 29c.

Large parts of the female figure (Fig. 28f) are obliterated, particularly the head and upper part of the body. A round eye and what is interpreted as part of a hair knot is seen on fig. 28e, while the end of a long pigtail is visible on fig. 28f. The lower part of the woman's dress including a long plain frock or skirt and a chequered cloak is seen on fig. 28f. The feet are clearly seen in both pieces. Faint imprints visible only on the back may mark the position of an arm or hand. A small disc-shaped figure on the woman's chest may be a brooch.

The male figure is more complete with a stylized head and a snip of shoulder-length hair. Both foils show quite clearly the arm and hand with upturned palm as well as the slightly curved legs. Double lines at the waist mark a belt, but otherwise the details of the man's dress are uncertain.

A V-shaped figure in the narrow space between the two figures, faintly visible on fig. 28e, may mark the woman's upturned hand or may indicate the presence of an attribute, (held by the woman?). However, it must be stressed that the details here are very blurred.

Both pieces are made of very thin, but good-quality gold foil. The die is unique to Uppåkra, and does not appear to be closely related to any established die-family.

Individually made figures (Fig. 30–31)

The at least six individually made gold foils from Uppåkra are all shaped by cutting the figures along the contours (Fig. 30). Finer details have been added by incision, scrat-



Fig. 30. Six figures from Uppåkra cut out of thick gold foil. a: fnr 6350, b: 75, c: 6348, d: 6187, e–f: 3444 (front and back), g–h: 6409 (front and back). Photo: B. Almgren, LUMH (4:1).

ching, drilling or hammering with a pointed instrument and – in one case – by using a circular stamp. Although the figures are essentially one-sided, the cutting marks show that they must have been turned, sometimes repeatedly, during the cutting process.

The gold alloys used for the cut-out figures vary in quality and the gold foil is mostly considerably thicker than the embossed figures.

The largest of the gold foils measures 2.5 cm in height (Fig. 30a). It shows a male figure depicted from the front with a mushroom-

shaped head and striking facial features. The large eyes are made with a circular stamp. The nose, mouth and what looks like a wide moustache are marked with deeply cut lines. A semicircular band of oblique lines and dents across the top of the head is assumed to represent hair. The arms and hands with outward-turned fingers are drawn with deep serrations. The legs are long and narrow each ending in neatly shaped toes. The figure shows no indication of clothing, but two parallel lines mark a broad belt across the low set

waist. Notches round the edges of the figure shows that the unusually thick gold foil has given problems during cutting.

The figure fnr 75 (Fig. 30b) is shown in a frontal posture with truncated arms and widely splayed legs. To make a definite gap between the legs they were pulled away from each other after cutting. A small pointed flap left in the crutch is considered to be a remnant from the cutting process rather than a deliberate attempt at marking the genitals.

The large head is pear-shaped with small deeply drilled eyes, a square nose and linear mouth above the pointed chin. The figure appears to be naked apart from a cross-hatched belt around the waist and a broad collar around the neck, both drawn with fine lines.

The figure is both stylistically and technically very similar to fig. 30c. The likeness seen in the facial features as well as the truncated arms and cross-hatched belt is so striking that it seems fair to assume that the two figures were made by the same person.

Fig. 30d is crudely shaped from a strip of gold foil. The vaguely octagonal head is without facial features. Some sketchy lines on the torso are difficult to decipher, but may represent arms and hands. The figure could be regarded as unfinished.

The small figure, figs. 30e–f (shown from front and back), is crudely made with a round head, no arms and the legs spread after cutting in the same way as fig. 30b. The only facial features are a pair of bulging eyes made from the back. Two hardly discernable points on the upper part of the torso mark the nipples, while some faint lines radiating upwards from the crutch may be perceived as a half-hearted attempt at depicting the genitals. Although the sexual markings may seem ambiguous, a comparison with naked or semi-naked figures from Bornholm suggests

that this small figure is to be perceived as male (Watt 2001:221 and Fig. 1).

Figure, figs. 30g–h, shows both sides of a male figure standing in a semi-frontal posture with the arms along the sides of the body and the head and feet turned sideways. The facial features are formed by incisions on one side of the head, though faint lines mark the hair even on the back. The small eye is made with a pointed instrument. The hands are large with clearly distinguishable fingers and one hand is carefully drawn with the thumb turned inward. On the lower part of the obviously naked body the male genitals are neatly drawn in the space between the hands in a similar manner to a large cut-out figure from Sorte Muld (Fig. 31a).

In addition to the group of six – at least semi-naturalistic – figures (Fig. 30) is a strip of gold foil which may be regarded as a highly stylized or symbolic gold-foil figure (Fig. 31b). It takes the shape of a 20 mm long and 3 mm wide gold strip, rounded at one end and with a pair of stubby “legs” at the other. Above the “legs” a small rectangular piece of gold (penis?) is pushed through a slit.

While fig. 31b is counted among the gold-foil figures, another 30 mm long and only 2 mm wide gold strip, pierced above the “feet” by a tiny rivet (Fig. 31c), seems more doubtful. The same applies to a few other small gold strips, forked at one end to form crude “legs”, but showing no other detail (Figs. 31d–e).

Iconographic analysis

The many new figure foils which have appeared since the mid-1980s have provided a wider scope for the analysis and interpretation of the figure foils. Where earlier discussions were limited to the relatively small number of figures available, it can now be replaced by a

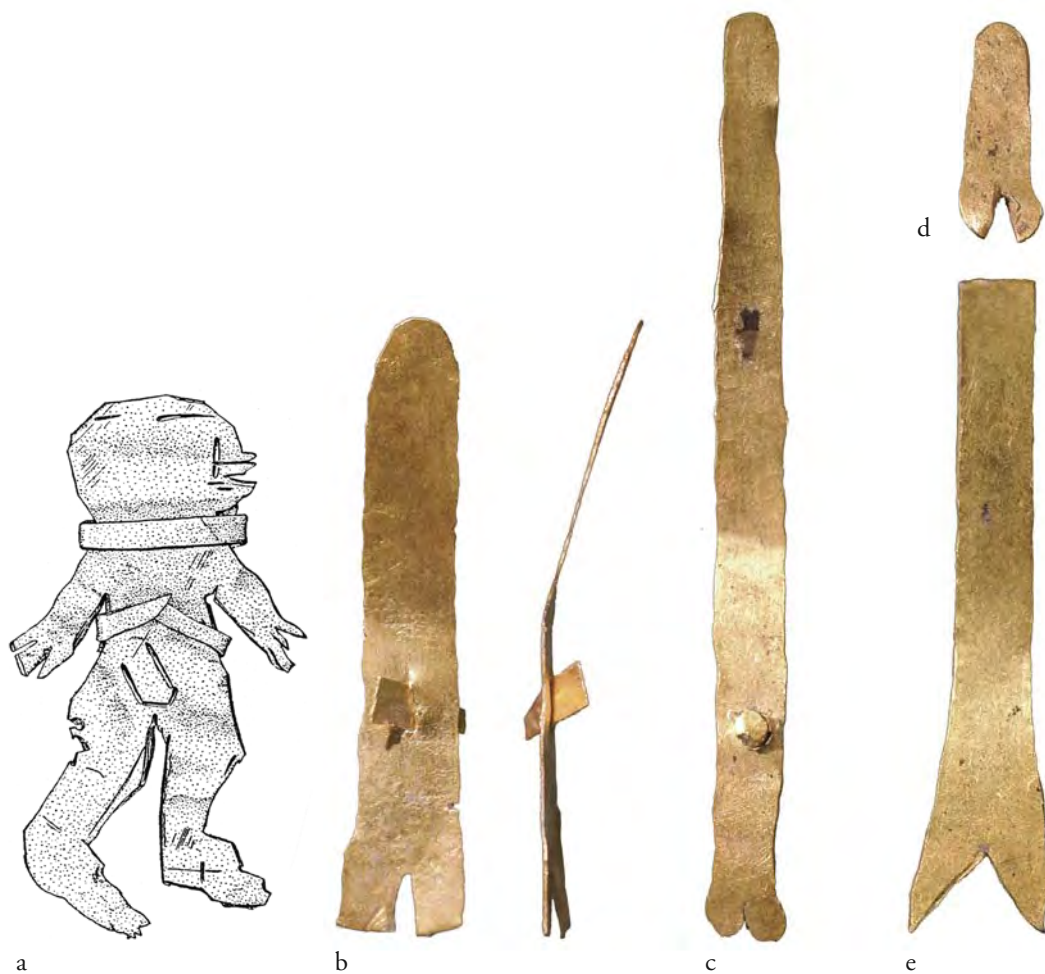

Fig. 31. a: The cut-out figure from Sorte Muld (R8:9a) is the only other gold foil, besides figs. 30g–h, where the male genitals are clearly drawn; b: crudely shaped phallic figure with short legs (fnr 7281); c: possible “phallic” figure of the same type as b (fnr 200); d–e: examples of gold strips with “legs” (fnr 201 and fnr 7282). It is questionable how many of the crudely shaped gold strips from Uppåkra should be regarded as human figures. Drawing: E. Koch; photo: B. Almgren, LUHM (4:1).

more statistical approach. Among those who have taken up the challenge of the growing number of new gold-foil figures is Karl Hauck, Münster. In a number of both inspiring and controversial articles he has compared details of the gold figure foils to the Migration Period bracteates, and has attempted to identify individual gods within this iconologic treasure.

The following analysis of the Uppåkra figure foils is based on the author’s research into the combined Scandinavian material in

connection with the publication of the ca. 2400 figure foils from Bornholm (Watt forthcoming). The iconographic analysis is based on a systematic registration of a range of different features, of which the most significant are hairstyle, details of dress, gesture and attributes. The relative frequency of occurrence as well as the repeated combination of certain elements helps to separate the unique from the norm. Regional patterns emerge from the study of die-links and die-dependency.

Physical appearance

The physical appearance of the figure foils and the amount of detail shown is not always in proportion to the size of any individual figure. It often depends just as much on “artistic style”, and in some obvious cases also on the skill of the individual goldsmith. Both large and small figures show some degree of exaggeration of specific details (e.g. the hands), which may carry a symbolic value of relevance to the interpretation of the figures. In other cases iconographic elements may be “reduced” or even implicit, as seen also on the Migration Period gold bracteates.

Almost a third of the figures from Uppåkra are shown without arms or hands. This apparent “reduction” seems particularly common in female figures and within the group of simple figures of indeterminate sex (e.g. Figs. 21, 24–26).

The legs and feet are mostly shown in a standing posture with straight or in some cases slightly bent knees. Notable exceptions are the interrelated dies figs. 15–17, where the legs are crossed over as an indication of movement or dance.

The figure foils from Uppåkra show considerable variation in facial features. The eyes are nearly always clearly marked and often disproportionately large. Even the mouth is usually marked, though rarely as demonstratively “open”, as on the group of die-identical figures shown in figs. 7 and 17.

The strongly protruding chin which characterises a number of figures from both Uppåkra and Sorte Muld is easily misinterpreted as a beard. However, several indisputably female figures demonstrate that this feature is a stylistic rather than a sexual trait (Figs. 23b–c). None of the figures from Uppåkra (and less than a handful from Sorte Muld) are equipped with a chin-beard, and even

moustaches are quite rare (Figs. 14d and 30a). Razor knives in Frankish graves from the 6th century suggest that beards – or at least chin-beards – were out of fashion at the time among the leading classes (Siegmund 1996:694).

Hairstyle

The Uppåkra figures show approximately the same variations in hairstyle as the figures from Sorte Muld. The majority of male figures have shoulder-length hair, either in side view (e.g. Figs. 3–9) or seen from the front (Figs. 10–11, 12c and 30a). Combination analyses have shown the shoulder-length hair to be dominantly – but not exclusively – male (Watt forthcoming). The magnificent display of hair seen on the assumed male figures of fnr 1912 and fnr 2984 (Figs. 12c and 25d) can only be interpreted as a symbol of “exalted rank”, as also underlined by the figure foil from Sorte Muld where it is combined with a diademe and a long staff (sceptre) (Fig. 32b). A similar version of the long male hairstyle is found on two die-identical figures from Bolmsö in Småland (Fig. 33a). The meticulous reproduction of long hair on many pictures of male figures from the Merovingian Period is clearly significant. It is found throughout the Germanic area on objects ranging from the well known seal-portrait of Childeric to disc brooches and gold pectoral crosses with portraits showing Christ as a reigning monarch (e.g. Menghin 1985:Taf. 32). Written sources, including Gregory of Tours’ 6th century “*History of the Franks*” (book II,9), mention the ‘*Reges criniti*’ (long-haired kings). Even contemporary legal texts list the proportionately stiff fines for committing violence against the “long haired” (*Lex Salica* XXIV and XLI).

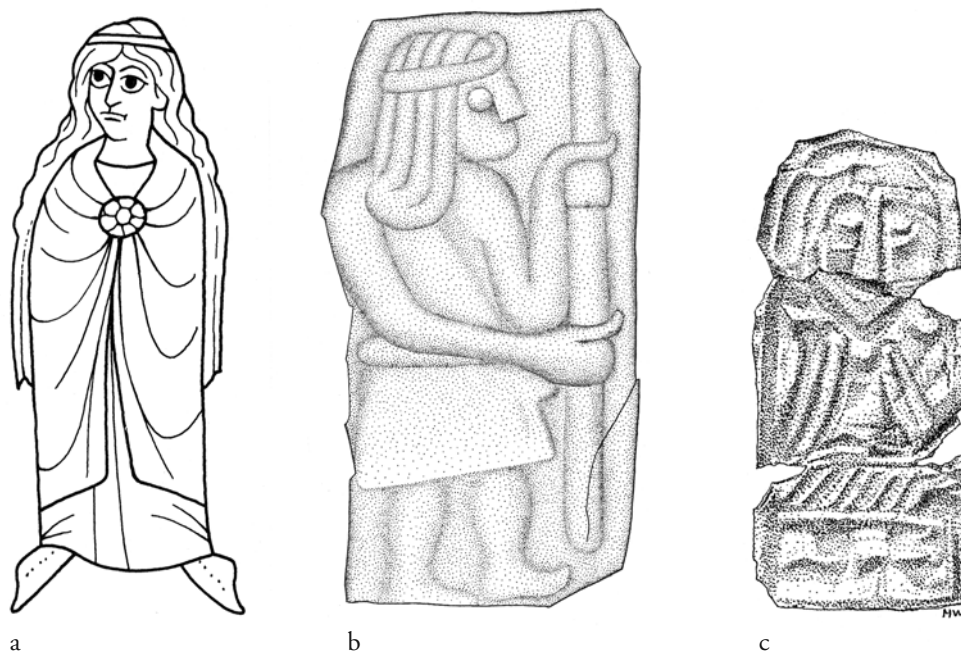

Fig. 32. The figure Sorte Muld 25 (b) with long-sceptre and diademe is considered to be a southern Scandinavian equivalent of the Merovingian “long-haired kings”. The female figure from Slöinge (Halland) (c) is dressed in a long frock or tunic and cloak held together on the chest by a disc fibula. This was the standard female dress combination throughout the Germanic area as shown by the example from the *Stuttgarter Psalter* (a: after Vierck 1978). Drawings: E. Koch (a); M. Watt (b) (drawn from a photograph by Gunnel Jansson) (4:1).

The obliquely hatched brim or “scull cap”-like hair seen on figs. 10d, 11 and 30a are unique to Uppåkra, as is also the combination of a crew-cut with long back hair on figs. 18a–c.

Many female figures have their long hair tied in a characteristic coil or complicated loose knot, long recognised as a reliable indicator of female sex. But simple hair knots and even rudimentary ones, as seen on figs. 21b–c and 23b–c, are also common, particularly in single figures.

With the exception of the group of cut-out figures, bald heads are rare at Uppåkra. Based on observations from the Sorte Muld figures, bald heads seem to be a stylistic trait confined to certain die-families or to highly

stylised figure types, including most of the individually made figures.

Dress

The figure foils from Uppåkra display a variety of dress types comparable to those of the Bornholm figure foils.

At least eight male figures (dies) from Uppåkra are depicted wearing a caftan. Four of them are die-identical with figures from Sorte Muld. The caftan worn by the unique figure fig. 3a has long sleeves with broad cuffs and an overall pattern. Other caftans have ornate or plain borders and some also a belt round the waist. The oblique border of one of the caftans is offset at the waist (Fig. 10d), presumably in

order to underline the overlap characteristic of this dress type. A stylised rendering of the caftan, seen on figs. 10b–c, is identifiable by comparison with the related fig. 10a.

At Sorte Muld caftan-clad figures make up 10–12% of all dies, including the numerically dominating die-families to which figs. 4, 5 and 6 belong.

When and how the caftan became part of the Germanic dress code has been the cause of much speculation. The general consensus is that it is of broadly eastern origin. But although the caftan may have been a familiar sight within Roman army units in the eastern part of the Empire, it does not seem to have spread into the Germanic area until sometime in the 6th century (e.g. Hägg 1985:190, 2000). However, pictorial representations of the caftan, some of them remarkably similar in style to the caftans on the figure foils, soon became widespread (Fig. 3d).

The use and symbolic value of the caftan as a regal or ceremonial garment is regarded as a reflection of Byzantine influence on Frankish, Anglo-Saxon and Scandinavian aristocracy in the late 6th and early 7th centuries (Nockert 1991:113; Watt 2003). The question of why no figure foils outside Bornholm and Uppåkra depict this dress type is puzzling (Watt forthcoming).

The long garment worn by fig. 12a with a double border round the bottom and a broad (double) belt is unique. The length suggests that even this garment could be interpreted as a “ceremonial” dress on a par with the caftan.

Most of the remaining male figures from Uppåkra, including those of the male-female pairs, appear to be wearing a short or medium length tunic, most of them with a plain border but with no belt marked. The tunic with a belt, most often worn with long narrow

trousers below, was the most common male garment throughout the Germanic area.

For many years the gold figure foils have played an important role in the discussion and reconstruction of the female dress in the Late Iron Age (Munksgaard 1974, 1990; Manneering 1999). The majority of female figures are wearing a cloak, shawl or jacket concealing the basic dress on the upper part of the body. The small number of female figures without a cloak appear to be dressed in a one-piece frock or tunic which can hardly be distinguished from that of their male counterparts (e.g. Figs. 21–22). This is hardly surprising, since the basic cut of the woman’s garment at the time did not differ significantly from the man’s except perhaps in length.

The characteristic train seen at the bottom of the dresses on many female figures, especially from Norway and the central part of Sweden, features only on one of the double figures from Uppåkra (Fig. 28c).

The sleeveless top garment, worn by ten or eleven female figures from Uppåkra, varies in length from a short cape or shawl to an ankle-length gown. Judging from the straight or slightly curved front edge the shape of the top garment may have been either semicircular or triangular (a folded square?) (Figs. 19–20) (Watt 1999a:Fig. 3). The female figure in the pair Fig. 28c appears to be wearing a long sleeveless coat. The double border – shown in perspective (?) – indicates that it is open at the front.

Like the long tunic, the cloak or shawl formed an integral part of the woman’s dress throughout the Germanic area. One of the single female figures from Slöinge shows how the cloak was normally held together in the front by a fibula (Fig. 32c). This closely matches depictions of women’s dresses from other parts of the Germanic area (Fig. 32a).

Only two of the female figures from Uppåkra are seen to be wearing a fibula as part of the dress. The circles on the double figure figs. 28e–f and the patrix fig. 20 may or may not be regarded as a brooch.

The group of figures described as sexually neutral (Figs. 24–26) (Watt 2001:Fig. 5) typically wear a one-piece “tunic-like” dress, either plain, vertically striped (pleated?) or with a fur-like pattern (Figs. 21d, 24, 25a–c).

A small number of the Uppåkra figure foils, including the six cut-outs, are perceived as naked apart from a belt and neck ring or necklace which in this instance are regarded as attributes (see below).

In a popular article Ulla Mannering divides the dresses of the gold-foil figures into three groups, incorporating evidence from textile fragments from burials. On the basis of a recognition of different textile types she suggests that the overall picture with older dress types in southern and eastern Scandinavia (which would now also include Uppåkra) has a chronological rather than a regional background (Mannering 1999).

A comprehensive analysis including a range of other iconographic elements, stylistic features and die-identity, carried out by the author, seems to point in the direction of a combination of both regional/stylistic and chronological factors for the differences in dress code (Watt forthcoming).

Gesture and posture

Gesture may be described as a wordless body language, reflecting the human urge to ritualise important events. Gesture is particularly important in an illiterate society or in a society where literacy is limited to the elite or a few officials. Some gestures are old while the meaning of others are linked to religious ce-

remonies (“lithurgy”), judicial acts or a time-honoured code of behaviour between persons of different rank. Some gestures are almost universal, while others with a very specific meaning are intellegible only to the initiated.

The figure foils from Uppåkra display a variety of gestures and postures, some of which can be deciphered only when examined in a wider context through comparison with interdependent die-types. Other gestures appear to have no obvious parallels and meantime remain a mystery.

In almost half the figure types (dies) the position of the hands is largely determined by the attributes they carry (e.g. staff/sceptre or drinking vessel, see below: attributes). A total of 21 figures, including two male-female pairs and three of the cut-outs, have no arms/hands – and hence no gesture. For the remaining figures there is a clear distinction between the gestures exhibited by 17 single male figures (including the small group of individual cut-outs) and the combined gestures of five male-female pairs.

The representation and variation of gestures depicted by the Uppåkra figure foils is more limited, but otherwise fall within the range of those from Sorte Muld (Watt forthcoming). The gestures of single male figures (without attributes) from Uppåkra are represented by five main configurations:

1. Both arms/hands are hanging straight down along the sides of the body (Figs. 10d, 11, 12a–b, cf. Fig 13).

While the Uppåkra figures show several variations on this gesture, depending on the position of the thumb, the majority of figures exhibiting this main gesture type from Sorte Muld, are depicted with out-turned thumbs and hence the palms of the hands facing forwards (e.g. Fig. 13c). Two figure foils from

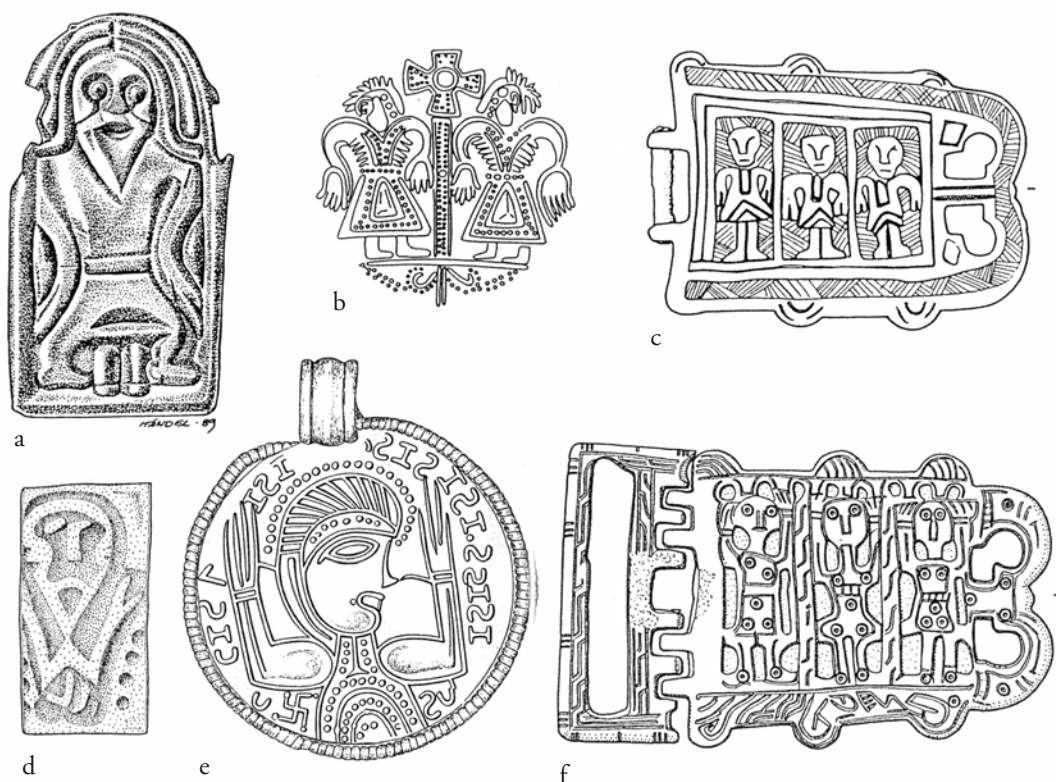

Fig. 33. Examples from the 5th–7th centuries of the gesture of adoration or divine epiphany. a: gold foil from Bolmsö, Småland, Sweden (after Lamm in press), b: fibula from Kirchheim Ries Gr. 208, Germany (after Klein-Pfeiffer 1993); c: belt buckle from Marlens, Switzerland (after Leuch-Bartels 1996); d: gold foil Sorte Muld 349 (drawn by E. Koch); e: bracteate from Skåne (after Axboe *et al.* IK no 326); f: belt buckle from Lutry, Switzerland (after Leuch-Bartels 1996). Different scales.

Bolmsö, Småland depict the same gesture (Fig. 33a). Outside Scandinavia this gesture is depicted on fibulae and belt buckles from the Merovingian and Burgundian areas, but there they belong in a Christian burial context (Figs. 33b–c). Based partly on examples like these, the gesture is believed to be a variation on the widespread gesture where both hands are raised, palms facing forward (Figs. 33d–f). The raised hands occur only on one small, highly stylised figure foil (several die-identical copies) from Sorte Muld (Fig. 33d) and – in a very similar configuration – on a bracteate from Skåne (Fig. 33e). In continental Europe this gesture is depicted on a wide range of objects, again in a Christian context (Fig. 33f).

In a paper discussing Adam of Bremen’s description of the idols in the “temple” at Gamla Uppsala in relation to the bracteates and gold foils, Hauck stresses that the interpretation of this gesture depends on whether the motif (based on other criteria) is deciphered as a divine epiphany or a gesture of adoration shown by a non-divine worshipper (Hauck 1993:456).

2. Both hands are placed on the belly.
This gesture also exhibits some variation depending on the orientation of the hands and fingers. It is depicted on five figures from Uppåkra, representing four different dies (Figs. 12c–d, 14a–d). The two figures

12c and 12d with enlarged hands and clearly inward-turned thumbs are strikingly matched in a recent find of small naked figurines from Lunda in Södermanland (Andersson *et al.* 2003:Figs. 1–2). While the Uppåkra figures are clad in respectable knee-length tunics, the Lunda figurines are conspicuously naked, apart from two of the figures wearing a belt round the waist.

The foils fig. 14 are believed to show the same gesture, but in a highly stylised form. Variations on the gesture are exhibited by some assumed male figures from Sorte Muld, including several which are cut out and drawn individually (Figs. 34a–b). So far no obvious parallels to this gesture have been found outside Scandinavia.

3. One hand under the chin, the other on the chest.

This gesture is exhibited by a group of 6 die-identical, apparently naked figures (Fig. 15) and on a fragment with a direct die-link to Bornholm (Figs. 16b–c).

The gesture may be related to that exhibited by a group of mostly naked figures with one hand raised in front of the face (Figs. 18 and 34c, see below: gesture 4), and possibly also to a number of other figures, where both hands are placed in different configurations in front of the body (e.g. Fig. 37; Watt forthcoming).

A variation on this gesture is shown by three stylistically similar die-identical gold foils assumed to have been found at Ravlunda in eastern Skåne (Fig. 16a) (Lamm 2004:78 and 97 p).

4. One arm raised in front of the body, the other reaching forward with the hand below the elbow of the raised arm.

This gesture is depicted on three die-identical figures from Uppåkra (Figs. 18a–c). De-

spite the fact that the hand of the raised arm is missing or stunted, the gesture is judged to be the same as that shown by the closely related figure Sorte Muld 280 where the fingers are shown pointing upwards (Fig. 18d).

This gesture is just one among a number of variations, and although the interpretation of these gestures is complex, it seems most likely that the hand raised in front of the face was originally inspired by the imperial saluting gesture, as seen on Late Roman coin portraits as well as on medaillons and gold bracteates (e.g. Fig. 34c) (Axboe & Kromann 1992:Fig. 7; Hauck 1992c:265 pp; Watt forthcoming).

5. One hand is raised in front of the face, thumb in mouth, the other holding a short staff.

This gesture, sometimes referred to as “The seer’s thumb”, is represented at Uppåkra by two different, but interdependent dies (Fig. 17). Fig. 17a–b, is die-identical with Sorte Muld die 281, while the coarser edition, figs. 17d–e, is unique to Uppåkra.

Although these figures are the only examples of this gesture among the Scandinavian gold-foil figures, the gesture appears in different contexts throughout the Germanic as well as the Celtic area from the Migration Period through to the Middle Ages.

The gesture is encountered as early as the 5th century in different parts of the Germanic area (e.g. Figs. 34e–h). In an article from 1986 Haseloff includes several examples of thumb-in-mouth figures from objects decorated in Nydam style and Style I, but offers no explanation beyond a general “Es kann keinem Zweifel unterliegen, dass dieser ständig wiederkehrende Gestus eine bestimmte – uns unbekannte – Bedeutung gehabt haben muss” (Haseloff 1986:68).

Hilda Ellis Davidsson was among the first to recognise the gesture as a symbol of second

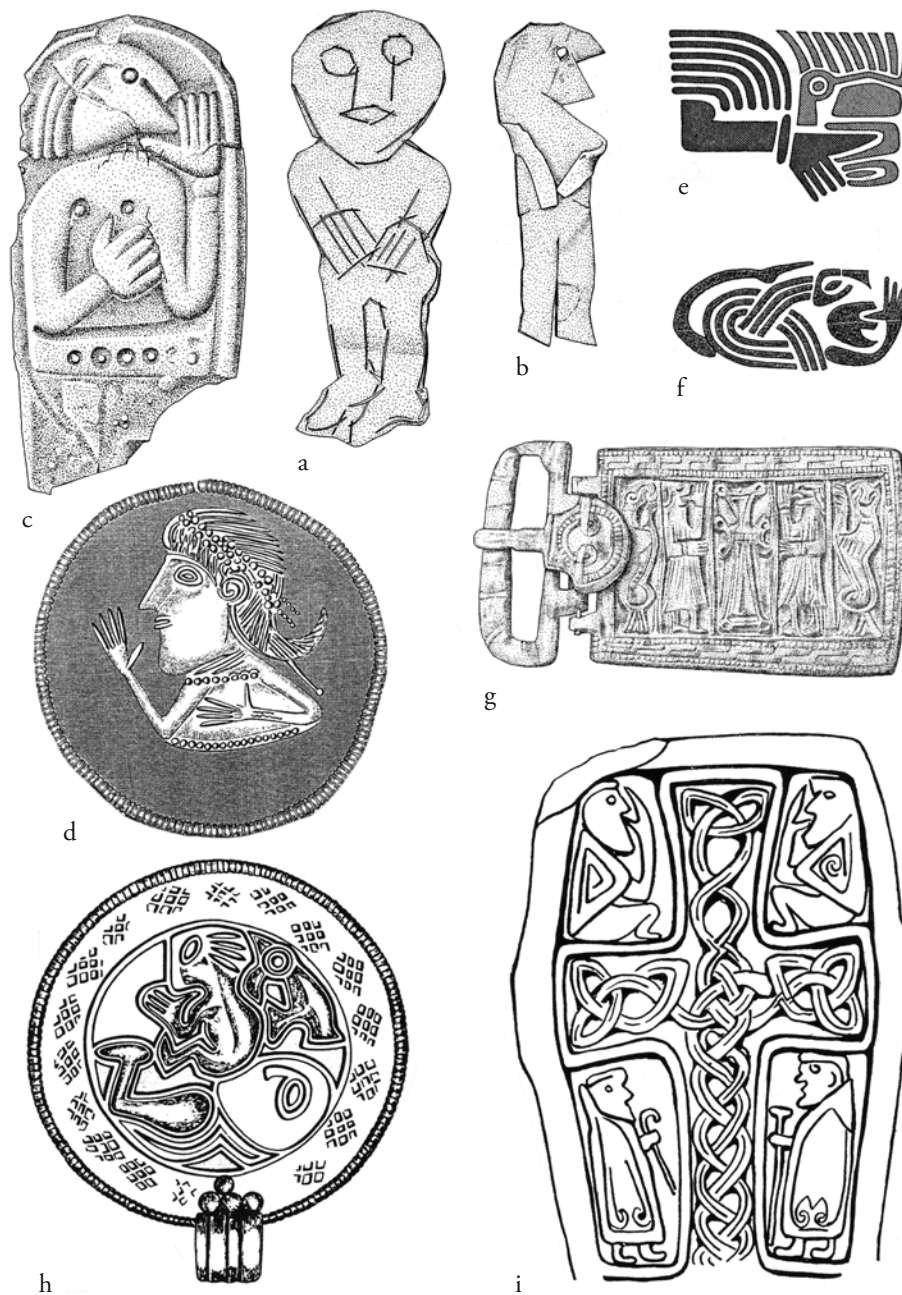

Fig. 34. Gestures exhibited by gold-foil figures and other finds from the 5th–7th centuries. a–c: Gold foil figures from Sorte Muld, Bornholm (drawn by E. Koch). d: Bracteate from Skovlund, Denmark (only the central part is shown) (after Hauck 1992b). e–i show the gesture of “prophecy” or “The seers thumb”; e–f: Details from fibulae from Kirchheim u. Teck, grave 85 and Pompei, Lothringen (after Haseloff 1975, 1981); g: Belt buckle from Echallens-Les Condemines showing a cross flanked by two figures with a ‘prophetic gesture’ (redrawn by the author after Haldimann & Steiner 1996); h: Bracteate from Penzlin, Mecklenburg-Schwerin, Germany (after Axboe *et al.*, IK 338); i: Stone cross from Drumhallach, Ireland (after Henry 1947). Different scales.

sight or prophesy (1989:74). She refers to the myth of Sigurd Fafnirsbani as depicted on a rock carving at Ramsundsberget, Södermanland, as a key to understanding this gesture. The same scene can be seen on several Norwegian church portals including that of Hylestad, carved as late as the beginning of the 13th century, where Sigurd sits under a tree licking his thumb and thereby becomes able to understand the language of the birds.

The seer plays an important role in Celtic Mythology. The Irish legendary figure Finn Mac Cumail is associated with this gesture, as tradition relates that he was able to foresee future events by biting his thumb (Scott 1930).

Hauck has discussed the gesture on several occasions in relation to the Migration Period gold bracteates, and refers to it as a “Ritual des Weisheitsgewinnen” (Hauck 1992b:238, 246, 1992a:470). Besides the bracteate Lelling-B he refers to Penzlin-B (Fig. 34h), which he interprets as Odin (the small figure) sitting beside his dead son Balder. By exhibiting this gesture Odin foresees the return of Balder in a new world order (after Ragnarök) (Hauck 1992a:470 p). Through the association with this scene Hauck identifies the gold foil Sorte Muld 281 – and hence also the new finds from Uppåkra – as the god Odin in a capacity of seer or prophet (Hauck 1992a: 470 pp, 1998:298 pp).

Although the gesture may in its nature be of shamanic origin it was obviously widely adopted also in a Christian context as the symbol of a prophet. In continental Europe it occurs on a 6th century bronze belt buckle from a Christian burial in the Burgundian area (Fig. 34g).

In post-Roman and Ireland the seer played an important role. With the introduction of Christianity the gesture came to symbolize prophets as seen in the company of two bi-

shops on a stone cross from Drumhallagh, County Donegal, Ireland (Fig. 34i).

To modern reasoning it may seem strange to encounter an obviously pagan gesture in a Christian context. There are, however, many examples of mixed pagan and Christian symbolism of which the 8th century Frank's casket is a well known example (Webster 1992). Hence at the time it would probably have seemed equally natural to use a gesture like this to foretell either Ragnarök or the coming of Christ.

The gestures shown by the male-female pairs differ naturally from those of the single figures. As the gold foils from Uppåkra include only 6 male-female pairs (Figs. 28–29), two of which appear die-identical and two are depicted with no arms, the scope for discussion is limited. They do, however, appear to represent three different configurations (below: A–C), one of which holds important clues to the understanding of the whole group of male-female pairs.

A. The smallest pair (Fig. 28a) is rather buckled, but the die can be recognized as belonging to a family with some better-preserved copies found at Toftegården (Sjælland) and Lundeborg (Fyn) (Figs. 29a–b). The gesture shows the woman holding the man's wrist.

A recent attempt at explaining this gesture as a visual rendering of the gestures connected with an official marriage ceremony has been proposed by Rudolf Simek with reference to a 13th century manuscript of *Sachsenspiegel* (Simek 2002:106 p, pl.19). Although the time gap to *Sachsenspiegel* is considerable, the conservatism attached to legal procedures makes this more general interpretation an attractive option. Examining the gestures of all male-female pairs, this particular variation occurs on a number of different figures from Lundeborg, Toftegården and Sorte Muld, all located

within the southern group of gold-foil figures (Watt forthcoming). Other interpretations of this combined gesture have been offered by Hauck (e.g. Hauck 1993:423, 426 pp, 1994: 248) (see also below: conclusions).

B. Both the man and the woman on fig. 28c hold their hands in front of their chest, but do not seem to be physically touching each other. The gesture may be described as a verbal exchange supported by individual gestures. The closest parallel are found within a group of die-identical figures (or die copies) from Slöinge in Halland (e.g. Lundqvist 1996:Fig. 10, bottom row).

C. The gestures of the damaged pairs figs. 28e–f are blurred. Only the position of the man's arm and hand can be determined with certainty. What looks like a V-shaped symbol obliquely above the man's hand on fnr 6512 may be interpreted as the woman's hand. If so, the combined gesture is similar to that of fig. 28c.

Attributes

The range and relative occurrence of attributes shown on the Uppåkra figure foils closely match those associated with the Sorte Muld figures. The scope of this paper does not allow a full discussion of all attributes, but draws attention to some main points, where the Uppåkra figure foils yield important information.

Staff/long-sceptre

Of the single male figures (dies) from Uppåkra eleven or twelve are depicted carrying a staff (Figs. 4, 7–10, 17, 27a–b). In most cases the staff is of “man height”, but the two closely related figures fig. 17 combine a short

staff with the “prophetic” gesture (above).

The staff or sceptre attribute was a familiar symbol used in secular as well as religious ceremonies. Most obvious as a model for the gold foils is the sceptre of imperial or regal power; but also military leaders and high officials could carry a staff of office. The staff held by fig. 10b, consisting of a line of closely spaced circles, suggests that this particular rendering of the staff may be inspired by the military signum depicted on both votive plaques and Late Roman coins like the 4th-century solidus of Constantine the Great from the Danish Brangstrup hoard (Kromann 1989:41, no. 123g; Speidel 1980:Abb. 32; Watt forthcoming).

Hauck has identified the numerous and especially some of the most detailed male figures dressed in a long caftan or similar “regal” garment and carrying a long staff or sceptre with the Æsir-god Donar/Thor (Hauck 1993:420). His argument is based partly on Adam of Bremen's 11th century description of the sceptred image of Thor sitting enthroned alongside Odin and Freyr in the sanctuary at Gamla Uppsala (“Thor cum sceptro Iovem simulare videtur” (Adam of Bremen:Book 4, chapter 26)). To support the identification he draws attention to the parallel in the names of the weekdays between the Roman Jupiter (*dies Iovis*) and the Germanic *Donnerstag* or *Thursday*.

Today we do not associate Thor with a staff, but instead with the hammer and “power belt”. However, bearing in mind that one of the responsibilities of Thor was that of keeping law and order, it does not seem inconceivable to add the judicial staff to his more celebrated attributes. In the post-Roman Germanic area the staff certainly played a part in judicial procedures, echoing a pre-Christian legal tradition (e.g. *Lex Salica*

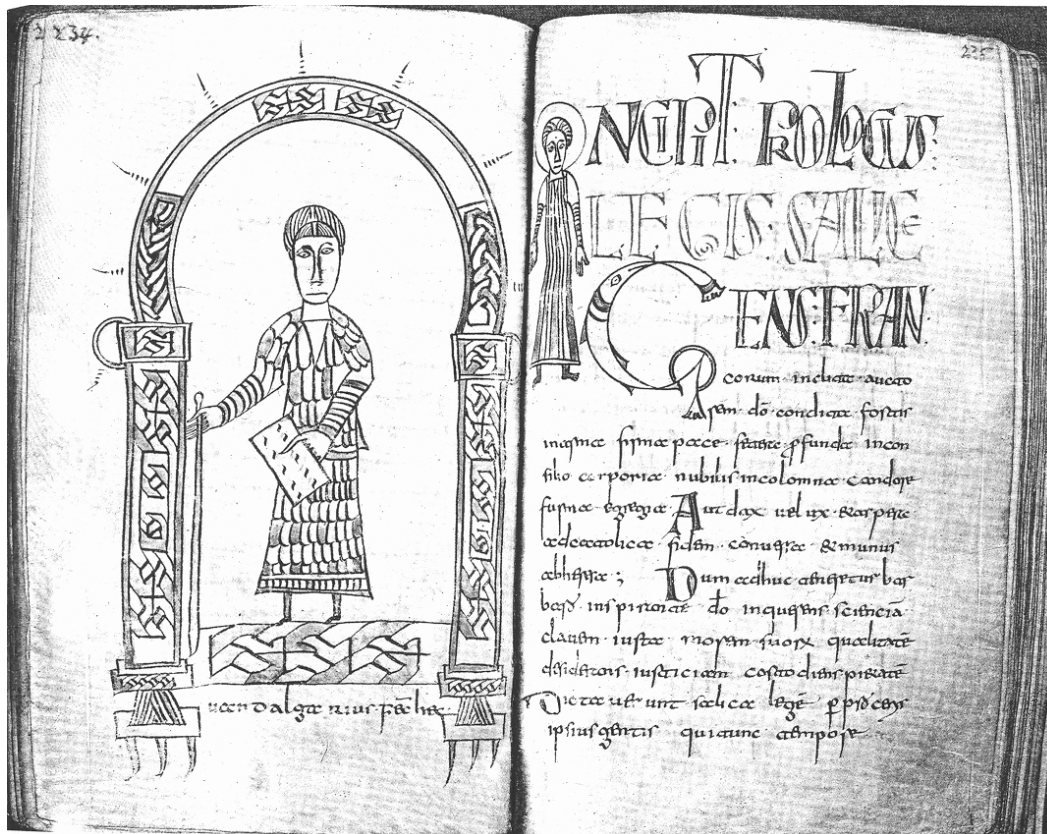

Fig. 35. Portrait of a legislator with his staff of office. From an 8th century copy of a manuscript of *Lex Salica* and *Lex Alamannorum* (after Mordek 1996:Fig. 374).

46; Schmidt-Wiegand 1982:367). The staff is often depicted as a symbol of a legislator or judge in several illuminated law codes (Fig. 35). The staff as an attribute of Thor could have been replaced by the hammer in the time space between the manufacture of the gold foils and the Christian mission in Scandinavia without this being mentioned in later sources. This possible replacement of attributes may be seen as a result of the inevitable tensions following in the wake of the mission, which made it necessary to invent a more appropriate symbol to compete with the Christian cross.

Just how intricate the deciphering of the images on the gold foils can be has already

been illustrated by the apparently naked figures, fig. 17. In addition to the “prophetic” gesture made with the left hand these two figures hold a short staff in their right hand. In several papers Hauck has discussed this key motif and argued for the identification of the short staff as a “wand”, symbolising one of the main functions of the Æsir-god Wodan/Odin, namely that of “seer” or shaman (Hauck 1998:309).

“Club”

The gold foils fig. 5 and the bronze patrices figs. 6 and 36 show a group of male figures which all hold a short club-like object with a



Fig. 36. The bronze patric (b) from Uppåkra and a die-identical gold foil figure from Sorte Muld (die 180) (a) both carry a club-like attribute in addition to a drinking vessel. A similar “club” is depicted on the unique figure Sorte Muld 181 (c). Photo: B. Almgren, LUHM; drawings: E. Koch (4:1).

broad lower end and narrowing towards the top. In its typical form this attribute is almost entirely associated with two distinct families of caftan-clad figures which so far are unique to Bornholm and Uppåkra.

The most obvious equivalent to this attribute is the club of the popular Roman demi-god Hercules. Coins with pictures of Hercules were certainly known in southern Scandinavia (Kromann 1989:6 and no. 104–105). But there are other options. In a discussion of the Sorte Muld gold foils in relation to the early 7th-century silver phalerae from Eschwege, Hessen (Germany) Kurt Böhner points to the fact that the club – like the staff – may be associated with judicial acts (1991:738). Whether or not this will provide sufficient justification for identifying even this group of figures with Thor seems a premature conclusion.

A very different, but less convincing theory has been launched by Hauck, who interprets the club-like attribute on Sorte Muld 181 (Fig.

36c) as a rudder identifying the figure with Freyr as master of his magic ship *Skíðblaðnir*. The brimming goblet beside it is seen as the container in which the magic ship is kept when not used (e.g. Hauck 1994:257 and Fig. 29b).

Sword

The sword is the only weapon depicted on the gold foils. It may be either a single edged “seax” as on the two very similar figures from Uppåkra and Sorte Muld, fig. 3, or a double edged sword carried by a unique “dancing” or “ecstatic” figure Sorte Muld 315 (Watt 1992:Fig. 9b).

Neck ring, collars and beads

The identification of the neck ring as an attribute is straight forward in those cases where it is associated with naked figures or have been added as a secondary feature. There are, however, many more examples, both from Uppåkra and other localities, where a “ring”

around the neck may simply represent the neck band of a dress (Figs. 12d, 23b–c, 28c).

Smooth neck rings are primarily associated with male figures and, in two cases from Uppåkra as well as several from Sorte Muld, are made of narrow gold strips added later to cut-out or embossed figures (Figs. 3a, 14a, 18d).

The broad ribbed collars worn by both the embossed figure represented by the patrix figs. 36a–b and the one scratched on the cut-out figure (Fig. 30b) may both imitate splendid composite gold collars such as Ålleberg, Möne and Färjestaden. The fact that the small figures mounted on the Ålleberg and Möne collars are very similar to some of the stylistically early gold-foil figures, suggests that the two may be connected in some way (Lamm 2004: 130; Watt forthcoming). The deposition dates of the collars are uncertain, but as they all show signs of wear and repair (Lamm 1994: 119, 1998:339), they could well have been in use long enough for ceremonies – secular or religious – to have been witnessed by the manufacturers of the gold-foil figures.

The figure foils figs. 17d–f, the three die-identical pieces from Uppåkra (Figs. 18a–c) and one from Sorte Muld (Fig. 37) all wear what looks like a beaded necklace. Here the rows of beads could represent neck rings like those from Hannenow (Falster), Hjallesø (Fyn) and Köinge (Halland) (Lamm 1991: 155, 1994:120). Again, this may not be the only option.

A recent find of a composite bracteate necklace or pectoral at Sorte Muld raises the question of whether the rows of beads adorning these figures may in fact represent bracteate necklaces. In his presentation of the Sorte Muld pectoral Morten Axboe suggests a deposition date to the beginning of the 6th century (Axboe 2002:299). If the figure foils



Fig. 37. The “bead” necklace worn by the assumed male figure Sorte Muld 347 may be interpreted as a bracteate collier. Drawing: E. Koch (4:1).

from both Uppåkra and Sorte Muld are also products of the 6th century, as argued below, the time gap between the two does not seem insurmountable. The figures with bead necklaces could also back a suggestion put forward by Henrik Thrane that a similar necklace or pectoral found at Gudme II, Fyn, may be the insignia of a high priest (Thrane & Porsmose 1996:168).

Large and heavy gold neck rings and collars as insignia of persons of exalted status or “divine” attributes have a very long tradition. That this did not end with the neck ring symbols on the Merovingian gold foils is illustrated by Medieval crucifixes such as that from Åby showing the partly naked, triumphant Christ with his crown, long hair and an elaborate gold collar (e.g. Roesdahl 1992:cover photograph).

While the neck rings and possible pectorals have so far been perceived as male attributes, some female figures are adorned with what look like one or several strings of beads. Whether in this case they should be

looked on as part of the dress or as attributes has been discussed by several authors. The same question applies to the female figures with oversized fibulae as an attribute of the goddess Freja (e.g. Arrhenius 1962; Hauck 1992a:522 pp).

Belt

The belt is only looked on as an attribute when it is associated with otherwise naked figures (Figs. 12b and 30a–c). The depiction of the belt as a potential attribute is by no means exclusive to the gold-foil figures, but also occurs on a number of bracteates and other objects from the 5th, 6th and 7th centuries.

As an attribute the belt is most often interpreted as the mythical “power belt” belonging to the Æsir-god Thor. Even this attribute has had a long history both as a ritual symbol and as a mark of rank. As early as the 5th century BC the Greek historian Herodotus tells that a claimant to kingship would have to prove his worthiness by “bending the bow and tightening the belt” (Simonenko 1991: 218). In his discussion of the Sutton Hoo regalia Bruce-Mitford mentions that the Celtic *Dux Britanniarum* Gwledig (Cunedden) wore a golden belt as a symbol of his elevated status, and suggests that the belt be included among regalia in Sub-Roman Britain (Bruce-Mitford 1978:350). Like the gold collars even the belt seems to have survived as a “symbol of power” or “regalia” on crucifixes from the Middle Ages (Anders Nyborg, personal communication).

Drinking horn

The gold foils showing a female figure with a drinking horn are – like the similar small Viking Age pendants – commonly referred to as “Valkyrie” figures because of their similarity

to female figures on Gotland picture stones. In a recent paper Simek has rejected this popular concept of the female figures with the argument that it would be unthinkable at the time to depict (or use as jewellery) such “guiding spirits of the dead” (Simek 2002:110). To back his argument he refers to passages in both Norse and continental Germanic literature. He also points to a number of iconographic parallels illustrating the widespread and lasting use of the horn of plenty as a symbol of good fortune and a plentiful harvest (Simek 2002:113). He concludes that the women with a drinking horn are most likely to be images of Dísir, a rather obscure group of minor deities or “venerable female ancestors”, which were revered until some time in the 11th century – at least in Sweden – at the *dísablót* or *disting* (Simek 2002:116). Other scholars view the figures in a purely secular light as women of high social standing (Nielsen 1986; Enright 1988).

Based partly on a unique male-female gold foil from Helgö Hauck has suggested that the horn-carrying females represent the bride of Freyr, Gerd, offering a drink to the bridegroom (Hauck 1993:426, 1994:245 pp). Following this train of thought he interprets the single male figures like figs. 36a–b as the bridegroom (Freyr) holding the drink handed to him by the bride (Hauck 1994: 253). However, the seemingly consistent “transformation” of the drinking horn (as offered by the female figures) into what is clearly a representation of a glass beaker is puzzling. Unfortunately drinking horns are rarely found in graves after the Roman Iron Age, but a few Norwegian Viking Age burials show that drinking horns at that time could be associated with both males and females (Haug 1999). The fact that the men on the gold foils – in contrast to the women – seem

to be depicted in the process of drinking the contents of the brimming beaker must also carry some significance. A possible explanation of this systematic difference could be that the drinking horn functioned as a jug (or pitcher) from which the drink was poured into the smaller and finer glass beakers.

Die-copies and die-families

Manufacture and die-copying of figure foils at Uppåkra has already been touched on in connection with the presentation of the first Uppåkra patrices (Watt 1999a:177). Since then new finds of patrices and experiments with production techniques has contributed to a better understanding of the skills required for making these flimsy gold figures (Lamm 2004:111 pp).

The recognition of die-copies and die-families is based on a combination of observations which, besides details of motif, also include technical and stylistic similarities. The complex of problems connected with die-copying and the die-families of gold-foil figures is in practice very similar to that of the bracteates, which has been studied by Alexandra Pesch, most recently in connection with the bracteates from Uppåkra and Skåne (Pesch 2002).

So far about 40 more or less close-knit families of gold-foil figures have been recognised within the combined Scandinavian material (Watt forthcoming). Many of these families are limited to one locality, but some, including several from Uppåkra, are linked to other southern Scandinavian localities.

Out of a total of at least 58 different dies, 48 occur only at Uppåkra. Nine figure-types (all single), including one of the Uppåkra patrices, are die-identical with figures from Bornholm (Fig. 38). One of the crumpled

double figures (Fig. 28a) can be matched with figures from Toftegården on Sjælland and Lundeborg on Fyn.

Several of the Uppåkra figures are pressed on dies with an unusually high relief almost unknown elsewhere. They also appear to be made of a better than average quality gold foil. Although the high relief figures differ from each other iconographically, it seems fair to assume that they were made within the settlement complex, some of them possibly even by the same highly skilled goldsmith. In his presentation of the gold figure foils from Helgö Jan Peder Lamm suggests that the patrices may have been the personal property of the individual craftsman (Lamm 2004:47; cf. Watt 1999a:188).

Within the series of die-copies or die-dependant figures it seems fair to regard some figure types, like Sorte Muld 180 (Figs. 36a–b), as “primary” or “prototypes” within a sequence of less elegant copies (cf. Watt 1999a:Fig. 6). Fig. 10a could be regarded as a possible prototype for the Sorte Muld die-family to which figs. 10b–c and e also belongs.

Even when it comes to figures made individually it seems possible to recognise the stylistic marks of individual craftsmen (e.g. Figs. 30b–c).

Dating the gold-foil figures

Of all the localities with figure foils relatively few have provided reliable information about find circumstances and time of deposition. The stratigraphic context of the Uppåkra figure foils strongly points to a time of deposition, at least for the majority of figures, within the early part of the Merovingian Age (see above: “The archaeological context”; cf. Larsson & Lenntorp, this volume). This means that Uppåkra has so far provided the

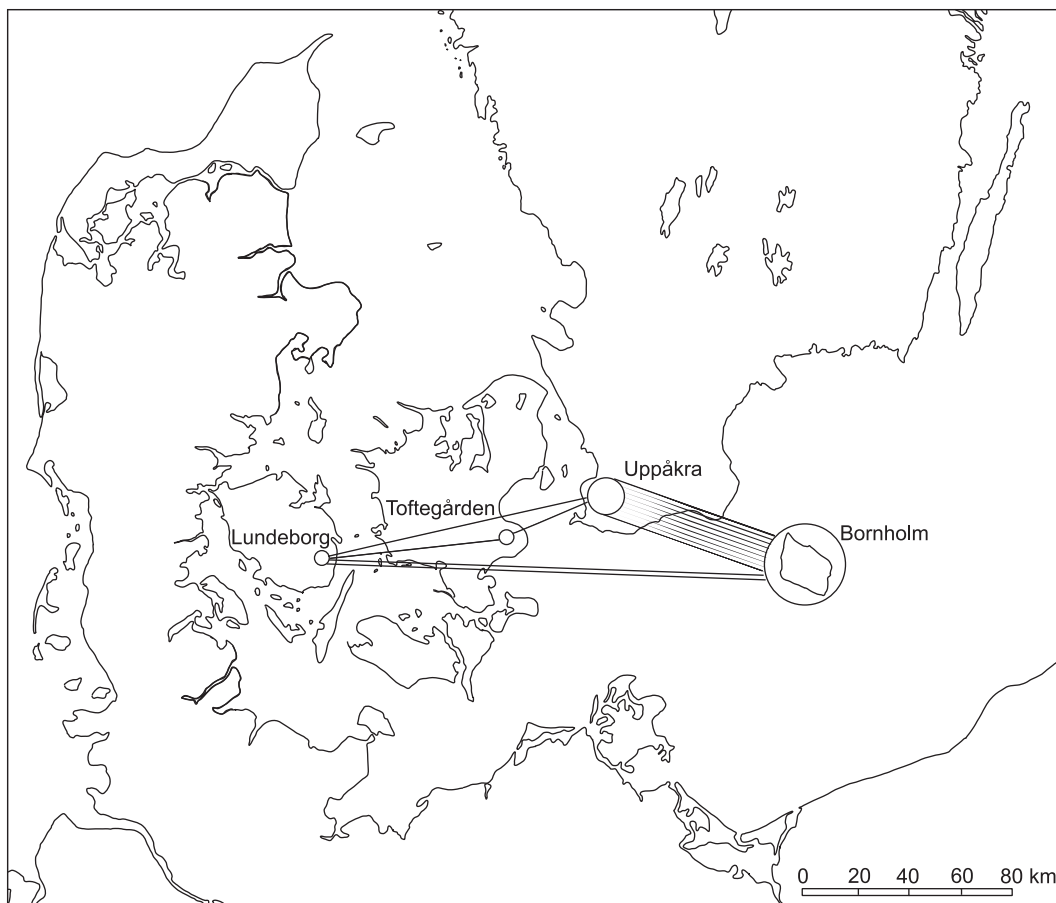

Fig. 38. Uppåkra die-links to Bornholm, Sjælland (Toftegården) and Fyn (Lundeberg).

earliest well documented deposition date for gold figure foils in Scandinavia. The early date agrees well with the find context and date obtained for the Sorte Muld foils (Watt 1991:92 pp). Observations made during the excavations at Sorte Muld in 1986–87 suggest that the extensive cultural layers associated with the gold foils were composed of material redeposited in connection with the collapse or demolition of a nearby building, and that this event took place during the Late Germanic Iron Age (Watt forthcoming).

In contrast to the early dates from Uppåkra and Sorte Muld, the figure foils from Slöinge in Halland appear (based on den-

drochronological evidence) to have been deposited as late as AD 720 or shortly after (Lundqvist 2003:45 pp). Lamm refers to the late date for the Slöinge figure foils to tentatively suggest an early 8th century date for the stylistically similar foils from Helgö (Lamm 2004:123). Early Viking Age dates have also been suggested for some of the Norwegian finds (e.g. Borg on Lofoten (Munch 1991: 329 pp)).

Attempts at identifying fibula types on some of the female figures are potentially important for the dating of the figures. However, the mere size of some of the figures calls for caution. The fibula depicted on fig. 19a is a

good example (bow fibula or disc-on-bow type?). Other renderings of disc-on-bow fibulae, such as those depicted on figures from Gudme and Helgö:1101, are more convincing (Mannering 1997:Fig. 145; Lamm 2004:83). Disc brooches of various types and sizes were common on the continent from the Late Roman Iron Age well into the high Middle Ages and were worn in the same manner holding the dress or cloak together at the front. In Scandinavia the disc brooch is rarely encountered before the 6th century, while the rectangular brooch, which does not appear in Scandinavia until the 7th century, is depicted on just one Norwegian figure from Mære (Lidén 1969:Fig. 12). Certain male figures from the Norwegian find from Hauge (Klepp) wear a cloak held together on the shoulder with a circular or pennanular brooch, a type which did not become widely used until the Viking Age (Gustafson 1900). These examples show that the evidence provided by the fibulae allows for a considerable time span.

The general similarity of female gold-foil figures to the so-called “Valkyrie” figures have from early on influenced the dating of the gold-foil figures, dragging them towards the Viking Age (Gustafson 1900:94). However, stylistic similarities between some Norwegian figure foils, traditionally dated to the Viking Age, and certain male-female pairs from Lundeborg with a considerably earlier date underline the need to look critically at the chronological framework for the iconographically and stylistically different groups of gold figure foils (Thomsen 1993:88; Watt forthcoming).

This review of some main points affecting the dating framework indicates that the gold-foil figures from both Uppåkra and Bornholm form the core of a south-eastern Scandinavian group of mainly single figures

which were made and used in the 6th century. Despite the fact that some figure foils may have been used, and certainly ended up in an Early Viking Age context in different parts of Scandinavia, the exact time span of individual figure types and die-families and the time of their manufacture is still open to discussion.

Conclusions

Many iconological as well as technical details have shown that the gold figure foils from Uppåkra are closely related to their Bornholm counterparts. They also suggest that Skåne may have had its own tradition in the production of figure foils. The few surviving gold foils attributed to Ravlunda, a patrix from Järrestad and two bronze figure foils from Vä and Gårdlösa contribute to this impression (Stjernquist 1993:27 and Fig. 5; Söderberg 2003:Fig. 13; Lamm 2004).

With an estimated total weight of 10–20 grammes of gold the 122 figure foils from Uppåkra do not represent a valuable “treasure”. While the modest value may reflect a general shortage of gold, which seems to characterize the Merovingian Period throughout Scandinavia, it is the symbolic value of the figures as potential offerings which are considered to be of greater importance. The interpretation of gold-foil figures as “temple money” (Watt 1992) is supported by the character of the building at Uppåkra with which they are associated.

One of many questions which arise in connection with the interpretation of the gold-foil figures, is the possibility of identifying named gods or persons. Magnus Olsen was the first to propose the generally accepted interpretation of the male-female pairs as Freyr and Gerd, based on the Norwegian find

from Hauge a few years earlier (Gustafson 1900; Olsen 1909). Olsen regarded the figure foils as symbols of fertility, an interpretation which has prevailed – at least in popular accounts – for nearly a century. The fertility aspect has since been played down by Gro Steinsland in favour of an ideology of kingship based on hierogamy between the Vanir-god and a woman descended from giants (Steinsland 1990). The recent finds of large numbers of single figures from both Sorte Muld and Uppåkra are forcing scholars from different disciplines to rethink their theories.

Hauck's many years of meticulous research into the iconology of the gold bracteates illustrates just how daunting a task this can be (e.g. Hauck 1986). Where the bracteates in many details resemble their late antique prototypes, the task of understanding the minute and often stereotyped gold foils from the Merovingian Age seems to pose an even greater challenge. Some groups of bracteates depict complicated, but – in some cases – “recognisable” scenes combining “humans” (or “gods”) and animals with a variety of symbols, and in some cases even semi-intelligible runic inscriptions.

A comparison of shared elements like specific gestures, posture or attributes has led Hauck to suggest that one of the key figures, figs. 17a–c, represents Odin in his capacity as seer (Hauck 1992b:470 pp, 1998:298 pp).

In articles from 1992 and 1993 dealing with the organised cult Hauck has pointed to the fact that the Æsir-god Thor is difficult to substantiate in the iconographic material. However, based on Adam of Bremen's description of the idols in the temple of Gamla Uppsala he suggested that at least some of the male figures from Sorte Muld with a staff-attribute may reflect a Thor cult (Hauck 1992a: 581, 1993:417 pp). Hauck is well aware of the considerable time span to the gold foils

of 400–500 years, but underlines, that while Adam of Bremen's knowledge was the product of his academic learning, the gold foils reflect a direct “heidnischen Priestertradition”.

If the identification of these popular deities is accepted also for the Uppåkra gold foils, it lends credibility to the interpretation of the unique building, with which they are associated, as a shrine of a polytheistic cult centred round the gods Thor, Odin and probably also Frey (the latter is not discussed in detail, but is possibly represented by the few male-female pairs and the at least two phallic figures (Figs. 30g and 31b). Exactly how and why the Uppåkra gold foils came to be deposited in the fill during the erection of the multi-phase building containing other spectacular finds, seems open for further discussion (Hauck 2002; Larsson & Lenntorp, this volume).

Did Uppåkra once enjoy a similar status in the cult site hierarchy as did the celebrated temple at Uppsala described several hundred years later. If so, when did it cease to exist as a central cult site?

Acknowledgements

I wish to thank professor Lars Larsson and the staff of the Uppåkra Project for giving me the opportunity to study and publish the figure foils from Uppåkra. My thanks also go to Karl-Magnus Lenntorp and Birgitta Piltz Williams for information relating to the find context of the figure foils from the excavations 2001–2003.

I am grateful to Jan Peder Lamm, Stockholm, who has kindly let me study a proof copy of his manuscript with a review of other Swedish finds of gold-foil figures (Lamm 2004).

The dresses displayed by the Scandinavian gold-foil figures are currently being studied by Ulla Mannering as part of a Ph.D. project at the University of Copenhagen.

References

- Adam af Bremen. *Beskrivelse af øerne i Norden*. Oversat og kommenteret af Allan A. Lund. Wormianum. Højbjerg 1978.
- Andersson, G., Jörpeland, L. B. & Dunér, J. 2003. Gudarnas gård. Tre fallosfiguriner från Lunda i Strängnäs socken, Södermanland. *Fornvännen* 98, 124–126.
- Arrhenius, B. 1962. Det flammande smycket. *Fornvännen* 57, 79–101.
- Axboe, M. 2002. Sølvkræmmerhuset og Balders død. Pind, J. et al. (eds.), *Drik – og du vil leve skønt. Festskrift til Ulla Lund Hansen på 60-årsdagen 18. august 2002*, 295–303 Publications from The National Museum Studies in Archaeology and History, Vol. 7.
- Axboe, M. et al. IK: Axboe, M., Düwel, K. Hauck, K. & Padberg, L. von 1985–1989. *Die Goldbrakteaten der Völkerwanderungszeit. Ikonographischer Katalog (IK)*. Münstersche Mittelalter-Schriften.
- Axboe, M. & Kromann, A. 1992. *DN ODINN P F AUC?* Germanic “Imperial Portraits” on Scandinavian Gold Bracteates. *Acta Hyperborea* 4, 271–305.
- Böhner, K. 1991. Die frühmittelalterlichen Silberphaleren von Eschwege (Hessen) und die nordischen Pressblechbilder. *Jahrbuch des Römisch-Germanischen Zentralmuseums Mainz*. 38. Jahrgang, 681–743.
- Bruce-Mitford, R.L.S. 1978. *The Sutton Hoo ship burial II. Arms, Armour and Regalia*. London.
- Davidsson, H. E. 1989. The Seers Thumb. Davidsson, H. E. (ed.), *The Seer in Celtic and other Traditions*, 66–78. Edinburgh.
- Davidsson, H. E. 1993. *The Lost Beliefs of Northern Europe*. London & New York.
- Enright, M. J. 1988. Lady with a mead-cup. Ritual, group cohesion and hierarchy in the Germanic warband. *Frühmittelalterliche Studien* 22, 170–203.
- Gregory of Tours. *The History of the Franks*. Translated by L. Thorpe. London 1974.
- Gullmann, J. 2004. The gold of the figural foils. Lamm 2004, 114–117.
- Gustafson, G. 1900. Et fund af figurerede gulplader. *Foreningen til norske fornminnesmærkers bevaring. Aarsberetning for 1899*, 86–95. Kristiania.
- Haldimann, M.-A. & Steiner, L. 1996. Les céramiques funéraires du haut Moyen Age en terre vaudoise. *Jahrbuch der Schweizerischen Gesellschaft für Ur- und Frühgeschichte* 79, 143–193.
- Haseloff, G. 1975. Zu den Goldblattkreuzen aus dem Raum nördlich der Alpen. Hübener, W. (ed.), *Die Goldblattkreuze des frühen Mittelalters*, 37–70. Baden.
- 1981. *Die germanische Tierornamentik der Völkerwanderungszeit. Studien zu Salin's Stil I*. Vorgeschichtliche Forschungen 17.
- 1986. Bild und Motiv in Nydam-Stil und Stil I. Roth, H. (ed.), *Zum Problem der Deutung frühmittelalterlicher Bildinhalte*, 67–102. Sigmaringen.
- Hauck, K. 1986. Methodenfragen der Brakteatendeutung. Erprobung eines Interpretationsmusters für die Bildzeugnisse aus einer oralen Kultur. Roth, H. (ed.), *Zum Problem der Deutung frühmittelalterlicher Bildinhalte*, 273–296. Sigmaringen.
- 1992a. Frühmittelalterliche Bildüberlieferung und der organisierte Kult. Hauck, K. (ed.), *Der historische Horizont der Götterbild-Amulette aus der Übergangsepoche von der Spätantike zum frühen Mittelalter*. Abhandlungen der Akademie der Wissenschaften in Göttingen, Philologisch-Historische Klasse. Dritte Folge Nr. 200, 433–574.
- 1992b. Der religions- und sozialgeschichtliche Quellenwert der völkerwanderungszeitlichen Goldbrakteaten. *Germanische Religionsgeschichte. Ergänzungsband zum Reallexikon der Germanischen Altertumskunde*, Bd.5, 229–269. Berlin & New York.
- 1993. Die bremische Überlieferung zur Götter-Dreiheit Altuppsalas und die bornholmische Goldfolien aus Sorte Muld. *Frühmittelalterliche Studien*, 409–79.
- 1994. Altuppsalas Polytheismus exemplarisch erhellt mit Bildzeugnissen des 5.-7. Jahrhunderts. *Studien zum Altgermanischen. Festschrift für Heinrich Bech*, 197–302. Berlin & New York.
- 1998. Zur religionsgeschichtlichen Auswertung von Bildchiffren und Runen der völkerwanderungszeitlichen Goldbrakteaten. Düwel,

- K. (ed.), *Runeninschriften als Quellen interdisziplinärer Forschung*, 298–353. Berlin & New York.
- 2002. Neues aus Uppåkra bei Lund, Südschweden. Zur Ikonographie der Goldbrakteaten, LXIV. Hårdh, B. & Larsson, L. (eds.), *Central Places in the Migration and the Merovingian Periods*, 79–95. Uppåkrastudier 6. Acta Archaeologica Lundensia, Series in 8°, No. 39.
- Haug, A. 1999. Drikkehorn i kvinnegrav. *SPOR, Nytt fra fortiden* 1999:2, 30–32.
- Helgesson, this volume. Helgesson, B. Tribute to be spoken of. Sacrifice and Warriors at Uppåkra
- Henry, F. 1947. *Irish Art in the Early Christian Period*. London.
- Hårdh, B. 2002. Uppåkra in the Migration and Merovingian Periods. Hårdh, B. & Larsson, L. (eds.), *Central Places in the Migration and the Merovingian Periods*, 41–54. Uppåkrastudier 6. Acta Archaeologica Lundensia, Ser. in 8°, No. 39.
- 2003. The Contacts of the Central Place. Larsson, L. & Hårdh, B. (eds), *Centrality – Regionality*, 27–66. Uppåkra Studier 7. Acta Archaeologica Lundensia, Ser. in 8°, No. 40.
- Hårdh, this volume. Hårdh, B. The Metal Beaker with Embossed Foil Bands.
- Hägg, I. 1985. *Die Textilfunde aus dem Hafen von Haithabu. Berichte über die Ausgrabungen in Haithabu* 20. Neumünster.
- 2000. Kleidung. Wikingerzeit. *Reallexikon der germanischen Altertumskunde* 16, 617–625.
- Klein-Pfeiffer, M. 1993 Merowingerzeitliche Fibeln und Anhänger aus Pressblech. *Marburger Studien zur Vor- und Frühgeschichte* 14.
- Kromann, A. 1989. *Romersk guld. Mønter i Den kgl. Mønt- og Medaillesamling*. København (Nationalmuseet).
- Lamm, J. P. 1991. Zur Taxonomie der schwedischen Goldhalskragen der Völkerwanderungszeit. *Fornvännen* 86, 153–167.
- 1994. Goldhalskragarna. Knape, A. (ed.), *Guldets magi i saga och verklighet*, 37–51. Statens Historiska Museum. Stockholm.
- 1998. Goldhalskragen. *Reallexikon der Germanischen Altertumskunde* 12: 335–43.
- 2004: Figural gold foils found in Sweden: a study based on the discoveries from Helgö.
- Clarke, H. & Lamm, K. (eds.), *Excavations at Helgö XVI*, 41–142. Stockholm.
- Larsson, L. 2002. Uppåkra – Research on a Central Place. Recent Excavations and Results. Hårdh, B. & Larsson, L. (eds.), *Central Places in the Migration and the Merovingian Periods*, 19–30. Uppåkrastudier 6. Acta Archaeologica Lundensia, Ser. in 8°, No. 39.
- Larsson & Lenntorp, this volume. Larsson, L. & Lenntorp, K.-M. The Enigmatic House.
- Larsson, L. & Hårdh, B. 1998. Uppåkra – ein eisenzeitlicher Zentralplatz in Südschweden. *Frühmittelalterliche Studien* 32, 57–71.
- Leuch-Bartels, K. 1996. Untersuchungen zur sechs Typen frühmittelalterlicher D-Schnallen. *Jahrbuch der Schweizerischen Gesellschaft für Ur- und Frühgeschichte* 79, 119–142.
- Lex Salica. The Laws of the Salian Franks*. Translated and with an introduction by Katherine Fischer Drew, 1991. University of Pennsylvania, Pennsylvania.
- Lidén, H.-E. 1969. From Pagan Sanctuary to Christian Church. The excavation of Mære Church in Trøndelag. *Norwegian Archaeological Review*, 3, 3–22. Oslo.
- Lundqvist, L. 1996. Slöinge – en stormansgård från järnåldern. Lundqvist *et al.* *Slöinge och Borg. Stormansgårdar i öst och vest*, 9–52. Riksantikvarieämbetet. Arkeologiska undersökningar. Skrifter nr. 18. Stockholm.
- 2003. *Slöinge 1992–96. Undersökningar av en boplats från yngre järnålder*. Slöingeprojektet 2. Gotarc Serie C. Arkeologiska Skrifter No 42. Göteborg.
- Mackeprang, M. B. 1943. Om de såkaldte “guld-gubber”. *Fra Nationalmuseets Arbejdsmark* 1943, 69–76.
- Mannering, U. 1997. The textiles from Nørre Sandegård Vest. Jørgensen, L. & Jørgensen, A. N. *Nørre Sandegård Vest. A Cemetery from the 6th–8th Centuries*. Nordiske Fortidsminder Ser. B, Vol. 14, 118–140. København.
- 1999. Sidste krig. *Skalk* 1999:4, 20–27.
- Melle, I. a 1725. *Commentatiuncula de simulacris aureis, quae in Boringholmia Maris Balthici insula, agris eruuntur, Lübeck*. (Translated into Danish in: Thykier *et al.* *Jacob von Melle og de bornholmske Guldgubber. Commentatiuncula de*

- simulacris aureis, quae in Boringholmia Maris Balthici insula, agris eruuntur, Lübeck 1725.* Gengivet i faksimile med dansk oversættelse ved lektor Else Thykier. Jubilæumsskrift 125 år). Rønne 1997.
- Menghin, W. 1985. *Die Langobarden. Archäologie und Geschichte.* Stuttgart.
- Mordek, H. 1996. Leges und Kapitularien. *Die Franken – Wegbereiter Europas*, 488–498. Bd.I. Mainz.
- Munch, G. S. 1991. Hus og hall. En høvdinggård på Borg i Lofoten. Steinsland, G. et al. (eds.), *Nordisk Hedendom. Et symposium*, 321–333. Odense.
- Munksgaard, E. 1974. *Oldtidsdragter.* København. – 1990. The costumes depicted on the gold sheet figures (guldgubber). Walton, P. & Wild, J.P. (eds.), *Textiles in Northern Archaeology*, 97–199. NESAT 3. London.
- Nielsen, E. K. 1986. Kvinden med Hornet. *Skalk* 1986:6, 1.
- Nockert, M. 1991. *The Högom find and other Migration Period Textiles and costumes in Scandinavia.* Högom Part II. Archaeology and Environment 9. University of Umeå. Riksantikvarieämbetet. Stockholm.
- Nordén, A. 1938. Le problèmes des “Bonshommes en or”. *Acta Archaeologica* 9, 151–63.
- Olsen, M. 1909. Fra gammelnorsk myte og kultur. *Mål og Minne* 1909, 17–36.
- Pesch, A. 2002. Uppåkra im Licht der Formular-Familien der völkerwanderungszeitlichen Goldbrakteaten. Hårdh, B. & Larsson, L. (eds.), *Central Places in the Migration and the Merovingian Periods*, 55–78. Uppåkra Studier 6. Acta Archaeologica Lundensia, Ser. in 8°, No. 39
- Roesdahl, E. (ed.) 1992. *Viking og Hvidekrist. Norden og Europa 800–1200.* København.
- Schmidt-Wiegand, R. 1982. Gebärdensprache im mittelalterlichen Recht. *Frühmittelalterliche Studien* 16, 63–379.
- Scott, R. D. 1930. *The Thumb of Knowledge in the Legends of Finn, Sigurd and Taliesin.* New York.
- Siegmund, F. 1996. Kleidung und Bewaffnung der Männer im östlichen Frankenreich. *Die Franken - Wegbereiter Europas*, 691–706.
- Simek, R. 2002. Goddesses, Mothers, Disir: Iconography and interpretation of the female deity in Scandinavia in the first millennium. Simek, R. & Heizmann, W. (eds.), *Mythological Women. Studies in memory of Lotte Motz (1922–1997)*, 93–123. Studia Mediaevalia Septentrionalia 7. Wien.
- Simonenko, A. V. 1991. Der linkshändige Sarmatenfürst von Porogi und die vornehme Dame aus dem Nogacik-Kurgan. *Gold der Steppe.* Schleswig.
- Sjöborg, N. H. 1791. *Topographia paroeciæ Raflunda et monumentorum quæ circa sunt.* Lund.
- Söderberg, B. 2003. Integrating Power. Some aspects of a magnates farm and presumed central place in Järrestad, South East Scania. Larsson, L. & Hårdh, B. (eds.), *Centrality – Regionality*, 283–310. Uppåkra Studier 7. Acta Archaeologica Lundensia, Ser. in 8°, No. 40.
- Speidel, M. P. 1980. *Jupiter Dolichenus. Der Himmelsgott auf dem Stier.* Kleine Schriften zur Kenntnis der römischen Besetzungsgeschichte Südwestdeutschlands 24. Limesmuseum Aalen.
- Sperling, O. 1700. *De nummorum bracteatorum et cavorum nostræ ac superioris atatis origine.* Lübeck.
- Steinsland, G. 1990. De nordiske gullblekk med parmotiv og norrøn fyrsteideologi. *Collegium Medievale* 3, 73–87.
- Stjernquist, B. 1993. *Gårdlösa. An Iron Age community in its natural and social setting III.* Lund.
- Thomsen, P. O. 1993. Handelspladsen ved Lundeberg. *Lundeberg – en handelsplads fra jernalderen*, 68–101. Skrifter fra Svendborg og Omegns Museum 32. Ringe.
- Thrane, H. & Porsmose, E. 1996. Stormand – præst – konge. Crumlin-Pedersen, O. et al. (eds.), *Atlas over Fyns kyst i jernalder, vikingetid og middelalder*, 166–177. Odense.
- Tornbjerg, S. Å. 1998. Toftegård ved Strøby. Arkæologiske udgravninger 1995–98 af en stormandsbebyggelse. *Køge Museum* 1997, 5–19.
- Vierk, H. 1978. Zur angelsächsischen Frauen-tracht. Ahrens, C. (ed.), *Sachsen und Angelsachsen. Ausstellung des Helms-Museums*

- Hamburgisches Museum für Vor- und Frühgeschichte* 18. November 1978 bis 28. Februar 1979, 245–254. Hamburg.
- Watt, M. 1991. Sorte Muld. Høvdingesæde og kultcentrum fra Bornholms yngre jernalder. Mortensen, P. & Rasmussen, B.M. (eds.), *Fra Stamme til Stat i Danmark 2. Høvdingesamfund og Kongemagt*, 89–106.. Jysk Arkæologisk Selskabs Skrifter XXII:2. Højbjerg.
- 1992. Die Goldblechfiguren (“guldgubber”) aus Sorte Muld, Bornholm. Hauck, K. (ed.), *Der historische Horizont der Götterbild-Amulette aus der Übergangsepoche von der Spätantike zum frühen Mittelalter*, 195–227. Abhandlungen der Akademie der Wissenschaften in Göttingen.
- 1999a. Guldgubber og patricer til guldgubber fra Uppåkra. *Fyndene i Centrum. Keramik, Glas och Metall från Uppåkra*, 177–190. Uppåkra-Studier 2. Acta Archaeologica Lundensia, Ser. in 8°, No. 30.
- 1999b. Gubber. *Reallexikon der Germanischen Altertumskunde* 13, 132–142.
- 1999c. Kings or Gods? Iconographic evidence from Scandinavian Gold Foil Figures. *Anglo-Saxon Studies in Archaeology and History* 10, 173–83.
- 2001. “Gummor” og “grodor”. Om kønsbestemmelse af guldgubber. Magnus, B. *et al.* (eds.), *Vi får tacka Lamm*, 219–228. The Museum of National Antiquities, Stockholm, Studies 10.
- 2003. Guldgubbernes dragter – mode eller herskersymbolik? Kragh Hedeager, A. (ed.), *Dragt og magt*, 28–45. Copenhagen.
- forthcoming. *Sorte Muld, guldgubberne og Ibskerbygden*.
- Webster, L. 1992. The Franks Casket. Webster, L. & Backhouse, J. *The Making of England. Anglo-Saxon Art and Culture AD 600–900*, 101–103. British Museum. London.

Tributes to be Spoken of Sacrifice and Warriors at Uppåkra

Bertil Helgesson

Abstract

This paper deals with the warriors' equipment which has been found close to the cult house in Uppåkra. Such equipment has been found all over the site but there is a striking concentration close to the house. Much of the equipment has been destroyed and deposited in a manner not unlike what has been documented in the famous bog finds, especially well known from Denmark. The finds from Uppåkra were deposited on dry ground and this is a feature which is quite unique. The finds from Uppåkra must be apprehended as offerings. They might further be interpreted as expressions of warfare, an institutionalized religion and a warriors' cult.

Bertil Helgesson, Department of Archaeology and Ancient History, University of Lund, Sandgatan 1, SE-223 50 Lund

Introduction

Finds of warriors' equipment from the Iron Age are best known from weapon graves which have been found in several areas in Northern Europe and from the large bog finds, especially well documented in Denmark. Warriors' equipment includes weapons, pieces of weapons, armour, shields, helmets, spurs, mountings, buckles, and also equipment for horses. The interpretation of these find categories is that they should be seen in connection with political, social and religious life in the Iron Age society. Weapon graves are thought to have been constructed for chieftains or warriors, and mark their social position or their possession of landed wealth (Randsborg 1980; Lund Hansen 1987; Nicklasson 1997; Nørgård Jørgensen 1999). The bog finds are often interpreted

as sacrificed remains of a defeated army or booty (Näsman 1996; Lund Hansen 2003). They are therefore strongly connected with actions of warfare.

Finds of warriors' equipment from settlements are not so common and have rarely been discussed by archaeologists. From Uppåkra large quantities of warriors' equipment has been found by excavations and by surveys with metal detectors. In this paper I will deal with the warriors' equipment that has been found in the immediate vicinity of the cult house, especially the lanceheads and spearheads. The entire corpus of warriors' equipment from the settlement will be dealt with on a later occasion.

In many ways the Uppåkra material represents a new find category and there are many

problems to be dealt with. Two central questions arise. What is the character of the finds of warriors' equipment from Uppåkra and how is it supposed to be interpreted?

Investigations

The Iron Age settlement of Uppåkra has been the object of intensive archaeological investigations since 1996. The site, however, was not unknown to archaeologists before. On several occasions finds have been made and archaeological investigations have been conducted (Stjernquist 1996). The investigations made by Vifot in 1934 have long been classic (Vifot 1936). The archaeological material from the site is large, and many finds indicate that the inhabitants of Uppåkra were involved in actions which are not commonly documented at most settlements (Helgesson 2002).

There have been several investigations and surveys at Uppåkra which have revealed weapons. Already in Vifot's investigations pieces of weapons were found, for example, a piece of a Viking Age sword haft (Vifot 1936:123 p.). For several years an amateur archaeologist did surface surveys on the site and his observations helped us to localize a concentration of lance- and spearheads. His collection contained about ten specimens. The use of metal detectors has been widespread at Uppåkra and many pieces of warriors' equipment have been found by this method (U 31000). The investigations of the cult house (Larsson & Lenntorp, this volume) yielded a large amount of warriors' equipment, most of it in a marked concentration north of the house.

An important source-critical point is that since the concentration of warriors' equipment became known, the search for iron has been more intensive in this particular area than in other parts of the settlement. Normal-

ly iron is discriminated by the metal detector surveys, so there might be other concentrations with warriors' equipment which are still to be detected. Another source-critical point is that it was not possible for the author to examine all the lance- and spearheads, due to conservation work in progress. Some objects are therefore only preliminarily classified.

The warriors' equipment from Uppåkra

The concentration of warriors' equipment
The marked concentration of warriors' equipment was found about 25 metres north of the cult house (Fig. 1 and 2) (Lenntorp & Piltz-Williams 2002). The objects were deposited in a shallow depression covering about 70 square metres. It is not known whether the depression was dug by humans or if it is natural. The objects were deposited in an irregular way, which greatly resembles the manner well known from the Danish bog finds (Fig. 3). The concentration contained about 300 objects and of these lance- and spearheads formed a marked group of 136 examples. There were also shield bosses, shield handles, arrowheads, slingstones, and a great many other iron implements, many whose function cannot be determined. Some special finds, which might come from the concentration, are pieces of skeletons, for instance a human cheek bone.

The lance- and spearheads from the concentration are of several types (Figs. 4 and 5; Tab. 1) (Lenntorp & Piltz-Williams 2002). Almost all of these types are well known from Danish bog finds and the types have been elaborately described and dated by Ilkjær (1990). Some of the lanceheads date from the Late Germanic Iron Age and these are

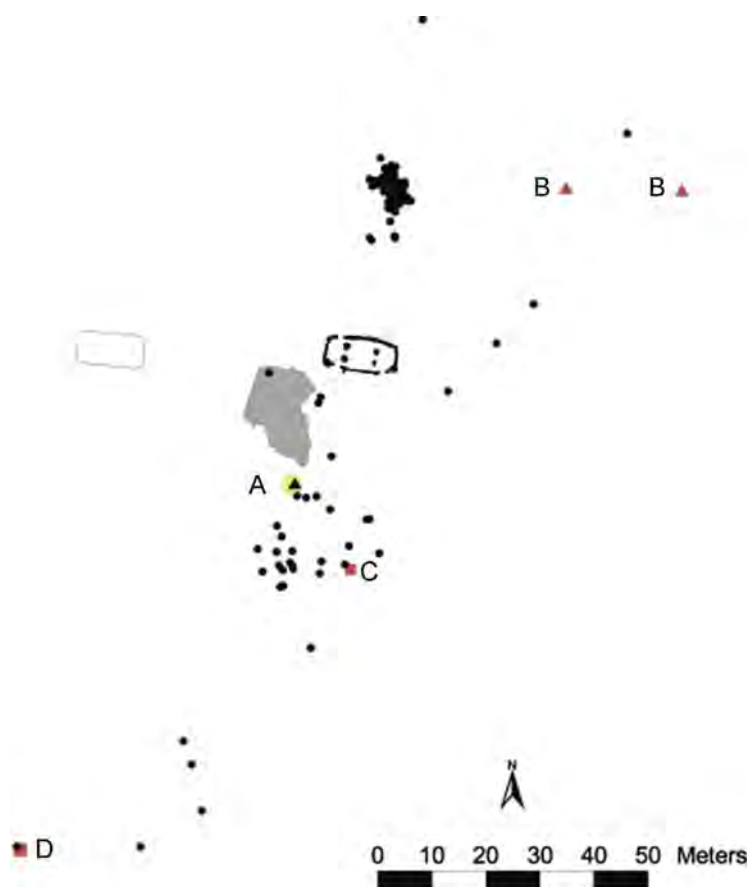

Fig. 1. The spread of lance- and spearheads close to the cult house in Uppåkra. The lance- and spearheads from the surface surveys by the amateur archaeologist are excluded since their exact find spots are unknown.

classified according to Nørgård Jørgensen (1999). It was possible to identify the type of 110 lance- and spearheads, and these are presented in table 1. From the concentration 24 different types of lance- and spearheads are represented. Many types are represented only by one example, while the most numerous types, lance type 11 and spear type 11 (Ilkjær 1990), are represented by 18 and 17 specimens respectively. There is a chronological spread among the lance- and spearheads from B1 of the Roman Iron Age until the beginning of the Late Germanic Iron Age. This means that the concentration represents the time from

soon after the birth of Christ until the mid-sixth century, i.e. a period of about 500 years. The majority of the lance- and spearheads, however, could be dated to the Late Roman Iron Age and the early part of the Early Germanic Iron Age. There is a minor interruption in this chronological sequence since no lance- and spearheads could be dated to the late part of the Early Germanic Iron Age, i.e. a period of about 60–70 years. This might be explained by the fact that the works of Ilkjær and Nørgård Jørgensen do not cover this period, and there is no other work dealing with this sequence. The interruption in time might



Fig. 2. The large concentration of lance- and spearheads north of the cult house in Uppåkra.

therefore be due to the absence of comparative material.

There are several other finds from the concentration (Fig. 6) (Lenntorp & Piltz-Williams 2002). Fragments of ten shield bosses have been found and among these only one could be classified precisely. It belongs to type 8ad according to Ilkjær (1990:35) and can be dated to C2–C3 (*ibid.*:330). There are also four shield handles, classified as type 5dx (Ilkjær 1990:331 pp.). These could be dated to the late C2 or C3. Other pieces of warriors' equipment are arrowheads and slingstones.

From the concentration there are many implements which cannot be apprehended as warriors' equipment (Lenntorp & Piltz-Williams 2002). Most common are rivets and mountings. There are also many pieces whose functions cannot be determined at all.

Some of the iron mountings are large, heavy and often roughly made. They might have been parts of wagons or chests, or other implements with functions which we are unable to determine today. A very special find with unknown function is two iron spirals, applied on a rough nail (Fig. 6).

Many of the implements from the concentration have been handled in a very brutal way (Lenntorp & Piltz-Williams 2002). This is quite obvious with the lance- and spearheads (Fig. 7), the shield bosses, the shield handles and the heavy iron mountings. On many lance- and spearheads the points has been bent and the edges have been battered. The shield bosses and the shield handles are often cut into small pieces. This treatment of the warriors' equipment is well known from the large bog finds (Ilkjær 1990:33).

Warriors' equipment from the vicinity of the cult house

Finds of warriors' equipment have not exclusively been found in the concentration dealt with above (Fig. 1; Tab. I). From the area around the cult house there is a marked concentration of especially lance- and spearheads, compared with other parts of the settlement (Lenntorp & Piltz-Williams 2002:47 p.). These points were normally found rather deep in the occupation layers and cannot have been ploughed out of the large concentration. The excavations uncovered about 25 lance- and spearheads. It is possible that many of these were deliberately deposited since some of them appear in pairs or minor clusters. The points from these minor depositions are all dated late in the period considered here. These small depositions differ in some ways from the large concentration. Almost all of these points are lanceheads and only few are



Fig. 3. A part of the large concentration during excavation. Note the three slingstones.

spearheads. Of these 25 heads five could be dated to the Late Germanic Iron Age, compared with only three from the large deposition. The majority of them, however, could be dated to the Late Roman Iron Age and the early part of the Early Germanic Iron Age. Lance- and spearheads has not only been found by excavations but also by surveys with metal detectors and surface reconnaissances by the amateur archaeologist. About 30 lance- and

spearheads have been found by these methods (U 31000; Welin 2002). These points too date from the Early Roman Iron Age and well into the early part of the Early Germanic Iron Age. These lance- and spearheads shows the same brutal treatment as the weapons from the large concentration.

The detector surveys and the excavations have also revealed another type of warriors' equipment. These are pieces of objects which



Fig. 4. Elder lance- and spearheads from the large concentration. Types: L 4 (length 142 mm; dating B1-B2), S5 (length 218 mm; dating late C1b), L 9 (length 228 mm; dating late C1b-C2) and L 26 Svennum (length 315 mm; dating C1b). After Ilkjær 1990.



Fig. 5. Younger lance- and spearheads from the large concentration. Types: L 11 Mollestad (length 344 mm; dating C3-D1), S 11 Sättra (length 200 mm; dating late C3-D1), L 5 Havor (length 201 mm; dating late C3-D1) and L 1 (length 195 mm; dating 520-570). After Ilkjær 1990 and Nørgård Jørgensen 1999 (L 1).

Tab. I. Lance- and spearheads from the concentration in Uppåkra (U1), and from excavations, metal detector surveys and surface surveys by the amateur archaeologist (U2) in the area close to the cult house. After Ilkjær (1990) and Nørgård Jørgensen * (1999). I=Illerup, V=Vimose, N=Nydam, E=Ejsbøl.

Type	U1	U2	Dating	I	V	N	E
L 20		1	A-B				
L 3	2	2	B1	8	48	14	X
L 4	6	1	B1-B2	14	73	4	
L 6	3	1	B1-C1a	23			
S 25		1	B2-m.C1a				
S 2		2	B2-C1b				
S 8	2	3	M. B2-C1	306	33		
L 8		2	C1b				
L 15	3	2	C1b	316	52		
L 14	1	7	Sl. C1b	111	119	18	
S 5	2	1	Sl. C1b	104	112	1	
L 9	1		Sl. C1b-C2	1		X	
S 5, 6	1	3	Sl. C1b-C2				
S 14	5		Sl. C2			16	7
S 3, 6, 15	1	2	C2-m. C3				
L 29		1	C2-C3				
S 10	8		Sl. C2-b.C3	3		7	75
L 26	4	1	Sl. C2-m.C3				
L 28	2		Sl. C2-m.C3			12	12
S 10, 11	1		Sl. C2-D1				
L 12		1	C3				
S 12	4		C3	3		2	1
S 9	2	1	C3	5		X	X
L 11	18	2	C3-D1	38		30	X
L 5	13	4	Sl. C3-D1	57		45	20
S 11	17		Sl. C3-D1	60		55	3
L 19	10	7	D1	3		X	
S 13	2		D1	1		X	
L 1 *	3	4	520-570				
L3d *		1	560-620				
L 10*		1	740-800				
L 18	1			62	18	1	
L 99	1						



Fig. 6. Various implements from the large concentration. Heavy iron implement with unknown function (width 113 mm), shield boss (width 175 mm), mounting for sword scabbard (?) (length 82 mm) and shield handle (length 155 mm).



Fig. 7. Examples of damaged lance- and spearheads from the large concentration. Types: L 1 (length 500 mm; dating 520-570)(upper left), L 11 Mollestad (length 380 mm; dating C3-D1)(upper right), S 14 (length 505 mm; dating Roman Iron Age)(center) and L 26 Svennum (length 470 mm; dating C1b)(bottom). After Ilkjær 1990 and Nørgård Jørgensen 1999 (L 1).

have an exclusive character. Just south of the cult house a splendid eyebrow arch was found and close to it two mountings shaped like pigs (A on Fig.1 and Fig. 8). These three objects probably belonged to the same helmet. The dating might be an early part of the Late Germanic Iron Age (Larsson, oral communication). About 40 metres north-east of the cult house and 25 metres to the east of the large concentration, two mountings and a lancehead were deposited (B on Fig.1 and Fig. 9). One of the mountings was found earlier by detector surveys and was then thought to have been a part of a reliquary (Helgesson 2001:206). The combination of the three finds makes it more likely that the mountings were parts of warriors' equipment. Perhaps they were once mounted to a sword scabbard. It is most certain that the mountings should be dated to the Germanic Iron Age (Helgesson 2001:207 p.). An iron sword pommel with inlaid gold and silver has also been found from the surroundings of the cult house (C on Fig.1 and Fig. 10). The pommel is of type SP9 (JP G) according to Nørgård Jørgensen and could be dated to 800–830/840 (1999:151). A piece of a sword haft with gold and garnets has also been found in the area (D on Fig.1; Hårdh 2003:63 and Fig. 14). The type is a German "Goldgriffspatha" and could be dated to the Migration period. Another sword pommel which probably comes from the area is of iron with inlaid gold threads. This pommel is of type JP H and could be dated to 800–950 (Strömberg 1961:136 p.). The pommel is unfortunately a stray find.

Just as with the implements from the large concentration, the handling of the equipment differs between the various find categories. Traces of destruction can be seen on most lance- and spearheads, but are not

so common on those dating to the Late Germanic Iron Age. The magnificent warriors' equipment does not show traces of destruction. It is rather dismantled pieces of warriors' equipment that were deposited.

Warriors' equipment during the Iron Age

The manner of depositing implements among the Germanic tribes is documented from the historical sources. From Tacitus we know that the Hermanduri killed men and horses of a defeated enemy, and destroyed their equipment (Grane 2003:145). Likewise, we know through Orosius that the Cimbri also destroyed the equipment of their enemy, and that much of it was sunk in water (ibid.). The large bog finds might very well mirror this custom. In *De Bello Gallico* Julius Caesar tells that many Gallic tribes had consecrated places with heaps of war booty. These places were collective and it was forbidden to keep booty privately (ibid.:146).

The view of the booty sacrifices has varied during the last 150 years or so (Lund Hansen 2003) and the interpretation of them has largely been based on the written sources. It was suggested rather early that the sacrifices were the remains of a beaten enemy, very much in accordance with the account of Orosius. This opinion was adapted already by C. Engelhardt in the mid 19th century (ibid.: 85). This interpretation of the booty sacrifices is still valid today but there are several ideas about how these finds should be apprehended in a larger social context.

An idea is that the booty sacrifices are the remains of raids against southern Scandinavia (Ilkjær 1993:374 pp.; Lund Hansen 2003:87 pp.). Ilkjær has shown that it is possible to



Fig. 8. Eyebrow arch (68 mm) and two mountings shaped like pigs (34 mm). The implements were perhaps applied on the same helmet. Early Late Germanic Iron Age. A on fig. 1.

determine the provenance of personal equipment from some of the booty sacrifices from Illerup, using combs, bosses, equipment for making fire and the location of the sacrificial bogs (*ibid.*). This is a scenario which ascribes people in southern Scandinavia, especially Denmark, a passive role in building society. This is the role of threatened units defending themselves. A contradictory opinion has been expressed by for instance Jørgensen, according to who the booty sacrifices might be apprehended as equipment brought home after a successful military campaign (Jørgensen 2001; Lund Hansen 2003:88). The equipment was brought home to be used in a triumphal procession just as the custom was in the Roman Empire (Lund 2003:166 pp.; Lund Hansen 2003:88). Following this interpretation,

people in southern Scandinavia are given an active role. They might be apprehended as active people, with warfare playing an important role in transforming Germanic society.

Interpreting the Uppåkra depositions – some suggestions

The area around the cult house is characterized by several special features (Larsson & Lenntorp, this volume) and might perhaps be interpreted as a temple area. It is obvious that the find material from this area is strongly characterized by the warriors' equipment. This special area must have played an important role for the warriors and the elite at the settlement, and perhaps for people from



Fig. 9. Two mountings which perhaps were applied on a sword scabbard (length 67 mm). Germanic Iron Age. B on fig. 1.

other areas. The implements must have been destroyed before they were deposited. There might have been rituals when the warriors returned to Uppåkra with the equipment after a successful campaign. There might have been triumphal processions at the settlement and the equipment might have been destroyed. On a special occasion, perhaps depending on social, political or religious circumstances, the objects were finally deposited in the shallow depression. The objects were probably already dead in a mental sense when they were buried north of the cult house.

Few or many depositions?

As mentioned above, the depositions of warriors' equipment around the cult house in Uppåkra might be interpreted as three types of depositions. The first of these is the large deposition north of the house. The similarities to the bog finds have been commented on above, and it is likely that the equipment was

sacrificed. On the other hand, there are some large differences between the Uppåkra deposition and the bog finds. One large difference is that the equipment from Uppåkra was deposited on dry land, which is quite unique. Another difference is that bog finds often consist of depositions which are fairly homogeneous in chronological terms, although there can be several chronologically different offerings in the same bog. The lance- and spearheads from the Uppåkra deposition, on the other hand, represent a time span of about 500 years. The question arises whether the lance- and spearheads were deposited continuously during this long time span or if we are dealing with one major deposition.

Believing in the first interpretation, the older points might have been attacked by rust due to changed conditions when the younger points were buried. They might have been in a worse condition than they actually are, if they survived at all. The fact is that they are very well preserved. On the other hand,



Fig. 10. Sword pommel with inlaid gold and silver (width 63 mm). Early Viking Age. C on fig. 1.

it is perfectly possible to dig just a small hole when offering new equipment and the older points would not have been disturbed at all. This special area of depositions was perhaps carefully managed and the inhabitants of Uppåkra knew very well where all implements were deposited.

Believing in the second interpretation, there must have been a special place where the points were collected for a long time. Where this possible place was situated is of course unknown. It might have been in the cult house or in some other building. There might even have been special features for this purpose which are unknown today. This indicates structures in the Iron Age society not unlike what Julius Caesar describes from Gaul, but also structures quite unlike the customs connected with the offerings in the Scandinavian bogs. There might have been a consecrated place with heaps of booty in Uppåkra.

Perhaps the shallow depression north of the cult house was used for both kinds of depositions here discussed. There were some larger depositions of collected equipment, but the normal manner was small depositions

in the shallow depression. These depositions might not have been unlike the other small depositions around the cult house. This changing manner in offering customs must reflect different ideas and rituals in Iron Age society.

The small depositions

Besides the large concentration there are several minor depositions of warriors' equipment. Most of them have been found spread over a large area inside the suggested temple area mentioned above. There is a cluster of minor depositions just south of the large concentration and there is a cluster some 20 metres south of the cult house (Fig. 1). As mentioned above, it is likely that each of these depositions should be seen as the result of a special event. Perhaps every successful military event resulted in rituals and offerings at the temple area. There might have been processions, rituals for destroying equipment and the depositions, either through offerings in the ground or by placing equipment in consecrated buildings or other features.

The exclusive equipment

The depositions of exclusive warriors' equipment from Uppåkra differ from those mentioned above. The treatment of these objects speaks for another interpretation. The custom of establishing warriors' graves in southern Scandinavia, with the exception of Bornholm (Nørgård Jørgensen 1999), is almost absent from the Late Roman Iron Age until the Viking Age. Perhaps there were other ways to commemorate great warriors and chieftains of significance for the community. The depositions of their dismantled equipment might have been combined with standing features. These minor shrines might have been altars or small buildings, perhaps containing more equipment, epitaphs and bones from the deceased. The finds of skeletal remains in the large concentration might be seen in the light of this.

Contrasts with the bogs

A comparison with the Danish bog finds must be made on the basis of lance- and spearheads, since these are the most frequent in the Uppåkra material. Other find categories which are well known from Denmark are, so far, only found in small quantities. In table 1 the frequency of the lance- and spearheads from Uppåkra is compared with some of the most famous bog finds from Denmark, namely Illerup, Vimose, Nydam and Ejsbøl (Ilkjær 1990). The depositions at Uppåkra start on a small scale contemporaneous with the Danish offerings in the Early Roman Iron Age. Large offerings are laid down in the Danish bogs in the early part of the Late Roman Iron Age, especially in Illerup and Vimose. In Uppåkra offerings are made during this period, but still on a small scale. In the late part of the Late Roman Iron Age and into the

Early Germanic Iron Age there is a shift in the ratio between Uppåkra and the Danish bogs. Vimose is not used anymore. Lance- and spearheads are deposited in Illerup, Nydam and Ejsbøl, but not in the same quantities as in the previous period. At Uppåkra there is a marked peak in the depositions at this time. After the early part of the Early Germanic Iron Age the Danish bogs seemingly are not used any more for booty sacrifices. At Uppåkra lance- and spearheads are still deposited in the area close to the cult house during the Late Germanic Iron Age and well into the Early Viking Age.

The finds from Uppåkra are an important contribution to our understanding of religious life during the Iron Age and this is a subject that has recently been debated (Fabeck 1991, 1999; Hedeager 1999). The main problem might be whether the bogs and other wet milieus were abandoned as sacred places in the Early Germanic Iron Age and were replaced by an institutionalized cult maintained by officials at central settlements. The Uppåkra material surely gives greater nuances to this debate. It is obvious that offerings were made already in the Early Roman Iron Age and that the continuous use of the cult house (Larsson & Lenntorp, this volume) speaks for institutionalized religious actions. Bogs were meanwhile used as offering places in the vicinity of Uppåkra, for instance at Gullåkra, Hassle-Bösarp and Onslunda (Helgesson 2002:257).

Where did they go and where did they come from?

As mentioned above, it has been possible to determine the provenance of some of the depositions in the bogs (Ilkjær 1993). From the early part of the Late Roman Iron Age

(2nd century) and even earlier, continental material is obvious in the bog finds. Later on (early 3rd century) much of the material from Thorsbjerg bog probably comes from north-western Germany. Meanwhile, finds from other bogs come from the areas around Kattegat in the North Sea. In the late Roman times (late 3rd century; early 4th century) much of the equipment has its provenance in the Baltic area (Lund Hansen 2003:88 pp.). The passive interpretation of the bog finds (Ilkjær 1993) assumes that the booty sacrifices are all remains of intruders in southern Scandinavia and that they were all defeated. The opposite is seldom discussed. There must have been successful armies who managed to beat the local defenders in southern Scandinavia and who took their equipment as booty. Some of it might have been destroyed and sacrificed close to the field of battle. This might be the case with the regional material from the bogs in the 2nd century (Lund Hansen 2003:88). Some equipment might have been brought back home by the intruders to be used in rituals and processions elsewhere.

The material from Uppåkra is an important contribution to the discussion about the role played by South Scandinavia during the Iron Age. Bearing in mind the discussion about a passive or active role in warfare, there might have been times when intruders threatened Uppåkra and perhaps also managed to conquer the place. Perhaps some of these battles meant that new leaders came into possession of the place. It is unclear whether this can be seen in the archaeological material. Although the archaeological material from Uppåkra changes through time, it does not indicate any major or dramatic events. Almost all changes can be related to the development of society in southern Scandinavia (Helgesson 2002).

Raids on and conquest of Uppåkra might have happened, but this is contradicted by the fact that the place managed to survive for a period of more than 1000 years. A considerable continuity is also seen in many features on the site, for instance that the cult house and the same temple area were used for 600–700 years. It is logical that there would have been structural changes if the place had been conquered or raided often. Unsuccessful raids on Uppåkra were perhaps more common and much of the enemies equipment from these battles might very well have been deposited inside the temple area.

The opinion that the booty sacrifices may have consisted of equipment which was brought home from military campaigns allows a more nuanced interpretation of the finds from Uppåkra. This was a custom well known in the Roman Empire, which meant that the empire grew bigger and more powerful. This custom might have been copied by the people of Uppåkra, and was an important part of political and religious life at the settlement.

There were perhaps two kinds of military campaigns from Uppåkra with different purposes. Some military expeditions might have had booty as their only purpose. Honour and glory were the motive force behind these campaigns. The victorious army returned home with booty and lots of stories about the battle. The warriors reputation was enhanced but the campaign did not play any important role in building society. The other type of campaign might have had the purpose of expanding the territory, and forcing other leaders to submission or to pay tribute. This was perhaps the most active type of campaign and might have had a great impact on the warriors' own society as well as the political geography of the region. The return home after such an campaign was perhaps the most

glorious, with triumphal processions, rituals and offerings of booty. There must also, of course, have been military expeditions from Uppåkra which were not so successful. Perhaps the Uppåkra armies were beaten and their equipment was offered by their enemies far away from home. These campaigns cannot be seen in the archaeological material from Uppåkra.

Speaking about active and passive roles of the Uppåkra warriors, it might be interesting to speculate as to who their enemies were. As mentioned above, Ilkjær has suggested the intruders' provenance for three phases during the Roman Iron Age (see above). This has not been possible in the case of the Uppåkra booties, since the equipment, especially the lance- and spearheads, is well known from many regions in Scandinavia (cf. Ilkjær 1990). It may be assumed that the enemies were the same as Ilkjær has suggested, even if this cannot be proved. This means large parts of central Sweden, southern Norway and even north-western Germany. It is also possible that warriors from Uppåkra meanwhile raided the Danish isles and Jutland, perhaps in connection with struggles for power in the South Scandinavian territory.

Epilogue

The depositions around the cult house in Uppåkra must be apprehended as sacrifices, but what was the meaning of these? When two armies faced each other, one of them had to leave the field of battle as a loser. Many of the warriors lost their life after the battle when they were killed by the victorious army. If the Uppåkra army was the successful one, some of the booted equipment was brought back to the settlement where it underwent the same treatment as their former owners. The equip-

ment was displayed to the people of Uppåkra in a procession, showering glory on the army leader and the warriors. The equipment was perhaps kept in the cult house for a while before it was destroyed in an act of symbolic killing. Finally the equipment was buried as an sacrifice to the gods. Perhaps this special burial spot was marked in commemoration of this important event for the community.

The area around the cult house is characterized by the many weapon finds. This might be interpreted as showing that this special area was primarily used by the warriors from the site, and perhaps we can speak of a special warriors cult and ideology. On the other hand, there are many other finds from the cult house and its surroundings which cannot be directly connected with the warriors, for example the glass bowl, the silver beaker and the gold-foil figures (Stjernquist, this volume; Hårdh, this volume; Watt, this volume). It is probably more logical to see the warriors cult as an integral part of the religious life of the settlement.

The temple area and the cult house were founded in the Roman Iron Age (Larsson & Lenntorp, this volume). The fact that the house was maintained and rebuilt at the same place for a period of about 600-700 years shows a stability in the cultic life of the site. The house must have become an institution, not only for the inhabitants of Uppåkra but also for people from the hinterland. It is obvious that the development of institutions requires a stable society. Perhaps there was already a tendency in society whereby social, religious and political functions were integrated and concentrated in special places. This high degree of integration might very well mirror the development in continental Europe and on the British Isles (cf. Harrison 1999).

The temple area might also have had another significance. It has been suggested that

the depositions in and around the cult house mirrors events in the history of the society. Damaged weapons speak of glorious warfare and magnificent chieftainly attributes of deceased leaders and warriors. Other features such as altars and shrines might be related to other types of events, unknown today. The temple area is perhaps not only a sacred place, but also a monumental history book of the society. This might be the Scandinavian equivalent of the written history from the continent, well known from Paulus Diaconus and Gregory of Tours (Harrison 1999).

References

- Fabech, C. 1991. Samfundsorganisation, religiøse ceremonier og regional variation. Fabech, C. & Ringved, J. (eds.), *Samfundsorganisation og Regional Variation. Norden i romersk jernalder og folkevandrings-tid. Beretning fra 1. nordiske jernaldersymposium på Sandbjerg Slot 11–15 april 1989. Jysk Arkeologisk Selskabs Skrifter XXVII*. Århus.
- Fabech, C. 1999. Centrality in sites and landscapes. Fabech, C. & Ringved, J. (eds.), *Settlement and Landscape. Proceedings of a conference in Århus, Denmark, May 4–7 1998*. Århus.
- Grane, T. 2003. Romerske kilder til Germaniens geografi og etnografi. Jørgensen, L., Storgaard, B. & Gebauer Thomsen, L. (eds.), *Sejrens Triumf. Norden i skyggen af det romerske Imperium*. Copenhagen.
- Harrison, D. 1999. *Krigarnas och helgonens tid. Västeuropas historia 400–800 e.Kr.* Stockholm.
- Hedeager, L. 1999. Sacred topography. Depositions of wealth in the cultural landscape. Gustafsson, A. & Karlsson, H. (eds.), *Glyfer och arkeologiska rum – en vänbok till Jarl Nordblad*. Gotarc Series A, vol. 3. Göteborg.
- Helgesson, B. 2001. Flera spår av en tidig kristen mission i Uppåkra. Hårdh, B. (eds.), *Uppåkra. Centrum och sammanhang*. Uppåkrastudier 3. Acta Archaeologica Lundensia, Series in 8°, No. 34. Lund.
- Helgesson, B. 2002. *Järnålderns Skåne. Sambälle, centra och regioner*. Uppåkrastudier 5. Acta Archaeologica Lundensia, Series in 8°, No. 38. Lund.
- Hårdh, B. 2003. Uppåkra i folkvandringstiden. Hårdh, B. (ed.), *Fler fynd i centrum. Materialstudier i och kring och Uppåkra*. Uppåkrastudier 9. Acta Archaeologica Lundensia, Series in 8°, No. 45. Lund.
- Hårdh, B. 2004. (this volume)
- Ilkjær, J. 1990. *Illerup Ådal. 1. Die Lanzen und Speere. Textband*. Jutland Archaeological Society Publications XXV:1. Århus.
- Ilkjær, J. 1993. *Illerup Ådal. 3. Die Gürtel. Bestandteile und Zubehör*. Jutland Archaeological Society Publications XXV:3. Århus.
- Jørgensen, L. 2001. The “warriors, soldiers and conscripts” of the anthropology in the Late Roman and Migration Period archaeology. Storgaard, B. (ed.), *Military aspects of the aristocracy in Barbaricum in Roman and Early Migration Periods*. Publications from the National Museum, Studies in Archaeology & History 5. Copenhagen.
- Larsson, L. & Lenntorp, K.-M. 2004. (this volume)
- Lenntorp, K.-M. & Piltz-Williams, B. 2002. *Rapport. Arkeologisk förundersökning. Stora Uppåkra 8:3, Fornlämning 5, Uppåkra socken, Staffanstorps kommun, Skåne län*. Lund.
- Lund, J. 2003. Ve de besejrede! Jørgensen, L., Storgaard, B. & Gebauer Thomsen, L. (eds.), *Sejrens Triumf. Norden i skyggen af det romerske Imperium*. Copenhagen.
- Lund Hansen, U. 1987. Römischer Import im Norden. Warenaustausch zwischen dem Römischen Reich und dem freien Germanien während der Kaiserzeit unter besonderer Berücksichtigung Nordeuropas. *Nordiske Fortidsminder*, Serie B, Bd. 10. Copenhagen.
- Lund Hansen, U. 2003. Väbenofferfundene gennem 150 år – forskning og tolkning. Jørgensen, L., Storgaard, B. & Gebauer Thomsen, L. (eds.), *Sejrens Triumf. Norden i skyggen af det romerske Imperium*. Copenhagen.
- Näsman, U. 1996. Från Region till Rike – Från Stam till Stat. Om danernas etnogenes och om den danska riksbildningen. Krøger J. F. (ed.),

- Rikssamlingen. Hovdingmakt og kongemakt.* Stavanger.
- Nicklasson, P. 1997. *Svärdet ljuger inte. Vapenfynd från äldre järnålder på sveriges fastland.* Acta Archaeologica Lundensia, Series in 8°, No. 22. Stockholm.
- Nørgård Jørgensen, A. 1999. *Waffen und Gräber. Typologische und chronologische Studien zu skandinavischen Waffengräber 520/30 bis 900 n. Chr.* Nordiske Fortidsminder, Serie B, Vol. 17. Copenhagen.
- Randsborg, K. 1980. *The Viking Age of Denmark. The Formation of a State.* London.
- Stjernquist, B. 1996. Uppåkra, a Central Place in Skåne during the Iron Age. *Lund Archaeological Review* 1, 1995. Lund.
- Stjernquist, B. 2003. (this volume)
- Strömberg, M. 1961. *Untersuchungen zur jüngeren Eisenzeit in Schonen. Textband.* Acta Archaeologica Lundensia, Series in 4°, No. 4. Malmö.
- Vifot, B. M. 1936. Järnåldersboplatsen vid Uppåkra. *Meddelanden från Lunds universitets historiska museum* 1936. Lund.
- Watt, M. 2004. (this volume)
- Welin, M. 2002. *Blod eller blot. De döda och begravda spetsarna vittnar om förhistorien.* C/D-uppsats i arkeologi. Institutionen för arkeologi och antikens historia. Lunds universitet.

Oral communication

Prof. Lars Larsson, Department of Archaeology and Ancient History, Lund.

Abbreviations

U 31000-Lund University Historical museum, Inventory No. 31000.