



LUND UNIVERSITY

Energy use in hotels and low-energy schools

Measurements and analysis of energy use and user-related parameters

Simanic, Branko

2020

Document Version:

Publisher's PDF, also known as Version of record

[Link to publication](#)

Citation for published version (APA):

Simanic, B. (2020). *Energy use in hotels and low-energy schools: Measurements and analysis of energy use and user-related parameters*. Lund University, Lund Institute of Technology, Division of Building Services, P.O. Box 118, SE-22100 LUND, Sweden,.

Total number of authors:

1

General rights

Unless other specific re-use rights are stated the following general rights apply:

Copyright and moral rights for the publications made accessible in the public portal are retained by the authors and/or other copyright owners and it is a condition of accessing publications that users recognise and abide by the legal requirements associated with these rights.

- Users may download and print one copy of any publication from the public portal for the purpose of private study or research.
- You may not further distribute the material or use it for any profit-making activity or commercial gain
- You may freely distribute the URL identifying the publication in the public portal

Read more about Creative commons licenses: <https://creativecommons.org/licenses/>

Take down policy

If you believe that this document breaches copyright please contact us providing details, and we will remove access to the work immediately and investigate your claim.

LUND UNIVERSITY

PO Box 117
221 00 Lund
+46 46-222 00 00

Energy use in hotels and low-energy schools

Measurements and analysis of energy use
and user-related parameters

BRANKO SIMANIC

FACULTY OF ENGINEERING | LUND UNIVERSITY



Energy use in hotels and low-energy schools

Measurements and analysis of energy use and
user-related parameters

Branko Simanic



LUND
UNIVERSITY

DOCTORAL DISSERTATION

by due permission of the Faculty of Engineering, Lund University, Sweden.
To be defended at John Ericssons väg 1, the “V-huset” building, lecture hall V:C.
on 16 October 2020, at 1 p.m.

Faculty Opponent

Prof. Per K. Heiselberg, Aalborg University, the Faculty of Engineering and
Science, Department of the Built Environment

Organization LUND UNIVERSITY	Document name: Doctoral thesis	
	Date of issue 2020-09-14	
Author: Branko Simanic		
Title and subtitle Energy use in hotels and low-energy schools Measurements and analysis of energy use and user-related parameters		
<p>Abstract Decreasing CO₂ emissions in the building sector by improving energy efficiency is an essential part of the goal to reduce global CO₂ emissions, as the sector accounted for nearly 40 percent of the energy-related CO₂ emissions in 2017.</p> <p>There are six main parameters that affect a building's energy use. These are outdoor climate, building envelope properties, building services and energy systems, operation and maintenance, user-related activities and indoor climate. The first three parameters can be classified as technical parameters and these have been very well studied in the past. To further improve a building's energy efficiency, more studies should be carried out with regard to the last three parameters, which have not been studied as extensively as the technical parameters. These parameters can be classified as user-related parameters.</p> <p>The overall aim of this thesis is to contribute to achieving global climate goals by improving the energy efficiency of buildings. This has been done by studying both calculated and measured energy use in order to understand which of the parameters have major impacts on energy use and should therefore be taken into consideration. This thesis studies calculated and measured energy use in two types of buildings. It focuses mainly on how user-related parameters affected energy use in five hotels, located in Stockholm and all belonging to the same hotel chain, and seven newly built low-energy schools located in the southern part of Sweden. Data from the hotels was collected over several years and included measurements of energy use and the influence of two user-related parameters. In the schools, data from measurements regarding energy use, indoor air temperature, indoor CO₂ concentration, and several user-related parameters were collected over a one-year period. Descriptive statistics and simulations of the buildings' energy uses were used to analyse the collected data.</p> <p>The hotels in the study showed large differences in total energy use. It was also shown that results from one hotel, with respect to the studied parameters that affected measured energy use, could not be applied to the other, similar, hotels. One way of attaining more detailed information and identifying the energy deviations would be to study a hotel's sub-systems (for space heating/cooling, pool, etc) individually. This would help engineers in their design work and allow more accurate calculations of potential energy savings of any capital investments in the space heating systems, or any other systems.</p> <p>Comparisons between measured and estimated energy use showed that there were large discrepancies in the studied schools. These varied from -44 to +28 percent. The study showed that the user-related parameters had a more dominant influence on the variations of building energy use than the technical parameters. Of the studied parameters, indoor air temperatures, ventilation rates and ventilation operating times were shown to be the user-related parameters having the greatest influence on building energy use. The use of electricity for lighting and electrical appliances had somewhat less influence on the total energy use while occupancy rates and energy use for domestic hot water supplies had little influence in the studied schools. Although only seven low-energy schools were included in the study, it could be seen that the measured user-related parameters could vary considerably. This means that not only more measurements in more schools are needed in the future but also that by only presenting an average value per parameter energy engineers could be misled when calculating energy use. For this reason, this study also presents standard deviations of the studied parameters.</p>		
Key words hotel buildings, low-energy school buildings, measured energy use, measured user-related parameters, long-term measurements, CO ₂ concentration, indoor air temperature		
ISRN LUTVDG/TVIT-20/1003-SE (266)	Language English	
ISSN 1652-6783 Energy use in hotels and low-energy schools	ISBN 978-91-85415-12-0	
Recipient's notes	Number of pages	
	Security classification	

I, the undersigned, being the copyright owner of the abstract of the above-mentioned thesis, hereby grant to all reference sources permission to publish and disseminate the abstract of the above-mentioned thesis.

Signature 

Date 2020-09-14

Energy use in hotels and low-energy schools

Measurements and analysis of energy use and
user-related parameters

Branko Simanic



LUND
UNIVERSITY

Copyright pp 1-87 Branko Simanic

Appended Publication 1 © 2011 KTH, Royal Institute of Technology, Stockholm

Appended Publication 2 © 2018 Springer

Appended Publication 3 © 2019 Elsevier

Appended Publication 4 © 2019 Elsevier

Appended Publication 5 © 2020 MDPI

Faculty of Engineering

Department of Building and Environmental Technology

Division of Building Services

ISBN 978-91-85415-12-0

ISRN LUTVDG/TVIT-20/1003-SE (266)

ISSN 1652-6783

Printed in Sweden, Lund 2020

Preface

This PhD study was carried out at two universities. The first part of the study, the Licentiate Thesis, was researched at the KTH Royal Institute of Technology in Stockholm between 2004 and 2006 and was finally presented in 2011. The second part was carried out at the Faculty of Engineering, LTH, Lund University. Research started in 2017 and was completed in 2020.

The second part of this research was funded by SBUF, the Development Fund of the Swedish Construction Industry, and Skanska Sverige AB. I would like to acknowledge their financial support and the opportunities provided to carry out this study. It would not have been possible without their involvement.

I would like to thank my supervisors Dennis Johansson, Birgitta Nordquist and Hans Bagge at LTH for their supervision, support and patience throughout the study. I would also like to thank all my colleagues at the Building Services and Building Physics Divisions at LTH for all our discussions and time spent together during these years. I am also grateful to my supervisors Ivo Martinac and Björn Palm at KTH as well as to all my colleagues at the Department of Energy Technology at KTH.

I would like to give thanks to my employer Skanska Sverige AB and my supervisors Joakim Jeppsson and Åsa Bolmsvik who made it possible for me to conduct and finish my PhD studies. I am also thankful to my colleagues at Skanska Teknik - Energi for supporting me through all these years.

I would like to thank Scandic for providing access to their hotels and the municipalities of Malmö, Lund, Ängelholm, Stenungsund, Ale, Karlstad and Örebro for providing access to their schools for this study.

Most importantly, I would like to give special thanks to my family – Linda, Timoti and Leona – for their everyday love, patience and support, which made all my work so much easier.

Lund, August 2020
Branko Simanic

Abstract

Decreasing CO₂ emissions in the building sector by improving energy efficiency is an essential part of the goal to reduce global CO₂ emissions, as the sector accounted for nearly 40 percent of the energy-related CO₂ emissions in 2017.

There are six main parameters that affect a building's energy use. These are outdoor climate, building envelope properties, building services and energy systems, operation and maintenance, user-related activities and indoor climate. The first three parameters can be classified as technical parameters and these have been very well studied in the past. To further improve a building's energy efficiency, more studies should be carried out with regard to the last three parameters, which have not been studied as extensively as the technical parameters. These parameters can be classified as user-related parameters.

The overall aim of this thesis is to contribute to achieving global climate goals by improving the energy efficiency of buildings. This has been done by studying both calculated and measured energy use in order to understand which of the parameters have major impacts on energy use and should therefore be taken into consideration.

This thesis studies calculated and measured energy use in two types of buildings. It focuses mainly on how user-related parameters affected energy use in five hotels, located in Stockholm and all belonging to the same hotel chain, and seven newly built low-energy schools located in the southern part of Sweden. Data from the hotels was collected over several years and included measurements of energy use and the influence of two user-related parameters. In the schools, data from measurements regarding energy use, indoor air temperature, indoor CO₂ concentration, and several user-related parameters were collected over a one-year period. Descriptive statistics and simulations of the buildings' energy uses were used to analyse the collected data.

The hotels in the study showed large differences in total energy use. It was also shown that results from one hotel, with respect to the studied parameters that affected measured energy use, could not be applied to the other, similar, hotels. One way of attaining more detailed information and identifying the energy deviations would be to study a hotel's sub-systems (for space heating/cooling, pool, etc) individually. This would help engineers in their design work and allow more

accurate calculations of potential energy savings of any capital investments in the space heating systems, or any other systems.

Comparisons between measured and estimated energy use showed that there were large discrepancies in the studied schools. These varied from -44 to +28 percent. The study showed that the user-related parameters had a more dominant influence on the variations of building energy use than the technical parameters. Of the studied parameters, indoor air temperatures, ventilation rates and ventilation operating times were shown to be the user-related parameters having the greatest influence on building energy use. The use of electricity for lighting and electrical appliances had somewhat less influence on the total energy use while occupancy rates and energy use for domestic hot water supplies had little influence in the studied schools. Although only seven low-energy schools were included in the study, it could be seen that the measured user-related parameters could vary considerably. This means that not only more measurements in more schools are needed in the future but also that by only presenting an average value per parameter energy engineers could be misled when calculating energy use. For this reason, this study also presents standard deviations of the studied parameters.

Sammanfattning

En minskning av koldioxidutsläppen från den byggda miljön genom att förbättra energieffektiviteten är en viktig del i att minska de globala koldioxidutsläppen, eftersom de stod för nästan 40 procent av de energirelaterade koldioxidutsläppen under 2017.

Det finns sex huvudparametrar som påverkar en byggnads energianvändning. Dessa är utomhusklimat, klimatskal, installationer/energisystem, drift/underhåll, brukarrelaterade aktiviteter och inomhusklimat. De tre första parametrarna kan klassificeras som tekniska parametrar och dessa har studerats tidigare. För att kunna förbättra en byggnads energieffektivitet ytterligare måste fokus även läggas på de tre sista parametrarna, vilka inte har studerats lika utförligt som de tekniska. Fler studier bör göras av dessa tre parametrar, som kan klassificeras som brukarrelaterade parametrar.

Det övergripande syftet med denna avhandling är att bidra till att uppnå klimatmålet genom att förbättra byggnaders energieffektivitet genom att undersöka både beräknad och uppmätt energianvändning samt att identifiera vilka parametrar som har stor inverkan på den totala energianvändningen och därför bör beaktas.

Denna avhandling studerar beräknad och uppmätt energianvändning i två byggnadstyper i Sverige. Den fokuserar på hur brukarrelaterade parametrar påverkar energianvändningen på fem hotell i Stockholm, tillhörande en och samma hotelloperatör, samt sju nybyggda lågenergiskolor belägna i södra halvan av Sverige. I data från hotellen som samlades in under flera år omfattade två brukarrelaterade parametrar och energianvändning. I de studerade skolorna samlades data in från mätningar av energianvändning, inomhustemperatur, inomhuskoldioxidkoncentration, och flera brukarrelaterade parametrar under en ettårsperiod. Beskrivande statistik och simuleringar av byggnadernas energianvändning användes för att analysera insamlade data.

De studerade hotellen visade stora skillnader i total uppmätt energianvändning. Det visade sig att resultat från ett hotell, med avseende på de studerade parametrarna som påverkade uppmätt energianvändning, inte kunde tillämpas på de andra, liknande, hotellen. Ett förslag på lösning är att dela upp varje enskilt hotell i delsystem t.ex. uppvärmning, komfortkyla och ventilation, och studera dessas påverkan på energianvändningen. Detta kan hjälpa till att bestämma, projektera och beräkna energibesparing i ett delsystem och därigenom lättare identifiera eventuella avvikelser.

En jämförelse av uppmätt och beräknad energianvändning visar att det förekommer en stor spridning i de studerade skolorna. Den uppmätta energianvändningen varierar mellan att understiga den beräknade med 44 procent respektive överstiga den beräknade med 28 procent. Det visade sig att de brukarrelaterade parametrarna hade större påverkan på variationerna i energianvändning än de tekniska parametrarna. Av de studerade parametrarna visade det sig att inomhustemperatur, luftomsättning och ventilationsdrifttid var de brukarrelaterade parametrarna som hade störst inflytande på byggnadernas energianvändning. Användningen av el för belysning och apparater hade något mindre inflytande på den totala energianvändningen. Persontäthet och energianvändningen för varmvattenuppvärmning hade lite påverkan i de studerade skolorna. Även om endast sju lågenergiskolor inkluderades i studien kan man se att de uppmätta brukarrelaterade parametrarna kan variera avsevärt. Detta innebär inte bara att fler framtida mätningar i fler skolor behövs men också att endast ett medelvärde per parameter skulle kunna vilseleda energiingenjörer vid beräkningen av en byggnads energianvändning. Av denna anledning presenterar denna forskningsstudie även standardavvikelser för de studerade parametrarna.

Table of Contents

Preface	5
Abstract	7
Sammanfattning	9
1 Introduction	13
1.1 Aim and objectives	17
1.2 Research Questions	17
1.3 Limitations.....	18
1.4 Thesis structure.....	18
1.5 List of appended publications and their relevance	19
1.5.1 Other publications.....	20
1.6 Ethics review	21
1.7 Nomenclature	21
2 Method	23
2.1 Method used in the hotel study.....	25
2.1.1 Energy auditing.....	25
2.1.2 Energy measurements.....	26
2.1.3 Data analysis.....	26
2.1.4 Descriptions of the studied hotels.....	27
2.2 Method used in the school study	29
2.2.1 Descriptions of the studied schools	31
2.2.2 Calculated building energy performance.....	36
2.2.3 User-related parameters	37
2.2.4 Measurement of energy	37
2.2.5 Measurement of ventilation rates, indoor air temperatures, CO ₂ concentrations, occupancy rates and presence times.....	39
2.2.6 Interviews with operation and maintenance personnel.....	40
2.2.7 Building simulations.....	40
3 Results	43
3.1 AP 1	43
3.2 AP 2	45
3.3 AP 3	47
3.4 AP 4.....	48
3.5 AP 5.....	49

3.6	Results from interviews with the operation and maintenance personnel	52
3.6.1	Airing and solar shading.....	53
3.6.2	Domestic hot water use.....	53
3.6.3	Ventilation systems.....	53
3.6.4	Indoor air temperatures.....	53
3.6.5	Time required for optimizing and balancing HVAC systems	53
3.6.6	Recommendations for future low-energy schools	54
4	Discussion.....	55
4.1	User-related parameters.....	55
4.1.1	User-related parameters in this research.....	56
4.2	BEN specified and measured user-related parameters in the studied schools.....	58
4.2.1	Indoor air temperatures, ventilation rates and E_{DHW} – measurements versus BEN 2 specifications	59
4.2.2	Occupancy rate and E_{TE} measurements versus BEN 2 specifications	62
4.2.3	Solar shading and airing	64
4.3	Measurements of thermal comfort and indoor air quality in the studied schools.....	65
4.4	Reporting systems and technical knowledge requirements for operating the hotels and schools in this study	66
4.5	Analysis of the energy use in the studied hotels and schools	68
4.6	Managing discrepancies between calculated and measured energy use	71
5	Conclusions	77
	References	81
	Appended publications.....	87
	Publication I	91
	Publication II.....	211
	Publication III.....	225
	Publication IV.....	239
	Publication V.....	253

1 Introduction

In 2017, the building sector accounted for 36 percent of the global final energy use and 39 percent of energy-related carbon dioxide (CO₂) emissions [1]. A decrease of CO₂ emissions in the building sector is essential for reducing global CO₂ emissions. The Global Alliance for Buildings and Construction in their 2018 Global Status Report recognises the impact of energy efficiency in buildings when aiming to reduce global energy use in the building sector. Globally, the energy intensity per unit of floor area in buildings has decreased since 2010 by improving the energy efficiency of space heating and lighting systems [1]. The building energy requirements in EU member states are approaching the nearly-zero energy buildings (nZEB) requirements due to EU directive 2010/31/EU [2], which aims to reduce the Union's energy dependency and CO₂ emissions. The directive will be implemented in Sweden by 2021. The International Energy Agency (IEA), through its Energy in Buildings and Communities (EBC) program [3], and the UN through its Sustainable Development Goals initiative [4], are helping countries outside the EU to implement building energy efficiency measures as a strategy to reduce energy use and, subsequently, climate change. A great need has been expressed by the building sector, research communities and building energy policy makers all over the world for more feedback on building energy use and parameters influencing this use in order to reduce global energy use and CO₂ emissions.

In the late 1990s and early 2000s, environmental measures were starting to be seen in the tourism industry. The drivers behind these measures quite often included the need for cost reductions due to the increasing costs of public utilities, rigorous environmental regulations including the need for environmental reporting, corporate governance, and pressure from customers, stake holders and “green” investors [5]. Environmental movements demanded that the industry reported how their resources were being used. Hotel buildings, with their significant use of resources, were key players within the tourism industry and were an important part of the sector's environmental strategy. At the beginning of the 2000s, there were very few references explaining the resources used within hotels and there was little understanding about the parameters that were the drivers behind their use [5]. Scandic, a Scandinavian hotel chain with about 65 hotels, was among the first of the hotel chains to start including sustainability strategies as part of their development strategy, with the use of resources being a key part. The strategies were defined by the “Nordic Swan Ecolable” in 1994 and the “Resource Hunt Program” in 1996 [6].

Scandic, subsequently, created an environmental reporting tool, the Scandic Utility System (SUS) in 1997 [5]. It started reporting resources used in hotels, such as energy and water use, and number of guest nights. However, Scandic needed to understand and gather more information about the parameters that were influencing energy and water use.

There are six main parameters that influence building energy use. These are: outdoor climate, building envelope properties, building services and energy systems, building operation and maintenance, occupants' activities and behaviour, and indoor environmental quality. The first three parameters have been very well studied in the past and focus needs to be placed on the last three parameters [7]. The last three parameters are human-related and their influence can be as significant as the first three [7]. Although the building industry has several decades of experience of carrying out building energy use calculations, the lack of knowledge about parameters influencing energy use is still one of the most significant barriers to improving energy efficiency [7]. Previous studies have shown large discrepancies between calculated energy performance in the design phase and measured energy performance in the operational phase of a building [7], [8]. Minimizing the discrepancies means improving the predictions relating to all the influencing parameters. Many research communities have identified that the discrepancies depend mainly on difficulties encountered when predicting users' behaviour and their relationships to a building during the design phase. In 2016 alone, about 200 publications dealt with users, focusing on their behavioural aspects and their influence on building energy use [8]. Users and their behaviour can have an impact ranging from 10 to 80 percent of building energy use [9]. D'Oca et al. [10] underlines the importance of the human dimension being as significant as the technological dimension when it comes to influencing building energy use. Hong et al. [11], in a review article, and Haldi et al. [12], in a study of offices and dwellings, identified the lack of data collection regarding user-related parameters as the main source of discrepancies, due to its complexity. The International Energy Agency (IEA) Energy in Buildings and Community (EBC) Programme Annex 66 has established a scientific methodological framework for occupant behaviour research. The framework identifies data collection of occupant behaviour, and improving behavioural data modelling and its integration with building performance simulation tools, as important aspects in building energy simulations that need to be developed [13].

Within a period of eight years from 2018, about 700 schools will have to be built in Sweden [14] as a consequence of population growth and continued urbanization [15]. In 2016 and 2017, the construction of about 200 school buildings began [16]. Scandic management has announced that there will be an annual growth of around 2500 to 3000 hotel rooms per year over the coming years due to the launch of a new hotel brand, mainly in Scandinavian countries [17]. Globally, there are about 6000 hotels under construction [18], of which 60 percent are in USA and China. Most of

these hotels and schools in Sweden, and globally, will be built as low-energy buildings in order to achieve climate change goals. Apart from being low-energy buildings, schools also need to provide satisfactory indoor environments to ensure children’s productivity and good health. Their learning performances have been shown to be affected by poor indoor environments, especially when caused by low ventilation rates [19], [20] and high indoor air temperatures [21].

Boverket (The Swedish National Board of Housing, Building and Planning) specifies that, in order for a new building to receive a construction permit, building energy use calculations must be carried out, as shown in Figure 1. The calculated energy use must comply with the Swedish national building energy requirements [22], issued by Boverket. On completion, a building energy verification process must be carried out to obtain a permit prior to the building being put into use, as shown in Figure 1. The verification process is described in the BEN 2 document [23], issued by Boverket. Verification can be carried out by providing updated energy calculations based on as-built documents or by measuring the building’s energy performance within the first two years of operation, as shown in Figure 1.

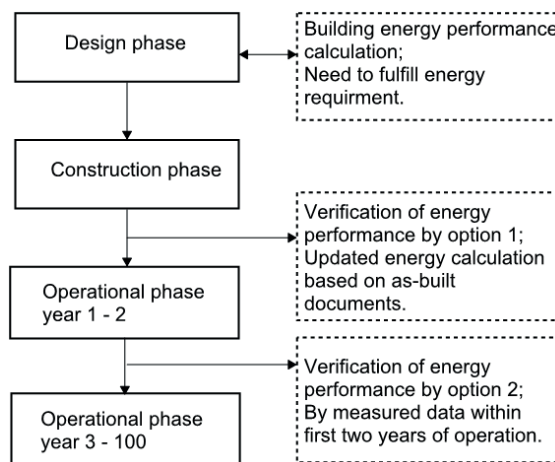

Figure 1. The building energy calculation and verification process for a Swedish construction project, as defined by Boverket (the Swedish National Board for Housing, Building and Planning) in BEN 2 [23].

By 2021, the Swedish national energy requirements will comply with the nZEB directive, which stipulates low-energy requirements for buildings. The nZEB directive emphasizes the importance of knowledge about the influence of user-related parameters on building energy use. User-related parameters are the parameters that can be influenced by a building’s users. In the case of school buildings, the main users are pupils, teachers and operation and maintenance personnel. In the case of hotels, the main users are their guests and, in many cases, even conference guests, as well as the hotel employees. The users and their

relationships to the building energy use are reflected in occupancy rates, occupancy presence times, electricity use for appliances and lighting, ventilation rates in buildings with demand-control, ventilation operating times, energy use for domestic hot water, indoor air temperatures, airing and use of solar shading. The same parameters were specified in a BEN document issued by Boverket, of which the latest version is BEN 2 [23]. BEN 2 specifies standard reference values that can be used by energy engineers to predict the effects of user-related parameters in building energy calculations in the design phase, which can help to minimize the influence of variations of user-related parameters on calculated energy use. Unless there are specific reference values for a specific building project, the idea is to apply the same reference values to all non-residential buildings. Among the different types of buildings, there is a list specifying parameters for elementary and upper secondary school buildings but no list of parameters for hotel buildings has yet been issued. However, the list covering school buildings is based on older references, such as the STIL2 [24] study, conducted in 2007. The relevance of this list for low-energy buildings needs to be reviewed.

Low-energy schools in the UK often failed to match their calculated energy use [9], [25], [26], [27]. Calculated energy use compared to measured energy use was shown to vary from -31 percent to +45 percent and occupant behaviour was identified as the largest contributing factor [9]. A similar study of hotel buildings has not been carried out, at least not one that is known to the author. There is, therefore, a need for references regarding user-related parameters in low-energy hotel buildings. Building operation practice and maintenance, as well as indoor environmental quality, are two other important user-related parameters influencing building energy use [7], [27]. Parameters related to the users and their relationships to building energy use were shown to be difficult to predict in the design phase. Demanuele et al. [28] showed that these parameters could vary significantly among their studied school buildings. For example, measured occupancy rates varied from 0.025 to 0.55 person/m², occupants' presence times from 31 to 51 h/week, and heating set points from 15 to 25 °C. Variations of these magnitudes can lead to overprediction or underprediction of building energy use during the design phase. For example, overprediction of energy use for a domestic hot water supply system could, in turn, require thicker thermal insulation in order for a building to comply with the national energy requirements. Such an overprediction can thus lead to increased building construction costs. Difficulties in predicting user-related parameters could, therefore, create unfair competition among bidding construction companies. They could also lead to lower or higher actual building operation costs than those predicted in the building energy calculation. The building sector and research communities need more references and data on user-related parameters and their influence on building energy use, especially in low-energy buildings. By being able to make more accurate calculations for energy use, the building sector will be

able to improve energy efficiency in buildings and reduce global CO₂ emissions, thus achieving their environmental goals [7].

1.1 Aim and objectives

The overall aim of this thesis is to contribute to achieving climate goals set by society by improving building energy efficiency. The thesis aims to provide results and feedback that will contribute to improving building energy efficiency by studying calculated and measured building energy use. The focus is on hotels, low-energy school buildings and on user-related parameters that influence building energy use.

The objectives of this thesis were to:

- Analyse the measured energy use in five hotels.
- Analyse the measured energy use and user-related parameters in seven low-energy school buildings.
- Analyse the measured indoor climate and air quality in seven low-energy school buildings.
- Analyse which parameters influence energy use in hotels and school buildings.
- Compare the calculated and measured energy uses in low-energy school buildings.
- Present the results regarding user-related parameters so that they can be used as reference values.

1.2 Research Questions

In order to fulfil the aim and objectives of the thesis, several questions needed to be addressed. These were:

- What is the building energy use in a group of five similar hotels?

- What parameters influence energy use, and by how much, in a single hotel building and in a group of similar hotel buildings?
- Can low-energy school buildings provide sufficient thermal comfort and indoor air quality in terms of indoor air temperatures and CO₂ concentrations?
- How well do the calculated and measured energy uses align in low-energy school buildings?
- How do user-related parameters influence the calculated and measured energy uses in low-energy schools and how much do they influence the total energy use?
- How do measured results from seven case studies of low-energy schools compare to the standard design values specified in BEN 2?

1.3 Limitations

The main limitations of this thesis concerned the types of buildings that were studied, which were hotels and low-energy schools. Furthermore, there were limitations due to the number of studied buildings, i.e. five hotels within the same hotel chain and seven low-energy schools. The number of measured parameters was also limited as only a certain number of meters and measurement sensors were available in the studied buildings. Although the quantitative aspects of users' influence were studied, e.g. number of users, users' presence time and domestic hot water usage, the study did not include the psychological aspects of users' influence on building energy use.

1.4 Thesis structure

The thesis results are presented in five published appended publications. One of the publications is the author's Licentiate Thesis monograph researched at the KTH Royal Institute of Technology, Stockholm. The other publications were researched at the Faculty of Engineering, LTH, Lund University, and comprise one conference paper and three journal articles. In addition to the analyses and results in the appended papers, Chapter 3 highlights the results answering the research questions based on the appended papers. In Chapter 4, the results are discussed and the ideas

and concrete examples regarding how the results from this study can be used are emphasized. Finally, the conclusions are presented in Chapter 5.

1.5 List of appended publications and their relevance

The following publications are included in this thesis:

Publication 1 (AP 1) – Monograph (Published)

Branko Simanic (2011), ‘Energy Auditing and Efficiency in a Chain Hotel – the Case of Scandic, Järva Krog’ Licentiate Thesis in Energy Technology from the KTH Royal Institute of Technology, Stockholm, Sweden: pp (1-117); <http://kth.diva-portal.org/smash/record.jsf?pid=diva2%3A413012&dswid=-2673>

Publication 2 (AP 2) – Conference paper (Published)

Branko Simanic, Dennis Johansson, Birgitta Nordquist and Hans Bagge (2018), ‘User Related Input Data for Energy Use Calculations – the Case of Low Energy Schools in Sweden’ in the Springer proceedings in Energy, The 9th International Cold Climate HVAC Conference 2018: pp 747-758; https://doi.org/10.1007/978-3-030-00662-4_63

Publication 3 (AP 3) – Journal Article (Published)

Branko Simanic, Birgitta Nordquist, Hans Bagge and Dennis Johansson (2019), ‘Indoor air temperature, CO₂ concentration and ventilation rates: long-term measurements in newly built low-energy schools in Sweden’, Journal of Building Engineering, Volume 25; <https://doi.org/10.1016/j.jobe.2019.100827>

Publication 4 (AP 4) – Journal Article (Published)

Branko Simanic, Birgitta Nordquist, Hans Bagge and Dennis Johansson (2019), ‘Predicted and Measured User-related Energy Use in Newly Built Low-energy Schools in Sweden’, Journal of Building Engineering, Volume 29; <https://doi.org/10.1016/j.jobe.2019.101142>

Publication 5 (AP 5) – Journal Article (Published)

Branko Simanic, Birgitta Nordquist, Hans Bagge and Dennis Johansson (2020), ‘Influence of user-related parameters on calculated energy use in low-energy school buildings’, MDPI Energies, 13, 2985; <https://doi.org/10.3390/en13112985>

The distribution of the work carried out for the APs is presented in Table 1 and the links between the research questions and the APs are presented in Table 2.

Table 1. Distribution of the work carried out for the appended papers

Paper	Distribution of work
AP 1	Simanic is sole author
AP 2	Simanic is the main author, Johansson, Nordquist and Bagge supervised and reviewed the work.
AP 3	Simanic is the main author, Norquist contributed to the writing of some minor parts, supervision and review, Bagge and Johansson supervised and reviewed the work.
AP 4	Simanic is the main author, Norquist contributed to the writing of some minor parts, supervision and review; Bagge and Johansson supervised and reviewed the work.
AP 5	Simanic is the main author, Johansson, Nordquist and Bagge supervised and reviewed the work.

Table 2. Links between the research questions and appended publications

Research question	Appended publication
What is the building energy use in a group of five similar hotels?	AP 1
What parameters influence energy use and by how much in a hotel building and in a group of similar hotel buildings?	AP 1
Can low-energy school buildings provide sufficient thermal comfort and indoor air quality in terms of indoor air temperatures and CO ₂ concentrations?	AP 3
How well do the calculated and measured energy uses align in low-energy school buildings?	AP 4
How do user-related parameters influence the calculated and measured energy uses in low-energy schools and how much do they influence the total energy use?	AP 2; AP 4; and AP 5

1.5.1 Other publications

Bohdanowicz Paulina, Simanic Branko, Martinac Ivo (2004), ‘Environmental Education at Scandic hotels: approaches and results’, Proceedings of the Regional Central and Eastern European Conference on Sustainable Buildings (SB04).

Bohdanowicz Paulina, Simanic Branko, Martinac Ivo (2005), ‘Environmental Training and Measures at Scandic Hotels, Sweden’, *Tourism Review International*, Volume 9, Number 1, pp 7-19; <https://doi.org/10.3727/154427205774791744>

Bohdanowicz Paulina, Simanic Branko, Martinac Ivo (2005), ‘Sustainable Hotels: environmental reporting according to Green Globe 21, Green Globes Canada / GEM UK, IHEI benchmarkhotel and Hilton International Reporting’, Proceedings of Sustainable Building (SB05) Conference, pp 1642-1649.

1.6 Ethics review

The Act in Swedish law (SFS 2003:460) concerning the ethical review of research involving other persons came into force in January 2004. The Act stipulates what type of research projects must conduct an “Ethical Review”. There was no obligation to conduct a review of the research for this thesis, as none of the stated conditions in the “Good research practice” document issued by Vetenskapsrådet (the Swedish Research Council) were fulfilled [29]. Other equally important aspects with regard to good research ethics when conducting this research study were: having an honest and careful approach during the entire study, displaying objectivity in treating and disseminating data and results, openly sharing data and information within the study, a fair and respectful treatment of all colleagues involved, the competence of all colleagues involved, and having a responsible approach towards all involved in this study, as well as towards society, which will, hopefully, benefit of this research study.

1.7 Nomenclature

AP	Appended publication
A_{temp}	Refers to floor area (m^2) in rooms/spaces heated to 10 °C or above
BAS	Building automation system
BEN	Swedish national building codes and recommendations for determining building energy use during normal operation in a normal year
CO ₂	Carbon dioxide
DCV	Demand control ventilation
DH	District heating
E_{BP}	Energy use for building property electricity
E_{cool}	Energy use for comfort cooling
E_{DHW}	Energy use for domestic hot water supply
EI	Energy Index
EP	Building energy use
E_{SH}	Energy use for space heating
E_{TE}	Energy use for tenant electricity
GSHP	Ground source heat pump
HDD	Heating degree days
HDH	Heating degree hours
HER	Hilton Environmental Reporting
IAQ	Indoor air quality
IEA EBC	International Energy Agency Energy in Buildings and Communities
nZEB	Nearly zero-energy building
SUS	Scandic Utility System
U_m	Overall thermal transmittance of a building [$W/(m^2 K)$]
VR	Ventilation rate

2 Method

In order to respond to the research questions, a quantitative research method was applied for this thesis, whereby data collection from sensors for energy use, user-related parameters influencing building energy use, and thermal comfort and indoor air quality (IAQ) were included.

A vast number of factors influence a building's energy balance, thermal comfort and indoor air quality. A case study approach was chosen in order to focus this research on two types of buildings, which enabled a deeper understanding of energy use, thermal comfort, IAQ and human-related processes driving the energy use in the studied buildings. The case studies included energy audits, site visits and field measurements for data collection. Long-term recorded measurements during a one-year period were used to gather an extensive amount of data. Focus in this study was on long-term measurements and a positivistic research approach, with analyses of measurement data covering long periods of time and with high time-resolution, was adopted to answer the research questions. Studying indoor climate could also have been possible by using questionnaires with an interpretivist research approach [30]. However, the interpretivist approach would not have fully provided answers to the research questions. It could, on the other hand, have been a complement to the quantitative research, by analysing the occupants' perceptions of thermal comfort and IAQ. The interpretivist research approach also has limitations, when compared to the positivistic approach, when it comes to long-term measurements and high time-resolution data, for which the positivistic approach is able to cover a much longer time span.

Descriptive statistics, with the help of tables, diagrams, regression analysis using the Microsoft Excel tool, and building simulations with the help of the IDA ICE building performance dynamic simulation tool [31] were used to analyse the measurement data. Two case studies were conducted in this study. The first case study was carried out in five hotel buildings in Stockholm, Sweden and the second was implemented in seven newly built low-energy schools in Sweden. The description of the research method applied in this study was based on Säfsten and Gustavsson [30].

An illustration of the thesis timeline in relation to the different phases during a building's lifetime and building type is shown in Figure 2. It also shows the parameters that were studied in each of the appended publications.

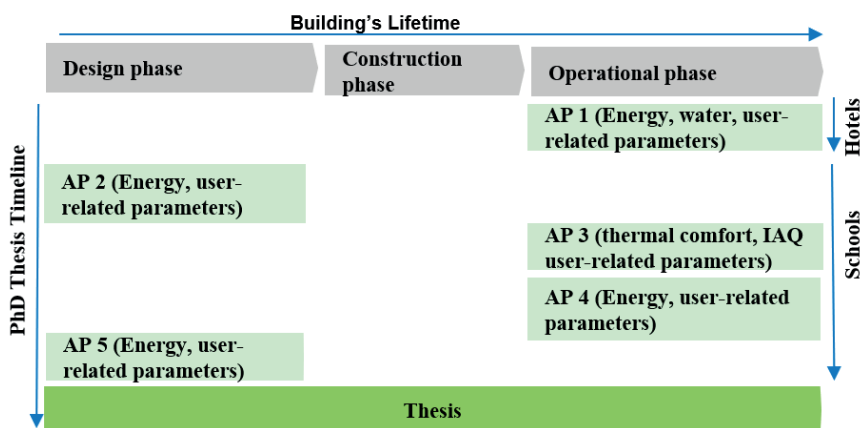

Figure 2. Timeline of the PhD research project in relation to the studied parameters and to the buildings' timelines.

The studied energy parameters in relation to the APs are shown in Table 3. The measured parameters were chosen based on the condition that the measurements for these had already been established in the studied buildings during normal operation over a one-year period. Most meters and sensors were installed in the studied buildings prior to this thesis work. Measurement methodology and data collection are described in detail in the respective APs.

Table 3. The studied parameters in the appended papers

Studied parameters	AP 1	AP 2	AP 3	AP 4	AP 5
Space heating energy	x	x		x	x
Space cooling energy	x				
Building property electricity	x	x		x	x
Energy for DHW	x	x		x	x
Energy for tenant electricity	x	x		x	x
Indoor air temperature		x	x	x	x
Water use	x				
Number of guest nights	x				
Number of food covers sold	x				
CO ₂ concentration			x		
Ventilation rate		x	x	x	x
Operational time of ventilation		x	x	x	x
Occupancy rate		x	x	x	x
Occupants presence time			x	x	

2.1 Method used in the hotel study

The first case study included an analysis of the measured energy use and the user-related parameters influencing energy use in hotel buildings. To get a deeper understanding of energy use in hotel buildings and the user-related parameters behind their energy uses, five hotels in the Scandic chain were chosen for this thesis. The Scandic management gave access to their resources use data base and to five of their hotels, as they also wished to gain a better understanding of the parameters behind energy use in their buildings. Only five hotels were chosen to be studied as this work was aimed at understanding the complexity in each building of the parameters influencing energy use. By studying a larger number of hotels, an understanding of this complexity could have been at risk. The study focused on hotels offering services at similar levels in order to minimize the influence of additional facilities, which were shown in the literature to be quite large [5]. In order to minimize the influence of the outdoor climate on the variations of energy use, only hotels in Stockholm were studied. Scandic will be called the hotel operator in this study.

The study started with a literature study to obtain a greater understanding of the energy use and the parameters influencing energy use in the hotel buildings, the energy auditing tools and the long-term energy measurements. As a next step, energy auditing and long-term measurements for data collection from Hotel J was carried out. Hotel J was chosen as a case study as it was possible to collect measurements of energy use and electricity use on an hourly basis. Later in the study, site visits were conducted at the other four hotels. Finally, data analysis with the help of descriptive statistics was performed. The measurement data was collected during 2004 and 2005, while the research was mainly conducted from 2004 to 2006. The study was finally presented in 2011.

2.1.1 Energy auditing

The auditing process enabled knowledge of the systems behind energy use to be gained. It also made it possible to carry out the necessary preparations before the long-term measurement process was begun. It was found that descriptions and documentation of the building services systems were outdated, as Hotel J had been rebuilt several times in the years prior to the study. To gain knowledge about the building services systems, a number of visits were conducted. Documentation of the heating, cooling and electrical power ratings of the space heating system, space cooling system, heat recovery system, lighting, kitchen appliances, ventilation system and domestic hot water system was compiled for Hotel J. Site visits to an additional four hotels were conducted. During these visits, an overall picture of the hotel buildings and facilities that could influence building energy use was formed.

2.1.2 Energy measurements

The long-term measurements included sub-metering of different energy end-users in Hotel J. Measurements of district heating, cooling and electricity use at 1-hour intervals were acquired from the utility companies. Long-term sub-metering of space heating was conducted using additionally installed non-intrusive energy meters. Annual data for electricity use, heating and cooling energy, and water use as well as for food covers sold and number of guest nights were then collected from all five hotels, see Table 4. The annual data was collected from the hotel operator's environmental reporting tool, the Scandic Utility System (SUS), which was later renamed the Hilton Environmental Reporting (HER) tool. The available data for Hotel J was from 1996 to 2004 and for the other hotels from 1998 to 2004. The data for each hotel is shown in Table 4. The total energy use comprises all supplied energy to the hotels.

Table 4. Studied energies and parameters per hotel. The hotels are represented by their code letters.

Hotels	Hotel J	Hotel K	Hotel M	Hotel C	Hotel A
Energy for heating	x	x	x	x	x
Energy for space cooling	x				
Electricity energy	x	x	x	x	x
Energy for DHW	x				
Water use	x	x	x	x	x
Number of guest nights	x	x	x	x	x
Number of food covers sold	x	x	x	x	x

2.1.3 Data analysis

In order to analyse the energy use, data tables and graphs were used. Statistical linear regression data analysis was used to determine which of the measured, and assumed to be independent, variables – heating degree days (HDD), number of guest nights and number of food covers sold – could explain the measured, assumed to be dependent, variables – heating and electrical energy use. Using the coefficient of determination R^2 , the relative correlations were determined between the two types of variables. If R^2 was between 0.8 and 1, it was assumed that the independent variable was a statistically strong factor to explain the dependent variable. If R^2 had a value between 0.6 and 0.8 it was assumed that the independent variable was a statistically significant factor to explain the dependent variable. The assumptions were based on Powel and Baker [32]. Heating energy was weather-normalised with the help of HDD tables, issued by the Swedish Metrological and Hydrological Institute (SMHI) [33]. Energy for DHW usage was included in the heating energy and was, therefore, also weather-normalised, as separate measurements of DHW usage were not available in four of the studied hotels.

2.1.4 Descriptions of the studied hotels

Short descriptions of the hotels, all located in Stockholm, investigated in this study are given in Table 5. The hotels are denoted by their code letters. Hotel C was completely demolished and rebuilt during 2016. Photographs of the hotels are shown in Figures 3 to 7.

Table 5. Some relevant details about the studied hotels.

Hotels	J	K	M	C	A
In operation since	1971	1968	1951	1962	1989
Floor area/ (m ²)	11300	11613	15494	12344	16000
Number of guest rooms	215	257	327	268	283
Number of conference rooms	17	5	-	8	17
Restaurant facilities	Yes	Yes	Yes	Yes	Yes
Indoor pool	No	Yes	No	No	No



Figure 3. Hotel J.



Figure 4. Hotel K [34].



Figure 5. Hotel C before demolition in 2016 [35].



Figure 6. Hotel M [36].



Figure 7. Hotel A [37].

2.2 Method used in the school study

The second case study comprised studying the calculated and measured energy use and user-related parameters in seven newly built low-energy schools in southern Sweden. The schools were chosen because they fulfilled a number of criteria. The first one was that the school buildings were to be newly built. The second criterion was that they had to be already classed as low-energy buildings, which meant that their calculated energy use was 75 percent of the national energy requirement, which implied that they would be able to meet the nZEB requirements. A building in which the energy use is 75 percent of the Swedish national building energy requirement is allowed to be classified as a low-energy building [38]. The schools were newly built and had, therefore, fulfilled the stringent building energy requirements, so they could be identified as standard nZEB schools in the near future. The third criterion was that the schools had already installed measuring equipment and could offer access to the measurement data. The last criterion was that the schools were to be located throughout the whole of Sweden, i.e. subject to outdoor climates with different numbers of heating degree hours (HDH). The number of schools was limited to seven as the study aimed to develop a deeper understanding of the user-related parameters and their influence on energy use. Studying a large number of low-energy schools in Sweden would probably have affected the understanding of the complexity of the relationships between users and their influence on energy use.

This study started with a literature study of energy use in low-energy school buildings, the users and their influence on building energy use. The literature study also included the acquisition of knowledge about the reasons behind discrepancies

between calculated and measured energy use in low-energy school buildings. The study continued with site visits to the chosen schools to get an overview of the buildings and to investigate the possibilities of performing long-term measurements. The visits helped to provide generic building information and information about the installation and location of the meters, sub-meters and sensors. The meters and sensors would be used for measuring indoor air temperatures and CO₂ concentrations, and for collecting presence data used for regulating demand-controlled ventilation (DCV) equipment and lighting. The visits also provided overall information about the DCV systems, ventilation rate (VR) measurements and solar shading installations. Contacts with the schools' operation and maintenance personnel enabled the collection of information about the buildings, such as original project documentation and energy calculation reports, as well as access to measurement data and building automation systems (BAS). When the installation of additional sub-meters was required, these contacts were invaluable. Long-term measurements were conducted over a one-year period covering both the heating and cooling seasons.

Statistical linear regression analysis was used to investigate which of the measured independent variables could explain the measured dependent variables. Independent variables were assumed to be the following user-related parameters: occupancy rate, energy use for tenant electricity, average indoor air temperature during the heating season, ventilation rate, ventilation running time, and average time that a school was in operation. Dependent variables were assumed to be energy use for space heating, building property electricity, and energy use for domestic hot water and tenant electricity. Using the coefficient of determination R^2 , the relative correlations between the variables were determined.

Rough estimates were made of the contributions of some of the technical parameters to the differences in total energy use in the studied schools to find the order of magnitude of these parameters. The parameters were outdoor climate, overall thermal transmittance and efficiency of each building's energy system. Additionally, building energy simulations were made in order to investigate the influence of user-related parameters on building energy use in three of the seven schools.

Finally, interviews with the schools' operation and maintenance personnel were conducted in order to collect data regarding experiences of user-related parameters and from operating low-energy schools. Two of the studied user-related parameters, airing and solar shading, were not possible to measure, but the interviews did provide information regarding perception and experiences of these two parameters. The interviews were semi-structured, as only specific questions were asked [30].

2.2.1 Descriptions of the studied schools

The schools were situated in the southern part of Sweden, from the very south of the country to as far north as the capital city of Stockholm, at latitudes from about 55° N to 60° N. Table 6 shows some of the characteristics of the schools. These are represented by their code letters throughout this study. Generic building information for the schools has already been presented in AP 2 to AP 5. In AP 2, the predicted energy use and user-related parameters were evaluated for an additional three schools. At that time, these three schools had not yet been built, which was why they were not included in any further studies, i.e. in AP 3 to AP 5. Figures 8 to 10 show 3D model views of the schools and Figures 11 to 17 show their floor layouts.

Table 6. Generic building information for seven low-energy schools.

	School						
	S	N	K	B	Vi	Ve	St
In operation since	2016	2017	2016	2014	2016	2015	2016
A_{temp}/ m^2	5641	8125	11222	8051	1725	3233	6695
School grade years	0 – 6	7 – 9	0 – 6	0 – 6	0 – 6	0 – 3	0 – 3
Number of buildings	1	1	1	1	1	1	1
Normal year HDH/ [(°C h)/y]	102600	92800	102600	111500	118000	92800	92800
Sports halls	Yes	No	Yes	Yes	No	No	No
Dining facilities	Yes	Yes	Yes	Yes	No	Yes	Yes
Cacluated $U_m/$ [W/(m ² K)]	0.23	0.18	0.18	0.2	0.21	0.21	0.29
Envelope area to volume ratio/ (m ² /m ³)	0.39	0.45	-	0.40	-	-	-
Cacluated SFP/ [kW/(m ² /s)]	1.8	1.6 to 2.0	1.4	1.7 to 2.0	2.2	1.5	-
Calculated efficiency of heat recovery/ %	80	82 to 85	80	80 to 83	63	80	80
Design air infiltration rate/ ([l/(s m ² of building envelope area)])	0.3 at +50 Pa	0.36 at +50 Pa	0.3 at +50 Pa	0.4 at +50 Pa	0.3 at +50 Pa	0.3 at +50 Pa	0.3 at +50 Pa
Space heating	GSHP	DH	DH	GSHP	DH	DH/GS HP	DH
DHW production	GSHP/dir ect electricity	DH	DH	GSHP/dir ect electricity	DH	DH/Sol ar heating	DH
Ventilation system	All schools were equipped with balanced mechanical ventilation systems with demand control, with centralised air handling units and rotary heat recovery						
Active cooling	No						

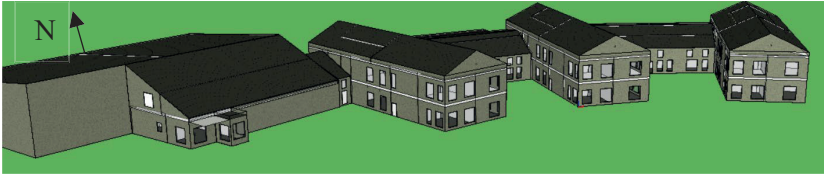

Figure 8. School S, IDA ICE 3D view model.

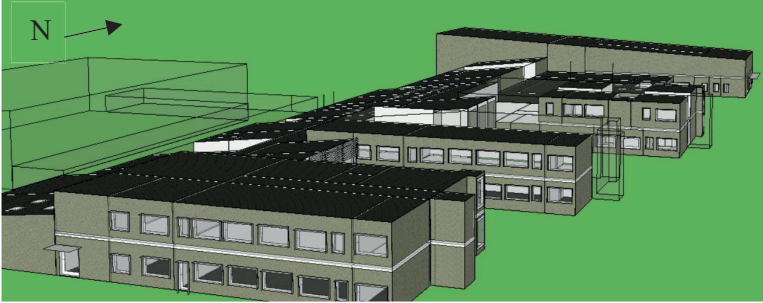

Figure 9. School N, IDA ICE 3D view model.

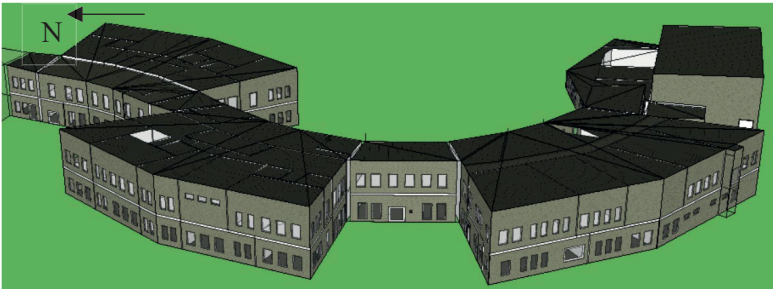

Figure 10. School B, IDA ICE 3D view model.

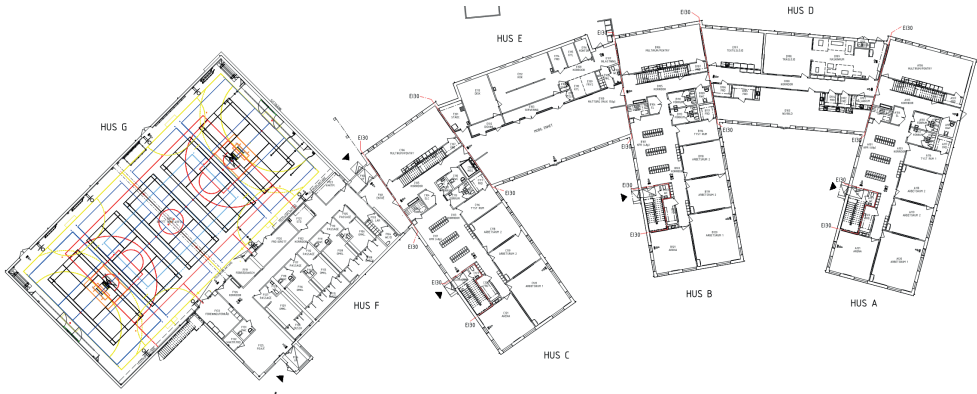

Figure 11. School S, ground floor layout of the two-storey building.

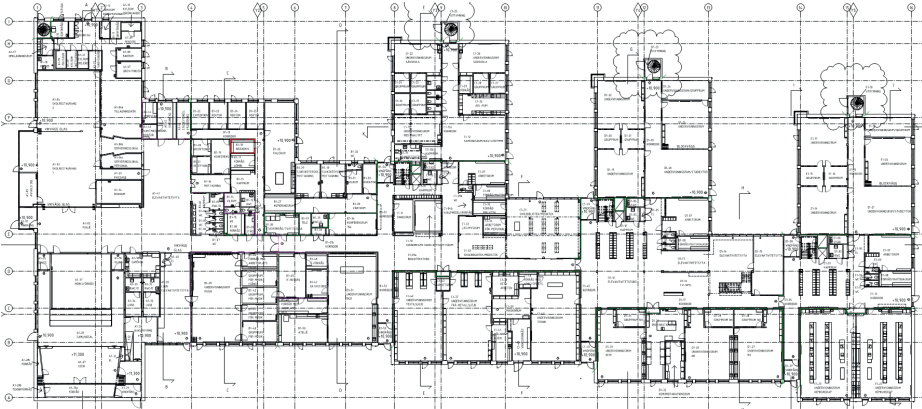

Figure 12. School N, ground floor layout of the two-storey building.

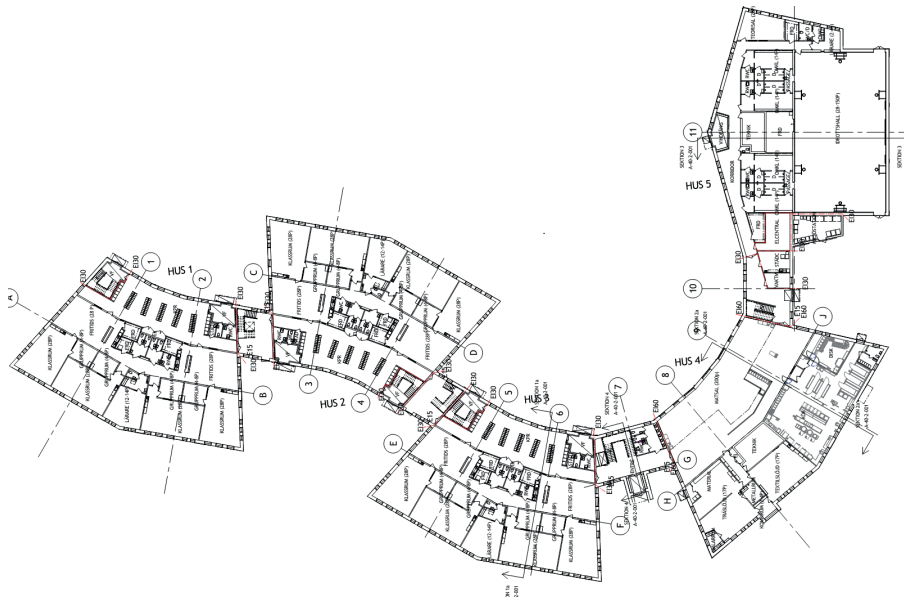

Figure 13. School B, ground floor layout of the two-storey building.

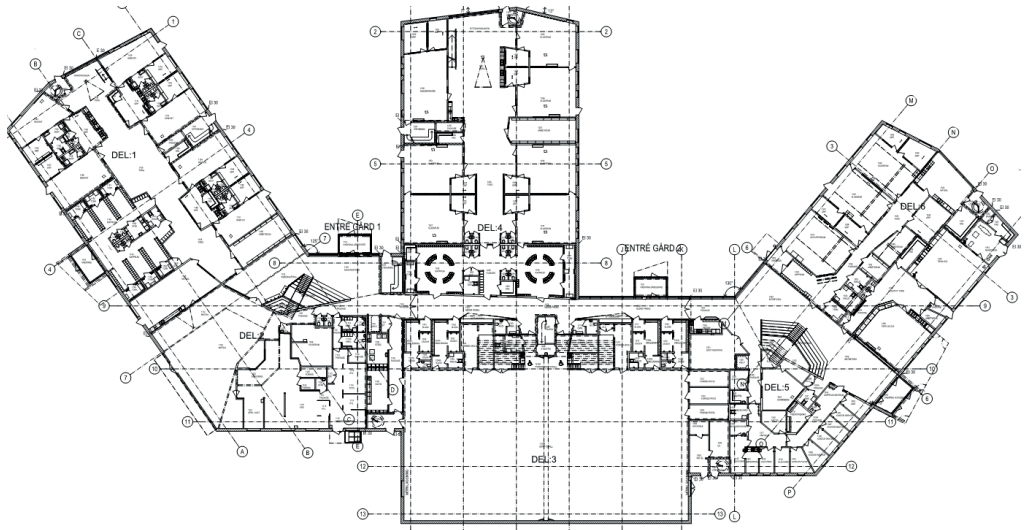

Figure 14. School K, ground floor layout of the two-storey building.

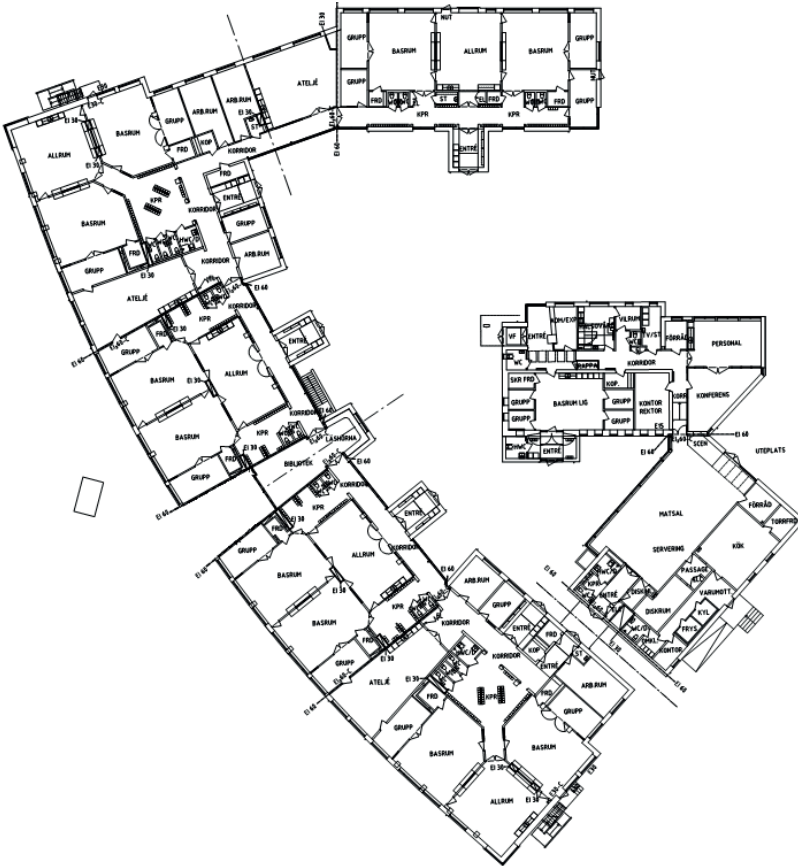

Figure 15. School Ve, ground floor layout of the four-storey building. School Ve only occupied the ground floor.



Figure 16. School Vi, ground floor layout of the two-storey building.

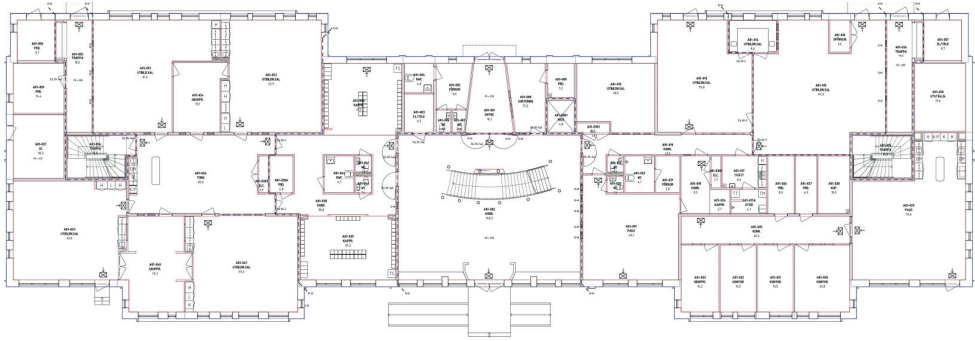

Figure 17. School St, ground floor layout of the four-storey building.

2.2.2 Calculated building energy performance

The calculated building energy performance was evaluated in the school study. It is presented in AP 2, AP 4 and AP 5. In order to calculate the building energy performance, Equation (1) was used. The energy balance in Equation (1) is based on purchased energy. For example, if ground source heat pumps (GSHPs) were used for space heating, the purchased electricity to run them was used in the equation. Equation (1) was defined by Boverket prior to the introduction of the primary energy requirements. National energy requirements and Equation (1) were introduced in BBR 12 in 2006 [39]. Primary energy in the calculated EP was introduced in 2017 in BBR 25 [40].

$$EP = (E_{SH} + E_{COOL} + E_{DHW} + E_{BP})/A_{temp} \quad \text{Equation (1)}$$

$$\text{Where } [EP] = \left(\frac{\text{kWh}}{\text{m}^2\text{year}}\right); [E_{SH}; E_{COOL}; E_{DHW}; E_{BP}] = \left(\frac{\text{kWh}}{\text{year}}\right); [A_{temp}] = \text{m}^2$$

EP is the building energy use. E_{SH} is the energy for space heating. E_{BP} is the energy used to run the ventilation system, pumps, lifts, BAS, lighting in building services areas, façade lighting and roof defrosting. E_{COOL} is the energy for active cooling, which was not relevant in the studied schools. E_{DHW} is the energy needed for the domestic hot water supply (DHW). E_{TE} is not included in the EP, although its free heat emission does contribute to the space heating. E_{TE} consists of energy to power lighting and electrical appliances in school areas occupied by pupils and teachers. Electricity use for kitchen appliances was not included in the EP, as it was assumed to be part of the tenant's process equipment. It is not included in the energy balance of a building according to the Swedish national building energy requirements. The total energy use includes both the EP and the E_{TE} . A_{temp} refers to floor area in spaces heated to 10 °C or above.

2.2.3 User-related parameters

User-related parameters investigated in this study were taken from AP 2 to AP 5. The parameters are the same as those presented in BEN 1 [41] and BEN 2 [23]. The investigated parameters for each of the schools are presented in Table 7.

Table 7. User-related parameters studied in each school.

Parameter	School						
	S	N	K	B	Vi	Ve	St
Indoor air temperature	x	x	x	x	x	x	x
Occupancy rate	x	x	x	x	x	x	x
Occupants' presence time	x			x	x		x
Ventilation rate	x	x	x	x	x	x	x
Ventilation operation time	x	x	x	x	x	x	x
E _{DHW}	x	x	x	x	x	x	x
E _{TE}	x	x	x	x	x	x	x

2.2.4 Measurement of energy

In order to measure the energy use in the studied schools, field measurements were conducted. The measurement of energy is described in detail in AP 4. The meters and other measuring sensors and data collection were all integrated parts of the BASs. The measurements were planned during the design phase and the metering equipment and sensors were installed during the construction phase. Figures 18 and 19 illustrate the basic measuring principles in the studied schools. In two of the schools, complementary energy sub-meters were installed, to be able to take into account all the end-users. Energy measurements were performed over a one-year period.

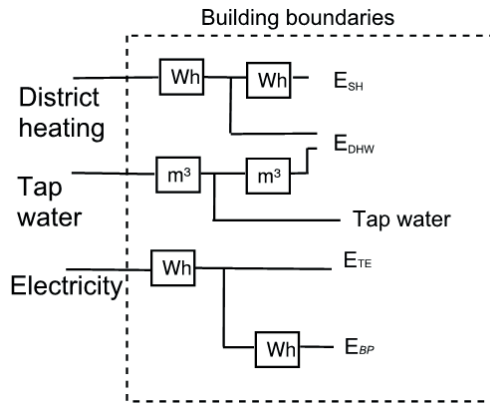

Figure 18. Simplified principles for metering and sub-metering in order to retrieve the actual energy use in buildings supplied with district heating. Boxes with “Wh” and “m³” represent energy and flow meters [42].

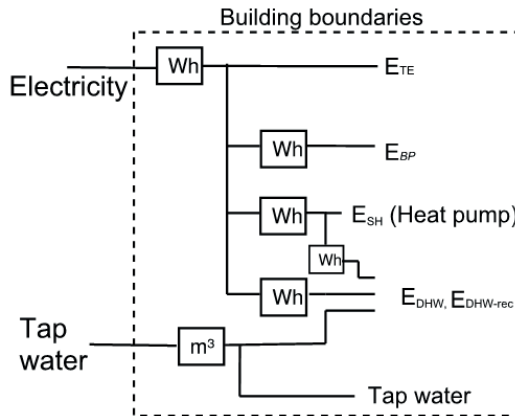

Figure 19. Simplified principles for metering and sub-metering in order to retrieve the actual energy use in buildings in which heat pumps supplied the heat for space heating and domestic hot water. Boxes with “Wh” and “m³” represent energy and flow meters [42].

Electrical equipment that was powered by the building property electricity E_{BP} , for example, fans, pumps, lifts, BAS and lighting in building services areas, was located over entire schools, which made it difficult to measure energy use at one point. For this reason, several electrical energy meters were installed to take into account the end-users that made use of the building property electricity.

Tenant electricity, E_{TE} , was measured in three of the seven schools. In the other four schools, E_{TE} was calculated by subtracting the measured E_{BP} and energy supplied to the GSHP, E_{SH} , (in School S) from the total amount of electricity purchased according to the utility meters, see Figure 19.

Energy use for domestic hot water recirculation ($E_{DHW-rec}$) in two of the schools was measured using energy meters, as shown in AP 4. In one of the schools, it was

calculated by subtracting E_{SH} and E_{DHW} from the district heating utility meter. In the other schools, energy use for DHW recirculation was included in the E_{SH} .

The measured energy use for space heating, E_{SH} , was weather-normalised with the help of monthly Energy Index (EI) data supplied by the Swedish Meteorological and Hydrological Institute (SMHI) [33] for each of the schools' locations. Energy Index data is a combination of heating degree hours and the effects of solar radiation and wind. The ratio between the normal and actual monthly Energy Index data gives a factor by which the measured E_{SH} can be multiplied in order to achieve a weather-normalised E_{SH} . When comparisons between calculated and measured E_{SH} were made, weather-normalisation was a requirement according to BEN 2 [23].

2.2.5 Measurement of ventilation rates, indoor air temperatures, CO₂ concentrations, occupancy rates and presence times

Thermal comfort and IAQ were analysed with the help of the available measurements of VRs, indoor air temperatures, CO₂ concentrations and movement detection sensors. The measurements were collected with a help of the DCV systems, which were integrated parts of the ventilation systems in each of the schools. Indoor air temperatures, CO₂ concentrations and movement detection were used to control the VRs of the air supplied to the classrooms and group rooms. The measurements were performed during both the heating and cooling seasons. The heating season was considered to last from October to April and the cooling season from May to September. Indoor air temperatures were measured in each of 144 classrooms and CO₂ concentrations in each of 61 school classrooms. In two of the schools, temperature/CO₂ sensors were positioned inside the classrooms next to the doors and in another four schools they were placed inside the main exhaust ventilation duct for every classroom. VR measurements were carried out in the centralised air-handling units. Each of the studied schools had several centralised air handling units supplying air to the entire school. The number of available parameters per school, measurement periods, measurement data resolution and set points for DCVs, and the type and accuracy of the measuring sensors were described in AP 3.

Data collection of the user-related parameters occupancy rate and occupants' presence time are described in AP 3 and AP 4. In order to quantify the occupancy rates in the studied schools, the numbers of enrolled pupils and full-time employees were used. The occupants' presence times were measured by counting signals from movement detection sensors installed in the demand-controlled ventilation system. The measured average presence times in the schools' classrooms was used as the presence time for the schools. Unfortunately, the sensors used only detected movement and not the actual number of occupants at any given time. Movement detection sensors were installed in four of the schools' DCV systems.

2.2.6 Interviews with operation and maintenance personnel

It was not possible to measure two of the user-related parameters, namely solar/blind shading and airing, as no measuring equipment had been installed in the schools. An alternative method to investigate these two parameters was chosen and this was by interviewing the operation and maintenance personnel. Other information collected during the interviews concerned their experiences, from an operational point of view, of low-energy school buildings. In five of the seven schools, telephone interviews with the operation and maintenance personnel were conducted during May 2019. The interviewed persons and their professional positions are presented in Table 8.

Table 8. Interviewed personnel and their position

School	Position of interviewed person
S	Energy and HVAC manager employed by the owner of the school buildings
K	Operating technician employed by the owner of the school buildings
Vi	Manager of the energy department, employed by the owner of the school buildings
Ve	Operating technician, employed by the owner of the school buildings
St	Manager/administrator, employed by the owner of the school buildings

The questions asked during the interviews covered the following topics:

- Airing: could windows be opened, how often and were there any complaints from the users?
- Solar shading: operation, function, control, and complaints from the users.
- Domestic hot water use: possible reasons for discrepancies between calculated and measured values, complaints from the users.
- Demand control ventilation: control systems, optimisation, complaints from both the users and operation and maintenance personnel.
- Indoor air temperature: achievement of setpoints, complaints from the users.
- Tenant electricity: possible reasons for discrepancies between calculated and measured values, complaints from the users.
- Optimisation and adjustments of heating and ventilation systems: difficulties and lessons learned.
- Recommendations to others when designing low-energy school buildings in the near future.

2.2.7 Building simulations

To determine how much the studied user-related parameters influenced the calculated EPs in three of the schools, building energy simulations were performed. The details are described in AP 5. The simulation models were built during the respective design phases and were created in the dynamic simulation program

IDA ICE [31]. IDA ICE has been validated according to ASHRAE 140-2004 and EN 15255-2007 [43], [44]. The measured values of the user-related parameters indoor air temperature during the heating season, occupancy rate, and E_{DHW} and E_{TE} were randomly chosen, with even distributions, as input data for the simulation models for all seven schools. Another two user-related parameters, the measured VR and ventilation running time, were used as well. These two parameters were implemented in the simulation models based on the measured energy used to run the ventilation system, E_{BP} .

25 randomly chosen combinations of measured user-related parameters were then used as input data for these three simulation models. These simulations were performed to find the distribution of calculated EPs based on measured user-related input data. 25 simulations were assumed to be sufficient to find relevant distributions in calculated EPs by varying the user-related parameters in all three models. If thousands of simulations had been performed, the results would probably have defined the type of distribution, but this was not the aim of the study.

To determine which of the user-related parameters had the most or the least influence on the calculated EPs, other sets of simulations were performed. Ten simulations were carried out, two simulations per user-related parameter. One user-related parameter was set to its lowest and thereafter to its highest measured values, while the other parameters were set to their average measured values in the respective simulations. The same principle was used for all five user-related parameters.

3 Results

This chapter highlights the results from AP 1 to AP 5 and summarizes the responses from the interviews with the operation and maintenance personnel with the aim of providing answers to the research questions.

3.1 AP 1

The aim of this publication was to investigate the studied hotels' measured energy use and which of the parameters that had extensive influence on this energy use. In order to optimize energy use when designing new hotel buildings or carrying out retrofits, these parameters need to be considered.

To conduct this work, a case study of Hotel J in Stockholm was initiated. The other four hotels were also included in this study to determine whether the parameters influencing energy use in Hotel J were the same as those in the other hotels. To determine which parameters had extensive influence on energy use, statistical regression analysis was used to investigate the correlations between the measured independent variables and energy use in all five hotels.

Of a total energy use of 3050 MWh/year in Hotel J, during 2005, the district heating system accounted for 50 percent, the use of electricity for 39.5 percent and the district cooling system for 10.5 percent. About 60 percent of the district heating energy use was used for space heating and 40 percent for the domestic hot water supply. Disaggregation of the electricity use showed that approximately 50 percent of the electricity was used to run the building services, such as ventilation fans and pumps, 31 percent was used for lighting, and the remaining 19 percent for the kitchen appliances. District cooling was used for comfort cooling. The annual averages and standard deviations of total energy and electricity energy use in the hotels in the period from 1996 to 2004 are shown in Table 9. The number of annually registered guest nights is shown in Table 10. The coefficients of determination, R^2 , are shown in Tables 11 and 12 for the independent variables heating degree days (HDD), number of guest nights and number of food covers sold, and these were used to explain the energy uses of the dependent variables heating energy use and electricity energy use.

Table 9. Annual energy use per hotel based on measurement data collected from 1996 to 2004 (except for Hotel A, from 1998 to 2004). The area m^2 refers to A_{temp} .

	Hotel J	Hotel K	Hotel M	Hotel C	Hotel A
	Energy/ [kWh/(m^2 year)]				
Total average energy use	269	288	207	353	203
Standard deviation of total energy use	16	27	21	15	22
Electricity, average energy use	124	106	87	131	113
Standard deviation of electrical energy use	15	14	7	6	19

Table 10. Annual number of registered guest nights per hotel, based on data collected from 1996 to 2004 (for Hotel A, from 1998 to 2004).

	Hotel J	Hotel K	Hotel M	Hotel C	Hotel A
	Annual number of guest nights				
Average	69 812	89 535	127 724	110 777	105 710
Standard deviation	7 560	14 177	9 712	5 161	6 947

The total average energy uses varied from 203 kWh/(m^2 year) to 353 kWh/(m^2 year), i.e. by a factor of 1.7, with a standard deviation varying from 4 to 11 percent of the average energy use of the five hotels. The total average electricity use varied from 87 to 131 kWh/(m^2 year), i.e. by a factor of 1.5, with a standard deviation from 5 to 17 percent of the average electricity use.

The linear regression analysis for the five hotels, presented in Tables 11 and 12, showed the parameters that could explain the heating and electricity energy use related to three independent variables: HDD, number of guest nights and number of food covers sold. HDD was a statistically strong factor explaining heating energy use in Hotel J and Hotel C, as the R^2 value was 0.83, while for Hotel A, HDD was a significant factor explaining the heating energy use. In two of the hotels, the explanation is weak, as the R^2 value is below 0.6. Two other independent variables, the number of guest nights and number of food covers sold, could not explain the heating energy use due to their low R^2 values.

None of the measured independent variables could explain the electrical energy use, due to the low R^2 values, see Table 12. A high electrical power base load could be a possible cause of the low R^2 values. The measured electricity power base load was about 50 percent of the peak load in Hotel J. A high power base load implied that none of the parameters could be correlated to the electricity use.

Table 11. R^2 values explaining measured weather-normalized annual heat energy use for three independent variables (HDD, number of guest nights and food covers sold), based on figures from 1998 to 2004.

	Hotel J	Hotel K	Hotel M	Hotel C	Hotel A
	R^2				
HDD	0.83	0.57	0.57	0.83	0.65
Number of guest nights	0.20	0.42	0.53	0.32	0.60
Number of food covers sold	0.00	0.48	0.47	0.01	0.43

Table 12. R² values explaining the measured annual electricity energy use for several independent variables (HDD, number of guest nights and food covers sold), based on figures from 1998 to 2004

	Hotel J	Hotel K	Hotel M	Hotel C	Hotel A
			R ²		
HDD	0.19	0.01	0.30	0.05	0.00
Number of guest nights	0.00	0.00	0.09	0.01	0.16
Number of food covers sold	0.00	0.01	0.11	0.07	0.44

Table 13. Information about additional facilities in the respective hotels.

Hotel	J	K	M	C	A
Number of conference rooms	17	5	-	8	17
Restaurant facilities	Yes	Yes	Yes	Yes	Yes
Indoor pool	No	Yes	No	No	No

The regression analysis showed that the hotels were unique and differed considerably in terms of energy use, even though they were all located in the same city and offered services at comparable levels. Findings at one hotel could not be seen in similar hotels in the group with comparable services, of comparable age, etc. Additional facilities, presented in Table 13, were other possible aspects that could have influenced the energy use, for example, the number of conference guests and the energy use for pool heating. Unfortunately, the influence of these factors was not quantified and, therefore, could not be evaluated.

Another aspect noticed during the study was that the operation and maintenance personnel did not have access to any user-friendly manuals or any education/training material regarding energy saving measures for the different building services. If these had been available, they would have been able to carry out energy auditing/monitoring, assess the building's energy use and determine points of interest for energy efficiency measures and, possibly, improve their building's energy performance.

3.2 AP 2

The aim in this publication was to present the schools and their predicted user-related parameters influencing their calculated EPs that had been taken into account during the schools' design phases. The publication compares the schools' calculated energy uses with the Swedish national building energy requirements.

To be able to conduct this work, a compilation of the information specified in the building energy use calculation reports for each of the seven newly built low-energy schools was made.

The average calculated building energy use in the schools was 48 kWh/(m² year). The average low-energy energy requirement was 64 kWh/(m² year). This meant that the schools complied with the low-energy building requirements, which was

assumed, in this study, to be 75 percent of the Swedish national building energy requirements. The calculated energy use and low-energy requirements are shown in Table 14 for each of the schools. The results showed that of the calculated EPs, the energy for domestic hot water, E_{DHW} , accounted for 9 percent, the energy for building property electricity, E_{BP} , for 32 percent, and the remaining 59 percent was energy for space heating, E_{SH} , for all the schools together. 41 percent of the calculated EPs depended on the user-related parameters E_{DHW} and E_{BP} . E_{BP} in the schools was mainly comprised of the electrical energy used to run ventilation fans. The mechanical ventilation systems were balanced and demand-controlled, meaning that the electricity used to run the ventilation systems was assumed to be a user-related parameter.

Table 14. The low-energy requirements and calculated values of EP, E_{SH} , E_{BP} , E_{DHW} and E_{TE} for the seven low-energy schools shown as purchased energy. The area m^2 refers to A_{temp} .

School	Energy/ [kWh/(m^2 year)]						
	S	N	K	B	Vi	Ve	St
Low-energy requirement	41	68	60	56	60	66	95
Calculated EP	38	62	38	38	51	40	66
Calculated E_{SH}	21	45	25	25	43	21	16
Calculated E_{BP}	13	13	9	12	6	15	38
Calculated E_{DHW}	4	4	4	1	2	4	12
Calculated E_{TE}	8	19	8	16	17	28	5

The calculated energy uses due to the user-related parameters, shown in Table 14, varied considerably. For example, the predicted energy for domestic hot water, E_{DHW} , varied from 1 to 12 kWh/(m^2 year), for E_{BP} from 6 to 38 kWh/(m^2 year), and for E_{TE} from 5 to 28 kWh/(m^2 year). The predicted ventilation running times varied from 39 to 52 weeks per year, as shown in AP 2. These variations illustrate the difficulties encountered when predicting and calculating the influence of user-related parameters on a building's energy use, even though all the schools were very well insulated, had been built during the same period, were airtight, had DCV systems and had the same intended usage. The original energy calculations for the schools were carried out separately from each other. Due to the large variations in energy use caused by the predicted user-related parameters in reality, the results support the idea that the building sector needs more reference data on the influence of user-related parameters on energy use to be able to accurately calculate building energy use.

3.3 AP 3

The aim of this paper was to investigate the achieved thermal comfort and IAQ in the studied low-energy schools. As the schools' thermal comfort and IAQ levels were designed to comply with the Swedish national regulations and the international standard EN 15251, the paper investigated whether the schools complied with the standards and regulations in terms of measured indoor air temperatures, CO₂ concentrations in the classrooms and VRs.

During an almost one-year period, including both the heating and cooling seasons, indoor air temperatures were measured in six of the schools in a total 144 classrooms and the CO₂ concentrations were measured in four of the schools in a total of 61 classrooms. The measurements were carried out at 5- to 10-minute intervals and the results were presented and analysed for weekdays from 07:30 to 16:00. The occupants' presence times were measured by using movement detection sensors installed in four of the schools.

The results showed that both the indoor air temperatures and the CO₂ concentrations in the majority of the classrooms complied with the Swedish national regulations issued by Arbetsmiljöverket (the Swedish Work Environment Authority) [45] and Folkhälsomyndigheten (the Swedish Public Health Agency) [46], as well as with the international standard EN 15251 [47]. The average measured presence times were from 1200 to 1776 h/year, with standard deviations between 400 and 795 h/year.

During the heating season, the majority of measured indoor air temperatures were within the Category II limits of EN 15251 as well as within the Swedish Work Environment Authority regulation limits, with temperatures from 20 to 24 °C. The Category II limits correspond to having 15 percent dissatisfied occupants. In about 25 classrooms, for about half of the time, a somewhat cold climate was identified, with temperatures below 20 °C.

During the cooling season, most of the measured indoor air temperatures were below 26 °C, which complied with the Category II limits of EN 15251 and Arbetsmiljöverket.

The 90 percentile of CO₂ concentrations measured in 60 of 61 classrooms were below 1000 ppm, during both the heating and cooling seasons, between 07:30 and 16:00 on weekdays. 1000 ppm fulfils the recommendations of Arbetsmiljöverket and Category II limits in EN 15251, which means having 20 percent dissatisfied occupants. CO₂ long-term measurement data from rooms with varying occupancies must be carefully studied as a peak CO₂ concentration could be hidden among the average daily concentrations, including during non-relevant periods when no pupils are present.

The median VRs in five of the seven schools, between 07:30 and 16:00 on weekdays and when measured for the entire floor areas, met the design criterion of

10 l/(s person) according to Category I in EN 15215. Four of the schools achieved median VR levels of 16 l/(s person), which meant having a maximum of 10 percent dissatisfied occupants.

3.4 AP 4

The aim of this article was to provide information as to whether measured building energy use complied with the calculated values in seven low-energy schools. It included measurements of the user-related parameters and a study of their influence on the building energy use as well as an investigation into which of the parameters that had the most significant influence on the building energy use. The article investigated whether the measurements could verify that the schools were low-energy schools.

The building energy uses and several of the user-related parameters were measured in seven low-energy schools over a one-year period. The measurement data was then compared to the calculated energy uses. The calculations were conducted during the schools' design phases by professional energy engineers, independently of each other, as each building project had been conducted independently. The coefficient of determination, R^2 , was used to investigate the correlations between independent and dependent variables.

The measurement data showed that the schools were low-energy schools as their measured EPs were below the low-energy requirements, set in this study at 75 percent of the Swedish national building energy requirements. The low-energy requirements were presented in Table 14. Table 15 shows the measured amounts of energy use.

Table 15. Measured energy use, in terms of purchased energy, in seven low-energy schools. Bold numbers indicate the highest and lowest uses. The area m^2 refers to A_{temp} .

School	Energy/ [kWh/(m^2 year)]							Average/ St.dev.
	S	N	K	B	Vi	Ve	St	
EP	34	51	48	26	50	56	79	49/ 17
E_{SH}	12	33	29	10	42	29	63	31/ 18
E_{BP}	18	11	14	9	6	20	10	13/ 5
E_{DHW}	4	3	3	1	2	7	6	4/ 2
$E_{DHW-rec}$		4	3	6				4/ 2
E_{TE}	22	19	32	24	13	48	26	26/ 11

All measured energy uses for EP, E_{SH} , E_{BP} , E_{DHW} , $E_{DHW-rec}$ and E_{TE} were shown to have large variations between the schools. The measured user-related parameters varied widely: E_{BP} from 6 to 20 kWh/(m^2 year), a factor of 3.3; E_{DHW} from 1 to 7 kWh/(m^2 year), a factor of 7; and E_{TE} from 13 to 48 kWh/(m^2 year), a factor of 3.7. Such variations not only illustrated the difficulties in predicting user-related

parameters and the need for reference values during the design phase, but also the importance of other parameters, such as having balanced space heating systems, good building operation practice, and achieving thermal comfort and IAQ during operational phase.

E_{BP} and E_{DHW} , both user-related parameters, together accounted for about 33 percent of the EP. Part of the E_{SH} is made up of user-related parameters, i.e. of the E_{TE} and the presence of occupants, due to their free heat emission influencing energy needs for space heating. This implied that user-related parameters had a significant influence on the EP in low-energy school buildings.

The regression analysis of the measured energy use and user-related parameters showed that the E_{SH} could be explained by the indoor air temperatures as the R^2 value was 0.63, which is a statistically strong factor. This means that the indoor air temperature would have had a significant influence on the E_{SH} . This, in turn, implies that the alignment between predicted and measured indoor air temperatures during the heating season must be achieved in order to decrease the discrepancies between the calculated and measured energy use for space heating. The E_{BP} can be explained by the VRs and ventilation operating times because the R^2 was above 0.86, which is a statistically strong factor. This means that measured ventilation rates and ventilation running times need to be aligned with predicted values during the design phase in order to minimize the discrepancies between the calculated and measured E_{BP} .

The measured E_{BP} , E_{DHW} and E_{TE} cannot be explained by the occupancy rates due to the low coefficient of determination, R^2 . It was not possible to quantify two other user-related parameters influencing E_{SH} , airing and solar shading, as no measuring equipment had been installed. It was, however, possible to provide feedback regarding these two parameters thanks to the interviews carried out with the operation and maintenance personnel, presented in Section 3.6.1.

3.5 AP 5

The aim of this publication was to investigate how large differences in calculated EPs for low-energy school buildings can be generated by only varying the user-related parameters. The publication also investigated which of the parameters had the most extensive influence and least influence on the calculated EPs. These user-related parameters, used as input data, were measured in real applications and, therefore, provided values that would be possible to attain in other instances. The measured user-related parameters were presented in Table 16 and in AP 4. All other parameters in the building simulation models were left unchanged.

To investigate the aim, the measured user-related parameters, shown in Table 16, were randomly chosen in sets of 25 combinations, with an even probability of all

possible alternatives, and then used as input data in three of the seven school building energy simulation models. All other parameters figuring in the models remained constant. The simulation models had been created during real school projects by professionals, independently of each other and prior to this research project.

Table 16. The measured user-related parameters in seven low-energy schools used as input values in the simulations. Average and standard deviation values were calculated from the measured values. Indoor air temperature was an average value measured during the heating season. E_{DHW} is presented in thermal energy units. Bold numbers indicate minimum and maximum values for each parameter. The area m^2 refers to A_{temp} .

School	Indoor air temperature/ (°C)	Occupancy rate/ (person/m ²)	E_{DHW} / [kWh/(m ² year)]	E_{TE} / [kWh/(m ² year)]	E_{BP} / [kWh/(m ² year)]
S	20.2	0.052	4.3	22.3	17.6
N	21.7	0.054	3.1	19.0	11.4
K	20.5	0.05	3.1	31.9	13.9
B	21.5	0.062	2.4	24.2	8.8
Vi	21.5	0.132	1.7	13.3	6.1
Ve	21.3	0.067	6.7	48.2	20.1
St	23.4	0.067	6.4	25.5	10.1
Average	21.4	0.069	4.0	26.3	12.6
St. deviation	0.7	0.027	1.9	11.2	5.0

The results, shown in Figure 20, indicated that by only varying the measured user-related parameters, the calculated EPs could vary from 30 to 160 kWh/(m² year) in all three simulation models. The ratio between the maximum and minimum calculated energy use is about four or five to one. There is an almost linear distribution of calculated EPs for each of the simulated schools. By excluding extreme results from the EP plots, and by only taking into consideration the EP values from 10 to 90 percent from Figure 20, there were still large discrepancies, 38 to 110 kWh/(m² year), a factor of 2.9.

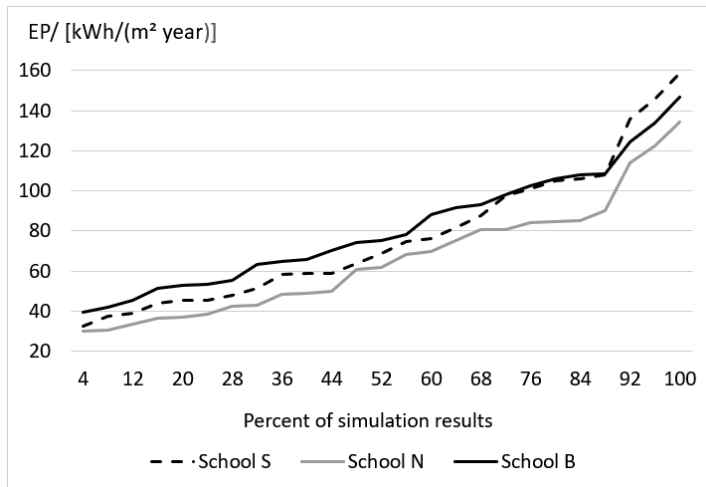

Figure 20. EP results from 25 simulations for School S, School N and School B. Thermal energy is included in the E_{SH} and E_{DHW} . The area m^2 refers to A_{temp} .

In order to investigate the influence of each user-related parameter on the calculated EPs, each of the parameters was set to its minimum and thereafter maximum value and the other parameters, from Table 16, to their average values. One simulation for the minimum and one for the maximum value, as shown in Table 16, per parameter were conducted.

The set points used for indoor air temperatures during the heating season and the energy used to run demand-controlled ventilation systems, presented in Figure 21, were shown to have the greatest influence on the calculated EPs in all three models. Varying the occupancy rates and E_{DHW} had the least influence on building energy use. The energy use, to provide the electricity to run appliances and lighting in areas occupied by the pupils and teachers, was not taken into account in the building energy performance EP. However, its free heat emissions did contribute to the space heating. These emissions were also shown to be a user-related parameter influencing building energy use, though to a lesser extent than the indoor air temperatures and VRs. The occupancy rates and E_{DHW} were shown to have the least influence of all the studied parameters on the calculated EPs. However, attention must still be paid to these two parameters when making predictions in EP calculations.

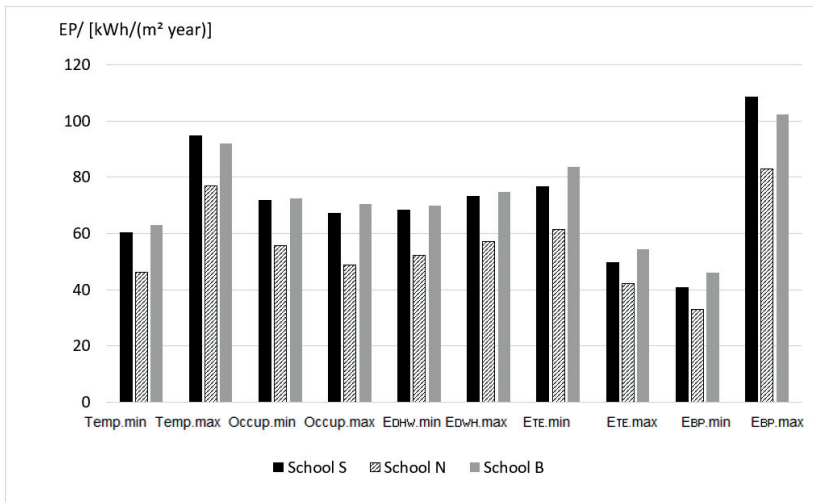

Figure 21. Calculated EPs in School S, N, and B, for which one user-related parameter was set to its minimum and thereafter to its maximum measured value, while the other parameters were set to their average values. Minimum, maximum and average values according to Table 16. The area m^2 refers to A_{temp} .

The calculated EPs showed that large variations were created when varying the user-related parameters as input data for the building energy simulation models. This implies that the user-related parameters had an extensive influence on the building energy use. Consequently, energy engineers need to carry out qualitative and quantitative analyses of this input data in order to improve the predictions of the user-related parameters in energy calculations based on specific project information.

3.6 Results from interviews with the operation and maintenance personnel

The aim of the interviews with the operation and maintenance personnel was to gather information about their experiences of the user-related parameters. A summary of the answers from the interviews is given in this section. The subjects of the questions used during the interviews are listed in Section 2.2.6.

3.6.1 Airing and solar shading

According to the operation and maintenance personnel, airing was very seldom used during the heating season. There were only a few windows that were openable in the classrooms and group rooms, which meant that the opportunities for opening windows were very limited. During the cooling season, airing was perceived to have been used more frequently. Solar shading was experienced by the operation and maintenance personnel to functioned very well and there were no complaints from the users.

3.6.2 Domestic hot water use

The domestic hot water systems had functioned very well and there were no recorded complaints.

3.6.3 Ventilation systems

In general, the ventilation systems functioned very well except in one school where the users complained about the air convection from the ventilation system. In another school, some of the actuators in the ventilation dampers and movement detection sensors had needed to be replaced. In yet another school, the kitchen personnel had complained about the functioning of the ventilation system. In this school, the ventilation unit for the kitchen also served the surrounding rooms.

3.6.4 Indoor air temperatures

Indoor air temperatures were perceived by the interviewed personnel to be satisfactory. Some small rooms and some parts of one school had been cold and complaints from the users had been recorded. Complaints about summertime temperatures in one of the schools had been reported.

3.6.5 Time required for optimizing and balancing HVAC systems

For optimizing and balancing, space heating and ventilation systems require about one heating season or up to one year for simpler systems, and up to two years for more technically advanced systems, such as GSHP systems.

3.6.6 Recommendations for future low-energy schools

The operation and maintenance personnel were also given the opportunity to recommend, based on their experiences, what should be improved and given attention to in the future.

- Having a separate ventilation unit just serving kitchen areas. The unit should be separated from the other spaces due to different operating times, and because contaminated exhaust air could cause the kitchen ventilation unit to malfunction.
- DCV and GSHP installations are usually separated from the BAS, as they both often have their own integrated control systems. Instead, it was suggested that these systems should be integrated with the BAS, which the operation and maintenance personnel were trained to use and had experience of operating.
- The advanced systems required training in order to operate them.
- The DCVs have many mechanical parts, which increases service and maintenance costs. They wished that there were fewer mechanically active parts. Some respondents recommended constant air volume ventilation in combination with movement detection sensors and better control of the ventilation running time schedules.
- The operation and maintenance personnel need to be trained in the new technologies installed in the buildings, in order to operate them at optimum levels.
- The construction of simpler buildings with low operation and maintenance demands, and lower capital costs.
- Large areas of glazing should be avoided due to problems with solar radiation and cold air draughts.
- Built-in underfloor space heating systems should be avoided, as they do not function very well.

4 Discussion

This chapter starts with a discussion of the user-related parameters as found in the literature and those analysed in this research study. User-related parameters specified in BEN and measured in the school study are discussed in the following section. The chapter continues with an analysis of the measured thermal comfort and indoor air quality in the studied schools. This is followed by a discussion of the reporting systems and technical knowledge requirements for operating the hotels and schools. It continues with a comparison and discussion of the total energy use in the studied hotels and low-energy schools. Finally, the discrepancies between calculated and measured building energy use in the studied schools are discussed and suggestions made for future work to minimize them.

4.1 User-related parameters

In this section, user-related parameters and their relationships to building energy use are defined, analysed and discussed. The vast majority of the literature references in this thesis use the term “occupant behaviour” when describing occupants and their relationships to a building and its energy use. In this study, the author has decided to use the term “user-related parameters” instead of “occupant behaviour”. This is for two reasons. The first is that, in the Swedish language the term “*brukarrelaterade*” is used, which literally means “user-related”. This term has been used by engineers in Sweden when describing users and their relationships to a building when determining their influence on building energy use. The second reason for using “user-related” is that it includes both occupants and operation and maintenance personnel, who are not necessarily occupants of a building. Operation and maintenance personnel can interact remotely with a building, for example, when they adjust ventilation running times or change set-points for heating, both of which influence energy use.

There are many publications dealing with users and focusing on their behavioural aspects with regard to influencing building energy use and, in 2016 alone, the number of publications was about 200 [8]. Hong et al. [11] in a review article identifies window opening, shading/blinds operation, lighting system interaction, thermostat set point adjustment, electrical equipment use, and occupancy as

parameters for which data is needed for occupant information modelling. These parameters are the same as those identified in the BEN 2 document [23] and were used by the author in this study, as shown in Table 7. Ventilation rate and ventilation operation time were not found to be user-related parameters in the literature [11], [13]. In many of the published articles, the buildings had been naturally ventilated or mechanically ventilated with constant air volumes. In these cases, ventilation rates and the electricity needed to run the ventilation systems had not been dependent on the building's users, which implied that the ventilation rates were not user-related parameters. However, schedules for ventilation operation are normally synchronised to when a building is occupied, which implies that in the buildings with scheduled ventilation operation, the use of electricity to run a ventilation system can be identified as a user-related parameter.

4.1.1 User-related parameters in this research

Users influence the energy needed for domestic hot water supplies, E_{DHW} , by opening and closing the hot water taps, which implies that the energy for domestic hot water use depends on users' behaviour. The descriptive statistics in AP 4 show that there was no correlation between the occupancy rate, occupants' presence time and the E_{DHW} due to a low coefficient of determination, R^2 . However, the occupancy rate was not measured in real time; it was based on the number of enrolled pupils and full-time teachers during the measurement period. The measured number of occupants in real time could have generated a higher R^2 and, subsequently, a better correlation between the E_{DHW} and the occupancy rate. Sports hall facilities could not explain the E_{DHW} in the studied schools. There were, most probably, some other parameters that had an influence on the E_{DHW} but it was not possible to identify them in this study. These should be investigated in future studies. Bagge et al. [48] had come to a similar conclusion when studying 1300 apartments in Sweden, for which the occupancy rate could not explain all of the use of domestic hot water.

The energy for tenant electricity, E_{TE} , includes energy to run lighting and electrical appliances in areas occupied by pupils and teachers. This means that the E_{TE} depended partly on users' behaviour, for example, by their use of plug-in appliances such as computers, which could have been on stand-by mode during non-occupancy. Lighting in the studied schools was mainly controlled by movement detection sensors and depended indirectly on users' presence, as the lights were switched on or off after a period of non-presence. The pupils' and teachers' movement patterns and presence schedules in the schools determined the use of electricity for lighting. Electrical appliances and lighting, with its heat emission, influenced indoor air temperatures and, therefore, the energy needs for the E_{SH} . The E_{TE} was, consequently, a user-related parameter influencing the energy needs for

the E_{SH} . Electricity load profiles for lighting and appliances were, however, not studied in this research.

The set point for the indoor air temperature was assumed to be a user-related parameter in this study, as its value was indirectly affected by the users. Users' presence and their interactions with lighting and appliances, and their heat emissions, influenced indoor air temperatures. Users could also influence set points for indoor air temperatures by complaining to the building owner about thermal comfort. The operation and maintenance personnel may have adjusted set points for indoor air temperature to reach comfort expectations from the users or to balance the space heating systems in order to optimise the energy use for space heating. For these reasons, the indoor air temperature was assumed to be a user-related parameter that influenced the E_{SH} . The indoor air temperature was assumed to be user-related in the BEN 2 document [23], and by Hong et al. [11].

The studied schools had demand-controlled ventilation systems, which meant that the ventilation rates could be controlled by the indoor air temperatures, CO_2 concentrations and movement detection sensors. In two of the schools, the control of the ventilation rates depended on one of the variables, in three of the schools on two of them, and in two of the schools on all three variables together. CO_2 concentrations, indoor air temperatures and movement detection sensors were influenced by users and their interactions with the buildings. In some cases, schedules for ventilation running times had been drawn up. For example, the shortest time was in School Vi with a running time of about 3000 h/year. In other schools, the ventilation running times had been set to 8760 h/year, i.e. they were completely independent of presence schedules. However, modern building automation systems allow the ventilation running schedules to be changed by the building operator. The ventilation rates and ventilation running times were, therefore, regarded as user-related parameters, and were included in the E_{BP} . In a building with a constant ventilation rate, this parameter does not depend on the varying presence of the users. It depends on, for example, the design ventilation rate specified in the international standard EN 15251. Ventilation rates and ventilation running times, as user-related parameters for schools, were specified in BEN 1 [41], while in the latest updated version, BEN 2 [23], the ventilation rates are not specified.

The occupancy rates and the occupants' presence times show the number of occupants per unit of floor area and the time that they occupy this area. The occupants' metabolism, and their resulting free heat emissions, contribute to E_{SH} . The occupants, via their heat emission, CO_2 generation and presence, contribute to the regulation of the ventilation rates in demand-controlled ventilation systems. Occupancy rate and presence time are, therefore, in this study, regarded as user-related parameters. The number of enrolled students and full-time employees was used as the measured occupancy rate, as real time occupancy measurements were not available. Lately, several new technologies have been identified as possible

methods for use in both the building sector and research communities. These include the use of Wi-Fi signals from occupants' smart phones to identify presence and movement patterns or motion-capturing cameras/sensors (i.e. Kinect cameras) for identifying occupancy rates and presence times [13], [49]. These methods are in their early stages and need to be developed if they are to be used as a standard, cost-effective measurement method for occupancy rates and presence times. Personal integrity is one of the aspects that will have to be addressed during their development. Some research communities have developed a data mining solution, to predict occupant behaviour and schedules, based on large amounts of data. For example, by measuring the energy used for office appliances, this data can be used to generate occupancy rates and presence times [50], [51]. The occupants' presence times, in this study, were measured by using signals from movement detection sensors, which were integrated parts of the demand control ventilation systems.

Solar shading that can be operated by occupants makes it a user-related parameter. If the internal shading can be manipulated, space heating systems need to compensate for the loss of free heat emissions from solar radiation and, subsequently, the energy needed for E_{SH} during the heating season.

Airing, initiated by occupants opening windows or external doors, is a user-related parameter. During a heating season, opening windows/doors means that an uncontrolled amount of cold fresh air will enter a room, so the space heating system will need to compensate for the sudden lowering of the indoor air temperature in order to achieve the set point. By allowing the cold fresh air to enter space heated rooms, the occupants influence the energy needs for E_{SH} .

4.2 BEN specified and measured user-related parameters in the studied schools

Boverket has issued instructions, in the BEN 2 document [23], regarding how building energy calculations are to be performed and, thereafter, how the calculated energy is to be verified. The first version, BEN 1, [41] was issued in November 2016. The latest version is BEN 2 and this has been in force since July 2017. The types of buildings listed in BEN 2 are single-family residential buildings, multi-family apartment buildings, offices, child day care buildings, elementary and upper secondary schools, and universities. BEN 2 provides a list of user-related parameters that can be used to calculate building energy performance. The list covering schools is based on older references, such as STIL2 [24] from 2007, which was based on schools built in the 1990s and early 2000s. The parts covering schools need to be updated and include newer references due to the constant development of energy efficient technologies and nZEB energy requirements, which will start to be

implemented by 2021 in Sweden, according to EU Directive 2010/31/EU [2]. The studied schools were designed prior to the BEN documents being issued. In these studied school projects, the energy engineers predicted the user-related parameters independently of each other.

The BEN 2 document does not specify user-related parameters for hotel buildings. Hotel buildings, like any other new buildings, will need to comply with the nZEB requirements in the near future. For the same reasons that there are BEN specifications for schools, there is a need for specifications covering hotel buildings, not least due to the constant increase in demand for new hotels in Sweden [17] and worldwide [18]. On the other hand, hotel chains such as Scandic, which plans to double its number of hotel rooms in the near future [52], have, with the help of their own reporting system, built a data-base for energy use and specific user-related parameters. Such a database can provide input data for, among other things, user-related parameters when calculating an EP in the design phase. Single hotel owners or small hotel chains will face difficulties when calculating EPs due to the absence of a suitable database and relevant input data.

The school study, which only included seven newly built low-energy schools, is assumed to be representative as a reference group, as the schools were built with energy efficient technologies that are usually present in new schools. The studied group was also shown to comply with low-energy requirements, which will then most probably be close to future nZEB requirements. This means that, despite the low number of studied schools, the results showed large variations for all the studied user-related parameters, which means that the results and findings from the studied schools can be used as reference values for schools that will be built in future.

4.2.1 Indoor air temperatures, ventilation rates and E_{DHW} – measurements versus BEN 2 specifications

Measured and predicted indoor air temperatures, ventilation rates and E_{DHW} in the studied schools are shown in Table 17 together with the values specified in BEN 2. The average measured indoor air temperature for all seven studied schools was 21.4 °C with a standard deviation of 0.7 °C. In six of the schools, the measured average temperatures were below the BEN 2 specified level of 22 °C. Only in one of the schools was the average temperature rather high, 23.4 °C, and above the BEN 2 specified level.

Table 17. Predicted, measured and BEN specified user-related parameters: indoor air temperatures (based on measurements during the heating season); ventilation rates (showing the estimated airflows for basic and forced ventilation rates, and number of hours per day, days per week and weeks per year for each ventilation rate); and E_{DHW} (presented as thermal energy).

	Indoor air temperature/ °C		Ventilation rates/ [l/(s m ²)] Basic;forced Running time; (h;d;w);(h;d;w)		E_{DHW} / [kWh/(m ² year)]	
	Predicted set point	Measured average; median; standard dev	Predicted	Measured	Predicted	Measured
BEN	22		3;- (10;5;44);-		$2/\eta_{DHW}$	
School S	21	20.2; 20; 0.6	0.5;2.2 (7;7;52); (7;7;52)	0.33;2.2 (24;2;52) and (3;5;52); (20;5;52)	4	4.3
School N	21	21.7; 21.7; 0.6	0.5;2.7 (6;5;52); (6;5;52)	0.54;1 (8;7;52); (12;7;52)	4	3.1
School K	21	20.5; 20.4; 1	1.3;1.9 (5;5;40); (5;5;40)	0.33;1.53 (8;5;52) and (20;2;52); (12;5;52)	4	3.1
School B	21	21.5; 21.5; 0.4	1.4;2.8 -; (13;5;52)	0.2;0.77 (5;7;52); (10;7;52)	3	2.4
School Vi	22	21.5; 21.5; 0.6	-;2.6 -;(9;5;39)	-;1.57 -;(11;5;52)	2	1.7
School Ve	21	21.3; 21.3; 0.7	Unknown	0.6;2.1 (24;2;52) and (9;5;52); (15;5;52)	4	6.7
School St	21	23.4; 22.3; 2.8	Unknown	0.32;1.65 (1;7;52); (9;7;52)	11.5	6.4
Average		21.4; 21.1; 0.7				4.0

The indoor air temperature was shown, with the help of descriptive statistics and building simulations presented in AP 4 and AP 5, to be one of the user-related parameters with a significant influence on the E_{SH} . In order to minimize the discrepancies between calculated and measured EPs, the predicted indoor air temperature during the design phase needs to align with the measured value during the operational phase. The energy engineers predicting indoor air temperatures need to communicate their predictions and discuss them with relevant key actors in building construction projects, such as HVAC designers, building operators, owners and representatives from the schools, and teachers, all of whom have first-hand knowledge about schools.

A building's space heating system needs to be well balanced in order to achieve the predicted values. The achieved standard deviation of 0.7 °C, shows the range of the room temperatures within the buildings. Well balanced heating systems need to

have room temperatures with as low deviations as possible. School St, with a standard deviation of 2.8 °C, showed large variations in the indoor temperatures, which implied that their heating system needed to be balanced. Due to the unbalanced space heating system in School St, the relevance of this school is questionable regarding its indoor air temperature. However, this deviation was measured and could probably have been achievable in other schools.

The BEN 2 specified 22 °C indoor temperature was higher than the measured temperature in the studied schools. 22 °C was only achieved in School St, which was shown to have an unbalanced space heating system. The other six schools had temperatures below 22 °C, with the average temperatures varying from 20.2 to 21.7 °C, the median temperature from 20.1 to 21.7 °C, with a standard deviation of about 0.5 to 0.7 °C. The descriptive statistics regarding measured indoor air temperatures showed that in a well-balanced space heating system in the studied schools the set points for room temperatures could vary from 20.5 to 21.5 °C, with a standard deviation of 0.5 to 0.7 °C. Dahlblom et al. [53], in his comprehensive long-term measurement study of 1177 apartments with 3248 rooms in Sweden, showed a standard deviation in room temperatures of about 1.2 °C during the heating season. This implies that a standard deviation of 0.5 to 0.7 °C could indicate a well-balanced space heating system, which needs to be achieved in order to minimize the discrepancies between predicted and measured indoor air temperatures.

Measured ventilation rates and ventilation running times were shown to vary among the studied schools. The lowest measured median ventilation rate during working hours was 0.77 l/(s m²) in School B, while the highest rate was 2.2 l/(s m²) in School S, as shown in Table 17. The ventilation running times varied from 3000 h/year in School Vi to 8760 h/year in School Ve. BEN specifies 3 l/(s m²) for 2200 h/year. The measured E_{BP}, which included the use of the electricity to run the ventilation systems, varied from 6 to 20 kWh/(m² year), while BEN specifies 6.6 kWh/(m² year) to run the ventilation systems. The descriptive statistics showed that the ventilation rates and ventilation running times were significant parameters explaining the E_{BP}. These results support the need for energy engineers to predict ventilation rates and ventilation running times as accurately as possible during the design phase. Another important aspect that can be valuable to address is that they also need to communicate their predictions both to the HVAC system designers and to the operation and maintenance personnel, who need to operate the ventilation systems at predicted ventilation rates and running times during operational phase. Any deviations from the predicted ventilation rates and running times during the operational phase can generate large discrepancies between the predicted and measured E_{BP}. The differences in measured ventilation running times, 3000 to 8760 hours/year, and ventilation rates, 0.77 to 2.2 l/(s m²) during working hours, in the schools illustrated the difficulties encountered in predicting these two parameters during the design phase. It was most probably for this reason that no

single values for ventilation rates and ventilation running times were stipulated in BEN 2. These values need to be predicted separately for each school project.

The average measured E_{DHW} was 4 kWh/(m² year) with a standard deviation of 1,9 kWh/(m² year) in the studied schools, as shown in Table 17. By excluding School Vi, which was the only one that had neither a sports hall nor a kitchen facility, the average E_{DHW} was 4.3 kWh/(m² year) and the standard deviation 1.8 kWh/(m² year). Even though the schools were similar, with similar facilities, the E_{DHW} could vary, from 2.4 kWh/(m² year) to 6.7 kWh/(m² year) with an average of 4.3 kWh/(m² year). BEN 2 specifies 2 kWh/(m² year) divided by the efficiency of the domestic hot water supply. The efficiency of a domestic hot water supply from a district heating system was assumed to be 1. Based on the measured values, the average E_{DHW} of 4 kWh/(m² year) with a standard deviation of 2 kWh/(m² year) was seen more often than the BEN 2 specified 2 kWh/(m² year) in the studied schools for domestic hot water supplied by a district heating system. Although the variations in predicting the E_{DHW} ranged, for example, from 2.4 kWh/(m² year) to 6.7 kWh/(m² year) for the studied schools, they did not have a high impact on the magnitude of the EP. However, energy engineers must still predict E_{DHW} as accurately as possible in order to minimize the discrepancies between calculated and measured EP.

4.2.2 Occupancy rate and E_{TE} measurements versus BEN 2 specifications

Table 18 shows two of the user-related parameters, occupancy rate and tenant electricity. The measurements showed that the occupancy rate, in the schools that had kitchen and sports hall facilities, varied from 0.05 to 0.067 person/m². BEN 2 specifies 0.067 person/m². School Vi, with neither restaurant/kitchen nor sports hall facilities, had an occupancy rate of 0.132 person/m². The ratio of classroom floor areas to total floor area probably influenced the occupancy rate. The ratio in School Vi was high in comparison to the other schools as there were neither kitchen nor sports hall facilities inside the school building. This ratio could have been investigated further to provide a deeper analysis of the occupancy rate, but such an investigation demanded knowledge of, for example, the school's interior design. Figures 11 to 17, illustrating the floor layouts, show the variations in the school layouts. It can be noted, for example, that the number of classrooms and common areas in each school is quite different.

Table 18. Predicted, measured and BEN specified user-related parameters with regard to occupants and E_{TE} .

	Occupants/ (person/m ²) Time/ (h;d:w) Heat/ (W/person)		E_{TE} / [kWh/(m ² year)] Lighting/ (W/m ²) Time/ (h;d:w) Equipment/ (W/m ²) Time/ (h;d:w)	
	Predicted	Measured	Predicted	Measured
BEN	0.067 (6;5;44) 80		22 5 (10;5;44) 5 (10;5;44)	
School S	0.06-0.13 (7;7;52) 108	0.052 (6;5;40)	7.8 2 (11;5;52) 2 (7;5;52)	22.3
School N	0.06 (8;5;52) 120	0.054 Unknown	19 4 (11;5;52) 3.5 (8;5;52)	19.2
School K	0.058 (8;5;40) Unknown	0.05 Unknown	8 3 (8;5;40) 2 (8;5;40)	31.9
School B	0.13 (5;5;46) 108	0.062 (8;5;44)	16 6.75 (6;5;52) 4 (6;5;46)	24.2
School Vi	0.11 (9;5;39) 70	0.132 (7;5;5;40)	17 1.5 (9;5;39) 8 (9;5;39)	13.3
School Ve	Unknown (11;5;52) 80	0.067 Unknown	28 10 (11;5;52)	48.2
School St	0.11 (9;5;52) 108	0.063 (7;5;43)	4.7 2 (9;5;52)	25.5

The measured average presence times in four of the schools varied from 1205 to 1776 h/year, with a standard deviation varying from 400 to 795 h/year. In three of the four schools, the standard deviation was about 450 h/year. Johansson [54], in a similar study of 12 Swedish secondary schools (years 7 to 9), showed presence times of 1300 h/year. The presence time specified in BEN 2 is 1320 h/year. The occupancy rate contribution to the building energy use, derived by analysing the measurements and building simulation results, showed that it did not have any large influence, shown in AP 5 and illustrated in Figure 21. From the lowest occupancy rate of 0.05 person/m² to the highest of 0.132 person/m² in the building simulation models, the calculated EP decreased by 3 kWh/(m² year) thanks to the additional heat from the occupants due to metabolic heat production. All the occupants used electrical appliances, lighting and domestic hot water, but the occupancy rate and presence time correlation to E_{TE} and E_{DHW} were weak, due to a low R^2 , which was why only the occupants' metabolic heat production influenced the EP. However, energy engineers will still need to make as accurate predictions as possible for the occupancy rates and presence times during the design phase in order to minimize the discrepancies between predicted and measured EPs. These predictions need to

be communicated and discussed with the school management, HVAC designers and interior design architects.

The average measured E_{TE} was 26 kWh/(m² year) with a standard deviation of 11 kWh/(m² year), presented in Table 16. BEN 2 specifies 22 kWh/(m² year). It was not possible to correlate the E_{TE} to the measured user-related parameters occupancy rate and the average time that the schools were in operation due to the low coefficients of determination, R^2 . The calculated E_{TE} during the schools' design phases varied between 5 and 28 kWh/(m² year). Such a high variation in calculated E_{TE} indicated the difficulties of predicting E_{TE} during the design phases even though the schools had been built with similar, and energy efficient, appliances and lighting. By increasing the E_{TE} in the schools' building simulation models, presented in AP 5 and Figure 21, from the lowest measured value of 13 kWh/(m² year) to the highest of 48 kWh/(m² year), the calculated EP decreased by about 20 to 30 kWh/(m² year). Such a large decrease in the calculated EP suggests the influence of the E_{TE} and, therefore, the importance of predicting this parameter as accurately as possible. On the other hand, this parameter was difficult to control during the operational phase. The BEN 2 specified E_{TE} of 22 kWh/(m² year) was close to the average measured values in this study, but it is important to take into account its variation, which in this study was shown to be 11 kWh/(m² year).

4.2.3 Solar shading and airing

In this study, it was not possible to quantify the influence of solar shading and airing on E_{SH} as no measurement sensors for these two parameters had been installed in the studied schools. Carrying out these measurements for a limited area over a limited period of time would have involved the risk of providing very limited information, which would then have been difficult to scale up for all seven schools. With the help of the interviews with the operation and maintenance personnel and site visits, the author, using an interpretivist research approach, created a perception of these two parameters. However, the study did not quantify the influence of these parameters on building energy use. Table 19 shows the predicted parameters of solar shading and airing in the studied schools and the specified values in BEN 2. Each of the schools had made its own predictions during the design phases, with regard to solar shading and airing, independently of each other.

Table 19. Solar shading and airing predicted in the schools and specified in BEN

	Solar shading g-value	Airing/ [kWh/(m² year)]
BEN	0.65	4
School S	0.29 – 0.5	1.86
School N	0.5	2
School K	0.75	Unknown
School B	0.24 - 0.51	1.86
School Ve	0.43	Unknown
School Vi	0.1	Unknown
School St	Unknown	Unknown

The solar shading parameter shown in Table 19 includes both internal and external shading devices. The two different values for one of the schools meant that two types of shading systems had been used, depending on façade orientation. The value shown for solar shading is the solar energy transmission factor, the g-value. The interviewed operation and maintenance personnel said that no complaints had been reported by the users about the solar shading.

Airing as a user-related parameter was introduced in BEN 1 [41] but excluded from the latest version, BEN 2 [23]. Unfortunately, the predicted values were not possible to quantify in the studied schools. The interviewed technical personnel said that during the heating season airing was seldom used. On the other hand, during the cooling season, airing had been used more frequently, as there was no active comfort cooling system in any of the schools. Based on the answers from the interviews, it was assumed that the energy engineers, when predicting the influence of airing on the EP, would have taken into consideration the outdoor climate, type of ventilation system, type of comfort cooling system and the openable window areas of the classrooms. The ventilation rate of, for example, 12 l/(s person), which corresponds to 10 percent dissatisfied occupants according to EN 15251, would probably make users open windows less often than in classrooms with lower ventilation rates, for example, below 5 l/(s person), which would correspond to 30 percent dissatisfied occupants.

4.3 Measurements of thermal comfort and indoor air quality in the studied schools

The field measurements in six of the schools showed that the classrooms complied with design values specified by the Swedish Work Environment Authority [45], the Swedish Public Health Agency [46] and the international standard EN 15251 [47] in terms of measured indoor air temperatures, CO₂ concentrations and ventilation rates during the vast majority of the measurement period and in the vast majority of

the classrooms. Indicators of thermal comfort and indoor air quality, indoor air temperatures and CO₂ concentrations do not themselves guarantee acceptable thermal comfort and indoor air quality. Draughts or short circuiting between supply and exhaust air can create unacceptable levels of thermal comfort and air quality. Lately, research evaluating thermal comfort for pupils has identified the need to use child-based adaptive comfort models [21], as children can have different perceptions of thermal comfort than adults. However, this study focused on the standards and regulations, which had originated in adult-based comfort models, as the schools were designed according to these standards and regulations.

There are a number of other parameters that can influence indoor air quality, such as the presence of carbon monoxide, volatile organic compounds, radon and mould [55], but sensors to measure these parameters had not been installed in the schools and these were, therefore, not investigated. On the other hand, CO₂ concentration levels and ventilation rates can indicate acceptable indoor air quality [56]. If ventilation systems are able to maintain CO₂ concentrations at design levels in premises with high occupant densities, it is usually assumed that other pollutant levels are also acceptable, but it is not possible to verify this assumption without measurements. Wargocki and Wyon [57] and Golshan et al. [58] expressed concerns about achieving low-energy use levels and, at the same time, achieving high indoor air quality levels. Even though the studied schools were confirmed to be low-energy buildings, they provided and maintained satisfactory thermal comfort and indoor air quality levels. As the schools' measured indoor air temperatures, CO₂ concentrations and ventilation rates achieved the design values, the schools were assumed to provide acceptable thermal comfort and indoor air quality levels, and were, therefore, relevant to be used as references for future low-energy school buildings.

4.4 Reporting systems and technical knowledge requirements for operating the hotels and schools in this study

The hotel operator had been using an environmental reporting system since 1996. This system enabled all the hotels, at the time of the study about 65 in Sweden and today 280 in six countries, to be benchmarked. This meant that if any of the hotels' key performance figures started to deviate from the group goals, it would be easy to identify and an investigation could be started to take remedial measures.

No such reporting systems exist for schools, at least none are known to the author. Large municipalities in Sweden, with many schools, probably have reporting systems in which they can benchmark their schools and, from a central location, can

obtain information about their energy use. On the other hand, all municipalities provide yearly reports about purchased energy supplied to their building stock, including schools, to Statistics Sweden [59], a government agency for official statistics.

The hotel operator had widely promoted its reporting system as a way towards sustainability, both within the industry and for society in general [6], [60] and within academia [5], [61], [62]. The author does not know whether similar initiatives have been taken by municipalities in Sweden to promote their reporting systems as part of their efforts towards sustainability, apart from in the STIL 2 report [24]. STIL 2 was a one-off measure conducted in 2007 regarding data collection of energy use in Swedish schools. Even though schools and hotels have different roles in society, with, for example, hotels operating under fully commercial conditions, they have similar challenges. For example, they need to operate as cost efficiently as possible and they need to reduce their CO₂ emissions. If a hotel chain can create and maintain a reporting system, then school building owners could also create a similar system at regional or national levels. The reporting system could then be used to promote measures taken by schools towards sustainability. They would also have the potential to teach pupils about sustainability, to promote competition in energy performance between schools, to support research communities with data as well as to be put to practical use for operating and maintaining school buildings. A calculated building energy use verification process could be conducted with the help of such reporting tool.

During this study, a lack of know-how regarding energy optimisation was expressed by the operation and maintenance personnel in the hotel study. The interviews in the schools also revealed that there was a lack of proper training of the operation and maintenance personnel regarding advanced energy-efficient building services. Modern technologies demand proper documentation, technical instructions and upgraded knowledge if building services are to be operated in an energy-efficient way. Providing proper instructions, and educating and training operational personnel, would create a basis for energy-efficient building operation, including, among other things, demand control ventilation systems, building automation systems, ground source heat pump systems and energy monitoring systems.

4.5 Analysis of the energy use in the studied hotels and schools

The low-energy schools, built between 2014 and 2017, were designed to be thermally well insulated with modern energy-efficient heat recovery systems, airtight building envelopes, low specific fan powers and modern building automation systems, as shown in Table 6, all of which made it possible for them to achieve a low-energy rating. The schools were shown in AP 2 and AP 4 to be rated as low-energy buildings, as their calculated and measured building energy uses were 75 percent of the Swedish national energy requirements, as shown in Table 14 and 15. The four hotels, built between 1951 and 1971, and the one built in 1989, were located in the same region, Stockholm, belonged to the same hotel chain and offered rooms and food and beverage services at comparable levels. One of the hotels had a spa facility with a pool, four of the hotels had conference facilities, presented in Table 5, and these probably influenced the energy use. The hotels were built at a time when there were no strict national energy requirements, which was not the case when the studied schools were built. This implies that the studied hotels had a higher total energy demand in comparison to the studied schools, as shown in Table 20. Another parameter that could have influenced the energy use was operating time. The hotels were running for 24 hours a day, all year around, which meant that the ventilation systems and corridor lighting had to be in operation for 24 hours a day, which increased the total energy use in comparison to the schools. The schools' demand-controlled ventilation systems were in operation from 3000 to 8760 h/year, and the schools were occupied from 1205 to 1776 h/year. The differences in the ages of the buildings, operating times and additional facilities, such as a pool, influenced the total average energy uses for these two groups of buildings. The total average energy uses for the hotels and schools is shown in Table 20. The total energy uses included all supplied energy to the hotels and the sum of EP and E_{TE} in the schools.

Table 20. Comparisons between total energy use in five hotels and seven schools.

	Hotels	Schools
	Energy/ [kWh/(m ² year)]	Energy/ [kWh/(m ² year)]
Average measured energy use	263	76
Median measured energy use	268	70
Standard deviation	62	22
Minimum measured energy use	203	50
Maximum measured energy use	353	105

The ratio between the maximum and minimum total energy use is 1.7 in the hotels and 2.1 in the schools. Five hotels and seven schools were studied. The different number of cases per studied group can have influenced the energy use ratio and a higher ratio can probably be expected in a group with more cases. Even though the

hotels offered services at comparable levels and were located in the same city, the differences among the hotels were substantial. All the schools had been built using similar energy efficient technologies but the ratio between the highest and the lowest total energy use was greater than for the hotels. On the other hand, the difference between the maximum and minimum energy use in the hotels was 150 kWh/(m² year) and in the schools 55 kWh/(m² year). Due to their low-energy performances, the school buildings showed lower differences in the absolute values in comparison to the differences in the total energy use for the hotels.

IEA EBC Annex 53 [7] describes six parameters that influence building energy use: outdoor climate, building envelope properties, building services and energy systems, building operation and maintenance, occupants' activities and indoor climate. The first three parameters are based on the technical parameters of a building whereas the last three include human-related aspects, called user-related parameters in this thesis. A number of parameters could, therefore, be investigated to explain the differences between the minimum and maximum total energy uses, in both the hotels and schools.

In the hotels, the outdoor climate was the only one of the parameters in the IAE EBC Annex 53 that could be assumed to have a minor influence on the differences in the total energy use, as the hotels were located within the same city. The descriptive statistics in AP 1 showed that the heating energy could be explained by the outdoor climate in terms of the number of heating degree days in three of the hotels. In the other two hotels, energy use for heating could not be explained by the number of heating degree days, which was unexpected. One of these hotels, Hotel M, had three underground floors with guest rooms and the other, Hotel K, was the only hotel to have a spa facility with a pool. The underground floors and the pool could be the reasons why the number of heating degree days could not explain the heating energy use. The measured user-related parameters, the number of guest nights and number of food covers sold could not explain the heating energy use in any of the studied hotels.

The use of electricity could not be explained by the number of heating degree days, number of guest nights or number of food covers sold in the studied hotels. The number of heating degree days could not explain the use of electricity as the electricity was not used for the space heating. The hotels operated 24 h/day, seven days a week, which demanded ventilation rates at fairly constant levels, which created a high electrical power base load. A high electrical power base load could be the reason why none of the measured parameters could explain the use of electricity.

Even though there were only five similar hotels, all within the same chain, in this study, the variations in energy use were large, as shown in Tables 9 and 20. This means that making decisions based solely on total energy use, in kWh/(m² year), can have misled the management of the hotels and influenced their expectations regarding investments in energy efficiency projects. One way of attaining more

detailed information and being able to identify the energy deviations would have been to divide a hotel into its sub-systems (for space heating/cooling, ventilation, water use, pool, etc). This would have enabled benchmarking, not for an entire hotel in kWh/(m² year), but for the sub-systems. For example, the effectiveness of a space heating system would have been simpler to determine by having a benchmark value for space heating. This would help engineers in their design work and allow more accurate calculations of potential energy savings of any capital investments in a space heating system, or any other system. Obstacles that could hinder such an evaluation of the sub-systems include measuring equipment and data logistics as well as the know-how of a hotel's operation personnel.

There are many other parameters that can influence energy use, such as the building envelope properties, building services and energy systems, building operation and maintenance, indoor climate, and occupant activities in terms of accommodated conference guests. Data concerning these parameters was, however, not available in this study and their influence on the differences in the energy use could, therefore, not be evaluated. However, these parameters need to be addressed when calculating energy use during the design phase and during the operational phase, in order to minimize the discrepancies between calculated and measured energy use.

In the schools case study, the measured user-related parameters E_{DHW} , E_{BP} and E_{TE} , contributed 57 percent of the total measured average energy use in the schools. According to AP 5, the variations of the user-related parameters, for example, the minimum measured E_{TE} of 13 kWh/(m² year) varying to a maximum of 48 kWh/(m² year), the measured average indoor temperature during the heating season varying from 20.2 °C to 23.4 °C, and the measured E_{BP} of 6 kWh/(m² year) varying to a maximum of 20 kWh/(m² year), as shown in Table 21, contributed significantly to the differences in the total energy use. The various parameters and their contributions to the total energy use are presented in Table 21. Variations in building-related parameters, called technical parameters in this thesis, such as outdoor climate, building envelope properties and energy systems were also found to contribute to the differences in the total energy use. Rough estimates of the contributions to the differences in total energy use made by the outdoor climate, overall thermal transmittance values, and efficiencies of building energy systems were made to find the orders of magnitude of these two parameters. The estimations are shown in Table 21. Increases in the schools' designed air infiltration rates, heat recovery efficiencies and the ratio between building envelope area and building volume, according to design values presented in Table 6, were, with the help of regression analysis, not found to correlate to the increase in the E_{SH} and these building parameters were, therefore, not shown in Table 21.

Table 21. The contributions to the total calculated energy uses in the studied low-energy schools due to changes in the technical parameters, shown in Table 6, and in the user-related parameters, shown in Figure 21. The area m^2 refers to A_{temp} .

Changed parameters	Difference in total energy use/ [kWh/(m^2 year)]
Technical parameters	
Energy system, changed from ground source heat pump to district heating supply	+ 20
Overall thermal transmittance, increased from 0.18 to 0.29 [W/(m^2 K)]	+ 15
Outdoor climate, lowered from the warmest to the coldest level	+ 3
User-related parameters	
E_{BP} , increased from 6 to 20 [kWh/(m^2 year)]	+ 58
Indoor air temperature, increased from 20.2 to 23.4 °C	+ 30
E_{TE} , increased from 13 to 48 [kWh/(m^2 year)]	+ 15
E_{DHW} , increased from 1.7 to 6.7 [kWh/(m^2 year)]	+ 5
Occupancy rate, increased from 0.05 to 0.13 person/ m^2	+2

The figures in Table 21 show that the user-related parameters in the low-energy schools dominated over the technical parameters in the generation of the differences in the total energy use. This is in line with recent studies of low-energy school buildings [9], [25], [27]. These results are also in line with those of the research communities where efforts are being made to include both the technical and user-related aspects in a more comprehensive way in building energy simulation tools [7], [13], [63].

Research studies of low-energy hotel buildings and parameters influencing their energy performance were not found in the literature. Similar studies to this school study should be performed for low-energy hotel buildings. Such studies should investigate the magnitude and the influence of user-related parameters on building energy use. They would then be able to explain the parameters and their contributions to the differences in total energy uses in a similar way to the school study. The building sector would, in turn, become better at predicting building energy use and, subsequently, improve energy efficiency.

4.6 Managing discrepancies between calculated and measured energy use

The discrepancies between the calculated and measured EPs, in the studied schools, varied from -44 to +28 percent, as shown in Table 22 and Figure 22. The average calculated EPs and average measured EPs for the seven schools were almost the same, 48 kWh/(m^2 year) and 49 kWh/(m^2 year) respectively, see Table 23. On the other hand, an individual school could have a large discrepancy between calculated and measured EP, for example, -44 percent or +28 percent, see Table 22. For each school built in Sweden, the building energy use calculation needs to be performed and thereafter verified during the operational phase, as illustrated in Figure 1. This

means that each new school needs to be studied and analysed individually regarding its energy use. Using only the average values of the studied group could lead to incomplete conclusions and important information about the differences between the individual school buildings could be lost.

Table 22. Differences between calculated and measured values of EP, E_{SH}, E_{BP}, E_{DHW} and E_{TE} for each of the seven low-energy schools. Bold numbers indicate the ranges of each parameter.

	School						
	S	N	K	B	Vi	Ve	St
EP diff/ %	-12	-21	+19	-44	-2	+28	+16
E _{SH} diff/ %	-43	-24	+12	+58.7	-3	+39	+284
E _{BP} diff/ %	+39	-12	+51	-22.8	+7	+34	-73
E _{DHW} diff/ %	+7	-22	-22	+20.0	-15	+67	-44
E _{TE} diff/ %	+185	+1	+300	+50	-20	+70	+442

Table 23. Measured and calculated average building energy use for the seven low-energy schools.

Energy/ [kWh/(m ² year)]	EP	E _{SH}	E _{BP}	E _{DHW}	E _{TE}
Measured average energy use	49	31	13	4	26
Standard deviation	17	18	5	2	11
Calculated average energy use	48	28	15	4	14
Standard deviation	12	11	11	3	8

The Swedish building industry, which has been carrying out building energy calculations for the last 15 years following the introduction of the Swedish national building energy requirements in 2006 [64], still experiences challenges when aligning calculated and measured EPs. The studied references [9], [25], [26], [27] show that there are discrepancies between calculated and measured energy use in recently built schools, which has also been shown in this study and is illustrated in Figure 22 and Tables 22 and 23.

A margin of safety of ± 10 percent of the calculated energy use, illustrated in Figure 22, when the calculated energy must be verified by the measured energy, is a praxis in the Swedish building industry. Only one of the studied schools was within this margin, which is seen between the dashed lines in Figure 22. The other schools were outside the margin. One way to stay within a given margin of safety would be to increase the limits of the margin. According to this study, and as illustrated in Table 22, the margin of safety would have to be -44 to +28 percent. If measurements had been performed in more than these seven schools, the margins would probably have needed to be even greater. However, this higher safety margin would mean that it would be necessary to invest more in energy efficient technologies. Extra costs, caused by increasing the margin of safety, would probably not be welcomed by the building industry and cannot, therefore, be proposed as a solution.

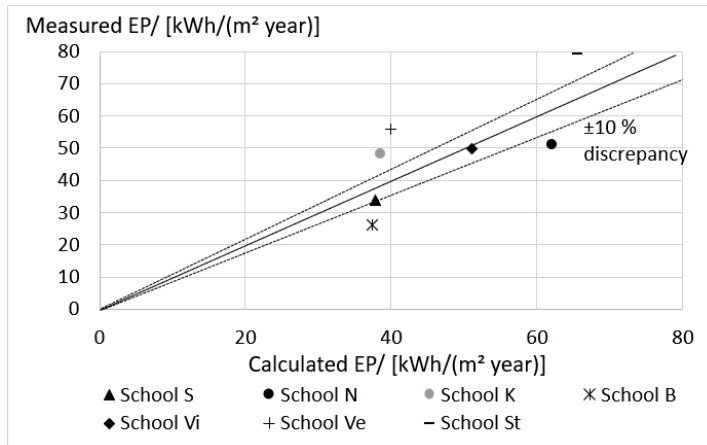

Figure 22. Calculated vs. measured EPs in the studied schools. The distance between the dashed lines represents a ± 10 percent deviation from the calculated values. The area m^2 refers to A_{temp} .

One alternative that would contribute to minimizing the discrepancies would be to improve the building energy calculations. In Table 21 it is obvious that the user-related parameters dominate in comparison to the technical parameters in creating the differences in the building energy calculations. However, the user-related parameters are difficult to predict and calculate, which was shown in AP 2, AP 4 and AP 5. Nevertheless, the technical parameters, such as the building envelope and building services, need to be calculated as accurately as possible when calculating energy use. The BEN 2 document [23] specifies the list of user-related parameters that can help energy engineers predict user-related parameters in the early design phases of a building construction project. In the later phases, when more input data and knowledge about the building and the user profiles are known, the engineers should update their predictions regarding user-related parameters based on the updated project information. The predictions regarding user-related parameters need to be communicated and discussed with relevant key actors in a building construction project. These actors could be architects, HVAC engineers, building automation system and electrical installation designers as well as the building's operator, its owner and representatives from the schools, and teachers, all of whom have first-hand knowledge about the running of schools. This would probably help with the prediction of the parameters and could, therefore, minimize the discrepancies between calculated and measured energy use, which will, subsequently, enable optimized choices of energy efficient technologies. However, random details concerning the user-related parameters will still be unknown during the design phase. For example, it is not possible to know in advance precisely how many pupils will attend a particular school.

Another alternative would be to use probabilistic building energy simulations, in which the building simulation software would predict the most probable distribution

of the results based on the variations of input parameters influencing energy use. Probabilistic simulations can deal with variations of the input data and can, subsequently, minimize the discrepancies between calculated and measured energy use. The drawback is that the results are not specific for one individual building, but provide a range of probable results [65].

IEA EBC Annex 53 [7], Dronkelaar et al. [9] and Huebner and Mahdavi [66] identified poor operational practice, impaired thermal comfort and poor air quality as sources of the discrepancies and these also need to be taken into account to minimize the discrepancies between calculated and measured EP. Descriptive statistics and building simulations in this study showed that the indoor air temperatures, ventilation rates and ventilation operating times were significant user-related parameters influencing building energy use. These three parameters should therefore be measured and then checked using modern building automation systems in order to align them with their predicted values and minimize the discrepancies. This can be achieved with the help of good building operation practice. The designed thermal comfort and air quality achieved during the operational phase, in terms of indicators such as indoor air temperatures, ventilation rates and CO₂ concentrations, indicated that good operation and maintenance practice was employed in the studied schools and could, therefore, enable the discrepancies between calculated and measured energy use to be minimized.

When searching in the literature for references about the discrepancies between measured and calculated building energy use, the importance of good operation practice was not mentioned in the vast majority of the studied publications. The role and importance of good operation and maintenance practice in minimizing the discrepancies should be given more attention by research communities as there is obviously room for improvement.

An important aspect when aiming to minimize the discrepancies is the precise and systematic measurement of supplied energy and parameters, such as indoor air temperatures and ventilation rates. The measurements conducted in this research study, described in AP 3 and AP 4 and illustrated in Figures 18 and 19, can be used by design engineers to establish an energy verification process. They can also help research communities to apply and further develop the measuring methods in order to minimize the discrepancies.

The BEN 2 document [23] issued by Boverket allows corrections to be made due to large discrepancies between some of the predicted and measured user-related parameters when calculated energy use is required to be verified by measured energy use. For example, a 1 °C discrepancy in the indoor air temperature allows energy use for space heating to be corrected by 5 percent. Furthermore, verified energy use for domestic hot water supplies must be set to the calculated value regardless of the difference between the calculated and measured energy use. However, there is a need for more refined methods, especially for low-energy buildings, when defining correction factors. For example, the influence of the indoor

temperature on energy use for space heating depends on a number of building parameters. Such work will enable the discrepancies between calculated and measured building energy use to be minimized.

Lately, the understanding of occupant behaviour in a more comprehensive way, i.e. by the integration of qualitative and quantitative approaches to guide the design and operation of low-energy buildings with regard to technical and human dimensions, was identified by research communities[10], [63], [66]. Based on the significant variations of the studied user-related parameters, the author has identified a need to increase the number of low-energy buildings that should be investigated by measuring their energy uses and user-related parameters in a similar way to this study. Larger numbers of investigated buildings will probably enable identification of the variations and extremes of the studied parameters. Such studies can then be used as references for more comprehensive approaches when integrating technological and human dimensions into building energy simulations.

Finally, by minimizing the discrepancies, buildings will be able to meet the set energy requirements. During the design phase, design engineers will then be able to optimise choices of energy efficient technologies, for example, for building envelopes and building services and energy systems, in terms of cost and energy performance and will, therefore, be able to contribute to improving energy efficiency in buildings.

5 Conclusions

Based on the results and discussions presented in this research study, the following conclusions have been drawn in relation to the research questions.

What is the building energy use in a group of five similar hotels?

The results from the field measurements and descriptive statistics showed that the total average energy use, including energy use for space heating, cooling, domestic hot water supplies and electricity varied between 202 kWh/(m² year) and 353 kWh/(m² year). The average measured total energy use was 263 kWh/(m² year) with a standard deviation of 62 kWh/(m² year) in the studied hotels. The use of electricity varied between 87 kWh/(m² year), and 131 kWh/(m² year), the average use was 112 kWh/(m² year) with a standard deviation of 17 kWh/(m² year). The difference between the lowest and highest total energy use was large although only five hotels had been included in the study. These were all located in the same city and offered services at comparable levels, which implied that a number of different parameters had influenced these differences.

What parameters influence energy use, and by how much, in a single hotel building and in a group of similar hotel buildings?

The results from the field measurements and descriptive statistics in the hotel study showed that the heating energy use can be correlated to the outdoor climate in three of the five hotels, i.e. those that fulfilled the criterion of the R² value being above 0.6. The other two measured parameters, the number of guest nights and food covers sold, could explain neither the use of heating energy nor the use of electricity. The study showed that parameters influencing the energy use in one hotel were not the same as in another hotel, even though the hotels offered services at the same level and were located in the same city. Offering additional services, such as conference or pool facilities, influenced the hotels energy uses. To facilitate the identification of the influencing factors, hotel energy use should be divided into its sub-systems, for example, space heating systems, domestic hot water supply systems and services offered, and then compared and benchmarked within the chosen systems or services. The contributions to the energy uses made by the building envelopes, building services and energy systems, building operation and maintenance routines, indoor

climate, and occupant activities (in terms of accommodated conference guests) were not included in this study.

Can low-energy school buildings provide sufficient thermal comfort and indoor air quality in terms of indoor air temperatures and CO₂ concentrations?

The studied schools were concluded to be low-energy buildings as their measured energy uses were lower than the maximum of 75 percent of the Swedish national building energy requirements. The results from the field measurements and descriptive statistics showed that the thermal comfort and indoor air quality, in terms of indoor air temperatures and CO₂ concentrations, complied with the design criteria stipulated in the international standard EN 15251 and in the Swedish national recommendations issued by the Swedish Work Environment Authority and the Public Health Agency of Sweden. However, in some of the studied classrooms, the indoor air temperatures were less than 20 °C for half of the measurement period during working hours.

How well do calculated and measured energy uses align in low-energy school buildings?

The results from the field measurements and building energy use calculations for the studied schools showed that the discrepancies between measured and calculated building energy uses varied from -44 percent to +28 percent. The conclusion can be drawn that a considerably large variation was found among the schools. Good building operation practice in the operational phase is as equally important as the energy calculation in the design phase, with respect to minimizing the discrepancies between calculated and measured energy use. The study showed that, as three of the user-related parameters – indoor air temperature, VR and ventilation operating time – had a significant influence on the energy use, these parameters need to be predicted as accurately as possible during the design phase and then aligned with actual values during the operational phase.

How do user-related parameters influence the calculated and measured energy use in low-energy schools and how much do they influence the total energy use?

The field measurements, descriptive statistics and building energy simulations showed that some of the studied user-related parameters had a major, and others a minor, influence on the use of building energy. Indoor air temperatures, ventilation rates and ventilation running times and the use of electricity to run lighting and appliances had major influences on building energy use. These parameters, therefore, need to be predicted as accurately as possible during the design phase and aligned with measured values during the operational phase. The energy used for

domestic hot water, the occupancy rates and occupants' presence times were shown to have only a minor influence on the building energy use. However, the last three parameters also need to be predicted as accurately as possible in order to minimize the discrepancies between calculated and measured building energy use.

How do measured results from seven case studies of low-energy schools compare to standard design values specified in BEN 2?

A user-related input data list for energy calculations for buildings in normal use, i.e. school buildings, is specified in BEN 2. Table 24 shows the measured user-related parameters in the studied schools and the values specified in BEN 2 for elementary school buildings.

Table 24. Comparisons between measured user-related parameters in the studied seven low-energy schools and values specified in BEN 2. E_{DHW} is shown as thermal energy with an assumed 100 percent efficient domestic hot water supply.

	Average measured	Standard deviation of average measured	Minimum to Maximum measured average per school	BEN 2
Indoor air temperature/ °C	21.4	0.7	20.2 to 23.4	22
VR between 08-16/ [l/(s m ²)]	1.54	0.55	0.77 to 2.20	3
VR between 16-08/ [l/(s m ²)]	0.48	0.45	0.0 to 1.1	-
Ventilation running time/ (h/year)	6000	2065	3000 to 8760	2200
Occupancy rate/ (person/m ²)	0.069	0.027	0.05 to 0.13	0.067
Occupancy time/ (h/year)	1500	200	1205 to 1776	1320
E_{DHW} / [kWh/(m ² year)]	4	2	1.7 to 6.7	2
E_{TE} / [kWh/(m ² year)]	26	11	13 to 48	22

Although only seven schools were included in the study and all of the buildings had similar technical properties in terms of building energy performance, it can be seen in Table 24 that the measured user-related parameters could vary considerably. This means that having only one input value per user-related parameter could have misled energy engineers when calculating building energy use. For this reason, a range of values for each parameter is presented. However, in BEN 2, the list of user-related inputs is a starting point for calculating building energy use, for buildings in normal use, at an early design phase and these could provide the necessary inputs when predicting these parameters. Later on in the design process, energy engineers will have to update their predictions based on specific project information and discussions with other project members during the design phase. Finally, these predictions need to align with measured values in the operational phase, in order to minimize discrepancies between calculated and measured energy use.

Finally

Better communication within a building construction project, in order to predict the parameters influencing energy use as accurately as possible, together with good building operation practice and field measurements are suggested courses of action that will contribute to minimizing the discrepancies between measured and calculated energy use. However, there is a pressing need for a larger number of low-energy buildings to be investigated, which will enable the variations and extremes of the parameters influencing energy use to be identified. The experience thus gained, and the measurements made, could then be used in a data base for research communities. This would help their efforts towards minimizing the discrepancies and improving building energy simulation tools by including technical and human aspects in a more comprehensive way. This would then contribute to fulfilling the overall aim of improving energy efficiency in the building industry and to mitigating the effects of the building sector on climate change. Nevertheless, there will always be variations in user-related parameters that will be difficult to predict and these will influence energy use. How we can best address this unavoidable aspect will be a matter for future research.

References

- [1] International Energy Agency, the United Nations Environment Programme, Global Alliance for Buildings and Construction, 2018 Global Status Report, 2018. doi:10.1038/s41370-017-0014-9.
- [2] European Parliament and the Council, DIRECTIVE 2010/31/EU OF THE EUROPEAN PARLIAMENT AND OF THE COUNCIL, Official Journal of the European Union, 2010. <http://data.europa.eu/eli/dir/2010/31/oj>.
- [3] IAE-EBC, International Energy Agency's in Building and Communities Programme, (n.d.). <https://www.iea-ebc.org/> (accessed April 23, 2020).
- [4] UNCE, Sustainable Development Goals, High Performance Buildings and Climate, (n.d.). <https://www.unece.org/index.php?id=41597> (accessed February 3, 2020).
- [5] P. Bohdanowicz, Responsible resource management in hotels - attitudes, indicators, tools and strategies; Doctoral Thesis, Royal Institute of Technology, Stockholm, 2006.
- [6] Scandic Hotels, Sustainable Partnership, (n.d.). <https://www.scandichotels.com/partners/sustainable-partnerships> (accessed February 26, 2020).
- [7] H. Yoshino, T. Hong, N. Nord, IEA EBC annex 53: Total energy use in buildings—Analysis and evaluation methods, *Energy Build.* 152 (2017) 124–136. doi:10.1016/j.enbuild.2017.07.038.
- [8] Y. Zhang, X. Bai, F.P. Mills, J.C.V. Pezzey, Rethinking the role of occupant behavior in building energy performance: A review, *Energy Build.* 172 (2018) 279–294. doi:10.1016/j.enbuild.2018.05.017.
- [9] C. van Dronkelaar, M. Dowson, C. Spataru, D. Mumovic, A Review of the Regulatory Energy Performance Gap and Its Underlying Causes in Non-domestic Buildings, *Front. Mech. Eng.* 1 (2016) 1–14. doi:10.3389/fmech.2015.00017.
- [10] S. D'Oca, T. Hong, J. Langevin, The human dimensions of energy use in buildings: A review, *Renew. Sustain. Energy Rev.* 81 (2018) 731–742. doi:10.1016/j.rser.2017.08.019.

- [11] T. Hong, S.C. Taylor-Lange, S. D'Oca, D. Yan, S.P. Corngnati, Advances in research and applications of energy-related occupant behavior in buildings, *Energy Build.* 116 (2016) 694–702. doi:10.1016/j.enbuild.2015.11.052.
- [12] F. Haldi, D. Cali, R.K. Andersen, M. Wesseling, D. Müller, Modelling diversity in building occupant behaviour: a novel statistical approach, *J. Build. Perform. Simul.* 10 (2017) 527–544. doi:https://doi.org/10.1080/19401493.2016.1269245.
- [13] D. Yan, T. Hong, B. Dong, A. Mahdavi, S. D'Oca, I. Geatani, X. Feng, IEA EBC Annex 66: Definition and simulation of occupant behavior in buildings, *Energy Build.* 156 (2017) 258–270. doi:10.1016/j.enbuild.2017.09.084.
- [14] Aftonbladet, Stora behov av nya förskolor och skolor närmaste åren, (2018). <https://www.aftonbladet.se/nyheter/samhalle/a/m6wnyp/stora-behov-av-nya-forskolor-och-skolor-narmaste-aren> (accessed May 27, 2019).
- [15] Skanska Sverige AB, 1 000 skolor på 10 år, Skanska Sverige AB, Stockholm, Sweden, 2016.
- [16] Byggfakta, Skolbyggandet 2011-2018, (2018).
- [17] Scandic Hotels, Scandic launches new hotel brand, (2020). <https://www.scandichotelsgroup.com/media/press-releases/2020/scandic-launches-new-hotel-brand/> (accessed March 16, 2020).
- [18] Besöksliv, 3 000 nya hotell öppnar 2020, (2020). <https://www.besoksliv.se/blogg/anders-johansson/3000-nya-hotell-oppnar-2020/> (accessed March 16, 2020).
- [19] Z. Bakó-Biró, D.J. Clements-Croome, N. Kochhar, H.B. Awbi, M.J. Williams, Ventilation rates in schools and pupils' performance, *Build. Environ.* 48 (2012) 215–223. doi:10.1016/j.buildenv.2011.08.018.
- [20] A.M.G. Mendell M. J., Eliseeva E. A., Davies M. M., Spears M., Lobscheid A., Fisk W. J., Association of classroom ventilation with reduced illness absence: a prospective study in California, *Indoor Air* 2013. (2013) 515–528. doi:doi:10.1111/ina.12042.
- [21] D. Teli, L. Bourikas, P.A.B. James, A.S. Bahaj, Thermal Performance Evaluation of School Buildings using a Children-Based Adaptive Comfort Model, in: ScienceDirect (Ed.), *Int. Conf. Sustain. Synerg. from Build. to Urban Scale*, SBE 16, Elsevier B.V., 2017: pp. 844–851. doi:https://doi.org/10.1016/j.proenv.2017.03.170.
- [22] Boverket, BFS 2011:6 med ändringar till och med BFS 2018:4, 1 (2018) 1–146.
- [23] Boverket, BFS 2017:6 BEN 2, Boverk. Sweden. (2017) 1–16.
- [24] A. Persson, M. Gullberg, A. Jansa, K. Andersson, A. Göransson, P. Brundell, I. Munkhammar, H.-M. Suvilehto, E. Öfverholm, M. Bengtsson,

- Energianvändning & inomhusmiljö i skolor och förskolor – Förbättrad statistik i lokaler , STIL2 (In Swedish), (2007) 92.
- [25] Amrita Dasgupta, Antonis Prodromou, Dejan Mumovic, Operational versus designed performance of low carbon schools in England: Bridging a credibility gap, *HVAC&R Res.* 18 (2012) 37–50. doi:10.1080/10789669.2011.614318.
- [26] I.M. Pegg, A. Cripps, M. Kolokotroni, Post-occupancy performance of five low-energy schools in the UK, *ASHRAE Trans.* 113 PART 2 (2007) 3–13.
- [27] E. Burman, J. Kimpian, D. Mumovic, Building schools for the future: Lessons learned from performance evaluations of five secondary schools and academies in England, *Front. Built Environ.* 4 (2018) 1–16. doi:10.3389/fbuil.2018.00022.
- [28] C. Demanuele, T. Tweddell, M. Davies, Bridging the gap between predicted and actual energy performance in schools, in: *World Renew. Energy Congr. XI*, Abu Dhabi, UAE, 2010: pp. 1–6.
- [29] Swedish Research Council (Vetenskapsrådet), Good Research Practice, Stockholm, 2017. <https://www.vr.se/english/analysis/reports/our-reports/2017-08-31-good-research-practice.html>.
- [30] K. Säfsten, M. Gustavsson, *Forskningsmetodik, för ingenjörer och andra problemlösare*, Studentlitteratur AB; ISBN 978-91-44-06742-1, Lund, 2019.
- [31] IDA Indoor Climate and Energy, (n.d.). <http://www.equa.se/en/ida-ice> (accessed November 15, 2019).
- [32] Powell G. S, Baker R. K., *The Art of Modeling with Spreadsheets: Management Science, Spreadsheet Engineering, and Modeling Craft*, John Wiley & Sons, INC; ISBN 0-471-45216-5, 2004.
- [33] SMHI, Swedish Meteorological and Hydrological Institute, (2019). <https://www.smhi.se/en> (accessed May 27, 2019).
- [34] Wikipedia, Hotel Kungens Kurva “Licens CC-BY-SA 4.0,” (2018). https://sv.wikipedia.org/wiki/Scandic_Kungens_Kurva#/media/Fil:Scandic_hotel_Kungens_kurva,_2018.jpg (accessed April 16, 2020).
- [35] Wikipedia, Hotel Continental “Licens CC-BY-SA 3.0,” (2011). https://commons.wikimedia.org/wiki/File:Hotell_Continental_Stockholm_2011.jpg (accessed April 16, 2020).
- [36] Wikipedia, Hotel Malmen “Licens CC-BY-SA 3.0,” (2009). https://sv.wikipedia.org/wiki/Hotell_Malmen#/media/Fil:Hotell_Malmen_2009.jpg (accessed April 16, 2020).
- [37] Wikipedia, Hotel Ariadne “Licens CC-BY-SA 3.0,” (2009). https://commons.wikimedia.org/wiki/File:Scandic_hotel_Värtahamn.jpg (accessed April 16, 2020).

- [38] Energimyndigheten, Boverket, Utvärdering av lågenergibygnader – fallstudie 2017. Rapport till regeringen mars 2018, 2018.
- [39] Boverket, Boverkets författningssamling BFS 2006:12 BBR12, 2006.
- [40] Boverket, BFS 2011:6 med ändringar till och med BFS 2018:4; BBR 25, Boverket, 2017.
- [41] Boverket, BFS 2016:12 BEN 1, (2016) 1–16.
- [42] B. Simanic, B. Nordquist, H. Bagge, D. Johansson, Predicted and measured user-related energy usage in newly built low-energy schools in Sweden, *J. Build. Eng.* 29 (2020). doi:doi.org/10.1016/j.jobbe.2019.101142.
- [43] EQUA, EQUA, Validation of IDA Indoor Climate and Energy 4. with respect to CEN Standards EN 15255-2007 and EN 15265-2007, 2010. (n.d.). <https://www.equa.se/en/ida-ice/validation-certifications> (accessed November 19, 2019).
- [44] EQUA, EQUA, Validation of IDA Indoor Climate and Energy 4.0 build 4 with respect to ANSI/ASHRAE Standard 140-2004, (2010). <https://www.equa.se/en/ida-ice/validation-certifications> (accessed November 15, 2019).
- [45] Arbetsmiljöverket, Arbetsplatsens utformning AFS 2009:2, Arbetsmiljöverket, 2013.
- [46] Folkhälsomyndigheten, Folkhälsomyndighetens allmänna råd om temperatur inomhus FoHMFS 2014:17, Folkhälsomyndighet, 2014.
- [47] Swedish Standards Institute, SS-EN 15251:2007 utgåva 1, SIS Förlag, 2007.
- [48] H. Bagge, V. Fransson, C. Hiller, D. Johansson, J. Ryden, Brukarnas påverkan på energianvändning och effekt behov i NNE-byggnader, (2018) 1–22. https://www.e2b2.se/library/4057/brukarnas_paverkan_pa_energianvandning_och_effektbehov_i_nne-byggnader.pdf.
- [49] M. Jia, R.S. Srinivasan, A.A. Raheem, From occupancy to occupant behavior: An analytical survey of data acquisition technologies, modeling methodologies and simulation coupling mechanisms for building energy efficiency, *Renew. Sustain. Energy Rev.* 68 (2017) 525–540. doi:10.1016/j.rser.2016.10.011.
- [50] Z. Jie, B. Lasternas, K. Lam Poh, R. Yun, V. Loftness, Occupant behavior and schedule modeling for building energy simulation through office appliance power consumption data mining, *Energy Build.* (2014) 341–355. doi:<https://doi-org.ludwig.lub.lu.se/10.1016/j.enbuild.2014.07.033>.
- [51] T. Hong, S. D'Oca, Occupancy schedules learning process through a data mining framework, *Energy Build.* 88 (2015) 395–408. doi:<https://doi-org.ludwig.lub.lu.se/10.1016/j.enbuild.2014.11.065>.

- [52] S. Sjögren, Dubbelt så många nya rum med Scandics nya budgethotell, *Besöksliv*. (n.d.). <https://www.besoksliv.se/nyheter/dubbelt-sa-manga-nya-rum-med-scandics-nya-budgethotell/>.
- [53] M. Dahblom, B. Nordquist, L. Jensen, Variations in indoor temperature in residential apartments of different size and building category, NSB 2014 10th Symp. Build. Physics, 2014 Lund Sweden. (n.d.) 820–837.
- [54] D. Johansson, Measured occupancy levels in Swedish classrooms, 9th Int. Conf. Air Distrib. Rooms, Roomvent. (2004).
- [55] World Health Organization, WHO guidelines for air quality, World Health Organization Regional Office for Europe; ISBN 978 92 890 02134, 2010.
- [56] M. Dias, H. Bernardo, J. Ramos, M. Egido, Indoor environment and energy efficiency in school buildings - part 1: Indoor Air Quality, Proc. 2011 3rd Int. Youth Conf. Energ. (2011) 1–7. doi:<https://doi.org/ludwig.lub.lu.se/10.1016/j.buildenv.2011.08.018>.
- [57] P. Wargoeki, D.P. Wyon, Providing better thermal and air quality conditions in school classrooms would be cost-effective, *Build. Environ.* 59 (2013) 581–589. doi:10.1016/j.buildenv.2012.10.007.
- [58] M. Golshan, H. Thoen, W. Zeiler, Dutch sustainable schools towards energy positive, *J. Build. Eng.* 19 (2018) 161–171. doi:<https://doi.org/10.1016/j.job.2018.05.002>.
- [59] SCB, Statistics Sweden, (2020). <https://www.scb.se/> (accessed March 3, 2020).
- [60] Scandichotels, 25 Years of Leading Sustainability Initiatives, 2018. <https://www.scandichotelsgroup.com/annualreports/2018/en/pdf/sustainability.f4dcbfc.pdf>.
- [61] P. Bohdanowicz, I. Martinac, Determinants and benchmarking of resource consumption in hotels—Case study of Hilton International and Scandic in Europe, *Energy Build.* 39 (2007) 82–95. doi:<https://doi.org/10.1016/j.enbuild.2006.05.005>.
- [62] P. Bohdanowicz, P. Zientara, Corporate Social Responsibility in Hospitality: Issues and Implications. A Case Study of Scandic, *Scand. J. Hosp. Tour.* 8 (2008). doi:<https://doi.org/10.1080/15022250802504814>.
- [63] T. Hong, D. Yan, S. D’Oca, C. fei Chen, Ten questions concerning occupant behavior in buildings: The big picture, *Build. Environ.* 114 (2017) 518–530. doi:10.1016/j.buildenv.2016.12.006.
- [64] Boverket, Regelsamling för byggande BFS 1993:57 med ändringar till och med 2006:12, Boverket, 2006.
- [65] S. Burke, J. Kronvall, M. Wiktorsson, P. Sahlin, A. Ljungberg, Method for probabilistic energy use in residential buildings (Beräkningsmetod för

sannolik energianvändning i bostadshus) in Swedish, 2017.
<https://www.sbuf.se/Projektsida/?id=e854c21a-49c2-4eb1-918b-43043a4d6543>.

- [66] G.M. Huebner, A. Mahdavi, A structured open data collection on occupant behaviour in buildings, *Nature Research Journal/Scientific Data*. (2019) 1–4. doi:10.1038/s41597-019-0276-2.



LUND
UNIVERSITY

Lund University
Faculty of Engineering
Department of Building and Environmental Technology
Division of Building Services

ISBN 978-91-85415-12-0

ISSN 1652-6783

ISRN LUTVDG/TVIT-20/1003-SE(266)

