



LUND UNIVERSITY

Activity Report 2020

Automatic Control Lund University

Rasmusson, Monika; Pates, Richard

2021

Document Version:

Publisher's PDF, also known as Version of record

[Link to publication](#)

Citation for published version (APA):

Rasmusson, M., & Pates, R. (Eds.) (2021). *Activity Report 2020: Automatic Control Lund University*. (Annual Reports). Department of Automatic Control, Lund University.

Total number of authors:

2

General rights

Unless other specific re-use rights are stated the following general rights apply:

Copyright and moral rights for the publications made accessible in the public portal are retained by the authors and/or other copyright owners and it is a condition of accessing publications that users recognise and abide by the legal requirements associated with these rights.

- Users may download and print one copy of any publication from the public portal for the purpose of private study or research.
- You may not further distribute the material or use it for any profit-making activity or commercial gain
- You may freely distribute the URL identifying the publication in the public portal

Read more about Creative commons licenses: <https://creativecommons.org/licenses/>

Take down policy

If you believe that this document breaches copyright please contact us providing details, and we will remove access to the work immediately and investigate your claim.

LUND UNIVERSITY

PO Box 117
221 00 Lund
+46 46-222 00 00

Activity Report 2020

AUTOMATIC CONTROL | LUND UNIVERSITY





LUND
UNIVERSITY

Department of Automatic Control
P O Box 118, 221 00 Lund, Sweden
www.control.lth.se

Annual Report TFRT--4048
ISSN 0280-5316

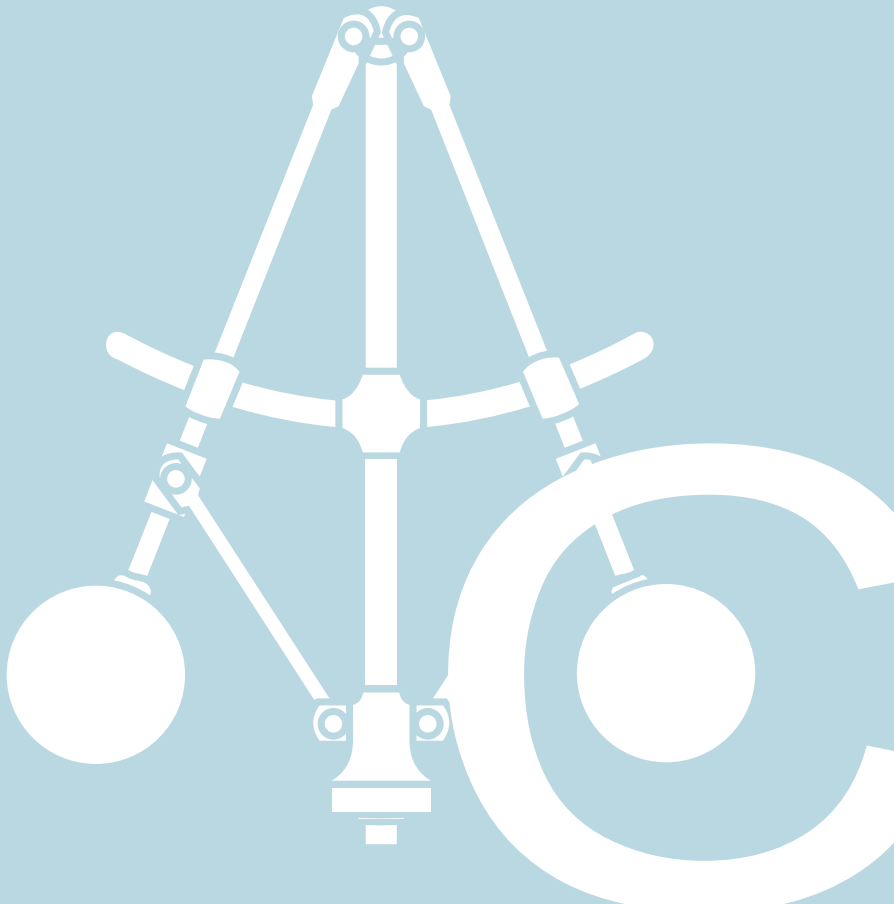

Activity Report 2020



LUND
UNIVERSITY

Department of Automatic Control

MAILING ADDRESS

Department of Automatic Control
Lund University
P O Box 118
SE-221 00 LUND, Sweden

VISITING ADDRESS 2020-2023

Reglerteknik, location KC4, 3rd floor
Naturvetarvägen 18
223 62 LUND

TELEPHONE

+46 46 222 87 87

WWW AND GENERIC E-MAIL ADDRESS

www.control.lth.se
control@control.lth.se

Edited by Monika Rasmusson and Richard Pates

Printed: Media-Tryck, Lund, Sweden, April 2021
ISSN 0280-5316
Annual Report TFRT--4048



Media-Tryck is a Nordic Swan Ecolabel certified provider of printed material. Read more about our environmental work at www.mediatryck.lu.se

MADE IN SWEDEN 

Content

Introduction	7
THE VISION	8
AUTOMATIC CONTROL HIGHLIGHTS OF 2020.....	9
Education	11
UNDERGRADUATE STUDIES	12
GRADUATE STUDIES	14
THE YEAR OF THE PANDEMIC	15
DOCTORAL DISSERTATION.....	16
LICENTIATE DISSERTATION.....	17
Research	19
RQ20 RESEARCH QUALITY EVALUATION	20
EXCELLENCE CENTERS AND NATIONAL PROJECTS.....	21
RESEARCH AREAS	27
LARGE SCALE SYSTEMS AND LEARNING	28
AUTONOMOUS REAL-TIME SYSTEMS.....	31
INNOVATIVE CONTROL APPLICATIONS	38
TOOLS AND SOFTWARE	50
Publications and seminars	53
PUBLICATIONS 2020.....	54
SEMINARS AT THE DEPARTMENT	61
External Contacts	65
Economy	71
ECONOMY.....	72
FUNDING - EXTERNAL GRANTS.....	73
Staff	75
BOARD OF THE DEPARTMENT	80
LONG-TERM VISITORS	80
STAFF ACTIVITIES	80
AWARDS	91
ASSIGNMENTS.....	92
LECTURES BY STAFF OUTSIDE THE DEPARTMENT	97
POPULAR SCIENCE PRESENTATIONS.....	98

Introduction

Our vision and a summary of the activities at the Department of Automatic Control, Lund University during the period January 1 to December 31, 2020

THE VISION

Towards the end of 2019, a working group consisting of teachers, PhD students and other staff started to draft a long-term vision for the department. High-level objectives and strategies to reach those objectives were developed under the headlines Research, Education, External Engagement and Organization. The result was iterated and discussed at the department kick-off as well as in the department board. The work resulted in the vision below being accepted by the board towards the end of 2020. The development on detailed strategies to reach the goals will continue in 2021.

VISION

- A world class department that explains, explores and expands control technology.

OBJECTIVES

- to create world class research.
- to educate at the highest international level.
- to exchange knowledge through engagement with society and industry.

GOALS FOR 2030

Research

- The department is recognized as one of world's top research groups in the field of systems and control.
- The research is driven by aspiration for fundamental contributions and addressing the needs of society in line with the global targets of Agenda 2030.

Education

- The courses given at the department are highly appreciated by our students, and their resulting capability is valuable and relevant to industry, academia and society.
- PhD graduates from our department are attractive for faculty positions at leading institutions and for leading roles in society.

External Engagement

- The department is a physical and virtual meeting point for students, researchers, industry and society.
- Ideas and knowledge are shared openly, with enthusiasm.

Organization

- A good working climate built on nearness, communication, sharing and inclusion.
- Every employee plays an important role as we work together towards common goals.

AUTOMATIC CONTROL HIGHLIGHTS OF 2020

This report covers the activities at the Department of Automatic Control during 2020. We can summarise the year in numbers as follows:

The economy showed a turnover for 2020 of 61 MSEK, an increase of 6,5 MSEK since last year. More about financial figures is found in the chapter *Economy*.

The department now has 55 members (excluding guests), divided into the following categories: 7 professors, 1 senior professor, 2 emeritus professors, 1 adjunct professor, 6 associate professors, 5 research engineers, 4 administrators, 4 post-docs, 2 researchers, 25 PhD students and 3 industrial PhD students (this includes part-time positions). During the year, two associate professors were appointed: Richard Pates and Emma Tegling (starting January 2021). There were also five new PhD students admitted to the department. Read more about this in the chapter *Staff*.

One PhD thesis by Marcus Thelander Andrén was defended during 2020. The total number of PhDs graduated from the department is now 128. One licentiate thesis by Martin Heyden was presented in April this year.

During 2020, the department gave 22 different courses to 1 246 students at LTH, and 37 students presented their masters' theses at the department. This year video lectures were introduced, as well as new labs. Since March, education has switched to a digital format, including exams. Read more about this in the chapter *Education*.

The department's involvement in WASP, the Wallenberg AI, Autonomous Systems and Software Program, has increased further during the year. The total number of WASP-funded PhD students at the department is now 13, including three industrial PhD students. This is an increase of 2 since last year.

A new EU funded project *Admorph* started up in the beginning of this year. We have also been successful in receiving more funding from ELLIIT for new PhD and Postdoc positions.

RQ20 - the assessment of the university wide quality research was performed by an international panel. The result will have an effect on our long term vision. Read more about our research in the chapter *Research*.

EURobotics week is now well established and took place during three days at the latter part of November. It was performed entirely digitally, with a couple of new films recorded specifically for this occasion.

In May we settled into a new office space, as the M-building will be reconstructed during the period 2020-2023. A small and effective team has been both interacting with the Architects responsible for the "new" M-building, and planning for the move to temporary facilities at KC4.

Late 2020, we held an election for Head and Deputy Head of the Department, and we are glad to announce that both Anders Rantzer and Anton Cervin will continue for another 3 years. In December, Charlotta Johnsson was elected new Dean of Campus Helsingborg, starting January 1.

We will welcome Margret Bauer who will start her position beginning 2021, funded by the Lise Meitner professorship fund.

This year has been different in many ways because of the pandemic. We have welcomed new colleagues, but the number of guests has been fewer than normal. New projects have started, opening up new challenges for the years to come.

Monika Rasmusson and Richard Pates

Education

Education at undergraduate and graduate level including dissertations 2020

UNDERGRADUATE STUDIES

The engineering education at LTH follows the central European system with five-year programs leading up to the university degree "civilingenjör", with the international title MSc.

Automatic control courses are taught as part of the engineering curriculum in Engineering Physics (F), Electrical Engineering (E), Computer Engineering (D), Mechanical Engineering (M), Information and Communication Engineering (C), Environmental Engineering (W), Engineering Mathematics (Pi), Industrial Management and Engineering (I), Biotechnology (B), Engineering Nanoscience (N), Chemical Engineering (K) and Biomedical Engineering (BME). Our advanced courses are included in more than fifteen of the master-level specializations in the various programs. During 2020, there were 1 246 course registrations and 1 189 passed grades were awarded. The number of registered students corresponds to 155 full-year equivalents. In the table on the next page, our undergraduate courses are listed, along with the number of students who passed each course.

37 students completed their master's thesis projects, and a total of 27 theses were presented during 2020. A list of the master theses is given in the *Publications and Seminars* chapter.

In 2020 we launched a new international Master's Program in *Systems, Learning and Control* in collaboration with the departments of Mathematics, Computer Science and Electrical and Information Technology. In connection to this, two new courses were launched at the department: *Introduction to Machine Learning, Systems and Control* and *Modeling and Learning from Data*. The latter course will be available in the regular engineering curriculum from next year.

Several courses had to swiftly transition to online teaching and virtual labs due to the pandemic. This was aided by the enthusiastic efforts of several PhD students and undergraduate TAs.

The recruitment of Alexander Pisarevsky as a research engineer puts new focus on strengthening our teaching lab.

TOTAL NUMBER OF STUDENTS WHO PASSED OUR COURSES 2020

Automatic Control, Basic Course	
(FRTF05 Reglerteknik)	659
Systems Engineering	
(FRTF10 Systemteknik).....	53
Control Theory	
(FRTF15 Reglerteori)	17
Applied Robotics	
(FRTF20 Tillämpad robotteknik).....	43
Introduction to Machine Learning, Systems and Control <i>NEW</i>	
(FRTF25 Introduktion till maskininläring, system och reglering)	12
Physiological Models and Computations	
(FRTF01 Fysiologiska modeller och beräkningar)	43
Nonlinear Control and Servo Systems	
(FRTN05 Olinjär reglering och servosystem).....	43
Multivariable Control	
(FRTN10 Flervariabel reglering).....	3
Predictive Control	
(FRTN15 Prediktiv reglering)	17
Automatic Process Control	
(FRTN25 Processreglering).....	19
Network Dynamics	
(FRTN30 Nätverksdynamik)	52
System Identification	
(FRTN35 Systemidentifiering)	4
Project in Automatic Control	
(FRTN40 Projekt i reglerteknik).....	32
Mathematical Modeling, Advanced Course	
(FRTN45 Matematisk modellering, fortsättningskurs)	41
Optimization for Learning	
(FRTN50 Optimering för maskininläring).....	51
Automatic Control, Advanced Course <i>NEW</i>	
(FRTN55 Reglerteknik, fortsättningskurs).....	63
Real-Time Systems	
(FRTN60 Realtidssystem)	27
Modeling and Learning from Data <i>NEW</i>	
(FRTN65 Modellering och inläring från data)	10
Bachelor Project in Automatic Control	
(FRTL01 Kandidarbete i reglerteknik).....	1
Degree Project in Automatic Control	
(FRTM01 Examensarbete i reglerteknik)	37

GRADUATE STUDIES

The PhD education consists of four years of studies, but since most students have 20% of department duties, the nominal time for the PhD education is 5 years. In the Swedish system there is also a possibility to do a half-time thesis called a "licentiate".

The general syllabus for PhD studies in Automatic Control states that the course requirement for a PhD degree is 90 credits, while the thesis scope is 150 credits. The syllabus specifies that 30 out of the 90 course credits should be courses in Automatic Control. The course component should also include at least 7.5 credits of general research studies courses. Similar changes are also adopted for licentiate thesis requirements.

In 2020 one doctoral thesis was defended by Marcus Thelander Andrén and one licentiate thesis was presented by Martin Heyden. We have admitted Felix Agner, Ylva Wahlquist, Manu Upadhyaya, Johan Lindberg and Jonas Hansson as new PhD students.

The course *Introduction to Research Methodology, Ethics and Innovation for Computing Disciplines*, a course available for PhD students. The course is given by our department together with the Departments of Computer Science and Electro- and Information Technology. The course is divided in three (3) parts, where Charlotta Johnsson is the course responsible for Part3-Innovation. This part was planned for March 2020 but had to be postponed due to the pandemic.

The following PhD Courses were given in 2020:

Large-Scale Convex Optimization; Sebastian Banert
Control Systems Synthesis; Pauline Kergus, Karl Johan Åström
Programming Languages and Concepts; Anton Cervin
Hands-on Machine Learning; Carolina Bergeling, Bo Bernhardsson incl PhDs

There are some mandatory PhD courses organised within the WASP-AS program, available for both WASP graduate and affiliated students:

- *Autonomous System 1 - Sensing, Perception, Control and Decision Making*
- *Autonomous System 2 - Learning, Knowledge, Interaction and Collaboration*
- *Software Engineering and Cloud Computing*
- *WASP Project Course*

There are also some mandatory PhD courses organised within the WASP-AI program, available for both WASP graduate and affiliated students:

- *Deep Learning and GANs*
 - *Graphical Models, Bayesian Learning, and Statistical Relational Learning*
 - *Artificial Intelligence and Society: Legal, Ethical, Societal and Economical Aspects of AI*
 - *Learning Theory and Reinforcement Learning*
 - *Scalable Data Science and Distributed Machine Learning*
- + a selection of elective courses

THE YEAR OF THE PANDEMIC

The pandemic has affected almost every aspect of life at the department, from lecturing, to PhD supervision, to the running of exams. This has brought many challenges, but also opportunities, as everyone has adapted to the world of working from home.

Teaching and research has been particularly affected. The difficulties in finding time/space to focus on research projects and ideas when one cannot “compartmentalise”, has impacted everyone. Teaching over zoom or through prerecorded lectures has also been challenging. However these challenges have also created opportunities. By moving online, department seminars have been opened up to an even wider international audience, and hopefully the new wealth of recorded lectures will help students taking our courses for years to come.

Unfortunately, the same trends look set to continue into 2021. There will be no office hours or spontaneous drop ins at the department, but a digital alternative will be offered in each course. During study period 3 (LP3), and probably also for study period 4 (LP4) all courses will be given online, with no teaching activities on campus. Laboratory exercises and projects will be substituted by assignments that can be completed at home. Supervision and presentation of master’s theses will also be performed online. However it is a tribute to the resilience and spirit of all involved, that with each new challenge, a new digital solution is found. Though we all dearly look forward to the return of fika breaks together!

The pandemic has also impacted the research agenda and activities at the department, with new focus areas emerging on the modelling and control of disease spread. This has mainly been through informal collaborations involving academics at LTH. Some notable initiatives have been the production of PPE equipment. Many thanks to all involved!



The new “normal” to meet during the pandemic...

DOCTORAL DISSERTATION

This year there was one PhD student defending his thesis. The abstract is presented below and is available at www.control.lth.se/publications



Thelander Andrén, Marcus

DISSERTATIONS 2020



Heyden, Martin

ON LQG-OPTIMAL EVENT-BASED SAMPLING

Thelander Andrén, Marcus

Event-based control is a promising concept for the design of resource-efficient feedback systems, where events such as sampling, actuation, and data transmissions are triggered reactively based on monitored control performance rather than a periodic timer. In this thesis, we investigate how sampling and communication events should be triggered to fully exploit the potential of event-based control based on the classic linear–quadratic–Gaussian (LQG) framework.

The design of the event trigger is formulated as a trade-off between a quadratic cost on control performance and the average event rate. The optimal event trigger is well-known for first-order systems, where it corresponds to a scalar symmetric threshold on the monitored control performance. In this thesis, we consider systems of higher order, where the shape of the optimal threshold is generally unknown. For two new system classes with previously unknown solutions, we prove that the optimal threshold is ellipsoidal for all system orders. Additionally, we propose two numerical methods for finding the optimal threshold shape for general systems.

Suboptimal but simpler designs in the form of event-based proportional–integral–derivative (PID) control are also considered. Inspired by results from LQG-optimal sampled-data control, we derive an “ideal” (in the LQG sense) sampled-data PID implementation, from which a range of design options of varying complexity for event-based PID control is proposed. Based on numerical evaluations, we present a proposal implementation that strikes a balance between performance and simplicity. Finally, this thesis also considers stochastic triggering, where events are triggered according to a certain probability. Two policies for stochastic triggering are proposed for a remote state estimation problem, both featuring predictions in the sensor for improved estimation performance. Both policies compare well to other proposals from the literature, and one of the policies also offers significantly simpler performance analysis.

LICENTIATE DISSERTATION

The licentiate thesis, of which the abstract is presented below, is available in its entirety at www.control.lth.se/publications

DYNAMIC OF OPTIMIZATION OF TRANSPORTATION NETWORKS WITH DELAYS

Heyden, Martin

The topic of this thesis is the optimal control of transportation networks. The problem studied is a dynamical extension of a classical problem in economics, in which the objective is to distribute goods to maximize welfare, whilst satisfying constraints on production and consumption. The main contribution is to show that for a class of welfare functions and dynamics, the optimal control is highly structured, and can be implemented in a way that scales gracefully with network size.

More specifically, it is shown that if the underlying transportation network is structured by a string graph with delays on the edges, an LQ optimal controller can be found by explicitly constructing the solution to a Riccati equation. Next the problem is studied from a user perspective. A method to compensate the users in the network, so that their choices of levels are also the social optimum is derived. Finally the results are extended to handle directed tree graphs, more general cost functions, and variable production in the network.

In all cases the optimal control can be found by sweeping through the graph once, calculating aggregate utilities and levels. This gives a serial implementation, that is suitable for systems where there is no need for high sample times, such as district heating systems and transportation networks.

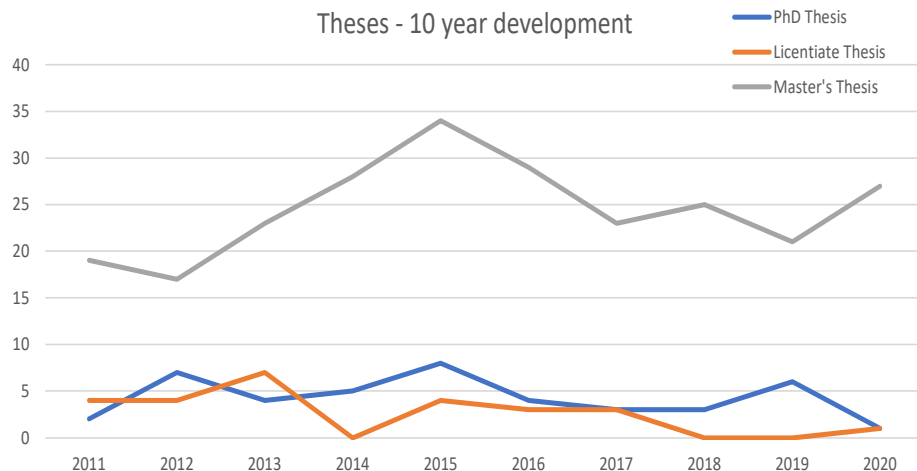

Research

This chapter presents our excellence centers and describes our three main research areas and their ongoing projects

RQ20 RESEARCH QUALITY EVALUATION

All research at Lund University has been evaluated in a total of 162 units in the Research Quality Evaluation Project 2020, RQ20. More than 4,700 employees have been involved in the RQ20 evaluation and 37 external panels with 220 advisors from around the world. Together, they have discussed and evaluated the University's long-term capacity to strengthen its position as one of the world's top universities.

Organization and governance, collaboration, the relationship between research and education, recruitment and funding strategies are things that have received special focus in the work because they are factors that are considered to have a major impact on research quality.

The university-wide research quality evaluation project RQ20 started already in the fall of 2019, with all research units (departments or subgroups of researchers at Lund University) writing comprehensive self-evaluations of their research environments.

During 2020, an external assessment of each unit was performed by expert panels with inter-

national researchers. The panels also did (virtual) site visits to Lund University, where they interviewed staff from each department.

The evaluation shows that Lund University has many assets and that its good international reputation is well deserved. In particular, the collegial spirit, the flexible leadership, the strategic research areas and the research infrastructures are highlighted as the University's real strengths.

The resulting assessment report for our department was discussed during our kick-off meeting in August. Some of the matters raised in the report were the department size (which we would like to maintain), the renewal of research directions (relating to new staff recruitment within the ELLIIT and WASP programs), funding diversity (with a recommendation on increased number of industrial projects and PhD students), and the gender policy (where more active involvement of improving the gender balance is desirable). The lessons learned from RQ20 will enter into our work with the long-term vision for the department.

EXCELLENCE CENTERS AND NATIONAL PROJECTS

ERC - Scalable Control of Interconnected Systems
 ELLIIT – The Linköping–Lund Initiative on IT and mobile communication
 WASP – Wallenberg AI, Autonomous Systems and Software Program
 HI2OT – Nordic University Hub on Industrial Internet of Things

SCALABLE CONTROL OF INTERCONNECTED SYSTEMS



Funding: European Research Council - ERC Advanced Grant

Modern society is critically dependent on large-scale networks for services such as energy supply, transportation and communications. The design and control of such networks is becoming increasingly complex, due to their growing size, heterogeneity and autonomy. A systematic theory and methodology for control of large-scale interconnected systems is therefore needed. In an ambitious effort towards this goal, this project will address the following key aspects:

- Modeling by leveraging tools from learning and adaption
- Control design by utilizing structural properties of the system
- Verification of system performance using decomposable certificates

Energy networks (electricity and district heating*) will be used as a guiding example for the development of theory and methodology. Close collaboration with industrial partners will ensure that the research is relevant and useful in practice.



***Scalable Control for Increased Flexibility in District Heating Networks** - This project investigates the development and application of scalable control strategies to explore the flexibility of large scale district heating networks. In particular, we aim to leverage theoretical tools from the field of control theory with a specific focus on those developed for positive systems. The objective is improving the operation of district heating networks while taking into account their limited communication architecture and the need for scalability to large network structures. These control strategies will be employed in demand response and load control architectures that can allow heating networks explore increased flexibility through e.g. demand response and direct load control.

ELLIIT – THE LINKÖPING–LUND INITIATIVE ON IT AND MOBILE COMMUNICATION

Funding: Government-funded Strategic Research Area

ELLIIT is a strategic research environment funded by the Swedish government in 2010, as part of its initiative to support strong research in information technology and mobile communications

ELLIIT has four partners: Linköping University, Lund University, Halmstad University and Blekinge Institute of Technology.

ELLIIT constitutes a platform for both fundamental and applied research, and for cross-fertilization between disciplines and between academic researchers and industry experts.

ELLIIT stands out by the quality and visibility of its publications, and its ability to attract and retain top talented researchers, and aims at being recognized as a top international research organization.

ELLIIT achieves its goals by a judicious choice of funded focus projects, a structured process for international recruitment, a balanced way of stimulating cooperation between research areas and between the sites involved (LiU, LU, BTH, HH), and a proactive approach towards fostering and maintaining cooperation with Swedish industry. The overarching objective of ELLIIT is to support scientific excellence in combination with industrial relevance and impact.

In the 2020 national budget bill for University Research and Education, an additional 72 MSEK/year were allocated to the strategic research area in IT and mobile communication with a focus on digitalization, i.e., an increase of the original budget with close to 200%. This initiated a major restart of ELLIIT including a new organization and restructuring of the research programme.

The following old ELLIIT projects have been running during 2020 with the participation of Automatic Control in Lund:

- Co-Design of Robust and Secure Networked Embedded Control Systems
- Collaborative Robotic Systems
- Local Positioning Systems
- Scalable Optimization for Control Systems
- Online Optimization and Control Towards Autonomous Vehicle Maneuvering

These projects were all terminated and new project proposals were submitted. This led to the following new projects (sometimes with very similar names as the old projects) involving Automatic Control that formally were started January 1, 2021. In each of the projects we have funding for one PhD student.

- Robust and Secure Control over the Cloud (Anton Cervin with Zebo Peng, Linköping University)
- Visual Feature-Based Data Reduction (Bo Bernhardsson with Ingrid Hotz, Linköping University)
- Scalable Optimization for Learning in Control (Anders Rantzer with Anders Hansson, Linköping University)
- Autonomous Force-Aware Swift Motion Control (Anders Robertsson with Lars Nielsen, Linköping University)
- Dynamics of Complex Socio-Technological Network Systems (Emma Tegling with Claudio Altafini, Linköping University)

Our department also received funding for three two-year postdoc projects starting July 1, 2020:

- Scalable Data Processing in Networked Systems (Anders Rantzer)
- Autonomous Radiation Mapping and Isotope Composition Identification by Mobile Gamma Spectroscopy (Anders Robertsson)
- Efficient and Reliable Training of Generative Adversarial Networks (Pontus Giselsson)

In addition to this we have also received ELLIT funding for Associate Professor Richard Pates. This replaces the funding for Bo Bernhardsson which will be ramped down over the coming years.

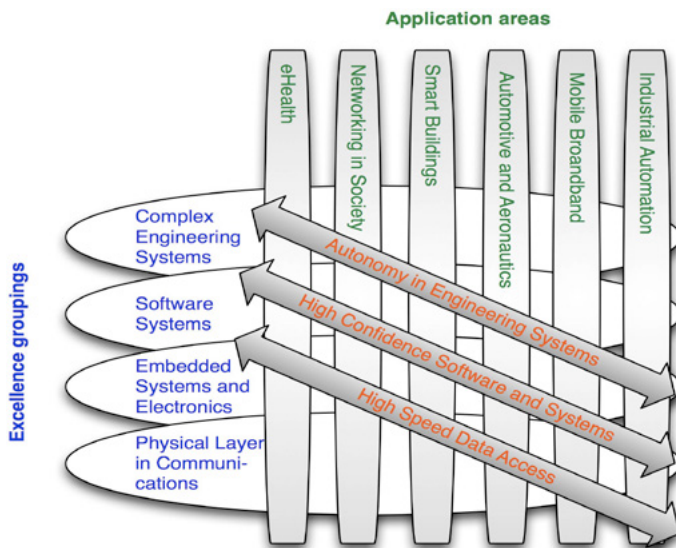

Illustration of the interaction between the themes, the application areas and the groupings (<http://www.liu.se/ellit>)



Funding: Knut and Alice Wallenberg Foundation (KAW)

Wallenberg AI, Autonomous Systems and Software Program (WASP) is Sweden's largest individual research program ever, and provides a platform for academic research and education, fostering interaction with Sweden's leading technology companies. The program addresses research on autonomous systems acting in collaboration with humans, adapting to their environment through sensors, information and knowledge, and forming intelligent systems-of-systems. Software is the main enabler in autonomous systems, and is an integrated research theme of the program. WASP's key values are research excellence and industrial relevance.

WASP is funded by the Knut and Alice Wallenberg Foundation with co-funding from industry and the involved universities. The programme, which started in 2015, will continue until 2030 with a total budget of SEK 5.5 billion out of which the Knut and Alice Wallenberg Foundation (KAW) provides SEK 4.2 billion.

The graduate school within WASP is dedicated to provide the skills needed to analyze, develop, and contribute to the interdisciplinary area of AI, autonomous systems and software. The curriculum provides the foundations, perspectives, and state-of-the-art knowledge in the different disciplines taught by leading researchers in the field. Through an ambitious program with research visits, partner universities, and visiting lecturers, the graduate school actively supports forming a strong multi-disciplinary and international professional network between PhD-students, researchers and industry. The graduate school provides added value on top of the existing PhD

programs at the partner universities, providing unique opportunities for students who are dedicated to achieving international research excellence with industrial relevance.

WASP involves seven Swedish universities together with numerous Swedish industries. At Lund University the following four departments participate: Department of Automatic Control, Department of Computer Science, Department of Electrical and Information Technology, and the Mathematical Imaging Group at the Department of Mathematics.

WASP is currently divided into 12 clusters. During 2020/2021 the introduction of a new cluster model has started. In the new model three types of clusters are supported. Core technical clusters are meeting points for WASP PhD students working with related research problems. The Application clusters gather students and WASP faculty that are active in the same application domain and, finally, the Area clusters gather students and WASP faculty that are active in the same technical area.

At the beginning of 2021 WASP funds the following positions at our department: 10 academic PhD students, 3 industrial PhD students (with Ericsson, Axis Communications, and Saab Kockums), 4 affiliated PhD students (funded from other sources), 1 associate professor (Emma Tegling), and 5 postdocs. In addition Karl-Erik Årzén and Anders Rantzer are involved in the management of WASP and Monika Rasmusson is the WASP Financial Officer for Lund University.

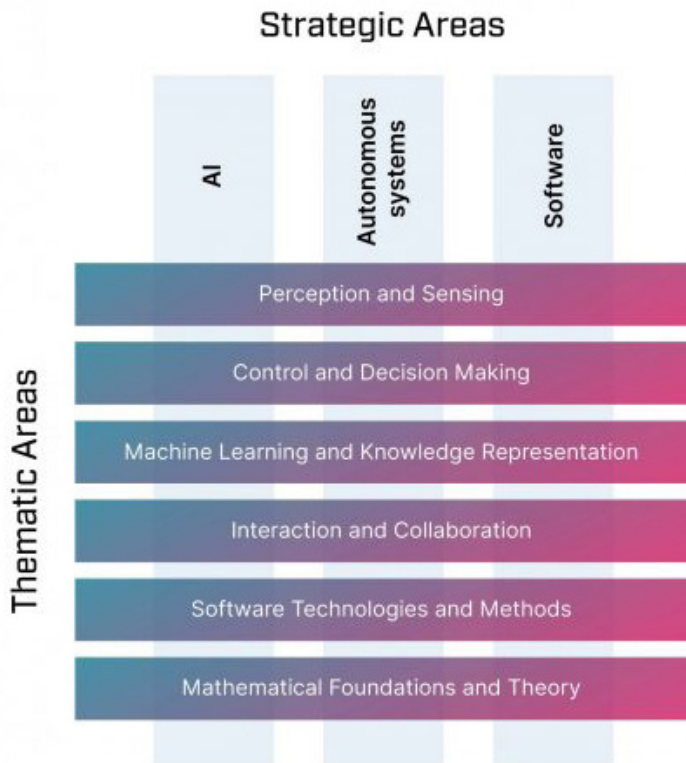

The research in WASP can be illustrated as a matrix with two dimensions, a strategic dimension and a thematic dimension. The strategic dimension emphasizes areas of impact on individuals, society, and industry, whereas the thematic areas represent the underlying scientific and technological challenges that are common to all types of autonomous systems.

The research is conducted at seven Swedish universities: Chalmers University of Technology, KTH Royal Institute of Technology, Linköping University, Lund University, Umeå University, Örebro University, and Uppsala University.

HIZOT – NORDIC UNIVERSITY HUB ON INDUSTRIAL INTERNET OF THINGS

Reseachers: Karl-Erik Årzén, Martina Maggio, Anders Robertsson, Anton Cervin, Johan Eker, Tommi Nylander, Per Skarin, Alexandre Martins, Claudio Mandrioli, Nils Vreman, Albin Heimerson, Johan Ruuskanen, Marcus Thelander Andrén, Marcus Greiff

Partners: DTU – Technical University of Denmark, Lund University, KTH – Royal Institute of Technology, NTNU – Norwegian University of Science and Technology, Aalto University

Funding: Nordforsk - Nordic University Hubs

The overall aim of HIZOT is to promote Nordic collaboration in Industrial Internet of Things (IIoT), which will increase the capacity of the participating organizations and create the critical mass needed to establish a world-leading Nordic research environment on IIoT.

There will soon be 50 billion “smart things” worldwide. When these become interconnected they form the Internet of Things, IoT. Industrial IoT (IIoT) is providing the infrastructure that underpins our Smart Society (Smart Energy Grid, Smart Cities, Smart and Green Mobility, Smart Manufacturing, etc.).

The proposal Nordic University (H)ub on (I)ndustrial (IoT) (HIZOT) is focused on Industrial IoT, a Nordic area of growth and a key technology enabler in solutions to several societal challenges. IIoT will only become a reality through the convergence of Operational and Information Technologies (OT & IT), which are currently separated. This will require multidisciplinary large-scale research effort. Hence, HIZOT brings together the strongest Nordic research groups in IIoT (8 groups at 5 universities) to form a long-term partnership for expanding IIoT cooperation in the Nordic region.

The overall aim of HIZOT is to promote Nordic collaboration in IIoT, which will increase the capacity of the participating organizations and create the critical mass needed to establish a

world-leading Nordic research environment on IIoT. HIZOT provides a unique integration of expertise, generating the synergies required to support the convergence of IT and OT. HIZOT will build a platform and a community to strengthen and structure the IIoT research and innovation. This will enhance strengthen national research and innovation systems by increasing their capacity, increase the ability of Nordic nations to address European and global cooperation and competition in IIoT, as well as increasing their competitiveness and growth via research and innovation.

The current Nordic IIoT research efforts are fragmented and address local national industries, lacking the necessary mass to become an international area of excellence. Research infrastructures are not cost-efficient, and will require the pooling of resources through increased coordination. HIZOT will build a platform and a community to strengthen and structure the IIoT research and innovation. HIZOT fits perfectly with the objectives of the participating universities, who have explicit IIoT strategies and strategies for Nordic cooperation. HIZOT will enhance the competitiveness of participating institutions, strengthen national research and innovation systems by increasing their capacity, and increase the ability of Nordic nations to address European and global cooperation and competition in IIoT.

RESEARCH AREAS

The goal of the department is to provide students with a solid theoretical foundation combined with a good engineering ability. This is reflected in the research program which covers both theory and applications. Automatic control, mathematics, and computer science form the core of all our research.

The research activities can roughly be divided into three thematic areas:



LARGE-SCALE SYSTEMS AND LEARNING

What do traffic networks, wind farms, Facebook and economic markets have in common? They are all large-scale networked systems, which can be analyzed and optimized using automatic control techniques.



AUTONOMOUS REAL-TIME SYSTEMS

Their vision? To create user-friendly, self-adaptive, resilient, high-performing systems, with low latency and jitter, while being cost-effective.



INNOVATIVE CONTROL APPLICATIONS

This is an area of application-driven research motivated by the desire to create a more sustainable society. It addresses several of the UN's 17 Sustainable Development Goals.

LARGE SCALE SYSTEMS AND LEARNING

What do traffic networks, wind farms, Facebook and economic markets have in common? They are all large-scale networked systems, which can be analyzed and optimized using automatic control techniques. By developing scalable methods for control and optimization, researchers at the Department of Automatic Control are contributing to solving one of the greatest challenges in modern engineering - the sustainable and safe operation of these large-scale systems.

A significant part of this field of research is directed towards developing theories and methodologies supporting the design and verification of distributed control structures. Other important parts focus on combining classical physics-based models with machine-learning tools, and combining models for traditional networks, for example, for electricity and heating, with learning algorithms for consumer behavior and decision-making. The aim is to improve efficiency and reliability, while at the same time reducing costs.

Ongoing projects:

- ICARUS - Intelligent Cell-Free Access for wiReless Ubiquitous Services
- Learning and Adaptation
- Large-Scale Convex Optimization
- Dynamics, Information and Control in networks

ICARUS -INTELLIGENT CELL-FREE ACCESS FOR WIRELESS UBIQUITOUS SERVICES

Researchers: Pontus Giselsson, Sebastian Banert, Mustafa Yetis

Funding: WASP

In this WASP expedition project, we lay the practical foundation for operating autonomous “cell-free” wireless networks. Instead of breaking down the network operation into independent cells, which is the cause of the inter-cell interference that drags down the performance of cel-

lular networks, all the access points in a cell-free network serve all users. Simply speaking, the interference is turned into desired signals. This project will take the first major leaps in achieving this using learning techniques.

LEARNING AND ADAPTATION

Researchers: Johan Grönqvist, Christian Rosdahl, Olle Kjellqvist, Frida Heskebeck, Carolina Bergeling, Bo Bernhardsson, Anders Rantzer

Funding: WASP and ERC

There are many important applications where classical physics based models need to be combined with machine learning tools. A good example is in autonomous driving, where automotive industry have extensive experience of control technology such as ABS braking, cruise control and ESP systems for vehicle stabilization. This technology now needs to be combined with machine learning methods to analyze traffic situations and human behavior. To do this in a safe and robust manner, it is essential to understand how learning algorithms for discrete sequential decision-making can interact with continuous physics based dynamics. Many other applications can be found. In the energy sector, well established control solutions for power networks and generators are increasingly being combined with learning algorithms for consumer behavior and decision-making, to minimize costs and optimize efficiency. In medicine, standard practice for disease therapies is combined with expert systems and sequential decision-making for medical diagnosis.

In our collaboration project with Alexandre Proutiere at KTH the aim is to bridge the gap between machine learning and control engine-

ering. These research fields have traditionally evolved more or less separately, but in recent years the intersections in terms of applications as well theoretical challenges have been growing. This project is concerned with sequential decision making in systems whose dynamics are initially unknown, i.e., with adaptive control or reinforcement learning. Statistical models are of fundamental importance in both areas, but while learning theory has been focused on sample complexity and regret, the corresponding control literature is discussing stability robustness and asymptotic performance. An important focus of our project is the tradeoff between exploration and exploitation, sometimes known as "dual control". The optimal tradeoff strategy can be formulated as the solution to a dynamic programming problem. We study properties of the solution as well as computational schemes. Optimal strategies are compared with common heuristics, both in control and reinforcement learning.

LARGE SCALE CONVEX OPTIMIZATION

Researchers: Pontus Giselsson, Sebastian Banert, Mattias Fält, Martin Morin, Hamed Sadeghi, Manu Upadhyaya

Funding: VR and WASP

Optimization is a modeling tool that has been used in many engineering fields for a long time. It can be used, e.g., for optimal control, financial decision making, signal reconstruction, route planning, statistical estimation, and training of supervised learning machines. Different optimization problems have different properties and fall into different categories. They can be coarsely divided into convex or nonconvex problems, smooth or nonsmooth problems, and small-scale or large-scale problems. Contemporary optimization problems in, e.g., machine learning, signal reconstruction, control, and statistical estimation are often large-scale. The research in this group is focused on understanding and developing efficient algorithms for solving such problems. We focus on convex and nonsmooth

problems with a primary focus is on so-called operator splitting methods and their stochastic variants. In particular, we develop frameworks for understanding a wide range of operator splitting methods that allow for a unified analysis and paves the way for design of new and improved algorithms. We also develop tools for automated algorithm analysis in which a so-called performance estimation optimization problem is formulated that exactly captures the worst possible performance of an optimization algorithm for some user-specified class of optimization problems. A solution to this, typically small-scale, performance estimation problem can give convergence guarantees for the analyzed algorithm.

DYNAMICS, INFORMATION AND CONTROL IN NETWORKS

Researchers: Carolina Bergeling, Martin Heyden, Richard Pates, Giacomo Como, Anders Rantzer, Emma Tegling

Funding: ERC, VR and SSF

Large-scale networks play a constantly increasing role in our modern society, e.g., affecting the access to essential services like mobility and energy, influencing the outcome of electoral polls, and determining the quality of the economic systems.

The Department hosts a research group on Dynamics, Information, and Control in Networks. The focus of this group is on the mathematical foundations of large-scale network systems with particular emphasis on issues related to their resilience, centrality, and scalability. Applications include cyber-physical systems, transportation networks, as well as social and economic networks.

One project is focused on transportation networks, with publications about decentralized traffic signal control and distributed dynamic tolls.

Another project studies the interplay between economics and traffic flows in transport networks. We will study exchange equilibria in traffic networks and network dynamics in presence of human decision makers. The goal is to gain deeper understanding of, and be able to exploit, the interaction between node demands and network flows.

AUTONOMOUS REAL-TIME SYSTEMS

A significant part of the research in this field revolves around cyber-physical systems, clouds, and cloud control. Historically, control systems have been deployed as monolithic software implementations on carefully tuned hardware, adjacent to the plants they control. This has resulted in systems that are undesirably non-modular, not easily extensible and that have limited ability to self-adapt. In contrast, feedback-based cyber-physical systems and cloud-native applications offer the prospect of greater accessibility and flexibility, as well as higher reliability and lower latencies. Furthermore, when applications are implemented in a disaggregated manner, their execution can be distributed across the system's many nodes, migrated, and scaled to meet individual objectives as well as that of the system as a whole.

Ongoing projects:

- Autonomous Cloud
- Co-Design of Robust and Secure Networked Embedded Control Systems
- Autonomous Datacenters – AutoDC
- Event-Based Control of Stochastic Systems with Application to Server Systems
- Event-Based Information Fusion for the Self-Adaptive Cloud
- Testing of Autonomous Systems
- Towards Adaptively Morphing Embedded Systems

AUTONOMOUS CLOUD

Researchers: Karl-Erik Årzén, Martina Maggio, Johan Eker, Tommi Nylander, Per Skarin, Alexandre Martins, in collaboration with the Department of Electrical and Information Technology at LTH, Umeå University, and KTH.

Funding: WASP

Background

An increasing amount of computing and information services are moving to the cloud, where they execute on virtualized hardware in private or public data centers. Hence, the cloud can be viewed as an underlying computing infrastructure for all systems of systems. The architectural complexity of the cloud is rapidly increasing. Modern data centers consist of tens of thousands of components, e.g., compute servers, storage

servers, cache servers, routers, PDUs, UPSs, and air-conditioning units, with configuration and tuning parameters numbering in the hundreds of thousands. The same increasing trend holds for the operational complexity. The individual components are themselves increasingly difficult to maintain and operate. The strong connection between the components furthermore makes it necessary to tune the entire system, which is complicated by the fact that in many cases the

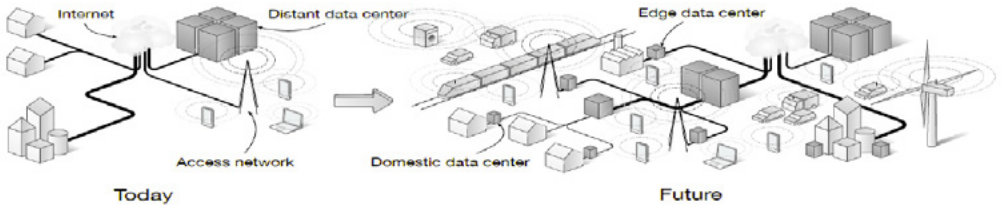

The following figure illustrates how the computations in the distributed cloud are migrating from back-end data centers out in the network.

behaviors, execution contexts, and interactions are not known a priori. The term autonomous computing or autonomic computing was coined by IBM in the beginning of the 2000s for self-managing computing systems with the focus on private enterprise IT systems. However, this approach is even more relevant for the cloud. The motivation is the current levels of scale, complexity, and dynamicity which make efficient human management infeasible. In the autonomous cloud control, AI, and machine learning/analytics techniques will be used to dynamically determine how applications should be best mapped onto the server network, how capacity should be automatically scaled when the load or the available resources vary, and how load should be balanced.

Currently there is also a growing interest in applying cloud techniques, such as virtualization and collocation, in the access telecommunication network itself. The unification of the telecom access network and the traditional cloud data centers, sometimes referred to as the distributed cloud, provide a single distributed computing platform. Here the boundary between the network and the data centers disappears, allowing application software to be dynamically deployed in all types of nodes, e.g., in base stations near end-users, in remote large-scale datacenters, or anywhere in between. In these systems the need for autonomous operation and resource management becomes even more urgent as heterogeneity increases, when some of the nodes may be mobile with varying availability, and when

new 5G-based mission-critical applications with harder requirements on latency, uptime, and availability are migrated to the cloud.

Project outline

In the project distributed control and real-time analytics will be used to dynamically solve resource management problems in the distributed cloud. The management problem consists of deciding the types and quantities of resources that should be allocated to each application, and when and where to deploy them. This also includes dynamic decisions such as automatic scaling of the resource amount when the load or the available resources vary, and on-line migration of application components between nodes. Major scientific challenges include dynamic modeling of cloud infrastructure resources and workloads, how to best integrate real-time analytics techniques with model-based feedback mechanisms, scalable distributed control approaches for these types of applications and scalability aspects of distributed computing.

In order to develop efficient methods for resource management, it is crucial to understand the performance aspects of the infrastructure, what the workloads look like, and how they vary over time. Hence, Infrastructure modeling and Workload modeling for the distributed cloud are important topics. Due to user mobility and variations in usage and resource availability, applications using many instances are constantly subject to changes in the number of instances; the individual instances relocated or resized;

the network capacity adjusted; etc. Capacity autoscaling is needed to determine how much capacity should be allocated for a complete application or any specific part of it; Dynamic component mapping to determine when, where, and how instances should be relocated, e.g., from a data center to a specific base station; and Optimized load mix management to determine how to “pack” different instances on individual servers or clusters. Since not all applications are equally important, e.g., due to differently priced service levels or due to some being critical to society (emergency, health care, etc.), the solutions to the three problems above must take into account Quality of Service differentiation. Finally, we address Holistic management to perform full-system coordination.

The primary software infrastructure will be based on Calvin, an open source application

environment developed by Ericsson and aimed at distributed clouds for IoT services. Calvin is based upon on the well-established actor model, it scales well, and it supports live migration of application components. We believe this infrastructure is suitable to investigate the application performance behavior of future commercial systems and validate our developed management solutions. It will enable accurate estimations of, for example, application latency and system loads.

The project results have the potential to be demonstrated in several WASP demonstrator arenas, including the Autonomous Research Arena (ARA), the Ericsson Research Data Center (ERDC), as well as in different university lab facilities.

CO-DESIGN OF ROBUST AND SECURE NETWORKED EMBEDDED CONTROL SYSTEMS

Researchers: Nils Vreman, Martina Maggio, Anton Cervin, Karl-Erik Årzén, Gautham Nayak Seetanadi, Marcus Thelander Andrén in collaboration with Linköping University

Funding: ELLIIT

In the design of embedded control systems it is important to use the limited platform resources (e.g., CPU time, network bandwidth, energy) as efficiently as possible. At the same time, any optimistic assumptions at design time may lead to runtime failures caused by missed deadlines, lost controls, or energy depletion. Shifting our focus from off-line optimization to on-line operation, in this project we aim to develop theory and co-design methodology for robust and secure embedded control systems that should operate efficiently also in the presence of uncertainties or unforeseen events. We will consider both passive and active robustness towards, among other things, plant perturbations, malicious intrusion, execution-time overruns, and varying network capacity. In the passive approach, we aim for techniques that take parametric plant and platform uncertainty into account at design

time, while the run-time system should provide predictable exception handling and provable performance bounds. In the active approach, the run-time system should be able to adapt to new and unexpected conditions via reconfiguration and self-optimization.

During 2020 we have researched different ways to on-line adapt controllers that suffer from real-time faults. We have also investigated reinforcement learning in the context of real-time networks. The proposed learning algorithm explores new routes while guaranteeing that no packet deadlines are missed. The results are included in the PhD thesis of Gautham Nayak Seetanadi. Our research partners in Linköping have focused on safe execution on control task code in the Cloud. The challenge is to verify that the control computations are correct, despite the Cloud being an unsafe execution environment.

AUTONOMOUS DATACENTERS – AUTODC

Researchers: Karl-Erik Årzén, Johan Eker and Albin Heimerson, in collaboration with KTH, Luleå University, Aalto University, Ericsson, RISE, and twelve other partners

Funding: Vinnova

With growth in the data center market expected to continue, the cost of operating and maintaining the data center footprint will increase. The aim of AutoDC is to provide an innovative design framework for autonomous data centers to enable ongoing operation and self-healing independent of contextual interference, e.g. intermittent power failure or overheating, without the need for any human intervention. Due to lower maintenance and operation costs, autonomous data centers can become key enablers of markets in developing countries.

The AutoDC project is led by Tor Björn Minde, Ericsson and consists of the following partners:

- Austria: AICo Software, Fluxguide
- Canada: Ericsson, Mariner Partners, Missing Link Technologies, Saint Mary's University
- Finland: Aalto University, Granlund Oy, kW-set Oy, Orbis Oy
- Sweden: 5 High Innovations, Clavister, Comsys, Ericsson, KTH, Luleå University of Technology, OP5, RISE, Swedish Modules, Swegon Operations

Towards closing the loop at datacenter scale

Increase availability, reduce power, improve service quality

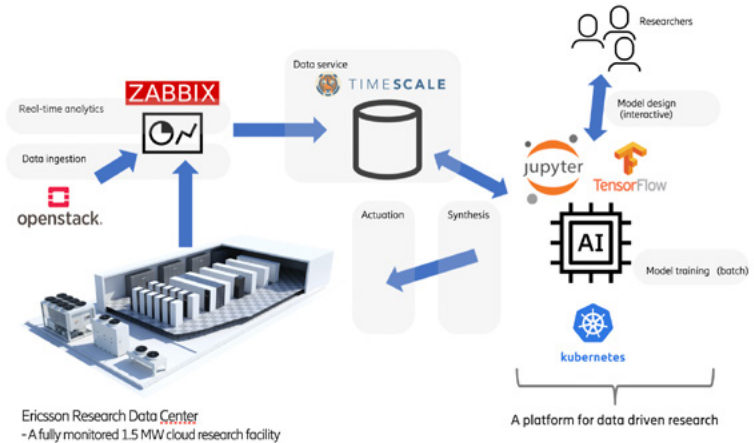

EVENT-BASED CONTROL OF STOCHASTIC SYSTEMS WITH APPLICATION TO SERVER SYSTEMS

Researchers: Marcus Thelander Andrén, Anton Cervin, Bo Bernhardsson, Kristian Soltész

Funding: VR

With the current strong trend towards networked and autonomous systems, it becomes less realistic to demand that all elements of a control loop should operate in a synchronous, time-triggered fashion. Above the lowest level of feedback control, it is often more natural and efficient to communicate, decide, and act based on events. Previous work shows that event-triggered control can achieve both lower average sampling rates and better performance than standard, periodic control. There is however not yet a coherent theory for analysis and synthesis of event-based controllers.

The aim of this project is to develop theory, tools, and design methodology for event-based

control of stochastic systems. The overall goals are more efficient resource usage and better performance compared to standard sampled-data control. At the same time, the methods are aimed at a wider class of control problems, including those that combine local feedback with higher-level decision making. Such features are common in various applications such as autonomous vehicles, traffic routing, control of computing systems, supervisory plant control, and resource management in the cloud.

During 2020, Marcus Thelander Andrén completed and successfully defended his PhD thesis, entitled *On LQG-Optimal Event-Based Sampling*.

EVENT-BASED INFORMATION FUSION FOR THE SELF-ADAPTIVE CLOUD

Researchers: Johan Ruuskanen, Anton Cervin, Karl-Erik Årzén

Funding: WASP

Successful self-adaptive resource provisioning in the cloud relies on accurate tracking of workload variations and timely detection of changes in the infrastructure. The general estimation problem is very challenging due to the massive number of observable events in various subsystems, each containing some useful information. In this project, we will develop novel, event-based estimation techniques for information fusion in cloud server systems. Our starting point will be the family of Monte Carlo-based inference methods known as Particle Filters, which will be adapted to handle event-based measurements

from different sources and with different time scales. The results will enable more responsive and exact decision making in the autonomous cloud.

During 2020 we have summarized our study on how particle filtering techniques can be adapted to better handle event-based measurements. In a parallel line of work, we have developed a testbed for experimenting with scalable cloud applications. We have also started to model and identify networks of microservices using queueing models and measurements from Cloud applications.

TESTING OF AUTONOMOUS SYSTEMS

Researchers: Claudio Mandrioli, Martina Maggio

Funding: WASP

Many cyber-physical systems change their behaviour depending on environmental data and internal states. This is the case of control systems, that compute a control signal that depends on input values like a desired position, measured values like the current position, and internal states like the previous control action. This is also the case of systems embedding machine learning algorithms, that receive new samples and incorporate what they learnt using these new samples into a policy that determines how to behave in new conditions. All these systems are adaptive, in that their behaviour changes over time in a prescribed - but a priori unpredictable - way. This project is about testing and comparing systems that incorporate some adaptivity.

Testing systems whose behaviour varies over time is difficult. Think of a machine learning algorithm: how many and which samples should we give to the system before we can consider its behaviour testable? And what is the correct outcome? Of course we can apply unit testing to each function in the code, check for coverage, select a few cases in which the ideal behaviour of the code is known. But this does not give us any guarantee that the code is behaving correctly for the task it has to complete in the physical environment.

We advocate that a formal and rigorous methodology is needed to test systems with adaptivity like self-adaptive software. This methodology should be used in conjunction with other forms of testing (e.g., unit testing) to provide guarantees on the cyber-physical system behaviour.

When learning is involved, it is impossible to provide any deterministic guarantees, since the function to be learnt may not have been explored. In such cases, drawing any general conclusion is impossible (and undesirable), unless probabilistic guarantees are targeted. We are convinced that this is true also for adaptive software and a paradigm shift is necessary for its testing: guarantees deriving from the tests' execution should be provided in the probabilistic space rather than in the deterministic one.

In the probabilistic space, we investigate three alternative methods to analyse testing data and provide guarantees:

- Monte Carlo experiments
- Extreme Value Theory
- Scenario Theory

TOWARDS ADAPTIVELY MORPHING EMBEDDED SYSTEMS - ADMORPH

Researchers: Martina Maggio, Nils Vreman, Anton Cervin

Funding: EU Horizon2020

Due to the increasing performance demands of mission- and safety-critical Cyber Physical Systems (of Systems) – CPS(oS) – these systems exhibit a rapidly growing complexity, manifested by an increasing number of (distributed) computational cores and application components connected via complex networks.

However, with the growing complexity and interconnectivity of these systems, the chances of hardware failures as well as disruptions due to cyber-attacks will also quickly increase. System adaptivity, foremost in terms of dynamically remapping of application components to processing cores, represents a promising technique to fuse fault- and intrusion tolerance with the increasing performance requirements of these mission- and safety-critical CPS(oS). In the ADMORPH project, we evaluate this hypothesis using a novel, holistic approach to the specification, design, analysis and runtime deployment of adaptive, i.e., dynamically morphing, mission- and safety-critical CPS(oS) that are robust against both component failures and

cyber-attacks. To this end, we will address four aspects that are instrumental for the realisation of these adaptively morphing systems:

- the formal specification of adaptive systems
- adaptivity methods like strategies for maintaining safe and secure control of CPS(oS)
- analysis techniques for adaptive systems to, e.g., perform timing verification of adaptive systems to avoid timing violations after system reconfigurations
- run-time systems for adaptive systems that realise the actual run-time system reconfigurations to achieve fault and intrusion tolerance

The developed methodologies, methods and tools will be evaluated using three industrial use cases taken from the radar surveillance systems, autonomous operations for aircrafts, and transport management systems domains.

INNOVATIVE CONTROL APPLICATIONS

This is an area of application-driven research motivated by the desire to create a more sustainable society. It addresses several of the UN's 17 Sustainable Development Goals. It also has an impact on LTH's five core research areas, meaning that this field of research is important in digitalization, industry, the built environment, our climate, and life itself.

Numerous applications are being addressed, for example, within robotics, health care, the process industry, combustion engines, and smart manufacturing. A substantial part of the research takes place in the robotics lab. Apart from research on automatic control, this focus area also concentrates on teaching and learning methods, standards for smart industries, and innovation indexes.

Much of the research is performed in collaboration with, and is co-funded by, industrial partners.

Ongoing projects:

- Robotics Lab
- Construction Robotics of today and tomorrow
- Semantic Mapping and Visual Navigation for Smart Robots
- Autonomous Flight (UAV@Lund)
- Decentralized Control Structures for Process Control
- Hemodynamic Stabilization
- On Humans for Humans
- Ventilator for Improved Cardiopulmonary Resuscitation
- Mind Methodology
- Strategies and Standards for Smart Swedish Industry
- Real-Time Individualization of BCIs

ROBOTICS LAB

The Robotics Lab at LTH is an experimental arena shared by the Department of Automatic Control and the Department of Computer Science. Robotics is a multi-disciplinary topic, and we collaborate with both national and international robotics colleagues regarding different aspects of robotics and we also have a close cooperation with industrial partners. Our main research is in motion and compliance control, control system architectures and different sensor fusion problems with application mainly to industrial manipulators. We mainly use modified industrial robot control systems and UAVs as experimental platforms.

The purpose of past and present research projects is to show how to organize open robot control systems and to verify these ideas by means of experimental verification. As a part of this research, we have developed several experimental open robot control systems. The systems are built around industrially available robots that have been reconfigured for experimental purposes.

The developed specific robot interfaces and the integration of the robots into a complete system forms a unique environment for testing and development of algorithms for improvement of performance, sensor integration, programming automation and autonomous operation. New sensor interfaces with modification of hardware and realtime software architectures have been developed to accommodate the use of force control algorithms based on workspace sensing. The research in this area has been awarded with e.g., the EURON Technology Transfer award and an ICRA Best Automation paper.

Current robotics-related projects at the department include:

- Construction Robotics of Today and Tomorrow
- Semantic Mapping and Visual Navigation for Smart Robots
- Autonomous Flight

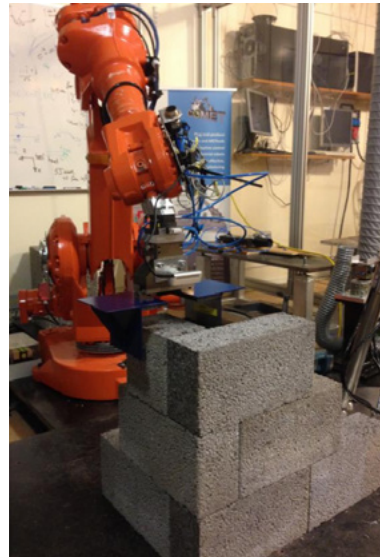
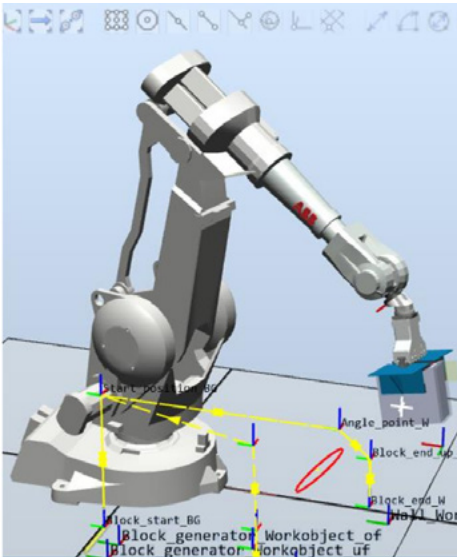

CONSTRUCTION ROBOTICS OF TODAY AND TOMORROW

Researchers: Anders Robertsson, Rolf Johansson, Manuel Korell and colleagues from the Department of Computer Science Maïke Klöckner, Mathias Haage.

Funding: Boverket and Vinnova

Since a couple of years new activities within construction robotics have started at LTH and a new cross-disciplinary laboratory facility is under establishment in the V-buiding, LTH, with serial and parallell kinematic robots for use in building construction, large structure 3D-printing etc.

Ongoing collaboration projects are

- Innovative Construction with Flexible Robot-Human Interaction (Boverket)
- Innovative Agile Construction for Globally Improved Sustainability (ACon 4.0) (VINNOVA UDI-2)

Purpose and goal

The construction industry has major problems linked to productivity, building quality, gender equality & safe work environment and environmental impact. Today's tools are developed to support existing value chains and building systems, and can be seen as part of the sector's problems. The ACon project will develop and develop solutions in construction by:

- Reducing the current fragmentation of the construction industry

- Link digital design to production automation
- Develop safer and more equal workplaces
- Develop customized robotization for collaboration with workers at construction sites

Planned presentation and action

Implementation of the ACon 4.0-project takes place in three work packages with underlying "tasks". There is a pronounced organization that ensures that deliveries and results are obtained.

- WP 1. Value chains & Business models - develop a traditional and new disruptive business model linked to small-scale robot production.
- WP 2. Technology development - digital information structure, building system, robot, rules and sensor technology
- WP 3. Communication & dissemination to Swedish construction industry and international collaboration - Initiate a construction robot lab at LTH with several stakeholders in academia and national construction industry, and there is also a dedicated international collaboration with the German INKOBÄU-project (<https://construction-robotics.de/>)

SEMANTIC MAPPING AND VISUAL NAVIGATION FOR SMART ROBOTS

Researchers: Marcus Greiff, Bo Bernhardsson, Anders Robertsson, Zhiyong Sun with colleagues from the Depts of Mathematics, Lund, and Chalmers University of Technology.

Funding: SSF

Why is it that today's autonomous systems for visual inference tasks are often restricted to a narrow set of scene types and controlled lab settings? Examining the best performing perceptual systems reveals that each inference task is solved with a specialized methodology. For instance, object recognition and 3D scene reconstruction, despite being strongly connected problems, are treated independently and an integrated theory is lacking. We believe that in order to reach further, it is necessary to develop smart systems that are capable of integrating the different aspects of vision in a collaborative manner. We gather expertise from computer vision, machine learning, automatic control and optimization with the ambitious goal of establishing such an integrated framework.

The research is structured into four work packages:

- Scene modelling
- Visual recognition

- Visual navigation
- System integration to achieve a perceptual robotic system for exploration and learning in unknown environments.

As a demonstrator, we will construct an autonomous system for visual inspection of a supermarket using small-scale, low-cost quadcopters. The system goes well beyond the current state-of-the-art and will provide a complete solution for semantic mapping and visual navigation. The basic research outcomes are relevant to a wide range of industrial applications including self-driving cars, unmanned surface vehicles, street-view modelling and flexible inspection in general.

AUTONOMOUS FLIGHT (UAV@LUND)

Participants: Rolf Johansson, Marcus Greiff, Anders Robertsson, Zhiyong Sun in cooperation with partners at 17 other departments at Lund University

Funding: Lund University cooperation grant *The future of drones*

In the last few years, several public and private research developers started investing a considerable amount of resources for the construction of human-friendly unmanned aerial vehicles (UAVs), or 'drones'. These devices immediately found a great deployment in the society opening an incredible amount of new opportunities as useful tools to address a variety of societal challenges, including agriculture and forest analysis, identifying property boundaries, surveying construction sites or corridors for roads and railroads, stockpile volume calculations, flooding and coastal erosion assessments, building information management, disaster planning and handling, surveys in remote or undeveloped areas, and the delivery of goods. The possibilities of digitalisation and technology development address societal challenges such as making societal sectors and domains more ecosystem friendly, efficient and competitive. This project will work to define societal challenges and ways to address them using applications of drone technology. The project will also study potential (unintended) consequences of such applications in terms of risks and ethical questions.

Despite the enormous achievements, drones have sufficient control autonomy and capability to complete only part of these activities and the majority of the applications previously described still rely on human supervision. This platform represents an important opportunity to develop and combine cross-disciplinary research activities in several strategic fields. Lund University has several ongoing activities and expertise related to autonomous drone flights, e.g. the drone pilot education at the School of Aviation in Ljungbyhed, the infrastructure projects ICOS, ACTRIS, NordSpec, and SITES Spectral, and research in remote sensing, drone archaeology, image analysis, machine learning, robot technology, air quality, and GIS. Strengthening and coordinating this capacity will enable rapid growth in terms of research, capacity building, and collaboration within the university. It will also stimulate regional development and innovation by increasing the collaboration with local companies and authorities.

DECENTRALIZED CONTROL STRUCTURES FOR PROCESS CONTROL

Researcher: Tore Hägglund

Funding: Vinnova

This project aims to revise, improve, and develop new basic control structures for decentralized control used in the regulatory control layer in process control. However, the ideas to be investigated in this project are relevant in other application areas as well. In previous parts of the project, feedforward design methods and a new ratio control structure have been developed. More information is given on the department's research web page.

Feedforward Mid-Ranging Control

Mid-ranging control is a control strategy that is used when there are more than one manipulated variable available to control a process variable. Mid-ranging control handles the redundancy by coordinating the roles of the different manipulated variables. The most common approach is to introduce valve position controllers (VPC) that control the steady-state position of manipulated variables. There are, unfortunately, some severe

drawbacks with the VPC approach that makes it unsuitable for many industrial applications.

In this project a new approach to mid-ranging control is investigated. The new strategy uses feedforward control to obtain desired steady-state values of the manipulated variables. The approach avoids the drawbacks associated with the VPC approach. The project is sponsored by PiiA-Vinnova and is performed in collaboration with ABB

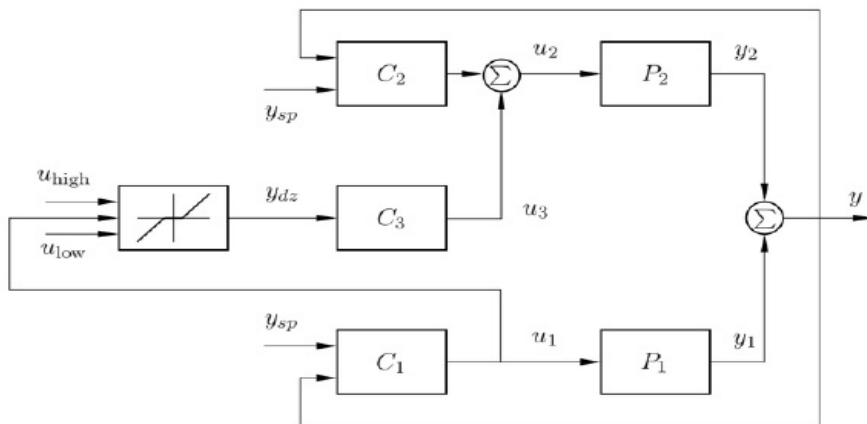

The feedforward mid-ranging control structure

Simple and efficient control loop decoupler for process control applications

A new project is initiated in collaboration with ABB, where the goal is to develop a simple control loop decoupler. It is based on inverted decoupling with static feedforward from control signals of opposite loops. Simple design rules for the feedforward gains are derived and found to provide gains that are close to the optimal ones. Different controller parameters of the feedback controllers should be used depending on whether the decoupling is in operation or not. This is obtained using gain scheduling, where the scheduling is determined by the decoupler.

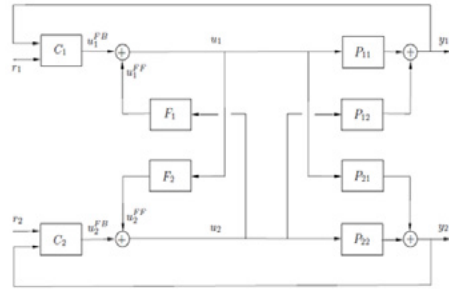

The control loop decoupler

HEMODYNAMIC STABILIZATION

Researchers: Kristian Soltesz, Henry Pigot, Ylva Wahlquist, Christopher Sturk and Trygve Sjöberg, Audrius Paskevicius (Heart and Lung transplantation), in collaboration with Igelösa Life Science

Funding: Vinnova and VR

Intensive care patients often rely on a combination of drug, fluid, and other therapies to achieve and maintain stable hemodynamics. This project investigates how pharmacology, mathematical modeling, signal processing and closed-loop control can be combined to control hemodynamic entities such as blood pressure, heart rate, and vascular resistance, as well as related entities such as diuresis. The research relies on close inter-disciplinary collaboration between medical and control systems researchers. It is conducted in a systems engineering framework and comprises the development of both methods and dedicated equipment for clinical verification.

The aim of the project is to develop methods for hemodynamic stabilization of intensive care patients. It comprises closed-loop control of readily measurable signals, including heart rate, arterial and venous blood pressure. Furthermo-

re, the project aims at optimizing hemodynamic parameters, which are not directly measurable, such as cardiac output and responsiveness to volume expansion.

The aim of the project is to develop a generic platform for closed-loop intravenous drug delivery. Apart from being used in research, such a platform can be adapted to a multitude of medical treatment scenarios, foremost in intensive care, where it has the potential to increase the availability of specialized physicians.

The aim of the project is to provide physicians with an 'auto pilot' for hemodynamic stabilization and optimization. The initially considered patient group are heart-beating braindead patients under intensive care (potential organ donors). Due to the complete loss of vasomotor center function, hormonal and fluid therapy is required to establish hemodynamic stability within this group.

We combine automatic control methods with medical insight, to develop closed-loop controlled therapies. Developed methods are implemented on our in-house developed control system comprising sensors for invasive blood pressure measurement, and urination rate, as well as syringe and volumetric infusion, pumps for closed-loop controlled intravenous drug and fluid administration.

The methods are pre-clinically evaluated in collaboration with the project partner Igelösa Life Science AB.

In 2019, Henry Pigot joined the team as PhD student. His project is strongly related to this project, but with ex vivo heart evaluation as application scenario. Henry and other collaborators are currently developing a research setup enabling the evaluation of hearts ex vivo, with the purpose of classifying whether they are suitable for transplantation. The same setup will also be a valuable tool in basic physiology and pharmacology research, in conjunction with the aforementioned closed-loop drug delivery system.

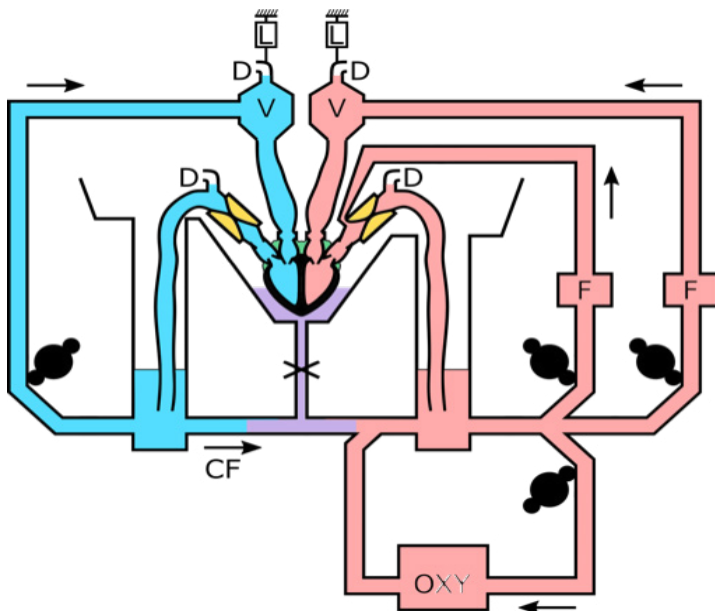

System diagram of the ex vivo heart evaluation system. The heart (center) is supplied with an oxygenated blood-like perfusate, and works against two automatically controlled dynamic impedances (yellow) that can be configured to mimic normal physiology of the prospective transplantation recipient. With this technology clinically available, it may be possible to utilize more than the current 30 % of available donor hearts.

ON HUMANS FOR HUMANS

Researchers: Charlotta Johnsson in collaboration with Skånes universitetssjukhus, Vårdnadsbanken, Cognibotics, and Robovision BVBA

Funding: Vinnova

By continuous development of new technology for surgical methods our healthcare is improved. Our vision of the project "On Humans for Humans" is to build a new testbed for groundbreaking robotics surgery, consisting of an operating theater with a nearby preparation and control room. The testbed will be located

close to Vårdnadsbanken in Lund, which is the largest tissue bank in Scandinavia. Novel methods in collaborative robotics will be evaluated and could eventually, after careful testing, be scaled up and reach the development regions of the world.

VENTILATOR FOR IMPROVED CARDIOPULMONARY RESUSCITATION

Researchers: Kristian Soltesz, Henry Pigot, and Trygve Sjöberg, Audrius Paskevicius (Thoracic surgery - Heart and Lung transplantation), in collaboration with Igelösa Life Science

Funding: Vinnova

Sudden cardiac arrest is the second most common cause of death in Sweden, following tumors. Annually, 10 000 persons are subject to sudden cardiac arrest outside of hospitals in the country. In 2015, 585 persons survived through resuscitation, which is the highest number since the 1992 establishment of the Swedish cardiopulmonary resuscitation registry.

Following cardiac arrest, blood circulation in the body ceases, and the brain is subject to irreversible damage within minutes. To counteract this, treatment of sudden cardiac arrest consists mainly in mechanical chest compressions - to circulate blood, combined with artificial gas exchange in the lungs - to deliver oxygen and ventilate carbon dioxide.

The clinical need addressed by this project is to improve survival statistics associated with sudden cardiac arrest. Pre-clinical pilots have demonstrated that it is possible to achieve improved circulation, combined with an increased

coronary perfusion pressure when the gas flow to the patient's lungs is automatically controlled based on the phase of the chest compression cycle. We have developed this idea into a research prototype of a mobile ventilator, specifically intended to be used in cardiopulmonary resuscitation.

The objective of this project is to investigate the efficiency of the new method through randomized pre-clinical studies and to further develop our research prototype. The long-term project goal is to achieve a decrease in deaths caused by sudden cardiac arrest.

In 2018, the results from a porcine study comparing our novel ventilation method to the state-of-the-art were compiled into a manuscript, and submitted to Elsevier Resuscitation. There are ongoing plans to incorporate the method into a commercial product and to initiate a human study.

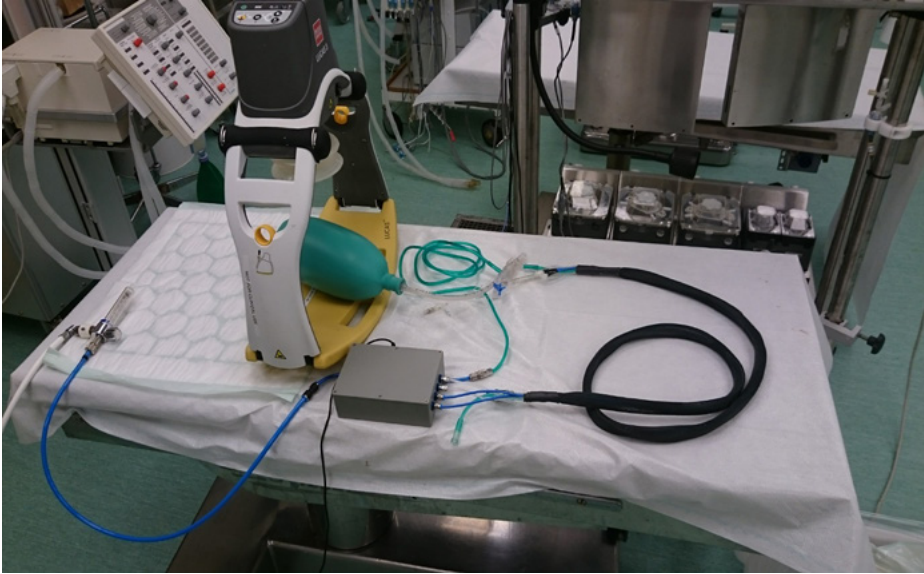

Our ventilator research prototype (gray box with tubing) together with the commercially available LUCAS chest compression device, developed at Igelösa.

MIND METHODOLOGY

Researchers: Charlotta Johnsson, in collaboration with UC Berkeley, CA, USA, and Jyväskylä University Finland



In a global context, education is seen as a main driving force for social development, and the pen as the best tool for shaping its future. This also applies to engineering and STEM education. However, traditional pedagogical approaches in teaching and learning are centered around theory and practice “to know how to do engineering and apply technology”. The mindset part, to “become an engineer and belong in the tech community” and “to feel how you can create

value for society” is often left out. The proposed new pedagogical methodology, called Mind Methodology, includes game-based and student-centered activities related to mindset and personal development of the students. Our vision for this novel methodology is to enhance and broaden traditional engineering and STEM education and, hence, to increase quality in education.

STRATEGIES AND STANDARDS FOR SMART SWEDISH INDUSTRY

Researchers: Charlotta Johnsson, in collaboration with Blue Institute, SIS, SEK, PiiA and Prod2030

Funding: Vinnova

Initiatives related to industrial digitalisation are ongoing around the globe. Also for Sweden, digitalisation and the concept of Smart industry is of importance. The Swedish government has selected "Connected Industry and New materials (also called Smart Industry)" as one of five cooperation programs. The vision is to apply new advanced technology to industrial production, with expected outcome of e.g. custom made individual products, and increased transparency (sustainability and work-ethics) of how each product was made.

In order to make this happen, collaboration in two forms, is needed. First, between the technical applications involved in the value-chains that the product is related to (design to product, raw material to product and reuse, etc). This requires international standards that the technical solutions can be based on. Second, collaboration between people, at national and international level, in order to develop these standards. This project aims at igniting the Swedish engagement, and enable Swedish industry

related research results to become international standards. The project aims at intertwining, on one hand the Swedish industry related research related to Smart industry, and on the other hand the Swedish standardisation organisations with their channels to the international arena. This is an example of novelty and hands on activities that have not been done before.

This requires involvement from the Swedish SIPs (mainly PiiA and Prod2030), researchers and industry, and the Swedish standardization organizations (SEK and SIS). This collaboration and joint effort is needed in order to generate a Swedish engagement and take an international position as a leading nationality in the area of Smart Manufacturing.



REAL-TIME INDIVIDUALIZATION OF BRAIN COMPUTER INTERFACES

Researchers: Frida Heskebeck, Olle Kjellqvist, Carolina Bergeling, Bo Bernhardsson, Johan Eker in collaboration with Professor Maria Sandsten and Postdoc Rachele Anderson at Mathematical Statistics, LTH, and Professor Mikael Johansson's group at the Department of Psychology, Lund University

Funding: WASP

Controlling the physical world with our mind only opens up for a vast number of exciting opportunities. This can be made possible through so called Brain Computer Interfaces (BCIs). In this project, we primarily focus on BCIs based on ElectroEncephaloGram (EEG) measurements, collected through the use of an EEG-cap. Although the technology behind BCIs have improved steadily over recent years, there is still much to be done. We investigate what the possibilities and limitations of BCIs are in terms of efficiency, reliability and individualizability.

The project is a collaboration between the Department of Automatic Control, the Department

of Mathematical Statistics and the Department of Psychology at Lund University. Bringing together cross-disciplinary expertise, we have identified several critical obstacles that prevent BCIs from becoming a truly life-changing technology, and methods to overcome them. We see several important areas of use such as communication and control for severely motor-impaired users, smart hearing aids, gaming-devices and forensics tools, as well as different health-related applications, such as rehabilitation, including restoration of motor control after stroke.

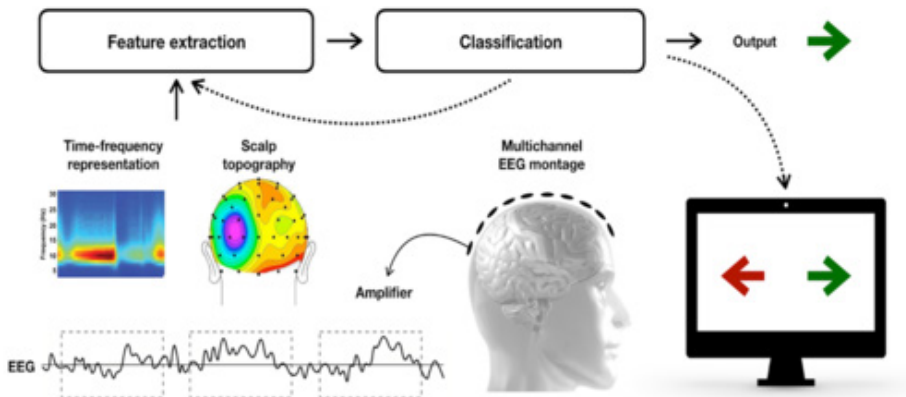

Our approach: Closed-loop design of the BCI with state-of-the-art time-frequency decomposition and feature extraction based on cognitive modeling.

TOOLS AND SOFTWARE

- Julia packages
- JGrafchart
- Jitterbug: A Matlab toolbox for real-time control performance analysis
- JITTERTIME: Real-time control performance simulation
- TrueTime: Simulation of Networked and Embedded Control Systems

JULIA PACKAGES

Researchers at the department, in particular Fredrik Bagge Carlson and Mattias Fält, have contributed to several registered packages for the Julia programming language:

- ControlSystems.jl – A control systems toolbox for Julia. (Several add-on packages are available.)
- BasisFunctionExpansions.jl – Basis function expansions for Julia.
- DeterministicPolicyGradient.jl – Reinforcement learning with deterministic policy gradient methods.
- DifferentialDynamicProgramming.jl – A package for solving differential dynamic programming and trajectory optimization problems.
- DynamicMovementPrimitives.jl – Learning dynamic movement primitives in Julia.
- LPVSpectral.jl - A toolbox for least-squares spectral estimation and (sparse) LPV spectral decomposition.
- SingularSpectrumAnalysis.jl – A package for performing singular spectrum analysis.
- CholmodSolve2.jl – Package for solving linear systems given an LDLt factorization.
- FirstOrderSolvers.jl – Large scale convex optimization solvers in Julia.

JGRAFCHART

Grafchart is a language for supervisory level sequence control and procedure handling that has been developed at the department since 1991. Grafchart is based on ideas from Grafcet/Sequential Function Charts, Petri nets, Statecharts, and object-oriented programming.

The original implementation of Grafchart had the same name and was developed in G2 from Gensym Corporation. Using this platform

Grafchart was used for batch recipe control, diagnosis of mode-changing processes, alarm filtering, implementation of operator decision support systems, and implementation of robot cells. In 2001 an open implementation of Grafchart was made in Java. It is called JGrafchart and is used in our laboratory exercises on logical sequence control and batch control as well as in several research projects.

JITTERBUG: A MATLAB TOOLBOX FOR REAL-TIME CONTROL PERFORMANCE ANALYSIS

Jitterbug is a MATLAB-based toolbox that allows the computation of a quadratic performance criterion for a linear control system under various timing conditions. Using the toolbox, one can easily and quickly assert how sensitive a control system is to delay, jitter, lost samples, etc., without resorting to simulation. The tool is quite general and can also be used to investigate jitter-compensating controllers, a periodic

controllers, and multi-rate controllers. As an additional feature, it is also possible to compute the spectral density of the signals in the control system. The main contribution of the toolbox, which is built on well-known theory (LQG theory and jump linear systems), is to make it easy to apply this type of stochastic analysis to a wide range of problems.

JITPERTIME: REAL-TIME CONTROL PERFORMANCE SIMULATION

JitterTime is a spin-off from the Matlab toolbox Jitterbug and can be used for calculating the performance of a controller under non-ideal timing conditions. Examples of such conditions include delay and jitter due to CPU and network scheduling, lost samples or lost controls due to packet loss or execution overruns, and aperiodic behavior due to clock drift, asynchronous nodes, and random sampling. Both Jitterbug and JitterTime evaluate a quadratic cost function for a mixed continuous-time/discrete-time linear system driven by white noise. The main difference is

the timing model. In Jitterbug, the timing of the discrete systems are governed by random delays with specified probability density functions. This allows the total system to be treated as a jump-linear system, and covariance can be calculated by solving a set of linear equations. In JitterTime, however, the timing is arbitrary and completely driven by the user. This allows for more complex timing scenarios to be analyzed, including scheduling algorithms with long-term timing dependencies and asynchronous execution in distributed control systems.

TRUETIME: SIMULATION OF NETWORKED AND EMBEDDED CONTROL SYSTEMS

TrueTime is a Matlab/Simulink-based simulator for real-time control systems. Offering Simulink blocks that model real-time kernels and wired/wireless networks, TrueTime facilitates co-simulation of scheduling algorithms, control tasks, network protocols, and continuous plant dynamics.

TrueTime has been developed at the Department of Automatic Control since 1999. It is open source, written in C++, and can easily be extended with new functionality. TrueTime has been used in wide range of research projects and has also found use in university courses and in industry.

Publications and seminars

This chapter contains a list of publications and seminars during 2020

PUBLICATIONS 2020

You can find references to all the publications on www.control.lth.se/publications and almost all of them can be downloaded from this site. Any of the reports may, however, be borrowed through your library service or from the following libraries in Sweden:

- Göteborgs universitetsbibliotek
- Kungliga Biblioteket
- Linköpings universitetsbibliotek
- Lunds universitetsbibliotek
- Stockholms universitetsbibliotek
- Umeå universitetsbibliotek
- Uppsala universitetsbibliotek

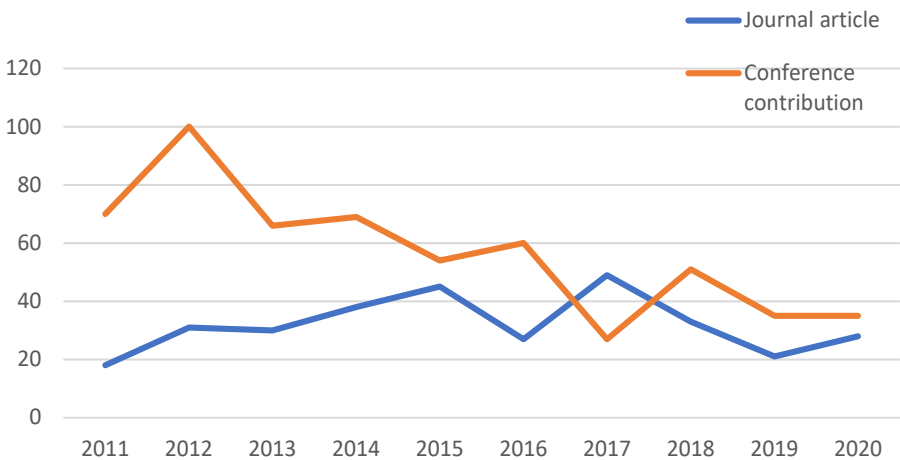
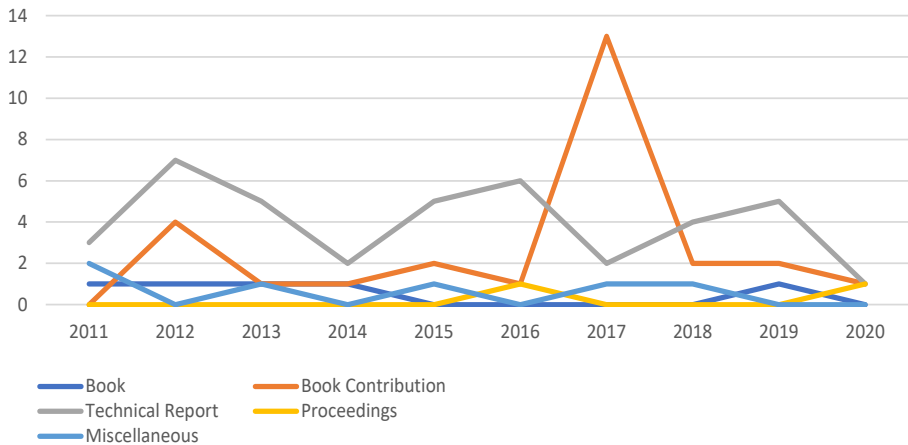

BOOK CONTRIBUTION

Soltész, Kristian; van Heusden, Klaske; Dumont, Guy A.; *Models for control of intravenous anesthesia*. In Automated drug delivery in anesthesia, Elsevier, 2020.

JOURNAL ARTICLES

- Abdelzaher, Tarek; Hao, Yifan; Jayarajah, Kasthuri; Misra, Archan; Skarin, Per; Yao, Shuochao; Weerakoon, Dulanga; Årzén, Karl-Erik; *Five Challenges in Cloud-Enabled Intelligence and Control*. ACM Transactions on Internet Technology, 20:1, 2020.
- Anistratov, Pavel; Olofsson, Björn; Burdakov, Oleg; Nielsen, Lars; *Autonomous-Vehicle Maneuver Planning Using Segmentation and the Alternating Augmented Lagrangian Method*. IFAC-PapersOnLine, 2020.
- Banert, Sebastian; Boł, Radu Ioan; Csetnek, Ernő Robert; *Fixing and extending some recent results on the ADMM algorithm*. Numerical Algorithms, 2020.
- Barzegaran, Mohammadreza; Cervin, Anton; Pop, Paul; *Performance Optimization of Control Applications on Fog Computing Platforms Using Scheduling and Isolation*. IEEE Access, 8, pp. 104085–104098, 2020.
- Bergeling, Carolina; Morris, Kirsten A.; Rantzer, Anders; *Closed-form H-infinity optimal control for a class of infinite-dimensional systems*. Automatica, 117, 2020.
- Bergeling, Carolina; Pates, Richard; Rantzer, Anders; *H-infinity Optimal Control for Systems with a Bottleneck Frequency*. IEEE Transactions on Automatic Control, 2020.
- Bjornson, Emil; Giselsson, Pontus; *Two Applications of Deep Learning in the Physical Layer of Communication Systems* [Lecture Notes]. IEEE Signal Processing Magazine, 37:5, pp. 134–140, 2020.
- Caverly, Ryan James; Pates, Richard; Bridgeman, Leila Jasmine; Forbes, James Richard; *MIMO Nyquist interpretation of the large gain theorem*. International Journal of Control, 93:10, pp. 2326–2335, 2020.
- Como, Giacomo; Frasca, Paolo; Yuksel, Serdar; *Technical Committee on Networks and Communication Systems* [Technical Activities]. In IEEE Control Systems, IEEE - Institute of Electrical and Electronics Engineers Inc., IEEE - Institute of Electrical and Electronics Engineers Inc. 2020.
- Fors, Victor; Olofsson, Björn; Nielsen, Lars; *Autonomous Wary Collision Avoidance*. IEEE Transactions on Intelligent Vehicles, 2020.
- Fransson, Per-Anders; Nilsson, Maria H.; Niehorster, Diederick C.; Nyström, Marcus; Rehn Crona, Stig; Tjernström, Fredrik; Magnusson, Måns; Johansson, Rolf; Patel, Mitesh; *Exploring the effects of deep brain stimulation and vision on tremor in Parkinson's disease - benefits from objective methods*. Journal of NeuroEngineering and Rehabilitation, 17:1, 2020.
- Heyden, Martin; Pates, Richard; Rantzer, Anders; *Optimal Transportation on Directed Tree Graphs*. Under Review, 2020. In submission.
- Huang, Na; Sun, Zhiyong; Anderson, Brian D.O.; Duan, Zhisheng; *Distributed and adaptive triggering control for networked agents with linear dynamics*. Information Sciences, 517, pp. 297–314, 2020.
- Jouini, Taouba; Sun, Zhiyong; *Steady state characterization and frequency synchronization of a multi-converter power system on high-order manifolds*. Under Review, 2020. In submission.
- Kergus, Pauline; *Data-driven control of infinite dimensional systems : Application to a continuous crystallizer*. IEEE Control Systems Letters, 2020.
- Li, Yuling; Yin, Yixin; Zhang, Sen; Dong, Jie; Johansson, Rolf; *Composite adaptive control for bilateral teleoperation systems without persistency of excitation*. Journal of the Franklin Institute, 357:2, pp. 773–795, 2020.

- Li, Yuling; Liu, Kun; He, Wei; Yin, Yixin; Johansson, Rolf; Zhang, Kai; *Bilateral teleoperation of multiple robots under scheduling communication*. IEEE Transactions on Control Systems Technology, 28:5, pp. 1770–1784, 2020.
- Nilsson, Gustav; Como, Giacomo; *A Micro-Simulation Study of the Generalized Proportional Allocation Traffic Signal Control*. IEEE Transactions on Intelligent Transportation Systems, 21:4, pp. 1705–1715, 2020.
- Olofsson, Björn; Nielsen, Lars; *Using Crash Databases to Predict Effectiveness of New Autonomous Vehicle Maneuvers for Lane-Departure Injury Reduction*. IEEE Transactions on Intelligent Transportation Systems, pp. 1–12, 2020.
- Patel, Mitesh; Nilsson, Maria H.; Rehncrona, Stig; Tjernström, Fredrik; Magnusson, Måns; Johansson, Rolf; Fransson, Per Anders; *Effects of Deep Brain Stimulation on postural control in Parkinson's disease*. Computers in Biology and Medicine, 122, 2020.
- Peng, Xiuhui; Sun, Zhiyong; Guo, Kexin; Geng, Zhiyong; *Mobile Formation Coordination and Tracking Control for Multiple Nonholonomic Vehicles*. IEEE/ASME Transactions on Mechatronics, 25:3, pp. 1231–1242, 2020.
- Rodríguez, Carlos; Aranda-Escolástico, Ernesto; Guzmán, José Luis; Berenguel, Manuel; Hägglund, Tore; *Revisiting the simplified IMC tuning rules for low-order controllers : Novel 2DoF feedback controller*. IET Control Theory and Applications, 14:13, pp. 1700–1710, 2020.
- Rodríguez, Carlos; Aranda-Escolástico, Ernesto; Guzmán, José Luis; Berenguel, Manuel; Hägglund, Tore; *Revisiting the simplified internal model control tuning rules for low-order controllers : Feedforward controller*. IET Control Theory and Applications, 14:12, pp. 1612–1618, 2020.
- Ryu, Ernest K.; Taylor, Adrian B.; Bergeling, Carolina; Giselsson, Pontus; *Operator splitting performance estimation : Tight contraction factors and optimal parameter selection*. SIAM Journal on Optimization, 30:3, pp. 2251–2271, 2020.
- Shahriari, Zahra; Bernhardsson, Bo; Troeng, Olof; *Convergence analysis of iterative learning control using pseudospectra*. International Journal of Control, 2020.
- Simoni, Luca; Beschi, Manuel; Visioli, Antonio; Åström, Karl Johan; *Inclusion of the dwell time effect in the LuGre friction model*. Mechatronics, 66, 2020.
- Soltesz, Kristian; Gustafsson, Fredrik; Timpka, Toomas; Jaldén, Joakim; Jidling, Carl; Heimerson, Albin; Schön, Thomas B.; Spreco, Armin; Ekberg, Joakim; Dahlström, Örjan; Bagge Carlson, Fredrik; Jöud, Anna; Bernhardsson, Bo; *The effect of interventions on COVID-19*. Nature, 588, pp. 26–28, 2020.
- Yin, Lianhao; Turesson, Gabriel; Tunestal, Per; Johansson, Rolf; *Model Predictive Control of an Advanced Multiple Cylinder Engine with Partially Premixed Combustion Concept*. IEEE/ASME Transactions on Mechatronics, 25:2, pp. 804–814, 2020.

CONFERENCE CONTRIBUTIONS

- Cervin, Anton; Thelander Andrén, Marcus; *LQG-Optimal versus Simple Event-Based PID Controllers*. In The 2020 American Control Conference, Denver, United States, July 2020.
- Eker, Johan; Millnert, Victor; *HoloScale: horizontal and vertical scaling of cloud resources*. In 13th IEEE/ACM International Conference on Utility and Cloud Computing, UCC 2020, Leicester, United Kingdom, December 2020.
- Greiff, Marcus; Sun, Zhiyong; Robertsson, Anders; *Coordination Control of Double-Integrator Systems with Time-Varying Weighted Inputs*. In 21st IFAC World Congress, Berlin, Germany, July 2020.

- Greiff, Marcus; Robertsson, Anders; Lefeber, Erjen; *Filtered Output Feedback Tracking Control of a Quadrotor UAV*. In 21st IFAC World Congress, Berlin, Germany, July 2020. Accepted for publication.
- Greiff, Marcus; Robertsson, Anders; Berntorp, Karl; *MSE-optimal measurement dimension reduction in gaussian filtering*. In 4th IEEE Conference on Control Technology and Applications, CCTA 2020, Virtual, Montreal, Canada, August 2020.
- Greiff, Marcus; Berntorp, Karl; *Optimal Measurement Projections with Adaptive Mixture Kalman Filtering for GNSS Positioning*. In 2020 American Control Conference, Denver, CO, United States, July 2020.
- Gustafsson, Fredrik; Soltesz, Kristian; Jaldén, Joakim; Bernhardsson, Bo; *Identifiability of non-pharmaceutical intervention effects on Covid-19 Spread in Europe*. In 59th IEEE Conference on Decision and Control, Jeju Island, Korea, Republic of, December 2020. Accepted for publication.
- Heyden, Martin; Pates, Richard; Rantzer, Anders; *Price Based Linear Quadratic Control Under Transportation Delay*. In IFAC PapersOnLine, 2020.
- Jafer, Amani; Nilsson, Gustav; Como, Giacomo; *Data Augmentation of IMU Signals and Evaluation via a Semi-Supervised Classification of Driving Behavior*. In 23rd IEEE International Conference on Intelligent Transportation Systems, ITSC 2020, Rhodes, Greece, September 2020.
- Jouini, Taouba; Tegling, Emma; Sun, Zhiyong; *Grid-forming lambda-omega virtual oscillator control in converter-based power systems*. In European Control Conference 2021, Rotterdam | De Doelen, Netherlands, June 2020. In submission.
- Jouini, Taouba; Sun, Zhiyong; *Fully decentralized conditions for local convergence of DC/AC converter network based on matching control*. In IEEE Conference on Decision and Control, January 2020.
- Jouini, Taouba; Sun, Zhiyong; *Distributed learning for optimal allocation in radial power systems*. 2020. In submission.
- Kergus, Pauline; *Data-driven stability analysis and enforcement for Loewner Data-Driven Control*. In IPAM Workshop on "Intersections between Learning, Control and Optimization", Los Angeles, United States, February 2020.
- Klößner, Maike; Haage, Mathias; Nilsson, Klas; Robertsson, Anders; Andersson, Ronny; *Parallel Kinematic Construction Robot for AEC Industry*. In 37th International Symposium on Automation and Robotics in Construction (ISARC 2020), Kitakyushu, Japan, October 2020.
- Maggio, Martina; Hamann, Arne; Mayer-John, Eckart; Ziegenbein, Dirk; *Control System Stability under Consecutive Deadline Misses Constraints*. In 32nd Euromicro Conference on Real-Time Systems (ECRTS 2020), Modena, Italy, July 2020.
- Mandrioli, Claudio; Maggio, Martina; *Testing self-adaptive software with probabilistic guarantees on performance metrics*. In 28th ACM Joint Meeting European Software Engineering Conference and Symposium on the Foundations of Software Engineering, ESEC/FSE 2020, Virtual, Online, United States, November 2020.
- Martins, Alexandre; Årzén, Karl-Erik; Maggio, Martina; Lindberg, Mikael; *Control-Based Resource Management for Storage of Video Streams*. In IFAC World Congress 2020, July 2020.
- Matni, Nikolai; Proutiere, Alexandre; Rantzer, Anders; Tu, Stephen; *From self-tuning regulators to reinforcement learning and back again*. In 58th IEEE Conference on Decision and Control, CDC 2019, Nice, France, December 2020.
- Nayak Seetanadi, Gautham; Årzén, Karl-Erik; *Routing using Safe Reinforcement Learning*. In 2nd Workshop on Fog Computing and the Internet of Things, , April 2020. Accepted for publication.
- Nylander, Tommi; Ruuskanen, Johan; Årzén, Karl-Erik; Maggio, Martina; *Towards Performance Modeling of Speculative Execution for Cloud Applications*. In 3rd Workshop on Hot Topics in Cloud Computing Performance, Edmonton, Canada, April 2020.

- Nylander, Tommi; Ruuskanen, Johan; Årzén, Karl-Erik; Maggio, Martina; *Modeling of Request Cloning in Cloud Server Systems using Processor Sharing*. In 11th ACM/SPEC International Conference on Performance Engineering, Edmonton, Canada, April 2020.
- Pates, Richard; *A Damping Ratio Bound for Networks of Masses and Springs*. In 18th European Control Conference, ECC 2020, Saint Petersburg, Russian Federation, May 2020.
- Pates, Richard; Bergeling, Carolina; Rantzer, Anders; *On the Optimal Control of Relaxation Systems*. In 58th IEEE Conference on Decision and Control, CDC 2019, Nice, France, December 2020.
- Pigot, Harry; Sancho, Carlos B.; Paskevicius, Audrius; Steen, Stig; Soltesz, Kristian; *Advantage of new ventilation method for cardiopulmonary resuscitation qualitatively captured by simple respiratory mechanics models*. In The 2020 American Control Conference, Denver, United States, July 2020.
- Rosdahl, Christian; Bernhardsson, Bo; *Dual Control of Linear Discrete-Time Systems with Time-Varying Parameters*. In 4th International Conference on Control, Automation and Diagnosis, ICCAD 2020, Paris, France, October 2020.
- Ruuskanen, Johan; Cervin, Anton; *On Innovation-Based Triggering for Event-Based Nonlinear State Estimation Using the Particle Filter*. In European Control Conference (ECC 20), Saint Petersburg, Russian Federation, May 2020.
- Salt Ducaju, Julian M.; Tang, Chen; Tomizuka, Masayoshi; Chan, Ching Yao; *Application Specific System Identification for Model-Based Control in Self-Driving Cars*. In 31st IEEE Intelligent Vehicles Symposium, IV 2020, Virtual, Las Vegas, United States, October 2020.
- Skarin, Per; Eker, Johan; Årzén, Karl-Erik; *A Cloud-Enabled Rate-Switching MPC Architecture*. In 59th IEEE Conference on Decision and Control, Jeju Island, Korea, Republic of, December 2020. Accepted for publication.
- Skarin, Per; Eker, Johan; Årzén, Karl-Erik; *Cloud-Based Model Predictive Control with Variable Horizon*. In 21st IFAC World Congress, Berlin, Germany, July 2020. Accepted for publication.
- Skarin, Per; Tärneberg, William; Årzén, Karl-Erik; Kihl, Maria; *Control-over-the-cloud: A performance study for cloud-native, critical control systems*. In 13th IEEE/ACM International Conference on Utility and Cloud Computing, UCC 2020, Leicester, United Kingdom, December 2020.
- Suttner, Raik; Sun, Zhiyong; *Exponential and practical exponential stability of second-order formation control systems*. In 58th IEEE Conference on Decision and Control, CDC 2019, Nice, France, December 2020.
- Visioli, Antonio; Hägglund, Tore; *Minimum-time feedforward control in ratio control systems*. In IFAC World Congress, Berlin, Berlin, Germany, July 2020.
- Vreman, Nils; Mandrioli, Claudio; *Evaluation of burst failure robustness of control systems in the fog*. In 2nd Workshop on Fog Computing and the IoT, Fog-IoT 2020, Sydney, Australia, April 2020.
- Wahlquist, Ylva; van Heusden, Klaske; Dumont, Guy A.; Soltesz, Kristian; *Individualized closed-loop anesthesia through patient model partitioning*. In 42nd Annual International Conference of the IEEE Engineering in Medicine and Biology Society, Quebec, Canada, July 2020.
- Zhao, Di; Rantzer, Anders; Qiu, Li; *A Convex Approach to Frisch-Kalman Problem*. In 58th IEEE Conference on Decision and Control, CDC 2019, Nice, France, December 2020.

LICENTIATE THESIS

- Heyden, Martin; *Dynamic Optimization of Transportation Networks with Delays*. Licentiate Thesis, Department of Automatic Control, Lund University, Sweden, March 2020.

PHD THESIS

- Thelander Andrén, Marcus; *On LQG-Optimal Event-Based Sampling*. PhD Thesis, Department of Automatic Control, Lund University, Sweden, November 2020.

TECHNICAL REPORTS

Ärzén, Karl-Erik; Rasmusson, Monika (Eds.); *Activity Report 2019 : Automatic Control Lund University*. Technical Report, Department of Automatic Control, Lund University, Sweden, May 2020.

MASTER THESES

Ahlqvist, Johan; Skoog, André; *Image-based anomaly detection using β -Variational Autoencoder for surface vehicle collision avoidance*. Master's Thesis TFRT-6121, Supervisors: Lindberg, Mikael, Axis Communications; Lindh, Jens-Olof, Saab Kockums AB; Nilsson, Mikael, Dept. of Mathematics, LTH and Robertsson, Anders, Grönqvist, Johan, Department of Automatic Control, Lund University, Sweden, December 2020.

Andersson, Oscar; Hindgren, Oskar; *Lifetime Predictions of Electrolytic Capacitors in Network Cameras with Random Forest*. Master's Thesis TFRT-6114, Supervisors: Åström, Kalle, Mathematics, LTH and Bernhardsson, Bo, Department of Automatic Control, Lund University, Sweden, September 2020.

Arbman Hansing, Anton; *Public Goods on Networks : Statics, Welfare & Mechanisms*. Master's Thesis TFRT-6099, Supervisor: Como, Giacomo, Politecnico di Torino and Department of Automatic Control, Lund University, Sweden, September 2020.

Bladh, Johan; *Sensorless Induction Welding of Carbon Fiber Reinforced Plastic Components*. Master's Thesis TFRT-6113, Supervisors: Hermodsson, Magnus, Corebon (external) and Robertsson, Anders, Department of Automatic Control, Lund University, Sweden, December 2020.

Christensen Strömngren, Jonas; *Modelling and Optimization of Peroxide Pulp Bleaching Process*. Master's Thesis TFRT-6120, Supervisors: Ingves, Sara, Södra Skogsägarna, Mörrum (external) and Hägglund, Tore, Department of Automatic Control, Lund University, Sweden, December 2020.

Cobleigh, Alexander; *TrustNet: Trust-based Moderation Using Distributed Chat Systems for Transitive Trust Propagation*. Master's Thesis TFRT-6102, Supervisors: Advisor: Eker, Johan, Ericsson Research and at Department of Automatic Control, Lund University, Sweden, June 2020.

Elmér, Kalle; *Controlling nutrients in a hydroponic growing system*. Master's Thesis TFRT-6109, Supervisor: Cervin, Anton, Department of Automatic Control, Lund University, Sweden, June 2020.

Fagerström Hedbrant, Olle; Gemborn Nilsson, Martin; *Robust Relative Positioning & Autonomous Landing of a Flying Wing MAV for Sea Rescue Applications*. Master's Thesis TFRT-6104, Supervisors: Robertsson, Anders and Greiff, Marcus, Department of Automatic Control, Lund University, Sweden, December 2020.

Hansson, Jonas; Svensson, Magnus; *Next Generation Relay Autotuners – Analysis and Implementation at ABB*. Master's Thesis TFRT-6107, Supervisors: Theorin, Alfred, ABB (external) and Soltesz, Kristian, Åström, Karl Johan, Department of Automatic Control, Lund University, Sweden, June 2020.

Hed, Simon; Knutsson, Axel; *Sensorless method of detecting plunger position in solenoid actuators*. Master's Thesis TFRT-6097, Supervisors: Blomberg, Johan and Högberg, Arne, BorgWarner (external) and Robertsson, Anders, Department of Automatic Control, Lund University, Sweden, June 2020.

Karlsson, Jonas; *Road friction estimation using an artificial neural network in a simulated environment*. Master's Thesis TRFT-6095, Supervisors: Yngve, Simon, Combine Control Systems (external) and Cervin, Anton, Department of Automatic Control, Lund University, Sweden, January 2020.

Klasson, Ricky; Frykebrant, Johan; *Control Strategies for Variable Air Volume Ventilation used as a Demand Response Resource*. Master's Thesis TFRT-6108, Supervisors: Håkansson, Annah, and Iggröm, Daniel, Siemens (external) and Soltesz, Kristian, Department of Automatic Control, Lund University, Sweden, June 2020.

- Kotarsky, Niklas; Bergvall, Eric; *Reinforcement Learning in Industrial Applications*. Master's Thesis TFRT-6111, Supervisors: Grönqvist, Johan, Department of Automatic Control, Lund University, Sweden, December 2020.
- Langebro, Ludvig; Puche Moreno, Baldomero; *Design of control system for UAV-based video recording and tracking*. Master's Thesis TFRT-6105, Supervisors: Helgertz, Johan, Sony (external) and Robertsson, Anders, Department of Automatic Control, Lund University, Sweden, July 2020.
- Lindberg, Johan; *Scalable Frequency Control in Electric Power Systems*. Master's Thesis TFRT-6115, Supervisors: Karlsson, Daniel, DNV GL; Olof Samuelsson, Olof, IEA, LTH and Pates, Richard, Department of Automatic Control, Lund University, Sweden, September 2020.
- Lundgren, Jonas; *Anomaly Detection in Streaming Time Series Data Using Active Learning and Metalearning*. Master's Thesis TFRT-6101, Supervisors: Ulrich, Kenneth, Sentian (external) and Giselsson, Pontus, Department of Automatic Control, Lund University, Sweden, June 2020.
- Nguyen, Mai Linh; *Automating the Evaluation Process of Software Testing in Vehicles*. Master's Thesis TFRT-6098, Supervisors: Andersson, Måns and Wonizak, Mattias (external) and Årzén, Karl-Erik, Department of Automatic Control, Lund University, Sweden, May 2020.
- Niles, Oscar; *Classifying Sensor Data Using Recurrent Neural Networks*. Master's Thesis TFRT-6096, Supervisor: Grönqvist, Johan, Department of Automatic Control, Lund University, Sweden, July 2020.
- Persson, Jonathan; *Numerical modelling of cold helium safety discharges from the cryogenic distribution line*. Master's Thesis TFRT-6117, Supervisors: Weisend, John and Fydrych, Jaroslaw, ESS (external) and Johansson, Rolf, Department of Automatic Control, Lund University, Sweden, December 2020.
- Rosenbecker, Linnéa *Vibration Attenuation for Satellite Reaction Wheels through the use of Field-Oriented Control*. Master's Thesis TFRT-6119, Supervisors: Monna, Bert, Hyperon Technologies (external) and Robertsson, Anders, Department of Automatic Control, Lund University, Sweden, February 2020.
- Rosvall, Hampus; *Learning Sampling Strategies for Stochastic Gradient Descent using Deep Reinforcement Learning techniques*. Master's Thesis TFRT-6118, Supervisors: Banert, Sebastian and Morin, Martin, Department of Automatic Control, Lund University, Sweden, October 2020.
- Samuelsson, Tobias; *Sound ranging using multilateration and Kalman filter*. Master's Thesis TFRT-6116, Supervisor: Cervin, Anton, Department of Automatic Control, Lund University, Sweden, September 2020.
- Stålbom, Henrik; *Adaptive PI-control for an air sterilization module*. Master's Thesis TFRT-6112, Supervisors: Darmell, Mattias, TetraPak (external) and Hägglund, Tore, Department of Automatic Control, Lund University, Sweden, September 2020.
- Tylstedt, Louise; Ågren, Simon; *Autonomous and Accurate Landing of an Unmanned Aerial Vehicle*. Master's Thesis TFRT-6100, Supervisors: Israelsson, Alexander, Verisure (external) and Robertsson, Anders, Department of Automatic Control, Lund University, Sweden, September 2020.
- Voigt, Jonas; Alkaysi, Abdulah; *Autopilot for a Personal Watercraft*. Master's Thesis TFRT-6103, Supervisors: Johansson, Anders J, Dept of EIT, LTH and Robertsson, Anders, Department of Automatic Control, Lund University, Sweden, July 2020.
- Watsfeldt, Elias; Åsljung, Andreas; *Temperature Control of Induction Heating Using a Multi Coil Solution*. Master's Thesis TFRT-6106, Supervisors: Frogner, Kenneth and Kjellstrand, Rasmus, Corebon AB, Malmö (external) and Robertsson, Anders, Department of Automatic Control, Lund University, Sweden, December 2020.

Wilroth, Johanna; *Domain Adaptation for Attention Steering*. Master's Thesis TFRT-6110, Supervisors: Alickovic, Emina, Eriksholm Research Centre (external) and Bergeling, Carolina; Heskebeck, Frida, Department of Automatic Control, Lund University, Sweden, July 2020.

PROCEEDINGS

Cervin, Anton; Yang, Yang (Eds.); 2nd Workshop on *Fog Computing and the IoT (Fog-IoT 2020)*. In OASICS, Schloss Dagstuhl - Leibniz-Zentrum für Informatik, 2020. Under Review, 2020. In submission.

SEMINARS AT THE DEPARTMENT

January

- 17 *About banking and digital revolution. Potential approaches and tracks for a universal bank*, Stephane Salle, Société Générale.
- 17 Master's Thesis Presentation: *Automate the Evaluation Process of Software Testing in Vehicle*, Linh Nguyen Mai, Lund University.
- 24 *Learning about wildlife from acoustic recordings*, Fredrik Bagge Carlson, National University of Singapore.
- 28 *Certified and efficient polynomial optimization via conic programming*, Victor Magron, LAAS (Toulouse), CNRS.

February

- 11 *Neural Network Based Diagnosis of Abnormal Events in Industrial Processes*, Ásgeir Daniel Hallgrímsson, DTU.
- 25 *Modeling and control of district heating networks + Latest news from Modelon*, Stéphane Velut, Modelon.

April

- 07 *[Cancelled] A set-based simulation approach for reachability analysis of LTV systems subject to IQC and QC disturbances*, Paul Rouse, ONERA (Toulouse, France).
- 08 Licentiate seminar: *Dynamic Optimization of Transportation Networks with Delays*, Martin Heyden, Lund University.
- 15 *[Cancelled] Exploiting Chordality in Optimization Algorithms for Model Predictive Control*, Anders Hansson, Regler teknik, Linköpings Universitet.
- 15 Master's Thesis Presentation: *Classifying Sensor Data Using Neural Networks*, Oscar Niles, LTH.
- 23 Master's Thesis Presentation: *Controlling Nutrients in a Hydroponic Growing System*, Kalle Elmér, LTH.

May

- 06 Master's Thesis Presentation: *Autopilot for RescueRunner*, Abdulah Alkaysi, Jonas Voigt, LTH.
- 29 Master's Thesis Presentation: *TrustNet: Trust-based Moderation - Using Trust to Hide Malicious Participants in a Distributed Chat Context*, Alexander Cobleigh, LTH.

June

- 01 Master's Thesis Presentation: *Public Goods Provision on Networks*, Anton Hansing, LTH.
- 02 Master's Thesis Presentation: *Wireless Charging Station and Autonomous Docking of an UAV*, Simon Agren, Louise Tylstedt, LTH.
- 04 Master's Thesis Presentation: *Automatic PID tuning revisited*, Jonas Hansson, Magnus Svensson, LTH.
- 04 Master's Thesis Presentation: *Control strategies for variable air volume ventilation systems used as demand response resources*, Johan Frykebrant, Ricky Klasson, LTH.
- 09 Master's Thesis Presentation: *Anomaly Detection in Streaming Time Series Data Using Active Learning*, Jonas Lundgren, LTH.
- 10 Master's Thesis Presentation: *Temperature Control of Induction Heating*, Elias Watsfeldt, Andreas Åsljung, LTH.
- 10 Master's Thesis Presentation: *Domain adaptation for attention steering*, Johanna Wilroth, LTH.
- 11 Master's Thesis Presentation: *Modelling and adaptive control of air sterilization*, Henrik Stålbom, LTH.
- 11 Master's Thesis Presentation: *Design of control system for UAV-based video recording and tracking*, Baldomero Puche Moreno, Ludvig Langebro, LTH.
- 16 *Economic optimization of the operation of energy production and district heating networks*, Björn Malmström, CTO at Energy Opticon.

August

- 17 Master's Thesis Presentation: *Sound ranging using multilateration and Kalman filter*, Tobias Samuelsson, LTH.
- 19 Master's Thesis Presentation: *Learning Sampling Strategies for Stochastic Gradient Descent Using Deep Reinforcement Learning Techniques*, Hampus Rosvall, LTH
- 24 Master's Thesis Presentation: *Robust relative positioning for flying-wing drone applications*, Martin Gemborn Nilsson, Olle Fagerström Hedbrant, LTH.
- 28 Master's Thesis Presentation: *Scalable Frequency Control in Electrical Power Systems*, Johan Lindberg, LTH.

September

- 04 Master's Thesis Presentation: *Lifetime Predictions of Electrolytic Capacitors in Network Cameras with Random Forest*, Oscar Andersson, Oskar Hindgren, LTH.
- 23 Master's Thesis Presentation: *Reinforcement Learning in Industrial Applications*, Niklas Kotarsky, Eric Bergvall, LTH.

October

- 03 *A control perspective on social economic decision-making processes and epidemics*, Alain Govaert, University of Groningen.
- 09 Master's Thesis Presentation: *Image-based anomaly detection for surface vehicles*, Johan Ahlqvist, André Skoog, LTH.
- 22 *Structured Closed-Loop versus Structured Controller Design*, Emily Jensen, University of California, Santa Barbara.

November

- 03 Master's Thesis Presentation: *Modelling and Optimization of Peroxide Pulp Bleaching Process*, Jonas Christensen Strömngren, LTH.
- 18 Master's Thesis Presentation: *Vibration Attenuation for Satellite Reaction Wheels through the use of Field Oriented Control*, Linnéa Rosenbecker, LTH.
- 24 Master's Thesis Presentation: *Sensorless Induction Welding of Carbon Fiber Reinforced Plastic Components*, Johan Bladh, LTH.

December

- 17 Defence of Doctoral Dissertation: *On LQG-Optimal Event-Based Sampling*, Marcus Thelander Andrén, Reglerteknik, LTH.
- 21 Master's Thesis Presentation: *Practical Comparison of MPC Toolboxes*, Emma Nilsson, LTH.

External Contacts

External contacts of importance to our projects, both academic and industrial

Together with external contacts and partners the goal is to solve real control problems. A mix of fundamental and applied work is a cornerstone of our activities. In these kind of projects the problems are approached with an open mind without glancing at particular methods. One purpose is to learn about real problems, another is to learn about new problems that are suitable for theoretical research. An important role for universities is to organize knowledge in such a way that the results can easily be digested by engineers in industry.

Lund / Academia

Lund University, AI Lund
Lund University, Dept of Architecture
Lund University, Dept of Chemical Engineering
Lund University, Dept of Clinical Sciences, Lund
Lund University, Dept of Computer Science
Lund University, Dept of Mathematics, LTH
Lund University, Dept of Electrical and Information Technology
Lund University, Dept of Heat and Power Engineering, Div. Combustion Engines
Lund University, Dept of Industrial Electrical Engineering and Automation
Lund University, Dept of Psychology
Lund University, Division of Thoracic Surgery
Skåne University Hospital, Medical Services

Lund / Industry & Society

Axis Communications AB
Business Region Skåne
Cognibotics
Combine Control Systems
Energy Opticon
Ericsson
Igelösa Life Science AB
Max IV
Modelon
TetraPak
Vävnadsbanken

Sweden / Academia

Blekinge Institute of Technology
Chalmers University of Technology
Halmstad University
KTH - Royal Institute of Technology
Linköping University
Luleå University of Technology
Umeå University
Uppsala University
Örebro University

Sweden / Industry & Society

5 High Innovations
ABB, Sweden
ABB Corporate Research, Västerås
ABB Automation, Malmö
ABB Robotics
AChoice
Assa Abloy, Landskrona
Blue Institute
BorgWarner, Landskrona
Cementa
Clavister
Comsys
Corebon
E.ON
Eriksholm Research Center
Gustaf Fagerberg AB
Hyperon Technologies
Inventor
IUC Syd/IUC Lab - Industriellt utvecklingscentrum Syd
Noda Intelligent Systems AB, Blekinge
OP5
PEAB, Sweden
Perstorp AB
PiiA
Prod2030
RISE
Saab AB, Linköping
Saab Bofors Dynamics, Linköping
Saab Kockums
Scania, Södertälje
Schneider Electric
Sectra Imtec
Sekvensa AB
SEK/IEC
Sentian AI
SESAM-Sverige
Siemens
SIS/ISO
Sony
Södra Skogsägarna, Mörrum
Swedish Energy Agency
Swedish Modules
Swegon Operations
SWEP International AB
Verisure

Nordic countries / Academia

Aalto University, Finland

DTU - Technical University of Denmark

Jyväskylä University, Finland.

NordForsk - Nordic University of Hubs

NTNU - Norwegian University of Science and Technology, Dept of Engineering Cybernetics

Nordic countries / Industry & Society

Granlund OY

kW-set OY

Orbis OY

Europe / Academia

ETH Zürich, Switzerland

European Innovation Academy, EU

Graz University of Technology - Institute of Computer Graphics and Vision, Austria

KU Leuven, Belgium

Lübeck University, Germany

Oxford University, UK

Max Planck Institute for Software Systems, Germany

Politecnico di Milano, Italy

Politecnico di Torino, Italy

Sant'Anna School of Advance studies, Real-Time Systems Labs, Pisa, Italy

Saarland University, Germany

Technion - Israel Institute of Technology, Haifa, Israel

Tel Aviv University; Israel

TU Chemnitz - Robotics and Human-Machine-Interaction Lab, Germany

TU Darmstadt, Germany

TU Delft, Netherlands

TU Eindhoven, Netherlands

TU Kaiserslautern, Germany

TU Munich, Germany

UNED, Spain

Universidad de Almeria, Spain

Universidad La Laguna, Spain

Universidad Nacional de San Juan, Spain

Università Luigi Bocconi, Milan, Italy

University Groningen, Netherlands

University of Brescia, Italy

University of Cyprus, KIOS Research and Innovation Center of Excellence, Cyprus

University of Cambridge, UK

University of Ghent, Belgium

University of Luxemburg

University of Modena, Italy

University of Rome Tor Vergata, Rome, Italy

University of Salerno - Dept of Industrial Engineering, Italy

Europe / Industry & Society

AlCo Software, Austria
AlfaEvolution Technology, Italy
Bosch Corporate Research, Germany
Città dell Salute e della Scienza, Turin, Italy
EURobotics
Fluxguide, Austria
Machine Learning Reply, Italy
Robovision BVBA
SmartFactory, DFKI, Kaiserslautern, Germany
Tecnalia, Spain
Telecom Italia

World / Academia

Beihang University, BUA, Beijing, China
California Institute of Technology, USA
Caltech, USA
Guangdong University of Technology, China
Hanyang University, Seoul, South Korea
Massachusetts Institute of Technology, USA
McGill University, Canada
Nanyang Technological University, Singapore
Northeastern University, China
Saint Mary's University, Canada
Sydney University, Australia
Tsinghua University, Dept Precision Instruments and Mechanology, Beijing, China
University of British Columbia (UBC), Vancouver, Canada
University of California, Sutardja Center for Entrepreneurship and Technology, Berkeley, USA
University of Maryland College Park, USA
University of Tennessee-Knoxville, USA
University of Texas at Arlington, USA
Zhejiang University, Control Science and Engineering, Hangzhou, China

World / Industry & Society

Lawrence Berkeley National Laboratory, USA
Mariner Partners, Canada
Missing Link Technologies, Canada
Mitsubishi Electric Research Laboratories, Massachusetts, USA
United Technologies, Hartford, USA



Economy

This chapter contains an overall view of the economy and funding

ECONOMY

The turnover for 2020 was 61 MSEK, an increase of 6,5 MSEK compared to 2019. About half of the income comes from Lund University and the remaining half from external grants.

The activities and the number of employees are now in a growing phase since last year. The number of employees is currently 55 including part-time positions (50 full-time equivalents).

The department participated in a second new project funded by the European Union, in Horizon 2020, called *Admorph*, which started January 2020. The Swedish Foundation for Strategic Research (SSF), Swedish Research Council (VR), Knut and Alice Wallenberg Foundation (KAW) and Swedish Government Agency for Innovation Systems (Vinnova) have also provided substantial support of our activities. ELLIIT has grown and we have been successful in receiving funding for both new PhD and Postdoc positions.

The block grants from VR, KAW and some of the SSF projects are long range. Several projects do, however, have shorter duration i. e. three years or less. To match these with the length of a PhD position, normally for 5 years, we have a long-term internal research planning, and we are careful to bid on projects that fit into our research plan. This has proven efficient to match short-term funding, research planning and personnel.

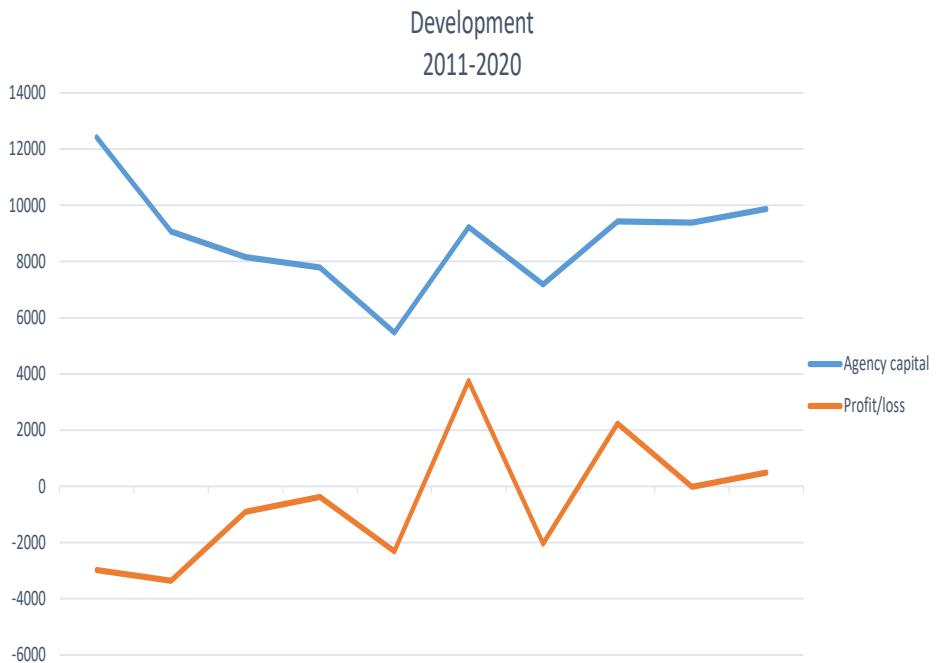

Profit/loss and agency capital development over the last 10 years

FUNDING - EXTERNAL GRANTS

VR – Resilient Control of Dynamical Network Flows
VR – Control of Monotone Systems and Diffusions
VR – Large Scale Convex Optimization
VR – Hemodynamic Modeling and Control
VR – Event-Based Control and Estimation with Application to Server Systems
VR – Fundamental mechanisms for scalable control of large networks
Vinnova – Hemodynamic Stabilization
Vinnova – Bloqqi: An Open Module Source Language in Automation
Vinnova – Surgeon’s Perspective UDI-2
Vinnova – Ventilator for Improved Cardiopulmonary Resuscitation
Vinnova – ISOTC184/SC5 Chair – Swedish Impact
Vinnova – Strategies and Standards for Smart Swedish Industries, part 2
Vinnova – Development of New Method for Midranging Control
Vinnova – ITEA3, AutoDC
Vinnova – On Humans for Humans: Testbed for New Surgical Methods
Vinnova – Innovative Agile Construction for Globally Improved Sustainability (ACon4.0)
Vinnova – Digitalisation and Standardisation for Customized Mass Production (DSKM) *NEW*
Boverket – Innovative Construction with Flexible Robot-Human Interaction
SSF – Societal-Scale Cyber-Physical Transport Systems
SSF – Semantic Mapping and Visual Navigation for Smart Robots
EU Horizon 2020 – Scalable Control of Interconnected Systems - an ERC project
EU Horizon 2020 – Admorph Towards Adaptively Morphing Embedded Systems
KAW – Wallenberg AI, Autonomous Systems and Software Program (WASP)
ELLIIT – Co-Design of Robust and Secure Networked Embedded Control Systems
ELLIIT – Collaborative Robotics Systems
ELLIIT – Local Positioning Systems
ELLIIT – Scalable Optimization for Control Systems
ELLIIT – Online Optimization and Control Towards Autonomous Vehicle Maneuvering
ELLIIT – Scalable Data Processing in Networked Systems
ELLIIT – Autonomous Radiation Mapping and Isotope Composition Identification by Mobile Gamma Spectroscop
ELLIIT – Efficient and Reliable Training of Generative Adversarial Networks
ELLIIT – Robust and Secure Control over the Cloud *NEW*
ELLIIT – Autonomous Force-Aware Swift Motion Control *NEW*
ELLIIT – Scalable Optimization for Learning in Control *NEW*
ELLIIT – Visual Feature Based Data Reduction *NEW*
ELLIIT – Dynamics of Complex Socio-Technological Network Systems *NEW*
SKB – Control of Stirwelding Process for Sealing
NordForsk – Nordic University Hub on Industrial Internet of Things (HI2OT)

Our major sources of funding for the research are currently;

- Lund University faculty funding
- EU - Horizon 2020
- VR – Swedish Research Council
- SSF – Swedish Foundation for Strategic Research
- Vinnova – Swedish Government Agency for Innovation Systems
- KAW – Knut and Alice Wallenberg Foundation

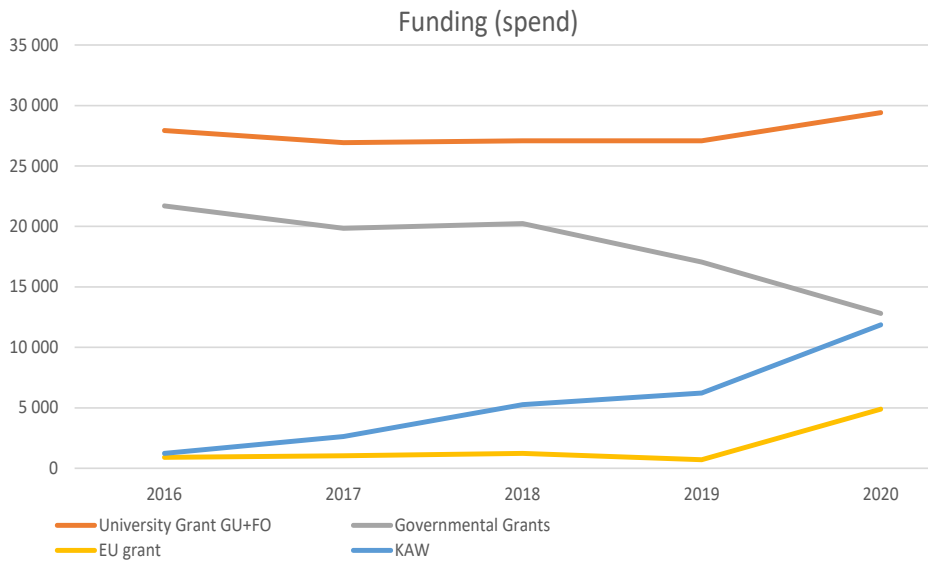

Staff

In this chapter the personnel and their activities are described





Professors

Ärzén, Karl-Erik
 Åström, Karl Johan; senior professor (20%)
 Bernhardsson, Bo
 Eker, Johan; adjunct professor (20%)
 Hagander, Per; professor emeritus
 Hägglund, Tore; assistant head of department
 Johansson, Rolf
 Johnsson, Charlotta
 Rantzer, Anders; head of department
 Robertsson, Anders
 Wittenmark, Björn; professor emeritus

Associate Professors

Cervin, Anton; deputy head of department,
 director of undergraduate studies
 Como, Giacomo
 Giselsson, Pontus; director of graduate studies
 Maggio, Martina
 Pates, Richard (from July)
 Soltesz, Kristian

Research engineers

Andersson, Leif (30%)
 Andersson, Pontus (until December)
 Blondell, Anders
 Korell, Manuel
 Nilsson, Anders
 Pisarevskiy, Alexander (from October)

Administrators

Edelborg, Cecilia
 Nishimura, Mika
 Rasmusson, Monika (70%)
 Westin, Eva

Postdocs

Banert, Sebastian
 Bergeling, Carolina
 Chen, Ci (from September)
 Kergus, Pauline (from January)
 Sun, Zhiyong (until January)
 Tegling, Emma
 Yetis, Mustafa

Researchers

Olofsson, Björn (20%)

PhD students

Agner, Felix (from January)
 Fält, Mattias
 Greiff, Marcus
 Grönqvist, Johan
 Hansson, Jonas (from August)
 Heimerson, Albin
 Heskebeck, Frida
 Heyden, Martin
 Jouini, Taouba
 Kjellqvist, Olle
 Lindberg, Johan (from September)
 Mandrioli, Claudio
 Morin, Martin
 Nayak Seetanadi, Gautham
 Nylander, Tommi
 Pigot, Henry
 Rosdahl, Christian
 Ruuskanen, Johan
 Sadeghi, Hamed
 Salt Ducaju, Julian
 Thelander André, Marcus
 Troeng, Olof (until October)
 Upadhyaya, Manu (from July)
 Vladu, Emil
 Vreman, Nils
 Wahlquist, Ylva (from May)

Industrial PhD students

Martins, Alexandre; Axis
 Skarin, Per; Ericsson
 Wingqvist, Birgitta; Saab Kockums



Personnel per category 2020

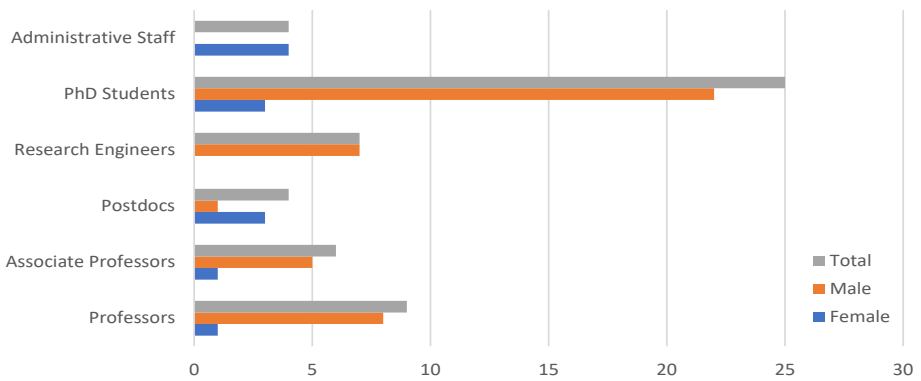

DEPARTMENT BOARD

Anders Rantzer
 Anton Cervin
 Kristian Soltész
 Pontus Giselsson
 Monika Rasmusson
 Carolina Bergeling
 Martin Morin

Deputy members

Tore Häggglund
 Karl-Erik Årzén
 Richard Pates
 Charlotta Johnsson
 Mika Nishimura
 Sebastian Banert
 Frida Heskebeck

LONG-TERM VISITORS

Liu, Yang; guest PhD student, Northwest Polytechnical University, China (until June)

Magron, Victor; guest researcher, CNRS France (from March)

Svensson, Lars; guest PhD student, KTH, Sweden

STAFF ACTIVITIES

Agner, Felix

MSc Engineering Physics, LTH, 2019. PhD student since January 2020.

His research interests are scalable control for energy systems under Anders' ERC-funded project in scalable control, focusing on load control and coordination. He is hoping to investigate and develop strategies that allow for system-level guarantees and benefits with minimal development in communication and measurements when utilizing load control to increase demand flexibility in energy systems.

Teaching assignments as Lab and exercise assistant in the *Automatic Control basic course*,

LP 3 and LP 1 2020, as well as project supervisor in the Mathematical Modelling project course LP3.

He is also coordinating the Friday seminars.

Andersson, Leif

MSc, Research Engineer since 1970. Leif started at the department with responsibility for the teaching and research laboratory. After some years he drifted to computer maintenance and became computer manager. He retired formally in 2012, but was immediately rehired on 30%.

A large part of his time the past year has been spent as an internal LaTeX consultant, helping the PhD students to make their theses beautiful, and also helping the staff with general LaTeX problems.

As previous years he has worked a lot with the publication database LUCRIS, and also with adjusting some web trees to the new accessibility rules.

There is a general trend in computing to move applications from complete virtual machines to the more lightweight container model. Leif has taken part in building department competence in these matters.

Årzén, Karl-Erik

Professor (2000), PhD (1987), joined the department in 1981.

His research interests are real-time and embedded control, real-time systems, cloud control, feedback computing, autonomous systems, and programming languages for control.

Coordinator for the Lund part of WASP (Wallenberg AI, Autonomous Systems and Software Program). Chair of the Program Management Group for WASP. During the year he has primarily been involved with WASP, the VINNOVA/ITEA3 AutoDC project, and the Nordforsk University Network HI2OT.

He is partly or fully involved in the supervision of six PhD students.

Åström, Karl Johan

Professor in Automatic Control since 1965 and founder of the department, emeritus from 2000, senior professor since 2008.

Work on the second edition of the book *Feedback Systems*, co-authored by Richard Murray Caltech, finished and sent to publisher.

Started work with Anders Rantzer on new PhD Course on *Adaptive control*. Several lecture trips had to be canceled because of the Covid virus.

He was also co-supervisor for master's thesis *Next Generation Autotuners - Analysis and Implementation* by Jonas Hansson och Magnus Svensson.

Banert, Sebastian

Sebastian obtained his diploma and PhD degrees in mathematics from Chemnitz University of Technology in 2012 and University of Vienna in 2017, respectively. After a postdoc position at KTH, he joined the department in September 2019.

His research interests are algorithms for convex and large-scale optimisation and monotone inclusions in connection with deep learning and inverse problems.

He is working together in the WASP project of Pontus Giselsson and Emil Björnson (LiU) on performance estimations for the aforementioned algorithms and their application in wireless communications.

Bergeling, Carolina

PhD (2019) and Lic. Tech. (2016) in Automatic Control, MSc in Engineering Physics (2013), from Lund University. Carolina has been with the department since 2013 and is currently a postdoc within the WASP Expedition Project *Realtime Individualization of Brain Computer Interfaces*, run by Professor Bo Bernhardsson.

Her research interests include Brain Computer Interfaces and control of large-scale systems.

She is the co-supervisor of PhD students Frida Heskebeck and Emil Vladu.

Carolina is also part of two working groups on gender equality and diversity.

Bernhardsson, Bo

PhD 1992, Professor since 1999, has also worked at Ericsson 2001-2010 as an Expert in Mobile System Optimization.

During 2020 he worked as one of the Master Programme Directors starting a new program in *Machine Learning, Systems and Control* and gave a new course entitled *Modeling and Learning from Data*. Together with Patric Jensfelt at KTH he also organized the WASP PhD course in *Autonomous Systems* for about 65 students on 5 universities.

During 2020 he increased work with statistical learning from EEG signals together with 3 new PhD students.

He is currently the main supervisor of 4 and co-supervisor of 7 PhD students.

Blomdell, Anders

Research Engineer at the department since 1988.

Heavily involved in almost all aspects of Robotics research at the department, also responsible for the department network and lab computers for teaching and research.

Lots of work associated to planning and realizing the big shuffle (renovation of the M-building).

Cervin, Anton

Docent (2008), PhD (2003), MSc (1998). Anton joined the department in 1998 and has been employed as an Associate Professor since 2007.

His research interests include event-based and networked control, real-time systems, cloud control, and computer tools for analysis and simulation of controller timing.

He is the main supervisor of three PhD students and leads research projects within event-based control and estimation and co-design of real-time control systems.

During 2020 he developed and gave the new second-cycle course *Automatic Control, Advanced Course*, and he was the supervisor of four master's theses.

His administrative tasks included being deputy

head of the department and director of studies for the first- and second-cycle education at the department.

Chen, Ci

Dr. Chen is a Wallenberg - NTU Presidential Postdoctoral Fellow hosted by Nanyang Technological University and the Wallenberg funded research program WASP (Wallenberg AI, Autonomous Systems and Software Program). He joined the Department of Automatic Control as a postdoc researcher in September 2020.

He works in the area of reinforcement learning for feedback control and resilient control of autonomous systems.

Como, Giacomo

PhD (2008), Docent (2012). He has been with the faculty at the Department of Automatic Control since 2011 and was promoted Associate Professor in 2013.

His research interests are in Dynamics, Information, and Control in Networks, with applications to transport, infrastructure, as well as social and economic systems.

During 2020, he has served as supervisor of 5 and co-supervisor of 3 PhD students at Politecnico di Torino. He also supervised four master's theses.

In Spring 2020, he taught the master level course *Network Dynamics* at Lund University.

During 2020, he has partly been on leave at Politecnico di Torino.

Edelborg, Cecilia

Financial Administrator at the department since 2017.

The responsibilities are primarily accounting regarding travel expenses, intermittent employments, reimbursements, invoices and projects. Also, administration of conferences and kick offs, committees and other administrative tasks.

She is also CPR trained as well as Fire protection trained and a member of the Equality group at the department and at LTH JäLM group to work with these questions. Also some responsi-

bility regarding human resources issues.

Her background is from the Faculty of Law at Lund University.

Eker, Johan

Docent (2010), PhD (1999). Johan is an adjunct Professor and spends one day a week at the department and the remaining time at Ericsson Research.

His main interests are the area of resource management of large scale compute systems and datacenters using control theory and machine learning. His current focus is on data-driven operations of large scale software systems.

Johan is the main supervisor for Albin Hejmerson and the industrial supervisor for Per Skarin. All three are part of the WASP program. He has also been master's thesis supervisor to Alexander Cobleigh.

Fält, Mattias

MSc, PhD student since August 2015.

His main research interest is methods for large-scale convex optimization. The focus has been on studying and improving convergence rates for first-order methods.

Giselsson, Pontus

Pontus is currently an Associate Professor at the Department of Automatic Control. He received his MSc from Lund University in 2006, his PhD from the Department of Automatic Control, Lund University in 2012, and became Reader (Docent) in 2018.

His research interests are in optimization and its wide range of applications.

During 2020, Pontus was responsible for the undergraduate level course on *Optimization for Learning* that was taught for the first time in 2019. He supervised four PhD students and two postdocs and is director of doctoral studies at the Department of Automatic Control.

Greiff, Marcus

Marcus received his MSc in 2017 at LTH, and has been a PhD student since then.

His main research topic concerns nonlinear control and output feedback for drones, but he has also made contributions to motion planning and estimation theory more broadly. He is involved in an SSF-project concerning the visual semantic mapping of indoor environments, as well as a recently started project concerning the mapping of radiation from drones.

Marcus is also working part-time for Mitsubishi Electric Research Laboratories.

Teaching duties during the year 2020 include *Nonlinear Control*, *Projects in Automatic Control*, as well as *Predictive Control*.

Marcus has also supervised one MSc project.

Grönqvist, Johan

PhD (Physics) from 2010, LTH and doctoral student, at the department since 2019.

His general control interests are Learning and, Robustness. During 2020 he has been supervisor for several Master's Thesis projects: Oscar Niles, together with Schneider Electric; Eric Bergvall and Niklas Kotarsky, together with Sentian AI; Axel Sondh and Björn Johnsson, with Elonroad. He has been co-supervisor for Johan Ahlqvist and André Skoog, together with Axis & Saab Kockums.

Hansson, Jonas

MSc, PhD student since August 2020.

Research interests in investigation of fundamental mechanisms in networked control.

He was involved as a project advisor in the course *Project in Automatic Control* and he also supervised laboratory excersies in *Automatic Control, Basic Course*.

Heskebeck, Frida

Frida graduated with a MSc in Biotechnology in 2019 from LTH. The same year, she started as a PhD student at the Department of Automatic Control.

She is part of the research group working with EEG-based Brain-Computer Interfaces led

by Professor Bo Bernhardsson. Her thesis aims to optimize the next generation of Brain-Computer Interfaces using cloud computing. The work she has done has focused on setting up a pipeline from EEG-experiments to interpreting the signals with machine learning methods. She has also tested some existing protocols for real-time reading of EEG-signals.

She has taught two courses during the year: *Process Control/Systems engineering* and *Automatic Control, basic course*. She has started webinars, which is a new way of teaching at the department. During a webinar, the students discuss the material from a lecture in an organized way with each other and the teacher. She has also been responsible for lab sessions in both courses and a project in the *Process control course*.

She was an assistant supervisor for the Master's thesis by Johanna Wilroth, *Domain Adaptation for Attention Steering*. Johanna was awarded a scholarship for her Master's thesis.

Frida was chosen as deputy PhD student representative in the Department Board of Automatic Control.

Hägglund, Tore

Professor, PhD (1984). Has been at the department since 1978 except for four years when he worked for ABB. He is responsible for two of the basic courses in *Automatic Control* in the engineering program.

Main research interests include process control, PID control, decentralized control, and monitoring and diagnosis.

Main research activities during the year have been feedforward control, ratio control, mid-ranging control, and control loop decoupling. The research projects are presented on his personal web page at www.control.lth.se/personnel/.

Heimerson, Albin

PhD student since August 2018.

His supervisor is Johan Eker and his main project will be a collaboration with Ericsson about automated datacenters.

His research interests are towards ML/RL, and he is very interested in how to control complex systems with RL and when this can be beneficial compared to classical control.

He has been a teaching assistant in the *Systems Engineering/Process Control* course and also in the new *Modelling and Learning from Data* course for the Masters program.

Heyden, Martin

MSc, PhD student since October 2016.

His main research interest is in the interaction between economics and traffic flows.

In 2020 he defended his Licentiate thesis *Dynamic of Optimization of Transportation Networks with Delays*.

He was also a TA in *Network dynamics* and *Nonlinear Control*.

Johansson, Rolf

Professor, MD (1986), PhD (1983). Active at the department since 1979.

Rolf Johansson's research interests are in system identification, robotics and nonlinear systems and automotive control. He is participates and leads the research projects KCFP Control and is project leader on system autonomy in UAV@Lund. He is coordinating director for Robotics Laboratory with cooperation partners from Dept Computer Science and industrial partners. He has industrial cooperation with Scania. He is responsible for the three courses *System Identification*, *Predictive Control*, and *Physiological Models and Computation*.

He is supervising 4 PhD students.

Johnsson, Charlotta

Professor (2018), PhD (1999).

Charlotta's main research interest covers Automation, Control and Operations. However, Charlotta is also involved in the research domains of Innovation and Entrepreneurship, Teaching and Learning in Higher Education, as well as Technology Management and Engineering Leadership. She is the Chair of ISO TC184/SC5, hence actively working on standardisation

activities for Smart Manufacturing and Industry 4.0. She is also leading the initiative of establishing a makerspace, called X-Lab, at LTH, an open innovation space for both students and colleagues at LTH.

During the year 2020, Charlotta has been involved in the Engineering course *Process Control*, and she has been a guest lecture in the course *Automation in Complex Systems* (given by the Department of Biomedical Engineering). Charlotta has also been involved in the PhD-courses *Research Methodology*, *Ethics and Innovation* and *Innovation and Value Creation in Research*. Charlotta has also given invited seminars to industry focusing on Industry 4.0/ Smart Manufacturing.

During the period mar 2017-dec 2020, Charlotta was the Vice Dean of Engineering Faculty with focus on Collaborations and Innovations.

In December, Charlotta was elected new Dean for Campus Helsingborg, starting on Jan 1, 2021.

Jouini, Taouba

MSc in Cybernetics Engineering from University of Stuttgart, Germany in 2016. Graduate research assistant at Automatic Control Laboratory (IfA) at ETH Zurich until January 2019. PhD student since August 2019.

Her research interests are related to the theory of modelling and control of networked systems with application to control of converters in power systems.

Kergus, Pauline

Postdoctoral researcher at the Department of Automatic Control since January 2020.

Her research interests are control, system theory, model order reduction and system identification. She currently works on the modelling and control of district heating and cooling networks through the project Scalable Control of Interconnected Systems.

She is also the co-supervisor of Felix Agner (PhD student) and organized the PhD class *Control Systems Synthesis* in 2020.

Korell, Manuel

MSc in Management Engineering. Works at Lund University since 2017.

Spends almost all his time on BYGGrobotics a research project, where we try to utilize industrial robots in the building sector.

Lindberg, Johan

Johan has a MSc in engineering Physics (2020) and started as a PhD student at the department in September 2020.

His supervisor is Richard Pates and he works with scalable, decentralized control.

Johan's research interests are towards how decentralized control can be used in the electrical power grid. Especially how to keep it in balance when more power production comes from renewables, that are less predictable than traditional power production, and where the power is injected to the power grid through power electronics, instead of traditional synchronous machines.

Johan was a teaching assistant in the *Automatic control, basic course*. He has also been working as a teaching assistant since 2017, during his time as a master student.

Maggio, Martina

PhD, 2012, Politecnico di Milano and is now Associate Professor and has now been at the department for 9 years (employed January 1st, 2012).

Her research interests is Real-Time Control Systems. Martina has mainly two research interests. The first one has been the design of controllers for computing systems. Many components of a computing system can be designed as controllers: memory allocators, schedulers, and similar components. This is true also for distributed infrastructures like cloud computing facilities. The second research interest concerns the implementation of control systems and their real-time properties. In that respect, she has been working on what happens when a controller designed with given proven characteristics is implemented and runs in a real

computing environment, where unpredictable workloads can lead to missing computational deadlines.

Mandrioli, Claudio

Claudio received Bachelor (2015) and Master degree (2017) from Politecnico di Milano, both of them in Automation and Control engineering. At the end of his master he was a visitor at the department and worked on his final thesis. Afterward he has then been employed as a PhD student at the department since January 2018.

He is part of and funded by the WASP research program.

The main focus of his research work in 2020 was on the implementation of controlled systems. This with two different directions: one when the system to be controlled is software-based and the other one that includes traditional control systems based on physical devices. The main focus has been on the testing methodologies that can be implemented during the development of such systems.

Another part of his work has been in the field of real-time system analysis. Specifically the study of how the real-time implementation of a control system affects its performance and vice versa how controllers can be implemented in a way that is aware of the real time aspects.

In 2020 he was involved as teaching assistant in the *Real-Time Systems* course and the *Advanced Control* course.

Morin, Martin

MSc in Engineering Physics 2017, Lund University. PhD student at the department since 2017.

Research interests are within large scale optimization with current work focusing on variance reduced stochastic first order methods applied to convex problems.

Development and teaching of the course *Optimization for Learning*.

Co-supervisor for one Master's thesis project.

Nayak Seetanadi, Gautham

MSc in IC design from NTU-TUM. PhD student at the department since January 2016.

Will defend his thesis titled *Improving Performance of Feedback-Based Real-Time Networks using Model Checking and Reinforcement Learning* on 5th February 2021.

Currently research interests include applications of model checking, bandwidth allocation schemes and safe reinforcement learning.

In Spring 2020, he was involved in teaching of the *Real-Time Systems*.

He is also a member of the Jälm board at the department.

Nilsson, Anders

PhD (2006), Research Engineer since 2010.

Spends most of the time looking after the department computers and their software. Also spends some time maintaining and developing the robotics lab.

Nishimura, Mika

Born in Japan. Administrator at the department since 2014.

She handles the exam results in Ladok. She has contact with the printing office about doctoral thesis and other publications. She is responsible for purchase of office supplies, books and handles Lucat-catalogue system for the employees at the department. She reviews Lucris-research portal, updates LUP-student paper and parts of the web pages and keeps keys in order among other service-oriented tasks.

She also teaches Japanese at Folkuniversitetet in Lund since 2006.

Under the Covid-19 pandemic, she was one of the responsible persons for laboratory sessions at the department and packed more than 2000 masks in the lab-boxes within one term.

Nylander, Tommi

MSc in Engineering Physics. PhD student since January 2016.

He is part of the WASP Autonomous Clouds and Networks research cluster, focusing on control-based resource management.

Olofsson, Björn

He obtained the MSc in Engineering Physics in 2010 and the PhD in Automatic Control in 2015, both from Lund University, and has been with the department since 2010. He is currently a part-time researcher at the department, with broad research interests in robotics and control for autonomous vehicles.

During the year, he has been involved in a research project within the ELLIIT Strategic Research Area, investigating optimal vehicle maneuvers and methods for autonomous driving in time-critical situations. Moreover, he has participated in a pre-study within the Swedish Electromobility Centre on fuel cells in vehicles. He has also taken active part in the teaching activities. He is the co-supervisor of two PhD students at the department and four PhD students at the Division of Vehicular Systems at Linköping University. He was also been acting as supervisor of Master's Thesis projects.

Pates, Richard

Richard obtained the M.Eng degree in 2009 and PhD degree in 2014, both from the University of Cambridge. He is currently an Associate Professor at the Department of Automatic Control.

His research focus is on control system design for electrical power systems and autonomous vehicles. The vision is to build a modular theory of control system design that can be used to address the requirements of future large-scale interconnected systems.

He has been involved in teaching the *Nonlinear Control and Servo Systems* course, and is involved in the supervision of 4 PhD students.

Pigot, Henry

Henry (Harry) joined the department as a Project Assistant in 2018 and became a PhD student in 2019. He has an Electrical Engineering (Biomedical Option) degree from the University of British Columbia in Vancouver.

Harry's main interest is medical technology development. The focus of his thesis is applying control theory to improve the safety and efficacy of a machine for evaluating heart organ function

outside of the body. He works together with Kristian Soltesz and researchers at Igelösa Life Science AB.

In 2020, Harry took courses in experimental design and machine learning. He was involved in lab development for the new Master's in *Machine Learning, Systems and Control* and was a lab supervisor for the program's introductory course. Harry assisted teaching in the *Systems Engineering and Process Control* course as well as *Physiological Modelling and Control*.

He is responsible for student engagement at X-Lab, a new makerspace on campus that transitioned into a larger location in 2020.

Pisarevskiy, Alexander

DipEng in Optoelectronics (2009). Research Engineer since October 2020.

Mainly participates in upgrading of lab equipment for education processes. Also involved in technical design for research projects such as e.g., development and assembly of the Ilon vehicle with control and sensor platform based on Lidar camera.

Rantzer, Anders

Professor of Automatic Control since 1999 and head of department.

Anders Rantzer is the main supervisor for several PhD students and postdocs. In 2020, he was teaching *Mathematical Modelling, Advanced Course* and *Nonlinear Control and Servo Systems* at the masters level.

He has broad interests in modeling, analysis and synthesis of control systems, with particular attention to uncertainty, optimization, scalability and adaptation.

Rasmusson, Monika

Bachelor's degree in Business administration, Lund University. Financial officer at the department since 2017. Her main responsibilities are year-end closing, budget, forecasts and reporting, both internally within the faculty and externally to sponsors.

As part of the administration team, her work includes backup function for her colleagues,

among other administrative related tasks. She is also the editor of the yearly Activity Report.

As from July, she is a member of the Department Board.

Robertsson, Anders

Professor (2012), Associate professor (2007), "Docent" (2005), Research Associate (May 2003), PhD (1999). Excellent Teaching Practitioner (ETP) in 2007.

His main interests are in nonlinear control, robotics and control of computing systems.

Currently, he is working on parallel kinematic robots, sensor-data integration and force control of industrial robots in collaboration with ABB Robotics/ABB CRC and Cognibotics. The research has been conducted within the RoboticsLab, ELLIIT network, and the projects Smart Systems (SSF) and within a couple of recently started projects related to construction robotics (VINNOVA and Boverket).

He is manager for the RobotLab@LTH and the Center for Construction Robotics, Faculty of Engineering, Lund University.

He has been teaching in the courses on *Applied Robotics, Control Theory* and been supervisor for several project groups in mechatronics, electronics and participated in the teacher education at Vattenhallen, LTH. He has guest lectured on robotics at NTNU.

He has acted as advisor/co-advisor for (2+5) PhD students and several Master's Thesis projects.

Rosdahl, Christian

MSc in Engineering Physics 2017, Lund University. PhD student at the department since September 2017.

He is part of the Wallenberg AI, Autonomous Systems and Software Program (WASP) and works on a project with focus on efficient learning of dynamical systems.

During the year, he has been a teaching assistant in the *Automatic Control, Basic Course* for several different engineering programs.

Ruuskanen, Johan

Graduated from Lund University with an MSc in Engineering Mathematics 2017, PhD student at the department since September 2017.

Johan is part of the WASP research program within the Autonomous Clouds and Networks cluster, and is supervised by Anton Cervin and co-supervised by Karl-Erik Årzén. His research interest includes event-based estimation and performance modeling within the area of autonomous cloud computing.

During the past year Johan has been a teaching assistant in the master level course in *Network Dynamics*, and has partaken in both course development and teaching in the new course *Modeling and Learning from Data*.

Sadeghi, Hamed

MSc (2013) in Mechanical engineering, PhD student since August 2016.

His research interest is in Large-scale Optimization and its vast areas of application. His research is a part of Large-scale Optimization and Control cluster within WASP-AS branch.

Salt Ducaju, Julian

Julian has a MSc in Aeronautical Engineering from Universidad Politecnica de Valencia (2018) and he did his master's thesis in the University of California, Berkeley with Professor Masayoshi Tomizuka as a visiting student researcher. Since February 2019 a PhD student at the department where he is an Affiliated WASP-AS student.

The main focus of his research work has been in the fields of autonomous vehicles and robotics.

Soltesz, Kristian

Kristian Soltesz defended his PhD in Automatic Control at Lund University in 2013, based on research conducted at University of British Columbia; his masters thesis from the same department was the result of a undergraduate research visit to Caltech. Since 2019 Kristian Soltesz is Reader (Docent) in Automatic control, with research focus on medical control systems.

He is the main supervisor of PhD students Ylva Wahlquist and Harry Pigot, both conducting experimental work within different areas of control systems for improved heart transplantation.

During 2020 Kristian Soltesz has been involved in teaching *systems engineering and process control*. He has coordinated the development of an introductory course that was given to the students of a new masters program in *machine learning, systems, and control*. Kristian Soltesz has also been involved as supervisor or examiner in several master's thesis projects. In February, Kristian Soltesz visited University of La Laguna in Spain, to collaborate around their clinical research program on automatic anesthetic drug delivery. Since then his main focus, apart from teaching and supervision, has been to coordinate and work on a project with the objective to map out fundamental difficulties in COVID-19 modeling. The improved understanding of such limitations could be used to propose cost-effective improvements of epidemiological data collection, and how to best combine available data to reduce the impact of bias and other uncertainties in model-based predictions and estimations.

Thelander Andrén, Marcus

MSc in Engineering Physics (2015) and a PhD student at the department since August 2015.

His main research interests are stochastic event-based control and estimation.

During 2020 he has done research on numerical methods for computing optimal sampling policies for event-based control. In December 2020 he defended his doctoral thesis *On LQG-Optimal Event-Based Sampling*.

Tegling, Emma

PhD in Electrical Engineering, KTH, 2019. Post-doctoral Researcher since August 2019 (Senior Lecturer from Januari 2021).

Her research interests are within analysis and control of large-scale network systems, with a particular focus on challenges related to highly distributed power generation and, since 2020, epidemics.

Emma Tegling's postdoctoral research was carried out at Massachusetts Institute of Technology (MIT), at the Institute for Data, Systems, and Society (IDSS), supported by the Swedish Research Council (Vetenskapsrådet) International Postdoc grant.

During 2020, she has been involved in the IDSS Covid-19 Collaboration Isolat.

She is co-supervising the PhD students Jonas Hansson and Taouba Jouini.

Vladu, Emil

MSc in Engineering Physics from Lund University, 2018. PhD student at the department since August 2019.

His supervisor is Anders Rantzer and his research project mainly concerns control in large-scale dynamic networks.

During the spring of 2020, he was a TA for the course *Automatic Control, Basic Course* and was also exam responsible. During the autumn of 2020, he was a TA for the course *Nonlinear Control and Servo Systems*, in which he was also responsible for one of the three laboratory exercises.

Upadhyaya, Manu

MSc in Engineering Physics 2020, MSc in finance, 2020, and BSc in mathematics 2015 from Lund University. PhD student since July 2020.

His research interests is in Continuous optimization. During the year he has been TA in *Optimization for Learning* and *Automatic Control, Basic Course*. He has also taken part in developing the course *Optimization for Learning*.

He has taken the following courses; Large-Scale Convex Optimization, Convex Optimization and participated at WASP AI Summer School 2020.

Vreman, Nils

Nils obtained a MSc (2018) from Lund University. He is now pursuing a PhD degree since August 2018.

His research interests include analysis of real-time control systems subject to faults, in parti-

cular weakly-hard switching system stability and performance.

During 2020, his research focus has been on analysing stability and performance of systems subject to weakly-hard constraints. Especially constraints extended to control systems.

He has also been teaching: *Real-time Systems* and *Automatic Control, Advanced Course*.

Wahlquist, Ylva

MSc (2019) and PhD student at the department since May 2020.

Her research interests include modelling and control of hemodynamic parameters for intensive care and heart transplantation, and identifiability in physiological models. She works together with Henry Pigot and Kristian Soltesz at Igelösa Life Science.

During the year, Ylva has been a teaching assistant for the *Physiological Models and Computation* course.

Westin, Eva

PhD in French linguistics. Administrator at Automatic Control since 2008 and administrative manager from December 2017 for the administrators and research engineers at the department.

She handles the overall responsibility of human resources, guests and conferences. She also handles part of the process for research studies.

Eva is part of the steering group for AI Lund. She is also part of the Togetherness group in the M-building and the steering group for gender and equality issues at the Faculty of Engineering. Eva is the health and safety representative substitute.

JÄLM@REGLER - THE GENDER EQUALITY, EQUAL OPPORTUNITIES, AND DIVERSITY GROUP AT THE DEPARTMENT

The working group on gender equality and diversity was formed in early 2014.

Since the start we have arranged some 20 seminars and workshops by invited speakers on different subjects ranging from research to ergonomics, security and how to implement this at our department.

The seminars have made issues on gender equality and diversity a natural talking point during our coffee breaks, which we believe is crucial for improving and tackling upcoming questions in these areas.

Since the Covid-19-situation has affected us all working at the department, we have tried to manage this situation through different actions in the JäLM-group in order to create a good equal working environment for all co-workers.

We also have a delegate from our department in the JäLM working group at LTH, Cecilia Edelborg.

TOGETHERNESS

Togetherness - a cooperation over department and group boundaries - is an initiative to promote information and discussion on diversity and gender equality among the employees as well as the students of the M-building. The initiative was taken by Carolina Bergeling and Eva Westin from the Department of Automatic Control in 2016 and has grown to include members from all departments in the M-building. The group arranges two seminars per semester, on the above topics. However, due to the Covid-19 situation, the seminars have been put on hold.

AWARDS

GRANTS

Scholarship Award

Frida was awarded this years scholarship from the Karl-Erik Sahlbergs foundation for her excellent Master's thesis. Motivation: Antibodies are target-searching drugs used for the treatment of severe diseases. The use of antibody-based drugs is, among other things, limited by expensive production methods. In Fridas Master's thesis, she gives an excellent description of how advanced process methods can contribute to improved antibody production. The presentation of results and suggestions of 'Future Work' is done excellently in the thesis.

Distinguished Paper Award

The paper by Claudio Mandrioli and Martina Maggio *Testing Self-Adaptive Software with Probabilistic Guarantees on Performance Metrics* presented at ESEC/FSE 2020 received the ACM Distinguished Paper Award.

Best Student Paper Award

Marcus Greiff, together with co-authors Anders Robertsson and Karl Berntorp, was awarded the 2020 IEEE CCTA Best Student Paper Award for the paper *MSE-Optimal Measurement Dimension Reduction in Gaussian Filtering*.

LTH Best Master's thesis

Johanna Wilroth was awarded Best Master's thesis at LTH for her thesis named *Domain Adaptation for Attention Steering*.

Best Paper Award

Victor Millnert and Johan Eker was nominated for best paper at the 13th IEEE/ACM International Conference on Utility and Cloud Computing for the paper *HoloScale: horizontal and vertical scaling of cloud resources*.

Scholarship Award

Emma Tegling received Scholarship from The Foundation Blanceflor Boncompagni Ludovisi, née Bildt.

ASSIGNMENTS

BOARD MEMBER

Årzén, Karl-Erik

Chair of the Program Management Group for the Wallenberg Autonomous Systems and Software Program (WASP).

Member of Research Board for the Faculty of Engineering, Lund University.

Como, Giacomo

Board member of the Excellence Project of the Department of Mathematical Sciences, Politecnico di Torino.

Eker, Johan

Board member of the research center IoTaP (Internet of Things and People Research Center) at Malmö University.

Johnsson, Charlotta

Board member of CIRCLE, Lund University, Sweden.

Board member of EFL (Executive Foundation Lund), Lund, Sweden.

Board member of Innovation Skåne, Sweden.

Board member of IUC Syd (Industriellt utvecklingscentrum Syd), Malmö, Sweden.

Board member of IUC Syd Lab, Lund, Sweden.

Other Board assignments in external companies.

Rantzer, Anders

Member of the steering committee for the International Symposium on Mathematical Theory of Networks and Systems.

Member of Editorial Board for the journal Annual Reviews in Control.

Member of WASP program management group for Mathematics in AI.

Robertsson, Anders

Member of Digitaliseringsrådet, Faculty of Engineering, Lund University.

Board member for Centre for Engineering Education (CEE), Faculty of Engineering, Lund University.

Member of work group for new master program in "Architecture and Digitalization" (lead by David Andreen), LTH, Lund University.

Westin, Eva

Member of the Board in AI Lund and AI initiative.

Eva is part of the Togetherness group in the M-building and the steering group for gender and equality issues at the Faculty of Engineering.

MEMBER OF INTERNATIONAL PROGRAM COMMITTEE (IPC)

Cervin, Anton

Co-chair of the 2nd Workshop on Fog Computing and the IoT (Fog-IoT 2020), Sydney, Australia, April 21.

Hägglund, Tore

IEEE International Conference on Emerging Technologies and Factory Automation, ETFA'2020, Vienna, Austria.

Maggio, Martina

IPC Member of ICPE 2020.
IPC Member of NG-RES 2020.
IPC Member of DATE 2020.
IPC Member of ECRTS 2020.
IPC Member of RTSS 2020.

Rantzer, Anders

Member of the IPC for L4DC - Conference on Learning for Decision and Control, UC Berkeley, 2020.
General Co-chair for the organization of European Control Conference 2024 in Stockholm
Co-organizer of Cambridge ERC workshop March 10-12.

Soltesz, Kristian

IPC member of the 27th Mediterranean Control Conference.

OPPONENT AND MEMBER OF EXAMINATION COMMITTEE

Årzén, Karl-Erik

Member of the PhD examination committee of Paula Pazzaglia, RETIS Lab, Scuola Superiore Sant Anna, Pisa, over zoom, July 2.

Bernhardsson, Bo

Deputy member in examination committee for Xi Chen, Computer Science at KTH.

Cervin, Anton

Deputy member of PhD examination committee of Mohammadhassan Safavi, Department of Electrical and Information Technology, Lund University, October 16.

Eker, Johan

PhD thesis committee member at Lund University (Mohammadhassan Safavi, 2020).
Licentiate thesis opponent Luleå Technical University (Rickard Brännvall, 2020).
PhD thesis committee member at Royal Institute of Technology (Slađana Jošilo, 2020).
Licentiate thesis opponent Linköping University (Klervie Toczé, 2020).

Hägglund, Tore

PhD thesis opponent: *Systematic design of advanced control structures*, by Adriana Reyes Lúa, at NTNU, Trondheim, Norway, February 28.

PhD thesis opponent: *Development and evaluation of methods for control of multiple-input multiple-output systems*, by Fredrik Bengtsson, Chalmers, Sweden, October 23.

Maggio, Martina

Member of PhD committee of Jezdimir Milosevic at KTH.

Member of PhD committee of Michael Gerke at UdS.

Robertsson, Anders

Member of PhD thesis committee, PhD Thesis defense Olov Andersson, LiU, April 27.

Chairman of PhD thesis committee, PhD Thesis defense Oskar Ljungqvist, LiU, May 29.

Faculty opponent, PhD thesis defence Ilker Erdem, Chalmers, *Efficiency of Flexible Fixtures: Design and Control*, June 8.

Chairman PhD thesis defence Filip Elvander, Mathematical Statistics, Lund University, June 12.

Faculty opponent, Licentiate thesis defense, Erik Hedberg, Department of Electrical Engineering (ISY), LiU, *Control, Models and Industrial Manipulators*, Dec 2.

ADVISORY COMMITTEES AND WORKING GROUPS**Årzén, Karl-Erik**

Member of the Norwegian committee on assessment of competence for the title of full professor in IT.

Chair of the Signals and Systems panel, Swedish Research Council (VR).

Elected member of the Royal Swedish Academy of Engineering Sciences (IVA).

Como, Giacomo

Chair of the IEEE-CSS Technical Committee on Networks and Communications.

Co-organizer of the Workshop *Dynamics in Social and Economic Networks* at the 59th IEEE Control Decision Conference.

Board member of the Excellence Project of the Department of Mathematical Sciences, Politecnico di Torino.

Eker, Johan

Program committee member for ECRTS 2020.

Organized ECRTS 2020 satellite workshop on real-time cloud (postponed to 2021).

Johnsson, Charlotta

Chair of ISO TC184/SC5 (Industrial Automation / Interoperability, integration and architectures for enterprise systems and automation applications).

Member in ISO SMCC (Smart Manufacturing Coordination Committee), reporting directly to ISO Technical Management Board.

Voting member in the standardization committee ISA95 and ISA88, and an information member in the standardization committee ISA99.

Member in SIS and SEK. She serves as the Swedish expert in the international IEC 62264, IEC 61512, ISO 22400 and ISO 15746 standards, as well as in the groups IEC AhG3, IEC TC65E AhG1, as well as in the joint committee IEC/TC65-ISO TC184 JWG21 (Reference Architecture for Smart Manufacturing).

Member of several boards and working groups at Lund University.

Rantzer, Anders

Member of the IEEE Control Systems Award Committee.

Chairman of the IFAC Fellow Selection Committee.

Member of the Advisory Board for Lecture Notes in Control and Information Sciences at Springer Verlag Heidelberg.

Member of the IEEE Control System Society Technical Committee on Nonlinear Systems and Control.

Member of the IFAC Technical Committee on Nonlinear Systems.

Member of advisory board for excellence center DISMA at Politecnico di Torino.

Soltesz, Kristian

Member of the IEEE Technical Committee of Healthcare and Medical Systems.

Tegling, Emma

Member of Technical Program Council for IEEE International Conference on Communications, Control, and Computing Technologies for Smart Grids (SmartGridComm) 2020.

OTHER ASSIGNMENTS

Årzén, Karl-Erik

Associate Editor for Real-Time Systems Journal.

Associate Editor for the Leibnitz Transactions on Embedded Systems (LITES).

Associate Editor for ACM Transactions of Cyber-Physical Systems.

Chen, Ci

Subject Editor for International Journal of Robust and Nonlinear Control (Wiley).

Associate Editor for Advanced Control for Applications (Wiley).

Como, Giacomo

Associate Editor of the IEEE Transactions on Control of Network Systems and of the IEEE Transactions on Network Science and Engineering.

Guest Editor for Special Issue *Dynamics and Behaviors in Social Networks* for the IEEE Transactions on Control of Network Systems.

Guest Associate Editor for Special Section *Mathematical Modeling, Analysis, and Control of Epidemics* for the SIAM Journal on Control and Optimization.

Edelborg, Cecilia

Representative for Automatic Control in the Equality working group (JäLM) at the Faculty of Engineering.

Johansson, Rolf

Editor, Mathematical Biosciences, (Elsevier).

Associate Editor, International Journal Adaptive Control and Signal Processing, (Wiley).

Associate Editor, Chinese Journal of Scientific Instrument (China Instrument and Control Society).

Editor, Intelligent Service Robotics (ISR), (Springer).

Member of Editorial Board, Robotics and Biomimetics, (Springer).

Johnsson, Charlotta

Serving as the IFAC Liaison with IEC 65A.

Maggio, Martina

Member of the Editorial Board of the ACM Transactions on Embedded Computing,

Associate Editor in the domain specific area of Self-Adaptive Embedded Systems.

Westin, Eva

Member in project group for TA future careers.

LONGER VISITS ABROAD**Maggio, Martina**

In April 2020, Martina Maggio started a double appointment as a professor at the Department of Computer Science of Saarland University in Germany. The double appointment is a good fit given the scope of her research, at the intersection of computer science and control. Recently, she has been investigating the effect of computational problems like deadline misses for control systems.

Tegling, Emma

Postdoctoral research is carried out at the Institute for Data, Systems, and Society at Massachusetts Institute of Technology (MIT).

LECTURES BY STAFF OUTSIDE THE DEPARTMENT

Cervin, Anton

LQG-Optimal versus Simple Event-Based PID Controllers, 2020 American Control Conference (ACC), Denver, Colorado, June 2.

Como, Giacomo

Structure and Control of Network Games, CDC Workshop on Dynamics in Social and Economic Networks, December 13. Invited presentation.

Network EPidemics Models and Control: A mini-review, Technion, (Haifa, Israel), July 6. Invited presentation.

Network EPidemics Models and Control: A mini-review, University of Groningen, Netherlands, May 26. Invited presentation.

The mathematics of Networks and Games, Applied Mathematics Campus, Bardonecchia (Italy), January 23-24. Invited presentation.

On Network Centrality, Influence, and Games, Department of Mathematics, Università di Torino, Italy, January 21. Invited presentation.

Eker, Johan

Johan Eker gave the keynote at the IEEE Melecon conference in June.

Giselsson, Pontus

Inverse Problems, Imaging, and Optimization. IFIP workshop at BEW Education Center, Essen, Germany, Jan. 6–8.

Projection Methods in Feasibility, Superiorization and Optimization – Theory and Practice. Fraunhofer Institute for Industrial Mathematics, Kaiserslautern, Germany (held online), June 24–25.

Continuous Optimization (held online) at Felix Klein Autumn School, 16-18 September, Fraunhofer-Institut für Techno- und Wirtschaftsmathematik ITWM (Responsible for one third of the course).

Hägglund, Tore

An efficient mid-ranging control strategy based on feed-forward control. IFAC Workshop Advanced Topics in PID Control System Design, Automatic Tuning and Applications, Berlin, July 12. Invited lecture.

Johnsson, Charlotta

Industry 4.0 and Change Management. Science and Innovation Talk together with N. Sörgärde at TetraPak, Lund, Sweden. November 23.

Industry 4.0. Science and Innovation Talk at Alfa-Laval, Lund, Sweden. February 7.

Smart Manufacturing. Invited presentation for Backer, Svedala, Sweden. January 22.

Maggio, Martina

Testing Adaptive Software with Probabilistic Guarantees, Joint CS@GSSI/ICE-TCS@Reykjavik University virtual seminar, November 25. Invited Presentation.

Rantzer, Anders

Scalable Control of Interconnected Systems, Invited lecture at ERC reception of the Swedish Research Council, Stockholm, March 6.

Towards a Theory of Scalable Control, Cambridge ERC workshop, United Kingdom, March 10.

Scalability and adaptation in H-infinity Control, Cambridge ERC workshop, United Kingdom, March 12.

On Minimax Adaptive Control, Lecture at WASP Workshop KTH, Stockholm, October 13.

Robertsson, Anders

2 guest lectures on *Robot force control and its applications*, NTNU, Norway April 3-4.

Introduction to *Automatic Control and Robotics*, "Tekniksommarskola för tjejer" Hässleholm (20 persons), August 14.

Innovation Open, presentation RobotLab [constructionrobotics], August 26.

Inspirational Lecture *Introduction to Industry 4.0*, Sept 8. Guest lecture.

Baxter LTH Open Door, presentation RobotLab, October 7.

Tegling, Emma

Satellite workshop on Complexity in Energy Systems, Conference on Complex Systems, *Scalability limitations in distributed primary and secondary frequency control*, December, online.

IEEE Conference on Decision and Control, Special Session on COVID-19, *The role of testing protocols in tracking Covid-19 — Can limited testing lead to useful data?*, December, online.

POPULAR SCIENCE PRESENTATIONS**Johnsson, Charlotta**

Industry 4.0 and Change Management, article in Tetra Pak's global magazine, 2020.

Förändringstakten ökar - Smartare produktion med Industry 4.0, article in Tetra Pak's national magazine, 2020.

Robertsson, Anders

Presentation *Construction Robotics at LTH* at co-organized workshop (Svenska Betongföreningen): *Automatisering av betongbyggandet*, October 22.

EUrobotics week 2020, Online presentations to students, November 24-26.

Seminar of *RobotLab*, LTH, November 24.

