



LUND UNIVERSITY

Integrated Computer Control of a Paper Machine: Quality Control

Åström, Karl Johan

Published in:
Integrated Computer Control of a Paper Machine

1966

Document Version:
Publisher's PDF, also known as Version of record

[Link to publication](#)

Citation for published version (APA):
Åström, K. J. (1966). Integrated Computer Control of a Paper Machine: Quality Control. In *Integrated Computer Control of a Paper Machine* (IBM Nordic Laboratory, TP 18.166). IBM Nordic Laboratory.

Total number of authors:
1

General rights

Unless other specific re-use rights are stated the following general rights apply:
Copyright and moral rights for the publications made accessible in the public portal are retained by the authors and/or other copyright owners and it is a condition of accessing publications that users recognise and abide by the legal requirements associated with these rights.

- Users may download and print one copy of any publication from the public portal for the purpose of private study or research.
- You may not further distribute the material or use it for any profit-making activity or commercial gain
- You may freely distribute the URL identifying the publication in the public portal

Read more about Creative commons licenses: <https://creativecommons.org/licenses/>

Take down policy

If you believe that this document breaches copyright please contact us providing details, and we will remove access to the work immediately and investigate your claim.

LUND UNIVERSITY

PO Box 117
221 00 Lund
+46 46-222 00 00



IBM

INTEGRATED COMPUTER
CONTROL OF A PAPER MACHINE

INTEGRATED COMPUTER CONTROL OF A PAPER MACHINE.

INTEGRATED COMPUTER CONTROL OF A PAPER MACHINE

Contents

1. Å. Ekström: System summary
2. E. Mårtensson: Production planning
3. O. Alsholm, G. Sangregoria: Process control
4. O. Tveit, K.J. Åström: Quality control
5. K.J. Åström, T. Bohlin: Control strategy design -
New methods in operation
6. O. Meurman, G. Sangregorio, B. Strid: Instrumentation
and computer connections
7. Å. Ekström, A. Hempel: Production supervising system

INTEGRATED COMPUTER CONTROL OF A PAPER MACHINE

System Summary

Å. Ekström
IBM

SYNOPSIS

This report presents the integrated system with emphasis on the layout and implementation of the various systems into which it was subdivided -- production planning, production supervising, process control, quality control and reporting. A short history of the project and a discussion of the economic incentives that justified it are included along with sections on programming and the configuration of the computer system.

TP 18.169
15 October 1966
IBM NORDIC LABORATORY
LIDINGÖ, SWEDEN

table of contents

Project Progress 1

Economic Incentives for the Integrated System 4

Systems and Information Flow
Included in the Integrated System 5

The Configuration of the Computer System 11

Programming 14

Implementation of the Integrated System
On the IBM Computer 16

 Production Planning 16

 Production Supervising Programs 18

 Process Control Programs 20

 Quality Control Programs 22

 Reporting and Analyzing Programs 22

Conclusion 24

PROJECT PROGRESS

Billerud AB, a leading Swedish pulp and paper manufacturer, and the IBM Nordic Laboratory, commenced work on a joint study in April, 1963. The initial objectives were to ascertain and evaluate any technical and economical advantages that could be gained by using a digital computer system to supervise and control a paper machine. Karlstads Mekaniska Werkstad (KMW), the paper machine manufacturer, also participated.

The kraft paper machine designated PM4 in the Billerud Mill at Gruvön, Sweden, was chosen as the main object of the study together with its stock preparation system. The PM4 was chosen primarily because its production exceeds that of any other paper machine operated by Billerud, and any improvements in its operation would thus provide the greatest savings.

A feasibility study was made first. It ran for five months and was terminated in September of 1963. The results showed that a process control computer could be used profitably for complete, integrated control of the PM4. Moreover, production planning for the entire Gruvön mill was shown to be feasible.

The results of the feasibility study justified continued activity, and an IBM 1710 system was ordered in January of 1964. The integrated system described briefly in this report was designed during 1964.

The project was subdivided into the following systems which were developed in parallel:

- production planning (for the entire mill)
- production supervising
- process control
- quality control
- reporting

The purpose of the installation was thus to provide total integration of all

aspects of the papermaking process, from the incoming orders to the sorting of the finished paper. In addition, reports were to be prepared for the Billerud management. All of the paper machines in the mill were included in the production planning system, but the other systems embrace only the largest, the PM4.

There were a number of reasons for the adoption of this arrangement. Complete production planning had to include all the paper machines, since orders sometimes have to be allocated to them on an alternative basis. The other systems, however, operate more independently, and it was decided to limit them to the PM4 for the following reasons: limited computer capacity, the necessity of taking it out of service occasionally for preventive service and the limited availability of personnel.

Work on the systems and most of the process-control programming and debugging for steady state operation was finished prior to installation in December, of 1964.

Monitor programs and programs for process data collection and process control were checked out by the end of March 1965. The closed-loop basis weight control was tested first. Most of the programs had to be modified several times, but by the end of 1965 some 30 process control loops were operating satisfactorily in the steady state condition.

Programs for making automatic grade changes were implemented early in 1966.

The programs for quality control and production supervising were finished by the end of 1965 and put into operation during the first months of 1966.

Work on the production planning system turned out to be more extensive than first expected. New methods had to be developed to handle sequencing and trim problems, and a great many exception routines had to be included in the system to make it usable. All this, together with extensive programming work delayed completion of this system until the Autumn of 1966.

Advanced theoretical work resulting in new methods for process identification and the estimation and prediction of quality control data has been carried out in connection with this project.

ECONOMIC INCENTIVES FOR THE INTEGRATED SYSTEM

The economic incentives for a computerized integrated system were evaluated in the feasibility study conducted prior to installation. Some of these are tangible. For example, an estimation of possible savings can be made if a specific paper market situation is assumed.

The following may be classified as tangible:

- Better planning will reduce trim, grade change losses, machine costs and pulp costs.
- Better process control will reduce process and quality variations, downtime and raw material consumption. Moreover, it will improve production and quality.
- Better quality control will enable quality variables to be estimated more accurately, thus reducing substantially the uncertainties involved in rejecting finished paper.

Savings realized by supplying management with better information may be classified as intangible incentives.

SYSTEMS AND INFORMATION FLOW INCLUDED IN THE INTEGRATED SYSTEM

Fig. 1 illustrates the systems which make up the integrated system and the paths along which information flows. The six upper blocks represent systems. The numbered arrows indicate information flow.

Fig. 1 also includes a simplified diagram of the stock preparation system and the kraft paper machine PM4. The pulp mill and bleach plant are not included in the integrated system. Paper coming from the paper machine is wound into large reels which accommodate about an hour's production and weigh 7-8 tons. The paper machine reel is then lifted to a winder which winds and slits the paper lengthwise into rolls of proper widths. Paper arriving from the reel is cut crosswise to provide rolls of the proper length. The rolls are sorted, and rolls not meeting the given specifications are rejected. Acceptable rolls are then shipped to the customer. Some rolls are cut into sheets before delivery (not shown on Fig. 1).

The three cross-hatched blocks shown on Fig. 1 represent important parts of the total integrated system that are not a part of the computer system: the machine tender, the winder crew (or shift foreman) and the laboratory.

Production planning embraces all five paper machines at the mill; the other systems include only the PM4 machine. New order information is punched on cards (arrow 1) and fed into the system. Orders with the same delivery date and grade specifications are grouped together. A determination of how the reel shall be cut into rolls with minimum trim loss is made. The orders are then allocated to the different paper machines manually. The optimal sequence is determined for production of the different groups on each paper machine with the shortest total grade change time while meeting the specified delivery dates.

On the PM4 information about new grades is supplied (arrow 2) to production supervising. This block has two functions: a) to supervise production so as to optimize planning; b) to administrate collected process and quality data. These two are sometimes closely related. For example, information about produced

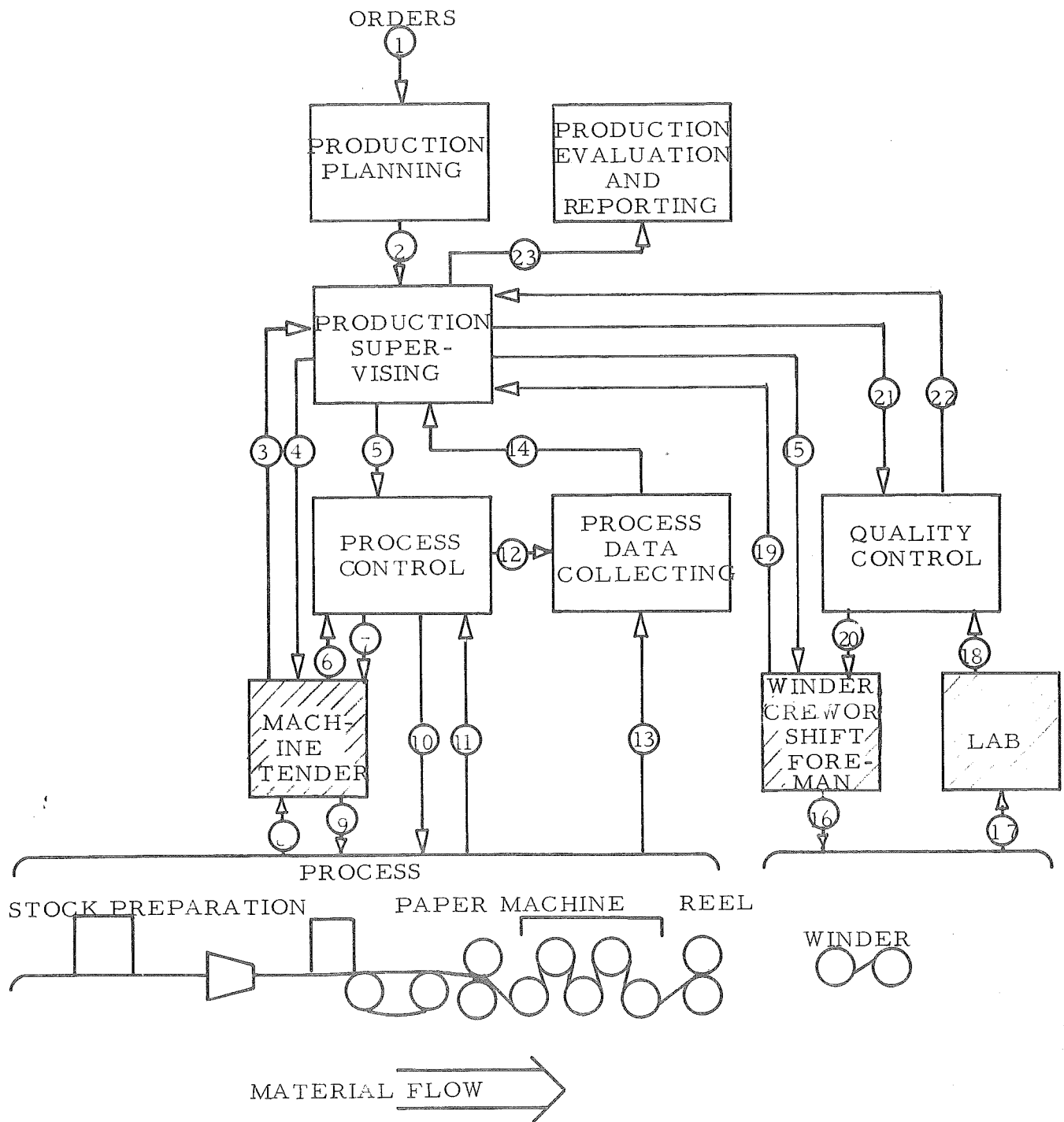

Fig. 1 SYSTEMS AND INFORMATION FLOW INCLUDED IN THE INCLUDED IN THE INTEGRATED SYSTEM AT GRUVÖN

sheet length of on-grade paper from process_data_collection (arrow 14) and about rejected rolls from quality_control (arrow 22) is needed to determine when one grade is finished and the next is to be started. This data is also collected and stored for subsequent use in the preparation of reports.

Before each grade change, production_supervising informs the machine_tender about the next grade (arrow 4). The machine_tender has the option of acknowledging the new grade or ordering another grade (arrow 3). At each grade change, production_supervising supplies process_control with new reference values (arrow 5). Information about how the reels shall be cut into rolls is issued to the winder_crew (arrow 15). Information about identification and sorting limits is issued to quality_control (arrow 21). Data from process_data_collection, quality_control and manual sorting information from the winder_crew (arrow 19) is stored for reporting purposes.

Process_control is probably the most important block in the system. The lion's share of the savings which the computerized system is expected to realize will stem from this system. The process_control function may be subdivided into three parts:

- Steady state control
- Grade change control
- Paper break control

The purpose of steady state control is to run the process as closely as possible to certain given primary reference values with a minimum of process variations. Steady state control is accomplished mainly by closed loop feedback control. The computer makes adjustments in the process (arrow 10) based upon process instrument readings (arrow 11).

The purpose of the grade change control system is to change the process from the production of one grade to another in the shortest possible time without causing the web to break. Feed-forward control techniques are used to obtain efficient grade change control strategy.

The most frequently encountered emergency condition requiring special action is paper break.

As indicated in Fig. 1, the process control system communicates with the machine tender. Information about abnormal conditions and changes in the status of the process is printed out to the machine tender (arrow 7) who has the option of making changes in the reference values, e. g. changing the desired degree of refining (arrow 6).

Process data collecting is shown as a separate block in Fig. 1. It could have been included in the process control block of course, since most of the process data has to be collected for process control purposes. However, data collected by the process data collecting is used mainly for reporting purposes. It is usually collected at the end of each reel or at a grade change. Some instrument-reading data (arrow 12) is available from process control while other readings (arrow 13) are taken specifically for data collecting purposes. These latter include steam and electricity consumption and sheet length.

Quality control is based upon quality data obtained in the laboratory from samples of the finished paper. On-line readings of moisture content and basis weight have been assigned to process control. Since the PM4 is a kraft paper machine, tensile strength and stretch data are highly significant. Quality control has two functions: a) to issue information to the machine tender which will help him control the paper machine and b) to determine whether or not the produced paper meets the given specifications. Paper failing to meet the specifications is rejected.

The information-issuing function is based mainly on data obtained from samples taken at the end of each reel. Information is printed out (not shown in Fig. 1) to the machine tender. The sorting function is based mainly on data obtained from samples taken at the end of each set. (All of the rolls slit side-by-side from a single length of reel paper are called a set).

Two options are included in the system: manual and automatic sorting. For

manual sorting the estimated quality test values are printed out to the shift foreman (arrow 20). He then has to determine whether the paper fulfills the specifications. When he wants to reject any roll he enters this information into the system (arrow 19). The sorting can also be performed automatically against fixed limits. In this case, information about sorted rolls is issued to the winder crew (arrow 20).

Special prediction and estimation techniques have been developed to improve the information issued to the machine tender and get a more accurate base for sorting. All collected data concerning quality and rejection is fed to the production supervising system. Calibration of on-line basis weight gauges and moisture gauges based upon quality test data, is automatically performed.

All of the process and quality data collected is used to prepare reports (arrow 23). Daily reports are printed out giving a synopsis of the production variations and the most important quality data. A list of all rejected rolls is also printed out. A report containing production figures and an economic evaluation is compiled every month. All important quality data for a given order can also be printed out on demand. The collected process and quality data is evaluated to ascertain improved standard settings of reference values for process variables for the different grades.

The machine tender supervises all manual process operations. He receives information about the process (arrow 8 in Fig. 1) from indicators, alarm signals and his own observations, and sends information back (arrow 9) as setting adjustments for analog controllers and valve positions.

The winder crew sets the winder slitters and rejects faulty rolls (arrow 14) in accordance with information from quality control (arrow 20). They also sort rolls manually on the basis of visual inspection and keep an eye out for wet sheets, curled paper, etc. Manual sorting information is fed to the computer system (arrow 19). These functions may also be performed in part by the shift foreman.

Samples are taken from the finished paper and sent to the laboratory

(arrow 17) where their quality is tested. Quality test data is then fed into the computer system (arrow 18).

THE CONFIGURATION OF THE COMPUTER SYSTEM

The computer system at Billerud (Fig. 2) consists of a central processing unit (1620 Mod 2) with 40K core memory positions (decimal digits), a disk storage unit with 2000K memory positions, input/output typewriter, card read-punch unit, input/output data converter and multiplexers, two output printers, one manual entry unit (decimal input) and one sense switch unit (binary input). The last four units are connected to a common Serial Input/Output Channel (SIOC). The sense switch unit and one output printer are placed in the machine tender booth adjacent to wet end of the paper machine. The manual entry unit is located in the laboratory and is used mainly for entering quality test data. It has twelve ten-position rotary switches. The remaining equipment is located in the computer room.

The digital computer system communicates with the process by means of the following input/output arrangements:

<u>Analog input</u>	Electrical instrument signal amplitudes are measured. About 80 inputs are connected.
<u>Pulse-count input</u>	Pulses generated by tacho-generators, wattmeters, etc., are counted. Twenty-two inputs are presently connected.
<u>Contact input</u>	The status of contacts of on-off detectors, manual switches, etc., is sensed. Up to 100 contact inputs are presently connected, twelve of which have an interrupt-function.
<u>"Analog" output</u>	Pulses of predetermined duration (0.5 and 2.5 sec.) are emitted to operate reversible motors used as set-point positioners, valve-drivers or the like. Forty-five "analog" outputs are presently connected.

CENTRAL COMPUTER ROOM

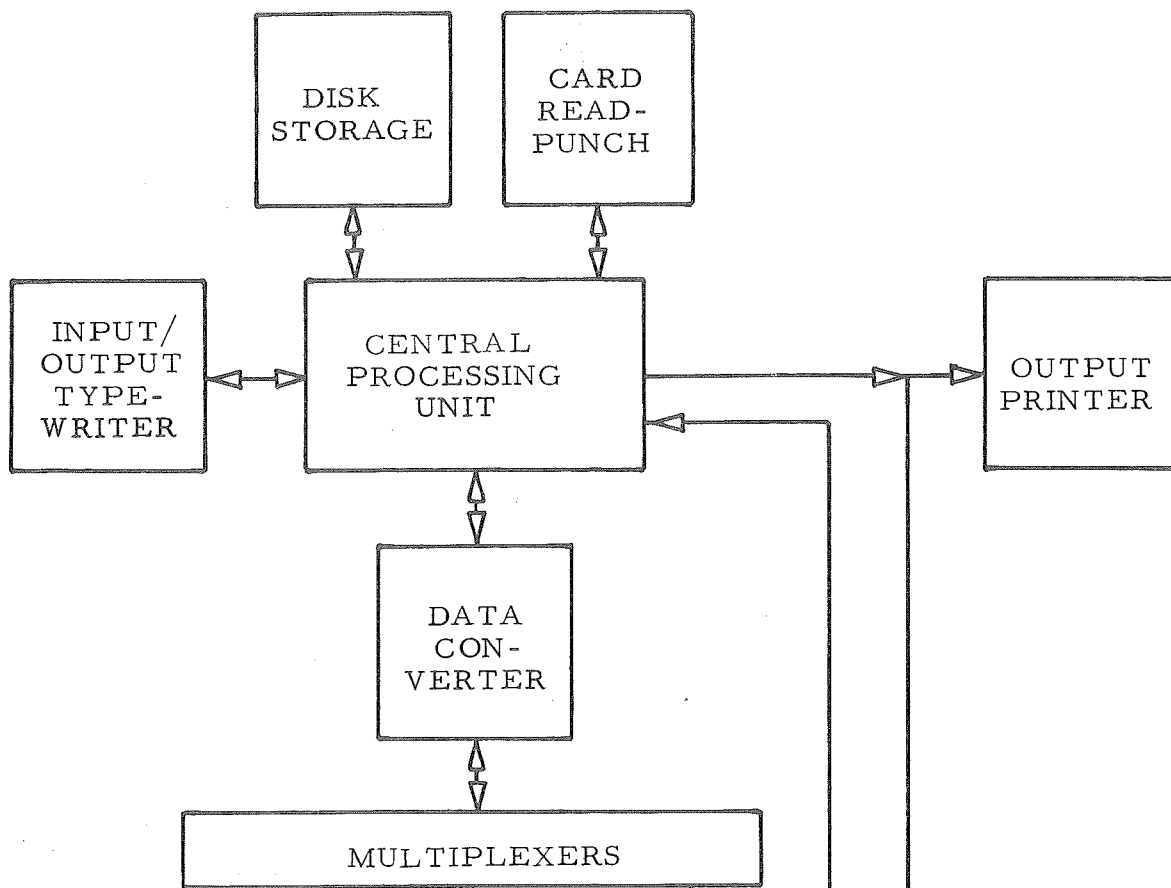

PROCESS

PROCESS INPUTS
ANALOG INPUTS
PULSE COUNT INPUTS
CONTACT INPUTS

PROCESS OUTPUTS
"ANALOG" OUTPUTS
CONTACT OUTPUTS

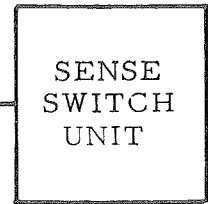
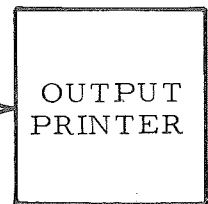

LABORATORY

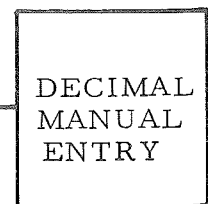

Fig. 2. CONFIGURATION OF THE COMPUTER SYSTEM

Contact
output

Contacts are used for on-off operation of electrical process equipment. Fourteen contact outputs are presently connected.

PROGRAMMING

The computer is designed to respond to special command codes or instructions called machine language. A system known as symbolic programming has been used in an effort to alleviate the difficulties of coding in machine language. The IBM 1710 SPS II System used at Billerud, permits the programmer to code in a symbolic language that is more meaningful and easier to handle than the machine language without any reduction in computer efficiency.

Further alleviation of programming difficulties by using a problem oriented language called FORTRAN (FORMula TRANslation) was discussed. This language would have been especially suitable for process control programs. There were, however, a number of drawbacks; FORTRAN entails less efficient programs taking longer to process and more space to store, and it was very poorly suited to the production planning and supervising programs in which it was important to take advantage of the fact that the 1710 is a variable word length computer.

Using SPS (Symbolic Programming System) for all programs was probably the correct procedure at Billerud where a limited capacity computer had to handle a large integrated system. However, writing and correcting the SPS program consumed far more time than FORTRAN would have required. FORTRAN or a similar language will probably be used in future projects.

Besides a suitable programming language, it is also important to have efficient monitor programs, especially for such a large system. The monitor program must supervise all data processing and the transfer of programs, subroutines and data between disk storage and core storage; read input points and set output points; control data transmission on the Serial Input/Output Channel; and handle all error conditions. An existing monitor program, the "Executive II" was used after a number of modifications were made.

The basic IBM system has two operation modes: main-line operation and interrupt operation. A main-line program may be interrupted by either internal interrupts (error or time for example) or external interrupts (a contact closure in the process for example). The interrupt program is then executed, and when it is finished the previously interrupted main-line program may continue. A special feature "Store IR1" makes it possible to provide two main-line program priority levels which we have called high-level and low-level.

Special routines have been written for queuing the main-line programs. In addition, a number of routines have been written to enable the contents of the disk storage or core storage to be obtained and interchanged on-line without interrupting the normal operation of the system. The card read-punch unit is used as input/output.

The IBM 1710 system adjusts positions by means of increase or decrease pulses called "analog" output pulses (A₀ pulses). Every 3.6 second (.001 hour) a determination is made as to whether pulses have to be sent out and if so, their duration (trim pulse duration, 0.5 second; slew pulse duration, 2.5 seconds). To avoid blocking this operation, all process control programs that are called periodically are synchronized with programs that control the A₀ pulses.

The 40,000 core storage positions are used as follows: the first 402 positions are used for input/output areas and tables. Positions 402 - 20,000 are used for programs and tables recalled from disk storage each time they are used; and the remaining 20,000 positions are used for programs and tables that are always kept in the core storage.

IMPLEMENTATION OF THE INTEGRATED SYSTEM ON THE IBM COMPUTER

The systems and information flow included in the integrated system have been described briefly above with frequent referrals to Fig. 1. This description will now be supplemented with information about how the integrated system is implemented on the IBM computer. Fig. 3 is a flowchart showing the main functions of the computer system (input/output, data processing and data storage blocks). The layout of Fig. 3 is similar to that of Fig. 1; production planning functions are grouped in the top left-hand section, process control in the lower left-hand section, etc.

Production Planning

The production planning programs which have low priority are written as low-level main-line programs, i. e. they may be interrupted by programs of higher priority such as process control programs. These programs may also be called off-line programs since they are not directly connected to any process but are called in by an operator for execution. The system consists of a large number of programs occupying a total of 0.3 million positions. These are normally disk-stored and called in to core storage when they are executed. Moreover, a number of disk-stored tables occupying about 0.5 million positions are used as input areas for new-order information, data-processing work areas and storage areas for planning-result data.

Planning may be either regular or emergency. Regular planning is subdivided into pre-planning and final planning. Pre-planning involves punching information onto cards and feeding it into the computer. Orders sufficiently similar to be produced together are grouped into "sections" and the minimum trim losses are calculated. All information about the orders (including trim losses, pulp consumption and the time required for production on alternative paper machines) is printed out on "order

IMPLEMENTATION OF THE INTEGRATED SYSTEM ON THE IBM COMPUTER

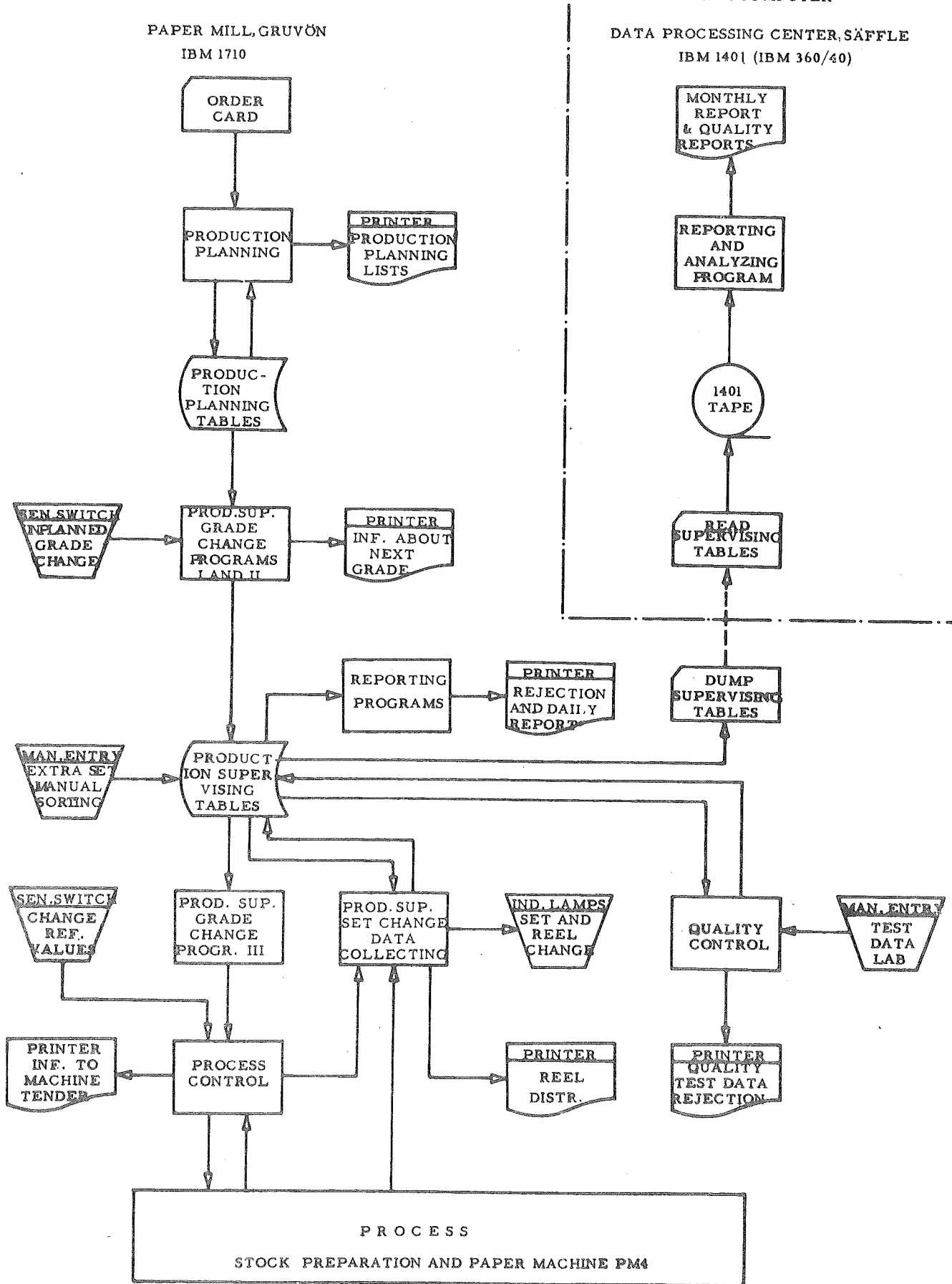

Fig. 3

lists". The mill planner uses this information for the allocation of order "sections" to suitable paper machine. He determines the time periods during which bleached, semibleached and unbleached paper is to be produced. He also determines the groups of orders ("rough planning groups") to be produced during these periods. This information is punched on cards and fed into the computer, thus completing pre-planning.

Final planning is initiated by optimal sequencing of the production of the various grades within each "rough planning group". Final planning results comprise a number of lists giving specific information on how the orders shall be produced. These lists are called "production program" and "combination lists". The final planning results are also disk-stored to be used as source information for the next regular planning (it is expected that regular planning will be scheduled every two days).

As mentioned previously, the production planning system embraces all paper machines, while the other systems address themselves only to the PM4 paper machine.

Production Supervising Programs

These are of higher priority than the production planning programs. For the most part they are interrupt programs that are either initiated by a time interrupt or a process interrupt. Production supervising programs cannot be interrupted by any other programs. In some cases in which program execution takes too long, say more than two seconds, the originally called interrupt program calls another program of lower priority - a high-level main-line program.

As stated above, most production supervising programs are of the interrupt type. Every .01 and .001 hour a check is made to see if any program shall be called in and executed. This check is made by comparing the length of on-grade paper produced to the length of the ordered rolls or sets. (As mentioned previously, all of the rolls slit side-by-side from a single length

of reel paper are called a set). Some programs are executed a few minutes before a planned set change; others are executed at the time of the set change. Different programs are called in if the set change occurs within a reel, at a reel change or at a grade change. Production supervising programs are also initiated by process interrupts, when the reel is changed or when the machine crew connects or disconnects the production counter.

Three different blocks in Fig. 3 have been labeled as production supervising programs, and all these blocks communicate with common disk-stored tables. Since an understanding of these tables is fundamental to the understanding of the system, they will be described first. The production supervising table is prepared prior to a grade change, and it contains all information about how the next grade shall be produced. In addition it contains order identification and information as to how the reels shall be cut into rolls. All information about production, process data and quality test data that is collected by the computer system is stored in this table. It is therefore an essential element in the operation of the quality control program and for reporting and analyzing programs.

Two blocks in Fig. 3 have been labeled as grade change programs. The first of these represents programs (I and II) that are called prior to a grade change. These programs make the necessary preparations for the change, including the setting up of the supervising table for the next grade based upon information from the production planning tables. These programs may either be called in when the previous grade is almost finished or when the machine tender orders an unplanned grade change.

When the previous grade is finished, grade change program III is called in. This program makes all the necessary reference-value changes for the process control programs and initiates the change.

As indicated in Fig. 3, minor changes in the production supervising tables may also be made using the manual entry units. For example,

an extra set may be added or the roll distribution within a set may be changed.

The supervising of a grade in production is executed by the set change programs and reel change program. These programs operate indicator lamps which inform the machine crew of the time at which set changes and reel changes are planned. The winder crew is also issued a printed message telling how the reels shall be cut into rolls. The process data collecting system (represented by a separate block in Fig. 1) is also handled by these programs. For the most part, data is collected when a reel is changed. However, consumption figures for electric power, chemicals, etc. are integrated throughout an entire grade.

Process Control Programs

All process control programs are interrupt programs, and thus cannot be interrupted by other programs. Most of them are fairly short and can be executed in less than one second. A determination as to which of the periodically processed programs is to be executed is made every .01 hour and .001 hour. The individual programs are called with a periodicity of .01 hour (36 seconds), .02 hour (72 seconds), .05 hour (3 minutes) or 0.1 hour (6 minutes). In some special cases, simple readings may also be taken more frequently. A few programs are initiated by process interrupts.

A total of about 70K positions are used for process control programs.

The various process control programs are data-processed solely on the basis of information collected on-line from instrument readings and by sensing the status of contacts.

For the most part, the output from the various programs comprises automatically-performed adjustment of controller set-points, reversible motors and valve-drivers. Forty-five "analog outputs" (pulse outputs) are connected to the system.

However, part of the output is in the form of printed messages issued to the

machine tender. He is informed of all changes in the process status, including information about whether set-points are remotely controlled from the computer or locally controlled, whether a controller or essential instrument is not working properly, and whether any variable such as a chest level is outside the alarm limits. Since almost no control is of the operator guide type, logged data is not printed out periodically. If the machine tender wants special information, he can get it on special request by using a sense switch unit (binary input).

The process control system has been divided into ten subsystems such as speeds, press sections, drier sections, etc. Efforts were made to establish these subsystems so that there would be a minimum of interconnection between them. Each subsystem corresponds to one or more programs. Communication between the different programs is accomplished within a common communication area that is always placed in the core storage.

The control in each subsystem is performed by a number of simple feedback control loops that are sometimes connected in cascade. The controlled variable may be directly measurable by a single instrument such as a level indicator, or it may be calculated from a number of different instrument readings. Specific refining energy is an example of the latter. The raw readings are normally filtered by mean-value calculation or exponential smoothing. The control laws for some loops are very simple, adjustments being proportional to the last measured deviation (difference between the desired and actual value of the controlled variable). Special emphasis has been placed on the control of refining, basis weight and moisture content - all of which required elaborate control laws that were drawn up on the basis of extensive theoretical studies.

The control of the various subsystems is closely interconnected of course. For example, a paper-machine speed change will affect most of the subsystems since it will alter the flow of stock and chemicals, the refining power consumption, the headbox level and (to some degree)

the pressures in the drying section.

Special routines are called in at grade change or at emergency conditions such as those arising in conjunction with paper breaks.

Quality Control Programs

The quality control programs are mostly interrupt programs that are called in when new quality test data is entered on the manual entry unit. These programs sometimes call in longer high-level main-line programs. About 70K disk storage positions are reserved for these programs. As mentioned previously, the production supervising tables are also used for the quality control programs.

The manual entry unit with twelve ten-position rotary switches is located in the laboratory. Laboratory personnel enter all quality test data for the PM4 machine on this unit using six switches to identify roll-sets, two switches for a test code and four switches for the measured data.

A special code indicates when all of the test data for a reel is entered. Special programs are called which calculate and print out quality information that assists the machine tender in running the process properly.

Another code is used subsequently when all of the test data obtained from the rewound rolls is fed in. New programs are then called in which perform all the requisite calculations for the sorting of finished rolls. Information about test data and sorted rolls is printed out to the winder crew or shift foreman. All test data that has been entered is stored in the supervising tables together with information about the sorted rolls.

Reporting and Analyzing Programs

The data stored in the production supervising tables may be used for a wide range of reports.

The computer prints out two daily reports. One presents a synopsis of production and quality variations; the other lists all rejected rolls.

Special routines have also been written for dumping the supervising tables on cards, a procedure which is expected to be carried out every second day. These cards will then be taken to the Billerud Data Processing Center at Säffle which is located about 19 miles from Gruvön.

Since all important process data and quality test data from the PM4 production are stored on cards, all types of reports can be edited and production data can be analyzed. Two examples: a monthly report containing a synopsis of production and efficiency figures for the past month, and quality reports covering specified orders that are printed out on special demand. Both these examples will be included as part of the system.

The parameters used for calculating estimates included in the quality control programs may be updated on the basis of collected data. Moreover, this data will be used for both process and quality optimizing purposes.

CONCLUSION

The major part of this presentation has dealt with a description of the system. No figures have been given showing how successful the system has been economically for this reason: completely automated control has been in operation only for a few months, and the results cannot be analyzed properly until after at least 12 months of operation. The greatest process-control profits are expected to stem from the improved settings of key process variables, i. e. from process optimization resulting in improved quality and increased production. The integrated system is expected to provide additional savings. The fact that the computer system has been able to take over many functions previously performed manually and to do them equally well is a very important first step toward a fully automated plant.

Another factor on which success depended was the acceptance of the computer system by the machine crews. They had to understand that it was being installed to help them run the paper machine, not to compete with them. Their training and re-education has been handled in an exemplary manner by the Billerud management. As a result, their acceptance and operation of the system have been wholly satisfactory.

Finally, it must be mentioned that the successful implementation of this integrated system has been possible due to the very close and harmonious cooperation between the paper manufacturer, Billerud, and the computer manufacturer, IBM.

INTEGRATED COMPUTER CONTROL OF A PAPER MACHINE
Production Planning

E. Mårtensson
IBM

SYNOPSIS

The integrated system is subdivided into five systems -- production planning, production supervising, process control, quality control and reporting. This report presents the reasoning on which the final formulation of the production planning problem was based -- including a discussion of the economic incentives involved. The functions and characteristics of the production planning system when applied to normal and emergency situations are discussed. In closing, a few aspects of computer operation are presented.

TP 18.168
Technical Paper
15 October 1966
IBM NORDIC LABORATORY
LIDINGÖ, SWEDEN

Introduction 1
 Economic Incentives 1

Formulating the General Problem 5

Searching for Solution Techniques 7

Sequencing Orders within Each Paper Machine 10

Optimizing Trim 11

Production Planning System -- Function and Characteristics 18
 Preparing Order Information 19
 Regular Planning 22
 Emergency Planning 27

A Few Aspects of Computer Operation 30
 Storage Requirements 30
 Information Sorting 30
 Printing and Computer Overlapping 31
 Timing Considerations 31

INTRODUCTION

Installation of the IBM Process Control System at the Gruvön Paper Mill of the Billerud Company aims at the total integration of all aspects of the papermaking process, from the incoming orders right through to the sorting of the finished paper. The production planning part of the system comprises all five paper machines at the mill, while the supervising and control sections are limited to paper machine number four. This machine alone, the largest paper machine at the mill, accounts for almost half of the mill's production. The main reason for including all five paper machines is that production planning, in order to be effective, must embrace the entire mill; supervision and control, on the other hand, may be effectively performed on a single paper machine.

Economic Incentives

At the outset, we took a very general view of the production planning problem. Our first task was to determine the economic incentives. Discussions with people at the mill indicated the following incentive areas:

- Trim losses
- Grade change losses
- Machine costs
- Pulping costs
- Storage costs
- Late delivery costs

In addition to these there were a number of minor losses in the winding, cutting and packing operations. These, however, were considered to be of secondary importance.

Trim Losses

Since a paper machine represents a large amount of invested capital, optimum production rates must be maintained insofar as possible. As a result, the full width of the paper machine must be utilized. The orders, however, call for rolls of paper of various widths and sheets of paper of various lengths and widths. The problem is therefore to cut the ordered amounts of rolls and sheets of paper from the paper produced in the paper machine in such a way that the total amount of narrow strips left over (the trim loss) is minimized.

Grade Change Losses

The grade of a paper is characterized by a number of factors. These include the way it is glazed, its color, its weight per unit area (basis weight), whether it is bleached, semibleached or unbleached, etc. Changing the grade of paper on a paper machine involves a number of adjustments; these include valve setting changes, speed changes, engaging or disengaging rolls, adding chemicals or color, etc. Many changes can be made without stopping the paper machine. Certain changes involving, for instance, colors or different grades of pulp may necessitate stopping the machine to clean it.

Each adjustment consumes a certain amount of time. Furthermore, there is a transient period during which the adjustment takes effect. During this period the changing grade may not fulfill either the old or the new grade requirements. Such paper has to be scrapped and consequently represents a loss.

Machine Costs

The only machine costs considered were those affected by the type of paper being run on the paper machine. Production speed and paper

quality are examples of factors affecting these costs. Assuming constant paper quality, it may be possible to increase the total production speed measured in tons per unit of time or dollars per unit of time by placing the various grades of paper on the machines best suited for these grades. On the other hand, assuming constant production, it may be possible to increase the quality of all the grades by selecting the machines best suited for each grade. A combination of the two methods is also possible.

Pulping Costs

These costs are dependent on how erratically the pulp mill is run. Since the Gruvön Mill is an integrated mill, the pulp mill production must be adapted to the pulp requirements of the paper mill. Mills are usually designed for high efficiency during steady state production. The steady state production efficiency cannot normally be maintained during changes in the production rate. If these changes are too frequent and/or too large, there will be a corresponding decrease in efficiency, which may be looked upon as a loss.

These losses prevail until the paper mill calls for pulp production which exceeds the capacity of the pulp mill. The losses then change character. When this situation occurs the pulp mill may be run steadily at maximum capacity, and the speed of one or more of the paper machines must be decreased, causing a corresponding loss.

Storage Costs

These costs are essentially of two kinds. One is the interest on capital tied up in stored paper. The other is the cost of storage space and protection of the stored paper.

Late Delivery Costs

These costs are also mainly of two kinds. One concerns direct penalties for late deliveries. These penalties are regulated by General Trade Rules adopted by the paper industry. The other is the loss of goodwill which may result in lost customers. This cost, although very important, is difficult to determine.

FORMULATING THE GENERAL PROBLEM

The following generalized problem may be formulated from the aforesaid costs; assign the orders to the paper machines and arrange them within each paper machine in such a way that the sum of all the costs is minimized. To solve this problem by computer, it must be given a mathematical structure. One prerequisite for this is the determination of the actual sizes of the problem parameters. An investigation of the possibilities of determining these parameters yielded the following result.

The parameters affecting trim losses and grade change losses could be determined with reasonable accuracy and effort. The determination of the parameters affecting machine costs would involve considerable effort, and the values of the parameters would be less reliable. However, at this stage of investigation the uncertainties were not sufficiently extensive to exclude the machine costs from the mathematical problem.

The pulping costs caused by the erratic running of the pulp mill were extremely uncertain. There was some doubt as to whether any such costs existed, since a large part of the pulp is supplied from a continuous digester able to operate efficiently within a wide range of production. Because of these uncertainties it was decided that these costs should be neglected. The other pulping costs incurred by slowing down the paper machines when the pulp mill capacity is exceeded are so large that they may be considered infinite. The pulping capacity may therefore be considered solely as a limit.

When considering the interest costs incurred by products in storage, it is important to note in what way the capital is actually tied up. Since most of the paper value stems from the raw materials, it is here that the primary interest savings are to be realized. If paper production could be delayed, the requisite raw materials could theoretically be purchased later, thus saving the interest on the cost of the raw materials. In practice, however, so many other factors influence the time when raw materials must be

acquired that the short time savings realized by better planning cannot be utilized to provide interest savings. Moreover, the sales planning department cannot utilize the time saved by better mill planning to shorten delivery times. Savings in storage costs were consequently neglected at Gruvön.

The other type of storage costs, i. e. the costs of storage space, could also be neglected since it was difficult to utilize any empty storage space economically for purposes other than storing paper. It was therefore decided that storage should be considered at most as a limitation. However, even this was doubtful since there is plenty of yard space at Gruvön and paper covered only by a tarpaulin can withstand long-term outdoor storage.

Finally, the delivery costs were so high that they could be considered as infinite since, in practice, much of the paper is delivered to the customers by ships that don't normally wait for late deliveries. Consequently, slight delays in delivery may mean long delays to the customer; the paper may have to wait quite some time until the next ship leaves for the customer's destination. The delivery problem was therefore looked upon solely as a limitation problem.

From what has been said above it is evident that the general problem may be reformulated in the following way:

Minimize the sum of:

- Trim losses
- Grade change losses
- Machine costs

Subject to the following restrictions:

- Delivery times
- Pulping capacity
- Storage space

SEARCHING FOR SOLUTION TECHNIQUES

Having formulated the general problem and having determined the feasibility of obtaining the relevant parameters, the next step was to investigate techniques for solving the problem.

A first step in this direction was to get an indication of the size of the problem. We therefore collected order information for a representative time period and found that a maximum of about 200 orders for all five paper machines had to be planned for simultaneously. We then investigated the structure of our problem in greater detail and found that it was essentially of a combinatorial nature. The only known technique for solving general combinatorial problems is by complete enumeration of all possible solutions. It was obvious, however, that no computer could enumerate all possible solutions for as many as 200 orders. Consequently, this method had to be abandoned.

During our search for solution techniques we came across a method called the "Branch and Bound Algorithm". This method was developed for solving the so-called "Travelling Salesman Problem", a problem rather similar to a subproblem that may be formed in our problem complex. Since there were no theoretical solution techniques for a problem as large as ours, we were forced to break it down into smaller parts solvable by existing methods. The Branch and Bound Algorithm seemed to hold some promise, and we tried to break the problem into parts of which at least one could be solved by this algorithm. We simultaneously investigated to see whether the problem formulation could be simplified.

Breaking a problem into parts normally results in suboptimization, and as a result one cannot be sure of doing the job as well or better than it is being done at present by manual means. However, if the overall problem can be broken into a chain of problems, the first problems in the chain solved by present methods and the remaining problems solved

by equally good or improved methods, then the overall results should be as good or better than those provided by present methods.

The problem was therefore broken down into the three following sub-problems:

1. Allocate the orders to the different paper machines in such a way that the machine costs are minimized and group the orders roughly within each machine so that the total pulp requirements at any time do not exceed the capacity of the pulp mill.
2. Sequence the orders within each paper machine so that the total grade change time within the paper machine is minimized and so that delivery times are not exceeded.
3. Optimize trim within each machine.

Storage space limitation was not included in this problem complex, the main reason being that the amounts stored are governed largely by the sales situation and cannot be efficiently controlled by sequencing.

Consequently, delivery times should be negotiated with the customers so that deliveries coincide as closely as possible with the finishing of the orders in the mill. Storage limitation, as stated previously, is not serious and including it in the problem complex would only complicate the problem without yielding much additional revenue.

Subproblem one is complicated by the fact that a certain amount of human decisions are involved. These decisions arise from the necessity of close cooperation between the sales planning and mill planning departments. The sales planning department must keep track of the actual order backlog, forecast sales in the immediate future and determine the loads on the different paper machines based on actual and predicted sales. The mill planning department is responsible for the efficient utilization of the paper machines and for keeping track of the mill status.

Because their responsibilities differ, the sales planning and mill planning departments often recommend conflicting action. Consequently, negotiations take place between the two departments, sometimes involving quite intricate decisions. The rules for making these decisions were judged to be too complex to allow them to be consolidated into a form suitable for computer handling in the time available for the study. It was therefore decided that the allocation and pulp checking problem should be handled manually for the time being.

Since sequencing and trim could be programmed using existing optimization techniques or modifications of such techniques, it was decided that these two sub-problems would be handled by the computer.

The above reasoning shows that the optimization introduced by the computer system together with the continued manual handling of a portion of production planning will result in overall results that are equally efficient or better than those provided by previous operations.

SEQUENCING ORDERS WITHIN EACH PAPER MACHINE

The order information must be arranged in a suitable form prior to sequencing. The starting point for sequencing is a square matrix called the "group change matrix", in which the group is the item that is sequenced. A group is formed in the following way. A customer order is composed of one or more order items, each of which is characterized by the grade properties, the physical dimensions and the delivery time of the paper. A group is composed of all order items of the same grade and with the same delivery time. The elements of the "group change matrix" give the time in minutes required to change from one arbitrary group to another on the paper machine.

The "group change matrix" may be formed in two basically different ways. If only a limited number of grades, i. e. on the order of less than 100 grades, are run on the paper machine, one matrix may be formed giving the times required to change from one arbitrary grade to another. This matrix may then be stored in the computer. When the "group change matrix" is to be formed, all the computer has to do is to locate in the stored matrix the grades of the groups to be sequenced and to select the elements corresponding to these grades. The selected elements then form the "group change matrix".

If the number of possible grades that may be run on the paper machine is large, i. e. on the order of more than 100 grades, the method is normally impractical and requires too much memory space. In such cases, a method based on forming the "group change matrix" straight from the so-called "individual grade changes" may be used. This method is used at the Gruvön Mill.

While there may be a very large number of possible grades, the number of parameters defining the grades is relatively small. Examples of such parameters are bleaching status, glazing status, color, basis weight, etc. Each parameter may have a number of different states, e. g. a grade may be bleached, semibleached

or unbleached, it may have one of various colors, etc. Associated with a grade change is the changing of one or more parameters from one state to another, e.g. from bleached to unbleached, from green to blue, from one basis weight to another basis weight, etc.

Changing the state of a parameter is called an "individual grade change". A complete grade change is built up of one or more "individual grade changes" which more or less overlap when executed. The degree of overlapping is defined in a matrix-like table called the "parallel/series matrix". Using the "parallel/series matrix" and a table giving the "individual grade change" times, it is possible to compute the "group change matrix". Unfortunately each paper machine at Gruvön must have its own "group change matrix" program since a generalized program would become too sophisticated and require excessive computing time in a system of the 1710 type. In addition, the program would be too large for the memory space available in the 1710 system.

When the "group change matrix" has been formed, the actual sequencing may take place. The sequencing method used is a modified version of the "Branch and Bound Algorithm". The "Branch and Bound Algorithm" as described in "Operations Research", November - December 1963, was developed for sequencing problems of the "Travelling Salesman" type.

This type of sequencing problem differs from paper machine sequencing in two ways: a) "Travelling Salesman" problem solutions represent a closed sequence, i.e. the salesman returns to the same city from which he started, whereas sequencing on a paper machine starts with a specified group and ends blindly; b) paper machine sequencing is subject to delivery time restrictions, whereas there are no such restrictions in "Travelling Salesman" problems.

Difference a) was easily overcome by modifying the input matrix slightly. As a result, the algorithm itself required no changing.

Difference b) required a considerable amount of algorithm modification.

The only way of checking for exceeded delivery times is to add the production times of the groups as the sequence is built up and check the delivery time of each group added to the sequence. This is illustrated in Fig. 1.



Fig. 1

The groups are represented by the letters A, B, C and D. A represents the starting group which is fixed in time. The lengths indicated along the time axis are the production times for each group including average times for grade changes. The grade change times in the production times are an approximation, but since the grade change times are small compared to the uncertainties in the production times, this is an allowable approximation.

The delivery times are indicated by arrows in Fig. 1. It is evident that none of the groups in Fig. 1 has exceeded its delivery time. If, however, the delivery time for a group is exceeded during the building up of a sequence, then this group must be placed earlier in the sequence. This means breaking up the sequence and starting from the beginning again, despite the fact that the sequence formed up to the point where the delivery time of a group was exceeded may have been fully satisfactory.

The disadvantages involved in having to start all over again when a delivery time is exceeded may be easily overcome by sequencing backwards in time as illustrated by Fig. 2.

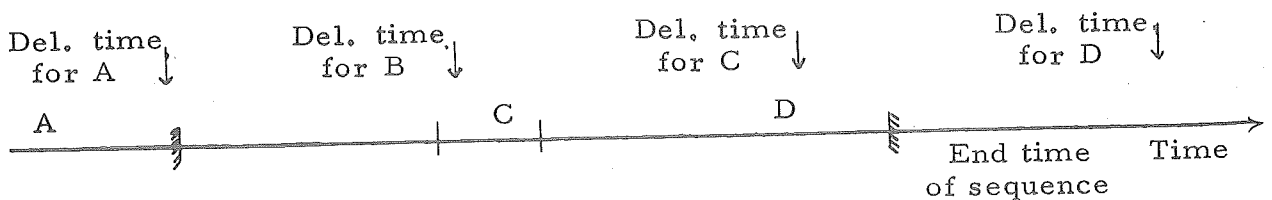

Fig. 2

In Fig. 2 the production times of the groups, including average group change times, have been added together to form the end time of the sequence. This is then considered the starting point of the sequencing operation. In Fig. 2 Group D was selected first, and then Group C. It can be seen that if a delivery time is exceeded when using this sequencing method, it is possible to skip the group with the exceeded delivery time and select a new group. The group with the exceeded delivery time can be selected later, and the sequence formed up to that point need not be broken up.

The method has been programmed and some typical examples have been tested. Although the "Branch and Bound Algorithm" cannot produce a theoretically optimal solution for more than 10 - 15 groups within the permissible computing time, the tests indicate that solutions very close to the optimal are obtained for up to 40 sequenced groups within the permissible computing time. The permissible computing time is estimated to be on the order of 0.5 hour for each paper machine.

OPTIMIZING TRIM

When setting out to trim-optimize the production of a paper mill, it is important to consider in what way the paper is wound and cut. At the Gruvön Mill all five paper machines have free-standing winders. This means that the paper is first rolled into a large reel at the end of the paper machine. The reel is then lifted to the winder (one winder for each paper machine) on which it is slit into narrower widths and simultaneously wound into rolls of smaller diameter.

In these winders the paper can only be slit to certain minimum widths and rolled to certain minimum diameters. In addition, the number of core sizes (the core is the cylindrical tube onto which the paper is wound) is limited. If narrower widths, smaller diameters or non-standard core sizes are desired, the paper has to be rewound in a secondary winder.

If the paper is to be cut into sheets, it is first slit and cut to form rolls of suitable dimensions in the winder, then brought to a cutter where it is cut into sheets. A certain amount of slitting may also be done in the cutters. Normally, several layers of paper are cut simultaneously to avoid folding the paper between the edges of the cutting knives. The number of layers depends on the stiffness of the paper.

The mechanical design of the winders and cutters imposes certain restrictions on the trim problem, and the customers impose other restrictions. The most important mechanical design restrictions are the following. First, it is obvious that only customer orders of an identical grade may be cut from the same reel. Furthermore, the roll diameters and core sizes within each trim problem must be the same since the reels are cut in parallel on the same shaft. They must therefore have cores of the same size in order to fit the shaft, and they must be of same diameter to provide the same paper speed.

The more important restrictions imposed by the customers are the following. The amount of paper delivered may not differ from the ordered amount by more than certain percentages which depend upon the total ordered amount. Roll paper must be delivered with roll diameters as close to the ordered maximum diameter as possible; these diameters must not be below a certain minimum tolerance limit. It may be difficult to remain within this restriction when the rolls are large and the ordered amounts are small. Finally, it is frequently specified that sheet paper be cut in a certain direction on the paper machine (lengthwise or crosswise).

Having formulated the general trim problem and investigated the restrictions imposed on the problem, the next step was to find methods, or preferably existing programs, for solving the problem. It was not difficult to find a number of programs for various types of trim problems, thanks to the fact that they have been extensively studied in the past. Two of these programs were selected for testing. One was the "1620-MT-01X 1-Dimensional Trim Program" which later became an announced program, and the other was a program by C. E. Berry for one-dimensional trim-optimization. The first program is based on the mathematical technique of "Linear Programming" and the second is a heuristic program based on the same lines of thought used in manual trim-optimization.

A number of various sized problems which have been solved by the mill planner were selected as test examples and were solved by both programs. The results of this test indicated that the computer programs provided smaller trim losses than the mill planner for large problems and about the same trim losses for small problems. However, the mill planner was generally better than the programs in two other respects. One concerns the tolerances on ordered amounts and the other concerns the number of so-called "combinations" or patterns.

A "combination" describes the way in which the paper is to be cut, i. e. how the winder slitters should be set, and the number of rolls of paper

that should be cut using this slitter setting. The solution to a trim problem shows the various "combinations" and the number of rolls to be cut for each "combination" in order to provide the ordered amounts of each width. Changing "combinations" involves readjusting the slitters on the winder. The machine has to be stopped during re-adjustment, thus decreasing the production efficiency. As long as the winder can keep up with the production on the paper machine, there is no serious problem. However, the winder is a potential bottleneck, and therefore the general tendency is to minimize the number of "combination" changes.

Since the tests showed that the mill planner produced fewer solutions outside the tolerances on ordered amounts and also produced fewer "combinations" than the computer programs, it was felt that some amendments should be introduced into the computer programs in order to improve them, if possible. The "1620-MT-1X" program showed more promising results than the "Berry" program; efforts were therefore concentrated on the former.

A section of the "1620-MT-01X" program was consequently rewritten and new tests were performed. These tests indicated that the program did a significantly better job than the mill planner for large problems, i.e. problems with three different widths or more. For small problems the mill planner was still slightly better. A completely new program based on a special search technique was thus written for these small problems. This program does not minimize trim losses as described above. Instead, it minimizes the weighted sum of trim losses, number of "combinations", deliveries beyond tolerances and deviations from nominal ordered amounts. As this program, when tested, produced better results than the mill planner, it was decided at the time that it should be used for small problems and the modified "1620-MT-01X" program for large problems. It was later found that this heuristic program could be adapted also to the larger problems, allowing the use of only one program for solving all the trim problems at the Gruvön mill.

Before the trim programs can be used the order material must be sorted so that it adheres to the input formats of the programs. For this reason the order items are grouped into "sections", each of which contains one trim problem. The "sections" may only contain order items that have the same grade, roll diameter, core size, core thickness and splicing. Since sheets may also be included in the same problem as rolls, the sheets should be recalculated into rolls with diameters that will allow the forming of trim problems that will provide as low losses as possible. Sorting into "sections" will be done by the computer.

PRODUCTION PLANNING SYSTEM -- FUNCTIONS AND CHARACTERISTICS

The production planning system is basically divided into two functions:

- 1. regular planning
- 2. emergency planning

Regular planning is performed at regular intervals. These intervals should be short enough to allow significant amounts of new order material to influence the planning, but not so short that changes in the production plan will cause the paper mill to be run erratically. The regular planning interval anticipated for the Gruvön paper mill is about two days.

As the name implies, regular planning takes care of the normal situation in the mill. Since disturbances in the mill are expected to be relatively infrequent, there is an incentive for optimizing the regular planning.

Emergency planning takes care of disturbances affecting the increment of the production plan extending from the present time to the next scheduled regular planning. Disturbances affecting the production plan after the next scheduled regular planning can be taken care of in the regular planning.

In emergency situations, there is normally a shortage of replanning time. It is therefore important that the emergency planning function be designed to keep replanning time at a minimum. Since disturbances are expected to occur infrequently and any replanning caused by disturbances need only be valid for a short time, i. e. until the next regular planning, there is no need for any sophisticated form of emergency planning. The only optimization included in emergency planning is trim-optimization of affected "sections". Reoptimizing the production sequence is not included, since it takes too much time without yielding any significant revenue.

Preparing Order Information

Before the actual planning can start, the order material must be prepared as follows. Each customer order arriving at the Billerud head office in Säffle is entered onto a special form shown in Fig. 3 (roll orders) and Fig. 4 (sheet orders). There is space on the forms for information comprising a complete description of the customer order including all grade properties, dimensions, dates, etc. At the head office, that portion of the information which is known there is filled in.

The forms are collected and sent to the Gruvön mill in batches via an internal messenger service. Upon arrival, the mill planner sorts them into priority levels. Those with the highest priority are handed over to the mill foreman. He completes them by filling in any missing information (normally grade information) and sends them to the punching department.

The orders are punched on cards, one master card for each order and one slave card for each order item. Since it is extremely important that the information be punched correctly, the cards must be checked in a verifier. After punching, the cards go to the mill planning department and are kept there until it is time for the next regular planning.

MASKINSEDEL, rullpapper

BILLERUDS AB
Gruvöns Bruk

Konto nr

Kundnamn

Kundkod 6

Stad

Order G

Masterkort		1	79	80	
Kvalitets- beteckning		74			
Special		68			
Skarvkod		67			
Hylstjocklek, mm		65			
Sulfitinblandning, %		63			
3-press, Pm 4		62			
Fyllnads- medel	Titandioxid askhalt, %	61			
	Kaolin askhalt, %	59			
Ytflimningskod		56			
Extensa	Längs- töj- ning %	55			
	Max Min	52			
Våtstyrka, %		51			
Våtstyrkemedelkod		49			
Randmarkering, cm		47			
pH		45			
Fiber- oriente- ring	god allm. styrka spinn god botten	44			
Maskinglätt		41			
MG, slätt , finrandigt, valsmarkerat , < , filtmarkerat , bredrandigt		40			
Mattglättat Oglättat		35			
Färgkod		33			
Oblekt Halvblekt Helblekt		32			
Centrumhål, mm		27			
Köres på Pm	26	27	28	29	
Orderdatum	år	21	22		
	mån dag	1	2	3	4
		15	16	17	18
Antal order pos.					

Pos nr	Lufmst. sek.	Lim- ning	Fukthalt %	Ytvikt g/m ²		Mängd kg	Rullantal st.	Rullbredd	Sort	Max. rullvikt kg.	Lev. tid		Intern kod			Anm.	Slavkort															
				Min.	Max.						mån.	dag.	Slit T	Töj T	Töj L																	
																		2	2	2	2	2	2									
6		8	10	11	12	13	15	16	19	20	23	24	27	30	31	33	34							37	40	41	42	44	45	47	48	49

ORDER G

BILLERUDS AB
Gruvöns Bruk

MASKINSEDEL, arkpapper

Order G		Sa ton		Kundkod		Kundnamn		Konto nr																																																																			
1		5		6		13																																																																					
Pos nr	Lufmoltst. sek.	Limning	Fukthalt %	Ytvikt g/m ²		Mängd kg	Format	Sort	Lev. tid män. dag	Arktantal per ris st.	P1 Fo Lp	Risvikt kg	Risvikt lbs	Risantal, st. Per bal / pall / Totalt	Nom. vikt bal / pall kg.	Slavkort																																																											
				Min.	Max.																																																																						
6	7	8	9	10	11	12	13	14	15	16	17	18	19	20	21	22	23	24	25	26	27	28	29	30	31	32	33	34	35	36	37	38	39	40	41	42	43	44	45	46	47	48	49	50	51	52	53	54	55	56	57	58	59	60	61	62	63	64	65	66	67	68	69	70	71	72	73	74	75	76	77	78	79	80	
Antal order pos.		Orderdatum		Köres på Pm		Centrumhål, mm		Helblekt		Halyblekt		Oblekt		Färgkod		Oglättat		Mattglättat		Bredrandigt		Filtmarkerat		Finrandigt, valsmarkerat		MG, slätt		Maskinglätt		Fiberorientering		god allm. styrka		god spinn		god botten		pH		Randmarkering, cm		Vätstyrkemedelkod		Vätstyrka, %		Extensa		Längstöjning		Max		Min		Ytlimningskod		Fyllnadsmedel		Titandioxid askhalt, %		Kaolin askhalt, %		3-press, Pm 4		Sulfitinblandning, %		Hylstjocklek, mm		Skarvkod		Special		Kvalitetsbeteckning		Masterkort	

ORDER G

Fig. 4

Regular Planning

A block diagram of the regular planning is shown in Fig. 5. It is initiated by entering a card indicating the orders that have been produced. The program then clears all tables of produced order information and makes an estimate of the number of order items that may be entered without causing overflow in the table areas. This information is printed out to the operator who feeds in the order cards while making sure that the maximum recommended amount of order information is not exceeded.

The program then sorts the order items into "sections" and trim-optimizes the "sections". One trim-optimization is performed per "section" and per alternative paper machine on which the "section" may be produced. Alternative paper machines are indicated on the order cards. The results of the trim-optimizations for the alternative paper machines are then stored. In addition, the results are printed on an "order list" like the one shown in Fig. 6. This list is used by the mill planner as a confirmation of the order material which has been entered. It is also used to aid the planner in allocating the orders to the paper machines.

The allocation is done manually by the mill planner. As a starting point for allocation, the planner draws up a rough production plan once each month in collaboration with people from the sales planning department and from the mill production departments. This rough plan shows the time periods during which bleached, semibleached and unbleached paper is to be produced on the different paper machines. The time periods are further subdivided into unglazed and machine glazed (MG) production. The main reason for making the rough plan is to aid the sales planning department so that orders are not accepted that would cause the pulping limitations to be exceeded.

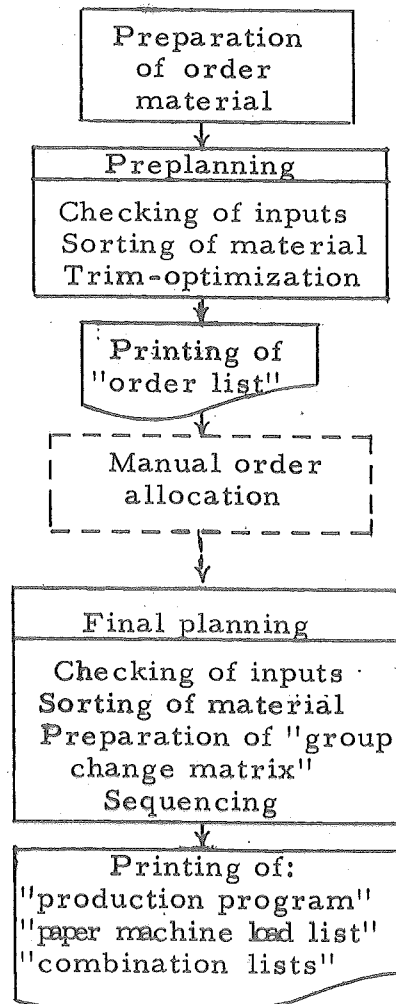

Fig. 5 BLOCK DIAGRAM OF REGULAR PLANNING

Orderlista

Sek- tions nr	Order nr	Kundnamn	Kvalitetsspecifikationer	Land- kod	Kvanti- tet i kg	Lever. dag		Körningstid i / Massaåtgångs- tim för sek. / hast. i kg/tim					Alternativa trimförlus- ter i %					
						mån	dag	PM 1	PM 2	PM 3	PM 4	PM 5	PM 1	PM 2	PM 3	PM 4	PM 5	
001	5011 5013	Andersson & P Lundström & Jag	Helbl.MG, Tit, 40/42, Fvitaste	516 786	40000 25000 <u>65000</u>	11	18	39 (1800)	41 (1700)	64 (1100)		47 (1500)	1,4	1,4	1,4	1,6	1,1	
002	5102 N 5107	A & O Papperspelle	Ob1, 0g1, 70g, F8	429 298	5000 100000 <u>105000</u>	12	01	47 (2400)	49 (2300)		14 (7900)		0,7	0,7		0,5		
003	N 5204 5213	Byggkonrad Socker & Sirap	Ob1, MG, 60g, F13	587 145	60000 30000 <u>90000</u>	12	10			44 (1000)		27 (1600)			2,6		2,5	

Nyttillkomna ordernummer jämfört med föregående orderlista markeras med N framför ordernumret samt med rött på originalet.
Sektibner i den låsta planeringsperioden markeras med L framför sektionsnumret samt med rött på originalet.

Fig. 6

The planner now has to fill up the time periods on the rough production plan with order material from the "order list". Since trim-optimization is performed on "sections", the smallest entry allocated is a "section". If the planner is doubtful about what paper machine he should allocate a "section" to, he may select the paper machine giving the lowest trim loss as indicated on the "order list". At the same time, the planner should make sure that the time periods given on the rough plan are not overfilled. As an aid to this, the production times for each "section" are given on the "order list" for the alternative paper machines.

When the "sections" in the "order list" have been assigned to the different time periods on the rough production plan, information concerning the assignments is punched on cards which are then entered into the computer. The computer checks that the accumulated production times of the "sections" assigned to each time period do not exceed the length of the time period. In addition the computer checks to see whether the sequencing problem is solvable. If the length of any time period is exceeded or the sequencing problem is not solvable, an error message is printed and the assignment must be readjusted. If the check indicates no error, then the sequencing part of the planning may proceed.

Before the actual sequencing takes place, the sections that have been allocated to each paper machine are sorted into groups (a group consists of order items with the same grade and delivery time). The "group change matrix" is then computed using the "individual grade change" times and the "parallel/series matrix". Using the previously described modified version of the "Branch and Bound Algorithm", the groups are sequenced for each paper machine in turn.

The result of the sequencing is printed on a list called the "production program". An example of such a print-out is shown in Fig. 7. Another list called the "paper machine load list", which is similar to the production program, is also printed. This list indicates the load and the maximum free capacity of each paper machine. Finally, the "combination lists" are printed. These lists show the optimum way of slitting the paper in the winders. An example of a "combination list" is shown

Körprogram för PM 4

26 mars-1 april

Gr. nr	Kvalitetsspecifikationer	Identifikation		Körningen börjar		Prod. tid Tim.	Klar för leverans		Önskad lev. tid marg. dagar					
		Körst. nr	Order & pos. nr	Kundnamn	Mån. Dag		Tim.	Mån. Dag		Mån. Dag				
						Mån. Dag			Tim.					
01	Oblekt, Våtstarkt 00,72g, Färg 53	001	2285-2	Andersson & Pettersson	03	26	16	8	03	27	03	31	4	
		002	2285-3	Lundström & Jag A&O										
		003	2290-1	2270-4	A&O									
02	Oblekt, Våtstarkt 00,80g, Färg 53	004	2270-5	A&O	03	26	24	16	03	28	03	31	3	
			2270-1											
03	Oblekt, Våtstarkt 00,85g, Färg 52		2270-2	Andersson & Pettersson										
			2285-1	Lundström & Jag A&O										
			2290-2	2270-3	A&O	03	27	16	125	04	01	04	10	9
		2285-4	2290-3	Andersson & Pettersson										
		2290-3	2290-3	Lundström & Jag										

Fig. 7

in Fig. 8. Since these lists take considerable time to print and much of the information going into the lists is revised at each regular planning, there is no point in producing "combination lists" for the entire amount of order material. The planner is therefore given the option of ordering the print-out for a specified length of time, normally until the next scheduled regular planning.

Emergency Planning

The emergency planning routines can take care of the following situations:

- Where one or more order characteristics must be changed. Examples of such changes include basis weight changes, changes in ordered amount, delivery time changes, etc.
- When an order item must be moved from its present position in the production sequence to another specified position in the production sequence for some reason.
- A combination of the two aforesaid situations. This may occur when a change in the order characteristics makes the order item so poorly suited to its present position that it must be moved.
- When an order item is cancelled.
- When an order item is produced earlier than indicated by the production plan. Such a situation may occur when an order item must hurriedly replace another order item which cannot be produced because of temporary disturbances such as bad pulp, etc.
- When it is desirable to resequence full groups. Such a resequencing could be performed by the second routine above. However, since this routine requires more input information and also places

KÖRSTÄLLNING NR 001 AV DEN 01/05 1966.

P.M. 1 MG, OBL, FÄRG 08, YTV. 60, 2 G/KVM
DIAM. 100 CM, CENTRA 7.5 CM, 10 M/M HYLSSOR, BRED TAPESKARV

ORDER NR.	POS NR.	ID-	BREDD CM.	ORD.V KG.	RULLV KG.	LEV.V KG.	ANT. RLR	MAX.RV KG.
15889	01	01	122	015000	419	13408	32	650
16293	03	02	142	010000	487	07792	16	650

SÄTTANT. SÄTTL. KOMB.

16 5700 2X122 + 1X142 SUMMA 386 CM

TOTALT BREDDSPILL 1250 KG /05,00/

Fig. 8

an unnecessarily heavy load on the computer, a special routine is provided for resequencing full groups.

A FEW ASPECTS OF COMPUTER OPERATION

In closing a brief discussion of computer storage requirements, information sorting, printing, overlapping and timing will be presented.

Storage Requirements

The disk storage space used by the production planning system is on the order of 0.6 million characters. Roughly 45% of this space is taken up by the programs. The remainder is needed for storing information. In addition, 0.2 million characters can be used for storing information if anything goes wrong in the planning.

Information Sorting

Because of the large amounts of information that have to be stored, the various tables used to store the information tend to be large. Some of the largest tables comprise 60,000 - 80,000 characters.

A great deal of sorting has to be done by the system. Normally, this involves reading a table from disk storage into core storage, extracting desired information and storing it in another table. However, this sorting is complicated by the availability of only 20,000 characters of core storage for this type of job. In order to simplify the sorting and minimize the number of disk operations, schemes such as grouping table records by the desired sorting characteristics have been very rewarding.

Printing and Computer Overlapping

Certain computer operations such as sequencing, trim-optimization and assembling messages for print-out take a long time to perform. The printing of lists is also very time-consuming. Since the printing in the 1710 system is controlled by a channel that is independent of the central processing unit, overlapping of printing and computing is possible. This feature is utilized by overlapping the sequencing, trim-optimization and message assembly for one paper machine with the print-out for another.

Timing Considerations

As stated earlier, it is anticipated that the regular planning will be repeated every other day. The planning will comprise orders for two to three weeks of continuous production. The planning itself is expected to take one to one and a half shifts, depending primarily on the amount of new order information and on the time needed by the mill planner to assign "sections" to the paper machines.

INTEGRATED COMPUTER CONTROL OF A PAPER MACHINE

Process Control

O. Alsholm G. Sangregorio
BAB IBM

SYNOPSIS

The integrated system is subdivided into five systems -- production planning, production supervising, process control, quality control and reporting. This report which deals with process control presents a description of the control objectives followed by a discussion of the functions of the control system and the duties of the machine tender. Three aspects of automatic control are discussed: steady state control, grade change control and paper breaks. Finally, the conclusions which have been drawn thus far are presented in brief.

TP 18.170
Technical Paper
15 October 1966
IBM NORDIC LABORATORY
LIDINGÖ, SWEDEN

table of contents

Control Objectives	1
The Process	2
Functions of Control System and Machine Tender	4
Automatic Control	7
Steady State Control	7
Grade Change Control	15
Paper Breaks	15
Conclusions thus Far	17

CONTROL OBJECTIVES

On the Billerud paper machine PM4 our objective is to produce the maximum amount of paper during the available time while consuming minimum amounts of raw material and energy and maintaining uniform quality. The production rate is limited by the physical constraints of the plant and by pulp availability. Moreover, production is reduced because of time lost due to rejected off-grade production or paper breaks.

High average production rates require that:

- the process be run as uniformly as possible during the production of a given grade of paper. The advantages of uniform operation include the following:
 - (a) plant operation near the upper capacity limit
 - (b) production of uniform-quality paper
 - (c) reduced paper-break risks
 - (d) average moisture content can be increased to obtain a higher paper yield per ton of pulp
- grade-changes be executed in a short time, but without breaks.
- the process be efficiently controlled during paper breaks in order to restore on-grade production as soon as possible.

The purpose of the control system is to attain the above objectives by automatic control action and by guiding the machine tender in his execution of manual operations when required.

THE PROCESS

The PM4 is a Fourdrinier machine which produces kraft paper at an average rate of 50,000 tons per year. Sack paper with a basis weight ranging from 60 to 140 g/m² is produced; for the most part it is unbleached, but semibleached and fully bleached grades are also produced. The speed of the machine varies from 200 to 370 m/min. The trim width is approximately 5.3 m.

The computer-controlled process starts at the pulp storage chest ahead of the refiners and ends at the reel of finished paper. The simplified diagram in Fig. 1 shows the main parts of the process: pulp storage chest, refiners, machine chest, centrifugal cleaners, screens, headbox, wire, press section, drying section, reel and overhead travelling crane for removing the reel.

Let's consider the process briefly from a control point of view. Paper must be produced within given specifications. These include basis weight, moisture content, porosity, strength characteristics, etc. To meet these specifications certain process variables have to be controlled. The basis weight is determined by controlling the fiber flow and the machine speed. Fiber flow control is obtained by controlling the stock consistency and the stock flow after the machine chest. The moisture content can be controlled by adjusting the temperature of the drier cylinders. The porosity and the strength characteristics depend on variables such as refining, formation, additives, draws, etc. The principal refining variables are refiner flows, the consistency of stock flowing through refiners and refiner power. Formation depends on the consistency in the headbox, the hydraulic characteristics of the headbox and the difference between the speed at the slice and the wire speed. The speed at the slice depends on the level in the headbox.

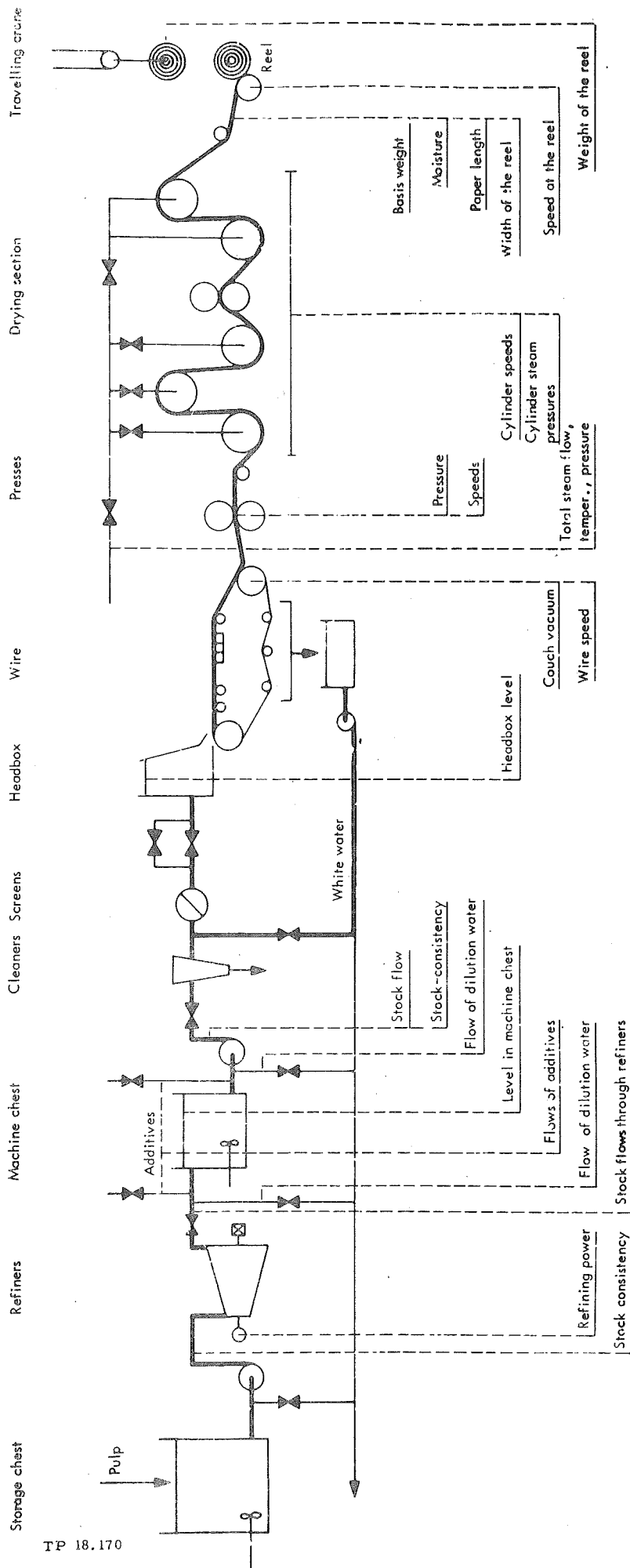

TP 18.170

Figure 1. The Controlled Process with Principal Variables.

FUNCTIONS OF CONTROL SYSTEM AND MACHINE TENDER

Process control includes more than automatic operations. We must also consider the action taken by the machine tender which, in spite of the high degree of automation, remains a fundamental part of the process control. The machine tender and the control system collaborate to run the process. Their contributions are complementary. This can be better understood by examining the flow of information between elements having a role in process control: the computer, the machine tender, the instrumentation and the process itself (Fig. 2).

Process control action is taken by the computer and by the machine tender.

- Computer control action (1) proceeds via analog controller set-points or, more directly, via valve-drivers or other electric actuators. Computer control action is based on information from:
- (2) production supervising program (recommended reference values of variables).
 - (3) process on-line sensors (actual value of process variables, on/off status of devices etc.)
 - (4) machine tender (reference value modifications) mainly via binary switch unit.

Machine tender action (5) proceeds via analog controller set-points, motor switches, manually-operated valves, etc. Machine tender action is based on information from:

- (6) process, via panel instruments or direct observation.
- (7) computer via print-out or lamp signals. (process data, alarm conditions, notice of automatic operations)

Before discussing automatic control, a few more words on the flow of information from computer to machine tender are in order. This information is supplied in the form of print-out messages or lamp signals. Messages are issued via a printer in the machine tender booth near the

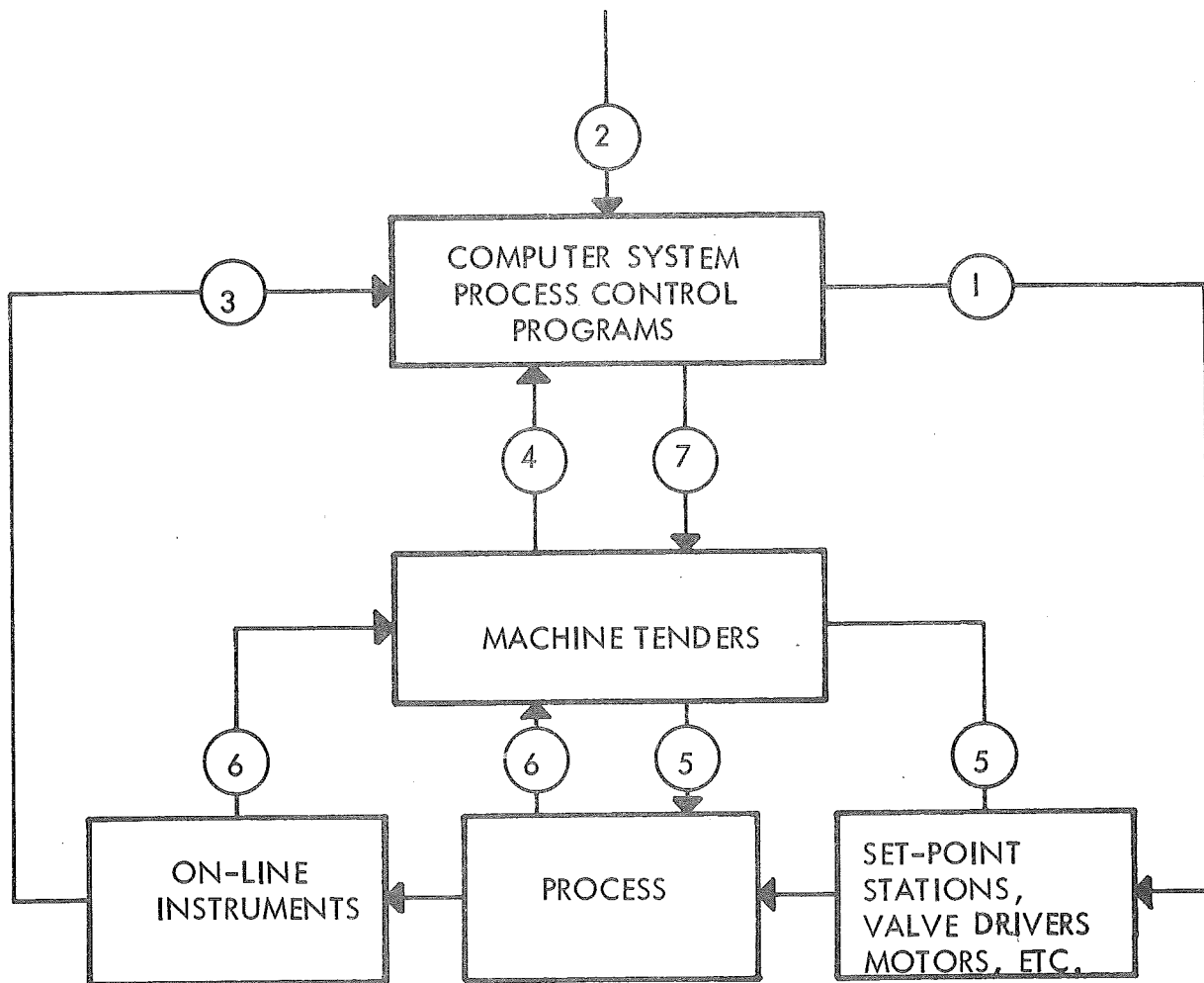

Fig. 2 FLOW OF INFORMATION BETWEEN ELEMENTS OF PROCESS CONTROL

1. Computer control action (pulses to set-point or valve positioners, on/off contact operations).
2. Recommended reference values from supervision programs.
3. Signals from on-line instruments (analog signals, pulse signals, contact status, etc.).
4. Machine tender, request for reference value modifications
Machine tender, requests for process data printing.
5. Machine tender action on process.
6. Machine tender, observations of panel indicators.
Machine tender, direct observations of process conditions.
7. Information to machine tender (process data, alarms, operating guide messages).

wet end of the paper machine. Lamp signals are issued via indicator lamps or legible lighted displays on instrument panels.

In print-out messages, the use of symbols or special codes is avoided as far as possible; short sentences are used where variables, process units, etc. are spelled out, and any numerical values of variables are given in engineering units. A message may contain one or more of the following types of information:

- value of a process variable, if print-out has been requested by the machine tender. Note that there is no data logging on the machine tender printer.
- alarm, for abnormal process conditions, malfunction of instruments, etc. Alarm messages are usually printed in red.
- operator-guide recommendations, to carry out manual adjustments on the process.
- notice of automatic control actions which are either under way or soon to be executed.

Lamp signals indicate alarm except for those used by the production supervising program to indicate set and reel changes. Their use is restricted to urgent situations which must be brought to the attention of the machine tender or of machine crew members who do not work in the vicinity of the machine tender printer.

AUTOMATIC CONTROL

With regard to control objectives, a distinction was made between:

- steady-state control
- grade change control
- control during paper breaks

Since control objectives determine control strategies, a similar distinction must be made for the latter.

Steady State Control

General Considerations

The ultimate objective of process control during production of a given grade of paper is to keep the production rate and product specifications close to the values prescribed by the production supervising system. This is achieved mainly by closed-loop control of process variables.

Control action is based mainly on feed-back signals, i. e. on on-line measurements of the controlled variable itself or on other related variables from which the actual value of the controlled variable can be calculated. Loops can be single or cascade. Manipulated variables are commanded via analog controller set-points (18 outputs) or directly (14 outputs).

The design philosophy has been that of single control loops, i. e. commanded changes of a manipulated variable are mainly function of the deviation of the controlled process variable from its reference value. From this point of view, any interaction with other variables is a disturbance. However, some form of programmed interacting control exists:

- the reference value in a loop may be changed as a consequence of changes in other loops

- changes of reference values in other loops which would cause a disturbance of approximately known magnitude on the controlled variable are taken into account to produce a counter-acting change in the manipulated variable before the disturbance is sensed. This is a simple form of feed-forward control.
- equations used to calculate control correction may contain terms or parameters which are functions of the reference values of other process variables. As a result, they take into account process-gain changes.

In order to show an example of general validity, a cascade control loop is shown in Fig. 3. The control objective is to keep the process variable x_1 close to the reference value x_1^0 . Deviations of the primary variable x_1 from the reference value x_1^0 determine the changes of the reference value x_2^0 of a minor loop for control of the secondary variable x_2 . Deviations $x_2 - x_2^0$ determine changes Δu of the manipulated variable.

Process-Variable Estimation

At regular intervals, signals y from on-line sensors are read and checked against validity limits. A signal outside of the limits is rejected. In such case, a message is printed out to the machine tender notifying him of the malfunction and the necessity of switching the loop to manual or local control. Input signals continue to be read at regular intervals, but no control action is undertaken if any of the input signals are unreliable. If the signal is subsequently found to be within the validity limits (because the cause of the malfunction has been removed) a new message so notifies the machine tender. He then has the option of re-closing the loop by switching to computer control.

Input readings are then filtered if necessary. Filtering is performed by a) mean value calculation on a number of samples or b) exponential smoothing. In the latter case, the filtered value is calculated with a formula of the type:

$$\bar{y}(t) = k_1 y(t) + (1 - k_1) \bar{y}(t - \tau_s)$$

where τ_s is the sampling interval.

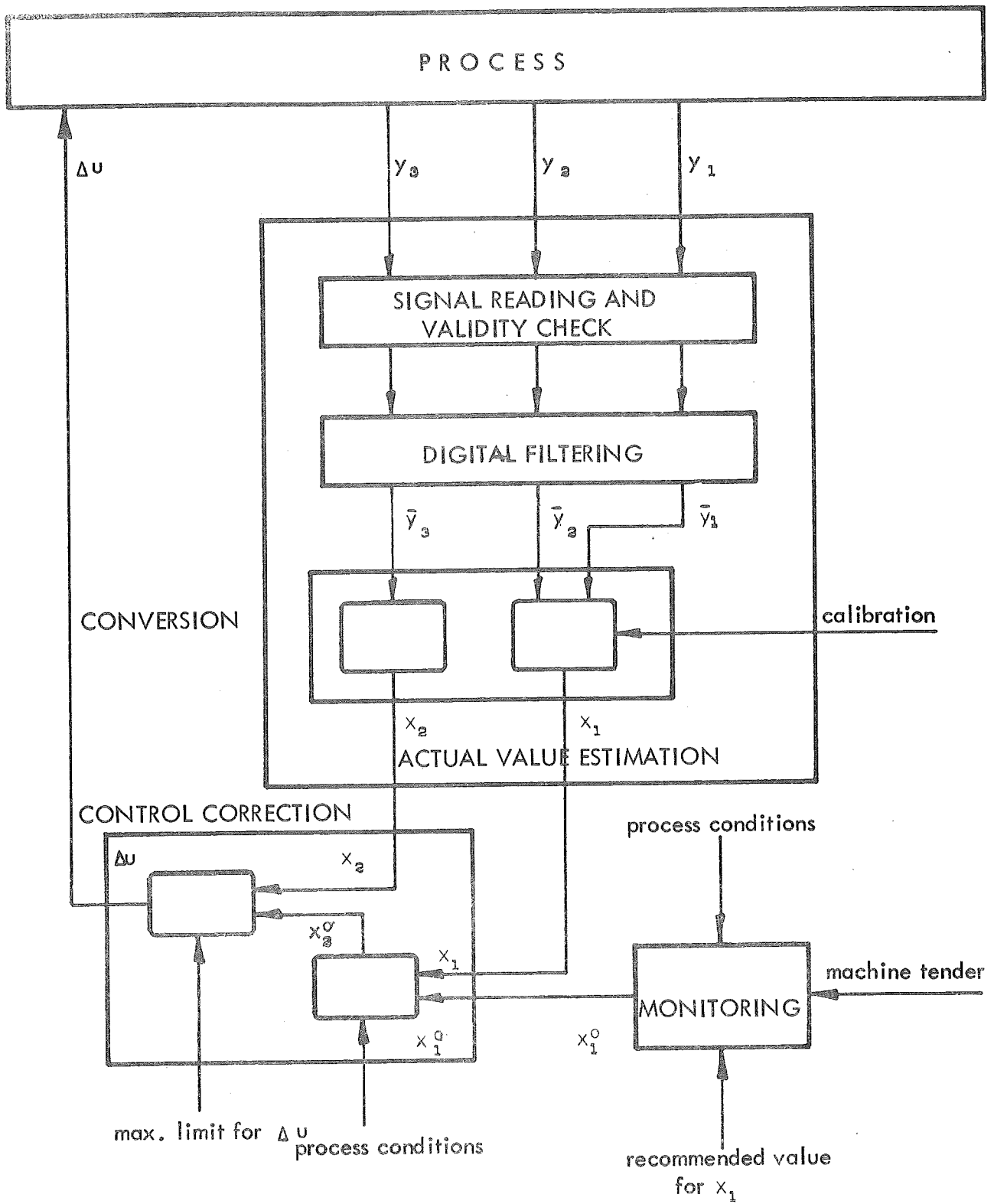

- y Reading from on-line sensor
- \bar{y} Filtered reading
- x Actual estimated value of process variable
- x^o Reference value of process variable
- u Manipulated variable

Fig. 3 COMPUTER CONTROL- TYPICAL CONTROL LOOP

Process variables x are calculated from filtered readings \bar{y} by means of conversion functions, which may contain calibration constants periodically updated by means of material balance calculations or laboratory test data.

Monitoring of Reference Value

The reference value x_1^0 of the controlled variable x_1 (the primary variable in case of cascade control) is determined when production of a new paper grade is initiated. A reference value may be contained in or calculated from specifications supplied by the production supervising program. During on-grade production the reference value should be constant. However, for several variables it may be modified at the request of the machine tender or automatically as a consequence of changed process conditions.

A case in point is the setting of reference values before switching from manual to computer control. In such a case a smooth transition is desired. The reference value x_1^0 of the controlled variable is therefore set equal to the actual value x_1 , as long as a loop is on the manual control mode.

Control Correction

Adjustments Δu of the manipulated variable and, for cascade control, adjustments Δx_2^0 of the reference value of a secondary variable are calculated at regular time intervals according to suitable control laws which take into account the dynamic characteristics of the controlled process. The interval τ_a between consecutive adjustments is chosen mainly with regard to process dynamics and frequency of disturbances, and it ranges between 36 seconds and 6 minutes.

Different approaches have been used to determine control laws for the different loops and sub-loops. Process identification methods were used if insufficient process characteristics were known. Process knowledge and common sense were used in most cases, however.

The form of control law is different for each loop, but some generalizations can be made.

- (a) - for processes with fast response times, considerably smaller than the adjustment interval τ_a , a simple integral action is suitable

$$\Delta u(t) = c e(t)$$

where $e(t) = x(t) - x^0$

- (b) - for processes (approximately first order) with a time constant of the same order of magnitude as the adjustment interval, but with negligible time-delay (dead-time), a P + I control action is suitable

$$\Delta u(t) = \underbrace{k_1 e(t)}_{\text{I term}} + \underbrace{k_2 [x(t) - x(t - \tau_a)]}_{\text{P term}} = c_1 [e(t) + c_2 e(t - \tau_a)]$$

- (c) - for processes (approximately first order) with time-delay of the same order of magnitude as the adjustment interval or longer, the latent influence of previous adjustments must be taken into account. The number of previous adjustments to be introduced in the control equation is the same as the time-delay expressed in number of adjustment intervals. The control law appears as follows:

$$\Delta u(t) = c_1 [e(t) + c_2 e(t - \tau_a)]$$

$$+ c_3 \Delta u(t - \tau_a) + c_4 \Delta u(t - 2\tau_a) + \dots$$

Parameter c_1 can be a function of reference values of other loops, thus adapting the control action to changing process conditions.

- The calculated adjustment Δu is usually compared with a maximum limit; if larger, only an adjustment equal to the limit is executed.

The Principal Control Loops

We shall now examine the most significant control loops in greater detail.

Control of Basis Weight

Readings of on-line basis weight and moisture gauges are filtered (exponential smoothing) and used to estimate the actual basis weight of the dry paper. The reference value is supplied by production supervising programs but may be modified by the machine tender. Control action is taken on the set-point of the controller of thick stock flow. The control law is of type (c) mentioned on page 11.

The conversion function for basis weight is calibrated approximately every hour at the completion of each reel with reference to measurements of reel weight, paper width and length.

Control of Moisture Content

There are two alternatives: analog or digital control.

Analog control is accomplished by an analog controller connected to the moisture gauge which governs the set-point of the steam-pressure controller in the last drying section. This is a typical case of cascade control.

For digital control, the set-point of the steam-pressure controller is governed by the computer instead. Readings from the moisture gauge are filtered (exponential smoothing) and used to estimate the actual value. The reference value is supplied by the production supervising program but may be modified by the machine tender. The control law is of type (c) mentioned on page 11.

Control of steam pressures for drying sections 1, 2, and 3 and for the felt drier can be considered as a complement to moisture control via the last drying section. Reference values for these pressures are given by the production supervising program but are automatically changed if necessary to keep the pressure in the last section within limits suitable for control. Changes are executed with respect to certain constraints (pressure differences between sections and top limits) and to a suitable temperature gradient along the machine.

Control of Level in the Headbox

Since the headbox is of the open type the level in the box determines the speed of the thin stock at the slice. The level must be kept constant to ensure a given difference in speed between the stock at the slice and on the wire. This difference influences web formation and thus the tensile strength properties. The reference value for headbox level is calculated from the desired value of the speed difference which is entered by the machine tender. Control action is taken on the set-point of an analog level-controller. The control law is of the simple type (a) mentioned on page 11.

Control of the Degree of Refining

Specific refining energy is used as a measure of the degree of refining. This is calculated as the ratio between the power input to the refiners and the fiber flow through the refiners. The latter is calculated from the stock flow and consistency. The reference value for the specific refining energy which is supplied by the production supervising program can either be modified manually by the machine tender or automatically from an external feedback control loop taking into account the vacuum at the couch roll. The deviation of the calculated specific energy from the reference value is used to adjust the desired value of the total refining power. This is then distributed among the individual refiners (there are 10 refiners arranged in three parallel lines). Power input is measured for the individual refiners and corrective action is taken directly on the refiners plugs by means of electrical positioning motors.

Thick Stock Consistency Control

Consistency is controlled at three different points: before refining, before the machine chest, and after the machine chest. The consistencies at the first and the third points are controlled by analog controllers supervised by the computer, while at the second point the consistency is controlled digitally via the set-point of an analog flow controller for dilution water. The reference values for the three points are adapted to process conditions, i.e. they are modified when positions of control valves are outside suitable operating ranges. Control laws are of type (a) on page 11.

The consistency before the refiners is calculated from consistency-sensor readings using a conversion function which includes a calibration constant periodically updated by means of material balance calculations. Consistencies at the second and third points are merely calculated from material balances.

Control of Level in the Machine Chest

The reference value of the level is a constant. The control law is of type (b) mentioned on page 11 and it is used to calculate the desired value of the total thick stock flow through the refiners. From the desired total flow, the desired partial flow in each of the three refiner lines is calculated taking into account the number of refiners in operation. The final control action is taken on the set-point of the analog controllers for the three partial flows.

Control of Additives and pH

The addition of alum, rosin and sulphuric acid is controlled digitally by means of volumetric pumps with variable stroke lengths. The rate at which rosin and alum are added is proportional to the fiber flow, and the reference values are set by the production supervising program. The flow of sulphuric acid is controlled by pH feedback.

Grade Change Control

Reference values for process variables for different grades are stored in a reference table. Twenty minutes before a grade change, the production supervising program, on the basis of the data in the table, determines new reference values for machine speed, basis weight, moisture content, steam pressures, percentage of chemical additives and specific refining energy.

The most important of the new grade specifications are printed out for the machine tender. If he acknowledges the new grade, the production supervising program calculates the starting time for the grade change. The change is initiated in the stock preparation area. The refining power and the additive flow are changed about ten minutes (time lag between refiners and paper machine) before changes are initiated on the paper machine. When the previous grade is completed, execution of normal routines for closed-loop control of basis weight, moisture content, headbox level and others are temporarily inhibited. The grade change program first calculates the new reference values of process variables not supplied by the supervising program. These include fiber flow (bone dry) thick stock flow, thick stock consistency and headbox level. A schedule for the change of the different variables is then prepared taking the amplitude and sign of the changes into account. Execution of the changes is then initiated according to the schedule. Variables are read during execution of the change to check that they follow the planned trajectories. When the new target values of the changed variables are reached, normal on-grade control programs are re-activated.

Paper Breaks

A paper break is detected immediately by photoelectric detectors distributed along the paper machine, and the execution of an emergency routine is initiated. Steam pressures in the drier cylinders are lowered,

and programs for control of basis weight and moisture content are temporarily inhibited. Other control loops continue in the normal way. When the paper web is restored, steam pressures in the various sections are automatically brought back to pre-break levels and normal control programs for basis weight and moisture content are re-activated.

CONCLUSIONS THUS FAR

The steady state control systems and part of the programming were completed prior to the installation of the computer. On-line, post-installation program tests frequently showed that the system designs worked well if normal conditions prevailed throughout the process; however they were inadequate when certain variables went outside the common operating ranges or some of the instruments failed to function properly. As a result, control strategies and instrument ranges had to be modified to deal with exceptional cases. Numerous modifications were necessary due to the vast number of possible combinations of unfavourable circumstances. Moreover, it should be noted that some program errors show up only when certain conditions are present and are therefore very difficult to trace and correct.

The instrumentation caused some trouble, particularly the logic circuits connected to break detectors. These circuits and the paper-break programs had to be altered to obtain greater reliability.

While the program tests were under way, data was collected to determine suitable reference values for the process variables for each paper grade. In addition, extensive investigations to identify process characteristics and to ascertain optimal control laws were carried out.

Data was logged during manual grade changes in order to develop a strategy for automatic grade changes. This data provided additional knowledge of process dynamics. The control strategy that has been developed, however, is not based on a mathematical model of the wet end of the paper machine. Instead, a simpler approach was possible because the retention on the wire is high and furnish requirements for the different grades are quite similar. When testing the control strategy, grade changes were made slowly at the beginning, but the rate of change has been successively increased.

At the time this paper is published, we can affirm that control objectives have, for the most part, been achieved. The process is under computer control during (a) normal production, (b) grade changes and (c) paper breaks. The next step is to further reduce the time required for grade changes, a step that we believe is feasible.

Accomplishing the above objectives is just a start toward the final goal, the optimal operation of the papermaking process. In other words we must find the optimal operating standards, i.e. the values of key process variables which, for each grade of paper, yield optimum quality and production rate. Thorough studies will be necessary, but Billerud has at its disposal a very powerful tool to achieve the goal: a computer able to control process conditions and to collect data.

The training and re-education of the machine tenders and crews was a very important aspect of the Billerud/IBM project. Personnel working on the machines were thoroughly informed about all phases of the project, and considerable time was spent on the machine floor giving instructions that would lead to full utilization of the facilities available for intercommunication between personnel and computer. It should be mentioned that we acquired new attitudes toward the intercommunication problem as time passed. At the outset, it was expected that these exchanges would be very limited; when the system configuration was decided upon it was thought that a binary switch unit, a printer and some indicator lamps would suffice. However, experience showed that there is a need for frequent personnel/computer intercommunication, and that it would be facilitated by a more extensive machine tender console. However, since this problem is not crucial, we have temporarily postponed its solution; the machine tenders have had no difficulty in learning to use the binary switch unit to enter data or to request print-out. Thus far, acceptance of the integrated system has exceeded expectations. "I thought it would be more difficult", was typical of the machine tender's comments.

INTEGRATED COMPUTER CONTROL OF A PAPER MACHINE
Quality Control

O. Tveit K.J. Åström
IBM IBM

SYNOPSIS

The integrated system is subdivided into five systems -- production planning, production supervising, process control, quality control and reporting. This report deals with quality control and presents the system for sampling and testing and the mathematical models used to describe the variations in quality variables. The design of estimators, predictors and interpolators using Kalman's method is discussed. In conclusion, the implementation of the quality control system including its various programs is presented.

TP 18.171
Technical Paper
15 October 1966
IBM NORDIC LABORATORY
LIDINGÖ, SWEDEN

table of contents

Introduction	1
Sampling and Testing	5
Mathematical Models Describing Variations in Quality Variables.	8
Mathematical Models	9
Example	10
Optimal Estimators, Predictors and Interpolators	12
Prediction of Quality Variables	12
The Sorting Problem - Cross-Direction Stretch Interpolation.	14
Implementation of the Quality Control System.	17
Survey of the Computer Programs for Quality Control.	20
Program for Testing and Sorting Quality Test Data.	22
Program for Computation of Reel-Sample Test Data	23
Programs for Computation of Winder-Sample Test Data and Sorting	23
Program for Manual Sorting	24
Program for Overriding the Sorting	25
References	26

INTRODUCTION

Quality control shall determine whether the product is within the given specification and whether it must be rejected. It should also indicate how to change the operating conditions in order to bring the product within the specification. This report presents a brief description of the quality control programs and their underlying theory. In kraft paper mills a large number of off-line measurements are used for quality control. For the most part, quality is evaluated from:

- basis weight
- moisture content
- tensile strength
- stretch (elongation)
- tensile energy absorption

Basis weight and moisture content are measured continuously, but the other variables are measured from samples taken at discrete times. This quality control presentation is limited to quantities that are measured discretely. The other quantities are discussed in the report on process control [9] [18]. This division is rather arbitrary, and it is justified mainly from a systems point of view because different data-processing techniques are used for discrete and continuous measurements.

Current estimates of the cross-direction stretch of flat kraft paper have been obtained that are up to 3 times more accurate than those previously obtained by using a single measurement [13], and we can produce predictions 30-90 minutes ahead that are as accurate as a single measurement. This depends on the statistical character of the fluctuations in quality variables. Statistical properties of fluctuations in quality variables and measurement errors have been investigated [6][7][10][14]. It has been found that there is considerable correlation between the values of cross-direction stretch in successive sets [6][8]. (A set is defined as all of the rolls slit side-by-side from a single length of full-machine-width reel paper.) By making use of this fact we can improve upon the estimate of cross-direction stretch in one roll by using measurements from neighboring rolls.

To do this systematically we have used filtering theory [2], [8], [12]. There are two basic problems:

- to predict quality variables during production (prediction problem)
- to obtain the best possible estimate of quality variables in a collection of produced rolls (interpolation problem).

The prediction problem must be solved to provide the machine tender with a sound estimate of the quality of rolls currently being produced. Prediction is required to compensate for measurement delay. The interpolation problem is of interest in connection with the sorting in order to evaluate whether or not the quality of a produced roll satisfies the given specification. We have constructed many predictors and interpolators using filtering theory. The results have been tested against special laboratory experiments, and the applicability of filtering theory has been verified [6][7].

This report is divided into four sections:

Section 1, "Sampling and Testing" presents the system for sampling and testing and indicates the improvements obtained by using the computer system.

Section 2, "Mathematical Model Describing Variations in Quantity Variables", presents the results of statistical analyses of the variations in cross-direction stretch based on the average data of many customers' orders for one grade of paper. Also presented is a technique used to obtain the mathematical model for the fluctuations in cross-direction stretch. The fluctuations are described as stationary time series, and the measurement errors are expressed as independent random variables with normal amplitude distribution.

Section 3, "Optimal Estimators, Predictors and Interpolators", presents the optimal filter, interpolators and predictors, all based on the mathematical models in Section 2. When the mathematical models for the vari-

ations are known, the design of the estimators, interpolators and predictors is a straight forward application of Kalman's theory [12].

Section 4, "Implementation of the Quality Control System", explains how the quality control functions are implemented on the IBM 1710 Control System controlling a kraft paper machine in the Billerud Mill at Gruvön, Sweden.

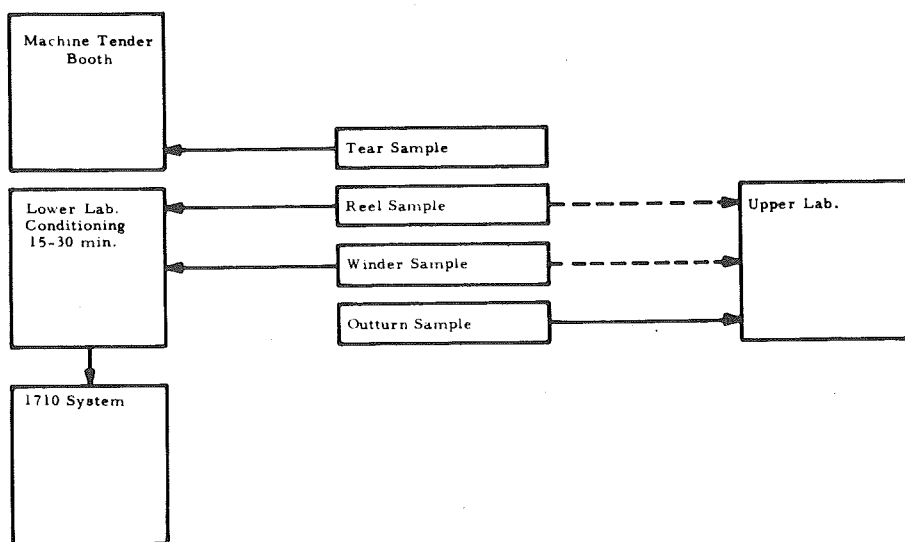

Fig. 1 INFORMATION FLOW

All quality data is introduced into the 1710 system via a manual entry unit in the lower laboratory. The continuous lines indicate the routine flow. The dashed lines indicate that samples are occasionally sent along these paths.

SAMPLING AND TESTING

This section presents the sampling and testing procedure. Fig. 1 shows the different samples, the laboratories where the samples are measured and the information flow. Samples for measurement of quality variables are taken from:

- the edge of the running web (tear sample)
- the end of the reel (reel sample)
- the end of each set (winder sample)

See references [13][18]. The samples taken from the running web are used by the machine tender to obtain a quick indication of the paper quality during normal operation and transient stages. The reel sample taken at the end of the reel is only obtained at reel changes. Since it takes about 30-90 minutes to produce a reel, these measurements may be considerably delayed. When a reel is completed it is moved to the winder and cut into rolls. The winder samples are taken at the end of each set at fixed positions. These samples are delayed more than the reel samples. The outturn sample is taken from representative rolls of each grade and sent to the customer together with the order.

Samples may be measured at:

- the machine tender's booth
- the upper and lower laboratories

There are two essential difficulties with the discrete quality-variable measurements:

- they are usually inaccurate
- the measurement procedure takes considerable time. A reel has to be completed before samples can be taken. The samples must be conditioned, i. e. kept in a room with specified temperature and humidity for about 15-30 minutes before measurements are taken.

Information obtained from the measurement of quality variables is used:

- by the machine tender
- for sorting
- for daily rejection reports
- for quality reports

There are two main reasons for using a digital computer for quality control:

- to simplify the administration of data
- to get more accurate quality estimates of quality variables by efficient data processing.

As stated above, virtually the same data is used for several different purposes. Moreover, several different reports are prepared on the basis of the quality measurements. Since all data is centrally stored, specialized reports are easily obtained. Quality data trends based on statistical analysis are especially easy to obtain.

By combining the existing measurement procedure with digital filtering

By combining the existing measurement procedure with digital filtering techniques it is possible to obtain better predictions and interpolations from the same measured data.

MATHEMATICAL MODELS DESCRIBING VARIATIONS IN QUALITY VARIABLES

Variations in quality have been observed during the normal operation of a kraft paper machine [6] [7] [8] [10]. They stem from many different sources: pulp properties, paper-machine irregularities (the wire for example), disturbances introduced by the machine tender, etc. We have found that these variations can be conveniently described using statistical methods. First order probability density functions and second order statistics of the variations have been computed. We have found that the variations observed during normal operation can be described as stationary random processes with a super-imposed drift. The statistical properties depend on the particular paper grade. Different quality variables, cross-direction stretch and cross-direction strength have been investigated for flat kraft paper, wet strength paper and Extensa. The analyses have mostly been based on a year's production of the respective paper grades.

The covariance function of cross-direction stretch shown in Fig. 2 is typical of the results obtained. For further details about the statistical properties of other quality variables we refer to [8] in which complete results for all quality variables are given.

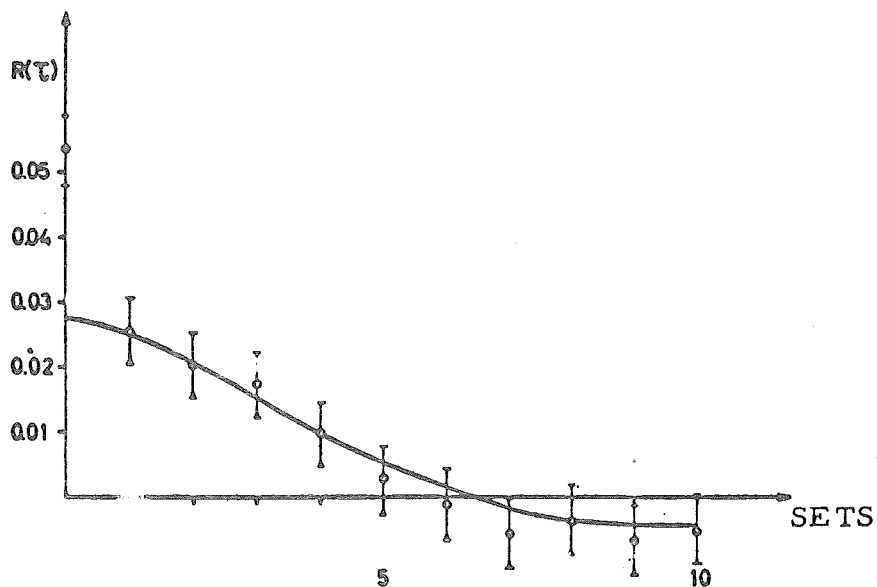

Fig. 2 COVARIANCE FUNCTION of CROSS-DIRECTION STRETCH FLUCTUATIONS

One X-axis represents the time required to produce on set (about 20 minutes). The continuous line shows the covariance function of a model of type 1 fitted to the data by using our identification programs.

Mathematical Models

In a typical case the fluctuations in quality from roll to roll can be represented as follows:

$$x(t+1) = \Phi' x(t) + e(t)$$

$$y(t) = \theta' x(t) + v(t) \tag{1}$$

where x is a $n \times 1$ vector, y a scalar, $\{e(t)\}$ a sequence of equally-distributed independent random vectors, and $\{v(t)\}$ a sequence of independent random variables. The scalar $\theta' x(t)$ can represent the mean cross-direction stretch of the roll completed at time t . $v(t)$ is the measurement error and $y(t)$ is the measured value of cross-direction stretch. The time unit is the time required to produce one set (an average of 20 minutes).

We have found that in many cases the fluctuations can be described as autoregressions with independent measurement errors, i. e.

$$\Phi' = \begin{bmatrix} 0 & 1 & 0 & \dots & 0 \\ 0 & 0 & 1 & & 0 \\ 0 & 0 & 0 & & 1 \\ \vdots & & & & \\ a_n & & a_{n-1} & & a_1 \end{bmatrix} \quad (2)$$

$$\text{cov} [e(t), e(t)] = \text{diag.} [0, 0, \dots, 0, \sigma^2] \quad (3)$$

To be able to use Kalman's results on digital filtering [3] we must have a method to determine such models from plant data. Such an identification method has been developed [1], [2], [3], [4], [5]. The identification technique is based on the fact that the covariance function of a process generated by the model (1) satisfies the equation

$$r(t) + a_1 r(t-1) + \dots + a_n r(t-n) = 0 \quad (4)$$

Furthermore, the condition that $r(t)$ is a positive definite function yields additional constraints on the initial values of $r(t)$. In the identification procedure we fit a function $r(t)$ satisfying (1) with additional constraint so that the least squares deviation between $r(t)$ and the sample covariance function is as small as possible. From the coefficients obtained we can then compute the coefficient of the model [1], [3], [16].

Example

We quote a typical result taken from reference [6]. To the covariance function shown in Fig. 2, denoted by circles, we fit a model of type (1) using the identification method. We found that a second order model was satisfactory. (The identification scheme operates sequentially in the order of the system until the value of the loss function is not decreased significantly). The following numerical values were obtained:

$$\begin{aligned}
 z(t) &= 1.556 z(t-1) - 0.678 z(t-2); & t \geq 3 \\
 z(0) &= 0.0278, z(1) = 0.0258
 \end{aligned}$$

This leads to a model of type (1) with

$$\Phi = \begin{bmatrix} 0 & 1 \\ -0.678 & 1.556 \end{bmatrix}$$

$$\theta = [1, 0]$$

$$\text{cov.}(e(t), e(t)) = \begin{bmatrix} 0 & 0 \\ 0 & 0.0021 \end{bmatrix}$$

$$\text{cov.}(v(t), v(t)) = [0.0260]$$

See reference [6]. The covariance function of this model is shown as a continuous line in Fig. 2.

OPTIMAL ESTIMATORS, PREDICTORS and INTERPOLATORS

Filtering theory has many applications in connection with quality control [2], [3]. In this section we shall discuss some applications of the prediction and interpolation of quality variables.

The mathematical models described in the previous section are a convenient way to describe the statistical character of the fluctuations in quality from one roll to another. Once the mathematical models are known, the design of estimators, predictors and interpolators is a straight-forward application of digital filtering theory.

Prediction of Quality Variables

It is important for the machine tender to know the quality of the paper currently produced. He gets information about this from the tear samples which he analyzes himself and also from the reel samples via the lower laboratory and the 1710 system. See Fig. 1. Tear sample measurements are rather inaccurate. The samples are not conditioned and are taken only from the edge of the web. Measurements made in the lower laboratory are more accurate. However, the results of these measurements are considerably delayed, as mentioned in section 2. To provide the machine tender with accurate information, it is natural to evaluate the best estimates of the actual values of quality variables on the basis of all measurements obtained. In other words we have to solve the following problem:

Given a set of measurements $y(0), \dots, y(t-k)$ find the "best" prediction of the cross-direction stretch at time t , where k is the measurement delay. The solution to this problem given by Kalman [2] is particularly well suited to our purposes since the estimate is obtained recursively as the measurements are obtained. Since the mean value of cross-direction stretch is not known, we must include it as an extra state variable $x_{n+1}(t)$.

Let x denote the augmented state vector

$$x = \text{col}[x_1, x_2, \dots, x_{n+1}]$$

and

$$\Phi = \begin{bmatrix} \Phi' & 0 \\ -\frac{\Phi'}{0} & -\frac{0}{1} \end{bmatrix}, \quad = [\theta', 0]$$

Applying Kalman's formulas we get the following equations for calculating the estimate

$$\begin{aligned} \hat{x}(t+1|t+1) &= \Phi \hat{x}(t|t) + K(t) [y(t+1) - \theta \Phi \hat{x}(t|t)] \\ \hat{x}(0|0) &= m \end{aligned} \quad (5)$$

$$\hat{x}(t+k|t) = \Phi^k \hat{x}(t|t) \quad k = 1, 2, \dots \quad (6)$$

where $\hat{x}(t+k|t)$ is the minimum mean square prediction of $x(t+k)$ based on the observation $y(1), \dots, y(t)$. The vectors $K(t)$ are filter gains which can be computed from the mathematical model of the process [1].

In the equation (5) the term $\Phi \hat{x}(t|t)$ represents the a priori estimate based on previous measurements and the term $y(t+1) - \theta \Phi \hat{x}(t|t)$ represents the correction to the a priori estimate based on the most recent measurement. The term $y(t+1) - \theta \Phi \hat{x}(t|t)$ is thus the difference between the measurement at time $t+1$ and the a priori estimate of this measurement. The filter gains $K(t)$ express the weighting between the last measurement and the a priori estimate. The recursive equation (5) is conveniently programmed into the real-time algorithm of the quality control programs. An example of cross-direction stretch prediction is shown in Fig. 3.

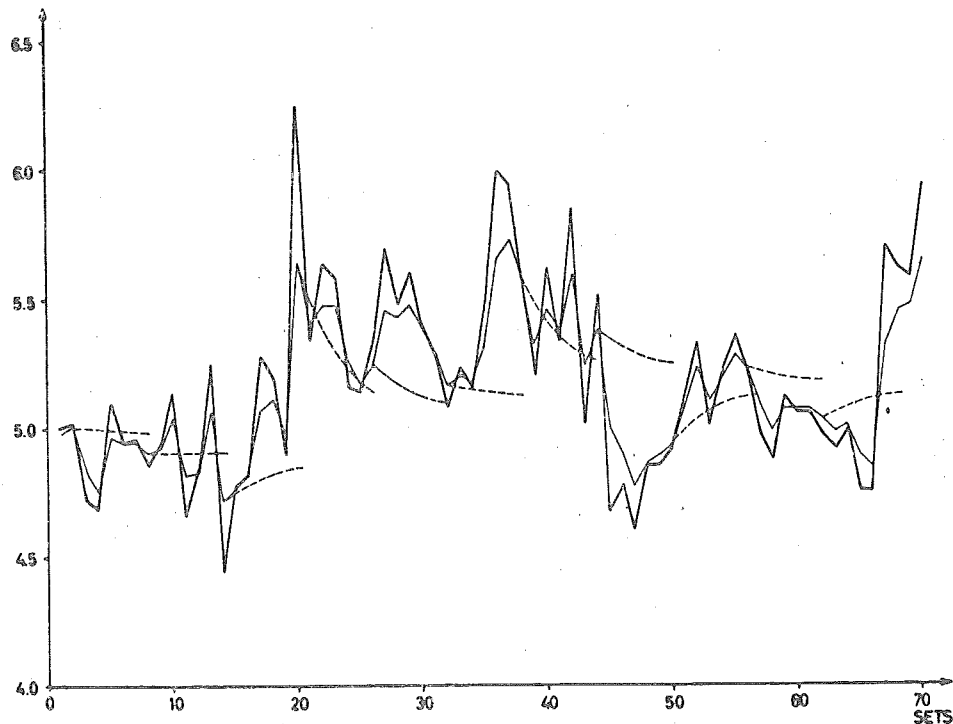

Fig. 3 CROSS-DIRECTION STRETCH PREDICTION

This diagram illustrates the prediction of cross-direction stretch. The continuous thick lines show the measured values of cross-direction stretch obtained using the normal measurement procedure. The continuous thin lines show the estimate $x(t|t)$ produced by the computer. The standard deviation of these estimates is 0.1%. The dashed lines show predictions $x(t+h|t)$. The predictors are designed from the data in the example. See also reference [6].

The Sorting Problem - Cross-Direction Stretch Interpolation

When an order is manufactured, the quality control department has to decide whether the individual rolls comprising it are within the customers' specification. If not, the bad rolls have to be sorted out and new ones manufactured. In a kraft paper mill the sorting is based largely on measurements of basis weight, cross-direction tensile strength, and cross-direction

stretch. As mentioned previously, measurements of quality variables are very inaccurate. Moreover, the cross-direction stretch of neighbouring rolls is very inter-dependent. We can expect to get estimates which are considerably better than individual measurements if the estimates are based on measurements of all the rolls comprising the order. The following problem must be solved in order to optimize measurement utilization.

We are given measurements $y(1), y(2), \dots, y(n)$ of a quality variable for N successive rolls in an order. Find the best estimate of the values of quality variables of each individual roll.

Let m be the prior estimate of $y(t)$ and R_0 the covariance of m . This data is mostly obtained from statistical data on the same grade. It can be shown that the maximum likelihood estimate $\hat{x}(t | n)$ of $x(t)$ based on measurements of all rolls $y(1), \dots, y(n)$ is given by the equations.

$$\hat{x}(t+1 | N) = \phi \hat{x}(t | N) + R_1 \lambda(t+1) \quad t = 1, 2, \dots, N-1$$

$$\lambda(t) = \phi^T \lambda(t+1) + \theta^T R_2^{-1} [y(t) - \theta \hat{x}(t | N)] \quad t = 2, 3, \dots, N-1 \quad (7)$$

These difference equations have the boundary conditions

$$\phi^T \lambda(2) = R_0^{-1} [\hat{x}(1 | N) - m] - \theta^T R_2^{-1} [y(1) - \theta \hat{x}(1 | N)]$$

$$\lambda(N) = \theta^T R_2^{-1} [y(N) - \theta \hat{x}(N | N)] \quad (8)$$

To determine the maximum likelihood estimate, we have to solve a boundary value problem for the difference equations (7). As the equations are linear, the problem can be solved in a straight-forward way by matching the initial conditions. Notice, however, that if the filtering problem is solved, we know $\hat{x}(N | N)$, and $\lambda(N)$ is then given by the boundary condition (8). If the filtering problem is solved, the interpolation problem is thus reduced to an initial value problem for the above equation (7).

This procedure has one disadvantage. The homogeneous part of

equation (7) is unstable, and we will have numerical difficulties if the solution has to be calculated for a large number of steps. For a few steps the method works very well.

For all cases encountered in the Billerud application it has been possible to solve the interpolation problem using backward integration. An example of the interpolation is illustrated in Fig. 4. In the next section we show how the interpolation is incorporated into the integrated system.

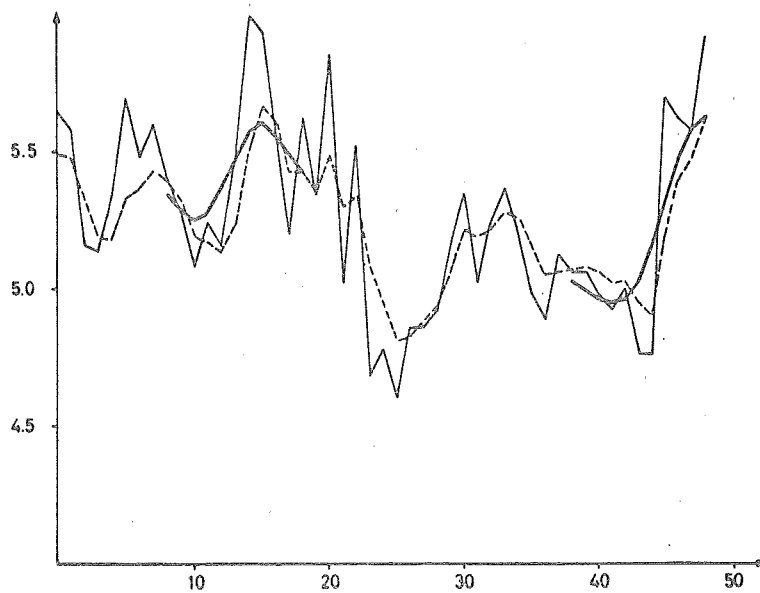

Fig. 4 INTERPOLATION EXAMPLE

This diagram shows the results of the application of the interpolation algorithm to cross-direction stretch interpolation. The measured values are indicated by the continuous thick line, the estimated values by the dashed line and the interpolated values by the continuous thin line. The interpolator is based on the data given in the example. See reference [8].

IMPLEMENTATION OF THE QUALITY CONTROL SYSTEM

In this section we shall describe how the quality control functions are implemented on the IBM Computer Control System installed at the Billerud Mill. A brief description of the different functions and the information flow of the system will be followed by a more detailed description of how they are implemented on the computer system as a number of computer programs.

Layout and Information Flow of the Quality Control System

The layout of the quality-control part of the integrated control system at Billerud is shown in Fig. 5. The interrelations between quality control and the other parts of the integrated system are discussed [11]. Production supervising and quality control are executed by the computer system.

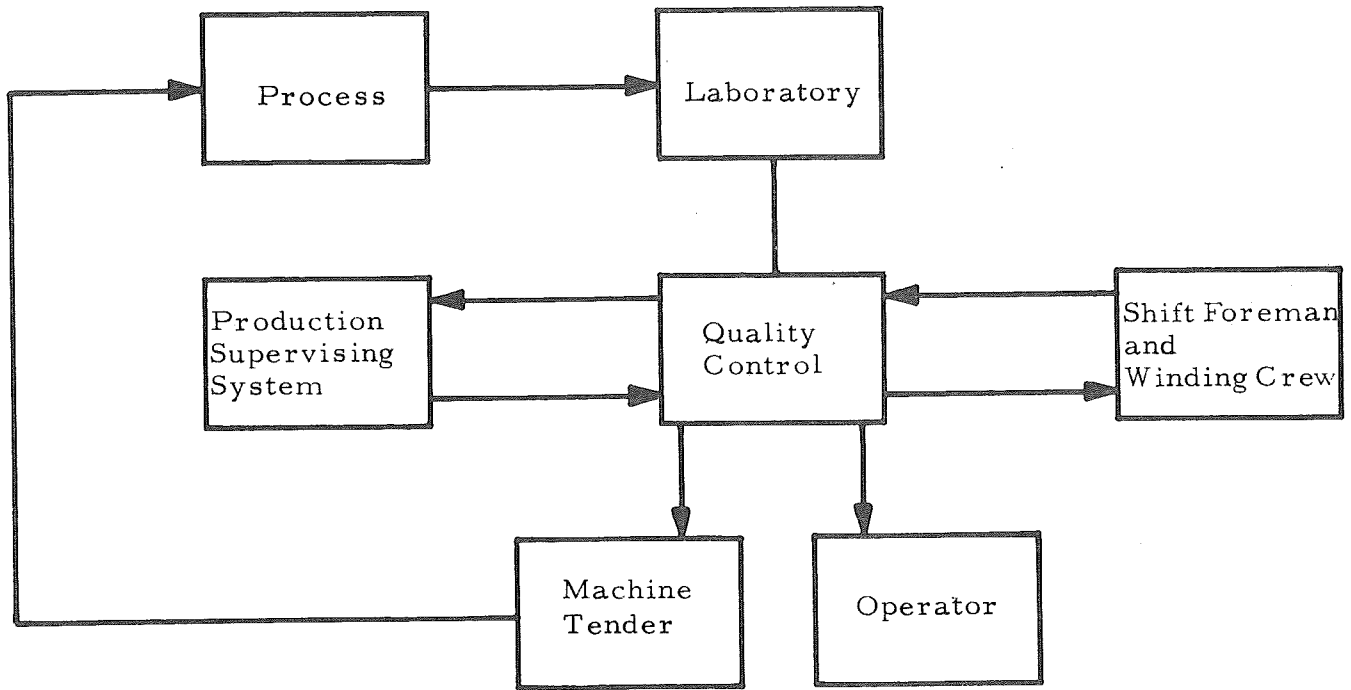

Fig. 5 THE LAYOUT AND INFORMATION FLOW OF THE QUALITY CONTROL SYSTEM

The block labelled process includes both the paper machine and the winder. As mentioned previously in the "Sampling and Testing" section, samples are taken at the end of the reel (reel samples) and at the end of each roll-set (winder samples). The samples are sent to the laboratory where quality test data is obtained. This data is then fed into the computer system via a manual entry unit located in the laboratory. Quality control has two functions: (a) to issue information to the machine tender that will help him control the paper machine; (b) to determine whether the produced paper is within the given specification and can be delivered to the customer or whether it must be rejected.

The first function is based mainly on test data from reel samples. Information about important quality data is printed out to the machine tender when all the reel-sample test data has been fed in.

The second function, sorting, is based mainly on test data from winder samples. Two options are included in the system.

The sorting can be done either in manual or in automatic mode. In the manual mode the estimated values are printed out to the shift foreman, who has to determine whether the paper is within the given specification. When the shift foreman wants to reject a roll he enters this information via the manual entry unit. In the automatic mode, the computer checks whether all variables are within the customer's specification.

Information about rejected rolls is printed out to the winding crew. The shift foreman can override previous automatic or manual sorting.

The estimation and prediction techniques described in the previous section are used to give the machine tender the best estimate of current values of quality variables and to get a more correct base for sorting.

All collected quality data and information about sorting are disk-stored. This data is administered by the production supervising system. The stored data may subsequently be transferred to cards for further processing on other computer systems if the operator so requests.

Survey of the Computer Programs for Quality Control

All programs for quality control are initiated by pressing an execute button on the manual entry unit located in the laboratory. An interrupt program is then called which may subsequently call other programs, mostly interrupt programs of high priority. However, in some cases, when the execution time for the programs is more than 1-2 seconds, even programs of lower priority (high-level main-line programs) are called. Fig. 6 shows an overall picture of the programs.

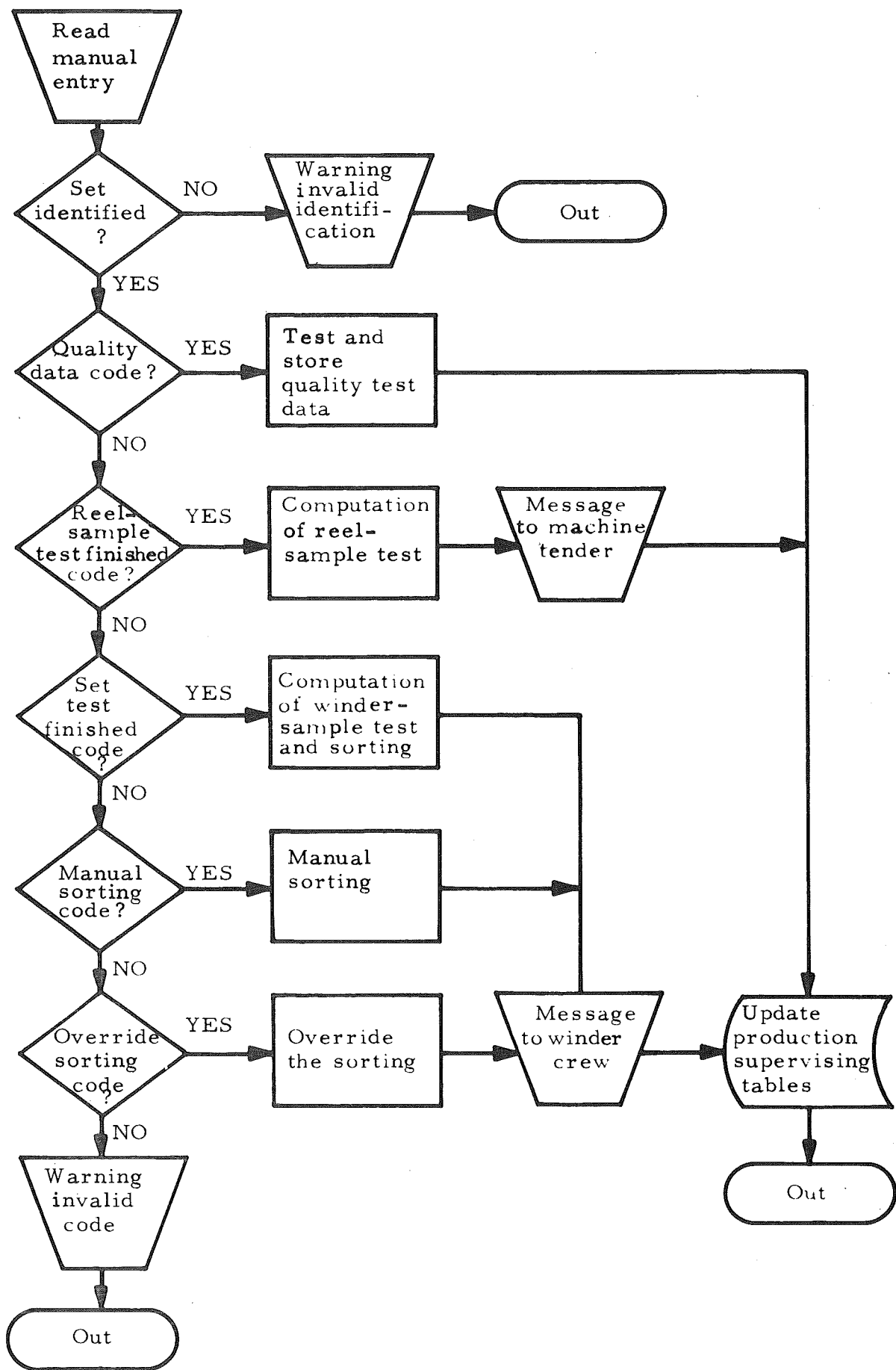

Fig. 6 FLOWCHART OF QUALITY CONTROL SYSTEM

The program called first starts reading the twelve ten-position rotary switches on the manual entry unit. The first six switches are used for identifying the roll-set from which the test sample is taken. The next two switches are for a code indicating the type of measurement or, in some cases, for giving a special command. The last four switches are usually for the entered test data. The entered identification is checked against the identification of the previously produced roll-set. If the identification is incorrect the enter light on the manual entry unit is turned on to warn the operator. He is then supposed to check the positions of all the switches and correct the faulty one. If the second check reveals that the identification is still incorrect, he will also be issued a printed message. The procedure used for checking the positions of the other switches is almost the same, and will be described later. The two digit codes will then be tested. Various programs may now be called in (see Fig. 6). If an invalid code is used, the operator will be warned as described above.

Fig. 6 shows clearly that certain programs print out messages either to the machine tender or to the winder crew (or shift foreman) and that all programs update the disk-stored production supervising tables. These functions are included in the various called programs.

Program for Testing and Sorting Quality Test Data

The entered test data is checked against certain established high and low limits. If the entered data violates any of these limits the operator is warned by the enter light as described above. Should the data still violate the limits when the data is entered the second time, the enter light is turned on again and a message is printed out giving the entered variable. However, the data is now accepted, except in cases involving an invalid identification or code. The entered test data is stored in the production supervising table.

Program for Computation of Reel-Sample Test Data

As mentioned earlier, the essential purpose of the program for computation of reel-sample test data is to provide the machine tender with the appropriate quality test data to help him run the process properly. This program is called in by a special code when all reel-sample test data has been fed in on the manual entry unit. A flowchart is shown in Fig. 6. Stretch, tensile strength and tear strength in both the machine-direction and the cross-direction, the resistance of paper to the passage of air are first calculated from reel-sample test data. If any test data is missing, a warning message is printed out. (In Fig. 6 the calculation of only one variable is indicated).

Since cross-direction stretch is the most important quality variable on a kraft paper machine this variable is specially processed. First the best estimate of the actual value is calculated taking previous measurements into account (equation 5). This estimate is then used to predict the cross-direction stretch one reel ahead (equation 6).

Finally, the calculated quality data is printed out in the machine tender booth and disk-stored in the production supervising table.

Programs for Computation of Winder-Sample Test Data and Sorting

Sorting is based mainly on winder-sample test data. The programs which perform the necessary calculations are called in when all test data from the winder samples taken from a reel have been fed in on the manual entry unit. A special code is used to indicate this. At present only cross-direction stretch and tensile strength data are treated.

The estimate procedure which has been described in the "Optimal Estimators, Predictors and Interpolators" section is used to get a better estimate of the quality variable. The coefficients of the models and gain constants $K(t)$ in equation (5) for each grade are stored in the program. The values of stretch and tensile strength in the cross-direction are estimated for the

three points across the web where the winder samples were taken. The cross-direction profile is determined by interpolation. Finally, stretch and breaking length for each individual roll are determined.

A check is now made to see whether sorting is to be done in the automatic or manual mode. This is governed by a two-position switch in the machine tender booth. When the sorting is automatic, all quality variables are tested to see that they are within the customer's specification. Rejection is indicated for all rolls not within the specification. Information about rejected rolls, reason for rejection and estimated values of cross-direction stretch and breaking length for the rejected rolls is printed out to the winder crew or shift foreman.

When sorting is manual, the estimated quality values for all produced rolls are printed out to the shift foreman who decides whether or not the rolls have to be rejected.

Finally, the production supervising tables are updated with the estimated quality values and information about accepted and rejected rolls.

Program for Manual Sorting

This routine is used to inform the system about all rejection of rolls or sets when the sorting, as described above, is done in the manual mode. It also provides information about reasons for rejection other than cross-direction stretch and breaking length when sorting is automatic. Information about rejected rolls or sets is fed into the computer system via the manual entry unit. Various codes are used for the different rejection reasons. When individual rolls are rejected, the roll numbers are entered on the last four switches. If an invalid roll number is entered, the operator is warned by the enter light in the same way as described previously, for invalid set identification.

Finally, information about rejected rolls or sets^e is acknowledged by a printed message and the supervising tables are updated.

Program for Overriding the Sorting

The shift foreman has the option of overriding previous automatic or manual sorting, i. e. sets or rolls previously indicated as rejected may be indicated as accepted. A different code is used, but otherwise the routine is the same as that described above for manual sorting.

REFERENCES

- [1] Åström, K. J. and Wensmark, S., Numerical Identification of Stationary Time Series. I & M Special Section of Automatic Control. The Royal Swedish Academy of Engineering Sciences. Stockholm, 1964. Proceedings. pp. 19-40.
- [2] Åström, K. J., Control Problems in Paper Making. - IBM Scientific, Computing Symposium: Control Theory and Applications. New York, 1964.
- [3] Åström, K. J. and Wensmark, S., Experiment with an Artificial Time Series. IBM Nordic Laboratory, Sweden. April 20, 1965. (Report TP 18.146.)
- [4] Åström, K. J., Bohlin, T. and Wensmark, S. Automatic Construction of Linear Stochastic Dynamic Models for Stationary Industrial Process with Random Disturbances using Operating Records. IBM Nordic Laboratory, Sweden. June 1, 1965. (Report TP 18.150.)
- [5] Åström, K. J. and Bohlin, T., Numerical Identification of Linear Dynamic System from Normal Operating Records. - IFAC Symposium on the Theory of Self-Adaptive Control Systems Teddington, England. September, 1965. Proceedings.
- [6] Åström, K. J. and Tveit, O., Quality Control in Paper Mills. IBM Nordic Laboratory, Sweden. January 17, 1966. (Report TP 18.155.)
- [7] Åström, K. J., Wensmark, S. and Tveit, O., Quality Control at Billerud. IBM Nordic Laboratory, Sweden. January 25, 1966. (Report TR 18.138. IBM Confidential.)

- [8] Åström, K. J. and Tveit, O. , Integrated Computer Control of a Kraft Paper Mill, Quality Control, Designing and Implementing Estimators, Interpolators and Predictors for Quality Variables. IBM Nordic Laboratory, Sweden. May 1, 1966.(Report TP 18.166.)
- [9] Åström, K. J. and Wensmark, S. , Basis Weight Control of a Kraft Paper Machine at Billerud. IBM Nordic Laboratory, Sweden.
- [10] Blomqvist, N. and Pettersson, S. , Quality Control on a Paper Machine. EUCEPA IU Symposium - Statistical Methods in the Pulp and Paper Industry. Helsinki. May, 1960.
- [11] Ekström, Å., Integrated Computer Control of a Kraft Paper Machine. - Systems Summary. IBM Nordic Laboratory, Sweden.
(Report TP 18.169)
- [12] Kalman, R. E. , New Methods and Results in Linear Prediction and Filtering Theory, in Bogdanoff, J. L. and Kozin, F. editors. - Proceedings of the First Symposium on Engineering Applications of Random Function Theory and Probability. Wiley, New York. 1963.
- [13] Larsen, H. and Pettersson, S. , 1710-projektet - kvalitetskontroll vid PM4, Gruvön (Quality Control of PM4, Gruvön) - Billeruds AB Forskningslaboratoriet. Feb. 19, 1964 (in Swedish).
(Report 645e.)
- [14] Lashof, T. W. , Precision of Methods for Measuring Tensile Strength, Stretch and Tensile Energy Absorption of Paper. - TAPPI 46. (1963) pp. 52-59.

- [15] Tveit, O. , Integrated Computer Control of a Kraft Paper Mill.
- Quality Data Collection and Sorting. IBM Nordic Laboratory,
Sweden. May 15, 1966. (Report TR 18.161. IBM Confidential.)
- [16] Tveit, O. , Integrated Computer Control of a Kraft Paper Mill.
- Quality Data Analysis. IBM Nordic Laboratory, Sweden.
May 15, 1966.(Report TR 18.162. IBM Confidential.)
- [17] Tveit, O. , Integrated Computer Control of a Kraft Paper Mill.
- Sampling and Testing. IBM Nordic Laboratory, Sweden.
April 20, 1966. (Report TR 18.163. IBM Confidential.)
- [18] Wensmark, S. , Moisture Control of a Kraft Paper Machine at
Billerud. IBM Nordic Laboratory, Sweden.

INTEGRATED COMPUTER CONTROL OF A PAPER MACHINE

Control Strategy Design -- New Methods in Operation

K. J. Åström T. Bohlin
IBM IBM

SYNOPSIS

This report describes a method developed for the synthesis of computer algorithms for optimal steady state control of dynamic, industrial processes with unknown characteristics -- a procedure involving automated model construction. Also included is a discussion of how the method was applied to the construction of control laws for steady state control of basis weight, moisture content and refining on a paper machine.

TP 18.172
15 October 1966
IBM NORDIC LABORATORY
LIDINGÖ, SWEDEN

table of contents

Introduction 1

Mathematical Formulation and Solution of the Problem . . . 4

 Identification Problem 5

 Control Problem 5

Control of Basis Weight and Moisture Content.10

 Basis Weight Control10

 Moisture Content Control.18

Refining Control21

 Control Configuration.21

 Modelling22

 Control Law26

 Performance26

References29

INTRODUCTION

The fundamental control problem is to decide what actions have to be taken on the basis of the information obtained from the process instruments, i. e., to formulate the control laws. Most control loops in the Billerud system have been designed heuristically on the basis of knowledge about the process. In the few cases where such knowledge has not been available there were two possible approaches: to obtain the lacking knowledge from experiments on the process, or to install a standard controller (P, PI or PID) and adjust the control parameters until the system behaved satisfactorily. Both approaches have their particular advantages. The trial-and-error approach is often preferred especially for simple control problems. In many situations, however, it is not practical. This is particularly true when:

- Several parameters are required for optimal control.
- The process reacts slowly.
- The amount of disturbances acting on the process varies.

The first case above applies to situations in which the process has significant time delay, dynamics, disturbances and measurement errors. In order to compare performance at different settings in the last two cases, the results of each trial setting have to be evaluated over a very long test period. In the last case, it may never be possible to get enough samples at comparable disturbance levels to provide a "fair" comparison.

The alternative to empirical control parameter adjustment may be stated more explicitly as follows:

- Obtain a mathematical model of the process and its environment.
- Obtain a control law that is in some sense optimal for the model.

A large variety of theories and methods are available which differ essentially in the types of models used and in the technique for solving the control problem.

Considering the generality of many of the new theoretical results, and the fact that they are apparently based on realistic assumptions, it seems reasonable to use the new theories as a basis for a general synthesis method. This would then be applicable to a large class of industrial process control problems in which the trial-and-error method cannot be used.

The purpose of part of the activities of the IBM Nordic Laboratory in connection with the Billerud study has been to develop such a method. It was recognized that many theoretical methods are developed in the literature but that, so far, very few of the effective techniques have been applied in practice. We have thus devoted more effort to researching certain Billerud control problems than was necessary to solve the particular problems. The purpose of the investigations has in fact been twofold:

- To develop and test on practical control problems a synthesis method based on modern control theory.
- To solve the particular problems involved in steady state control of basis weight, moisture content and refining on the PM4.

The synthesis procedure developed includes the following steps:

1. Perturb the process during production, applying a sequence of pulse changes of varying lengths to the input variable and log the resulting output variable.
2. Feed the input/output record into an off-line computer to obtain the model (IBM 1401 has been adequate for the processes studied).
3. Repeat the procedure to check invariance of conditions and other assumptions on which the model structure was based.
4. Derive the minimum variance control law. (The rules for doing this are simple.)
5. Enter the control law into the control computer and test the performance of the on-line control in operation.

The theoretical basis is the linear stochastic control theory [1], [6] which is particularly well suited for steady state control of in-

dustrial processes [2]. This theory requires a mathematical model of the process and its disturbances. To construct such models from measurements taken directly on the process, a new identification method has been developed [3], [4]. This method is tailored to the linear stochastic control theory and is particularly suitable for situations where:

- The problem is to keep the process variables close to a fixed operating point.
- The process is dynamic with a possible time delay, but time-invariant.
- Disturbances are a main concern.
- The process cannot be shut down, and consequently has to be studied under normal operating conditions.

The results of the applications have been very satisfactory. Thus it has been demonstrated that the synthesis method based on linear stochastic control theory can be conveniently used to design control strategies for steady state control of basis weight, moisture content, and refining. In all cases we have considered the systems simply as input/output systems, and have not exploited the particular characteristics of the paper machine. We therefore believe that our technique is generally applicable to steady state control of industrial processes in which the basic assumptions are valid.

MATHEMATICAL FORMULATION AND SOLUTION OF THE PROBLEM

In this section we will give a mathematical formulation of the control problem, and briefly state the solution to the formulated problem.

Assume that the input/output relation can be described by the following mathematical model

$$y(t) + a_1 y(t-1) + \dots + a_n y(t-n) = b_0 u(t-k) + b_1 u(t-k-1) + \dots + b_n u(t-k-n) + \lambda [e(t) + c_1 e(t-1) + \dots + c_n e(t-n)] \quad (1)$$

where $y(t)$ are the output values and $u(t)$ the input values at time t , and where $\{e(t), t = 0, \pm 1, \pm 2, \dots\}$ is a sequence of independent normal $(0, 1)$ random variables. The sampling interval is chosen as the time unit. To write the above model in a more convenient form, we introduce the shift operator z defined by

$$zx(t) = x(t+1)$$

and the polynomials

$$\begin{aligned} A(z) &= 1 + a_1 z + \dots + a_n z^n \\ B(z) &= b_0 + b_1 z + \dots + b_n z^n \\ C(z) &= 1 + c_1 z + \dots + c_n z^n \end{aligned} \quad (2)$$

The equation (1) then becomes

$$A(z^{-1}) y(t) = B(z^{-1}) u(t-k) + \lambda C(z^{-1}) e(t) \quad (3)$$

This model implies that the output sequence is the sum of two sequences. One term

$$\{A^{-1}(z^{-1}) B(z^{-1}) u(t-k), t = 0, \pm 1, \pm 2, \dots\}$$

depends on the input. This corresponds to the solution of a general n th order differential equation sampled at equal intervals with a time delay that is an integer multiple of the sampling interval. The other term

$$\{A^{-1}(z^{-1})C(z^{-1})e(t), t = 0, \pm 1, \pm 2, \dots\}$$

defines a random process with rational power spectral density.

Assuming that the process and its environment can be described by a model of type (3), we have to solve two problems in order to arrive at the control law.

Identification Problem

Given a sequence $\{u(t)\}$ of input values and a corresponding sequence $\{y(t)\}$ of output values generated by a model of type (3), estimate the coefficients of the polynomials A , B and C and the parameters k and λ .

Control Problem

Given a model (3), find a control law, i. e. a function

$$u(t) = F [u(t-1), u(t-2), \dots, y(t), y(t-1), \dots]$$

such that the sequence of outputs $\{y(t)\}$ has minimum variance.

We will now give the solution of the problems that have been stated.

The solution of the identification problem has been documented elsewhere, [3], [4] and we will not go into any details of the procedure here. Let it suffice to say that the problem is solved by determining the maximum likelihood estimates of the parameters

$$\theta = \{a_1, a_2, \dots, a_n, b_0, b_1, \dots, b_n, c_1, c_2, \dots, c_n\}$$

in the model (3) based on the sequence of input/output pairs

$$\{u(t), y(t), t = 1, 2, \dots, N\}$$

It has been shown that maximizing the likelihood function is equivalent to minimizing the loss function

$$V(\theta) = \frac{1}{2} \sum_{t=1}^N \epsilon^2(t) \quad (4)$$

where $\epsilon(t)$ is the one-step ahead prediction error

$$\epsilon(t) = C^{-1}(z^{-1}) [A(z^{-1})y(t) - z^{-k}B(z^{-1})u(t)] \quad (5)$$

Hence the parameters of the model are determined in such a way that the mean-square, one-step ahead prediction error is as small as possible. Computer algorithms have been developed doing this. Let us also point out that provided the input/output data is generated by a model of type (3), it can be shown that under mild restrictions the estimates obtained will converge to the true parameters as the number N of observations increases. It can also be shown that for large values of N , there is no possible way of finding the parameters that will give estimates with a higher accuracy. Estimates of the parameter accuracies are obtained conveniently in each case.

The solution of the control problem is a straight forward application of linear stochastic control theory. For the model (1) a particularly simple derivation is available [5]. To solve this problem we introduce the identity

$$C(z) = A(z)E_{k-1}(z) + z^k F_{k-1}(z) \quad (6)$$

where $E_{k-1}(z)$ and $F_{k-1}(z)$ are the polynomials

$$E_{k-1}(z) = 1 + e_1 z + \dots + e_{k-1} z^{k-1}$$

$$F_{k-1}(z) = f_0 + f_1 z + \dots + f_{k-1} z^{k-1}$$

Using this identity we find, after some algebraic manipulations, the

minimum variance control law

$$u(t) = - \frac{E_{k-1}(z^{-1})}{B(z^{-1}) F_{k-1}(z^{-1})} y(t) \quad (10)$$

Notice that the k-steps ahead prediction error is

$$y(t) - \hat{y}(t | t - k) = \lambda [e(t) + e_1 e(t-1) + \dots + e_{k-1} e(t-k+1)] \quad (11)$$

where $\hat{y}(t | t - k)$ is the predicted value at time t based on observations up to and including time t-k. See [5].

The minimum mean square control law is thus obtained from the condition that the k-steps ahead prediction is equal to zero. The control error equals the k-steps ahead prediction error and is a moving average of order k. This observation gives a method to test an operating control loop to find if it is a minimum variance law.

The calculation of the minimum variance control law will be illustrated by an example:

Example

Consider the following model:

$$y(t) = 27.1 \frac{z^{-4}}{1-0.38z^{-1}} u(t) + \lambda \frac{1-0.62z^{-1}}{(1-z^{-1})(1-0.38z^{-1})} e(t)$$

The process dynamics are of first order with a time delay of four sampling intervals, and the environment is represented by a disturbance whose first time-difference is a stationary random process with the power spectral density

$$\Phi(w) = \lambda^2 \frac{1.38 - 1.24 \cos w}{1.14 - 0.76 \cos w} =$$

which is a rational function in $\cos w$.

We find

$$A(z) = 1 - 1.38z + 0.38z^2$$

$$B(z) = 27.1$$

$$C(z) = 1.062z$$

The identity (6) becomes

$$1 - 0.62z = (1 - 1.38z + 0.38z^2)(1 + e_1z + e_2z^2 + e_3z^3) + z^4(f_0 + f_1z)$$

Equating coefficients of the different powers of z we get

$$-0.62 = e_1 - 1.38$$

$$0 = 0.38 - 1.38e_1 + e_2$$

$$0 = 0.38e_1 - 1.38e_2 + e_3$$

$$0 = 0.38e_2 - 1.38e_3 + f_0$$

$$0 = 0.38e_3 + f_1$$

Hence

$$e_1 = 0.76$$

$$e_2 = 0.67$$

$$e_3 = 0.63$$

$$f_0 = 0.62$$

$$f_1 = -0.24$$

and the minimum variance control law becomes

$$\nabla u(t) = - \frac{F(z^{-1})}{B(z^{-1})E(z^{-1})} y(t) = - \frac{0.0229(1 - 0.38z^{-1})}{(1 + 0.76z^{-1} + 0.67z^{-2} + 0.63z^{-3})} y(t)$$

Writing this out fully we get

$$\begin{aligned} \nabla u(t) = & - 0.0229 [y(t) - 0.38y(t-1)] - 0.76 \nabla u(t-1) - 0.67 \nabla u(t-2) - \\ & - 0.63 \nabla u(t-3) \end{aligned}$$

The minimal variance of the output is

$$E y^2 = \lambda^2 [1 + e_1^2 + e_2^2 + e_3^2] = 2.24 \lambda^2$$

Hence, after solving the identification and control problem we also know what can be expected when the minimum variance control law is applied to control the process. Notice that the control law is independent of λ .

CONTROL OF BASIS WEIGHT AND MOISTURE CONTENT

In this section we will summarize some of the practical design experiences and give some results achieved with on-line control of basis weight and moisture content. The two problems have many features in common, and we will therefore describe the basis weight control problem in more detail and give only the results of the moisture control problem. As stated previously, the experimental program has had a dual purpose: to arrive at the control laws for the particular application and to test a synthesis procedure.

We used our synthesis procedure to design the control laws for the basis weight control loop. A mathematical model was first determined using the identification technique. The minimum variance control strategy was calculated from the mathematical model as illustrated in the example in the previous section. The minimum variance control law was introduced in the control computer, and the on-line operation of the system was then tested

Basis Weight Control

The object of basis weight control is to control the paper machine so that the basis weight is close to a prescribed value. The feasibility study indicated that the standard deviation of basis weight from the reference value is a good measure of the performance of the system.

Dry basis weight is proportional to the ratio of fibre flow out of the head box to wire speed, and the basis weight can thus be controlled using either of these two quantities. The choice of primary control variables depends on the construction details of the paper machine and will vary with the particular application. In the case of the PM 4 paper machine at Billerud the primary control variables could be

chosen from the following:

- machine speed
- thick stock concentration
- thick stock flow

We have investigated to see if it is possible to control the basis weight by a careful regulation of the three factors. Other experiments have also been performed in order to correlate the fluctuations in basis weight to fluctuations in fibre flow and machine speed. The results have shown that it is not possible to keep the basis weight constant by a good regulation of machine speed and thick stock flow only. The essential difficulty has been keeping the concentration constant. For this reason, it was decided to control basis weight by feedback from basis weight measurements at the dry end to thick stock flow.

Basis weight is measured on-line with a β -ray gauge. Since the coefficient of absorption of beta rays in water and fibres is approximately the same, the β -ray gauge reading has to be compensated for the moisture content of the paper web in order to give oven-dry basis weight. The errors of the β -gauge basis weight meter are due to electronic drift, changes in temperature and moisture of the air, dust contamination, static electricity when paper is over dry, etc. Cross direction fluctuations might cause a β -gauge set at a fixed position to give a biased estimate of the cross direction average of basis weight. Investigation has shown however that the variations in the cross direction are comparatively stable.

When a reel is produced, its weight and dimensions are determined. This gives an accurate determination of the average basis weight of the reel, and the information can be used to calibrate the β -gauge. The basis weight profiles of samples of the finished paper are also determined regularly in the laboratory.

We have tested control of dry basis weight as well as the wet basis weight. The concentration of the thick stock flow was chosen as control variable in the earlier experiments. A subsequent change to the thick stock flow was made essentially for two reasons. The basis weight responds faster to changes in the set point of the thick stock flow regulator than to changes in the set point of the concentration regulator. We also found that the dynamics of the concentration regulator changed with operating conditions thereby introducing variations in the system dynamics. The moisture gauge was not operating properly in the earlier experiments; in these cases only wet basis weight was controlled. In the earlier experiments we also had difficulties with the calibration of the β -gauge. Even if the gauge reading was constant, the actual values of basis weight could vary considerably (several g/m^2 over 5 - 10 hour intervals). We tried to overcome this difficulty in different ways including a complete overhaul of the instrument by the manufacturer, but we were not able to achieve substantial improvements until the automatic calibration scheme was included in the system.

Modelling

The record shown in Fig. 1 was obtained as a result of a perturbation experiment. The set point of the thick stock flow regulator was changed systematically and the corresponding variations in wet basis weight (β -gauge reading) were observed.

Fig. 1

Results of perturbation experiment for determination of mathematical model relating wet basis weight to set point of thick stock flow regulator

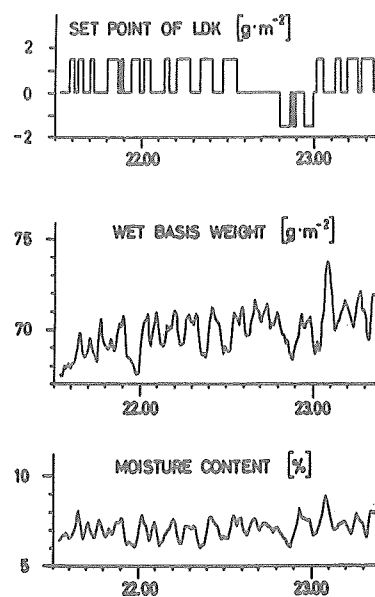

The effect of the perturbation is clearly visible. The response is however heavily corrupted with noise. The data shown in Fig. 1 was fed into our identification program and mathematical models of the following type were obtained

$$y(t) = \frac{b_0 + b_1 z^{-1} + \dots + b_n z^{-n}}{1 + a_1 z^{-1} + \dots + a_n z^{-n}} u(t-k) + \lambda \frac{1 + c_1 z^{-1} + \dots + c_n z^{-n}}{(1 - z^{-1})(1 + a_1 z^{-1} + \dots + a_n z^{-n})} e(t)$$

The numerical values of the parameters obtained are summarized in the table below.

n	1	2
k	4	4
a ₁	-0.38 ± 0.05	-0.55 ± 0.07
a ₂	-	0.20 ± 0.08
b ₀	27.1 ± 2.1	24.9 ± 2.2
c ₁	-0.62 ± 0.10	-0.77 ± 0.12
c ₂	-	0.23 ± 0.12
V	6.60	6.27

Table 1.

Coefficients of mathematical models relating wet basis weight to changes in thick stock flow.

The table gives the significance of the two models. The second order model is just significant. To increase the order further does not improve on the model. The results given in Table 1 are based on 100 pairs of inputs and outputs corresponding to a one-hour experiment duration. The accuracies given are typical of those obtained using a sample with the signal, disturbance levels and duration shown in

Fig. 1. Several such samples were usually required to formulate the control laws.

The identification algorithm separates the recorded output sequence into two parts: the effect of input variations and of disturbances. This is illustrated in Fig. 2, which shows the input, the output, the part of the output caused by the input and the disturbances. It is clear from Fig. 2 that the identification procedure can separate the effect of the input even if the disturbance level is quite high. This is important when modelling industrial processes for which the tolerable perturbation level is low. Fig. 2 shows the difference between first and second order models.

Performance of Basis Weight Controller

It is generally very difficult to evaluate the performance of the control loops, and in particular to compare different control laws. The essential reason is that there is a considerable variation in the disturbance level. This implies that in order to evaluate the control loops, test periods of considerable length have to be used.

A thorough investigation of the basis weight variations was made in connection with the feasibility study before the computer was installed. When analyzing the variations, the records were first divided into samples of about 5 hours duration. The trends were eliminated and the residuals were analyzed as time series. In all cases studied the variations had standard deviations greater than or equal to 1.3 g/m^2 . A record of basis weight variations before the computer was installed is shown in Fig. 3. In the feasibility study the target value for the basis weight variations was set at 0.7 g/m^2 wet basis weight.

The first successful on-line basis weight control operation was executed on April 28, 1965 covering a test period of 10 hours, and since that date

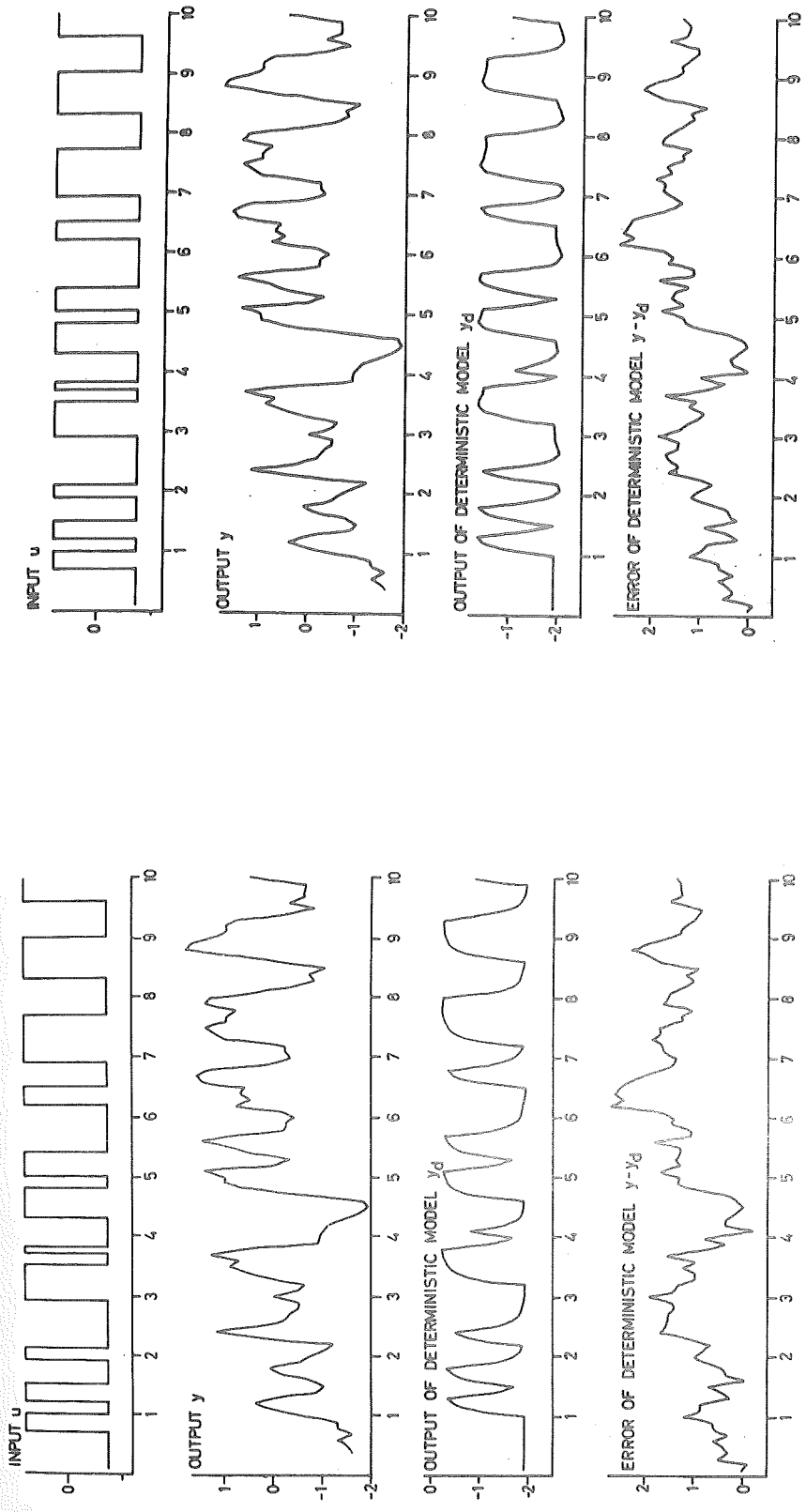

B

A

Fig. 2

An illustration of the identification procedure. The figures show input u , output y , the part of the output that can be explained by the input y_d , (the deterministic model), and the disturbance $y - y_d$ (error of deterministic model). Fig. A shows the curves for the first order model and B the corresponding curves for the second order model.

we have done a large number of experiments. The outcome of the experiments have been compared with what was expected from the results of the identifications. The theoretical limits have been achieved. The data obtained in the on-line experiments has also been used for additional modelling to improve the models already obtained.

Because of the long testing period, we feel confident in stating that on the PM4 basis weight can be controlled with a standard deviation of 0.5 g/m^2 wet basis weight and 0.3 g/m^2 dry basis weight. A record of basis weight variations with on-line computer control is shown in Fig. 3

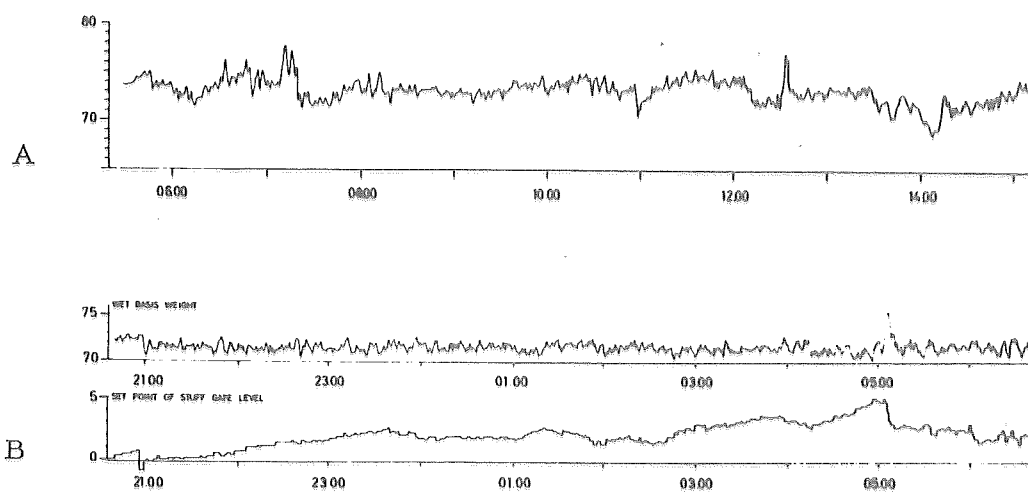

Fig. 3

Variations in wet basis weight before (A) and after (B) the installation of the control computer. A shows a sample of basis weight obtained during a preinstallation test. B shows a result of on-line control of wet basis weight using the minimum variance control law. The upper curve in B shows the wet basis weight and the lower curve shows the control signal (set point of thick stock flow regulator). The units for the control signal is g/m^2 . The control signal thus shows how much of the disturbance is eliminated. Notice the similarity between the control signal variations and the low-frequency variations in basis weight in A. The large deviation of basis weight at time 05.00 is caused by a step change of thick stock concentration. This illustrates the performance of the minimum variance control law when subject to step disturbances.

We have compared the cases when the wet and the dry basis weight are controlled. In one 30-hour test period when wet and dry basis weight were controlled alternatively we found the standard deviations given in the table below:

	Wet	Dry
Wet basis weight controlled	0.50	0.32
Dry basis weight controlled	0.52	0.28

Table 2.

Standard deviations of basis weight for different choice of control variables.

Moisture Content Control

The dry end of the PM4 comprises four drying sections; each consists of a number of steam-heated cylinders used to dry the paper. Steam pressures are set individually for each section. The moisture content of the outgoing paper is measured by a moisture gauge with dielectric sensor. The moisture gauge can traverse across the paper web, but it is normally set at a fixed position. Moisture content is normally manipulated by changing the set point of a regulator that controls the steam pressure in the fourth dryer section. The three remaining pressures are normally set to guarantee feasibility of regulation by the fourth and also to provide the desired drying profile.

In the original plans, moisture was to be controlled by an analog feedback loop. The analog regulator operates satisfactorily under normal conditions. However, difficulties have been encountered during grade changes and at paper breaks. The difficulties depend on the fact that in order to have a good regulation during normal operation a large integral term has to be used. However, a large integral term leads to saturation and instability when the system is subject to large disturbances -- at grade changes for instance. For this reason it seemed desirable to change the strategy depending on the operating conditions. This is difficult to do with analog equipment, but easy to do with a digital loop.

The including of digital moisture control in the process control program was initiated recently, and to date only a limited number of tests have been carried out. For that reason we shall not give general conclusions about performance and no figures will be given.

To design a digital control system for moisture content on the PM4, we proceeded as for basis weight, i. e., by perturbation, identification and derivation of the minimum variance control law.

It was shown as a result of the identification that the pressure-moisture relation could be approximated well by a first order system including a time delay of 50 seconds. Due to this long time delay it seemed reasonable to use a control-adjustment interval of 36 seconds. A minimum variance control law was derived for this interval.

A substantial improvement in performance over that of the uncontrolled process was evident. Attempts were therefore made to determine whether, in this particular case, digital control is superior or inferior to regulation by an analog (PI) moisture regulator, which has also been installed.

Digital control has the obvious advantage of being easier to connect or disconnect automatically at grade changes and paper breaks. Furthermore, the control parameters can be set by the computer.

The evaluation of performance during steady state operation has not revealed any significant superiority of one alternative over the other. This has also been verified by theoretical analysis. The rms deviation of moisture content from its target value has in some cases been higher with the digital loop and in some cases lower, depending on the character of the disturbances. The digital loop maintains average value better, but has slightly more high-frequency variations.

Experiments also indicate that the character of disturbances and the process dynamics vary with the operating conditions (speed, moisture content, pressure, production rate, etc.). The drying process might thus be a possible case for adaptive control.

As seen from Fig. 1, the moisture content changes considerably with the thick stock flow. This means that some of the disturbances can be eliminated by including information about changes of thick stock flow in the moisture control loop.

REFINING CONTROL

The ultimate object of refining control is to control the beating of the pulp in such a way that certain properties of the finished paper are held constant and close to optimal values. To achieve this on the PM4, an intermediate step has been taken to implement control of a refining index calculated on-line from measurement of process variables which (as a hypothesis) influences important paper properties. The next step is then to correlate this refining index with paper properties in order to determine reference values for the refining index. Such reference values should then be assigned to each particular grade and selected in such a way that the paper properties are good. This has not yet been done. It may be regarded as "process optimization."

Control Configuration

On the PM4, refining is controlled by two digital control loops in cascade. The controller of the inner loops senses the power consumed by each one of a number of parallel refiners and adjusts refiner plug positions in such a way that the powers are held close to individual reference values. The latter are computed in the following way: a desired total refining power is obtained by multiplying the desired total fiber flow through refiners by a desired specific refining energy. This is defined as total refining energy per amount of dry beaten pulp and may be regarded as a measure of refining. The desired total refining energy is then distributed on the various refiners. Specific refining energy may be set in one of two ways:

- Set equal to a constant value which the machine tender may then modify by a constant increment upwards or downwards, whenever he chooses to do so.

- Set automatically by the outer loop controller. The switch connecting the outer loop is located in the machine tender's booth. The outer loop adjusts specific refining energy in such a way that the refining index is held close to its reference value.

The refining index used is calculated from readings of couch vacuum and basis weight. The idea is that since couch vacuum is not regulated on the PM4, its value may serve as an indication of the air penetration resistance of the wet sheet. Basis weight is taken into consideration in an attempt to define some "specific resistance." $(P-P_0)/W$ as an index of refining, where P is couch vacuum, W basis weight and P_0 a constant.

Modelling

When formulating control laws for control of the refining process (inner loop), it was possible to base the synthesis on existing curves giving normal refining power as functions of refiner plug positions and other available knowledge about the refiners.

For the web forming process, however, very little such knowledge was available, and it was considered necessary to identify the process in order to be able to synthesize a good control law for the outer loop. The process to be identified is the one seen from the outer control loop; it has specific refining energy as manipulated variable (input), and two observed variables (outputs), viz. couch vacuum and basis weight. Thus, the actions of the inner loop should ideally be included in the model.

The model construction has in this case deviated from the normal procedure in two respects. This was partly due to the fact that at the time when the model was needed, the inner control loop did not

yet exist. Therefore, the assumption had to be made that the inner loop would react rapidly as compared to the outer loop. Thus, when modelling, measurements of the actual specific refining energy were taken as inputs. Furthermore, only natural perturbations were used. This calls for special care in interpreting the results of modelling, and we do not generally recommend it.

The modelling was done in two steps:

1. A short (two-hour) pilot-logging was executed to obtain a crude model and a suitable interval between control adjustments. This interval (six minutes) was then chosen as the sampling interval for the second logging experiment.
2. The second experiment covered a period of 30 hours (300 observations) and included a number of variables that influence the refining. The record of the three main variables is shown in Fig. 5.

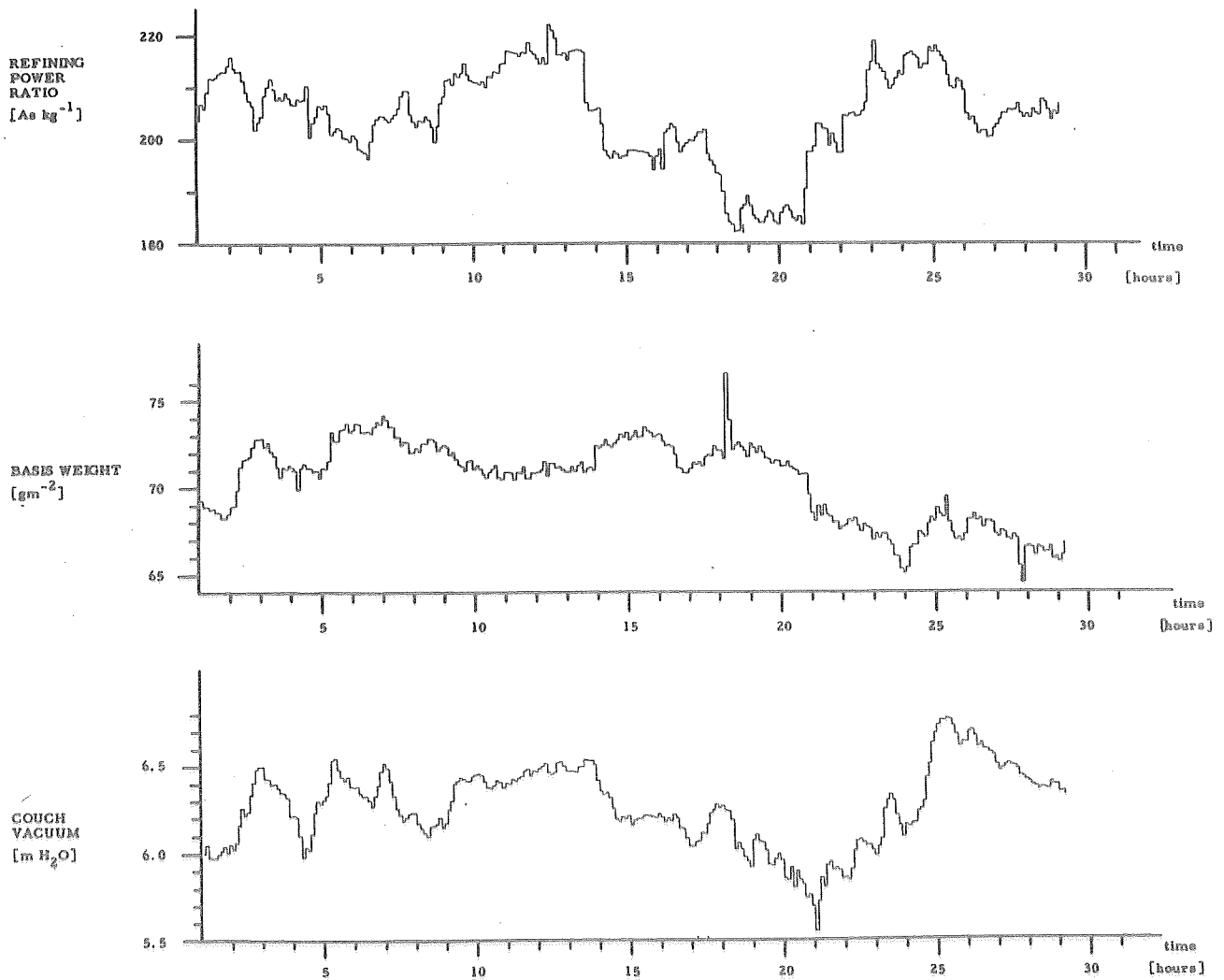

Fig. 5

Results of logging of process variables for the determination of mathematical model relating couch vacuum and basis weight to specific refining energy. Each point is an average of ten consecutive readings. The basis weight record includes three manual grade changes and two speed changes. During the experiment paper breaks occurred at approximately 4, 18, and 28 hours, and between 24 and 26 hours.

The record showed sufficient variation and was long enough to permit a simultaneous estimation of all unknown elements including the statistical properties of disturbances.

The following model was found:

$$\begin{aligned}
 P(t) - \bar{P} - \beta[W(t) - \bar{W}] &= x(t) + \epsilon(t) \\
 x(t) &= -\alpha x(t - 0.1) + \beta_1 [u(t - 0.1) - \bar{u}] \\
 \epsilon(t) &= \epsilon(t - 0.1) + \lambda [e(t) + \gamma e(t - 0.1)]
 \end{aligned}$$

where $\{e(t)\}$ is a sequence of independent normal random numbers. $\alpha, \beta, \beta_1, \gamma, \lambda$ are model parameters and x is an auxiliary state variable. The refining index = $P - \beta W$.

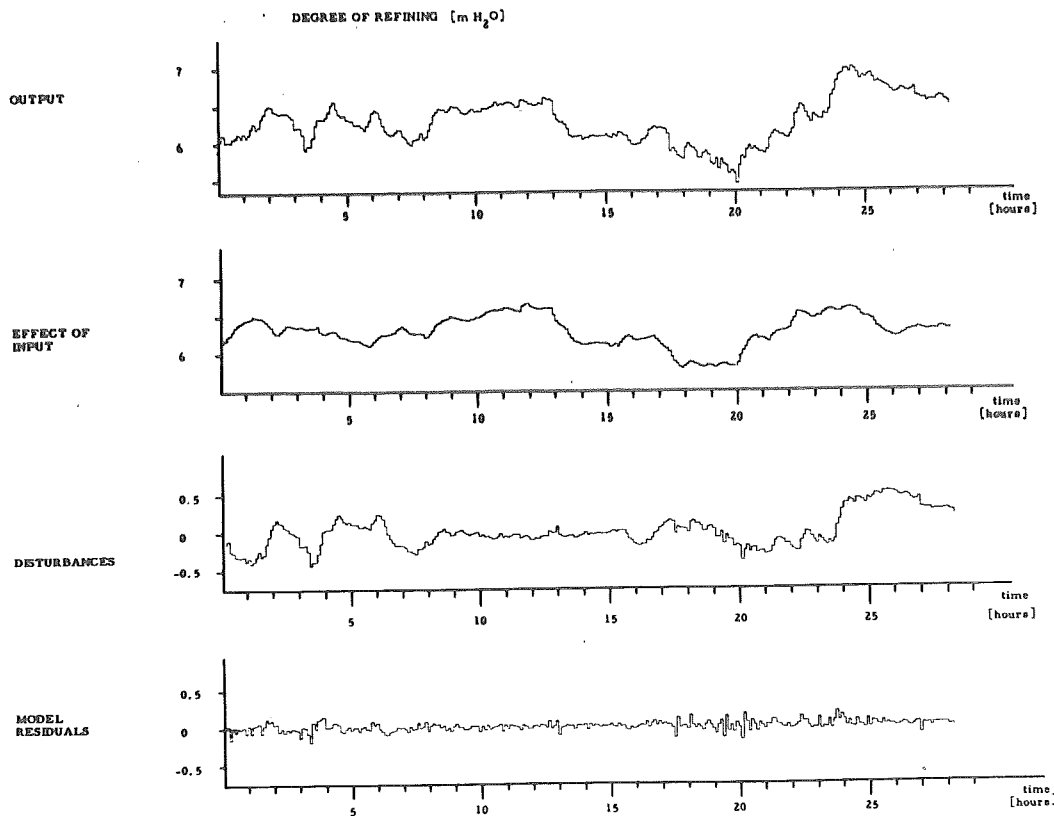

Fig. 6

Illustrating identification for the refining model. The top curve shows the refining index calculated from couch vacuum and basis weight. It is separated into the two curves below it which represent effect of input and disturbances. The bottom curve shows the one-step ahead prediction error.

Invariance of conditions has been checked by comparing those characteristics of the two models that are comparable and by analyzing test runs with closed loop control. The agreement has been satisfactory, and the material gathered to date has not invalidated the hypothesis of an approximately invariant process. The amount of disturbance, however, varies considerably from one time to another.

Control Law

For various reasons the interval between control corrections was chosen as 0.05 h and the refining index $P - \beta W$ was replaced by $\frac{P - P_0}{W}$. The optimal control law, in the minimum variance sense, derived from the model is then

$$\nabla u(t + 0.05) = c_1 [\nabla u(t) + \nabla u(t - 0.05)] - c_2 [\tilde{y}(t) - c_3 \tilde{y}(t - 0.05)]$$

where $\tilde{y} = \frac{P - P_0}{W} - y^0$ is the control error y^0 is the reference value for the refining index. The three control parameters c_1, c_2, c_3 are easily calculated from the model parameters.

This control law has been fed into the computer in an attempt to control refining.

Performance

The question of whether the defined refining index should indeed be controlled will be left open. This of course depends on whether or not the index has a relation to any important paper properties. The purpose of the investigations was to determine whether control is possible.

The refining control loop has been particularly difficult to test for performance under normal operation. The main reason for this is

that the process is slow (a characteristic period for the closed loop is about half an hour). Consequently very long uninterrupted test runs under uniform conditions (grade, speed, etc.) are needed to give reliable averages. The data collected is not considered sufficient for this purpose.

However, by analyzing the individual records, some conclusions can be drawn. The main factor for the variation of the control error from one sample to another is the varying amount of disturbance. This is indicated by the amount of control adjustment, i. e. how much the controller has to operate in order to keep the output constant. (Compare with the situation illustrated in Fig. 3). By observing the controlled variable and the manipulated variable simultaneously, we are able to decide approximately how the process would have behaved if uncontrolled, in this case with specific refining energy held constant. Elaborating on this idea a little we can even reconstruct the disturbance sequence acting on the process during the test with the aid of the model that has been obtained.

Fig. 7 shows the results of a few such test runs with the refining index controlled according to the derived law.

Visual inspection indicates roughly the amount of disturbance eliminated by the controller. It is evident that the decrease in fluctuation of the refining index under control is substantial.

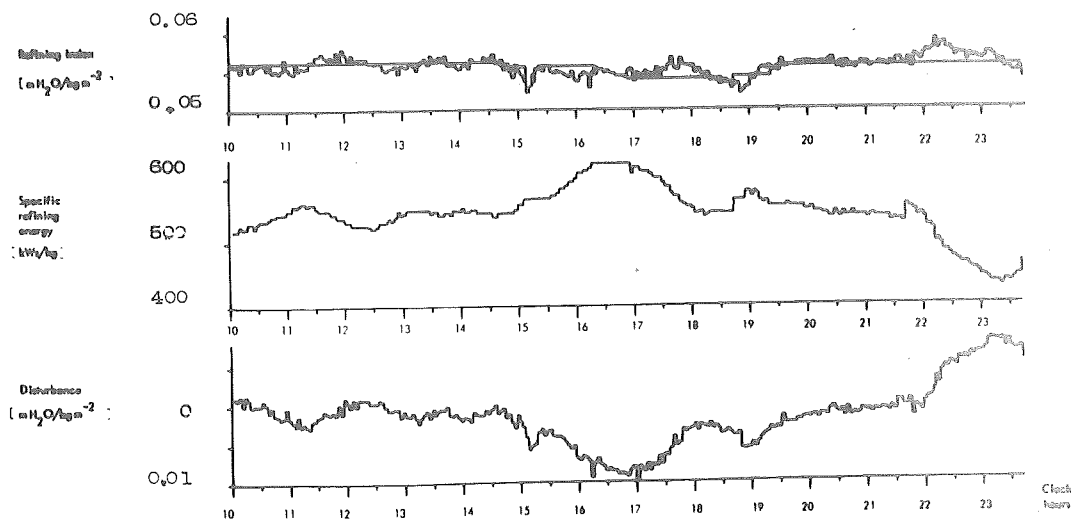

Fig. 7

Variations in refining index when controlled by feedback to refiners (reference value of specific refining energy). The curves represent (from top) controlled variable and reference value, manipulated variable, reconstructed disturbance. The disturbance sequence contains high and low frequencies, a fact which could be interpreted as follows: low frequencies are compensated for by control action (middle curve) while the high frequencies (top curve) remain.

REFERENCES

- [1] Åström, K. J. & Koepcke, R. W. & Tung, F., On the Control of Linear Discrete Dynamic Systems with Quadratic Loss RJ-222, IBM Research, San Jose, September 10, 1962.
- [2] Åström, K. J., Control Problems in Papermaking, IBM Symposium on Control Theory, October, 1964.
- [3] Åström, K. J. & Bohlin, T. & Wensmark, S., Automatic Construction of Linear Stochastic Dynamic Models for Stationary Industrial Processes with Random Disturbances using Operating Records, Report TP 18.150, IBM Nordic Laboratory, June 1, 1965.
- [4] Åström, K. J. & Bohlin, T., Numerical Identification of Linear Dynamic Systems from Normal Operating Records, Proc. IFAC Conference on Self-Adaptive Systems, Teddington, September, 1965.
- [5] Åström, K. J., Notes on a Regulation Problem, Internal Report CT209, IBM Nordic Laboratory, August 30, 1965.
- [6] Joseph, P. D. & Tou, J. T., On Linear Control Theory, AIEE Trans. Application and Industry, 1961, pp. 193-96.

INTEGRATED COMPUTER CONTROL OF A PAPER MACHINE
Instrumentation and Computer Connections

O. Meurman G. Sangregorio B. Strid
 BAB IBM BAB

SYNOPSIS

After a short review of the IBM 1710 system configuration, this report presents the basic computer-connected instrumentation with major emphasis on transmitters for process variables and on analog control stations. Instrument calibration methods which utilize the computer are described, and the report closes with a discussion of the reliability of the equipment.

TP 18.173
15 October 1966
IBM NORDIC LABORATORY
LIDINGÖ, SWEDEN

table of contents

Introduction 1

Computer Configuration 2

Basic Instrumentation 5

Transmitters for the Process Variables 8

Analog Control Station11

Instrument Calibration13

Equipment Reliability16

INTRODUCTION

The instrumentation supplies the computer system with information on process variables and process status. This information is then used by the computer in many different ways for process control, for quality control for production supervising, etc. The process control programs automatically make the necessary adjustments in the process via set-points of analog controllers or direct digital actuation.

The computer system is housed in a separate air-conditioned computer room near the dry end of the paper machine. The instrumentation is located in the operating area where there are three main control panels. One of the panels is close to the stock preparation area, the second is near the wet end and the third near the dry end of the paper machine.

COMPUTER CONFIGURATION

Fig. 1 shows the configuration of the computer system at Billerud.

The main units are:

- central processing unit which has total of 40,000 core storage positions.
- disk storage unit which provides additional 2 million positions.
- input/output console typewriter, used mainly during program testing.
- card-read/punch used for assembling of programs, for entering program instructions and for input and output of data during normal on-line operation.
- data converter and multiplexer units which connect the computer to the process and make the necessary signal conversions.
- output printers, the sense switch unit and the manual entry unit are used for communication with the operating personnel.

For communication with the process, the computer system has the following input/output features:

- analog inputs. Electric signals from measuring instruments can be read randomly or at a rate of 200 measuring points per second. In our case 80 inputs are connected, most of them ranging from 0-50 mV and 0.3-1 mA DC.
- pulse inputs. Pulses generated by tachometers, flow- and power-integrators are counted at a maximum rate of 60 pulses per second. 22 pulse-inputs are presently connected.
- contact inputs. The status of contacts of manual switches, on/off detectors, limit sensors, etc., is sensed. These contacts are used in three ways.

The contact sense feature permits sensing of contact status by scanning contact-points on demand of programmed instructions.

The process-branch-indicator feature relates the on-off status of process contacts with the status of internal indicators which can be interrogated directly by programs.

The process-interrupt feature permits the routine operation of the computer to be interrupted and high priority programs to be executed. Interruption is caused by process-contacts related

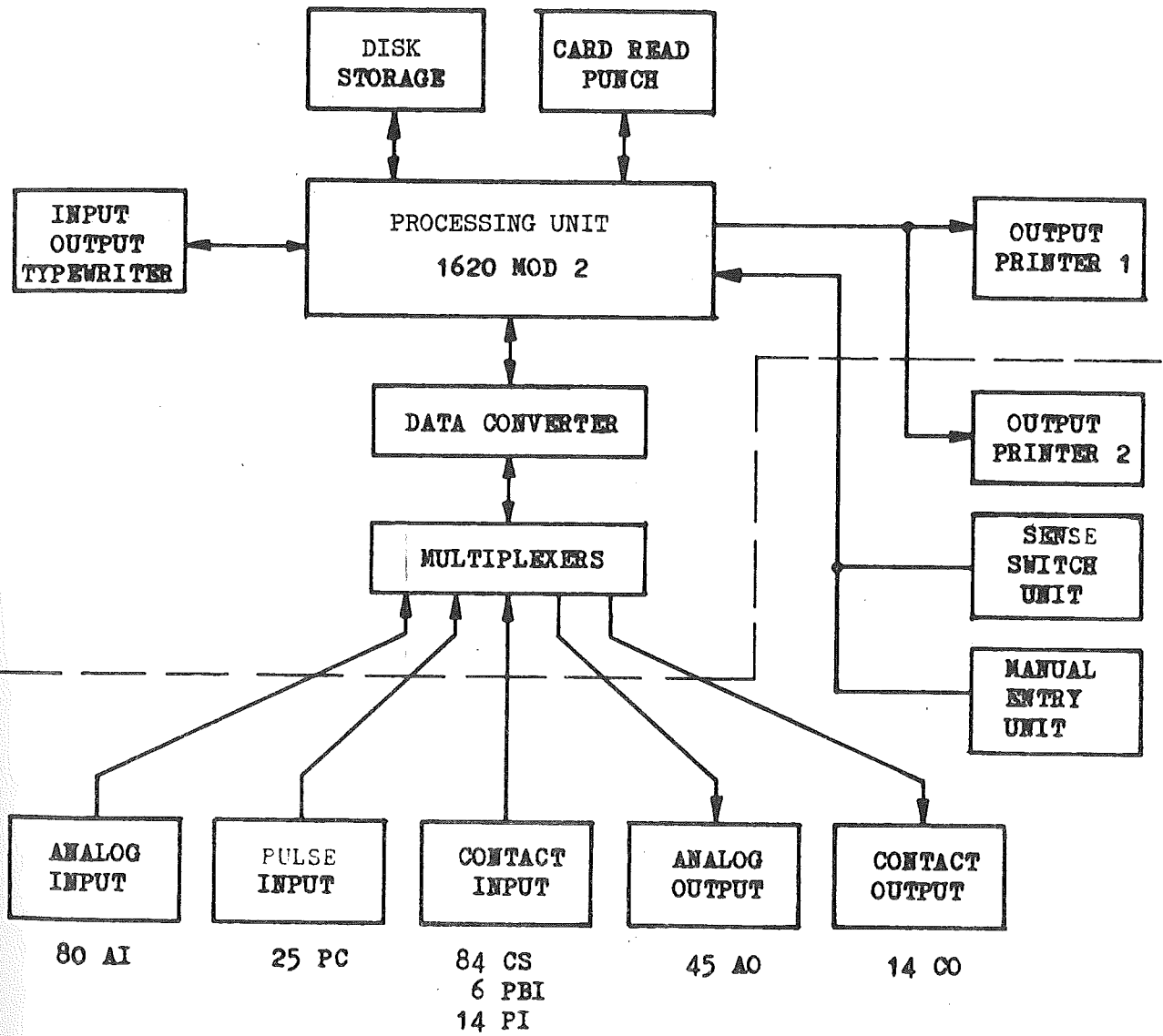

Fig. 1 CONFIGURATION OF THE COMPUTER SYSTEM USED IN THE PAPER MILL AT GRUVÖN, SWEDEN

to conditions demanding immediate action.

Up to 104 contact-inputs are presently connected.

- analog outputs. An output-timer provides pulses of predetermined duration (0.5 and 2.5 sec.) at a rate of one pulse per 3.6 seconds. These pulses operate reversible motors, used as set-point positioners and relays for operating other actuating devices. Several actuators can be pulsed simultaneously. A total of 45 analog outputs are connected, 32 of which are presently used.
- contact outputs. Contacts are momentarily closed to switch process devices on and off.
14 contact-outputs are presently connected.

BASIC INSTRUMENTATION

The original paper machine instrumentation was of older design and could not be connected to a computer system. It was necessary to design new instrumentation. We were fortunate in being able to select most of the equipment to suit our requirements.

The selection of the instrumentation was based on the following considerations:

1. Instruments should provide the computer with suitable measuring signals and be designed to accept computer commands.
2. They should provide the operator with adequate information and means to run the mill independently of computer operation.
3. Their accuracy and the reproducibility should be adequate. The drift should be low.
4. Their design should be simple to provide high reliability and minimal maintenance.
5. The number of different types should be as small as possible. This will facilitate servicing and make training easier.

Practically all instruments are from manufacturer's standard lines. Only the set-point stations were especially designed.

Both pneumatic and electric (electronic) instruments have been used.

Pneumatic transmitters are used for all measurements needed for analog controllers. Standardized pneumatic-to-electric converters, Fig. 2, convert the 3 to 15 psi signals to low-level electric signals, 0.3 to 1.5 mA, sent to the computer.

Electric transmitters are used for measurements needed only by the computer.

Pneumatic analog controllers are all of indicating type, with pneumatic set-points, proportional and reset mode of control action, and manual-automatic switches.

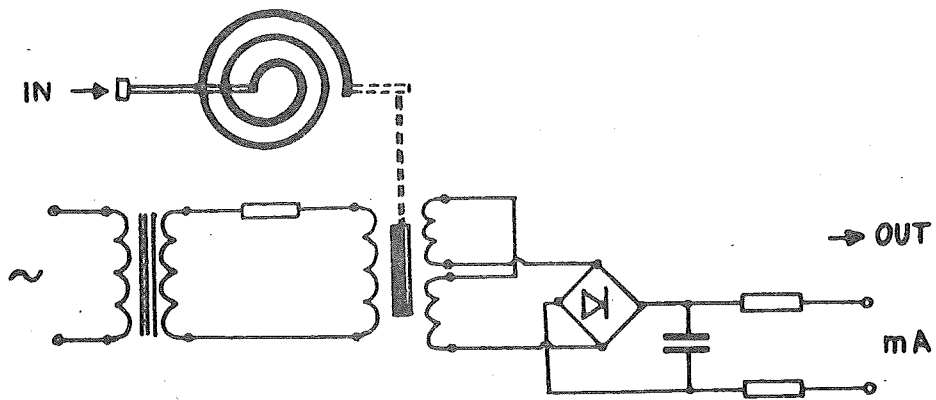

FIG. 2 PNEUMATIC-TO-ELECTRIC SIGNAL CONVERTER

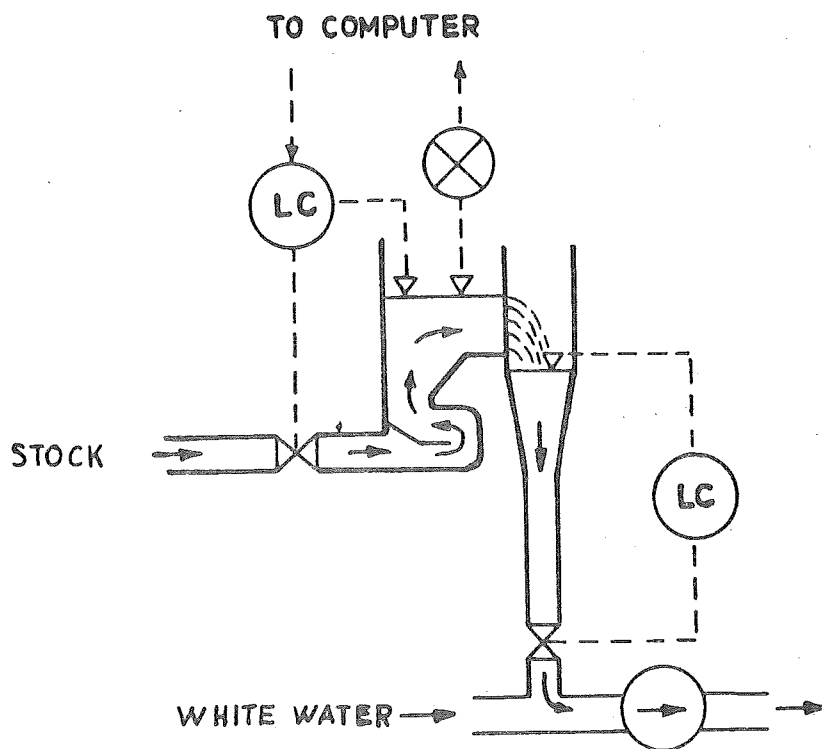

FIG. 3 STUFF BOX FOR STOCK PROPORTIONING

Separate recorders have been used only for the key variables, because of the logging facility of the computer.

The analog input and pulse input signals are transmitted via special shielded cables. These cables are run in separate conduits. The cable shields are grounded and the wires are twisted in pairs. One side of the signal lines is grounded at the computer end to a common instrument ground. Any 50 cycle voltage will be reduced to 1/500th by the computer RC input filters. These arrangements keep the signal noise down to an acceptable level.

Analog output, contact sensing and contact operate signals are transmitted via ordinary shielded cables.

TRANSMITTERS FOR THE PROCESS VARIABLES

Transmitters for pressure, differential pressure and temperature are conventional pneumatic 3 to 15 psi or electric mA- or mV instruments.

The consistency transmitters are of the in-line type working on the shear force principle. We selected this type primarily because it offers the possibility of measuring in the main stream close to the dilution point and because of its simple construction, lack of moving parts and low price. We have made extensive tests of the measuring characteristics of these sensors and now feel confident that they will perform well if used within specified limits.

The stock flow measuring system after the machine chest (Fig. 3) consists of a specially designed flow box, with an accurate level transmitter. The computer calculates the flow from the level measurement. This type of flow box has been used by Billerud for many years. Its main advantage is that it is practically free of drift errors.

The basis weight at the dry end is measured by a stationary β -ray gauge. Early investigations showed that the basis weight profile in the cross direction was stable. Since we take cross direction samples from each reel to an off-line profiler, we felt that a traversing β -ray gauge was not absolutely necessary.

The moisture meter at the dry end is of the dielectric type. It will traverse at the command of the back-tender or of the computer.

Measurement of sheet length on the reel and the weighing of the finished reel on the crane are special features used by the computer to calibrate the basis weight and the moisture meter.

The speeds of the different machine sections are measured in a very simple way. An AC-voltage proportional to the section speed is taken from the rotor fields of the DC electric drive motors. An ordinary transformer is connected to this voltage for isolation, and the signal

is modified by two zener diodes, Fig. 4. The resultant pulses are connected to the pulse counters in the computer. The computer reads the pulse counters at two successive times and calculates the average speed. A 20 second interval is needed to get a 1% resolution.

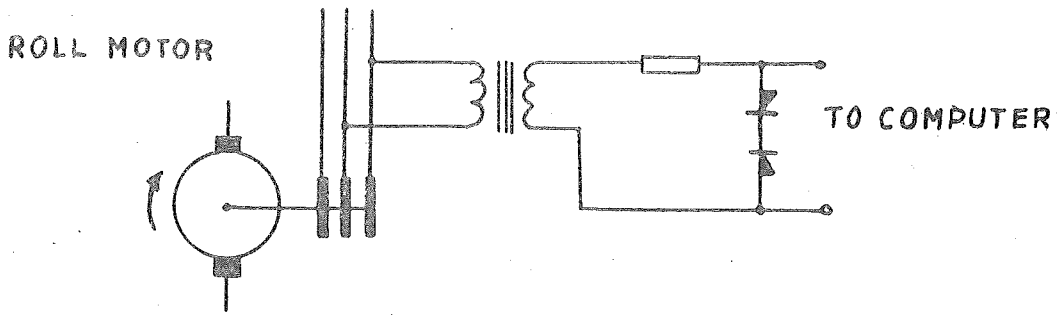

FIG. 4 PULSE GENERATOR FOR ROLL SPEED

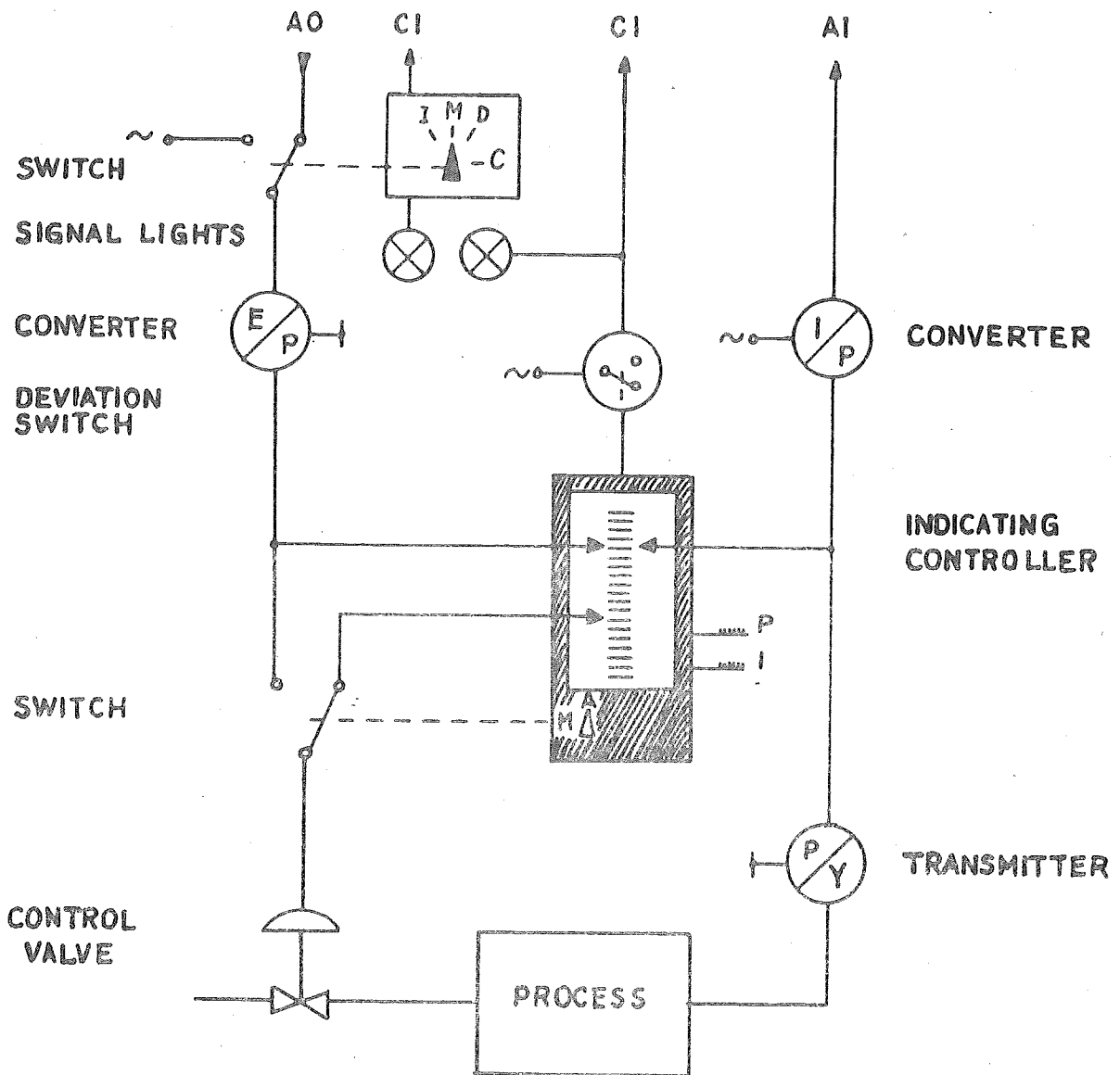

FIG. 5 ANALOG CONTROL STATION

ANALOG CONTROL STATION

At the design stage, the following requirements were specified for the control station:

1. Indication of the set-point and the measuring signals on a common scale, and indication of the output signal to the control valve.
2. Provision for automatic and/or manual operation of the valve.
3. Conversion of the computer electric pulse signal to pneumatic set-point signal. The set-point should remain unchanged, if a power failure should occur.
4. Provision for bumpless manual transfer from computer to manual set-point adjustment, and vice versa.
5. An on/off signal to indicate when the controller is under manual or computer set-point operation.
6. An on/off signal to indicate that the control-loop is not working properly, based on the deviation between set-point and actual value.

Fig. 5 shows how we have solved these problems. A conventional transmitter converts the process variable to a pneumatic signal. This signal goes to the controller and to the pneumatic-to-electric converter. The electric signal is connected to the computer.

The computer output is connected to a set-point converter via a switch. The switch is used to change from computer to manual set-point operation and vice versa. Manual operation is indicated by a signal light. The switch position is sensed by the computer.

Fig. 6 shows schematically the set-point converter and its electric connections. The converter consists of a 100-pole synchronous motor, a gear reducer and a proportional pressure reducing valve. The motor is bi-directional and has extremely short start and stop times. It operates on 110V, 50 cycles. 0.5% resolution is obtainable. Electric limit switches protect the converter from damage at the ends of the

range. If a brief power failure should occur, the output of the converter would remain unchanged, and the normal operation undisturbed.

INSTRUMENT CALIBRATION

Careful consideration is given to the periodic checking and updating of instrument readings. A conventional preventive maintenance program takes care of the static calibration of the transmitters for pressure, differential pressure, temperature, pH, etc., and the calibration of analog recorders, indicators and controllers in the instrument shop.

A special routine is used for in-plant calibration of the standardized pneumatic-to-electric converters. This routine is executed during a wire change. The computer output (Fig. 7) is converted to air pressure and is connected to the input of the converter to be checked. A reference converter is connected in parallel to the same pressure. The computer adjusts the pressure in steps from 3 to 15 psi and from 15 to 3 psi. The signals from the two converters are measured and the values are stored in the computer memory. After the run is completed the computer calculates the regression equation and the standard deviation of the tested converter. The result is printed out together with the measured values. We are thus able to adjust the calibration of our pneumatic-to-electric converters very accurately during a wire change.

Many of the basic instruments used in the papermaking cannot be adequately checked off-line in the instrument shop. This applies, for example, to the:

- . stock proportioning system
- . consistency transmitters
- . on-line basis weight instruments
- . moisture content instruments

In these cases the computer can be used for periodic calibration. For example, the following method is used to calibrate the basis weight meter. During normal production the basis weight meter is read every 7.2 seconds. When the reel is changed the average basis weight for the reel is calculated and the value is stored in the computer memory.

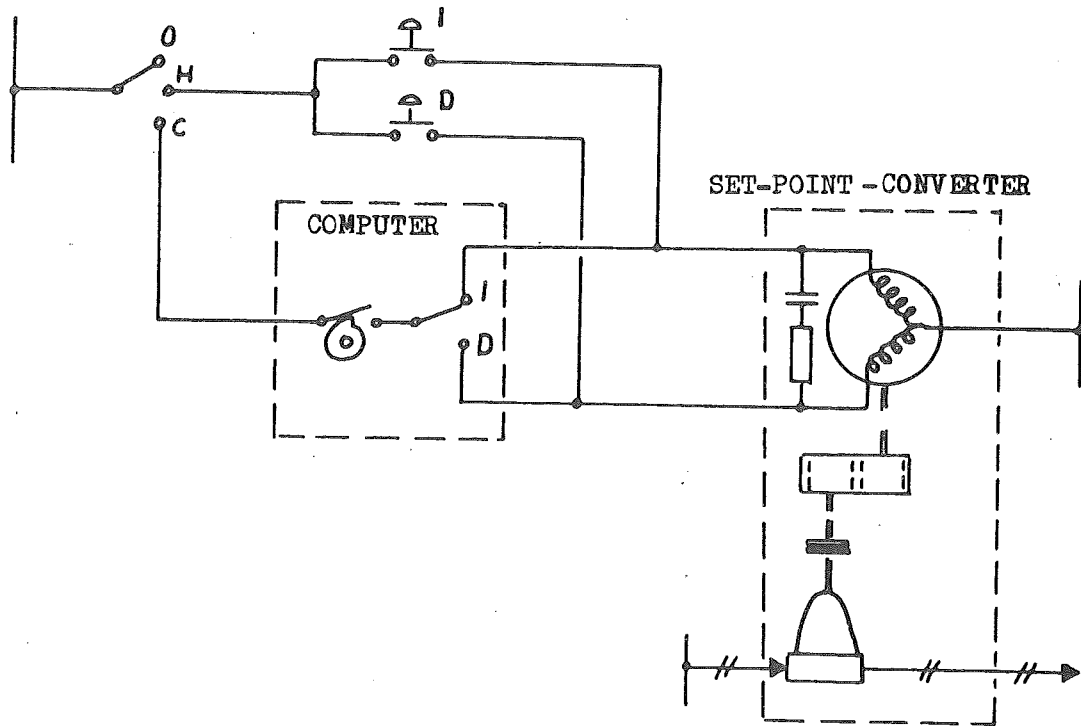

Fig. 6 SET-POINT-CONVERTER

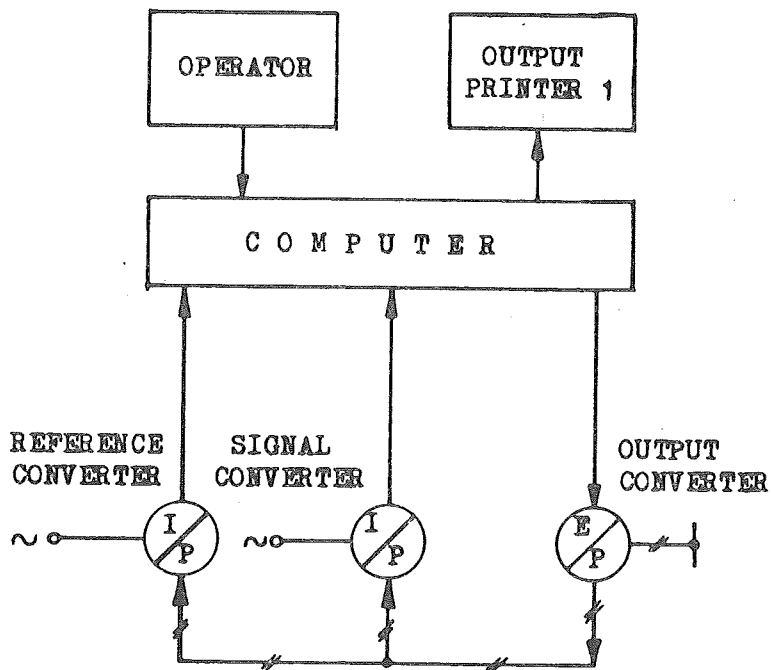

Fig. 7 HOOKUP FOR CALIBRATION OF SIGNAL CONVERTER

EQUIPMENT RELIABILITY

The main part of the instrumentation was installed and wiring was completed in August 1964 prior to the delivery of the computer. It has been in continuous operation since this time.

Most of the instruments have worked satisfactorily. However we have had a number of faults which have disturbed the on-line testing and operation of the computer. The reasons for these faults include:

- . faulty location of measuring points
- . poor mechanical installation
- . faults in the electric wiring and connections
- . broken parts in the instruments, etc.

Once the reasons have been ascertained it has usually been easy to eliminate the faults.

The performance of the computer hardware has been satisfactory. However, some relay faults have occurred in the terminal unit circuit boards and the output printers due to faulty terminal connections.

Various faults in the console typewriter have put the system out of operation about 7 times. The reason for this seems to have been the unusually heavy burden during the initial testing period. The time required to correct these faults has varied from minutes to five hours.

A fault occurred in the disk file operation which occasionally blocked the transfer of data and took considerable time to locate and correct.

Emergency service on each of the output printers has been required three times during a period of 15 months.

We have had no trouble with the signal wiring.

It is obvious from what has been mentioned that many faults have occurred during the initial testing period. Our records indicate however that the number of faults have gradually decreased, and we believe that this trend will continue. It should also be noted that only a few of the faults are such that they will affect production.

Simultaneously, some of the equipment has been in operation more than 20 months without any maintenance. We thus conclude that the overall system reliability has been quite satisfactory.

INTEGRATED COMPUTER CONTROL OF A PAPER MACHINE
Production Supervising System

Å. Ekström A. Hempel
 IBM BAB

SYNOPSIS

The integrated system is subdivided into five systems -- production planning, production supervising, process control, quality control and reporting. This report presents the production supervising system. A description of its dual supervising/identifying purpose is followed by a discussion of how it is incorporated into the integrated system with regard to grade changes, normal supervising functions, sheet length meter interrupts and set length adjustments. The report closes with a discussion of management reports and a few final comments.

TP 18.174
15 October 1966
IBM NORDIC LABORATORY
LIDINGÖ, SWEDEN

table of contents

Introduction 1

Purposes of the Production Supervising System 2

 Supervising Function 2

 Identifying Function 3

Production Supervising System as Part of
The Integrated System 5

 Grade Changes 5

 Normal Supervising Functions 9

 Sheet Length Meter Interrupt 11

 Adjustment of the Set Length. 13

Management Reports 15

Final Comments 20

INTRODUCTION

The integrated system implemented on the IBM 1710 process control computer in operation at Gruvön, Billerud, includes a complete series of functions such as planning the production, controlling the production, controlling the quality and reporting the results. The integrated system has been broken down into a number of systems, most of which are separate and closed. These include production planning, process control and quality control. A number of routines which serve mainly as linkages between the different systems have been grouped together in another system called the production supervising system.

In this report, the purposes of the supervising system are studied first. The main part of the description will be devoted to the various functions performed by the system together with some information about how it is implemented on the computer.

For the sake of simplicity, only the main functions normally performed will be described. The control system is very complex, however, and is able to handle emergency situations -- an unplanned grade change, for instance.

Since the production supervising system supplies input information for the printing of management reports, and since these reports are not discussed elsewhere, they will be mentioned briefly here.

PURPOSES OF THE PRODUCTION SUPERVISING SYSTEM

The two main functions of the production supervising systems are:

- . To supervise production, i. e., to set new reference values for the process control system, and start grade changes at the proper time.
- . To identify and store collected process and quality data.

Supervising Function

The first function is mainly to determine suitable settings for important process variables such as moisture content, basis weight and machine speed based on the given specifications for each grade. New reference values should be fed into the process control system in good time before a grade change, and the change should be initiated at the correct time and in a suitable sequence, starting with the refiners and ending with the drying section.

It would have been possible, of course, to design a system by which the machine tender performs these functions manually. He could determine new reference values and insert them in the process control system before the grade change, and he might also keep track of the produced paper and initiate the change when the previous grade is finished.

However it was decided that most functions should be performed automatically by the computer system. One of the reasons for this was the desire to run the process control system with reference values that are independent of different machine tenders.

Identifying Function

The purposes of the second main function are closely related to the fact that the desired quality control system was to provide complete identification of each individual roll, i. e., information about how the reels were cut into rolls including the corresponding order identification number. This was also desired for production reporting purposes.

When designing the system we had to choose between two alternatives:

- 1) Let the winder crew decide how the produced paper should be rolled up in reels and how these reels should be divided into rolls by the winder in the same way as before. The winder crew would also allocate an order-position identification to each individual roll and then insert all this information into the computer system. This system would have put a heavy burden on the winder crew, increasing instead of decreasing their duties since they also would have had to feed information to the computer in addition to their previous duties. The computer programming for this type of system would have been rather simple.
- 2) Let the computer determine completely how the paper should be produced, rolled into reels and how the reels should be cut into rolls by the winder. The computer would also allocate order identification to each produced roll. All this information would be printed out to the winding crew who would proceed accordingly, or make any necessary changes and inform the computer system about the changes.

This system was expected to decrease the burden on the machine crew, but it would be very complex and require additional programming. It was also believed that this system would lead to more accurate management reporting, since the manual handling of information would be decreased.

Since the advantages of the second alternative were considered very important, this type of system was chosen. The specific purposes of the system are given below.

- . Identify the production down to each individual roll and allocate the identification for each roll.
- . Optimize the sequence of the width combinations to obtain a minimum of slitter changes in the winder.
- . Follow the production set^x by set and keep the machine tender informed about set changes, reel changes and grade changes, including the adjustments of set lengths to take into account the variations in paper thickness.
- . Keep the winder crew informed about how the reels should be divided into rolls.
- . Supervise the collection of process and production data and organize the data for later use in managements reports.

^x All of the rolls slit side-by side from a single length of full- machine-width reel paper are called a set.

PRODUCTION SUPERVISING SYSTEM AS PART OF THE INTEGRATED SYSTEM

Before describing the production supervising system in more detail, we shall briefly review the total integrated system. A simplified block diagram of the whole system is shown in Fig. 1. The supervising system is split into several main blocks, namely:

- . the routines connected to grade changes
- . the actual supervising routines
- . the supervising tables used for storing and identifying process and quality data

The other parts of the integrated system -- production planning, reporting, quality control, process control and the Billerud Data Processing Center in Säffle -- are all connected in some way to the production supervising system.

In the following description of the supervising system, the grade change routines will be discussed first, and then the normal supervising functions executed during the production of one grade.

Grade Changes

At a grade change, the production supervising system performs most of the identifying work by formulating the supervising tables for the new grade. The new reference values are calculated and the actual grade change is initiated in the process at the right time. Three different grade change programs are used for this purpose. The block diagram shown in Fig. 2 illustrates the main function of the three different programs.

Normally the grade change program 1 is called when there are still about two and a half sets of one grade to produce. Information about the next planned grade is collected from tables supplied by production

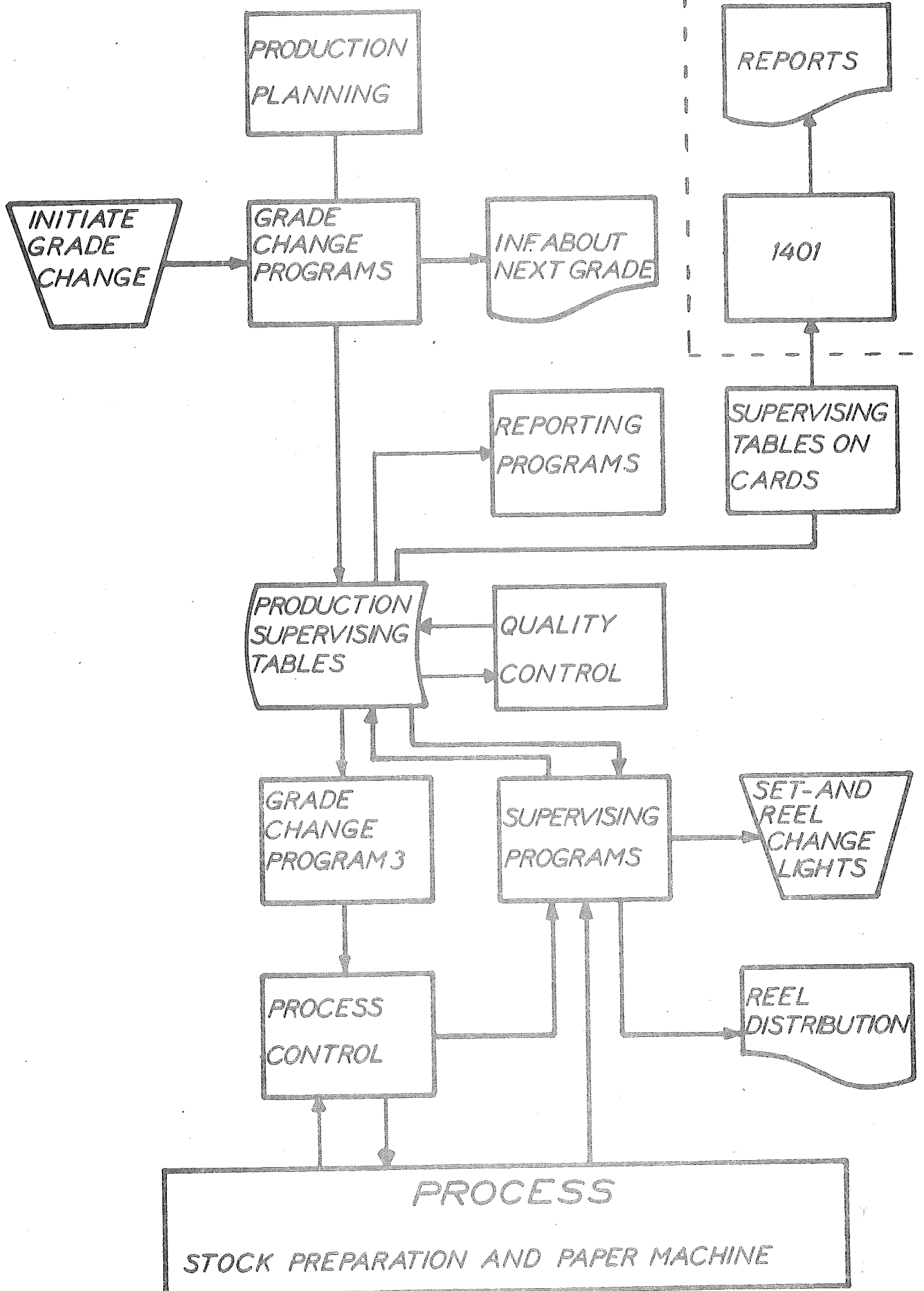

Fig. 1 INTEGRATED CONTROL SYSTEM

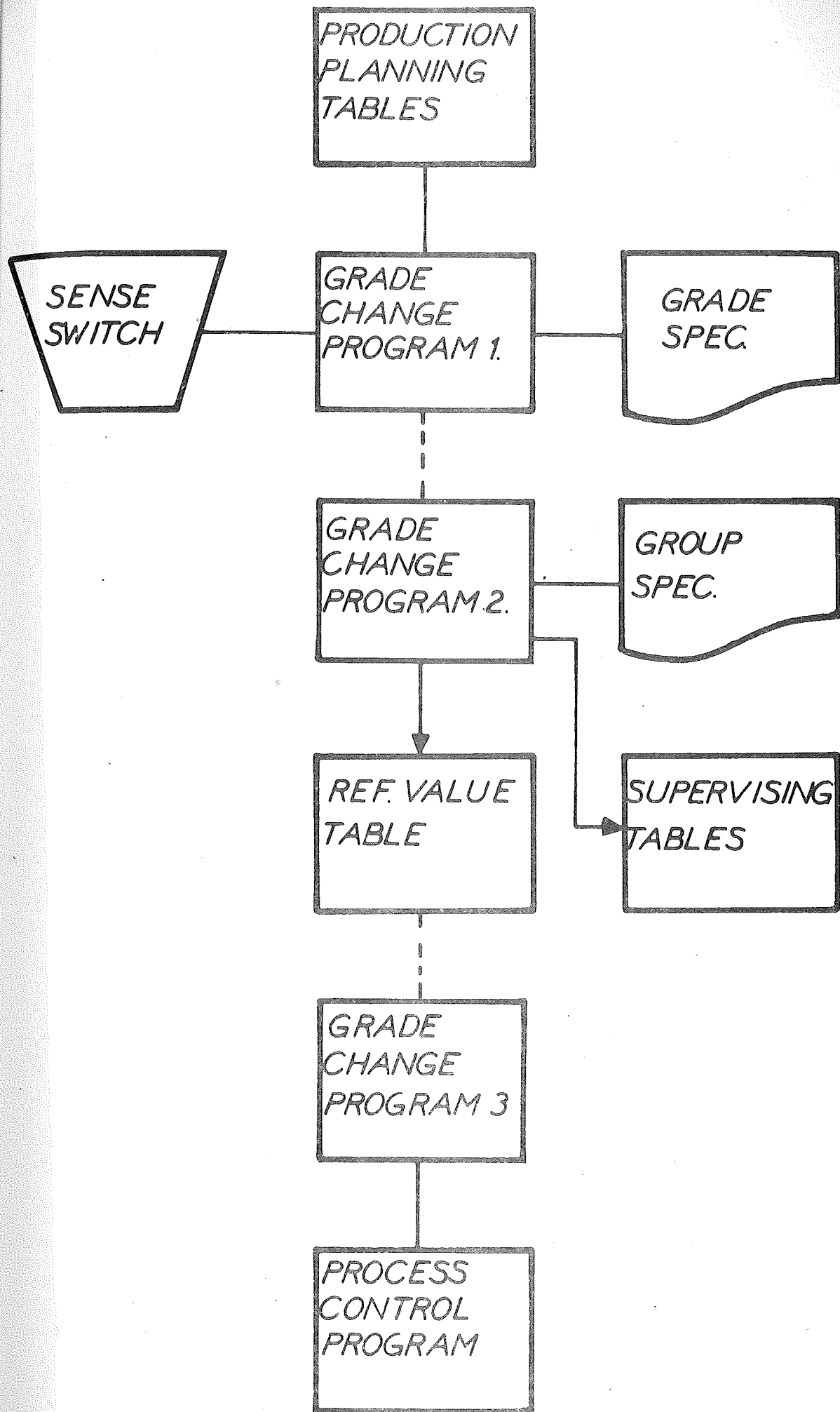

Fig. 2 GRADE CHANGE PROCEDURE

planning. The machine tender is then informed, via his printer, of the approximate time at which the grade change will take place and the specifications of the next grade. He is also asked to accept the new grade within a specified time. He accepts the new grade by turning on a switch on his sense switch unit. If he does not accept within the specified time, a message is printed out, and grade change program 1 is called once more. Grade specifications for another grade are then printed out and acceptance of the new grade is requested. This may continue until acceptance is given or until the grade under production is finished. If no acceptance is given at that time, the supervising programs are disconnected, and the machine tender is so informed via a print-out message.

When the new grade has been accepted, grade change program 2 will be called about twelve minutes before the present grade is finished. This program formulates the important supervising tables. The first is the supervising head sector table which contains grade specifications, information about the orders that are included in the grade, and other general information about the grade. The second is the set table which contains the following information:

Set identification

Section number and set number

Set length

Roll distribution within the set

The following information is supplied as the production of the grade proceeds and quality data is entered.

Date, start time and end time for each set

Sorted rolls in the set

Mean value of basis weight and moisture content for the set

Quality data from reel and set tests

Process and production data

Having formulated the supervising tables grade change program 2 prints

a message to the machine tender specifying the orders and order positions included in the group. From the grade specifications in the tables, the program then calculates new reference values for the process control programs. Some of these new values are also printed out together with the latest measured values of the same variables. This will indicate the approximate change in the running conditions. Finally grade change program 2 will initiate the process control programs to start the grade change in the refiners.

The remainder of the grade change routine is not executed before the back tender turns off the sheet length meter and thus indicates that the grade is finished. Then grade change program 3 is called. The reference values for the new grade are transferred to the process control programs, and the grade change on the paper machine is initiated. When the machine tender finds that the paper has reached the new specifications, the sheet length meter is turned on, and the reel must be changed. The grade change is then completed and production of the first set in the new group starts.

Normal Supervising Functions

During the production of one grade, the supervising programs follow the production of each set by reading the sheet length meter. Paper produced when the sheet length meter is off is considered off-grade paper.

Fig. 3 illustrates the procedure during the production of one reel. The reel contains three sets. These are indicated on the sheet, which is shown in full length. About two and a half minutes before a set change, a signal light marked "Set change" is turned on in the panels in the dry and wet end of the paper machine. At set change these signal lights are turned off thus indicating that the set is finished. At reel change another light marked "Reel Change" is turned on and off together with the set change light.

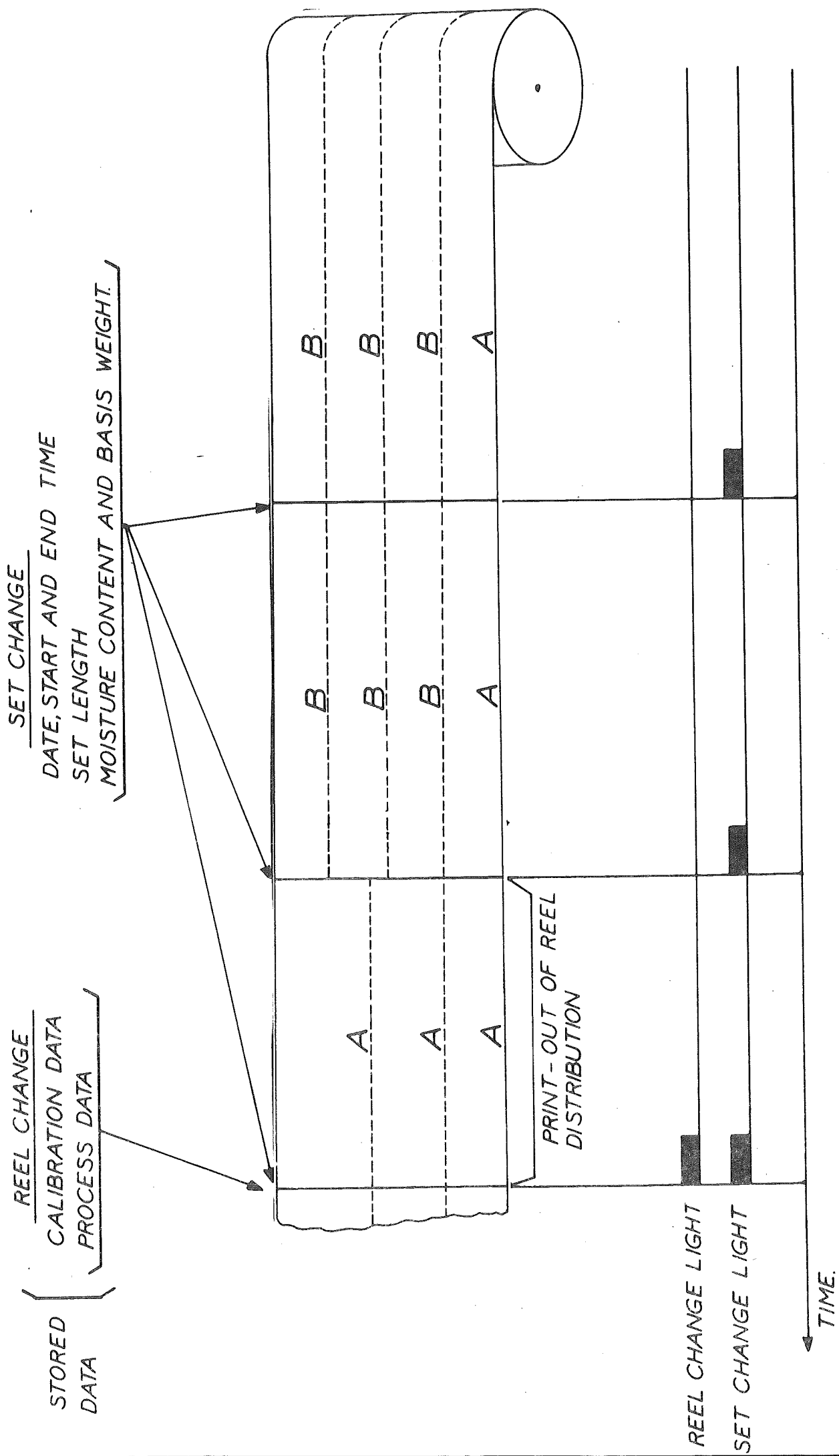

Fig. 3 NORMAL PRODUCTION SUPERVISING FUNCTION

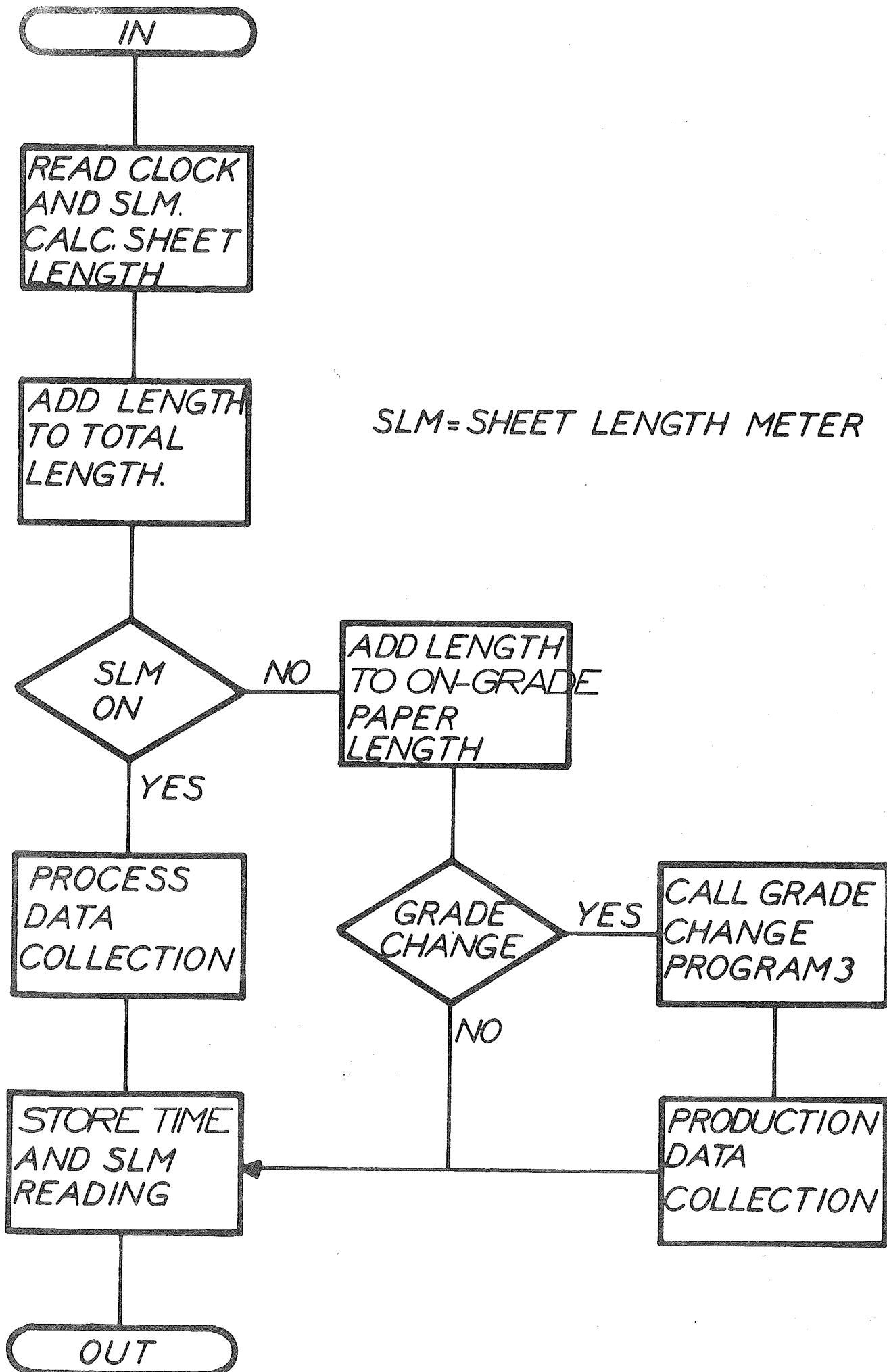

Fig. 4 SHEET LENGTH METER PROGRAM

When the sheet length meter is turned off at the end of a grade, a special data collection program will organize and store production and consumption data gathered during the production of the grade just finished for later use in the reports.

Adjustment of the Set Length

Many customers specify certain roll diameters in their orders. From the roll diameter, production planning calculates the set length using a certain value for the apparent bulk or thickness of the sheet. This value varies, however, and to obtain a correct roll diameter despite the variations in thickness, the apparent thickness is measured on-line and the set length is adjusted according to the measurement.

The method used for measuring the apparent thickness is illustrated in Fig. 5. During production, when a reel has reached a certain diameter, an interrupt occurs and the sheet length on the reel, L_1 , is determined and stored in the computer. Some time later the reel has reached a new specified diameter and a new interrupt occurs. The sheet length on the reel, L_2 , is determined, and the apparent thickness of the sheet is calculated by equating the area determined as length of sheet times apparent thickness and the area between the two specified diameters.

Actually there are three different diameters on the reel that give interrupts. If a paper break occurs, or off-grade paper is produced between two of the interrupts, the calculation of the sheet thickness between those two diameters is bypassed. Exponential smoothing of the calculated values is used to minimize the influence of random measurement errors.

REEL

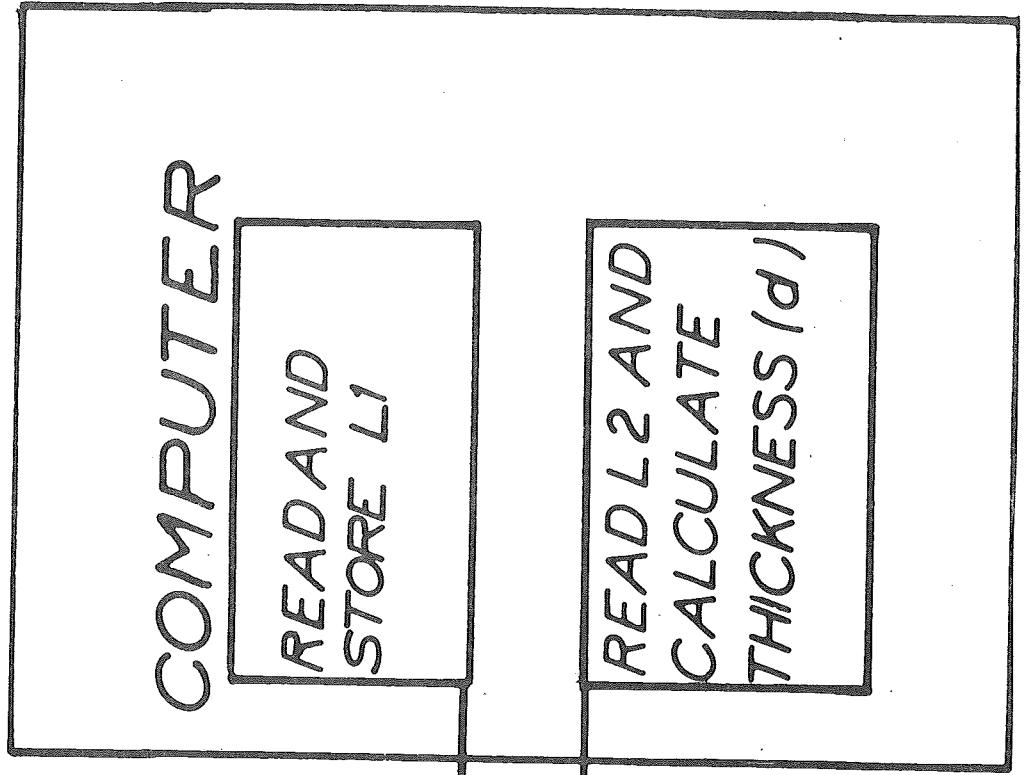
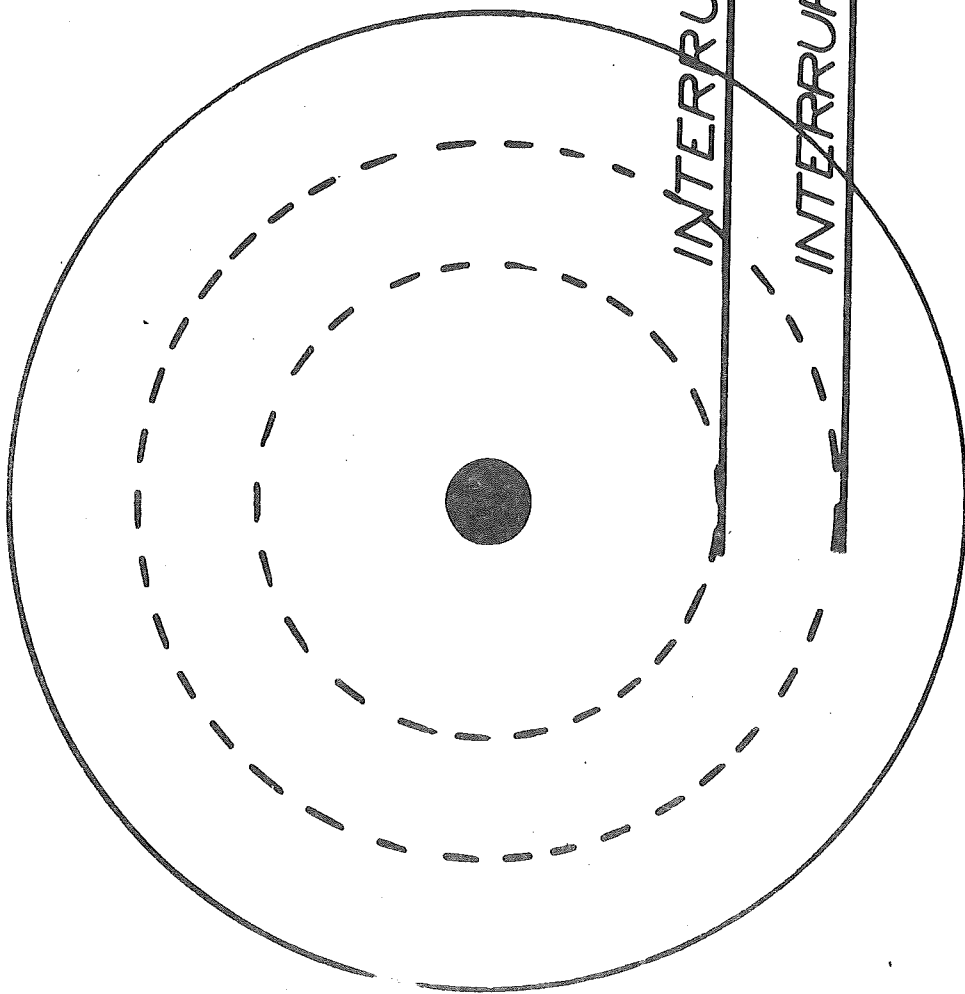

$$d = \frac{\pi (R_2^2 - R_1^2)}{L_2 - L_1}$$

Fig. 5 CALCULATION OF APPARENT THICKNESS

MANAGEMENT REPORTS

Two reports are printed in the computer room at Gruvön on demand from an operator:

1. The rejection report
2. The daily report

The rejection report gives a list of all the rejected rolls. For each roll the most important quality properties are printed out together with the reason for rejection. The latter is given as a code number. The layout of the rejection report is shown in Fig. 6.

The daily report gives the management an overall view of the production and the paper quality during the last day and night. The layout of the report is in Fig. 7. Quality data determined at the end of each reel is printed out as curves showing the variation about fixed values. Each grade starts with a line giving start time for the grade, the time for changing grade, the ordered basis weight and, if it is extensible paper, the desired stretch value in the machine direction. At the end of each grade, the mean value of the basis weight is printed out together with the standard deviation.

At the end of the report, information is given about the total amount of on-grade and off-grade paper produced during the period. Total stop time and the time consumed by paper breaks are given, and finally the different paper breaks are listed separately.

Other management reports will be printed out by the Billerud Data Processing Center at Säffle. On demand, the supervising tables will be punched on cards that will be transferred to the Data Processing Center where the tables will be stored on magnetic tape.

A special program has been written which collects quality data from the tables for any specified order position and prints out the data as shown in Fig. 8. Stretch and tensile strength at three points in the

REJECTION REPORT

DATA XX/XX KL XX.XX

K-NO	S-NO	ID-NO	R-NO	DESIRED BASIS WEIGHT	BASIS WEIGHT	TENSILE STRETCH		TENSILE STRENGTH		INTEGR. VALUE		TEAR STRENGTH		WET STRENGTH	REASON FOR REJECT
						M	C	M	C	M	C	M	C		
XXX	XXX	XX	X	XXX.X	XXX.X	XX.X	X.X	X.X	X.X	X.X	X.X	XXX	XXX	XX.X	XXX
XXX	XXX	XX	X	XXX.X	XXX.X	XX.X	X.X	X.X	X.X	X.X	X.X	XXX	XXX	XX.X	XXX
XXX	XXX	XX	X	XXX.X	XXX.X	XX.X	X.X	X.X	X.X	X.X	X.X	XXX	XXX	XX.X	XXX
XXX	XXX	XX	X	XXX.X	XXX.X	XX.X	X.X	X.X	X.X	X.X	X.X	XXX	XXX	XX.X	XXX

Fig. 6

DAILY REPORT
 DATE XX/XX KL XX.XX.

MACHINE MOISTURE AIR TENSILE
 SPEED CONTENT RESISTANCE AIR RESISTANCE STRENGTH STRETCH C.M.D. M.D. C.M.D. M.D. C.M.D.

START TIME XI.XX GRADE CHANGE TIME XXX MIN BASIS WEIGHT XXX.X STRETCH MD XX.X
 XXX 8 1 8 1 8 1 8 1 8 1
 8 1 8 1 8 1 8 1 8 1
 8 1 8 1 8 1 8 1 8 1
 8 1 8 1 8 1 8 1 8 1
 8 1 8 1 8 1 8 1 8 1

BASIS WEIGHT XXI.X STAND. DEV. XX.X

START TIME XI.XX GRADE CHANGE TIME XXX MIN BASIS WEIGHT XXX.X STRETCH MD XX.X
 XXX 8 1 8 1 8 1 8 1 8 1
 8 1 8 1 8 1 8 1 8 1 8 1
 8 1 8 1 8 1 8 1 8 1 8 1
 8 1 8 1 8 1 8 1 8 1 8 1
 8 1 8 1 8 1 8 1 8 1 8 1

BASIS WEIGHT XXX.X STAND. DEV. XX.X

TOTAL PRODUCTION XXX TON OFF GRADE PRODUCTION XX TON REJECTED XX TON
 TOTAL STOP TIME XXX MIN TOTAL TIME FOR PAPER BREAKS XXX MIN

PAPER BREAKS;

START LASTING

XX.XX XXX MIN

XX.XX XXX MIN

Fig. 7

cross-direction are printed out for each roll in the set. Other properties of the sheet are measured at the end of each reel, and these values are therefore printed out only for the last set on the reel. Mean values and standard deviations for the different properties are also given in the table.

Sufficient data is collected in the supervising tables for printing out a monthly report that will include the efficiency of the paper machine and a survey of the production during the last month. Consumption data for electricity, steam and some chemicals are also included in the monthly report.

Quality data in the supervising tables will be used to update the statistical models used in the quality control for estimating purpose, and the process data will be used later for optimizing the paper-machine operating conditions.

FINAL COMMENTS

It should be emphasized once again that all of the exceptional situations have not been discussed here. Their consideration has made the production supervising system quite complicated. A few exceptions from the normal routine which have been considered should be mentioned.

Rush orders may be received. These must be produced before any new production planning can be done. Rush orders sometimes make it necessary to interrupt the production of one grade and produce the rush order first. Special programs have been made for feeding the order information into the computer and taking care of the necessary changes in the supervising tables.

For some reason the winder crew may change the sequence of width combinations. Information about this must be entered from the manual entry unit in the laboratory.

To compensate for rolls that have been rejected it may be necessary to add extra sets to a group. The set table must then be expanded accordingly; special routines have been prepared for this.

Minor details which must be considered -- starting up the system and the fact that paper breaks may occur at any time for instance -- add considerably to the complexity of the system.

To provide some idea of its size, it should be noted that when measured in terms of programmed instructions, the supervising system is about the same size or larger than the process control system.

The reference value is determined from the calculated sheet length of the reel, the sheet width (measured manually) and the weight of the reel (measured in the crane when the reel is removed). The two values are compared and the difference is used to adjust the conversion equation of the basis weight meter.

A similar but more complicated method is used for the on-line calibration of the moisture meter.

By using the materials balance principle it is possible to use a few basic accurate instruments as a reference and to have all of the important mass flow instruments calibrated periodically.