



LUND UNIVERSITY

Simulated Fires in Substances of Pesticide Type

Andersson, Berit; Babrauskas, Vytenis; Holmstedt, Göran; Särdaqvist, Stefan; Winter, Göran

1999

[Link to publication](#)

Citation for published version (APA):

Andersson, B., Babrauskas, V., Holmstedt, G., Särdaqvist, S., & Winter, G. (1999). *Simulated Fires in Substances of Pesticide Type*. (LUTVDG/TVBB--3087--SE; Vol. 3087). Department of Fire Safety Engineering and Systems Safety, Lund University.

Total number of authors:

5

General rights

Unless other specific re-use rights are stated the following general rights apply:

Copyright and moral rights for the publications made accessible in the public portal are retained by the authors and/or other copyright owners and it is a condition of accessing publications that users recognise and abide by the legal requirements associated with these rights.

- Users may download and print one copy of any publication from the public portal for the purpose of private study or research.
- You may not further distribute the material or use it for any profit-making activity or commercial gain
- You may freely distribute the URL identifying the publication in the public portal

Read more about Creative commons licenses: <https://creativecommons.org/licenses/>

Take down policy

If you believe that this document breaches copyright please contact us providing details, and we will remove access to the work immediately and investigate your claim.

LUND UNIVERSITY

PO Box 117
221 00 Lund
+46 46-222 00 00

Simulated Fires in Substances of Pesticide Type

*Berit Andersson
Vytenis Babrauskas
Göran Holmstedt
Stefan Särdaqvist
Göran Winter*

Department of Fire Safety Engineering
Lund University, Sweden

Brandteknik
Lunds tekniska högskola
Lunds universitet

Report 3087, Lund 1999

**Simulated Fires
in Substances of
Pesticide Type**

**Berit Andersson
Vytenis Babrauskas
Göran Holmstedt
Stefan Särdaqvist
Göran Winter**

Lund 1999

Simulated Fires in Substances of Pesticide Type

Berit Andersson
Vytenis Babrauskas
Göran Holmstedt
Stefan Särdaqvist
Göran Winter

Report 3087

ISSN: 1402-3504

ISRN: LUTVDG/TVBB--3087--SE

Number of pages: 95

Illustrations: Andras Kenés, Stefan Särdaqvist

Keywords

Simulated fire, medium scale fire experiment, combustion gases, combustion products, phi value, chemicals, polymers, ventilation condition.

Abstract

In order to characterise fires in chemical warehouses, 38 medium scale experiments have been conducted. The experiments were performed in a 0.66m³ combustion chamber. On-line measurements were made of combustion gases (CO₂, CO, HC and NO_x), mass loss, smoke, temperatures, external radiation and phi-values. Intermittently gas and soot samples were collected and analysed for content of organic compounds and amount of soot produced. Main variables during the experiments were external radiation, fire diameter, opening configuration and ventilation condition. The medium scale was chosen in order to give a test method which is more convenient to work with, less expensive than full-scale experiments and still rather well simulates the conditions in a real fire.

© Copyright: Brandteknik, Lunds tekniska högskola, Lunds universitet, Lund 1999.

Brandteknik
Lunds tekniska högskola
Lunds universitet
Box 118
221 00 Lund

brand@brand.lth.se
<http://www.brand.lth.se>

Telefon: 046 - 222 73 60
Telefax: 046 - 222 46 12

Department of Fire Safety Engineering
Lund University
P.O. Box 118
SE-221 00 Lund
Sweden

brand@brand.lth.se
<http://www.brand.lth.se/english>

Telephone: +46 46 222 73 60
Fax: +46 46 222 46 12

Summary

During the 20th century a number of disastrous fires in warehouses storing chemicals, and in chemical production plants have occurred. This has increased the awareness of the problems connected with storing large amounts of chemicals. As a result of this, new legislation and guidelines have been implemented through out Europe. One part of this is the SEVESO directive, which was introduced in Europe during 1987. Currently the SEVESO II directive is being introduced. A lack of knowledge was found concerning substances produced in fires involving chemical substances, especially organic substances containing heteroatoms, like nitrogen, sulphur, phosphorus and chlorine.

The project TOXFIRE [1], a part of the CEC ENVIRONMENT programme, has as its main objective to develop a basis for two sets of guidelines in relation to fires in chemical warehouses. These are guidelines for the fire safety engineers to be used in accident prevention [2] and guidelines for the fire brigade to be used if an accident occurs [3]. The guidelines will be the outcome of a detailed and systematic study of chemical fires supplemented by experiments based on model compounds to determine important properties of the substances involved and the source characteristics and assessment of other parameters of importance for fire scenarios.

In this report results from experiments in a medium scale combustion chamber are presented. The chamber was 0.66m³ and the amount of substance burned was between 0.3kg and 2.3kg. The walls and the ceiling of the combustion chamber can be heated electrically in order to apply external radiation. Experiments were carried out using a number of chemical substances of different nature as fuel. The tested substances were: chlorobenzene, dimethoate, heptane, nylon-6,6, tetramethylthiuram monosulfide (TMTM) and 4-chloro-3-nitrobenzoic acid (CNBA). During the experiments online measurements in the exhaust duct were made of combustion gases such as CO, CO₂, NO_x, O₂ and unburned hydrocarbons. Results from the gas analysis are presented as yields in g component produced per g substance burned. Yields are given for CO, CO₂, NO_x, HC and soot. Grab samples were taken intermittently and analysed by GC-MS with respect to content of organic combustion products. A qualitative analysis of organic substances found in the GC-MS analysis is presented. A large number of substances were detected, including varying amounts of the original substance being burned. The rate of heat released, RHR, during the experiments was measured using the oxygen consumption technique. The RHR ranged from 0.4kW to 47kW. Continuous measurements were also made of temperatures inside the combustion chamber, in the opening of the chamber and in the exhaust duct. Radiation inside the chamber and mass loss was also monitored continuously.

In all 38 experiments were conducted. The conditions during the experiments varied with respect to the degree of ventilation, measured as the phi-value. Phi-values ranging from 0.04 to 1.4 were detected. It was found impossible to achieve higher phi-values in the experimental set-up used here. The ventilation was varied by changing the opening height. The results indicate that the phi-value is a useful parameter when it comes to characterisation of enclosure fires. The opening width was kept constant at 0.45m in all experiments. A comparison between the measured and calculated phi-values show that these are in good agreement. Since some of the substances contain heteroatoms like chlorine and phosphorus they are difficult to

ignite, in fact these elements are used in fire retardant applications. Thus it was necessary to apply external radiation in some of the experiments in order to achieve sustained burning of the tested substance.

Contents

Summary.....	i
Contents.....	iii
Nomenclature.....	v
1 Introduction.....	1
2 Experimental method.....	3
2.1 The combustion chamber.....	4
2.2 On line measurements inside the combustion chamber.....	4
2.3 Measurements in the opening.....	5
2.4 On line measurements in the exhaust duct.....	7
2.5 Intermittent gas samples.....	9
2.6 Selection and properties of tested substances.....	9
2.7 Experiments.....	10
3 Calculations.....	13
3.1 Mass loss and mass loss rate.....	13
3.2 Equivalence ratio.....	14
3.3 Combustion gas yields: CO ₂ , CO, NO _x and HC.....	15
3.4 Rate of heat release and total heat release.....	16
3.5 Smoke production.....	17
4 Results.....	19
4.1 Phi-values.....	19
4.2 Temperatures inside the combustion chamber.....	20
4.3 Rate of heat release and total heat release.....	21
4.4 Yields of CO ₂ , CO, HC, NO _x and smoke.....	22
4.5 Recovery of carbon.....	22
4.6 Gas analysis.....	26
5 Discussion.....	33
6 References.....	37
Appendix A: Detailed information from the experiments	
Appendix B: Diagrams of time dependant variables	

Nomenclature

A	Area of the exhaust duct [m^2]
C_d	Discharge coefficient [-]
h	Height of opening [m]
g	Gravitational constant [m/s^2]
$\Delta H_{C,ox}$	Heat release per unit mass oxygen consumed [kJ/gO_2]
ΔH_T	Theoretical heat of combustion [kJ/g]
I	Light intensity during the test [-]
I_0	Light intensity without smoke [-]
K	Extinction coefficient [$1/\text{m}$]
L	Light beam length through the smoke [m]
m	Mass concentration of the smoke aerosol [g/m^3]
m_{fuel}	Total mass of sample burned [g]
m_i	Total mass of gas i produced [g]
m_{soot}	Amount of soot [g]
\dot{m}_{fuel}	Amount of fuel burned [g/s]
\dot{m}_{O_2}	Amount of oxygen consumed [g/s]
M_C	Molecular weight of carbon [g/mole]
M_{CO}	Molecular weight of CO [g/mole]
M_{CO_2}	Molecular weight of CO_2 [g/mole]
M_{NO_2}	Molecular weight of NO_2 [g/mole]
M_{nylon}	Molecular weight of nylon [g/mole]
Δp	Pressure difference in the exhaust duct [Pa]
q	Rate of heat release [kW]
r	Stoichiometric fuel/air mass ratio [-]
T_0	Temperature of ambient air [K]
T_e	Temperature in the exhaust duct [K]
T_u	Mean temperature in the hot upper layer in the combustion chamber [K]
\dot{V}	Volume flow in the exhaust duct [m^3/s]
w	Width of opening [m]
X_0	Concentration of oxygen in the surrounding air [-]
X_i	Mole fraction of gas i in the exhaust duct [-]
X_m	Scale value on the oxygen meter [-]
X_{O_2}	Molar fraction of oxygen in the oxygen meter with extra oxygen [-]
$X_{O_2}^0$	Mole fraction of O_2 in the incoming air [-]
Y_i	Yield of product i [g/g]
α	Expansion factor [-]
ϕ	Equivalence ratio [-]
ρ_0	Density of air at ambient temperature [kg/m^3]

σ_m	Extinction area [m ² /g]
Ψ_C	Yield of C [g/g]
Ψ_{CO}	Yield of CO [g/g]
Ψ_{CO_2}	Yield of CO ₂ [g/g]
Ψ_{NO_2}	Yield of NO ₂ [g/g]

1 Introduction

This report constitutes a part of the CEC ENVIRONMENT project entitled "TOXFIRE - Guidelines for Management of Fires in Chemical Warehouses"[1].

The objective of the project is to develop a basis for two sets of guidelines in relation to fires in chemical warehouses; guidelines for the fire safety engineers to be used in accident prevention [2], and guidelines for the fire brigade to be used if an accident nevertheless occurs [3]. The guidelines will be the outcome of a detailed and systematic study of chemical fires supplemented by experiments based on model compounds to determine important properties of the substances involved and the source characteristics and assessment of other parameters of importance for fire scenarios. In addition, the consequences to humans and the environment of the fire will be included. A common introduction and approach to the guideline documents is presented in [4].

Based on a number of parameters the substances will be classified. The classification of substances requires studies and experiments of ignitability, heat release, burning rate, smoke evolution, combustion products and influence on the combustion products of the packaging materials. The characterisation of the source will use parameters obtained by carrying out combustion experiments of various scales and by studying the effects of scaling. In addition, the fire scenarios will be characterised by the degree of ventilation, the packaging materials, the stacking of the materials and the response of the building. In addition, the suppression is an important parameter, i.e. active and passive suppression and the fire brigade tactics. The consequences to humans as well as the environment will be assessed. Finally, existing modelling methods used for risk assessment will be studied, along with the handling and prevention of accidents. These investigations will lead to the development of the basis for guidelines document for the fire safety engineers and the fire brigades. In parallel also a quick decision system to be used by the fire chief in case of a chemical fire will be developed.

The project comprises the following workpackages:

- WP 1: Screening of substances and micro scale experiment
- WP 2: Small scale cone calorimeter experiments
- **WP 3: Medium scale (model scale) experiments**
- WP 4: Indoor large scale underventilated fire tests
- WP 5: Effects of storage configuration and fire spread models
- WP 6: Sampling and analysis of dioxins
- WP 7: Consequence models for health hazards
- WP 8: Consequence models for ecotoxicological effects
- WP 9: Quick decision system
- WP10: Guidelines for safety engineers
- WP11: Guidelines for fire brigades
- WP12: Project management

The participants in the project are:

- Risø National Laboratory, Denmark
- South Bank University, UK
- VTT - The Technical Research Centre of Finland
- **Lund University, Sweden**
- SP - The Swedish National Testing and Research Institute
- DMU - The Danish National Environmental Research Institute

This report contains the results and conclusions from WP 3: Medium scale experiments.

2 Experimental method

The medium-scale combustion tests were performed in a 0.66m^3 combustion chamber. The amount of substance burned was between 0.3kg and 2.3kg. The combustion chamber is equipped with a hood to collect all smoke and combustion gases. The hood is connected to an exhaust duct where on-line measurements were made. A phi-meter was incorporated into the measuring system to determine the degree of ventilation during the experiments. Gas samples and soot samples were collected intermittently. The gas samples were analysed with gas chromatography-mass spectrometry and with ion chromatography. Soot was collected intermittently on a filter in order to determine the mass of soot produced.

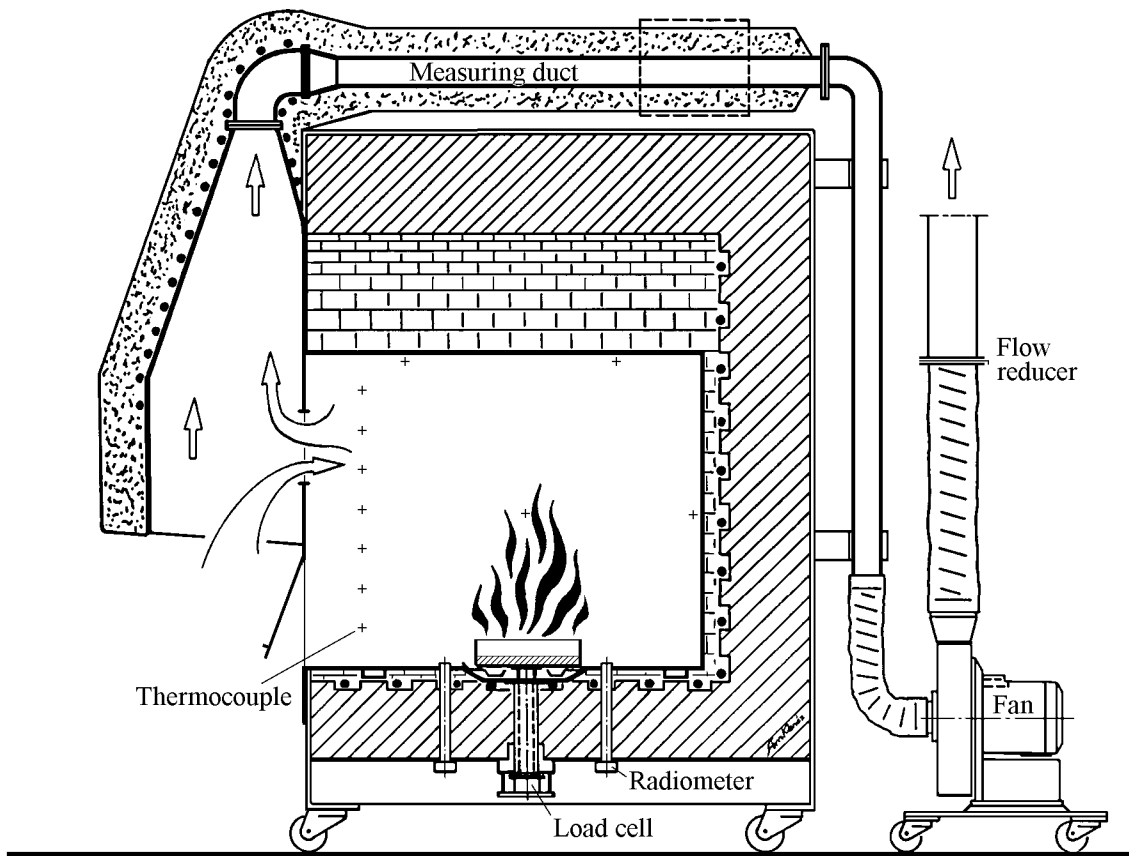

Figure 1. Overall, configuration of the combustion chamber.

2.1 The combustion chamber

The stainless steel combustion chamber used during these experiments is fitted inside a furnace constructed of ceramic, high temperature bricks. The internal dimensions of the steel chamber are 0.75m (width), 1.10m (depth) and 0.80m (height), giving a volume of 0.66m³. This is approximately 1/3 of the standard, ISO room corner test (ISO 9705). The internal dimensions of the oven are 0.80m (width), 1.10m (depth) and 1.09m (height). This gives a portion of air above the steel chamber and between the sidewalls of the chamber and the oven sidewalls. There is an opening in one wall. The opening width is 0.45m. The height of the opening is adjustable in order to change the ventilation conditions. Stainless steel covers were used to change the opening height. The walls and ceiling in the combustion chamber can be electrically heated in order to apply external radiation. The maximum temperature achievable in the chamber corresponds to a radiation towards the floor of approximately 50kW/m². The over all configuration of the combustion chamber is given in figure 1.

2.2 On line measurements inside the combustion chamber

A number of measurements were made inside the combustion chamber. A load cell was positioned in the centre of the floor beneath the chamber. The exact position can be seen in figure 1. The load cell was connected to a platform inside the chamber via a ceramic rod. This arrangement was made to avoid thermal influence on the load cell as much as possible. Thus, the tested substances are placed 0.05m above the bottom of the combustion chamber. Two radiometers were mounted in the floor of the combustion chamber. They were of the Gunners' type [5], and were positioned in front and behind the weight-measuring device. The exact positions of the radiometers were 0.43m from the opening and 0.20m from the rear wall. Both radiometers were positioned along the centre line of the chamber. The upper surfaces of the radiometers were 10mm above the bottom of the combustion chamber. The radiometers were calibrated in a spherical furnace according to the procedure described in [6]. An array of eight thermocouples was mounted vertically in one corner of the chamber, 0.05m from the adjacent walls. The thermocouples were mounted at the following distances from the ceiling: 5mm, 10mm, 15mm, 20mm, 30mm, 40mm, 50mm and 60mm. Three thermocouples were placed on the walls; each of these was mounted in the centre of the wall and three in the ceiling to measure surface temperatures. The thermocouples in the ceiling were mounted according to the following specification: One thermocouple was placed 0.30 m from the opening wall and 0.15m from the right-hand wall and two thermocouples were placed 0.30m from the rear wall and 0.15m from the right-hand wall and from the left-hand wall respectively. Specifications on the measuring equipment are presented in table 1.

Table 1. Measuring equipment used inside the combustion chamber.

Measurement	Equipment	Range	Accuracy
Radiation	Gunners' radiometers	0 - 100kW/m ²	± 5%
Mass	Load cell	0 - 10kg	± 1g
Temperature	Thermocouple Chromel Alumel, d=0.25 mm	0 - 1300°C	0.4%

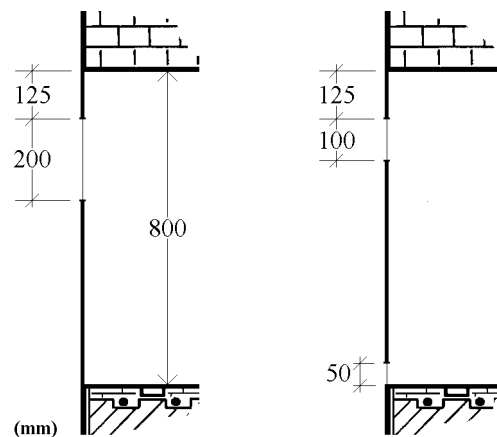

Figure 2. Opening configurations used in the combustion chamber. The left one was used in test 001-021 and the right was used in test 022-038

2.3 Measurements in the opening

The opening of the chamber had a width of 0.45m in all experiments. The height of the opening however was varied in order to change the ventilation conditions. This was achieved by placing stainless steel covers of different size in the opening. The design of the opening is presented in figure 2. In the centre of the opening an array of seven thermocouples was mounted in order to measure the gas temperature of the hot combustion gases and the air entering the chamber. The thermocouples were evenly distributed along the vertical centreline of the opening. See figure 3 for position of the thermocouples. Two probes were mounted in the opening for taking gas samples to the phi-meter and for gas analysis. Each of these probes had three 1.5mm holes. The positions of these holes are indicated with small arrows in figure 3. The gas samples were drawn to the phi-meter and in some tests, concentrations of CO, CO₂ and O₂ in the opening were measured. The probes were mounted diagonally in the upper part of the opening to ensure that the samples were taken in the hot gases leaving the chamber. The concentrations are a mean value of the concentrations in the hot upper layer in the chamber. The probes are made with three holes equally spaced along the probe. The phi probe was mounted with the holes facing the inside of the chamber in order to get samples containing all types of combustion products, including soot. The probe for gas sampling on the other hand was mounted with the holes facing the outside in order to avoid soot in the samples. The positions of the probes are given in figure 3.

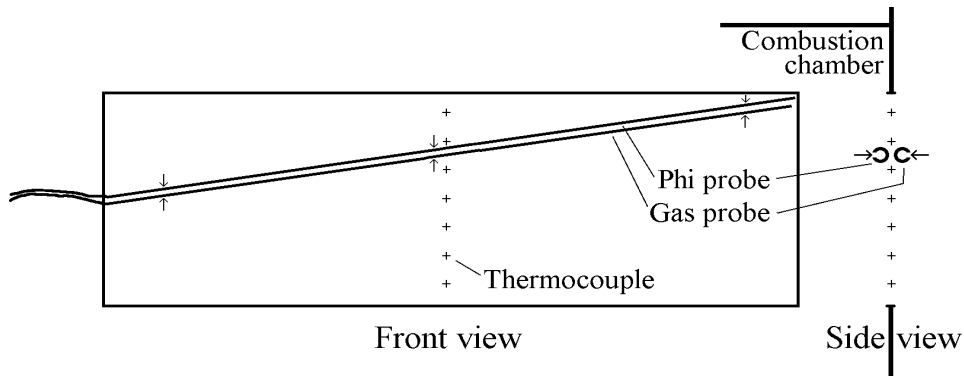

Figure 3. Positions of thermocouples and gas probes in the opening of the combustion chamber.

When studying fires with varying degrees of ventilation a parameter phi, the combustion equivalence ratio has been introduced to describe the ventilation condition [7]. Equipment by which this parameter can be measured has been used in these experiments. The main principle for the phi-meter is to expose the combustion gases to a catalytic combustion in a reactor with a platinum wire catalyst. In the original layout for the phi-meter, the temperature in the reactor was 1000°C. A change of the catalyst, to a platinum catalyst in pellet form, made it possible to reduce the reactor temperature to 400°C. In the reactor, all combustion products are transformed to CO₂ and H₂O. Following the reactor, the gases go through a train of filters where CO₂ and H₂O are removed. The dry remaining nitrogen-oxygen mixture is then analysed with respect to oxygen content. In order to cover fuel rich conditions a known amount of pure oxygen is introduced to the reactor. An overall view of the phi-meter is given in figure 4. The conditions of the phi-measurements were the same throughout the experimental series. The total mass flow through the system was $0.6 \cdot 10^{-3} \text{ m}^3/\text{min}$, the flow of pure oxygen was $0.13 \cdot 10^{-3} \text{ m}^3/\text{min}$ and the temperature in the reactor was 400°C.

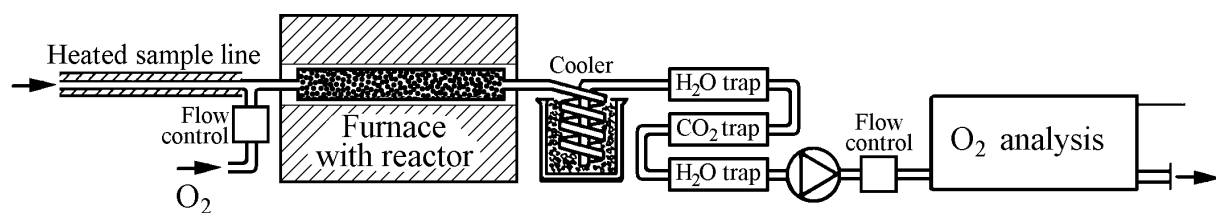

Figure 4. Overall view of the phi-meter.

Much effort has been put into calibrating and verifying the function of the phi-meter. In figure 5 a calibration diagram for the phi-meter is presented. The calibration was performed with propane. The time constant for the phi-meter was measured to 30 s. The phi-meter is sensitive to the amount of oxygen added to the system. This means that by changing the added amount of oxygen, the working range for the phi-meter is also changed. When a certain level of phi is anticipated the oxygen level should be chosen accordingly to suit this measuring range.

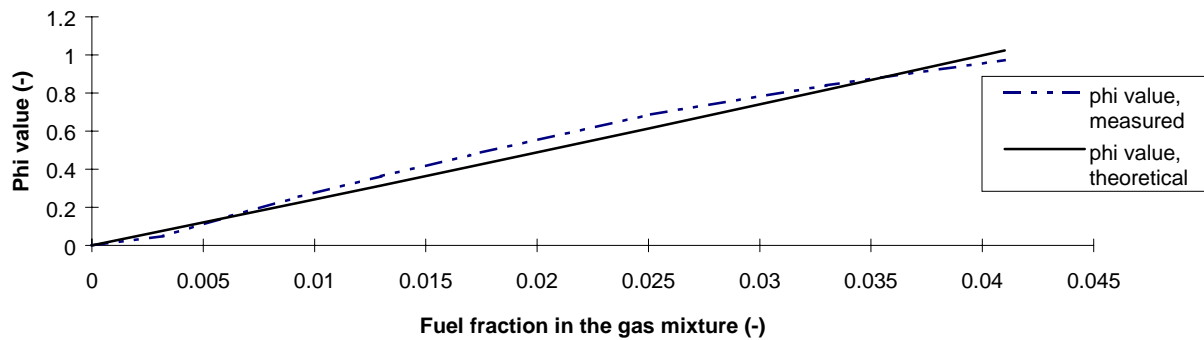

Figure 5. Calibration curve for the phi-meter showing a comparison between theoretical and measured phi values.

2.4 On line measurements in the exhaust duct

A hood, which collects all smoke and combustion gases from the combustion chamber, is located outside the opening. The hood is connected to an exhaust duct, including a flow stabilising section, where all sampling probes are located. The whole system is thermally insulated to avoid condensation problems. A 2.2kW radial fan exhausts the smoke. The flow in the duct can be regulated by means of introducing flow reducers of varying size.

The exhaust duct is equipped with a bi-directional pitot tube, a thermocouple, a light absorption measuring device and a probe for continuous measurements of concentrations of O_2 , CO_2 , CO , NO_x and HC (unburned hydrocarbons). Specifications for the measuring equipment are presented in tables 2 and 3. The overall layouts are given in figure 6.

Table 2. Measuring equipment used in the exhaust duct.

Measurement	Equipment	Range	Accuracy
Smoke	Lamp with colour temperature $2900 \pm 100K$ And photo cell detector	0 - 100%	Lamp: $\pm 0.2\%$ Detector: Linear within 5%
Pressure drop	Pressure transducer connected to a Bi-directional pitot tube	0 - 400Pa	$\pm 0.5\%$
Temperature	Thermocouple, Chromel Alumel, D= 0.25mm	0 - 1300°C	$\pm 0.4\%$

Table 3. Gas analysis equipment for continuous analysis in the exhaust duct.

Measurement	Equipment	Range, accuracy	Calibration gas
O ₂	Siemens Oxymat 5E Paramagnetic	10-21vol% ± 1% of full scale	21% 9.94 ± 0.200%
CO	Siemens Ultramat 22P, Non-dispersive IR-absorption	0-1vol% ± 1% of full scale	0.202 ± 0.0040ppm 202 ± 4.04ppm
CO ₂	Siemens Ultramat 22P, Non-dispersive IR-absorption	0-20vol% ± 1% of full scale	4.99 ± 0.0998% 0.502 ± 0.010%
NO _x	Analysis Automation Limited, Chemiluminiscens analysis, model 443	0-100ppm ± 1% of full scale	93.6 ± 1.9ppm
HC	Siemens Fidamat K FID (flame ionisation detector)	0-100ppm ± 1% of full scale	50.9 ± 1.0ppm propane

The mass flow in the exhaust duct was calculated according to NT FIRE 025 [8], using the values from the pitot tube and the thermocouple in the duct. The smoke extinction was also measured according to NT FIRE 025. The gas samples for continuous measurement of O₂, CO and CO₂ were cooled and dried and freed from particles before they entered the analysis instruments. The samples for NO_x and HC measurements were taken through a sampling line heated to 200°C and a heated smoke filter. The gas analysis equipment was calibrated with zero and span gases of concentrations within the same area of magnitude as the expected test samples. All measurements were performed on-line and a Schlumberg data-logger was used to collect the data and transfer them to a PC. The scan interval was 5s.

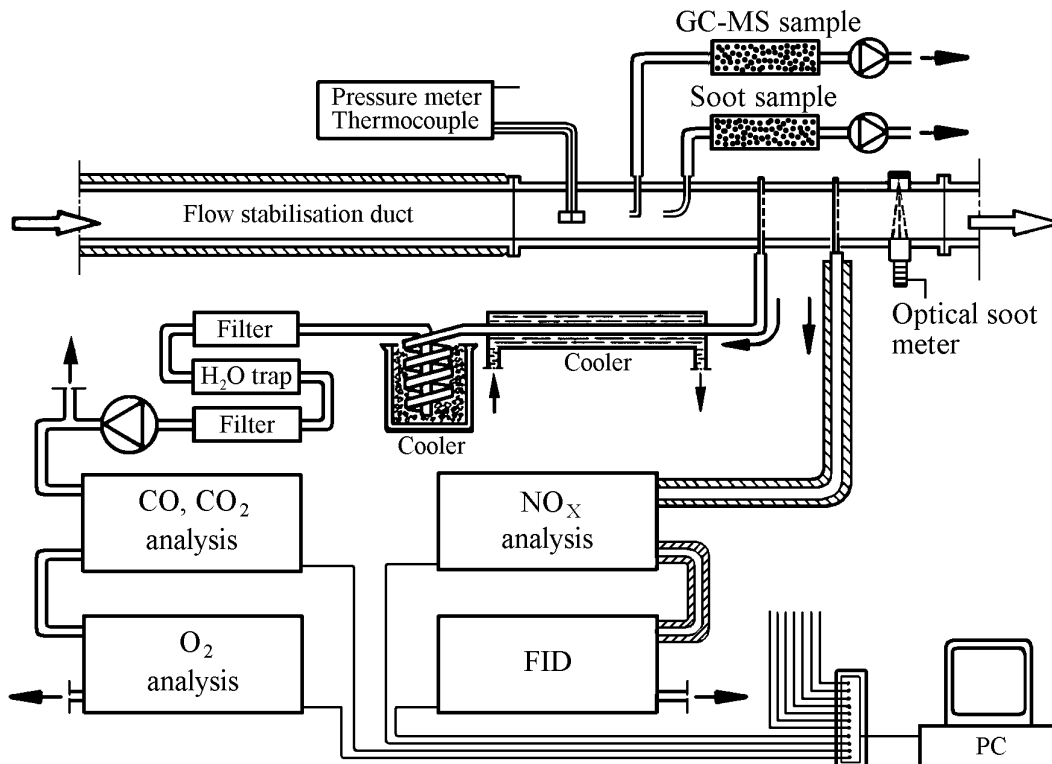

Figure 6. Layout of the measuring equipment for the on line measurements in the exhaust duct.

2.5 Intermittent gas samples

Gas samples were taken intermittently from the exhaust duct in order to determine the main components in the combustion gases. The samples were drawn iso-kinetically from the sample probe at intervals during which the combustion was deemed approximately constant. The sampling period was typically 5 minutes. The combustion products were adsorbed on Amberlite XAD-2 and on activated carbon. XAD-2 is a frequently used adsorbent for sampling of gaseous components. An extra XAD-2 tube was mounted directly after the first one to take care of any excess products. The first tube was filled with 600 mg XAD-2 and the second tube with 300 mg. After the XAD-2 tubes were two tubes with activated carbon in order to collect the substances that are not adsorbed on the XAD-2. The combustion gases collected on XAD-2 were extracted with diethyl ether and the products adsorbed on carbon were extracted with carbon disulphide. The extracts were subsequently analysed with GC-MSD and GC-MSD-FID. The column in the MSD was a non-polar column.

The identification of the substances in the combustion gases was made with the GC-MSD and subsequently a quantitative analysis was made with FID when this was feasible. Analysis was also made of the content of anions in the combustion gases. This was achieved by letting the gas flow through a train of two impinger bottles with a water solution of NaOH with pH9. Analyses were made of Cl⁻ and SO²⁻ content when this was relevant. These analyses were made with ion chromatography.

Gas samples were also taken in order to study the soot content in the combustion gases. The soot particles were collected on filters that were dried and weighed before test and after test to determine the amount of soot produced during the test. The soot filters were made of Teflon and were of the type Millex-FG₅₀ from Millipore. The optical measurements in the duct were transformed to yields and together with the amount of soot collected on the filter, this gave the smoke extinction area for the burned substance. This was done according to the principles described in section 3.5.

2.6 Selection and properties of tested substances

As mentioned earlier the TOXFIRE project comprises a number of different work packages. In WP1 to WP4, substances were tested in different scales and thus varying amounts of substances were tested. Depending on the tested amount the number of substances that could be tested varied between the testing methods. Different criteria had to be met in different testing situations. The largest number of tested substances could be dealt with in the small-scale tests. In the medium scale tests six substances were tested. The tested substances are presented in table 4.

Table 4. Materials tested

Substance	State, form
Heptane, C ₇ H ₁₆	Liquid
Chlorobenzene, C ₆ H ₅ Cl	Liquid
Tetramethylthiuram monosulfide, TMTM, C ₆ H ₁₂ N ₂ S ₃	Extrusion granules
4-Chloro-3-nitrobenzoic acid, CNBA, C ₇ H ₄ ClNO ₄	Powder
O,O-dimethyl-S-(N-methylcarbamoylmethyl)-Phosphorodithioate, Dimethoate, C ₅ H ₁₂ NO ₃ PS ₂	Formulation with cyclohexanon and xylene
Nylon-6,6, C ₁₂ H ₂₂ N ₂ O ₂	Solid polymer, pellets

The materials in table 4 were chosen from the list of materials common to the TOXFIRE project. They represent a number of different types of substances. Heptane is a simple hydrocarbon fuel, chlorobenzene is a chlorinated solvent, TMTM represents substances containing sulphur, CNBA contains chlorine and nitrogen, Dimethoate is a pesticide containing nitrogen, phosphorus and sulphur and nylon-6,6 is a polymer which has been used as a reference material throughout the STEP [9] and the TOXFIRE projects. The selection of substances was made to give a wide spectrum of types of substances as regards content of heteroatoms such as chlorine, nitrogen, phosphorus and sulphur. It was also required that the substances have controllable combustion behaviour and they could not be so highly toxic that the staff or nearby persons would be endangered.

The tested substances represent a wide spectrum as regards their burning behaviour. The chlorine containing substances are inherently fire retardant and thus rather difficult to ignite. Nylon 6,6 is a thermoplastic polymer and melts before it is possible to ignite the substance. Nylon 6,6 therefore needs external heat flux in order to ignite. CNBA was also found hard to ignite. In some of the tests polypropylene was added and acted as an ignition source. Selected properties of the tested substances are given in table 5.

Table 5. Molecular weight, theoretical heat of combustion and theoretical yields for the tested substances.

Substance	M _w [g/mole]	ΔH _{C,ox} [kJ/gO ₂]	ΔH _T [kJ/g]	Ψ _C [g/g]	Ψ _{CO2} [g/g]	Ψ _{CO} [g/g]	Ψ _{NO2} [g/g]	Ψ _{HCl} [g/g]	Ψ _{SO2} [g/g]
Heptane	100.2	13.1	44.59	0.84	3.08	1.96	-	-	-
Chlorobenzene	112.6	13.16	26.19	0.64	3.66	1.49	-	0.325	-
TMTM	208.4	13.96	25.73	0.35	1.28	0.82	0.442	-	0.922
CNBA	201.6	14.96	13.66	0.42	1.54	0.98	0.228	0.181	-
Dimethoate*	152.6	13.1	42.76	0.46	3.66	1.03	0.301	-	0.327
Nylon-6,6	226.4	12.38	28.94	0.64	2.35	1.49	0.407	-	-

* Dimethoate was tested as a formulation consisting of 41% Dimethoate, 45% cyclohexanon and 14% xylene. The figures in the table refer to the formulation.

2.7 Experiments

The performance of each experiment followed a standard procedure. The measuring equipment was calibrated prior to start of the experiment. After the calibration the data logger was started. The substance was placed in a cylindrical container on the load cell, in the centre of the combustion chamber. Containers having an inner diameter from 0.10m to 0.40m were used. The tested substance was in most experiments ignited with a small flame. For some substances, more intense ignition sources were necessary. The sample was left to burn until self-extinction in most experiments. In a few experiments, extinction with CO₂ was necessary due to uncontrolled burning.

Apart from the variation in size of the sample, the ventilation and the external radiation to the sample was varied. The ventilation was changed by altering the height of the opening to the combustion chamber. The largest ventilation was with an opening of 0.2m, at the top of the chamber. For the other ventilation conditions, the opening at the top was 0.1m and in addition, a small opening was arranged at the bottom of the chamber. The size of the small opening varied from 0.01m to 0.05m. External radiation was achieved by electrically heating the walls

and the ceiling of the combustion chamber. Two levels of external radiation were used during the experiments, namely 4.2kW/m^2 and 22.4kW/m^2 .

In all 38 experiments were performed within the project. The conditions for each experiment are given in tables 6 to 11.

Table 6. Experimental conditions for tests with heptane.

HEPTANE					
Test Number	Substance	Amount burned (kg)	Diameter of fire (m)	Opening height (m)	External radiation (kW/m^2)
HEP001	Heptane	1	0.2	0.2	0
HEP002	Heptane	2	0.3	0.2	0

Table 7. Experimental conditions for tests with chlorobenzene.

CHLOROBENZENE					
Test Number	Substance	Amount burned (kg)	Diameter of fire (m)	Opening height (m)	External radiation (kW/m^2)
CB003	Chlorobenzene	-	0.2	0.2	0
CB004	Chlorobenzene	1.2	0.2	0.2	0
CB005	Chlorobenzene	1	0.3	0.2	0
CB006	Chlorobenzene	0.8	0.4	0.2	0
CB019	Chlorobenzene	2.1	0.2	0.2	0
CB020	Chlorobenzene	2.5	0.2	0.2	0
CB021	Chlorobenzene	2.3	0.2	0.2	4.2
CB022	Chlorobenzene	0.7	0.1	0.1+0.05*	4.2
CB023	Chlorobenzene	0.3	0.1	0.1+0.02*	4.2
CB024	Chlorobenzene	0.4	0.15	0.1+0.02*	4.2
CB025	Chlorobenzene	1.4	0.2	0.1+0.02*	4.2
CB026	Chlorobenzene	0.6	0.1	0.1+0.02*	22.4
CB027	Chlorobenzene	0.8	0.15	0.1+0.02*	22.4
CB028	Chlorobenzene	0.6	0.15	0.1+0.01*	22.4
CB029	Chlorobenzene	0.4	0.1	0.1+0.01*	22.4
CB030	Chlorobenzene	0.3	0.15	0.1+0.01*	22.4

* The opening was divided into two parts, 0.1m at the top and 0.05m, 0.02m and 0.01m respectively at the bottom.

Table 8. Experimental conditions for experiments with TMTM.

TMTM					
Test Number	Substance	Amount burned (kg)	Diameter of fire (m)	Opening height (m)	External radiation (kW/m ²)
TMTM007	TMTM	1	0.2	0.2	0
TMTM008	TMTM	1	0.3	0.2	0
TMTM009	TMTM	1.5	0.4	0.2	0
TMTM010	TMTM	2.2	0.4	0.2	0
TMTM014	TMTM	2	0.4	0.2	0
TMTM037	TMTM	0.7	0.3	0.1+0.01*	22.4
TMTM038	TMTM	1.1	0.3	0.1+0.01*	22.4

*The opening was divided into two parts, 0.1m at the top and 0.01m at the bottom.

Table 9. Experimental conditions for tests with CNBA.

CNBA					
Test Number	Substance	Amount burned (kg)	Diameter of fire (m)	Opening height (m)	External Radiation (kW/m ²)
CNBA016	CNBA	0.3	0.2	0.2	0
CNBA017	CNBA	2.3	0.3	0.2	0
CNBA018	CNBA*	1.6	0.3	0.2	0

* Polypropylene was added as ignition source.

Table 10. Experimental conditions for tests with dimethoate.

DIMETHOATE					
Test Number	Substance	Amount burned (kg)	Diameter of fire (m)	Opening height (m)	External radiation (kW/m ²)
DIM011	Cyclohexanone + xylene	1	0.2	0.2	0
DIM012	Dimethoate	0.6	0.2	0.2	0
DIM013	Dimethoate	0.6	0.3	0.2	0
DIM015	Dimethoate	1.2	0.3	0.2	0

Table 11. Experimental conditions for tests with Nylon 6,6.

NYLON 6,6					
Test Number	Substance	Amount burned (kg)	Diameter of fire (m)	Opening height (m)	External radiation (kW/m ²)
NYL031	Nylon 6,6	0.3	0.1	0.1+0.01*	22.4
NYL032	Nylon 6,6	0.3	0.15	0.1+0.01*	22.4
NYL033	Nylon 6,6	0.5	0.2	0.1+0.01*	22.4
NYL034	Nylon 6,6	0.6	0.3	0.1+0.01*	22.4
NYL035	Nylon 6,6	1	0.4	0.1+0.01*	22.4
NYL036	Nylon 6,6	1.2	0.4	0.1	22.4

*The opening was divided into two parts, 0.1m at the top and 0.01m at the bottom.

3 Calculations

A large amount of data was collected during each experiment. The data was recorded by means of a data logger. After the experiment the recorded data was processed and transformed to variables that could be interpreted and used as results from the performed tests. In the following sections, descriptions are given of the calculations performed during the evaluation of each experiment.

3.1 Mass loss and mass loss rate

The mass and the mass loss were measured with a load cell as described in section 2.2. The mass of the sample was registered every 5s and thus the mass loss was also calculated every 5s. This gives a very fluctuating curve. The turbulence in the room caused by the flow of air and combustion gases also influences the mass measurements. In order to make the influence of these fluctuations as small as possible the mass loss was calculated as the mean values over periods of various duration. In figure 7, examples are given from DIM013 with Dimethoate. Curve 1 is calculated with a mean value of the mass taken over 232s and curve 2 is calculated with a mean value over 72s. As can be seen the curve becomes much smoother when the period, over which the mean value is taken, is increased. As can be seen in figure 8, the mass loss is relatively constant, over a long period of the experiment. It is therefore possible to take the mean value over a long period, without making a large error in the calculation of the mass loss rate.

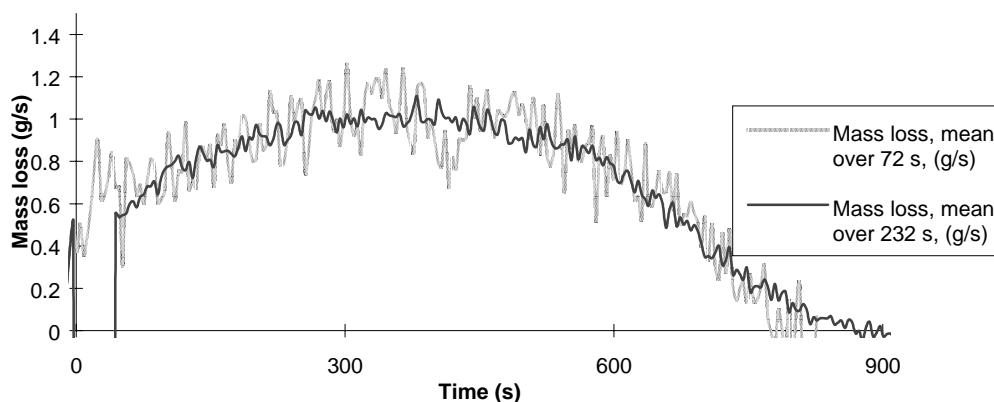

Figure 7. Mass loss as a function of time for DIM013 with Dimethoate.

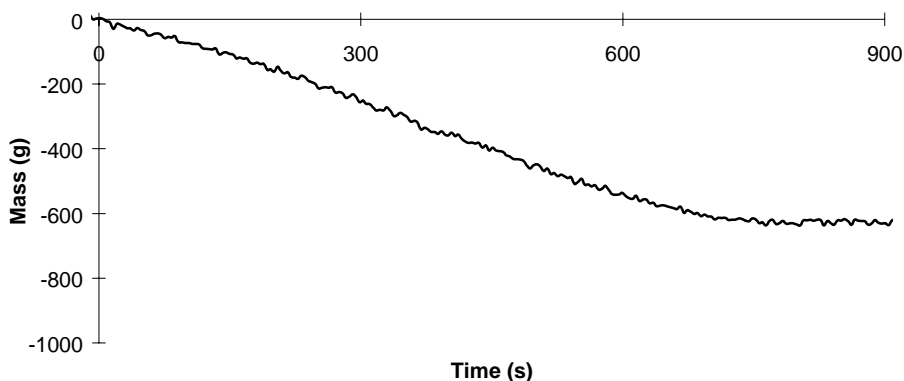

Figure 8. The mass of the sample, as a function of time for DIM013 with Dimethoate.

3.2 Equivalence ratio

The ventilation condition during the experiment has a great influence on the development of the fire. One way of describing the ventilation is to use the equivalence ratio or as it is often called the phi-value. The theoretical phi-value can be written as in equation [3.1]:

$$\phi = \left(\frac{\dot{m}_{fuel}}{\dot{m}_{O_2}} \right) / \left(\frac{\dot{m}_{fuel}}{\dot{m}_{O_2}} \right)_{stoich} \quad [3.1]$$

Where the ratio between \dot{m}_{fuel} , the amount of fuel and \dot{m}_{O_2} , the amount of oxygen available, in the actual case is compared to the same ratio at stoichiometric conditions. \dot{m}_{fuel} is determined by measuring the mass loss of the burned substance and massflow of oxygen entering the combustion chamber.

Experimentally the phi-value is measured with an apparatus called a phi meter. The principle of this equipment is described in section 2.3. The phi-value was determined from the phi meter reading by equation [3.2]:

$$\begin{aligned} \phi &= (X_{O_2} - X_m) / (X_o \cdot (1 - X_m)) \\ \phi &= 1 \text{ stoichiometric combustion} \\ \phi &< 1 \text{ well - ventilated combustion} \\ \phi &> 1 \text{ under - ventilated combustion} \end{aligned} \quad [3.2]$$

X_{O_2} is the molar fraction of oxygen in the oxygen meter with extra oxygen, X_m is the scale value on the oxygen meter and X_o is the concentration of oxygen in the surrounding air, normally 20.9 %. This measured phi-value can then be compared to the theoretical value.

The stoichiometric fuel/air mass ratio, commonly known as r, is given in kg_{fuel} per kg_{air} . r can be calculated from the reaction formula for complete combustion of the burned substance. The reaction formula for complete combustion of heptane is given below, [3.3]:



This gives a value of r for heptane of $0.0662kg_{fuel}/kg_{air}$. The value of r for the substances tested are given in Table 12.

Table 12. The stoichiometric fuel/air mass ratios for tested substances.

Substance	r [kg _{fuel} /kg _{air}]
Heptane, C ₇ H ₁₆	0.0662
Chlorobenzene, C ₆ H ₅ Cl	0.1171
TMTM, C ₆ H ₁₂ N ₂ S ₃	0.1264
Dimethoate, C ₅ H ₁₂ NO ₃ PS ₂ , formulation*	0.1145
Cyclohexanone, C ₆ H ₁₀ O + xylene, C ₈ H ₁₁ **	0.0854
CNBA, C ₇ H ₄ CINO ₄	0.2551
Nylon 6,6, C ₁₂ H ₂₂ N ₂ O ₂	0.0999

* Dimethoate was tested in a solution with 77% (by weight) cyclohexanone and 23% xylene

** The formulation consisted of 41% dimethoate, 45% cyclohexanone and 14% xylene.

The r-values are calculated for complete combustion. This means that all carbon is transformed to carbon dioxide, CO₂ and all hydrogen is transformed to water, H₂O. Some of the tested substances contain other atoms as well. These are supposed to react as follows: Chlorine, Cl reacts to hydrogen chloride, HCl, nitrogen, N reacts to NO₂, phosphor, P reacts to H₃PO₄ and sulphur, S reacts to SO₂.

The phi-value can also be calculated from measurements of fuel mass loss, opening size and temperature of the air entering the combustion chamber and temperature of the combustion gases leaving the combustion chamber. The following equation, [3.4] from reference [10] has been used in comparisons between measured and calculated phi-values:

$$\phi = m_{fuel} \cdot 10^{-3} \cdot \left[h \cdot w \cdot \sqrt{h} \cdot \frac{2}{3} \cdot C_d \sqrt{2 \cdot g} \cdot \rho_0 \left(\frac{1 - (T_0 / T_u)}{1 + (T_u / T_0)^{1/3}} \right)^3 \cdot r \right]^{-1/2} \quad [3.4]$$

Phi-values have been calculated using the above expression for all experiments with a single opening. For the experiments with two small openings, this expression is not applicable. m_{fuel} is the mass loss of the fuel during the experiment given in [g/s]. C_d , the discharge coefficient is set to 0.68 in the calculations and ρ_0 , the density of the surrounding air is taken as 1.2kg/m³. An ambient temperature of 293K is used throughout the whole series of experiments and the temperature of the hot upper layer T_u is taken as a mean of the four upper thermocouples inside the combustion chamber. The factor 2/3 in the equation comes from the experience that the hot gases leaving the combustion chamber comes through the upper half to two thirds of the opening.

3.3 Combustion gas yields: CO₂, CO, NO_x and HC

The measured concentrations of CO₂, CO, NO_x and HC (unburned hydrocarbons) are presented as gas yields, Y_i [g/g]. The combustion gas yields were calculated using measurements of the total gas production, m_i [g] and the total mass of the sample burned, m_{fuel} [g], according to equation [3.5].

$$Y_i = \frac{m_i}{m_{fuel}} \quad [3.5]$$

The carbon content of the fuel, Ψ_c [g/g] is known and thus the maximum yields, Ψ_i [g/g] of CO₂ and CO can be calculated. These values are given in Table 5. The maximum yields were calculated according to equations [3.6] and [3.7] using the molecular weights, $M_{CO_2} = 44.01$ g/mole, $M_{CO} = 28.01$ g/mole and $M_C = 12.01$ g/mole respectively. The assumption is made that all carbon is converted to CO₂ and CO.

$$\Psi_{CO_2} = \Psi_c \cdot \frac{M_{CO_2}}{M_C} \quad [3.6]$$

$$\Psi_{CO} = \Psi_c \cdot \frac{M_{CO}}{M_C} \quad [3.7]$$

The theoretical yields of NO₂ for TMTM, dimethoate, CNBA and nylon are calculated accordingly assuming all nitrogen in the fuel to be converted to NO₂. The calculation for nylon is given below as an example, equation [3.8].

$$\Psi_{NO_2} = 2 \cdot \frac{M_{NO_2}}{M_{nylon}} \quad [3.8]$$

$M_{NO_2} = 46.01$ g/mole and $M_{nylon} = 226.4$ g/mole.

The theoretical yields of HCl for chlorobenzene and CNBA and of SO₂ for TMTM and dimethoate are calculated following the same procedure.

The gas analysis equipment measures unburned hydrocarbons with a boiling point below 200°C. The hydrocarbons are calculated as propane equivalents. Hydrocarbons with a boiling point over 200°C, soot particles etc., are defined as the survival fraction and are not included in the unburned hydrocarbons. The amount of soot produced is also calculated. This procedure is described in section 3.5.

3.4 Rate of heat release and total heat release

The heat released during the experiments was calculated using the standard, oxygen consumption, calorimetry method [7, 10]. Concentrations of O₂, CO₂ and CO were used for the calculations.

The volume flow \dot{V} [m³/s], at STP, in the duct, equation [3.9] was calculated using the exhaust duct area A [m²], the pressure difference in the exhaust duct Δp [Pa] and the gas temperature in the duct T_e [K]. The ratio between the average mass flow per unit area and the

mass flow per unit area in the centre of the exhaust duct is 0.9. The calibration constant for the bi-directional Pitot tube is 1.08.

$$\dot{V} = \frac{22.4 \cdot A \cdot 0.9}{1.08 \cdot \sqrt{\frac{\Delta p}{T_e}}} \quad [3.9]$$

The rate of heat release q [kW] was calculated using the following expression, equation [3.10]:

$$q = \Delta H_{C,ox} \cdot 1.31 \cdot 1000 \cdot \frac{\Phi}{1 + \Phi(\alpha - 1)} \dot{V} \cdot X_{O_2}^0 \quad [3.10]$$

Where $\Delta H_{C,ox}$ [kJ/gO₂] is the heat released per unit mass oxygen consumed. The values of the various constants can be found in Table 5. The density of oxygen is 1.31kg/m³. The expansion factor α is set to 1.1. Φ is the oxygen depletion factor, i.e. the fraction of the incoming air that is fully depleted of its oxygen. Φ can be calculated using the expression in equation [3.11]:

$$\Phi = \frac{X_{O_2}^0 (1 - X_{CO_2}) - X_{O_2} (1 - X_{CO_2}^0)}{X_{O_2}^0 (1 - X_{O_2} - X_{CO_2})} \quad [3.11]$$

Where X_i^0 is the mole fraction of gas i in the incoming air and X_i the mole fraction of gas i in the exhaust duct. $X_{O_2}^0$ was set to 0.209.

The total heat release is taken, as the integrated value of the rate of heat release, during the entire experiment. This gives the energy in [kJ].

3.5 Smoke production

The smoke production can be presented in a number of ways. In this report, the extinction coefficient K [1/m] is defined as in [3.12] from reference [11]:

$$K = \sigma_m \cdot m \quad [3.12]$$

Where σ_m is the extinction area per unit mass [m²/g] and m is the mass concentration of the smoke aerosol [g/m³]. From the measurements in the duct, K is calculated as given by equation [3.13] below:

$$K = \left(\frac{I}{L} \right) \cdot \ln \left(\frac{I_0}{I} \right) \quad [3.13]$$

Where L [m] is the beam length of the light through smoke. I_0 [-] is the light intensity without smoke and I [-] is the light intensity during the test. σ_m is also determined from the measurements in the duct and from the samples of soot collected during the experiments, as given in equation [3.14].

$$\sigma_m = K \cdot (V \cdot (273 + T_e) / 273) / m_{soot} \quad [3.14]$$

Where V is the volume of gas [m³] that has flown through the filter, T_{duct} is the temperature in the duct and m_{soot} is the amount of soot in [g] which has been collected on the filter during the experiment. σ_m is determined for the tested substances and the values are given in table 21.

The smoke production is also given as a yield in [g/g]. This means gram soot produced per gram substance burned.

The smoke production given as [g/s] can be calculated in the following way, equation [3.15]:

$$K \cdot \dot{V} \cdot ((T_e + 273) / 273) \cdot (1 / \sigma_m) \quad [3.15]$$

The smoke production in [g/s] is divided by the substance mass loss also given in [g/s]. This gives the smoke yield in g soot produced per gram substance burned.

4 Results

The work within WP3 of the TOXFIRE project comprises 38 medium scale experiments with 6 different substances, 3 levels of external radiation, 5 fire diameters and 3 different opening heights. In this section, the results will be given in tables and for selected experiments as diagrams. A comprehensive report of the results, from all experiments in the form of diagrams is given as an appendix to the report.

One important variable for characterising the results from combustion experiments in enclosures is the degree of ventilation here given as the equivalence ratio or the phi-value. The phi-value varies between the experiments and during the course of a single experiment. This has been dealt with in the following way: During each experiment, periods with relatively constant phi-value have been chosen and the other measured variables have been evaluated during these periods.

4.1 Phi-values

As mentioned earlier the phi-value gives a measure of the degree of ventilation, during the course of the fire. One objective with the experiments was to study how a variation in ventilation influences the burning conditions and hence the production of combustion gases. The phi-value varies between the experiments, and during the course of a single experiment since it is difficult to achieve long periods with steady state burning, in the type of experimental set up that has been used in the reported experiments. The measured phi-value varied, between 0.04 and 1.4 in the conducted experiments. A phi-value over 1.0 indicates poorly ventilated conditions. During the performance of the experimental series, it was found that the conditions and the design of the experimental apparatus made it difficult to reach high phi-values, at least for the low-energy content substances tested. Efforts were made to force the fire into low ventilation conditions by increasing the exposed area of the substance burned. The result of this was a pulsating fire and no stable conditions.

Comparisons were made between the measured and the theoretical phi-values when this was feasible. For experiments where the opening was divided into one upper and one lower part the theoretical phi-value has not been calculated. The methods of calculation for measured and theoretical phi-values are given in section 3.2. In figures, 9 and 10 examples are given of comparisons between measured and theoretical phi-values. Results for all experiments are given in tables 13 to 18.

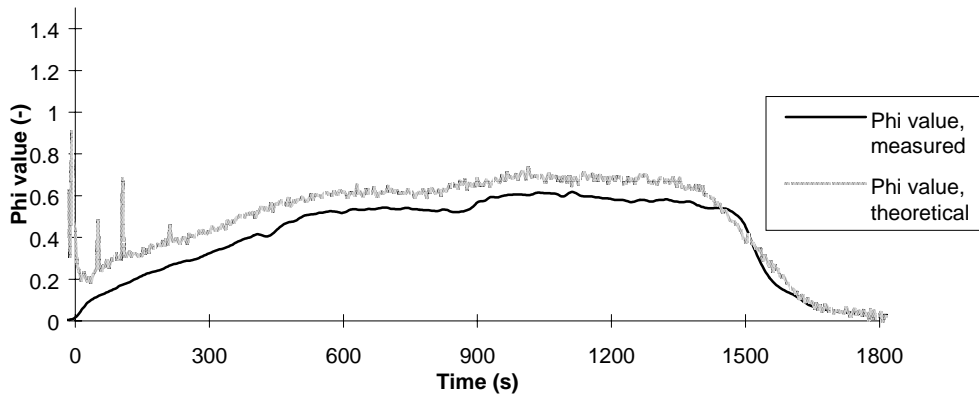

Figure 9. Comparisons between measured and theoretical phi-value for experiment CB019 with chlorobenzene.

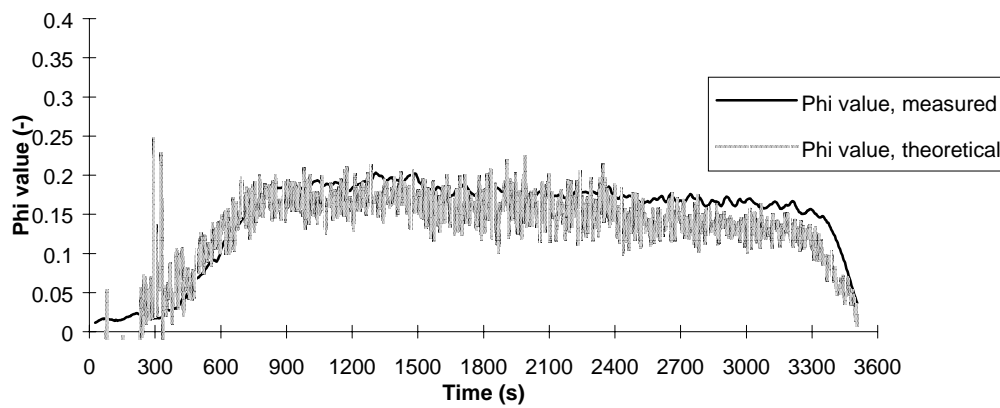

Figure 10. Comparisons between measured and theoretical phi-value for experiment TMTM007 with TMTM.

4.2 Temperatures inside the combustion chamber

The temperature was measured on a great number of locations inside the combustion chamber as described in section 2.2. Surface temperatures on the walls and in the ceiling as well as gas temperatures were measured. The mean upper temperature for the periods with constant phi-value is given in tables 13 to 18 and in the appendix. In figures 11 and 12 examples are given of surface temperatures and gas temperatures for an experiment with nylon6, 6.

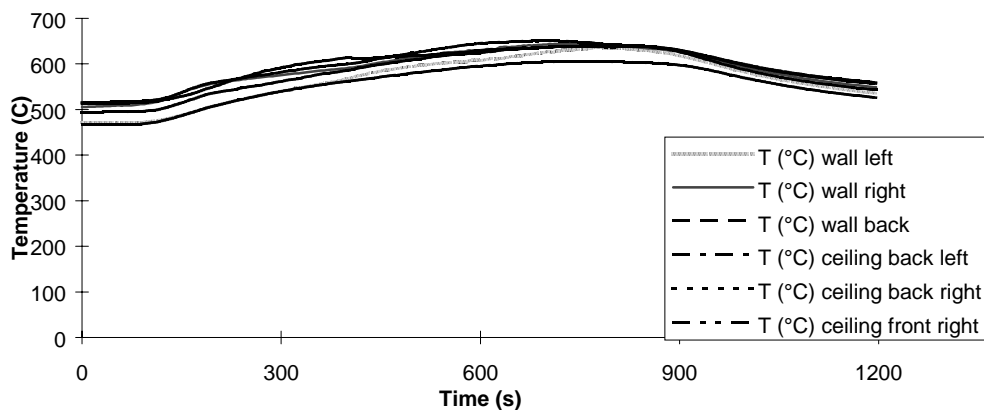

Figure 11. Surface temperature inside the combustion chamber for NYL035 with nylon6,6.

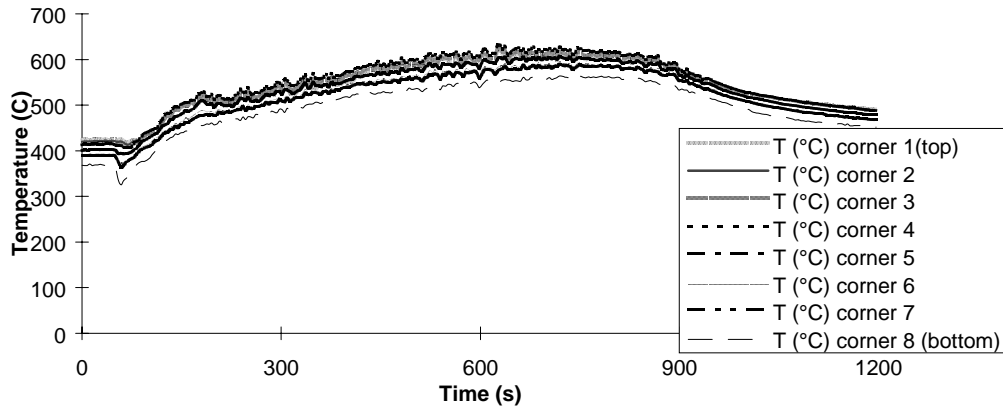

Figure 12. Gas temperature inside the combustion chamber for NYL035 with nylon6, 6.

4.3 Rate of heat release and total heat release.

The amount of heat produced was measured during all experiments. The oxygen consumption technique was used to monitor the heat output. The rate of heat release for all experiments is given in tables 13 to 18 and in the appendix. An example of a heat release curve is also given in figure 13 for an experiment with TMTM. In figure 14 the total energy released during experiment TMTM010 is given as a function of time.

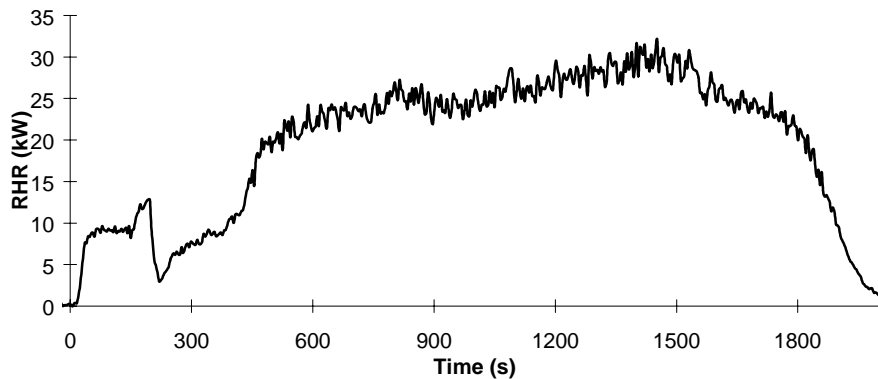

Figure 13. The RHR for experiment TMTM010 with TMTM.

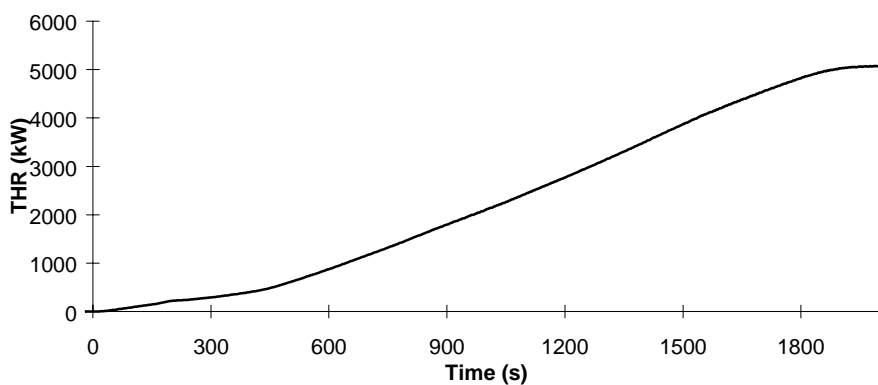

Figure 14. Total energy released during experiment TMTM010 with TMTM.

4.4 Yields of CO₂, CO, HC, NO_x and smoke

During the experiments the concentrations of CO₂, CO, HC, NO_x and smoke were measured continuously in the exhaust duct. From these levels of concentration the yields of the species could be determined by dividing the produced amounts with the mass burning rate thus giving the yield in grams of the species produced per gram burned substance. The yields are given in tables 13 to 18 and in the appendix, the yields are presented as a function of time. The yields of CO₂ and CO were determined in all experiments. The yield of HC was difficult to measure in the experiments with TMTM since hardly any soot or unburned hydrocarbons could be detected during the experiments. NO_x was mainly detected in the experiments with nitrogen containing substances such as CNBA, TMTM, dimethoate and nylon 6,6. For the other substances the amounts of NO_x were very low.

4.5 Recovery of carbon

The amount of carbon showing up among the totality of the combustion products should be equal to the amount of carbon leaving the fuel. The carbon in the products can show up as CO₂, CO, unburned hydrocarbons or as soot. In figure 15 an example of carbon recovery from experiment CB023 with chlorobenzene is presented. As can be seen, the main part of carbon is found in the smoke and as unburned hydrocarbons.

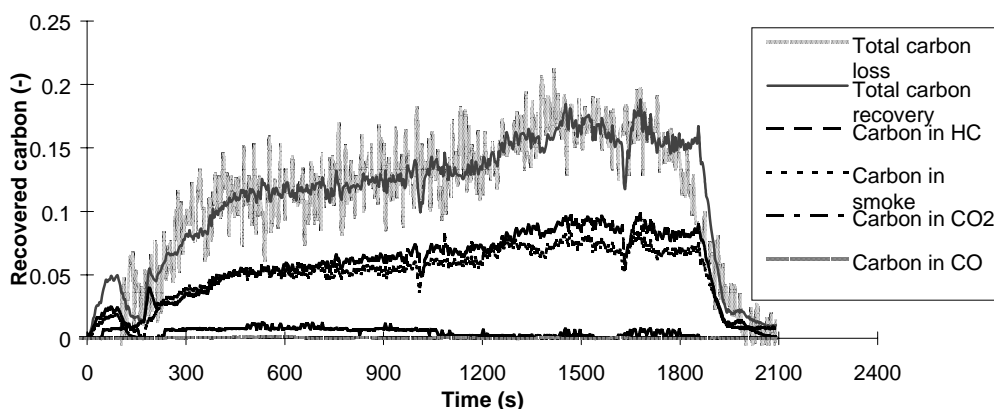

Figure 15. Recovered carbon for experiment CB023 with chlorobenzene.

Table 13. Results from experiments with heptane.

HEPTANE										
Test number	Phi-value, measured	Phi-value, theoretical	Upper layer temp (°C)	Mass loss (g/s)	RHR (kW)	Yield CO ₂ * (g/g)	Yield CO** (g/g)	Yield NO _x (g/g)	Yield HC (g/g)	Yield soot (g/g)
HEP001	0.8	0.8	474	1.1	28.0	2.09 68%	0.007 0.4%	0.0004	0.002	0.012
HEP002	1.4	1.6	562	2.2	34.6	1.24 40%	0.168 8%	0.0001	0.22	0.007

* The yield of CO₂ is given in g CO₂ produced/g substance burned and in % of the amount theoretically possible.

** The yield of CO is given in g CO produced/g substance burned and in % of the amount theoretically possible.

Table 14. Results from experiments with chlorobenzene.

CHLOROBENZENE										
Test number	Phi-value, measured	Phi-value, theoretical	Upper layer temp (°C)	Mass loss (g/s)	RHR (kW)	Yield CO ₂ * (g/g)	Yield CO** (g/g)	Yield NOx (g/g)	Yield HC (g/g)	Yield soot (g/g)
CB004	0.23	0.28	138	0.5	6.3	0.08 2%	0.044 2.9%	0.0002	0.208	0.163
CB005	0.28	0.43	180	0.9	7.8	0.36 10%	0.051 3.4%	0.0001	0.195	0.102
"	0.54	0.56	274	1.4	13.8	0.74 20%	0.063 4.2%	0.0002	0.169	0.072
"	0.74	0.80	343	1.9	17.8	0.82 22%	0.059 4.0%	0.0002	0.130	0.041
CB019	0.53	0.61	309	1.5	7.5	0.89 24%	0.061 4.1%	-	0.160	0.061
"	0.60	0.69	350	1.7	10.6	0.98 27%	0.063 4.2%	-	0.131	0.046
"	0.57	0.66	370	1.6	8.6	0.89 24%	0.060 4.0%	-	0.136	0.059
CB020	0.58	0.63	302	1.5	24.0	1.61 44%	0.122 8.2%	-	0.442	0.087
"	0.65	0.72	344	1.7	26.3	1.50 41%	0.114 7.7%	-	0.315	0.072
"	0.72	0.77	403	1.9	29.1	1.50 41%	0.134 9.0%	-	0.452	0.095
CB021	0.65	0.69	381	1.7	24.2	1.66 45%	0.118 7.9%	-	0.123	0.088
"	0.92	0.73	448	1.8	34.3	2.07 57%	0.173 12%	-	0.120	0.079
CB023	0.39	-	215	0.2	0.7	0.16 4%	0.002 0.1%	-	0.402	0.292
"	0.40	-	230	0.2	0.6	0.04 1%	0.000 -	-	0.407	0.305
CB024	0.16	-	242	0.4	0.4	-	-	-	-	0.263
"	0.19	-	255	0.5	0.8	-	-	-	-	0.201
"	0.23	-	273	0.6	0.9	-	-	-	-	0.223
CB025	0.50	-	345	1.3	12.9	1.07 29%	0.079 5.3%	-	0.266	0.163
"	0.83	-	405	1.9	26.6	1.44 39%	0.146 9.8%	-	0.383	0.111
CB026	0.27	-	466	0.9	12.1	1.50 41%	0.100 6.7%	-	0.186	0.166
"	0.71	-	505	1.5	38.3	2.38 65%	0.283 19%	-	0.264	0.128
CB027	0.48	-	493	1.6	19.6	1.22 33%	0.223 15%	-	0.023	0.121
"	0.90	-	530	2.1	37.0	1.64 45%	0.457 31%	-	0.027	0.071
"	0.86	-	544	2.0	34.5	1.62 44%	0.456 31%	-	0.021	0.072

* The yield of CO₂ is given in g CO₂ produced/g substance burned and in % of the amount theoretically possible.

** The yield of CO is given in g CO produced/g substance burned and in % of the amount theoretically possible.

Table 14 continued. Results from experiments with chlorobenzene.

CHLOROBENZENE										
Test number	Phi-value, measured	Phi-value, theoretical	Upper layer temp (°C)	Mass loss (g/s)	RHR (kW)	Yield CO ₂ * (g/g)	Yield CO** (g/g)	Yield NO _x (g/g)	Yield HC (g/g)	Yield soot (g/g)
CB028	0.41	-	476	-	17.0	1.08 30%	0.089 6.0%	0.0001	0.104	0.046
"	0.98	-	510	7.8	24.2	0.30 8.0%	0.035 2.3%	0.0000	0.121	0.023
CB029	0.32	-	480	1.1	18.8	1.66 45%	0.112 7.5%	0.0006	0.314	0.083
"	0.27	-	488	1.1	18.6	1.55 42%	0.098 6.6%	0.0006	0.196	0.075
"	0.15	-	492	0.8	16.1	1.88 51%	0.11 7.3%	0.0007	0.253	0.116
CB030	0.30	-	486	1.1	12.4	1.31 36%	0.064 4.3%	0.0002	0.388	0.098
"	0.40	-	495	1.1	18.2	1.73 47%	0.11 7.4%	0.0003	0.495	0.096

* The yield of CO₂ is given in g CO₂ produced/g substance burned and in % of the amount theoretically possible.

** The yield of CO is given in g CO produced/g substance burned and in % of the amount theoretically possible.

Table 15. Results from experiments with TMTM.

TMTM										
Test number	Phi-value, measured	Phi-value, theoretical	Upper layer temp (°C)	Mass loss (g/s)	RHR (kW)	Yield CO ₂ * (g/g)	Yield CO** (g/g)	Yield NO _x *** (g/g)	Yield HC (g/g)	Yield soot (g/g)
TMTM007	0.18	0.15	180	0.4	5.8	-	0.001 0.12%	0.0363 8.2%	-	-
TMTM008	0.40	0.35	289	0.9	15.6	0.52 41%	0.001 0.12%	0.0240 5.4%	-	-
TMTM009	0.62	0.54	386	1.4	26.8	0.75 59%	-	0.0106 2.4%	-	-
TMTM010	0.71	0.60	446	1.6	28.0	0.91 71%	-	0.0099 2.2%	-	-
TMTM014	0.62	0.53	334	1.4	18.3	0.78 61%	-	0.0106 2.4%	-	-
"	0.70	0.57	426	1.5	21.1	0.89 70%	0.000 -	0.0118 2.7%	-	-
TMTM037	0.77	-	609	1.8	41.9	1.11 87%	0.095 12%	0.0181 4.1%	0.074	-
"	0.86	-	618	1.8	45.3	1.18 92%	0.132 16%	0.0264 6.0%	0.121	-
TMTM038	0.90	-	602	2.1	46.7	0.90 70%	0.176 21%	0.0295 6.7%	0.192	-

* The yield of CO₂ is given in g CO₂ produced/g substance burned and in % of the amount theoretically possible.

** The yield of CO is given in g CO produced/g substance burned and in % of the amount theoretically possible.

*** The yield of NO_x is given in g NO_x/g substance burned and in % of the amount theoretically possible.

Table 16. Results from experiments with CNBA

CNBA										
Test number	Phi-value, measured	Phi-value, theoretical	Upper layer temp (°C)	Mass loss (g/s)	RHR (kW)	Yield CO ₂ * (g/g)	Yield CO** (g/g)	Yield NO _x *** (g/g)	Yield HC (g/g)	Yield soot (g/g)
CNBA016	0.04	0.06	78	0.3	-	0.30 19%	0.689 70%	0.0856 38%	0.006	0.127
"	0.16	0.06	187	0.4	13.4	2.76 1.8%	0.755 77%	0.0547 24%	0.047	0.131
CNBA017	0.13	0.16	177	1.2	0.9	0.47 31%	0.071 7.2%	0.0971 43%	0.024	0.150
"	0.24	0.25	310	2.0	24.3	2.21 >100%	0.114 12%	0.0551 24%	0.044	0.165
"	0.16	0.18	209	1.3	1.7	0.47 31%	0.062 6.3%	0.0881 39%	0.026	0.140
CNBA018	0.17	-	214	0.1	17.0	-	-	-	0.075	0.041
"	0.23	0.17	216	1.3	7.0	0.528 34%	0.039 4%	0.0003 0.13%	0.036	0.121
"	0.24	0.10	301	0.8	24.0	2.046 >100%	0.050 5%	0.0237 10%	0.026	0.103

* The yield of CO₂ is given in g CO₂ produced/g substance burned and in % of the amount theoretically possible.

** The yield of CO is given in g CO produced/g substance burned and in % of the amount theoretically possible.

*** The yield of NO_x is given in g NO_x/g substance burned and in % of the amount theoretically possible.

Table 17. Results from experiments with dimethoate.

DIMETHOATE										
Test number	Phi-value, measured	Phi-value, theoretical	Upper layer temp (°C)	Mass loss (g/s)	RHR (kW)	Yield CO ₂ * (g/g)	Yield CO** (g/g)	Yield NO _x *** (g/g)	Yield HC (g/g)	Yield soot (g/g)
DIM011	0.22	-	192	0.4	6.8	0.48 13%	0.002 0.19%	0.0008 0.27%	0.012	0.070
"	0.44	-	333	0.8	13.6	1.19 33%	0.014 1.4%	0.0007 0.23%	0.013	0.057
DIM012	0.06	0.16	191	0.3	7.6	0.18 4.9%	0.027 2.6%	0.0010 0.33%	0.014	0.081
"	0.20	0.19	287	0.6	11.5	0.96 26%	0.010 0.97%	0.0014 0.47%	0.010	0.064
DIM013	0.55	0.42	351	1.0	14.3	1.20 33%	0.022 2.1%	0.0012 0.40%	-	0.046
DIM015	0.48	0.37	309	0.8	12.9	1.68 46%	0.022 2.1%	0.0006 0.20%	0.018	0.055
"	0.73	0.55	429	1.3	21.5	1.7 46%	0.023 2.2%	0.0006 0.20%	0.006	0.013
"	0.94	0.61	490	1.5	27.1	1.93 53%	0.031 3.0%	0.0010 0.33%	0.008	0.002

* The yield of CO₂ is given in g CO₂ produced/g substance burned and in % of the amount theoretically possible.

** The yield of CO is given in g CO produced/g substance burned and in % of the amount theoretically possible.

*** The yield of NO_x is given in g NO_x/g substance burned and in % of the amount theoretically possible.

Table 18. Results from experiments with Nylon 6,6

NYLON 6,6										
Test number	Phi-value, measured	Phi-value, theoretical	Upper layer temp (°C)	Mass loss (g/s)	RHR (kW)	Yield CO ₂ * (g/g)	Yield CO** (g/g)	Yield NO _x *** (g/g)	Yield HC (g/g)	Yield soot (g/g)
NYL031	0.09	-	460	0.2	5.2	3.387 >100%	0.004 0.27%	0.2904 71%	0.004	0.043
"	0.05	-	454	0.1	1.6	1.309 56%	0.001 0.07%	0.3046 75%	0.009	0.114
NYL032	0.04	-	459	0.1	0.2	-	-	0.2137 53%	0.007	0.025
"	0.04	-	465	0.1	4.4	2.856 >100%	0.002 0.13%	0.2309 57%	0.010	0.049
NYL033	0.70	-	519	0.9	28.9	2.955 >100%	0.159 11%	0.0289 7.1%	0.075	0.022
NYL034	0.16	-	498	0.5	13.6	2.306 98%	0.077 5.2%	-	0.012	0.082
"	0.16	-	507	0.5	14.1	2.488 >100%	0.069 4.6%	-	0.017	0.091
NYL035	0.91	-	587	1.4	38.3	2.349 100%	0.120 8.1%	0.0166 4.1%	0.135	0.021
"	0.77	-	603	1.5	42.8	2.493 >100%	0.151 10%	0.0214 5.3%	0.280	0.012
"	0.86	-	613	1.4	37.3	2.375 >100%	0.125 8.4%	0.0190 4.7%	0.214	0.018

* The yield of CO₂ is given in g CO₂ produced/g substance burned and in % of the amount theoretically possible.

** The yield of CO is given in g CO produced/g substance burned and in % of the amount theoretically possible.

*** The yield of NO_x is given in g NO_x/g substance burned and in % of the amount theoretically possible.

4.6 Gas analysis

As reported above a number of common combustion gases have been detected on line. A large number of other substances are also produced during the combustion process. One important task in this project has been to try to identify these substances and to be able to compare the substances produced in one scale with substances produced in the other studied scales. The comparisons with other scales are reported elsewhere [13]. Only the results from the studies in medium scale are reported here. In table 23 most of the substances that were found in the GC-MS analysis are reported and in table 19 the ten most frequently appearing substances are given. It was possible to make quantitative analysis of a few of the gas samples. The results of the quantitative GC-MS analysis are given in table 20. In figure 16 an example of a spectrum from GC-MS is given. As can be seen the main component is tetra methyl thiourea, this is a compound very similar to TMTM.

Figure 16. Spectrum from GC-MS analysis of sample from an experiment with TMTM.

Table 19. Compounds, most frequently detected in GC-MS analysis of gas samples

Detected compound	Compound found in number of samples/samples analysed	Compound detected in samples from experiments with
Naphthalene, C ₁₀ H ₈	17 of 21	Chlorobenzene, TMTM, dimethoate, CNBA, Nylon
Benzene, C ₆ H ₆	16 of 21	Chlorobenzene, TMTM, dimethoate, CNBA, Nylon
Toluene, C ₇ H ₈	14 of 21	Chlorobenzene, TMTM, dimethoate, CNBA, Nylon
Heptadecane, C ₁₇ H ₃₆	10 of 21	Chlorobenzene, TMTM, CNBA, Nylon
Tetramethyl-thiourea, C ₅ H ₁₂ N ₂ S	10 of 21	TMTM, dimethoate
Thiram, C ₆ H ₁₂ N ₂ S ₄	8 of 21	TMTM
Chlorobenzene, C ₆ H ₅ Cl	7 of 21	Chlorobenzene, CNBA
Phenol, C ₆ H ₆ O	7 of 21	Chlorobenzene, TMTM, CNBA
Cyclooctatetraene, C ₈ H ₈	7 of 21	TMTM, dimethoate
Methanethioamide, CH ₃ NS	7 of 21	TMTM

Table 20. Amounts of compounds detected in GC-MS analysis of gas samples

Detected compound	Sample description, Yield of detected compound [mg/g burned]										
	CB 005	CB 019	CB 023	TMTM 014	TMTM 038	DIM 011	DIM 013	CNBA 017	CNBA 018	NYL 032	NYL 034
Benzene	0.8	0.7	1							8.4	12
Toluene		0.6				20	17			34	40
Chlorobenzene	30	10	31					11	14		
Chlorophenol									9		
2-chloro-benzonitrile								2	8		
Naphthalene	0.9		4					8	13	17	2
2,6,11-trimethyl-dodecane										0.6	
2-methyl-1-(1,1-dimethyl)propanoic acid	0.7										
Eicosane	0.7		2								
Benzonitrile									3		
Methyl-ester thiocyanic acid				4	2						
Tetramethyl-thiourea				75	71						
Thiram				0.9	1.1						
Xylene						50	76				
Cyclohexanone						32	39				

Samples of soot were also collected during the experiments, these soot samples were weighed, and from these measurements, the smoke extinction areas have been determined according to the procedure described in section 3.5. The values of the smoke extinction area for the tested substances are given in table 21. The values presented in table 21 are mean values for all experiments performed with each substance.

Table 21. Smoke extinction area for tested substances.

Substance	Smoke extinction area (m ² /g)
Chlorobenzene	11.3
TMTM	0.8*
Dimethoate	12.6
CNBA	10.4
Nylon-6,6	20.4

*This value is not to be taken as the smoke extinction coefficient for TMTM it only indicates that very small amounts of smoke are formed in the experiments with TMTM.

The solutions in the impinger bottles were analysed with ion chromatography and for the tests with chlorobenzene and with CNBA, they were analysed with respect to content of HCl. When comparing the amount of HCl formed during combustion with the maximum amount of HCl that can be produced from chlorobenzene, given in table 22, it is found that the majority of Cl in chlorobenzene goes into formation of HCl. In addition, for CNBA a large portion of the Cl is transformed to HCl during the combustion. For both chlorobenzene and CNBA the main part of the remaining Cl is to be found in chlorobenzene that either survives the combustion or is formed during combustion. In table 23, the compounds that were found in the GC-MS analysis are presented. For chlorobenzene and CNBA, it can be seen that other complex chlorine containing compounds are formed as well but these account for minor parts of the total Cl content.

Table 22. Detected amount of HCl in combustion gases from experiments with CNBA and chlorobenzene

Test number	Detected amount HCl Mg HCl/g burned substance	Theoretical amount HCl mg HCl/g burned substance
CNBA018	120.4	180.9
CB022	279.1	325.2
CB023	293.8	325.2
CB025	378.0	325.2

5 Discussion

The results indicate that the equivalence ratio or as it is often referred to the phi-value is a useful variable when it comes to means of characterising enclosure fires. In the series of experiments presented here, it has been shown that the experimentally measured and the calculated phi-values are in good agreement. The phi-values vary between 0.04 to 1.4 in the experiments. Attempts were made to reach higher phi-values. These attempts were however not successful. This was found to depend mainly on the design of the experimental set up. When the fire was forced into lower ventilation conditions the fire quickly reached unstable and uncontrollable conditions. One typical result was a pulsating fire with long flames coming out of the opening.

The measurements of the phi-values were made with equipment suggested by Babrauskas et al [7]. In order to make good measurements in a repeatable way some parts of the equipment had to be redesigned. The reactor was originally made of quartz glass but this material was too brittle to withstand a long series of experiments and was replaced by a stainless steel reactor. The suggested catalyst had a working temperature of about 1000°C, which is a very high temperature to have in an environment where pure oxygen and combustible gases of various compositions are mixed. The original catalyst was exchanged for a catalyst working at around 400°C.

The rate of heat release was measured in all experiments using the oxygen consumption technique. Measured RHR ranged from 0.4kW to 47kW, depending on the substance burned and whether external radiation was imposed or not.

The yields of CO₂, CO, NO_x, HC and soot were determined in all experiments where possible. For CO₂, CO and NO_x a comparison was also made between the measured yield and the highest yield theoretically possible. For heptane the yield of CO₂ was over 40% and the yield of CO under 10% of the theoretical maximum yields. The yield of NO_x was very low as can be expected for a non-nitrogen compound. The yields of HC and soot were low and this is in agreement with the general observations during the experiments.

Results are presented from 13 experiments with chlorobenzene. For chlorobenzene, the CO₂ yield covers a wide range, from 1% to 65% of the theoretically possible. The yield of CO goes up to 31% of the maximum theoretical value. It has not been possible to establish any relationships between the produced amounts of CO₂ and the phi-values or the RHR during the experiments. The yield of unburned hydrocarbons was less than 0.5g/g substance burned during all tests with chlorobenzene.

Thirteen experiments were performed with TMTM. The CO₂ production varied between 41% and 92% of the theoretical values in all experiments. The production of CO was extremely low. In fact, no CO was detected except for the experiments with external radiation where 12% to 21% of the theoretically possible amount of CO was detected. TMTM is a nitrogen containing substance and hence a production of NO_x could be anticipated during the combustion. NO_x was also detected during the experiments but the yield of NO_x compared to the theoretically possible yield was still rather low. It ranged from 2.2% to 8.2%. The combustion of TMTM differs from the normal combustion of organic compounds. The

combustion of TMTM gave hardly any unburned hydrocarbons that could be detected with the flame ionisation detector. Only when external radiation was applied some unburned hydrocarbons were detected. In line with the low content of unburned hydrocarbons, no soot could be found on the filters used for collecting soot during the experiments with TMTM.

Results are presented from three experiments with CNBA. All experiments were performed without external radiation. The phi-value was very low, below 0.25, in all experiments and the upper layer temperature reached 310°C at the most. The yields of NO_x were considerable, reaching values from 10% to 43% of the theoretically possible amount. Some unburned hydrocarbons were detected but the yields were rather low, with a highest value of 0.075g HC/g substance burned. Soot was also collected during the experiments giving yields in the area of 0.1g soot/g burned substance.

Four experiments were performed with dimethoate and in no case external radiation were applied. Dimethoate is a nitrogen containing substance and hence rather high yields of NO_x were expected. However only low concentrations were detected. The yields correspond to below 1% of the yield theoretically possible. The amounts of soot collected on the sampling filters were very low. Below 0.1g soot/g burned substance was found during all the experiments with dimethoate.

Results are reported from five experiments with nylon 6,6. It was found that nylon 6,6 is rather hard to ignite with small ignition sources. As a sustained burning was needed in the experiments presented here, external radiation had to be applied. An external radiation of 22.4 kW/m² was used in all experiments with nylon 6,6. The external radiation gives upper layer temperatures in the area from 450°C to 600°C. A problem arose concerning the detection of CO₂ during the experiments. In most of the experiments, a concentration of CO₂ corresponding to a yield of 100% or more was detected. The reason for this has not been found in the equipment. A remaining cause might be the way in which the highest possible yield of CO₂ is calculated. One monomer unit is used when calculating the theoretical yield but it is possible that this could be done in a more relevant way.

All substances included in this work are organic substances and thus they all contain coal. After combustion, the coal can be found as soot, CO₂, CO and as unburned hydrocarbons. Other compounds can also be formed but these account for minor parts of the carbon balance. An attempt has been made to make a balance after combustion for the carbon present in the original substance. The result of these calculations are presented in table 24, where the amount of carbon lost during the experiment is compared to the amount of carbon found in the various analyses of the combustion products. As can be seen in table 24 the results vary considerably between the different substances and between different experiments with the same substance. Some conclusions can however be drawn.

For heptane, which is a simple hydrocarbon with no heteroatoms, the yield is approximately 70%.

Chlorobenzene is a substance with one chlorine atom per unit. Chlorine is or rather has often been used in chemicals with fire retardant qualities. This makes chlorobenzene a substance that is rather difficult to ignite and in the experiments without external radiation, the chlorobenzene is very close to extinction during the course of the experiment. For the experiments without external radiation, the carbon yield varies from 58 to 84%. When external

radiation was applied, the yields rise to 100% or more. The highest values were reached with high external radiation. Most of the carbon is found in CO₂ but the amount found as unburned hydrocarbons seems to increase when the external radiation is increased. There is an analytical problem in analysing unburned hydrocarbons containing heteroatoms since the flame ionisation meter used in the analysis is calibrated with propane. Calibration with other substances has not been made and it is not fully understood how the flame ionisation reacts when atoms like e.g. chlorine and sulphur are introduced.

TMTM is a substance containing nitrogen and sulphur. This substance behaves differently compared to heptane and chlorobenzene. It produces very little smoke. In fact, no smoke at all could be detected on the sampling filter. Instead, a yellow sulphur containing substance was found. Without external radiation, hardly any unburned hydrocarbons could be found and most of the recovered carbon was found as CO₂. When external radiation was applied the yield of unburned hydrocarbons increased drastically, giving total carbon yields over 100%. The problem here as with chlorobenzene is the heteroatoms giving unreliable results in the FID.

Dimethoate apart from carbon and hydrogen contains nitrogen, oxygen, phosphorus and sulphur. Most recovered carbon is found as CO₂ and only extremely small amounts of soot were detected. In one experiment, the carbon yield reaches more than 100%. The reason for this is not found.

CNBA is a hydrocarbon containing chlorine, nitrogen and oxygen. The carbon yield in the experiments with CNBA is close to 100%. Most of the carbon in the combustion gases is found in CO₂ and as soot.

Nylon 6,6 is a nitrogen-containing polymer. Since polymers react somewhat differently, from other substances, when heated, it is not evident what base substance to use when calculating yields and other substance depending variables. In this report the monomer, C₁₂H₂₂N₂O₂ is used as the smallest unit taking part in the combustion process. This might be a simplification of the reactions involved in the combustion of nylon 6,6 and might be one reason to why the carbon yields are high, over 100%, in the main part of the experiments.

Samples of combustion gases from experiments with chlorobenzene and CNBA were analysed with ion chromatography with respect to content of HCl. GC-MS analysis was also performed in order to determine the main compounds formed during combustion of these substances. It was found that for both chlorobenzene and CNBA, a large part of the chlorine available goes into formation of HCl. 67% or more of the theoretically possible amount of HCl is formed. The dominating chlorine containing organic compound found in the GC-MS analysis is chlorobenzene. This is true both for chlorobenzene and for CNBA. In the analysis of samples from experiments with CNBA some other chlorine containing compounds were also found in so large amounts that it was possible to quantify them.

As could be expected an immense number of substances could be identified in the GC-MS analysis. Most of them could however only be identified qualitatively but for those, where it was possible a quantitative analysis was also made. The results are presented in table 20 but in short, it was found that from chlorobenzene the main compounds were unburned chlorobenzene, benzene and naphthalene. In the analysis of samples from experiments with TMTM, substances of almost the same composition as TMTM were the main compounds

found. The combustion gases from dimethoate were found to contain large amounts of the solvents xylene and cyclohexanone which were used in the tested formulation. Apart from these solvents, toluene was also found in rather large quantities. The main components in the combustion gases from CNBA were chlorobenzene, naphthalene and 2-chlorobenzonitrile. Nylon 6,6 produces benzene, toluene and naphthalene as the main combustion products in the series of experiments presented here.

Table 24. Carbon recovered in gas analyses compared to carbon mass loss.

Test number	Carbon mass loss (g)	Carbon recovered (g)	Carbon Recovered (%)
HEP001	803.5	552.5	69
HEP002	1255.9	852.6	68
CB004	725.8	424.0	58
CB005	643.3	429.8	67
CB019	1309.0	947.6	72
CB020	743.4	626.9	84**
CB021	1411.7	1414.4	100
CB023	228.7	227.8	100
CB025	862.1	963.6	112
CB026	362.2	466.7	128
CB027	466.3	508.7	109
CB029	207.1	258.3	125
CB030	143.1	206.1	144
TMTM008	406.0	115.8	29*
TMTM009	419.1	187.5	45*
TMTM010	190.5	123.1	65*
TMTM014	684.4	502.8	74*
TMTM037	234.4	284.2	121*
TMTM038	370.5	462.0	125*
DIM011	786.5	291.6	37
DIM012	252.7	126.2	50
DIM013	219.2	182.8	83**
DIM015	499.6	590.2	118
CNBA017	940.9	912.5	97
CNBA018	663.8	609.8	92
NYL031	165.1	127.4	77
NYL032	112.0	121.5	109
NYL033	280.6	380.1	135
NYL034	390.8	505.1	129
NYL035	611.4	804.9	132

* The production of soot has not been included in the calculation of the carbon recovered in the gas analyses.

** The content of carbon found as unburned hydrocarbons has not been included in the calculation of carbon recovered in the gas analyses.

6 References

- [1] Petersen, K. E., Markert, F. (Ed)., *Assessment of Fires in Chemical Warehouses. An Overview of the TOXFIRE Project.*, Risø National Laboratory, Roskilde Denmark, Risø-R-932, May 1999;
- [2] Hietaniemi, J., Mikkola, E., *Minimising fire risks at chemical storage facilities, Basis for the guidelines for fire safety engineers*, VTT Research Notes 1811, 29 p. + app. 14 p., Espoo 1997;
- [3] Särdaqvist, S., *An Engineering Approach to Fire-Fighting Tactics*, Department of Fire Safety Engineering, Lund University, ISRN LUTVDG/TVBB -- 1014 -- SE, Lund 1996;
- [4] Rasmussen, B., *Managing Fires in Chemical Warehouses*, Risø National Laboratory, Roskilde, Denmark, Risø-R-888 (EN), December 1996;
- [5] Gunners, N.E., *Methods of Measurement and Measuring Equipment for Fire Tests*, National Swedish Institute for Materials Testing, Fire Engineering Laboratory 1967:1, 1967;
- [6] Nordtest Inquiry No 1131-93, *Heat Flux Meters: Calibration*, Finland 1993;
- [7] Babrauskas, V., Parker, W. J., Mulholland, G. and Twilley, W. H., *The phi-meter: A simple, fuel-independent instrument for monitoring combustion equivalence ratio*, Re. Sci. Instrum. 65 (7), July 1994;
- [8] *Room Fire Test in Full Scale for Surface Products*, NORDTEST Fire Test Method, NT Fire 025;
- [9] Andersson, B., Davie, F., Holmstedt, G., Kenéz, A., Särdaqvist, S., *Combustion of Substances and the Impact on the Environment of the Fire Products – 1/3 Scale Room Furnace Experiments*, Department of Fire Safety Engineering, Lund University, ISRN LUTVDG/TVBB--307--SE, 1994;
- [10] Babrauskas, V., Williamson, R. B., *Post-flashover Compartment Fires*, Fire Research Group, University of California, Berkeley, USA, Report No. UCB FRG 75-1, December 1975;
- [11] Babrauskas, V., Grayson, S. J., *Heat Release in Fires*, Elsevier Applied Science, England 1992;
- [12] Mulholland, G. W., p 22-221 - 222 in *The SFPE Handbook of Fire Protection Engineering*, NFPA, 1995;

- [13] Andersson, B., Babrauskas, V., Holmstedt, G., Särqvist, S., Winter, G., *Scaling Effects*, Department of Fire Safety Engineering, Lund University, ISRN LUTVDG/TVBB -- 3078 -- SE, 1997;

Appendix A: Detailed information from the experiments

HEPT001

Date 960401
Substance Heptane
Mass 1050 g
Pan diameter 20 cm
Air inlet width 45 cm, height 20 cm
Duct diameter 70 mm
14.33 Log start time
14.40 Ignition time
14.45 Start chem. sample.
Flow 1.0 l/min
14.55 Stop chem. sample.
15.03 Log end time

HEPT002

Date 960410
Substance Heptane
Mass 2218 g
Pan diameter 30 cm
Air inlet width 45 cm, height 20 cm
Duct diameter 100 mm
Log start time
Ignition time
11.38 FID range changed from 500
to 1000
11.39 FID range changed from
1000 to 2000
11.41 FID range changed from
2000 to 5000
11.45 Several changes in FID range
Test aborted due to explosion
hazard
Log end time

CB003

Date 9604010
-- Test failed --

CB004

Date 960412
Substance Chlorobenzene
Mass 1169 g
Pan diameter 20 cm
Air inlet width 45 cm, height 20 cm
Duct diameter 70 mm
11.56.05 Log start time
Ignition time
12.01.33 FID range changed from 500
to 1000
12.02.16 Start soot sample. 3.1 l/min
12.07.16 Stop soot sample
12.20.28 Start chem. sample
12.25.28 Stop chem. sample
12.40.30 Log end time

The furnace was covered by a 1 cm thick soot layer after the test. Ranges possibly changed in channel 6 (NO_x). Out of calibration gas M3.

CB005

Date 960412
Substance Chlorobenzene
Mass 1026 g
Pan diameter 30 cm
Air inlet width 45 cm, height 20 cm
Duct diameter 70 mm
14.30 (appr.) Log start time
14.36.14 Ignition time

14.48.44 FID range changed from 1000 to 5000
 14.43.01 Start chem. sample. 5 min.
 14.43.16 Start soot sample. 5 min. 3.2 l/min
 15.05.00 Log end time

CB006

Date 960415
 Substance Chlorobenzene
 Mass
 Pan diameter 40 cm
 Air inlet width 45 cm, height 20 cm
 Duct diameter 70 mm
 appr. 14.30. Log start time
 15.06.15 Ignition time
 15.11 Re-ignited
 15.13 Re-ignited
 15.12 FID range changed from 1000 to 5000
 15.27 Log end time
 FID range 1000 from start. The test was terminated due to self-choking.

TMTM007

Date 960417
 Substance TMTM
 Mass 1024 g
 Pan diameter 20 cm
 Air inlet width 45 cm, height 20 cm
 Duct diameter 70 mm
 15.13 Log start time
 15.14.50 Start propane burner for ignition
 15.18 Stop propane burner
 15.20.10 Ignition hatch closed
 15.32.18 Start chem. sample

15.32.30 Start soot sample
 15.39.30 Stop soot sample
 15.40.00 Stop chem. sample
 16.21.38 Log end time
 FID range 1000 from start.

TMTM008

Date 960418
 Substance TMTM
 Mass 1000 g
 Pan diameter 30 cm
 Air inlet width 45 cm, height 20 cm
 Duct diameter 70 mm
 11.23 Log start time
 11.26.26 Start propane burner for ignition
 11.29 Ignition
 11.29.20 Stop propane burner
 11.31 NOx range changed from 100 to 250
 11.44.00 Start chem. sample
 11.44.05 Start soot sample
 11.59.40 Stop soot sample
 11.59.40 Stop chem. sample
 11.59 Log end time
 FID range 1000 from start.

TMTM009

Date 960418
 Substance TMTM
 Mass 1500 g
 Pan diameter 40 cm
 Air inlet width 45 cm, height 20 cm
 Duct diameter 70 mm
 14.31.50 Log start time

14.31.50 Start propane burner for ignition

15.34.50 Stop propane burner

15.04.35 Start chem. sample

15.25.00 Stop chem. sample.
Note: 21 min

15.19.30 Log end time

Slow spread of fire in pan. FID range 1000 from start.

TMTM010

Date 960419

Substance TMTM

Mass 2164 g

Pan diameter 40 cm

Air inlet width 45 cm, height 20 cm

Duct diameter 70 mm

14.30.41 Log start time

14.36.22 Start propane burner for ignition

14.39.15 Stop propane burner

14.46.08 Start chem. sample

14.53.46 Start chem. sample.
Note: 21 min

15.11.57 Log end time

Ring burner output 15 kW. Bluish-white flames at 14.53. All yellow flames at 15.04.

DIM011

Date 960429

Substance Cyclohexanone 77%
Xylene 23%

Mass 1000 g

Pan diameter 20 cm

Air inlet width 45 cm, height 20 cm

Duct diameter 70 mm

18... Log start time

18.31.04 Ignition

18.38.24 Start chem. sample

18.45.31 Stop chem. sample. 1 l/min

15.11.57 Log end time

Pre-test with solvents in dimethoate solution.

DIM012

Date 960429

Substance Cyclohexanone 442.5 g,
Xylene 132.5 g,
Dimethoate, 44.6 g,
Emulgator 5.4 g,

Mass 511 g solver from previous test + 114 g dimethoate solution = 625 g

Pan diameter 20 cm

Air inlet width 45 cm, height 20 cm

Duct diameter 70 mm

20.37.07 Log start time

20.42.17 Start chem. sample

20.42.28 Start soot sample

20.47.17 Stop chem. sample

20.47.28 Stop soot sample

21.06.47 Log end time

DIM013

Date 960430

Substance Cyclohexanone 442.5 g,
Xylene 132.5 g,
Dimethoate, 44.6 g,
Emulgator 5.4 g,

Mass 511 g solver from test DIM011 + 114 g dimethoate solution = 625 g

Pan diameter 30 cm

Air inlet width 45 cm, height 20 cm

Duct diameter 70 mm

09.43.07 Log start time

09.45.24	Ignition
09.50.14	Start soot sample
09.50.26	Start chem. sample
09.55.06	Stop soot sample
09.55.54	Stop chem. sample
09.56.57	Start extra chem. sample
10.00.15	Stop chem. sample. (After extinction)
10.01.31	Log end time

TMTM014

Date	960514
Substance	TMTM
Mass	2000 g
Pan diameter	40 cm
Air inlet	width 45 cm, height 20 cm
Duct diameter	70 mm
11.04.26	Log start time
11.05.13	Start propane burner for ignition
11.07.00	Stop propane burner
11.19.42	Start wet chem. sample 1 l/min
11.19.57	Start soot sample. 3.1 l/min
11.24.43	Stop wet chem. sample
11.26.13	Start chem. sample 1 l/min
11.29.57	Stop soot sample
11.31.13	Stop chem. sample
11.37.33	Log end time

DIM015

Date	960514
Substance	Cyclohexanone 858 g, Xylene 282 g, Dimethoate, 98 g, Emulgator 12 g,

Mass	750 g cyclohexanone + 250 g xylene + 250 g dimethoate solution = 1250 g
------	---

Pan diameter	30 cm
Air inlet	width 45 cm, height 20 cm
Duct diameter	70 mm
15.00.05	Log start time
15.01.43	Start propane burner for ignition
15.02.07	Stop propane burner
15.06.40	Start wet chem. sample
15.07.00	Start soot sample
15.12.00	Stop wet chem. sample
15.13.23	Start chem. sample
15.13.34	Stop soot sample
15.18.44	Stop chem. sample
15.24	Log end time

About 2-3 ml of a very evil smelling liquid left in pan after the test.

CNBA016

Date	960515
Substance	CNBA
Mass	1087 g
Pan diameter	20 cm
Air inlet	width 45 cm, height 20 cm
Duct diameter	70 mm
09.29.29	Log start time
09.33.28	Start propane burner for ignition
09.35.05	Stop propane burner
09.35.53	Start propane burner
09.37.23	Stop propane burner
09.39.43	Start propane burner
09.41.41	Stop propane burner
09.42.04	Start propane burner

09.45.12 Stop propane burner

09.47.00 Log end time

Test terminated. Didn't burn

CNBA017

Date 960515

Substance CNBA

Mass 2460 g

Pan diameter 30 cm

Air inlet width 45 cm, height 20 cm

Duct diameter 70 mm

11.01.56 Log start time

11.06.26 Start propane burner for ignition

11.12.10 Stop propane burner

11.12.40 Ignition hatch closed

11.18.20 Start wet chem. sample

11.18.33 Start soot sample. Failed

appr. 11.21 Self extinction

11.21.58 Stop wet chem. sample. Failed.

11.26.24 Start propane burner

11.28.37 Start propane burner

11.32.45 Start chem. sample

11.36.38 Stop chem. sample

11.36.50 Self extinction

11.39.50 Start propane burner

11.46 Log end time

Test terminated.

CNBA018

Date 960515

Substance CNBA and Polypropylene (non woven)

Mass 2478 g CNBA + 222 g PP

Pan diameter 30 cm

Air inlet width 45 cm, height 20 cm

Duct diameter 70 mm

15.11.02 Log start time

15.41.46 Start propane burner for ignition

15.47.48 Stop propane burner

15.48.15 Ignition hatch closed

15.50.22 Start wet chem. sample

15.50.32 Start soot sample

15.52.26 Stop wet chem. sample

15.53.05 Stop soot sample

15.54.06 Start chem. sample

15.56.15 Stop chem. sample

16.09.00 Ignition hatch open

16.09.20 Hatch closed

16.11 Self extinction

16.12.31 Start propane burner

16.15.07 Stop propane burner

16.21.35 Log end time

Log channel 17 (load cell) show 5 kg. Check did not give any clue.

CB019

Date 960521

Substance Chlorobenzene

Mass 2041 g

Pan diameter 20 cm

Air inlet width 45 cm, height 20 cm

Duct diameter 70 mm

13.56.40 Log start time

14.07.20 Ignition

14.10.00 FID range changed from 500 to 2000

14.17.42 Start wet chem. sample

14.17.53 Start soot sample

14.20.19 Stop soot sample

14.23.03 Stop wet chem. sample
 14.24.11 Start chem. sample
 14.29.11 Stop chem. sample
 14.42.52 Log end time
 No NOx measurements.

CB020

Date 960603
 Substance Chlorobenzene
 Mass 2514 g
 Pan diameter 20 cm
 Air inlet width 45 cm, height 20 cm
 Duct diameter 30 mm
 appr. 15.35 Log start time
 15.41.40 Ignition
 15.42.30 FID range changed from 500 to 5000
 15.43.15 Duct changed from 30 mm to 50 mm
 16.03.19 Duct changed from 50 mm to 60 mm
 16.11.16 Log end time
 No NOx measurements. Runtime error in computer during the test. A couple of minutes delay, then restart of computer. Computer files ..020 and ..020B.

CB021

Date 960607
 Substance Chlorobenzene
 Mass 2312 g
 Pan diameter 20 cm
 Air inlet width 45 cm, height 20 cm
 Furnace temp. appr. 250 °C
 Duct diameter 70 mm
 14.18.18 Log start time
 Ignition

14.19.50 Duct changed from 70 mm to 50 mm
 No NOx measurements. FID range 5000.
 Test emergency terminated. Flow reducer in duct removed. Ignition hatch partly opened.

CB022

Date 960612
 Substance Chlorobenzene
 Mass 678 g
 Pan diameter 10 cm
 Air inlet width 45 cm, height: see below
 Furnace temp. appr. 250 °C
 Duct diameter 70 mm
 10.45.18 Log start time
 10.48.40 Ignition
 10.55.08 Start wet chem. sample
 10.56.02 Start soot sample
 11.00.02 Stop wet chem. sample
 11.00.02 Stop soot sample
 11.40.18 Log end time

Opening modified:

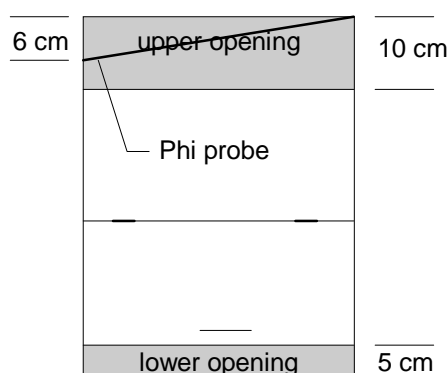

No NOx measurements. FID range 5000.

CB023

Date 960612
 Substance Chlorobenzene
 Mass 356
 Pan diameter 10 cm
 Air inlet width 45 cm, height: see below

Furnace temp. appr. 250 °C

Duct diameter 30 mm

14.06.30 Log start time
 14.10.21 Ignition
 14.24.29 Start chem. sample
 14.25.40 Start soot sample. 0.9 l/min
 14.29.29 Stop chem. sample
 14.25.41 Stop soot sample
 14.27-14.31 Phi probe cleaned by back blowing.
 14.45.20 Log end time

Opening modified:

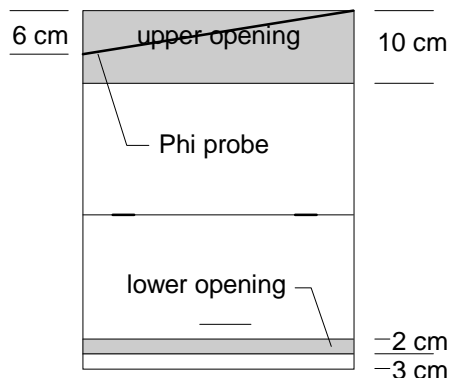

No NOx measurements. FID range 5000.
 Phi meter smoke logged during end of test?

CB024

Date 960612
 Substance Chlorobenzene
 Mass 463
 Pan diameter 15 cm
 Air inlet as in CB023

Furnace temp. appr. 250 °C

Duct diameter 30 mm

15.47.26 Log start time
 15.49.08 Ignition
 15.57.54 Phi = 40
 16.09.59 Log end time

No NOx measurements. FID range 5000.
 No calibration made after test.

CB025

Date 960614
 Substance Chlorobenzene
 Mass 1426 g
 Pan diameter 20 cm
 Air inlet width 45 cm, height 10 cm (upper) + 2 cm (lower)

Furnace temp. appr. 260 °C

Duct diameter 40 mm

14.58.00 Log start time
 15.00.37 Ignition
 15.03.10 Duct changed from 40 mm to 60 mm
 15.10.43 Start wet chem. sample
 15.11.33 Start soot sample
 15.15.39 Stop wet chem. sample
 15.15.50 Stop soot sample
 15.15.55 Duct changed from 60 mm to 70 mm
 15.16.30 Duct changed from 70 mm to 90 mm
 15.28.30 Log end time

No NOx measurements. FID range 5000.

CB026

Date 960618
Substance Chlorobenzene
Mass 614 g
Pan diameter 10 cm
Air inlet width 45 cm, height 10 cm
(upper) + 2 cm (lower)
Furnace temp. appr. 520 °C
Duct diameter 50 mm
09.24.30 Log start time
09.31.04 Ignition
09.35.57 Duct changed from 50 mm to
70 mm
09.44.53 Log end time
No NOx measurements. FID range 5000.

CB027

Date 960618
Substance Chlorobenzene
Mass 812 g
Pan diameter 15 cm
Air inlet width 45 cm, height 10 cm
(upper) + 2 cm (lower)
Furnace temp. appr. 520 °C
Duct diameter 70 mm
11.36.50 Log start time
11.42.36 Ignition
11.47.17 Duct changed from 70 mm to
90 mm
11.56.00 Log end time
No NOx measurements. FID range 5000.

CB028

Date 960619
Substance Chlorobenzene
Mass 1045 g

Pan diameter 15 cm
Air inlet width 45 cm, height 10 cm
(upper) + 1 cm (lower)
Furnace temp. appr. 520 °C
Duct diameter 70 mm
14.13.00 Log start time
14.15.25 Ignition
14.19.22 Duct flow reducer removed.
Extinction soon after
14.27 Log end time
Chlorobenzene spilled in furnace at
ignition
FID range 5000.

CB029

Date 960619
Substance Chlorobenzene
Mass 371 g
Pan diameter 10 cm
Air inlet width 45 cm, height 10 cm
(upper) + 1 cm (lower)
Furnace temp. appr. 520 °C
Duct diameter 70 mm
14.35.05 Log start time
14.36.35 Ignition
14.48.50 Log end time
FID range 5000. Calibration: see CB028

CB030

Date 960619
Substance Chlorobenzene
Mass 289 g
Pan diameter 15 cm
Air inlet width 45 cm, height 10 cm
(upper) + 1 cm (lower)
Furnace temp. appr. 520 °C
Duct diameter 70 mm

14.53.00 Log start time
 14.55.20 Ignition
 15.03.25 Log end time
 FID range 5000. Calibration: see CB028

NY031

Date 960620
 Substance Nylon
 Mass 434 g
 Pan diameter 10 cm
 Air inlet width 45 cm, height 10 cm
 (upper) + 1 cm (lower)

Furnace temp. appr. 500 °C

Duct diameter 70 mm

10.42.00 Log start time
 10.43.30 Material placed on load cell
 10.54 Ignition
 11.02.52 Duct changed from 70 mm to
 30 mm
 11.51 Log end time.

NOx range 1000. FID range 1000. Test
 terminated at 11.51: gave no more data of
 interest.

NY032

Date 960620
 Substance Nylon
 Mass 494 g
 Pan diameter 15 cm
 Air inlet width 45 cm, height 10 cm
 (upper) + 1 cm (lower)

Furnace temp. appr. 520 °C

Duct diameter 30 mm

11.57.30 Log start time
 11.58.30 Material placed on load cell
 12.02.45 Duct changed from 30 mm to
 40 mm

12.05.30 Start propane burner for
 ignition
 12.06.30 Ignition. Stop propane burner
 12.19.00-12.21.30 Cleaning the O2-CO2-
 CO meter
 12.23.23 Start wet chem. sample
 12.24.20 Start soot sample
 12.30.10 Stop wet chem. sample
 12.30.20 Stop soot sample
 12.31.53 Start chem. sample
 12.37.10 Stop chem. sample
 12.42.30-12.44.00 Cleaning the O2-CO2-
 CO meter
 12.49 Self extinction
 12.56.14 Log end time.
 NOx range 1000. FID range 1000.

NY033

Date 960624
 Substance Nylon
 Mass 560 g
 Pan diameter 20 cm
 Air inlet width 45 cm, height 10 cm
 (upper) + 1 cm (lower)

Furnace temp. appr. 520 °C

Duct diameter 40 mm

14.36.30 Log start time
 Material placed on load cell
 14.39.30 Ignition
 14.42.20 Duct changed from 40 mm to
 60 mm
 appr. 14.45 Boiled-over material almost
 burnt up.
 14.48.38 Duct changed from 60 mm to
 40 mm
 14.55.10 Start soot sample
 14.57.45 Stop soot sample. Fire out

15.00.37 Log end time.

The material melted and boiled over the pan, thus making the burning diameter larger.

NOx range 1000. FID range 500. Load cell may be out of function, due to lack of cooling water during the weekend.

NY034

Date 960625

Substance Nylon

Mass 700 g

Pan diameter 30 cm

Air inlet width 45 cm, height 10 cm (upper) + 1 cm (lower)

Furnace temp. appr. 520 °C

Duct diameter 40 mm

appr. 10.40 Material placed on load cell for melting

11.05.30 Log start time

11.11.08 Ignition

11.16.28 Start soot sample

11.21.19 Stop soot sample

11.21.42 Start wet chem. sample

11.23.42 Stop wet chem. sample

11.24.25 Start chem. sample

11.26.24 Stop chem. sample

11.42 Log end time.

NOx range 1000. FID range 1000. NOx meter smoke logged?

NY035

Date 960625

Substance Nylon

Mass 1000 g

Pan diameter 40 cm

Air inlet width 45 cm, height 10 cm (upper) + 1 cm (lower)

Furnace temp. appr. 520 °C

Duct diameter 40 mm

14.53 Material placed on load cell for melting

15.09.00 Log start time

15.10.20 Ignition

15.20.12 Start soot sample

15.25.00 Stop soot sample

15.17.35 Start wet chem. sample

15.18.20 Duct changed from 40 mm to 60 mm

15.20.00 Stop wet chem. sample

15.21.50 NOx meter tested with calibration gas. Conclusion: out of order.

15.23.04 - 15.23.24 NOx meter measuring only NO.

15.29.20 Log end time.

NOx range 1000. FID range 1000.

NY036

Date 960627

Substance Nylon

Mass 1300 g

Pan diameter 40 cm

Air inlet width 45 cm, height 10 cm (upper) + 0 cm (lower)

Furnace temp. appr. 520 °C

Duct diameter 50 mm

10.54.00 Material placed on load cell for melting

appr. 11.09.30 Spontaneous ignition

appr. 11.09.30 Log start time

11.18.48 Start wet chem. sample

11.20.48 Stop wet chem. sample

11.23.13 Start chem. sample

11.27.13 Stop chem. sample
11.22.50 Duct changed from 50 mm to 60 mm
11.40.00 Log end time.
NOx range 1000. FID range 1000. NOx meter OK?

TMTM037

Date 960627
Substance TMTM
Mass 700 g
Pan diameter 30 cm
Air inlet width 45 cm, height 10 cm (upper) + 1 cm (lower)
Furnace temp. appr. 520 °C
Duct diameter 60 mm
13.48.40 Log start time
appr. 13.50 Material placed on load cell for melting
appr. 13.52 Spontaneous ignition
13.55 Bluish white flames
13.58 Brown flames
13.59.42 Start wet chem. sample
14.00 Yellow flames
14.01.42 Stop wet chem. sample
14.03.25 Log end time.
NOx range 1000. FID range 1000. NOx meter OK?

TMTM038

Date 960627
Substance TMTM
Mass 1100 g
Pan diameter 30 cm
Air inlet width 45 cm, height 10 cm (upper) + 1 cm (lower)
Furnace temp. appr. 520 °C

Duct diameter 60 mm
14.32.21 Log start time
14.32.45 Pan placed on load cell
14.35 Not possible to ignite with propane burner
14.36.20 Spontaneous ignition
14.43.02 Start wet chem. sample
14.43.50 Duct changed from 60 mm to 70 mm
14.47.30 Stop wet chem. sample
14.03.25 Log end time.
NOx range 1000. FID range 1000. Test similar to TMTM037 but having larger mass.

Appendix B: Diagrams of time dependant variables

Contents:

Test number:

Test	Page
HEP 001	2
HEP 002	2
CB 004	4
CB 005	4
CB 006	6
TMTM 007	20
TMTM 008	20
TMTM 009	22
TMTM 010	22
DIM 011	28
DIM 012	28
DIM 013	30
TMTM 014	24
DIM 015	30
CNBA 016	32
CNBA 017	34
CNBA 018	34
CB 019	6
CB 020	8
CB 021	8
CB 022	10
CB 023	10
CB 024	12
CB 025	12
CB 026	14
CB 027	14
CB 028	16
CB 029	16
CB 030	18
NYL 031	36
NYL 032	36
NYL 033	38
NYL 034	38
NYL 035	40
NYL 036	40
TMTM 037	26
TMTM 038	26

Page number:

Test	Page
HEP 001	2
HEP 002	2
CB 004	4
CB 005	4
CB 006	6
CB 019	6
CB 020	8
CB 021	8
CB 022	10
CB 023	10
CB 024	12
CB 025	12
CB 026	14
CB 027	14
CB 028	16
CB 029	16
CB 030	18
TMTM 007	20
TMTM 008	20
TMTM 009	22
TMTM 010	22
TMTM 014	24
TMTM 037	26
TMTM 038	26
DIM 011	28
DIM 012	28
DIM 013	30
DIM 015	30
CNBA 016	32
CNBA 017	34
CNBA 018	34
NYL 031	36
NYL 032	36
NYL 033	38
NYL 034	38
NYL 035	40
NYL 036	40

Appendix: Heptane

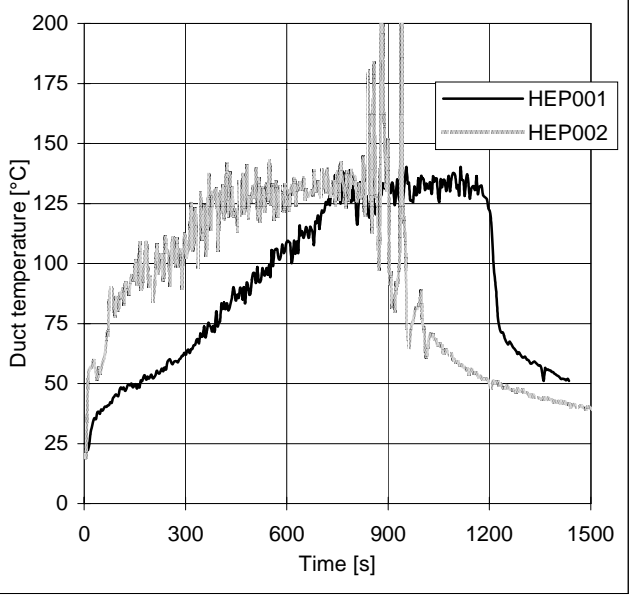
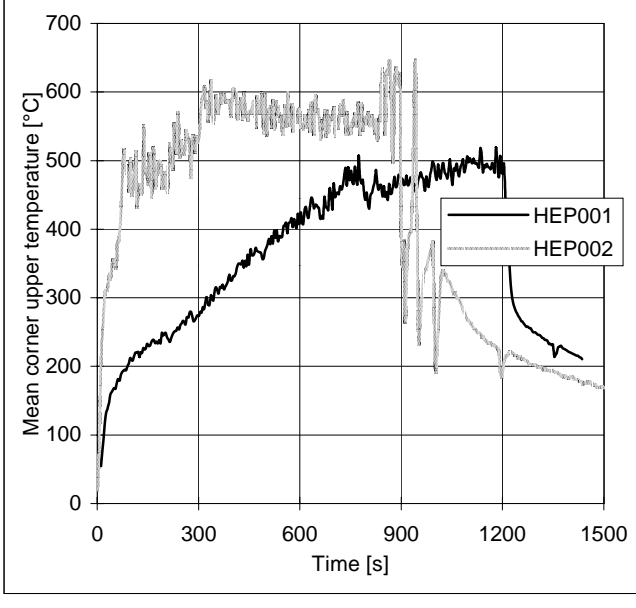
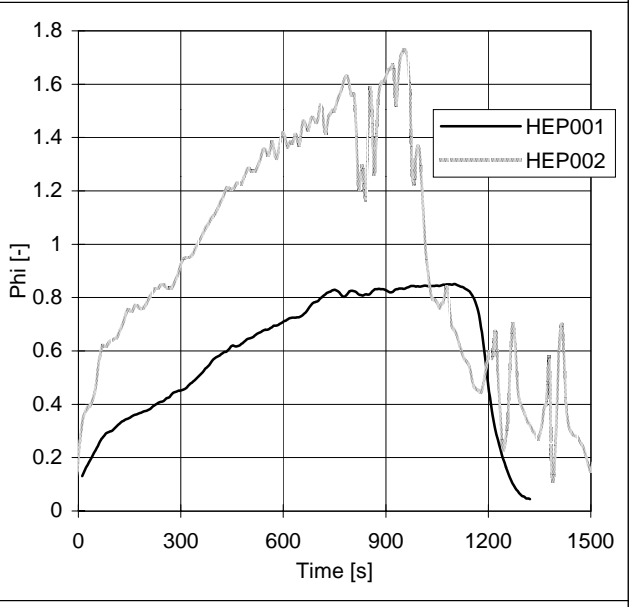
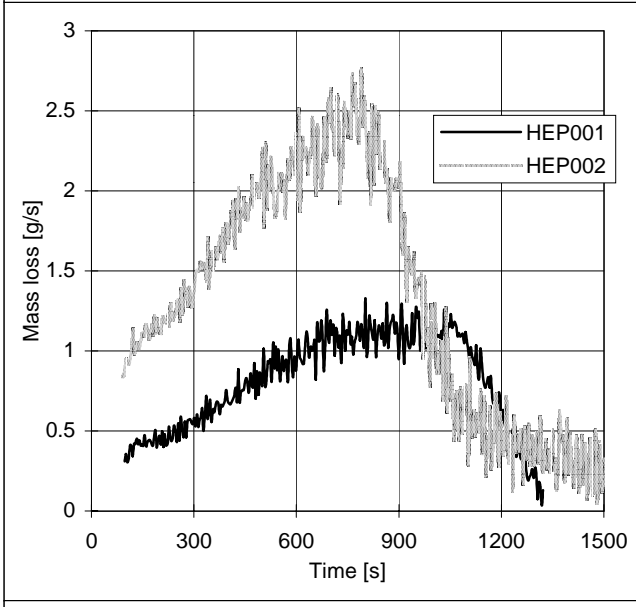
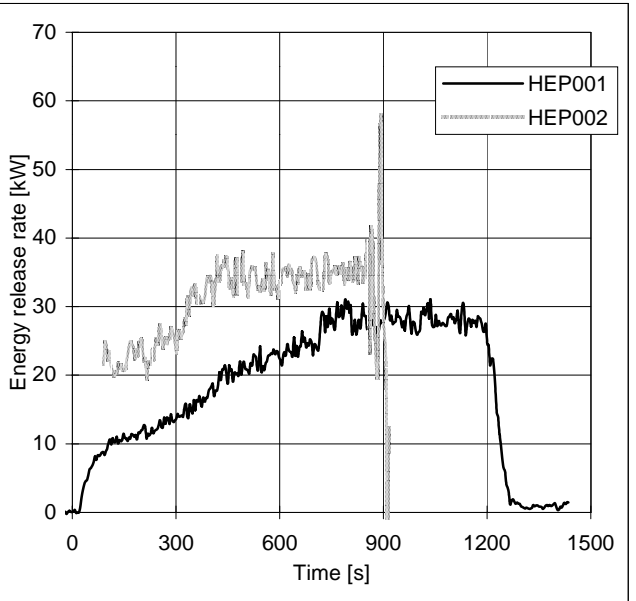
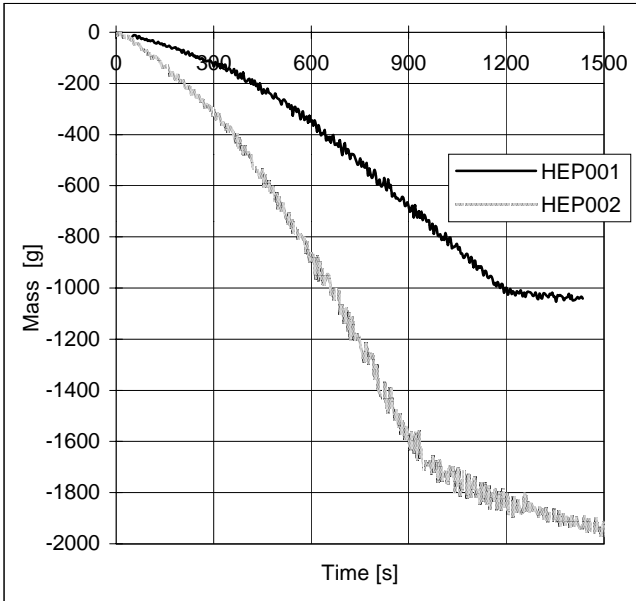

Appendix: Heptane

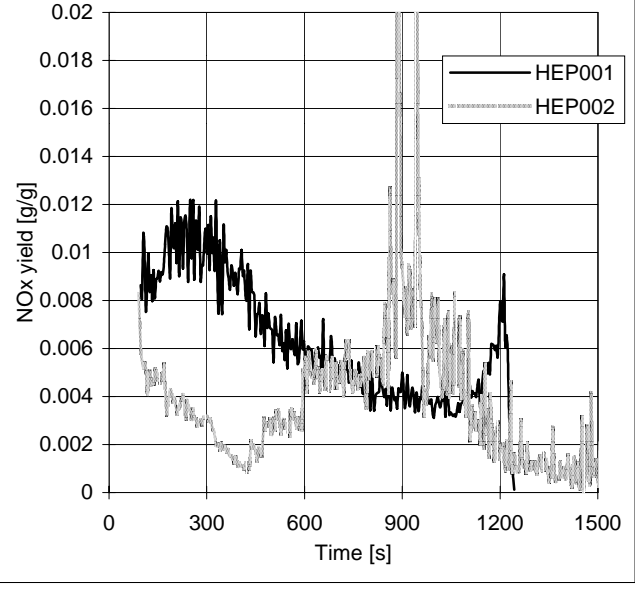
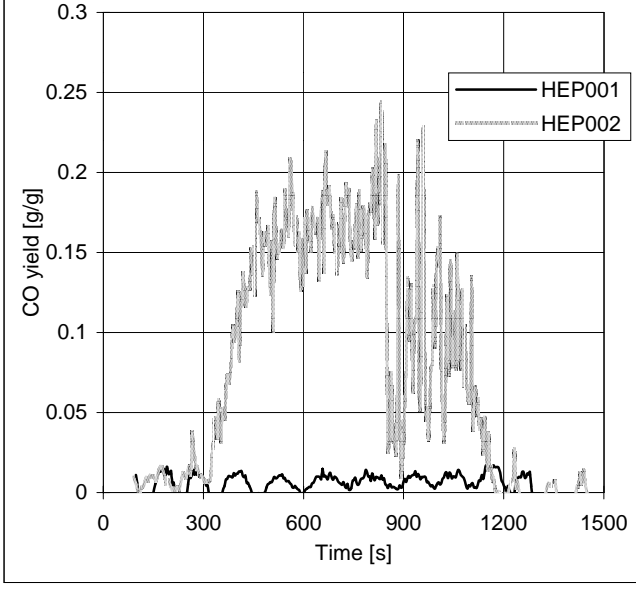
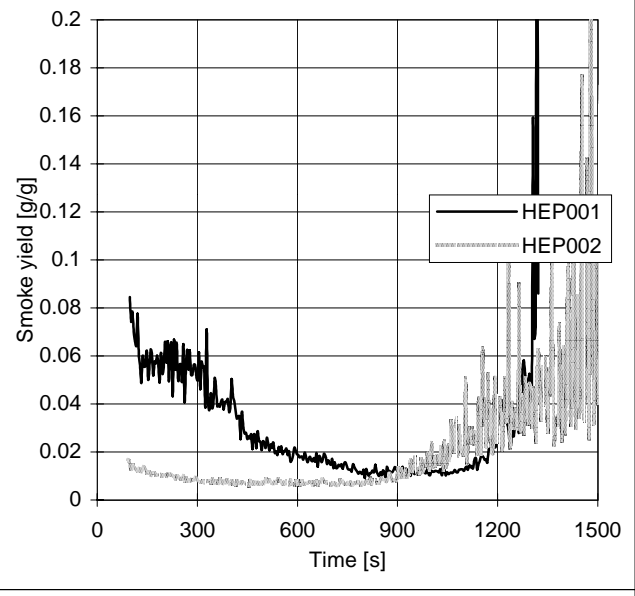
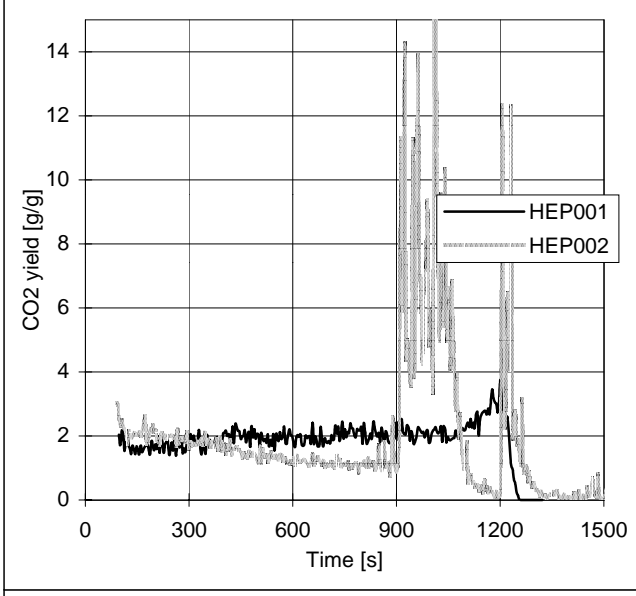
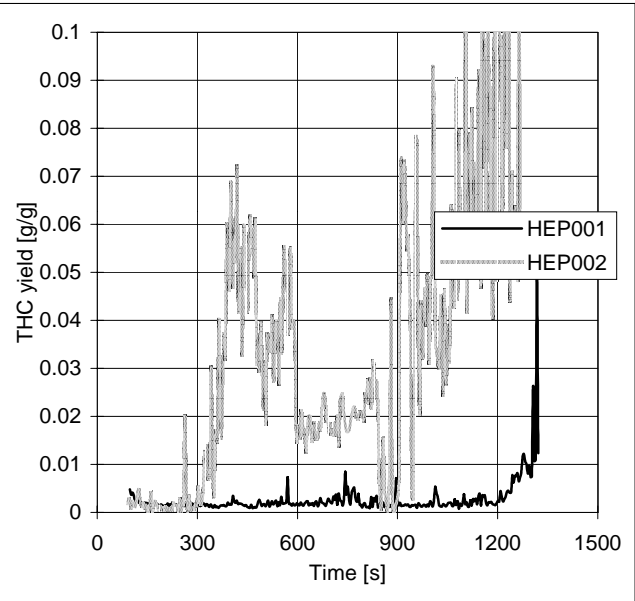
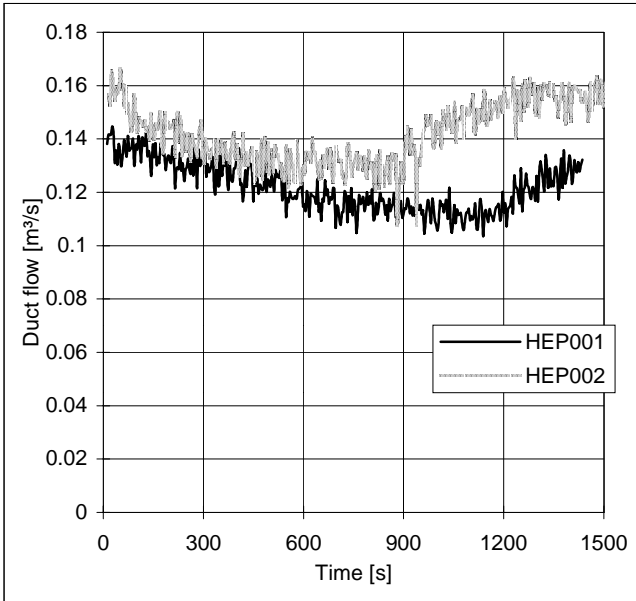

Appendix: Chlorobenzene

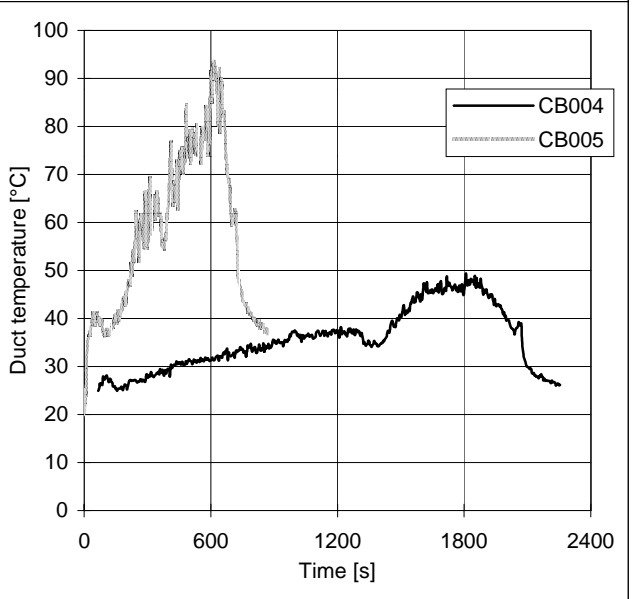
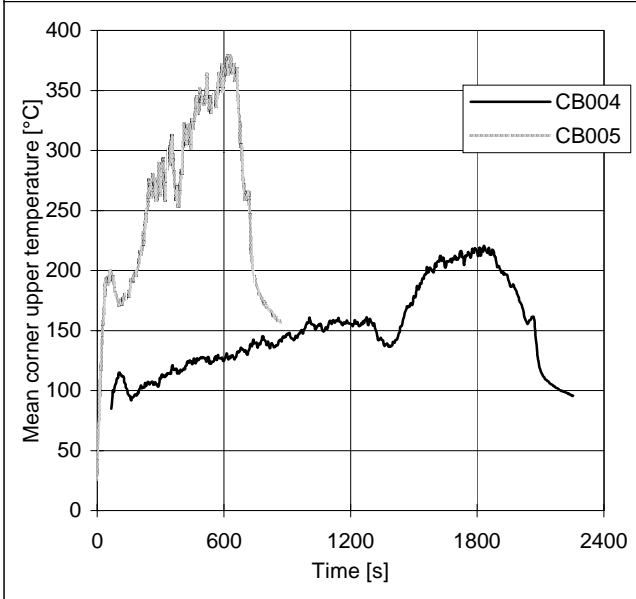
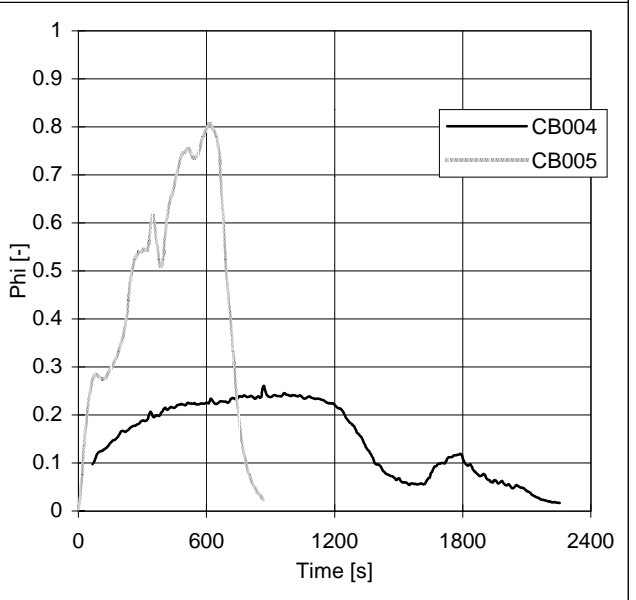
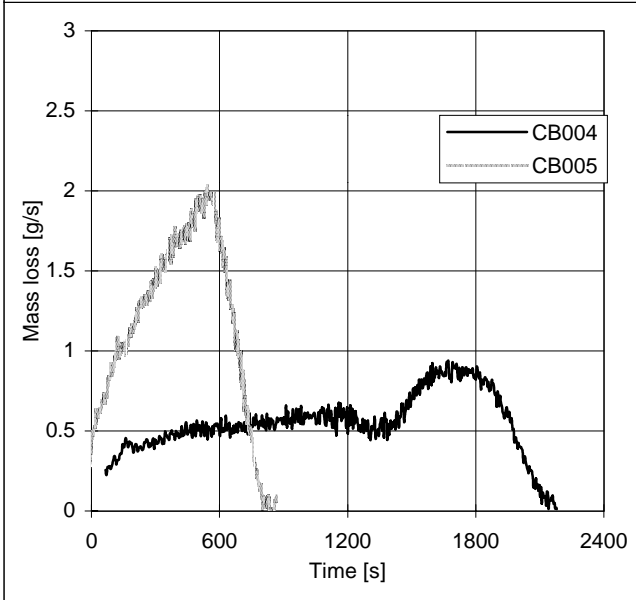
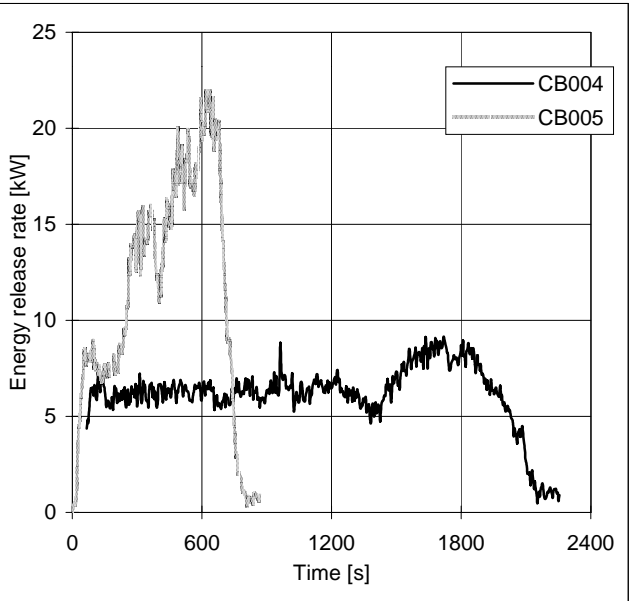
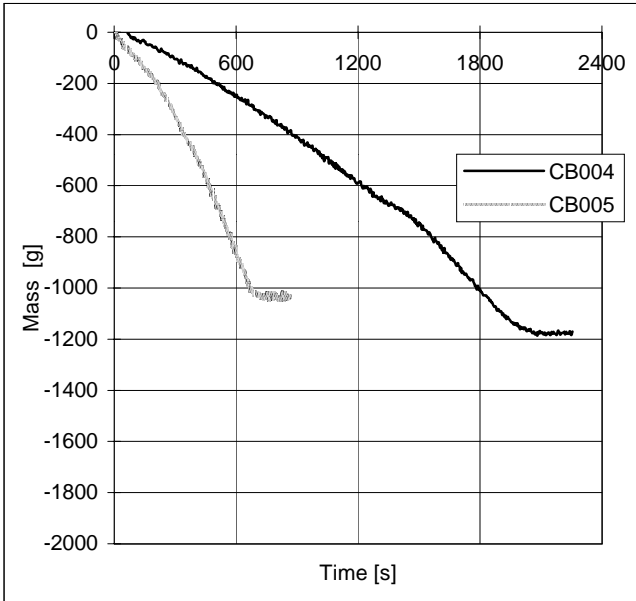

Appendix: Chlorobenzene

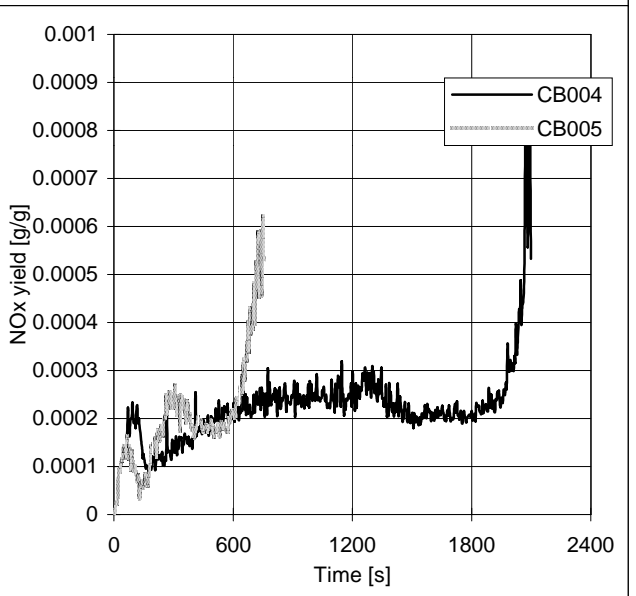
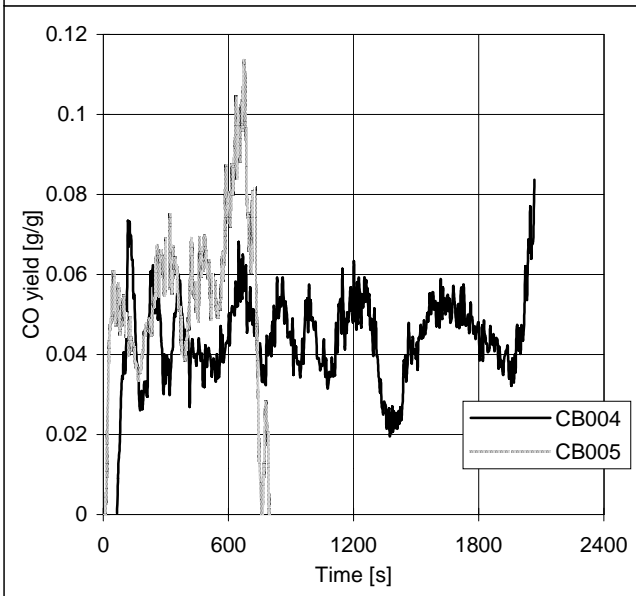
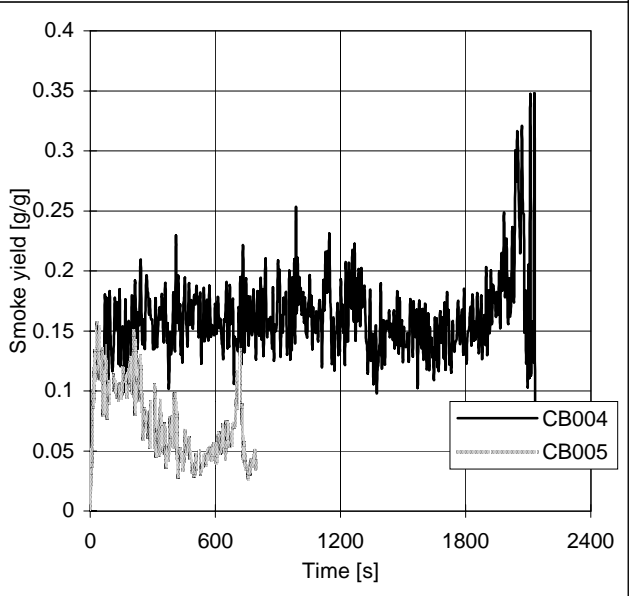
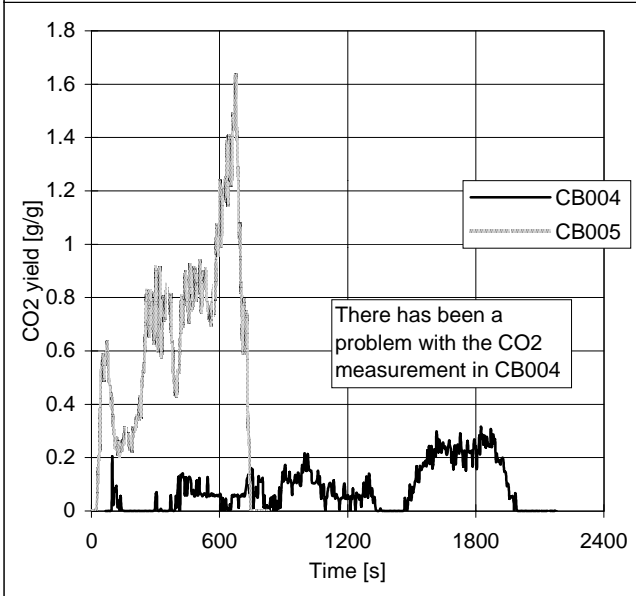
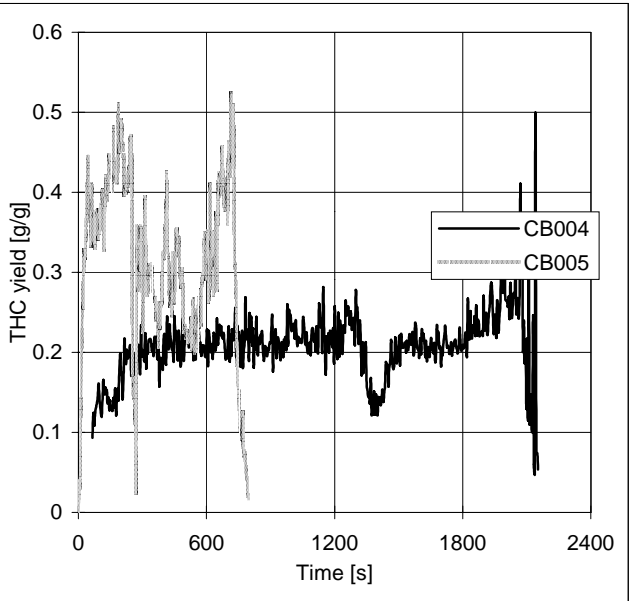
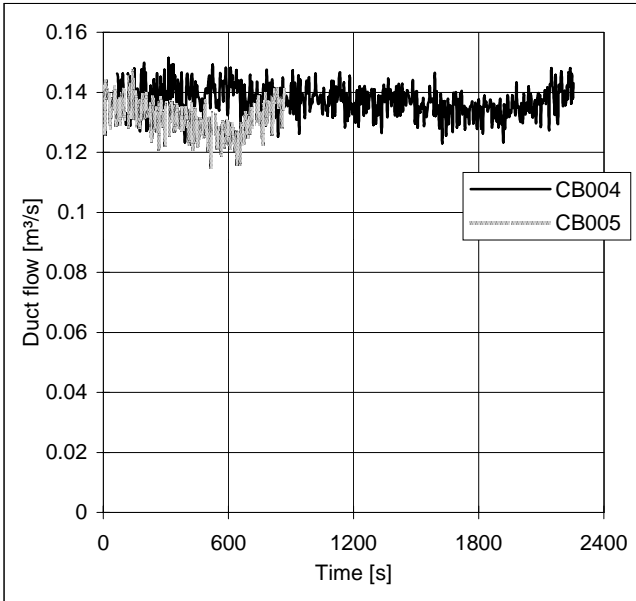

Appendix: Chlorobenzene

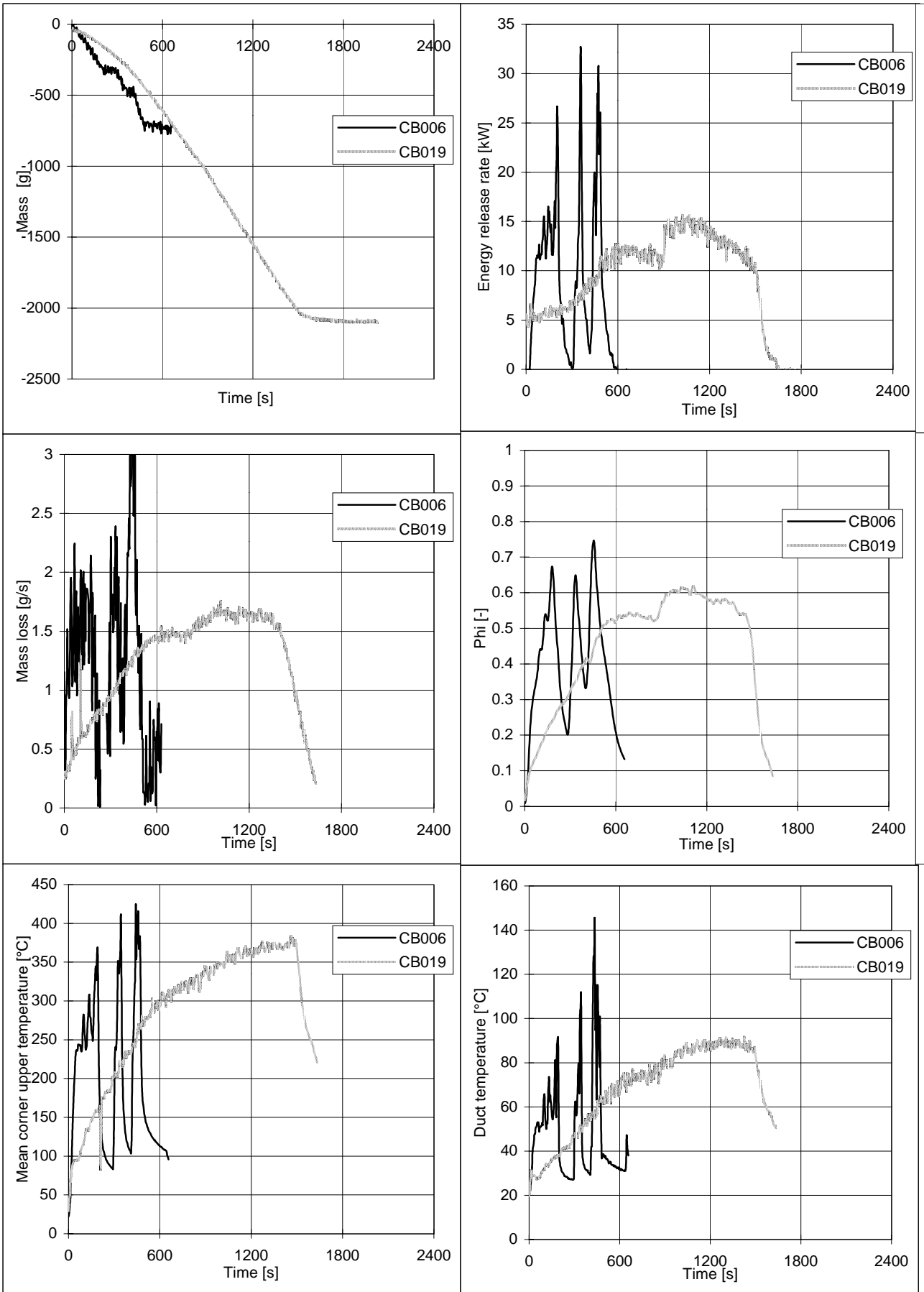

Appendix: Chlorobenzene

Appendix: Chlorobenzene

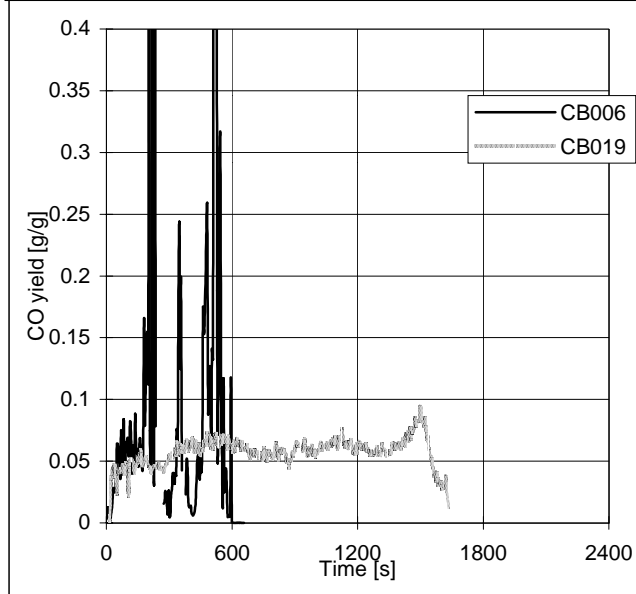
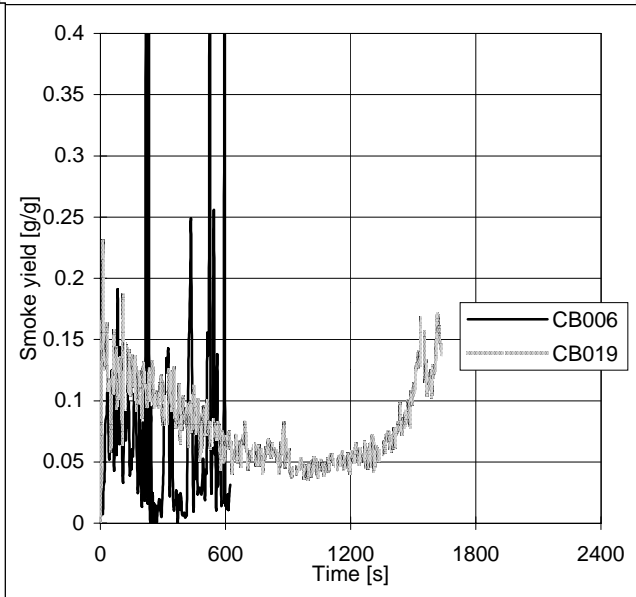
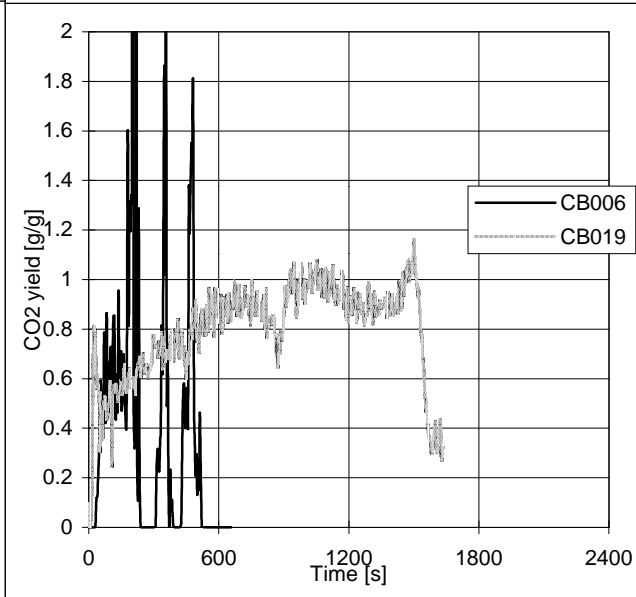
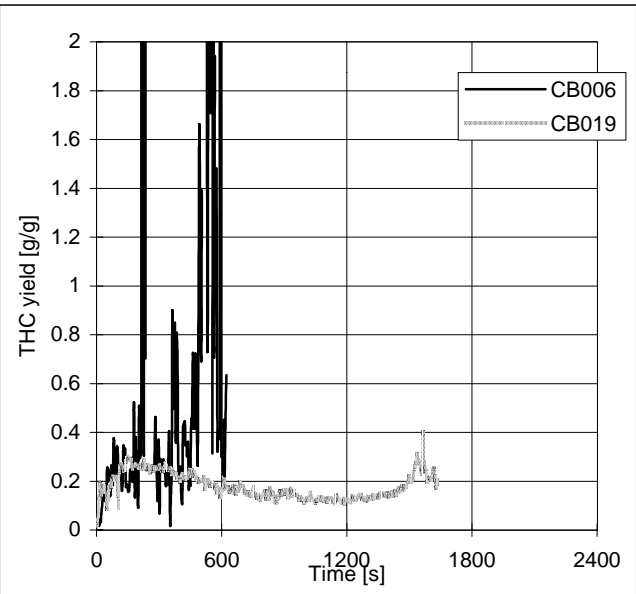
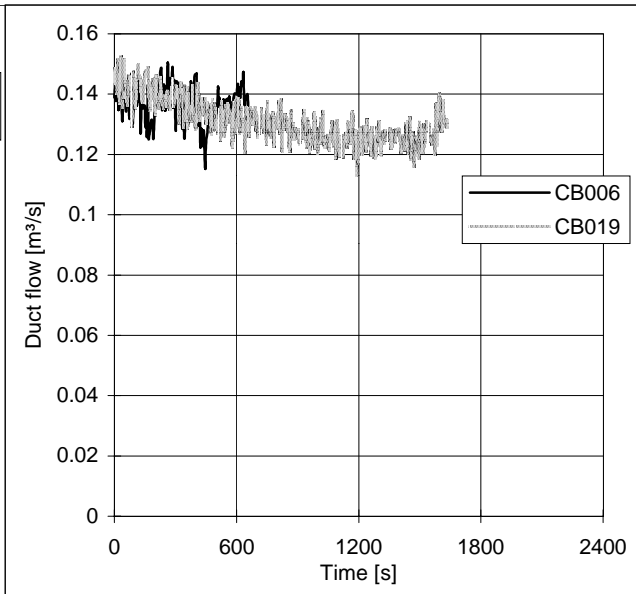

The NO_x production was not measured during these tests.

Appendix: Chlorobenzene

Appendix: Chlorobenzene

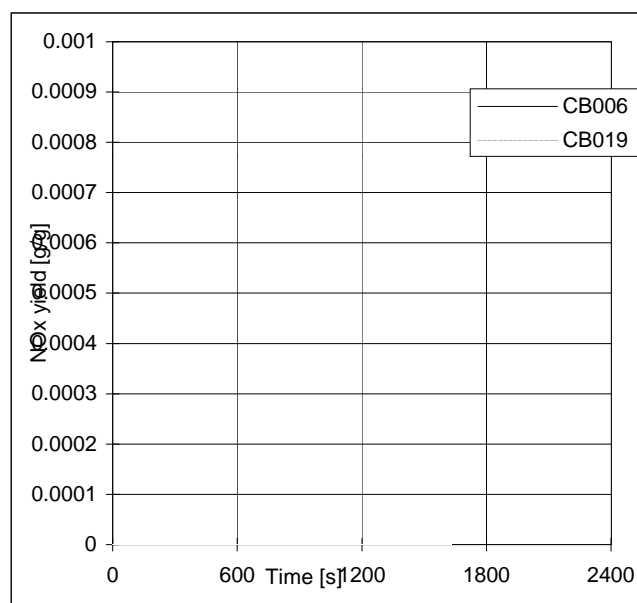

Appendix: Chlorobenzene

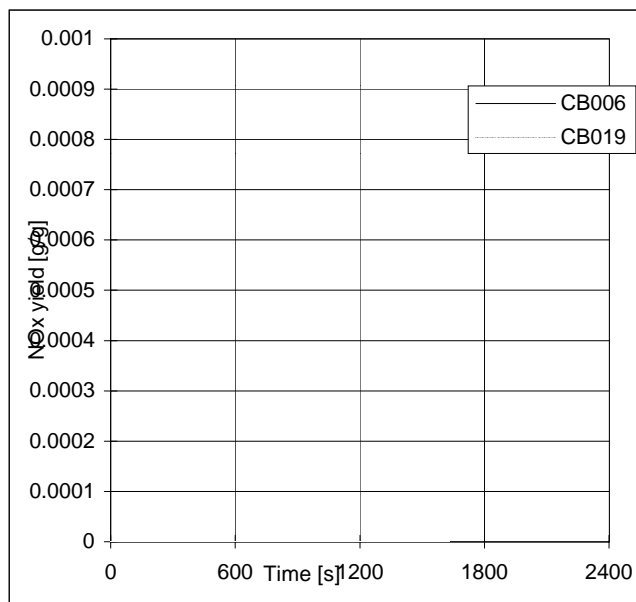

Appendix: Chlorobenzene

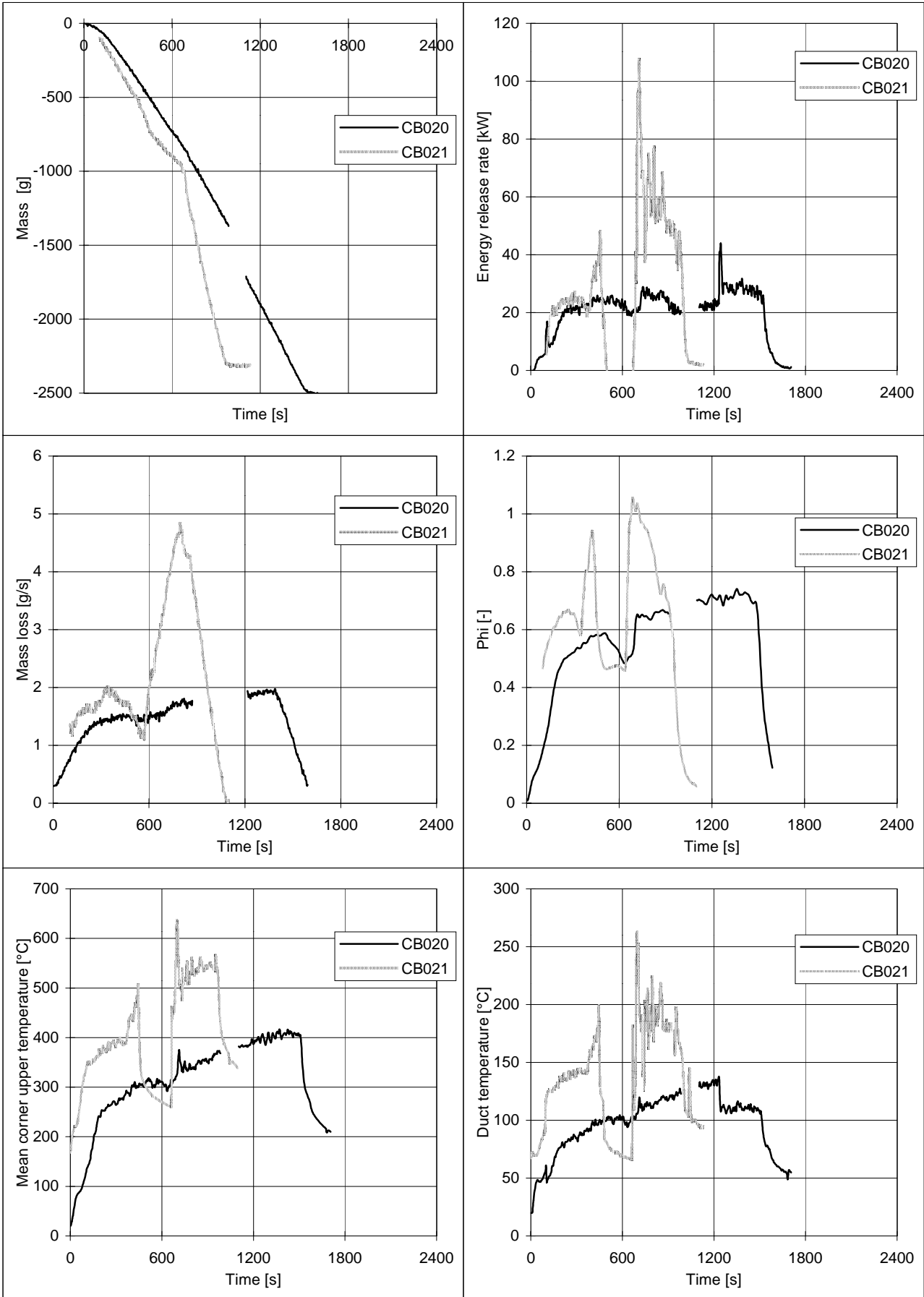

Appendix: Chlorobenzene

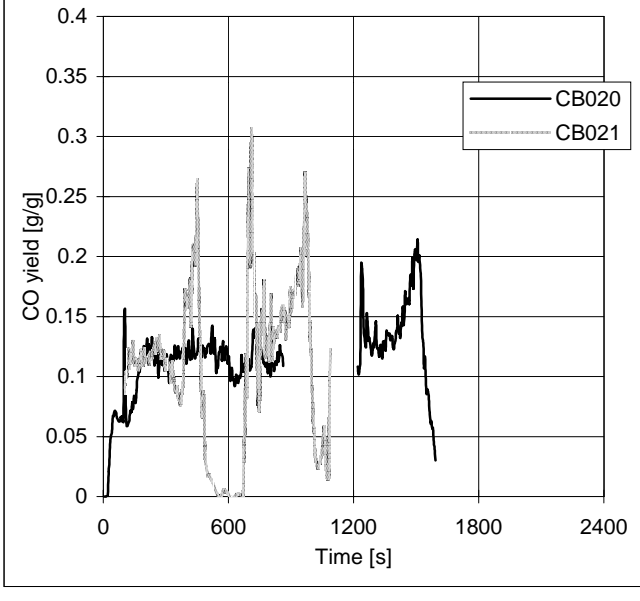
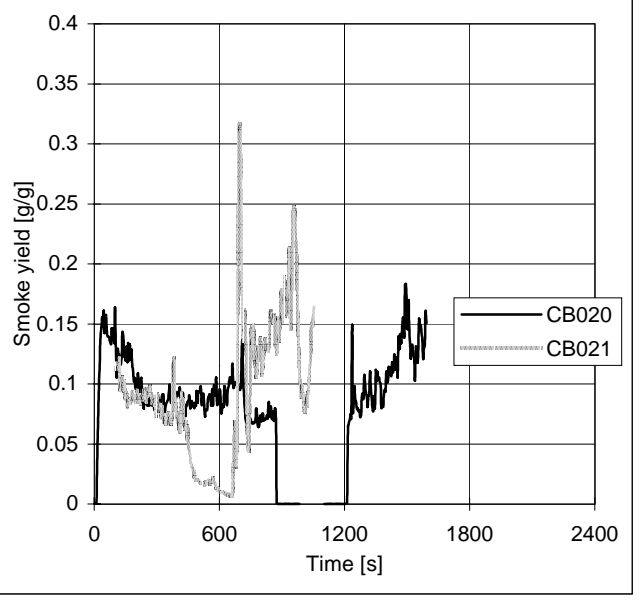
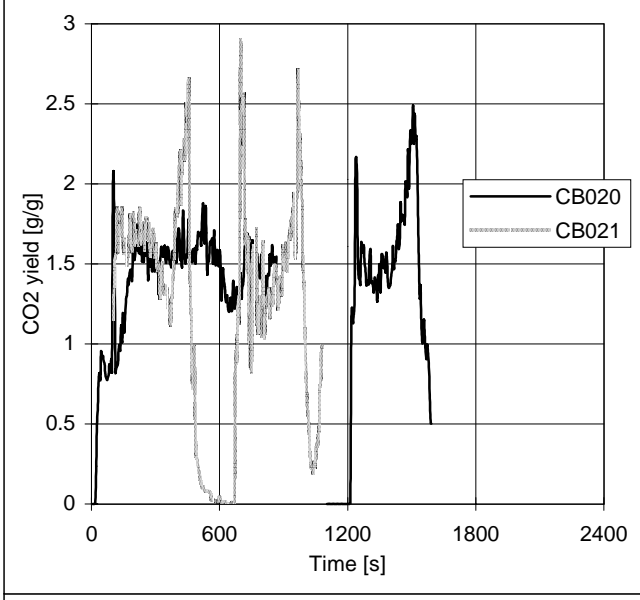
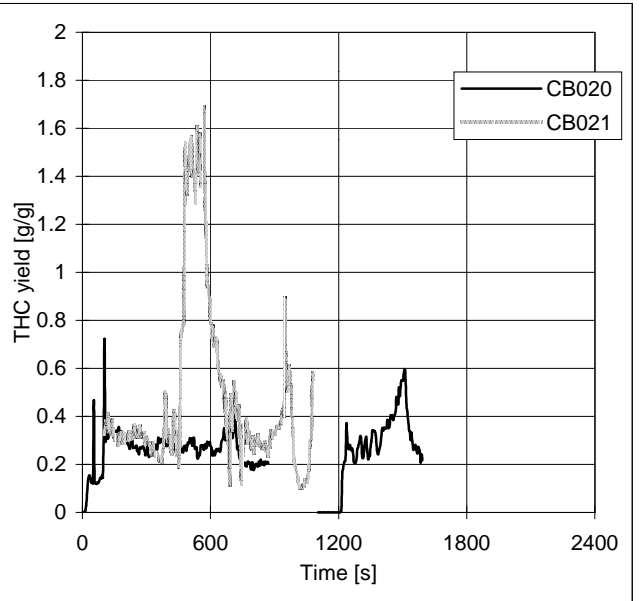
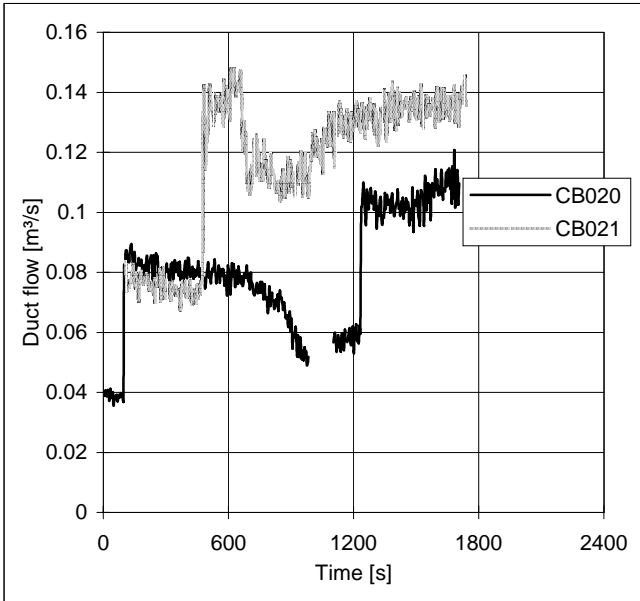

The NO_x production was not measured during these tests.

Appendix: Chlorobenzene

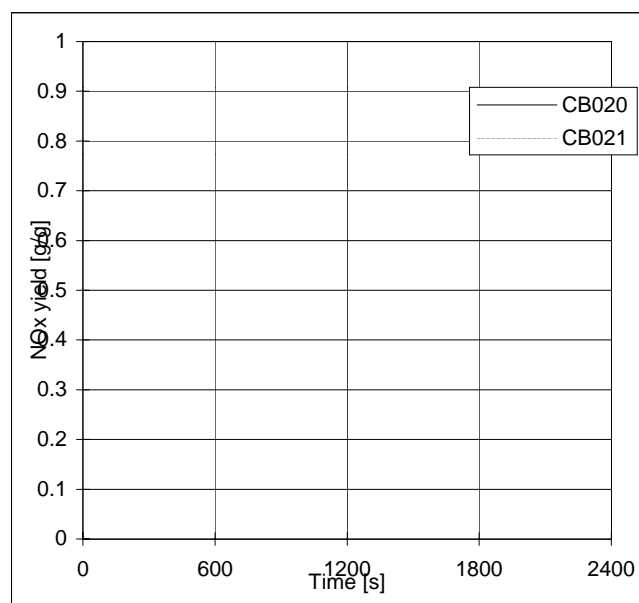

Appendix: Chlorobenzene

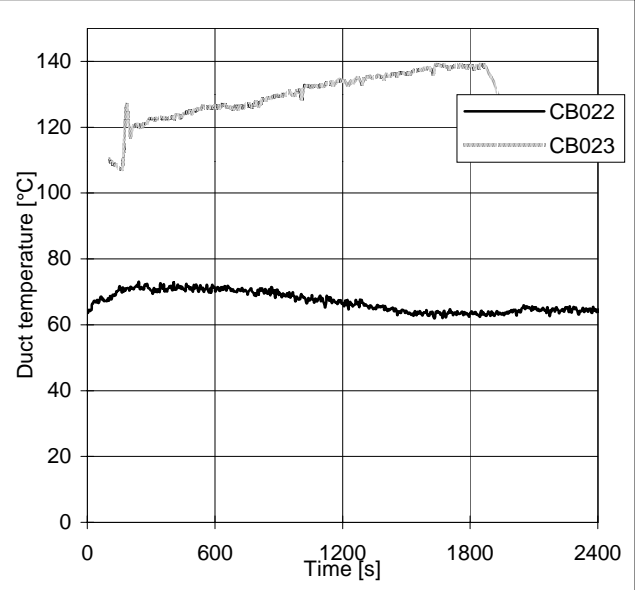
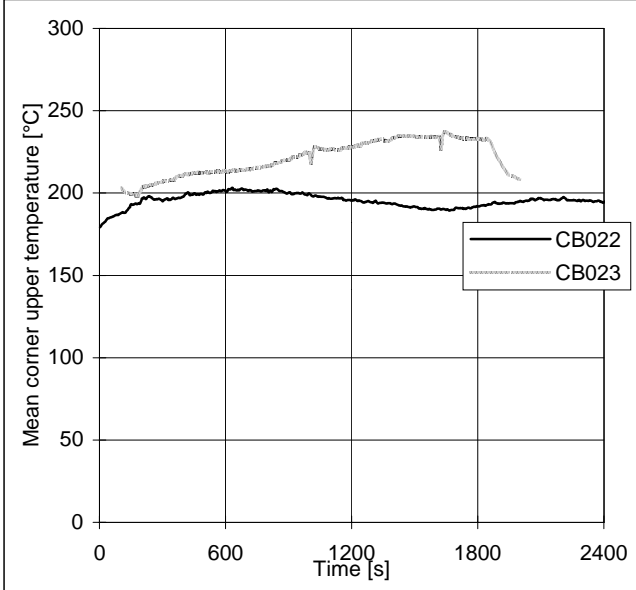
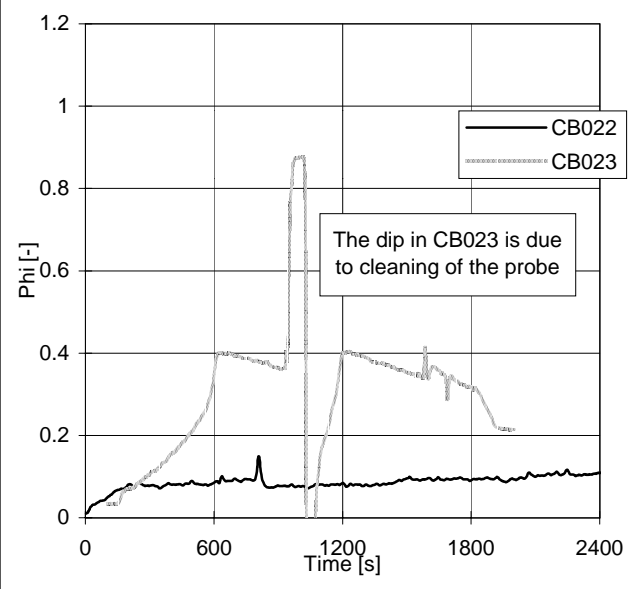
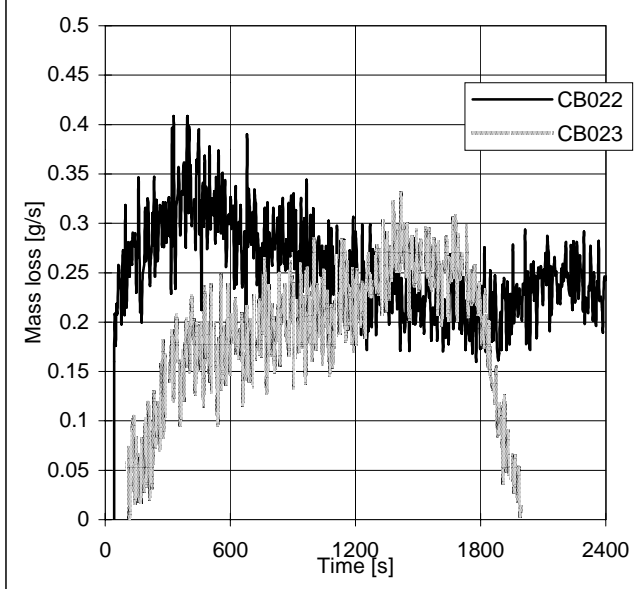
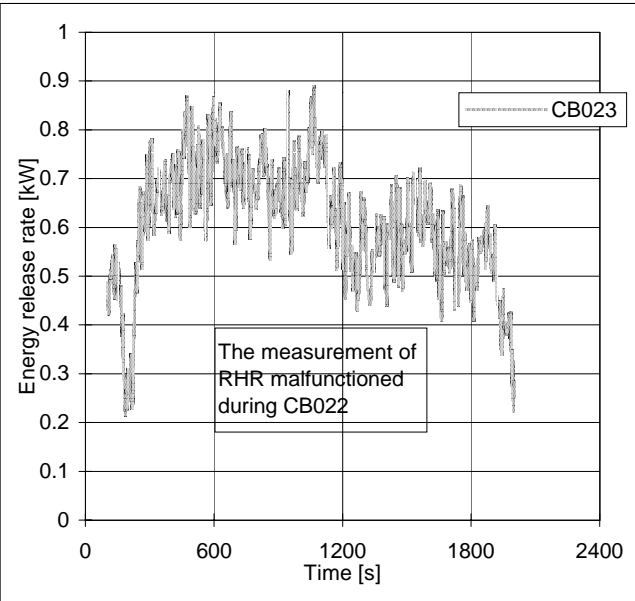
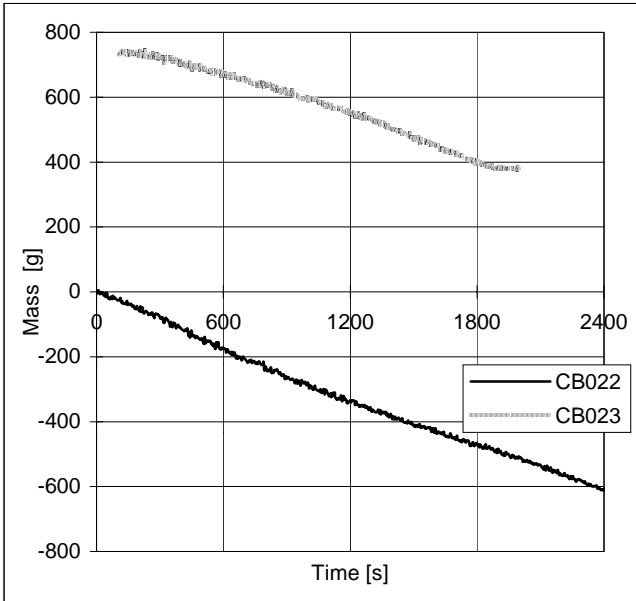

Appendix: Chlorobenzene

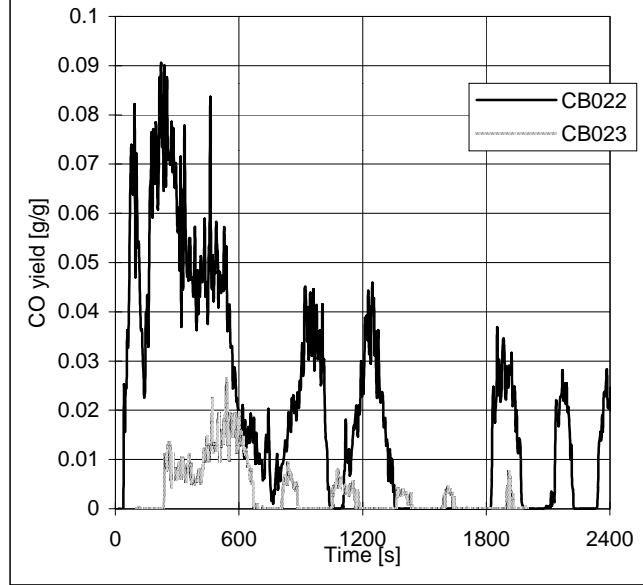
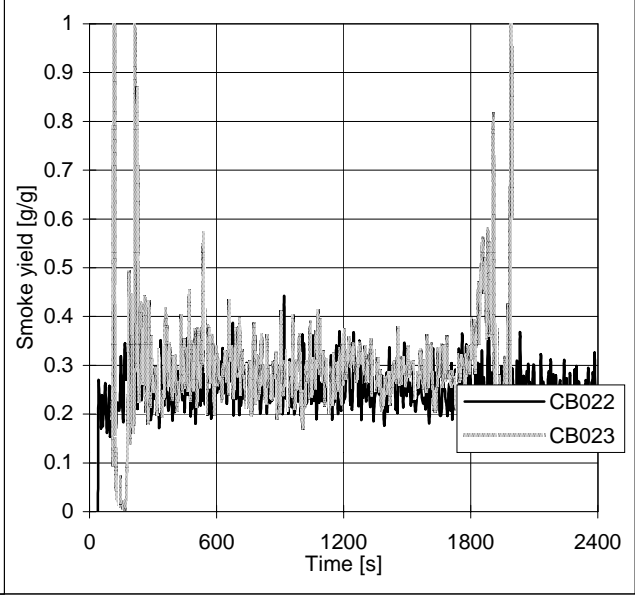
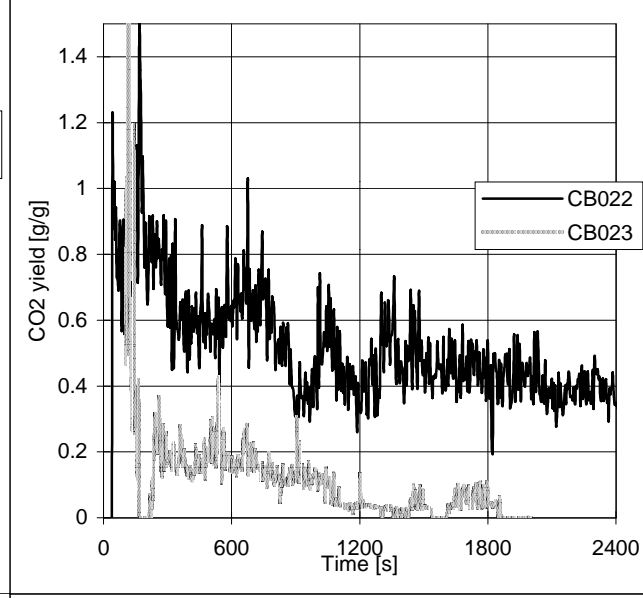
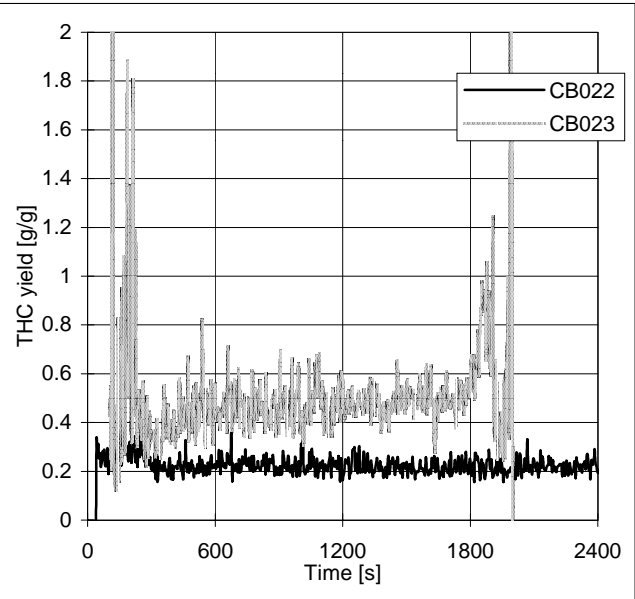
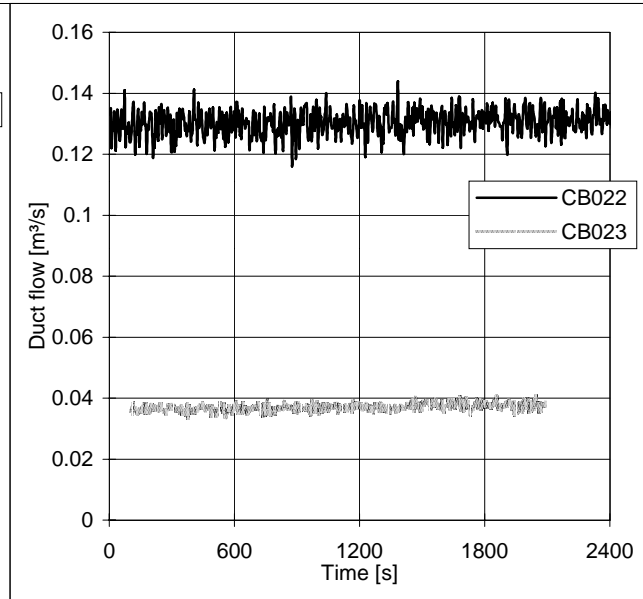

The NO_x production was not measured during these tests.

Appendix: Chlorobenzene

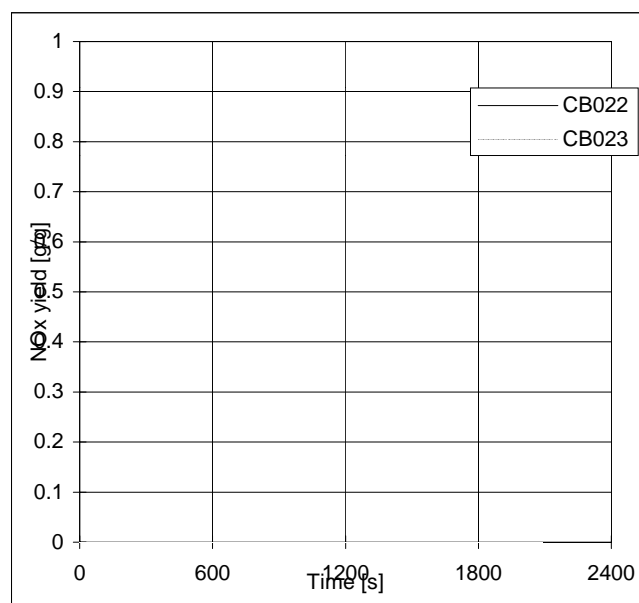

Appendix: Chlorobenzene

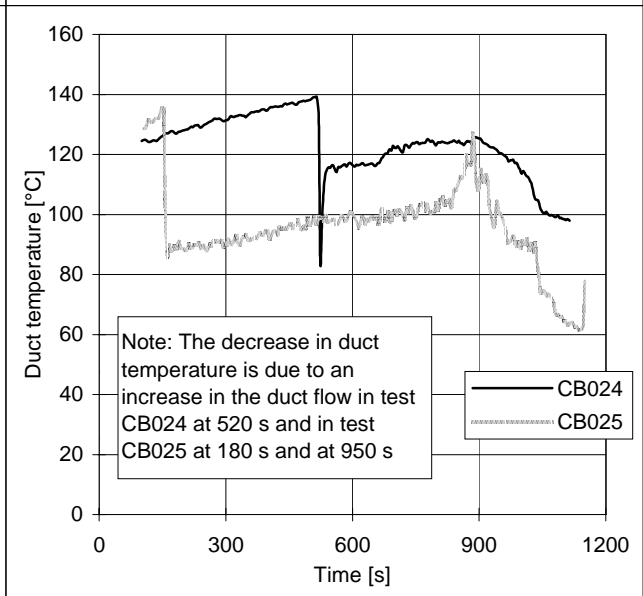
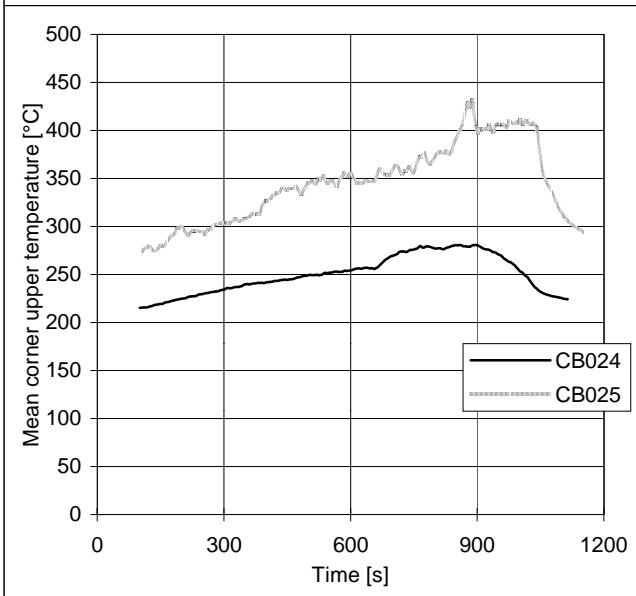
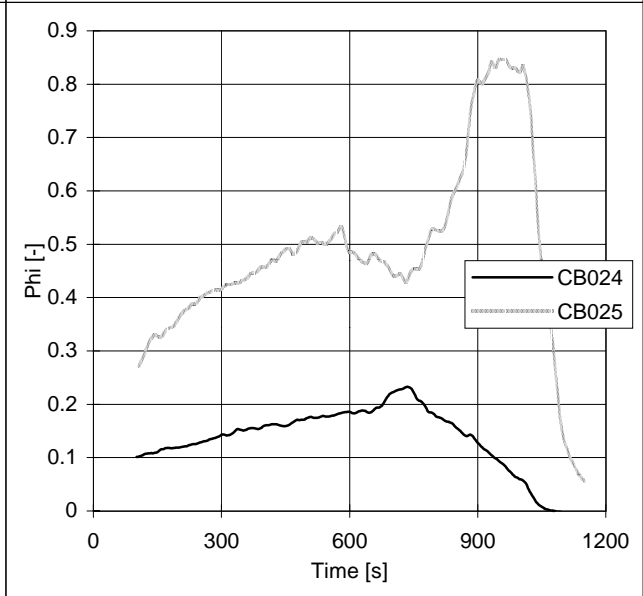
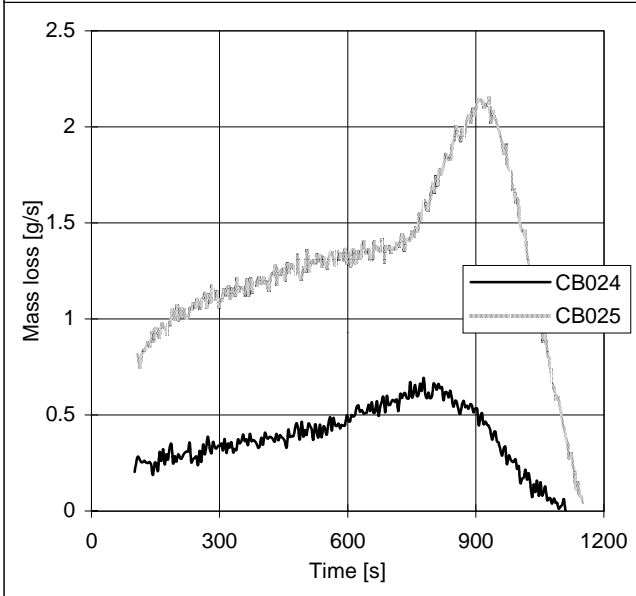
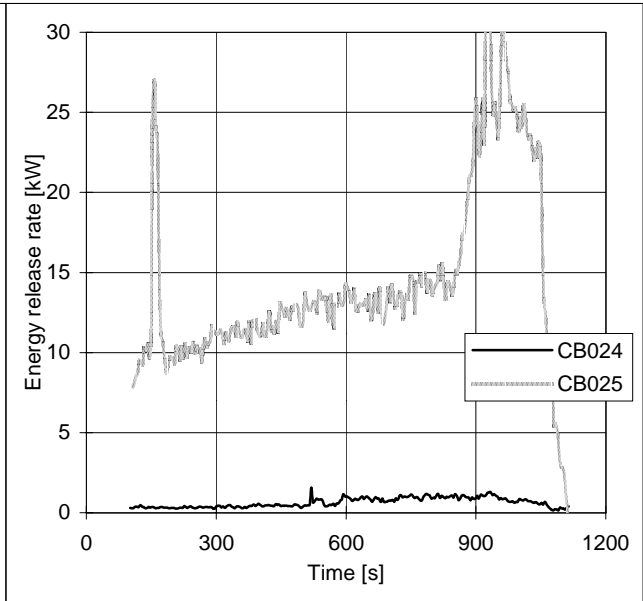
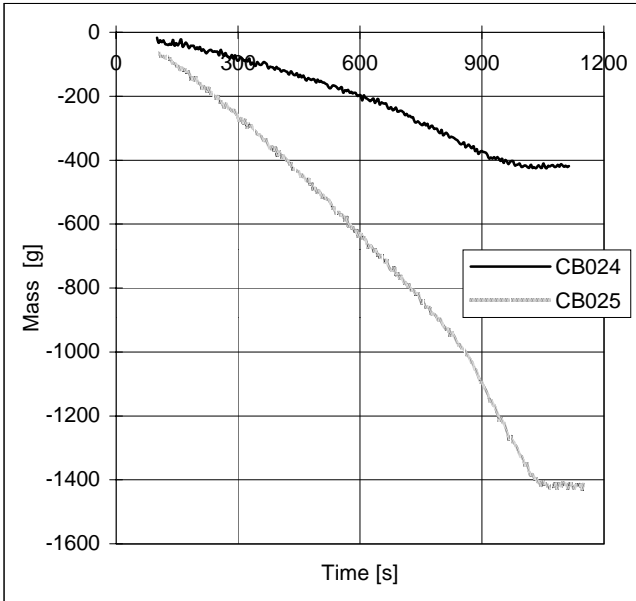

Appendix: Chlorobenzene

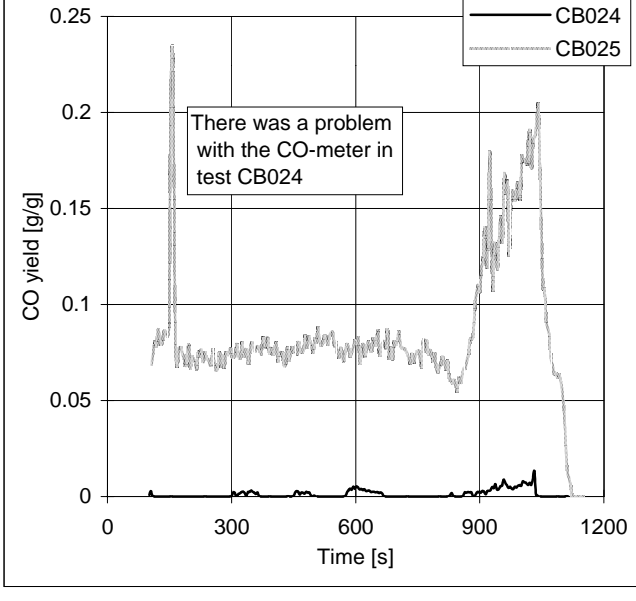
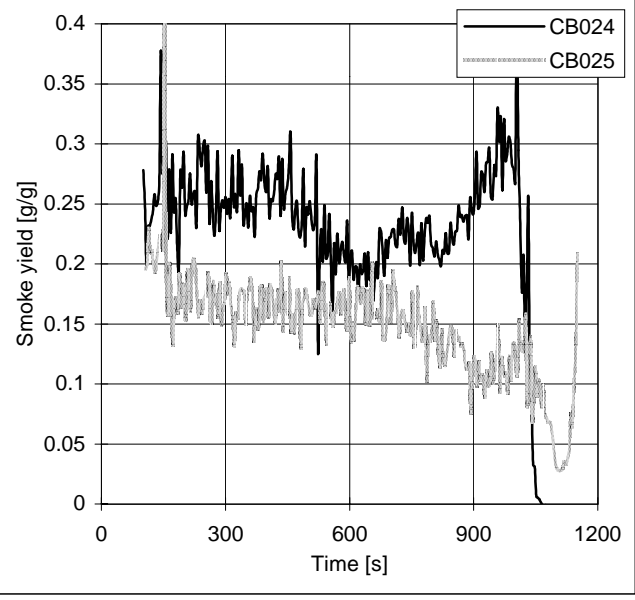
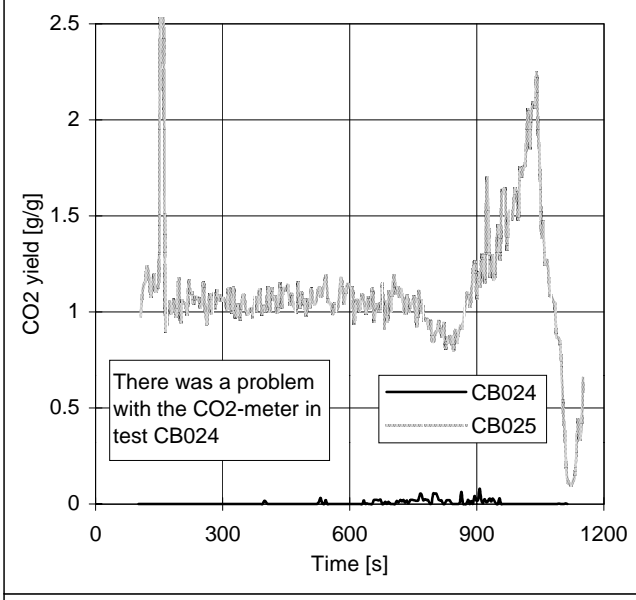
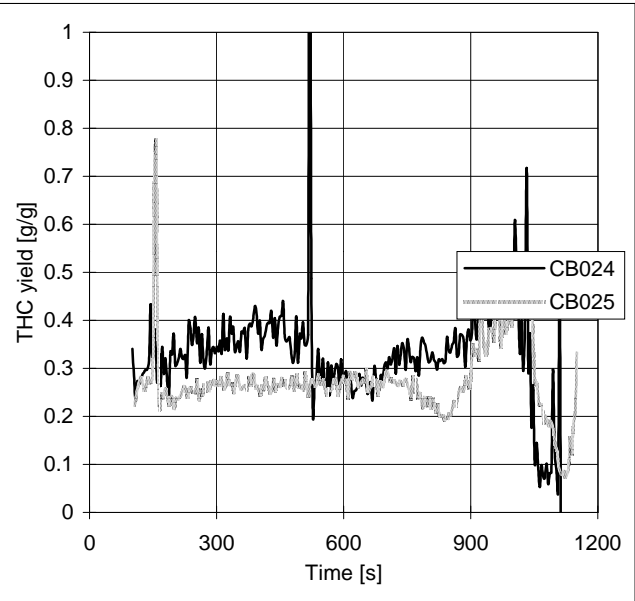
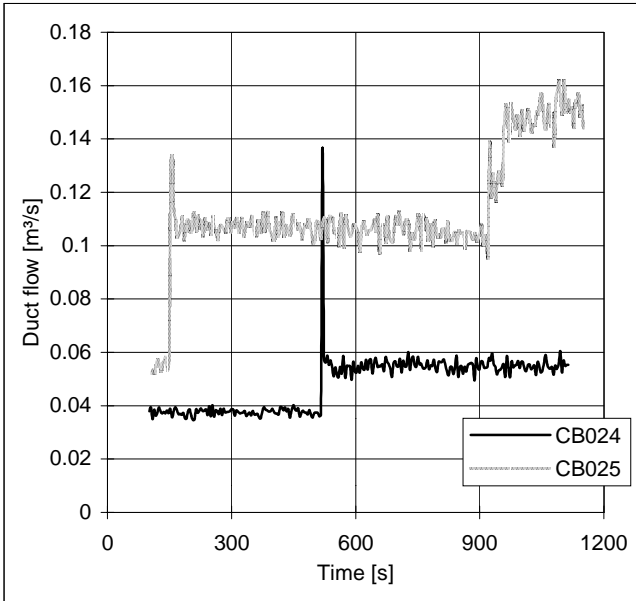

The NO_x production was not measured during these tests.

Appendix: Chlorobenzene

Note: The decrease in duct temperature is due to an increase in the duct flow in test CB024 at 520 s and in test CB025 at 180 s and at 950 s.

Appendix: Chlorobenzene

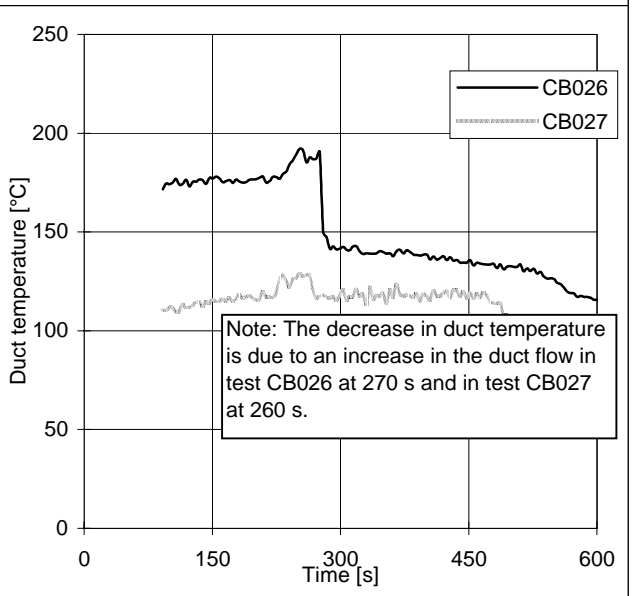
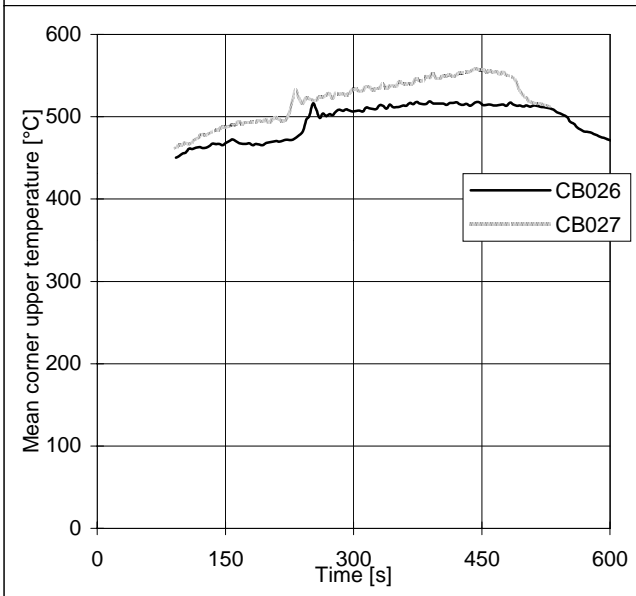
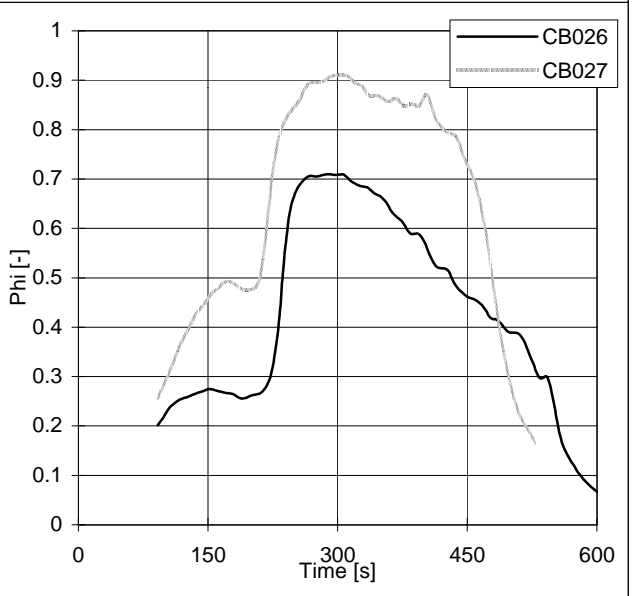
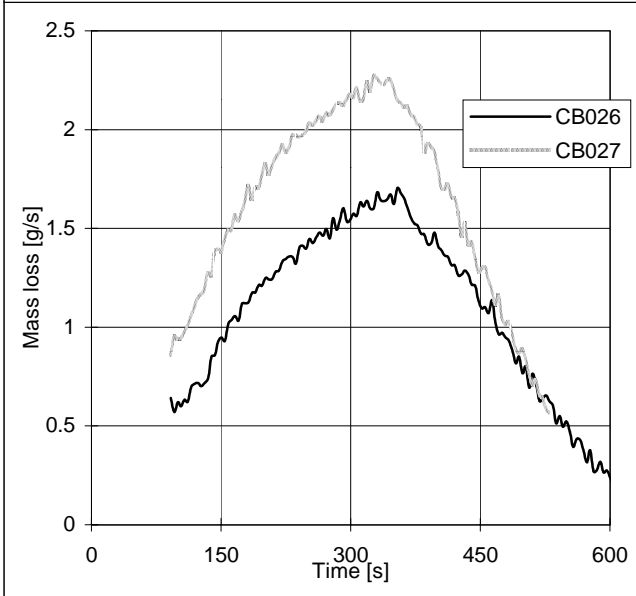
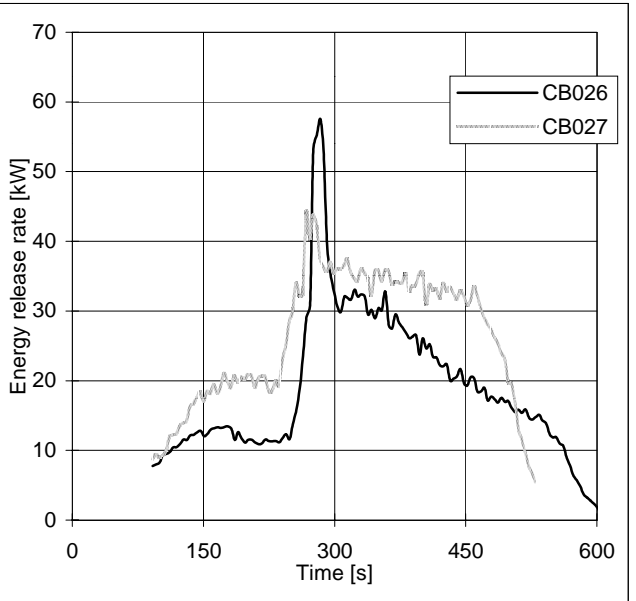
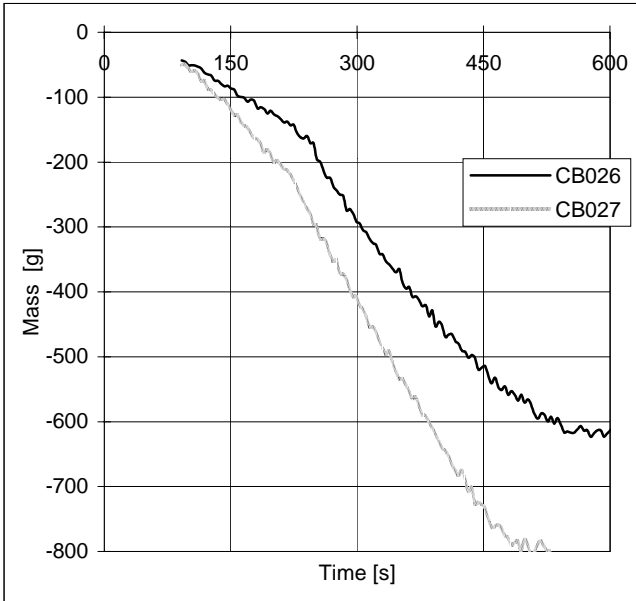

Appendix: Chlorobenzene

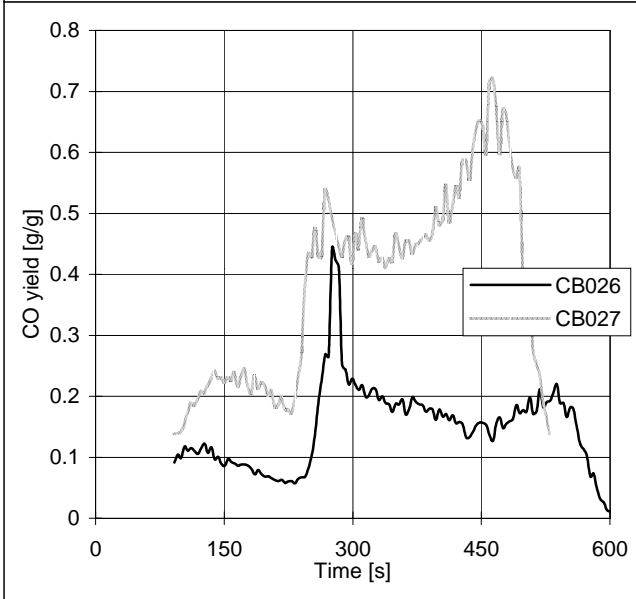
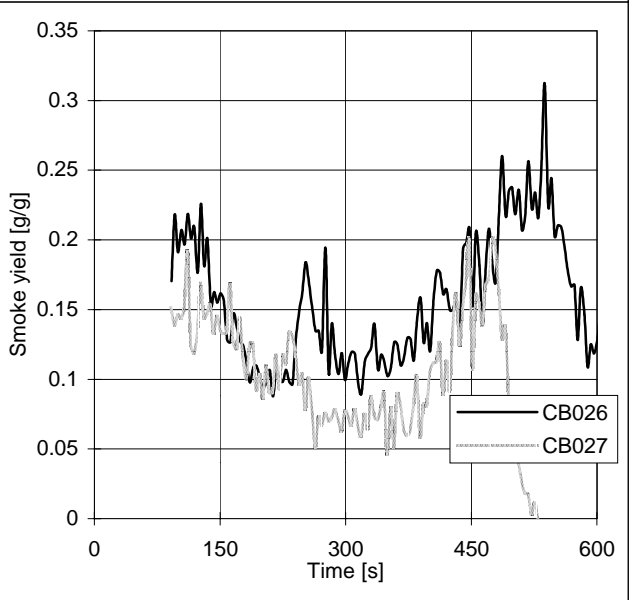
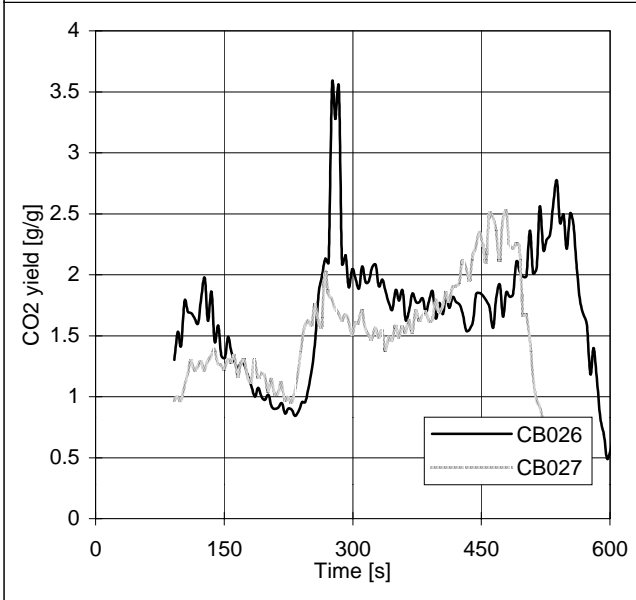
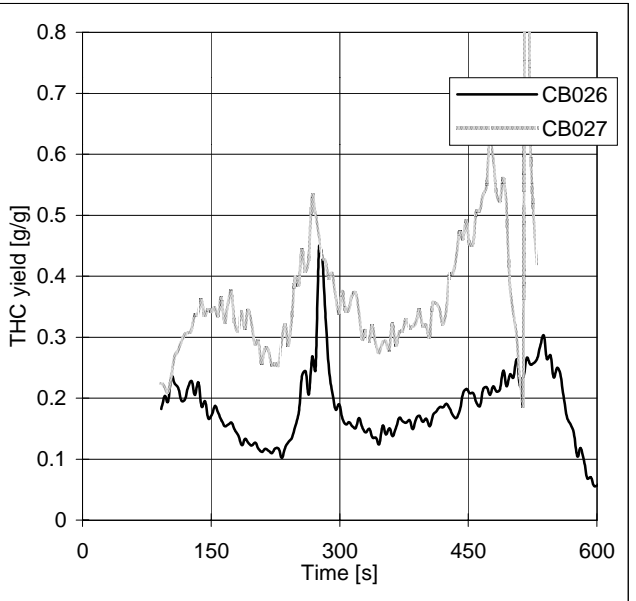
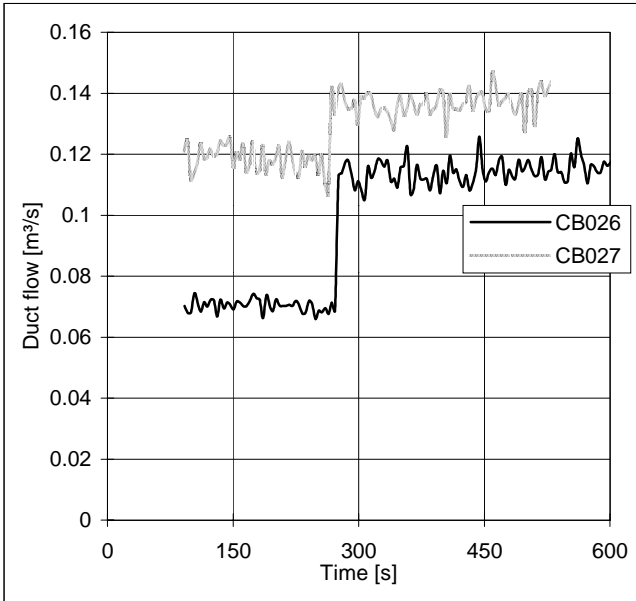

The NO_x production was not measured during this test.

Appendix: Chlorobenzene

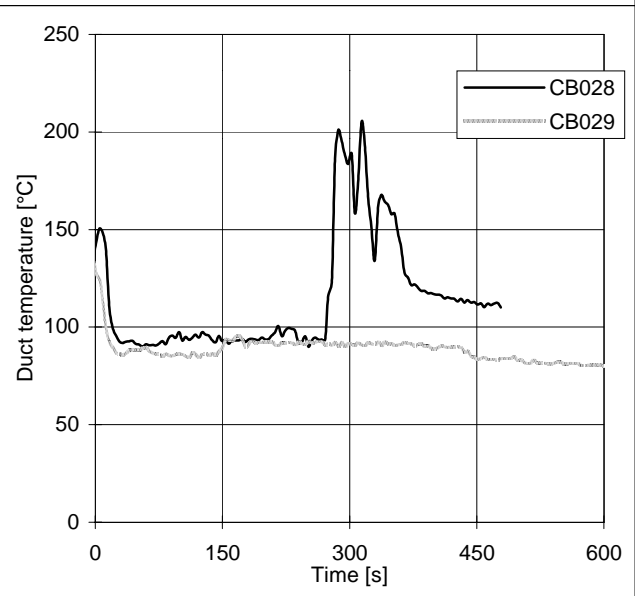
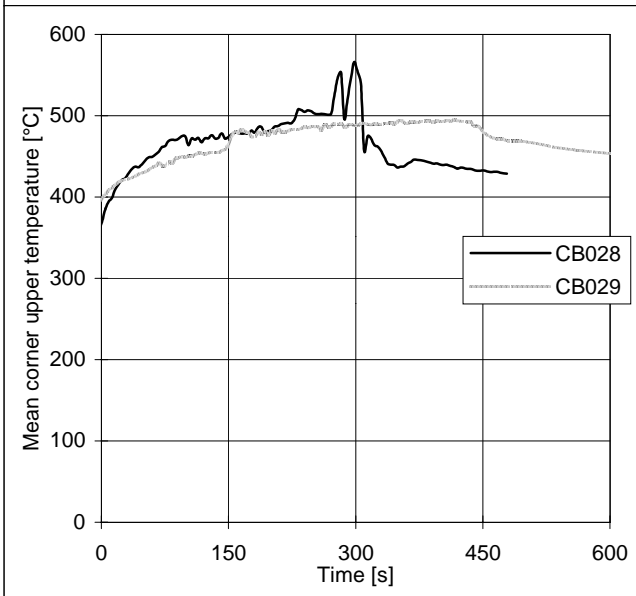
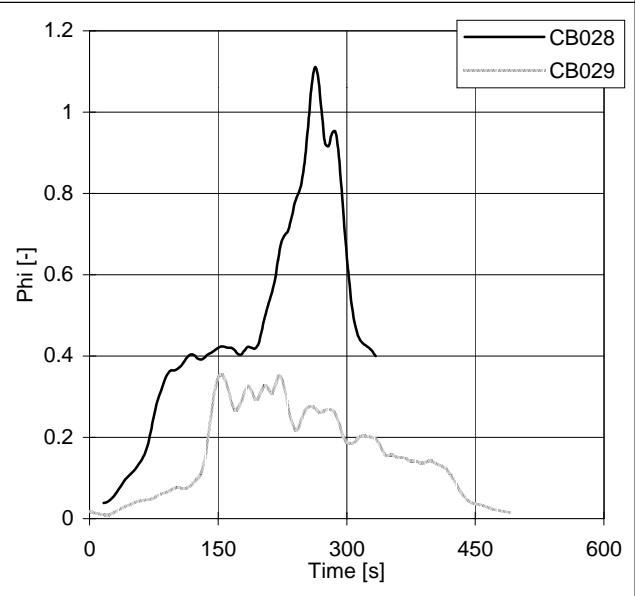
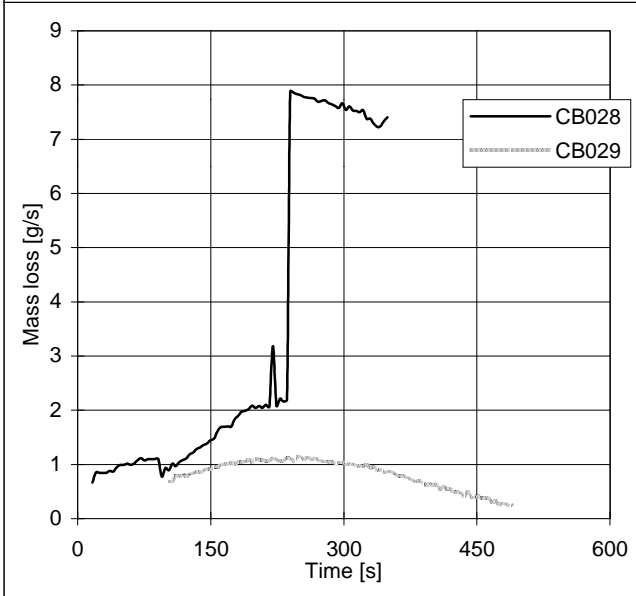
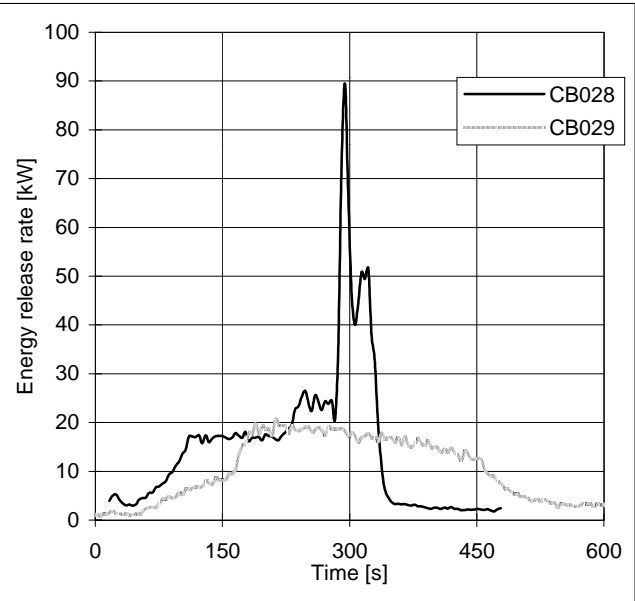
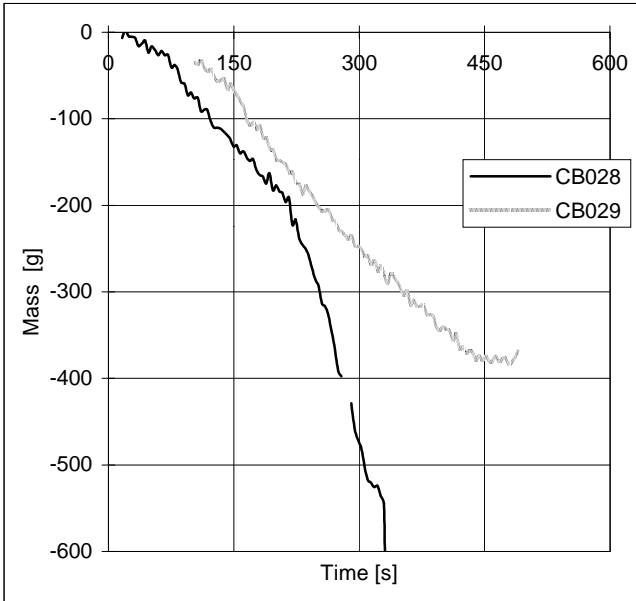

Appendix: Chlorobenzene

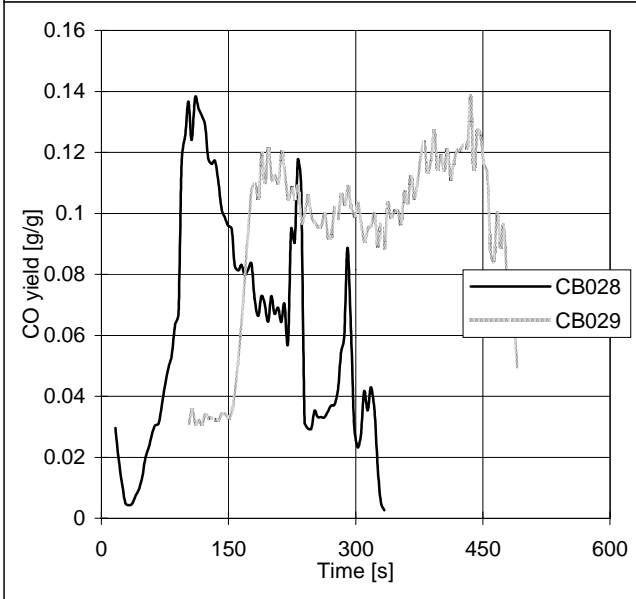
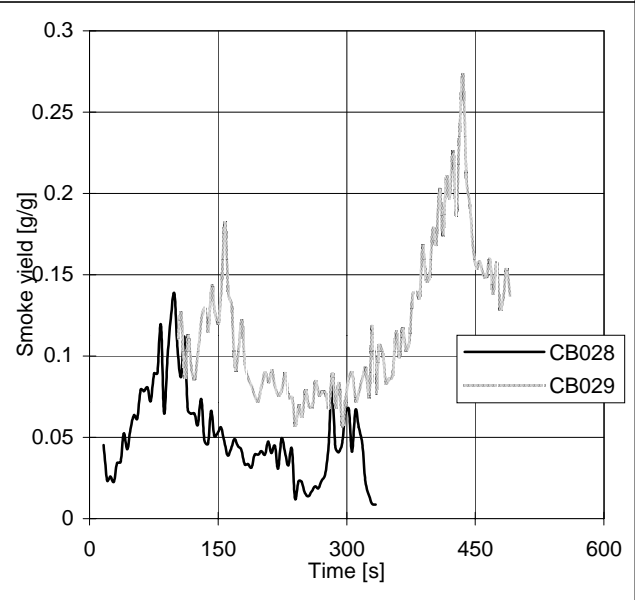
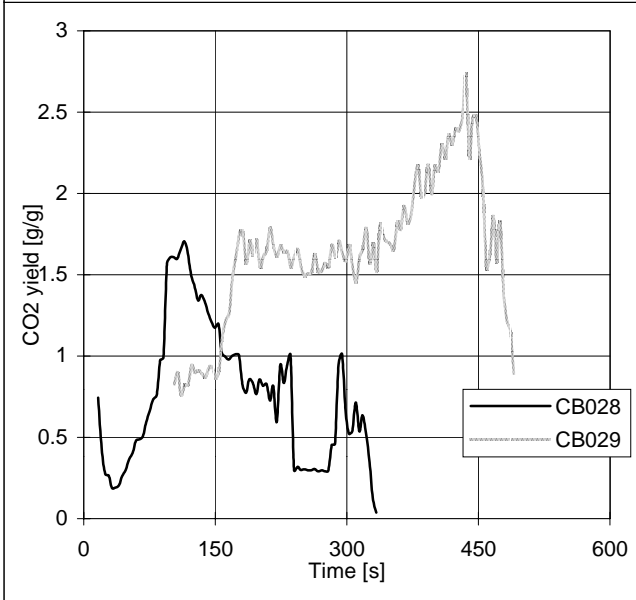
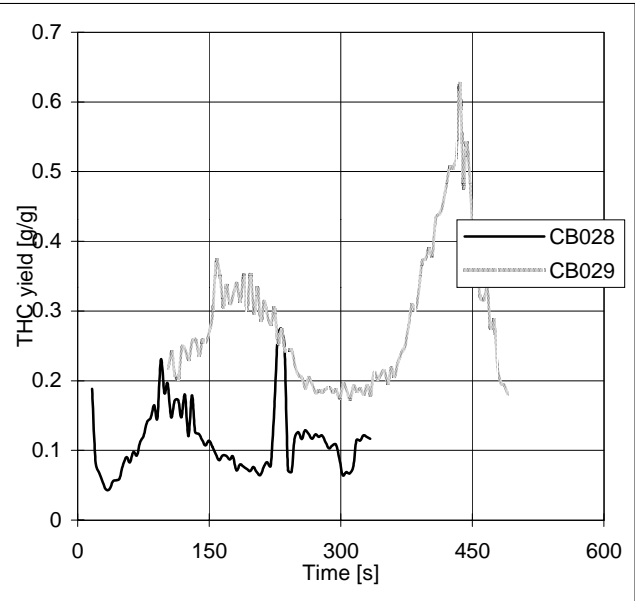
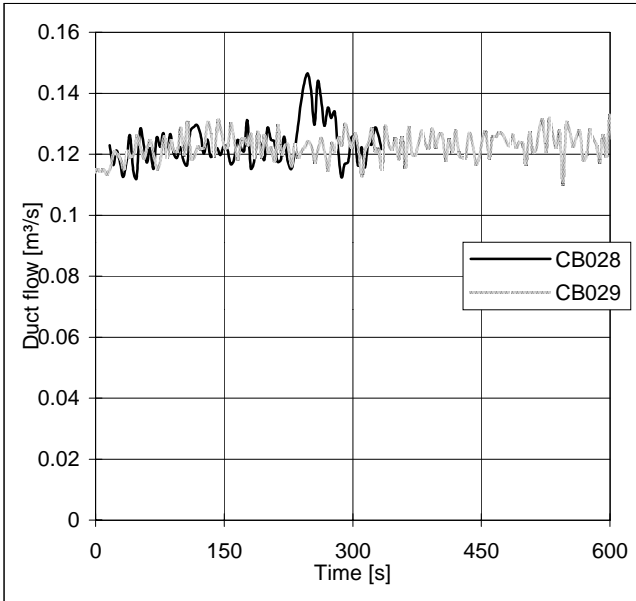

The NO_x production was not measured during these tests.

Appendix: Chlorobenzene

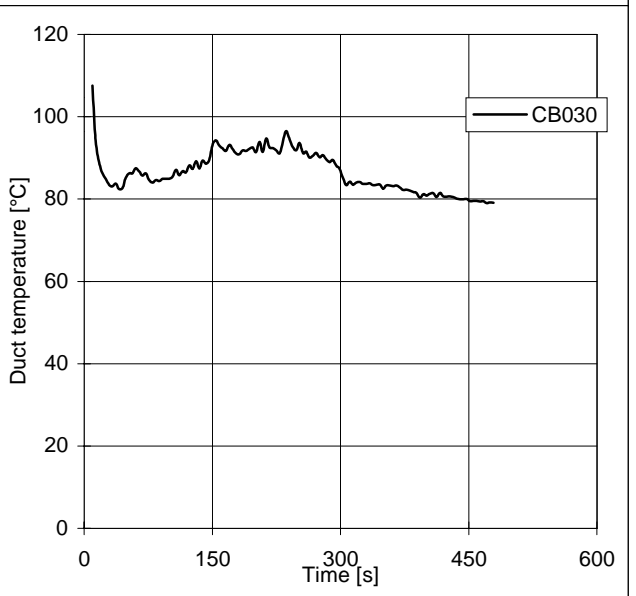
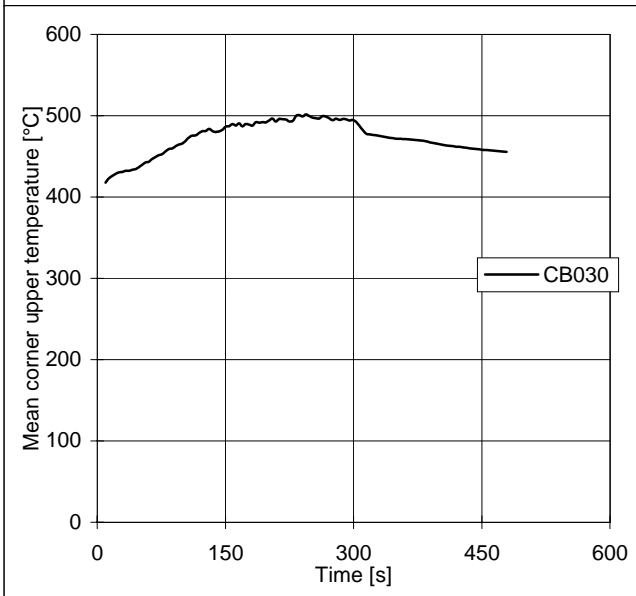
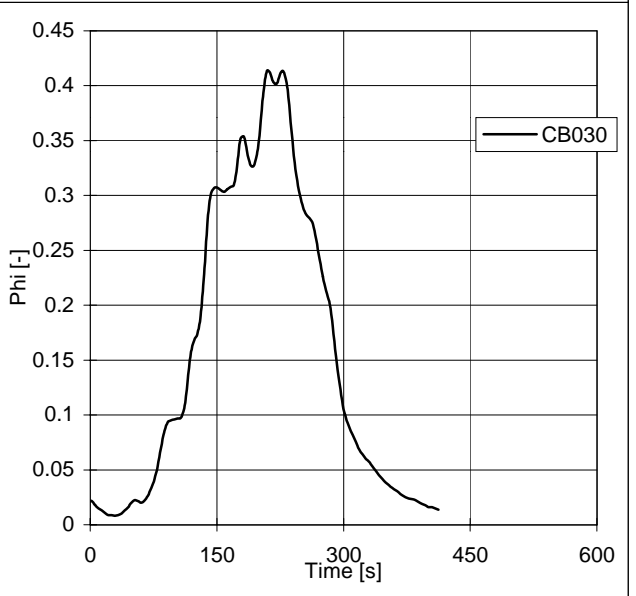
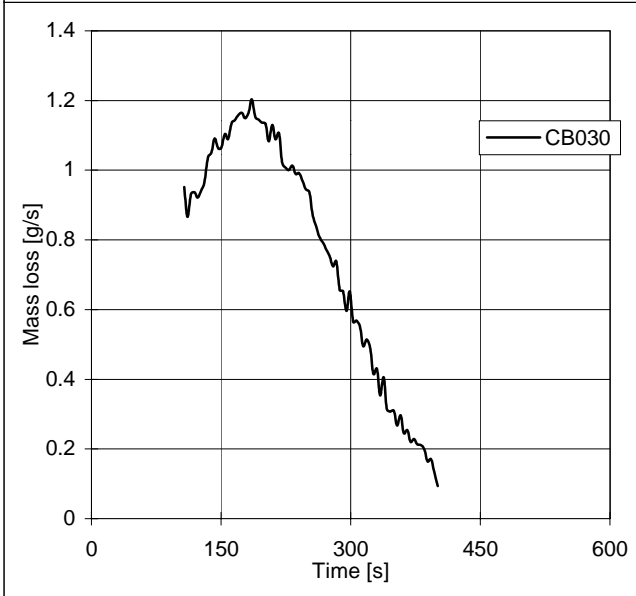
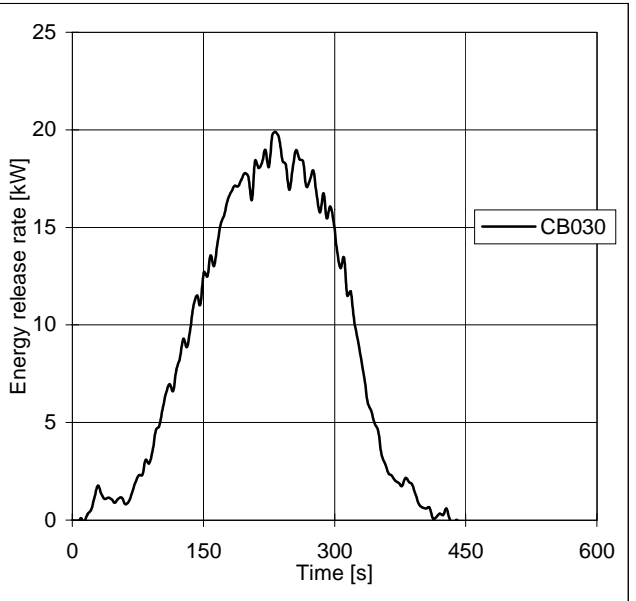
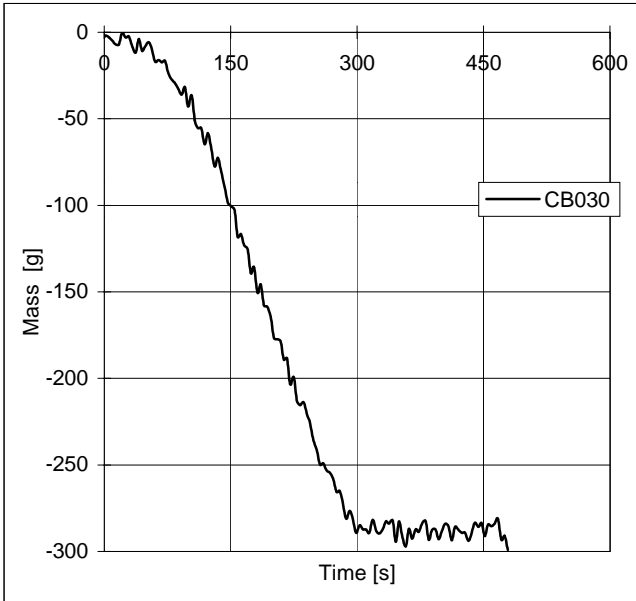

Appendix: Chlorobenzene

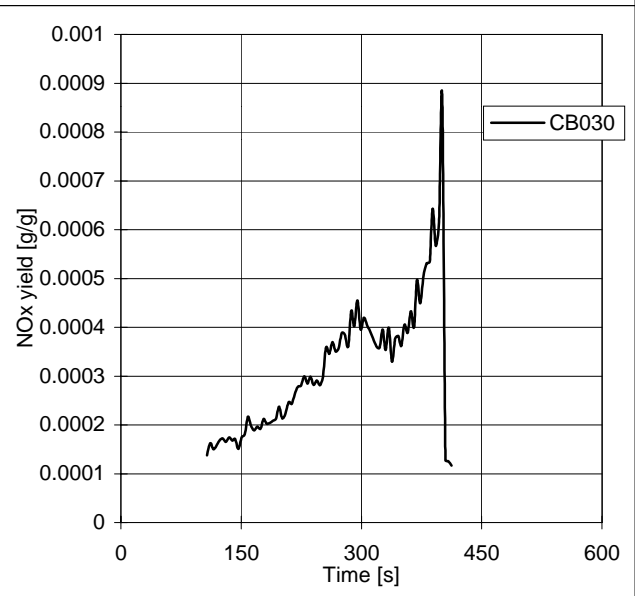
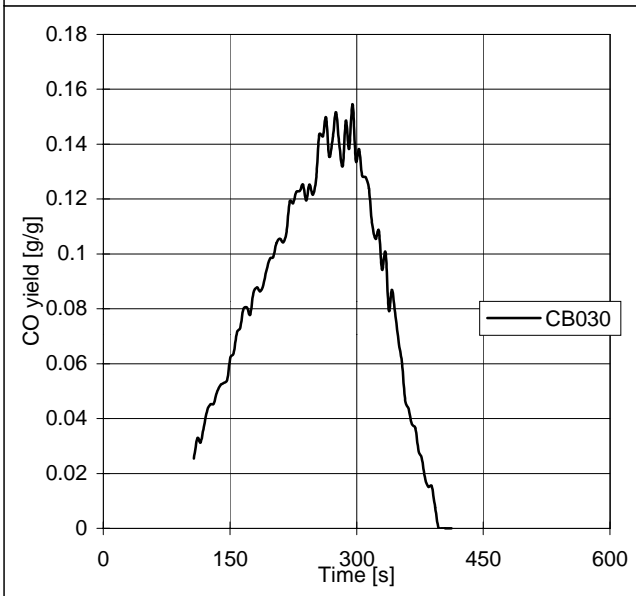
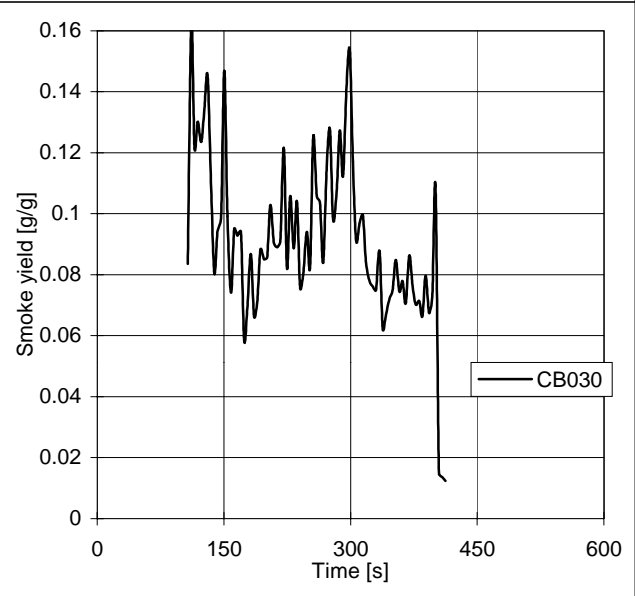
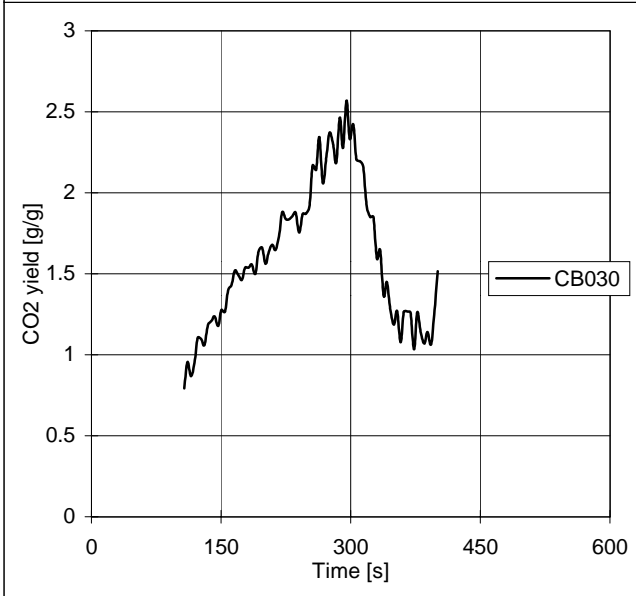
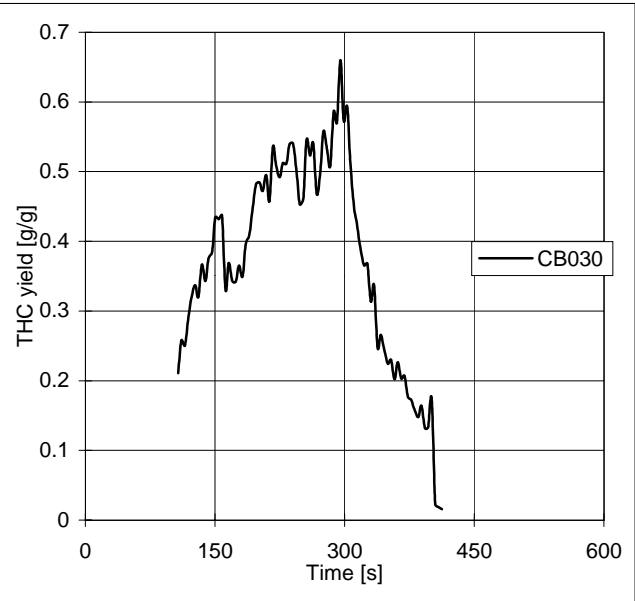
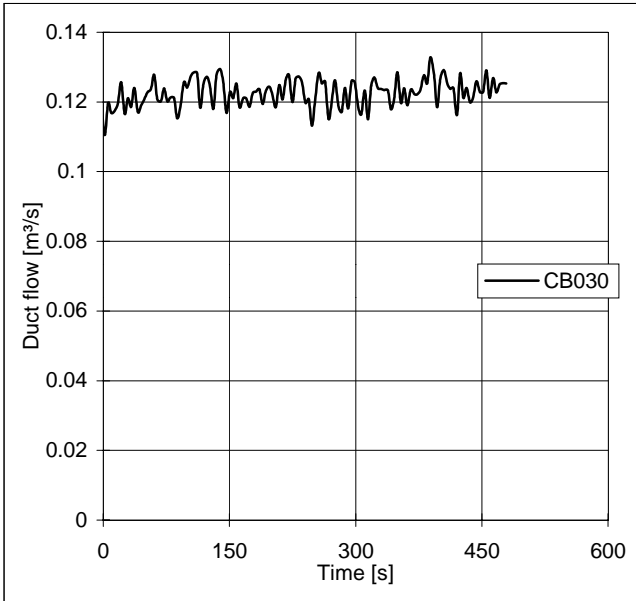

Appendix: TMTM

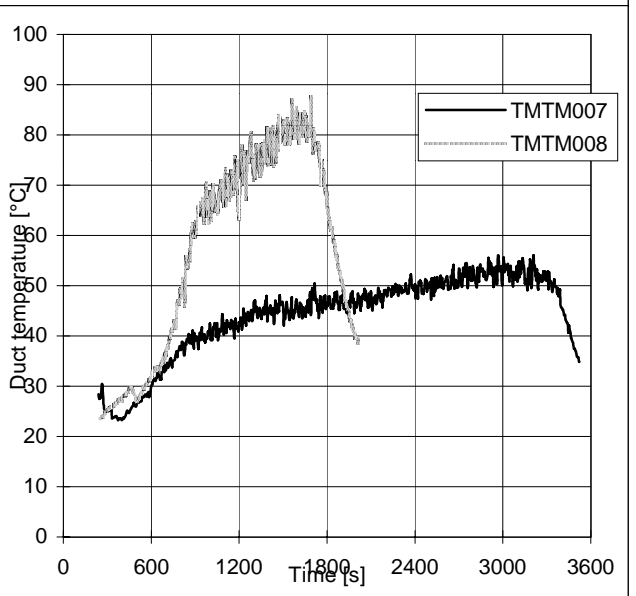
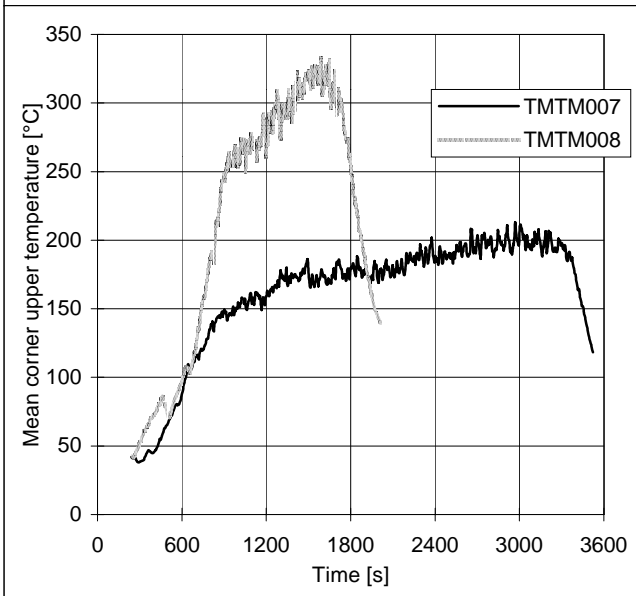
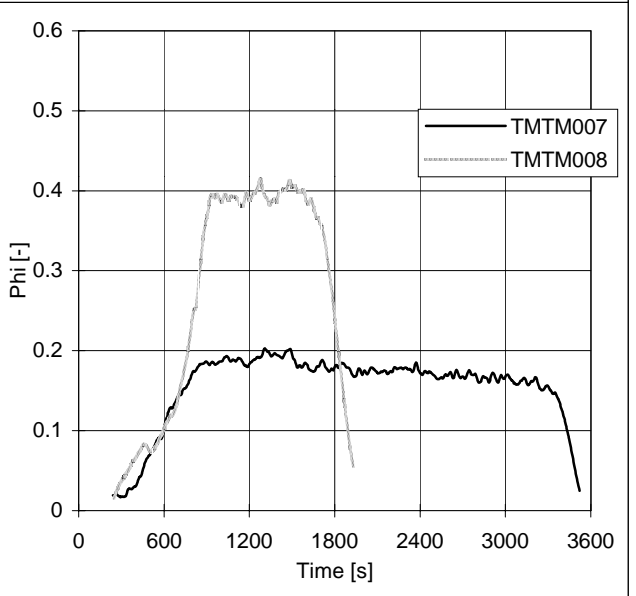
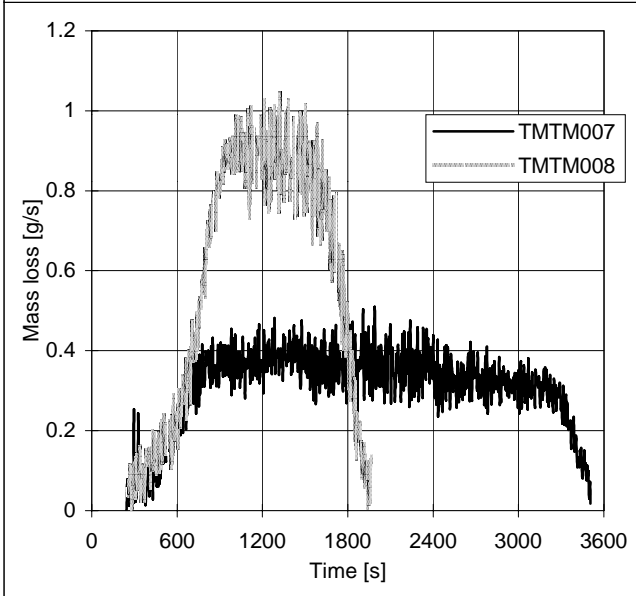
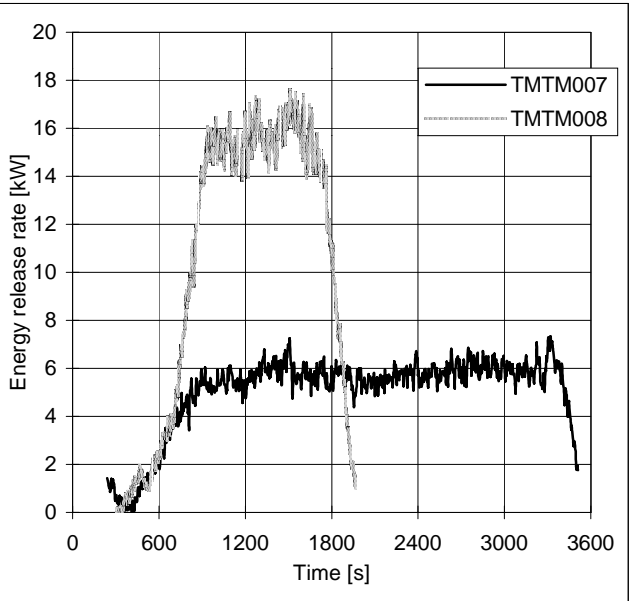
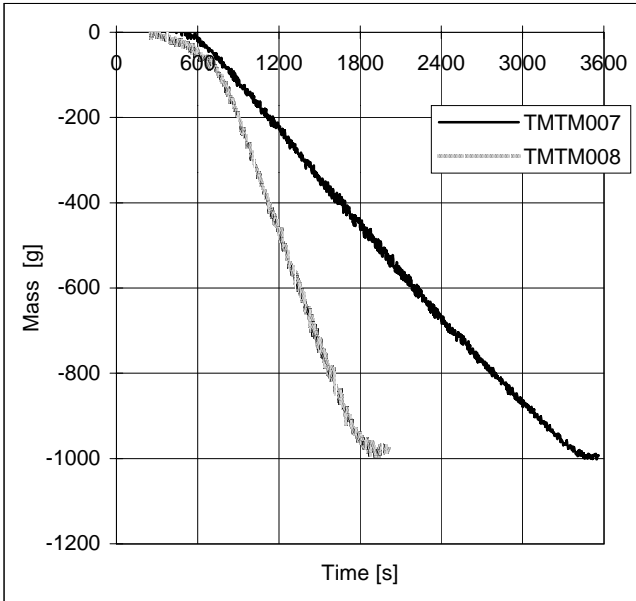

Appendix: TMTM

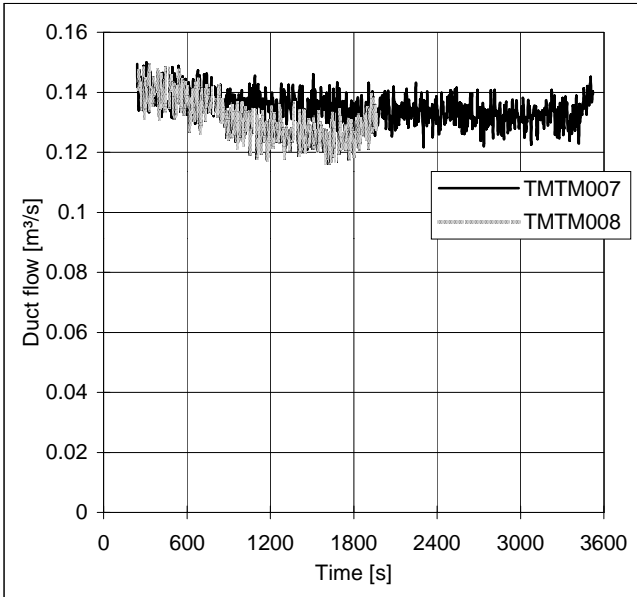

The production of THC was very low and because of this the yield of THC was not calculated.

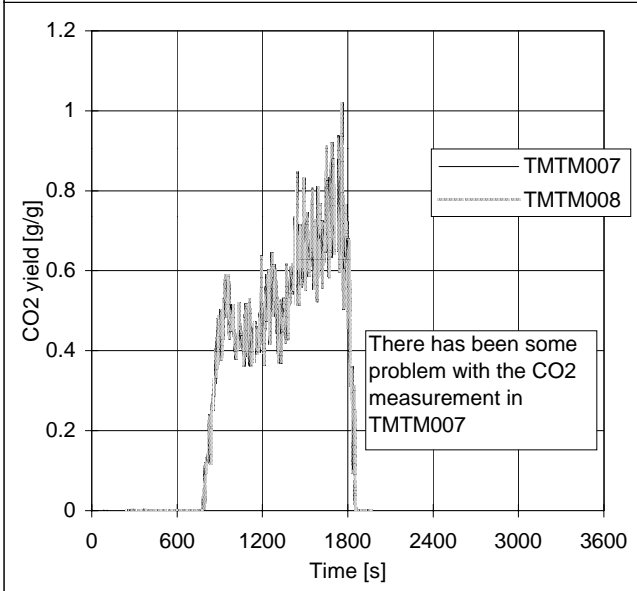

The smoke production was very low and because of this the yield of smoke was not calculated.

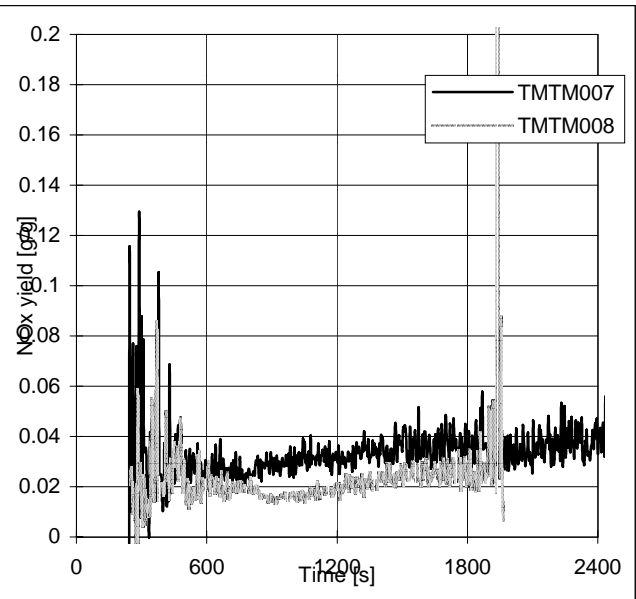
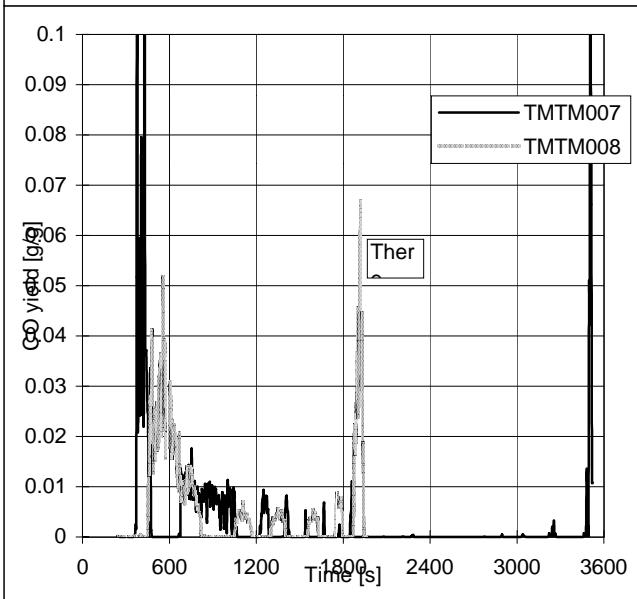

Appendix: TMTM

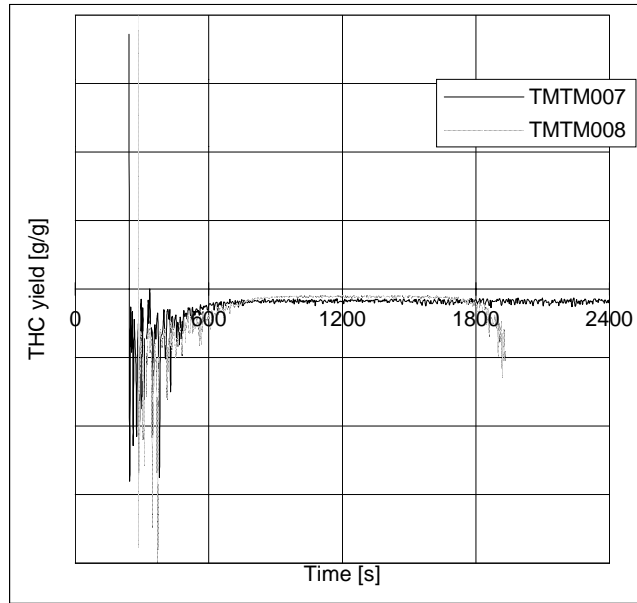

Appendix: TMTM

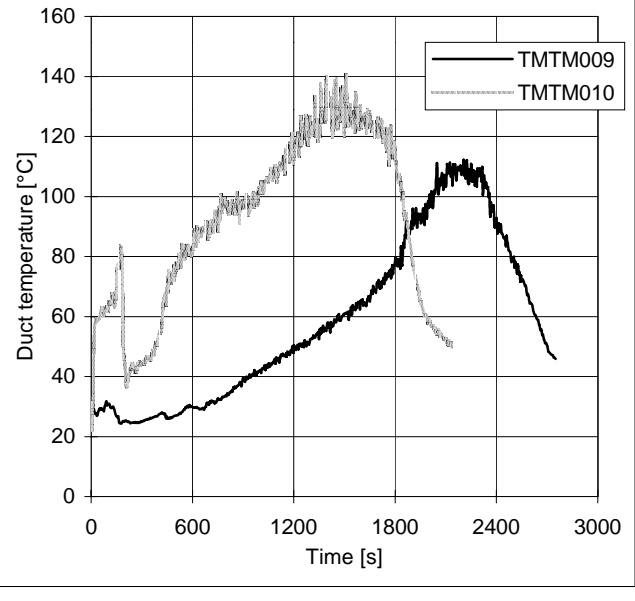
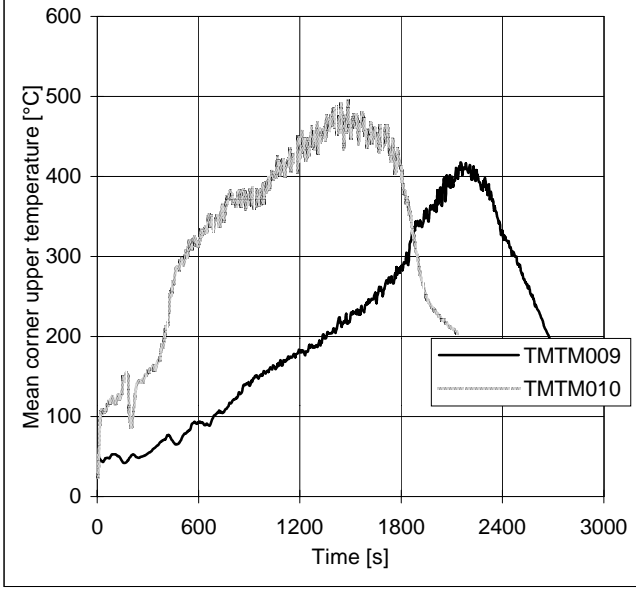
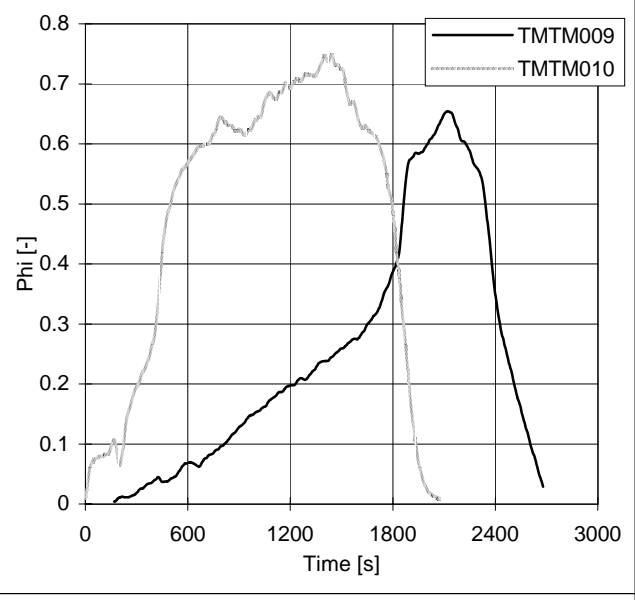
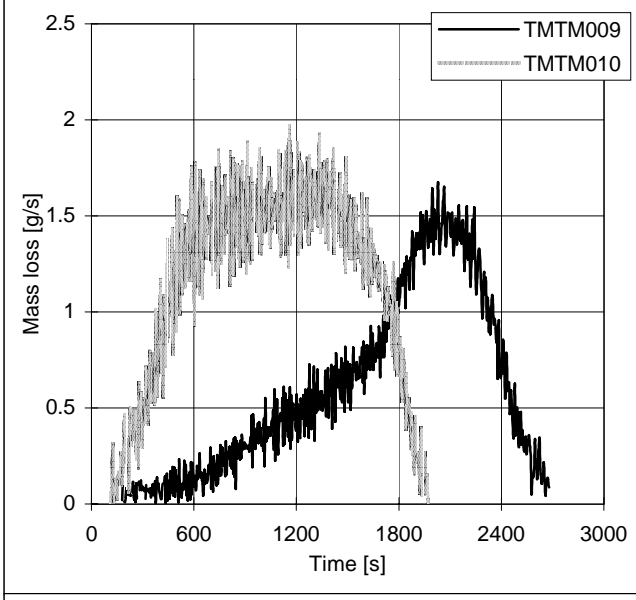
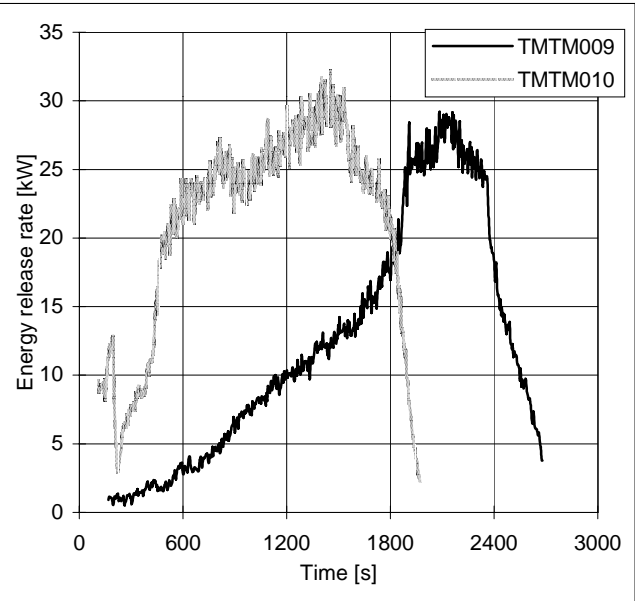
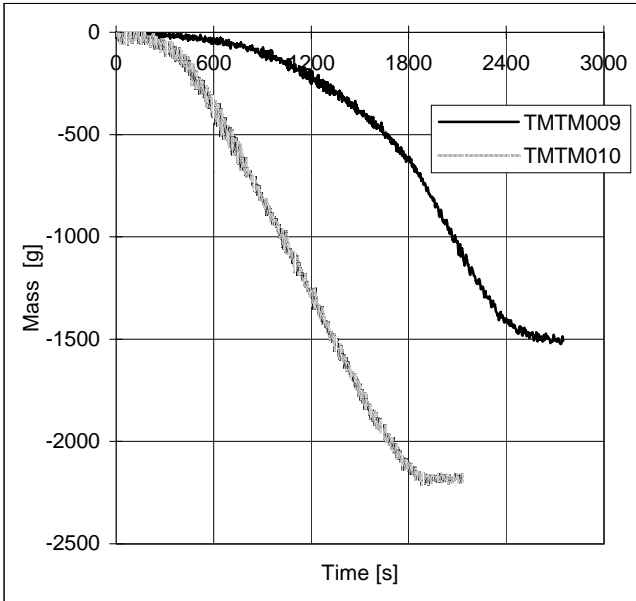

Appendix: TMTM

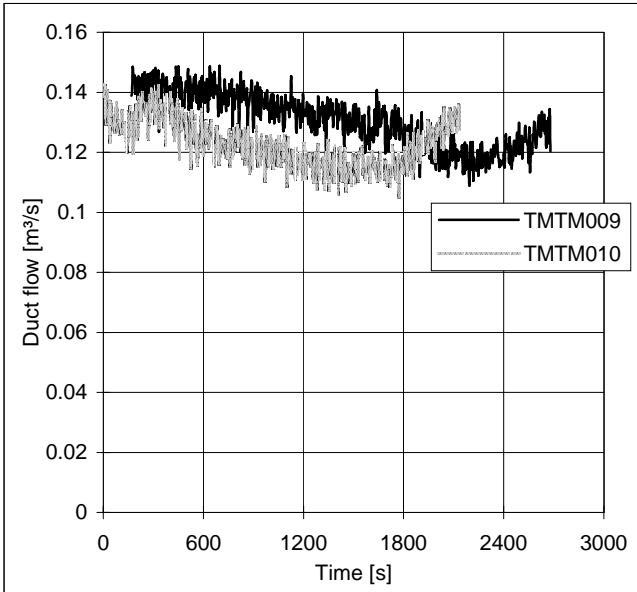

The production of THC was very low and because of this the yield of THC was not calculated.

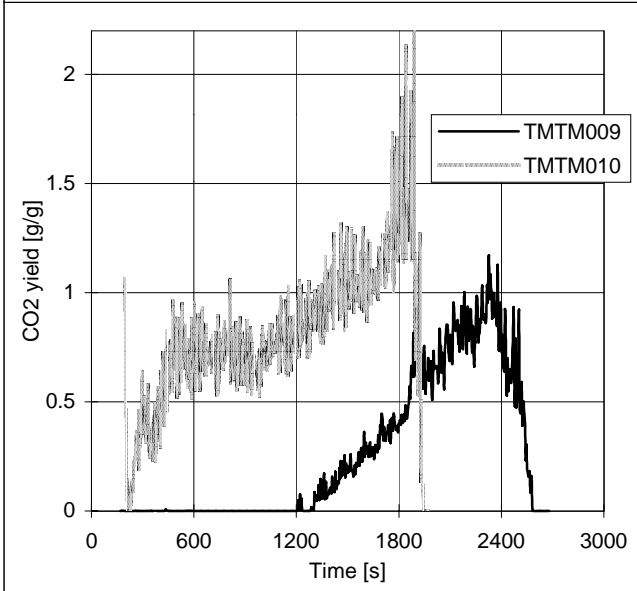

The smoke production was very low and because of this the yield of smoke was not calculated.

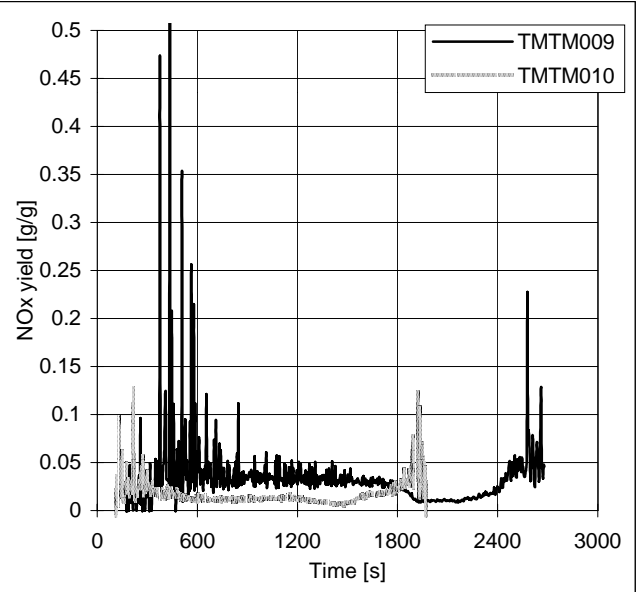
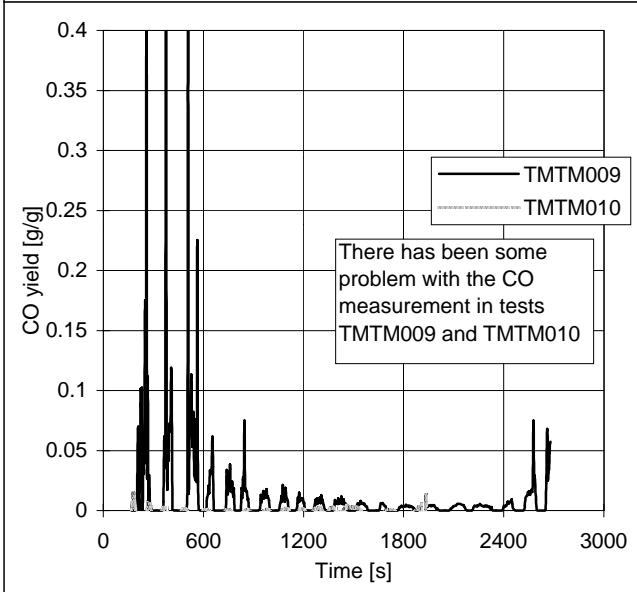

Appendix: TMTM

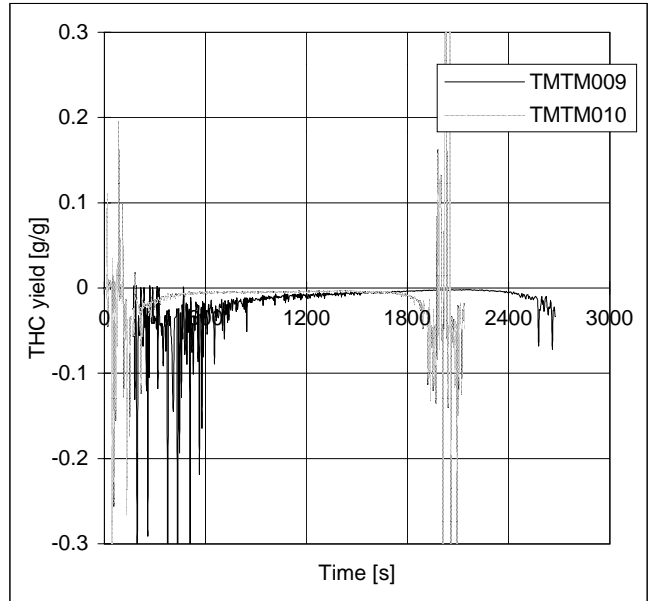

Appendix: TMTM

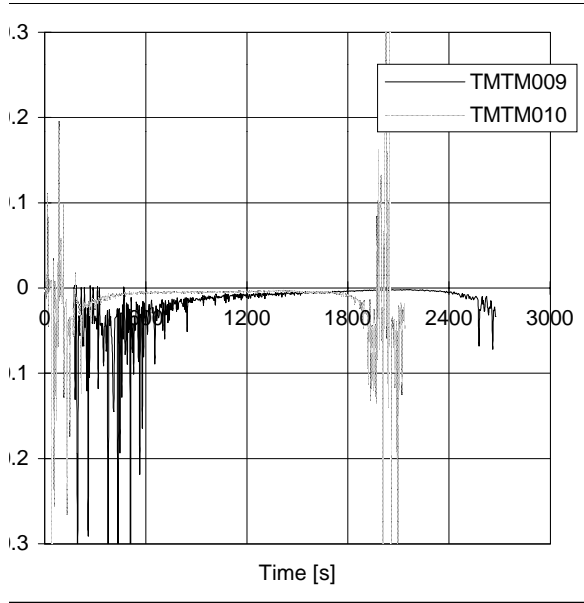

Appendix: TMTM

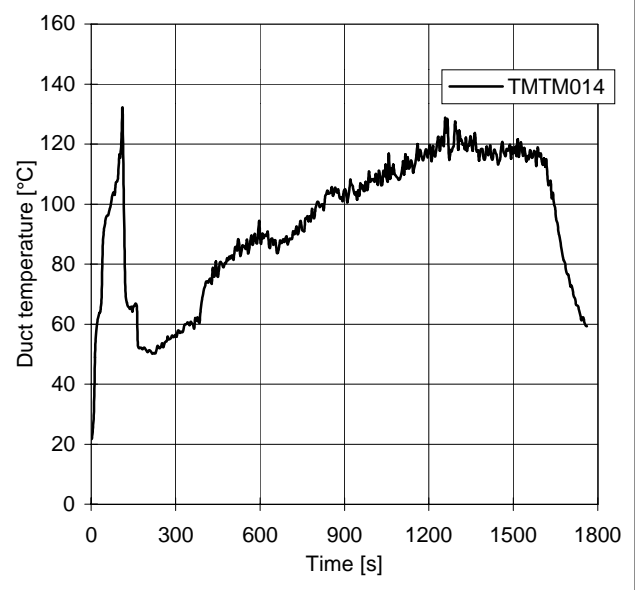
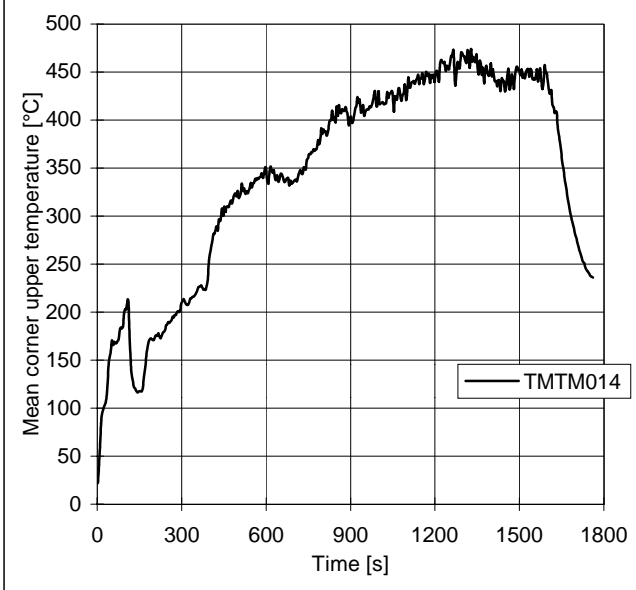
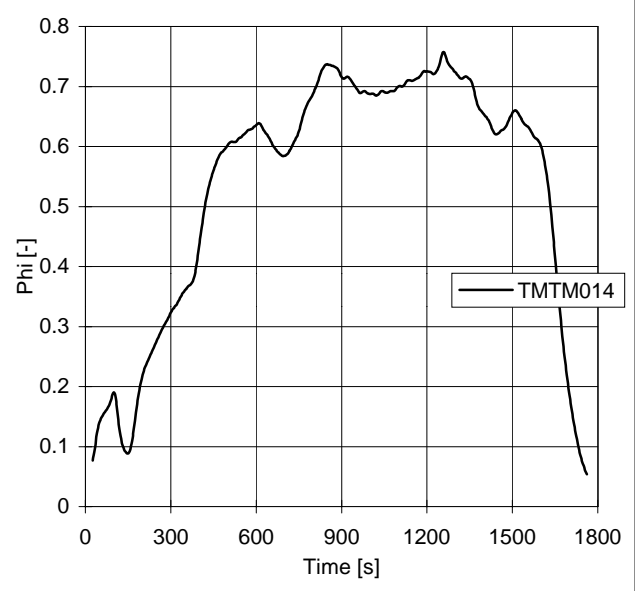
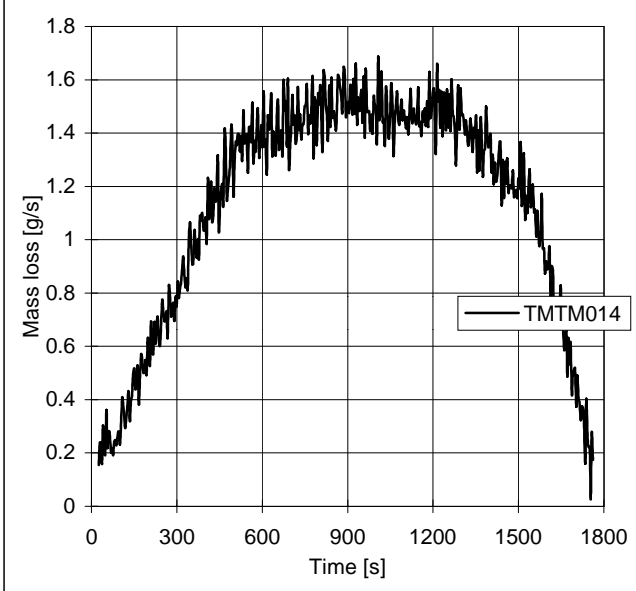
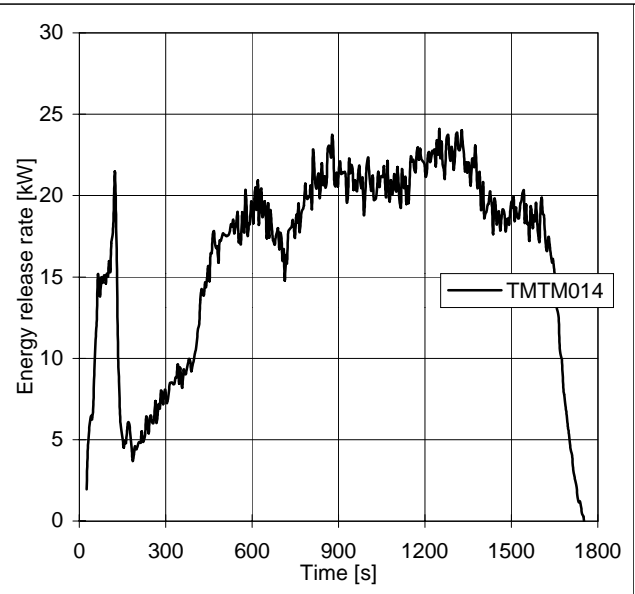
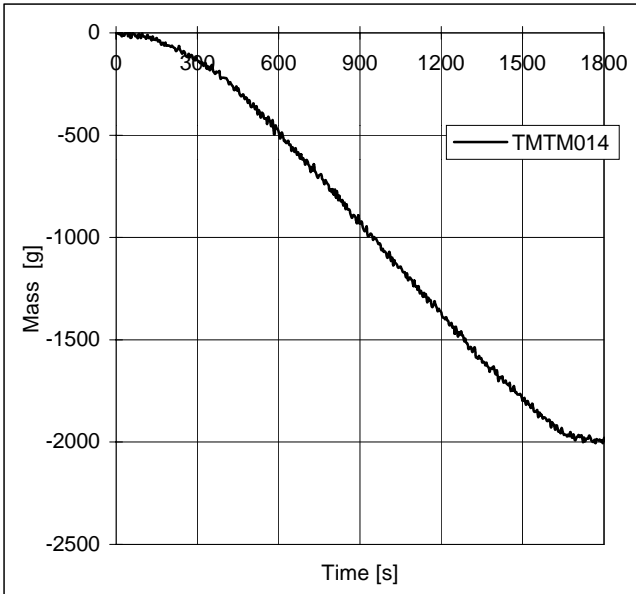

Appendix: TMTM

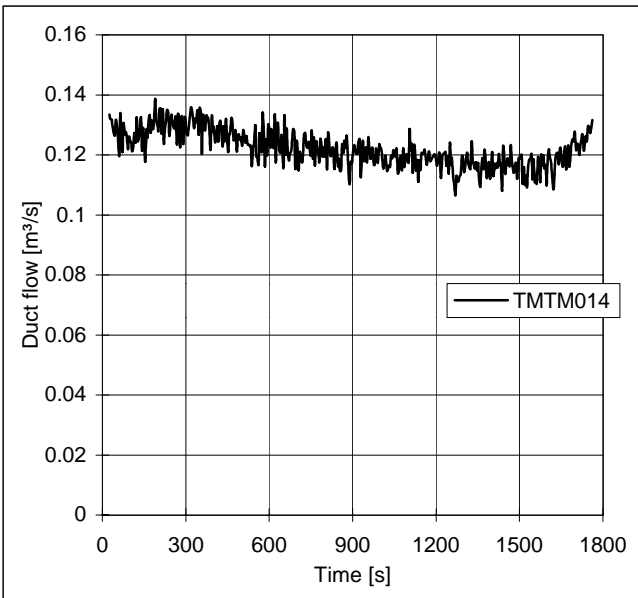

The production of THC was very low and because of this the yield of THC was not calculated.

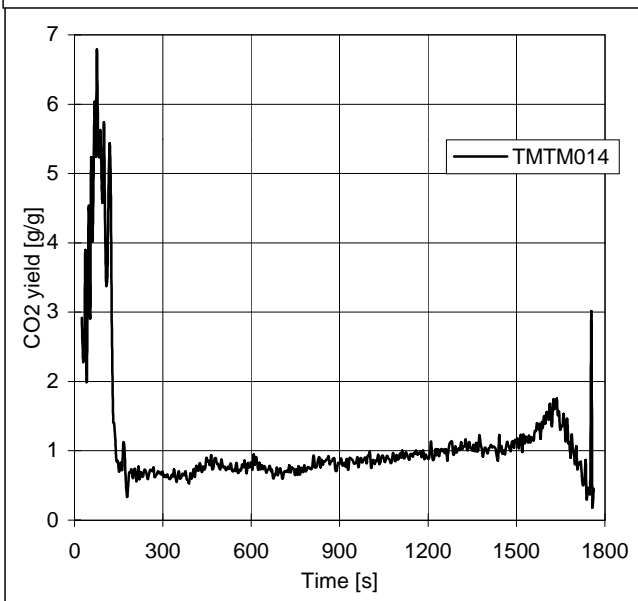

The smoke production was very low and because of this the yield of smoke was not calculated.

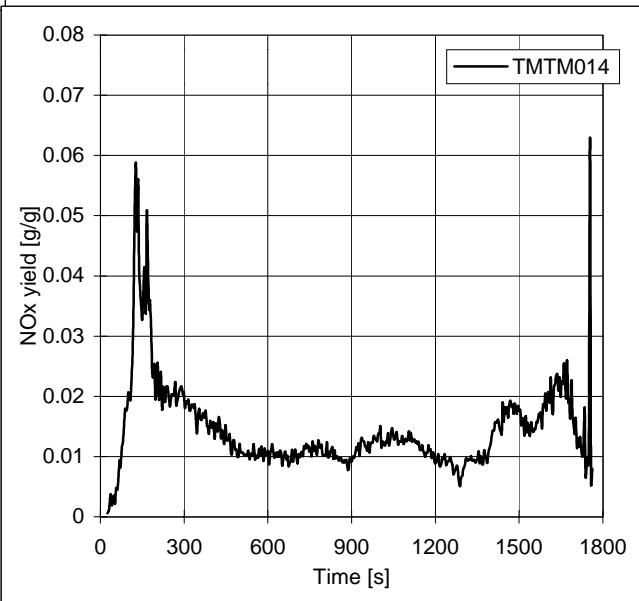
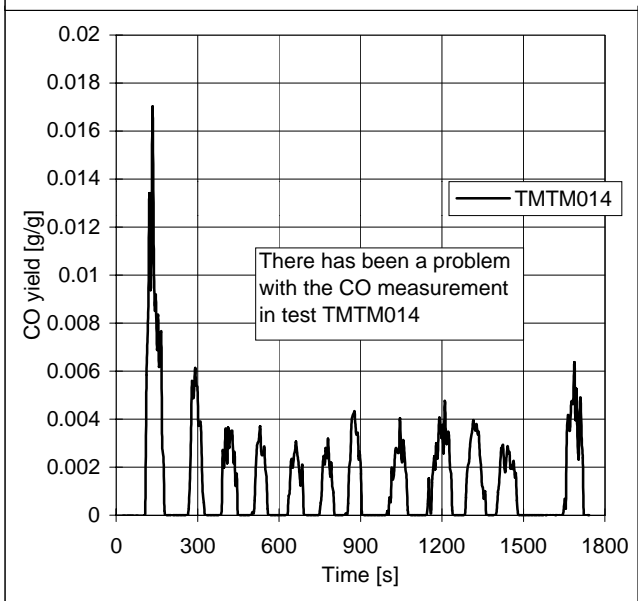

Appendix: TMTM

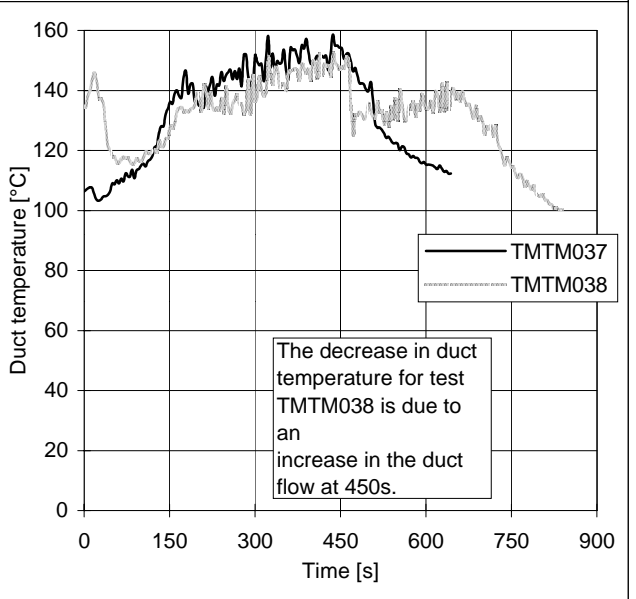
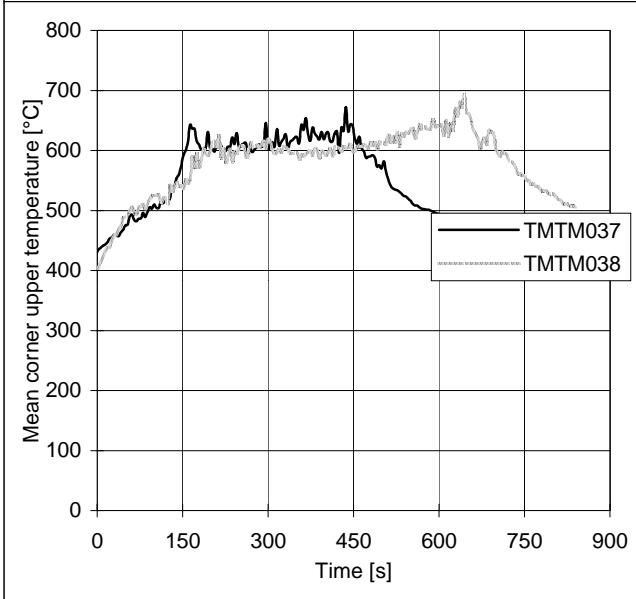
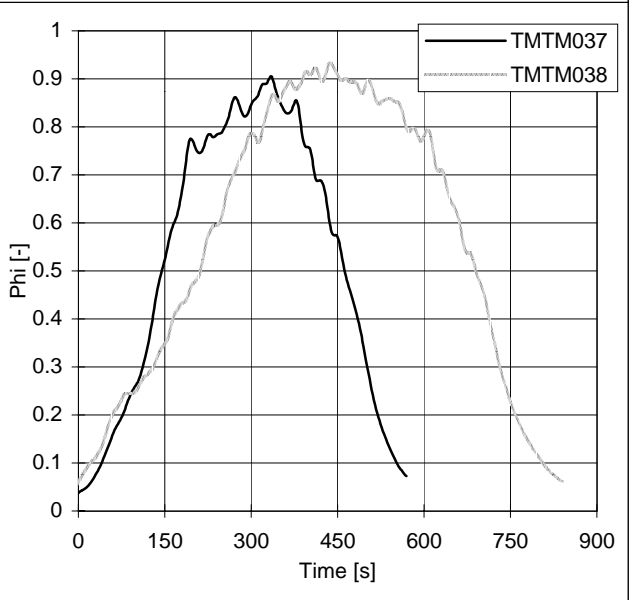
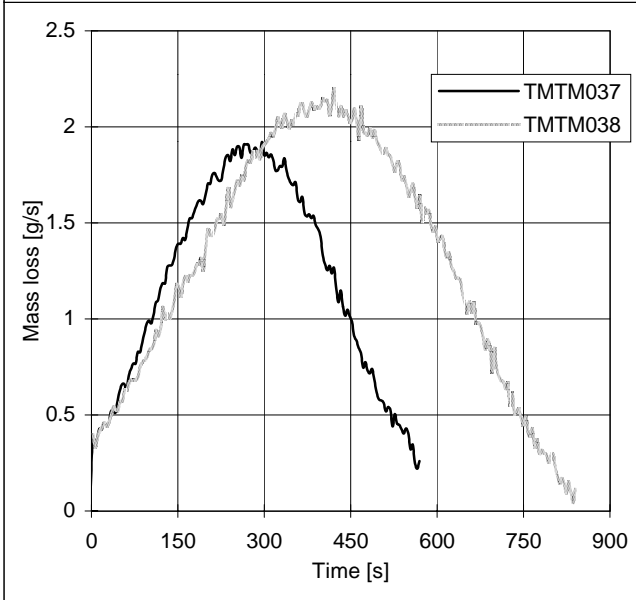
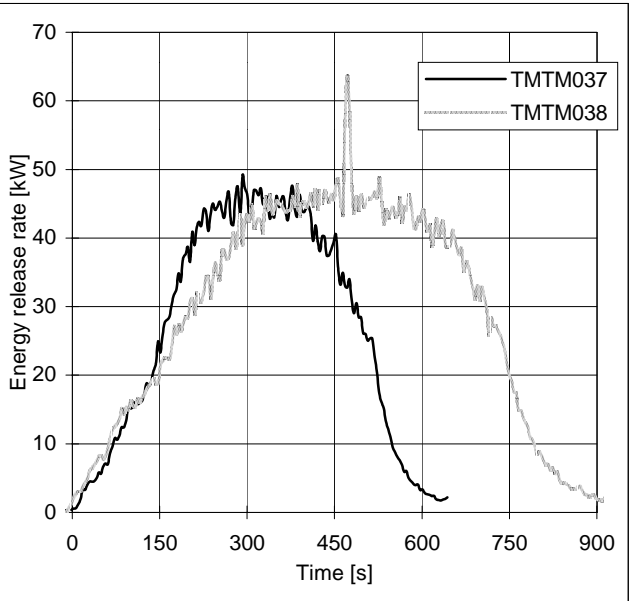
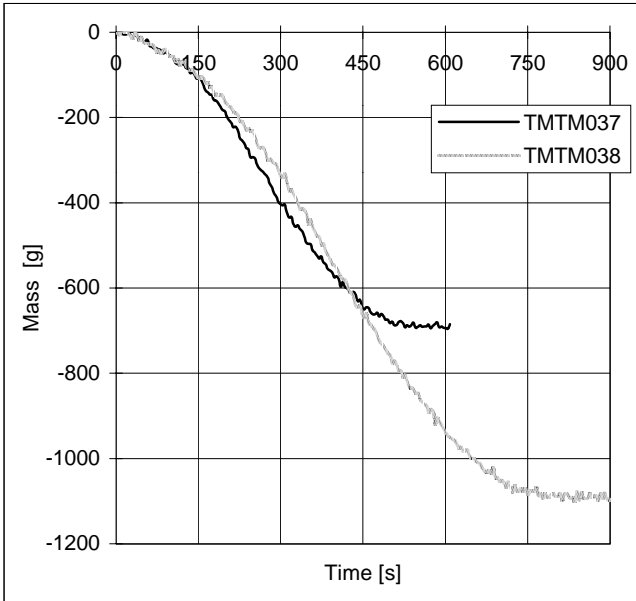

Appendix: TMTM

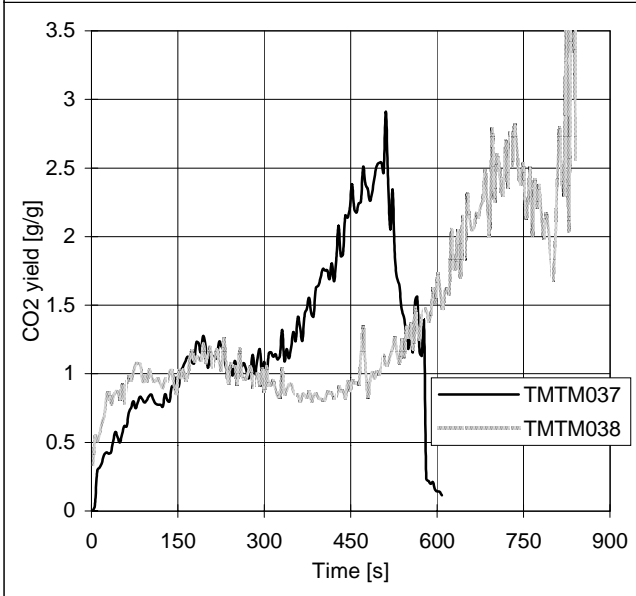
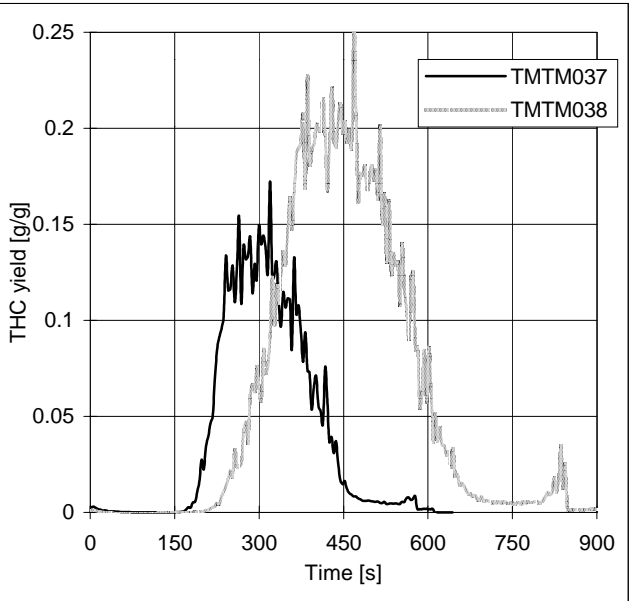
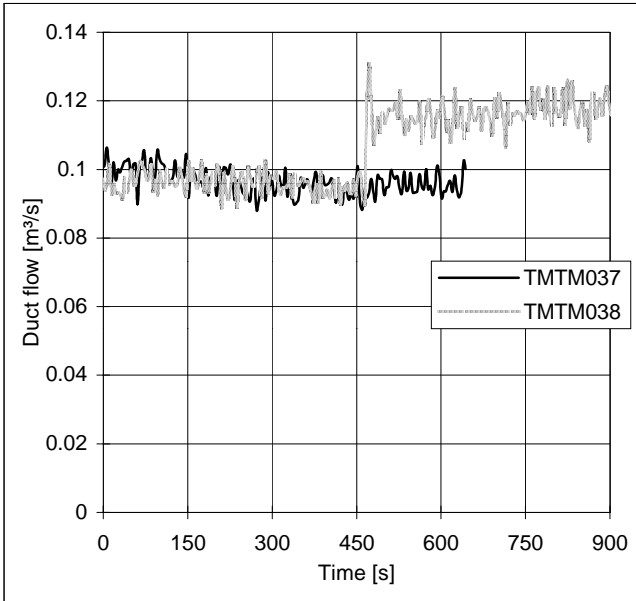

The smoke production was very low and because of this the yield of smoke was not calculated.

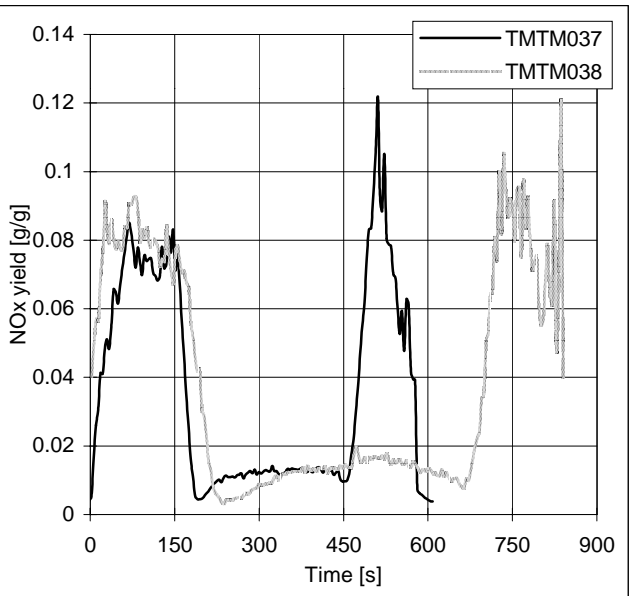
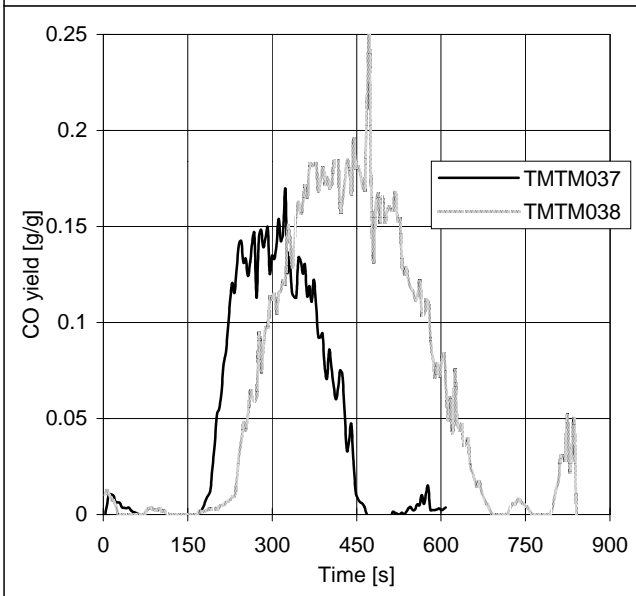

Appendix: TMTM

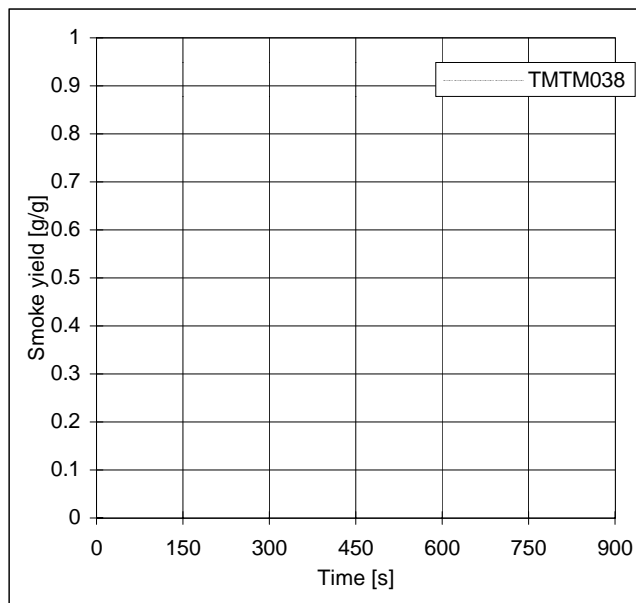

Note: The decrease in duct temperature for test TMTM038 is due to an increase in the duct flow at 450s.

Appendix: Dimethoate

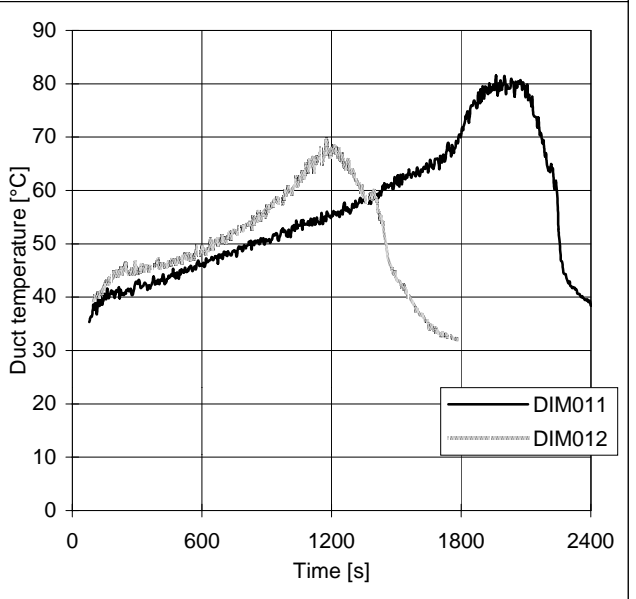
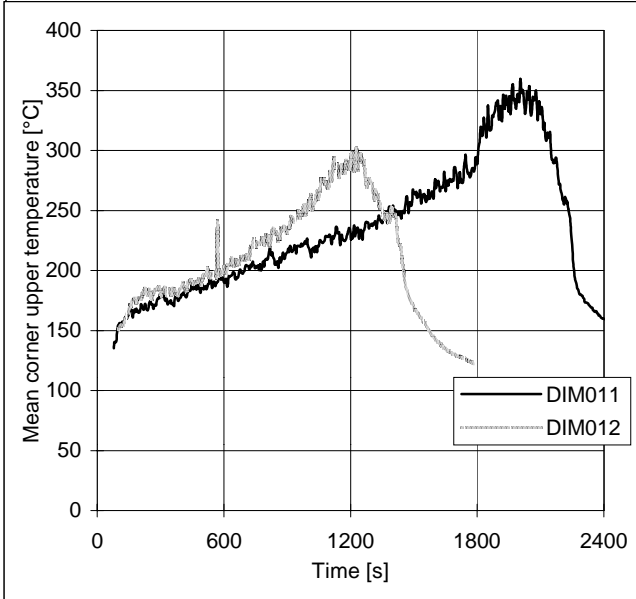
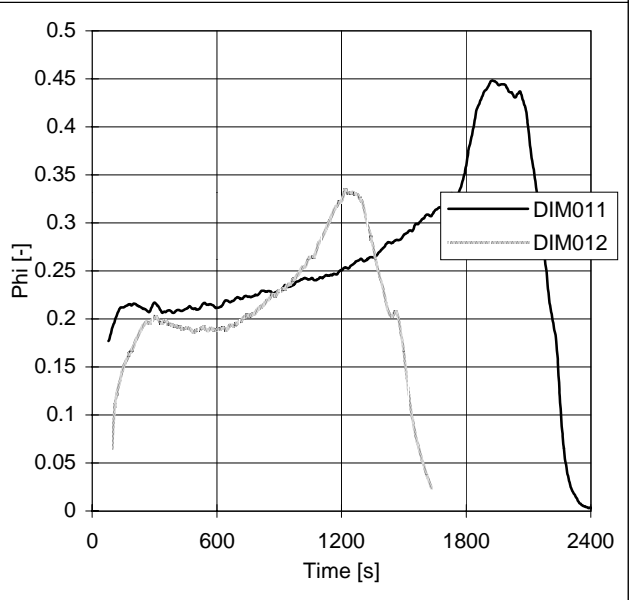
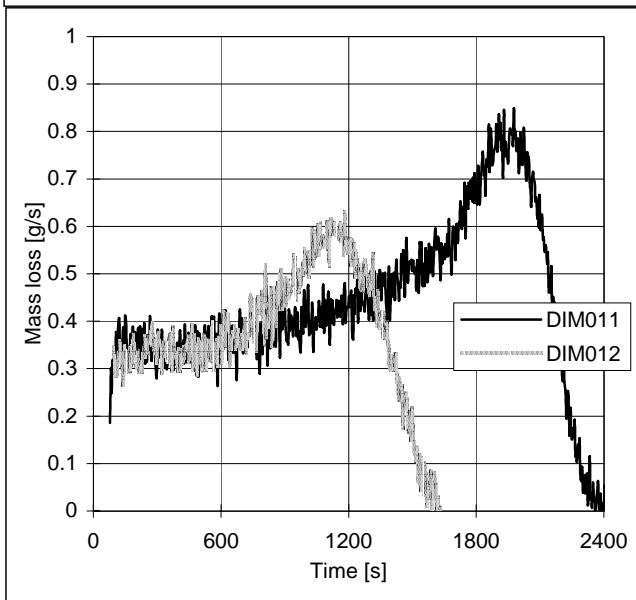
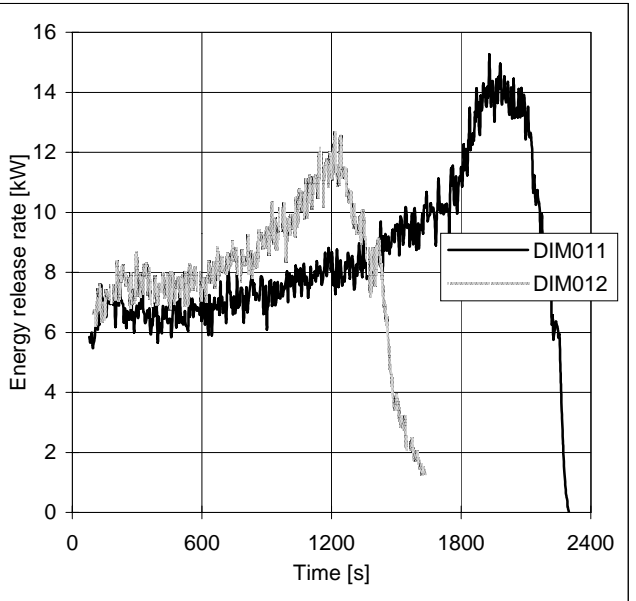
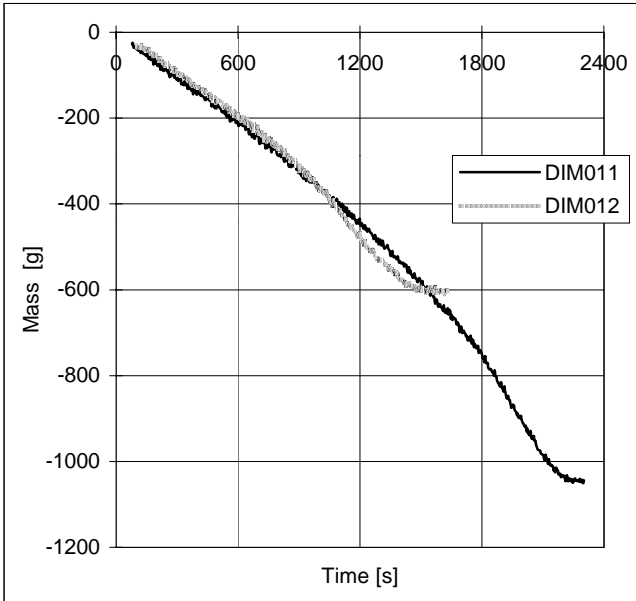

Appendix: Dimethoate

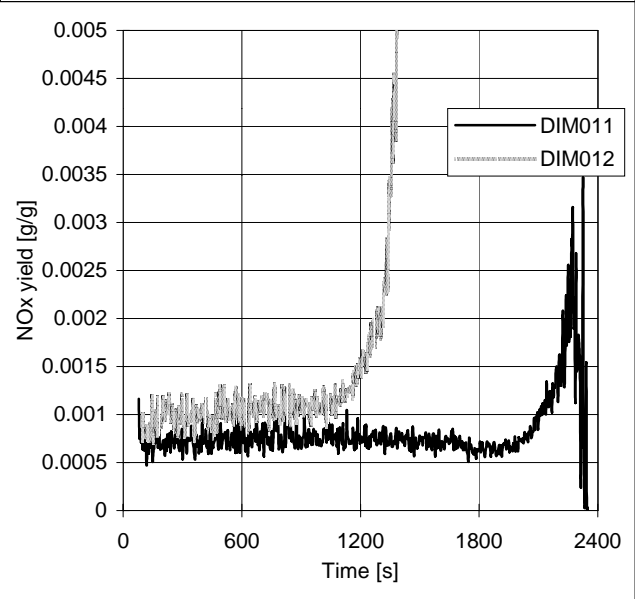
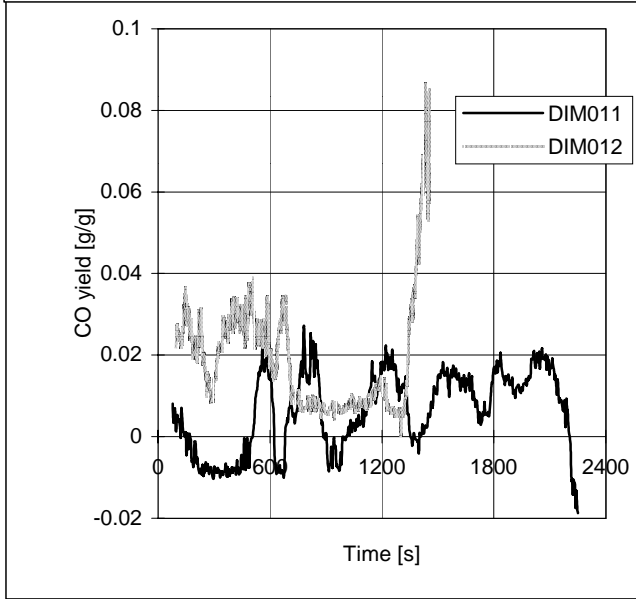
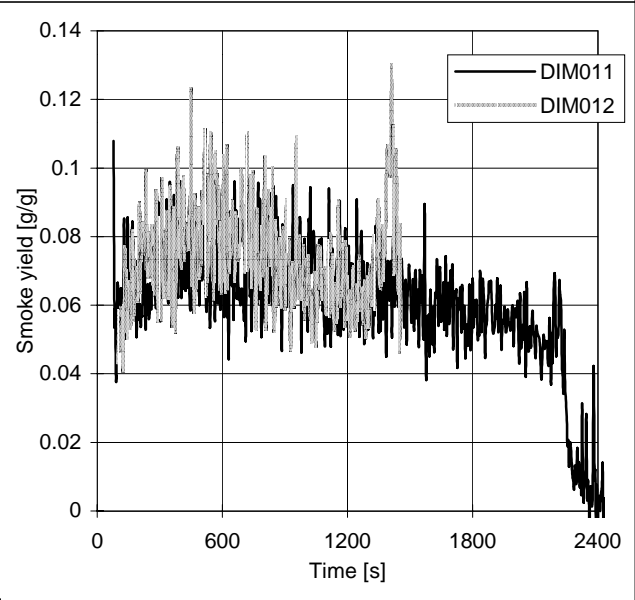
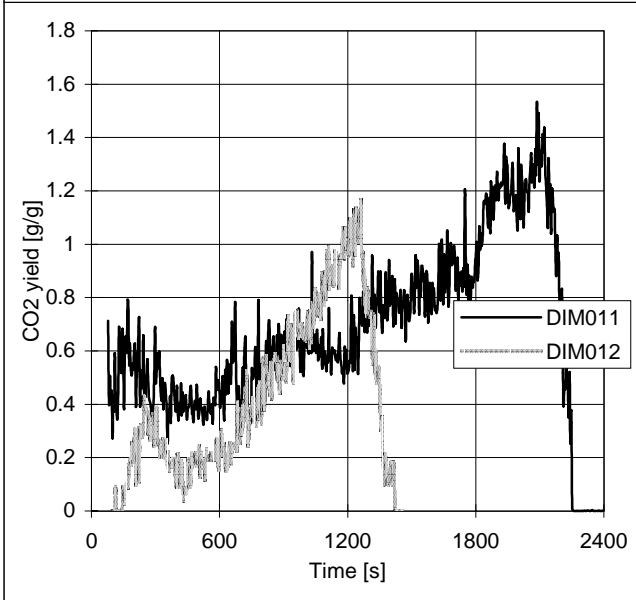
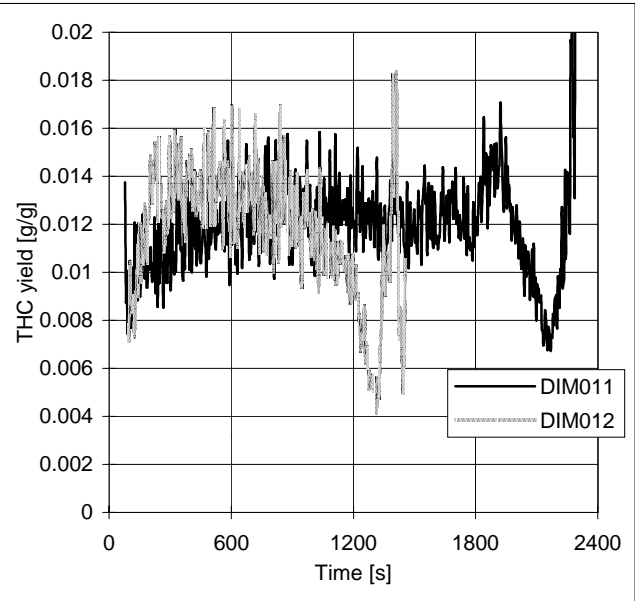
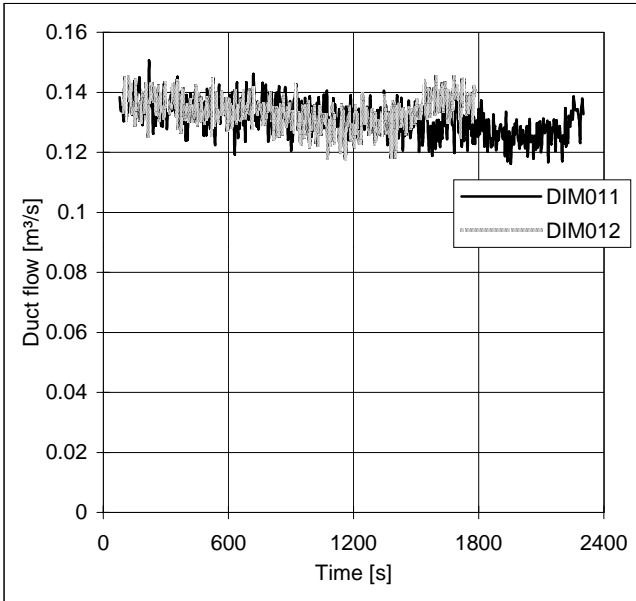

Appendix: Dimethoate

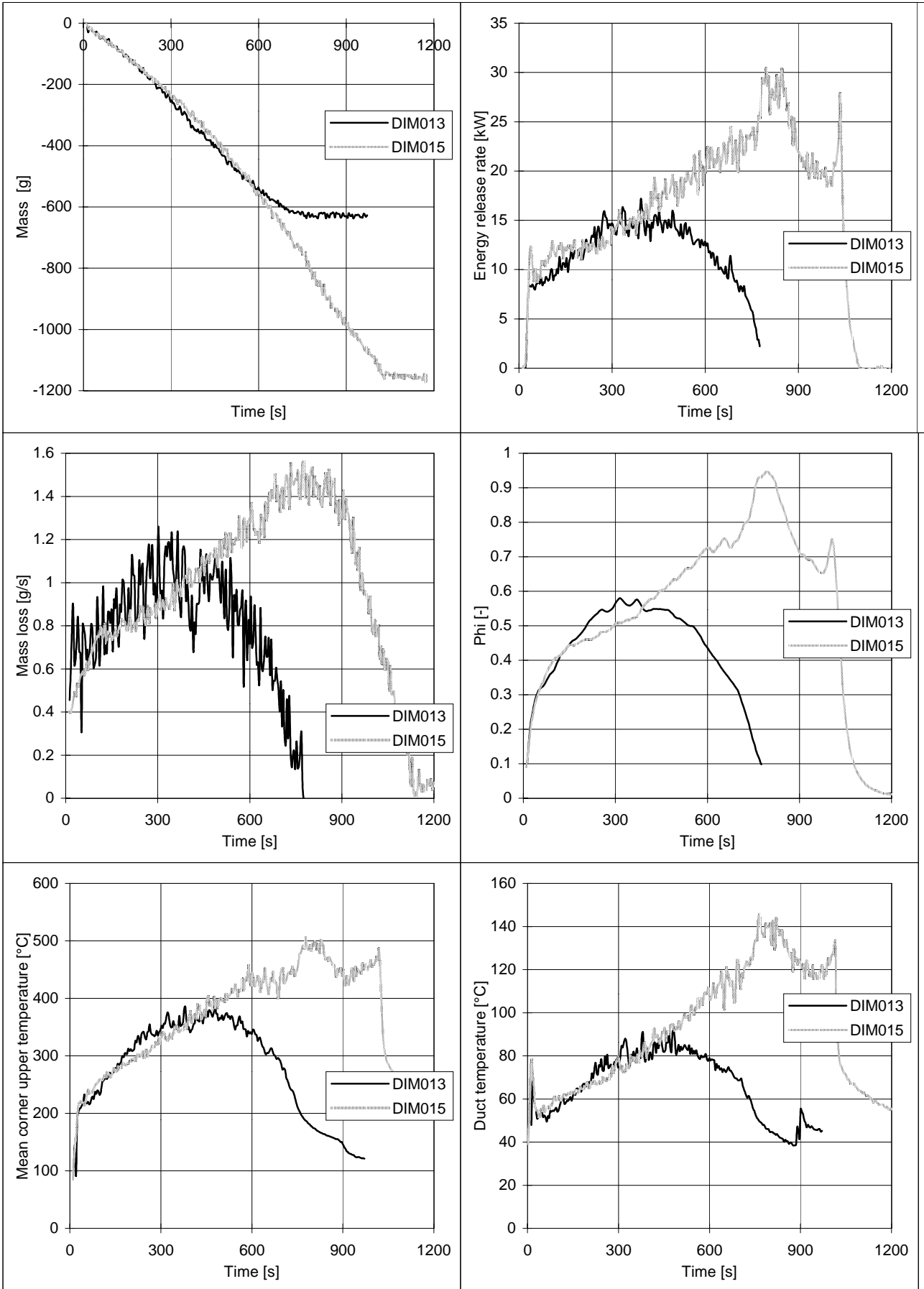

Appendix: Dimethoate

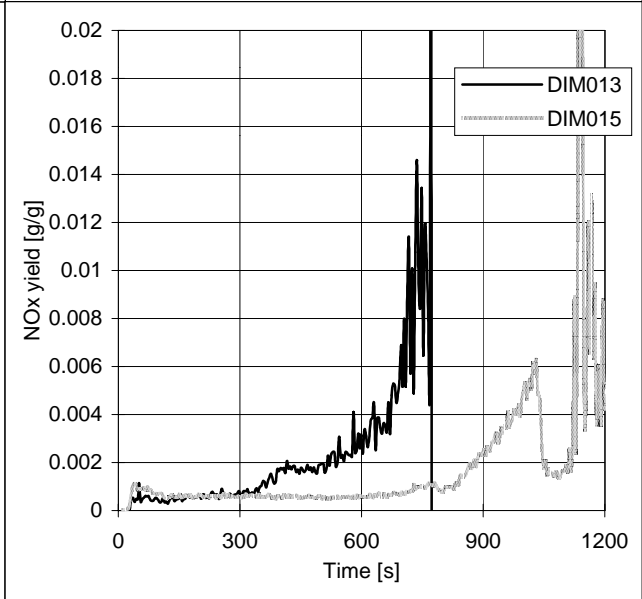
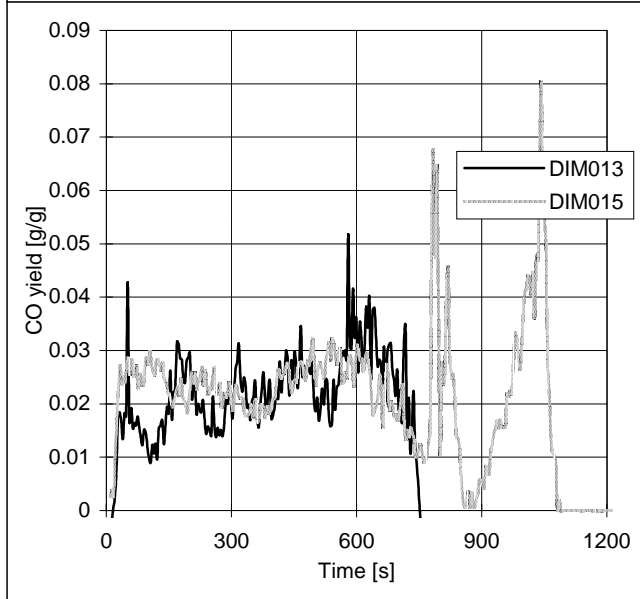
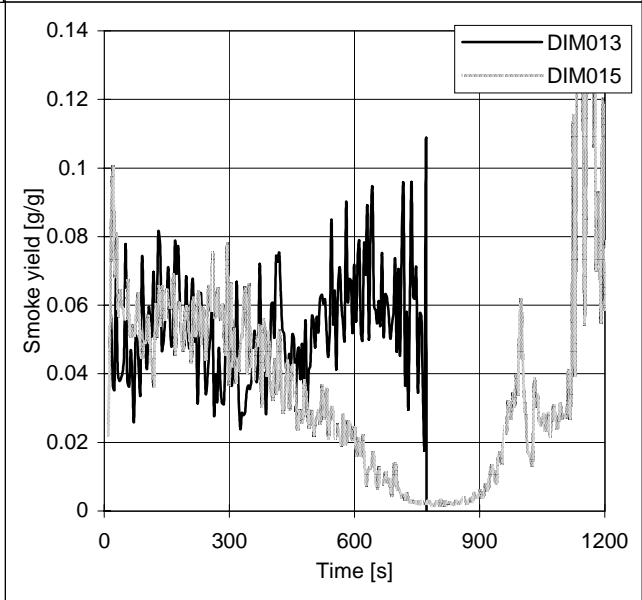
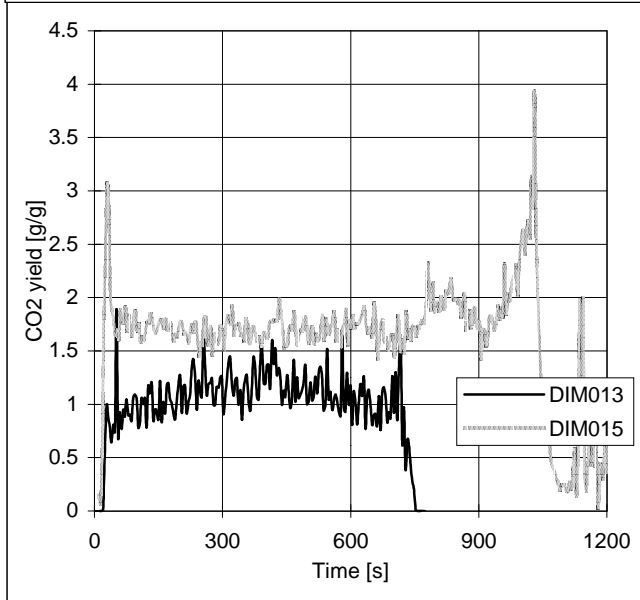
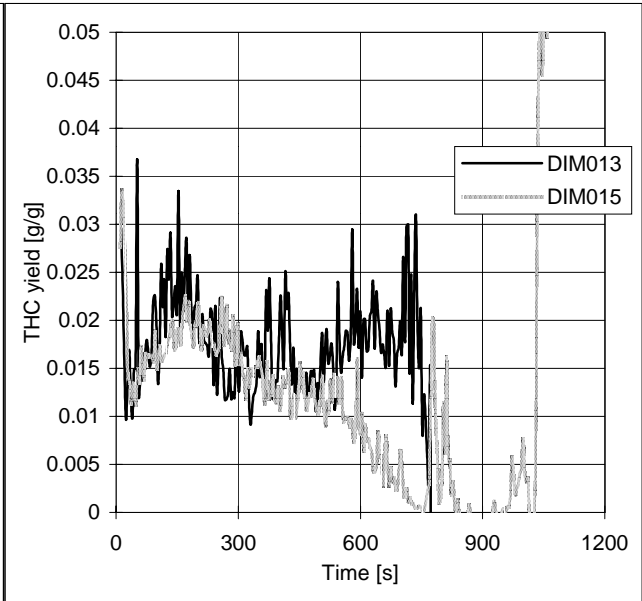
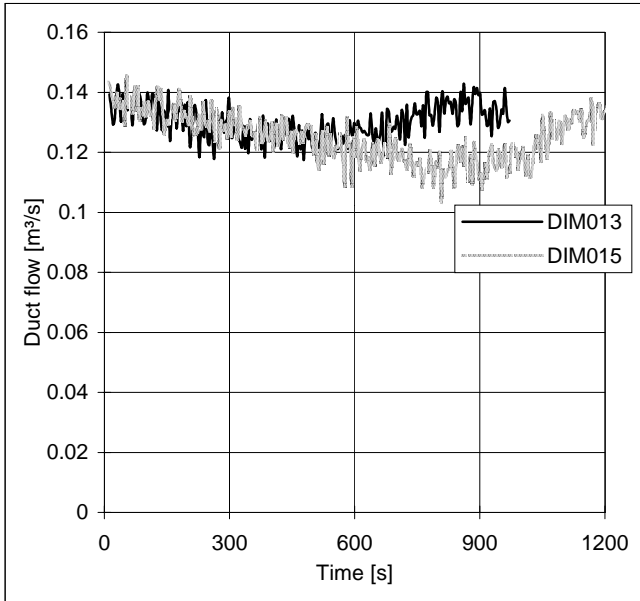

Appendix: CNBA

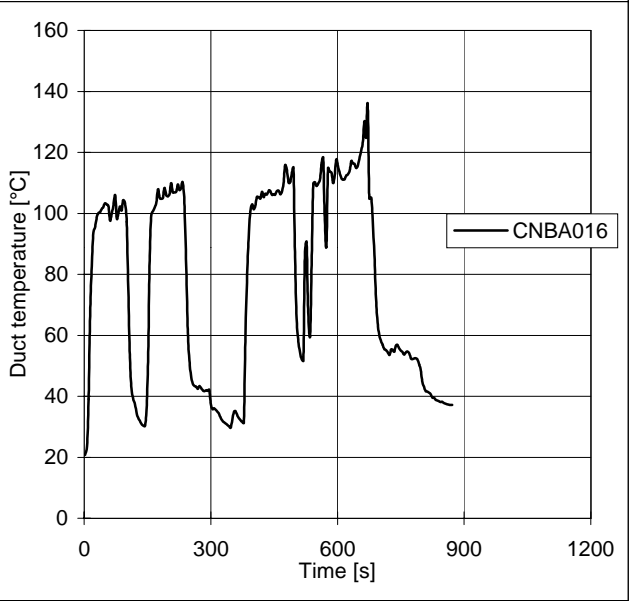
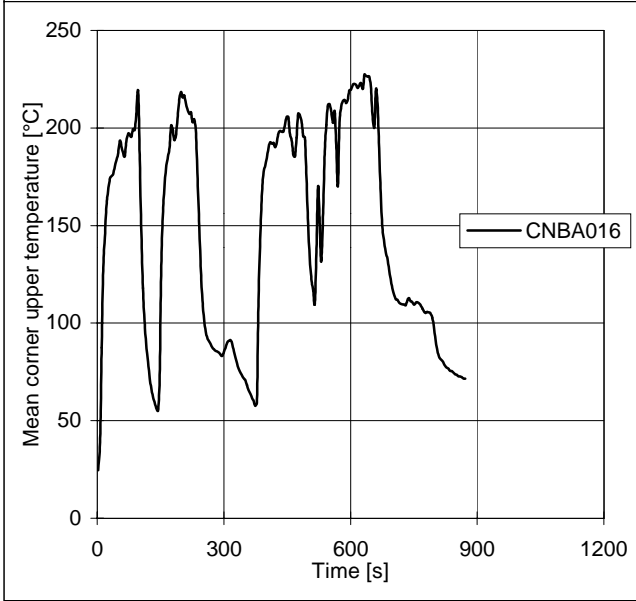
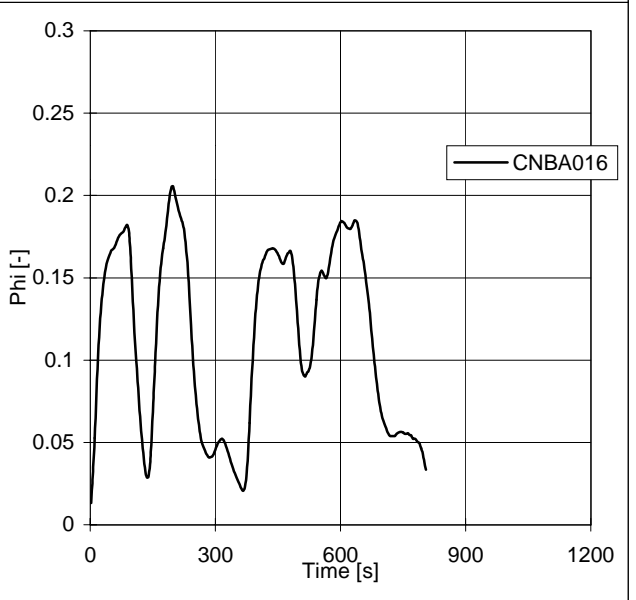
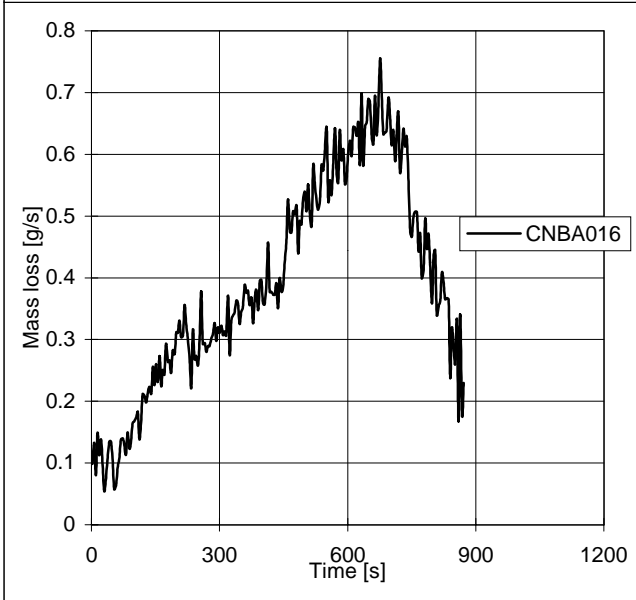
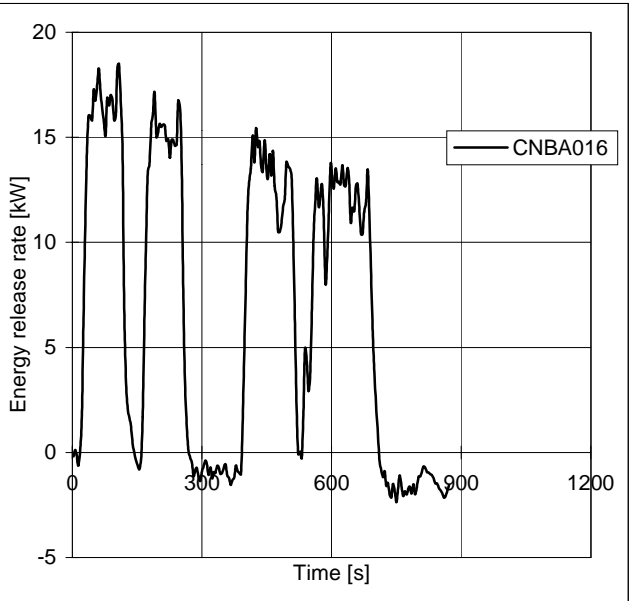
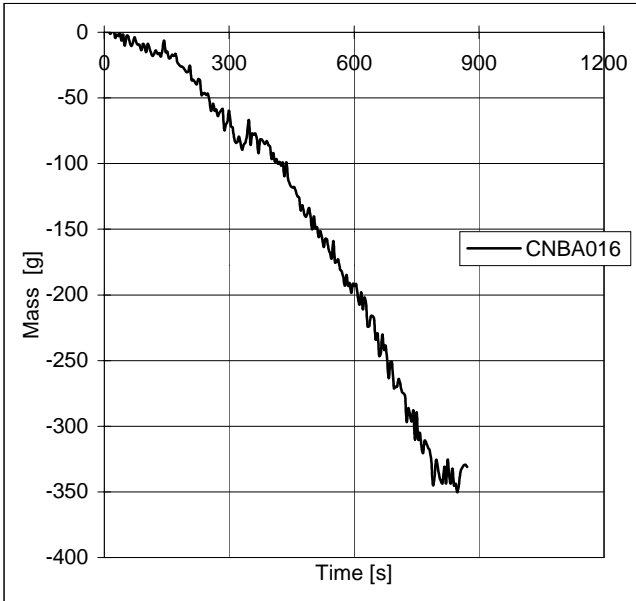

Appendix: CNBA

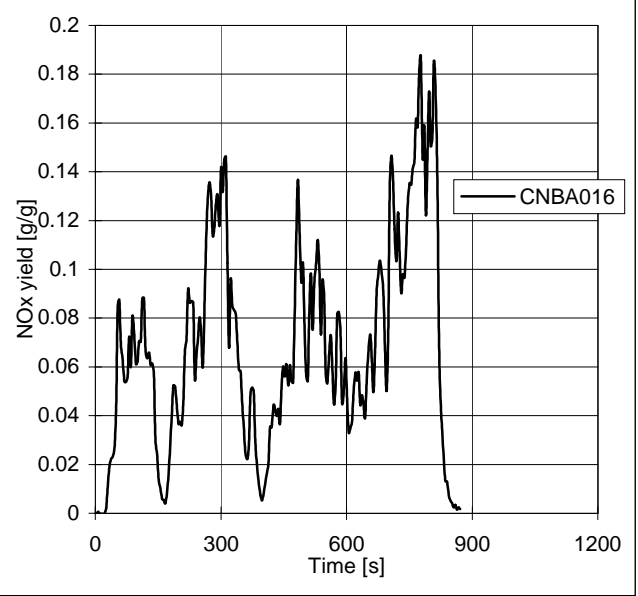
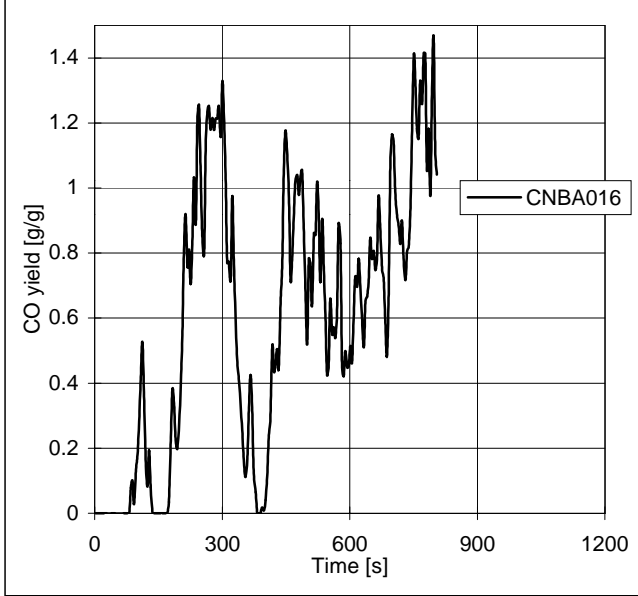
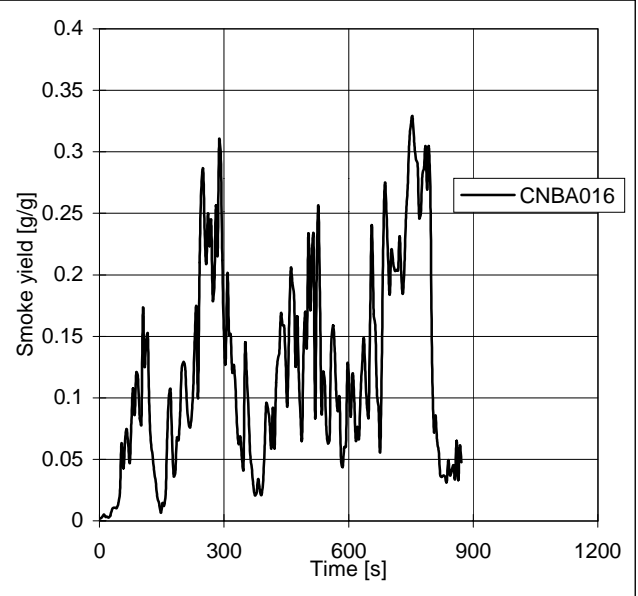
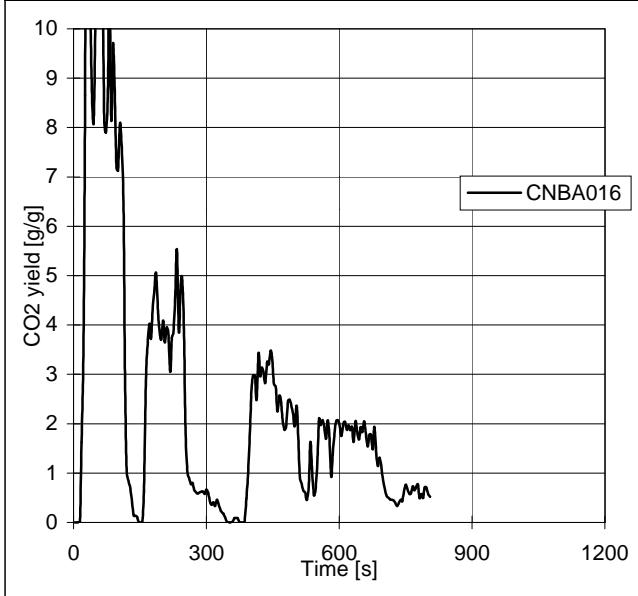
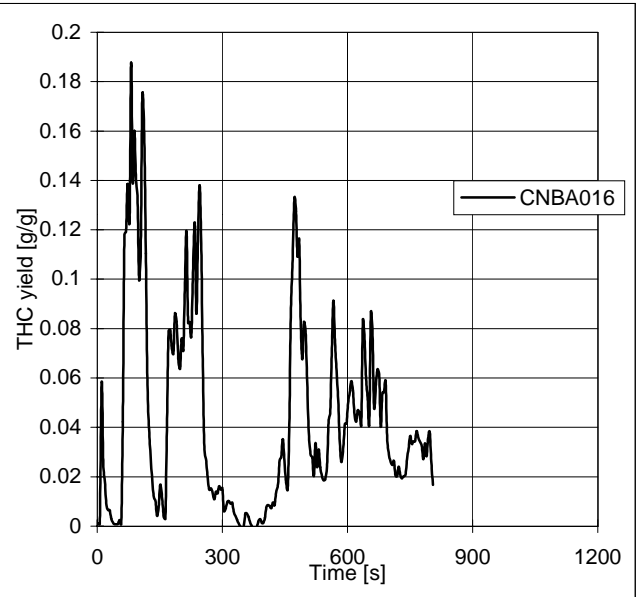
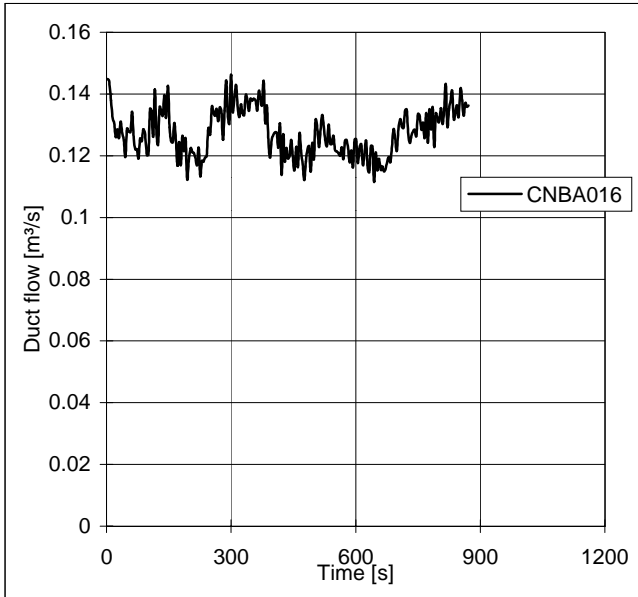

Appendix: CNBA

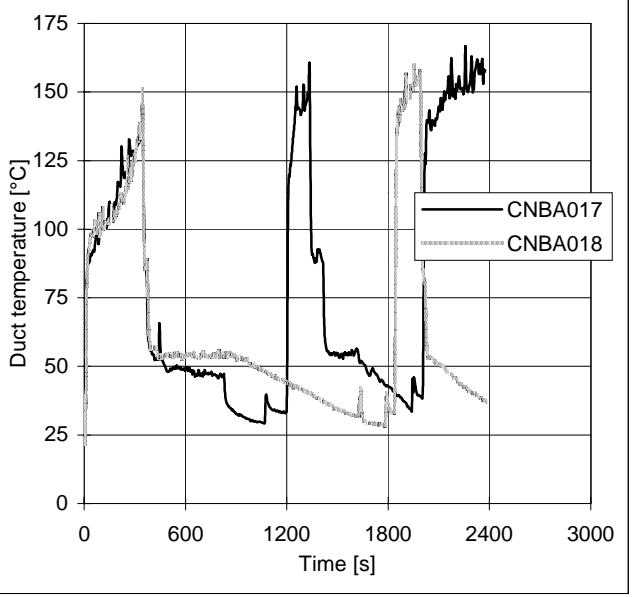
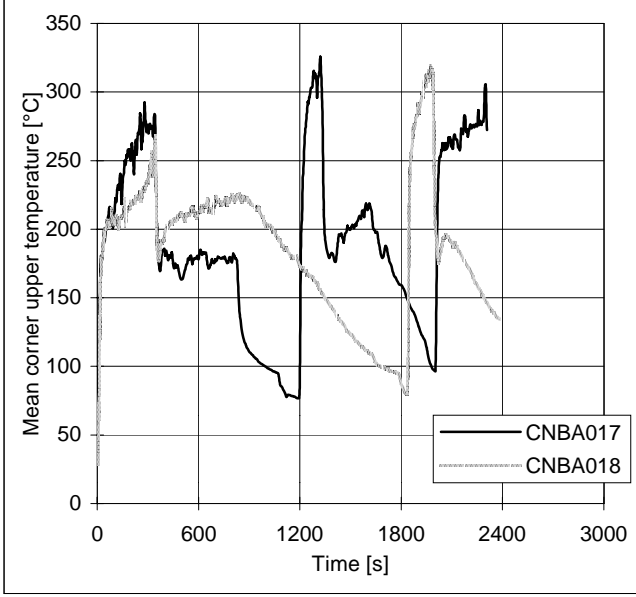
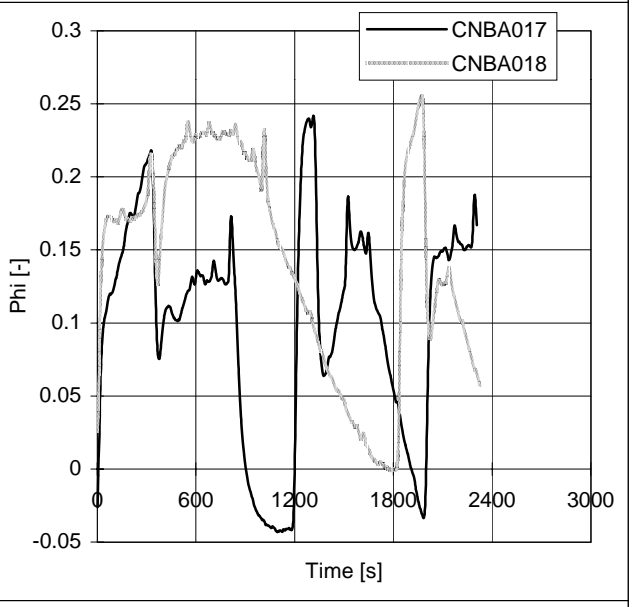
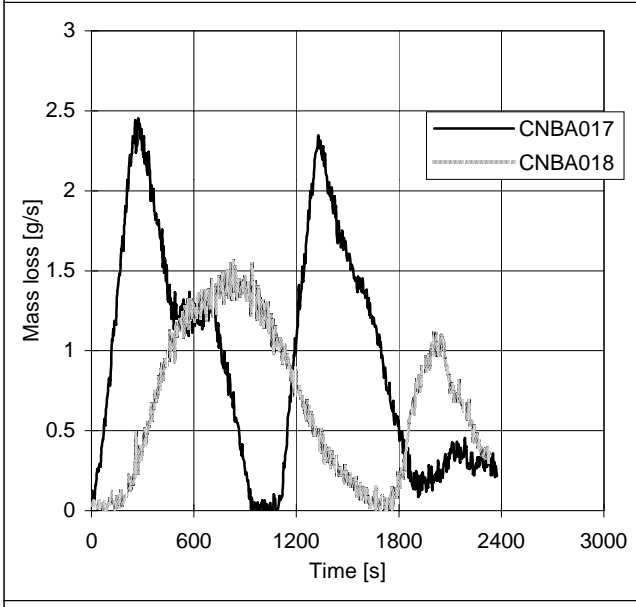
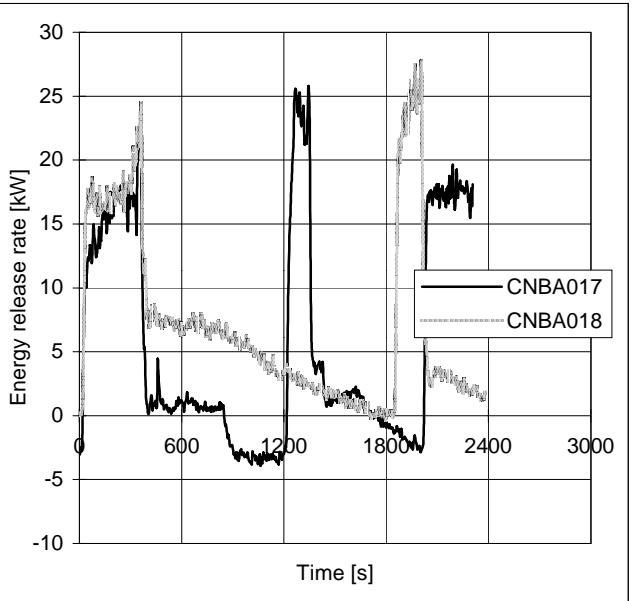
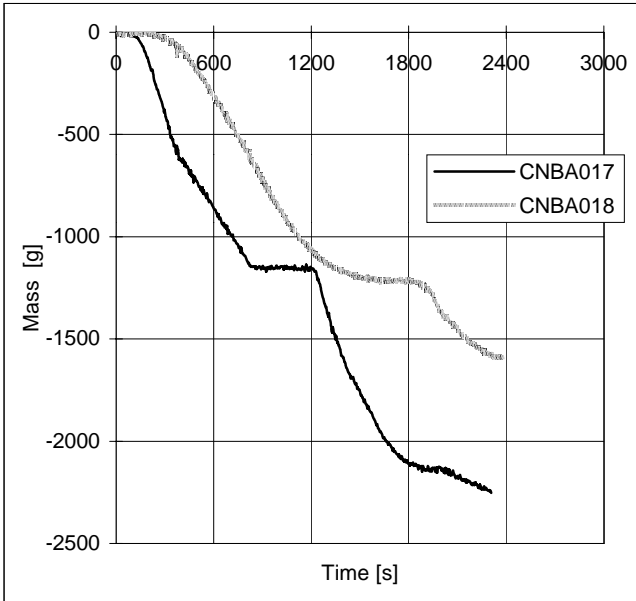

Appendix: CNBA

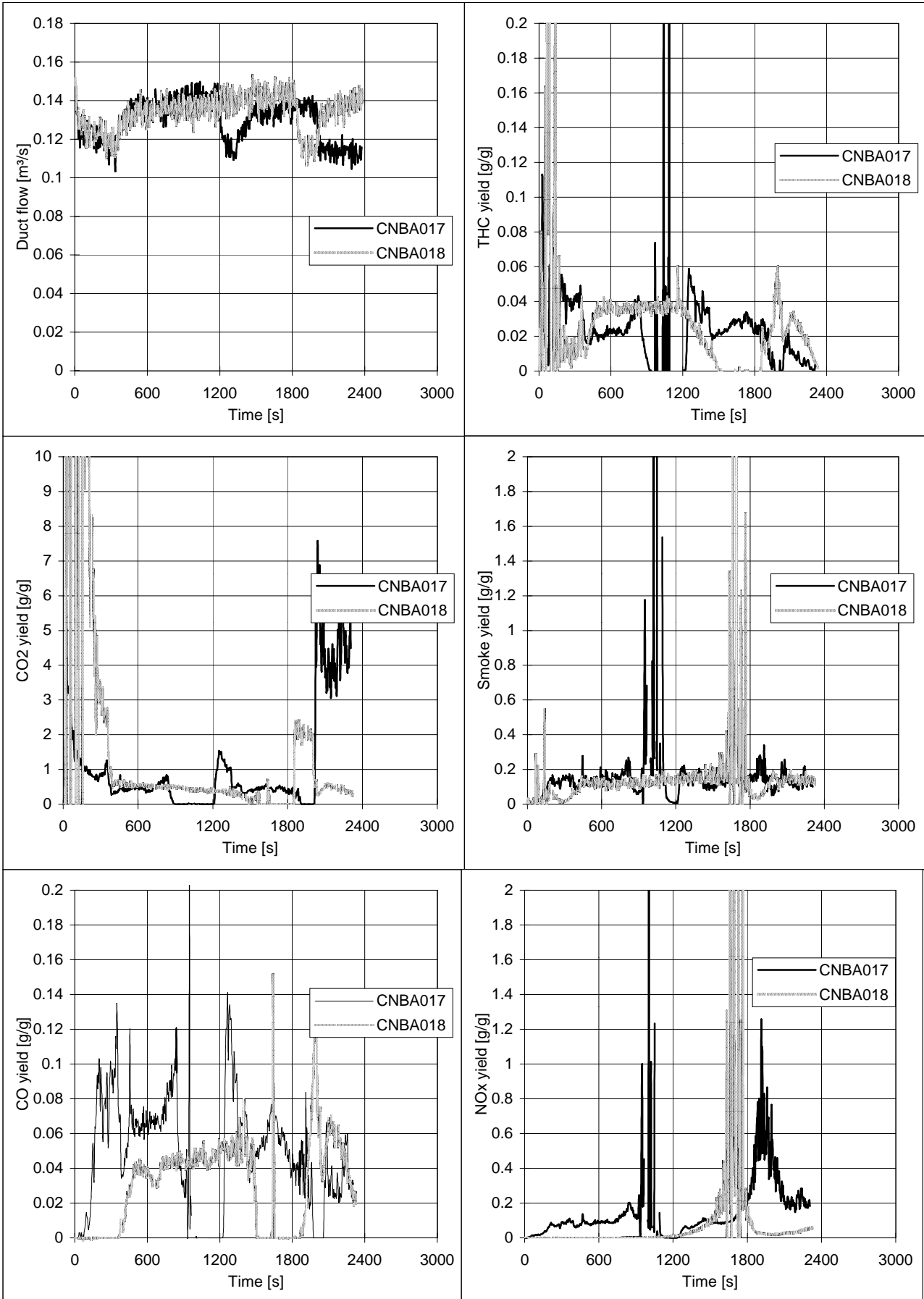

Appendix: Nylon

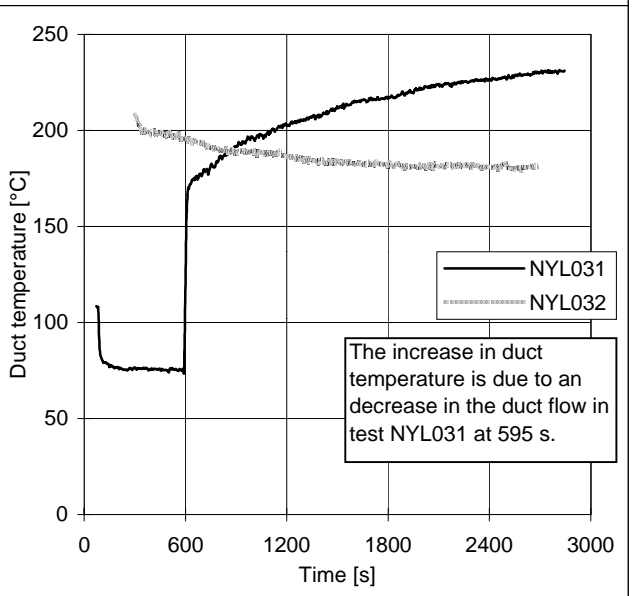
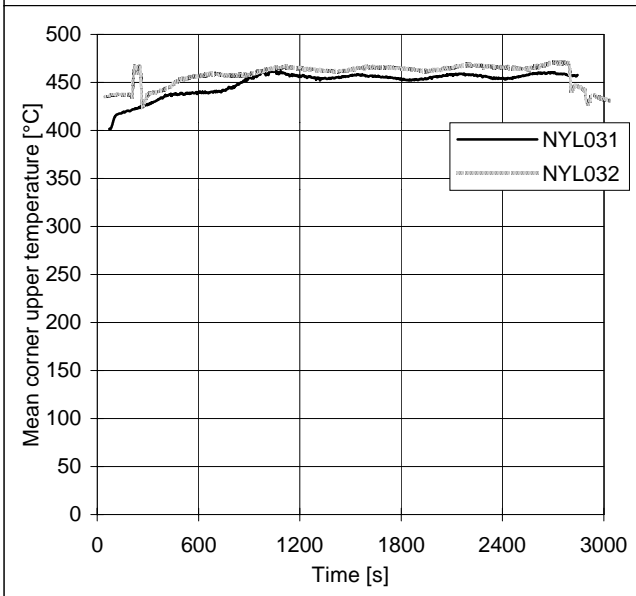
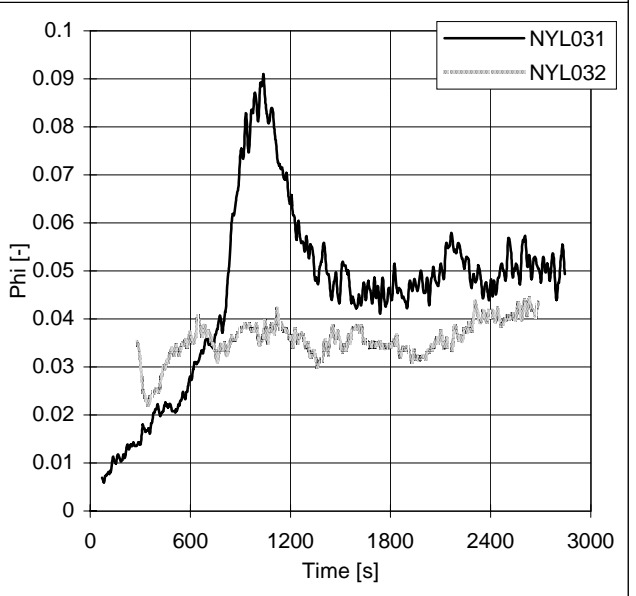
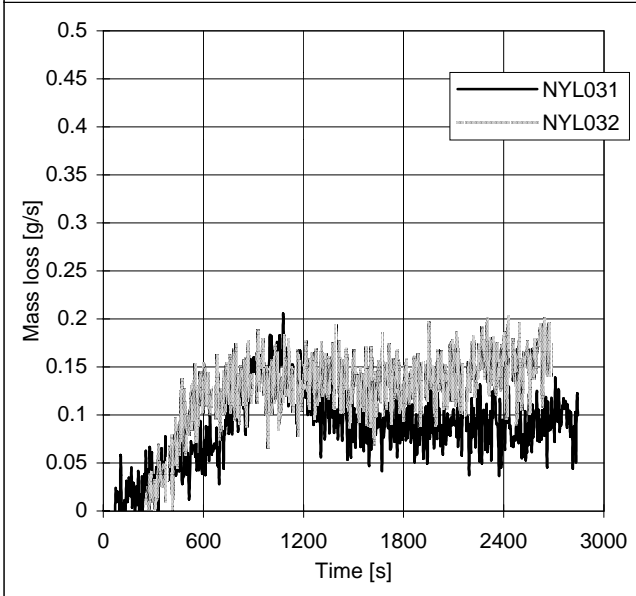
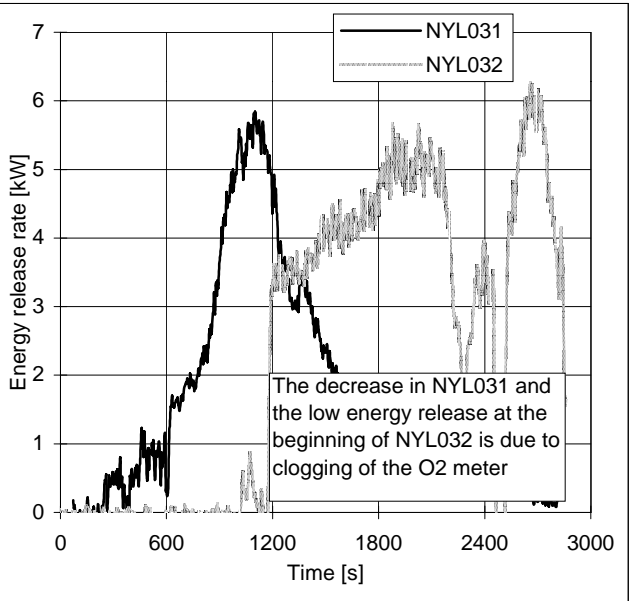
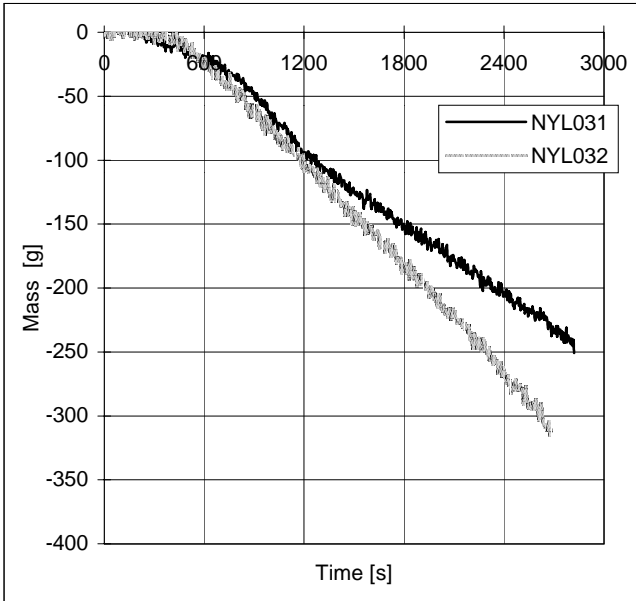

Appendix: Nylon

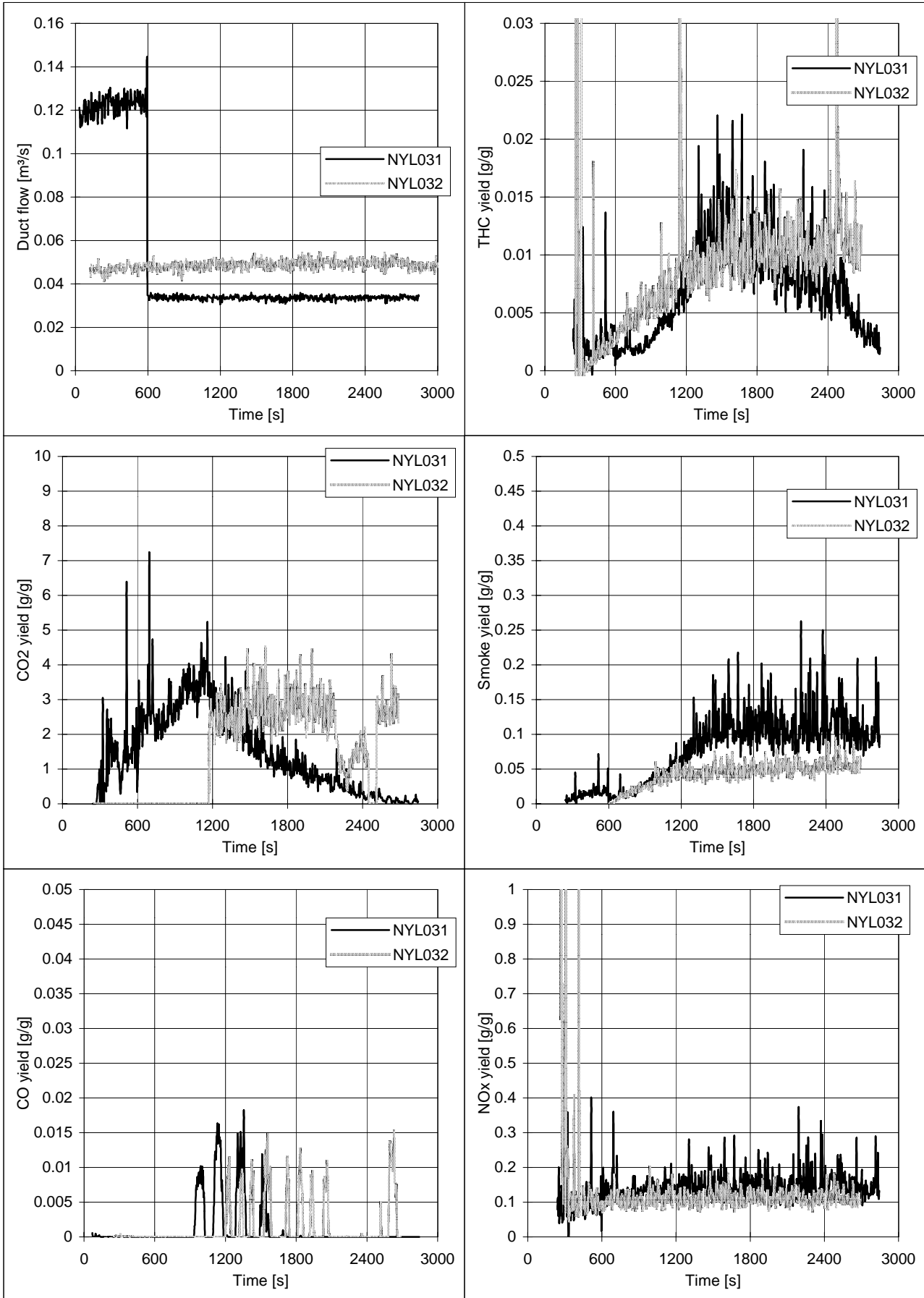

Appendix: Nylon

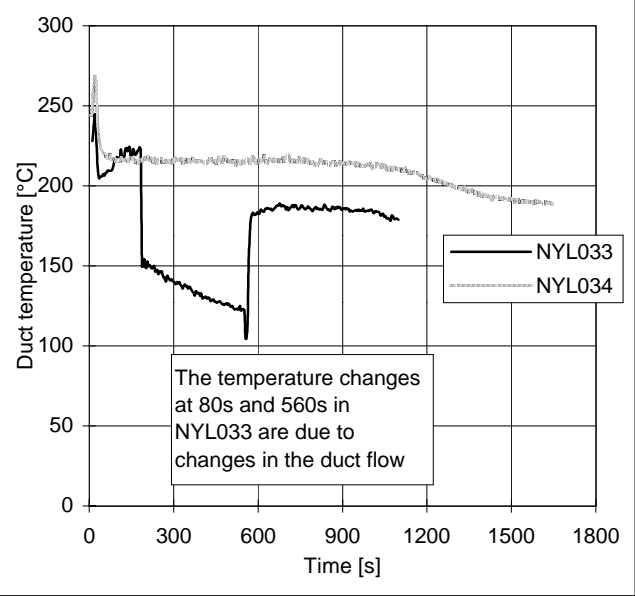
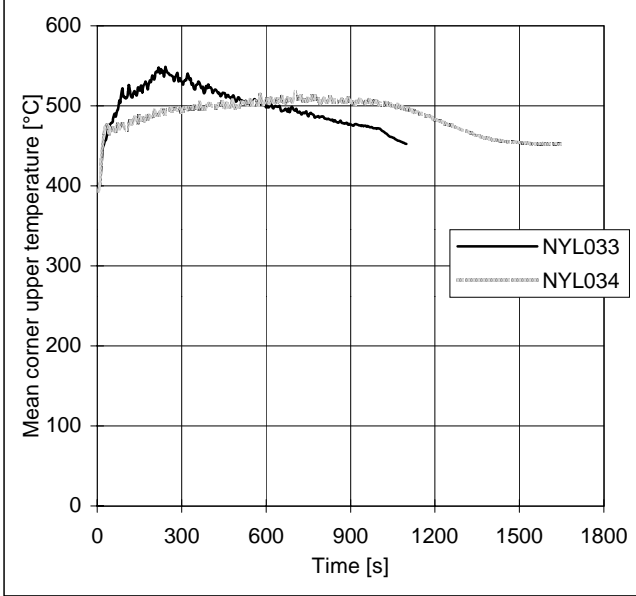
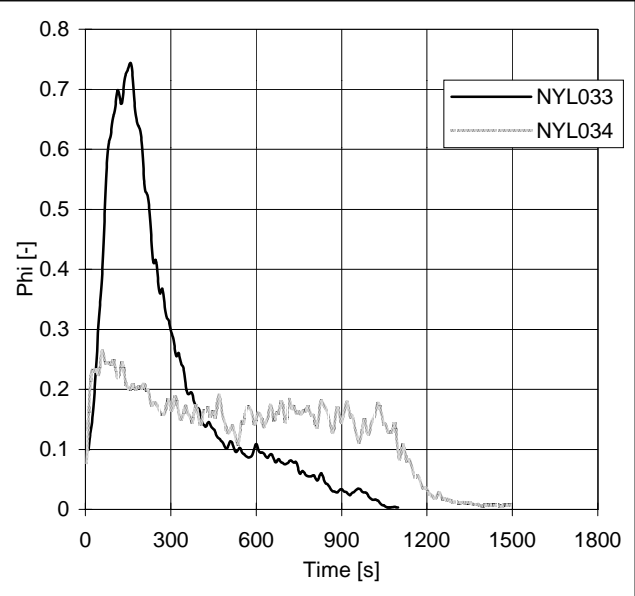
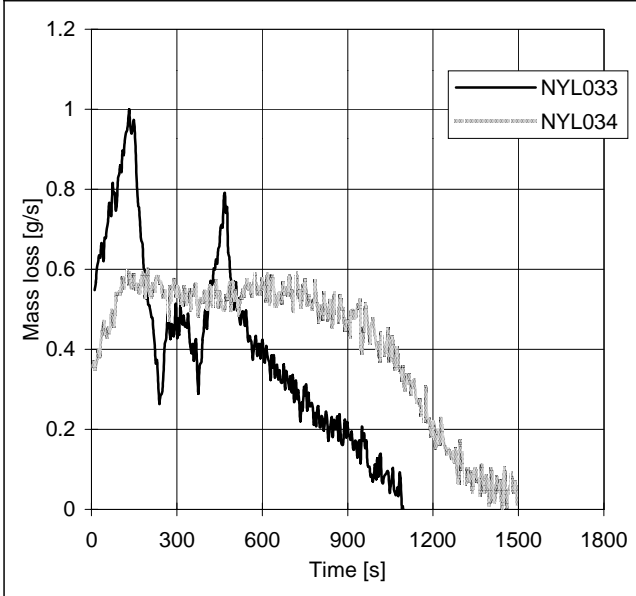
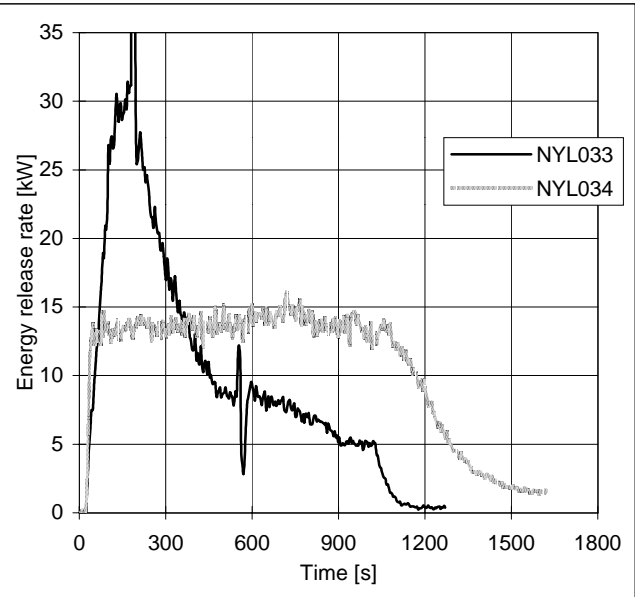
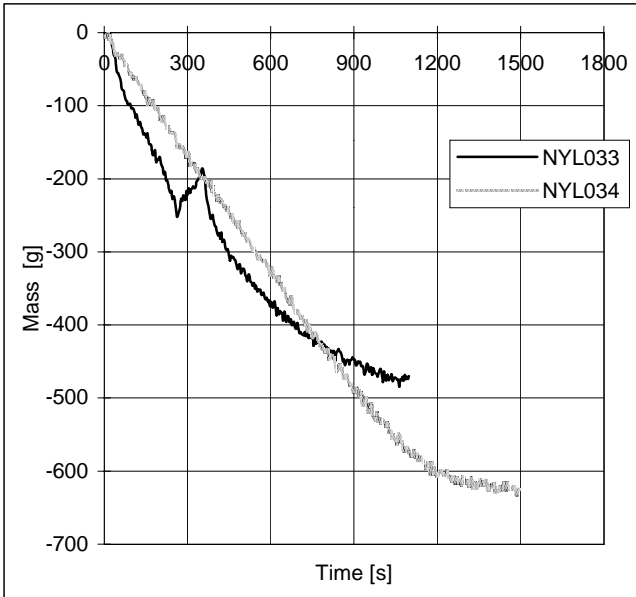

Appendix: Nylon

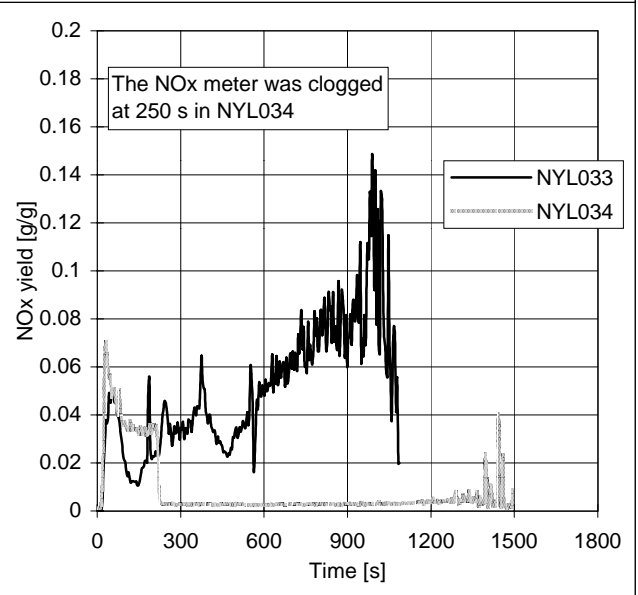
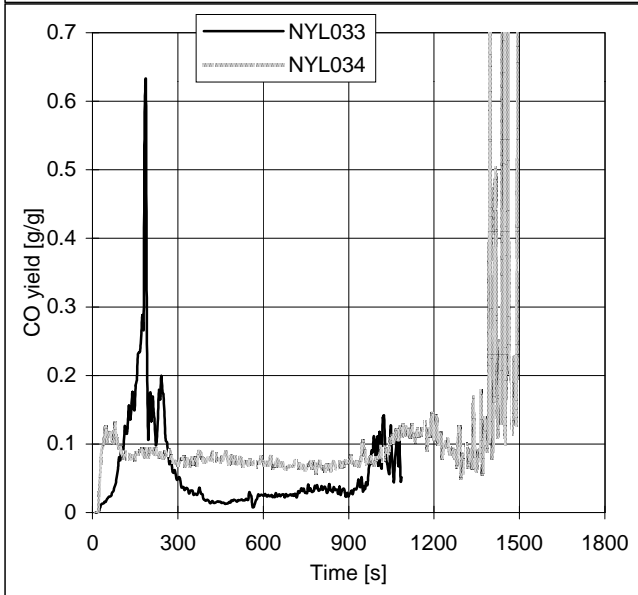
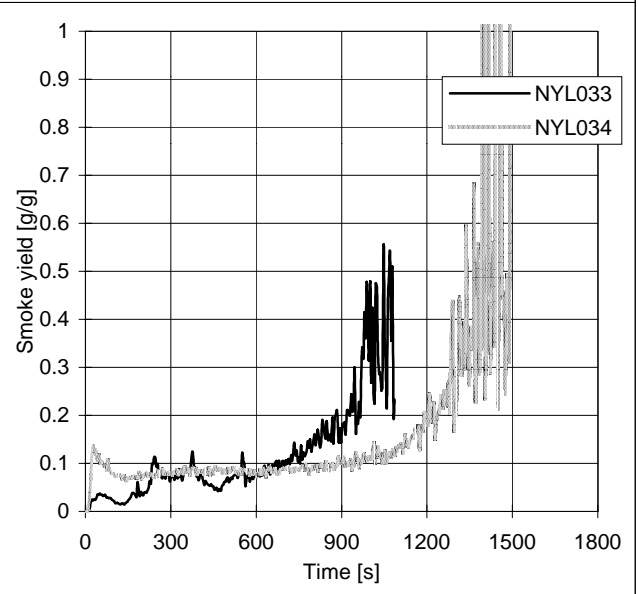
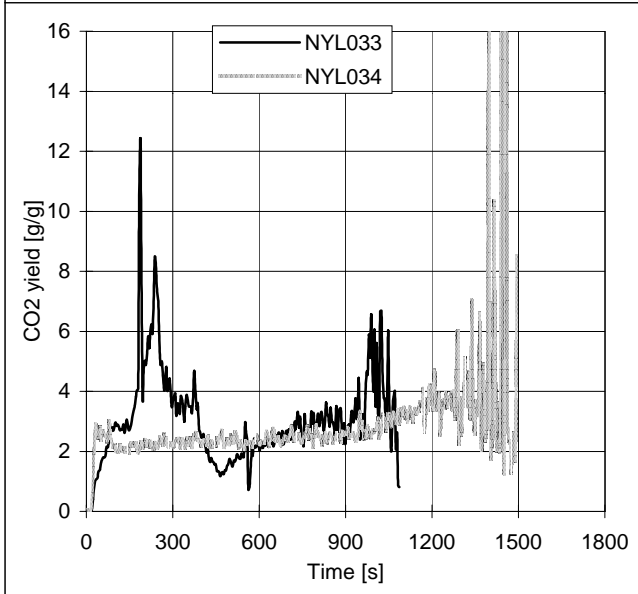
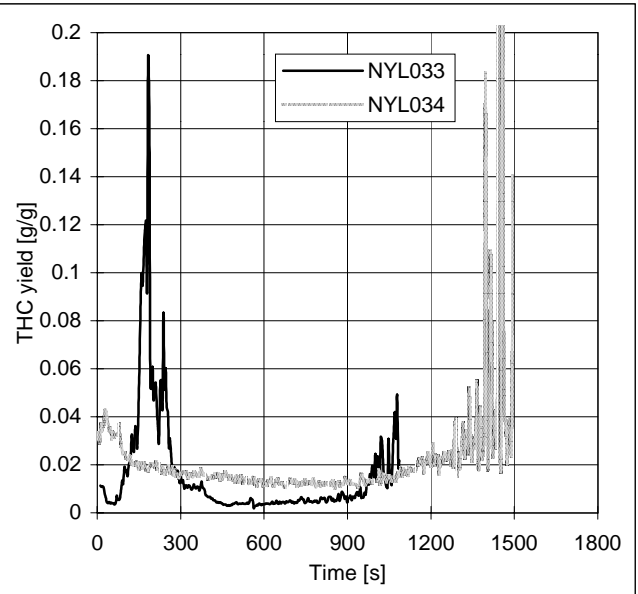
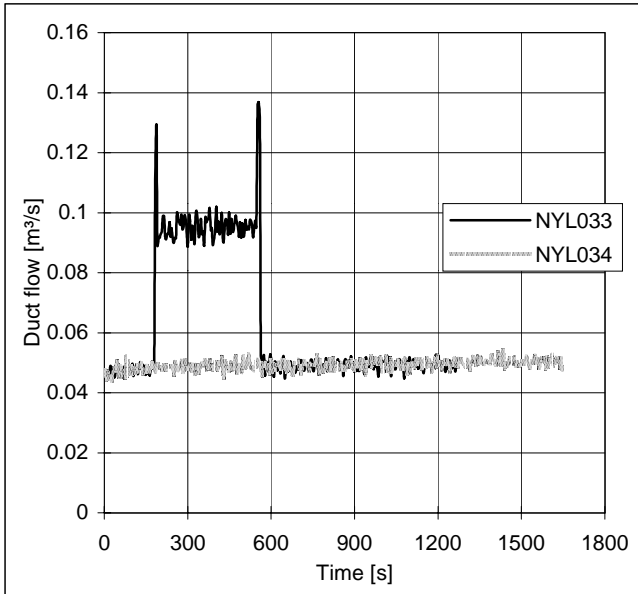

Appendix: Nylon

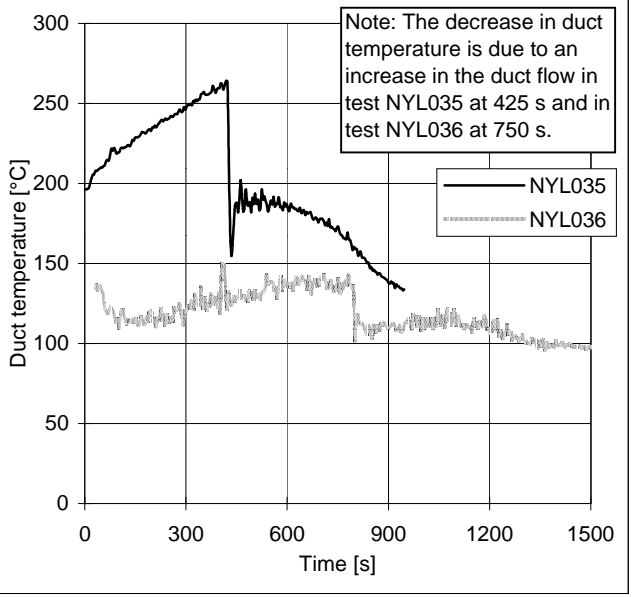
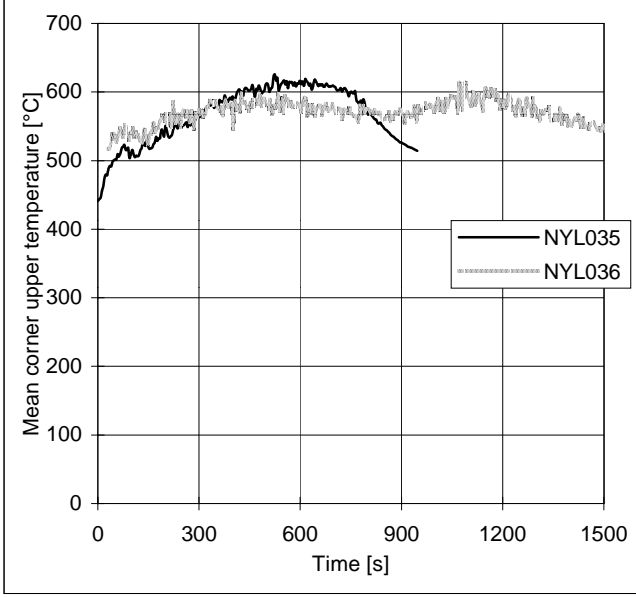
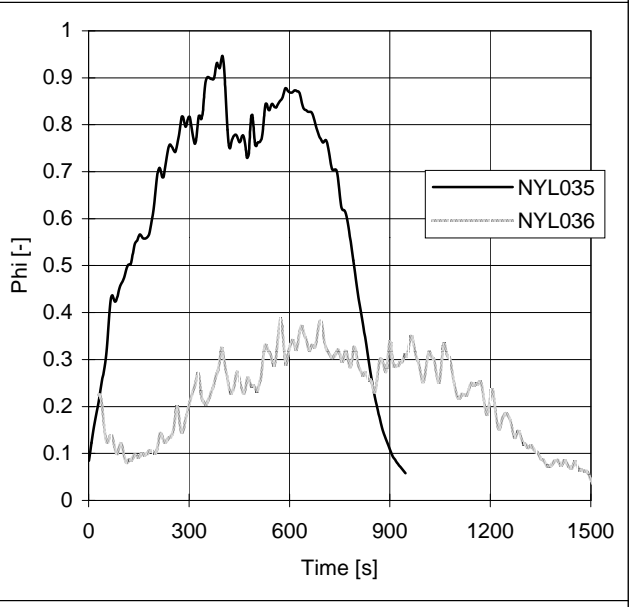
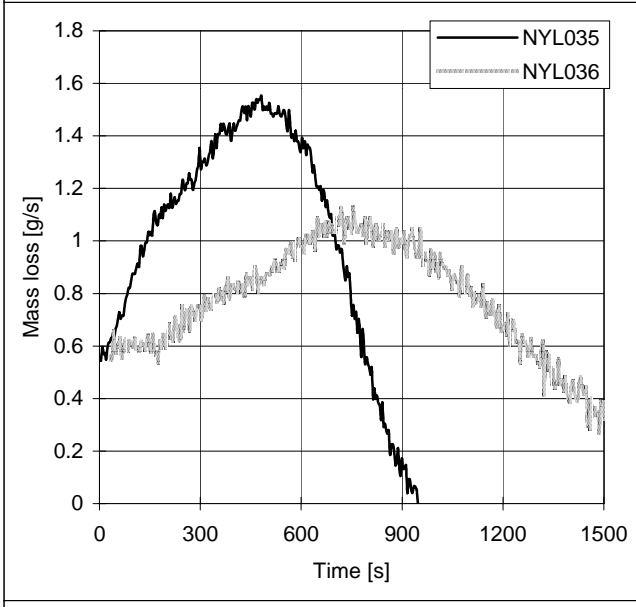
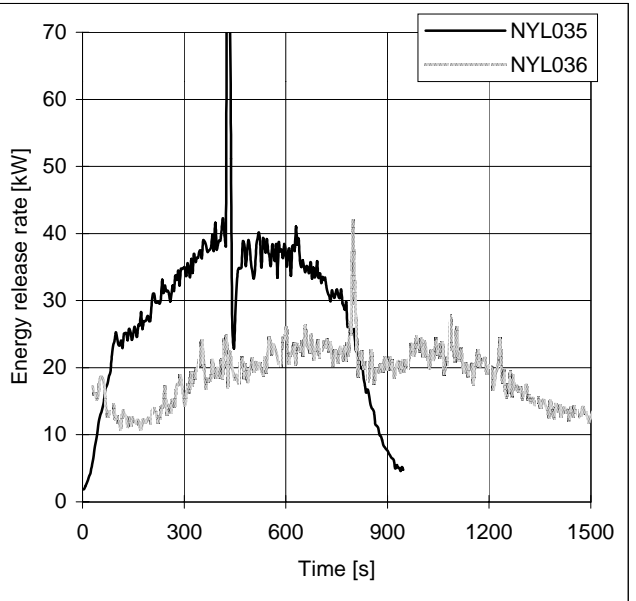
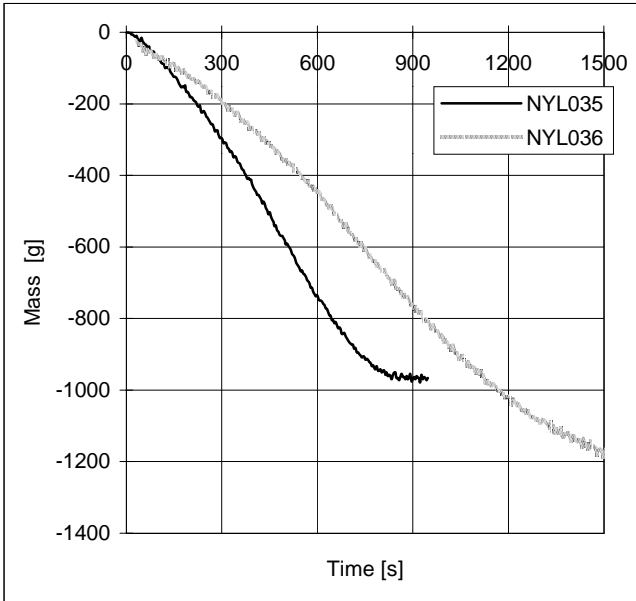

Appendix: Nylon

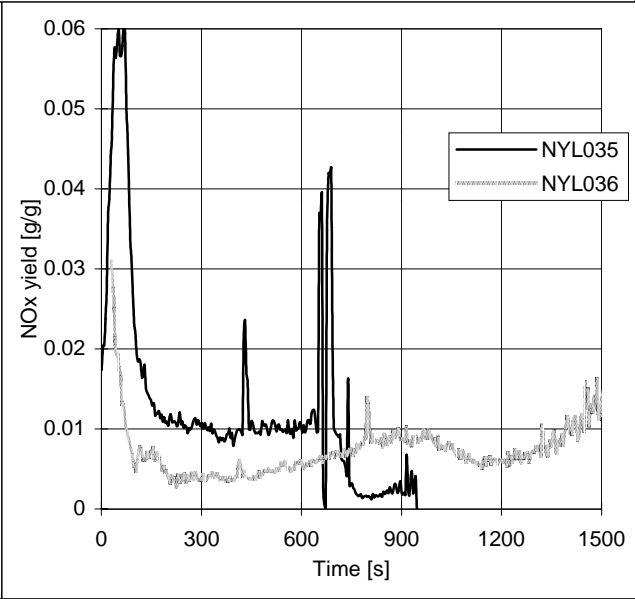
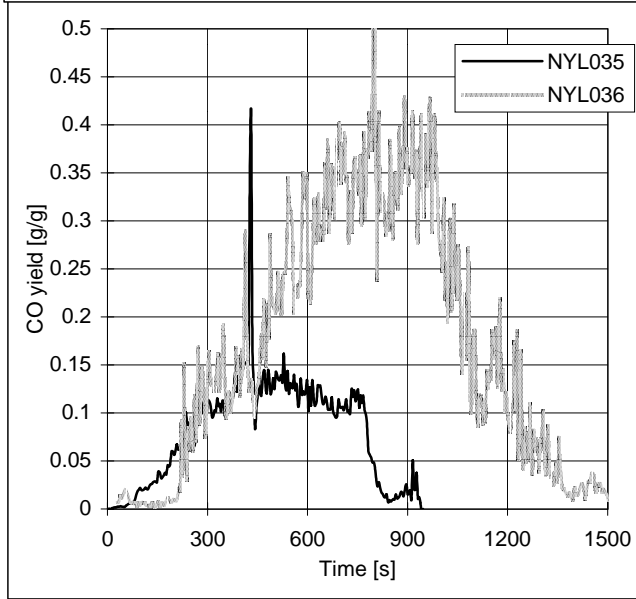
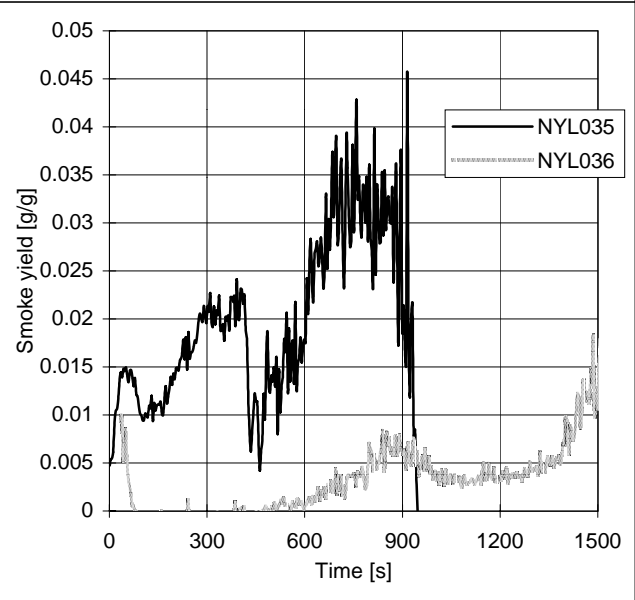
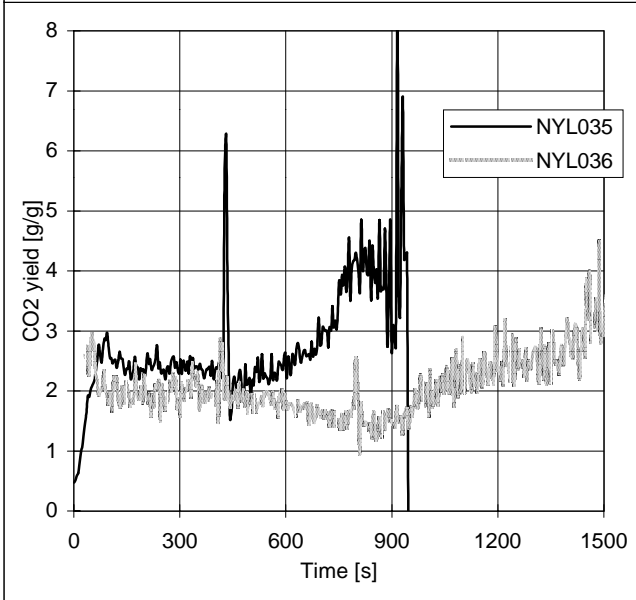
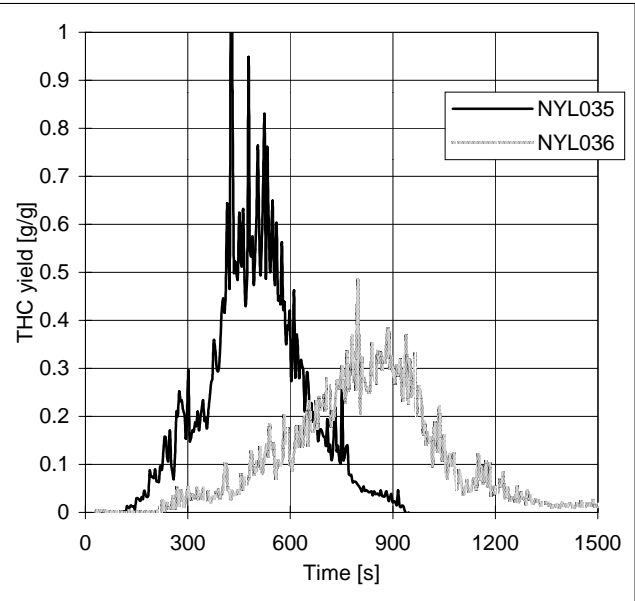
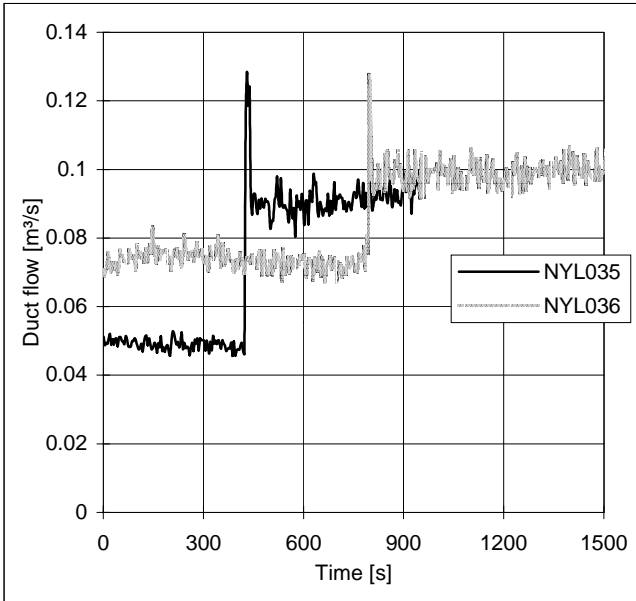

Appendix: Nylon

