



LUND UNIVERSITY

Multiple Point Ion Current Diagnostics in an HCCI Engine

Vressner, Andreas; Strandh, Petter; Hultqvist, Anders; Tunestål, Per; Johansson, Bengt

Published in:
SAE Transactions, Journal of Engines

DOI:
[10.4271/2004-01-0934](https://doi.org/10.4271/2004-01-0934)

2004

[Link to publication](#)

Citation for published version (APA):
Vressner, A., Strandh, P., Hultqvist, A., Tunestål, P., & Johansson, B. (2004). Multiple Point Ion Current Diagnostics in an HCCI Engine. *SAE Transactions, Journal of Engines*, 113(3), 544-550. Article 2004-01-0934. <https://doi.org/10.4271/2004-01-0934>

Total number of authors:
5

General rights

Unless other specific re-use rights are stated the following general rights apply:
Copyright and moral rights for the publications made accessible in the public portal are retained by the authors and/or other copyright owners and it is a condition of accessing publications that users recognise and abide by the legal requirements associated with these rights.

- Users may download and print one copy of any publication from the public portal for the purpose of private study or research.
- You may not further distribute the material or use it for any profit-making activity or commercial gain
- You may freely distribute the URL identifying the publication in the public portal

Read more about Creative commons licenses: <https://creativecommons.org/licenses/>

Take down policy

If you believe that this document breaches copyright please contact us providing details, and we will remove access to the work immediately and investigate your claim.

LUND UNIVERSITY

PO Box 117
221 00 Lund
+46 46-222 00 00

Multiple Point Ion Current Diagnostics in an HCCI Engine

Andreas Vressner, Petter Strandh, Anders Hultqvist, Per Tunestål & Bengt Johansson

Division of Combustion Engines, Lund Institute of Technology

Copyright © 2004 Society of Automotive Engineers, Inc..

ABSTRACT

Interest in ion current sensing for HCCI combustion arises when a feedback signal from some sort of combustion sensor is needed in order to determine the state of the combustion process. A previous study has revealed that ion current sensors in the form of spark plugs can be used instead of expensive piezoelectric transducers for HCCI combustion sensing. Sufficiently high ion current levels were achieved when using relatively rich mixtures diluted with EGR. The study also shows that it is not the actual dilution per se but the actual air/fuel equivalence ratio which is important for the signal level. Conclusions were made that it is possible to obtain information on combustion timing and oscillating wave phenomena from the measurements. However, the study showed that the ion current is local compared to the pressure which is global in the combustion chamber. This observation triggered the present study where the aim is to investigate the ion current at different locations in the combustion chamber. The ion current was measured simultaneously at seven locations in the combustion chamber. In order to achieve this, 6 spark plugs were fitted circumferentially in a spacer placed between the cylinder block and the head. The seventh spark plug was placed in the cylinder head. Individual DC sources of 85 volts were applied across the spark plug gaps. The present study indicates that the combustion timing seems to be dependent on the wall temperature at the different spark plug locations. The largest difference in timing between different locations in the combustion chamber was 2 CAD. The ion current amplitude varies with different spark plug locations up to 1.5 μA . The signal strength increases with decreasing air/fuel ratio and is also affected by dilution.

INTRODUCTION

Auto-ignition timing in an HCCI engine is influenced by numerous operating parameters such as inlet air temperature and air/fuel ratio [1, 2]. Therefore a direct timing sensor is needed in order to control the combustion process. This has been conducted in earlier studies using expensive piezoelectric pressure transducers [6, 1].

In SI engines spark plugs have been used for knock and misfire detection for a long time [3, 4]. The basic principle of ion current sensing is that a voltage is applied over an electrode gap inserted in the combustion chamber. The ion current appears only in a reacting, i.e. burning charge. This means that the ion current reflects the conditions in the gas volume inside the electrode gap.

Recent research has revealed that spark plugs can be used as ionization sensors in HCCI engines [3]. They are inexpensive and are appropriate when switching between SI and HCCI combustion. However, the ion current phenomenon in HCCI engines was found to be local in the combustion chamber [3]. Therefore an interest arises in this study where the aim is to investigate the ion current at different locations in the combustion chamber. In SI engines the ion current signal strength is not very dependant on the spark plug location. However, if the spark plug is placed near the center of the combustion chamber and good cylinder swirl is present, signal quality seems to improve [4].

EXPERIMENTAL APPARATUS

ENGINE - The engine used for the tests was an inline six-cylinder *Volvo TD100*, converted to HCCI operation. Several modifications have been done to the engine during its time at *the Division of Combustion Engines* in Lund. For instance, only cylinder number 6 is operational, the rest are motored and the cylinder head for cylinder 5 has been removed, and replaced with a sealing plate. The removal of cylinder head number 5 facilitates maintenance and general mounting operations on cylinder 6. The combustion chamber is of a disc shaped design. A water cooled Kistler pressure transducer, placed 38mm from the center of the bore axis, is used for in-cylinder pressure capture. A photo of the engine can be seen in Figure 1 and a table containing some vital engine specifications of the *VOLVO TD100* are shown in Table 1.

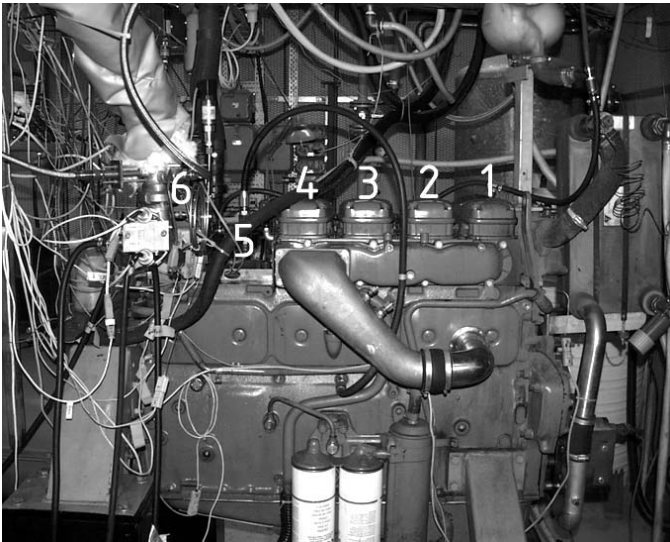

Figure 1. The modified VOLVO TD100, the engine used for all the experiments conducted.

Table 1. Geometric properties of the TD100 engine.

Displaced volume	1600 cc
Stroke	140 mm
Bore	120.65 mm
Connecting Rod	260 mm
Compression ratio	15:1
Exhaust Valve Open	39° BBDC @ 1 mm lift
Exhaust Valve Close	10° BTDC @ 1 mm lift
Inlet Valve Open	5° ATDC @ 1 mm lift
Inlet Valve Close	13° ABDC @ 1 mm lift
Valve Lift Exhaust	13.4 mm
Valve Lift Inlet	11.9 mm

In order to achieve richer mixtures than λ 2.2 dilution with EGR was used. Figure 2 shows the EGR system with cooling. In order to use high EGR rates when having atmospheric pressure conditions in the inlet manifold, the back pressure had to be raised by throttling of the exhaust, thus forcing exhaust gases in to the inlet manifold.

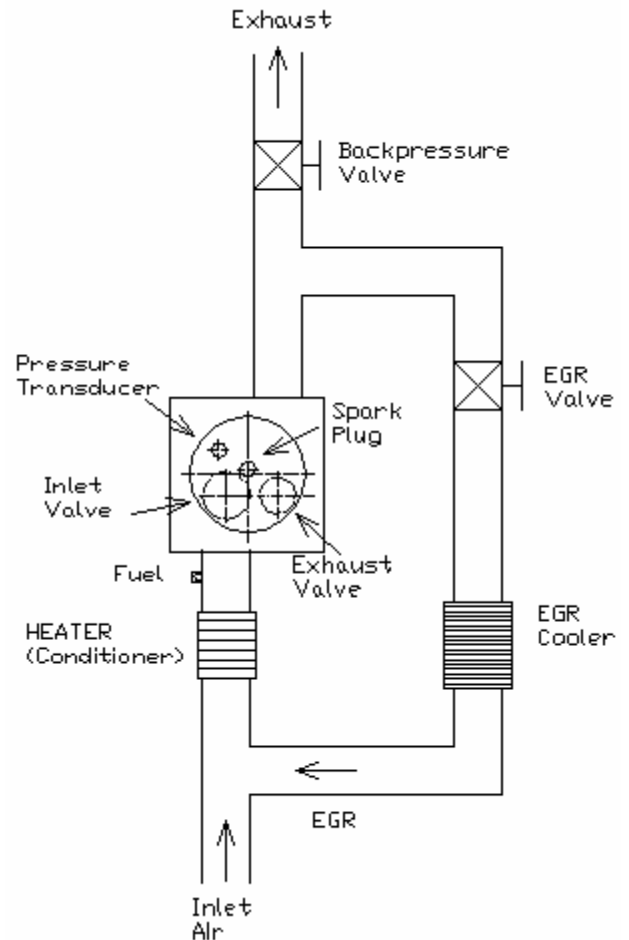

Figure 2. The EGR system used for the TD100 engine.

ION CURRENT SENSING SYSTEM – In SI engines ion current measurements is limited by the spark duration, since the actual measurement is taking place after ignition [5]. Since autoignition is used in HCCI engines this limitation does not exist.

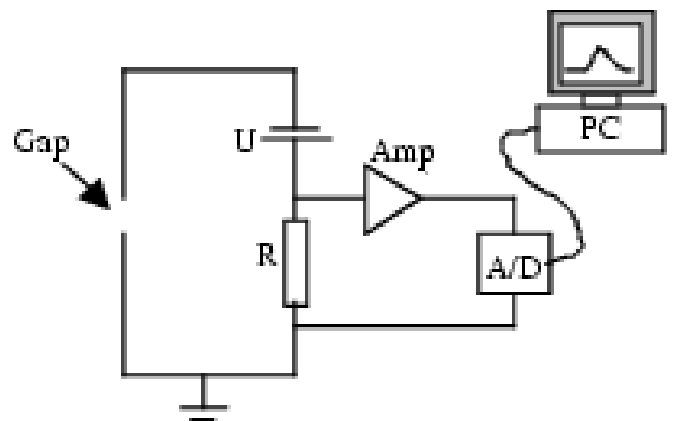

Figure 3. Schematic of the ion current measuring system.

Modified spark plugs were used as ionization sensors where the side electrodes have been removed. This

modification has resulted in higher signal strength in earlier studies [3].

Figure 3 shows the principal ion current measuring system, used for each ion current measuring position. A DC voltage (U) of 85 volts was applied over the spark plug gap. The ion current was measured by measuring the voltage over a resistance of 100k Ω , inserted in the electrical circuit. Since the ion current signal is low, μA or lower, it had to be amplified 20 times (Amp) before it was A/D converted and sampled by the PC. The sampling system consisted of a DAP 5400a/627, which has an individual A/D converter for each of the 8 channels. The system has a theoretical capacity of 1.2MHz, but during these test a sample frequency of 30 kHz was used.

In order to monitor the ion current at different locations within the combustion chamber, the decision fell on usage of a number of spark plugs. Strategic placement of the spark plugs throughout the combustion chamber allows a correct analysis of the local ion current phenomena. In this case the number of spark plugs to be used was specified beforehand to seven due to limited data acquisition equipment. Accommodations for six of these spark plugs were made in a designed spacer which was placed between the engine block and cylinder head. In order to monitor the in-cylinder pressure a pressure transducer was placed in the cylinder head. The spark plug arrangement in the spacer can be seen in Figure 4.

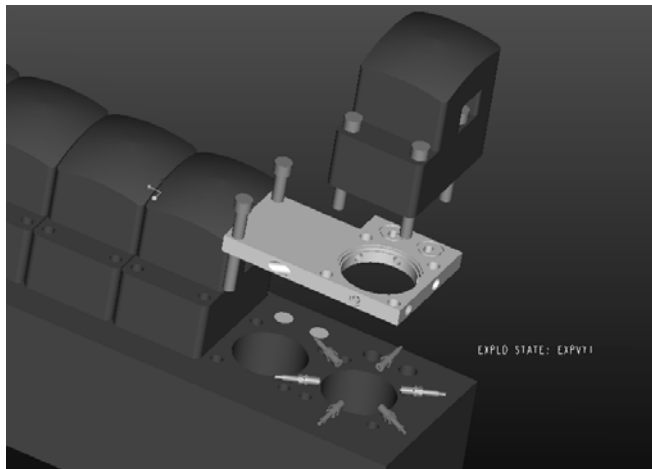

Figure 4. Picture of spark plug arrangement with a 60 degree angular separation.

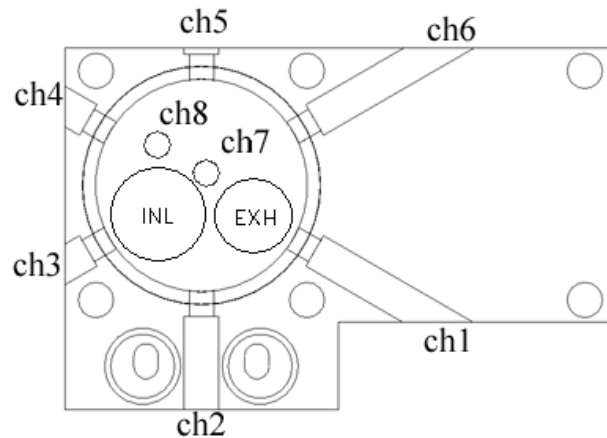

Figure 5. Picture of the spacer with seven ion current measuring positions and one pressure measuring position (ch8).

Figure 5 shows the designed spacer where Channel 1 to 7 is spark plugs and Channel 8 is a piezoelectric pressure transducer.

EXPERIMENTS

All tests were conducted at 1000 rpm with dilution of air and/or EGR. The EGR rates were 26% and 40% and λ values from 2.7 to 0.8. The crank angle degree where 50% of the fuel is burned (CA50) was kept about 5 degrees after TDC. This position where 50% of the fuel is burned is called timing in the figures. The timing was kept constant during the tests by changing the inlet air temperature.

In the first test, λ was varied between 2.7 and 2.2 and no EGR was used. Thereafter lean operation with 26% EGR was conducted. When the mixture was diluted with 40% EGR, λ could be varied between 1.5 and 0.8. The leanest cases were limited by the absence of ion current signal. The richer cases were limited by high pressure gradients. The case of λ 0.8 was limited by unstable combustion. Finally, timing was varied at a constant λ of 2.5 by means of altering the inlet air temperature.

RESULTS

In all test cases the results are presented with a figure containing a single cycle of ion current traces and an in-cylinder pressure trace. Further, peak ion current amplitudes versus λ for the mean of 500 cycles are presented. Ion current timing, i.e. 50% of ion rise (the position where half of the peak amplitude is located), is then presented together with CA50 versus λ .

LAMBDA SWEEP WITH NO EGR

Ion current traces and a cylinder pressure trace can be seen in Figure 6. As can be seen, variations between the ion current traces are significant. This can be

explained by the fact that the ion current phenomenon is local [3]. The timing between ion currents and pressure (CA50) differ between the different probe locations. To ensure that there were no manufacturing defects or variances in the spark plugs themselves, the spark plugs were switched to different locations.

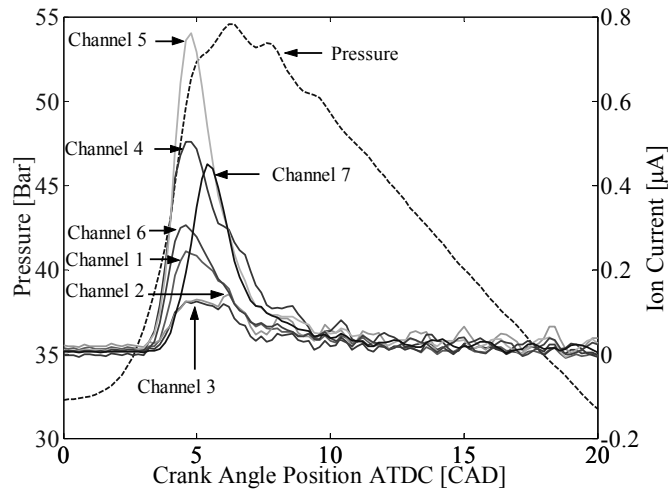

Figure 6. Ion current traces and cylinder pressure trace for a single cycle at $\lambda 2.5$ without EGR.

The mean ion current amplitudes for 500 cycles can be seen in Figure 7 for the different λ cases. The amplitude increases as the mixture becomes richer [3].

There seems to be a systematic difference in amplitude between the measurement locations. Locations 4 and 5 have the highest amplitude for all λ values, followed by 6, 7 and 3.

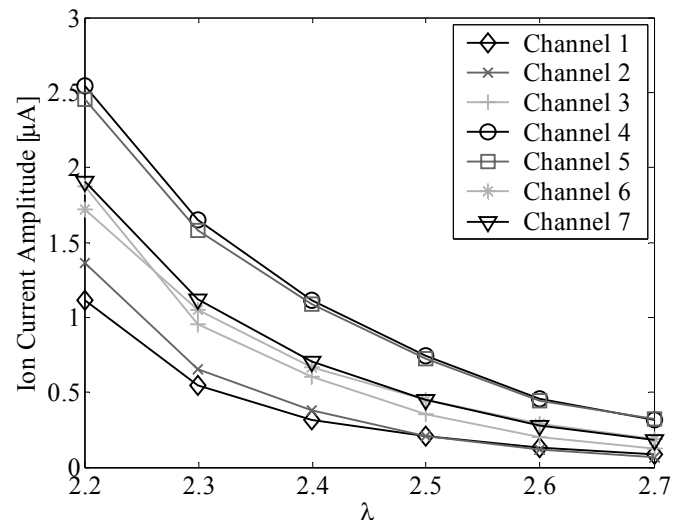

Figure 7. Ion current amplitudes for a lambda sweep without EGR.

Figure 8 shows the mean timing for the ion current signals and cylinder pressure. The timing trends are the same for all ion current signals and CA50. There is an

almost constant offset between CA50 and ion current timing, 1-1.5 degrees depending on measuring position. Channels 4 and 5 have the earliest timing for all λ values.

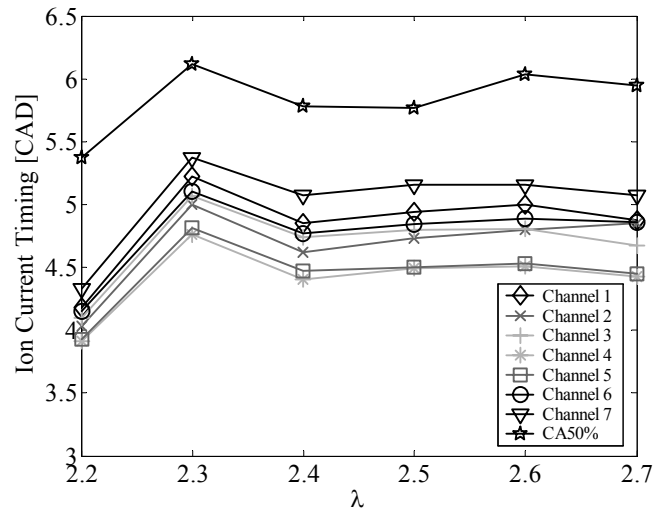

Figure 8. Ion current timing information for a lambda sweep without EGR.

LAMBDA SWEEP WITH 26% EGR

Similar features can be seen in Figure 9 as in Figure 6, showing ion currents and cylinder pressure for a single cycle. In this case there are larger variations in timing between the different measuring positions.

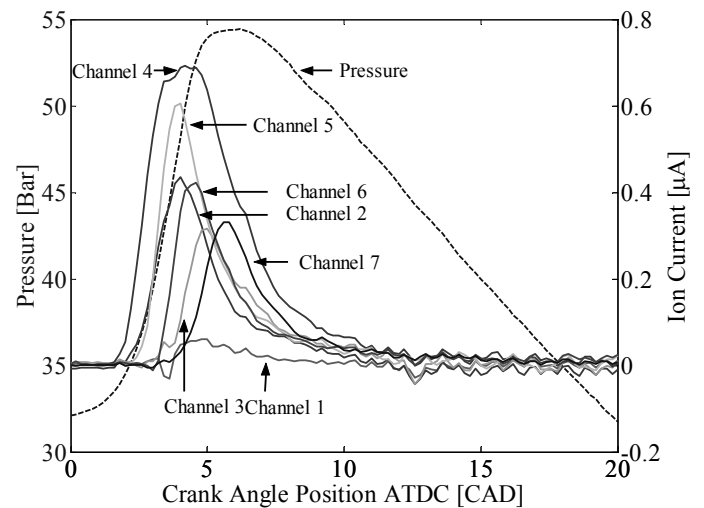

Figure 9. Ion current traces and cylinder pressure trace for a single cycle at $\lambda 1.8$ with 26 % EGR.

Figure 10 shows the mean ion current amplitudes versus λ with 26% EGR. As in Figure 7 the amplitudes increases as the mixture becomes richer and the same trends between the channels can be seen. However, the amplitudes at $\lambda 2$ are much lower in this case than at $\lambda 2.2$ with no EGR dilution.

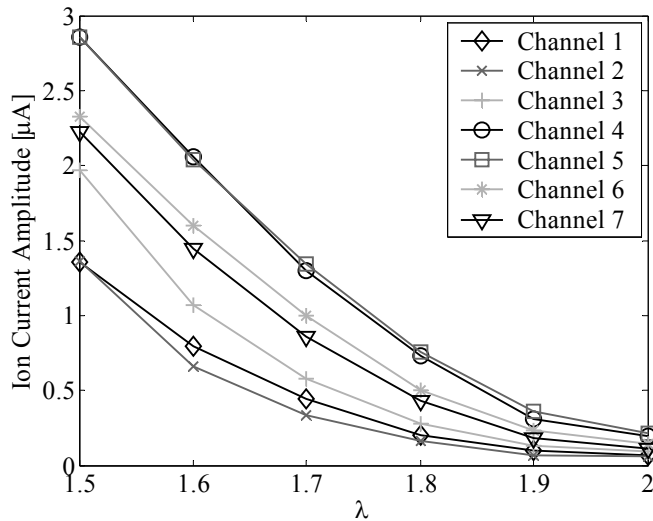

Figure 10. Ion current amplitudes for a lambda sweep with 26% EGR.

The timing, Figure 11, of the ion currents and CA50 is not influenced by the dilution of EGR, as the peak amplitudes are. The trends in timing are the same as in Figure 8.

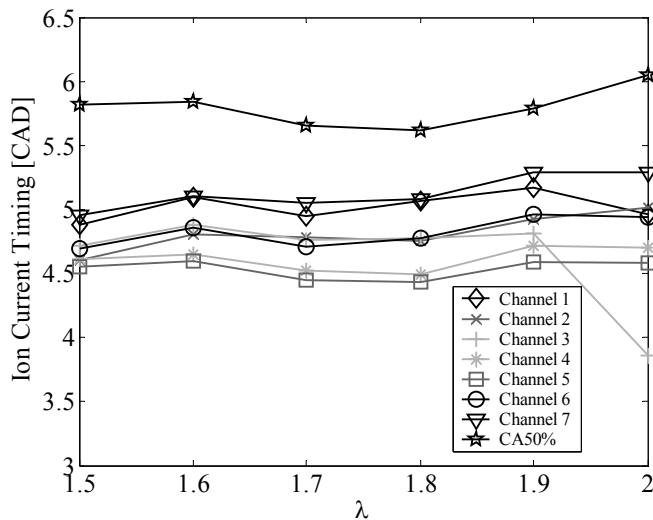

Figure 11. Ion current timing information for a lambda sweep at 1000 rpm with 26% EGR.

LAMBDA SWEEP WITH 40% EGR

The single cycle case in Figure 12 has the same trends as in Figure 6 and Figure 9, but the signal strength has increased.

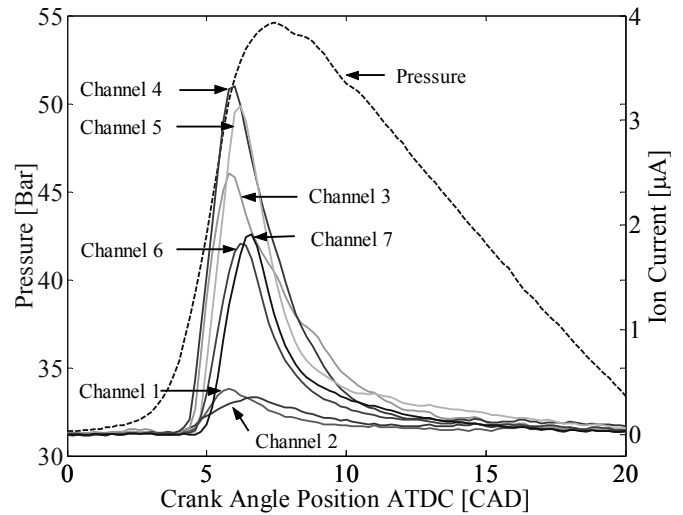

Figure 12. Ion current traces and cylinder pressure trace for a single cycle at $\lambda 1.2$ with 40% EGR.

The ion current amplitudes increase rapidly when the mixture composition moves towards stoichiometric, see Figure 13. The information on the rich side can not be shown since the amplifiers were set to measure much lower currents.

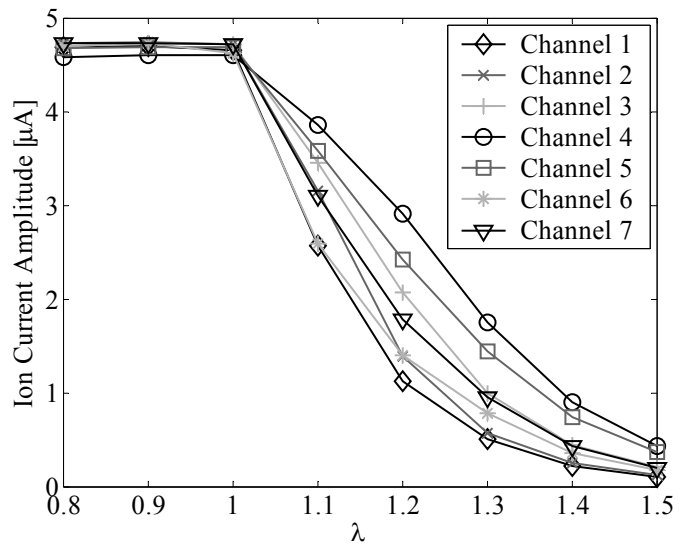

Figure 13. Ion current amplitudes for a lambda sweep with 40% EGR.

Even if the mean combustion timing (CA50) varies, the trends between CA50 and ion current timings are the same, see Figure 14. The inlet air temperature could not be further increased at $\lambda 0.8$ (above 220 °C), which resulted in that the timing could not be kept around 5 CAD ATDC.

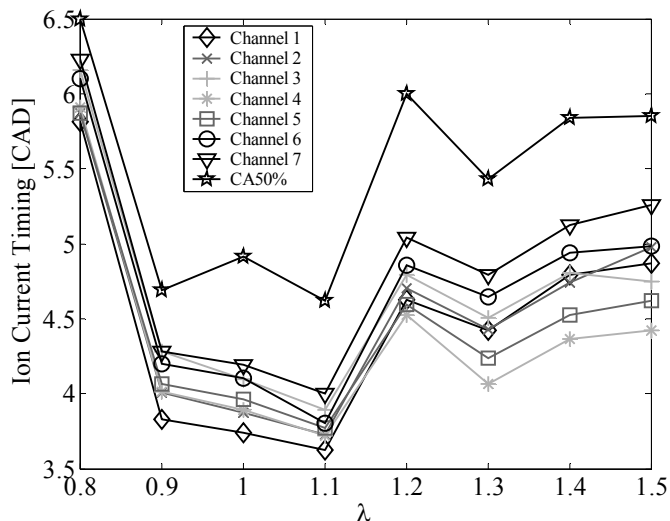

Figure 14. Ion current timing information for a lambda sweep with 40% EGR.

TIMING SWEEP WITHOUT EGR

In Figure 15 the peak ion current amplitudes are shown versus CA50 for a timing sweep from 8 to 0 CAD ATDC. As can be seen the amplitudes increase when the auto-ignition starts earlier in the combustion process [3]. It is however not clear why the amplitude decreases again when CA50 is advanced beyond 1-2 CAD ATDC. A hypothesis was that the maximum gas temperature peaks when CA50 is at 1-2 CAD ATDC, but Figure 16 shows that this is not the case.

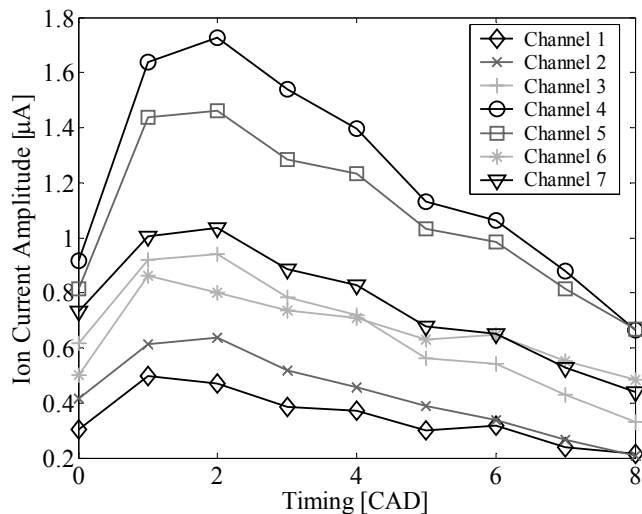

Figure 15. Ion current amplitudes for a timing sweep without EGR.

The most efficient HCCI combustion is achieved when CA50 is at about 1-2 CAD ATDC [7]. This could be an explanation to the peak ion current amplitudes at 1-2 CAD ATDC in the timing sweep, see Figure 15.

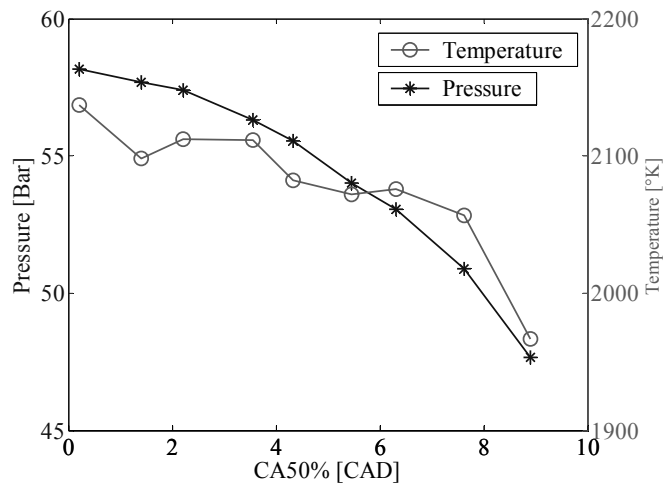

Figure 16. Maximum in-cylinder temperatures and pressures for a timing sweep without EGR.

Figure 17 shows the ion current timing compared to CA50 for the timing sweep from 8 to 0 degrees. As has been seen before there is an almost constant offset between the ion current timing and CA50. Depending on the ion current measuring locations the offset is about 1 to 1.5 degrees to CA50.

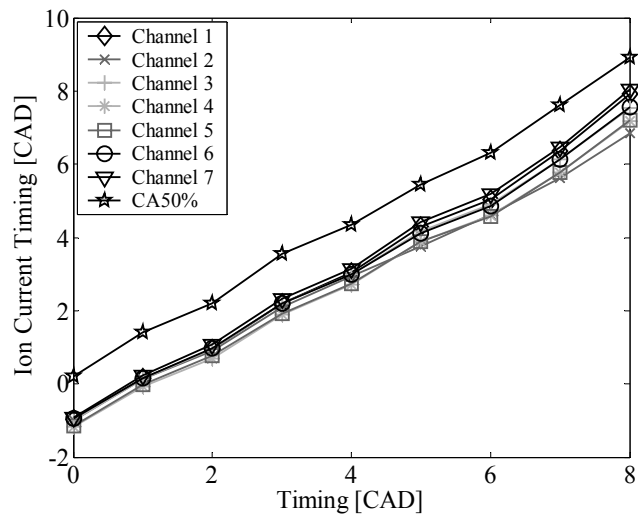

Figure 17. Ion current timing information for a timing sweep without EGR.

CONCLUSION

The ion current timing and amplitude is dependant on the spark plug locations. In these tests where 7 different locations were used a distinctive pattern was observed. The spark plugs were switched to different locations in order to ensure that the variations were not dependent on manufacturing defects or variance in the spark plugs themselves. An explanation to the variations could be that some parts of the combustion chamber are hotter than the rest. This could induce earlier auto-ignition at these locations. Inhomogeneous gas composition could

also affect ion concentration and thus ion current amplitude. Therefore, it is a good idea to find appropriate spark plug locations for adequate signal strength in ion sensor based timing control systems.

Richer mixtures increase the ion current signal strength [3]. When diluting the mixture with EGR the ion current amplitude decreases. Highest ion current amplitudes were achieved at stoichiometric air/fuel ratio. In order to reach these rich mixtures 40% EGR was used. The ion current signal strength is also affected by the auto-ignition timing. Earlier combustion timing increases the signal strength [3] unless CA50 is advanced beyond 1-2 CAD ATDC.

However the ion current timing is not affected by either mixture proportions or EGR. The ion current timing seems to be about 1 to 1.5 CAD ahead of CA50 depending on the spark plug locations.

ABBREVIATIONS

ABDC: After Bottom Dead Center
ATDC: After Top Dead Center
BBDC: Before Bottom Dead Center
BTDC: Before Top Dead Center
CA50: Crank Angle of 50% burned fuel
CAD: Crank Angle Degree
EGR: Exhaust Gas Recycling
HCCI: Homogeneous Charge Compression Ignition
SI: Spark Ignition

REFERENCES

1. Magnus Christensen. *Homogeneous Charge Compression Ignition (HCCI) Engine –Mixture*

Requirements, Engine Load Range and Emission Characteristics. Department of Heat & Power Engineering, Lund 2002

2. Bengt Johansson. *Internal Combustion Engines, part 1 & 2*, Department of Heat & Power Engineering, Lund

3. Petter Strandh, Magnus Christensen, Johan Bengtsson, Rolf Johansson, Andreas Vressner, Per Tunestål, Bengt Johansson. *Ion Current Sensing for HCCI Combustion Feedback*. In SAE 2003-01-3216

4. John Auzins, Hasse Johansson, Jan Nytomt. *Ion-Gap Sense in Misfire Detection, Knock and Engine Control*. In SAE 950004.

5. Jürgen Förster, Achim Günther, Markus Ketterer and Klaus-Jürgen Wald. *Ion Current Sensing for Spark Ignition Engines*. In SAE 1999-01-0204

6. Jan-Ola Olsson, Per Tunestål and Bengt Johansson. *Closed-Loop Control of an HCCI Engine*. In SAE 2001-01-1031

7. Jan-Ola Olsson, Per Tunestål, Jonas Ulfvik and Bengt Johansson. *The Effect of Cooled EGR on Emissions and Performance of a Turbocharged HCCI Engine*. In 2003-01-0743

CONTACT

Andreas Vressner, andreas.vressner@vok.lth.se