



LUND UNIVERSITY

Transient Response Analysis

Åström, Karl Johan

1985

Document Version:

Publisher's PDF, also known as Version of record

[Link to publication](#)

Citation for published version (APA):

Åström, K. J. (1985). *Transient Response Analysis*. (Research Reports TFRT-3177). Department of Automatic Control, Lund Institute of Technology (LTH).

Total number of authors:

1

General rights

Unless other specific re-use rights are stated the following general rights apply:

Copyright and moral rights for the publications made accessible in the public portal are retained by the authors and/or other copyright owners and it is a condition of accessing publications that users recognise and abide by the legal requirements associated with these rights.

- Users may download and print one copy of any publication from the public portal for the purpose of private study or research.
- You may not further distribute the material or use it for any profit-making activity or commercial gain
- You may freely distribute the URL identifying the publication in the public portal

Read more about Creative commons licenses: <https://creativecommons.org/licenses/>

Take down policy

If you believe that this document breaches copyright please contact us providing details, and we will remove access to the work immediately and investigate your claim.

LUND UNIVERSITY

PO Box 117
221 00 Lund
+46 46-222 00 00

CODEN: LUTFD2/(TFRT-3177)/1-143/(1985)

Transient Response Analysis

Karl Johan Åström

Department of Automatic Control
Lund Institute of Technology
September 1985

Department of Automatic Control Lund Institute of Technology P.O. Box 118 S-221 00 Lund Sweden	<i>Document name</i> Report	
	<i>Date of issue</i> September 1985	
	<i>Document Number</i> CODEN: LUTFD2/(TFRT-3177)/1-143/(1985)	
<i>Author(s)</i> Karl Johan Åström	<i>Supervisor</i>	
	<i>Sponsoring organisation</i>	
<i>Title and subtitle</i> Transient Response Analysis.		
<i>Abstract</i> <p>This report gives an overview of transient response measurement techniques. Standard control applications are covered. Particular attention is given to the use of transient response methods in the exploration of flow systems.</p>		
<i>Key words</i>		
<i>Classification system and/or index terms (if any)</i>		
<i>Supplementary bibliographical information</i>		
<i>ISSN and key title</i>		<i>ISBN</i>
<i>Language</i> English	<i>Number of pages</i> 143	<i>Recipient's notes</i>
<i>Security classification</i>		

The report may be ordered from the Department of Automatic Control or borrowed through the University Library 2, Box 1010, S-221 03 Lund, Sweden, Telex: 33248 lubbis lund.

<u>TABLE OF CONTENTS</u>	<u>Page</u>
1. INTRODUCTION	1
2. PULSE TESTING	4
Impulse Response Analysis	4
Nonideal Pulses	6
Pulse Forms	8
Numerical Calculation of Laplace Transforms	10
Integration Formulae	12
Sampling	13
Truncation	16
Aircraft Pitch Dynamics	16
Heat Exchanger Dynamics	20
Exercises	25
3. TANK SYSTEMS - INPUT OUTPUT ANALYSIS	27
Simple Flow Systems	30
An Axiomatic Approach	33
Tracer Propagation in Interconnected Tank Systems	36
The Stewart-Hamilton Equation	43
Volume and Flow Measurements	46
Physiological Applications	50
Industrial Applications	55
Analysis of Mixing Tanks	56
Mixing Efficiency	57
Dynamics of Drying Drum	60
Applications to Ecosystems	61
Exercises	62
4. TANK SYSTEMS - INTERNAL STRUCTURE	67
Formal Description of Tank Systems	68
Flow Systems	71
Eigenvalues	74

Symmetric Systems	78
Catenary Systems	79
Cyclic Systems	81
Mammillary Systems	83
The Transition Matrix and the Impulse Response	86
Identifiability	90
Catenary Systems	95
Mammillary Systems	97
Compartment Analysis	99
Pharmacokinetics	104
Exercises	113
5. SUMMARY	115
6. ACKNOWLEDGEMENTS	117
7. NOTES AND REFERENCES	118
APPENDIX A - Proof of Theorem 4.6	
APPENDIX B - Proof of Theorem 4.7	

1. INTRODUCTION.

In the frequency response method the value of the transfer function of the process for one frequency was determined from the steady state response to a sinusoidal input. To apply the method it is thus necessary to wait until steady state conditions are obtained. If the values of the transfer function for several frequencies are required, it is also necessary to repeat the experiment for each frequency desired. The basic idea of the transient response method is instead to determine the dynamics from the transient response to an input signal. If the input signal is sufficiently rich in frequencies, the values of the transfer function for many frequencies can then be determined from one experiment. There are many possible choices of input signals. The simplest case is when an impulse is chosen. The output is then simply the impulse response or the weighting function of the process. This particular method is therefore often called impulse response analysis. It is clearly a nonparametric method.

Since perfect impulses are not realizable, various approximations like rectangular, triangular or sinusoidal pulses are often used in practice. It is also possible to use other input signals like step functions, Jensen's multi-frequency signal, a pseudorandom binary signal or an arbitrary signal. When using such inputs much of the simplicity of the impulse response method is lost because it is then necessary to use deconvolution in order to obtain the impulse response or numerical fourier transformation to obtain the transfer function.

Simplicity and short experimentation time are the major advantages of the transient response method.

The major drawbacks are that the method is fairly sensi-

tive to disturbances and that there are few synthesis methods that operate directly on the impulse response.

For these reasons transient response analysis is often used for diagnostics rather than synthesis. The method is also frequently used for exploratory studies. Since the method is nonparametric, it is not necessary to make any assumptions regarding the magnitude of possible time delays, the order of the system, etc. The method is therefore very valuable in order to obtain the gross characteristic of the dynamics of a system before using more precise parametric methods which require more a priori assumptions. Transient response analysis is also useful in order to obtain guidelines for choice of input signals and sampling rates for other identification methods.

The chapter is organized as follows. Pulse methods are discussed in Section 2. This section includes impulse response analysis, selection of pulse forms and a brief discussion of numerical Laplace transformation. This is needed both to compute the transfer function from the measured impulse response and in order to do the necessary deconvolution when the pulses are not short in comparison with the time constants of the system. Applications to determine dynamics of an aircraft and a heat exchanger are also given.

There are many specialized measuring techniques which are based on impulse response measurements. In particular it is possible to determine volumes and flows in a system of interconnected tanks by the so-called Stewart-Hamilton equation. This approach is described in Section 3. To provide the necessary background the propagation of a tracer in a tank system is also investigated. It turns out that the tracer propagation can be characterized as a linear dynamical system with nonnegative impulse response, having

a unit area. Such systems are called flow systems. The special properties of such systems are also explored in Section 3. The resulting measuring techniques, which are nonparametric, are discussed together with industrial and physiological applications.

In Section 4 finally we analyse state models of flow systems. This gives parametric models. Possibilities to determine parameters of such models from impulse response measurements are also explored. This leads to a problem of parametric identifiability. The applications include compartment models and pharmacokinetics.

2. PULSE TESTING.

When determining the dynamics of a process using pulse testing the input signal is chosen as a pulse, i.e. a signal which is different from zero for a finite time only. The input and the output are recorded and the process dynamics is obtained by analysing these signals.

Impulse Response Analysis.

The simplest case of pulse testing is obtained when the input is chosen as an impulse or a delta-function. If the system is at rest at the start of the experiment the output obtained is the impulse response. Impulse response analysis is thus a direct measurement of the impulse response of the process.

It is instructive to see how this scheme fits into the general problem formulated in Chapter 2. The class of models is thus the class of all linear, time invariant systems characterized by their impulse response. The inputs are chosen as impulses (δ - functions or distributions). The criterion could be to minimize

$$v = \int_0^{\infty} [y(t) - y_m(t; x_0)]^2 dt \quad (2.1)$$

where $y_m(t; x_0)$ is the output of the model whose impulse response is h and whose initial state is x_0 .

If the class of models include linear systems with arbitrary impulse responses, the optimization problem has the solution

$$y_m(t, x_0) = y(t) \quad (2.2)$$

Notice that there is no fitting involved. The impulse response is equal to the measured output. The criterion (2.1) is equal to zero. Errors in the output will directly show up as errors in the impulse response. The only possibility to reduce errors is to repeat the experiment.

Also notice that

$$y_m(t; x_0) = h(t) + h_0(x_0; t) \quad (2.3)$$

where h is the impulse response and $h_0(x_0; t)$ is the free response of the model when the initial condition is x_0 . For finite dimensional systems we have in particular

$$h(t) = Ce^{At}B$$

$$h_0(x_0; t) = Ce^{At}x_0$$

All models such that

$$h(t) + h_0(x_0; t) = \tilde{h}(t) + \tilde{h}_0(\tilde{x}_0; t) \quad (2.4)$$

Will thus be equivalent in the sense that the equation (2.1) is satisfied. The identification problem thus will not have a unique solution unless the experimental conditions are such that the initial state of the process is zero. This is a very serious restriction. Notice that it follows from (2.4) that nonzero initial state does not introduce any new modes. The weighting of the modes will, however, be influenced by the initial state. In practice the output can be observed over a finite interval only. This means that the tail of the impulse response is often badly estimated.

Nonideal Pulses.

In practice it is seldom possible to introduce a perfect impulse into a system. It is thus natural to ask how the result is influenced by inputs which are not perfect impulses. Assuming zero initial conditions the output is given by

$$y(t) = \int_{-\infty}^t h(t-s)u(s)ds = \int_0^{\infty} h(s)u(t-s)ds = (h*u)(t) \quad (2.5)$$

where $h*u$ denotes the convolution of the functions h and u .

The estimated impulse response is thus the convolution of the impulse response and the input. In the particular case when

$$u(t) = \begin{cases} \frac{1}{T} & 0 < t < T \\ 0 & t > T \end{cases}$$

The output becomes

$$\hat{h}(t) = \frac{1}{T} \int_{t-T}^t h(s)ds$$

If the output is taken as an estimate of the impulse response the estimate at time t is thus the mean value of the correct impulse response over the interval $(t-T, t)$. For other pulse forms, h is instead a weighted mean of the true impulse response where the weighting is given by the actual pulse form. It is thus easy to visualize, estimate and compute the effect of pulses that are not perfect. A good rule of thumb is that the pulse width T , or the support of the pulse, should be chosen so short that the impulse response does not change significantly

over an interval of length T . To use this rule it is necessary to know the impulse response at least approximately. In practice it is therefore necessary to make several experiments using different pulse widths.

In Fig. 2.1 it is illustrated how the estimated impulse response is gradually distorted with increasing pulse width.

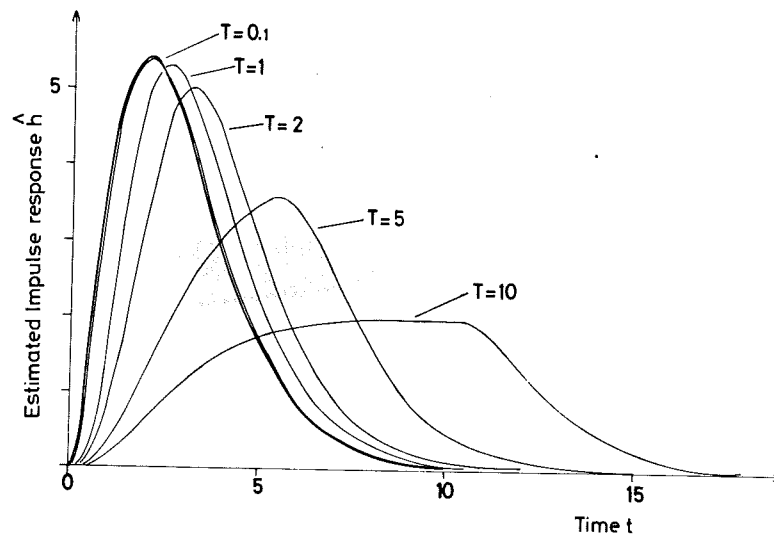

Fig. 2.1 - Illustrates the distortion of the impulse response estimate obtained when a rectangular pulse is used instead of an ideal pulse. The impulse response of the system is $h(t) = 10t^2 \exp - t$ and the pulse width is 1, 2, 5 and 10s. For a pulse width of 0.1s the distortion is not noticeable in the graph.

Pulse Forms.

Equation (2.5) holds for any input signal and the impulse response can thus be determined from the output generated by an arbitrary input by solving the integral equation (2.5) with respect to h . Since (2.5) is a convolution the problem is often referred to as the deconvolution problem. Assuming that the integral in (2.5) is computed by a rectangular approximation we find

$$y(nT) = \sum_{k=0}^{\infty} h(kT)u(nT-kT)T$$

The impulse response is then obtained from the following infinite set of algebraical equations

$$y(0) = Th(0)u(0)$$

$$y(t) = T[h(0)u(t) + h(t)u(0)]$$

$$y(2T) = T[h(0)u(2T) + h(T)u(T) + h(2T)u(0)]$$

⋮

These equations are readily solved recursively. The method can easily be improved by using better approximations of the integral. Notice, however, that no matter which approximation is used the result will be very sensitive to the basic assumption that the output was zero for $t < 0$ and that the system was initially at rest. Due to the structure of the equations an error in $y(0)$ will propagate to all estimates of $h(kT)$.

The deconvolution problem can also be solved by Laplace transformation.

Introduce

$$Y(s) = L\{y\}(s) = \int_0^{\infty} e^{-st} y(t) dt \quad (2.6)$$

The Laplace transform H of the impulse response h is then given by

$$H = \frac{L\{y\}}{L\{u\}} \quad (2.7)$$

To determine the impulse response it is thus necessary to compute the Laplace transforms of the process input and the process output numerically. The transfer function is then given by (2.7) and the impulse response is obtained by numerical inversion of the Laplace transform. For control system design it is often more convenient to work with the transfer function than to work with the impulse response and the inverse transform can therefore sometimes be avoided. Much of the simplicity of the impulse response method is, however, lost.

The selection of pulse shape is a compromise between several factors. The important considerations are pulse area and pulse width. It is desirable to have a large pulse area to get a good signal to noise ratio. The pulse area must, however, not be chosen so large that the process is driven into a nonlinear region. For processes with rate limitations it is for the same reason important to have a smooth pulse. Examples of simple pulses which have been found useful are shown in Fig. 2.2. The magnitudes of the Laplace transforms of the pulses are also shown in the same figure. Additional examples are given in the sections on aircraft pitch dynamics and heat exchanger dynamics. The input signal must also have proper spectral properties

because the formula (2.7) will give good estimates only for those frequencies for which the system is excited by the input signal. Since the impulse has the property $L\{\delta\} = 1$ it will excite all frequencies equally. The other pulses shown in Fig. 2.2 have large transforms for $\omega T < 2\pi$ only. Using a rectangular pulse with a width of 1 s it is not possible to get good estimates of the transfer function for frequencies above 6 rad/s. The useful frequency range is somewhat extended by choosing a triangular pulse or a displaced cosine pulse.

If Laplace transforms are computed it is not necessary to restrict the input to be a pulse. In many cases other inputs are more efficient. A detailed discussion of the selection of inputs is given in Chapter 10.

Numerical Calculation of Laplace Transforms.

Laplace transformation was one possibility to solve the deconvolution problem. Laplace transforms are also required in order to determine the transfer function from a measured impulse response. This is required for control system design because many design methods are based on knowledge of the transfer function. Numerical calculation of Laplace transforms will therefore be discussed. Since the Laplace transform is analytic for $\text{Re } s \geq s_0$ it is sufficient to know the transform in a dense set. The values for arbitrary arguments can then be obtained through analytic continuation. Having control applications in mind it is natural to evaluate the transform for arguments on the imaginary axis in the s -plane.

Numerical evaluation of Laplace transforms is a badly conditional numerical problem because the Laplace transform

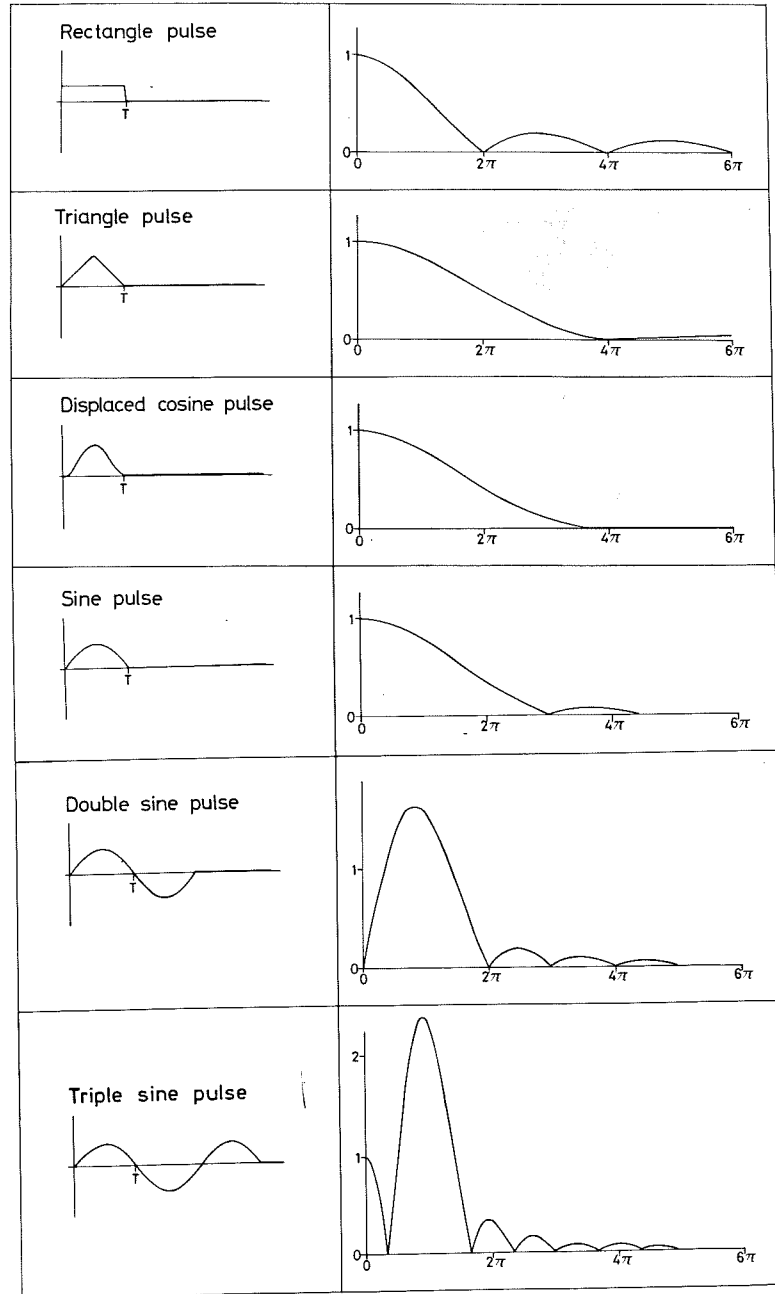

Fig. 2.2 - Examples of simple input signals used in pulse testing. The magnitudes of the Laplace transforms of the pulses are shown to the right of the pulses.

is an unbounded operator in the space of bounded functions. Compare Chapter 2. To compute the transform of pulse responses obtained from process experiments the following facts must be considered.

- o Choice of integration formula.
- o Choice of sampling intervals for discretization.
- o Truncation of the integration interval.

It is not our intention to give a detailed discussion of numerical inversion of Laplace transforms but to give examples of difficulties that may arise.

Integration Formulae.

Assume that the values of the signal y are available at equally spaced times $0, T, 2T, \dots$. The simplest way to evaluate the integral (2.6) is to approximate the integrand by a piecewise constant function. This gives the well-known formula for rectangular approximations

$$I_1(\omega) = \sum_{n=0}^{\infty} T y(nT) e^{-i\omega nT} \quad (2.8)$$

Observing that the integral (2.6) can be evaluated exactly if the function y is a polynomial on each interval $(nT, (n+1)T)$ more refined formulae can be obtained. If y is linear over each interval, the following result is obtained.

$$I_2(\omega) = Y_0(\omega) + \frac{2(1-\cos \omega T)}{\omega^2 T} \sum_{n=1}^{\infty} y(nT) e^{-i\omega nT}$$

$$Y_0(\omega) = y(0) \frac{1}{\omega^2 T} [(1-\cos \omega T) - i(\omega T - \sin \omega T)] \quad (2.9)$$

This formula is a special case of a general class of integration formulae by Filon () for integrals of trigonometric functions. Similar equations can also be derived when the measurements are not equally spaced in time or if the output is a polynomial.

Sampling.

The fact that function values are available at discrete times only has striking effects on the transform computed by (2.7) or (2.9). It follows from (2.8) that

$$I_1(\omega + \omega_s) = I_1(\omega) \quad \omega_s = 2\pi/T$$

The function I_1 is thus periodic with period $\omega_s = 2\pi/T$. If $y(0) = 0$ the function I_2 will vanish at $\omega_s, 2\omega_s, \dots$. It is thus clear that the equations (2.8) and (2.9) give very bad estimates of the Laplace transform for $|\omega| > \omega_s/2$. This is a consequence of the Shannon sampling theorem which is stated without proof.

Theorem 2.1.

Consider a signal whose Fourier transform has the support $(-\omega_0, \omega_0)$. Let the signal be sampled at arguments with a constant spacing T . A necessary and sufficient condition that the signal can be reconstructed from its sampled version is that $T < \pi/\omega_0$.

The frequency $\omega_s/2 = \pi/T$ is called the Nyquist frequency.

The effect of sampling is illustrated by the following example.

Example 2.1.

Consider the function

$$y(t) = te^{-t}$$

whose graph is shown in Fig. 2.3. To exaggerate the effects due to sampling the sampling intervals are chosen as $T = 0.2\pi$ and $T = 0.4\pi$. See Fig. 2.3. A much shorter sampling interval would be chosen in practice.

Fig. 2.4 shows the Laplace transform of the function evaluated by (2.8) and (2.9) for the two different sampling intervals. The periodicity of I_1 is apparent. The superiority of the formula (2.9) is also apparent, as well as the necessity of selecting the sampling interval properly with respect to the frequency range of interest. Shannon's sampling theorem gives $\omega T < \pi$. Common rules of thumb are $\omega T < \pi/4$ for (2.8) and $\omega T < 3\pi/4$ for (2.9).

□

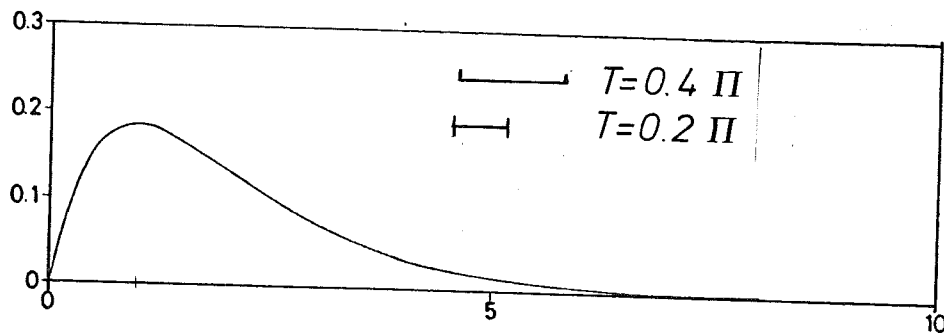

Fig. 2.3 - Graph of the function $y(t) = t \exp -t$.

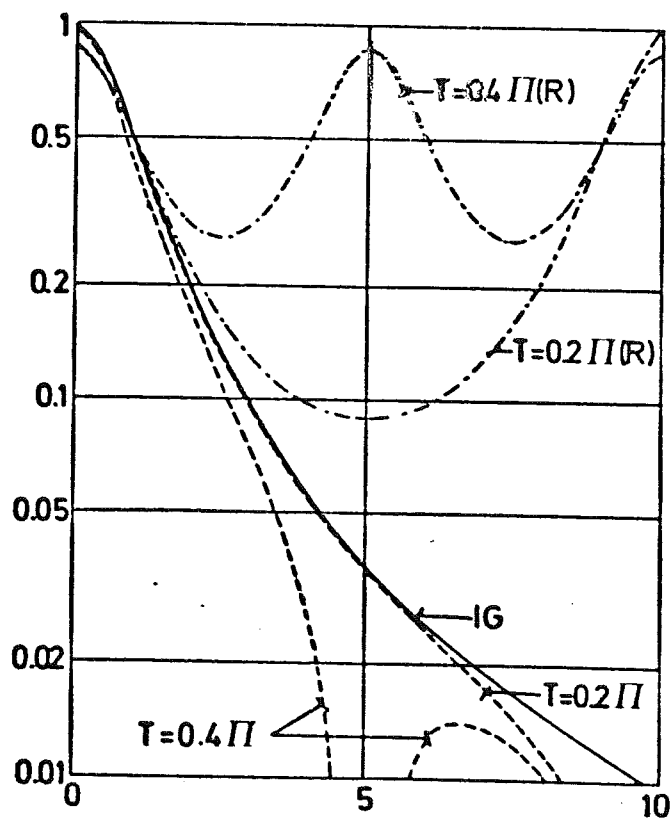

Fig. 2.4 - The magnitude of the Fourier transform of the function $t \exp -t$ evaluated by the equations (5.4) and (5.5) using different sampling intervals.

Truncation.

When a pulse response is measured it is never available for the whole interval $(0, \infty)$. The infinite series (2.8) and (2.9) must therefore be truncated. If the process is stable the pulse response will go to zero and the truncation interval is chosen so long that the output is negligible. Some care must, however, be exercised because it is well-known from the theory of trigonometric series that truncation may lead to an oscillatory behaviour of the truncated series. The effect is often referred to as Gibb's phenomenon. The effects of truncating the series for the Laplace transforms of the function $t e^{-t}$ are illustrated in Fig. 2.5.

Notice that $N = 16$ corresponds to truncation of the output for $t = 5.03$. See Fig. 2.4. For $N = 32$ which corresponds to a truncation at $t \approx 10$ there is no noticeable effect due to truncation.

Aircraft Pitch Dynamics.

Transient response analysis has been applied to determine aircraft dynamics since 1948. The method is now a standard technique used in flight testing. When performing the experiment the aircraft is flown on straight course in level flight. It is attempted to do the tests during nice weather when there are few disturbances from air turbulence. The trim of the aircraft is adjusted so that the aircraft is in stationary conditions. A pulse command is then given and the resulting motion of the aircraft is observed. The data given in the following are based on Smith and Triplett (1953).

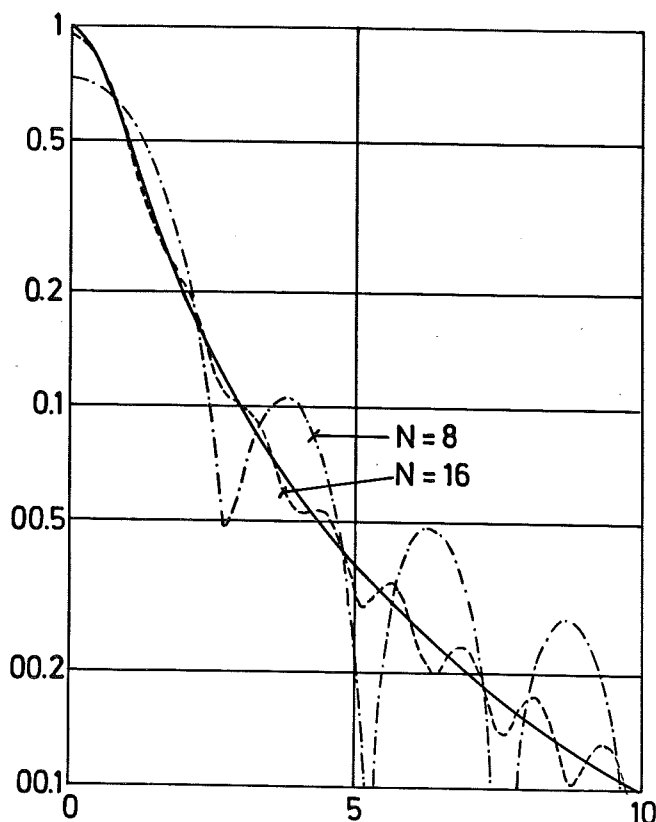

Fig. 2.5 - The effect of truncation of the series (2.9) when evaluating the Laplace transform of the function $y(t) = t \exp - t$. The sampling interval used was $T = 0.1\pi$.

Fig. 2.6 shows the elevator deflection and the corresponding response in pitch rate obtained in one experiment. It is clear from the figure that the signal to noise ratio is very high under the given experimental conditions. It is also clear from Fig. 2.6 that the pulse duration is not so short that the output can be considered as the impulse response. If nonlinearities are to be avoided it is not possible to use rudder angles above 10° . There are thus no margin for increasing the pulse amplitude. Since the pulse width is about 0.4 s and the pulse is smooth, reasonable estimates of the transfer function can be expected up to a frequency of about 15 rad/s. If the pulse width is decreased the signal to noise ratio will also decrease.

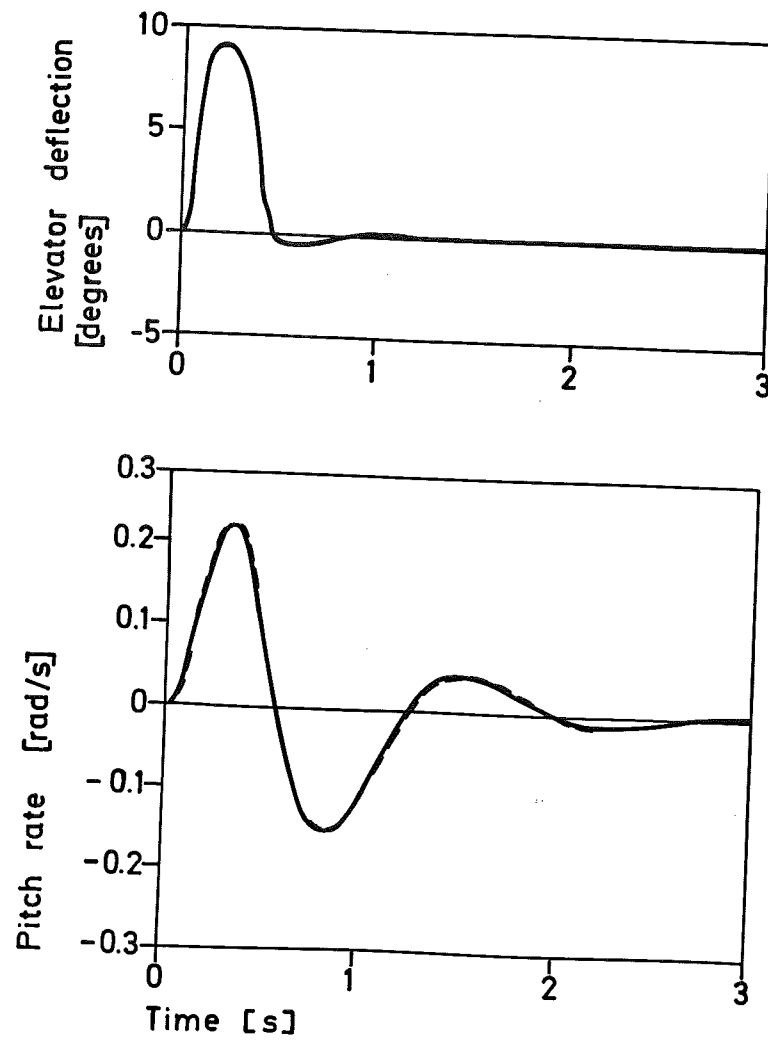

Fig. 2.6 - Elevator deflection and response in pitch rate obtained in pulse experiment designed to determine aircraft pitch dynamics.

To determine the transfer function the input-output signals shown in Fig. 2.6 were sampled manually at 0.05s intervals. The Laplace transforms were computed using Filon's formula (2.9). The output was truncated for $t = 3.5s$. The transfer function obtained is shown in Fig. 2.7.

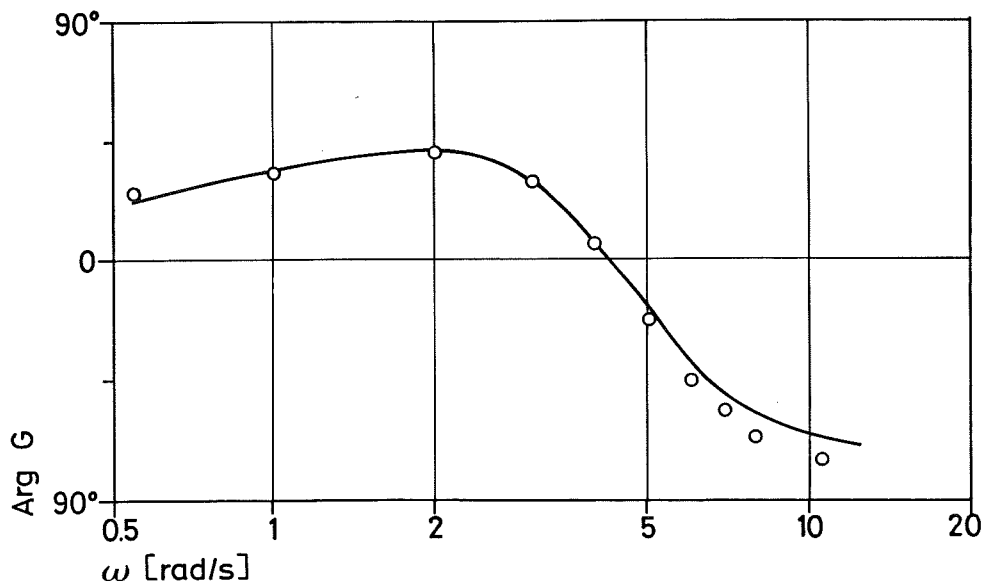

Fig. 2.7 - Bode diagram of transfer function relating pitch rate to elevator angle obtained by numerical Laplace transformation of data of Fig. 2.6.

For control system analysis and design it is convenient to have analytical expressions for the transfer function. In the particular case Smith and Triplett (1953) fitted a rational function to the estimated transfer function. For the data shown in Fig. 2.7 the following result was

obtained

$$G(s) = \frac{9.16 + 9.52s}{s^2 + 3.35s + 22.1}$$

The Bode diagram for this transfer function is also shown in Fig. 2.7.

Heat Exchanger Dynamics.

Transient response analysis has been used extensively to determine the dynamics of industrial processes. Determination of heat exchanger dynamics will be discussed as a typical example. This example is based on Lee and Hougen (1956).

A schematic diagram of the process is shown in Fig. 2.8.

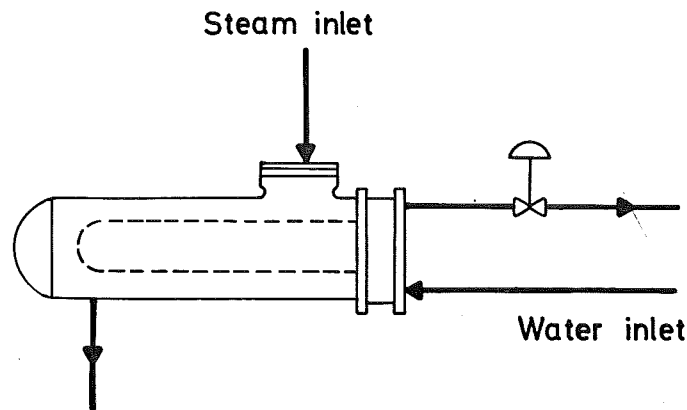

Fig. 2.8 - A schematic diagram of the heat exchanger studied by Lees and Hougen.

The heat exchanger is of the tube and shell type. It consists of twenty-two V-shaped copper tubes inclosed in a shell. Water passes through the tubes and is heated by steam in the shell. The water inlet temperature was about

13°C and the outlet temperature about 57°C. The water flow through the tubes is considered as the input and the water temperature at the outlet is the process output.

In the experiment a pulse from a specially designed pulse generator was fed to the valve motor. The valve position and the outlet temperature were recorded using a two-channel recorder. A pulse amplitude corresponding to displacement of the valve stem of 1 mm was used. This is only a fraction of the maximum valve displacement of 16 mm. A record of the results of one experiment is shown in Fig. 2.9.

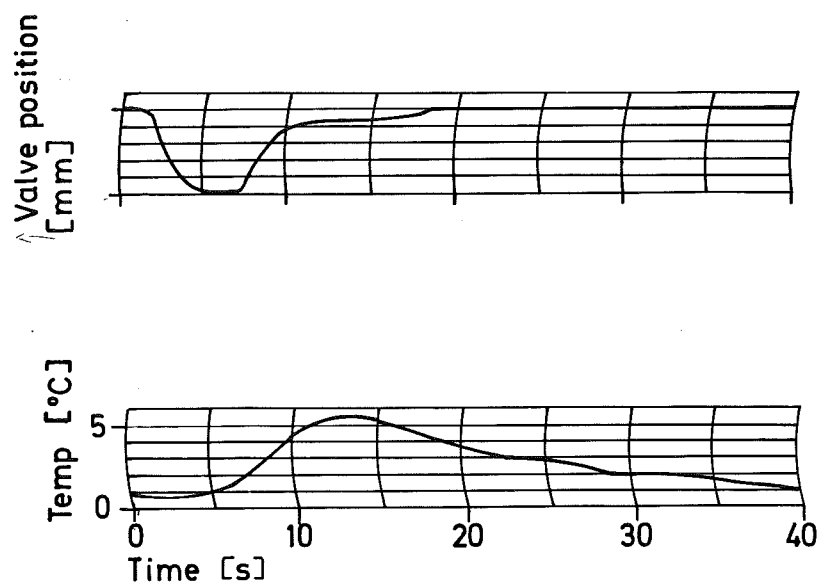

Fig. 2.9 - Results of an impulse response analysis of a heat exchanger.

Fig. 2.9 shows clearly that the pulse width is so large that the output is not equal to the impulse response. It is thus necessary to use deconvolution to obtain the transfer function of the system. To do this the recorded inputs and outputs were sampled manually.

About 100 points were used for the temperature curve in Fig. 2.9, and 60 points were used for the valve position. The Laplace transform of the input and the output were computed using the equation (2.9), and the transfer function was determined from (2.7). The calculated transfer function is shown in Fig. 2.9. The results of the impulse response measurement were also compared with the results of a direct measurement of the frequency response using the techniques discussed in Chapter 3. The results of these measurements are also shown in Fig. 2.9. Notice the remarkable good agreement between the results. The time required to perform the impulse response was significantly shorter than the time required to do the frequency response measurement.

Hougen applied impulse response analysis to many industrial processes and found the method to be easy to use. The results were generally quite good in the cases where there were small disturbances, as was the case for the heat exchanger. The accuracy of the results obtained from an impulse response measurement will, however, be of limited accuracy. This is illustrated by the following example.

Example 2.2.

Consider a linear system with the transfer function

$$G(s) = \frac{1}{(s+1)^2}$$

Assume that the impulse response is measured, and that an error of a magnitude a is made in determining the level of the output. Then the estimated transfer function becomes

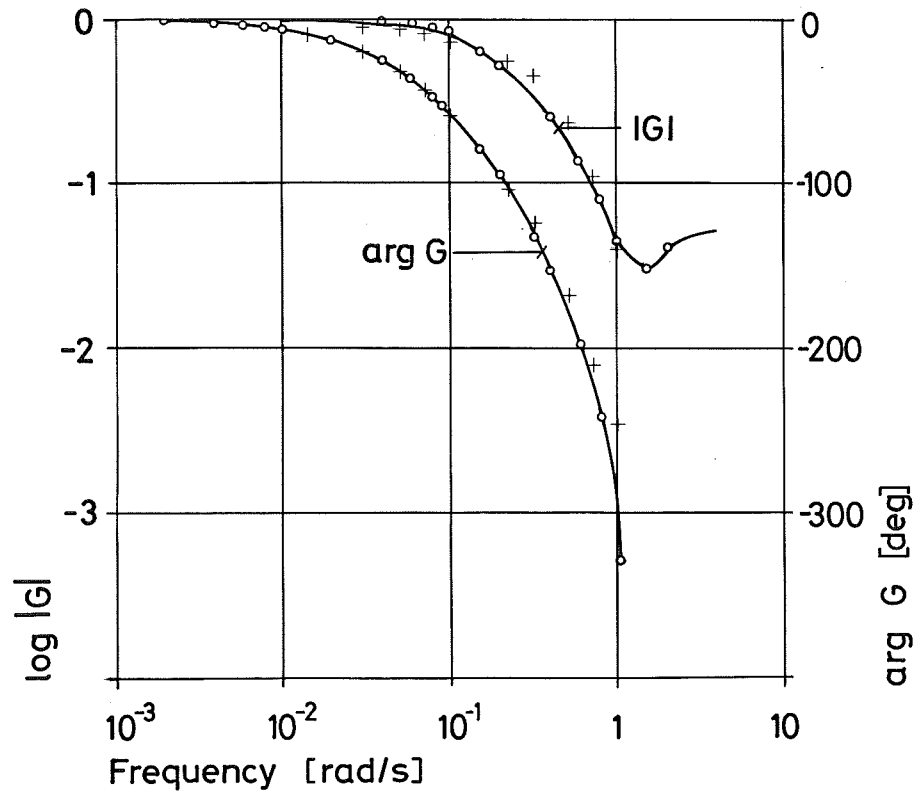

Fig. 2.10 - Bode diagram of the transfer function of the heat exchanger. The values computed from the pulse test are marked with o and the results of the direct frequency response measurement with +.

$$\hat{G}(s) = \frac{1}{(s+1)^2} + \frac{a}{s}$$

The Bode diagram of the estimated transfer function is shown in Fig. 2.11. It is clear that the estimate is very poor both at low frequencies and at high frequencies.

□

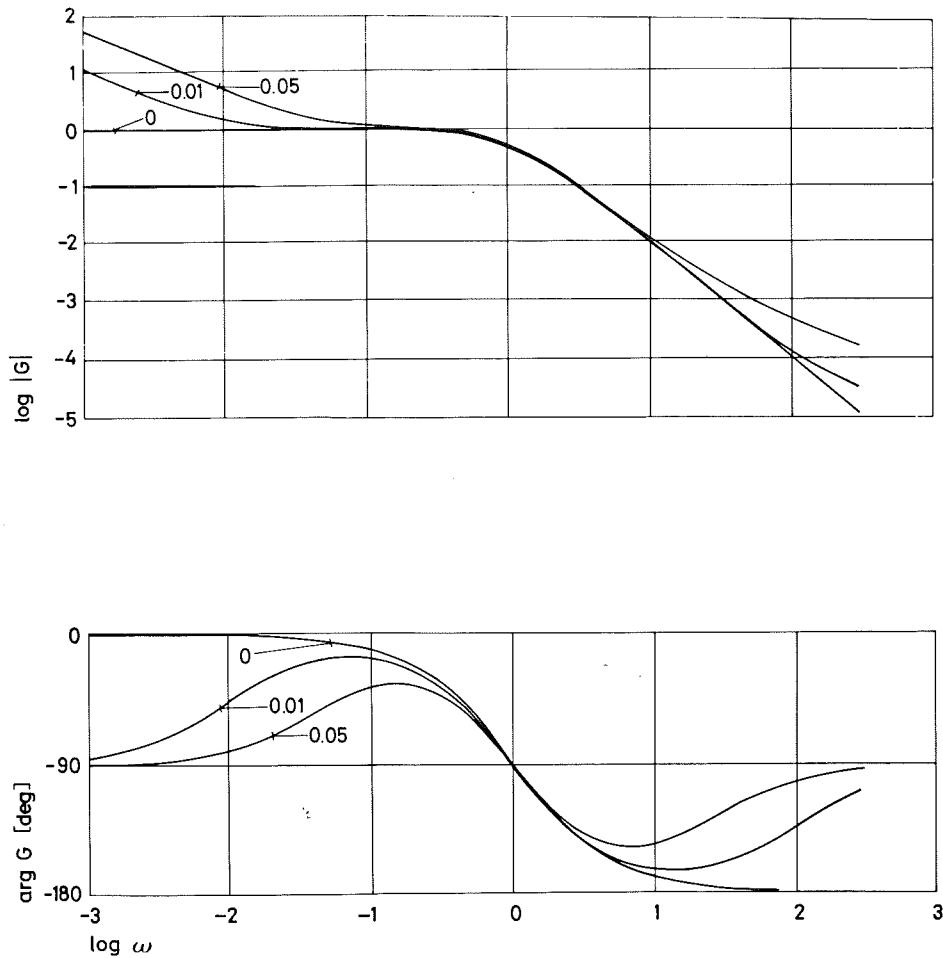

Fig. 2.11 - Bode diagram of the transfer function

$$G(s) = \frac{1}{(s+1)^2} + \frac{a}{s}$$

for $a = 0, 0.01$ and 0.05 . The graph illustrates the errors obtained if an error a is made when determining the transfer function using impulse response analysis.

Considering the curves of Fig. 2.9 it is not unreasonable to have an error in the DC level of the output of some per cent. Since an error in the level of the output signal is so significant the measured output is usually "fudged" to ensure that the level is zero before the Laplace transform is computed. The "fudging" is sometimes glorified by the name of "closing the output curve".

Exercises.

1. Show that the Laplace transforms of the pulses shown in Fig. 2.2 have the following magnitudes:

$$|Y(i\omega)| = \frac{2}{\omega T} \left| \sin \frac{\omega T}{2} \right| \quad \text{rectangular pulse}$$

$$|Y(i\omega)| = \frac{8}{(\omega T)^2} \left(1 - \cos \frac{\omega T}{2} \right) \quad \text{triangular pulse}$$

$$|Y(i\omega)| = \frac{4\pi^2}{|4\pi^2 - (\omega T)^2|} \cdot \frac{2}{\omega T} \left| \sin \frac{\omega T}{2} \right| \quad \text{displaced cosine pulse}$$

$$|Y(i\omega)| = \frac{\pi^2}{|\pi^2 - (\omega T)^2|} \left| \cos \frac{\omega T}{2} \right| \quad \text{half period sine pulse}$$

$$|Y(i\omega)| = \frac{\pi^2}{|\pi^2 - (\omega T)^2|} \left| \sin \omega T \right| \quad \text{double sine pulse}$$

$$|Y(i\omega)| = \frac{\pi^2}{|\pi^2 - (\omega T)^2|} \left| \cos \frac{3\omega T}{2} \right| \quad \text{triple sine pulse}$$

2. Assume that the output in an impulse response measurement is measured with an error $e(t)$. Show that the corresponding error in the transfer function can be estimated by

$$|E(i\omega)| \leq \min \left[\int_0^{\infty} |e(t)| dt, \frac{1}{\omega} \int_0^{\infty} |\dot{e}(t)| dt \right]$$

In particular show that the error due to a rectangular pulse of amplitude a and length T is bounded by

$$|E(i\omega)| \leq \min[aT, 2a/\omega]$$

3. Step functions are sometimes used in transient response analysis. Let y be the measured output. Show that the estimated transfer function is given by

$$G(s) = sL\{y\}$$

Assume that there is an error e in the measured output. Show that the corresponding error in the transfer function can be estimated by

$$|G(i\omega)| \leq \min \left[\omega \int_0^{\infty} |e(t)| dt, \int_0^{\infty} |\dot{e}(t)| dt \right]$$

In particular if the error is a pulse of area A and peak a show that the error can be estimated by

$$|G(i\omega)| \leq \min[\omega A, a]$$

Exact expressions for specific pulse forms are computed by Unbehauen (). They show good agreement with the estimate given above.

3. TANK SYSTEMS - INPUT OUTPUT ANALYSIS.

A collection of tanks connected by pipes is called a tank system. See Figure 3.1. This section will be devoted to a study of such systems through impulse response analysis. Throughout the section it will be assumed that the tank system is in equilibrium i.e. that the flows and volumes are constant.

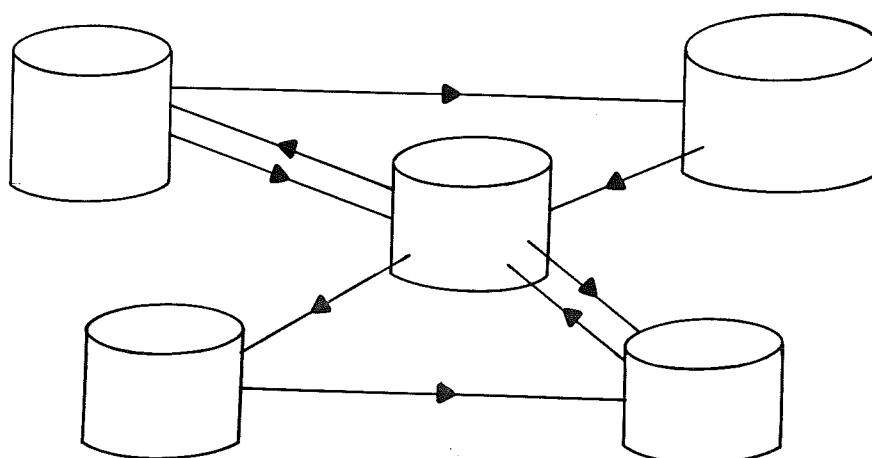

Fig. 3.1 - Schematic diagram of a tank system.

Tank systems are common in industry. They have also been extensively used as models for biological and ecological systems. It is frequently of interest to determine the flows in the pipes and the volumes of the tanks. It is also of significant interest to know if the flow penetrates all parts of the tanks and to know the mixing conditions. Many of these problems can be resolved by impulse response analysis. The basic idea is very simple. A traceable substance, which propagates through the system in the same way as the fluid, is introduced at some point of the system. The tracer concentration at another point in the system is then measured. The key problem is then to analyse what properties of a tank system that can be found from

such an experiment. The technique may appear as a very indirect way to determine volumes and flows at least when a physical tank system like the one shown in Figure 3.1 is considered. However, in many physiological systems the tank system is simply used as a mathematical model of the real system. The tanks and flows are not directly accessible and the proposed method is then one of the few tools available. Flow measurement by impulse response analysis is in fact a technique that is used daily for flow measurements in many hospitals.

The tracer can be of many different forms. It can be a colour, which can be followed optically or by eye, it can be an electrolyte, which can be traced by conductivity measurements. Radioactive tracers are often very convenient because the flow particles themselves can be tagged and the tracer can easily be measured externally without interfering with the system.

To analyse if volumes, flows and mixing conditions in a tank system can be determined from a tracer experiment it is necessary to study the propagation of a tracer through a tank system and to find out how the tracer propagation is influenced by the properties of the tank system. It will be shown that the tracer propagation can be described as a linear time invariant dynamical system. The dynamical systems describing tracer propagation have, however, some special properties which motivates that they are given a special name flow systems. The impulse response of a flow system is nonnegative which reflects the fact that the tracer concentration is never negative. Moreover, if the tanks system is open which means that all tanks are connected to an outlet (possibly indirectly through other tanks) all tracer will eventually leave the system. The corresponding open flow systems then have the property that the integral of the impulse response is unity.

Open flow systems will be investigated in this section. They have many interesting properties which have largely been found in connection with impulse response analysis of tank systems. The results are widely scattered in literature. Important contributions are found both in engineering and medical literature. In this section an attempt is made to present a unified approach.

Two simple examples corresponding to a tank with pure mixing and a tank with pure plug flow are first investigated. It is shown that there are several ways to determine the volumes and flows of such simple systems from impulse response measurements. A formal definition of an open flow system is then given and interconnections of open flow systems are introduced. The so called Stewart-Hamilton equation which can be used to determine the total volume of an open tank system is then derived. The volume obtained is the part of the volume which participates in the flow also called the volume of distribution. Application of impulse response analysis to determine flows and volumes are then discussed. The section ends with examples of applications in physiology, industry and ecology.

Simple Flow Systems.

Simple examples of flow systems will now be discussed.

Example 3.1 (Ideal mixing).

Consider a tank with volume V and constant inflow and outflow q (volume flow). See Fig. 3.2. Assume that there is perfect mixing in the tank and that the fluid is not compressible.

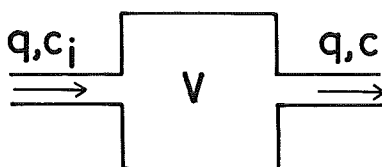

Fig. 3.2 - Schematic diagram of a simple flow system with perfect mixing. The inflow q equals the outflow. The concentration of the inflow is c_i and that of the outflow is c .

Let c_i be the concentration of a tracer in the inflow and c the tracer concentration in the tank and at the outflow. A mass balance for the tracer gives

$$V \frac{dc}{dt} = q(c_i - c) \quad (3.1)$$

The propagation of the tracer through the system can thus be described as a linear time invariant dynamical system (3.1).

The input output relation is

$$c(t) = \int_{-\infty}^t h(t-s) c_1(s) ds = \int_0^{\infty} c_1(t-s) h(s) ds$$

where the impulse response h is given by

$$h(t) = \left(\frac{q}{V} \right) e^{-qt/V} \quad (3.2)$$

The corresponding transfer function is

$$H(s) = \int_0^{\infty} e^{-st} h(t) dt = \frac{1}{1 + sV/q} \quad (3.3)$$

□

Example 3.2 (Pure transport or plug flow).

Consider a pipe where there is a pure material transport with uniform velocity and no mixing. Let the volume of the tube be V and the flow q . Let c_i denote the concentration of some substance in the inlet and c the concentration of the same substance at the outlet. The concentrations are related by

$$c(t) = c_i(t - V/q) \quad (3.4)$$

and the impulse response of the system becomes

$$h(t) = \delta(t - V/q) \quad (3.5)$$

where δ is the Dirac delta function. The transfer function of the system is

$$H(s) = e^{-sV/q} \quad (3.6)$$

□

For a tank with ideal mixing and for a pipe with pure plug flow we find that the propagation of a tracer through the system can be described by a linear time invariant dy-

namical system. In both cases the impulse responses of the systems have the properties

$$h(t) \geq 0 \quad (3.7)$$

$$\int_0^{\infty} h(t) dt = H(0) = 1 \quad (3.8)$$

and

$$\int_0^{\infty} th(t) dt = -V/q \quad (3.9)$$

The equation (3.7) means that the tracer concentration is never negative and the equation (3.8) implies that all tracer will finally leave the system. If the impulse response is measured by injecting a tracer in the inlet and measuring the tracer concentration in the outlet the volume to flow ratio V/q can thus be determined from the equation (3.9) both for an ideal mixing tank and for a pipe with pure plug flow.

For a tank with perfect mixing the volume to flow ratio can also be determined from the equation

$$V/q = h(0) \quad (3.10)$$

which is obtained by putting t equal to zero in (3.2). It also follows from (3.2) that

$$\log h(t) = -qt/V + \log(V/q) \quad (3.11)$$

The ratio V/q can thus also be determined by plotting h on a semi-logarithmic paper and evaluating the slope. Notice, however, that the equations (3.10) and (3.11) are only valid for tanks with ideal mixing while the

equation (3.9) holds both for ideal mixing and for pure plug flow.

An Axiomatic Approach

After the introductory examples the theory of flow systems will now be developed systematically. The analysis will be carried out for systems with one inlet and one outlet. There are, however, no difficulties to extend the results to more general situations. In analogy with the simple examples the systems will be characterized by their impulse responses. Introduce axiomatically

Definition 3.1.

A single-input single-output time invariant linear system is called a flow system if the impulse response has the property

$$h(t) \geq 0 \quad (3.12)$$

It is called an open flow system if the impulse response also has the property

$$\int_0^{\infty} h(t) dt = 1 \quad (3.13)$$

□

Interpreting an open flow system as the dynamical system which describes the propagation of a tracer through a collection of tanks in flow equilibrium the condition (3.12) simply implies that the tracer concentration in the outlet will never be negative. An alternative statement is that the step response of the system is non-de-

creasing. The condition (3.13) means that all the injected tracers will eventually leave the system, which motivates the word open.

It follows from the previous examples that the transportation of a substance through a tank with perfect mixing and a through pipe with pure mass transport without mixing can be described by flow systems.

Notice that the quantity

$$\int_{t_1}^{t_2} h(t) dt$$

can be interpreted as the probability that a particle entering the system at time 0 will exit in the interval (t_1, t_2) . The impulse response of a flow system can thus be interpreted as a probability density. It is, therefore, also called the residence time distribution or more correctly the density of the residence time distribution. The properties (3.12) and (3.13) are far reaching. It follows e.g. from (3.13) that a flow system is always input-output stable. To explore the properties further we analyse the transfer function H defined by

$$H(s) = \int_0^{\infty} e^{-st} h(t) dt \quad (3.14)$$

The equation (3.12) implies that

$$H(0) = \int_0^{\infty} h(t) dt = 1 \quad (3.15)$$

Furthermore let $\text{Re } s \geq 0$ then

$$\begin{aligned}
|H(s)| &= \left| \int_0^{\infty} e^{-st} h(t) dt \right| \leq \int_0^{\infty} |e^{-st}| h(t) dt \leq \\
&\leq \int_0^{\infty} h(t) dt = 1 \qquad \text{Re } s \geq 0 \qquad (3.16)
\end{aligned}$$

The magnitude of the transfer function of a flow system is thus less than or equal to one in the closed right half plane.

Let ω_i be arbitrary real numbers and x_i arbitrary complex numbers. Then

$$\begin{aligned}
\sum_k \sum_{\ell} x_k \bar{x}_{\ell} H(i\omega_k - i\omega_{\ell}) &= \int_0^{\infty} \sum_k \sum_{\ell} x_k \bar{x}_{\ell} e^{i\omega_k t} e^{-i\omega_{\ell} t} h(t) dt = \\
&= \int_0^{\infty} (\sum_k x_k e^{i\omega_k t}) (\sum_{\ell} \bar{x}_{\ell} e^{-i\omega_{\ell} t}) h(t) dt = \\
&= \int_0^{\infty} |\sum_k x_k e^{i\omega_k t}|^2 h(t) dt \geq 0 \qquad (3.17)
\end{aligned}$$

It follows from a famous theorem of Bochner (1932) that the conditions (3.15) and (3.17) also imply (3.12) and (3.13).

An open flow system can thus also be defined as a linear time invariant system whose transfer function satisfies (3.15) and (3.17). This is not done because the conditions (3.12) and (3.13) are much more appealing to physical intuition.

Tracer Propagation in Interconnected Tank Systems.

There are several ways to interconnect flow systems. They can e.g. be connected in series, parallel or in feedback connections in the same way as ordinary linear systems are interconnected. More interesting and more useful results are, however, obtained if the interconnection is done in a different way. Since flow systems are used to describe the propagation of a tracer in a tank system we will first consider different ways to connect tanks together. Interconnection of flow systems will then be defined by considering the flow systems which describe the propagation of a tracer in the interconnected tanks.

Tanks can be connected in many different ways. The outflow of one tank can be sent to another tank (series connection). A flow can be split up in different parts which are sent through tanks and again continued (parallel connection). Part of the outflow of a tank can be mixed with the inflow and sent to the tank again (feedback connection).

It seems intuitively clear that if the tracer propagation in two tanks, S_1 and S_2 , are described by flow systems in the sense of Definition 3.1. then the propagation of a tracer in the interconnected tanks is also a flow system. It will now be shown that this is indeed the case.

By a series connection of two tanks S_1 and S_2 we mean the system obtained by letting the outlet of S_1 be connected to the inlet of S_2 as illustrated in Fig. 3.3.

Assume that the tracer propagation in S_1 and S_2 can be described by flow systems with the transfer functions H_1 and H_2 . Let c_i , c_1 and c denote the tracer concentrations at the inlet of S_1 , the outlet of S_1 and the outlet of S_2

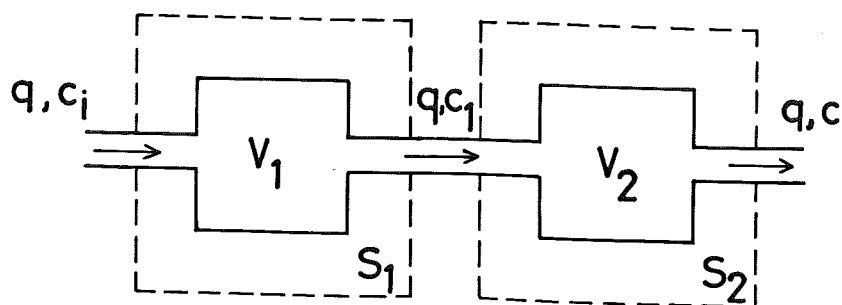

Fig. 3.3 - Series connection of the tanks S_1 and S_2 .

respectively. Then

$$C_1(s) = H_1(s)C_i(s)$$

$$C(s) = H_2(s)C_1(s)$$

Elimination of C_1 gives

$$C(s) = H_2(s)H_1(s)C_i(s)$$

and we thus find that the propagation of a tracer in a series connection of two tanks can be described by a linear system with the transfer function

$$H_s(s) = H_2(s)H_1(s) \quad (3.18)$$

To show that the transfer function H_s corresponds to a flowsystem we introduce the corresponding impulse responses, i.e.

$$h_s(t) = \int_0^{\infty} h_2(t-s)h_1(s)ds$$

It is clear that if h_1 and h_2 are nonnegative then h_s is also nonnegative. Furthermore it follows from (3.17) that

$$H_s(0) = H_2(0)H_1(0) = 1$$

Taking (3.18) as the definition of a series connecting of two flow systems it has thus been shown that the series connection of two flow systems is a flow system.

We will now proceed to other ways of connecting flow systems. A parallel connection of two tanks is obtained by splitting the inflow q into two flows $\alpha_1 q$ and $\alpha_2 q$ where $0 \leq \alpha_1 \leq 1$ and $\alpha_1 + \alpha_2 = 1$. These flows are then taken as inflows to the tanks S_1 and S_2 whose outflows are then combined assuming perfect mixing. The parallel connection is illustrated in Fig. 3.4.

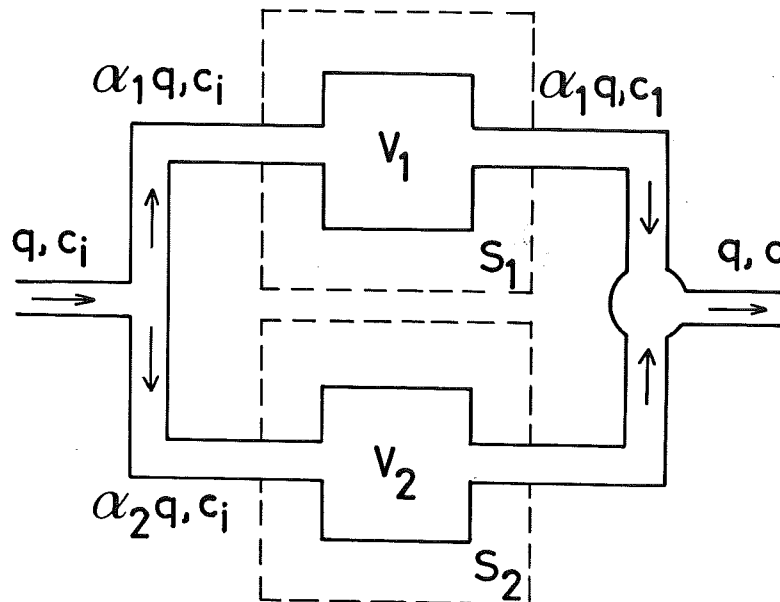

Fig. 3.4 - Parallel connection of the tanks S_1 and S_2 .

To analyse the propagation of a tracer through two tanks S_1 and S_2 in parallel it is assumed that the tracer propagation through S_1 and S_2 can be described by flow systems with the transfer functions H_1 and H_2 . Let c_i denote the tracer concentration at the inlet and c_1 and c_2 the tracer concentrations at the outlets of the tanks. Then

$$C_1(s) = H_1(s)C_i(s)$$

$$C_2(s) = H_2(s)C_i(s)$$

Since the output flow is obtained by ideal mixing of the flows $\alpha_1 q$ and $\alpha_2 q$, with tracer concentrations c_1 and c_2 , the concentration at the outlet becomes

$$C(s) = \alpha_1 C_1(s) + \alpha_2 C_2(s) = [\alpha_1 H_1(s) + \alpha_2 H_2(s)] C_i(s)$$

The propagation of a tracer through a parallel connection of two tanks can thus be described by a linear system with the transfer function

$$H_p(s) = \alpha_1 H_1(s) + \alpha_2 H_2(s) \quad 0 \leq \alpha_1, \alpha_2 \leq 1, \alpha_1 + \alpha_2 = 1$$

To verify that this is a transfer function of a flow system the impulse responses are introduced. Hence

$$h_p(t) = \alpha_1 h_1(t) + \alpha_2 h_2(t)$$

It is clear that if h_1 and h_2 satisfy (3.12) and (3.13), then h_p will also satisfy the same equations.

The feedback connection S_f of two tanks S_1 and S_2 is illustrated in Fig. 3.5. Let the inflow to S_3 be q and the tracer concentration c_i . Furthermore let the proportion α , $0 \leq \alpha < 1$, of the outflow of S_1 be the inflow to

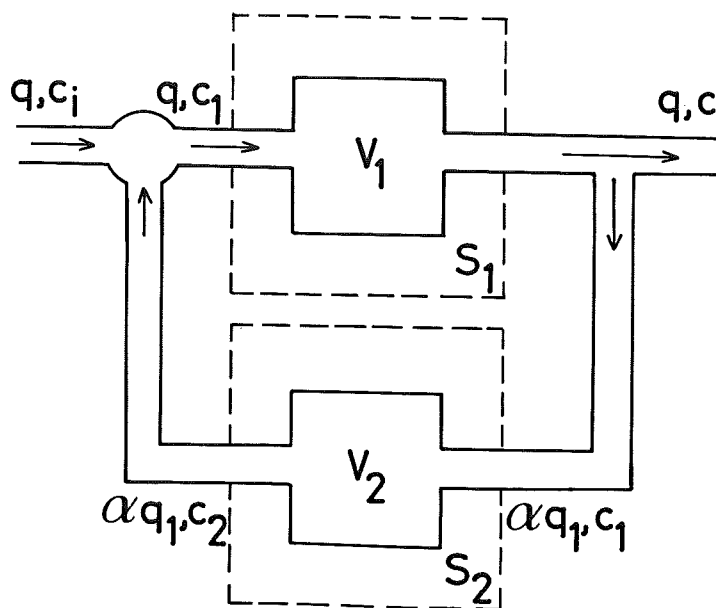

Fig. 3.5 - Feedback connection of the systems S_1 and S_2 . The inflow q is perfectly mixed with the outflow of S_2 , and the mixture is fed to S_1 . The outflow of S_1 is split into two streams, one of which goes to S_2 and the other part is the outflow of S_f .

S_2 . It is assumed that the outflow of S_2 is perfectly mixed with the system inflow.

If αq_1 is the flow through S_2 , a flow balance then gives

$$(\alpha q_1 + q) = q_1$$

Hence

$$q_1 = \frac{q}{1 - \alpha}$$

Let c_2 denote the concentration at the outlet of S_2 then

$$C_2(s) = H_2(s)C(s)$$

The input to S_1 is a mix of two flows q and $\alpha q/(1-\alpha)$, having concentrations c_i and c_2 respectively. The concentration c_1 at the inlet of S_1 is thus

$$C_1(s) = (1-\alpha)C_i(s) + \alpha C_2(s)$$

Furthermore

$$C(s) = H_1(s)C_1(s) = (1-\alpha)H_1(s)C_i(s) + \alpha H_1(s)H_2(s)C(s)$$

which gives

$$C(s) = \frac{(1-\alpha)H_1(s)}{1 - \alpha H_1(s)H_2(s)} C_i(s)$$

The tracer propagation through a feedback connection of two tanks can thus be described by a linear system with the transfer function

$$H_f(s) = \frac{(1-\alpha)H_1(s)}{1 - \alpha H_1(s)H_2(s)} \quad 0 \leq \alpha < 1 \quad (3.20)$$

Assuming that H_1 and H_2 are transfer functions of flow systems it will now be shown that H_f is also such a transfer function. We have

$$H_f(0) = \frac{(1-\alpha)H_1(0)}{1 - \alpha H_1(0)H_2(0)} = \frac{1 - \alpha}{1 - \alpha} = 1$$

Furthermore introduce $H = H_1H_2$. Since S_1 and S_2 are flow systems, it follows from the equation (3.15) that

$$|H(s)| \leq 1 \text{ for } \operatorname{Re} s \geq 0$$

The series expansion

$$H_f(s) = (1-\alpha)H_1(s)[1 + \alpha H(s) + \alpha^2 H^2(s) + \dots]$$

thus converges uniformly for $\alpha \leq \alpha_0 < 1$ and $\operatorname{Re} s \geq 0$. The corresponding impulse response then satisfies

$$h_f = (1-\alpha)h_1*[1 + \alpha h + \alpha^2 h*h + \dots]$$

where * denotes convolution. Since S_1 and S_2 are flow systems, we have $h_1(t) \geq 0$ and $h_2(t) \geq 0$, and we find $h_f(t) \geq 0$.

Summing up we get

Theorem 3.1

Let S_1 and S_2 be open flow systems with the transfer functions H_1 and H_2 . The series S_s , parallel S_p and feedback S_f connections of S_1 and S_2 whose transfer functions are defined by

$$H_s = H_2 H_1 \tag{3.18}$$

$$H_p = \alpha_1 H_1 + \alpha_2 H_2 \quad 0 \leq \alpha_1, \alpha_2 \leq 1, \alpha_1 + \alpha_2 = 1 \tag{3.19}$$

$$H_f = \frac{(1-\alpha)H_1}{1 - \alpha H_1 H_2} \quad 0 \leq \alpha < 1 \tag{3.20}$$

are then also open flow systems.

Remark. Notice that the series connection of two flow systems is identical to the series connection of two linear

systems. The parallel and feedback connections of flow systems are, however, not the same as the parallel and series connection of linear systems.

Using Theorem 3.1 the propagation of a tracer through a tank system can be studied in the same way as signal propagation is analysed in an ordinary linear system.

The Stewart-Hamilton Equation.

The analysis of the simple tank systems corresponding to a tank with ideal mixing in Example 3.1 and to a tank with pure plug flow in Example 3.2 show that the following equation

$$\int_0^{\infty} th(t)dt = V/q \quad (3.21)$$

hold in both cases. Compare with the equations (3.2) and (3.5). Recalling the probabilistic interpretation of the impulse response h as the residence time distribution the equation (3.21) simply says that for a tank system with one inlet and one outlet the ratio of volume to flow equals the mean residence time. The equation (3.21) was first used by the physiologists Stewart (1897) and Hamilton (1932) who developed methods to determine the blood volume of the heart. The equation (3.21) will therefore be called the Stewart-Hamilton equation. The equation has been widely used both in biology, physiology and engineering. It has also been misinterpreted and therefore the cause of much controversy. Conditions for (3.21) will therefore be discussed in detail. A heuristic argument can be obtained as follows. Consider an open tank system with inflow q . The fraction $h(t)dt$ of the particles which

enter the system at time zero will exit in the interval $(t, t+dt)$. These particles have traversed the volume $dv = v \cdot q$. Integrating over all particles now gives (3.21). The validity of the equation (3.21) can also be shown formally in many cases. We have the following result:

Theorem 3.2.

Let S_1 and S_2 be tank systems with one inlet and one outlet and volumes V_1 and V_2 . Let the tank system S_3 be a series, parallel or feedback connection of S_1 and S_2 . Assume that the Stewart-Hamilton equation holds for S_1 and S_2 then it also holds for S_3 .

Proof. Let H_1 and H_2 be the transfer functions which characterize the tracer propagation in S_1 and S_2 . The different ways to interconnect the systems will be discussed separately.

First consider a series connection. It follows from Theorem 3.1 that the tracer propagation in S_3 then is characterized by the transfer function $H_3 = H_1 H_2$. The mean residence time of S_3 is then given by

$$\begin{aligned} \int_0^{\infty} t h_3(t) dt &= -H_3'(0) = -H_1'(0)H_2(0) - H_1(0)H_2'(0) = \\ &= (V_1 + V_2)/q = V_3/q \end{aligned}$$

The third equality follows from the fact that the flows through S_1 and S_2 are the same in a series connection.

Now consider a parallel connection. See Fig. 3.2. Since the flow through S_1 is $\alpha_1 q$ and that through S_2 is $\alpha_2 q$, we get

$$- H_1'(0) = V_1/(\alpha_1 q) \quad \text{and} \quad - H_2'(0) = V_2/(\alpha_2 q)$$

The mean residence time of S_3 is given by

$$\begin{aligned} \int_0^{\infty} t h_3(t) dt &= - H_3'(0) = - \alpha_1 H_1'(0) - \alpha_2 H_2'(0) = \\ &= (V_1 + V_2)/q = V_3/q \end{aligned}$$

and the result is thus established also for a parallel connection.

For a feedback connection, Fig. 3.3, the flow through S_1 is $q_1 = q/(1-\alpha)$ and the flow through S_2 is $\alpha q_1 = \alpha q/(1-\alpha)$. Hence

$$- H_1'(0) = V_1/q_1 = (1-\alpha)V_1/q$$

$$- H_2'(0) = V_2/(\alpha q) = (1-\alpha)V_2/(\alpha q)$$

The equation (3.19) gives

$$H_3' = \frac{(1-\alpha)H_1'}{1 - \alpha H_1 H_2} + \frac{(1-\alpha)H_1(\alpha H_1' H_2 + \alpha H_1 H_2')}{(1-\alpha H_1 H_2)^2} = \frac{(1-\alpha)(H_1' + \alpha H_1^2 H_2')}{(1-\alpha H_1 H_2)^2}$$

The mean residence time is then given by

$$\begin{aligned} \int_0^{\infty} t h_3(t) dt &= - H_3'(0) = - \frac{1}{1-\alpha} H_1' - \frac{\alpha}{1-\alpha} H_2' = \\ &= (V_1 + V_2)/q = V_3/q \end{aligned}$$

and the proof is now complete. □

Remark. Combining Theorem 3.2 with the results of Example 3.1 and Example 3.2, it is thus found that the Stewart-Hamilton equation holds for systems which are obtained by series, parallel or feedback connections of simple flow systems with pure transport or with ideal mixing.

The Stewart-Hamilton equation has been derived only for systems which are open flow systems. Internal recirculations are allowed provided that only a fraction of the flow is recirculated ($\alpha < 1$ in Theorem 3.1). All fluid particles must, however, sooner or later leave the system, or formally the equation (3.12) must hold. This will not be the case if all the flow is recirculated.

Volume and Flow Measurements.

Impulse response analysis has been applied extensively in studies of tank systems. Determination of flows and volumes through impulse response analysis is, in fact, a standard technique which is widely used in many different fields.

To determine the flow in a tank system with one inlet and one outlet it is assumed that the tracer is injected so quickly that it can be regarded as an impulse. The tracer concentration at the outlet is then proportional to the impulse response i.e.

$$q_c(t) = Mh(t) \tag{3.22}$$

where M is the total amount of injected tracer. Since the integral of the impulse response of an open flow system is unity we get

$$q = \frac{M}{\int_0^{\infty} c(t) dt} \quad (3.23)$$

It is sometimes difficult to measure the concentration at the outlet in absolute units. This is not important if the concentration c_0 of the injected tracer is also measured. If the injected volume is V_0 we have $M = c_0 V_0$ and the above equation becomes

$$q = V_0 \frac{c_0}{\int_0^{\infty} c(t) dt} \quad (3.24)$$

where c_0 and c can be given in relative units.

The determination of the volume of a tank system can be done from the Stewart-Hamilton equation (3.21) which gives

$$V = q \int_0^{\infty} th(t) dt = \frac{M \int_0^{\infty} tc(t) dt}{\left[\int_0^{\infty} c(t) dt \right]^2} = V_0 \frac{c_0 \int_0^{\infty} tc(t) dt}{\left[\int_0^{\infty} c(t) dt \right]^2} \quad (3.25)$$

where the second equality is obtained by replacing h by c from (3.22) and using (3.23) to eliminate q .

Many different methods have been used to evaluate the integrals appearing in (3.25) graphical techniques, planimeters and numerical integration. It has also been attempted to fit a function to the observed concentration curve and to determine the integrals of the approximating function analytically. Some examples are given below.

Example 3.3.

If the measured concentration curve is approximated by

$$c(t) = A_1 e^{-a_1 t} + A_2 e^{-a_2 t} + \dots + A_n e^{-a_n t} \quad (3.26)$$

the integrals become

$$\int_0^{\infty} c(t) dt = A_1/a_1 + A_2/a_2 + \dots + A_n/a_n \quad (3.27)$$

$$\int_0^{\infty} tc(t) dt = A_1/a_1^2 + A_2/a_2^2 + \dots + A_n/a_n^2 \quad (3.28)$$

□

The approximation by a sum of exponentials has the advantage that it will always give a nonnegative function provided that the coefficients A_i are positive. Notice, however, that the function (3.26) is not well suited to approximate an oscillatory impulse response. Systems whose impulse response have the form (3.26) are discussed in Section 4. The approximation by a sum of exponentials is often done graphically by plotting the method of "peeling off the exponentials" which is described in detail in Section 4. The approximation by a sum of exponentials is unfortunately a very badly conditioned numerical problem as was already mentioned in Chapter 2. The reason for this is that the exponential functions are not orthogonal on the interval $(0, \infty)$. For this reason it is therefore also attempted to approximate the concentration curve by orthogonal functions.

Example 3.4.

The Laguerre functions

$$f_n(t) = \sqrt{a} e^{-at/2} \sum_{k=1}^n \binom{n}{k} \frac{(-at)^k}{k!}$$

are orthonormal on the interval $(0, \infty)$. It is therefore straightforward to fit a sum of Laguerre functions to an observed concentration curve. Since

$$\int_0^{\infty} f_n(t) dt =$$

and

$$\int_0^{\infty} t f_n(t) dt =$$

it is also easy to determine the integrals which appear in (3.25). Notice, however, that the Laguerre functions are negative for certain arguments. This means that the approximating function may be negative.

□

Impulse response analysis is thus a useful method to determine volumes and flows in tank systems. The major difficulties of the method are

- o The evaluation of the integrals $\int h(t) dt$ and $\int th(t) dt$ may be difficult. This is particularly true when it is difficult to measure the reference value of the concentration accurately and when the function h decays slowly.

- o There may be an external recirculation.
- o It may not be possible to make the tracer injection so short that the measured concentration is proportional to the impulse response. It is then necessary to know the injection function and to apply deconvolution before applying the Stewart-Hamilton equation.

Physiological Applications.

There are many physiological systems which can be modelled as tank systems. The obvious examples are found in the circulatory system. Other less obvious examples will be discussed in Section 4. Even if the bloodflow through the heart varies periodically with the heartbeat the average conditions can often be described as a tank system in equilibrium. In the periferal organs there is also a considerable filtering so that the flows can be considered as being constant. It is of considerable interest for the physiologist to know the amounts of blood in different organs and the blood flow through the organs. The knowledge is useful both for pure scientific reasons and for diagnosis. Impulse response measurements using a tracer is one technique that can be used for volume and flow measurements. Such measurements are in fact done as routine tests for diagnosis in many physiological laboratories.

The measurements can be done in many different ways. The straightforward technique is illustrated in Fig. 3.6. The tracer is injected into a vessel which supplies an organ and the tracer concentration is measured in the outlet from the organ.

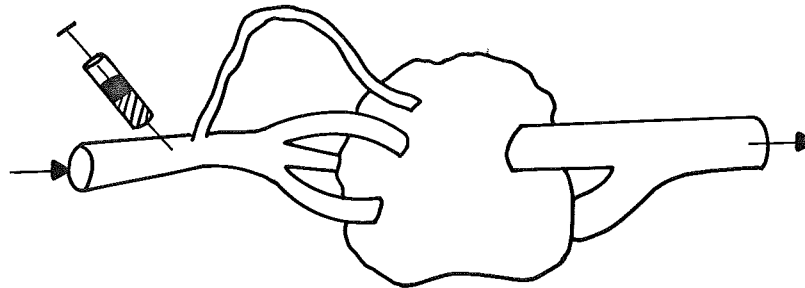

Fig. 3.6 - Illustrates the application of impulse response analysis to the determination of blood volume and blood flow.

In many cases the organ may have many inlets and outlets. To apply the impulse response method it is then necessary to measure the tracer concentration in all the outlets. It may then be advantageous to measure the total amount of tracer in the organ. The rate of change of the total amount of tracer is then equal to the outflow from the organ. The technique is illustrated in Fig. 3.7.

In a variation of the method described, the tracer is injected continuously until the tracer concentration in the organ is constant. The tracer injection is then suddenly interrupted and the total tracer concentration or the tracer concentration in the outlet is measured subsequently. The curve obtained is called a wash-out curve.

Determination of blood flow through the heart and the volume of blood in the heart is a typical application of impulse response analysis. An indicator, bromsulphophalein (BSP), which binds to the blood plasma is used. A fixed

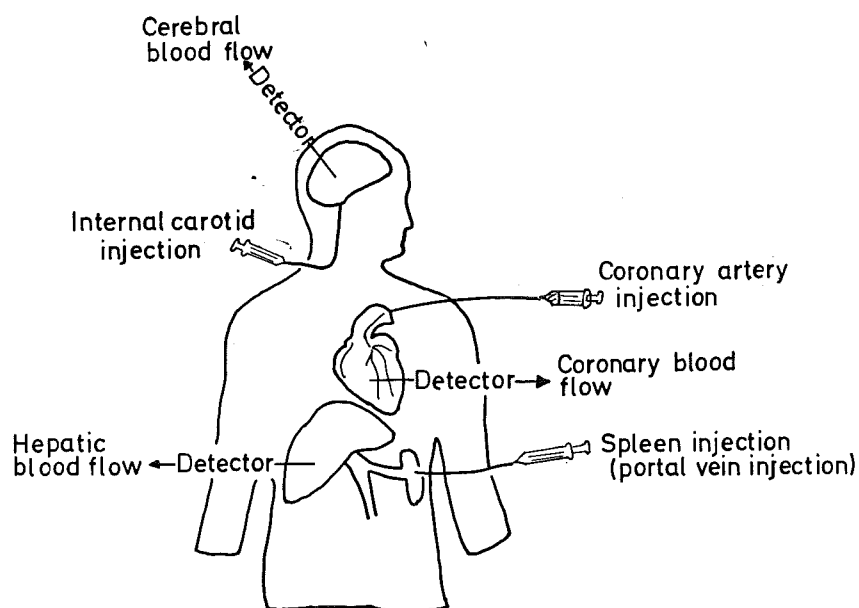

Fig. 3.7 - Illustrates a variation of the impulse response method. The total amount of tracer in an organ is measured instead of the tracer concentration in the outlet.

amount of indicator is injected through a catheter in a vein. The blood flow in an artery is sampled at regular intervals and the concentration of the tracer is determined in a laboratory using photometry. It is common to take a sample every second. To take samples at that rate a clever technique is used. The catheter from the artery is led to a cassette of test tubes which moves at such a rate that the test tubes pass the catheter outlet once every second. A typical impulse response is shown in Fig. 3.8. The flow is determined from equation (3.21), and the volume from (3.22). Since the indicator binds to the plasma the plasma flow and the plasma volume is obtained primarily. To determine blood flow and blood volume it is necessary to know the ratio of plasma in blood.

Since the blood recirculates through the body there will be an increase in the impulse response corresponding to the circulation time. This is clearly seen in Fig. 3.8. The effect due to recirculation must be eliminated in order to determine the blood flow or the blood volume. This can be done by approximating the tail by an exponential or by solving the integral equation which corresponds to the system with recirculation.

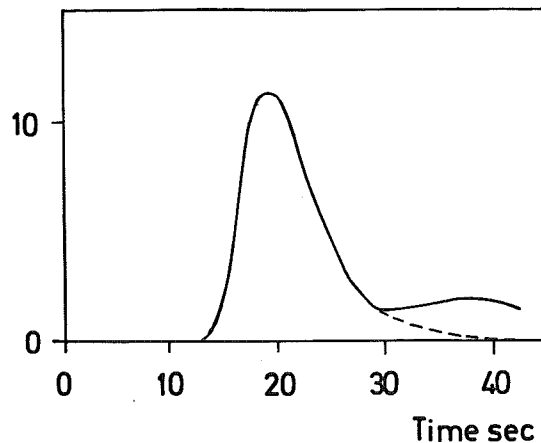

Fig. 3.8 - Impulse response of the heart. The curve shows the arterial concentration of an indicator which is injected intravenously.

The difficulty associated with the recirculation of the tracer can be avoided by using a gaseous tracer. An example is illustrated in Fig. 3.9. A radioactive tracer Krypton 85 was used. The experiment was performed on a dog. The experimental procedure shown in Fig. 3.7 was used and the total tracer activity in the heart was measured. Notice that there is no noticeable effect of recirculation because virtually all krypton in the blood stream is eliminated when the blood passes through the lungs. The curve on the right of Fig. 3.9 which shows the logarithm of the activity indicates that the process can be well described by assuming a single tank with perfect mixing.

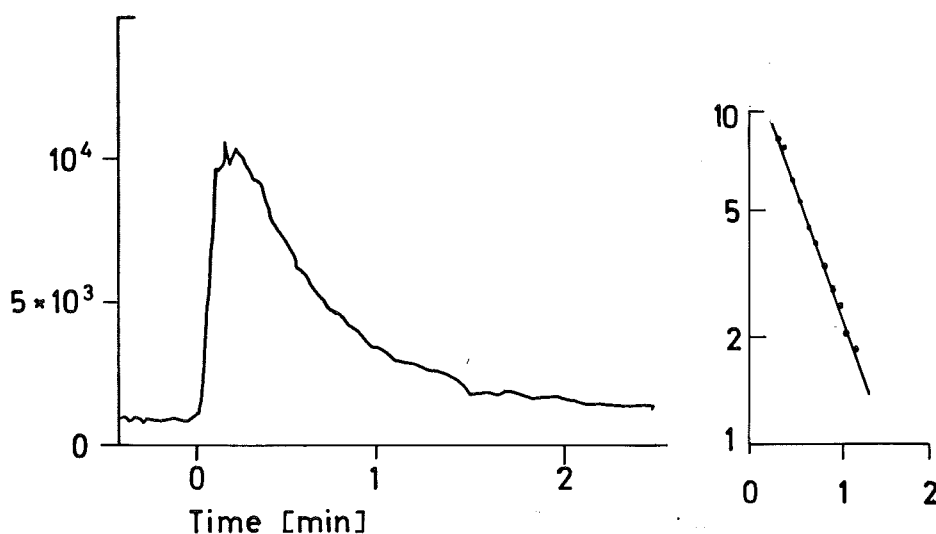

Fig. 3.9 - Impulse response of the heart of a dog. A tracer Kr^{85} was injected into the left coronary artery of the dog. The curve on the left shows the total activity in the heart muscle and the curve on the right shows the logarithm of the total activity. The curves are redrawn from Wagner (1964).

There are several problems connected with the application of impulse response measurements to physiological systems. Blood is composed of many different components which could propagate differently through the system. It is thus necessary to choose the tracers appropriately to ensure that the tracers will follow the component of interest. For example, if the volume of the red blood cells should be determined, it is necessary to tag red blood cells; and if the plasma volume is desired, it is necessary to tag the plasma.

Fig. 3.10 shows the impulse response of the liver obtained using different tracers. One tracer is ^{51}Cr -labeled red blood cells. This tracer stays intravascular. The other tracer tritium-enriched water (THO) also penetrates the extracellular fluids freely. The curve illustrates that different components of blood may have drastically different flow patterns.

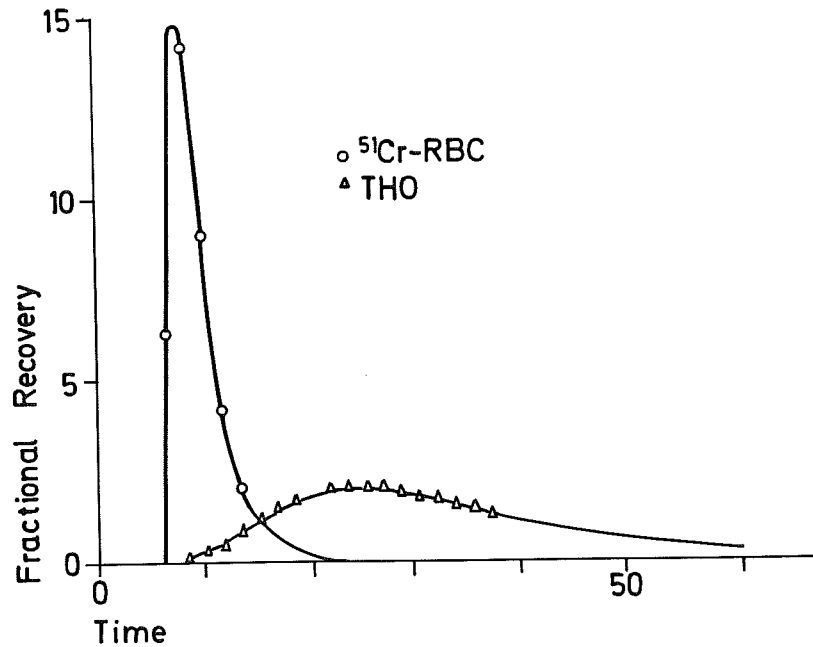

Fig. 3.10 - Impulse response analysis for the determination of the volume of the liver using different tracers. Adapted after Goresky (1967).

Industrial Applications.

Many industrial processes can be conveniently modelled as tank systems. Typical examples are continuous processes with no generation or destruction of material. To illustrate the use of impulse response analysis for analysis of such processes examples of investigation of mixing tanks and drying drums will be discussed.

Analysis of Mixing Tanks.

Mixing tanks are frequently used in industry for the purpose of eliminating variations in a quality variable. Under the assumption that there is perfect mixing in the tank, it follows from the analysis of Example 3.1 that a mixing tank can be considered as a first order, low pass filter with the time constant $T = V/q$. Hence the larger the tank, the more efficient is the smoothing. It has been found in practice that storage tanks do not necessarily behave according to equation (3.14). Instead it happens that the mixing is incomplete and also that there are "pockets" in the tanks where material stays for a long time. It is possible to find out if such pockets exist by an impulse response measurement. An evaluation of the volume V from the Stewart-Hamilton equation and a comparison of V with the geometric volume gives the possibility to detect pockets.

As an illustration we will consider an investigation of a mixing tank in a paper mill. The analysis was made using the radioactive isotope ^{82}Br which has a half life of 36 hours. A solution of about 100 ml NH_4Br corresponding to 500 millicuri was mixed with pulp and used as an input. The tank volume was about 4000 m^3 . The measured impulse responses of tanks when 2 and 4 stirrers were used are shown in Fig. 3.11.

An analysis of the impulse responses gives that the mean residence time is 3.5 h for the tank with two stirrers and 10.6 h when four stirrers are used. The volume to flow ratio for the tank is 11.7 h, and we can thus conclude that there are large portions of the tank which are not penetrated by the flow when only two stirrers are used, but that almost the whole tank participates when four stirrers are in operation. The example clearly illustrates the ef-

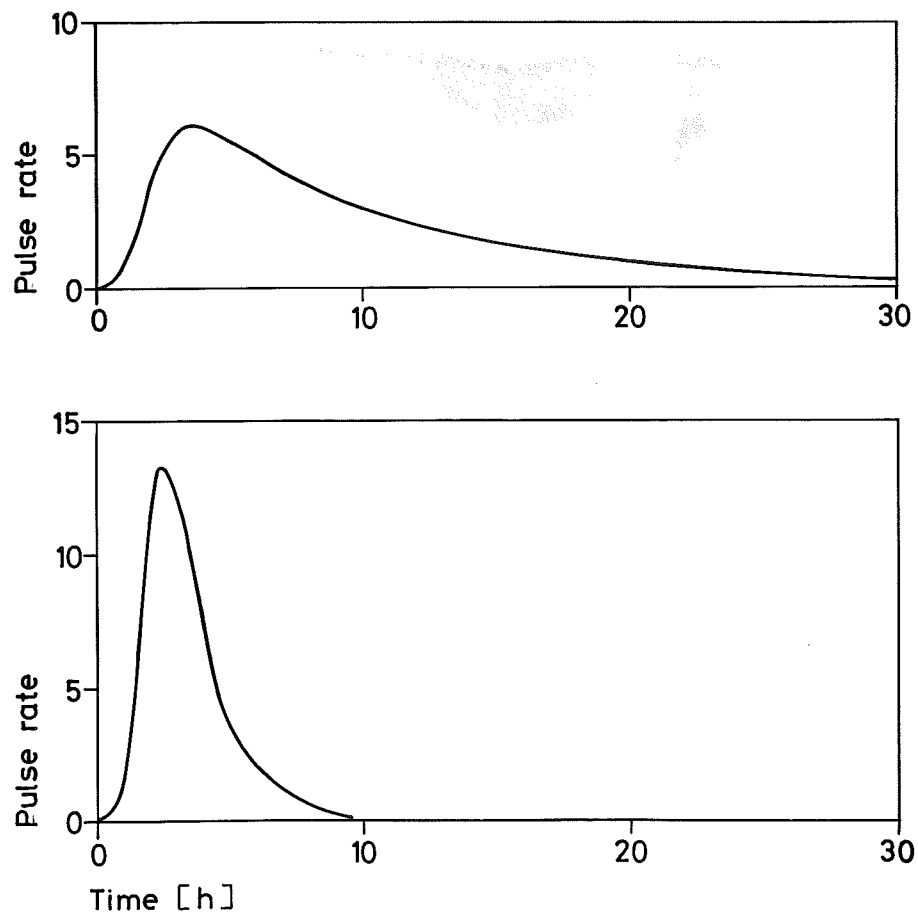

Fig. 3.11 - Impulse responses for a mixing tank in a paper mill when four and two stirrers are used. The data is kindly provided by AB Isotopteknik.

fectiveness of the impulse response technique for process analysis.

Mixing_Efficiency.

Apart from detecting pockets it is, of course, also of interest to know if the mixing is efficient in the sense that disturbances are attenuated. It follows from Example 3.1 and Example 3.2 that a tank with ideal mixing and a tank with pure transport have the same mean residence time. The mean residence time thus nothing tells about

the mixing properties of a tank.

The impulse response function itself will, however, completely characterize the mixing properties. An evaluation of the transfer function will also clearly show the extent to which disturbances of different frequencies are eliminated.

Fig. 3.12 shows a schematic diagram of a mixing tank of special construction, which is sometimes used in the pulp and paper industry.

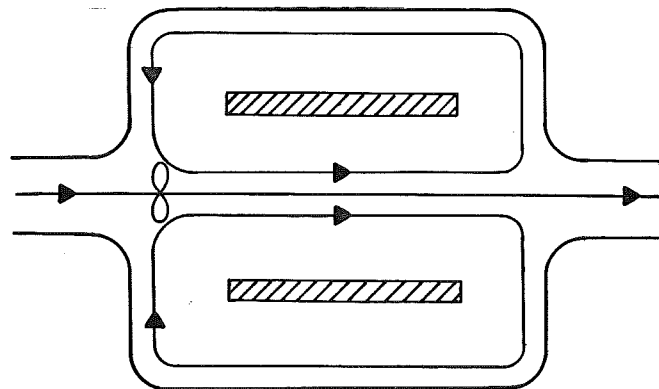

Fig. 3.12 - Schematic diagram of a mixing tank of a special kind.

Fig. 3.13 shows the results of an impulse response measurement of the tank in Fig. 3.12. Notice the pronounced oscillatory pattern which is due to the circular flow pattern. Analysis of the frequency response that the mixing tank will in fact increase the amplitudes of disturbances with frequencies in the neighbourhood of X Hz.

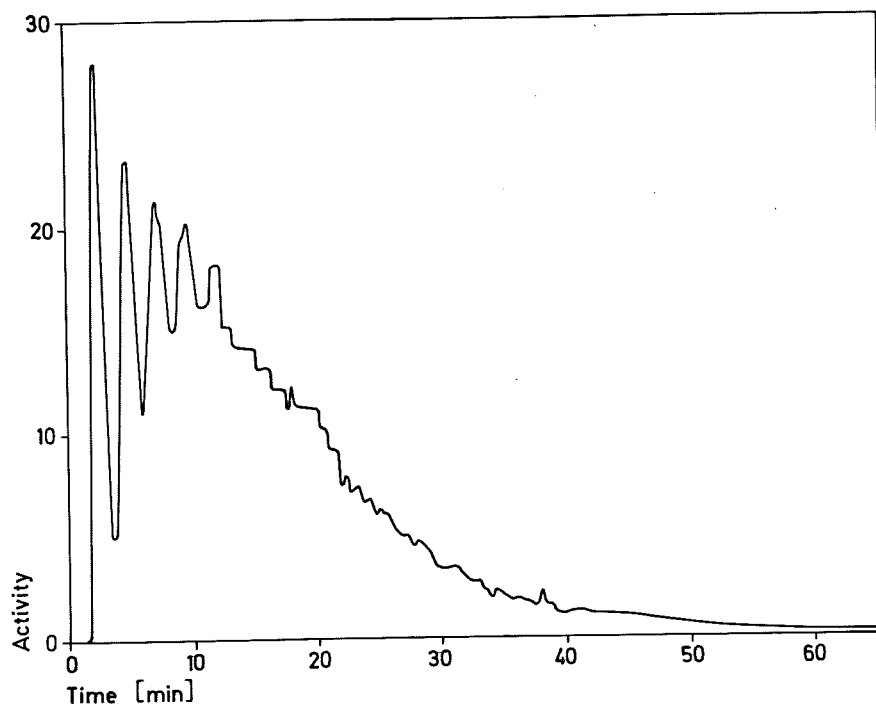

Fig. 3.13 - Results of an impulse response analysis of the flow system shown in Fig. 3.10. This measurement was made on a machine chest at a paper mill by glass fibres tagged with ^{24}Na . The glass fibres will propagate through the system in the same way as the wood fibres in the paper pulp.

Dynamics of a Drying Drum.

Drying drums are commonly used in many industrial processes. It is not easy to derive the dynamics from first principles and it is therefore necessary to make experiments. In steady state a drying drum is clearly a tank system. To be able to judge the quality of the product it is often of interest to know the residence time distribution. This can be measured by impulse response analysis. A drum for drying pellets from a granulator in a fertilizing plant will be discussed as an example. The drum which is 35 m long and 3.3 m in diameter rotates with a speed of 2.5 revolutions per minute. The mass flow through the drum is about 30 kg/s. To measure the impulse response 10 kg of pellets were coloured. These pellets were introduced in the pellet stream to the dryer. Samples of the pellets from the drum were taken and the number of coloured pellets in each sample was counted. A typical result is shown in Figure 3.14.

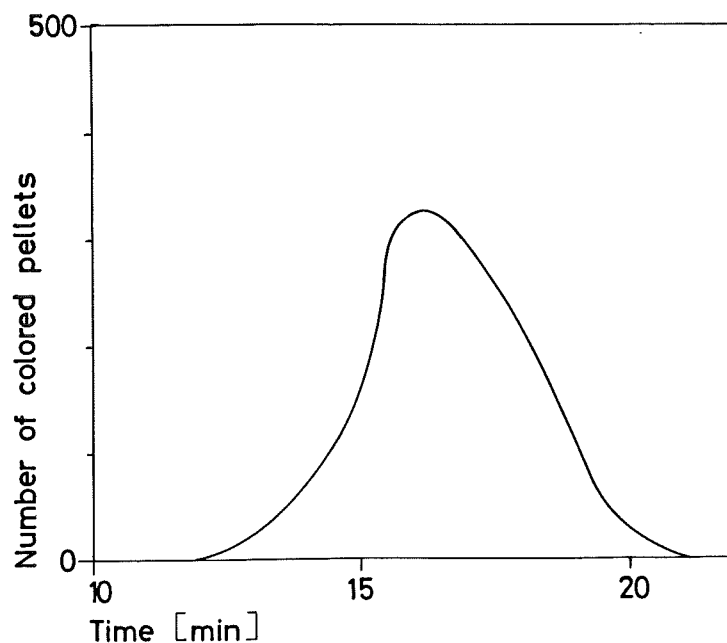

Fig. 3.14 - Impulse response for a drying drum.

Applications to Ecosystems.

The flow patterns in rivers, streams and lakes can be of many different forms. Some examples are given in Fig. 3.15. When analysing ecosystems it is of considerable importance to know the flow pattern as well as the water volume which is actually penetrated by the flow (the recipient volume). By injecting a tracer at the inlet to the lake and measuring the tracer concentration at the outlet the recipient volume between the point of injection and the observation point can be determined using the Stewart-Hamilton equation e.g. in the form (3.25). The shape of the impulse response will also give valuable information about the mixing properties.

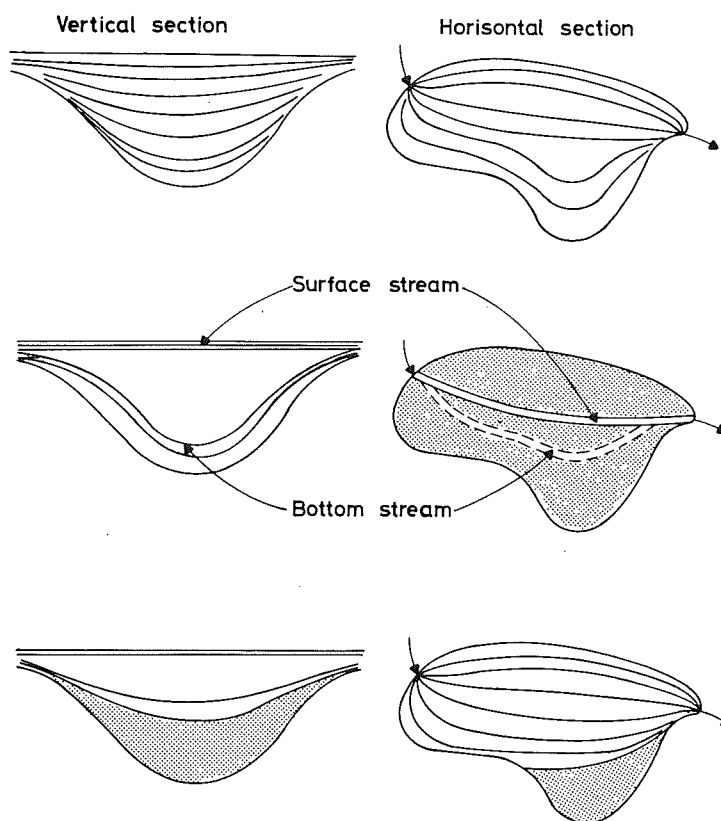

Fig. 3.15 - Examples of flow patterns in a lake.

Exercises.

1. Show that a linear, time invariant system with the transfer function

$$H(s) = \frac{\xi\omega^3}{(s+\xi\omega)(s^2+2\xi\omega s+\omega^2)}$$

is a flow system.

2. Show that a linear, time invariant system with the transfer function

$$H(s) = \frac{s+10}{s^2+2s+10}$$

cannot be a flow system.

3. Consider a flow system which corresponds to n tanks with ideal mixing in series. Show that the transfer function of the flow system is

$$H(s) = \left(\frac{a}{s+a} \right)^n$$

and that the impulse response is

$$h(t) = a \frac{(at)^{n-1}}{(n-1)!} e^{-at}$$

Furthermore show that

$$\int_0^{\infty} th(t)dt = n/a$$

(Hint.: Use Theorem 3.1 and Theorem 3.2.)

4. Consider a tank whose tracer propagation is given by the transfer function of Example 1. Assume that the flow through the system is $1 \text{ m}^3/\text{s}$. Show that the volume is given by

$$V = \frac{1 + 2\xi^2}{\omega\xi}$$

5. A substance called creatinine is distributed throughout the blood plasma and in the so-called "intracellular fluid". To determine the volume where the creatinine is distributed a dose of 10 g creatinine was administered intravenously to a human subject. The concentration of creatinine in the plasma was subsequently measured. After correcting for the creatinine generated by the human body, it was found that the concentration of creatinine in the plasma could be approximated by

$$C(t) = Ae^{-\alpha t} + Be^{-\beta t}$$

where the following numbers were obtained $A = 0,38 \text{ g/l}$, $B = 0.18 \text{ g/l}$, $\alpha = 1.65 \text{ h}^{-1}$ and $\beta = 0.182 \text{ h}^{-1}$. Assume that all creatinine leaves the body through the urine and that the creatinine concentration in the excretion is the same as in the blood plasma. Determine the volume of distribution for the creatinine.

6. It has been mentioned that the Stewart-Hamilton equation can be used to estimate the volume which participates in the flow, but that it does not give any information on the mixing efficiency. Such information can, however, be obtained from the impulse response. The integral

$$I_2 = \int_0^{\infty} h^2(t) dt$$

is for example proportional to the variance of the concentration fluctuations if the input concentration is white noise. The integral I_2 can thus be taken as a measure of the mixing efficiency. Show that $I_2 = 0.5$ for a tank system which corresponds to a tank with perfect mixing and mean residence time 1.

7. Find the impulse response h for a system which minimizes the integral

$$I_2 = \int_0^{\infty} h^2(t) dt$$

subject to the constraint

$$\int_0^{\infty} th(t) dt = 1$$

(Hint.: $\min I_2 = 4/9!$)

8. Consider the flow system of Exercise 1. Determine the integral I_2 defined by (*) for the system.
9. Consider the system discussed in Exercise 3. Show that

$$\int_0^{\infty} h^2(t) dt = a \cdot 2^{-2n+1} \cdot \frac{(2n-1)!}{[(n-1)!]^2}$$

10. The Stewart-Hamilton equation (3.21) is based on the assumption that an ideal impulse is used. Determine the error obtained if the Stewart-Hamilton equation is used to estimate the volume when the input is a rectangular pulse with pulse length T . (Hint.: Use Theorem 3.2.)
11. Consider a tank system with recirculation according to Fig. 3.4. Assume that it is desired to measure the mean residence time in the tank S_1 by injecting a tracer at the inlet to S_1 and measuring the concentration at the outlet. Determine the error in the determination of the mean residence time that occurs if it is not observed that the system has recirculation.
12. Give an analytic expression for a transfer function which corresponds to the impulse response curve of Fig. 3.11.
13. The impulse response h of a flow system can be interpreted as a probability density for the residence time. The corresponding distribution function is defined as

$$H(t) = \int_0^t h(s) ds$$

To determine $H(t)$ n labeled particles were injected and the number $K(t)$ of particles which had left the system in the interval $(0, t)$ was observed. Show that

$$P\{K(t) \leq k\} = \binom{n}{k} H^k(t) [1 - H(t)]^{n-k}$$

and that

$$EK(t) = nH(t)$$

$$\text{Var } K(t) = nH(t)[1 - H(t)]$$

4. TANK SYSTEMS - INTERNAL STRUCTURE.

The analysis of tank systems in the previous section shows that several properties of the systems can be found from an impulse response measurement. In this section tank systems will be explored from a different point of view. The systems considered will be more specialized than those in Section 3. It will be assumed that they are composed of tanks with ideal mixing connected by pipes with negligible volumes. The analysis is on the other hand more general because it is not assumed that the systems have one inlet and one outlet only. The purpose of the analysis is to determine the volumes and the flows from impulse response measurements.

The representation of a tank system by a graph is first discussed and tank systems with a special structure are defined. Analysis of propagation of a tracer through a tank system then follows. It turns out that the tracer propagation can be described by a linear time-invariant dynamical system, if the tank system is in equilibrium in the sense that all volumes and flows are constant. The system has special properties which has important consequences for its dynamical behaviour. In analogy with Section 3 the systems describing tracer propagation are called flow systems. In this section such systems are first defined through their state space properties and it is then shown that they are also flow system in the previously defined sense. The dynamical properties of flow systems are explored using state space techniques. The problem of determining the volumes and flows from impulse response measurements is discussed. This leads to the notion of identifiability. Criteria for identifiability of tank systems having special topologies are then given. Compartment analysis and pharmacokinetics are finally given as examples.

Formal Description of Tank Systems.

Consider a system composed of tanks which are connected by pipes. Let fluid be pumped into the system at points called sources and let the points where fluid is pumped out of the system be called sinks. It is assumed that there is no accumulation of fluid in the system. The flow into a tank is thus equal to the flow out of a tank. A tank system can be represented as a directed graph. Each tank, sink and source is a node in the graph and the pipes connecting tanks, sinks and sources are represented by branches. An arrow on the branch indicates the direction of the flow. Numbers can be introduced in the graph to show tank volumes and the magnitudes of the flows. An example of a graph representation of a flow system is shown in Fig. 4.1.

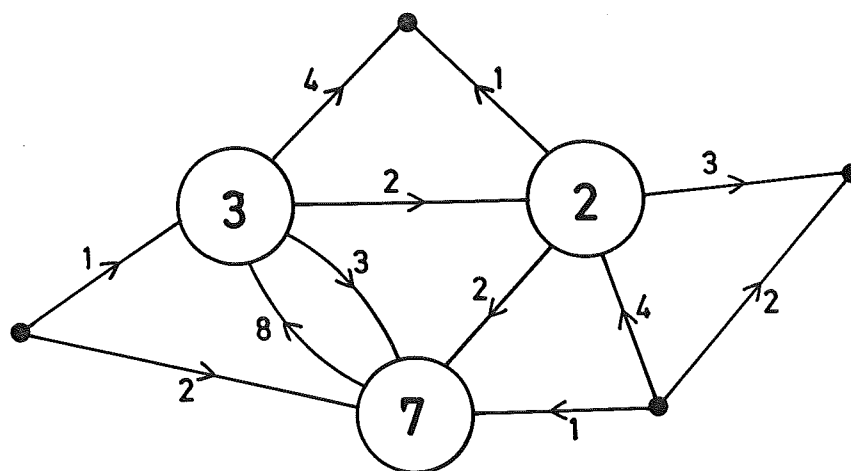

Fig. 4.1 - Schematic diagram of a tank system. The tanks are denoted by circles, the sinks and sources by dots and the pipes by branches. The arrows on the branches indicate the direction of the flow, the numbers on the branches give the flow rates and the numbers in the circles give the tank volumes. Sinks and sources can also be represented as tanks with zero volume.

Tank systems can be characterized in many different ways. A tank system is called a closed system if it does not have sinks and sources. An open tank system has sinks and sources. If it is possible to find a true subset of tanks which are not connected to any tank not belonging to the subset, the system is called reducible. A system which is not reducible is called irreducible.

There are tank systems with certain topologies which are given special names. A system where the tanks are arranged in a chain where each tank is only connected to its nearest neighbours is called a catenary system. The first tank in the chain is not connected to the last. Catenary systems can be either open or closed. Examples of catenary systems are given in Fig. 4.2.

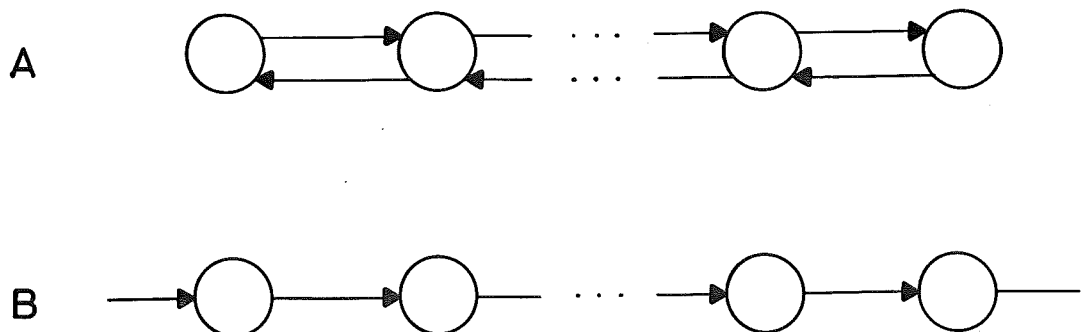

Fig. 4.2 - Examples of catenary tank systems. The system A is closed and the system B is open.

A cyclic system is obtained if the first and the last tank of a catenary system are connected. See Fig. 4.3.

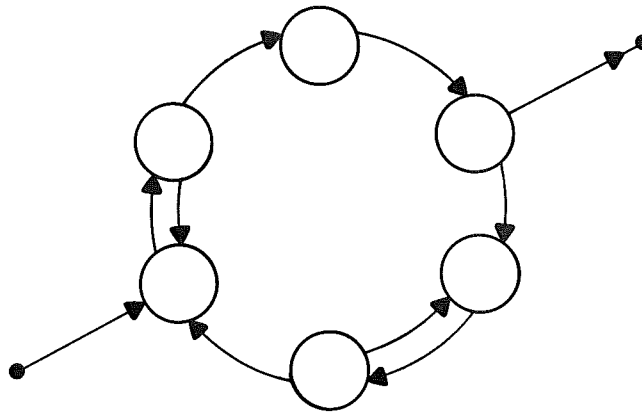

Fig. 4.3 - A circular tank system.

A system is called mammillary if it consists of a central tank surrounded by peripheral tanks which are connected to the central tank but not to each other. An example of a mammillary system is shown in Fig. 4.4.

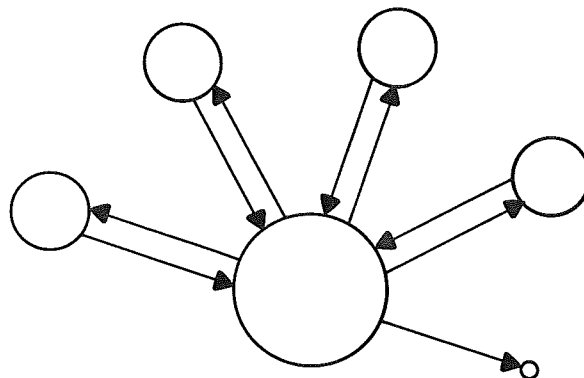

Fig. 4.4 - A mammillary tank system.

The classifications given so far only reflect the way in which the tanks are interconnected. Other classifications also reflect the numerical values of the flows. A is called system symmetric if the flow between any pairs of tanks

labelled i and j are such that the flow from tank i to tank j is the same as the flow from tank j to tank i .

Flow Systems.

It will be shown later that many properties of a flow system can be found from impulse response measurements. To trace the flow it is assumed that part of the fluid can be labelled. The labelled substance is called the tracer. The tracer can be introduced in many different ways, by injecting it into a sink or a tank or into several tanks. Through the flow the tracer is then propagated into different tanks. The tracer propagation will now be analysed. It will be assumed that there is perfect mixing in the tanks. It will also be assumed that the transit times in the pipes are negligible.

Assume that there are n tanks numbered from one through n , let the sources be numbered from $n+1$ to ℓ and the sinks from $\ell+1$ to m . Let q_{ij} denote the flow from the j :th node to the i :th node. The flows are defined as zero if there is no pipe connecting two nodes and they are always nonnegative i.e.

$$q_{ij} \geq 0 \quad i \neq j \quad (4.1)$$

It is assumed that there is no inflow to the sources, i.e.

$$q_{ij} = 0 \quad i = n+1, \dots, \ell \quad j = 1, \dots, m \quad (4.2)$$

This means that in the graph all branches originating at a source will be directed away from the source. Similarly it is assumed that there is no outflow from a sink, i.e.

$$q_{ij} = 0 \quad i = 1, \dots, m \quad j = \ell+1, \dots, m \quad (4.3)$$

The total outflow from the i :th node is defined as $-q_{ii}$.
Hence

$$-q_{ii} = \sum_{j \neq i}^m q_{ji} = \sum_{j \neq i}^m q_{ij} \quad i = 1, 2, \dots, \ell \quad (4.4)$$

where the last equality follows from the fact that there is no accumulation of fluid in the tanks.

Let V_i denote the volume of the i :th tank and let c_i be the concentration of the labelled substance of the i :th node. A mass balance for the labelled substance in the i :th tank now gives

$$V_i \frac{dc_i}{dt} = \sum_{j=1}^{\ell} q_{ij} c_j \quad i = 1, 2, \dots, n \quad (4.5)$$

The last equality follows from the equation (4.4). Since all tank volumes are assumed positive, we also get

$$\frac{dc_i}{dt} = \sum_{j=1}^{\ell} (q_{ij}/V_i) c_j \quad i = 1, 2, \dots, n \quad (4.6)$$

It is assumed that there is ideal mixing of the inflows at the sinks. The tracer concentration at the i :th sink is then given by

$$c_i = \left(\sum_{j=1}^{\ell} q_{ij} c_j \right) / q_{ii} = \left(\sum_{j=1}^{\ell} q_{ij} c_i \right) \left(\sum_{j=1}^{\ell} q_{ij} \right)^{-1} \quad i = \ell+1, \dots, m \quad (4.7)$$

The equations (4.6) and (4.7) can be written as

$$\begin{aligned} \frac{dx}{dt} &= Ax + Bu \\ y &= Cx + Du \end{aligned} \tag{4.11}$$

which is the standard form for a linear, dynamical system. Notice, however, that the matrices A, B, C and D have the properties

$$\begin{aligned} a_{ij} &\geq 0 & i \neq j \\ b_{ij} &\geq 0 \\ c_{ij} &\geq 0 \\ d_{ij} &\geq 0 \end{aligned} \tag{4.12}$$

and

$$\sum_{j=1}^n a_{ij} + \sum_{j=1}^r b_{ij} = 0 \quad i = 1, 2, \dots, n \tag{4.13}$$

$$\sum_{j=1}^n c_{ij} + \sum_{j=1}^r d_{ij} = 1 \quad i = 1, 2, \dots, p \tag{4.14}$$

The equations describing the propagation of a tracer in a tank system can be interpreted as state equations for a linear, time invariant dynamical system. The special properties of the tracer equations are expressed by the conditions (4.12), (4.13) and (4.14). These conditions are so far-reaching that they motivate the introduction of a special notion.

Definition 4.1.

A flow system is a linear, time invariant dynamical system $S(A,B,C,D)$ where the matrices A , B , C , and D have the properties given by the equations (4.12), (4.13) and (4.15).

Eigenvalues.

The properties of flow systems will now be analysed. In particular it will be shown that the Definition 4.1 of a flow system is compatible with the previous Definition 3.1. Before this can be done it is necessary to analyse the eigenvalues of the system (4.11).

The eigenvalues of the matrix A in equation (4.11) will be investigated. It will be shown in general that the eigenvalues are in the left half plane for an open flow system. Closed, irreducible systems may have an isolated eigenvalue at the origin. Stronger statements about the eigenvalues will be made for systems with a special topology.

It is convenient for the analysis to introduce the matrix

$$Q = \{q_{ij}, i, j = 1, \dots, n\}$$

which is the matrix of flows in the pipes connecting the tanks. The structure of the graph of a tank system is reflected in properties of the matrix Q . If there is no flow from tank j to tank i , then q_{ij} is zero. For a reducible system it is always possible to relabel the tanks in such a way that the tanks in the subset which are not connected with the rest of the systems are num-

bered sequentially from $i = 1$. The matrix Q then has the block diagonal structure

$$Q = \begin{vmatrix} Q_1 & 0 \\ 0 & Q_2 \end{vmatrix}$$

Since the matrix A is given by

$$A = V^{-1}Q$$

where V is the diagonal matrix whose elements are the tank volumes, i.e.

$$V = \text{diag}\{V_1, V_2, \dots, V_n\}$$

the matrix A also has a block diagonal structure for a reducible system. The eigenvalues of the matrix A will first be investigated. We have

Theorem 4.1.

Consider an irreducible tank system. All eigenvalues of the matrix A of the tracer equations have strictly negative real parts if the system is open. If the system is closed, there is also an isolated eigenvalue $\lambda = 0$.

Proof. It follows from a theorem by Gersgorin that all eigenvalues of the matrix A are in the union of the sets

$$|s - a_{ii}| = \sum_{j \neq i} |a_{ji}|$$

See Bellman (1960 p. 106).

Since $a_{ij} \geq 0$, $i \neq j$ and $b_{ij} \geq 0$, it follows from (4.13) that

$$\sum_{j \neq i} a_{ji} \geq a_{ii}$$

All eigenvalues are thus in the left half plane. If the system is closed, all inequalities above are reduced to equalities. Hence

$$\sum_{j=i}^n a_{ji} = 0 \quad i = 1, \dots, n$$

which means that there is an eigenvalue $\lambda = 0$ corresponding to the left eigenvector

$$e_1 = (1 \quad 1 \quad \dots \quad 1)$$

Now consider the matrix

$$B = A + I \cdot \max_i (-a_{ii}) = A + kI$$

The matrix B is a non-negative matrix, i.e. all its elements are non-negative. It then follows from a theorem by Frobenius that B has a positive eigenvalue λ which is simple. See Gantmacher (1960 p. 53). All other eigenvalues are less than or equal to λ in magnitude, and all elements of the corresponding eigenvector are positive. Let e denote the eigenvector then

$$(A+kI)e = \lambda e$$

$$Ae = (\lambda - k)e$$

(4.15)

If the system is open, we have

$$\sum_{j=1}^n a_{ji} \leq 0$$

where there is a strict inequality for at least one i . The equation (4.15) now gives

$$0 > \sum_{j=1}^n \sum_{i=1}^n a_{ji} e_i = (\lambda - k) \sum_{i=1}^n e_i$$

Since all e_i are positive, we thus find that

$$\lambda < k = \max(-a_{ii})$$

and the eigenvalues of the matrix B are then inside or on the circle $|s| \leq \lambda < k$. The eigenvalues of the matrix A are then inside or on the circle

$$|s - k| \leq \lambda < k$$

But this circle is strictly in the left half plane, and the proof is complete. □

Remark. A reducible system can be divided into irreducible subsystems. Applying the theorem to each subsystem we find that a reducible system has eigenvalues with strictly negative real parts if all subsystems are connected to sinks and sources. We also find that the only eigenvalues with zero real parts are $\lambda = 0$. If there are multiple eigenvalues at the origin, they are associated with different subsystems and thus also different Jordan blocks. All flow systems are thus stable although not necessarily asymptotically stable.

The eigenvalues associated with some special tank system will now be investigated.

Symmetric Systems.

For a symmetric system we have

Theorem 4.2.

Consider a symmetric tank system. The eigenvalues of the matrix A of the tracer equations are then real and non-positive.

Proof. It follows from Theorem 4.1 that the eigenvalues are nonpositive. Since the system is symmetric, it follows that Q is symmetric. Now let W denote the positive square root of the diagonal matrix V . Then $Q = W^2 A$ and we get

$$\begin{aligned} WAW^{-1} &= W^{-1}(W^2 A)W^{-1} = W^{-1}QW^{-1} = W^{-1}Q^T W^{-1} = \\ &= W^{-1}A^T W^2 W^{-1} = W^{-1}A^T W \end{aligned}$$

The matrix WAW^{-1} is thus symmetric and has real eigenvalues. Since eigenvalues remain invariant under similarity transformations, the matrix A has also real eigenvalues.

□

Catenary Systems.

Now consider catenary systems. See Fig. 4.2. Let there be n tanks in the chain numbered consecutively from 1 to n . The matrix A then has the form

$$A = \begin{vmatrix} -\alpha_1 & \beta_1 & & 0 \\ \gamma_2 & -\alpha_2 & \beta_2 & \\ & \ddots & \ddots & \ddots \\ 0 & \gamma_{n-1} & -\alpha_{n-1} & \beta_{n-1} \\ & & \gamma_n & -\alpha_n \end{vmatrix} \quad (4.16)$$

where α_i , β_i and γ_i are positive, real numbers. We have the following result.

Theorem 4.3.

Consider a catenary tank system. Then all the eigenvalues of the matrix A of the tracer equations are real.

Proof. Introduce

$$d_k(\lambda) = \det \begin{vmatrix} \lambda + \alpha_1 & -\beta_1 & & 0 \\ -\gamma_2 & \lambda + \alpha_2 & -\beta_2 & \\ & & \ddots & \ddots \\ 0 & & & -\beta_{k-1} \\ & & -\gamma_k & (\lambda + \alpha_k) \end{vmatrix}$$

Elementary rules for calculation with determinants give

$$d_1(\lambda) = \lambda + \alpha_1 \quad (4.17)$$

$$d_{k+1}(\lambda) = (\lambda + \alpha_{k+1})d_k(\lambda) - \gamma_{k+1}\beta_k d_{k-1}(\lambda) \quad k \geq 1 \quad (4.18)$$

where we have defined

$$d_0(\lambda) = 1$$

The characteristic polynomial of the matrix A is then equal to $d_n(\lambda)$.

The theorem will first be proven in the case

$$\gamma_{k+1}\beta_k > 0 \quad k = 1, \dots, n-1$$

The polynomial $d_0(x)$ does not vanish for any x .

If one of the polynomials $d_k(x)$ in the sequence $d_0(x), \dots, d_n(x)$ vanishes we have

$$d_{k+1}(x)d_{k-1}(x) = -\gamma_{k+1}\beta_k d_{k-1}^2(x) < 0 \quad (4.19)$$

The polynomials $d_0(x), d_1(x), \dots, d_n(x)$ thus form a Sturm sequence. Let $V(x)$ denote the number of variations in sign of the sequence for a fixed x . The value of $V(x)$ can only change when one of the functions of the sequence changes sign. Because of (4.19) the value of $V(x)$ does, however, not change when $d_1(x), \dots, d_{n-1}(x)$ changes sign. We thus find that $V(b) - V(a) =$ number of sign changes of $d_n(x)$ in (a, b) since $V(+\infty) = 0$ and $V(-\infty) = n$. The function $d_n(x)$ has n sign changes on $(-\infty, \infty)$. Because $d_n(x)$ is a polynomial of degree n it must thus have n real roots.

To handle the case where $\gamma_{k+1}\beta_k$ vanishes for some value of k the matrix is simply partitioned into block triangular form, and the result above is applied to each block.

□

Cyclic Systems.

The eigenvalues of the matrix A for a cyclic tank system can be both real and complex as shown in the examples below.

Example 4.1.

Consider the closed tank system shown in Fig. 4.5.

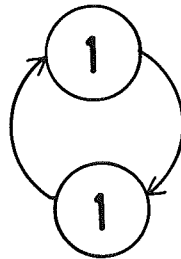

Fig. 4.5 - A simple cyclic tank system.

Since all volumes are equal, the matrix A becomes

$$A = Q = \begin{pmatrix} -1 & +1 \\ +1 & -1 \end{pmatrix}$$

The matrix has real eigenvalues since it is symmetric. The characteristic polynomial is

$$d(s) = (s+1)^2 - 1 = s(s+2)$$

Example 4.2.

Consider the closed tank system shown in Fig. 4.6.

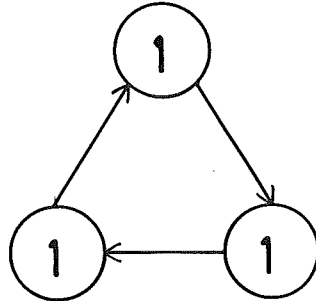

Fig. 4.6 - A simple cyclic tank system.

Since all volumes equal one, we have

$$A = Q = \begin{pmatrix} -1 & 0 & 1 \\ 1 & -1 & 0 \\ 0 & 1 & -1 \end{pmatrix}$$

The characteristic polynomial is

$$\begin{aligned} d(s) &= (s+1)^3 - 1 = s(s^2+3s+3) = \\ &= s(s-1.5+i\sqrt{3/2})(s-1.5-i\sqrt{3/2}) \end{aligned}$$

which obviously has two complex zeroes.

□

Mammillary Systems.

Now consider a mammillary system. See Fig. 4.4. Let the central tank have index $i = 1$. Since there are no pipes connecting peripheral tanks to each other, we have $q_{ij} = 0$ for $i \neq j$ and $i, j > 1$. For a mammillary system the matrix A thus has the following form

$$A = \begin{pmatrix} a & b \\ c & d \end{pmatrix}$$

where a is a scalar, b a row vector, c a column vector and d a diagonal matrix. We have the following result.

Theorem 4.4.

Consider mammillary tank system, let the central tank have index 1. Assume that the flows are such that $q_{j1} \cdot q_{1j} > 0$ for $j > 1$. Then all eigenvalues of the matrix A are real. Moreover, if all number q_{ii}/V_i , $i \geq 1$ are different, then the eigenvalues of A are separated by q_{ii}/V_i .

Proof. To prove that the eigenvalues are real it will be shown that the matrix A can be transformed to a symmetric matrix by similarity transformations. Let the matrix S be defined by

$$S = \begin{pmatrix} 1 & 0 \\ 0 & U \end{pmatrix}$$

where U is nonsingular. Then

$$SAS^{-1} = \begin{pmatrix} 1 & 0 \\ 0 & U \end{pmatrix} \begin{pmatrix} a & b \\ c & D \end{pmatrix} \begin{pmatrix} 1 & 0 \\ 0 & U^{-1} \end{pmatrix} = \begin{pmatrix} a & bU^{-1} \\ cU & UDU^{-1} \end{pmatrix}$$

This matrix is symmetric if

$$bU^{-1} = U^T c^T$$

If U e.a. is chosen as a diagonal matrix, we get

$$b_i = u_i^2 c_i$$

In the particular case we have

$$b_i = q_{i+1}^2 / v_i$$

$$c_i = q_i^2 / v_{i+1}$$

Because of the assumption $q_{j1} q_{1j} > 0$ the numbers b_i and c_i will thus vanish simultaneously, and we can thus choose

$$u_i = \begin{cases} \sqrt{b_i / c_i} & \text{for indices such that } c_i \neq 0 \\ 1 & \text{otherwise} \end{cases}$$

and we have thus constructed a similarity transformation which transforms the matrix A to a symmetric matrix.

To prove the second part of the theorem the characteristic equation will be analysed in detail. We have

$$d(s) = \det[sI - A] = \begin{vmatrix} s - a_{11} & -a_{12} & \dots & -a_{1n} \\ -a_{21} & s - a_{22} & & \\ & & & \\ -a_{n1} & 0 & & s - a_{nn} \end{vmatrix}$$

where it is assumed that the elements are ordered such that $a_{11} < a_{22} < \dots < a_{nn} < 0$

$$a_{ii} = q_{ii}/V_i$$

$$a_{ij} = q_{1j}/V_i$$

$$a_{il} = q_{il}/V_i$$

Eliminate the second element in the first column by adding the second column multiplied by $a_{21}/(s-a_{22})$ and proceed similarly to eliminate all off diagonal elements in the first column. The characteristic polynomial can then be written as

$$\begin{aligned} d(s) &= \left| s - a_{11} - \sum_{j=2}^n \frac{a_{1j}a_{j1}}{s - a_{jj}} \right|_{i=2}^n (s - a_{ii}) = \\ &= f(s) \prod_{i=2}^n (s - a_{ii}) \end{aligned}$$

Since all a_{ii} are distinct, $d(a_{ii}) = a_{1j}a_{j1} \neq 0$. Furthermore

$$f(a_{ii} + \varepsilon) = \begin{cases} -\infty & \varepsilon > 0 \\ +\infty & \varepsilon < 0 \end{cases}$$

and we can thus conclude that f must vanish in the intervals $(a_{i+1, i+1}, a_{ii})$. Since $f(s) \rightarrow -\infty$ as $s \rightarrow -\infty$, there is also a zero at $f(s)$ in the interval $(-\infty, a_{nn})$. Furthermore

$$f(0) = -a_{11} - \sum_{j=2}^n \frac{a_{1j}a_{j1}}{-a_{jj}} \geq -a_{11} - \sum_{j=2}^n a_{1j} \geq 0$$

where the inequalities follow from the equation (4.13). The inequalities in the above equation degenerate to equalities if the system is closed. In such a case the characteristic equation has a zero at the origin. Otherwise there is a zero in the interval $(a_{nn}, 0)$, and the proof is thus completed. \square

The Transition Matrix and the Impulse Response.

The transition matrix of a flow system has the following property.

Theorem 4.4.

The transition matrix of a flow system is a matrix with nonnegative elements.

Proof. The elements of the transition matrix are obtained as the solutions of the differential equations

$$\frac{dx_i}{dt} = a_{ii}x_i + \sum_{j \neq i} a_{ij}x_j$$

where the initial conditions are such that $x_i(0) = 0$, $i \neq k$ and $x_k(0) = 1$. We have

$$\frac{d}{dt} (e^{-a_{ii}t} x_i) = \sum_{j \neq i} a_{ij} e^{-a_{ii}t} x_j$$

Since the system is a flow system, all a_{ij} with $i \neq j$ are nonnegative. When the initial conditions are nonnegative, it thus follows that $x_i(t) \geq 0$ and the theorem is proven. □

The impulse response of an irreducible open flow system with one inlet and one outlet, see Fig. 4.7, will now be analyzed.

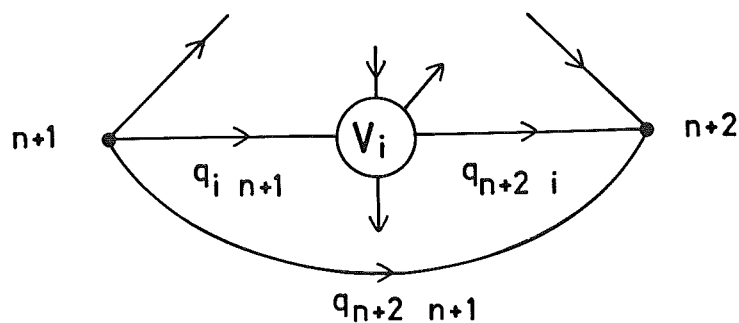

Fig. 4.7 - Graph of an open flow system with one inlet and one outlet.

The tracer equations (4.8) give

$$V_i \frac{dc_i}{dt} = \sum_{j=1}^{n+1} q_{ij} c_j$$

Assuming that the system is initially at rest and that the inflow is chosen as a unit impulse then

$$V_i [c_i(\infty) - c_i(0)] = \sum_{j=1}^n q_{ij} \int_0^{\infty} c_j(t) dt + q_{i n+1} \cdot 1 \quad (4.19)$$

The left hand side vanishes because the system is stable according to Theorem 4.1. It also follows from the same theorem that the matrix $\{q_{ij}; i, j = 1, \dots, n\}$ has all its eigenvalues strictly in the left half plane. The above equation can thus be solved for

$$\int_0^{\infty} c_j(t) dt$$

Since

$$\sum_{j=1}^{n+1} q_{ij} = 0$$

the solution is

$$\int_0^{\infty} c_j(t) dt = 1$$

The tracer concentration at the sink is

$$c_{n+2}(t) = \left[q_{n+2, n+1} c_{n+1}(t) + \sum_{i=1}^n q_{n+2, i} c_i(t) \right] / q_{n+2, n+2}$$

If the inlet flow is an impulse we thus get

$$\int_0^{\infty} c_{n+2}(t) dt = \left(q_{n+2, n+1} + \sum_{i=1}^n q_{n+2, i} \right) / q_{n+2, n+2} = 1$$

because the sum of the terms within brackets equals the total outflow which is $q_{n+2, n+2}$.

Similarly multiplication of (4.19) by t and integration gives

$$\begin{aligned} \int_0^{\infty} t V_i \frac{dc_i}{dt} &= \int_0^{\infty} t V_i c_i - V_i \int_0^{\infty} c_i(t) dt = \\ &= \sum_{j=1}^{n+1} q_{ij} \int_0^{\infty} t c_j(t) dt \end{aligned}$$

Hence

$$- V_i = \sum_{j=1}^n q_{ij} \int_0^{\infty} t c_j(t) dt$$

and

$$\begin{aligned} - \sum_{i=1}^n V_i &= \sum_{j=1}^n \sum_{i=1}^n q_{ij} \int_0^{\infty} t c_j(t) dt = \\ &= - \sum_{j=1}^n q_{n+1 j} \int_0^{\infty} t c_j(t) dt \end{aligned}$$

Since the tank system is irreducible and only has one outlet, the quantity

$$\sum_{j=1}^n q_{n+1 j}$$

equals the total outflow of the tanks, Hence

$$V = q \int_0^{\infty} t h(t) dt$$

where V denotes the total tank volume and q the total outflow. It has thus been shown directly that the Stewart-Hamilton equation holds for the system. Summarizing the results we get

Theorem 4.5.

Consider an irreducible tank system with one inflow and one outflow. Let h be the impulse response of the associated flow system. Then

$$h(t) \geq 0$$

$$\int_0^{\infty} h(t) dt = 1$$

and

$$V = q \int_0^{\infty} th(t) dt$$

where V denotes the sum of all the tank volumes, and q denotes the total inflow.

Identifiability.

It has been found that the propagation of a tracer through a tank system can be characterized by a linear, time invariant dynamical system which has special properties. The name "flow system" was given to such dynamical systems. The properties of flow systems have also been investigated. The properties of a tank system that can be found from a tracer experiment will now be explored. The experiments can be performed in many different ways. A tracer can be injected into a tank, into a source or into a pipe. The tracer concentration can be measured in a tank or in a pipe. In some cases it is also possible to measure the total tracer concentration in several tanks. There are many different problems that can be posed, for example

- o Determine the total number of tanks.
- o Discriminate between two structures.
- o Given a structure, determine the flows and the tank volumes.

A tracer experiment will typically give the impulse response or equivalently the transfer function of a flow system. The possibility to determine the volumes and flows from a measured impulse response or from a measured transfer function will now be investigated. This is a problem of parameter identifiability. Since the mapping relating physical parameters to the coefficients of the transfer function is nonlinear it is possible to resolve the identifiability problem in special cases only. A more general discussion on identifiability is given in Chapter X.

Example 4.3.

Consider the tank system whose graph is shown in Fig. 4.8. Assume that a tracer is injected momentarily into the first tank and that the tracer concentration is measured in the same tank. The possibility to determine the tank volumes V_1 and V_2 and the flows q_1 and q_2 will now be investigated.

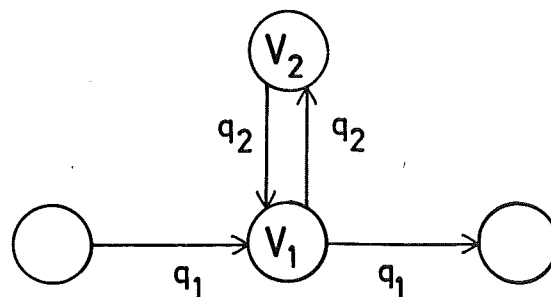

Fig. 4.8 - Graph of a simple tank system.

The tracer equations are

$$V_1 \frac{dc_1}{dt} = - (q_1 + q_2)c_1 + q_2c_2 + q_1c_i$$

$$V_2 \frac{dc_2}{dt} = q_2c_1 - q_2c_2$$

With the given experimental conditions the tracer concentration c_i of the inflow is zero. If the amount of tracer injected is M , the initial conditions become

$$c_1(0) = M/V_1$$

$$c_2(0) = 0$$

The volume V_1 can thus be determined from the total amount of tracer M and the initial concentration in tank number one.

It is easily found that the Laplace transform of the concentration in the first tank is given by

$$\begin{aligned} C_1(s) &= \frac{M}{V_1} \cdot \frac{s + q_2/V_2}{s^2 + s[(q_1 + q_2)/V_1 + q_2/V_2] + q_1q_2/(V_1V_2)} = \\ &= K \cdot \frac{s + b}{s^2 + a_1s + a_2} \end{aligned}$$

Analysing the concentration curve it is possible to determine all coefficients of s in this rational function. The parameter combinations q_1/V_1 , q_2/V_2 and q_2/V_1 can thus be determined. Since V_1 was already determined, it is thus found that all the desired parameters can be determined from the proposed experiment.

□

To show that the volumes and the flows cannot always be determined uniquely the Example 4.3 will be modified slightly.

Example 4.4.

Consider the system shown in Fig. 4.8. Assume that a tracer experiment is performed as in Example 4.3 by injecting a tracer into tank 1 but that the tracer concentration in tank 2 is measured. Let the total amount of injected tracer be M . The Laplace transform of the measured tracer concentration is then

$$C_2(s) = \frac{M}{V_1} \cdot \frac{q_2/V_2}{s^2 + s[(q_1+q_2)/V_1 + q_2/V_2] + q_1q_2/(V_1V_2)} =$$

$$= M \cdot \frac{b}{s^2 + a_1s + a_2}$$

where

$$a_1 = (q_1+q_2)/V_1 + q_2/V_2$$

$$a_2 = q_1q_2/(V_1V_2)$$

$$b = q_2/(V_1V_2)$$

By analysing the measured tracer concentration it is thus possible to determine the parameters a_1 , a_2 and b . These coefficients are, however, not sufficient to determine two flows q_1 and q_2 and two volumes V_1 and V_2 uniquely. To be specific the flow q_1 is uniquely given by

$$q_1 = a_2/b$$

The other variables are given as a one parameter family

$$V_1 = \text{arbitrary pos}$$

$$q_2 = a_1 V_1 - a_2/b - bV_1^2$$

$$V_2 = q_2/(bV_1)$$

The variables can also be parametrized as follows

$$V_2 = \text{arbitrary positive}$$

$$V_1 = q_1/\alpha$$

$$q_2 = a_2 V_2/\alpha$$

where α is a root of the equation

$$\alpha^2 - (a_1 - bV_2)\alpha + a_2 = 0$$

□

Example 4.3 is thus a case where all volumes and flows can be determined from the proposed experiment while Example 4.4 shows a situation where the volumes and flows cannot be determined uniquely. Since investigations of parametric identifiability reduces to the analysis of nonlinear algebraic equations it is very little to be said about the general problem. Some results are, however, available for systems having a special topology.

Catenary Systems.

The possibility to determine the volumes and the flows of a catenary system will now be investigated. There are several different cases to consider. If the system is open the inflow and the outflow can be arranged in many different ways as is shown in Fig. 4.9. The tracer experiment can also be performed in many different ways. The tracer can be injected into the inflow or into a tank. The concentration of the tracer can be measured in the outflow or in a tank. If a radioactive tracer is used it is also possible to measure the total tracer concentration in several tanks.

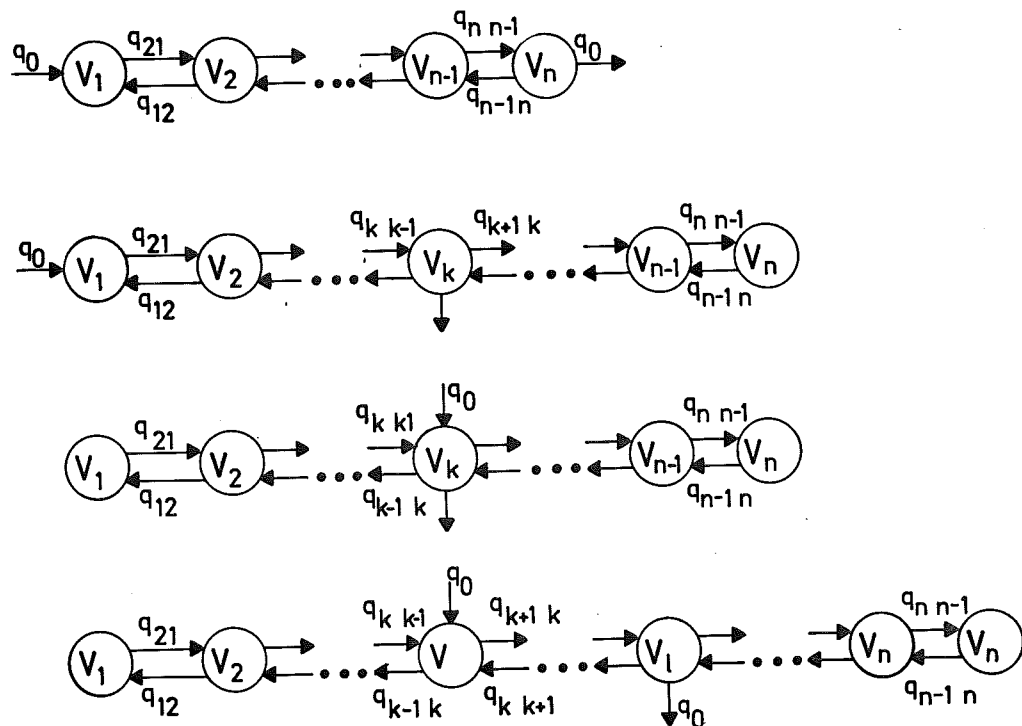

Fig. 4.9 - Examples of open catenary systems having different arrangements of inlets and outlets.

Assuming that there are n tanks in the system there are $2n$ parameters to determine in an open system namely n tank volumes and n flows. For a closed system there are only $n-1$ unknown flows.

The analysis boils down to investigating the nonlinear function which maps the volumes and flows to the parameters of the transfer function obtained in a tracer experiment. The analysis is tedious because many different cases have to be considered. We have

Theorem 4.6.

Consider a catenary system which is closed, or open with one inlet and one outlet. Assume that there is a bidirectional flow between all tanks. Let an experiment be performed by injecting a tracer in one end tank and let the tracer concentration be measured in the same tank. Then all volumes and flows can be determined if the total amount of injected tracer is known.

Remark 1. The arrangement of the inlet and the outlet must be known a priori.

Remark 2. If the tracer is not measured in the tank where it was injected all volumes and flows cannot be determined.

Remark 3. If the tracer is injected and measured in a tank which is not an end tank the volumes and flows can in general not be determined uniquely. Excluding parameters in an algebraic variety there are $\binom{n-1}{m-1}$ different sets of volumes and flows which are consistent with the measurements, where n is the number of tanks and m the number of tanks between the inlet and the closest end tank.

The proof of the theorem is given in Appendix A.

The tracer experiment can also be performed by injecting the tracer in the inlet and measuring the tracer concentration in the outlet. Provided that the total amount of injected tracer is known the identifiability conditions in this case are also given by Theorem 4.6.

Mammillary Systems.

The determination of volumes and flows in mammillary tank systems will now be explored. In analogy with catenary systems there are many different possibilities depending on the experiment and the arrangement of the inlet and the outlet. See Fig. 4.10. For the case when a tracer is injected in one tank and the tracer concentration is measured in a tank the following result is obtained.

Theorem 4.7.

Consider an irreducible mammillary system which is open or has one inlet and one outlet. Assume that the position of the inlet and the outlet are known. Then all volumes and flows can be determined from a tracer experiment if the tracer is injected into one tank and the tracer concentration is measured in the same tank. If the tracer is injected into one tank and if the tracer concentration is measured in another tank, all volumes and flows cannot be determined uniquely.

Proof. The proof which is straightforward but tedious is given in Appendix B.

For open flow systems it is natural to analyse the system by injecting a tracer in the inlet and measuring the tracer concentration in the outlet. The system is identifiable

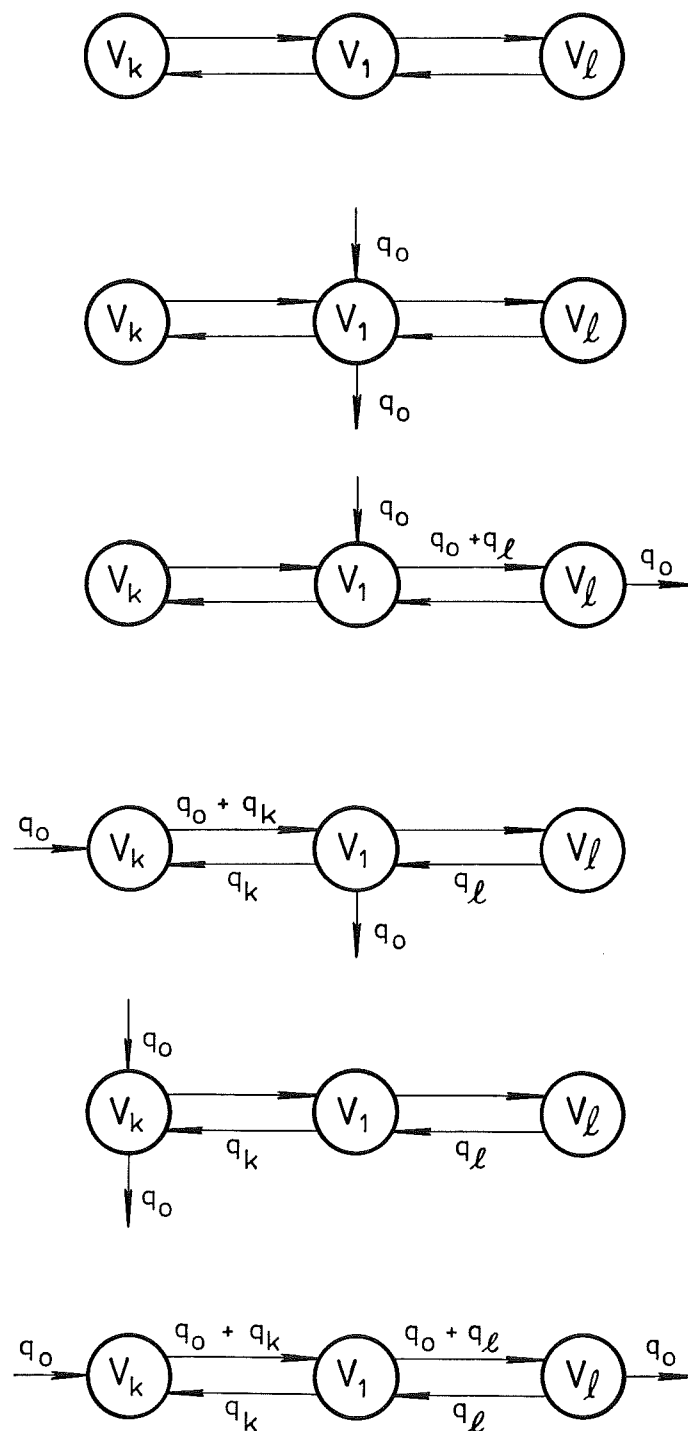

Fig. 4.10 - Graphs of mammillary systems having different arrangements of inlets and outlets.

if the total amount of injected tracer is known and if the inlet and the outlet are to the same tank.

Compartment Analysis.

Flow systems are frequently used as models for ecological and physiological processes. In this context they are often referred to as compartment models. The models arise when it is attempted to analyse the generation, transportation and disintegration of a substance in a system. The fundamental assumption is that there are parts of the system, called compartments, where the concentration of the substance is constant. The transportation of the substance between the compartments is governed by processes like convection, diffusion, membrane processes and chemical reactions. The transport rate will depend on many factors like concentration, ion mobility and the nature of the driving forces. Even if the transport phenomena are very complex, it may be assumed by the usual linearization assumption that the massflow r_{ij} from compartment j to compartment i is proportional to the concentration i.e.

$$r_{ij} = \lambda_{ij}c_j, \quad \lambda_{ij} \geq 0 \quad (4.20)$$

The parameters λ_{ij} are nonnegative since r_{ij} and c_i are nonnegative by definition. If the transport is governed by diffusion only we have

$$\lambda_{ij} = \lambda_{ji}$$

If the concentration of a substance is constant throughout a compartment we have

$$c_i = Q_i/V_i \quad (4.21)$$

where Q_i is the total amount of substance in the compartment and V_i is the compartment volume. Notice, however, that the concentration must not necessarily be uniform throughout a compartment. A compartment may be composed of parts where the concentrations are different provided that the exchange of the substance is so rapid that the concentrations in different parts are always proportional.

Provided that there is neither generation nor destruction of the substance in a compartment a mass balance for the substance in the i :th compartment gives

$$V_i \frac{dc_i}{dt} = \sum_{j \neq i} \lambda_{ij} c_j - \left(\sum_{j \neq i} \lambda_{ji} \right) c_i$$

Introducing

$$\lambda_{ii} = - \sum_{j \neq i} \lambda_{ij}$$

the equation above is conveniently written as

$$V_i \frac{dc_i}{dt} = \sum_j \lambda_{ij} c_j \quad (4.22)$$

where

$$\lambda_{ij} \geq 0 \quad \text{and} \quad \sum_i \lambda_{ij} = 0 \quad (4.23)$$

The net flow from compartment j to compartment i is then

$$r_{ij} - r_{ji} = \lambda_{ij} c_j - \lambda_{ji} c_i$$

If $\lambda_{ij} = \lambda_{ji}$ the net flow becomes

$$r_{ij} - r_{ji} = \lambda_{ij}(c_j - c_i)$$

which means that the flow is driven by the concentration gradient (Fick's law). Notice, however, that the assumption (4.20) is much more general. It allows for example that there is material transport in a direction opposite to the concentration gradient. Such mechanism may be found in material transport across a cell membrane. Also notice that the equation (4.20) cannot be expected to describe the transport for large concentrations because the mechanisms are most likely nonlinear.

Under the assumption (4.20) the equation (4.22) which describes the mass transport is thus a flow system in the sense of Definition 4.1. In particular, the flow system is symmetric if all mass transport is by diffusion.

Flow systems are thus useful to describe the kinetics of material transport in a compartment system. In this sense compartment systems are also analogues of tank systems if the coefficients λ_{ij} , which appear in the linearized expressions (4.20) for the flow rates, are interpreted as flows.

In several applications it is of significant interest to determine the total amounts of substance in the compartments and the transport rates. In steady state these quantities are constants. Their values can be determined by a tracer experiment in the same way as the flows and volumes of a tank system could be determined. It is thus assumed that the substance (sometimes referred to as mother substance) is tagged with a tracer and that a small amount of the tagged substance is introduced in a system in equilibrium. A mass balance for the tracer in the i :th compartment gives

$$Q_i \frac{da_i}{dt} = \sum_{j \neq i} r_{ij} a_j - a_i \sum_{j \neq i} r_{ji} = \sum_j r_{ij} a_i \quad (4.24)$$

where a_k is the proportion of tracer in compartment k . The coefficients r_{ij} are positive by definition and r_{ii} is defined by

$$r_{ii} = - \sum_{j \neq i} r_{ji}$$

Provided that there is no destruction or generation of the substance a mass balance gives

$$\sum_j r_{ij} = \sum_j r_{ji} = 0 \quad (4.25)$$

Compartment systems in equilibrium are thus equivalent to tank systems if compartments, mass of substance in a compartment Q_k and mass transportation rates r_{ij} are identified with tanks, volumes V_k and volume flow rates q_{ij} respectively. Tracer analysis can thus be used to determine transport rates and the amount of substance in a compartment in the same way as it was used to determine flows and volumes in tank systems. The technique has been used extensively in physiology.

Example 4.5.

The metabolism of proteins can be crudely described as follows. Proteins in the food are broken down into amino acids in the process of digestion. The amino acids enter the blood stream and are carried to all parts of the body where they are utilized in the cells to synthesize proteins. Amino acids are also used to produce new cells, enzymes and hormones. Amino acids which are not used are deaminized in the liver to form urea. Urea leaves the liver through the blood stream and is excreted by the kid-

neys in the urine. The urea in the urine is also partly created from breakdown of proteins in various tissues of the body. The process can be described by the simplified compartmental model shown in Fig. 4.11. The model has three compartments representing amino acids in the body, urea and protein.

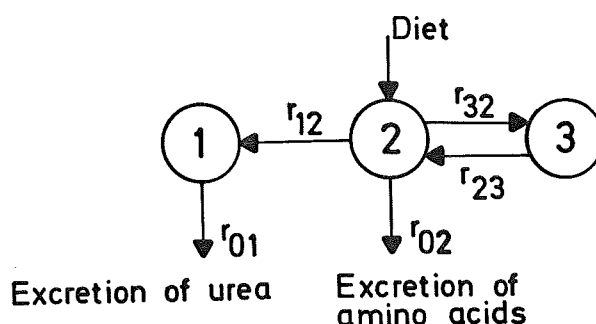

Fig. 4.11 - Compartmental model representing metabolism of protein. The compartments 1, 2 and 3 represent urea, amino acids and protein resp.

Assuming that the system is in equilibrium it can be attempted to determine the amounts of nitrogen in the compartments and the flow rates by tracer analysis. Such experiments have been performed by taking radioactive nitrogen (^{15}N -glycine) orally and measuring the total excretion of ^{15}N .

An analysis of the identifiability conditions show that the compartment sizes and the flow rates cannot be determined from such an experiment. The excretion of urea can, however, be determined by separate methods, and the remaining parameters can then be obtained from a tracer experiment. Rittenberg (1951) applied this technique and

obtained in a particular case the compartment sizes 5.65 g N in urea and 0.61 g N in amino acids. The flow rates obtained were $r_{32} = 39$ g N/day, $r_{23} \approx 0$, $r_{01} + r_{02} = 11.5$ g N/day. □

Pharmacokinetics.

It has been found empirically that a medical drug given to a human does not dissolve and spread instantaneously. The distribution of a drug in the human body can instead be described by a compartment model. The particular branch of compartmental analysis devoted to the dynamics of drug distribution is called pharmacokinetics. A model commonly used in pharmacokinetics is shown in Fig. 4.12. The model has three compartments roughly speaking representing the stomach, the blood including the intracellular fluid and the tissues. More complicated models are sometimes used. For example one might distinguish between different tissues.

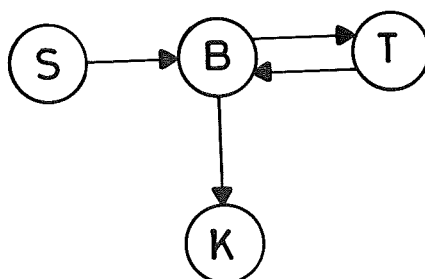

Fig. 4.12 - A simple pharmacokinetic model which describes the dynamics of drug propagation in the human body.

If the drug is taken through the mouth it first enters the stomach, compartment S, where it is dissolved. The drug then diffuses into the blood stream, compartment B. When the blood passes through the body, there is an exchange of drug between the blood and the tissues, compartment T. The drug is removed from the blood by the kidneys, and it is then excreted in the urine.

Standard recipes like to take two tablets every six hours found in handbooks are sometimes inadequate. For certain drugs like digitalis the concentration in the body is critical. For a proper treatment it is then important to understand the kinetics of drug transport both qualitatively and quantitatively. The required knowledge can sometimes be obtained from compartmental analysis and system identification. The identification experiment is performed by administering the drug orally (through the mouth) or in the blood stream and measuring the drug concentration in the different compartments.

If V_i are the compartment volumes and the transportation rates are given by (4.20) the drug kinetics is given by (4.22). In pharmacokinetics it is the custom to use the total amount of drug in a compartment as independent variables instead of the concentrations. The equation (4.22) then becomes

$$\frac{dQ_i}{dt} = \sum k_{ij} Q_j \quad (4.26)$$

where

$$k_{ij} = \lambda_{ij}/V_j \quad (4.27)$$

Notice that if the compartments representing elimination are also included it follows from (4.25) that

$$\sum_i k_{ij} = 0$$

This implies that

$$\sum \theta_i = \text{constant}$$

which means that the total amount of drug in the system is constant.

In pharmacokinetics it is customary to use the parameters k_{ij} defined by (4.27) instead of λ_{ij} . This is of course not a major issue, but it is useful to know that transport rates are defined using different parameters.

Example 4.6.

The kinetics of the drug digoxin is taken as an illustration. To find a model an experiment was performed by injecting the drug into the blood stream and by measuring the drug concentration in samples of the blood. The results of such an experiment are shown in Fig. 4.13. A candidate for a compartment model is shown in Fig. 4.14. The model contains five parameters, the compartment volumes V_1 and V_2 and the transport rate coefficients k_1 , k_2 and k_3 . By analogy with the analysis of tank systems, Theorem 4.7, it follows that these parameters can be determined from the given experiment. It will now be shown how this is done.

Let x_1 and x_2 denote the total amounts of the drug in the blood and tissue compartment respectively. The mass balances then give

$$\frac{dx_1}{dt} = -(k_1+k_2)x_1 + k_2x_2$$

$$\frac{dx_2}{dt} = k_1x_1 - k_2x_2$$
(4.28)

These equations are sufficient for the analysis to account for all mass we can also include the equation

$$\frac{dx_3}{dt} = k_2x_1$$

which represents the total excretion of the drug.

The corresponding time function is of the form

$$c(t) = Ae^{-\alpha t} + Be^{-\beta t}$$

It follows from Theorem 4.3 or Theorem 4.4 that α and β are real numbers.

The following simple graphical method is commonly used to analyse physiological data. The measured concentration is first plotted in semilogarithmic scales as shown in Fig. 4.13. For large t the curve has an asymptote whose slope is $-\beta$ where $1/\beta$ is the smallest time constant. The intercept of the asymptote gives the parameter B . The function $B \exp(-\beta t)$ is then subtracted from the measured concentration, and the resulting function is again plotted on semilogarithmic scales. See the crosses in Fig. 4.13. The curve obtained has an asymptote with slope $-\alpha$. The intercept of the asymptote gives A . In the particular case we find

$$c(t) = 14.1e^{-1.03t} + 1.06e^{-0.014t} = Ae^{-\alpha t} + Be^{-\beta t}$$

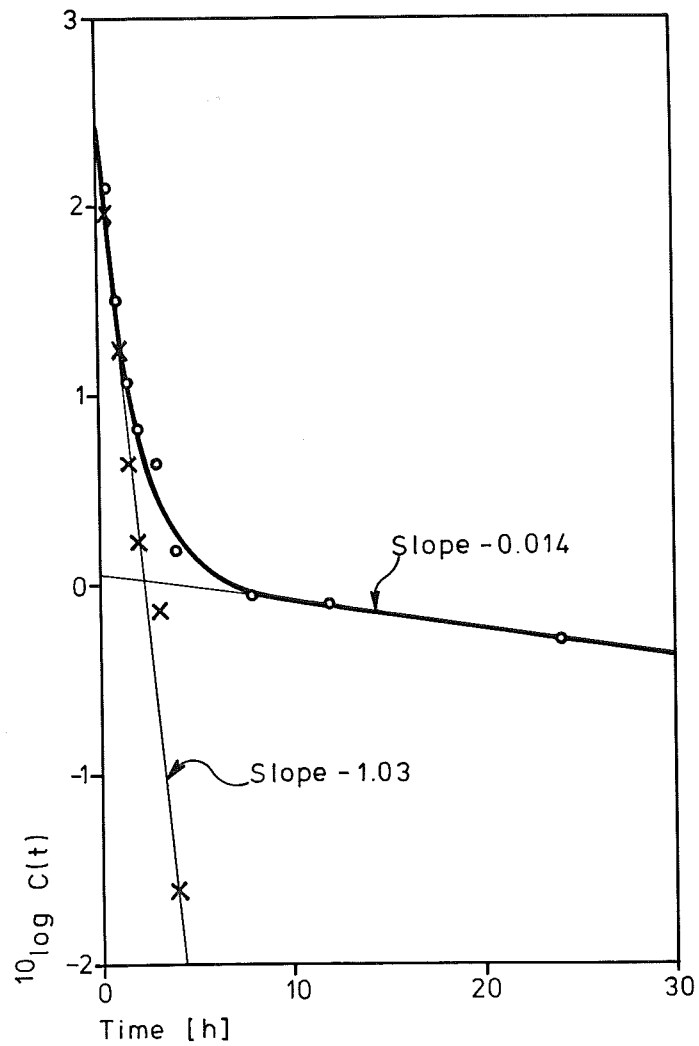

Fig. 4.13 - The concentration of digoxin in the blood obtained from an impulse test when digoxin is injected intravenously.

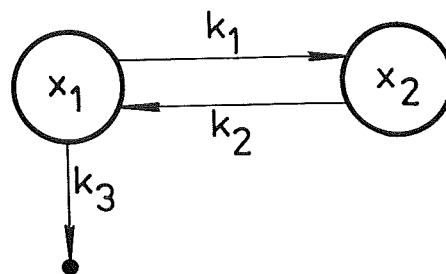

Fig. 4.14 - A simple compartment model which describes the digoxin kinetics.

The Laplace transform of this function is

$$C(s) = \frac{A}{s + \alpha} + \frac{B}{s + \beta} = \frac{(A+B)s + \alpha B + \beta A}{s^2 + s(\alpha + \beta) + \alpha\beta}$$

Comparing this expression with equation (4.29) gives the following set of algebraic equations

$$\frac{M}{V_1} = A + B$$

$$k_2 = \frac{\alpha B + \beta A}{A + B}$$

$$k_1 + k_2 = \alpha + \beta$$

$$k_2 k_3 = \alpha\beta$$

These equations can be solved with respect to the parameters V_1 , k_1 , k_2 and k_3 which characterizes the compartment model. We get

$$V_1 = \frac{M}{A + B}$$

$$k_2 = \frac{\alpha B + \beta A}{A + B}$$

$$k_3 = \frac{\alpha\beta}{k_2}$$

$$k_1 = \alpha + \beta - k_2 - k_3$$

In the particular case we find

$$v_1 = 2.51$$

$$k_1 = 0.79$$

$$k_2 = 0.085$$

$$k_3 = 0.17$$

Notice that the parameter k_3 can be determined as follows

$$M = \int_0^{\infty} k_3 x_1(t) dt = k_3 V_1 \int_0^{\infty} C(t) dt$$

The first equation simply says that the total outflow of the drug equals the injected drug and the second equation says that the total amount of drug in compartment equals the concentration times the volume. Hence

$$k_3 = \frac{C(0)}{\int_0^{\infty} C(t) dt}$$

This equation is identical to (3.24). The argument used to derive it can obviously be extended to any compartment model with a single outlet. It shows that the elimination rate k_3 can be determined without reference to a parametric model.

If it is assumed that there is no net material transport between the compartments when the concentrations are the same the equation (4.28) gives

$$0 = \frac{dx_2}{dt} = k_1 x_1 - k_2 x_2 = k_1 c_1 V_1 - k_2 c_2 V_2 = (k_1 V_1 - k_2 V_2) c =$$

Under the assumption the volume V_2 is thus given by

$$V_2 = k_1 V_1 / V_2 = 23.3 \ell$$

This volume is referred to as the volume of distribution of the second compartment. In many physiological systems the volume is a fictitious quantity which does not have a physical interpretation because it was obtained under the assumption that the concentrations in the compartments were the same under equilibrium conditions. As has been mentioned before the transport mechanisms may very well be such that the concentrations are different in equilibrium. In the particular case the volume is larger than the volume of the patient this clearly shows that the transport is not governed by diffusion.

□

The graphical method used in the example to fit a sum of exponentials is commonly referred to as "peeling off exponentials". The technique can apparently be applied to fit any number of exponentials. The method is, however, very sensitive to errors, because the exponentials are not orthogonal. A typical example was given in Chapter 2. The method is useful for crude estimates. It should, however, be used with great care.

In conclusion we find that there are many complicated processes that can be approximated by flow systems. To facilitate a comparison the table below gives the analogies between some models that lead to flow systems.

	"Volume"	"Flow"	State	Equation
Tank system	Volume	Volume flow	Con- centration	(4.5)
Blood flow	V	q	C	
Compartment model	Volume	Mass trpt. coeffs. (4.20)	Con- centration	(4.22)
Pharmacokinetics	V	λ	C	
Metabolism	Mass Q	Trpt. rates r	Tracer act. a	(4.24)

Finally it should be emphasized that if the models have only one outlet the total "volume" and the outflow can also be determined using the nonparametric methods described in Section 3.

Exercises.

1. Consider the tank system illustrated by the graph below. Assume that a tracer is injected in the first tank and that the tracer concentration is measured in the same tank. Determine the tracer concentrations in both tanks as a function of time. Discuss if it is possible to determine all parameters of the tank system and give suitable procedures.

2. Consider the tank system illustrated by the graph below. Determine the impulse response for tracer propagation through the system and analyse if it is possible to determine all parameters of the system from a tracer experiment. Discuss alternative methods to carry out the necessary calculations.

This model has in fact been used to model simple body functions. The tank 1 represents the blood, the tank V_2 the "intracellular" fluid. The flow q_2 represents the removal of some substance through the kidneys and the flow q_1 represents the exchange which takes place between the blood and the "intracellular" fluid. The following numbers have been found $V_1 = 3\ell$, $V_2 = 9\ell$, $q_1 = .200 \ell/\text{min}$, $q_2 = 0.12 \ell/\text{min}$.

3. Consider the model of Exercise 2. Determine the error in the determination of q_2 obtained if the concentration in V_1 is approximated by the dominating mode.

Consider the catenary system shown in Fig. 4. Show that all volumes and flows can be determined uniquely from a tracer experiment where the tracer is injected and measured in tank 2 if $q_1 V_3 \neq q_2 V_1$ and that the parameters cannot be uniquely determined if $q_1 V_3 = q_2 V_1$.

5. SUMMARY.

Transient response analysis is a simple method to determine the dynamics of a linear system. The input signal can often be generated manually. The method is particularly simple if the pulse width can be chosen significantly smaller than the smallest relevant time constant of the system. The output is then equal to the impulse response of the system. For wider pulses it is necessary to perform a deconvolution in order to obtain the impulse response. This can be done by numerical Laplace transformation. The major drawback of the transient analysis is that it works well only when the signal to noise ratio is very high and that it is necessary that the system is in equilibrium when the pulse is introduced.

The transfer function of a linear system can thus be determined both by a direct frequency response measurement, as was discussed in Chapter 3, and by an impulse response analysis followed by the numerical computation of the Laplace transform. It is then natural to compare these two approaches.

The impulse response experiment is undoubtedly simpler to do. It does not require special equipment to generate the inputs, and the time for testing is short. The disadvantages of the impulse response method is that the determination of the transfer function is more complicated (numerical Laplace transforms), and the accuracy of the results are limited. The transfer function can only be determined over a few decades in frequency. There is no possibility to increase the accuracy, as can be done using the frequency response method. The impulse response method is also much more sensitive to disturbances.

As a typical example of the trade-offs made when choosing an identification method we quote from Smith and Triplett (1953):

"The most direct method for obtaining a frequency response of a physical system is to measure the steady-state response to a sinusoidal input at a number of different frequencies. While this procedure has often been used successfully to obtain frequency responses of aircraft in flight, Campbell et al (1947), it is not feasible in many cases. This method requires the installation of equipment to drive the control surfaces in a sine-wave pattern and may involve an excessive amount of flight time, particularly if data are to be taken at a large number of frequencies.

In general, a more practical method of obtaining a frequency response is to analyse the transient response of the aircraft to an arbitrary deflection of the control surface (generally a step or a pulse). A single transient contains the entire frequency spectrum and can be obtained in flight in a matter of seconds. A transient wave shape may be considered to be made up of a sum of sinusoidal wave shapes of various amplitudes and covering the entire frequency band. Therefore the response of a linear system to a transient input can be viewed as its response to the sum of sinusoidal waves contained in the transient input."

There are, however, many other cases where frequency response is preferable. For example when the signal to noise ratio is very low as in Example in Chapter 3 the transient response method would be useless.

Finally there are many specialized techniques commonly used in ecology and physiology which are directly based on the application of impulse response.

6. ACKNOWLEDGEMENTS.

I have had the pleasure of learning this material from many talented persons. My first contact with the problem was made in the early fifties during work on flow measurements at Södersjukhuset in Stockholm. I would like to thank my supervisor Professor Bengt Joel Andersson who introduced me to the Stewart Hamilton equation and its applications. I learned a lot about tracer measurements in the industry from Knut Ljunggren at Isotoptekniska Institutet in Stockholm. Knut has also supplied the mixing tank data used in Chapter 3.

The analysis and description of flow system is based on work I did with Richard Bellman at USC in the summer of 1969. During this time we started the work on identifiability of flow systems which then has flourished. The particular data on the farmacobinetics was obtained during joint work with one of my neighbors Göran Wettrell. Thank you all for what I have learned from you.

7. NOTES AND REFERENCES.

Transient response analysis has been used in engineering for a long time. Even before mathematical tools like transfer functions and impulse responses were used it was natural to investigate a system by observing its response to a step change in the reference value. In this form step response analysis has been used as long as regulators have been available, i.e. from the end of the eighteenth century. This is also reflected in the fact that the specifications for the command following properties are still given in terms of properties of the step response. Procedures for adjusting PID regulators based on an observed step response are found in the well-known paper by Ziegler and Nichols (1943). With the advent of servomechanism theory transient analysis became a standard tool together with frequency analysis. Transient analysis was not as commonly used as frequently used analysis because a numerical Laplace transformation was required to obtain the transfer function from a measured impulse response. These calculations could not be done conveniently until digital computers were commonly available. Transient response analysis was found to be a useful tool to determine aircraft dynamics. It was used for this purpose as early as 1948. See for example the excellent and survey article by Bollay (1951), the reports Greenberg (1951) and Shinbrot (1951, 1952) and the papers by Rea and Walters (1949), Seamans et. al. (1950) and Smith and Triplett (1953). The example in Section 2 based on the last reference shows typical results. This particular application of pulse testing is now a standard method to analyse flight test data. Pulse testing was also extensively used to analyse fire control systems during the Second World War. See Gardner and Ross (1953). These applications are also reviewed in Draper et.al. (1953). A discussion of the selection of pulse forms with parti-

cular emphasis on avoiding saturation and rate saturation is found in Coppedge and Wolf (1954).

Hougen and his coworkers made extensive use of transient response to determine dynamics of industrial processes. The transition from military to nonmilitary applications can be traced to Lees and Hougen (1956). The determination of heat exchanger dynamics discussed in Section 2 was based on this paper. Methodological problems and many applications are discussed in Hougen and Walsh (1961). This paper also contains many references. Hougen has obtained very good results when using impulse response analysis to determine the transfer function of industrial processes. He has also made comparisons with the results of direct frequency analysis. For processes with small disturbances Hougen reports very good agreement between the transfer functions computed from impulse response measurements and those obtained by direct frequency analysis. In his writing Hougen is, however, sometimes carried away by his enthusiasm for the pulse testing method and states accuracies which are neither supported by theory nor by independent experiments.

A review of the relative merits of frequency response and transient response for determination of dynamics of industrial processes are given in Ceaglske (1961). The accuracy of the transfer function obtained from a transient response analysis is discussed by Unbehauen and Schlegel (1967). The book by Strobel (1968) also contains much material on transient response analysis. There are in particular error estimates and many examples. There is also a careful treatment of the problem of approximating a measured frequency response by a rational function.

The possibility to apply impulse response analysis to determine flows and volumes was early recognized by physiologists. See e.g. Stewart (1897) where the technique was introduced under the name indicator-dilution technique. The method was further developed and extended by Hamilton et.al. (1932). The so-called Stewart-Hamilton equation is first given in these publications. The use of impulse response analysis to determine volumes and flows is now a standard method which is used routinely in hospitals. Surveys on determination of blood flow and blood volumes are given in Meier and Zierler (1954) and Stephenson (1958). The well-written and critical book by Riggs (1963) also covers much material on volume and flow determination. The determination of cardiac output and the blood volume in the heart is critically reviewed in Dow (1956). Model studies of this problem have been performed by Kressig (1971). The blood flow in the brain is more complicated because there are many inlets and many outlets. Generalizations of the Stewart-Hamilton equation to the multivariable case are done by Andersson (1957). His results have been applied to analyse the blood flow through the brain by Nylin et.al. (1961). A significant improvement in the measuring technique has been made by Hedlund et.al. (1964).

Many papers on the theory, philosophy and the application of impulse response analysis to determine volumes and flows are found in the proceedings Kniseley et.al. (1964) and Bergner et.al. (1968) of symposia sponsored by AEC.

Industrial applications of impulse response analysis to investigate flow systems grew rapidly with the increased availability of radio active tracers. These tracers are very convenient to use because the measurements can be made without making holes in pipes and tanks for sampling. A review of applications is given in Danckwertz (1953). The work with radio active tracers is usually carried out

by organizations which are closely related to the national atomic energy organizations. Many applications of impulse response analysis are found in the symposia on industrial applications of radio isotopes and related topics which are organized by the International Atomic Energy Agency in Vienna. The applications discussed in Section 3 are based on Ljunggren (1968) and Ryti (1966).

The theory of flow systems is closely related to many fields of applied mathematics. Since the impulse response of an open flow system can be interpreted as a probability density, there are obvious connections to probability theory. The transfer function H is e.g. a characteristic function. The complete characterization of the transfer function goes also back to the famous theorem by Bochner (1932).

Other characterizations are found in Lukacs (1910).

The internal properties of flow systems discussed in Section 4 do largely depend on the theory of positive matrices, which were originally developed by Perron and Frobenius. Positive matrices appear in many branches of applied mathematics, e.g. in mathematical economy and probability theory. Good expositions of the theory are found in Bellman (1960) and Gantmacher (1960).

Compartment models which are mathematically equivalent to flow systems were introduced by Widmark (1920) who investigated the absorption and metabolism of alcohol in humans. Pioneering work in this area was done by Teorell (1937) who first formulated the compartment models that are now commonly used in pharmacokinetics. Teorell's original paper is still one of the best introductions to the field because he has a very good discussion of the basic transport mechanisms and a motivation for the linearization as-

sumptions. Compartment systems are extensively discussed in the books Sheppartd (1962) and Atkins (1969). The notions of catenary and mammillary systems were introduced in Sheppartd and Householder (1951). They are further pursued in Berman and Schoenfeld (1956). The eigenvalues of catenary and mammillary systems were analysed by Hearon (1961 and 1963). The identifiability conditions for catenary systems were given by Bellman and Åström (1970).

The application of compartmental models to describe the propagation of drugs in the body is commonly discussed under the name of pharmacokinetics. The work was pioneered by Widmark and Teorell. The name pharmacokinetics was coined in Dost (1953). Further expositions are found in Dost (1968) and Rescigno and Segre (1966). The application of pharmacokinetics is now spreading rapidly. Recent material are found in Raspé (1970), Wagner (1971), Teorell et.al. (1974).

APPENDIX A - Proof of Theorem 4.6.

The proof is straightforward but tedious. The basic idea is to derive the Laplace transform of the measured transfer tracer concentration and to analyse how the parameters of the Laplace transform depend on the flows and volumes. Two different arrangements of the inlet and the outlet are considered. See Fig. A.1.

It is assumed that the inlet is connected to tank number k and that the outlet is connected to tank number ℓ . The numbers k and ℓ may assume the values $1, 2, \dots, n$. Let the tracer be injected into tank j . The tracer propagation is described by the equation

$$\frac{dc}{dt} = \begin{vmatrix} -\alpha_1 & \beta_1 & & & \\ \gamma_2 & -\alpha_2 & \beta_2 & & \\ & & & & \\ & & & & \\ & & & \gamma_{n-1} & -\alpha_{n-1} & \beta_{n-1} \\ & & & & \gamma_n & -\alpha_n \end{vmatrix} \quad c = Ac \quad (A.1)$$

where the elements of the tridiagonal matrix A are given by

$$\begin{aligned} \alpha_i &= -q_{ii}/V_i \\ \beta_i &= q_{i \ i+1}/V_i \\ \gamma_i &= q_{i \ i-1}/V_i \end{aligned}$$

where $q_{n \ n+1}$ and q_{10} are interpreted as being zero.

A flow balance for the i :th tank gives

$$q_{i \ i-1} + q_{ii} + q_{i \ i+1} = \begin{cases} q_0 & i = k \\ 0 & i \neq k \end{cases} \quad (\text{A.2})$$

Hence

$$\alpha_i = \begin{cases} \beta_i + \gamma_i + q_0/V_i & i = k \\ \beta_i + \gamma_i & i \neq k \end{cases} \quad (\text{A.3})$$

where

$$\gamma_1 = 0 \quad \text{and} \quad \beta_n = 0$$

The tracer equation (A.1) thus contains $3n-1$ parameters for open systems and $3n-2$ parameters for closed systems. Since there are n constraints (A.3) among the parameters the free parameters are $2n-1$ and $2n-2$ respectively. There are n volumes and $n-1$ respectively $n-2$ flows to be determined.

Recalling that tracer was injected into tank j . The tracer equations then become

$$\begin{vmatrix} s+\alpha_1 & -\beta_1 & & & & \\ -\gamma_2 & s+\alpha_2 & -\beta_2 & & & \\ & & & & & \\ & & & & & \\ & & & -\gamma_{n-1} & s+\alpha_{n-1} & -\beta_{n-1} \\ & & & -\gamma_n & s+\alpha_n & \end{vmatrix} \begin{vmatrix} c_1(s) \\ c_2(s) \\ \vdots \\ c_{n-1}(s) \\ c_n(s) \end{vmatrix} = \begin{vmatrix} 0 \\ 0 \\ \vdots \\ M/V_j \\ 0 \\ 0 \end{vmatrix}$$

Using Cramer's rule for evaluating determinants it is straightforward to show that the transfer function for the concentration in tank i is given by

$$C_i(s) = \begin{cases} \frac{M}{V_j} \cdot \frac{\left(\prod_{m=i}^{j-1} \beta_m \right) d_{i-1}^+(s) d_{n-j}^-(s)}{d_n(s)} & i < j \\ \frac{M}{V_j} \cdot \frac{d_{j-1}^+(s) d_{n-j}^-(s)}{d_n(s)} & i = j \\ \frac{M}{V_j} \cdot \frac{\left(\prod_{m=j+1}^i \gamma_m \right) d_{j-1}^+(s) d_{n-i}^-(s)}{d_n(s)} & i > j \end{cases} \quad (\text{A.4})$$

where the polynomials $d_i^+(s)$ and $d_i^-(s)$ are defined by

$$d_0^+(s) = 1$$

$$d_1^+(s) = s + \alpha_1$$

$$\vdots$$

$$d_i^+(s) = (s + \alpha_i) d_{i-1}^+(s) - \beta_{i-1} \gamma_i d_{i-2}^+(s)$$

$$\vdots$$

$$d_0^-(s) = 1$$

$$d_1^-(s) = s + \alpha_n$$

$$\vdots$$

$$d_i^-(s) = (s + \alpha_{n-i+1}) d_{i-1}^-(s) - \beta_{n-i} \gamma_{n-i+1} d_{i-2}^-(s)$$

$$\vdots$$

(A.5)

Furthermore

$$d_n(s) = d_n^+(s) = d_n^-(s) \quad (\text{A.6})$$

The transfer function (A.4) will be of order n only if there are no common factors in the numerator and the denominator. A necessary and sufficient condition for that is that all the numbers $\gamma_2\beta_1, \gamma_3\beta_2, \dots, \gamma_n\beta_{n-1}$, are different from zero. The sequences $\{d_0^+(s), d_1^+(s), \dots, d_n^+(s)\}$ and $\{d_0^-(s), d_1^-(s), \dots, d_n^-(s)\}$ are then Sturm sequences whose elements cannot have common factors. Compare the proof of Theorem 4.3. The numbers $\beta_1\gamma_2, \dots, \beta_{n-1}\gamma_n$ are all nonzero because it was assumed that there was bidirectional flow between all tanks.

By injecting a tracer in tank j the Laplace transform of the measured tracer concentration in tank i is a rational function

$$C_i(s) = \frac{M}{V_j} \cdot \frac{B(s)}{A(s)}$$

where the polynomial $A(s)$ has degree n and $B(s)$ has a degree lower than n . The coefficients of the polynomials $A(s)$ and $B(s)$ can be determined from the measured data. The analysis of identifiability is then reduced to the problem of determining the volumes and the flows from the coefficients of the polynomials $A(s)$ and $B(s)$.

The coefficients of s^n in $A(s)$ is one. The constant term of $A(s)$ will according to Theorem 4.1 vanish for closed system. The transfer function thus contains $2n-1-|i-j|$ parameters for open systems and $2n-2-|i-j|$ parameters for closed systems. By a simple count of parameters and equations it is thus found that the volumes and flows cannot be determined uniquely unless $i = j$. A necessary condition is thus that the tracer is injected and measured in the same tank.

Assuming $i = j$ we will now proceed to analyse sufficient conditions. For this purpose two cases will be separated.

Case 1: i = j = 1.

It is first assumed that the tracer is injected into an end tank. By relabelling it can always be assumed that the tank has number 1. Since

$$c_1(0) = \frac{M}{V_1}$$

the parameter V_1 can be determined directly. The polynomial $B(s)$ can then be normalized.

Let the polynomials $A(s)$ and $B(s)$ be given by

$$A(s) = s^n + a_1 s^{n-1} + \dots + a_n$$

$$B(s) = s^{n-1} + b_1 s^{n-2} + \dots + b_{n-1}$$

Notice that it follows from Theorem 4.1 that a_n is zero for a closed system. Division of the polynomial $A(s)$ by $B(s)$ gives

$$\frac{A(s)}{B(s)} = s + a_1 - b_1 + \frac{C(s)}{B(s)} \quad (\text{A.7})$$

where

$$\begin{aligned} C(s) = & [(a_2 - b_2) - b_1(a_1 - b_1)]s^{n-2} + \\ & + [(a_3 - b_3) - b_2(a_1 - b_1)]s^{n-3} + \dots + \\ & + [(a_{n-1} - b_{n-1}) - b_{n-2}(a_1 - b_1)]s + \\ & + [a_n - b_{n-1}(a_1 - b_1)] \end{aligned}$$

Equation (A.6) gives

$$\frac{d_n(s)}{d_{n-1}(s)} = s + \alpha_n - \gamma_n \beta_{n-1} \frac{d_{n-2}(s)}{d_{n-1}(s)} \quad (\text{A.8})$$

Since the tracer was injected and measured in tank 1 it follows from (A.5) that

$$\frac{A(s)}{B(s)} = \frac{d_n(s)}{d_{n-1}(s)}$$

Equations (A.7) and (A.8) then give

$$\alpha_n = a_1 - b_1$$

$$\gamma_n \beta_{n-1} = - [(a_2 - b_2) - b_1(a_1 - b_1)]$$

$$C(s) = - \gamma_n \beta_{n-1} d_{n-2}(s)$$

Proceeding recursively it is thus possible to determine the parameters α_i and the parameter combinations $\gamma_i \beta_{i-1}$. Notice that it follows from the assumption that there was bidirectional flows between all tanks that $\gamma_i \beta_{i-1} \neq 0$ for $i = 2, \dots, n$. Since there was only one inflow one of the end tanks must be without an inflow. Equation (A.3) gives $\gamma_i = 0$ for $i = 1$ and $\beta_i = 0$ for $i = n$. It then follows from (A.3) that $\beta_1 = \alpha_1$ and $\gamma_n = \alpha_n$. One of the parameters β_1 and γ_n can thus be determined uniquely. The other parameters are then determined recursively from the products $\gamma_i \beta_{i-1}$.

It now remains to determine the flows and the volumes from the parameters α_i , β_i and γ_i . The possibility to do so follows from the following lemma and the proof is complete. \square

Lemma A.1.

Consider a catenary system with one inflow and one outflow. Assume that the parameters α_i , β_i and γ_i are known, and that the volume of the tank where the tracer is injected is also known. Then all volumes and flows can be determined.

Proof. The proof is an explicit construction. Let the tracer be injected into tank i . The flows associated with this tank are given by

$$\begin{aligned} -q_{jj} &= \alpha_j V_j \\ q_{j \ j-1} &= \gamma_j V_j \\ q_{j \ j+1} &= \beta_j V_j \quad j = i \end{aligned} \tag{A.9}$$

Two cases will be considered separately.

Case_a. If there is no inflow and no outflow to tanks with indices $\geq i$ it follows the flow balance that

$$q_{i \ i+1} = q_{i+1 \ i}$$

The volume of tank $i+1$ is then given by

$$\gamma_{i+1} V_{i+1} = q_{i+1 \ i} = q_{i \ i+1} = \gamma_i V_i$$

The volume of the tank $i+1$ can then be determined. Equation (A.9) then gives the flows associated with this tank. Proceeding recursively all volumes and flows can thus be determined for $j \geq i$. Analogously it is possible to determine all volumes and flows if there are no inflows and outflows for tanks with indices $\leq i$.

Case b. If the tank where the tracer is injected is between the inlet and the outlet say $k \leq i \leq \ell$ a flow balance gives

$$q_{i+1} = q_i + q_0 \quad k \leq i \leq \ell-1$$

The volume V_{i-1} is then given by

$$\gamma_{i-1} V_{i-1} = q_0 + q_{i-1} = q_0 + \gamma_i V_i$$

Proceeding recursively we thus find

$$V_k = e V_i + f q_0$$

provided $\gamma_i \neq 0$ for a flow balance for tank k gives

$$\alpha_k = \beta_k + \gamma_k + q_0/V_k$$

The flow q_0 and the volume V_k can thus be determined uniquely. It is then straightforward to determine the other flows and volumes.

□

Case 2: $i = j = 1$.

The volume V_1 can be determined by

$$c_1(0) = M/V_1$$

The Laplace transform of the measured concentration can then be written as

$$C_1(s) = \frac{M}{V_1} \cdot \frac{B(s)}{A(s)} = \frac{M}{V_1} \cdot \frac{d_{i-1}^+(s) d_{n-i}^-(s)}{d_n(s)}$$

The determinant $d_n(s)$ can be written as follows

$$d_n(s) = (s + \alpha_i) d_{i-1}^+(s) d_{n-i}^-(s) - \beta_{i-1} \gamma_i d_{i-2}^+(s) d_{n-i}^-(s) \\ - \beta_i \gamma_{i+1} d_{i-1}^+(s) d_{n-i-1}^-(s)$$

Hence

$$A(s) = (s + \alpha_i) B(s) - \beta_{i-1} \gamma_i d_{i-2}^+(s) d_{n-i}^-(s) - \\ - \beta_i \gamma_{i+1} d_{i-1}^+(s) d_{n-i-1}^-(s)$$

$$B(s) = d_{i-1}^+(s) d_{n-i}^-(s)$$

Given the polynomials $A(s)$ and $B(s)$ the parameter α_i can be determined uniquely. A factorization of the polynomial $B(s)$ will also give $d_{i-1}^+(s)$ and $d_{n-i}^-(s)$. This factorization is, however, not unique. If $m = \min(i-1, n-i)$ there are $\binom{n-1}{m-1}$ different possibilities. Having obtained the factors $d_{i-1}^+(s)$ and $d_{n-i}^-(s)$ the polynomials $d_{i-2}^+(s)$ and $d_{n-i-1}^-(s)$ and the reals $\beta_{i-1} \gamma_i$ and $\beta_i \gamma_{i+1}$ can then be determined from () provided that $d_{i-1}^+(s)$ and $d_{n-i}^-(s)$ are relatively prime. Since there was bidirectional flow between all tanks the numbers β_m and γ_m are all different from zero. Proceeding in the same way as was done in case 1 all the coefficients α_m , β_m and γ_m can then be determined and the volumes and flows are then obtained from Lemma A.1.

APPENDIX B - Proof of Theorem 4.7.

The proof follows the same lines as the proof of Theorem 4.6. It is straightforward but tedious because many different cases have to be considered. The possible combinations of inlets and outlets are given below.

Case	Inlet	Outlet
a	N_0	N_0
b	C	C
c	C	P
d	P	C
e	P	P
f	P	P1

In the table C denotes the central tank and P and P1 denote peripheral tanks. The graphs of the corresponding systems are shown in Fig. B.1.

The experiment can be arranged in many different ways.

1. The tracer is injected in the central tank and the tracer concentration is measured in the same tank.
2. The tracer is injected in the central tank and the tracer concentration is measured in a peripheral tank.
3. The tracer is injected in a peripheral tank and the tracer concentration is measured in the central tank.
4. The tracer is injected in a peripheral tank and the tracer concentration is measured in the same peripheral tank.
5. The tracer is injected in a peripheral tank and the tracer concentration is measured in another peripheral tank.

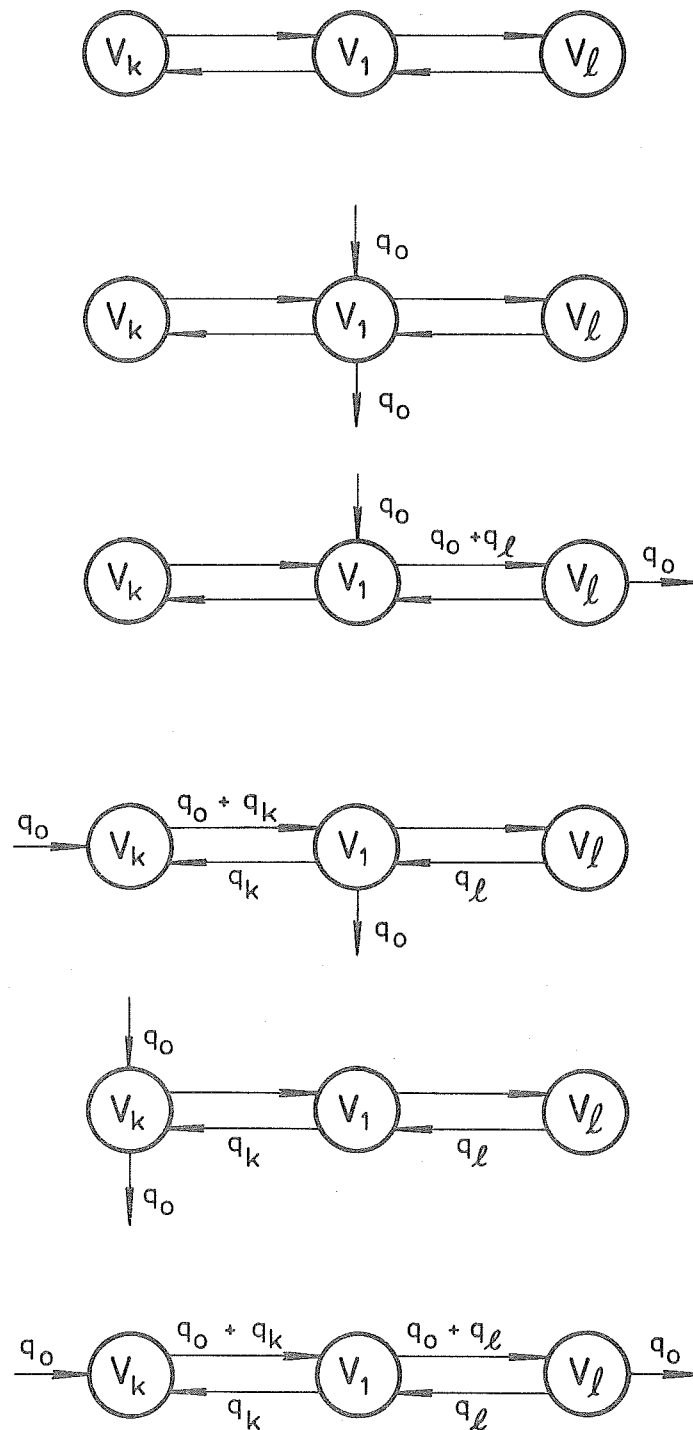

Fig. B.1 - Graphs of mammillary systems having different arrangements of inlets and outlets.

Considering all possibilities there are 30 different cases to consider. The tracer equations can be written as

$$\frac{dc}{dt} = \begin{pmatrix} -a_{11} & a_{12} & a_{13} & \cdots & a_{1n} \\ a_{21} & -a_{22} & 0 & \cdots & 0 \\ a_{31} & 0 & -a_{33} & \cdots & 0 \\ \vdots & & & & \\ a_{n1} & 0 & 0 & \cdots & -a_{nn} \end{pmatrix} c \quad (\text{B.1})$$

where

$$a_{11} = \begin{cases} \left(-\sum_{i=2}^n q_i \right) / V_1 & \text{case a, e} \\ -\left(q_0 + \sum_{i=2}^n q_i \right) / V_1 & \text{case b, c, d, f} \end{cases} \quad (\text{B.2})$$

$$a_{kk} = \begin{cases} -q_k / V_k & \text{case a, b, c,} \\ -(q_k + q_0) / V_k & \text{case d, e, f} \end{cases} \quad (\text{B.3})$$

$$a_{ll} = \begin{cases} -q_l / V_l & \text{case a, b, d, e} \\ -(q_l + q_0) / V_l & \text{case c, f} \end{cases} \quad (\text{B.4})$$

$$a_{ii} = -q_i / V_i \quad i \neq 1, k, l \quad (\text{B.5})$$

$$a_{1k} = \begin{cases} q_k / V_1 & \text{case a, b, c, e} \\ (q_k + q_0) / V_1 & \text{case d, f} \end{cases} \quad (\text{B.6})$$

$$a_{1i} = q_i / V_1 \quad i \neq 1, k \quad (\text{B.7})$$

$$a_{i1} = q_i/V_i \quad i \neq 1, \ell \quad (\text{B.8})$$

$$a_{\ell 1} = \begin{cases} q_{\ell}/V_{\ell} & \text{case a, b, d, e} \\ (q_{\ell}+q_0)/V_{\ell} & \text{case c, f} \end{cases} \quad (\text{B.9})$$

It has been assumed that the tanks are numbered in such a way that the central tank has number 1. Without loss of generality it can also be assumed that if a tracer is injected in a peripheral tank it is injected in tank 2.

Laplace transformation of the tracer equations give

$$\begin{vmatrix} s-a_{11} & -a_{12} & -a_{13} & \dots & -a_{1n} \\ -a_{21} & s-a_{22} & 0 & \dots & 0 \\ -a_{31} & 0 & s-a_{33} & \dots & 0 \\ \vdots & & & & \\ -a_{n1} & 0 & 0 & \dots & s-a_{nn} \end{vmatrix} \begin{vmatrix} C_1(s) \\ C_2(s) \\ C_3(s) \\ \vdots \\ C_n(s) \end{vmatrix} = \begin{vmatrix} c_1(0) \\ c_2(0) \\ 0 \\ \vdots \\ 0 \end{vmatrix} \quad (\text{B.10})$$

where

$$c_i(0) = \begin{cases} M/V_m & i = m \\ 0 & i \neq m \end{cases}$$

where m is the index of the tank where the tracer is injected, if the tracer is injected in the second tank.

To discuss identifiability the different cases will now be discussed separately.

Case 1.

In this case the tracer is injected in the central tank and the tracer concentration is measured in the same tank.

Solving $C_1(s)$ from (B.10) and (B.11) gives

$$C_1(s) = \frac{M}{V_1} \cdot \frac{\prod_{i=2}^n (s - a_{ii})}{\prod_{i=2}^n (s - a_{ii}) \left| s - a_{11} - \sum_{i=2}^n \frac{a_{1i} a_{i1}}{s - a_{ii}} \right|} = M \frac{B(s)}{A(s)}$$

For an open system there are $2n$ parameters to be determined, the volumes V_1, \dots, V_n and the flows q_0, q_2, \dots, q_n . For a closed system there are $2n-1$ parameters to be determined because $q_0 = 0$. From a tracer experiment the coefficients of the polynomials $A(s)$ and $B(s)$ can be determined if the total amount of injected tracer is known. This corresponds to $2n$ parameters for open systems and $2n-1$ parameters for closed systems.

Since

$$B(s) = \frac{1}{V_1} \prod_{i=2}^n (s - a_{ii})$$

the parameters a_{ii} , $i = 2, \dots, n$, are uniquely determined from the zeros of $B(s)$. The volume V_1 is obtained from the coefficient of s^{n-1} in $B(s)$. Furthermore since

$$A(s) = \prod_{i=2}^n (s - a_{ii}) \left| s - a_{11} - \sum_{i=2}^n \frac{a_{1i} a_{i1}}{s - a_{ii}} \right|$$

a division of $A(s)$ by $B(s)$ and a partial fraction expansion gives the parameter a_{11} and the products $a_{1i} a_{i1}$,

$i = 2, \dots, n$. The equations (B.5) and (B.7) then give

$$a_{ii} = -a_{li} \quad i \neq 1, k, \ell$$

The parameters a_{li} and thus also a_{i1} can thus be determined for $i \neq 1, k, \ell$. To determine a_{1i} , a_{1k} and $a_{1\ell}$ different subcases have to be considered.

Cases 1a and 1b. In these cases it follows from the mass balances for the tanks k and ℓ that

$$a_{kk} = -a_{1k}$$

$$a_{\ell\ell} = -a_{1\ell}$$

The parameters a_{1k} , $a_{1\ell}$ and thus also a_{k1} , $a_{\ell 1}$ can thus be determined. It now remains to determine the volumes and the flows. The volume V_1 has already been determined.

The flows q_i , $i = 2, \dots, n$, are then obtained from equation (B.6) and (B.7), i.e.

$$q_i = a_{1i}V_1 \quad i = 2, \dots, n$$

Equations (B.3), (B.4) and (B.5) then give the volumes

$$V_i = -q_i/a_{ii} \quad i = 2, \dots, n$$

In case 1b it also remains to determine q_0 . The equation (C.2) implies

$$q_0 = -a_{11}V_1 - \sum_{i=2}^n q_i$$

and all physical parameters are thus determined.

Remark. The analysis of case 1a is somewhat simplified if it is observed that a flow balance for the central tank (B.2), (B.7) gives

$$\sum_{i=1}^n a_{1i} = 0$$

and that a flow balance for a peripheral tank gives

$$a_{ii} + a_{li} = 0 \quad i = 2, \dots, n$$

A combination of the equations above gives

$$-a_{11} = \sum_{i=2}^n a_{1i} = \sum_{i=2}^n a_{li} a_{il} / a_{ii}$$

Hence

$$\begin{aligned} A(s) &= s - a_{11} - \sum_{i=2}^n \frac{a_{li} a_{il}}{s - a_{ii}} = s + \sum_{i=2}^n a_{li} a_{il} \left(\frac{1}{a_{ii}} - \frac{1}{s - a_{ii}} \right) \\ &= s \left| 1 + \sum_{i=2}^n \frac{a_{ii}}{s - a_{ii}} \right| \end{aligned}$$

Case 1c. In this case the inflow is to a central tank and the outflow from a peripheral tank. The equations (B.3) and (B.8) give

$$a_{k1} = -a_{kk}$$

and the equations (B.4) and (B.9) give

$$a_{\ell 1} = - a_{\ell \ell}$$

The parameters a_{1i} and a_{i1} can thus be determined.

The flows q_i are then given by (B.6) and (B.7), i.e.

$$q_i = a_{1i} V_1 \quad i = 2, \dots, n$$

Equation (C.2) then gives

$$q_0 = - a_{11} V_1 - \sum_{i=2}^n q_i$$

The volumes are then given by (B.8) and (B.9), i.e.

$$V_i = \begin{cases} q_i / a_{i1} & i \neq 1, \ell \\ (q_\ell + q_0) / a_{\ell 1} \end{cases}$$

Case 1d. In this case there is an inflow to a peripheral tank and an outflow from the central tank. Equations (B.4) and (B.9) give

$$a_{\ell 1} = - a_{\ell \ell}$$

The parameter $a_{1\ell}$ can then be determined and the flow q_ℓ is then given by (B.7). Equation (B.2) gives $(q_0 + q_k)$ and (C.6) then gives a_{1k} which means that a_{k1} can also be determined. The volume V_k is then given by (B.3) and the flow q_k is finally obtained from (B.8).

Case_1e. In this case both the inlet and the outlet are connected to a peripheral tank. Equations (C.4) and (B.9) give

$$a_{\ell 1} = - a_{\ell \ell}$$

The parameter $a_{1\ell}$ can then be determined and the flow q_{ℓ} is then given by (B.7). Equation (B.2) gives q_k and a_{1k} can then be determined from (B.6). The parameter a_{k1} is then also given and V_k is then obtained from (B.8). The flow q_0 is finally determined from (B.2).

Case_1f. In this case the inlet is connected to one peripheral tank and the outlet to another. Equations (B.4) and (B.9) give

$$a_{\ell 1} = - a_{\ell \ell}$$

The parameter $a_{1\ell}$ and thus also the flow q_{ℓ} can thus be determined using (B.7). The parameter combination $q_0 + q_k$ is then given by (B.2). This gives the volume V_k by (B.3) and the parameter a_{1k} by (B.6). The parameter a_{k1} can then be determined from the knowledge of the product $a_{1k} a_{k1}$ and the flow q_k is then obtained.

The proof of the theorem is now complete in case 1.

Case_2.

In this case the tracer is injected in the central tank and the tracer concentration is measured in a peripheral tank. It is assumed that the tanks are numbered in such a way that the measurement is made in tank n. Equations (B.10) and (B.11) give

$$C_n(s) = \frac{M}{V_1} \frac{a_{n1} \prod_{i=2}^{n-1} (s-a_{ii})}{\prod_{i=2}^n (s-a_{ii}) \left| s - a_{11} - \sum_{i=2}^n \frac{a_{1i} a_{i1}}{s - a_{ii}} \right|} = \frac{1}{M} \frac{B(s)}{A(s)}$$

As before the coefficients of the polynomials A(s) and B(s) can be determined from a tracer experiment if the total amount M of injected tracer is known. Since the polynomial B(s) is of degree n-2 the experiments give 2n-1 parameters for open systems and 2n-2 parameters for closed system. These coefficients are not enough to determine the n volumes and n flows.

Case_3.

In this case the tracer is injected in a peripheral tank and the tracer concentration is measured in the central tank. It is assumed that the tanks are numbered in such a way that the tracer is injected in tank number n. Equations (B.10) and (B.11) give

$$C_1(s) = M \frac{B(s)}{A(s)}$$

where

$$A(s) = \prod_{i=2}^n (s-a_{ii}) \left| s - a_{11} - \sum_{i=2}^n \frac{a_{1i}a_{i1}}{s-a_{ii}} \right|$$

$$B(s) = \frac{a_{1n}}{V_2} \prod_{i=2}^{n-1} (s-a_{ii})$$

Since the polynomial B(s) is of degree n-2 it is not possible to determine the volumes and flows uniquely.

Case 4.

In this case the tracer is injected into a peripheral tank and the tracer concentration is measured in the same peripheral tank. Assuming that this tank is given number n equations (B.10) and (B.11) give

$$C_n(s) = M \frac{B(s)}{A(s)}$$

where

$$A(s) = \prod_{i=2}^n (s-a_{ii}) \left| s - a_{11} - \sum_{i=2}^n \frac{a_{1i}a_{i1}}{s-a_{ii}} \right|$$

$$B(s) = \frac{1}{V_1} \prod_{i=2}^{n-1} (s-a_{ii}) \left| s - a_{11} - \sum_{i=2}^{n-1} \frac{a_{1i}a_{i1}}{s-a_{ii}} \right|$$

If the total amount of injected tracer is known the polynomials A(s) and B(s) can be determined from the tracer experiment. Division of A(s) by B(s) gives

$$V_1 \frac{A(s)}{B(s)} = \frac{s - a_{nn} - \frac{a_{1n}a_{n1}}{s - a_{11} - \sum_{i=2}^{n-1} \frac{a_{1i}a_{i1}}{s - a_{ii}}}}{s - a_{nn} - \frac{C(s)}{D(s)}}$$

The coefficient a_{nn} and the polynomials $C(s)$ and $D(s)$ can thus be determined. Since

$$C(s) = a_{1n}a_{n1} \prod_{i=2}^{n-1} (s - a_{ii})$$

a factorization of C gives a_{ii} , $i = 2, \dots, n-1$. The products $a_{1i}a_{i1}$ are then obtained from a partial fraction expansion of $D(s)$. The volumes and flows can then be determined in the same way as in Case 1.

Case 5.

In this case the tracer is injected into one peripheral tank (#n) and the tracer concentration is measured in another peripheral tank (#2). Equations (B.10) and (B.11) give

$$C_2(s) = M \frac{B(s)}{A(s)}$$

where

$$A(s) = \prod_{i=2}^n (s - a_{ii}) \left| s - a_{11} - \sum_{i=2}^n \frac{a_{1i}a_{i1}}{s - a_{ii}} \right|$$

$$B(s) = a_{21} a_{1n} \prod_{i=3}^{n-1} (s - a_{ii}) / V_n$$

Since the polynomial $B(s)$ is of degree $n-3$ it is characterized by $n-2$ coefficients there are not enough conditions to determine the unknown parameters.

REFERENCES

- ✓ Andersson, B. J. (1957). Studies on the Circulation in Organic Systems with Applications to Indicator Methods. *Trans. Roy. Inst. of Technology* 114, Stockholm, Sweden.
- ✓ Atkins, G. L. (1969). *Multicompartment Model for Biological Systems*. Methuen, London.
- ✓ Bellman, R. (1960). *Introduction to Matrix Analysis*. Mc Graw-Hill, New York. *Inversion of the Laplace Transform*. Elsevier New York.
- ✓ Bergner, P. E. E. and Lushbaugh, C. C. (1968). *Compartments, Pools and Spaces in Medical Physiology*. Proc. Symp. at Oak Ridge Inst. of Nuclear Studies. U.S. Atomic Energy Com. Available as CONF-661010. U.S. Dept of Energy, Springfield, Virginia.
- ✓ Berman, M. and Schoenfeld, R. (1956). Invariants in Experimental Data on Linear Kinetics and the Formulation of Models *J. Appl. Phys.* 27, 1361-1370.
- ✓ Bollay, W (1951). Aerodynamic Stability and Automatic Control. *J. Aeron. Sci.* 18, 569-624.
- ✓ Ceaglske, N. H. (1961). Transient vs. Frequency Response in Analyzing Chemical Process Systems. *Chem. Eng. Progr.* 57, 53-58.
- ✓ Coppedge, T. M. Jr and Wolf, R. L. (1954). Report T-68. Instrumentation Laboratory MIT.
- ✓ Danckwerts, P. V. (1953). *Continuous Flow Systems*. *Chem. Eng. Sci.* 2 (1953), pp. 1-13.
- ✓ Dost, F. H. (1953). *Der Blutspiegel Kinetik der Konzentrations-abläufe in der Kreislaufflüssigkeit*. Leipzig.
- ✓ Dost, F. H. (1968). *Grundlager der Pharmakokinetik*. G. Thieme Stuttgart.
- ✓ Dow, P. (1956). Estimation of Cardiac Output and Central Blood Volume by Dye Dilution. *Physiol. Revs.* 36, 77-103.
- ✓ Draper, C. S., McKay, W. and Lees, S. (1953). *Instrument Engineering* 2.
- ✓ Gardner, M. T. and Ross, C. W. (1953). Rept. T-30. Instrumentation Lab. MIT. (Confidential).
- ✓ Gantmacher, F. R. (1960). *The Theory of Matrices*. 11, Chelsea, New York 1960-1964.
- ✓ Greenberg, H. (1951). A Survey of Methods for Determining Stability Parameters on an Airplane from Dynamic Flight Measurements. MACA TN 2340, April 1951.
- ✓ Hamilton, W. F., Moore, J. W., Kinsman, J. M. and Spurling, R. G. (1932). Studies on the Circulation. *Am. J. Physiol.* 99, pp. 534-551.

- ✓ Hearon, J. Z. (1961). A Property of second order differential equations with applications to formal kinetics. *Biophysics J* 1 (1961) pp. 581-587.
- ✓ Hearon, J. Z. (1961). Interpretation of tracer data. *Biophysical J* 1 (1969), pp. 810-821.
- Hearon, J. Z. (1961). On the roots of a certain type of matrix. *Bullet. Mathem. Biophys.* 28 (1961), pp. 217-221.
- Hearon, J. Z. (1963). Theorems on Linear Systems. *Ann. New York Acad. Sci.* 108, pp 36-68.
- Hearon, J. Z. (1968). The Washout curve in Tracer Kinetic. *Mathematical Biosciences* 3, pp 31-39.
- ✓ Hedlund, S., Ljunggren, K., Berggren B. and Brundell, P. O. (1964). Scintillation Detectors for Determination of Cerebral Blood Flow. *Acta Radiologica* 2, pp. 51-64.
- ✓ Hougén, J. O. and Walsh, R. A. (1961). Pulse Testing Method. *Chem. Eng. Progr.* 57, 69-79.
- ✓ Kniseley, R. M., Newton, Tauxe, W. and Anderson, E.B. (1963). Dynamic Clinical Studies with Radioisotopes. Proc. Symp. at Oak Ridge Inst. of Nuclear Sciences, Oct. 21-25, U.S. Atomic Energy com. 1964, Available as TID-7678, Clearinghouse for Federal Scientific and Tech. Information NBS. U.S. Dept. of Commerce.
- ✓ Kressig, W. (1971). Ermittlung der Übertragungsfunktionen von Hertz und Lunge mit Hilfe der Farbstoffverdünnungsmethode. Thesis Nr 4213. Eidgenössischen Technischen Hochschule, Zurich.
- ✓ Lees, S. and Hougén, J. O. (1956). Pulse Testing a Model Heat Exchange Process. *Ind. and Eng. Chem.* 48, 1064-1068.
- ✓ Ljunggren, K. (1968). Review of the Application of Radioactive Tracers in the Pulp and Paper Industri. Proc. Symp. on Radioisotopes in the Pulp and Paper Industri. International Atomic Energy Agency Vienna.
- ✓ Lukacs. (1910 ~~eller~~ 1960). Characteristic Function.
Lukas, E. (1960). Characteristic Functions. Griffin, London.
- ✓ Meier, P. and Zierler, K. L. (1954). On the Theory of the Indicator - Dilution Method for Measurement of Blood Flow and Volume. *J. App. Physiol.* 6, 731-744.
- ✓ Nylin, G., Hedlund, S. and Regnström, O. (1961). Studies of the Cerebral Circulation with labelled Erythrocytes in healthy man. *Circulat. Res.* 9, pp. 664-674.
- ✓ Raspé, G. (1970). Advances in the Biosciences, 5. Proc. Schering Workshop on Pharmacokinetics, Pergamon Press, Oxford.

- ✓ Rea, L. B. and Wallers. E. R. (1949). Determination of Frequency Characteristics from Response to Arbitrary Input. *J. Aeron. Sci.* 17 (1949), pp. 446-452.,
- ✓ Rescigno, A. and Segre, G. (1966). *Drug and Tracer Kinetics*. Blaisdell, Waltham.
- ✓ Riggs, D.S. (1963). *The Mathematical Approach to Physiological Problems*. The MIT Press, Cambridge Mass.
- ✓ Ryti, N., Aaltonen, P. and Arjas, A. (1966). Utjämnande av processvariationer med hjälp av massakypar. (Smoothing of Processvariations with the Aid of Mixing Tanks), *Norsk Skogsindustri* 20, 381-389 (In swedish).
- ✓ Seamans, R. C., Blasingame, B. P. and Clementson, G. (1950). *J. Aeronaut. Sci.* 17, 22-38.
- ✓ Sheppard, C. W. and Householder, A. S. (1951). The Mathematical Basis of the Interpretation of Tracer Experiments in Closed Steady State Systems. *J. Appl. Phys.* 22, pp. 510-520.
- ✓ Sheppard, C. W. (1962). *Basic Principles of the Tracer Method*. John Wiley, New York.
- ✓ Shinbrot, M. (1951). A Least-squares Curve Fitting Method with Applications to the Calculation of Stability Coefficients from Transient Response Data.
- ✓ Shinbrot, M. (1952). An Analysis of the Errors in Curve-Fitting Problems with an Application to the Calculation of Stability Parameters from Flight Data. *NACA TN 2820*, July 1952.
- ✓ Stephenson, J. L. (1958). Theory of measurement of blood flow by dye dilution technique. *IRE Trans on med Electronics* PGME-9, pp. 82-88.
- ✓ Stewart, G. N. (1897). Researches on the circulation time and on the influences which affect it. *J. Physiol.* 22, pp. 159-183.
- ✓ Strobel, H. (1968). *Systemanalyse mit determinierten Testsignalen*. VEB. Verlag, Berlin.
- Unbehauen, H. and Schlegel, G. (1967). Estimation of the Accuracy in the Identification of Control Systems using Deterministic Test Signals. Paper 1.12. *Proc. IFAC Symposium on Identification in Automatic Control Systems*. Academia Praha.
- ✓ Wagner, G. G. (1971). *Biopharmaceutics and Relevant Pharmacokinetics*. Drug Intelligence Publications, Hamilton, Illinois.
- Teorell, T., Dedrick, R. L. and Condliffe, P. G. (1974). *Pharmacology and Pharmacokinetics*. Plenum Press, New York.
- ✓ Teorell, T. (1937). Kinetics of Distribution of Substances Administered to the Body. I. The Extra Vascular Modes of Administration. *Arch. Int. de Pharm. et de Therapie* 57, 205-225. II. The Intravascular Modes of Administration *ibid.* 57, 226-240.