



LUND UNIVERSITY

Combustion Chambers for Natural Gas SI Engines Part I: Fluid Flow and Combustion

Johansson, Bengt; Olsson, Krister

Published in:
SAE Transactions, Journal of Engines

1995

[Link to publication](#)

Citation for published version (APA):

Johansson, B., & Olsson, K. (1995). Combustion Chambers for Natural Gas SI Engines Part I: Fluid Flow and Combustion. *SAE Transactions, Journal of Engines*, 104(SAE Technical Paper 950469).
<http://www.sae.org/technical/papers/950469>

Total number of authors:

2

General rights

Unless other specific re-use rights are stated the following general rights apply:
Copyright and moral rights for the publications made accessible in the public portal are retained by the authors and/or other copyright owners and it is a condition of accessing publications that users recognise and abide by the legal requirements associated with these rights.

- Users may download and print one copy of any publication from the public portal for the purpose of private study or research.
- You may not further distribute the material or use it for any profit-making activity or commercial gain
- You may freely distribute the URL identifying the publication in the public portal

Read more about Creative commons licenses: <https://creativecommons.org/licenses/>

Take down policy

If you believe that this document breaches copyright please contact us providing details, and we will remove access to the work immediately and investigate your claim.

LUND UNIVERSITY

PO Box 117
221 00 Lund
+46 46-222 00 00

Combustion Chambers for Natural Gas SI Engines Part I: Fluid Flow and Combustion

Bengt Johansson and Krister Olsson
Lund Institute of Technology

The appearance of the ISSN code at the bottom of this page indicates SAE's consent that copies of the paper may be made for personal or internal use of specific clients. This consent is given on the condition however, that the copier pay a \$5.00 per article copy fee through the Copyright Clearance Center, Inc. Operations Center, 222 Rosewood Drive, Danvers, MA 01923 for copying beyond that permitted by Sections 107 or 108 of the U.S. Copyright Law. This consent does not extend to other kinds of copying such as copying for general distribution, for advertising or promotional purposes, for creating new collective works, or for resale.

SAE routinely stocks printed papers for a period of three years following date of publication. Direct your orders to SAE Customer Sales and Satisfaction Department.

Quantity reprint rates can be obtained from the Customer Sales and Satisfaction Department.

To request permission to reprint a technical paper or permission to use copyrighted SAE publications in other works, contact the SAE Publications Group.



GLOBAL MOBILITY DATABASE

All SAE papers, standards, and selected books are abstracted and indexed in the SAE Global Mobility Database.

No part of this publication may be reproduced in any form, in an electronic retrieval system or otherwise, without the prior written permission of the publisher.

ISSN 0148-7191

Copyright 1995 Society of Automotive Engineers, Inc.

Positions and opinions advanced in this paper are those of the author(s) and not necessarily those of SAE. The author is solely responsible for the content of the paper. A process is available by which discussions will be printed with the paper if it is published in SAE transactions. For permission to publish this paper in full or in part, contact the SAE Publications Group.

Persons wishing to submit papers to be considered for presentation or publication through SAE should send the manuscript or a 300 word abstract of a proposed manuscript to: Secretary, Engineering Activity Board, SAE.

Combustion Chambers for Natural Gas SI Engines Part I: Fluid Flow and Combustion

Bengt Johansson and Krister Olsson
Lund Institute of Technology

ABSTRACT

The most economical way to convert truck and bus DI-diesel engines to natural gas operation is to replace the injector with a spark plug and modify the combustion chamber in the piston crown for spark ignition operation. The modification of the piston crown should give a geometry well suited for spark ignition operation with the original swirling inlet port.

Ten different geometries were tried on a converted VOLVO TD102 engine and a remarkably large difference in the rate of combustion was noted between the chambers. To find an explanation for this difference a cycle resolved measurement of the in-cylinder mean velocity and turbulence was performed with Laser Doppler Velocimetry (LDV).

The results show a high correlation between in cylinder turbulence and rate of heat release in the main part of combustion. The very early part of combustion is more affected by other parameters but the intermediate part of combustion corresponding to 0.5-10% of the total heat released is influenced by both mean velocity and turbulence. There is a surprisingly good correlation between the average level of turbulence and the used squish area.

INTRODUCTION

Most natural gas commercial vehicles are using converted, relatively large, diesel engines. The combustion chamber in these engines is most commonly located in the piston crown and a flat cylinder head is used. The inlet port of these engines often generates a highly swirling gas motion to enhance the diesel combustion process. In the conversion to spark ignition operation, the original inlet port is most often used. The original combustion chamber is, however, not directly suitable for SI

operation as the compression ratio often is too high and the flow structure is optimised for spray combustion rather than the flame propagation of a SI engine. But the question is how the piston crown modification should be performed to get the minimum amounts of emissions and at the same time a high thermal efficiency.

There seem to be at least two different opinions in this matter. The first states that a minimum amount of in-cylinder flow velocity and turbulence is wanted to reduce the heat loss to the walls and hence improve efficiency. The slower combustion expected with this strategy should reduce the maximum pressure and temperature during the cycle and nitrogen oxides (NO_x) should then be low. This strategy could be effective for engines operating with $\lambda=1$ and a three-way catalyst, but the strategy is expected to be less suitable for operation with very lean mixtures as the cycle to cycle variations in the combustion event would be severe.

The other "school" states that a very fast combustion event is wanted. This fast combustion should enable operation with extremely lean air/fuel-mixtures without large cycle to cycle variations in the combustion. The very lean mixture should be favourable from a thermodynamic point of view as the ratio of specific heats C_p/C_v during the expansion stroke is higher. A higher compression ratio would also be possible as the tendency to knock is much reduced with an extremely lean mixture. These effects would compensate for the higher heat loss to the walls due to the higher levels of bulk flow and turbulence which is used to increase the rate of combustion. The level of NO_x should be very low with this strategy as the extremely lean mixture would give a low maximum temperature. The unburned hydrocarbons (HC) would, however, be a problem with extremely lean mixtures as flame quenching and partial burn could be expected.

To get an indication of the importance of the combustion chamber geometry ten different geometries were manufactured to fit a Volvo TD102 1.6 litre single cylinder engine. For these geometries, the in-cylinder flow, combustion and the emission characteristics were measured for different air/fuel-ratios and amounts of EGR.

In this paper the in-cylinder flow as well as the combustion event for an 50% lean air/fuel mixture ($\lambda=1.5$) will be presented. The following paper will present the effects of different air/fuel ratios and amounts of EGR on combustion and exhaust gas emissions.

The combustion events were measured by using the cylinder pressure and a heat release analysis. The duration of 0-0.5%, 0.5-10% and 10-90% heat released were registered among other parameters. It was found that there was a large influence on the main combustion from changing the geometry of the piston crown. The different combustion durations would be expected to be the result of changes in the cylinder flow pattern. The rate of combustion in a SI engine is expected to be proportional to the speed with which a turbulent flame propagates through the unburned mixture. This flame speed in turn depends mainly on the level of turbulence present in the combustion chamber.

To find out to what extent the changes of heat release rate depend on the changes of turbulence, the in-cylinder flow was measured by using 2-component Laser Doppler Velocimetry (LDV).

COMBUSTION CHAMBERS

The combustion chambers used to study the effect of chamber geometry on flow and combustion rates were designed in a cut and try fashion. To simplify the change of piston crown geometry, a built piston with different crowns was used. The nominal compression ratio for most chambers was set to 12:1. This ratio corresponds well to the ratio used in present natural gas heavy duty engines [1],[2]. Three geometries were designed with a higher ratio to study the effects of changing compression ratio. A very short description of the selected geometries will be presented as follows:

Flat- The simplest type of combustion chamber uses a piston with a flat crown. With this geometry the swirling flow, resulting from the helical inlet port, is more or less undisturbed during the compression and expansion strokes. The resulting level of turbulence during combustion would then be expected to be low. The available flame surface area in this geometry would be limited in the early phase of the combustion due to the small height between piston and cylinder head close to TDC. The flame must travel in a close to two-dimensional fashion.

Cylinder- A cylindrical bowl in the piston crown gives an increased angular velocity of the swirling flow as the radius is dramatically reduced when the gas is forced into the bowl. The squish effect resulting from the small clearance height between cylinder head and piston at TDC will also contribute to the overall flow pattern in the bowl. The resulting flow is believed to be a toroidal complex rotation [3]. The squish and dramatic change of swirl are expected to give rise to a high level of turbulence. The flame surface area in the early part of the combustion is much improved compared to the flat geometry, as much of the combustion chamber volume is located close to the spark plug.

Square- The piston bowl does not need to be cylindrical. A square cross section of the piston bowl has been tried on a medium size diesel engine [4]. The square cross section gave a higher rate of combustion in the diesel. This is possibly due to higher amounts of small scale turbulence which results from eddy break-ups in the corners of the square cross section [5]. The flame surface area is favourable for the square geometry as most of the volume is close to the spark plug.

Cross- A geometry close to the square cross section is a cross. Earlier experiments with requirements of optical access through the engine in two orthogonal directions, in combination with a high compression ratio, resulted in a piston with two deep grooves manufactured in the piston. The resulting cross together with four sectors with squish area forces the swirling inlet motion to break down close to TDC [6],[8]. The deep grooves of the former piston were, however, not possible to use in the present experiments as it requires a large distance between the upper piston ring and cylinder head. The choice of a built piston also gave a problem with the available space for the cross with the desired compression ratio. Hence a small cylindrical bowl was drilled below the cross. The resulting geometry can be found in Figure 1. The flow of the cross combustion chamber is expected to be very complex. The swirling inlet flow must in some way break down to smaller eddies that geometrically will fit in the chamber close to TDC. The flame surface area will be favourable for the chamber as a large part of the volume is located close to the spark plug.

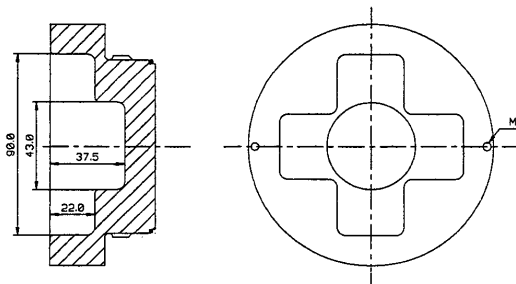

Figure 1: The geometry of the cross combustion chamber.

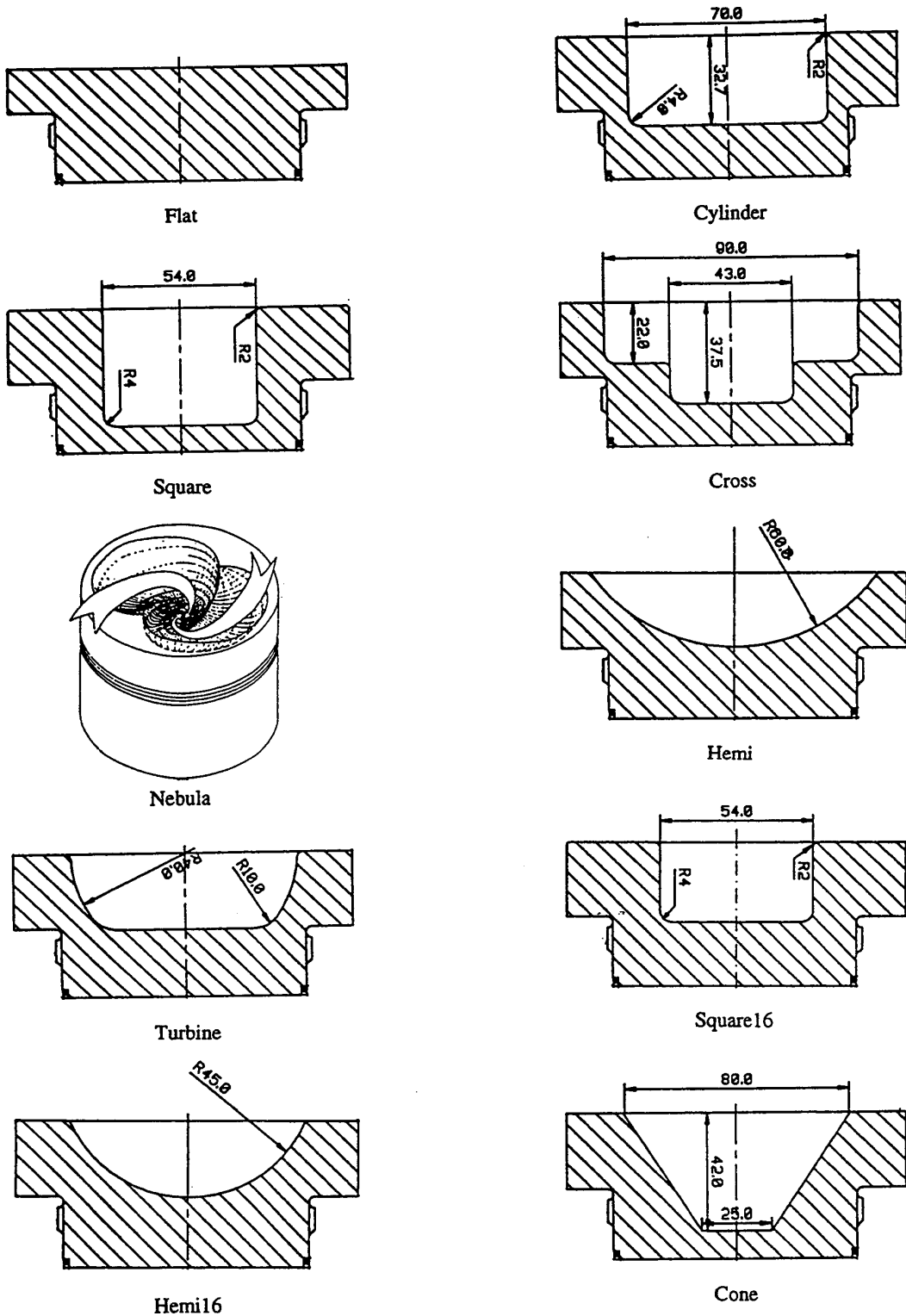

Figure 2: Geometry of the combustion chambers used.

Nebula- Ricardo has presented a special design of piston crown which should give favourable characteristics for gas engines [9]. The nebula is designed to use the swirling motion generated by the inlet port, and close to TDC direct the flow into two jets in the piston bowl. The two jets should then collide with each other and cause the large scale flow structure to break down to small scale turbulence, see Figure 2. A high level of turbulence should then result and hence a fast and stable combustion would occur. Ricardo has machined a nebula chamber in a Volvo TD102 piston for Lund Inst of Tech. The geometrical parameters of the nebula were, however, not optimised for the Volvo. An already optimised geometry for Scania DSC11 was instead used as a base and only the compression volume was changed to obtain a nominal compression ratio of 12:1.

In one important aspect the nebula and other combustion chamber are incomparable. Due to the requirements of the nebula chamber, a built piston could not be used. This means that the nebula piston has an advantage in heat transfer and crevice volumes. This in turn means that the volumetric and thermal efficiencies and to some extent emissions of unburned hydrocarbons are slightly biased.

The flame surface area for the nebula must be considered to be quite good in the early part of the combustion, although is hard to get an exact measure due to the complex shape of the chamber.

Hemi- Ricardo states in their promotion of the nebula combustion chamber that a fast combustion is favourable for lean operation of gas engines [9]. This opinion is, however, not the only one in the gas engine community. Southwest Research Institute (SwRI) states that no differences could be found in the level of NOx and thermal efficiency between a fast burn combustion chamber and one with only moderate burn rate [11]. The only significant difference SwRI found between a fast cylindrical geometry and a shallow hemispherical bowl was a better volumetric efficiency of the hemispherical geometry. To test the SwRI concept a chamber with a hemispherical bowl was manufactured. This geometry gives a low chamber wall area and minimum interference with the swirling flow.

Turbine- A slightly modified version of the cylindrical bowl is used by Volvo Aero Turbine in the natural gas converted TD102 which is in commercial operation in Malmoe and Gothenburg, Sweden. This chamber has a shallower bowl and uses a large radius in the transition from bottom to the wall of the bowl. The squish area for this geometry has a clearance height of 1.5 mm compared to 1 mm for the rest of the geometries. According to Volvo Aero Turbine this would give a HC benefit, as flame quenching in the squish area is less likely with the larger distance [10]. The flame surface area in the earlier parts of the combustion will be less favourable for this geometry than the cylinder, as the cylinder has a much deeper bowl.

Square and Hemi with Rc=16:1- To study how a change of compression ratio influences the performance of different chamber geometries, two of the above geometries were modified for a geometrical compression ratio of 16:1. The square chamber had shown significantly faster combustion than the rest and was therefore chosen. It was interesting to see if a shallower bowl would give an even faster combustion rate. To get a counterpart to the square, a slow chamber was also wanted. The hemi geometry was found suitable as it had a small chamber area and had shown a moderate combustion rate in the 12:1 case.

Cone- During the engine runs with the above combustion chambers a conical geometry was manufactured in the work shop for another project. Even though it was not intended at the start of the experiments to include a conical geometry, the possibility to use the cone was tempting. The nominal compression ratio was set to 14:1.

Table 1: Geometry of the used combustion chambers.

Comb Chamber	Squish/ Bore	Area/ Bore	Bowl depth	Bowl diam.
			mm	mm
Flat	0	1.3572	"10.7"	-
Cylinder	0.66	1.5709	32.7	D=70
Square	0.74	1.7297	42.5	54x54
Cross	0.42	1.7830	22&37	see Fig 1
Nebula	0.25	-	28.5	-
Hemi	0.30	1.2631	28.3	R=60
Turbine	0.55	1.4069	25	D=80
Square16	0.74	1.4740	29.1	54x54
Hemi16	0.55	1.2257	29	R=45
Cone	0.55	1.2886	42	D=80, d=25

EXPERIMENTAL APPARATUS

The engine- The measurements were made in a single cylinder engine based on a six-cylinder Volvo TD 102 diesel engine. Its main geometric properties are shown in table 2.

The LDV system- The velocity measurements were performed with a 2-component DANTEC fibre-flow system. This system consists of a 4W Ar-ion laser, a transmitter that splits the multicolour laser beam into 514.5 and 488 nm wavelength components, frequency shifts half of each colour 40 MHz and leads the four resulting beams into optical fibres, a fibre optic probe which sends out the laser beams and collects the scattered light, two photomultipliers that convert the optical signal to electrical and two signal processors (BSA enhanced) which perform a "real-time" FFT to extract velocity information. The system is controlled by a standard 486/33 PC. The main LDV specifications are given in table 3.

Table 2: Geometric properties of the engine.

Displaced volume	1600 cm ³
Bore	120.65 mm
Stroke	140 mm
Connection rod	260 mm
Exhaust valve open	39 CAD BBDC
Exhaust valve close	4 CAD ATDC
Inlet valve open	2 CAD BTDC
Inlet valve close	42 CAD ABD

Table 3: LDV system specifications

wavelength	488 nm	514.5 nm
focal length	310 mm	310 mm
beam spacing	41.23 mm	40.87 mm
beam intersection-angle	3.804°	3.771°
beam diameter	4.3 mm	mm
fringe spacing	3.678 μm	3.911 μm
probe volume diameter	45 μm	48 μm
probe volume length	680 μm	724 μm

Optical access- To get optical access to the combustion chamber, the original spark plug was replaced by a spark plug adapter with a $\phi = 10$ mm quartz window. To be able to run the engine in a skip fire mode the pressure transducer was replaced by a spark plug during the LDV measurements. This arrangement enabled LDV measurements with an engine temperature level close to normal operation.

The LDV measurement volume was located 5 mm below the cylinder head and had a 20 degree angle from the vertical axis. The measurement was thus performed in the same spot as the spark gap on the original spark plug.

Seeding- To obtain scattered light from the laser beam crossings some kind of seeding particles must be added to the inlet air/fuel mixture. The seeding used was a polystyrene-latex dispersion in water. The mean polystyrene particle size was 0.28 μm and the mean droplet size from the liquid atomisers used was 3-4 μm. The dry weight of the dispersion was less than 1%, which means that the resulting dry particle size was below 1 μm [12].

The Pressure measurement system- The pressure in the cylinder was measured with a AVL QC42 piezo-electric transducer connected to a Kistler 5001 charge amplifier. The charge amplifier voltage output was connected to a 486/66 PC with a Data Translation DT2823 100 kHz 16-bit A/D-card. A more detailed description can be found in [8].

The control system - The ignition timing and skip-fire were controlled with a PC-based system. Triggering signals to the LDV- and pressure-systems were also included in this system. Input signals to the control system were a sync-pulse (1 pulse per 2

revs), a TDC-pulse (1 pulse per rev) and a crank angle-pulse (5 pulses per crank angle degree, CAD). The LDV-system required crank angle and Top Dead Centre pulses. To reduce the amount of data to be stored in the LDV-PC there was also an enable signal from the triggering system which disabled the BSA:s during times when the velocity was of minor interest.

OPERATING CONDITIONS

The engine was run on natural gas which was fed to the engine through two pulse width-modulated solenoid valves. To get a homogenous charge the mixing length from the solenoid valves to the engine was 3 m with a 16 litre mixing tank in the middle. The contents of the gas used is given in table 4.

Table 4: Contents of the natural gas used.

Component	Vol.%	Mass%
Methane	91.1	81.0
Ethane	4.7	7.9
Propane	1.7	4.2
n-Butane	1.4	4.7
Nitrogen	0.6	0.9
Carbon dioxide	0.5	1.2

During the LDV measurements, the engine was run in a skip-fire mode in which the engine was fired for 3 cycles and then motored for 3 cycles. In this skip fire mode the LDV-system was enabled only in a crank angle interval between -60 to +60 degrees from TDC in the last cycle without combustion. Velocity measurements were performed at 800, 1000 and 1200 rpm to detect possible trends from changing engine speed.

During all cylinder pressure measurements the engine was run at 1200 rpm, without skip fire. The air/fuel-ratio was changed from $\lambda=1$ to the lean limit. The lean limit was defined as the air/fuel-ratio where the level of unburned hydrocarbons (HC) exceeds 1000 ppm. Ignition timing was set to maximise imep for each λ (MBT). No throttling was applied at any time.

DATA REDUCTION

One-zone heat release model- To extract information on the flame development, a cycle-resolved heat release calculation was performed. In the computations Wochnis heat transfer model [7] was applied and the ratio of specific heats was assumed to have a linear dependence on temperature. Further details concerning the heat release calculation have been described elsewhere [8].

Mean velocity and turbulence- The LDV signal, with random arrival time for the velocity registrations, was post processed by using the conventional filtering technique with a moving window [8], [13]. The low-pass filtered

velocity trace, commonly called mean velocity, was obtained with an 12 degree wide window. This corresponds to a cut-off frequency of 600 Hz at the engine speed of 1200 rpm. The high frequency part of the flow was obtained by taking the difference between the mean velocity trace and samples during a 10 degree long period. The RMS of this difference is then considered to be an estimate of the level of turbulence.

RESULTS

Combustion- The different combustion chambers have, as indicated before, a large spread in the rate of heat release. Figure 3 below shows the development of the heat release from 0 to 90% of the total heat released when the engine was run with MBT, $\lambda=1.5$. As can be seen the combustion chambers with a square cross section of the piston bowl have the fastest combustion, and hence late ignition timing for MBT. The flat chamber, with no squish, is clearly the slowest with a twice as long duration for the combustion. It is interesting to note that the combustion for the Nebula chamber phased earlier than the rest of the chambers for MBT operation.

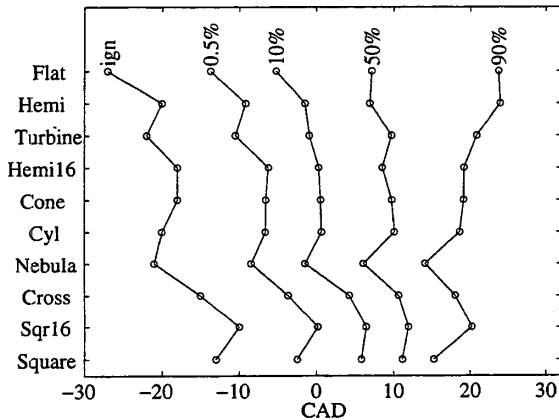

Figure 3: The crank angle position for ignition timing and different percentages of heat released when different combustion chambers are used. The engine operated at 1200 rpm, $\lambda=1.5$.

Mean velocity- The combustion chambers have very different amounts of squish area and can consequently be expected to show a large spread in the bulk flow pattern. The mean velocities for the different chambers are shown in Figures 5 and 6 with the flow directions indicated by the solid and dashed arrows in Figure 4 below.

The mean velocity in the cylindrical geometry has the shape expected from the squish effect, with a large inward motion from the squish area just before TDC.

The two square combustion chambers on the other hand tend to have a large inwards mean velocity some 10 degrees after TDC. This kind of flow pattern with a squish effect after TDC is remarkable and not at all expected.

The cross chamber shows very effective in reducing the mean velocity flow in both directions very early in the cycle. The other geometries do not show such easily interpreted flow patterns.

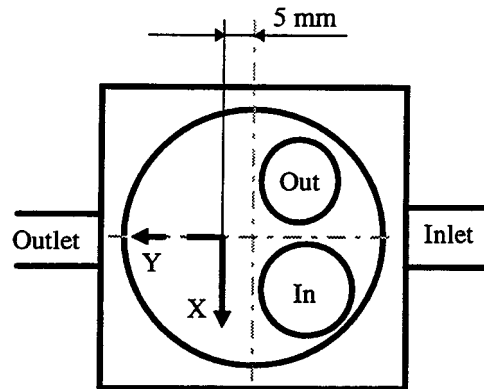

Figure 4: Schematic view of the engine with the measured velocity components. The swirl is rotating clockwise.

Turbulence- Although the mean velocity can influence the early part of the combustion event through changes of wall contact area, its impact on the overall combustion rate must be considered to be less important than the turbulence. The turbulence, as well as the mean velocity, changes significantly during the compression and expansion strokes. Figure 5-6 shows the turbulence for the engine speed of 1200 rpm, as well as the rate of heat release for $\lambda=1.5$, MBT. The change of turbulence during the engine revolution will give completely different possibilities for the turbulent flame propagation. This can also be noted in the graphs of the rate of combustion.

The cylindrical combustion chamber has for instance a high peak turbulence but this peak comes too early in the cycle to be very useful to the main flame propagation.

The square geometry has a similar peak value but the turbulence has a better timing and hence gives a much faster combustion rate. The same kind of turbulence curve shape is obtained in the square chamber with a compression ratio of 16:1 and the cross geometry.

The Hemi chamber with a compression ratio of 16:1 has also a distinct peak in turbulence a few degrees after TDC, although the peak in this chamber is much less pronounced

The turbine chamber shows the opposite trend. Before TDC a peak in turbulence is reached and a local minimum is reached close to 10 degrees after TDC, where the turbulence is less effective for enhancing the main combustion event.

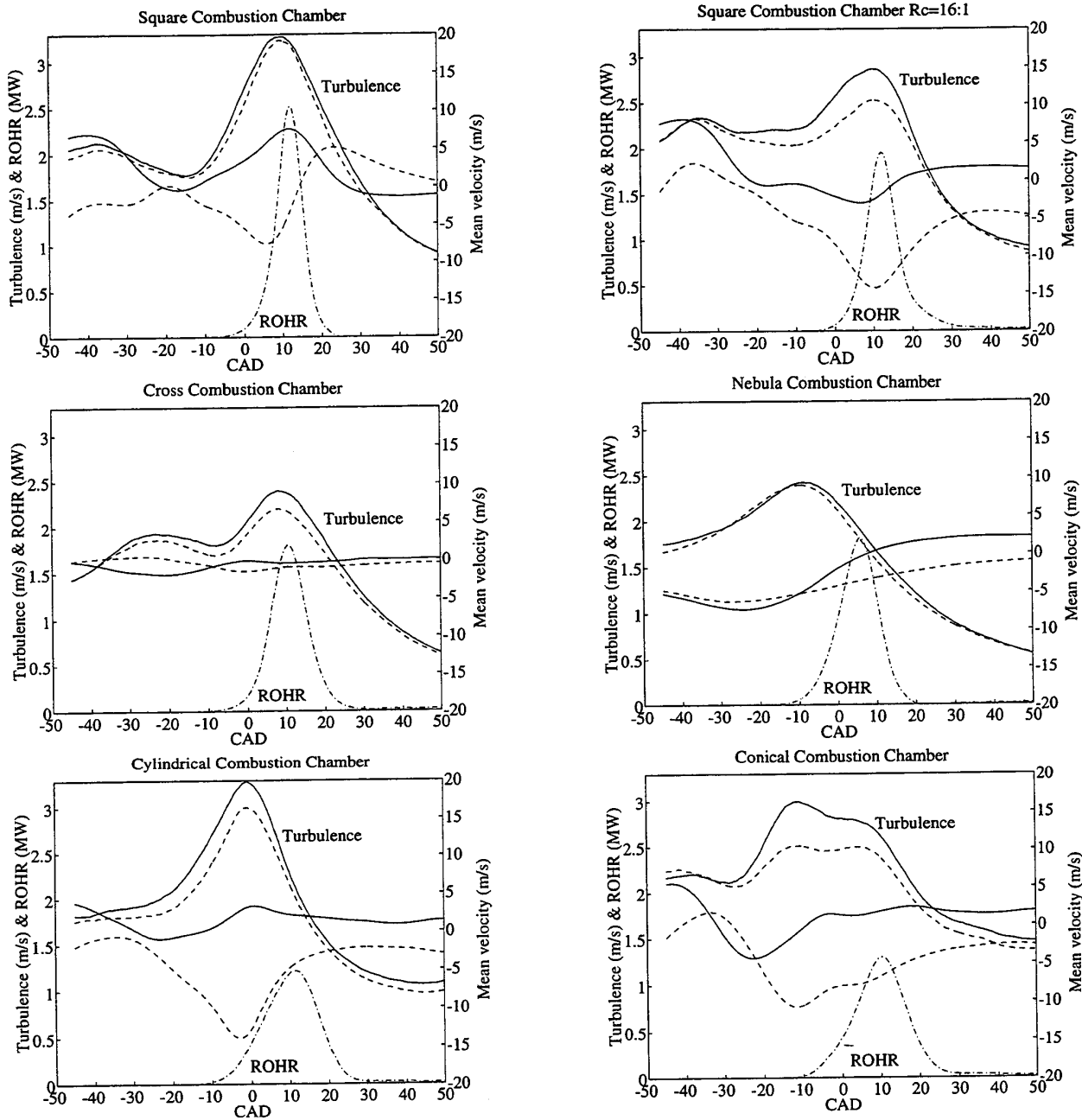

Figure 5: Mean velocity, turbulence and rate of heat release during the crank angle interval -50 to 50 degrees from top dead center (TDC).

The same kind of trend is found in the nebula chamber with a maximum turbulence some 10 degrees before TDC and a rapid decay after TDC. The flat and hemi chambers have moderate levels of turbulence with peaks just prior to TDC.

The anisotropy of the turbulence is quite low for most chambers during the entire measured period.

The cone is the only chamber with a distinct difference of turbulence in the X and Y directions. This difference would be explained by the excessive shear that will result during the flow into the very deep conical bowl.

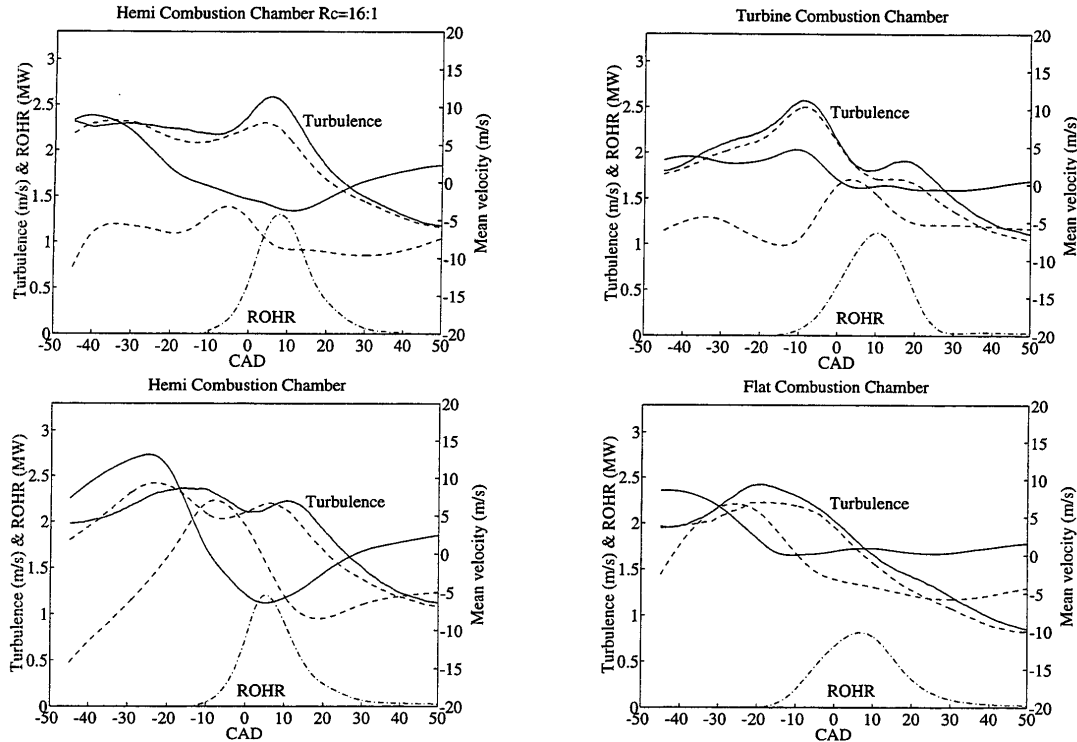

Figure 6: Mean velocity, turbulence and rate of heat release during the crank angle interval -50 to 50 degrees from top dead center (TDC).

Turbulence-Engine speed- The turbulence in an engine cylinder is known to scale almost linearly with the engine speed. To verify this assumption velocity measurements were performed with the engine running at 800 and 1000 rpm, as a complement to the already presented runs at 1200 rpm. Figure 7 below shows the average turbulence within the interval -40 to 40 degrees from TDC normalised with the mean piston speed, S_p ($=2 \cdot \text{Stroke} \cdot \text{Engine speed}$). In most combustion chambers the level of turbulence scales well with engine speed. The hemi chamber is, however, an exception. In this chamber the turbulence measured at the three speeds is almost the same and consequently the ratio of turbulence to S_p is reduced for higher engine speeds.

It must be stated that the effective cut-off frequency in the low-pass filtering in the mean velocity estimations has been changed between the different engine speeds. The window width in the moving window technique has been kept constant for all speeds. This means that the cut-off frequency is proportional to the engine speed. The procedure with constant window width can be assumed to give a

higher level of turbulence at the lower speed as more of the turbulent spectrum is included in the turbulence, but no such trend is found in Figure 7. Four chambers give the highest ratio of turbulence to mean piston speed at 1000 rpm, and three find the highest ratio at 800 and 1200 rpm.

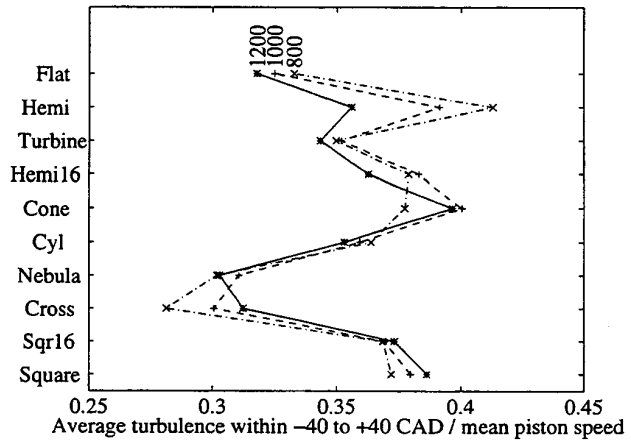

Figure 7: Turbulence normalised by mean piston speed. The engine speed was set to 800, 1000 and 1200 rpm.

Squish-turbulence- One way to increase the level of turbulence in a combustion chamber is to increase the percentage of the bore which is occupied with squish area. This squishing effect at the end of the compression stroke would give a high level of shear and hence turbulence. Figure 8 below shows turbulence plotted against the squish area. A surprisingly good correlation results from the regression. The turbine chamber which according to the plot have to little turbulence has a 1.5 mm clearance height as compared to the others 1 mm. This higher clearance height would give a lower squish velocity and consequently give a lower turbulence.

The only two chambers that do not fit in the line are the two squares. They have the same squish area and only differ in the bowl depth. The deeper bowl of the chamber with Rc=12:1 seems to give a more beneficial turbulence production.

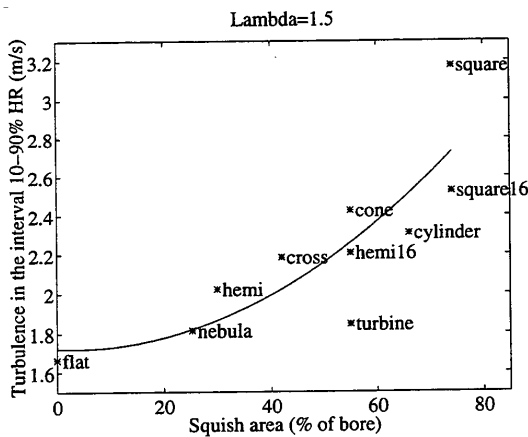

Figure 8: Turbulence in the crank angle interval corresponding to 10-90% HR as a function of squish area.

FLOW AND COMBUSTION INTERACTIONS

Main combustion period 10-90% HR- It is well recognised that there exists a direct relationship between the level of turbulence and the propagation speed of a turbulent flame [14],[15]. The rate of heat release in a spark ignition engine with a homogeneous charge in turn can be expected to be a function of the rate of flame propagation and the available flame surface area for a given fame radius [16]. As there exists dramatic changes in the level of turbulence for the different combustion chambers as well as changes in the rate of heat release, there would be expected to be a correlation between the two parameters. Figure 9 shows the average rate of heat release in the interval 10-90% HR as a function of the average turbulence level in the same crank angle interval. The engine in this case was operated with an air excess factor of 1.5. As expected a correlation between turbulence and rate of combustion can be found, but there exists a spread

around the regression line. This spread can be the result from two major parameters: The turbulence in the chambers can be inhomogeneous. If large inhomogenities are present the measured turbulence in one single point close to the spark plug will not be sufficient. The chamber geometry itself will also be important. The combustion chambers have their volume located at different radius from the spark plug and hence have different available flame areas during the early, intermediate, and later stages of combustion. Figure 10 shows this effect of available flame area. The chambers are sorted in two groups. One group has more chamber volume close to the spark plug. In figure 11 the correlation between the rate of heat release and turbulence is shown to decrease for leaner mixures. This can be due to the longer heat release period which gives more turbulence decay.

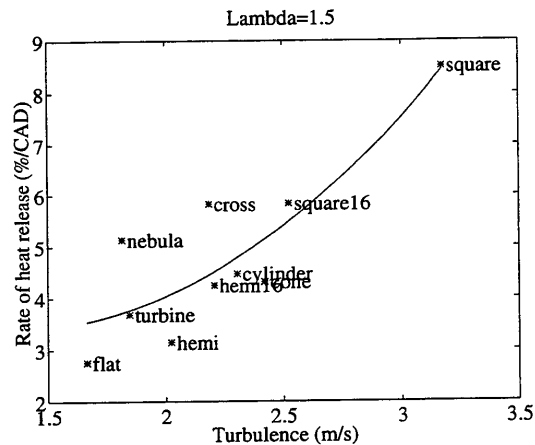

Figure 9: Rate of heat release in the interval 10-90% HR as a function of average turbulence in the same interval.

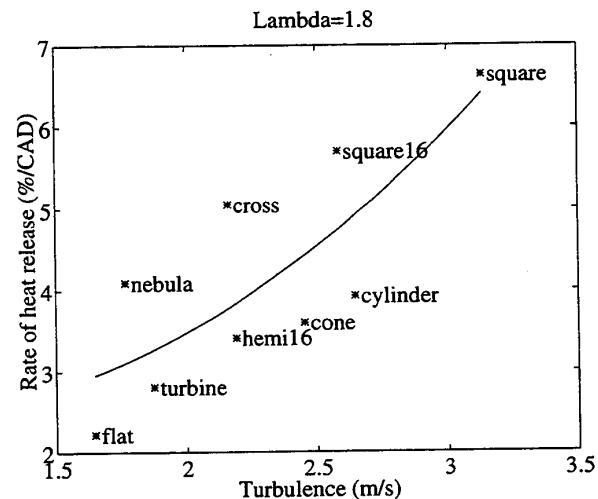

Figure 10: Rate of heat release in the interval 10-90% HR as a function of average turbulence in the same interval.

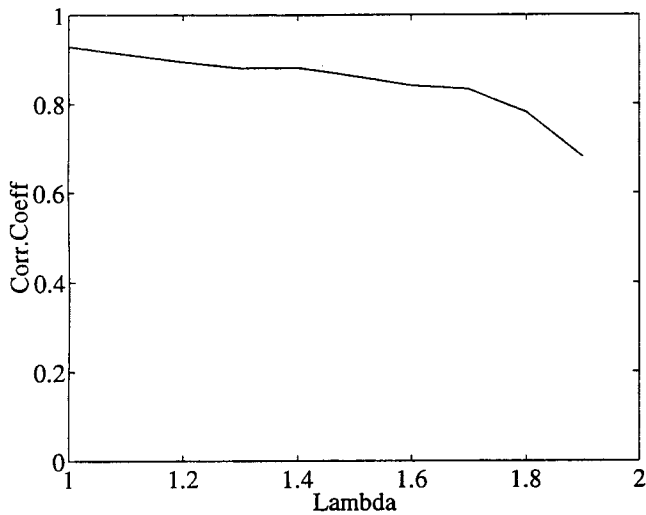

Figure 11: Correlation between rate of heat release and turbulence in the interval 10-90% HR for different air/fuel-ratios

Early part of combustion- In the flame development period the wall contact area of the small flame is of major importance for the flame speed. It has been shown that the mean velocity in the very early phase of the flame propagation can respond more to changes in the mean velocity than changes in the turbulence [17],[18]. This is explained as an effect of the changing heat loss to the spark plug electrodes depending on mean flow direction and magnitude. For the different combustion chambers no correlation of significance could be found between mean flow or turbulence and the 0-0.5% HR period. This can possibly be due to the very laminar-like flame behaviour in this period. As the chambers require different ignition timing of MBT, the pressure and temperature in the 0-0.5% HR period will change from chamber to chamber. The laminar flame speed is known to have a dependence on both temperature and pressure. This means that the possible changes of the flame speed from mean flow and turbulence will disappear in the major change of laminar flame speed.

Intermediate part of combustion- After approximately 0.5% HR the flame propagation will be less dependent on the laminar flame speed and respond to changes in flow pattern. In this period no correlation can be found between rate of heat release and turbulence, see Figure 12. In this case the mean flow in the Y direction will give a higher correlation to rate of heat release, see Figure 13. This correlation can be explained by two geometrical properties. In all runs the spark plug side electrode was located to the left in Figure 4. This would give chambers with an average mean velocity to the right a benefit in the early part of the combustion as less heat will be lost to the side electrode. The second benefit of a mean velocity to the right in Figure 4 would be a centring of the flame in the combustion chamber. The spark plug is located 9 mm to the

left of the geometrical centreline of the cylinder due to the limitations of the original engine cylinder head.

The correlation between rate of combustion in the interval 0.5-10% and both mean velocity and especially turbulence shown in the above figures is not that strong. But if they are combined in a multiple regression analysis they together can explain the variation of combustion rate with a reasonable correlation coefficient, as shown in Figures 14 and 15. It seems reasonable that both mean velocity and turbulence would influence the combustion in this part of the flame development but the correlation coefficients presented in Figure 15 must not be compared with the ones obtained in Figure 11 as one more degree of freedom is used in the statistics [19].

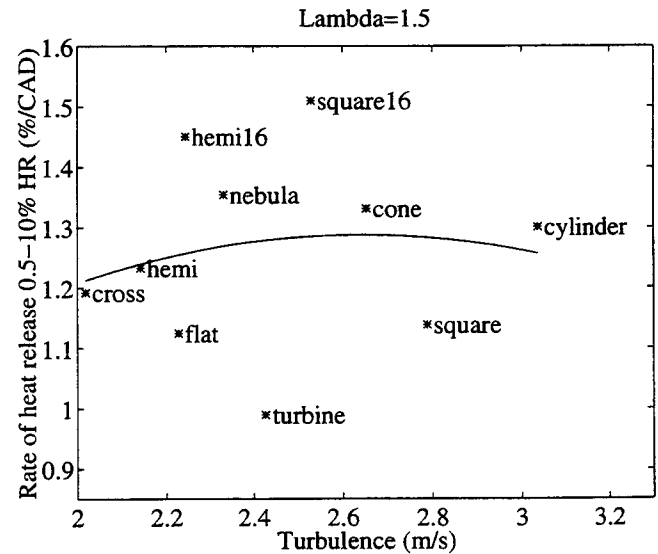

Figure 12: Rate of heat release in the interval 0.5-10% HR as a function of average turbulence in the same interval.

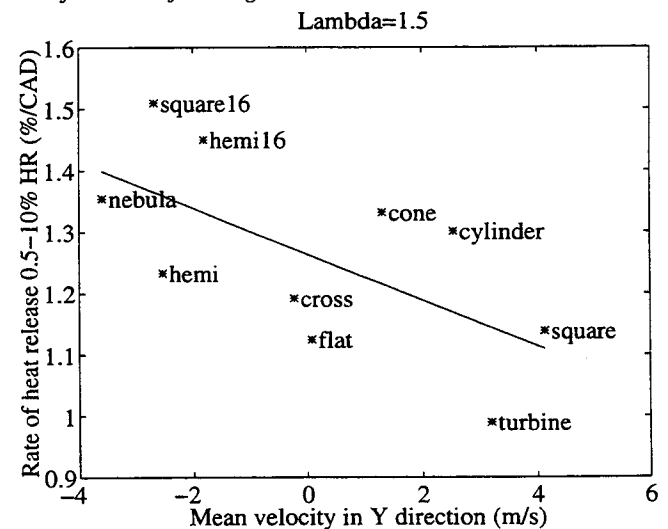

Figure 13: Rate of heat release in the interval 10-90% HR as a function of mean velocity in the Y direction.

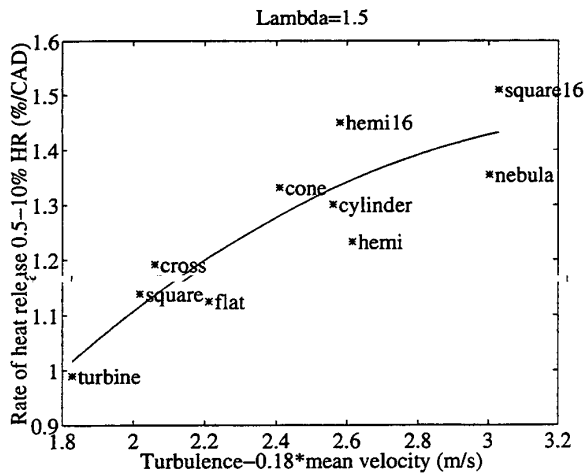

Figure 14: Rate of heat release in the interval 0.5-10% HR as a function of turbulence-0.18*V mean velocity.

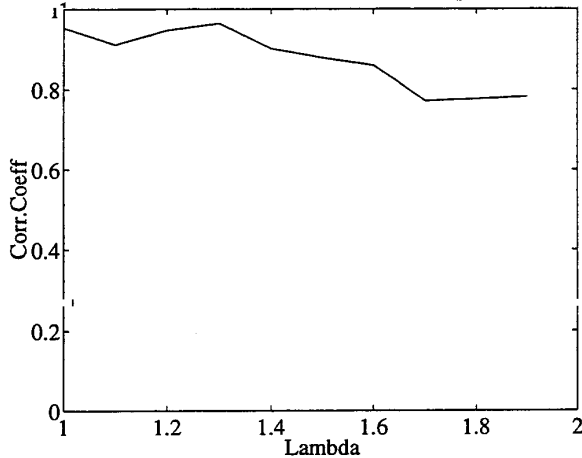

Figure 15: Correlation between heat release rate in the interval 0-5-10% HR and turbulence-0.18*V mean velocity

CONCLUSIONS

1. The flow field in the cylinder of a medium size natural gas engine is much affected by the design of the piston crown.
2. The turbulence in all combustion chambers changes dramatically during the combustion duration.
3. The pistons with cylindrical and square cross sections of the bowl give the highest peak levels of turbulence. The phase for the peak value is, however, different. The cylindrical has its peak close to TDC whereas the square reaches the peak some 10 degrees later. This later phasing gives a higher rate of heat release as the combustion is centred around 10 degrees ATDC for MBT operation.
4. The level of turbulence in the cylinder scales well with the squish area.

5. The rate of heat release in the main part of the combustion (10-90% HR) have a strong correlation to the average turbulence during combustion.

6. The correlation between heat release in the 10-90% period and turbulence decays for leaner mixtures.

7. The intermediate rate of combustion (0.5-10% HR) scales fairly well to the mean velocity in one direction. When both the mean velocity and turbulence during the interval are used as explaining parameters a strong correlation is obtained.

8. The earliest part of combustion (0-0.5%) does not correlate to the flow pattern. The reason is believed to be the different demands of spark advance for the chambers. The changing advance gives varying pressure and temperature and hence a change of laminar flame speed.

REFERENCES

- [1] T. Naganuma, M. Iko, T. Sakonji, F. Shoji: "Basic Research on Combustion Chambers for Lean Burn Gas Engines", 1992 Int. Gas Research Conf.
- [2] W.R. Dietrich, W. Grundmann, G. Langeloth: "Pollutant Reduction on Stationary S.I. Engines from Motoren-Werke Mannhiem for Operation on Natural Gas Applying the Lean-Burn Principle", MTZ, Motortechnische Zeitschrift 47(1986) 3 pp83-87
- [3] C. Arcoumanis, A.F. Biecen, J.H. Whitelaw: "Squish and Swirl-Squish Interaction in Motored Model Engines", ASME Trans., J. Fluids Engng, vol 105, pp. 105-112, 1983.
- [4] T. Kato, K. Tsujimura, M. Shintani, T. Minami, I. Yamaguchi: "Spray Characteristics and Combustion Improvement of D.I. Diesel Engine with High Pressure Fuel Injection", SAE890265
- [5] T.D. Fansler: "Turbulence Production and Relaxation in Bowl-in-Piston Engines", SAE930479
- [6] B. Johansson: "Influence of the Velocity Near the Spark Plug on Early Flame Development", SAE930481
- [7] G. Woschni: "A universally Applicable Equation for Instantaneous Heat Transfer Coefficient in the Internal Combustion Engine", SAE670931
- [8] B. Johansson: "Correlation Between Velocity Parameters Measured with Cycle-Resolved 2-D LDV and Early Combustion in a Spark Ignition Engine", Licentiate Thesis, ISRN LUTMDN/TMVK7012SE, Dept. of Heat&Power Engrg, Lund Inst. of Techn. 1993
- [9] M.G. Kingston Jones, M.D. Heaton: "Nebula Combustion System for Lean Burn Spark Ignited Gas Engines", SAE890211

- [10] H. Larsson, L.JTMnsson, L. Karlsson, P-M. Einang: "Volvo THG103 - A Low Emission CNG Engine", The 3rd Biennial Int. Conf & Exhib. on Natural Gas Engines, Sep 22-25, pp. 332-351, Gothenburg, 1992
- [11] E.C. Kienzle, P.F. Cassidy, A. Wells, J.J. Cole, C. Meyer:
"Lean Burn Combustion for Low Emission Medium and Heavy Duty Natural Gas Vehicle Engines", 1992 Int. Gas Research Conf.
- [12] C.Halldin:
"Particle size measurements from the Hudson atomiser" (In Swedish).
- [13] F.E.Corcione, G.Valentino:
"Characterization of Fluid-Dynamic Behaviour of Diesel Engine by LDA Technique", Laser Anemometry, pp-159-167, Vol 1, ASME 991
- [14] D.R. Lancaster, R.B. Krieger, S.C. Sorenson, W.L. Hull:
"Effects of Turbulence on Spark-Ignition Engine Combustion", SAE760160
- [15] J.B. Heywood:
"Internal Combustion Engine Fundamentals", McGraw Hill, New York, 1988
- [16] G.P. Beretta, M. Rashidi, J.C. Keck:
"Turbulent Flame Propagation and Combustion in Spark Ignition Engines", Combust. Flame vol. 52, pp. 217-245, 1983
- [17] Pischinger, S, Heywood, J.B:
"How Heat Losses to the Spark Plug Electrodes Affect Flame Kernel Development in an SI-Engine", SAE900021
- [18] K.Marforio, B.Lassesson, B.Johansson:
"Influence of Flow Parameters and Spark Characteristics on the Early Flame Development in a SI-Engine", The 3rd Int Symposium on diagn. and model. of combustion in ICE, COMODIA94, Yokohama, 1994
- [19] H.R. Draper, H.Smith:
"Applied Regression Analysis", Wiley, New York, 1981