



LUND UNIVERSITY

Activated Sludge Dynamics

Static Analysis

Olsson, Gustaf

1976

Document Version:

Publisher's PDF, also known as Version of record

[Link to publication](#)

Citation for published version (APA):

Olsson, G. (1976). *Activated Sludge Dynamics: Static Analysis*. (Research Reports TFRT-3129). Department of Automatic Control, Lund Institute of Technology (LTH).

Total number of authors:

1

General rights

Unless other specific re-use rights are stated the following general rights apply:

Copyright and moral rights for the publications made accessible in the public portal are retained by the authors and/or other copyright owners and it is a condition of accessing publications that users recognise and abide by the legal requirements associated with these rights.

- Users may download and print one copy of any publication from the public portal for the purpose of private study or research.
- You may not further distribute the material or use it for any profit-making activity or commercial gain
- You may freely distribute the URL identifying the publication in the public portal

Read more about Creative commons licenses: <https://creativecommons.org/licenses/>

Take down policy

If you believe that this document breaches copyright please contact us providing details, and we will remove access to the work immediately and investigate your claim.

LUND UNIVERSITY

PO Box 117
221 00 Lund
+46 46-222 00 00

TFRT-3129

(7612)

ACTIVATED SLUDGE DYNAMICS. STATIC ANALYSIS.

Gustaf Olsson

Department of Civil Engineering

University of Houston

Houston, Texas

ABSTRACT

Static analysis for an activated sludge system has been performed. Models of different complexity have been analyzed in order to determine which model complexity would be needed to describe a plant for control purposes.

Some basic phenomena are analyzed for very simple models. Different approximations of the hydraulics are made in order to describe the influence of different flow patterns. It is also demonstrated that the step load is an important control variable. The biosorption phenomenon is analyzed in some detail and the consequence of taking biosorption into a model is demonstrated for different aerator systems.

The dissolved oxygen concentration is important to control out of economical reasons. It is, however, also interesting as an indicator of the biological activity. It is shown, that the oxygen profile provides an interesting information that can be used to indicate completion of the biological reaction.

CONTENT	PAGE
1. Introduction	1
2. Complete mix aerator with basic kinetics	5
2.1 Equations and steady state solution	6
2.2 Steady state analysis	9
3. Sludge age calculations	21
3.1 Basic definitions	22
3.2 Steady state expressed in sludge age	25
4. Conventional aerator with basic kinetics	30
4.1 Representation of the aerator by several subreactors	31
4.2 Concentrations as functions of the number of subreactors	34
4.3 Sludge age calculations	41
4.4 Plug flow aerator	43
5. Step feed aerators	46
5.1 General remarks	47
5.2 Two subreactors	49
5.3 Four subreactors	53
5.4 Plug flow aerators	56
6. Biosorption in complete mix aerators	58
6.1 Equations	59
6.2 Steady state analysis I	61
6.3 Steady state analysis II	63
7. Plug flow and step feed aerators with biosorption	73
7.1 Plug flow aerator	75
7.2 Step feed aerator equations	82
7.3 Step feed of two subreactors	83
7.4 Step feed of four subreactors	87

	PAGE
8. Dissolved oxygen	89
8.1 Dissolved oxygen equations	89
8.2 Calculation of oxygen profiles	93
8.3 Analysis of the oxygen profile	98
8.4 Analysis of the oxygen sensitivity to air flow rate changes	101
8.5 Analysis of the oxygen sensitivity to disturbances	106

Appendix

 List of symbols

References

ACKNOWLEDGEMENTS

The financial support for this work has come from two sources, from the Swedish Board for Technical Development (Project Control of Wastewater treatment plants) and from the University of Houston. The report is based on research carried out by the author both in the Department of Automatic control, Lund Institute of Technology, Lund, Sweden and the University of Houston.

The computations have been performed both at the Lund University Computing Center and at the Engineering Systems Simulation Laboratory, University of Houston.

The author is indebted to Professor John Andrews, University of Houston, for his advice and comments during many discussions on the different topics. Sincere thanks are extended to Dr. Geoffrey Hansford, Visiting Professor at University of Houston for his comments and review of the manuscript. Thanks also to Ms Susan Goolsby for typing the manuscript and to Miss Britt Marie Carlsson (Lund, Sweden) and Mr. Charles Hatfield who prepared the figures.

1. INTRODUCTION

In the present report static analysis and computations have been performed for an activated sludge system. Models of quite different complexity have been analyzed in order to determine which model complexity would be needed to adequately describe a plant for control purposes.

The present report is based on a previous report on biological models in activated sludge systems, Olsson (1975). The latter is referred to as "part I".

The first model approach is the simplest possible. Soluble substrate and microorganisms are represented by one variable each in a complete mix reactor. The steady state solution is simple enough to calculate analytically, and the influence from different parameters can easily be computed. The influence of different parameters give good indications what to expect in more elaborate models. The concept of sludge age is considered, and some discussion is performed in order to clarify some misconceptions seen in the literature.

The flow pattern has a major influence on the plant behaviour, and therefore an accurate model must reflect the flow pattern reasonably well. A complete mix reactor behaves quite differently compared to a plug flow reactor. There are several plants, which need a description somewhere between the two extremes. It is shown, that a description with a reasonable number of subreactors in series approximating the aerator will be a useful approximation in many cases.

If an aerator is supplied with step feed loading, there is an extra control variable available, which may be very valuable under certain conditions. Some calculations have been made to show, under what conditions it is preferable to use the step feed pattern to improve the process.

In order to be able to explain the dynamical behaviour of a contact stabilization process the phenomenon of biosorption has to be modeled. Two different approaches of biosorption modeling are analyzed, and it is found that one of the approaches is not feasible, while the other is. The biosorption phenomenon is applied both to plug flow reactors and to step feed reactors. In the plug flow case the substrate concentration profile indicates clearly, how the biosorption acts in a biological reactor.

In many situations the dissolved oxygen (DO) concentration is a limiting factor for the biological activity. The dynamics of the dissolved oxygen is formulated and its coupling to the biological equations is given. The profile of the DO concentration in a plug flow reactor is analyzed and computed for some different cases. It is demonstrated how the DO profile is a very important tool to indicate, how the biological reactions behave. Some analysis of the DO profile is made.

The DO concentration sensitivity to different disturbances and inputs is also analyzed. It is shown analytically, and verified by computations, that there is a maximum sensitivity of the DO concentration for changes in the air flow rate. This maximum appears at DO levels at about 2 to 4 mg/l, depending on other operational conditions of the plant. The sensitivity to substrate or influent flow rate disturbances is also analyzed. This sensitivity is always increasing with an increasing DO

level.

The emphasis throughout the report is placed at the biological reactor and the effects of biological parameters of the system, while using only the simplest models for the settler. Throughout the report the operation of the settler is represented by using a constant compaction ratio between the mixed liquor suspended solids concentration in the feed and the underflow concentration.

Such a model is certainly insufficient to adequately describe a final clarifier. For static analysis, however, the approach with a constant compaction ratio may be adequate, as long as the ratio is given a reasonable numerical value to fit the operational condition.

In most of the models the compaction ratio parameter is coupled to other parameters, primarily the return sludge flow rate. Therefore it is preferable to examine not primarily the influence from the compaction ratio but rather the combination of return sludge flow rate and compaction ratio. Those parameters are in turn strongly related to the sludge age.

The material is organized as follows. The complete mix reactor with basic kinetics is analyzed in chapter 2. Some considerations about the sludge age concept are made in chapter 3, and the different concentrations are analyzed with respect to the sludge age. In Chapter 4 different approximations of the hydraulics of an aerator are analyzed and computed. The step feed calculations are performed in Chapter 5.

The biosorption is treated in two chapters. In Chapter 6 some fundamental properties of the biosorption approaches are analyzed. Only a complete mix aerator has been used here. In Chapter 7 more complex reactor systems are analyzed. Different plug flow concentration profiles

are computed, and it is concluded which operational conditions will affect the biosorption behaviour. Step feed reactors are also considered, and a contact stabilization plant is examined as a special case.

In Chapter 8, finally, the influence of DO limiting mechanisms on the biological activity is computed and analyzed. It is shown how different parameters influence the DO profile in a plug flow reactor. The DO concentration sensitivity to different disturbances is then analyzed.

2. COMPLETE MIX AERATOR WITH BASIC KINETICS

It is possible to gain a good insight into some basic phenomena of activated sludge dynamics by considering only the basic substrate and microorganism equations. The results are of course not quantitatively accurate, but very often they will give qualitative indications about parameter sensitivity, time constants and control possibilities.

Static analysis similar to the one given in this chapter can be found elsewhere. Andrews (1971) has examined the basic kinetics in some detail and looked at parameter influences. Some additional conclusions are made here. The model complexity is increased in the following chapter. Then comparisons are made with the simplest models.

2.1 Equations and steady state solution

The aerator is assumed to be a complete mix type and the kinetic equations are the simplest possible, only representing substrate and microorganisms. The equations are derived in part I but are repeated here for convenience. Referring to Figure 2.1 for the definitions of the flows and to appendix for the terminology the eq. (5.18), (5.19) and (5.22) of part I are repeated here. Inert bacteria as well as dispersed bacteria are neglected. The substrate equation is

$$\frac{ds}{dt} = D (s_i - s) - \frac{\mu_x c_x}{Y_x} \quad (2.1)$$

The microorganism equation is

$$\frac{dc_x}{dt} = D (r\gamma - 1 - r) c_x + (\mu_x - d_x) c_x \quad (2.2)$$

It has been assumed that the settler is characterized by a simple compaction ratio γ ,

$$c_{x,r} = \gamma c_x \quad (2.3)$$

$$s_r = s$$

The growth rate μ_x is assumed to obey the Monod equation

$$\mu_x = \hat{\mu}_x \frac{s}{K_x + s} \quad (2.4)$$

Elementary calculations give the steady state values for (2.1) and (2.2).

They have previously been calculated by other authors, e.g. Andrews (1971),

$$c_x^0 = \frac{DY_x (s_i - s^0)}{d_x + D\eta} \quad (2.5)$$

$$s^0 = \frac{K_x (D\eta + d_x)}{\hat{\mu}_x - d_x - D\eta} \quad (2.6)$$

where the parameter η is defined

$$\eta = 1 + r - r\gamma \quad (2.7)$$

The parameter η must always be positive in a static condition. This can be realized from the settler mass balance for the microorganisms. In part I chapter 8.1 the mass balance is derived, and it is found that the waste sludge flow rate w is

$$w = \frac{1 + r - r\gamma - \epsilon}{\gamma - \epsilon} \quad (2.8)$$

As w must be non-negative, η must be positive.

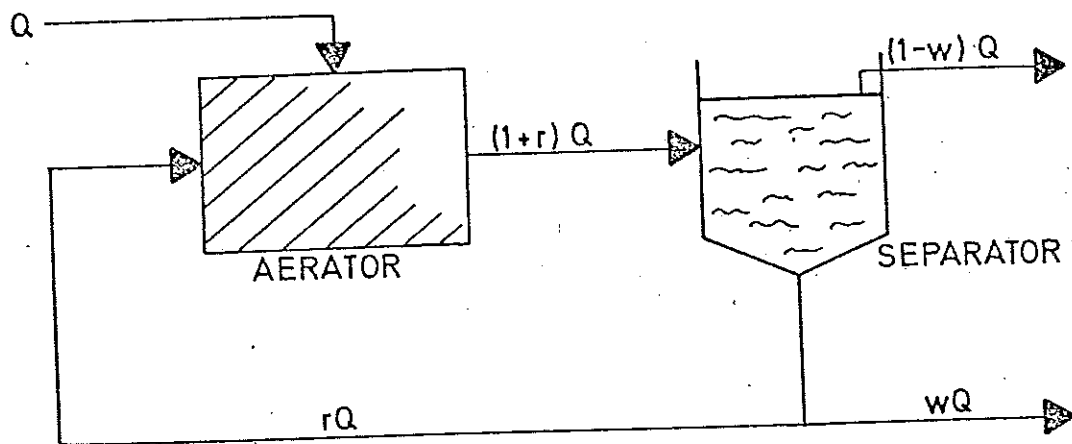

Fig. 2.1. Schematic flow diagram of a complete mix activated sludge system.

The relation (2.8) between w and r is linear and is shown graphically in figure 2.2 for some different values of the clarifier efficiency η .

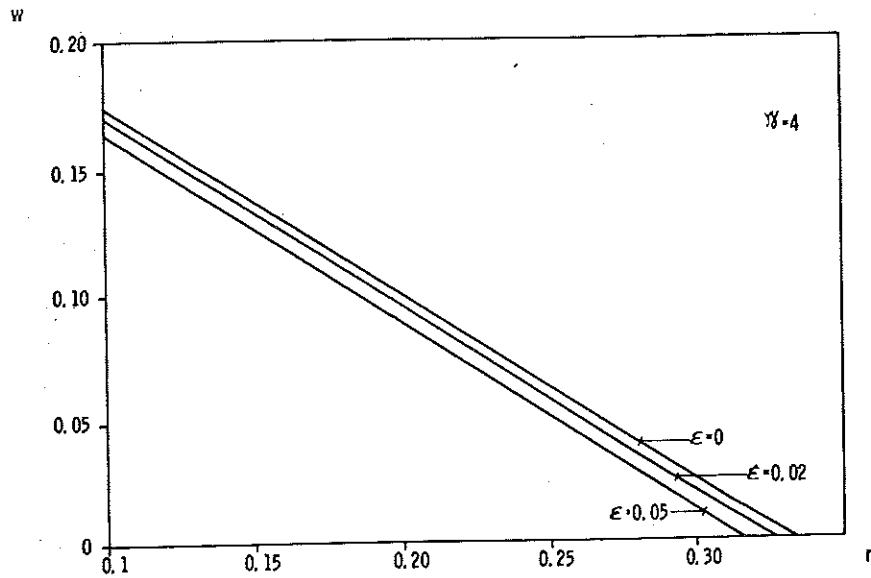

Fig. 2.2. Relation between the settler flow rates w and r for different values of the settler efficiency

2.2 Steady state analysis

The two steady state equations (2.5) and (2.6) for the complete mix system will now be analyzed, and the influence of the different parameters will be discussed.

From (2.5) and (2.6) the wash-out time can be easily calculated, i.e. the minimum aerator detention time for any substrate removal. For detention times smaller than the wash-out time θ_w the bacteria concentration $c_x = 0$ and from (2.5) it is concluded that $s = s_i$, which means no substrate reduction. Inserting s_i instead of s^0 in (2.6) gives directly the washout time

$$\theta_w = \frac{\eta (s_i + K_x)}{s_i (\hat{\mu}_x - d_x) - K_x d_x} \quad (2.9)$$

A word of caution must be said here. The wash-out time is defined as the minimal hold-up time θ for substrate removal, where θ is defined

$$\theta = V/Q \quad (2.10)$$

The real detention time for the aerator, however, is

$$\tau = \frac{V}{Q(1+r)} = \frac{\theta}{1+r} \quad (2.11)$$

as a result of the return sludge flow rate.

In order to further study the parameter influence on the steady state solution (2.5), (2.6) a simple Fortran program has been written. Naturally all conclusions are only qualitative in nature, but they still give a feeling for the essential features of the system behaviour.

In Figure 2.3 the substrate concentration has been plotted as function of the real hold-up time τ of the reactor.

Equation (2.6) shows that the substrate concentration is independent of the influent concentration s_i as long as the detention time exceeds the wash-out time. Thus, if the influent concentration should be 150 instead of 200 mg/l the upper limit of the curves are moved from 200 to 150.

Generally the substrate concentration decreases with the hold-up time. For sufficiently great hold-up times its sensitivity decreases. Physically this means, that the effluent substrate concentration should not be sensitive to hydraulic load disturbances. This is true only if the settler conditions are considered independent of the flow rate.

The higher the return flow rate the smaller is the substrate concentration. Also observe, that the slope of the curve for small detention times gets higher for higher return sludge flow rates.

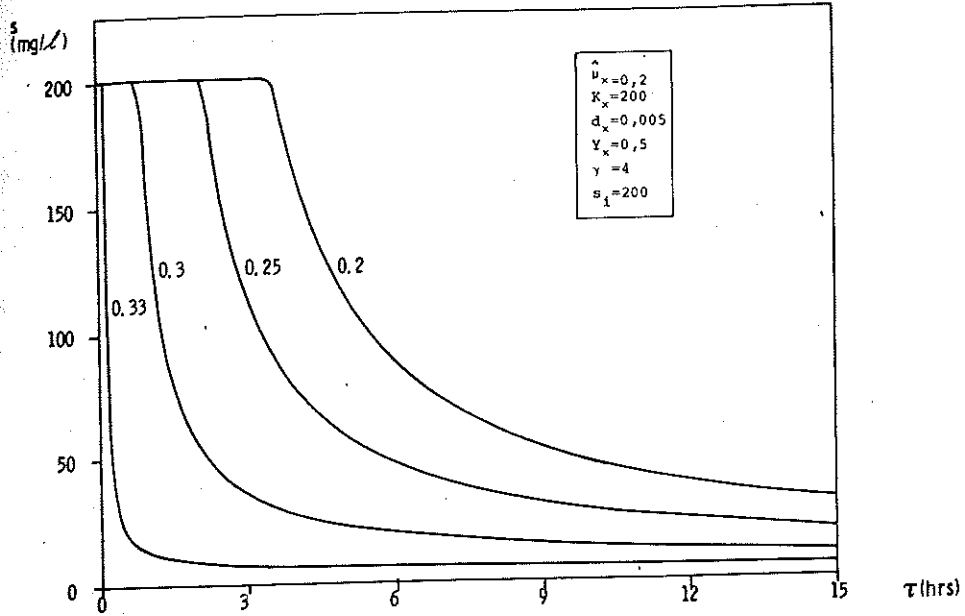

Fig. 2.3. Substrate concentration in steady state as function of the actual aerator detention time. The return sludge flow rate is a parameter.

In this simple model the influences from the return sludge flow rate and the compaction ratio are similar. Both of them appear in the term η (eq. (2.7)) in the steady state equations (2.5) and (2.6). This means that a small value of the compaction ratio γ can always be compensated by a large value of r and vice versa. The upper limit of r is determined by the condition $\eta \geq 0$.

For an infinite hold-up time the substrate concentration approaches the value

$$s^0 = \frac{K_x d_x}{\mu_x - d_x} \quad (2.12)$$

which is independent of r . For the actual parameter values

$$s^0 = 5.1 \text{ mg/l}$$

The same limiting value is achieved for an infinite sludge age (see chapter 3). In such a case no sludge is wasted, and it is also assumed that no sludge goes over the weirs in the clarified water, i.e.

$$\begin{aligned} \epsilon &= 0 \\ 1 + r - r\gamma &= \eta = 0 \end{aligned} \quad (2.13)$$

The microorganism concentration (2.5) is also plotted against the reactor hold-up time, in figure 2.4. For detention times greater than the wash-out time it is positive and then increases with the detention time. It actually has a maximum for a certain detention time for every constant r . In figure 2.4 it is most clear for the large values of r . For larger values of the hold-up time the organism decay becomes more important, and consequently the organism concentration will be smaller. For an infinite value of the hold-up time the organism concentration approaches zero, according to equation (2.5) ($D=0$).

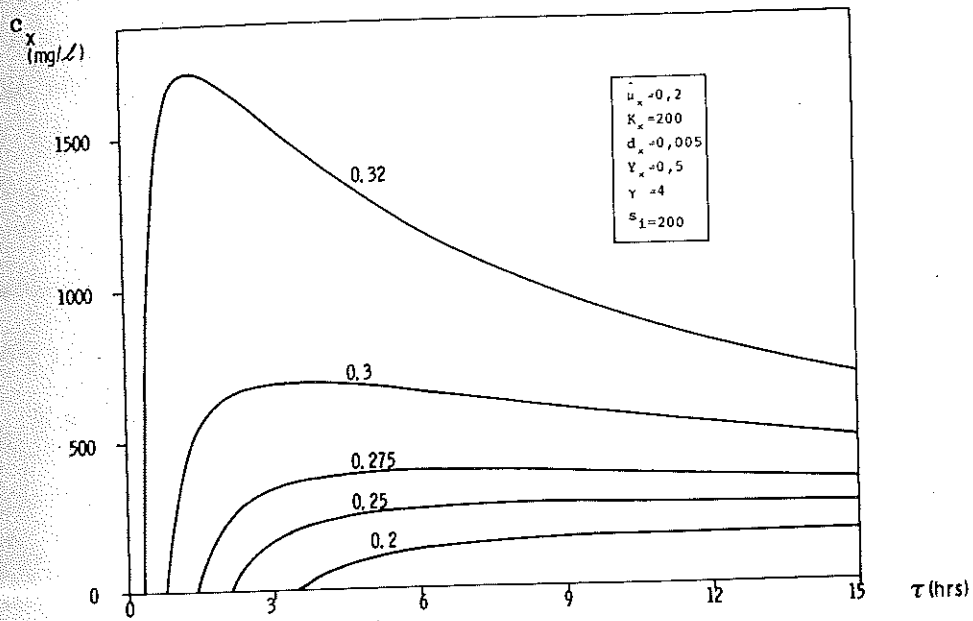

Fig. 2.4. Microorganism concentration as function of the actual aerator detention time. The return sludge flow rate is a parameter.

The process loading intensity (PLI), sometimes called the food-to-microorganism ratio F/M, will now be considered. Generally it is defined as

$$\text{PLI} = \frac{\text{influent substrate concentration flow rate}}{\text{* organism concentration*reactor volume}} \quad (2.14)$$

With the actual symbols inserted (see appendix) this becomes

$$\text{PLI} = \frac{s_i Q}{c_x V} = \frac{s_i}{c_x \theta} \quad (2.15)$$

where the detention time should be expressed in days. For large detention times the PLI approaches a constant value which can be derived from (2.5) and (2.6),

$$\text{PLI} = \frac{s_i d_x}{Y_x (s_i - s^0)} \quad (2.16)$$

where s^0 is given in (2.12). Observe that d_x is expressed in days⁻¹.

For the parameter values used in figures 2.3 and 2.4 PLI approaches

$$\text{PLI} = 0.25 \quad (\text{days}^{-1})$$

The PLI is plotted in figure 2.5 as function of the real hold-up time for some different return flow rates. As for the substrate concentration the PLI decreases with the detention time, and the slope decreases as well. This means that the PLI is less sensitive to hydraulic disturbances for large values of the detention time. On the other hand it may be too low for large detention times or for large values of r .

The microorganism concentration is actually a linear function of the influent wastewater substrate concentration, see eq. (2.5) and figure 2.6. In figure 2.7 it is also demonstrated that the organism concentration is very sensitive to the recirculation flow r at large recirculation values. This is the same as to say that the concentration is sensitive to r at high

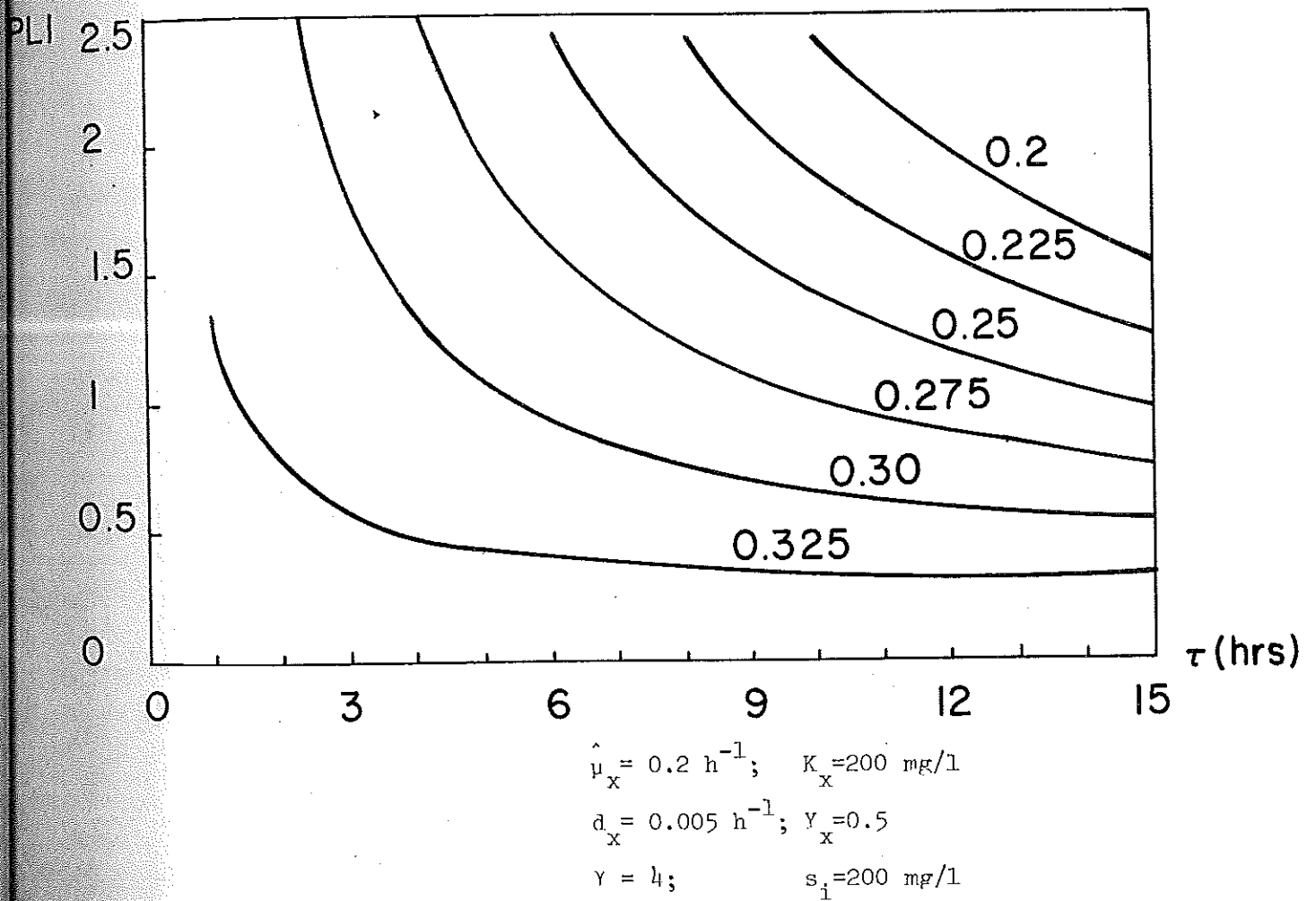

Fig. 2.5. Process Loading intensity as function of the real aerator detention time. The return sludge flow rate is a parameter.

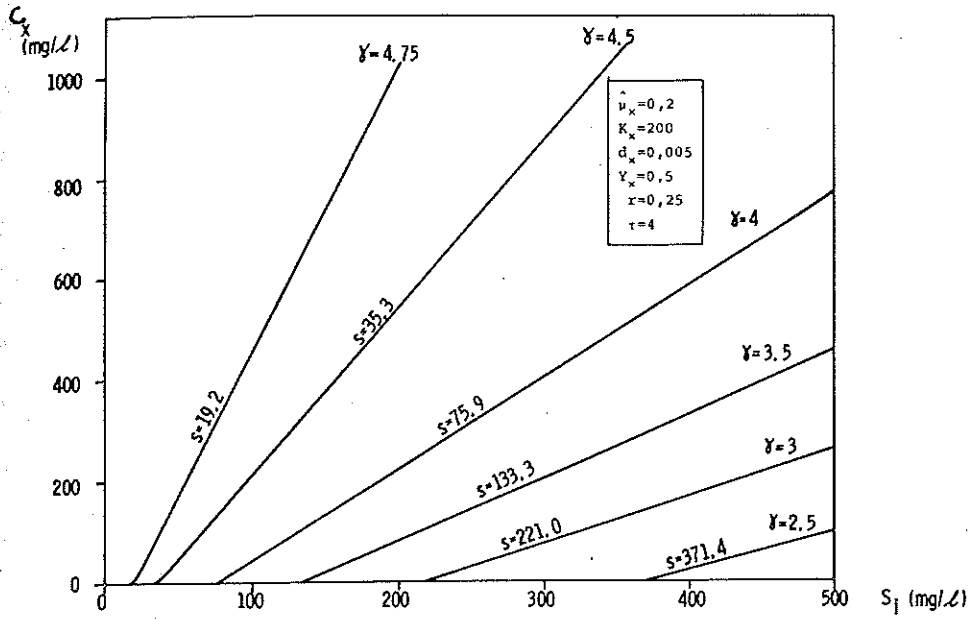

Fig. 2.6. Microorganism concentration as function of influent substrate concentration. The compaction ratio for the settler is the parameter. For each value of the compaction ratio there is a unique value of the substrate concentration, independent of the influent substrate concentration.

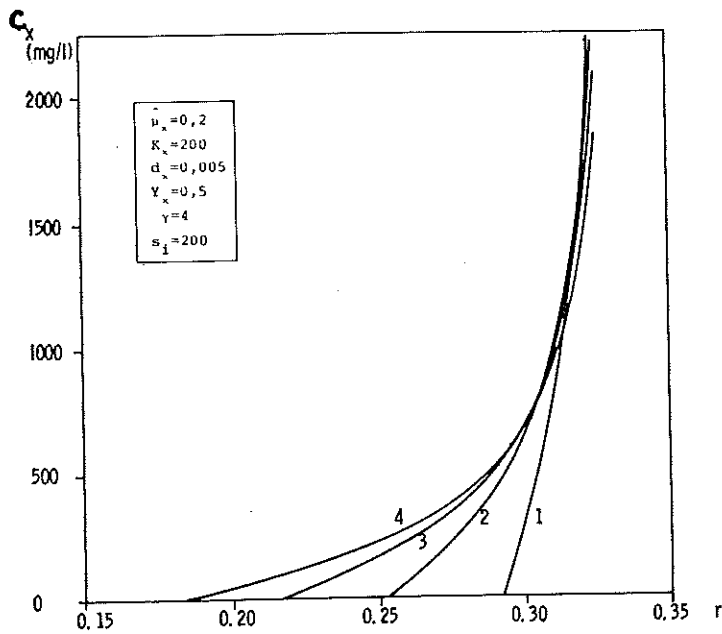

Fig. 2.7. Microorganism concentration as function of return sludge flow rate. The aerator hold-up time (V/Q) is the parameter.

sludge ages. The sludge age itself is inversely proportional to the value of η and is therefore very sensitive to r for small values of η , i.e. large values of r (see fig. 2.8). Consequently, if the organism concentration is calculated as function of the sludgeage, it is relatively insensitive to the sludge age at high sludge age values. See further 3.2.

The substrate as a function of r is shown in the figure 2.9. The horizontal lines 200 or 300 mg/l show the upper limits of the substrate concentration for the two influent substrate concentrations 200 and 300 mg/l respectively.

The substrate is a linear function of K_x and quite sensitive for small values of r , see figure 2.10. The organism concentration is also sensitive but not as much, see the lower half of figure 2.10.

Another interesting parameter is the specific growth rate $\hat{\mu}_x$. A higher value of $\hat{\mu}_x$ will of course favour a better growth of the organisms and a better removal of the substrate, see figure 2.11.

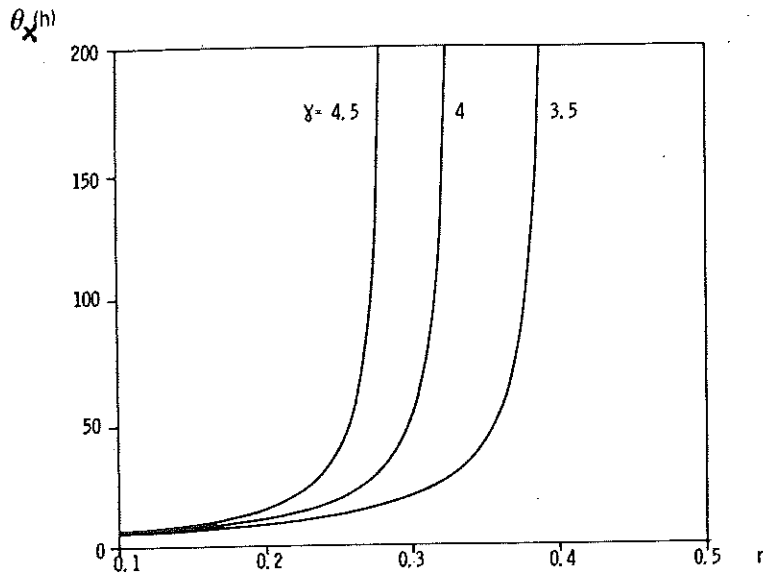

Fig. 2.8. Sludge age expressed as a function of the return sludge flow rate, assuming compaction ratio and constant settler efficiency. The relationship here is derived in eqs (3.11) and (3.12).

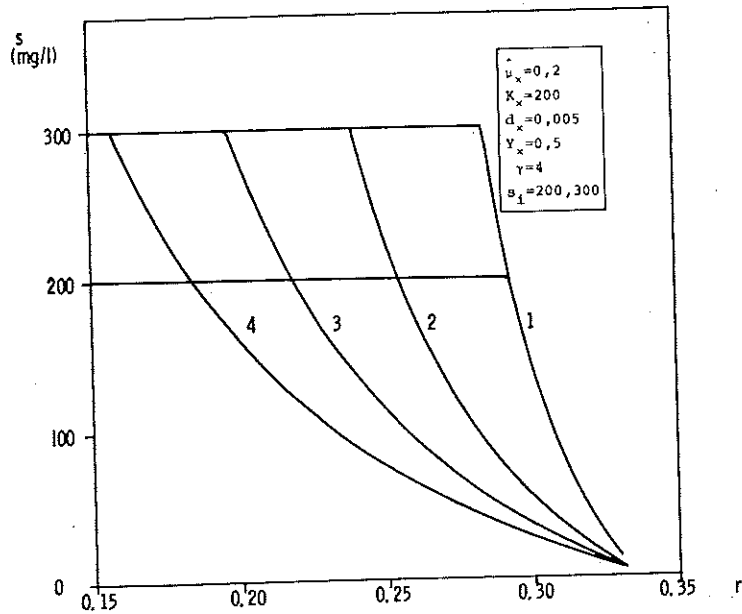

Fig. 2.9. Substrate concentration as function of the return sludge flow rate. The maximum value of the substrate concentration is limited by the influent substrate concentration. The aerator hold-up time (V/Q) is the parameter.

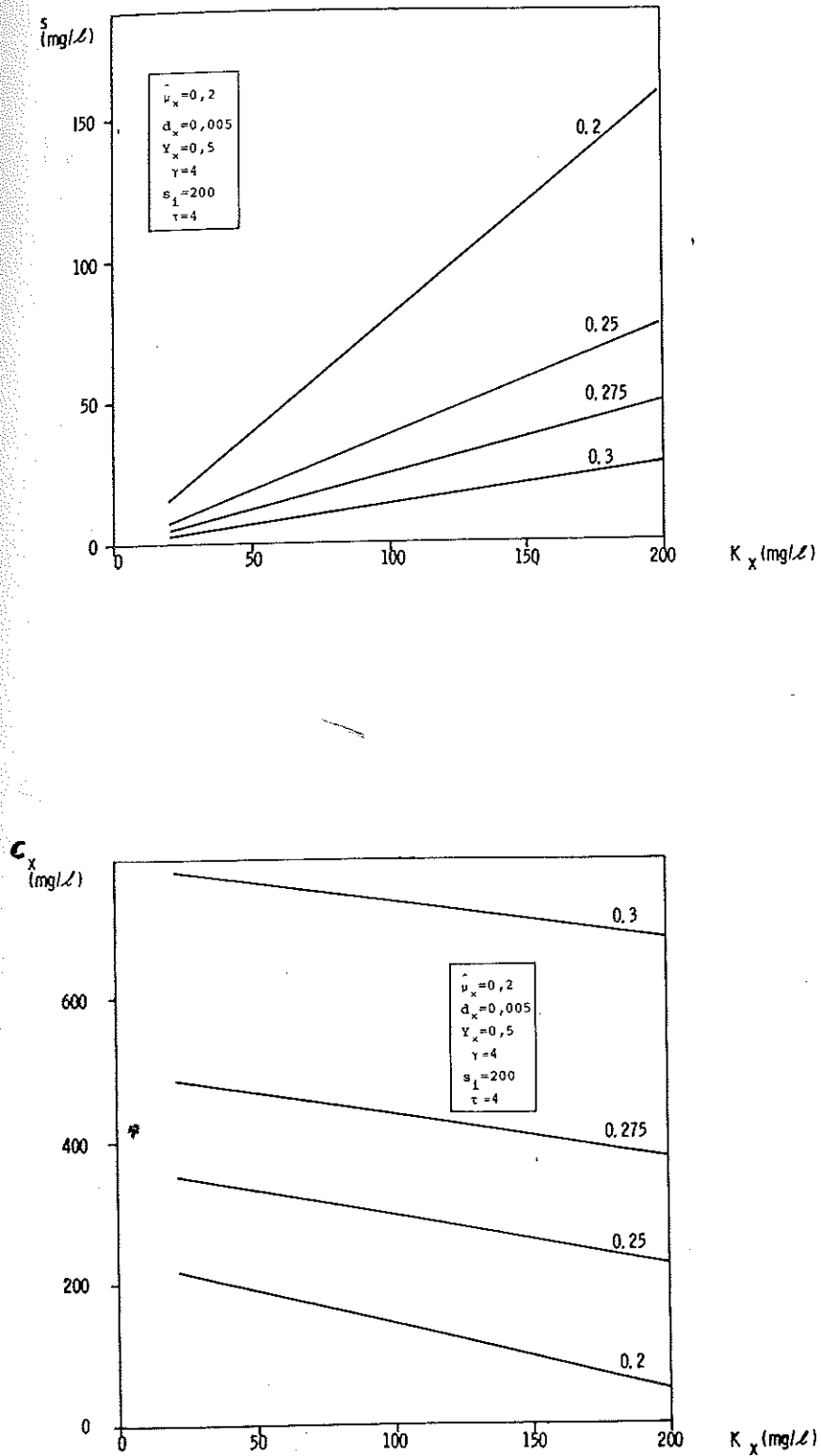

Fig. 2.10. Substrate and microorganism concentrations respectively as functions of the limiting constant K_x in the Monod function. In both diagrams the return sludge flow rate is the parameter.

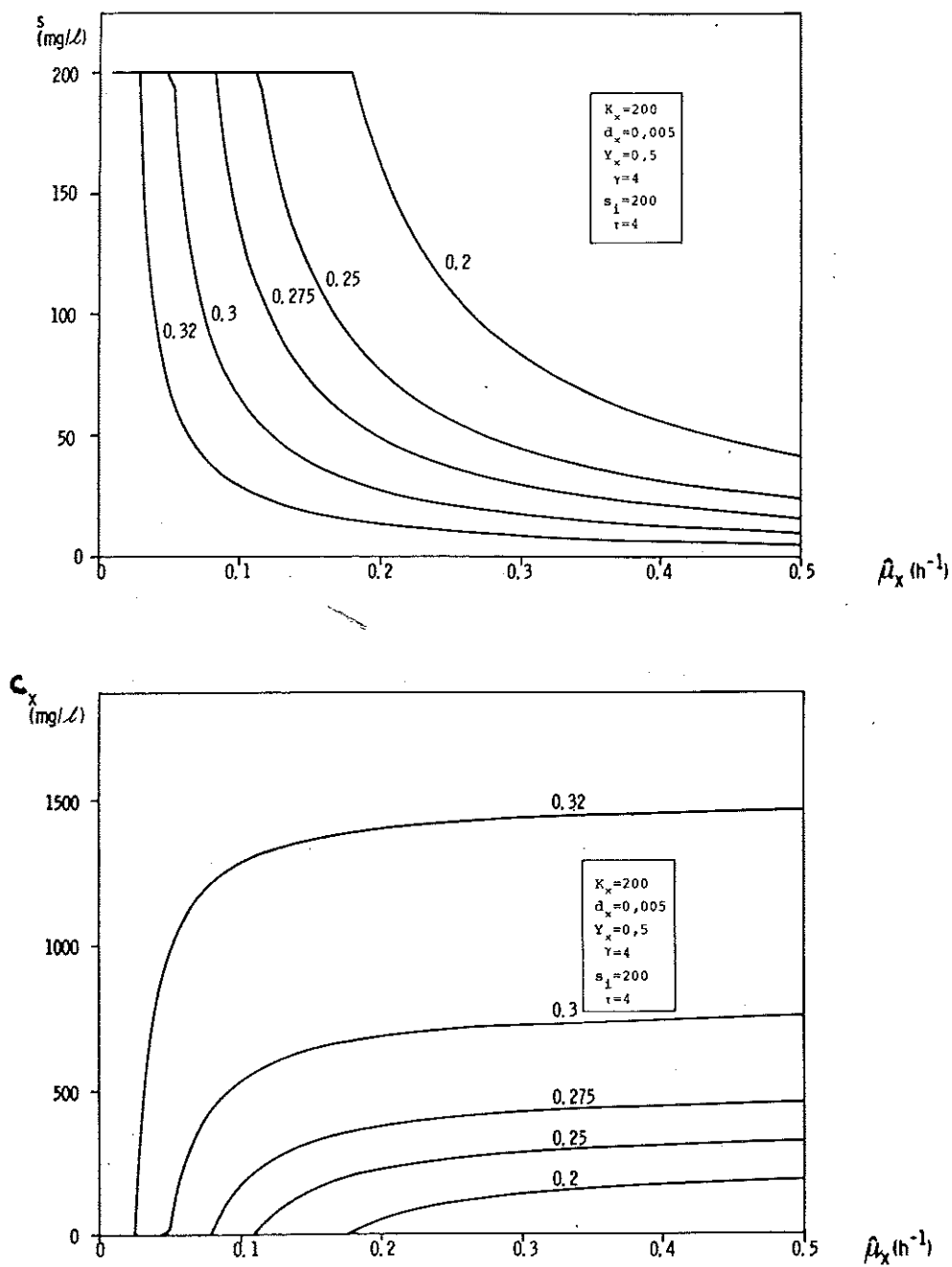

Fig. 2.11. Substrate and microorganism concentrations respectively as functions of the maximum specific growth rate. The return sludge flow rate is the parameter in both diagrams.

3. SLUDGE AGE CALCULATIONS

The concept of sludge age (or mean cell residence time, MCRT) is used often in the wastewater treatment literature as a design parameter. The sludge age can be a good indicator both of the biological condition in the aerator and of settlability conditions for the sludge.

The sludge age has also been used in control schemes, see e.g. Flanagan (1974). Quasi-stationary control laws are constructed, so that the sludge age is kept constant by means of the return sludge or waste sludge flow rates. It should be emphasized, that the sludge age is defined from steady state conditions. Therefore the concept of sludge age cannot be defined adequately in a truly dynamical situation. When concentrations and flows are varied on an hourly basis it is not adequate to calculate a sludge age - which often is of the order of days - based on varying flow rates and concentrations. This problem, however, will be the subject for a forthcoming report.

In this chapter some basic definitions are discussed in 3.1. In 3.2 the steady state solutions from chapter 2 are expressed in terms of the sludge age.

3.1 Basic definitions

Several different definitions of the sludge age can be found in the literature. It is sometimes unclear whether there is any relationship between these different concepts. Therefore the different definitions will be discussed in some detail here. A further discussion of the topic can be found elsewhere, e.g. Deaner et al (1974).

Generally the sludge age is defined as

$$\theta_x = \frac{\text{Total sludge volume}}{\text{Total wasted sludge per unit time}} \quad (3.1)$$

Some authors include in total sludge volume only that in the aerator, see e.g. Metcalf & Eddy (1972). Some others include also the buffer volume in the settler. The sludge can be either purposefully wasted (the waste flow) or not purposefully (the sludge remaining in the clarified water) wasted.

Whether or not to include the sludge in the settler into the total mass is unclear. Often it is claimed, that the sludge stored in the settler should not be included. The reason would be, that the oxygen level is very low in the thickening zone. Therefore the organisms are inactive, while they are trapped in the settler. Consequently they do not synthesize, and should not be included in the sludge age calculation.

Here it is assumed that the aerator is a complete mix reactor with the volume V . It is also assumed that the sludge volume of the settler is V_s with the homogeneous concentration c_{xs} . Then four different definitions of the sludge age can be given

$$(i) \quad \theta_x = \frac{Vc_x + V_s c_{xs}}{wQc_{xr} + (1-w) Qc_{xe}} \quad (3.2)$$

$$(ii) \quad \theta_x = \frac{Vc_x}{wQc_{xr} + (1-w) Qc_{xe}} \quad (3.3)$$

$$(iii) \quad \theta_x = \frac{Vc_x + V_s c_{xs}}{wQc_{xr}} \quad (3.4)$$

$$(iv) \quad \theta_x = \frac{Vc_x}{wQc_{xr}} \quad (3.5)$$

where θ_x = sludge age (or MCRT)

c_x = microorganism concentration in the aerator

c_{xr} = " " return sludge flow

c_{xe} = " " in clarifier effluent

c_{xs} = microorganism concentration in settler

V = aerator volume

V_s = settler sludge buffer volume

The other terms are defined in the appendix. In the nominator, Vc_x means the total mass in the aerator and $V_s c_{xs}$ is the total solids mass in the settler. The first term in the denominator is the purposefully wasted sludge while the second term is the sludge wasted by the clarified water stream.

If there is a large buffer volume of sludge in the settler or if the settler efficiency is low, then the four expressions may vary considerably.

Expression (ii) seems to be the most frequently used one and is found e.g. in Metcalf & Eddy (1972), Roper-Grady (1974), and Sherrard-Lawrence (1973) or Sherrard-Schroeder (1973).

Now consider definition (iv) of the sludge age (3.5). This definition is equivalent to (ii) if the efficiency is considered very high of the settler, i.e. $\epsilon = 0$.

Westberg (1967) has another definition of sludge age,

$$\theta_x = \frac{r\theta}{(1+r)w} \quad (3.6)$$

If it is still assumed $\epsilon = 0$, then eq (2.8) is simplified to

$$w = \frac{1 + r - r\gamma}{\gamma} \quad (3.7)$$

or
$$\gamma = \frac{1 + r}{r + w} \quad (3.8)$$

Now if it is assumed that $w \ll r$ then γ can be approximated

$$\gamma = \frac{1 + r}{r} \quad (3.9)$$

With these approximations (3.6) can be rewritten as

$$\theta_x = \frac{\theta}{\gamma w} \quad (3.10)$$

It is then easily verified, that (3.10) is equivalent to (3.5). Compare further with eqs. (3.11) and (3.12) below.

3.2 Steady state expressed in sludge age

The definition (3.3) will be analyzed in some detail here. The concentrations of substrate and microorganisms will be expressed in terms of the sludge age. The expression (2.8) is used here to simplify the formulas. It can be rewritten,

$$w\gamma + (1-w) \epsilon = 1 + r - r\gamma = n \quad (3.11)$$

If this expression is replacing the denominator in (3.3), then

$$\theta_x = \frac{V}{Q\eta} = \frac{\theta}{n} \quad (3.12)$$

Now consider the equilibrium for sludge bacteria. It can easily be derived from (2.2) and be expressed in terms of the sludge age. If the term $D(r\gamma - 1 - r)$ is replaced by $1/\theta_x$ according to (3.11) and (3.12) it follows easily,

$$\theta_x = \frac{1}{\mu_x - d_x} \quad (3.13)$$

where

$$\mu_x = \frac{\hat{\mu}_x s}{K_x + s} \quad (3.14)$$

Combination of (3.13) and (3.14) gives an alternative expression for the substrate concentration, expressed in sludge age, (cf (2.6))

$$s^0 = \frac{K_x (1 + d_x \theta_x)}{\theta_x (\hat{\mu}_x - d_x) - 1} \quad (3.15)$$

Now use (3.15) to get an alternative expression for the microorganism concentration as function of the sludge age. If (3.12) is inserted in (2.5) then

$$c_x^0 = \frac{Y_x (s_i - s^0) (\theta_x)}{(1 + d_x \theta_x) (\theta)} \quad (3.16)$$

Some observations can be made directly. As the sludge age is inherently dependent of the return sludge flow, the term r does not appear explicitly in (3.15) or (3.16). Figure 3.1 shows the graphs of s^0 and c_x^0 as functions of the sludge age respectively. At sludge ages more than about 100 hours the substrate concentration is relatively independent of the sludge age. Similarly it is demonstrated that the microorganism concentration is monotonously increasing with the sludge age.

Another parameter of interest is the production rate of waste sludge per unit time. The production corresponds to the denominator in one of the expressions (3.2) to (3.5). If the definition (3.3) is used, then the production rate P_x is expressed as

$$P_x = \frac{V c_x}{\theta_x} \quad (\text{mass units/time}) \quad (3.17)$$

The value of P_x per unit volume (g/hr/m^3) is plotted as function of θ_x in figure 3.2. It is shown that the production rate has a maximum for a certain sludge age.

The PLI (2.14) can also be expressed as function of the sludge age. Combining (2.15) and the (3.16) the PLI is expressed as

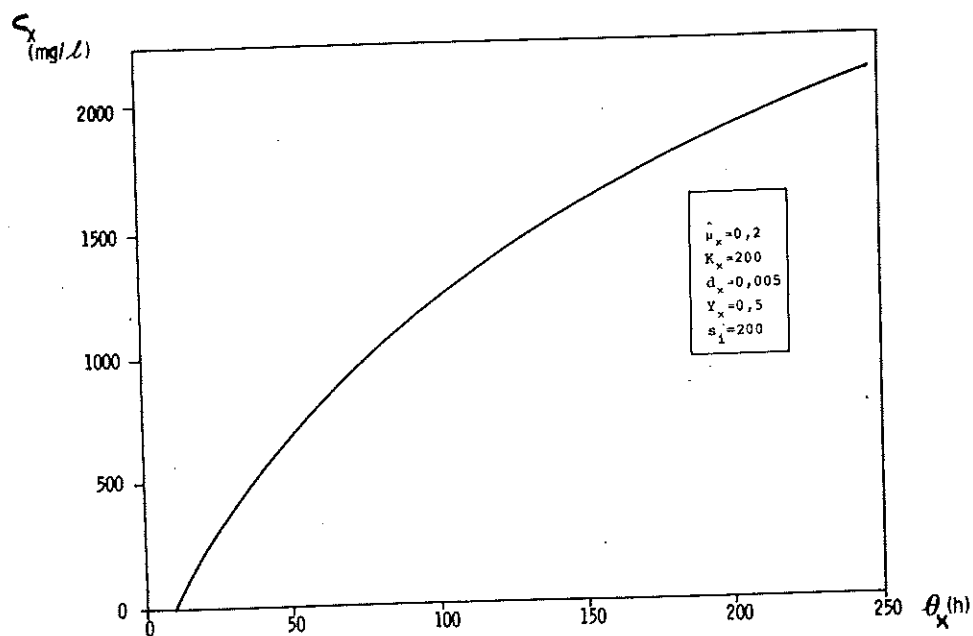
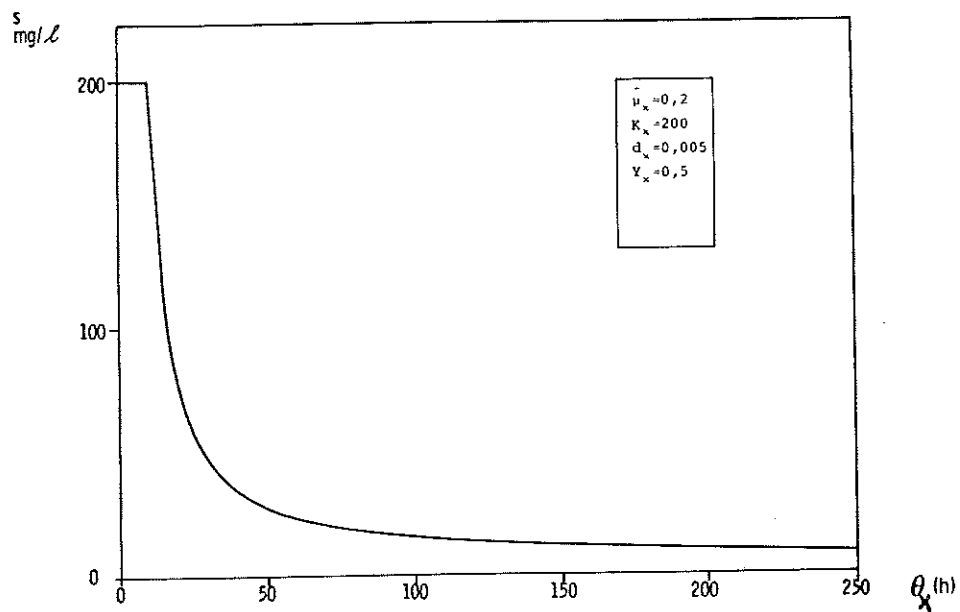

Fig. 3.1. Substrate and microorganism concentrations respectively as functions of sludge age.

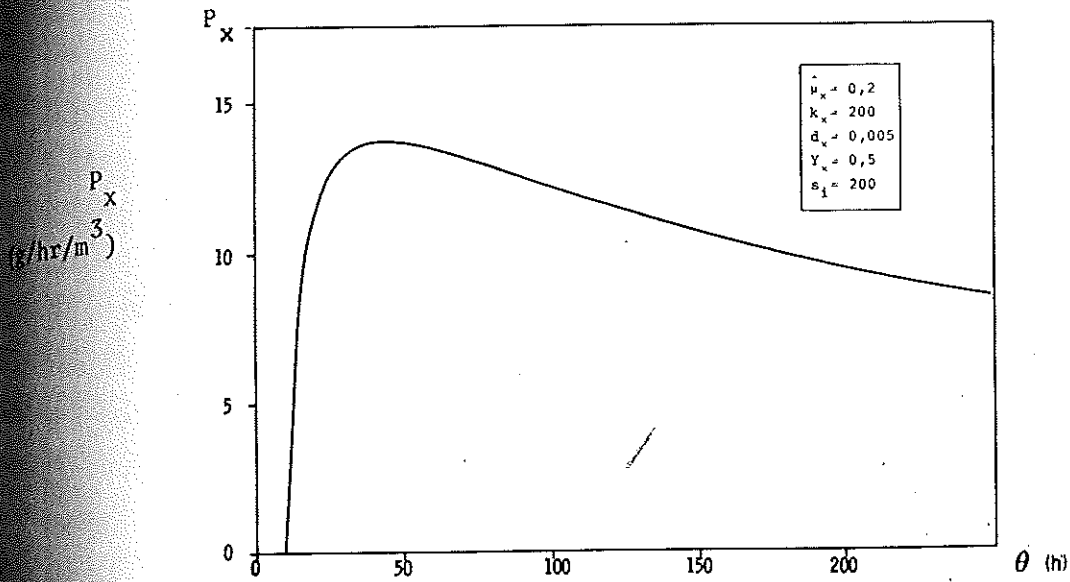

Fig. 3.2. Sludge production rate as function of the sludge age.

$$PLI = \frac{1 + d_x \theta_x}{Y_x \theta_x} \cdot \frac{s_i}{s_i - s^0} \quad (3.18)$$

Figure 3.3 then shows a plotting of the PLI as function of the sludge age. It should be noted that the sludge age in (3.18) is expressed in days. The term d_x is accordingly also expressed in days⁻¹.

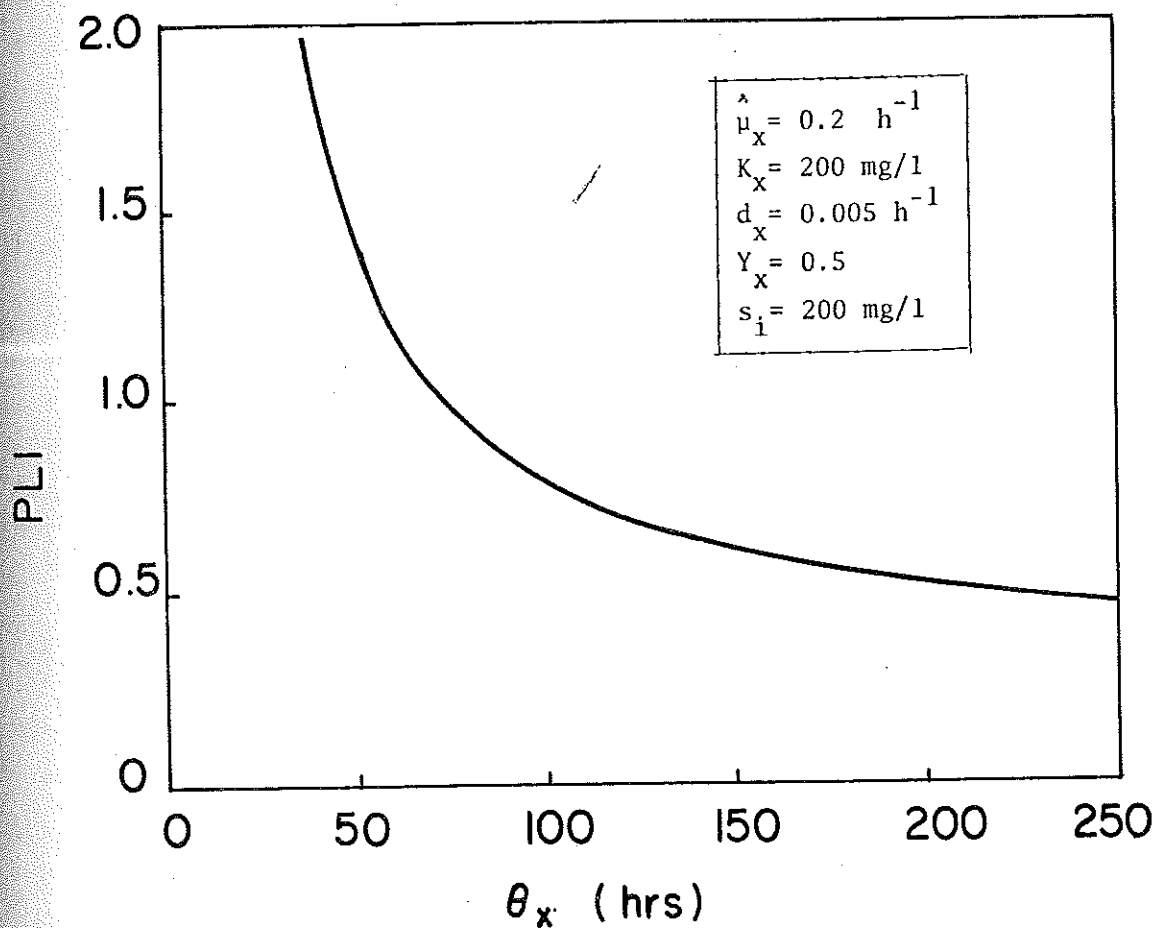

Fig. 3.3. Process loading intensity as function of sludge age.

4. CONVENTIONAL AERATOR WITH BASIC KINETICS

In many plants the hydraulic behaviour of the aerator is not a complete mix pattern, and the simple equations given in chapters 1, 2 or 3 do not apply. Neither is it a pure plug flow pattern but is most often a mixture of both these extremes. Therefore the aerator dynamics is often approximated with several subreactors in series. This type of approach is quite common in chemical engineering. Levenspiel (1962) has treated the same type of problem for the steady state behaviour of chemical reactors with first order reactions.

In this chapter we will look at the problem from a certain aspect. It will be shown how the concentration of substrate and microorganisms vary when the description of the aerator is changed gradually from complete mix to plug flow. The discussion gives some background material to discuss reasonable approximations of the hydraulics. It is of particular interest to calculate the concentrations in the head and tail ends of the aerator. It will be discussed how these concentrations vary with the assumed number of subreactors representing the aerator.

In 4.1 the equations are given to describe the basic kinetics of an aerator, represented by several subreactors. In 4.2 the most interesting concentrations are calculated for different number of subreactors. The sludge age definitions, made in chapter 3, do not apply for the conventional aerator case. A corrected definition is given in 4.3. The plug flow case, finally, is discussed in 4.4. It can also be considered as the limiting case for an infinite number of subreactors.

4.1 Representation of the aerator by several subreactors

The kinetic equations for the conventional aerator are already derived in part I, chapter 6. For easy reference they are repeated here (see part I, eqs (6.7), (6.14) and the sum of (6.15) and (6.17)).

The activated sludge system is shown schematically in fig. 4.1. The influent flow is shown as for the step loaded cases, but in this chapter only the special case $\alpha_1 = 1$, i.e. the conventional process, will be considered. The same equations as below will be discussed for the step loaded case (arbitrary α_k) in chapter 5.

The kinetic equations are represented only by substrate (s), living organisms (c_x) and inert organisms (c_z). No biosorption is considered. The consequence of the biosorption terms in the model will be discussed in chapters 6. and 7.

Referring to appendix for the symbols and to fig 4.1 for the flows, the microorganism equations are

$$\frac{dc_{x,k}}{dt} = D_k \{ (\beta_{k-1} + r) c_{x,k-1} - (\beta_k + r) c_{x,k} \} + (\mu_{xk} - d_x) c_{x,k}$$

$$k = 1, \dots, n \quad (4.1)$$

where k indicates subreactor number.

The inert organism equations are

$$\frac{dc_{z,k}}{dt} = D_k \{ \alpha_k c_{z,i} + (\beta_{k-1} + r) c_{z,k-1} - (\beta_k + r) c_{z,k} \} + Y_z (d_x c_{x,k}) - \eta c_{x,k} c_{z,k}$$

$$k = 1, \dots, n \quad (4.2)$$

The substrate concentrations, finally, are

$$\frac{ds_k}{dt} = D_k \{ \alpha_k s_i + (\beta_{k-1} + r) s_{k-1} - (\beta_k + r) s_k \} + \mu_{x,k} c_{z,k} - \mu_{xk} c_{x,k} \frac{1}{Y_x} \quad k = 1, \dots, n \quad (4.3)$$

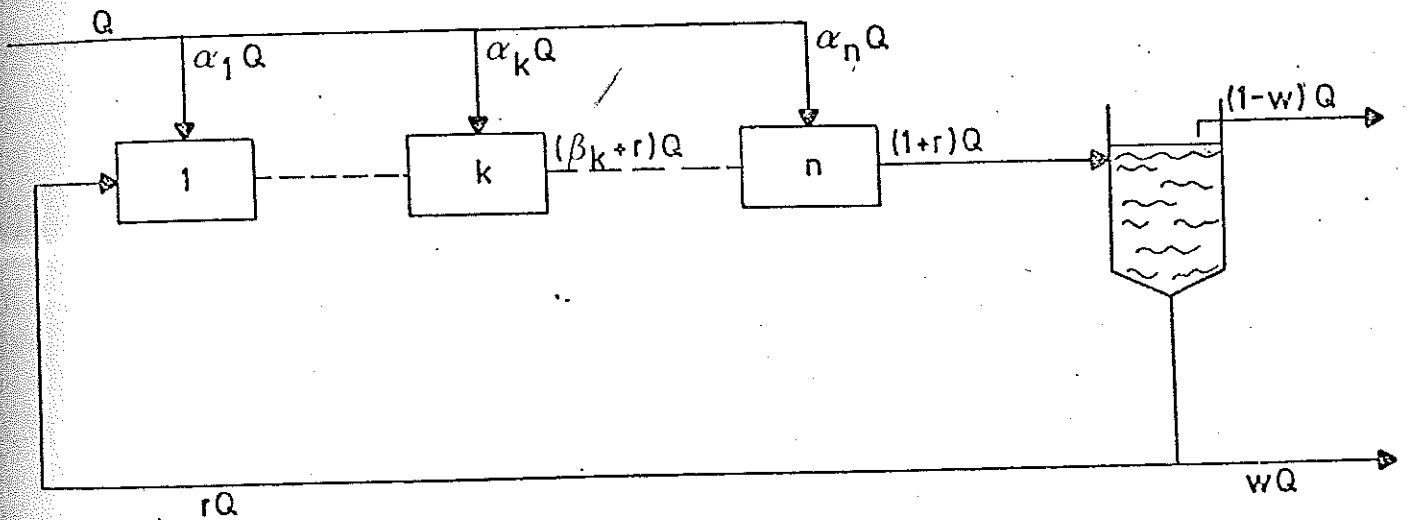

Fig. 4.1 Schematic flow diagram of a step loaded activated sludge system.

The subscript "o" refers to the recirculation, and simple settler equations are assumed, i.e.

$$c_{x,r} = c_{x,o} = \gamma c_{x,n} \quad (4.4)$$

$$c_{z,r} = c_{z,o} = \gamma c_{z,n} \quad (4.5)$$

$$s_r = s_o = s_n \quad (4.6)$$

In order to achieve the steady state solution two approaches can be taken. The stationary equations (4.1) - (4.3) can be solved by algebraic methods. Alternatively the differential equations can be integrated to steady state. Here the latter method has been preferred, as a more general simulation program could be written for both static and dynamical studies. The integration has been performed with a Runge Kutta integration method. Variable as well as fixed step length has been used.

4.2 Concentrations as functions of the number of subreactors

It is crucial to describe the flow pattern correctly, since it influences the concentrations of microorganisms and substrate significantly. It is a great difference between the complete mix case and the plug flow case, a fact that will be demonstrated in this section.

Many of the results can still be considered only qualitative in nature. Especially the settler is poorly described. In the steady state case, however, it is reasonable to describe the settler with only a compaction ratio. In a dynamical case, however, the conclusions made here have to be adjusted, as a more refined model of the settler is needed in that case.

Simulations have been performed in order to get steady state concentration profiles as functions of the number of subreactors. The number of subreactors has been varied from one to infinity. The total detention time is the same for all cases.

Some variables have special interest. The substrate concentration in the last subreactor is the same as the soluble substrate in the clarifier effluent. There is also BOD bounded in the suspended solids in the effluent. According to Pflanz (1969) there is a correlation between the clarified water suspended solids content SS_e and the MLSS (c_x), i.e. in this case the sludge concentration in the last subreactor,

$$SS_e = k(1+r) Qc_x \quad (4.7)$$

where $k = \text{constant}$

Even if this expression is not accurate it gives an indication of the influence from the organism concentration. In order to minimize the

suspended solids in the effluent the tail end MLSS should be minimized. On the other hand, a high total mass of sludge is needed in order to get a reasonable value of the PLI (eq.(2.15)).

In figure 4.2 the substrate concentration of the first (s_1) and the last subreactors (s_n) are plotted as function of the number of subreactors (n). It is found empirically, that the difference to the plug flow case is halved, when the number of subreactors is doubled. This conclusion is demonstrated in figure 4.2, where the plots are straight lines. If the results are extrapolated according to the assumption (Richardson extrapolation) the effluent plug flow concentration should be

$$\lim_{n \longrightarrow \infty} s_n = 5.6 \text{ mg/l} \quad (4.8)$$

A corresponding extrapolation for the concentration of the first subreactor (see fig 4.2) gives

$$\lim_{n \longrightarrow \infty} s_1 = 160 \text{ (mg/l)} \quad (4.9)$$

In the next section the plug flow concentration profiles are calculated. Then it is shown that the tail end concentration of substrate is 5.6 mg/l, so eq (4.8) quite accurately predicts this value. The head end concentration of the plug flow is 161 mg/l, which should be compared to (4.9).

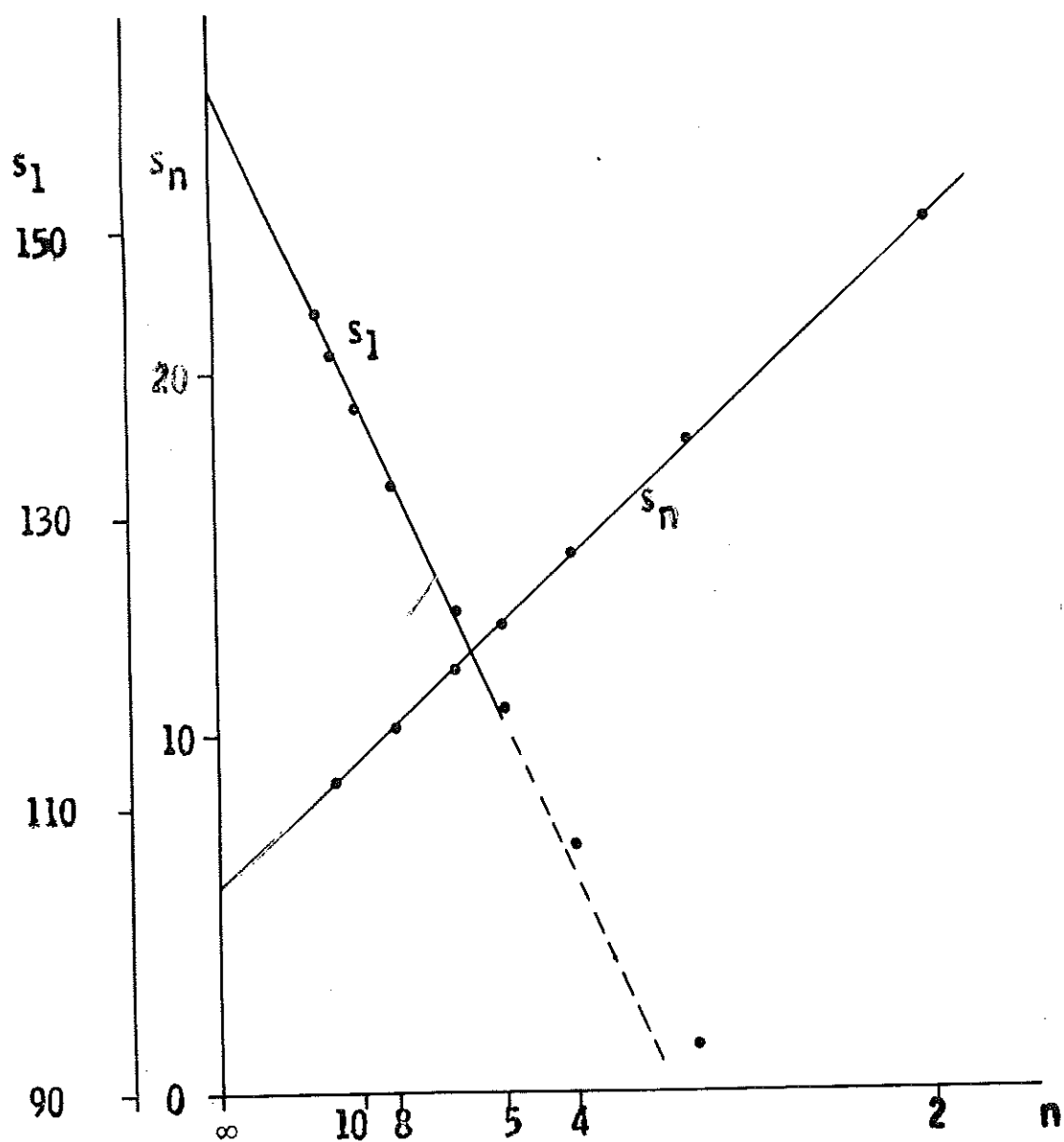

Fig. 4.2. Substrate concentration in first and last subreactors for different number of subreactors (n)

In table 4.1 the mean values of the substrate and the microorganism concentrations are displayed as functions of the number of subreactors. It is shown, that the average value of the substrate concentration actually increases, but as figure 4.2 indicates, the tail end substrate concentration decreases when the flow pattern approaches plug flow.

Also the average microorganism concentration increases from the complete mix case to plug flow case.

TABLE 4.1

Average concentrations of substrate and microorganisms as function of the number of subreactors (n)				
n	\bar{s}	\bar{c}_x	\bar{c}_z	
1	40.8	303	7.1	$c_{zi} = 0 \text{ mg/l}$ $s_i = 200 \text{ mg/l}$ $r = 0.25$ $\gamma = 4.0$ $d_x = 0.005 \text{ h}^{-1}$ $Y_x = 0.5$ $\theta = 4 \text{ hrs}$ $\hat{\mu}_x = 0.2 \text{ h}^{-1}$ $K_x = 80 \text{ mg/l}$ $\mathcal{N} = 0.0005$
2	48.0	324	7.1	
3	51.7	331	7.1	
4	53.8	334	7.1	
5	55.2	337	7.1	
6	56.2	338	7.1	
8	57.5	340	7.1	
10	58.4	341	7.1	
12	58.9	342	7.1	
∞	61.6	346	7.1	

In fig 4.3 the substrate spatial distribution is plotted for different number of subreactors. For n subreactors the tank length is divided into n parts. The concentration for each subreactor is plotted in the center of the actual subdivision. The subreactor concentrations are connected by straight lines. From the horizontal profile in the complete mix case there is a significant change to the two subreactor case. Then the differences become gradually smaller for increasing numbers of subreactors.

The profile for 8 - 10 subreactors is actually quite a reasonable approximation for the plug flow case. (The plug flow case equations are discussed in 4.4). On the other hand, a real plant is neither purely plug flow nor complete mix. It can often be represented by a dispersed plug flow pattern, if the aerator is long and narrow. Fig 4.3 indicates that four subreactors may often be a reasonable approximation of the dispersed plug flow case.

Now consider the tail end substrate concentrations in fig 4.3. The concentrations for 8 or 14 subreactors are relatively close to the infinity case. On the other hand, in the head end the concentration differences are much larger. In the tail end the substrate concentrations are so low, that because of the Monod type of growth there is a first order biological reaction. A first order reaction case but for a chemical reactor system has also been considered by Levenspiel (1962), chapter 6. He indicates that 8 - 10 subreactors seem to be a reasonable approximation of the plug flow case.

In the head end, however, there is a zero order biological reaction. The substrate concentration is relatively high, so the growth rate is

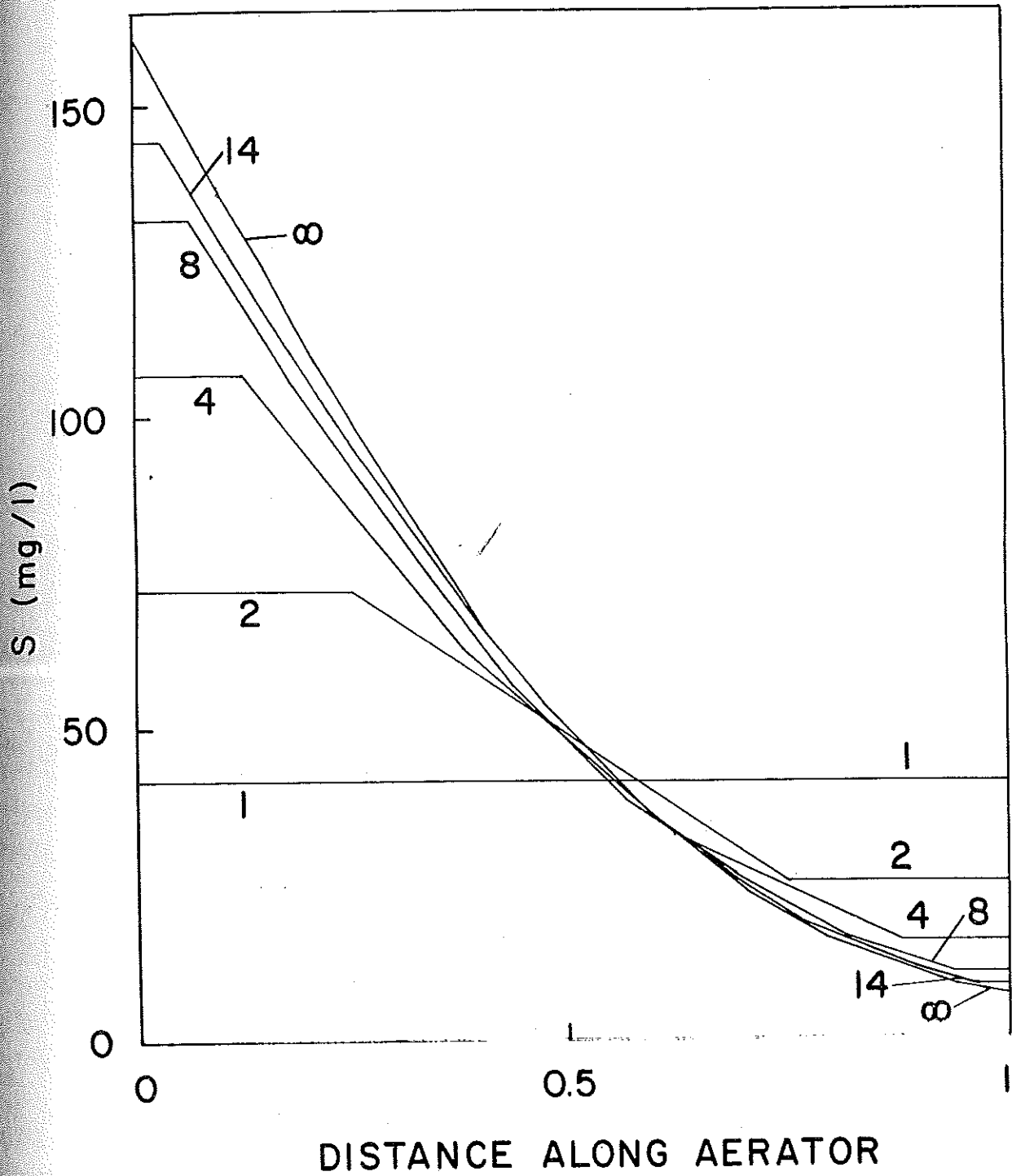

Fig. 4.3. Spatial distribution of the substrate concentration in the aerator for different number of subreactors, approximating the aerator.

much closer to its maximum value. Therefore the approximation is different in the head end.

Now consider the microorganism profiles for different numbers of subreactors, fig 4.4. The figure clearly demonstrates that the average organism concentration actually increases with n . The major change takes part in the tail end, while much less of a change can be observed in the head end. Compare this conclusion with the substrate profiles in fig 4.3 where the opposite conclusion could be made.

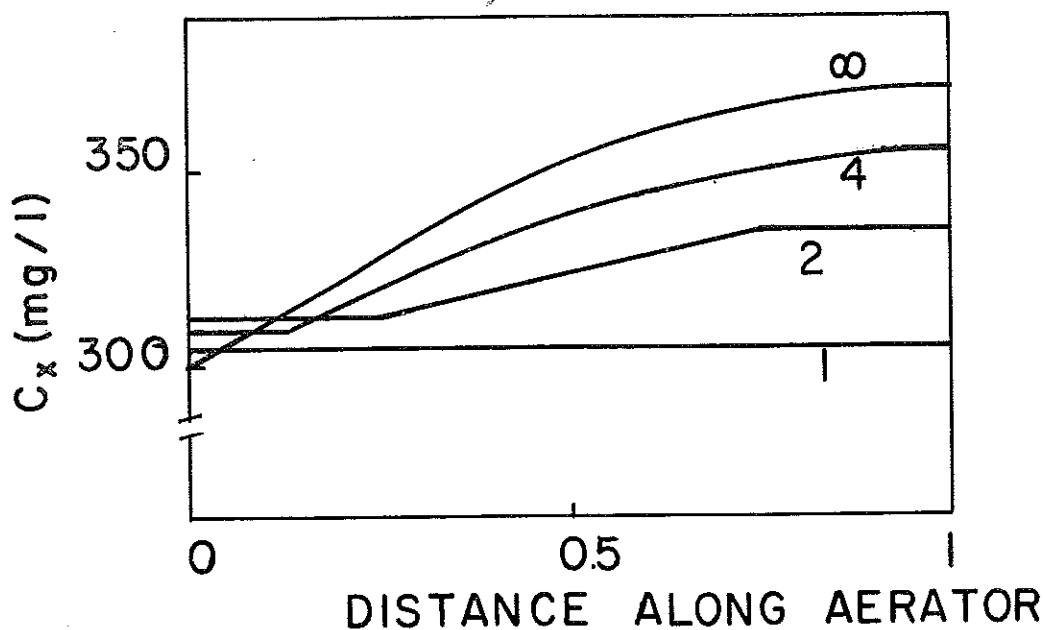

Fig. 4.4. Spatial distribution of the microorganism concentration along the aerator for different number of subreactors.

4.3 Sludge age calculations

The return sludge flow rate and the compaction ratio, given in table 4.1, correspond to a relatively small sludge age. According to eq. (3.12), it is only 16 hours for the complete mix case.

The definition of sludge age must be adjusted when the aerator is not a complete mix one. If the basic definition (3.1) is applied then the term Vc_x in the expressions (3.2) to (3.5) should be replaced by $V\bar{c}_x$, where \bar{c}_x is the average sludge concentration in the aerator.

The denominator in (3.2) or (3.3) is also adjusted slightly. If a mass balance equation around the settler is made (see Chap 2), then the expression (2.8) still holds. The denominator of (3.2) or (3.3) can therefore be written

$$Q \{wc_{x,r} + (1-w)c_{x,e}\} = Q \{w\gamma c_{x,n} + (1-w)\epsilon c_{x,n}\} =$$

$$Qc_{x,n} \{w\gamma + (1-w)\epsilon\} = Qc_{x,n} \eta \quad (4.10)$$

where $\eta = 1 + r - r\gamma$ (=(2.7))

and $c_{x,n}$ is the microorganism concentration in the n:th subreactor. The sludge age definition, according to (3.1), therefore should be adjusted slightly. The definitions (3.2) and (3.3) are changed to

$$(i) \quad \theta_x = \frac{Vc_x + V_s c_{xs}}{Q\eta c_{xn}} \quad (4.11)$$

$$(ii) \quad \theta_x = \frac{Vc_x}{Q\eta c_{xn}} = \frac{\bar{\theta}c_x}{\eta c_{xn}} \quad (4.12)$$

respectively. The definitions (3.4) and (3.5) are changed analogously.

The sludge ages for the actual systems in 4.2 will vary slightly with the number of subreactors. The definition (4.12) is used for the calculation. Then the complete mix sludge age is 16 hours. For two subreactors it is 15.5 hours, for four ones it is 15.2 hours. In the plug flow case it is calculated to 14.9 hours.

These figures are sufficient to demonstrate that the sludge age definitions must be used with some care.

4.4 Plug flow aerator

The plug flow reactor is the extreme case of infinite number of subreactors. The equations are derived in part I, Chapter 6.4 and are just repeated here (see appendix for the terminology)

$$\frac{\partial s}{\partial t} = -v \left(\frac{\partial s}{\partial \xi} \right) - \frac{\hat{\mu}_x^{sc} c_x}{K_x + s} + Y c_x c_z \quad (4.13)$$

$$\frac{\partial c_x}{\partial t} = -v \left(\frac{\partial c_x}{\partial \xi} \right) + \frac{\hat{\mu}_x^{sc} c_x}{K_x + s} - d_x c_x \quad (4.14)$$

$$\frac{\partial c_z}{\partial t} = -v \left(\frac{\partial c_z}{\partial \xi} \right) + Y d_x c_x - N c_x c_z \quad (4.15)$$

where ξ is the spatial coordinate. In the steady case the equations can be solved as ordinary differential equations, where space instead of time is the independent variable.

The boundary conditions are not initial value conditions. Instead the initial and final values (i.e. the concentrations in the head end and at the tail end of the aerator) are related to each other by the settler characteristics. A simple steady state mass balance relation for the head end of the aerator gives (see fig 2.1)

$$Qs_i + rQs_r - (1+r)Qs_o = 0 \quad (4.16)$$

$$rQc_{xr} - (1+r)Qc_{xo} = 0 \quad (4.17)$$

$$Qc_{zi} + rQc_{zr} - (1+r)Qc_{zo} = 0 \quad (4.18)$$

The subscript "r" refers to return sludge flow and "o" refers to the head end of the aerator.

When elementary settling properties are added,

$$c_{xr} = \gamma c_{x1} \quad (4.19)$$

$$c_{zr} = \gamma c_{z1} \quad (4.20)$$

$$s_r = s_1 \quad (4.21)$$

where the subscript 1 indicates the tail end of the aerator, then the boundary conditions are

$$s_o = \frac{s_i + r s_1}{1 + r} \quad (4.22)$$

$$c_{xo} = \frac{r \gamma c_{x1}}{1 + r} \quad (4.23)$$

$$c_{zo} = \frac{c_{zi} + r \gamma c_{z1}}{1 + r} \quad (4.24)$$

As the values of s_o , c_{xo} and c_{zo} are not known a priori, the ordinary differential equations have to be solved iteratively. There are two possible solutions, the trivial zero solution ($c_z = 0$, $c_x = 0$ and $s = s_i$) and the real physical solution.

The equations have been integrated with a Runge Kutta method with variable step length. The head end conditions are initially guessed. After one integration new initial values are calculated according to (4.22) - (4.24). The calculated initial values are not used directly for next iteration, but are corrected according to an over-relaxation method. For any component concentration x the new initial values are adjusted as

$$x_o^{(i+1)} = x_o^{cal} + \delta \{x_o^{cal} - x_o^{(i)}\} \quad (4.25)$$

where the notations mean

$$\begin{aligned} x_0^{(i+1)} &= \text{initial condition for the } (i+1)\text{th integration} \\ x_0^{(i)} &= \text{initial condition for the } i\text{:th integration} \\ x_0^{\text{cal}} &= \text{the initial condition calculated from (4.22) -} \\ &\quad (4.24) \text{ after the } i\text{:th integration} \end{aligned}$$

The value of the relaxation constant has to be tested out empirically but generally $\delta=0.2 - 0.4$ has been used.

The integrations have been iterated until the changes of the initial conditions have been sufficiently small.

Typical results are shown in figures 4.3 and 4.4 where the plug flow case is indicated as the extreme value for infinite number of subaerators. In this case the stream velocity v is

$$v = \frac{Q_0}{A} = \frac{Q(1+r)}{A} = 0.3125 \frac{\text{tank lengths}}{\text{hr}} \quad (4.26)$$

which corresponds to a hydraulic hold-up time

$$\tau = \frac{V}{Q(1+r)} = \frac{4}{1.25} = 0.3125^{-1} \text{ hours.}$$

5. STEP FEED AERATORS

If the influent wastewater is fed into the reactor along the length of the reactor then it is called step feed. It has been shown earlier by Andrews (1972) that the step feed flow pattern is an important control variable. By means of that, the sludge mass can actually be moved in the reactor-settler system in order to achieve a better distribution in the system according to the loading and settling conditions.

The basic equations including substrate, microorganisms and inert bacteria are shown in 4.1, and fig 4.1 shows the hydraulic flow pattern in the system.

Here only the static relations will be emphasized, as the dynamical properties are not within the scope of this report.

Some general remarks are made in 5.1 how to evaluate and compare the different flow patterns. Most of the basic ideas can be demonstrated for the case, when the aerator is represented by only two subreactors. This is made in 5.2. This case can also represent a contact stabilization plant where both the contact and the stabilization tanks are complete mix reactors. In 5.3 the aerator is described by four subreactors, and the calculations and conclusions become more sophisticated. It is also discussed that it is essential to model the biosorption in order to achieve a reasonable accuracy of the plant behaviour. In 5.4, finally, some remarks are made about a plug flow reactor with a step feed load pattern.

5.1 General remarks

The purpose of this chapter is to examine in some detail how the step load pattern influences the activated sludge plant behaviour. In order to systematize the comparisons some specific items will be discussed.

The substrate concentration in the last subreactor is related to the effluent BOD content (except the BOD found in the suspended solids). This concentration varies significantly with the feed pattern.

The total mass of microorganisms depends to a large extent on the feed pattern. It is here defined as

$$M_x = \sum_{k=1}^n V_k c_{xk} \quad (5.1)$$

If all the subreactors have the same volume, the total mass is proportional to the average concentration. The total mass naturally influences the PLI for the system.

The sludge concentration in the last subreactor determines the settler loading. The loading is proportional to the sludge concentration i.e.

$$L_s = Q_n c_{xn} A \quad (5.2)$$

where Q_n = total hydraulic flow in the last subreactor

c_{xn} = organism concentration

A = settler area

L_s = settler loading factor

According to Pflanz (1969) the effluent suspended solids concentration is proportional to the loading (see eq (4.7))

The sludge age (see eq. (4.12)) will vary with the step loading. Both the average concentration and the last subreactor sludge concentration depend on the step loading conditions.

We remark once more, that the settler is assumed to have a constant compaction ratio. This will certainly influence the results, but the general conclusions still hold qualitatively. In a forthcoming report it will be considered how a more general settler model may affect the conclusions made here.

5.2 Two subreactors

The basic ideas of the step feed pattern can be illustrated with only two subreactors. For a specific aerator the influent flow pattern has been varied continuously from $\alpha_1 = 1$ (conventional aerator, see fig. 4.1) to $\alpha_2 = 1$ (all the influent water is fed into the second tank) while all other reactor parameters are held constant. All parameter values are shown in table 4.1.

The result is shown in fig 5.1. It shows that the average sludge concentration \bar{c}_x (i.e. the total mass) increases when α_2 is varied from 0 to 1. This increase is due to a very significant increase of microorganisms in the first reactor. This serves as a stabilization tank for the sludge, and almost all the substrate is consumed there. The sludge mass in reactor two decreases with an increasing α_2 . This means that the settler loading decreases, and the effluent suspended solids quality would consequently be improved. The sludge age, defined as (4.12), also increases significantly when α_2 varies from 0 to 1. This is natural, as the average sludge concentration increases, while the second subreactor mass decreases. In the specific case the sludge age is 15.5 hours for $\alpha_1 = 1$, 20.1 hours for $\alpha_1 = 0.5$ and 41.3 hours for $\alpha_1 = 0$.

The effluent BOD is not equal to the substrate concentration in the last subreactor. As discussed by Busby-Andrews (1975), part of the substrate is captured in the floc (see further Chapter 6). Therefore this part of the substrate settles with the sludge, and a minor part is captured in the clarifier effluent suspended solids. With better settler loading condition the effluent BOD bounded in suspended solids may decrease and can compensate for a higher value of soluble substrate.

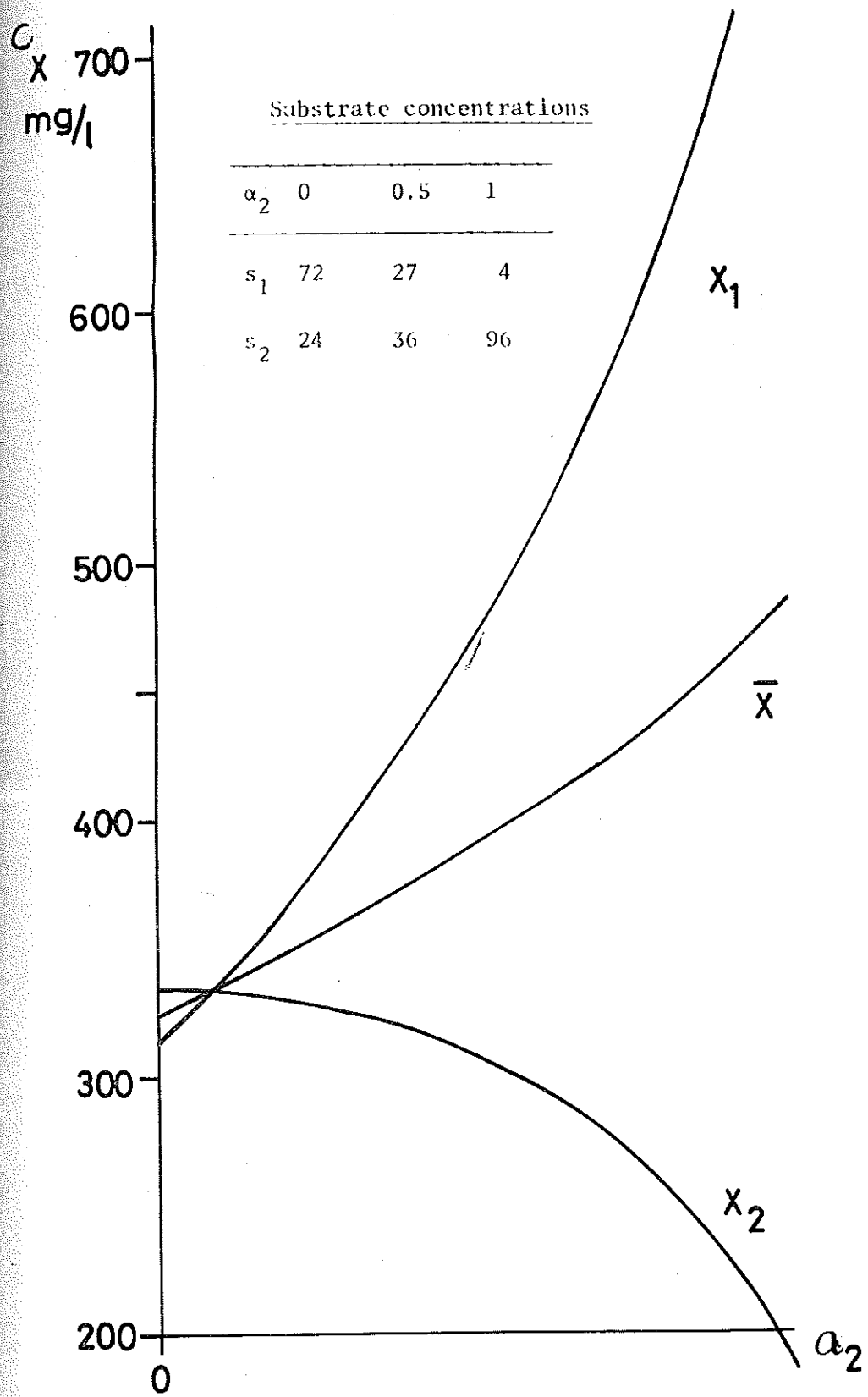

Fig. 5.1. Concentration of microorganisms for a two reactor system as function of the step feed pattern. ($\alpha_2=0$ means conventional plant). For other parameter values, see table 4.1.

The PLI (or F/M ratio) can also be controlled by the step feed pattern. As the average sludge concentration increases, the PLI decreases for an increasing α_2 .

In this discussion we have neglected completely the process of biosorption. This will change the substrate concentration significantly in the contact tank. This will be discussed further in Chapter 6.

The static analysis can indicate how to use the step feed pattern as a control variable in a dynamical situation. Two different disturbances will be discussed. Andrews (1972) and Busby-Andrews (1975) have already indicated some consequences.

Assume that a big hydraulic load is coming to the plant. The loading to the settler is consequently/increased, and more suspended solids go out into the effluent. This also means that organisms are lost from the system. If step feed is not used as a control variable, only two control variables remain. The waste activated sludge flow rate cannot be used. It must be zero in such a situation, otherwise even more organisms are lost from the system. The return sludge pump cannot either help to keep the organisms in the system. If the return flow is high, then the organisms are pumped back into the aerator. The hydraulic flow gets even higher, and finally the organisms still are lost in the effluent. If the return flow is low, then the sludge blanket rises and the organisms are also lost from the settler.

Now if a step feed control variable can be used, then the organisms can more easily be kept in the system. The influent can be led directly into the last subreactor. At the same time the return sludge flow is kept at a maximum. Then a sludge storage can be kept in reactor one. Still organisms are lost in the effluent, but the process will not be destroyed, due to the storage of organisms in the first subreactor.

Now consider a large organic load to the system. If it is known a priori, that the disturbance will arrive, then the flow pattern can be changed to prepare the plant for the disturbance. The influent water should be led into the last reactor. Then the mass of organisms will be built up in the first reactor. When the disturbance arrives, then the influent can be led to the first reactor again. There the influent is met directly by a large amount of organisms in the right condition, in other words, the PLI can be damped. It should be remarked, that the step feed control is only useful in a long time scale - several hours or more.

5.3 Four subreactors

When the aerator is described by four subreactors there is of course a more sophisticated flow pattern. Therefore the conclusions are somewhat more complex. As for the two reactor case no biosorption effect has been taken into account. The model includes only soluble substrate, viable and inert microorganisms, according to 4.1.

The general conclusions will be made from table 5.1. It shows the steady state conditions for different step feed patterns and some different operational parameters. The numerical results are achieved by integrating the system differential equations to steady state. The inert organism concentrations are not listed as they are very small all the time (less than 10 mg/l).

In the table the return sludge flow rate r is varied as well as K_x . This is made to illustrate, that the general influence of the step feed pattern is the same for some different parameter combinations. All the operational parameters except the feed pattern are the same for all cases indicated by A. The same is true for the cases B and C respectively.

First, consider the cases 1A - 8A. The "average" feeding point is moved gradually towards the last reactor. The total mass, represented by the average sludge concentration first increases and has a maximum for case 5A. Then it decreases again and the total mass in case 8A is almost as small as in case 1A. There is a rational explanation for this behaviour. When the flow is directed into the last subreactors, as in cases 7 and 8, there is a very short contact time between the substrate and the organisms, only 1 - 2 hours. The metabolism does not get enough time, and most of the substrate becomes lost through the effluent. Consequently the organisms get less food for growth. In chapter 6 it will be discussed how the biosorption will influence the results.

Table 5.1 Steady state concentrations for a step feed aerator with four subreactors. Eight different flow patterns are calculated, and for each flow pattern there are three different operational conditions.

Constants:	$T_1 = T_2 = T_3 = T_4 = 1 \text{ hr}$	$\gamma = 4$
	$\hat{\mu}_x = 0.2 \text{ h}^{-1}$	$\hat{N} = 0.0005 \text{ mg}^{-1} \text{ h}^{-1}$
	$d_x = 0.005 \text{ h}^{-1}$	$Y_x = 0.5$
		$s_i = 200 \text{ mg/l}$
		$c_{zi} = 0$

	α_k	K_x mg/l	r	s_k	c_{xk}	\bar{c}_x	θ_x (h)
1	0	0	0	80 0.25	107 62 32 15	304 325 339 346	329 15.2
				200 "	151 127 104 84	186 198 208 218	203 14.9
				200 0.3	85 43 20 10	781 800 808 811	800 39.5
0.5	0.5	0	0	80 0.25	44 62 32 15	502 322 336 343	376 17.5
				200 "	96 112 90 70	350 221 232 241	261 17.3
				200 0.3	37 52 25 12	1214 769 779 783	886 45.3
0.25	0.25	0.25	0.25	80 0.25	19 24 30 35	641 453 357 299	438 23.4
				200 "	55 61 68 75	489 346 272 226	333 23.6
				200 0.3	19 23 28 33	1475 1034 803 661	993 60.1
0	1	0	0	80 0.25	2 113 73 42	1126 248 267 281	481 27.3
				200 "	18 144 124 106	702 150 159 168	295 28.1
				200 0.3	2 93 52 28	2621 633 652 661	1142 69.1
0	0.5	0.5	0	80 0.25	2 49 70 40	1133 417 269 283	599 33.9
				200 "	15 92 115 96	758 274 174 183	347 30.3
				200 0.3	3 42 60 33	2497 973 618 629	1179 75.0
0	0	1	0	80 0.25	7 1 129 99	716 708 156 171	438 41.0
				200 "	30 7 147 133	496 499 107 113	304 43.0
				200 0.3	6 1 108 72	1792 1769 430 446	1109 99.5
0	0	0.5	0.5	80 0.25	6 1 64 87	785 775 291 190	510 43.0
				200 "	26 6 10 125	542 543 197 126	352 44.7
				200 0.3	7 1 54 75	1721 1699 669 428	1129 105.5
0	0	0	1	80 0.25	18 2 1 141	429 429 423 94	343 58.3
				200 "	45 12 4 150	363 373 371 79	297 60.1
				200 0.3	19 3 1 126	964 958 946 231	775 134.2

If the cases 1B-8B or 1C-8C are considered the same general conclusions can be made.

The total mass of sludge kept in the tanks before the first feed point can be considered the mass in the "stabilization" tank. If this mass is compared for the A cases, then there is a maximum for cases 7A, where $M = 11560$ kg, i.e. 76% of the sludge is kept in the stabilization part of the aerator. In case 8A, 93% of the sludge is in the stabilization part, but the total sludge mass is less than in case 7A.

Now consider the sludge loading (5.2) to the settler. It has definitely a minimum for the feed patterns 8A, 8B or 8C. The soluble substrate concentration however has a maximum for the case 8. This means that the effluent quality - suspended solids plus soluble BOD - has a minimum for some of the intermediate cases.

The sludge age (4.12) varies significantly when the step feed pattern changes, a factor of three to four from case 1 to case 8. It should be observed, that the clarifier efficiency is taken into account in the (4.10) and (4.12).

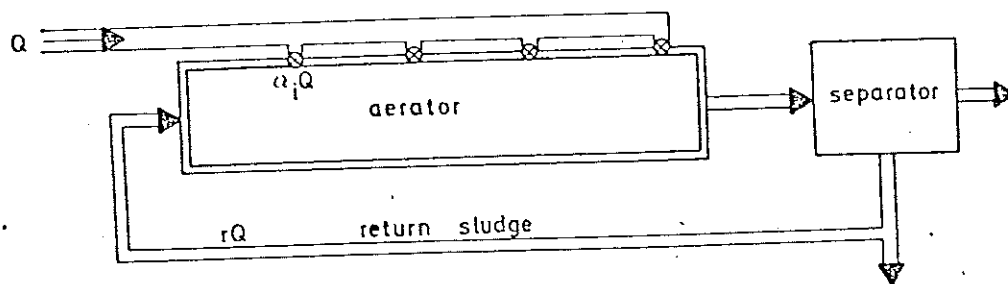

Fig. 5.2. Step loaded plug flow aerator.

5.4 Plug flow aerator

Some remarks will be made in this section about a step feed aerator of the structure, shown in fig. 5.2. If it is assumed that the reactor is a plug flow type, then the differential equations (4.13) - (4.15) still are valid. The boundary conditions however, are different.

For the microorganisms the boundary relations (4.17) between the head and tail end concentrations still hold. For the substrate the term s_i in (4.16) is replaced by a term $\alpha_0 s_i$, where α_0 is the fraction of the influent wastewater entering the aerator at the head end.

At each feed point it is assumed, that the influent wastewater is completely mixed with the mixed liquor just before it enters the aerator. At the feed point number k_i the intermediate boundary condition for the substrate is calculated by a simple mass balance

$$\beta_k Q s^+ = \beta_{k-1} Q s^- + \alpha_k Q s_i \quad k=1, \dots, N \quad (5.3)$$

where

- s^- = substrate concentration just before the feed point
- s^+ = " " " after " " "
- α_k = fraction of influent flow entering at the feed point
- $\beta_{k-1} = \sum_{j=0}^{k-1} \alpha_j$
- $\beta_k = \sum_{j=0}^k \alpha_j$
- $N =$ number of feedpoints

The microorganisms are diluted at every feed point. With a similar mass balance their concentration is changed stepwise,

$$\beta_k Q c_x^+ = \beta_{k-1} Q c_x^- \quad (5.4)$$

or

$$c_x^+ = c_x^- \frac{\beta_{k-1}}{\beta_k} \quad (5.5)$$

where c_x^+ = microorganism concentration just after the feed point

c_x^- = " " " " before " , "

The boundary conditions for the inert organisms are exactly similar to (5.3).

The boundary conditions at the feed points show, that both the substrate and the organism concentrations actually undergo step changes at the feed points. Especially for the substrate concentration those steps can have a very large value. In any practical situation it is impossible to verify any sudden concentration changes of that magnitude. The peaks of substrate or steps of organism concentrations at the feed points are attenuated quite significantly. Therefore an adequate description of step feed in a long tank should not be by plug flow equations.

One better description of step feed for long aerators may be to assume, that the feed points are not point sources. Rather they have a continuous distribution along a finite part of the tank. The other way is to assume that the flow is dispersed. Then the dispersion causes an attenuation of the peaks. The third way to overcome the problem is of course to describe the tank by several subreactors, as done in the previous section.

6. BIOSORPTION IN COMPLETE MIX AERATORS

In order to adequately describe the contact stabilization process it is necessary to include the biosorption dynamics into the activated sludge equations. This fact has been explained by Busby-Andrews (1975). The biosorption process was also discussed in some detail in part I chapter 4.1. .

When the contact time between substrate and microorganisms becomes very small there is too little time for the metabolism and the substrate removal due to synthesis is very small. Therefore the dominating process in the contact tank of/a contact stabilization process is not metabolism, but the physical-chemical phenomenon when soluble and colloidal substrate is captured in the floc phase. This is a process with a typical time constant of the order of 15 - 30 minutes.

It will be demonstrated in this chapter, that the biosorption process must be modeled primarily to explain the dynamical behaviour of a plant. In static conditions it has much less importance and could probably be excluded in many static models. Its relevance for the dynamical case is clearly demonstrated in the static analysis of plug flow reactors. Those will be considered in chapter 7.

The basic equations for the biosorption are repeated from part I in chapter 6.1. The complete mix reactor is analyzed for two different forms of the growth rate expression, in 6.2 and 6.3. It is found, that for one growth expression it is possible to find two steady state solutions. This fact makes the first approach not feasible.

Some parameter sensitivity calculations are finally performed in order to find adequate numerical values of some parameters.

6.1 Equations

In this section the basic equations for the complete mix reactor are repeated for convenience. For the symbols we refer to the appendix. All equations are derived in part I, chapter 5, and are given there as eqs. (5.20) - (5.22).

The substrate in liquid phase (cf. eq (2.1)) is now described differently from eq (2.1). Instead of the consumption term due to synthesis, there is a transfer rate from liquid phase to floc phase substrate. According to Busby-Andrews (1975) the equation is

$$\frac{ds}{dt} = D (s_i - s) - r_s c_T \left(f_s \frac{s}{K_s + s} - f_s \right) \quad (6.1)$$

where the last term is the transfer rate.

The dynamics of the stored mass (or floc phase substrate) contain the same transfer rate term. Moreover it includes a consumption term due to the organism synthesis,

$$\frac{ds_m}{dt} = D (r\gamma - 1 - r) s_m + r_s c_T \left(f_s \frac{s}{K_s + s} - f_s \right) - \frac{\mu_x c_x}{Y_x} \quad (6.2)$$

Two different forms of the specific growth rate μ_x will be analyzed in this chapter. The first obeys the Monod form,

$$\mu_x = \hat{\mu}_x \frac{s_m}{K_x + s_m} \quad (6.3)$$

and is further analyzed in 6.2. In 6.3 it is motivated further, that a modification of eq (6.3) has to be done,

$$\mu_x = \hat{\mu}_x \frac{f_s}{K_x + f_s} \quad (6.4)$$

The model with the growth rate (6.4) included is further analyzed in 6.3.

The microorganism concentration is the same as (2.2)

$$\frac{dc_x}{dt} = D(r\gamma - 1 - r) c_x + \mu_x^* c_x - d_x c_x \quad (6.5)$$

but μ_x is now given by (6.3) or (6.4).

The complete mix model thus includes the equations (6.1), (6.2), and (6.5) with either the growth rate (6.3) or (6.4). In the model the inert organisms are not included for the moment. It is found, that for the steady state behaviour of the process they play a minor role. Moreover, the analysis becomes significantly easier with three instead of four state variables, describing the complete mix system.

6.2 Steady state analysis I

It is possible to find an analytical expression for the steady state solution of the equations (6.1) - (6.5), but the expression becomes extremely tedious. The calculation is, however, straightforward.

There is always the trivial solution, $c_x=0$, in (6.5) but this is not considered.

From (6.5) the steady state stored mass can be solved uniquely

$$s_m = \frac{K_x (D\eta + d_x)}{\mu_x - d_x - D\eta} \quad (6.6)$$

$$\text{where } \eta = 1+r-r \gamma \quad (6.7)$$

By combining (6.1) and (6.2) a linear relation between s and c_x is found,

$$c_x = a_1 s + a_2 \quad a_1 < 0 \quad (6.8)$$

When (6.6), (6.8) and (6.1) are combined it is not always possible to find a unique solution, because a quadratic equation in s or c_x has to be solved. Therefore for some realistic parameter combinations only complex roots are found, which means that no steady state solution exists. In a few cases there is only one positive real root of s and c_x respectively. In most cases two positive solutions of both s and c_x exist. As both solutions are positive it is generally very difficult to neglect one of them.

The fact that there can exist several solutions is of course disturbing. In the cases of two real solutions figure 6.1 indicates the nature of them.

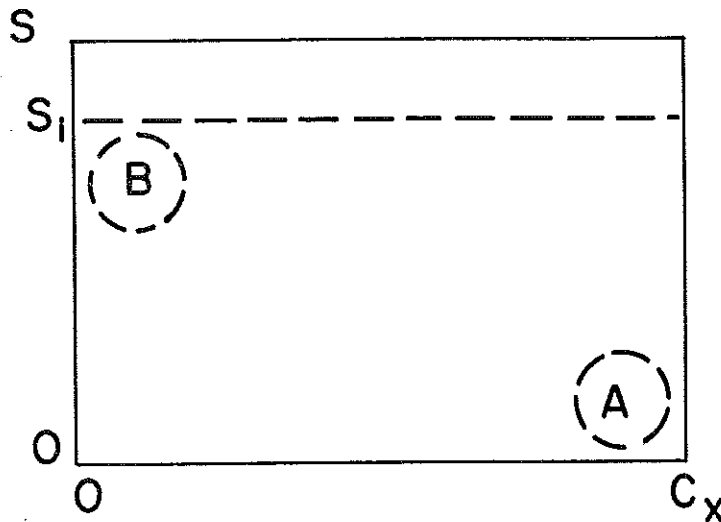

Fig. 6.1 Phase plane of substrate and microorganisms for a complete mix reactor.

One solution generally lies within a region A as indicated by fig. 6.1 and the other one lies within the area B. A seems to be the desired solution, with a relatively low substrate concentration and a corresponding high sludge concentration. The solutions B are generally stable for local disturbances, which means that also B is a truly steady state solution. As it has never been reported two different steady state solutions in any experiments the approach (6.1) - (6.4) is apparently not feasible, and some other dynamical description has to be looked for.

Another more physical argument can also be applied. It is not reasonable that the stored mass concentration is independent of the microorganism concentration, as in (6.6). The "B" solution then gives a steady state where the ratio of stored mass over total mass is much larger than the value of \hat{f}_s (see eq. (6.1)).

Independent of the author, Stenstrom (1975) has discovered some problems in the approach, as described by Busby-Andrews (1975).

6.3 Steady state analysis II

Because of the analytical problems discovered with the approach in 6.2 the growth rate expression (6.3) has been changed slightly to the form (6.4), according to a suggestion by Andrews (1975).

The practical motivation for (6.4) is the following. The concentration s_m represents a macroscopic measure of the total stored mass concentration in the tank. The organism growth rate does not primarily depend on this overall concentration. Instead the concentration ratio f_s represents a microscopic concentration measure within the floc. The organisms only use this stored mass for their growth.

If (6.4) replaces (6.3) in the description of the complete mix reactor, it is in fact possible to show, that for any parameter combination there is a unique steady state solution. To be feasible, all concentrations of course must be positive. It can be shown by tedious but straightforward calculations, that there always exists a linear relationship between the concentration of substrate in liquid phase and viable organisms,

$$s = s_i + a_3 c_x \quad a_3 < 0 \quad (6.9)$$

Similarly there is always a linear relation between the stored mass concentration and the organism concentration,

$$s_m = a_4 c_x \quad a_4 > 0 \quad (6.10)$$

The numerical value of the constants in the growth rate expression will now be considered. It is clear, that if the growth rate equations (2.4), (6.3) or (6.4) are compared the numerical values of the constants must be different.

First consider the maximum specific growth rate $\hat{\mu}_X$. In order to get a consistent comparison between the models with and without biosorption the organism maximum specific growth rate should be the same. Therefore it is assumed, that $\hat{\mu}_X$ is the same in (2.4) and in (6.4).

It is much more complex to establish a comparison between the K_X values of (2.4) and (6.4). In order to avoid confusion, let us call K_X of (2.4) K_X^I , while K_X of (6.4) is called K_X^{II} .

In order to be able to make a reasonable comparison between the models with and without biosorption, it is here assumed, that the microorganism concentration should be the same in both cases. This implies that μ_X would have the same numerical value in (2.4) and in (6.4).

The numerical value of K_X^I is of the order 75 - 200 mg/l. In order to make (6.4) equal to (2.4) the value of K_X^{II} must be much smaller. As the value of the stored mass fraction does not exceed 0.3 a 0.4 and is often much smaller a reasonable value of K_X^{II} would be of the order 0.03 - 0.7 (dimensionless).

Table 6.1

Numerical values of the plant parameters

$$r = 0.25 - 0.32$$

$$\hat{\mu}_X = 0.2 \text{ h}^{-1}$$

$$\gamma = 4.0$$

$$(K_X = 0.15)$$

$$s_i = 200 \text{ mg/l}$$

$$d_X = 0.005 \text{ h}^{-1}$$

$$r_S = 3.0$$

$$Y_X = 0.5$$

$$\hat{f}_S = 0.45$$

$$\theta = V/Q = 4 \text{ h}$$

$$K_S = 150 \text{ mg/l}$$

In order to examine the parameter influence the steady state solutions have been calculated for different parameter combinations. As the parameter K_X'' is essentially unknown the sensitivity with respect to K_X'' is first examined. In the figures 6.2 - 6.4 the soluble substrate, the stored mass and the viable microorganism concentrations respectively have been plotted against the parameter K_X'' . The other parameter values are found in table 6.1.

Looking first at the sensitivity it is demonstrated, that for small sludge ages the sensitivity is relatively large for variations in K_X'' . In order to determine a probable numerical value for K_X'' we compare the figures 2.10 and 6.4. If it is assumed that the microorganism concentrations in fig 2.10 and 6.4 should be the same, then a value of K_X'' between 100 and 200 mg/l corresponds to K_X'' of the order 0.1 to 0.2.

As the behaviour of stored mass as function of K_X'' is quite complex (fig. 6.3) we discuss what happens, when K_X'' increases. For an increasing K_X'' the specific growth rate of the organisms decreases. Therefore less stored mass is consumed, and consequently the ratio f_s increases. This causes the driving force (see eq (6.1) - (6.2)) from liquid phase substrate to stored mass to decrease, thus giving a higher liquid phase substrate concentration. For very large values of K_X'' the steady state concentration of the microorganisms becomes very small, at least for small sludge ages. Consequently the stored mass concentration must become smaller, as the floc cannot hold as much stored mass. The transfer rate from liquid phase substrate to stored mass is consequently decreased, so the liquid phase substrate concentration is increasing.

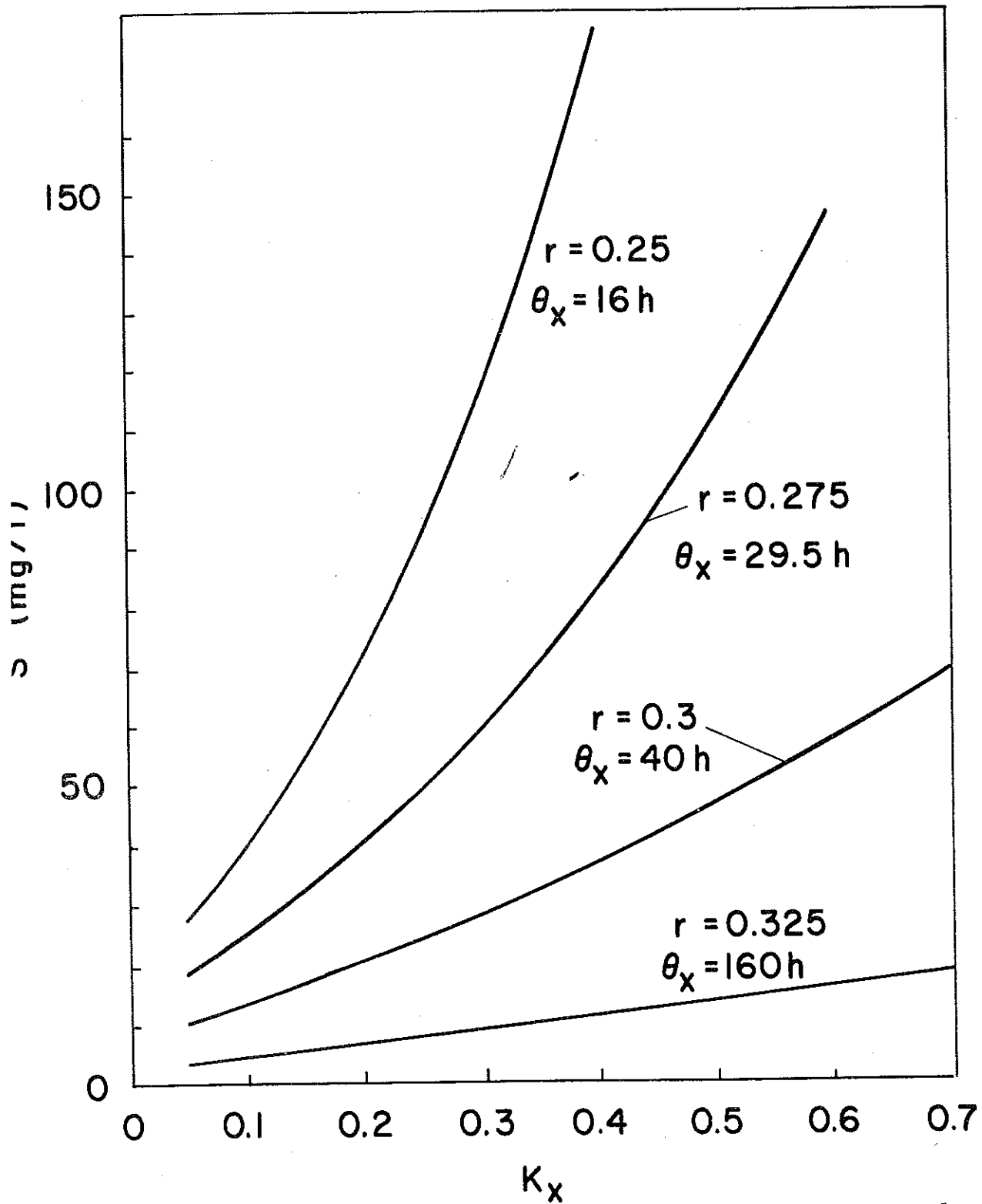

Fig. 6.2. Soluble substrate concentration as function of the growth limiting constant K_x for different return sludge flow rates.

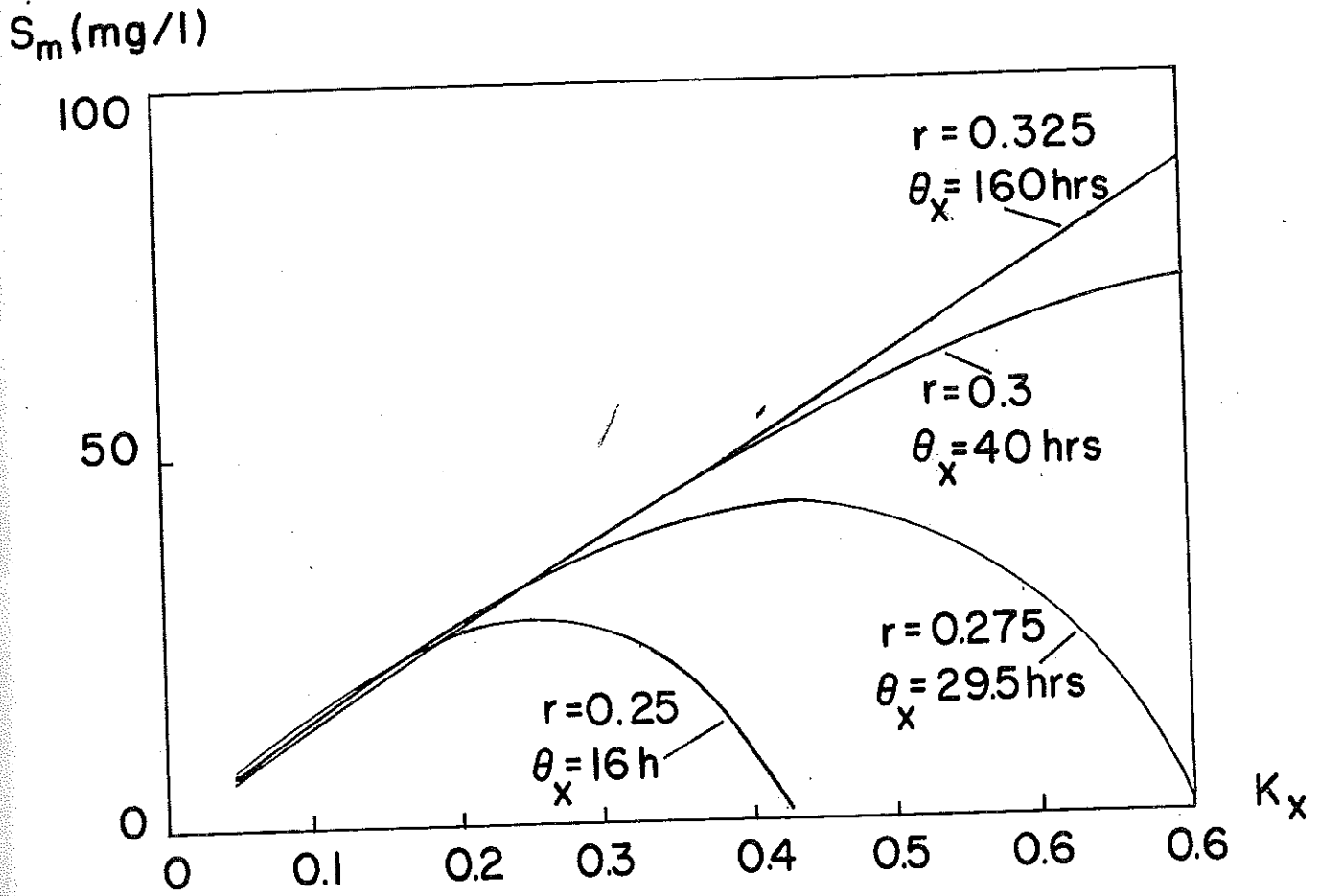

Fig. 6.3. Stored mass concentration as function of the growth limiting constant K_x for different return sludge flow rates.

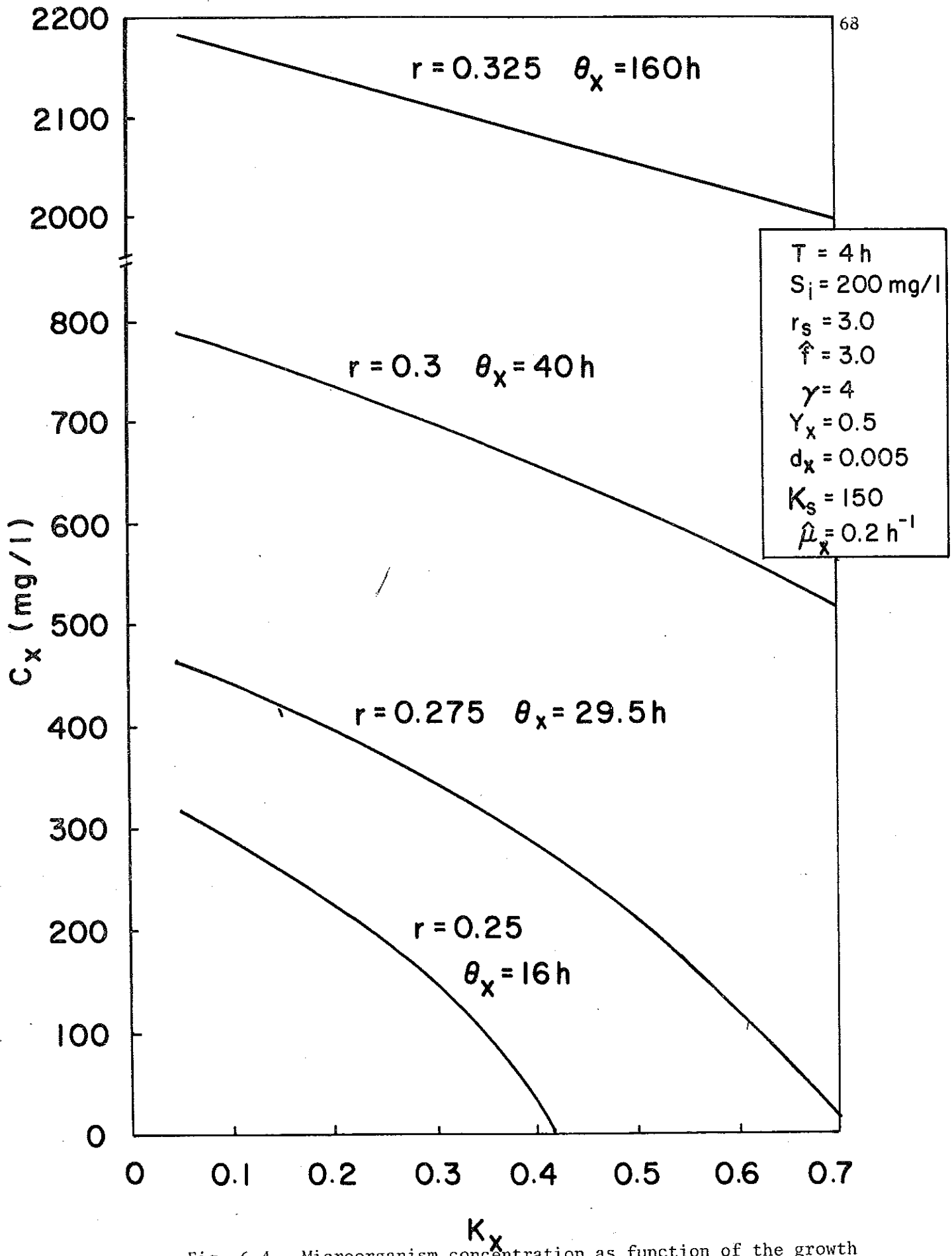

Fig. 6.4. Microorganism concentration as function of the growth limiting constant K_x for different return sludge flow rates.

Now consider the sensitivity with respect to the maximum specific growth rate $\hat{\mu}_x$, fig 6.5 - 6.6. Qualitatively it is found what is expected. The microorganism production naturally increases, fig. 6.6., and therefore more stored mass is consumed. Consequently more soluble substrate can be transferred to stored mass. It should be observed, that the sensitivity is very high for growth rates less than 0.2 h^{-1} . Compare these results with the diagrams 2.11.

Another observation can now be made from the diagrams 6.2 and 6.3. Let us compare two cases, with and without biosorption respectively, where the organism concentration is the same. Compare the figures 6.2 and 6.3 with fig. 2.10. In the biosorption case the sum of the stored mass and substrate in liquid phase is bigger than the substrate concentration in the case without biosorption. This means that the total food concentration is assumed to be bigger in the biosorption model. The reason for this is quite natural! Without biosorption it is assumed that all the substrate is soluble. Consequently it does not settle in the sedimentation unit. The stored mass however, will settle together with the organisms. Therefore it is kept longer in the system, and the total food concentration therefore becomes higher in the biosorption model.

It is easy to show analytically, that the total food concentration is higher in the biosorption model. If the eq. (6.1) and (6.2) are added, than an equation for the total food concentration, defined by

$$s_T = s + s_m \quad (6.11)$$

is achieved, i.e.

$$\frac{ds_T}{dt} = D (s_i - s + r\gamma s_m - s_m - r s_m) - \frac{\mu_x c_x}{Y_x} \quad (6.12)$$

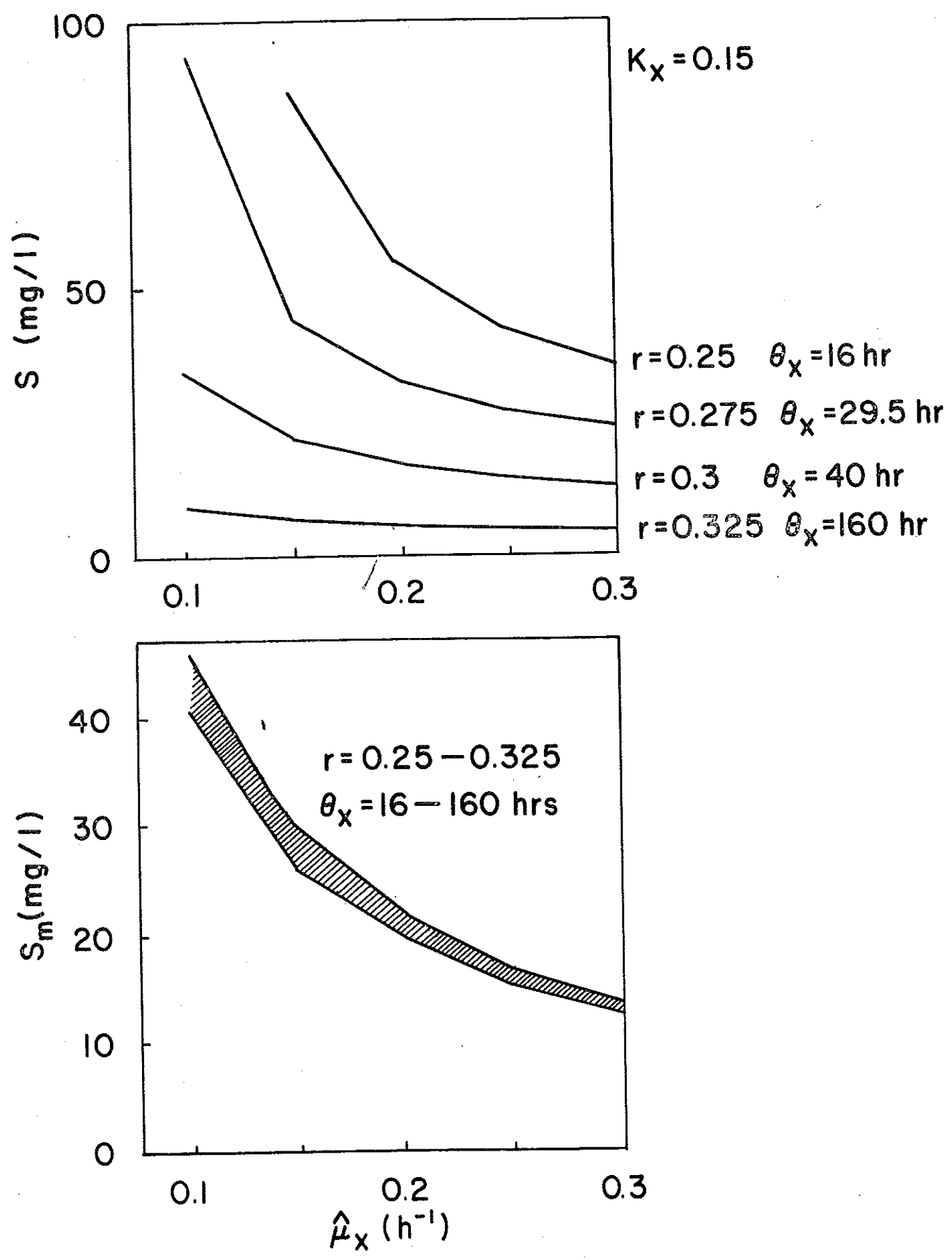

Fig. 6.5. Substrate (s) and stored mass (s_m) concentrations respectively as functions of maximum specific growth rate for different return sludge flow rates.

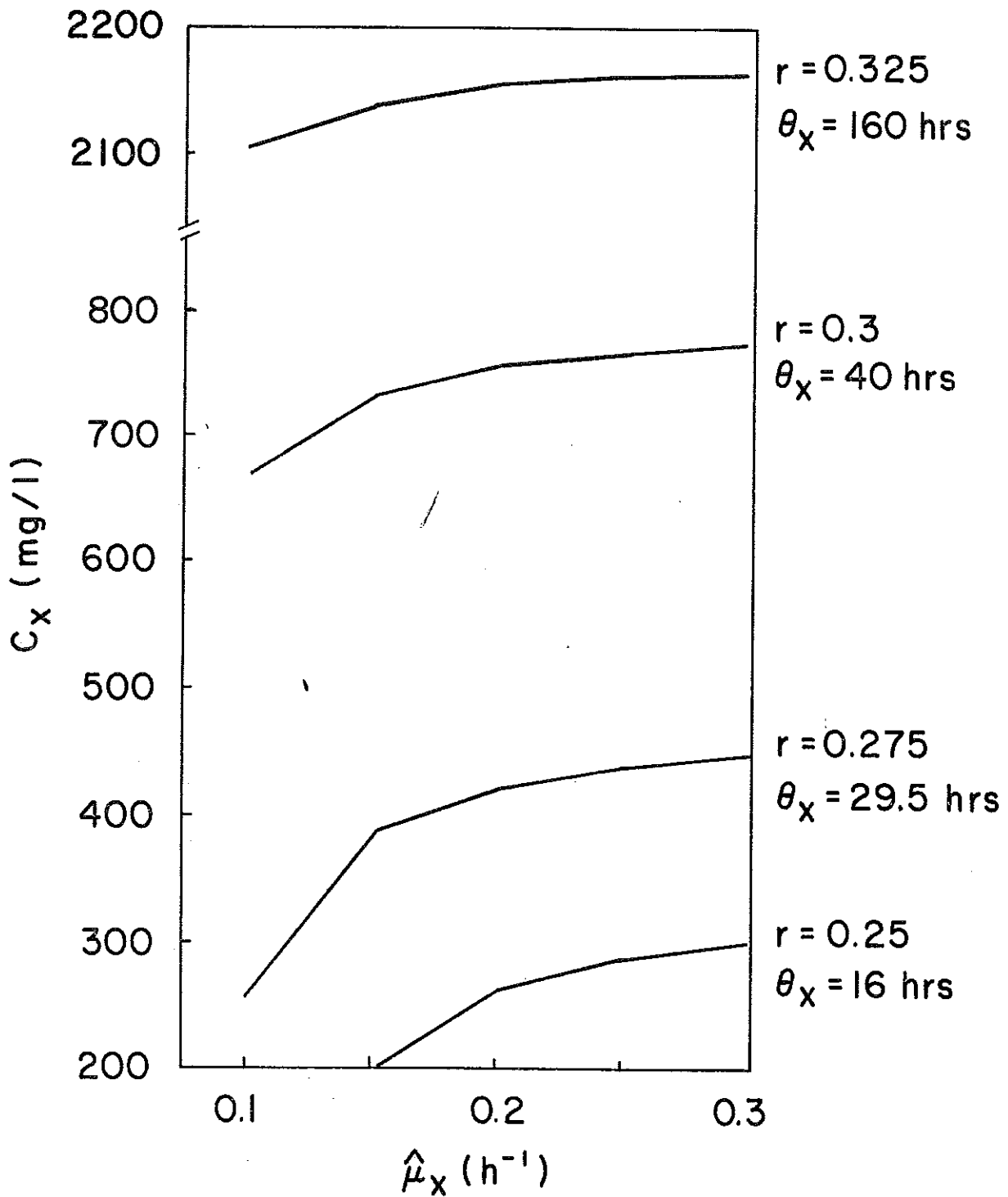

Fig. 6.6. Microorganism concentration as function of maximum specific growth rate for different return sludge flow rates.

By rearranging the terms in (6.12) we get

$$\frac{ds_T}{dt} = D (s_i - s_T + r (\gamma - 1) s_m) - \frac{\mu_x^c c_x}{Y_x} \quad (6.13)$$

The concentration s_i now indicates the total influent food concentration.

Now compare eqs (2.1) and (6.13). We assume that the organism concentration and its growth rate are the same for the two cases. Then there is a positive term in (6.13) $\{r (\gamma - 1) s_m\}$ which is missing in (2.1). This term makes the steady state value of s_T larger than corresponding value of s in (2.1).

7. PLUG FLOW AND STEP FEED AERATORS WITH BIOSORPTION

For a complete mix aerator it is not crucial to include the biosorption phenomenon into the model description. The reason is that both biosorption and synthesis have to take place in the same basin. Therefore the tank has to be big enough to make metabolism possible. Consequently the dominating time constant for the tank is determined not by the biosorption but rather by the synthesis time for the bacteria.

There is a more significant need to include the biosorption in a model of a plug flow reactor or a series of well mixed subreactors. The contact stabilization process has already been mentioned. There the contact time is very short between the influent wastewater and the mixed liquor in the contact tank. The only way to describe the substrate reduction in such a plant is to model the biosorption. Similarly in a step feed aerator the concept of a contact stabilization process can often be applied. Therefore the biosorption is also important in a step feed aerator model.

For a plug flow aerator the biosorption will significantly influence the profile of liquid phase substrate. The rapid uptake of substrate into stored mass is reflected in the fact, that the substrate level can decrease significantly within a short distance from the inlet. Such a phenomenon must be explained by the biosorption terms in the model. Moreover, many COD and BOD tests reflect the soluble substrate concentration and not the total food concentration. A model without biosorption is therefore not consistent in this case.

In this chapter the consequence of the biosorption terms in the different models will be discussed. In 7.1 the plug flow aerator is considered, and the profiles are compared to the ones discussed in chapter 4.4. The step feed aerator equations including the biosorption are given in 7.2. The results for two subreactors describing the aerator are discussed in 7.3. As a special case the contact stabilization unit is considered, where both the contact tank and the stabilization tank are assumed well mixed. The four subreactor step feed plant is finally considered in 7.4 and the conclusions are compared to those of 5.3.

7.1 Plug flow aerator

The influence of the biosorption is clearly demonstrated in the plug flow case. The reason is, that it is possible to give a "dynamical" interpretation to the concentration profiles. As the mixed liquor flow has a constant velocity the distance from the aerator inlet can be interpreted as a time variable.

When raw wastewater enters the aerator it is brought into contact with the organisms. The biosorption then causes the substrate concentration to fall rapidly along the tank. At the same time the stored mass concentration will be built up along the tank.

The plug flow equations (4.13) - (4.15) are changed to include a biosorption term. Analogously to (6.1) and (6.2) the biosorption gives the following dynamics

$$\frac{\partial s}{\partial t} = -\frac{1}{v} \frac{\partial s}{\partial \xi} - r_s c_T \left(f_s \frac{s}{K_s + s} - f_s \right) \quad (7.1)$$

$$\frac{\partial s_m}{\partial t} = -\frac{1}{v} \frac{\partial s_m}{\partial \xi} + r_s c_T \left(f_s \frac{s}{K_s + s} - f_s \right) - \frac{\mu_x c_x}{Y_x} \quad (7.2)$$

$$\frac{\partial c_x}{\partial t} = -\frac{1}{v} \frac{\partial c_x}{\partial \xi} + \mu_x c_x - d_x c_x \quad (7.3)$$

where μ_x is given by (6.4)

The stationary equations are solved in a way similar to that described in section 4.4. The boundary condition for the stored mass is of the same form as for the organisms, eq. (4.23).

The substrate and stored mass profiles are calculated for three different return sludge flow rates, corresponding to different sludge ages. The latter ones are calculated according to (4.12).

r	c_x	c_x / c_{x1}	θ_x (h)	figure
0.25	290	0.91	14.5	7.3
0.30	815	0.98	39	7.2
0.32	1640	1.00	100	7.1

The other parameter values are found in table 6.1.

Consider fig 7.1. The soluble substrate concentration rapidly decreases to a low value within a short distance. Considering the real hold up time to be $4/1.32 = 3.0$ hours it is noted that the biosorption takes place within some 10 - 15 minutes. Consequently the stored mass concentration rises very rapidly in the upper part of the tank. Soon the synthesis consumption of the stored mass becomes greater than the biosorption from soluble substrate, and the stored mass concentration decreases along the tank. The broken line in fig 7.1 indicates the substrate concentration when no biosorption is taken into consideration, i.e. the model (4.13) - (4.15).

Fig 7.2 shows the corresponding profiles for a shorter sludge age. As the total sludge concentration is lower in this case, the forcing function for the biosorption is lower. Consequently the biosorption is not as fast as in the previous case. The 10 - 15 minutes in the previous case now correspond to about 20 - 50 minutes.

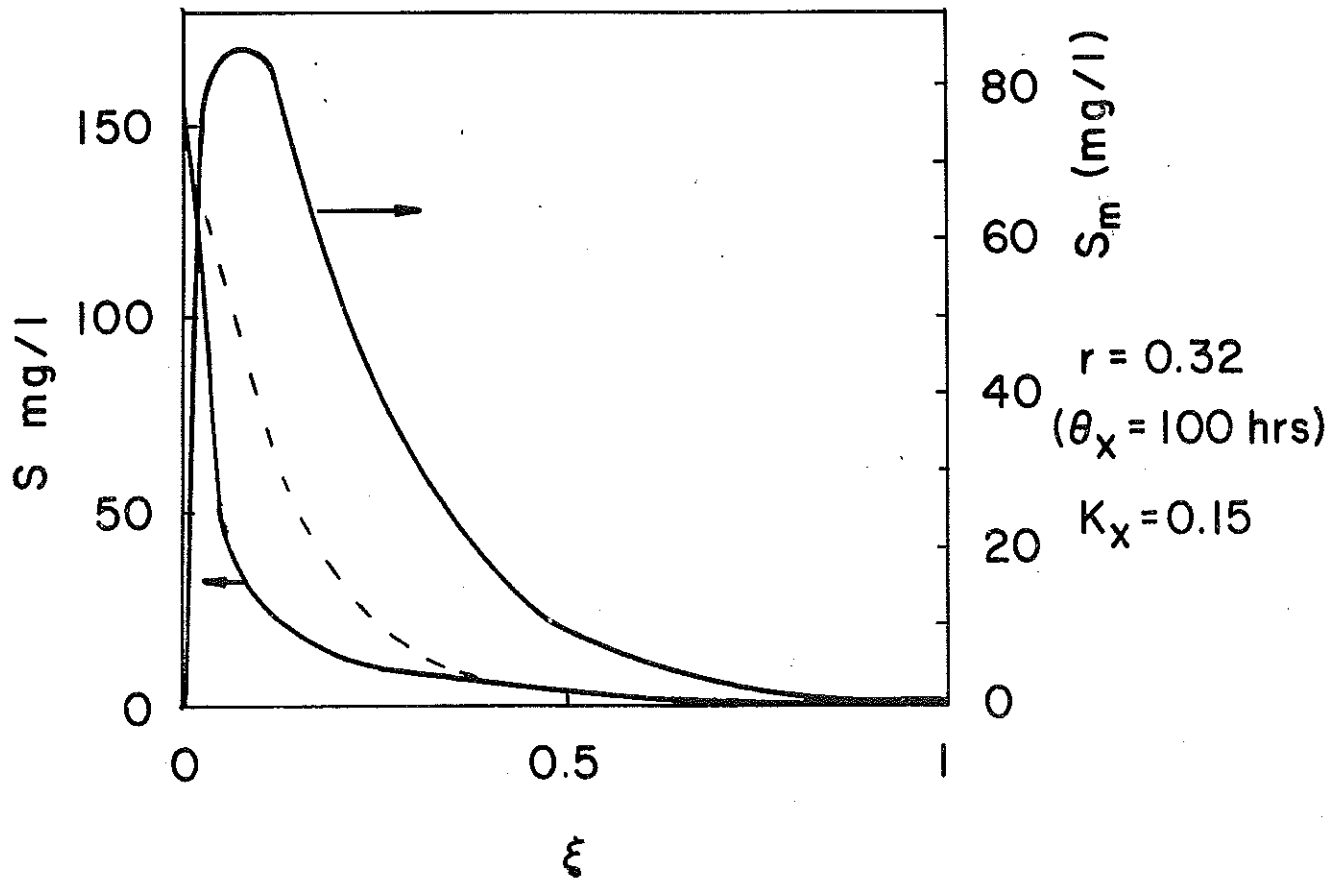

Fig. 7.1. Profiles of liquid phase substrate and stored mass in a plug flow aerator. The broken line shows the substrate profile if no biosorption is assumed in the model.

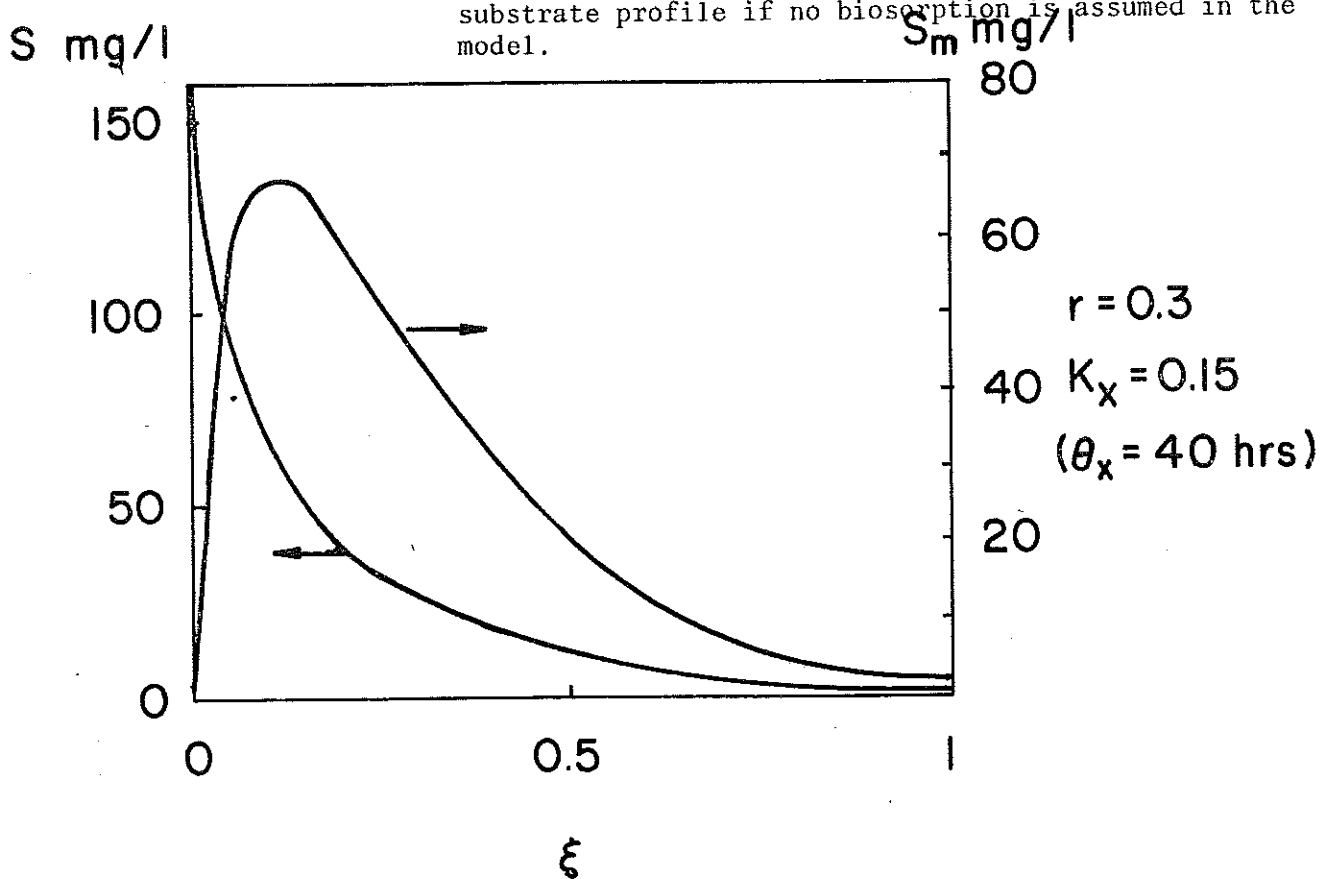

Fig. 7.2. Profiles of liquid phase substrate and stored mass in a plug flow aerator.

In fig 7.3 no rapid removal of substrate can be noticed. The reason is, that the sludge age is so low, that the metabolism does not have enough time. Consequently the stored mass concentration at the tail end of the tank is relatively high. This stored mass is partially recycled. This means, that the floc already contains a relatively high concentration of stored mass, when it is brought into contact with the influent raw wastewater at the head end. Consequently there is no significant driving force for the biosorption, and the substrate remains for a relatively long time in the liquid phase. Its concentration at the tail end is consequently relatively high.

Fig 7.4 illustrates what happens when the tank volume is increased, while all other parameters are the same as for figure 7.3. Here

$$V/Q = 10 \text{ h}$$

which corresponds to a velocity of

$$0.125 \text{ tank lengths /hour}$$

The stored mass is almost completely removed at the tail end through the synthesis. Therefore the flocs contain very little stored mass at the head end and the biosorption is more emphasized than in fig 7.3.

Some comparisons of the stored mass profiles in figures 7.3 and 7.4 can now be made. The maximum values are approximately the same and are reached at about the same time, i.e. about 50 minutes after inlet. The reason, that the maximum amplitudes are the same is; that the organism concentrations are almost equal. The biosorption driving force in the first case is somewhat smaller, as the stored mass concentration initially is larger than in the second case. Therefore the initial effect of the biosorption amplitude is more notable in the second case.

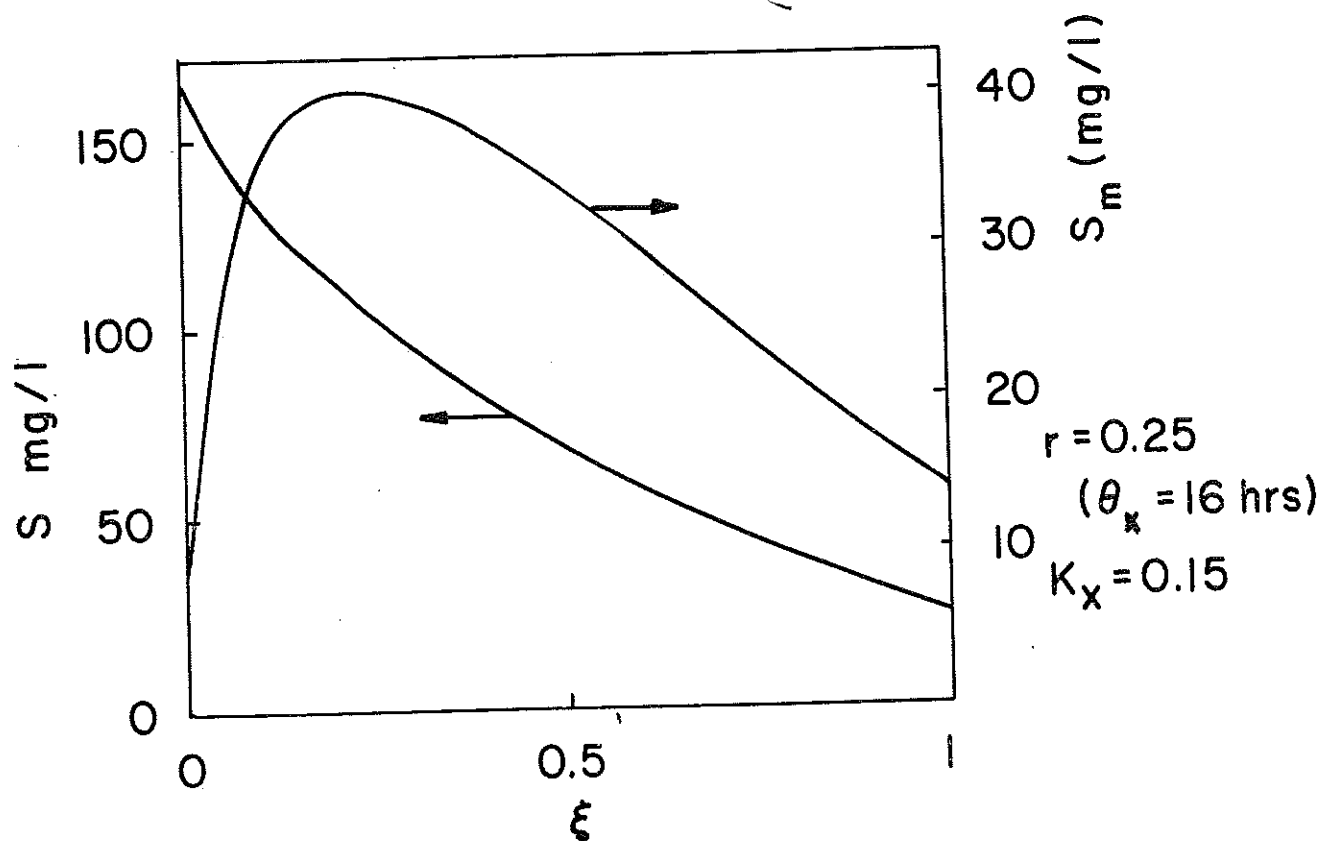

Fig. 7.3. Profiles of liquid phase substrate and stored mass in a plug flow aerator.

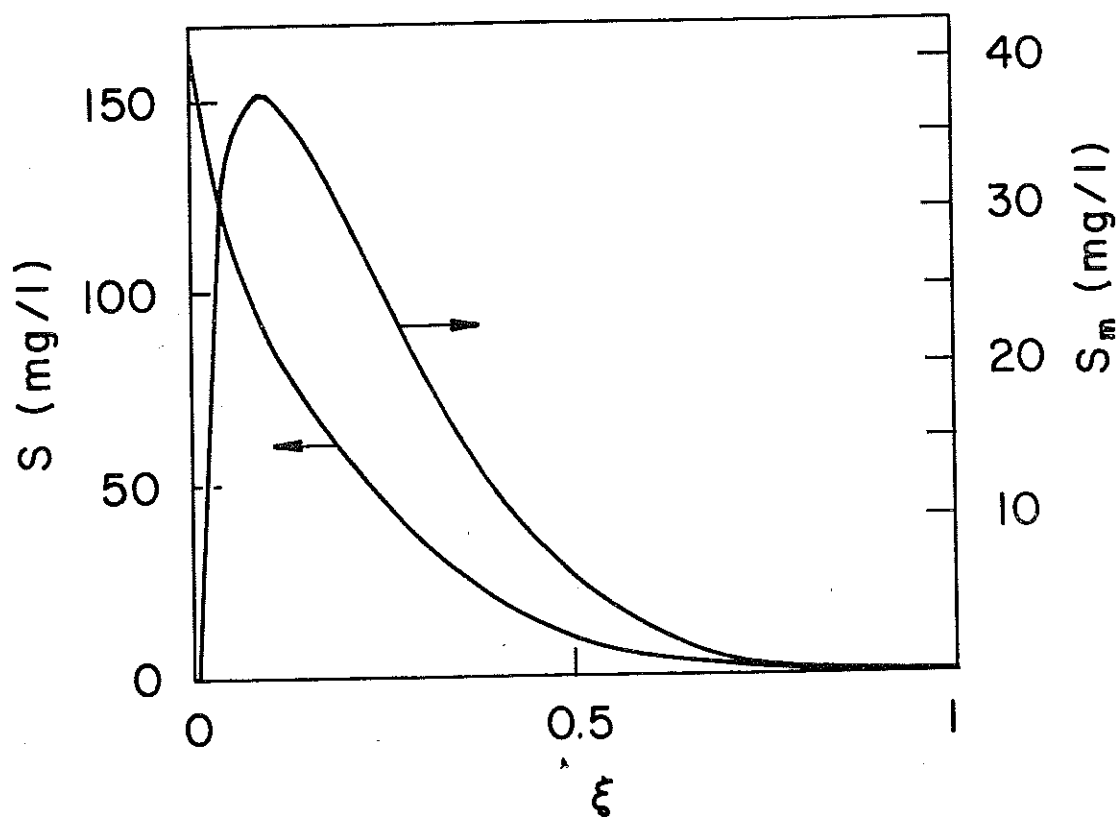

Fig. 7.4. Profiles of liquid substrate and stored mass in a plug flow reactor. The parameter values are the same as for fig. 7.3., except the transit time. The plug flow velocity corresponds to a transit time of 8 hours.

To summarize the results of the profile calculations there are two essential conditions that have to be satisfied in order to achieve an effective biosorption. The first condition is, that the organisms should be in the right condition. By this we mean that the stored mass concentration in the flocs must be small, when the mixed liquor meets the influent wastewater. This can be achieved only by a sufficiently long time for metabolism of the organisms. The second (and even more important) condition is, that the sludge concentration should be large enough. With a high sludge concentration two goals are reached. The synthesis becomes more rapid so more stored mass is consumed, and there is more "storage volume" available for the stored mass in the flocs.

Both the mentioned conditions for good biosorption are reflected in the second term of eq (6.1).

7.2 Step feed aerator equations

The step loaded aerator equations (4.1) - (4.3) have to be adjusted in order to incorporate the biosorption equations. The equations are formulated analogously to (6.1) - (6.5). The derivation of the equations can be found in part I, chapter 6.2. We refer to fig 4.1 and appendix for definition of the symbols. The substrate in soluble and colloidal form obeys the differential equations

$$\frac{ds_k}{dt} = D_k \{ \alpha_k s_i + (\beta_{k-1} + r) s_{k-1} - (\beta_k + r) s_k \} - r_{sT,k} c_{T,k} \left\{ f_{sk} \frac{s_k}{K_s + s_k} - f_{sk} \right\} \quad k=1, \dots, n \quad (7.4)$$

As the substrate does not settle the relation

$$s_r = s_n$$

holds, i.e.

$$s_o = s_r = s_n \quad (7.5)$$

The stored mass dynamics is formulated from (6.2)

$$\frac{ds_{m,k}}{dt} = D_k \{ (\beta_{k-1} + r) s_{m,k-1} - (\beta_k + r) s_{m,k} \} + r_{sT,k} c_{T,k} \left\{ f_{sk} \frac{s_k}{K_s + s_k} - f_{sk} \right\} - \frac{\mu_{Xk} c_{X,k}}{Y_X} \quad k=1, \dots, n \quad (7.6)$$

where μ_{Xk} is given according to (6.4),

$$\mu_{Xk} = \hat{\mu}_{Xk} \frac{f_{sk}}{K_X + f_{sk}} \quad k=1, \dots, n \quad (7.7)$$

Like before the settler equations are the simplest possible

$$s_{m,o} = s_{m,r} = Y s_{m,n} \quad (7.8)$$

The microorganism equation is identical to (4.1) but μ_{xk} is instead given by (7.7).

As in chapter 6 the inert microorganisms are not included in the model, as their influence upon the actual phenomena are considered marginal.

7.3 Step feed of two subreactors

The examination in this section will be a comparison to the two reactor cases without biosorption, in chapter 5.2. Two different operational conditions have been considered, and the parameter values are given in table 6.1.

First a system will be examined which corresponds to the one considered in 5.2. The total retention time (V/Q) is 4 hours and $r = 0.25$. Figure 7.5 shows how the steady state concentrations depend on the flow pattern. The microorganism concentrations in fig 7.5 are quite similar to the ones in fig 5.1. In chapter 6 the value of K_x was chosen in order to get similar microorganism concentrations with and without biosorption, so the result in fig 7.5 is expected.

Now consider the soluble substrate concentrations s_1 and s_2 in fig 7.5. Because of the biosorption one would expect a lower substrate concentration s_2 compared to the one in fig 5.1. This is, however, not the case. The reason is, that the stabilization time in tank 1 for the synthesis is too short. Therefore the stored mass concentration in the floc is large enough to make the biosorption smaller. Compare the plug flow case, figure 7.3.

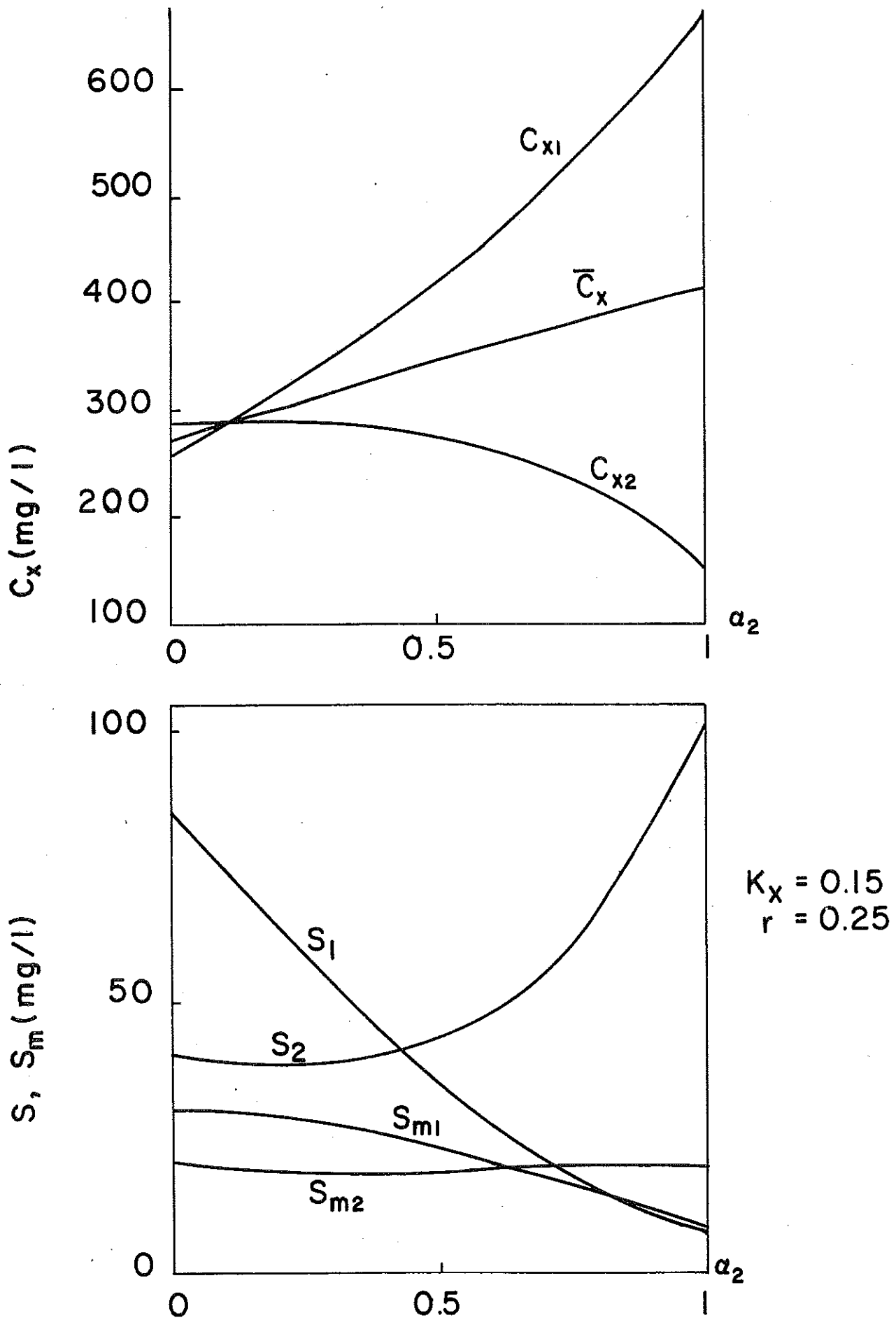

Fig. 7.5. Steady state concentrations of soluble substrate (s), stored mass (s_m) and microorganisms (c_x) for different inflow patterns. The aerator is described by two subaerators. Parameter values are found in table 6.1.

For the case $\alpha_2 = 1$, the flow pattern corresponds to a contact stabilization configuration. Here the contact time is 2 hours. The contact time seems to be too small. This is however not the case. The reason why too little biosorption takes place is, that the stored mass concentration must first be consumed by the synthesis. There has been too little stabilization time in tank 1 to consume enough amount of stored mass, only $2/1.25 = 1.6$ hours, why the organisms are not in the proper condition.

Now look at the stored mass concentrations, fig 7.5. The concentration in tank 2 (s_{m2}) does not vary very much with α_2 , despite the fact that s_2 becomes very large. The microorganism concentration has become so small in tank 2, that the biosorption forcing function (which is almost proportional to the organism concentration) has approximately been halved, compared to the conventional configuration ($\alpha_2 = 0$).

In fig 7.6 the return sludge flow rate is larger, $r = 0.32$, increasing the sludge age from about 16 to 100 hours for the conventional configuration ($\alpha_2 = 1$). The microorganism concentrations are consequently much larger and more substrate is consumed in the synthesis.

The behaviour of the microorganism concentration as function of α_2 is the same as in previous case. The biosorption is, however, somewhat larger in this case. This can best be seen from the stored mass curve for tank 2 (s_{m2}). The stored mass increases significantly with α_2 in contrast to the previous case. It is actually larger than the soluble substrate concentration s_2 . The reason is, that the biosorption driving force is larger in this case, mainly because of the high microorganism concentration.

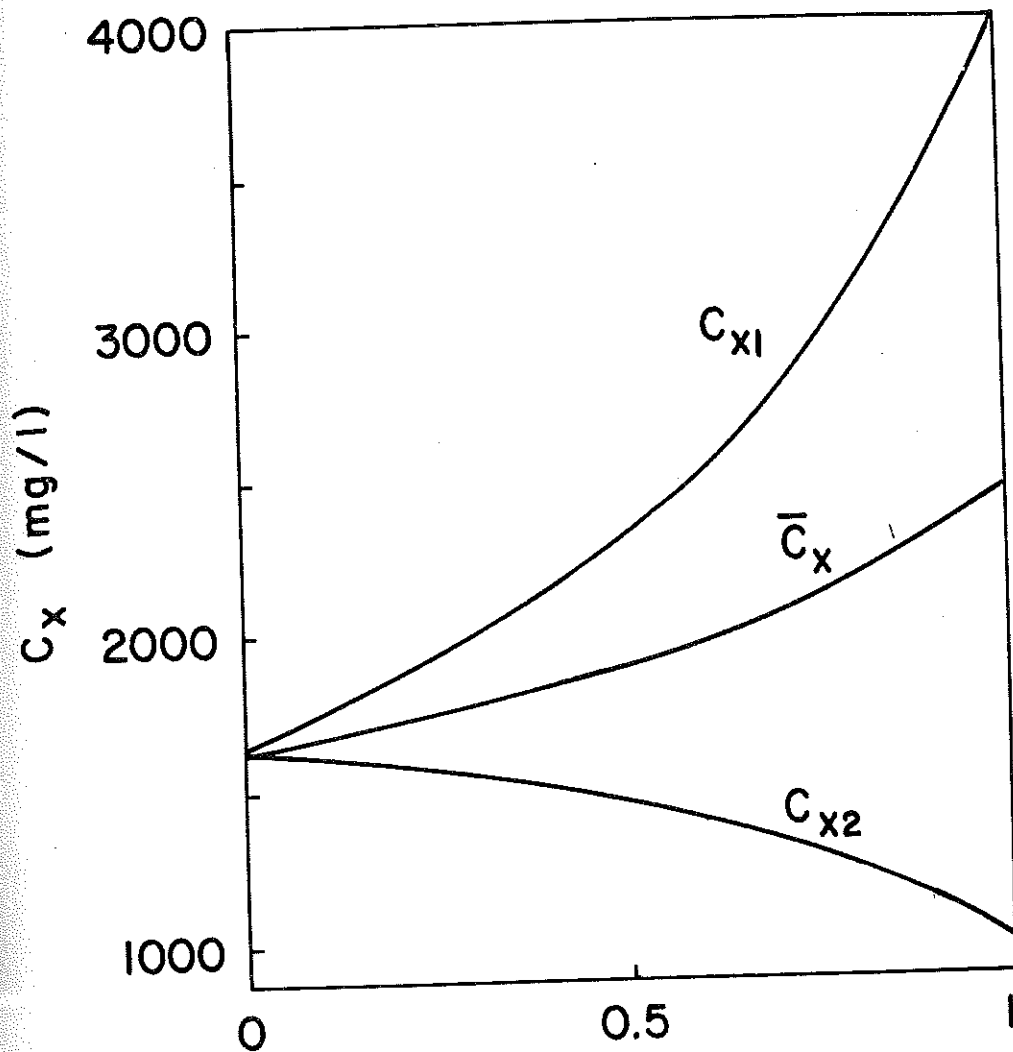

$$r = 0.32$$

$$K_x = 0.15$$

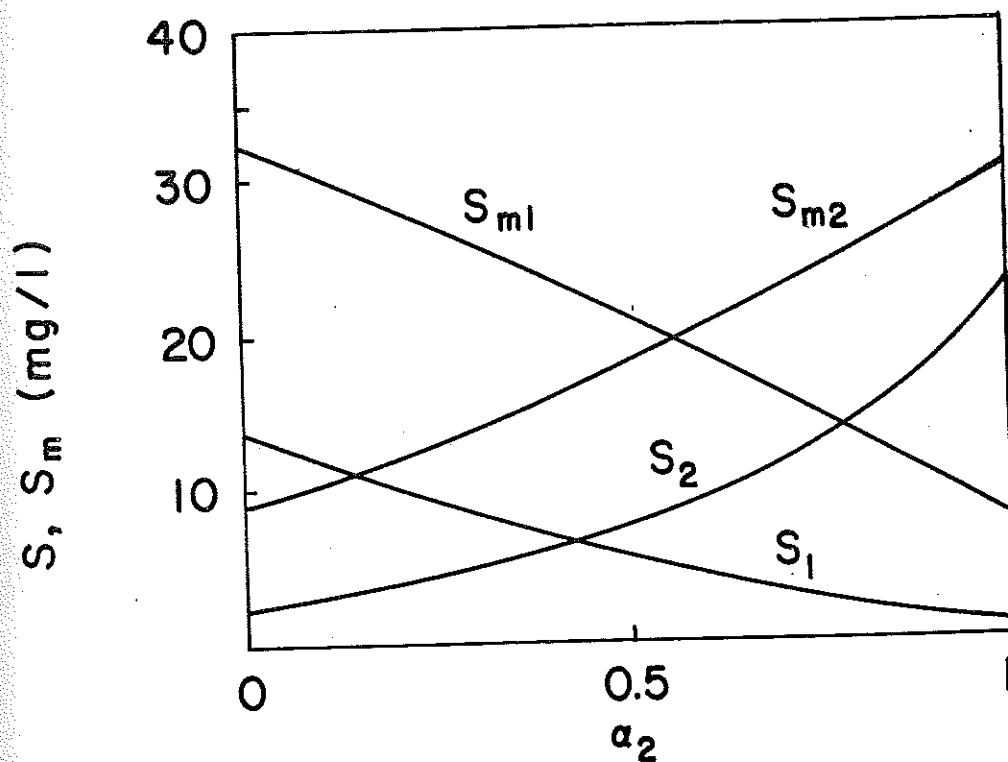

Fig. 7.6. Steady state concentrations of soluble substrate (s), stored mass (s_m) and microorganisms (c_x) for different inflow patterns. The aerator is described by two subreactors. Parameter values are found in table 6.1.

The fact that too short stabilization time gives a poorer result in contact stabilization has been known for a long time. Eckenfelder - O'Connor (1961) as well as Busby - Andrews (1975) have discussed this topic. It is an important design task to find the right proportion between the contact and stabilization basins. Also the return sludge flow rate is crucial. Those optimization criteria have also been discussed by Gujer - Jenkins (1975) in static design of contact stabilization plants.

7.4 Step feed of four subreactors

If the aerator is described by four subreactors the same qualitative conclusions can be made as for the two subreactor cases. The quantitative results are of course more complex. The influence of the biosorption for different operational conditions is examined in this section and compared to the results of section 5.3.

Table 7.1 summarizes the results of the steady state calculations. As in table 5.1 there are eight different flow patterns compared.

Looking first at the microorganism concentrations we find, as in 5.3, that case 7A gives the largest sludge mass of the system when $r = 0.25$. For the case $r=0.32$ case 6B gives a slightly higher sludge mass than case 7B. Case 7A and 8A still give a very high effluent substrate concentration. It seems as if the biosorption does not help to sufficiently quickly reduce the liquid phase substrate concentration in the last tanks. This is in fact true. The biosorption driving force depends both on the microorganism concentration and the stored mass concentration ratio in the floc. Here the microorganism concentrations are too small (due to a too small sludge age) and the stored mass ratio has not been sufficiently reduced by synthesis. The biosorption in the cases 7B and 8B is significantly larger than in the cases 7A and 8A, because the sludge age is larger in the B cases. Still the biosorption is, however, not sufficiently large. With a longer stabilization time the results would look better.

Table 7.1 Steady state concentrations of soluble substrate and microorganisms for a step feed reactor with four subreactors. Eight different flow patterns are calculated. For each flow pattern there are two return sludge flow rates.

	α_k	r	S_k		C_{Xk}		C_X	θ_X	S_m							
1A	1	0.25	111	76	50	32	260	278	293	305	284	14.9	33	32	25	18
B	0	0.32	24	6.5	2.3	0.9	1644	1659	1662	1659	1656	99.8	50	24	10	3.7
2A	0.5	0.25	53	70	45	28	448	285	299	310	336	17.3	34	28	23	16
B	0	0.32	8.7	14	4.0	1.4	2492	1570	1577	1577	1804	114	31	31	14	5.7
3A	0.25	0.25	26	30	36	41	599	422	332	277	408	23.6	26	20	18	17
B	0.25	0.32	4.4	5.5	6.9	8.4	3071	2150	1660	1357	2060	152	23	18	18	17
4A	0	0.25	5.6	110	78	55	1023	218	232	245	430	28.1	13	25	27	22
B	1	0.32	0.3	30	9.0	3.4	5192	1291	1308	1313	2276	173	4.8	48	25	11
5A	0	0.25	5.1	53	75	51	1039	374	238	250	475	30.4	12	26	24	21
B	0.5	0.32	0.5	11	17	5.5	4947	1961	1240	1249	2349	188	7.0	29	31	15
6A	0	0.25	12	1.5	122	96	711	709	151	162	433	42.8	17	2.4	18	22
B	1	0.32	1.1	0.1	37	13	4149	4092	1022	1041	2576	247	13	1.5	46	26
7A	0	0.25	10	1.3	64	89	750	746	271	173	485	44.9	16	2.1	22	20
B	0.5	0.32	1.6	0.2	14	22	3810	3759	1498	952	2505	263	16	1.8	28	30
8A	0	0.25	22	3.6	0.6	135	446	454	448	96	361	60.2	17	3.3	0.5	12
B	1	0.32	3.6	0.4	0.1	52	2825	2793	2752	693	2266	327	24	3.0	0.3	42

Constants: $T_1 = T_2 = T_3 = T_4 = 1$ hr

Other constants are given in table 6.1

8. DISSOLVED OXYGEN

In the previous analysis it has been assumed that the biological reactions are supplied with the proper amount of dissolved oxygen (DO). It will be considered here what happens when the DO concentration is a limiting factor for the cell synthesis.

The equations for the dissolved oxygen dynamics are derived in part I chapter 7, but will be repeated here for easy reference. In 8.1 the equations are discussed for the plug flow and complete mix aerator cases. Some numerical calculations of dissolved oxygen profiles are discussed in 8.2. The equations for the oxygen profile are analyzed in 8.3 to further illustrate the character of the solutions. In 8.4 the sensitivity of the DO concentration to the air blower flow rate is analyzed.

8.1 Dissolved oxygen equations

The plug flow form of the dissolved oxygen dynamics can be written (see part I, eq (6.22) and ch. 7)

$$\frac{\partial c}{\partial t} = -v \frac{\partial c}{\partial \xi} + c_{\text{prod}} - c_{\text{cons.}} \quad (8.1)$$

The production term is

$$c_{\text{prod}} = k_1 u_{\text{air}} (c_{\text{os}} - c_o) \quad (8.2)$$

where the overall oxygen transfer coefficient $k_L a$ is written

as $k_1 u_{\text{air}}$.

while the consumption terms for biological uptake is

$$c_{\text{cons}} = \frac{1 - Y_X}{Y_X} \mu_X c_X - k_2 d_X c_X \quad (8.3)$$

In the models no biosorption has been included. The reason is that no oxygen consumption takes place because of the biosorption. Therefore all substrate is assumed to be in soluble form, like the models in chapters 2 - 5. A biosorption term in the model would not change the conclusions as far as the DO profiles and concentrations are concerned.

The specific growth rate μ_X is a function of both the substrate concentration and the DO concentration,

$$\mu_X = \hat{\mu}_X f(c_o) \frac{s}{K_X + s} \quad (8.4)$$

where the function $f(c_o)$ is some limiting function due to the DO concentration. Qualitatively it resembles a Monod function, and can be expressed in a couple of different ways, either

$$f(c_o) = \frac{c_o}{K_o + c_o} \quad (8.5)$$

or

$$f(c_o) = 1 - \exp(-\kappa c_o) \quad (8.6)$$

where the parameters K_o and κ are constants. Which equation to choose may be a matter of taste. Here we prefer the form (8.6) because the exponential function approaches its limiting value faster than the function (8.5). In Mueller et al (1968) some data are presented for the oxygen limiting function.

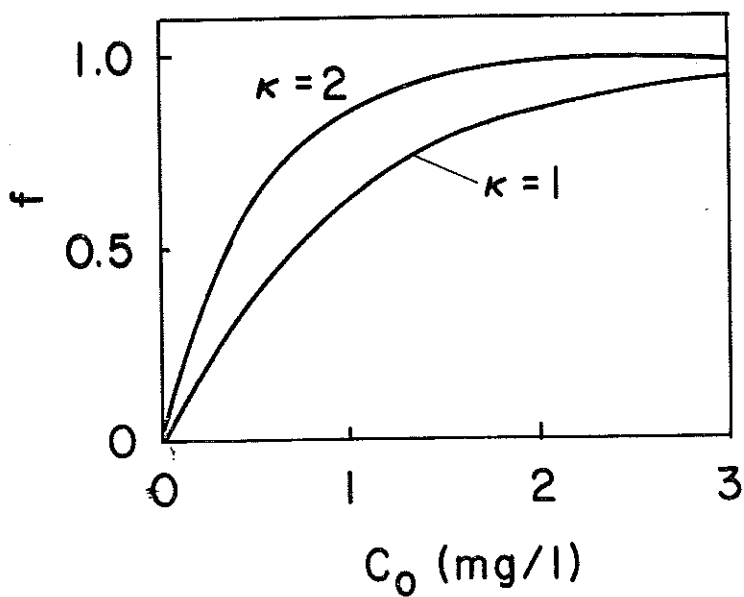

Fig. 8.1. Illustration of the function $f(c_0)$ (8.6)

Table 8.1.

Parameter values for the oxygen profile calculations		
$\theta = V/Q = 4$ hrs	$\hat{\mu}_x = 0.2$ h ⁻¹	$k_2 = 0.25$
$r = 0.25$ or 0.32	$K_x = 80$ or 200 mg/l	$c_{os} = 10$ mg/l
$\gamma = 4$	$d_x = 0.005$ h ⁻¹	$c_{oi} = 0.5$ mg/l
$s_i = 200$ mg/l	$Y_x = 0.5$	$\kappa = 1.0, 2.0$
$c_{zi} = 0$	$\mathcal{N} = 0.0005$ mg ⁻¹ h ⁻¹ l	$k_1 u_{air} \leq 10$

For a municipal biological sludge it is generally recognized, that the biological activity approaches its maximum for DO levels larger than about 1-2 mg/l. The DO limiting conditions are illustrated in fig 8.1, where the function $f(c_o)$ (8.6) has been plotted for two different values of the constant κ . The numerical values of the parameters used for the parameters are listed in table 8.1.

For the DO profile calculations the equations (8.1) - (8.4) are combined with the biological equations (4.13) - (4.15). The boundary conditions are still (4.22) - (4.24). For the DO concentration there is an initial condition given, as the influent flow DO concentration is assumed to be known. The DO content of the return sludge flow is assumed to be negligible.

The DO concentration dynamics for a complete mix aerator is derived from a mass balance over the aerator shown in figure 2.1. The production term is described by (8.2) and the biological uptake term by (8.3). The DO concentrations are now representing the homogeneous tank concentration. Neglecting the DO concentration in the return sludge a simple mass balance for oxygen gives

$$\frac{dc_o}{dt} = D (c_{oi} - (1+r) c_o) + k_l u_{air} (c_{os} - c_o) - \frac{1 - Y_x}{Y_x} \hat{\mu}_x \frac{s}{K_x + s} c_x f(c_o) - k_2 d_x c_x \quad (8.7)$$

Eq (8.7) can be combined with the eq (2.1) and (2.2) to achieve the basic kinetics and DO dynamics.

8.2 Calculation of oxygen profiles

The DO profiles for different reactor conditions have been studied. The model for the plug flow reactor case, given in 8.1, has been used in the calculations. It has been assumed all the time that the air flow is distributed uniformly along the aerator. This type of aeration is quite common. Nevertheless it is not suitable in all cases, and a poor performance might result from such an air flow profile.

In the head end of the aerator there is a very high biological uptake rate. This is clearly seen in (8.3) where μ_x is large in the beginning. The high uptake causes the DO level to remain at a relatively low value. In the tail end, on the other hand, the biological uptake is relatively small, as most of the substrate would have been consumed at that stage. Therefore the oxygen level rises generally towards the tail end, conditioned that the air inflow is sufficiently large.

Fig 8.2 shows some different DO profiles for a plug flow reactor. The air flow rates have been varied from the value $k_1 u_{\text{air}} = 10$ down to $k_1 u_{\text{air}} = 2.5$. In order to easily refer to the different cases we simply call them by the numbers, e.g. "10". The corresponding substrate profiles are shown in the lower figure.

First consider the "10" curve which has the highest air flow rate. The DO profile has the typical S-shape which is found in many plants, see e.g. Jones et al (1969). At the head end there is a low DO level, and the synthesis is actually oxygen limited (see figure 8.1). After some 20% of the distance from the inlet the DO concentration is high enough to allow a maximum synthesis rate. Towards the tail end the DO concentration approaches its saturation value (10 mg/l) and the DO profile becomes almost horizontal.

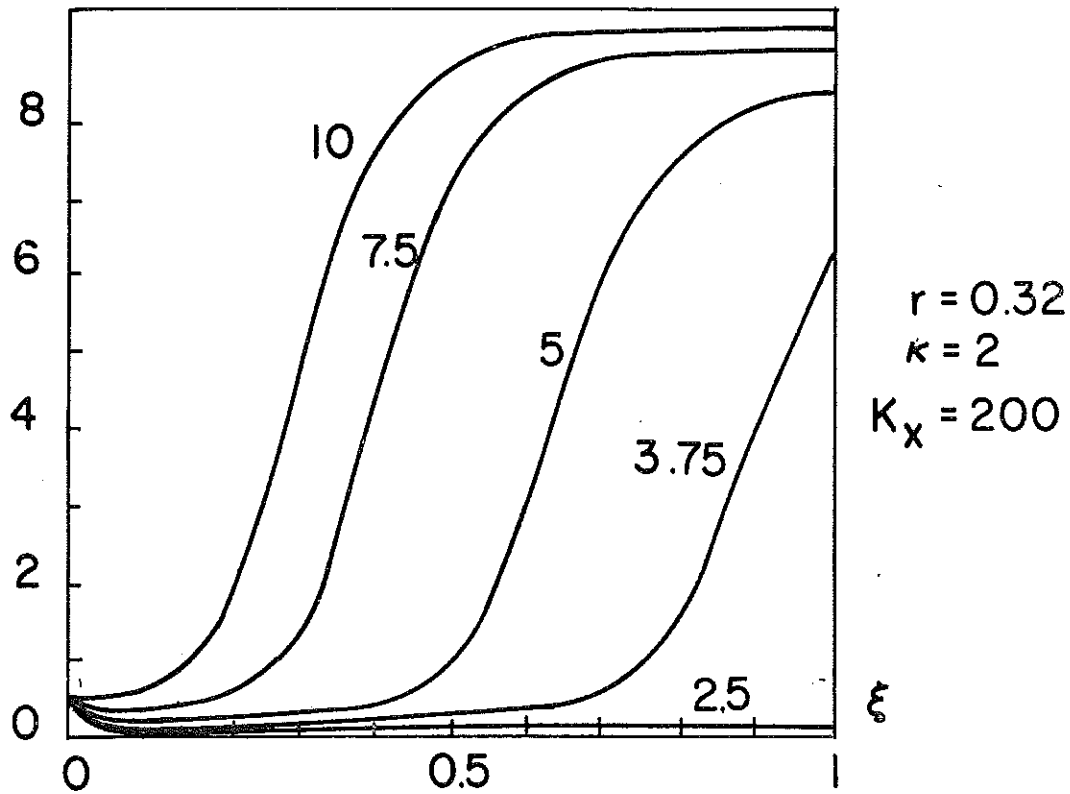
C_o (mg/l)

S (mg/l)

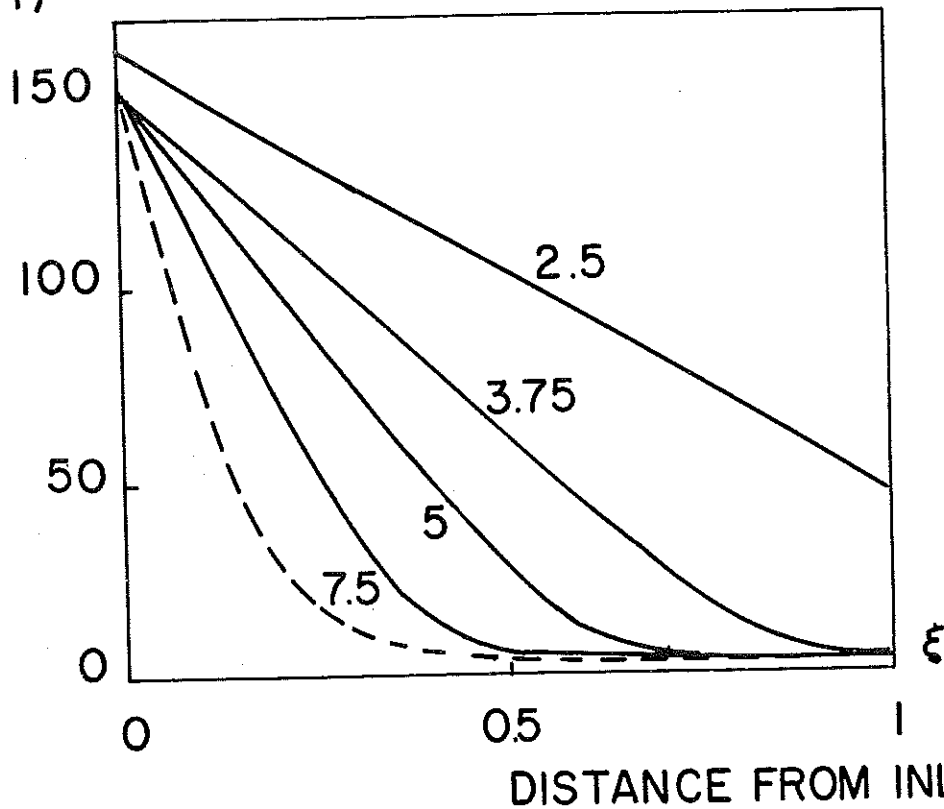

Fig. 8.2. DO and substrate concentration profiles respectively for a plug flow aerator. The value of $k_1 u_{air}$ is the parameter. Other parameter values are given in table 8.1.

The broken line among the substrate profiles shows the substrate concentration in the case, that no oxygen limitation occurs. The "10" substrate concentration is somewhat higher in the beginning, because the substrate removal has been limited. Towards the tail end, however, both the substrate profiles converge to almost identical concentrations. The reason is, that even if the synthesis for the "10" curve has been slowed down there is enough time available to complete the reaction along the tank. The almost horizontal slopes of both the DO and the substrate concentrations towards the tail end are good indications, that the biological reaction is completed.

Now consider the different profiles for different air flow rates. The DO profiles in the "7.5" and "5" cases also approach a horizontal slope. As for the "10" case the biological reactions are completed towards the tail end, and the substrate concentration becomes almost the same as for the "10" case. When the air flow rate is decreased further the oxygen limitation for the synthesis is getting significant. In the "3.75" case the DO profile has a large positive slope at the tail end, which indicates that the synthesis is not completed. For another decrease of the air flow to "2.5" there is a large change in both the substrate removal and in the DO level. The synthesis is oxygen limited along the whole tank.

Now consider the sensitivity of the DO concentration to changes in the air flow rate. In the beginning and towards the tail end of the tank the DO concentration changes are relatively small compared to the changes in the middle part. This is particularly clear when the cases "10", "7.5" and "5" are compared in fig 8.2. The reason for the different sensitivity will be further analyzed in chapter 8.4.

The mentioned differences in the sensitivity to the air flow rate is important, when the problem to place a DO sensor is considered. Figure 8.2 indicates that it may be easier to detect changes in the DO level in the middle of the tank than in the tail end.

Now consider an operational condition, when the sludge age is considerably lower, only about 15 hours. Figure 8.3 shows the DO profiles and corresponding substrate concentrations for this case. For $k_1 u_{\text{air}} = 5$ the DO concentration is sufficiently high along the whole tank to allow a maximum synthesis rate. This is further illustrated by the lower figure, where the "5" substrate profile is close to the substrate profile without any oxygen limitation (broken line). On the other hand neither the DO concentration nor the substrate concentration profile becomes horizontal at the tail end. This is an indication, that the synthesis is not sufficiently completed, and a higher sludge age should be needed (e.g. by increasing the return sludge flow rate). For lower air flow rates the DO profile becomes even lower, and the substrate removal becomes deteriorated.

The examples in figures 8.2 and 8.3 clearly indicate, that with a uniform air flow distribution along the tank, there is a large waste of compressor energy to keep the synthesis at a reasonable level. The biological activity can not make use of the abundant concentration of oxygen at the tail end. This is of course the reason why tapered aeration is used in some plants. There is an important design optimization problem to find the best air flow distribution along the tank, so the air flow is sufficient but not more for an adequate biological uptake.

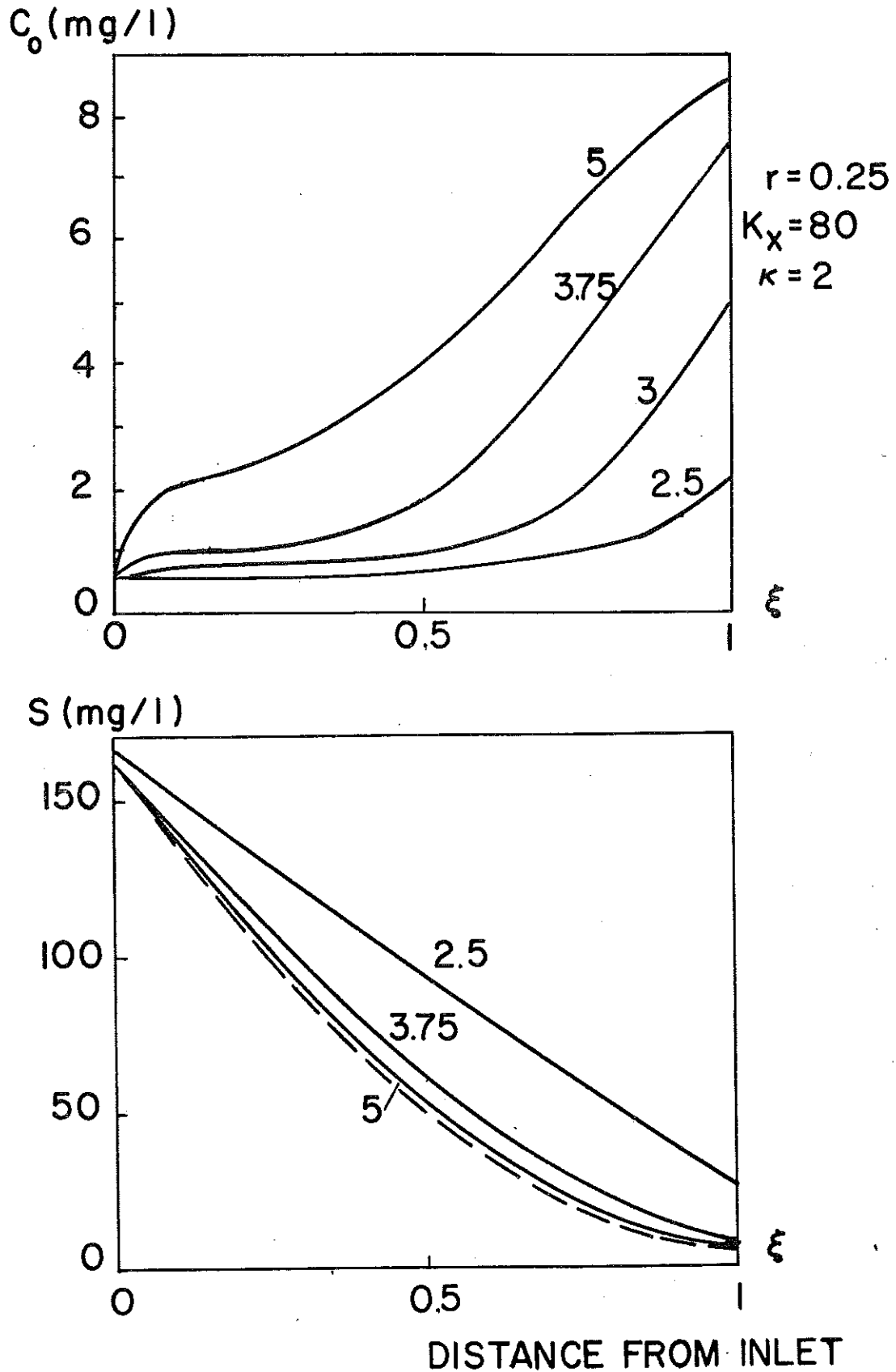

Fig. 8.3. DO and substrate concentration profiles respectively for a plug flow aerator. The value of $k_{u_{air}}$ is the parameter. Other parameter values are given in table 8.1.

8.3 Analysis of the oxygen profile

The DO equation will be analyzed here in order to illustrate some features which are well-known for the practitioner. Consider the situation when the DO profile is horizontal, or almost horizontal, which can happen either at the head end or close to the tail end of the aerator.

For the horizontal profile the spatial derivative is zero, and a simple equality expression is derived from (8.2) - (8.4).

$$k_1 u_{\text{air}} (c_{\text{os}} - c_o) - \frac{1-Y}{Y} \mu_x c_x - k_2 \frac{d c_x}{d x} = 0 \quad (8.8)$$

where μ_x is given by (8.4) and $f(c_o)$ by (8.6). First it will be shown, that there exists only one solution to eq (8.8), and the proof is made graphically.

Consider the order of magnitude of the parameters. The DO concentration can never be negative. Therefore the spatial derivative in (8.1) must be greater or equal to zero for zero DO concentration, i.e.

$$k_1 u_{\text{air}} c_{\text{os}} - k_2 \frac{d c_x}{d x} \geq 0 \quad (8.9)$$

This means that the oxygen support to the aerator must have a smallest value which is corresponding to the endogeneous oxygen uptake rate. Often the coefficient $k_1 u_{\text{air}}$ is written

$$k_o + k_1 u_{\text{air}} \quad (8.10)$$

to take this into consideration, where k_o is the oxygen transfer when no blowers are in use. To make the analysis simpler, the equation (8.9) must instead be satisfied.

Now, assume that the substrate and microorganism concentration and c_x respectively are given in the actual space point. Then the equality (8.8) can be written

$$c_{os} - c_s = a_1 f(c_o) + a_2 \quad (8.11)$$

where

$$a_1 = \frac{k_3 \hat{u}_x c_x}{k_1 u_{air}} \cdot \frac{s}{K_x + s}, \quad k_3 = \frac{1 - Y_x}{Y_x} \quad (8.12)$$

$$a_2 = \frac{k_2 d_x c_x}{k_1 u_{air}} \quad (8.13)$$

The equality (8.11) can be represented graphically by the two curves $c_{os} - c_o$ and $a_1 f(c_o) + a_2$. The principal result is shown in fig 8.4, and it is demonstrated that at most one solution can exist. The inequality (8.9) furthermore tells that

$$c_{os} > a_2 \quad (8.14)$$

so there always exists one unique solution to (8.11).

In fig. 8.5 some numerical examples are given. The air flow and oxygen transfer are assumed to be constant and only the biological uptake is varied. For a high substrate concentration the biological uptake rate is very high and therefore the equilibrium concentration is low. For a small substrate concentration (close to the tail end) the biological uptake rate is comparatively small and the DO concentration is relatively high.

Now consider the case, when the DO profile is not horizontal. It is desired to keep the air flow rate high, so that the oxygen transfer is higher than the biological uptake rate. The derivative $\frac{\partial c_o}{\partial \xi}$ must consequently be nonnegative, i.e.

$$c_{os} - c_o \geq a_1 f(c_o) + a_2 \quad (8.15)$$

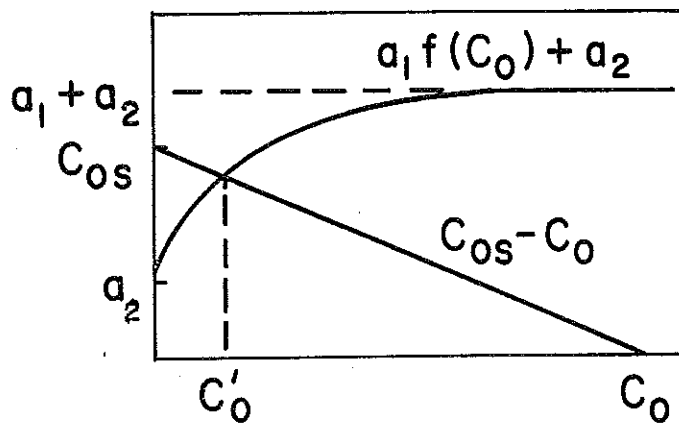

Fig. 8.4. Illustration of the graphical solution of eq (8.11).

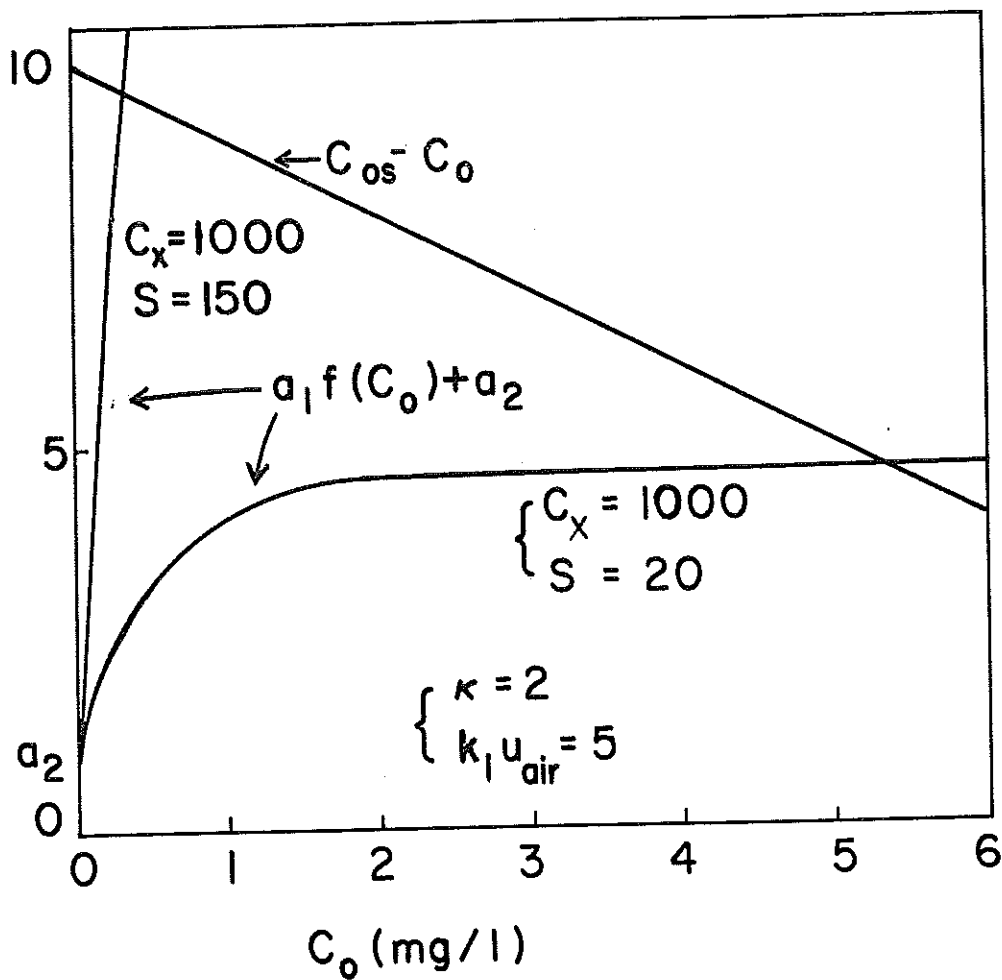

Fig. 8.5. Graphical solution of the eq. (8.11) for two different operating conditions.

The DO concentration, which is marked c'_0 in fig 8.4 corresponds to a horizontal profile and satisfies the equality in (8.15). For DO concentrations smaller than c'_0 the inequality in (8.15) is satisfied, and the DO profile is then positive. If it is desired to increase the DO concentration in steady state and still keep a positive slope, then the intersection point c'_0 in fig 8.5 must be moved to the right in the figure. The intersection can be moved by changing either the value of a_1 or a_2 . According to (8.12) and (8.13) a_1 and a_2 are primarily influenced by the air flow rate. For an increasing air flow rate both a_1 and a_2 will decrease, and the intersection point c'_0 will move to the right.

This conclusion is of course not original. The analysis can, however, give more insight into the quantitative importance of the different parameters, which determine the necessary air flow rate for the process.

8.4 Analysis of the oxygen sensitivity to air flow rate changes

It was shown in 8.2, that the DO concentration is less sensitive for air flow changes at concentrations close to zero or close to the saturation value, compared to concentrations in the intermediate range. The reason for this will be analyzed in this section. For the analysis a complete mix aerator will be considered, but the conclusions can be extrapolated into other aerator configurations as well.

The DO concentration dynamics is described by (8.7) together with for example (2.1) and (2.2).

The DO concentration dynamics has a typical dominating time constant of about 10 - 15 minutes. Therefore the DO changes can take place significantly faster than other dynamical changes due to either

hydraulic manipulations or biological activities. It is therefore reasonable to assume, that both substrate and microorganism concentrations remain constant in the fast time scale, when the DO concentration is changing dynamically.

The oxygen transfer constant $k_1 a$ may also be varying with time and operational conditions, but for the present analysis it is considered constant.

For the analysis eq (8.7) is considered, where the substrate concentration (s) as well as the microorganism (c_x) are considered constant in the actual time scale.

In order to simplify the notations eq (8.7) can be written

$$\frac{dc_o}{dt} = a_1 - a_2 c_o + k_1 \bar{u}_{air} (c_{os} - c_o) - a_3 f(c_o) - a_4 \quad (8.16)$$

where

$$a_1 = c_{oi} D \quad (8.17)$$

$$a_2 = (1+r)D \quad (8.18)$$

$$a_3 = \frac{1-Y_x}{Y_x} \hat{\mu}_x \frac{s}{K_x + s} c_x \quad (8.19)$$

$$a_4 = k_2 d_x c_x \quad (8.20)$$

The function $f(c_o)$ is defined by (8.6).

As eq (8.16) is nonlinear it will be linearized around an operating point with DO concentration \bar{c}_o and air flow rate \bar{u}_{air} . The actual variables can be written as

$$c_o = \bar{c}_o + \Delta c_o \quad (8.21)$$

$$u_{air} = \bar{u}_{air} + \Delta u \quad (8.22)$$

Considering only small variations around the operating point eq (8.16) is linearized to the form

$$\frac{d(\Delta c_o)}{dt} = -a_2 \Delta c_o + k_1 (c_{os} \Delta u - \bar{c}_o \Delta u - \bar{u}_{air} \Delta c_o) - a_3 \left\{ \frac{df}{dc_o} \right\} \frac{\Delta c_o}{\bar{c}_o} \quad (8.23)$$

The static gain G of changes in oxygen concentration with respect to air flow rate changes is calculated from (8.23). The time derivative is set to zero. By definition G is

$$G = \frac{\Delta c_o}{\Delta u} = \frac{k_1 (c_{os} - \tau_o)}{a_2 + k_1 \bar{u}_{air} + a_3 \left\{ \frac{df}{dc_o} \right\} \frac{\tau_o}{\bar{c}_o}} \quad (8.24)$$

where

$$\left\{ \frac{df}{dc_o} \right\} \frac{\tau_o}{\bar{c}_o} = \kappa e^{-\kappa \bar{c}_o} \quad (8.25)$$

The concentrations of substrate and microorganisms influence only the term a_3 in (8.24). For small values of the DO level the values of these concentrations have a significant influence upon the sensitivity. For large DO values, the influence of (8.25) and a_3 is negligible, and the air flow to DO sensitivity is only dependent on the oxygen transfer rate. The appearance of G as function of the DO concentration is best illustrated by a diagram. Two numerical examples are considered.

Example 1. The parameter values are shown in table 8.1.

Particularly,

$$c_x = 1000 \text{ mg/l}$$

$$s = 150 \text{ mg/l}$$

$$r = 0.25$$

$$k_1 \bar{u}_{\text{air}} = 5.0$$

$$\kappa = 2$$

Fig. 8.6 curve 1, shows the gain as function of the DO concentration. The maximum G is found for

$$c_o = 3.0 \text{ mg/l}$$

If instead $\kappa = 1$ the maximum will be at

$$c_o = 4.5 \text{ mg/l}$$

Example 2

In this example the substrate concentration is instead

$$s = 20 \text{ mg/l}$$

Then the curve 2 in fig 8.6 shows corresponding gain as function of DO level. The maximum is now found for

$$c_o = 2.3 \text{ mg/l}$$

For $\kappa = 1$ corresponding maximum is achieved for

$$c_o = 3.2 \text{ mg/l}$$

It is easy to verify analytically, that G has only one maximum.

The derivative of G with respect to c_o is

$$\frac{dG}{dc_o} = \frac{-k_1 (a_2 + k_1 \bar{u}_o + a_3 k e^{-\kappa c_o}) + k_1 (c_{os} - \bar{c}_o) \kappa^2 e^{-\kappa c_o}}{(DN)^2} \quad (8.26)$$

where DN means the denominator of (8.24).

The derivative is zero if

$$e^{-\kappa \bar{c}_o} \cdot \kappa a_3 (\kappa (c_{os} - \bar{c}_o) - 1) = a_2 + k_1 \bar{u}_{\text{air}} \quad (8.27)$$

It is easy to verify (by a graphical representation of (8.27)) that there exists one and only one solution to (8.27) as long as κ is large enough.

For all physically reasonable values of κ (0.5 - 2) there is a unique solution of (8.27).

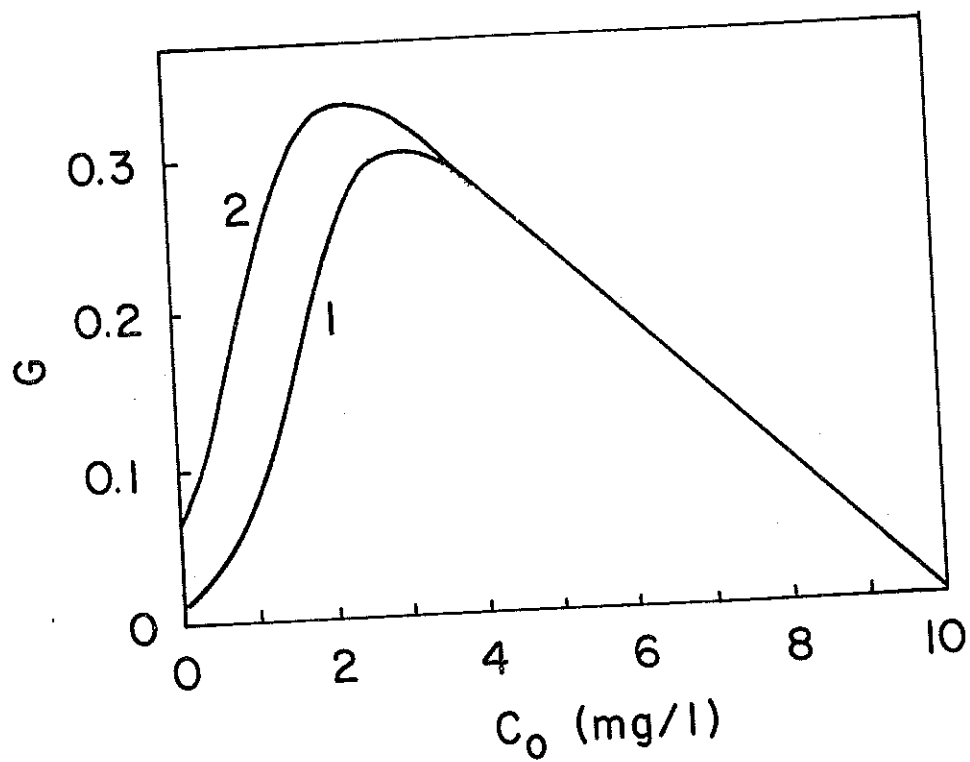

Fig. 8.6. Graphical representation of the DO sensitivity with respect to air flow changes, eq (8.24).

The solution of (8.27) always gives a maximum. For large values of \bar{c}_o the derivative (8.26) is always negative, as the exponential function in the nominator approaches zero. If a solution for (8.27) exists, then the derivative must be positive for small values of \bar{c}_o . Consequently the zero derivative indicates a maximum of G.

8.5 Analysis of the oxygen sensitivity to disturbances

The major external disturbances to the DO concentration level are changes in substrate concentration and in influent flow rate. In this section it will be analyzed how the DO concentration is changed at different operating levels due to disturbances of this nature. As in the previous section the sensitivity will be analyzed by linearizing the DO equation. Only small disturbances will be considered.

As before the microorganism concentration is considered constant, and the air flow rate is also unchanged. Also here a complete mix aerator is considered and eq. (8.7) is rewritten in the form

$$\begin{aligned} \frac{dc_o}{dt} = & Q \frac{c_{oi}}{V} - \frac{1+r}{V} Qc_o + k_1 u_{air} (c_{os} - c_o) - \\ & - \frac{1-Y_x}{Y_x} \hat{\mu}_x c_x \frac{s}{K_x+s} f(c_o) - k_2 d_x c_x \end{aligned} \quad (8.28)$$

where the flow rate Q is shown explicitly instead of the hold-up time.

The eq (8.28) is simplified in notation to

$$\begin{aligned} \frac{dc_o}{dt} = & b_1 Q - b_2 Qc_o + b_3 (c_{os} - c_o) - b_4 \frac{s}{K_x+s} f(c_o) - b_5 \\ & \text{where } b_1, \dots, b_5 \text{ are constants.} \end{aligned} \quad (8.29)$$

As in 8.4 we make a linearization around the operating point

$$\begin{aligned} Q &= \bar{Q} \\ c_o &= \bar{c}_o \\ s &= \bar{s} \end{aligned}$$

and consider small changes in c_o , s , and Q , i.e.

$$\begin{aligned} c_o &= \bar{c}_o + \Delta c_o \\ Q &= \bar{Q} + \Delta Q \\ s &= \bar{s} + \Delta s \end{aligned} \tag{8.30}$$

After linearization (8.29) becomes

$$\begin{aligned} \frac{d(\Delta c_o)}{dt} &= b_1 \Delta Q - b_2 \bar{Q} \Delta c_o - b_2 \bar{c}_o \Delta Q - b_3 \Delta c_o - b_4 \frac{\bar{s}}{K_x + \bar{s}} \left(\frac{df}{dc_o} \right)_{\bar{c}_o} \Delta c_o \\ &\quad - b_4 \frac{\bar{s}}{(K_x + \bar{s})^2} \frac{K_x}{f(\bar{c}_o)} \Delta s \end{aligned} \tag{8.31}$$

Under static conditions (8.31) can be written

$$\Delta c_o = G_1 \Delta Q + G_2 \Delta s \tag{8.32}$$

where

$$G_1 = \frac{b_1 - b_2 \bar{c}_o}{b_2 \bar{Q} + b_3 + b_4 \frac{\bar{s}}{K_x + \bar{s}} \left(\frac{df}{dc_o} \right)_{\bar{c}_o}} \tag{8.33}$$

$$G_2 = \frac{b_4 \frac{\bar{s}}{(K_x + \bar{s})^2} \frac{K_x}{f(\bar{c}_o)}}{b_2 \bar{Q} + b_3 + b_4 \frac{\bar{s}}{K_x + \bar{s}} \left(\frac{df}{dc_o} \right)_{\bar{c}_o}} \tag{8.34}$$

The constants G_1 and G_2 are the static gains of the DO concentration change with respect to disturbances in influent flow rate and substrate concentration respectively.

To illustrate what G_1 and G_2 looks like for some typical parameter values, the numerical values from examples 1 and 2 respectively in 8.4 are used. Fig. 8.7 and 8.8 show the gains as functions of the DO level.

The flow rate sensitivity (fig. 8.7) increases with the DO level. In the calculation of G_1 it was assumed that $V=1$. Therefore G_1 has to be divided by the real value of V in order to show the real sensitivity. The actual operating value of the substrate has very little influence on the sensitivity, which can be seen at comparison of the examples 1 and 2 in fig. 8.7.

Considering fig. 8.8 the sensitivity with respect to substrate disturbances also increases with the DO level. The sensitivity is larger for large substrate levels (example 1) than for small levels of substrate (example 2). This conclusion is quite natural. At high substrate levels the biological uptake rate is relatively high. Therefore all disturbances at this level will be more amplified than for a small biological uptake rate.

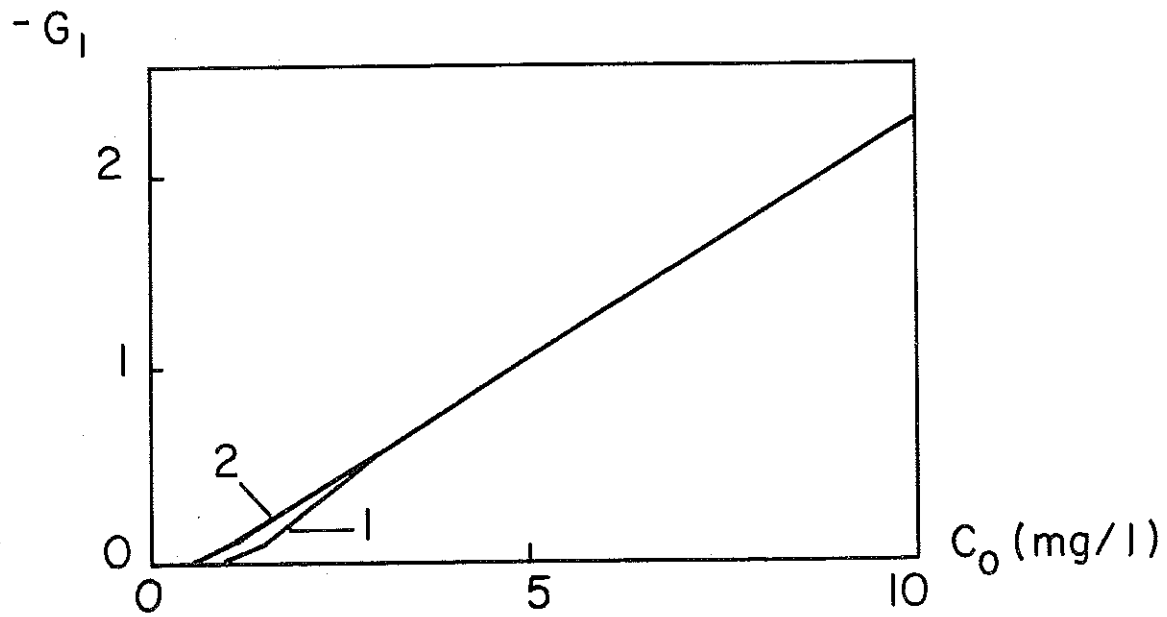

Fig. 8.7. Sensitivity of the DO concentration to disturbances in influent flow rate for a complete mix aerator.

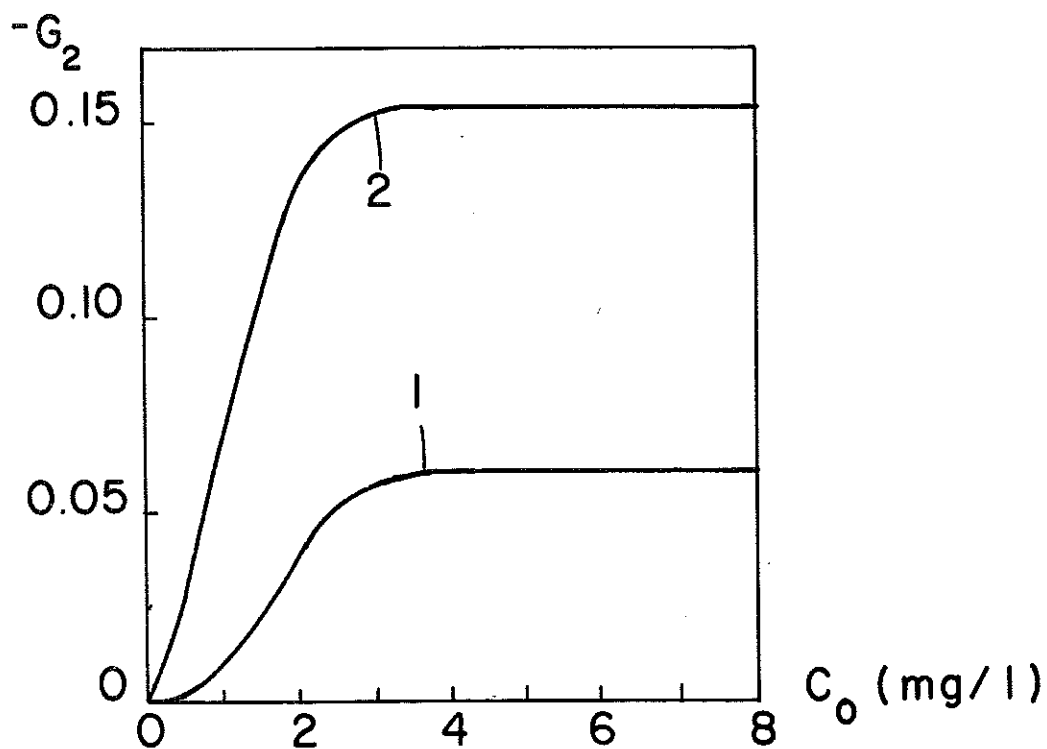

Fig. 8.7. Sensitivity of the DO concentration to disturbances in influent flow rate for a complete mix aerator.

APPENDIX

LIST OF SYMBOLS

Concentration variables

c_x	= microorganism concentration (sludge bacteria)
c_o	= dissolved oxygen concentration
c_z	= inert microorganism concentration
s	= soluble substrate concentration
s_m	= stored mass concentration
c_T	= total sludge mass concentration (MLVSS)
f_s	= s_m / c_T

Kinetic constants

μ_x	= specific growth rate of microorganisms
$\hat{\mu}_x$	= maximum specific growth rate
K_x	= growth limiting constant for microorganisms
Y_x	= yield constant
α	= dissolution constant
d_x	= decay constant for microorganisms
Y_z	= unit mass of inert bacteria per unit mass of viable bacteria decayed

Biosorption constants

r_s	= transfer rate constant
f_s	= fraction of MLVSS that is stored mass
\hat{f}_s	= maximum value of f_s
K_s	= limiting constant for the biosorption

Aerator and settler constants

Subscripts

- r = refers to return activated sludge flow
 w = refers to waste activated sludge flow
 e = refers to clarified water, effluent of settler
 i = refers to influent flow
 s = refers to settler
 k = refers to subreactor no k

Hydraulic flows, see fig 2.1 and 4.1

- V = aerator volume
 V_s = volume of the sludge mass in the settler
 Q = influent flow rate
 rQ = return activated sludge flow rate
 wQ = waste activated sludge flow rate
 α_k = fraction of influent water entering subreactor k
 $\beta_k = \sum_{i=1}^k \alpha_i$
 $\theta = V/Q =$ retention time
 D = $1/\theta =$ dilution rate
 $\tau_k = \frac{V_k}{Q(\beta_k + r)}$ = real hold-up time of subreactor k
 θ_x = sludge age (mean cell residence time)
 v = stream velocity in a plug flow reactor
 ξ = distance along aerator from inlet (normalized to 1)
 $\gamma =$ compaction ratio = c_{xr}/c_x
 $\epsilon =$ settler efficiency = c_{xe}/c_x
 $\eta = 1 + r - r\gamma$

Dissolved oxygen constants

c_o = dissolved oxygen concentration

c_{os} = saturation value of DO concentration

$k_L a$ = oxygen mass transfer coefficient = $k_1 \cdot u_{air}$

u_{air} = air flow rate

k_2 = constant

REFERENCES

1. Andrews, J.F., (1971), 'Kinetic models of biological waste treatment processes,' Biological Waste Treatment (edited by Canale R.P.), Wiley, New York.
2. Andrews, J.F., (1972), 'Dynamic Models and Control Strategies for Wastewater Treatment Processes,' Paper, Eighth Annual Workshop, Association of Environmental Engineering Professors, Nassau, Bahamas, Dec. 18-22, 1972.
3. Andrews, J.F., and C.R. Lee, (1972), 'Dynamics and control of a multi-stage biological process, Proc. IV IFS: Ferment. Technol. Today, 55-63.
4. Andrews, J.F., (1975), Personal communication.
5. Busby, J.B., and J.F. Andrews, (1975), 'Dynamic modeling and control strategies for the Activated Sludge Process', Journal of Water Pollution Control Federation, 47, 5, 1055-1080.
6. Deaner, D.G., and S. Martinson, (1974), 'Definition and calculation of mean cell residence time', Journal Water Pollution Control Federation, 46, 2422-2424 (Oct.).
7. Eckenfelder, W.W., and D.J. O'Connor, (1961), 'Biological Waste Treatment,' Pergamon Press.
8. Flanagan, M.J., (1974), 'Automation of the activated sludge process;' Paper, presented at Research Needs for Automation of Wastewater Treatment Systems, Workshop sponsored by EPA and Clemson Univ., Clemson, S.C., Sep. 1974.
9. Gujer, W., and D. Jenkins, (1975), 'The contact stabilization activated sludge process - oxygen utilization, sludge production and efficiency,' Water Res., 9, 553-560.
10. Jones, K., R. Briggs, J.G. Carr and A.H. Potten, (1969), 'Automatic control of aeration in a fully nitrifying activated - sludge plant,' Inst. Publ. Health Engr. J., LXIII, 4, 271-295, Oct. 1969.

11. Kynch, G.J., (1952), 'A Theory of Sedimentation,' Transactions of the Faraday Society, 48, 166-176.
12. Levenspiel, O., (1962), 'Chemical Reaction Engineering,' Wiley.
13. Metcalf & Eddy, (1972), 'Wastewater Engineering,' McGraw Hill.
14. Mueller, J.A., W.C. Boule and E.N. Lightfoot, (1968), 'Oxygen diffusion through Zooglocal flocs,' Biotechnology and Bioengineering, Vol. X, 331-358.
15. Olsson, G., (1975), 'Activated Sludge Dynamics I', Biological Models, Report 7511, Dep. of Automatic Control, Lund Institute of Technology, Lund, Sweden.
16. Pflanz, P., (1968), 'Performance of (Activated Sludge) Secondary Sedimentation Basins', Fourth Int. Conf. on Water Poll. Res., Prague.
17. Roper, R.E., and C.P.L. Grady, Jr., (1974), 'Activated sludge hydraulic-control techniques evaluation by computer simulation,' Journal Water Pollution Control Federation, 46, 11, 2565-2577.
18. Sherrard, J.H., and A.W. Lawrence, (1973), 'Design and operational model of Activated sludge,' Journal of the Environmental Engineering Div., ASCE, EE6, 773-784.
19. Sherrard, J.H., and E.D. Schroeder, (1973), 'Cell yield and growth rate in activated sludge,' Journal Water Pollution Control Federation, 45, 9, 1889-1897.
20. Stenstrom, M., (1975), 'A dynamic model and computer compatible control strategies for wastewater treatment plants,' Ph.D. thesis, Dep. of Environmental Systems Engineering, Clemson Univ., Clemson, S.C.
21. Westberg, N., (1967), 'A study of the activated sludge process as a bacterial growth process,' Water Research, 1, 795-804.