



LUND UNIVERSITY

Island Operation of the Induction Generator - Fault Currents and Protection

Sulla, Francesco

2007

[Link to publication](#)

Citation for published version (APA):

Sulla, F. (2007). *Island Operation of the Induction Generator - Fault Currents and Protection*. (TEIE; Vol. 7220). Department of Industrial Electrical Engineering and Automation, Lund Institute of Technology.
<http://www.iea.lth.se/publications/Reports/LTH-IEA-7220.pdf>

Total number of authors:

1

General rights

Unless other specific re-use rights are stated the following general rights apply:

Copyright and moral rights for the publications made accessible in the public portal are retained by the authors and/or other copyright owners and it is a condition of accessing publications that users recognise and abide by the legal requirements associated with these rights.

- Users may download and print one copy of any publication from the public portal for the purpose of private study or research.
- You may not further distribute the material or use it for any profit-making activity or commercial gain
- You may freely distribute the URL identifying the publication in the public portal

Read more about Creative commons licenses: <https://creativecommons.org/licenses/>

Take down policy

If you believe that this document breaches copyright please contact us providing details, and we will remove access to the work immediately and investigate your claim.

LUND UNIVERSITY

PO Box 117
221 00 Lund
+46 46-222 00 00

Island Operation of the Induction Generator

Fault currents and Protection



Francesco Sulla

Dept. of Industrial Electrical Engineering and Automation
Lund University

Island Operation of Induction Generator

Fault currents and Protection

Francesco Sulla

Table of Contents

1 INTRODUCTION.....	3
2 SOME ASPECTS ON EARTHING OF DISTRIBUTION NETWORKS IN SWEDEN	4
3 ISLAND OPERATION OF DISTRIBUTION NETWORKS – EARTHING ISSUES .	6
4 BEHAVIOUR OF THE INDUCTION GENERATOR OPERATING IN ISLAND UNDER FAULT CONDITIONS.....	7
4.1 DESCRIPTION OF THE SIMULATED SYSTEM.....	8
4.2 SINGLE PHASE TO EARTH FAULT	9
4.3 PHASE - PHASE FAULT	12
4.4 THREE - PHASE FAULT.....	15
5 EARTH FAULT PROTECTION OF THE INDUCTION GENERATOR OPERATING IN ISLAND.....	17
5.1 EARTH FAULT ON THE 10 KV D-SIDE OF THE STEP-UP TRANSFORMER....	17
5.2 EARTH FAULT ON THE 400 V Y-SIDE OF THE STEP-UP TRANSFORMER.....	18
6 PHASE-PHASE FAULT PROTECTION OF THE INDUCTION GENERATOR OPERATING IN ISLAND.....	21
6.1 PHASE-PHASE FAULT ON THE 10 KV D-SIDE OF THE STEP-UP TRANSFORMER	21
6.2 PHASE-PHASE FAULT ON THE 400 V Y-SIDE OF THE STEP-UP TRANSFORMER	21
7 THREE-PHASE FAULT PROTECTION OF THE INDUCTION GENERATOR OPERATING IN ISLAND.....	22
7.1 THREE-PHASE FAULT ON THE 10 KV D-SIDE OF THE STEP-UP TRANSFORMER	22
7.2 THREE-PHASE FAULT ON THE 400 V Y-SIDE OF THE STEP-UP TRANSFORMER	22
8 CONCLUSIONS	23
9 REFERENCES.....	23

1 Introduction

During the last years, costs for power interruptions to customers have increased and from 2011 a new legislation will not allow power interruptions longer than 24 hours. Electric power utilities are facing important costs to decrease the likelihood of power interruption in the future.

Island operation of distribution systems is not commonly employed in Sweden, also for safety reasons. The penetration of distributed generation into distribution networks is expected to grow in the next years; induction generators will represent a large amount of distributed generation and may dominate in local areas.

In this scenario, island operation of distribution networks with distributed generation can be regarded as a means to reduce power interruptions to final customers and improve power supply security. There are still many barriers to be removed before island operation of distribution networks can be accepted. Beside safety reasons, the quality of the delivered power may be a concern.

With induction generators operating in an island system, voltage and frequency control issues must be addressed; moreover safe operation requires that the protection system be adequately adapted so that any fault in the distribution system operating in island is promptly detected and cleared.

In this report, the behaviour of the induction generator in island operation under faulted conditions is investigated through simulations and some protection issues are addressed. But first a brief overview on earthing practices of distribution networks in Sweden is performed.

2 Some Aspects on Earthing of Distribution Networks in Sweden

Distribution networks in Sweden are mainly 10 kV and 20 kV systems, operated radially with only one in-feed. There exist small systems with unearthed neutral, but the prevalent earthing practice is to connect a resonance inductance at one neutral point in the system, dimensioned to match the total equivalent system capacitance to earth (resonance earthing with Petersen coil).

At a phase to earth fault the inductive current in the Petersen coil compensates the capacitive currents flowing into the healthy phases of the faulted feeder and into the other parallel feeders, see **Figure 2.1**. If the inductance of the Petersen coil matches exactly the system capacitance to earth, only a small resistive fault current will flow, due to line-to-earth conductance G , copper losses in the coil and a resistance possibly added in parallel to the resonance inductance. In practice, the inductive current is made somewhat greater than the capacitive one.

Reducing the fault current is a main advantage of compensated networks with overhead lines. The small earth fault currents, in turn, permit self-extinction of transient arcs at current zero-crossing so that circuit breaker operation and auto-reclosing schemes are not needed. Since loads are connected phase-to-phase and during an earth fault the phase-to-phase voltage triangle is not altered, there is no need for power interruption to customers. This is a great benefit considering that the great majority of system faults are transient earth faults [1, Winter].

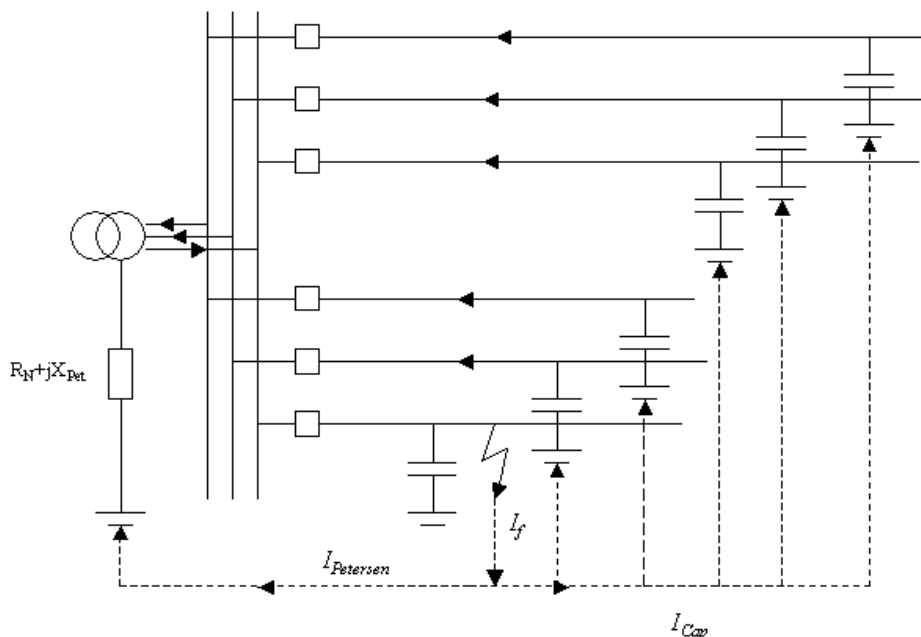

Figure 2.1 Earthing of distribution network with Petersen coil

The protection scheme used in such distribution networks allows selective disconnection of the faulted feeder.

Multi-phase faults protection is normally achieved with non-directional over-current relays or fuses. Coordination of inverse-time characteristics assures selectivity with upstream relays.

Directional over-current relays provide protection for phase to earth faults. The polarizing quantity is normally the zero sequence voltage V_0 (in alternative the residual current I_N) and the operating quantity is the zero sequence current I_0 . Directional over-current relays respond to the in-phase component of the zero sequence current I_0 with respect to the zero sequence voltage V_0 , detecting the faulted feeder, see **Figure 2.2**. Directional over-current relays may have some limitations in detecting very high resistance faults since the polarizing quantity V_0 may be small in this case. Zero sequence over-voltage relays may be used as back-up protection, but they are not selective.

For permanent earth faults, the Swedish regulation [4, ELSÄK-FS 2004:1] prescribes “fast and automatic” disconnection of the faulted part of the system; earth faults with a fault resistance up to 5000Ω must be detected and cleared.

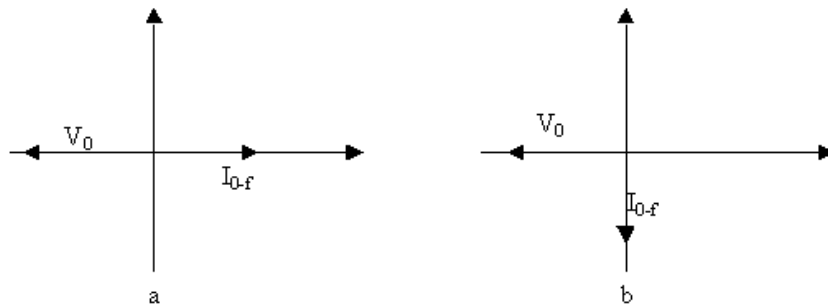

Figure 2.2 Phase relation between zero sequence voltage and current on the faulted feeder at an earth fault in (a) compensated system with Petersen coil earthing, (b) unearthed system

3 Island operation of distribution networks – earthing issues

In the previous chapter it has been seen that distribution networks in Sweden are normally earthed with Petersen coil at a neutral point.

If the same distribution network is operated in island, the connection with the strong net is lost altogether with the earthing equipment, i.e. the distribution network operating in island is unearthed.

The loss of the earthing equipment determines different current distribution at an earth fault, as a consequence of the loss of the compensating inductive current through the Petersen coil, see **Figure 3.1**. As a result the earth fault current may increase and the phase relation between zero sequence voltage and current on the faulted feeder changes. The earth fault protective relays operate selectively on a principle based on directionality between the zero sequence voltage and current on a feeder: they must be in phase (or out of phase).

In the unearthed system, these protective relays will not operate, see **Figure 2.2**. A different solution must be adopted to detect and clear an earth fault.

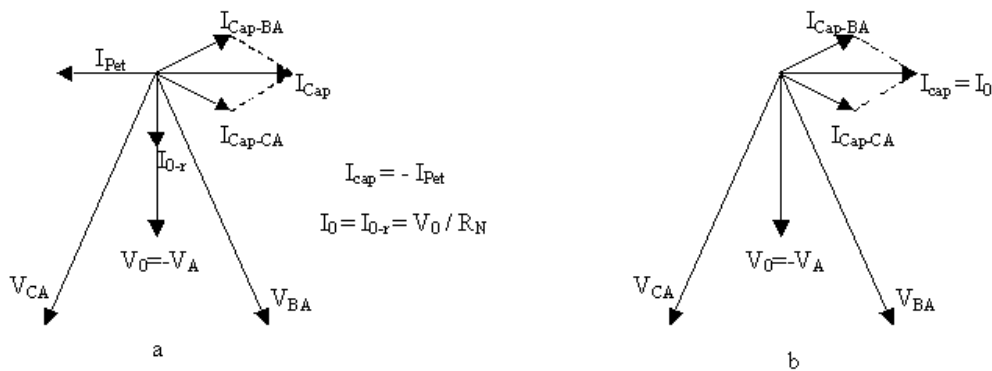

Figure 3.1 Fault currents on the faulted feeder at an earth fault with zero fault resistance in (a) system with Peterson coil earthing, (b) unearthed system

4 Behaviour of the induction generator operating in island under fault conditions

The behaviour of an induction generator operating in island under fault conditions is analyzed in this section. Simulations have been performed using MATLAB SimPowerSystems. Many power systems simulation software do not allow simulating a power system without any synchronous machine or infinite bus. In SimPowerSystems, this fact can be overcome by having an infinite bus and disconnecting from it the system (whose behaviour in island operation is to be analyzed) at a certain time, creating an islanded system with only induction generators. RMS-simulations have been performed: this means that only 50 Hz components are considered and no harmonics or DC-decaying components are taken into account.

The analysis of the behaviour of the induction generator following a fault is important for setting up the right protection system. The induction generator post-fault behaviour is different from that of a synchronous generator. The main difference consists in that the synchronous generator has a separate excitation system that will set up a magnetization that can be considered constant following the fault, while the induction generator receives its excitation from the network. Following a fault, the internal magnetization of the induction generator will change influencing the currents and voltages in the system. For example, if a solid ($R_f = 0\ \Omega$) three or two-phase fault occurs at the generator terminals, the induction generator will demagnetize; during un-symmetrical faults, also the internal magnetization will be un-symmetrical.

Different kinds of faults at different location are considered. For each case, the influence of some system parameters on the post-fault generator behaviour and system currents and voltages is pointed out.

The faults are not cleared since we are interested in the behavior of the generator under persisting fault conditions. The dynamics of a speed governor (representing the behaviour of a regulator for an hydraulic turbine) is included in the simulations. No voltage regulation is considered, but the amount of fixed capacitors is adjusted in each case so that nominal pre-fault voltage is achieved at the generator's terminals. If voltage regulation is present but it is slow enough to be assumed that it will not react in a few seconds after the fault, then the following results are still valid, at least a few second after fault occurrence.

The names of the quantities reported in the plots appear in **Figure 4.1**, where an earth fault case on the 10 kV side is represented. The quantities on the 10 kV side are named with capital letters sub-indexes.

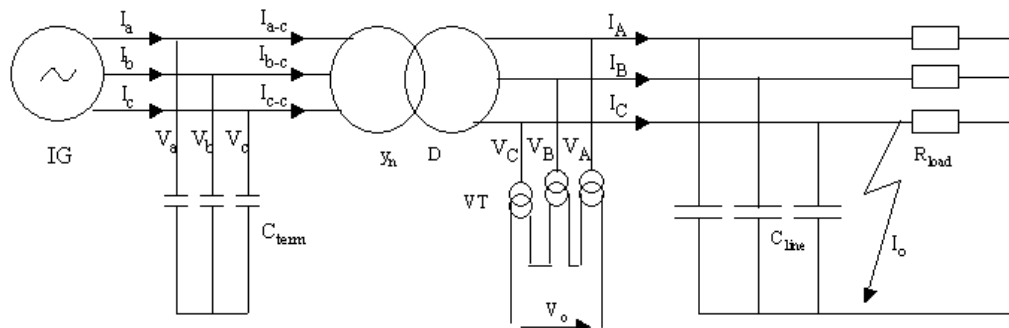

Figure 4.1 Designation of the quantities reported in the plots from simulations

4.1 Description of the simulated system

The electric system that has been simulated is shown in *Figure 4.2*.

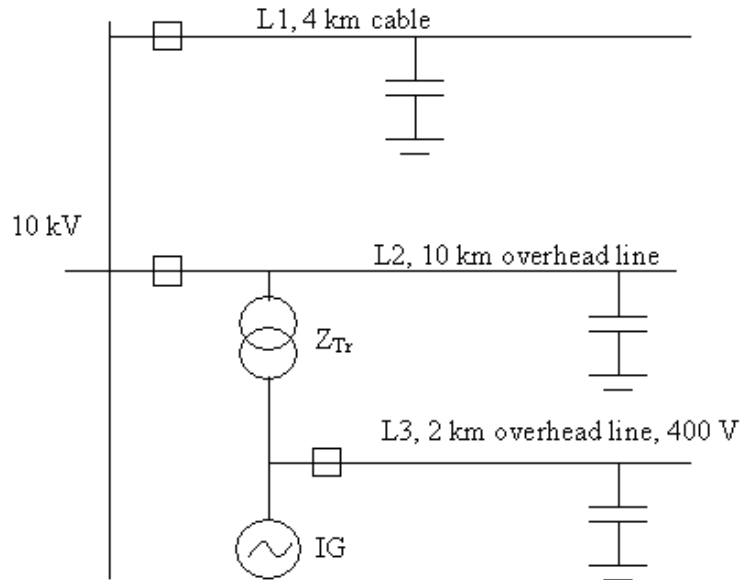

Figure 4.2 Simulated system with one induction generator operating in island

Data for lines and cables have been taken from [2, Roeper] and are as follows:

Name	Length [km]	Area [mm ²]	X [Ω /km]	R [Ω /km]	C [μ F/km]	X _o [Ω /km]
L1	4	25	0,16	1,2	0,2	0,8
L2	10	25	0,39	1,2	0,0095	1,6
L3	2	95	0,30	0,31	0,012	1,5

Table 1. Data for overhead and cable lines

The value of X_o for line L1 has been assumed equal to five times the positive sequence impedance.

One 275 kW induction generator is connected at the beginning of line L2. The parameters for the induction generator are reported in the next table.

S _N [kW]	V _N [V]	n. poles	J [kgm ²]
250	400	4	22,3
R _S [Ω]	L _{ls} [H]	R _R [Ω]	L _{lR} [H]
0,0314	1,48e-4	0,0233	1,48e-4

Table 2. Data for induction generator

Main flux saturation is modelled and the saturation curve used in the simulations is shown in *Figure 4.3*

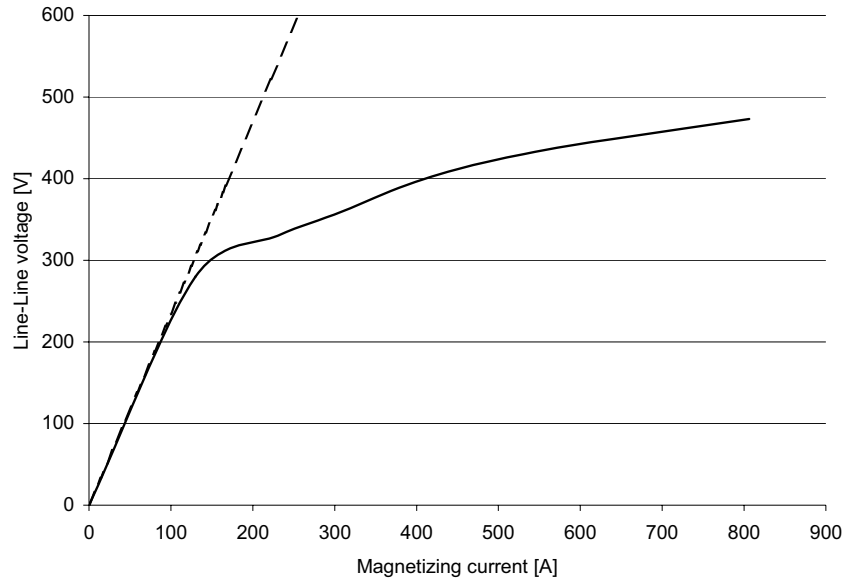

Figure 4.3 Main flux saturation curve for the induction generator

The induction generator is connected to the 10 kV network through a Dyn transformer. Transformer data are reported in the following table. Data are taken from [2, Roeper].

Name	S_N [kVA]	V [kV]	type	X_{sh} [pu]	R_{sh} [pu]	X_o [pu]
Step-up	350	10/0,4	Dyn	4%	1,65%	3,8%

Table 3. Data for step-up transformer

A resistive load of 5 kW is connected at the end of line L3, on the 400 V side. No load is connected on the 10 kV side unless explicitly specified.

Plots from simulations are reported in **Appendix 1**.

4.2 Single phase to earth fault

Different single phase to earth faults have been simulated at different locations: at the end of line (EOL) L2 on the high voltage side of the step-up transformer, at the EOL L3 on the 400 V side, and at generator terminals. At each of these locations, six cases have been simulated:

- $R_f = 0 \Omega$ and $R_f = 5 k\Omega$
- $P_{load} = 5 kW$ and $P_{load} = 80 kW$, $R_f = 0 \Omega$ and $l_{L1} = 4 km$
- $l_{L1} = 2 km$ and $l_{L1} = 6 km$, $R_f = 0 \Omega$ and $P_{load} = 5 kW$

P_{load} is made up of resistive loads, Y-connected at the end of feeders L1, L2 and L3. l_{L1} is the length of cable L1.

Results are reported in **Appendix 1**, with plots from the simulations. The behaviour shown by the induction generator during these fault cases will indicate which

protections should be used to detect and clear the fault by promptly disconnecting the generator from the net.

4.2...1 Single phase to earth fault at 10 kV side

A single phase to earth fault on the D-side of the step-up transformer appears as a phase-phase fault at the generator terminals.

In both $R_f = 0 \Omega$ and $R_f = 5 k\Omega$ cases, all of the terminal currents are well below the nominal value; also the 10 kV side currents are very low. Currents cannot be used for detecting the fault.

Terminal voltages vary less than 10% in the worst case ($R_f = 0 \Omega$). The voltages on the high voltage side of the step-up transformers behave in a non-expected way. In the $R_f = 0 \Omega$ case, V_C (after a fast transient) is as high as 1,08 times and V_B as high as 1,05 times the nominal line-line voltage. In the $R_f = 5 k\Omega$ case, V_C increases while V_B decreases. The high value of V_C in the solid fault cases deserves deeper analysis to predict the highest reachable value, see **Section 4.2.3**.

Generator speed does not vary much in both cases, and is not approaching pick-up values of over/under-frequency relays (assume 52,5 and 47,5 Hz).

The zero sequence voltage on the high voltage side of the step-up transformer is in both cases high enough to be used for protection purposes.

The influence of P_{load} is marginal. In the high load case, the pre- and post- fault voltages are lower, as expected (though the amount of fixed capacitors was increased from 150 kVar to 180 kVar in the high load case to achieve acceptable voltages). Generator speed is a bit lower in the high load case.

The length of the cable L1, and hence the total system capacitance to earth affects the terminal currents after the fault and the phase to earth voltages on the healthy phases on the high voltage side. If L1 is a cable of 6 km length, the terminal currents are much higher and the voltage to earth V_C is as high as 1,1 times the line-line nominal voltage (10 kV).

4.2...2 Single phase to earth fault at 400 V side

A solid ($R_f = 0 \Omega$) single phase to earth fault at the generator terminals causes its rapid demagnetization. Very high currents are delivered for a few periods, before the current decays to zero.

Totally different is the situation when a high resistance earth fault (in the simulated case, $R_f = 5 k\Omega$) occurs at generator terminals: the post-fault quantities are practically equal to their pre-fault values. The generator speed is unchanged.

A fault at the end of feeder L3 appears as somewhat in between a solid fault and a high resistance fault at generator terminals.

It is interesting to find the maximum fault resistance that causes demagnetization of the generator. In the simulations it has been observed that with $R_f > 0,2 \Omega$ the generator does not demagnetize.

The generator pre-fault loading does not affect the generator behaviour during a low resistance earth fault, except for the speed that can reach very high values after machine demagnetization if the pre-fault load was high.

The line length of cable L1 does not affect the generator behaviour for an earth fault on the 400 V side. Also, the line capacitance on the 400 V side does not affect the

fault current since the major source of capacitance to earth is, by far, represented by the fixed capacitors at generator terminals (if these are Y-connected and earthed).

It is interesting to note that if the generator and the 400 V system are connected to the step-up transformer, the fault current will flow through the neutral earthing of the transformer, which represents a low impedance path to the zero sequence current. This neutral current can be used to detect an earth fault on the 400 V side.

4.2...3 Over-voltages on the healthy phases on the 10 kV D-side during a single phase to earth fault

In case of a solid earth fault in an unearthed system (as the 10 kV system operating in island in our case) and accordingly to the classical theory, we would predict a maximum phase-to-earth voltage on the healthy phases (and equal on both phases) equal to $\sqrt{3}$ times the line-to-line nominal voltage.

The simulations show that if the source is an induction generator, the voltage to earth on the healthy phases may exceed the one predicted accordingly to the theory. The discrepancy arises from the fact that the voltage triangle set-up by the induction generator is not constant after the fault (as supposed in the classical theory), but it will change and become un-symmetric.

A number of cases have been simulated to check the highest values of the voltages on the healthy phases arisen after the fault. For a fixed length of cable L1 ($l_{L1} = 4\text{ km}$), the load P_{load} was varied in steps from 5 kW to 205 kW , increasing accordingly the amount of fixed capacitors (total reactive power) installed at generator terminals to keep constant pre-fault voltage. The same has been done with a length of cable L1, $l_{L1} = 10\text{ km}$.

The voltage to earth V_C assumes higher values than V_B for a phase A to earth fault. It experiences a very fast transient lasting less than a cycle just after the fault occurrence, and then decays to lower values during the post-fault dynamics. Both maximum values of voltage V_C , including and excluding the fast transient, are reported in the next figures as a function of P_{load} for $l_{L1} = 4\text{ km}$ and $l_{L1} = 10\text{ km}$.

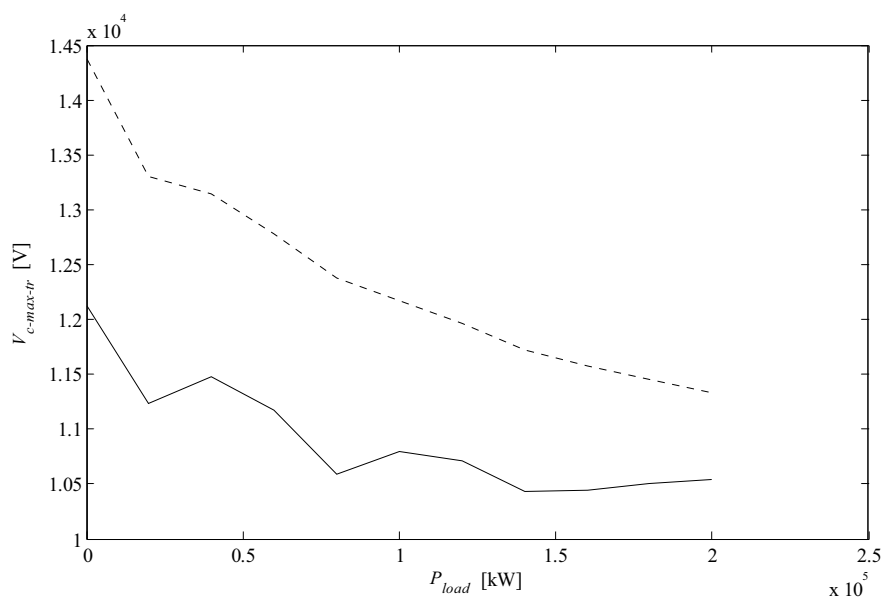

Figure 4.4 Maximum voltage V_C on the 10 kV side after a Phase A to earth fault, considering the fast post-fault transient. $l_{L1} = 4\text{ km}$ (solid line) and $l_{L1} = 10\text{ km}$ (dashed line).

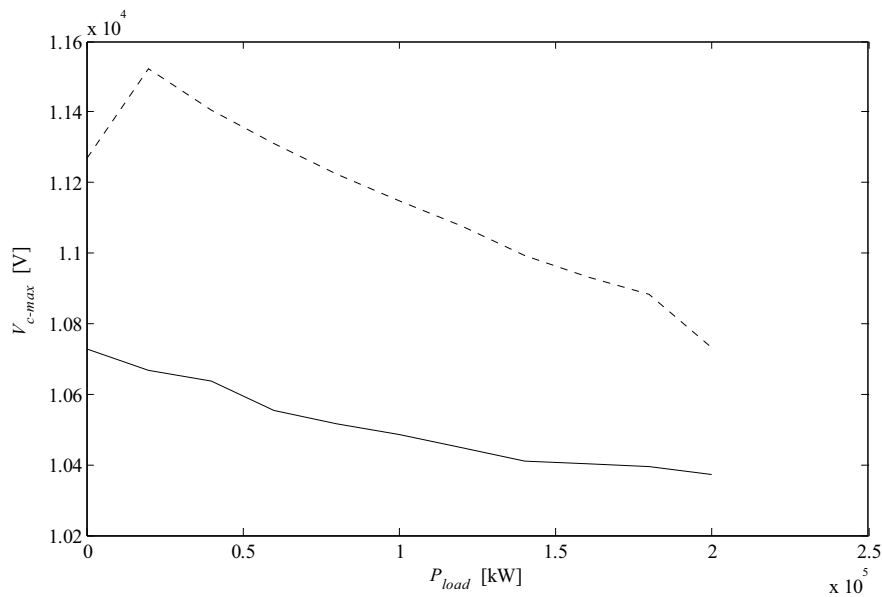

Figure 4.5 Maximum voltage V_C on the 10 kV side after a Phase A to earth fault, excluding the fast post-fault transient. $l_{L1} = 4$ km (solid line) and $l_{L1} = 10$ km (dashed line).

It is observed that in the simulated cases the maximum value of V_C , considering the fast post-fault transient, is 45% higher than the line-line nominal voltage. It is 15% higher than the line-line nominal voltage, considering only the post-fault dynamics without the fast post-fault transient.

It is also apparent that the maximum post-fault value of V_C decreases with increasing pre-fault loading of the generator, though more reactive power is installed at the generator terminals.

Also, the maximum post-fault voltage increases with increasing system capacitance (total lengths of cables and lines) on the 10 kV side.

Deeper analysis is needed for a better understanding of the phenomenon and to predict the maximum possible phase-to-earth voltage that may arise.

4.3 Phase - phase fault

Phase-phase faults have been simulated at the same locations as for earth faults. When simulating a fault on the high voltage side, fault resistances $R_f = 0 \Omega$ and $R_f = 200 \Omega$ have been assumed. This last value represents a very high fault resistance not likely to be encountered in reality.

On the low voltage side, fault resistances $R_f = 0 \Omega$ and $R_f = 0,6 \Omega$ have been simulated. It will be seen that even low fault resistances on the 400 V side could not cause demagnetization of the generator that would continue to feed fault current.

Influence of total system capacitance on the fault currents has been considered by simulating solid faults for different lengths of the cable feeder L1.

Also, influence of pre-fault generator loading is considered.

4.3...1 Phase – phase fault at 10 kV side

A phase-phase fault on the high voltage side of the step-up transformer causes demagnetization of the generator, for all practical fault resistances (in our case, $R_f = 200 \Omega$).

Generator loading does not affect its post-fault behaviour with the exception of the speed that will grow high if the pre-fault load was high.

Total system capacitance does not affect the post-fault behaviour of the generator.

4.3...2 Phase – phase fault at 400 V side

A phase-phase fault at generator terminals will cause demagnetization of the generator if the fault resistance is low enough. It is a similar scenario to the single phase to earth fault at generator terminals. The simulations have shown that a fault resistance $R_f > 0,7 \Omega$ will not cause demagnetization of the generator.

Negative sequence current is high, up to a certain fault resistance, and can be used for protection purposes. If the fault resistance is above a certain value (which is still quite small, $R_f = 2\Omega$) the negative sequence current becomes small; for these same values of fault resistance the voltage could not drop much, depending on load conditions. As a consequence it is difficult to detect high resistance phase-phase faults on the 400 V side of the step-up transformer.

Generator speed changes after the fault. If the generator is sufficiently unloaded, the speed could decrease down to low values that cause under-frequency relays to trip the machine. The minimum speed, reached after the fault, depends on the fault resistance and the loading, see **Figure 4.6**. In this figure, the minimum speed first decreases (when the generator is demagnetizing) up to $R_f = 1\Omega$ and then starts increasing (and the generator does not demagnetize).

A phase-phase fault at the EOL on the 400V feeder L3, appears as a fault at generator terminals with a certain fault resistance. The generator is not demagnetized because of the impedance to the fault of the feeder itself. Faults with higher resistance can lead to higher voltages at generator terminals and hence to higher currents, compared to cases with lower fault resistances.

The initial loading of the generator affects the lower speed reached after the fault. Lower initial loadings lead to lower minimum speeds, see **Figure 4.6**.

Total system capacitance does not affect its post-fault behaviour.

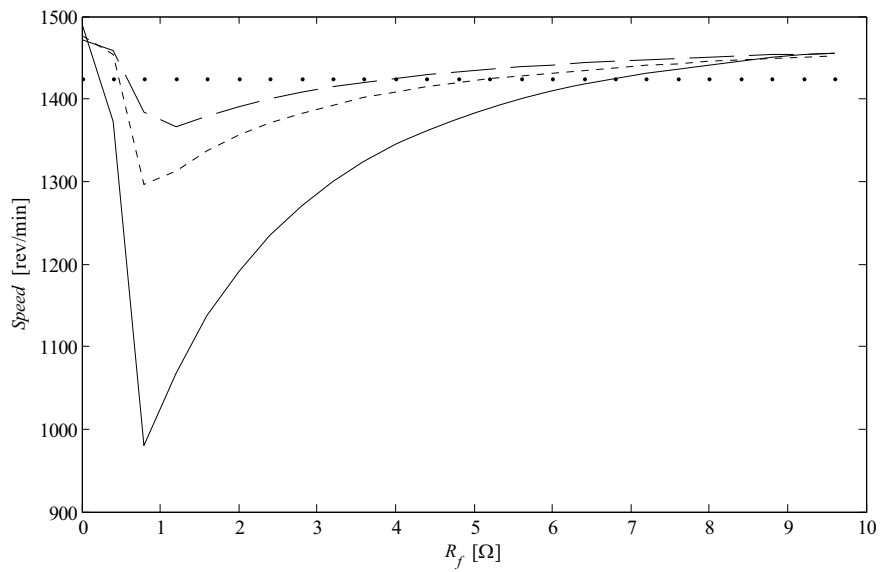

Figure 4.6 Minimum speed after phase-phase fault at generator terminals as a function of R_f with initial generator loading of 5 kW (solid), 105 kW (dotted), 145 kW (dashed). The dotted horizontal line represents under-frequency relay pick-up (corresponding to 47,5 Hz)

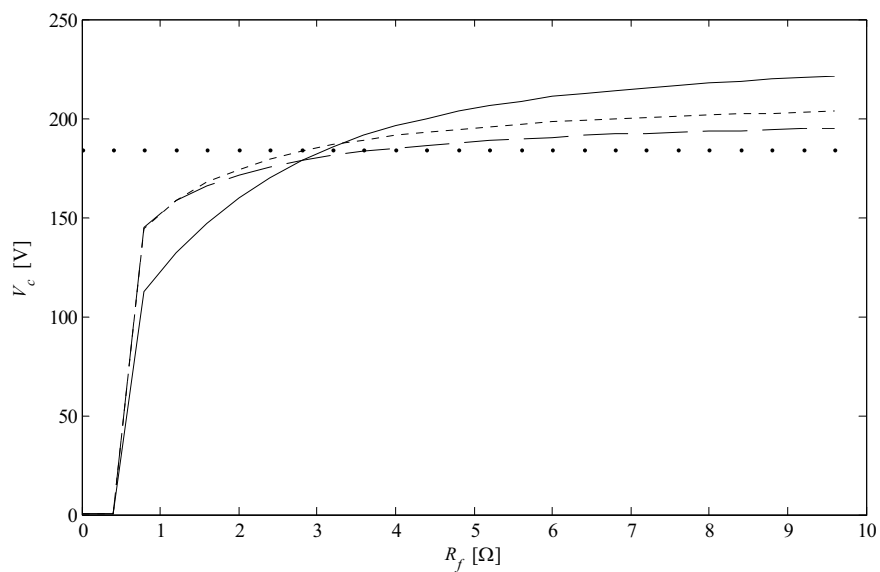

Figure 4.7 Minimum voltage V_c after phase-phase fault at generator terminals as a function of R_f with initial generator loading of 5 kW (solid), 105 kW (dotted), 145 kW (dashed). The dotted horizontal line represents under-voltage relay pick-up (80% of $V_{nominal}$)

4.4 Three - phase fault

4.4...1 *Three – phase fault at 10 kV side*

As in the phase-phase fault, a three phase fault on the 10 kV side of the step-up transformer causes a rapid demagnetization of the generator for all practical values of fault resistance that are likely to occur. In simulations, a fault resistance $R_f = 200 \Omega$ still causes demagnetization of the generator.

Generator loading and total system capacitance do not affect its post-fault behaviour with the exception of the speed that will grow high if the pre-fault loading was high.

4.4...2 *Three – phase fault at 400 V side*

The same considerations done in the phase-phase short circuit case apply also for three phase short circuits (except those on negative sequence current, of course) and in particular:

- even low resistance faults at generator terminals could not cause demagnetization and can be difficult to be detected if the fault resistance is sufficiently high
- generator speed decreases after a fault with non-zero fault resistance and under-frequency relays would trip for fault resistances up to a certain value
- higher initial loadings of the generator cause less speed decrease after the fault

For three phase faults, however, the maximum values of fault resistance that still cause generator demagnetization are somewhat higher than in the phase-phase fault: for ex. a fault at the EOL on feeder L3 with only the feeder's impedance interposed between generator and fault, causes demagnetization in the three phase fault but not in the phase-phase fault.

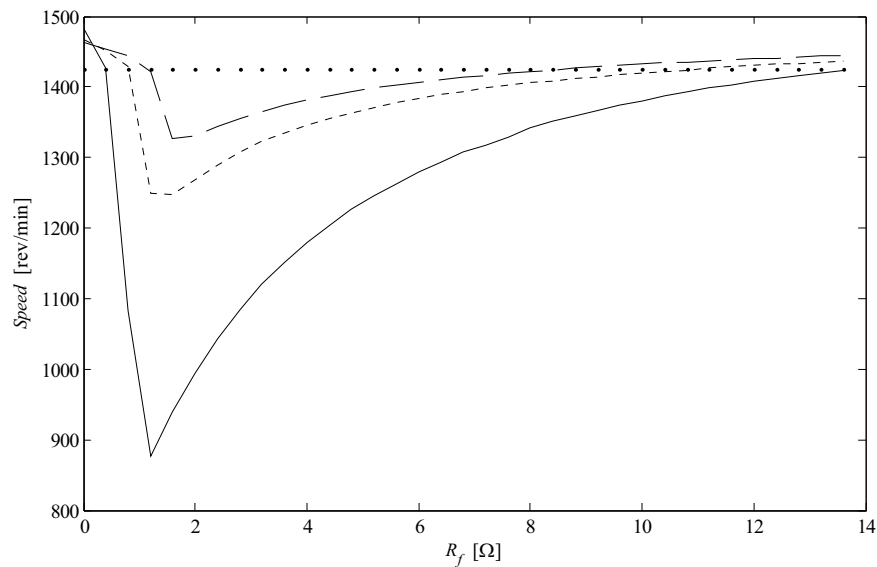

Figure 4.8 Minimum speed after three-phase fault at generator terminals as a function of R_f with initial generator loading of 5 kW (solid), 105 kW (dotted), 145 kW (dashed). The dotted horizontal line represents under-frequency relay pick-up (corresponding to 47,5 Hz)

In **Figures 4.8** and **4.9** it can be seen how the minimum post-fault speed depends upon the fault resistance and the generator loading. Respect to the phase-phase fault case, now faults with higher fault resistance can be detected.

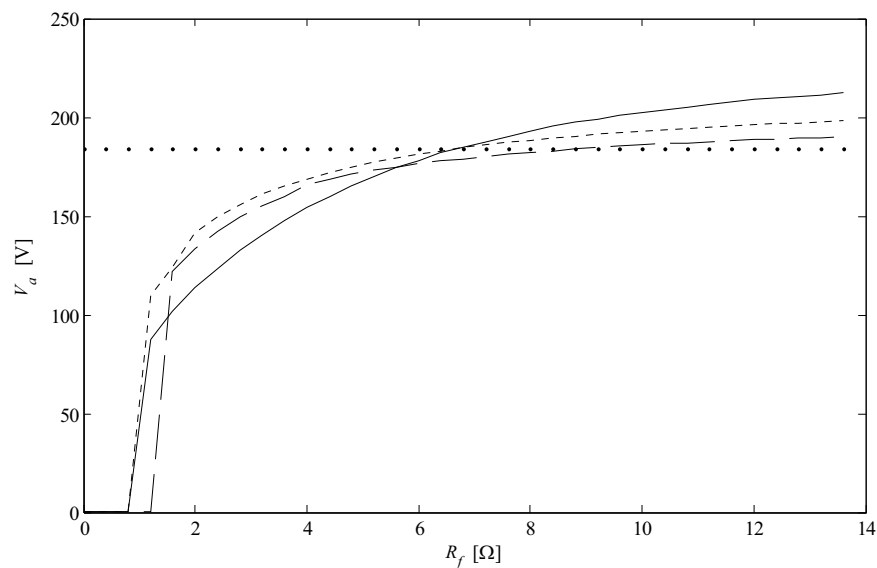

Figure 4.9 Minimum voltage V_c after three-phase fault at generator terminals as a function of R_f with initial generator loading of 5 kW (solid), 105 kW (dotted), 145 kW (dashed). The dotted horizontal line represents under-voltage relay pick-up (80% of $V_{nominal}$)

5 Earth fault protection of the induction generator operating in island

5.1 Earth fault on the 10 kV D-side of the step-up transformer

An earth fault on the high voltage side of the step-up transformer, with fault resistance $R_f \leq 5k\Omega$ must be cleared within 5 seconds by disconnecting the generator. The generator phase currents and voltages are not affected much by a high resistive fault. Simulations have shown that the negative sequence voltage at generator terminals is too low to be used for fault detection without the risk of unwanted operation in case of un-faulted unbalanced operation in the system.

When a earth fault occurs with the system operating in island, the directional n fault relays installed on each feeder (for earth fault protection when operating connected to the net) will not operate since zero sequence currents lag or lead the zero sequence voltage by 90 degree, see *Section 3*.

The only way to detect high resistance earth faults is by sensing the zero sequence voltage on the high voltage side of the step-up transformer. The zero sequence quantities originated by an earth fault on the D-side of the transformer are not observable by its y-side. Sensing the zero sequence voltage on the D-side can be achieved by installing three open delta connected Voltage Transformers (VT) on the D-side. An alternative way could be to estimate the zero sequence voltage through an algorithm that requires the installation of only one VT on the high voltage side and the use of the information from the three VT on the y-side (normally, already installed). This last method could have the advantage to be cheaper compared to the classical method requiring three VT on the D-side [Internal report LUTEDX/(TEIE-7920)/1-007/(2007)].

In any case, the RMS value of zero sequence voltage arising from an earth fault on the high voltage side is:

$$V_0 \approx \frac{X_c}{\sqrt{9R_f^2 + X_c^2}} V_{nom} \quad (5.1)$$

V_{nom} is the nominal phase to earth voltage. The sign of “almost equal” is due to the fact that the voltage triangle is not constant since the electromagnetic force induced in the induction generator is not constant (as in the synchronous generator case) but will vary after the fault. *Figure 5.1* shows the calculated zero sequence voltage as a function of system capacitance, with $R_f = 5 k\Omega$.

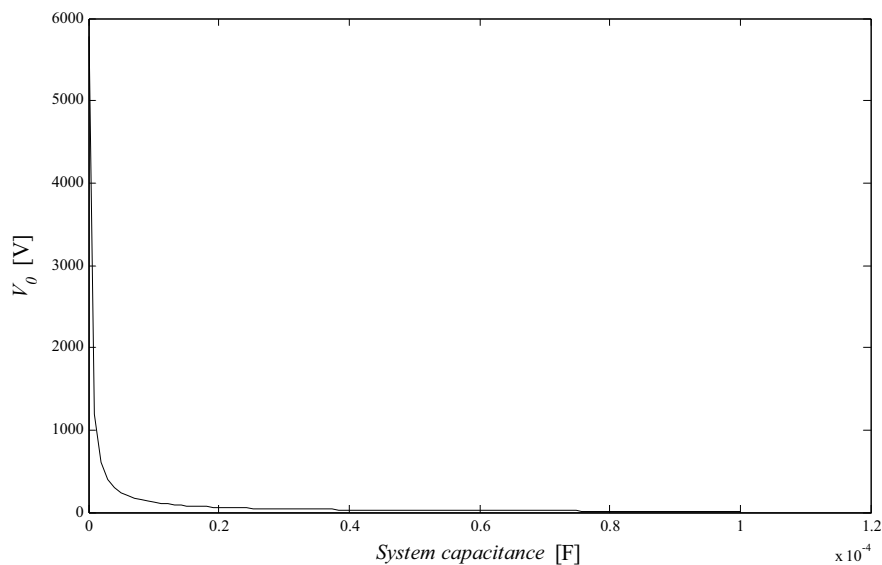

Figure 5.1 Zero sequence voltage as a function of system capacitance, during an earth fault with $R_f = 5 \text{ k}\Omega$

With a total system capacitance $C = 20 \text{ }\mu\text{F}$, corresponding to 100 km cable, the zero sequence voltage would be 50 V . The results from simulation with 100 km cable have shown a zero sequence voltage of 50 V . This assures that, practically, there should be no difficulty in detecting an earth fault on the high voltage side by sensing the zero sequence voltage.

In conclusion, it can be asserted that to clear earth faults on the 10 kV side and to disconnect the induction generator when the system is operating in island, it is necessary to sense the zero sequence voltage on the high voltage side of the step-up transformer.

5.2 Earth fault on the 400 V y-side of the step-up transformer

There are two cases to be considered: a) a direct contact between a phase conductor and the PEN conductor or an exposed part at an utility b) a fault of a phase conductor directly to earth (on overhead lines, mainly).

The common practice in Sweden is to use TN systems at the 400 V level and the touch voltage is not allowed to be higher than 50 V ; if a fault should cause higher touch voltages, a proper device should interrupt within prescribed times [SS 436 40 00, pag. 51-54]. The PEN conductor of an installation is normally connected to the earthed neutral of the low voltage y-side of the feeding transformer (the step-up transformer in our case). The total impedance of the conductors in the faulted path must be low enough to satisfy **Equation 5.2**.

$$Z_s \times I_a \leq U_0 \quad (5.2)$$

where Z_s is the total conductors impedance in the faulted circuit path (from the voltage source to an utility), I_a is the pick-up value of the used current interrupting device, and U_o is the nominal voltage to earth.

When the induction generator is connected to the step-up transformer, the transformer earthed neutral still accomplishes its function (to provide an earthed point to which the PEN is connected) even if the system is isolated from the strong network.

If the induction generator feeds directly the 400 V system without being connected to the step-up transformer, the system earthing is lost and the PEN conductor is not earthed anymore. Swedish regulations prescribes that the PEN must be connected to a system earthed neutral point or, if no neutral point is available, a phase conductor must be earthed (if no phase to earth voltages are required for supplying loads).

In our case a possible solution would be to yn-connect the capacitors at generator terminals and earth the neutral point. The PEN conductors can then be connected to this earthing point.

Moreover, to avoid touch voltages higher than 50 V on exposed parts, in case of a fault of a phase conductor directly to earth in an overhead line, the following relation should also be fulfilled:

$$\frac{R_B}{R_E} \leq \frac{50}{U_o - 50} \quad (5.3)$$

where R_B is the earthing resistance of the system earthed neutral, R_E is the lowest possible fault resistance to earth for an exposed conductive part not connected to the PEN conductor and on which a phase to earth fault can occur.

Equation 5.3 implies a requirement on the earthing resistance of the system earthed neutral: this must be low enough. If the neutral point of the fixed capacitors is earthed, its earthing resistance must be low. If possible, the same earthing system for earthing the transformer neutral should be used.

If the induction generator feeds directly the 400 V system without being connected to the step-up transformer, the source impedances changes respect to the normal operation and attention must be paid so that **Equation 5.2** is still satisfied. This is essential in assuring safe fault clearing for the various utilities (in a private house, for example). Next figure depicts the different situations that can arise for a fault between a phase and PEN conductor, depending on which sources are connected.

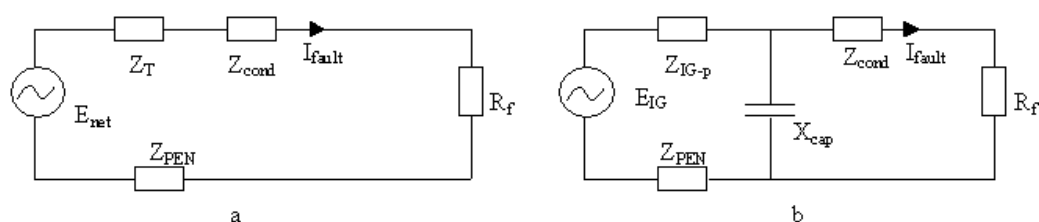

Figure 5.2 Impedances in a phase to PEN conductor fault with a) only the transformer connected, b) only the induction generator connected to the 400V system

When both the induction generator and the transformer are connected, the source impedance of generator is in parallel with the one of the transformer and the former can be neglected, since it is much higher.

The problem can arise because the source impedances can be higher when only the induction generator (without step-up transformer) is connected to the 400 V side. The fault current may be lower than that for which the current interrupting devices are set for, and as a consequence a touch voltage higher than 50 V can result without interrupting the fault within the required time.

In this case, operation without the step-up transformer is not allowed.

The above considerations are necessary to fulfil prescriptions of regulations, but do not say anything about detection of a phase conductor fault directly to earth (when using overhead lines, mainly).

Detection of such a single phase to earth fault can be achieved by the use of an over-current relay in the system earthed neutral. If the neutral current would be too low, when using the fixed capacitor neutral earthing, detection of a single phase to earth fault would not be possible because of the high source impedances: this would mean that the transformer should be connected.

6 Phase-phase fault protection of the induction generator operating in island

6.1 Phase-phase fault on the 10 kV D-side of the step-up transformer

A phase-phase fault at the high voltage side of the step-up transformer causes demagnetization of the generator for every practical value of fault resistance likely to be encountered (much below than the simulated $R_f = 200 \Omega$).

The generator must be promptly disconnected from the island-operated network when such a fault occurs, to avoid re-magnetization if the fault is temporarily removed. This could in fact cause safety problems. The ability to re-magnetize after fault removal depends also upon the total system capacitance.

Under-voltage relays can be used for this. Over-frequency relays could serve as back-up, provided that the generator is initially sufficiently loaded. Only in this last case, in fact the generator speed would increase sufficiently to make the over-frequency relay pick-up.

6.2 Phase-phase fault on the 400 V y-side of the step-up transformer

A phase-phase fault on the 400 V side is different from a phase-phase fault on the 10 kV side because even low fault resistances (above $0,6 \Omega$) do not cause demagnetization of the generator.

Under-voltage relays will detect phase-phase faults on the 400 V side if the fault resistance is below a certain value, depending also on the initial generator loading (see **Figure 4.7**). Higher fault resistances will not cause the terminal voltage to drop enough to determine under-voltage relays to pick-up.

Negative sequence over-current relays can be used to detect phase-phase faults on the 400 V side, but do not improve the range of fault resistances for which detection is achieved. That is, the under-voltage relay detects phase-phase faults up to a maximum fault resistance, which is higher than the maximum fault resistance for which faults are detected by negative sequence over-current relay. Negative sequence over-current relays can however be used as back-up (up to a certain fault resistance); moreover they improve phase-phase fault detection sensitivity when operating connected to the main network.

Under-frequency relays can detect faults with higher fault resistances than under-voltage relays (compare **Figure 4.6** and **4.7**) increasing the fault detection sensitivity with respect to fault resistance. Phase-phase fault detection with under-frequency relays depends on generator initial loading; if the generator loading is increased, the under-frequency relay will detect phase-phase faults with lower maximum fault resistance, see **Figure 4.6**.

A fault with high resistances at the EOL of feeder L3 is even more difficult to detect because of the feeder impedance.

Phase-phase faults at generator terminals with $R_f \gg 6\Omega$ and a generator loading of 5 kW, will not be detected.

7 Three-phase fault protection of the induction generator operating in island

For three-phase faults the same considerations done for phase-phase faults apply. The values of maximum fault resistances for which demagnetization occurs are different and are higher in the three-phase fault case.

7.1 Three-phase fault on the 10 kV D-side of the step-up transformer

Three-phase fault at the high voltage side of the step-up transformer causes demagnetization of the generator for every practical value of fault resistance likely to be encountered (much below the simulated $R_f = 200 \Omega$).

Under-voltage relay can be used for this. Over-frequency relay could serve as back-up, provided that the generator is initially sufficiently loaded.

7.2 Three-phase fault on the 400 V y-side of the step-up transformer

Under-voltage relay will detect three-phase faults on the 400 V side if the fault resistance is below a certain value (for ex. $R_f < 6 \Omega$ with generator loading of 5 kW, see *Figure 4.9*). Higher fault resistances will not cause the terminal voltage to drop enough to determine under-voltage relay to pick-up.

Under-frequency relay can detect faults with higher fault resistances than under-voltage relay, increasing the fault detection sensitivity with respect to fault resistance. Three-phase fault detection with under-frequency relay depends on generator initial loading; if the generator is heavily loaded, the under-frequency relay will trip for three phase faults with maximum fault resistance lower than in the case when the generator is initially unloaded. For ex., when the generator loading is equal to 5 kW, the under-frequency relay will detect faults up to $R_f = 14 \Omega$. Here it has been assumed that the under-frequency relay trips at 47,5 Hz. With higher loadings, the advantages of the under-frequency relay vanishes.

Under-voltage and under-frequency relays should always be used together, each of them offering better protection below or above a certain fault resistance, depending on the generator loading.

A fault with high resistances at the EOL of feeder L3 is even more difficult to detect because of the feeder impedance.

Three phase faults at generator terminals with $R_f > 14 \Omega$ and generator loading of 5 kW, will not be detected.

8 Conclusions

The behavior of a 275 kW island-operated induction generator has been analyzed during fault conditions. A consistent number of cases have been simulated and results from simulations are reported in *Appendix 1*.

Phase to earth faults on the 10 kV D-side of the step-up transformer can be detected by sensing the zero sequence voltage on that side. If the total system capacitance in the network increases, the generated zero sequence voltage after an earth fault decreases. Up to a total system capacitance corresponding to an amount of 100 km cables in the network, this scheme assures protection for earth faults up to 5 k Ω fault resistances.

Solid earth faults on the D-side can cause over-voltages on the un-faulted phases, higher than nominal phase-phase voltage. Much deeper analysis is required to investigate to which extent this could represent a problem.

On the 400 V y-side, a neutral earthing must be available to connect the PEN conductors from utilities. If the generator serves directly the 400 V utilities without being connected to the step-up transformer, a new earthed neutral point must be created, whose earthing resistance should be sufficiently low. An over-current relay in the earthed neutral point of the transformer accomplishes the detection of a phase conductor to earth fault on the 400 V side.

Multi-phase faults on the 10 kV D-side cause rapid demagnetization of the generator, independently of the fault resistance. For one or few cycles, currents can be high but they decay very rapidly. Under-voltage relays provide protection against these faults.

On the 400 V y-side, multi-phase faults cause demagnetization of the generator only if the fault resistance is very low. For higher fault resistances, the generator will continue to feed current into the fault. In this last case, however, currents are low. Under-voltage and under-frequency relays in combination provide protection up to a certain value of fault resistance, each of the relays offering better protection in a particular range of fault resistances depending also on the generator loading.

9 References

- 1) Winter, "Swedish distribution networks-aspects on neutral treatment, earthfault clearance and related matters", Distribution Switchgear, 1990. Third International Conference on Future Trends in Year 1990
- 2) Roeper, "Short-circuit Currents in Three-phase Systems – Siemens", Wiley
- 3) Sulla, "Estimation of the Zero Sequence Voltage on the D-side of a Dy Transformer by Using One Voltage Transformer on the D-side", Internal report LUTEDX/(TEIE-7920)/1-007/(2007)
- 4) ELSÄK-FS 2004:1, Elsäkerhetsverkets Föreskrifter
- 5) Svensk Standard SS 436 40 00, "Elinstallationsreglerna", Svenska Elektriska Kommissionen, 2005

Appendix 1 – Plots from Simulations

In this appendix, plots from all the simulations are reported. The idea is that these plots may serve as a first reference to predict the behavior of an induction generator operating in island during faults. Often the results from different simulations are very similar, but they are all reported since this still contains information and helps in appreciating the influence of the different parameters on the generator post-fault behavior.

RMS-simulations have been performed: this means that only 50 Hz components are considered and no harmonics or DC-decaying components are taken into account.

It is recalled that only a turbine governor is included in the simulations; no voltage regulator is present (see *Section 4*). However, when varying the connected load in different simulations, the amount of fixed capacitors is changed accordingly, to get the same nominal pre-fault voltage at generator terminals.

The following cases have been simulated, for a total number of 48 cases. Refer to *Figure 4.2*.

	$P_{load} = 5 \text{ kW}$ $l_{L1} = 4 \text{ km}$	$R_f = 0 \Omega$ $l_{L1} = 4 \text{ km}$	$R_f = 0 \Omega$ $P_{load} = 5 \text{ kW}$
Phase a – earth EOL feeder L2, 10 kV	$R_f = 0 \Omega$ $R_f = 5 \text{ k}\Omega$	$P_{load} = 5 \text{ kW}$ $P_{load} = 85 \text{ kW}$	$l_{L1} = 2 \text{ km}$ $l_{L1} = 6 \text{ km}$
Phase a – earth EOL feeder L3, 400 V	$R_f = 0 \Omega$ $R_f = 5 \text{ k}\Omega$	$P_{load} = 5 \text{ kW}$ $P_{load} = 85 \text{ kW}$	$l_{L1} = 2 \text{ km}$ $l_{L1} = 6 \text{ km}$
Phase a – earth IG terminals, 400 V	$R_f = 0 \Omega$ $R_f = 5 \text{ k}\Omega$	$P_{load} = 5 \text{ kW}$ $P_{load} = 85 \text{ kW}$	$l_{L1} = 2 \text{ km}$ $l_{L1} = 6 \text{ km}$
Phases a – b EOL feeder L2, 10 kV	$R_f = 0 \Omega$ $R_f = 200 \Omega$	$P_{load} = 5 \text{ kW}$ $P_{load} = 85 \text{ kW}$	$l_{L1} = 2 \text{ km}$ $l_{L1} = 6 \text{ km}$
Phases a – b EOL feeder L3, 400 V	$R_f = 0 \Omega$ $R_f = 0,6 \Omega$	$P_{load} = 5 \text{ kW}$ $P_{load} = 85 \text{ kW}$	$l_{L1} = 2 \text{ km}$ $l_{L1} = 6 \text{ km}$
Phases a – b IG terminals, 400 V	$R_f = 0 \Omega$ $R_f = 0,6 \Omega$	$P_{load} = 5 \text{ kW}$ $P_{load} = 85 \text{ kW}$	$l_{L1} = 2 \text{ km}$ $l_{L1} = 6 \text{ km}$
3 – Phase EOL feeder L2, 10 kV	$R_f = 0 \Omega$ $R_f = 200 \Omega$	$P_{load} = 5 \text{ kW}$ $P_{load} = 85 \text{ kW}$	$l_{L1} = 2 \text{ km}$ $l_{L1} = 6 \text{ km}$
3 – Phase EOL feeder L3, 400 V	$R_f = 0 \Omega$ $R_f = 0,6 \Omega$	$P_{load} = 5 \text{ kW}$ $P_{load} = 85 \text{ kW}$	$l_{L1} = 2 \text{ km}$ $l_{L1} = 6 \text{ km}$
3 – Phase IG terminals, 400 V	$R_f = 0 \Omega$ $R_f = 0,6 \Omega$	$P_{load} = 5 \text{ kW}$ $P_{load} = 85 \text{ kW}$	$l_{L1} = 2 \text{ km}$ $l_{L1} = 6 \text{ km}$

Table A.1 Simulated cases

Appendix 1.1 - Phase *a* to earth fault at 10 kV side

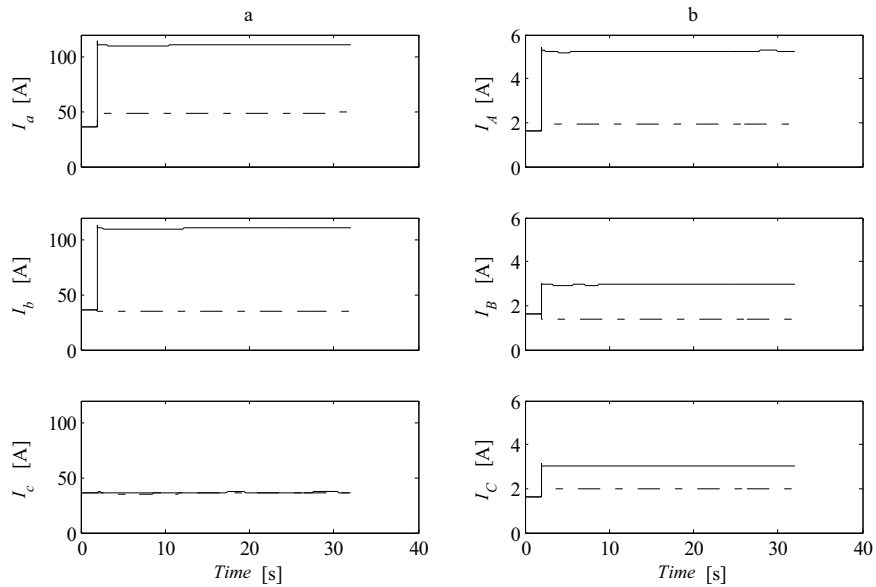

Figure A1.1.1 Phase A to earth fault. a) Phase currents at induction generator terminals b) Phase currents on the high voltage side of step up transformer. $R_f = 0 \Omega$ (solid lines) and $R_f = 5 k\Omega$ (dashed lines). $l_{L1} = 4 km$, $P_{load} = 5 kW$

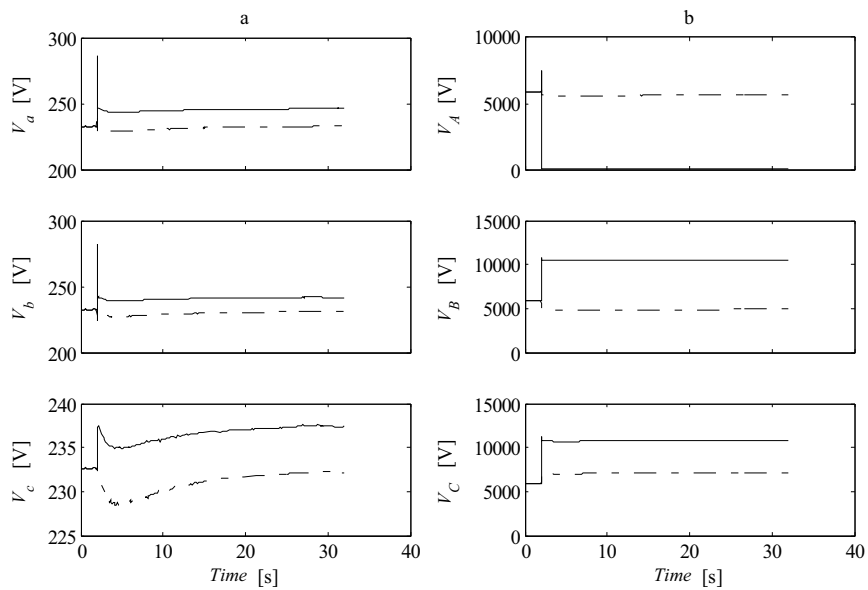

Figure A1.1.2 Phase A to earth fault. a) Phase voltages at induction generator terminals b) Phase voltages on the high voltage side of step up transformer. $R_f = 0 \Omega$ (solid lines) and $R_f = 5 k\Omega$ (dashed lines). $l_{L1} = 4 km$, $P_{load} = 5 kW$

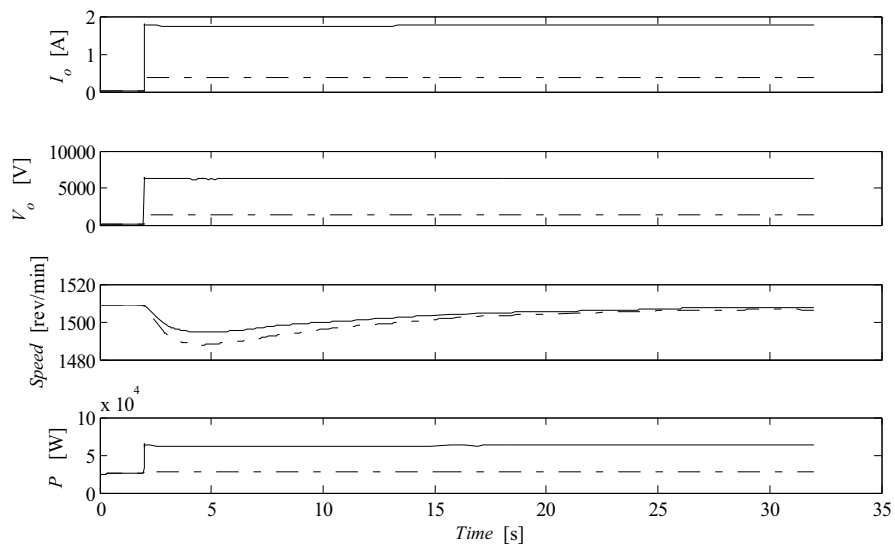

Figure A1.1.3 Phase A to earth fault. Zero sequence current and voltage at fault point, generator speed, generator active power. $R_f = 0 \Omega$ (solid lines) and $R_f = 5 \text{ k}\Omega$ (dashed lines). $l_{L1} = 4 \text{ km}$, $P_{load} = 5 \text{ kW}$

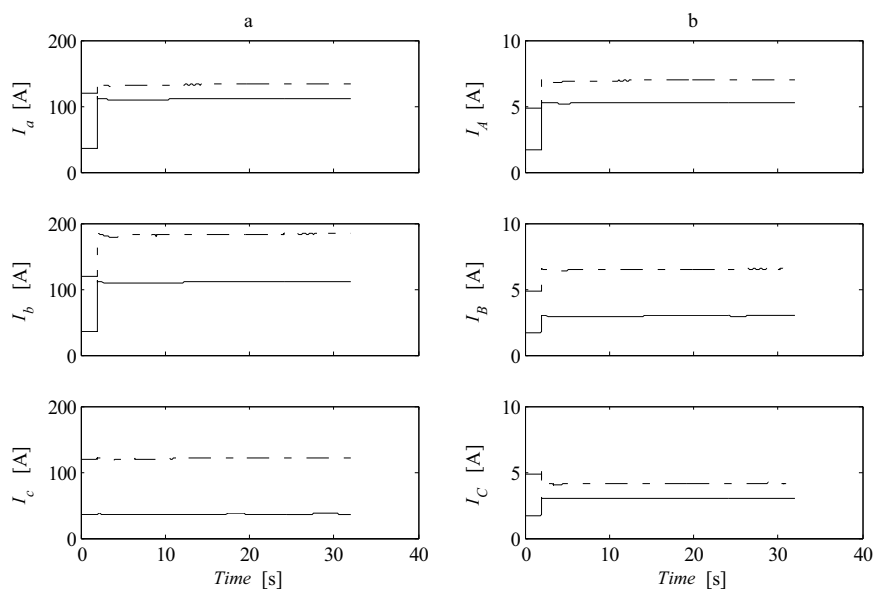

Figure A1.1.4 Phase A to earth fault. a) Phase currents at induction generator terminals b) Phase currents on the high voltage side of step up transformer. $P_{load} = 5 \text{ kW}$ (solid lines) and $P_{load} = 85 \text{ kW}$ (dashed lines). $l_{L1} = 4 \text{ km}$, $R_f = 0 \Omega$

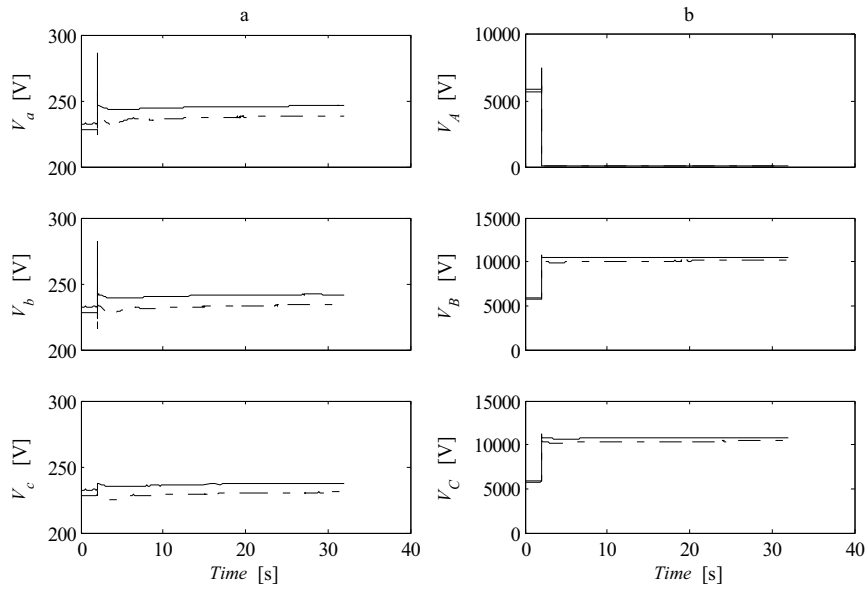

Figure A1.1.5 Phase A to earth fault. a) Phase voltages at induction generator terminals b) Phase voltages on the high voltage side of step up transformer. $P_{load} = 5 \text{ kW}$ (solid lines) and $P_{load} = 85 \text{ kW}$ (dashed lines). $L_{L1} = 4 \text{ km}$, $R_f = 0 \Omega$

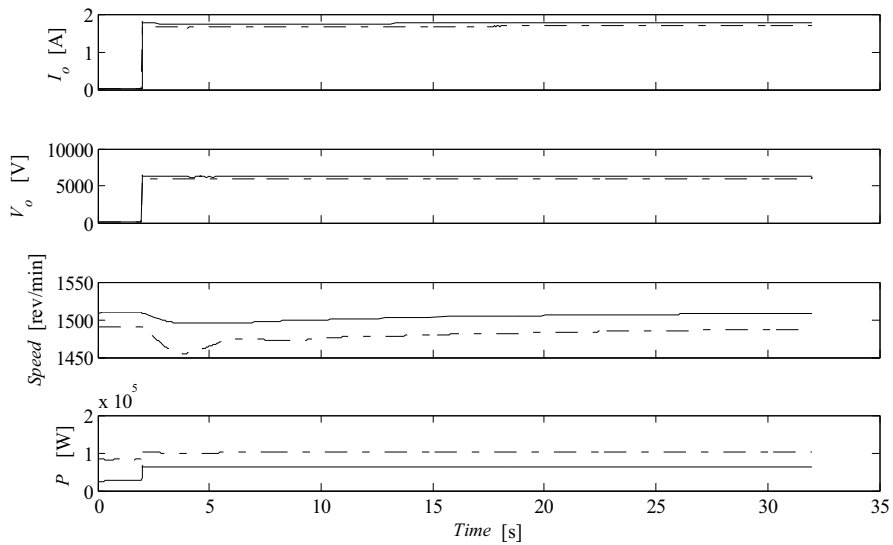

Figure A1.1.6 Phase A to earth fault. Zero sequence current and voltage at fault point, generator speed, generator active power. $P_{load} = 5 \text{ kW}$ (solid lines) and $P_{load} = 85 \text{ kW}$ (dashed lines). $L_{L1} = 4 \text{ km}$, $R_f = 0 \Omega$

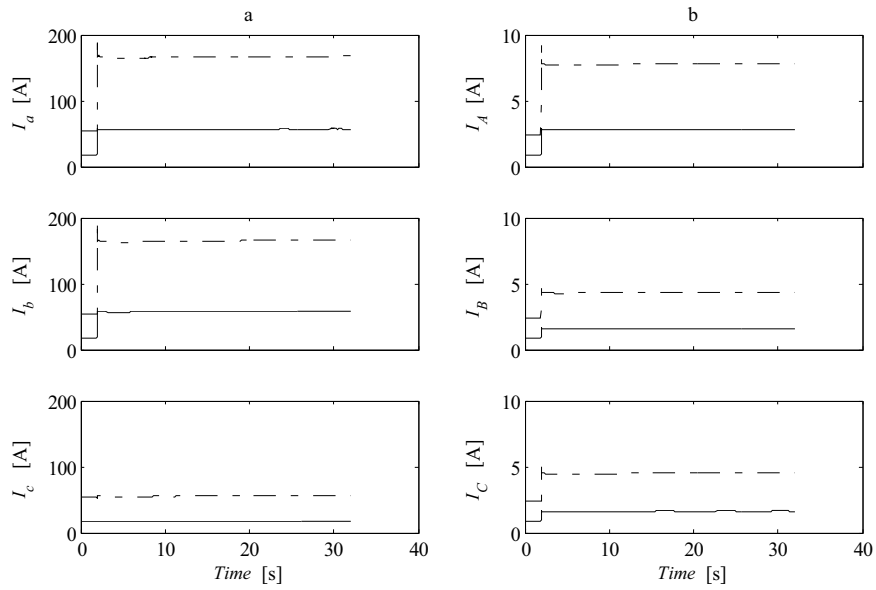

Figure A1.1.7 Phase A to earth fault. a) Phase currents at induction generator terminals b) Phase currents on the high voltage side of step up transformer. $l_{L1} = 2$ km (solid lines) and $l_{L1} = 6$ km (dashed lines). $P_{load} = 5$ kW, $R_f = 0 \Omega$

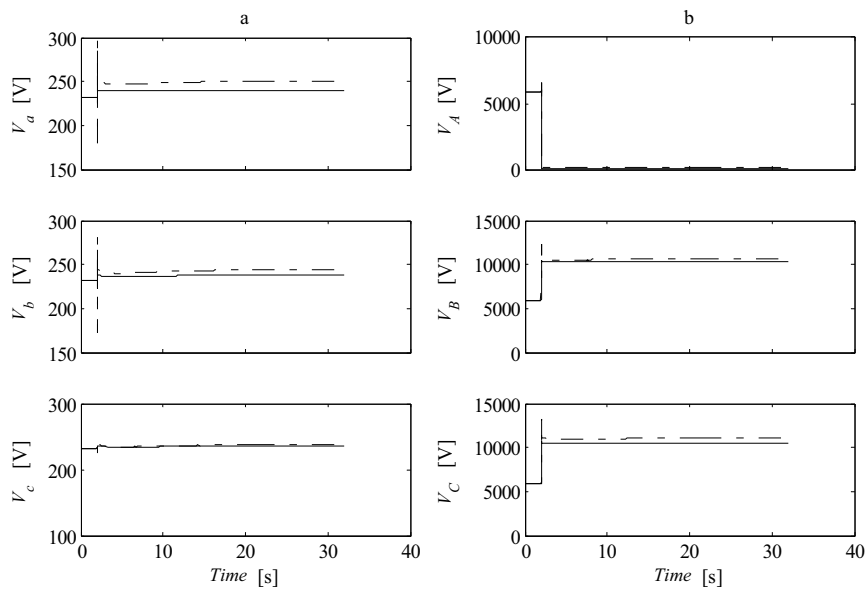

Figure A1.1.8 Phase A to earth fault. a) Phase voltages at induction generator terminals b) Phase voltages on the high voltage side of step up transformer. $l_{L1} = 2$ km (solid lines) and $l_{L1} = 6$ km (dashed lines). $P_{load} = 5$ kW, $R_f = 0 \Omega$

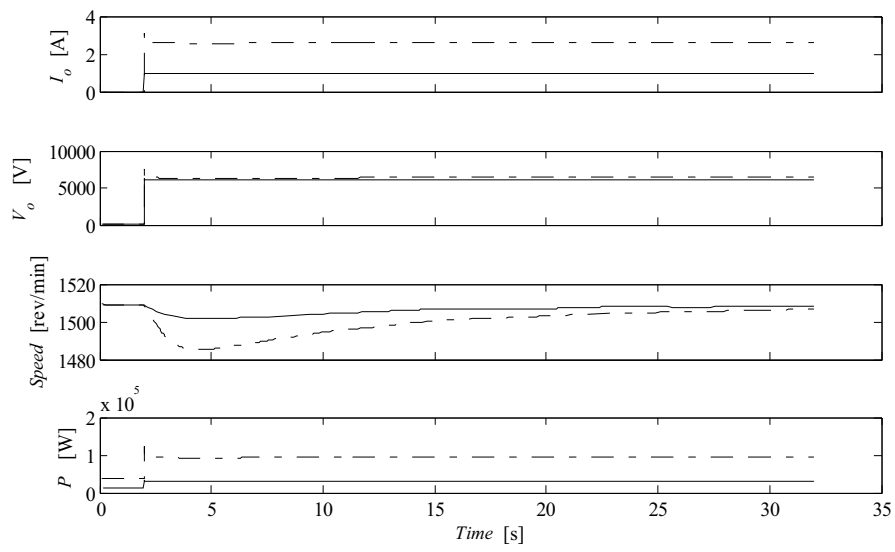

Figure A1.1.9 Phase A to earth fault. Zero sequence current and voltage at fault point, generator speed, generator active power. $l_{L1} = 2$ km (solid lines) and $l_{L1} = 6$ km (dashed lines). $P_{load} = 5$ kW, $R_f = 0 \Omega$

Appendix 1.2 - Phase *a* to earth fault at 400 V side, EOL of line L3

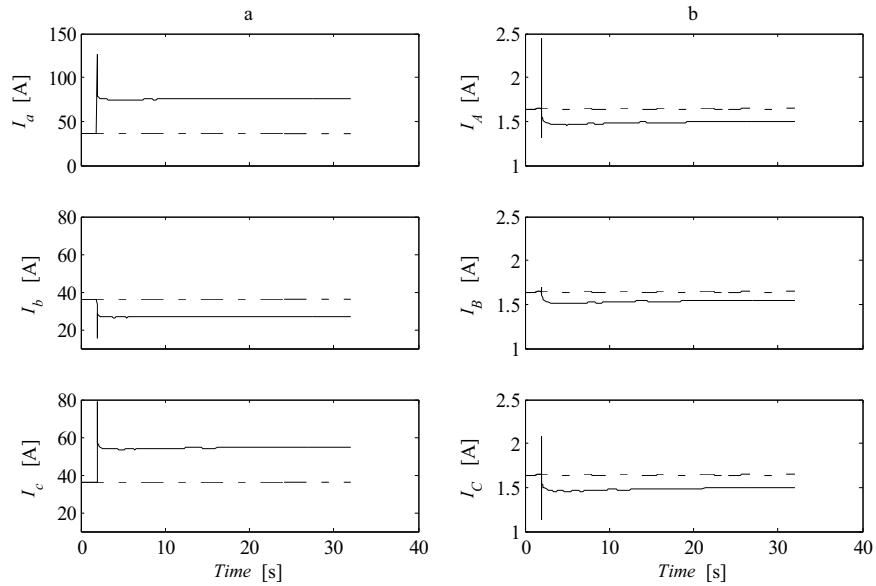

Figure A1.2.1 Phase *a* to earth fault. a) Phase currents at induction generator terminals b) Phase currents on the high voltage side of step up transformer. $R_f = 0 \Omega$ (solid lines) and $R_f = 5 \text{ k}\Omega$ (dashed lines). $l_{L1} = 4 \text{ km}$, $P_{load} = 5 \text{ kW}$

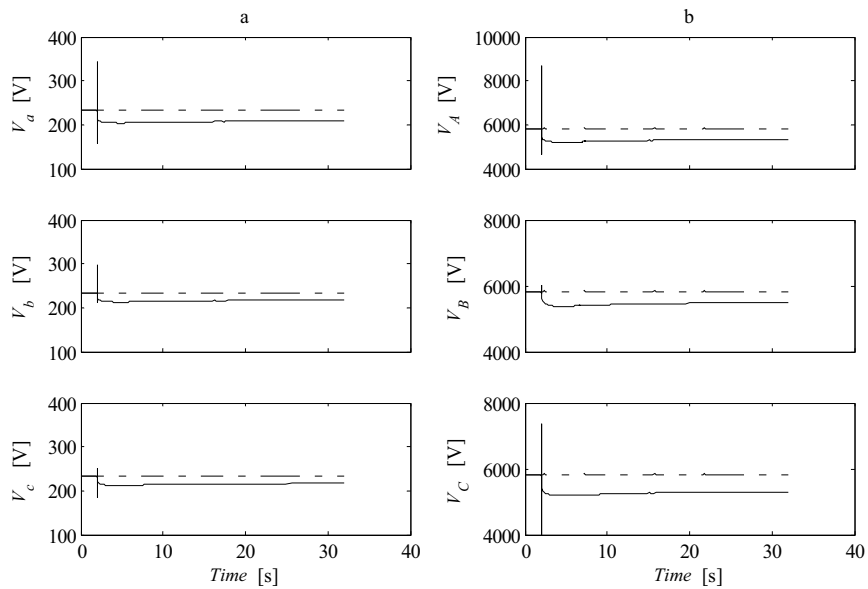

Figure A1.2.2 Phase *a* to earth fault. a) Phase voltages at induction generator terminals b) Phase voltages on the high voltage side of step up transformer. $R_f = 0 \Omega$ (solid lines) and $R_f = 5 \text{ k}\Omega$ (dashed lines). $l_{L1} = 4 \text{ km}$, $P_{load} = 5 \text{ kW}$

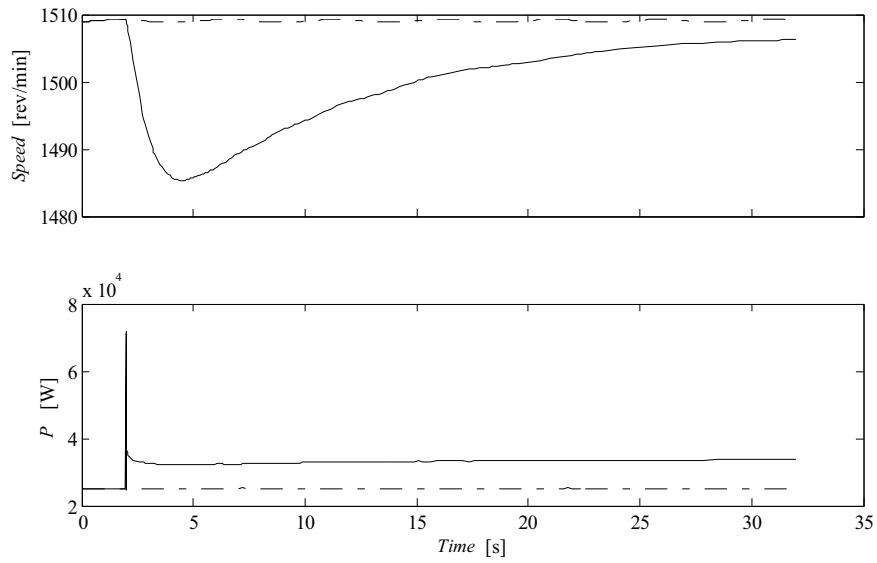

Figure A1.2.3 Phase a to earth fault. Generator speed, generator active power. $R_f = 0 \Omega$ (solid lines) and $R_f = 5 \text{ k}\Omega$ (dashed lines). $l_{L1} = 4 \text{ km}$, $P_{load} = 5 \text{ kW}$

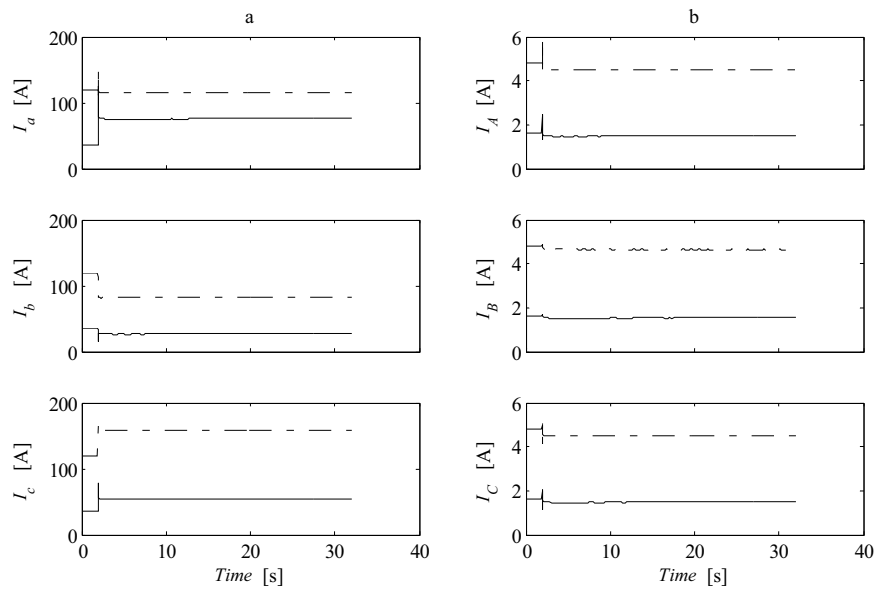

Figure A1.2.4 Phase a to earth fault. a) Phase currents at induction generator terminals b) Phase currents on the high voltage side of step up transformer. $P_{load} = 5 \text{ kW}$ (solid lines) and $P_{load} = 85 \text{ kW}$ (dashed lines). $l_{L1} = 4 \text{ km}$, $R_f = 0 \Omega$

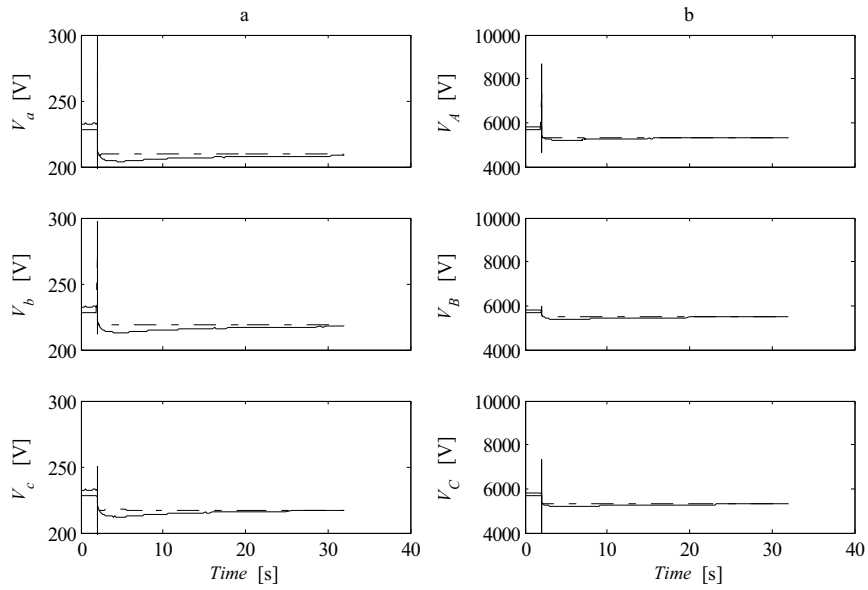

Figure A1.2.5 Phase a to earth fault. a) Phase voltages at induction generator terminals b) Phase voltages on the high voltage side of step up transformer. $P_{load} = 5$ kW (solid lines) and $P_{load} = 85$ kW (dashed lines). $l_{L1} = 4$ km, $R_f = 0 \Omega$

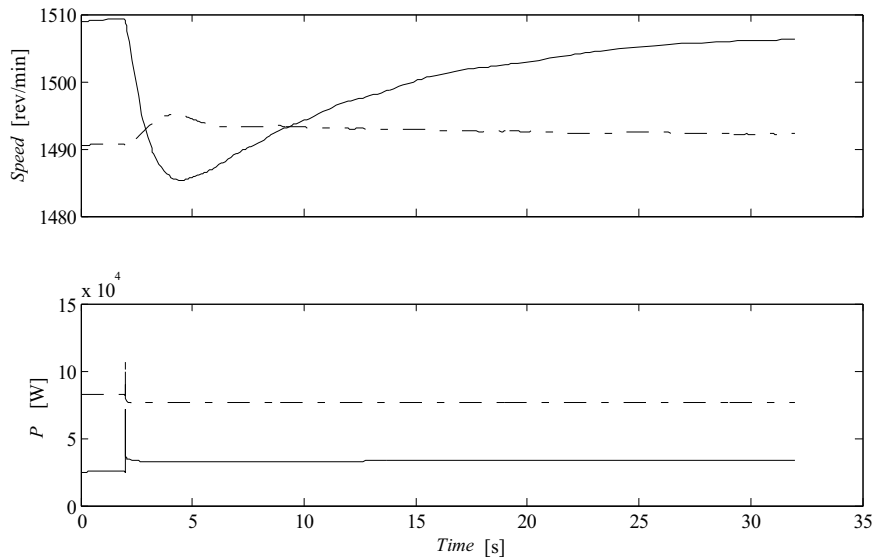

Figure A1.2.6 Phase a to earth fault. Zero sequence current and voltage at fault point, generator speed, generator active power. $P_{load} = 5$ kW (solid lines) and $P_{load} = 85$ kW (dashed lines). $l_{L1} = 4$ km, $R_f = 0 \Omega$

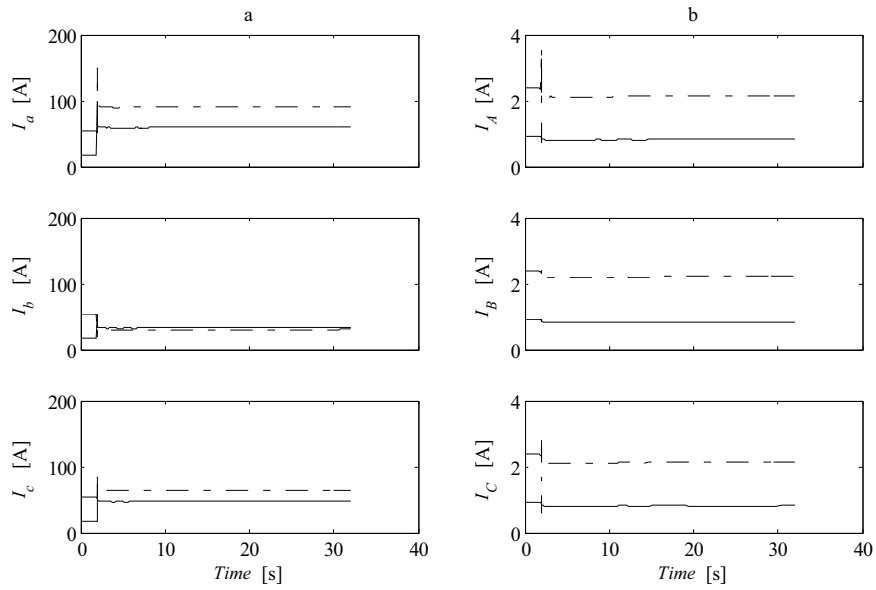

Figure A1.2.7 Phase a to earth fault. a) Phase currents at induction generator terminals b) Phase currents on the high voltage side of step up transformer. $l_{L1} = 2$ km (solid lines) and $l_{L1} = 6$ km (dashed lines). $P_{load} = 5$ kW, $R_f = 0 \Omega$

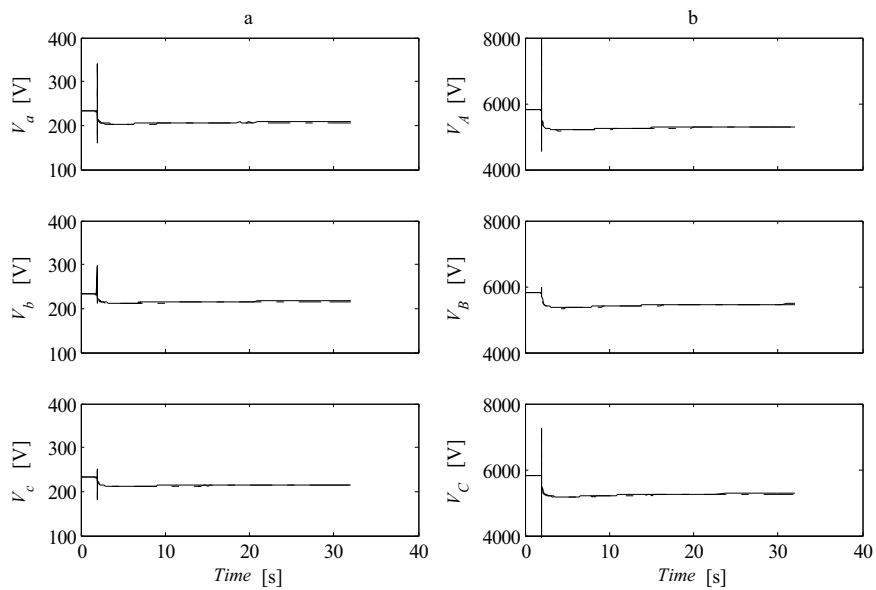

Figure A1.2.8 Phase a to earth fault. a) Phase voltages at induction generator terminals b) Phase voltages on the high voltage side of step up transformer. $l_{L1} = 2$ km (solid lines) and $l_{L1} = 6$ km (dashed lines). $P_{load} = 5$ kW, $R_f = 0 \Omega$

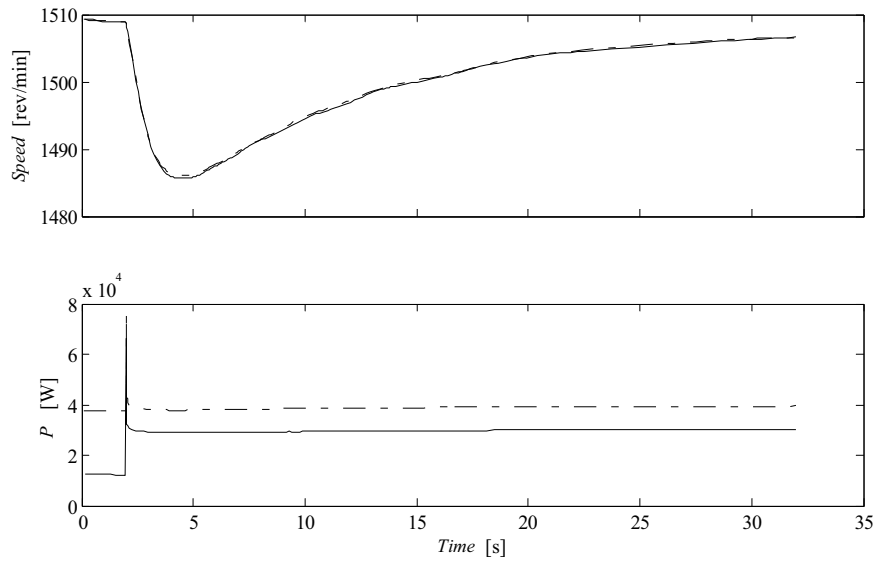

Figure A1.2.9 Phase a to earth fault. Generator speed, generator active power. $l_{L1} = 2$ km (solid lines) and $l_{L1} = 6$ km (dashed lines). $P_{load} = 5$ kW, $R_f = 0 \Omega$

Appendix 1.3 - Phase *a* to earth fault at 400 V side, IG terminals

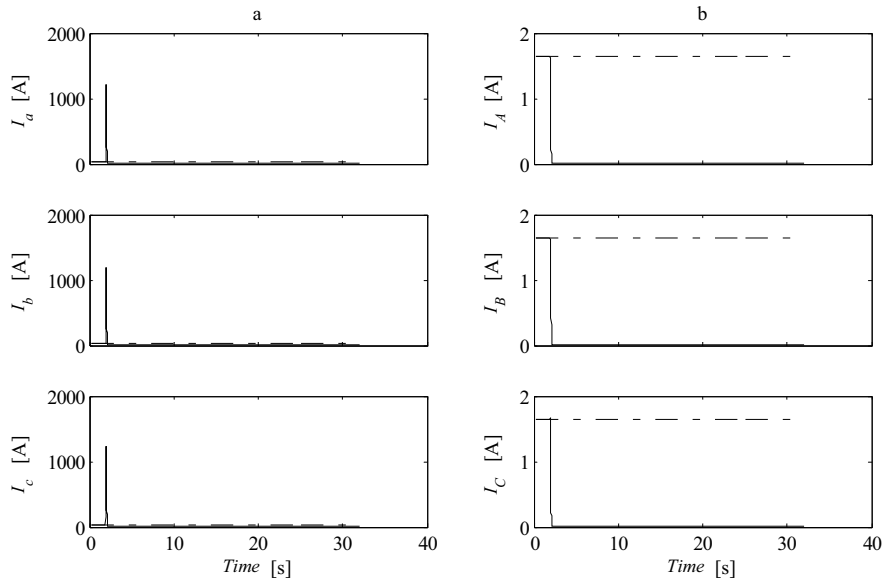

Figure A1.3.1 Phase *a* to earth fault. a) Phase currents at induction generator terminals b) Phase currents on the high voltage side of step up transformer. $R_f = 0 \Omega$ (solid lines) and $R_f = 5 k\Omega$ (dashed lines). $l_{L1} = 4 km$, $P_{load} = 5 kW$

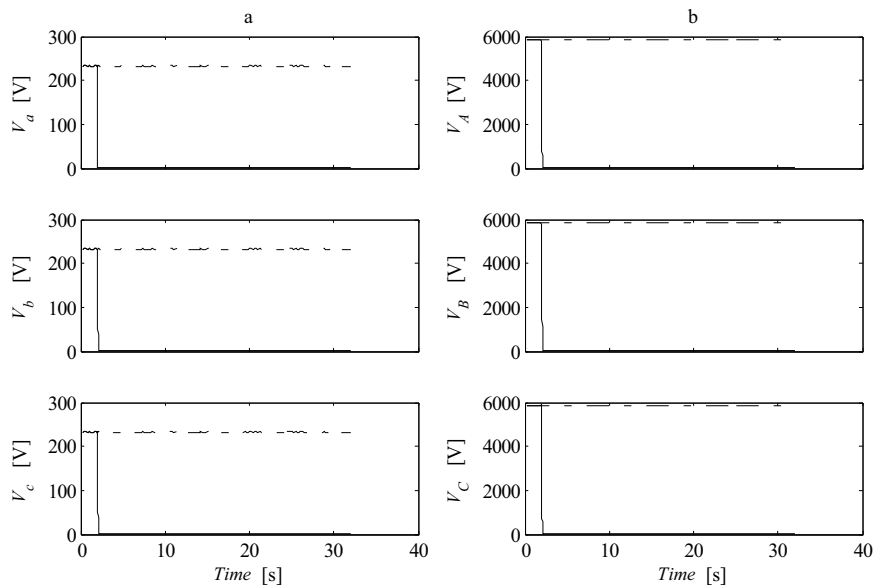

Figure A1.3.2 Phase *a* to earth fault. a) Phase voltages at induction generator terminals b) Phase voltages on the high voltage side of step up transformer. $R_f = 0 \Omega$ (solid lines) and $R_f = 5 k\Omega$ (dashed lines). $l_{L1} = 4 km$, $P_{load} = 5 kW$

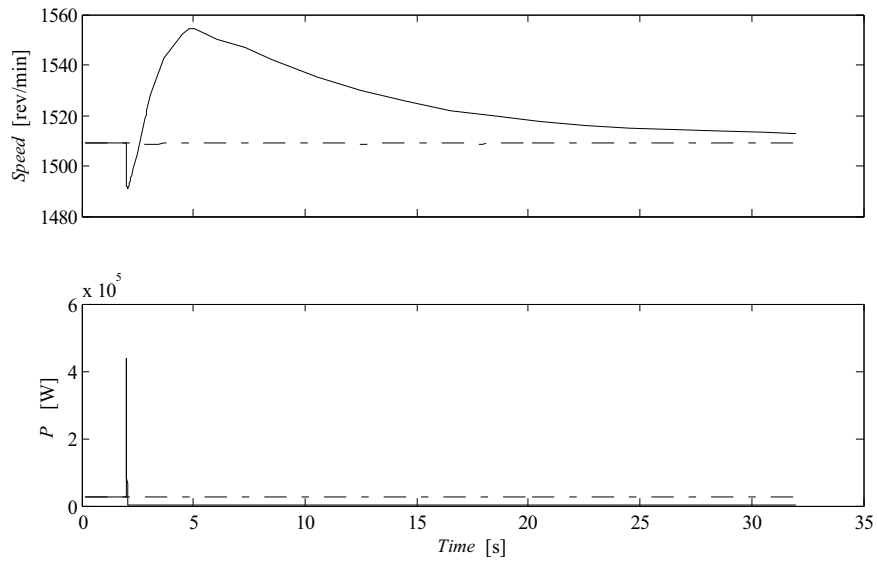

Figure A1.3.3 Phase a to earth fault. Generator speed, generator active power. $R_f = 0 \Omega$ (solid lines) and $R_f = 5 \text{ k}\Omega$ (dashed lines). $l_{L1} = 4 \text{ km}$, $P_{load} = 5 \text{ kW}$

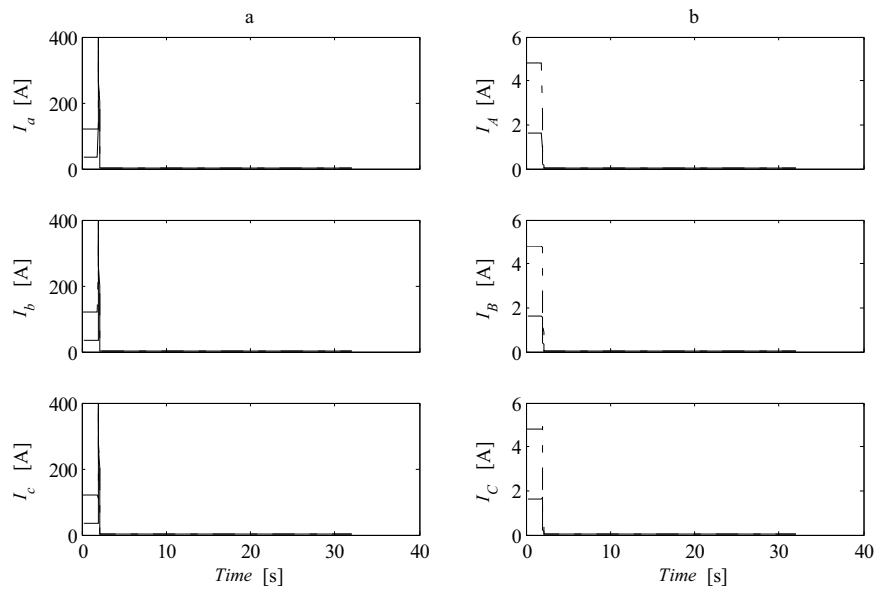

Figure A1.3.4 Phase a to earth fault. a) Phase currents at induction generator terminals b) Phase currents on the high voltage side of step up transformer. $P_{load} = 5 \text{ kW}$ (solid lines) and $P_{load} = 85 \text{ kW}$ (dashed lines). $l_{L1} = 4 \text{ km}$, $R_f = 0 \Omega$

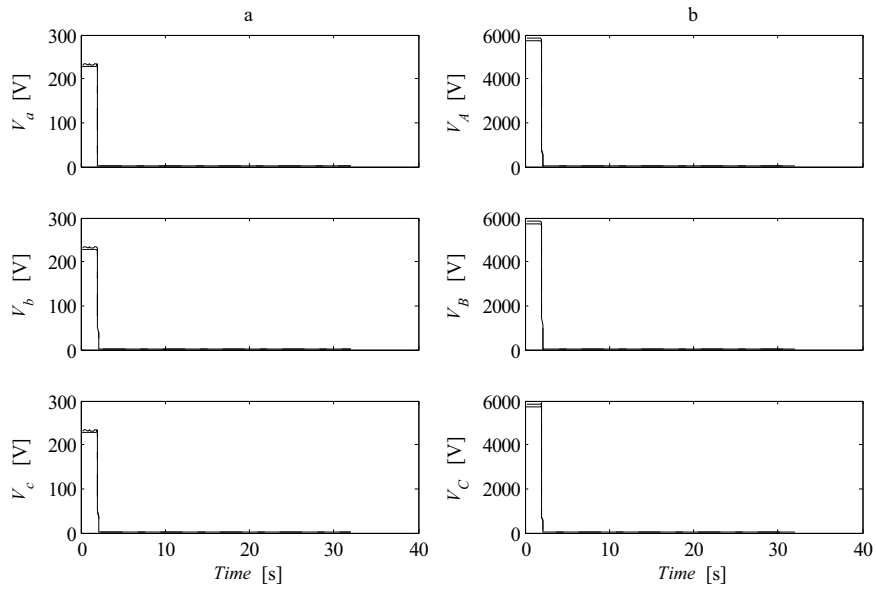

Figure A1.3.5 Phase a to earth fault. a) Phase voltages at induction generator terminals b) Phase voltages on the high voltage side of step up transformer. $P_{load} = 5$ kW (solid lines) and $P_{load} = 85$ kW (dashed lines). $l_{L1} = 4$ km, $R_f = 0 \Omega$

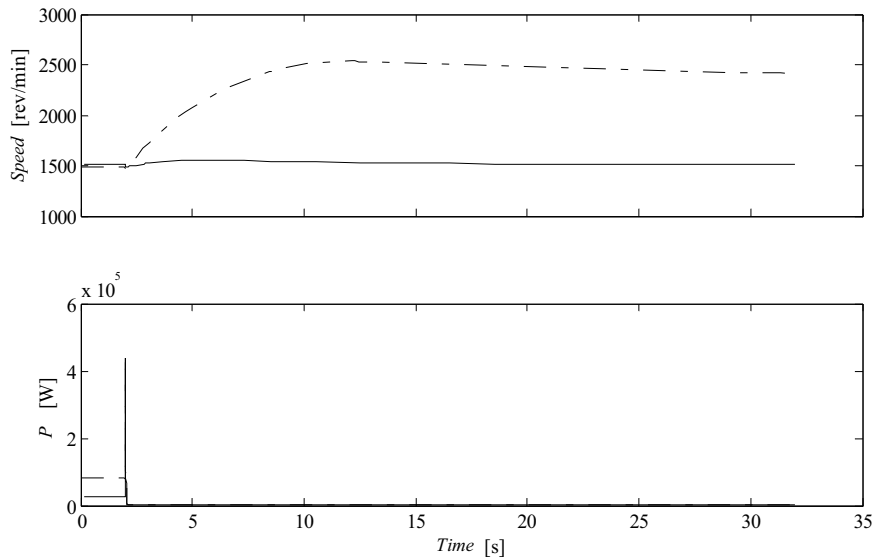

Figure A1.3.6 Phase a to earth fault. Zero sequence current and voltage at fault point, generator speed, generator active power. $P_{load} = 5$ kW (solid lines) and $P_{load} = 85$ kW (dashed lines). $l_{L1} = 4$ km, $R_f = 0 \Omega$

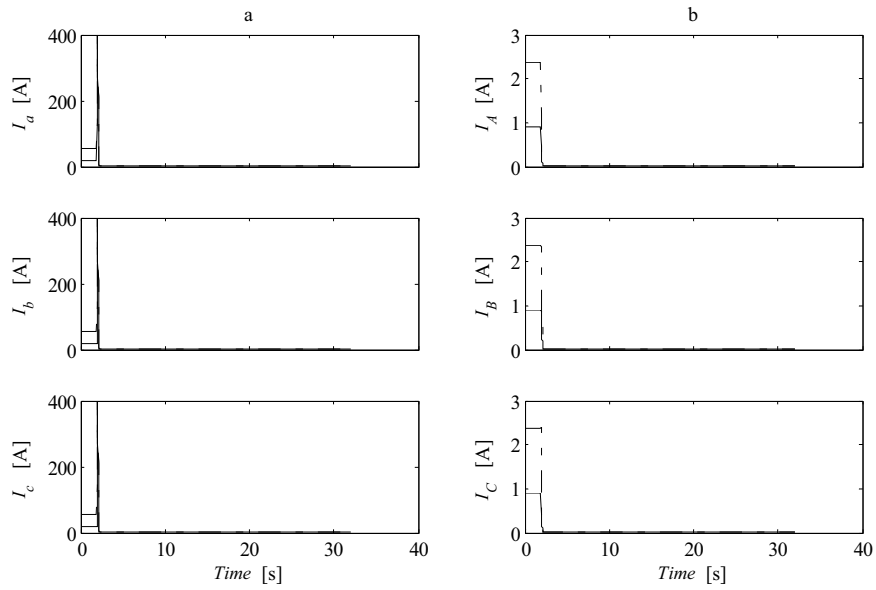

Figure A1.3.7 Phase a to earth fault. a) Phase currents at induction generator terminals b) Phase currents on the high voltage side of step up transformer. $l_{L1} = 2$ km (solid lines) and $l_{L1} = 6$ km (dashed lines). $P_{load} = 5$ kW, $R_f = 0 \Omega$

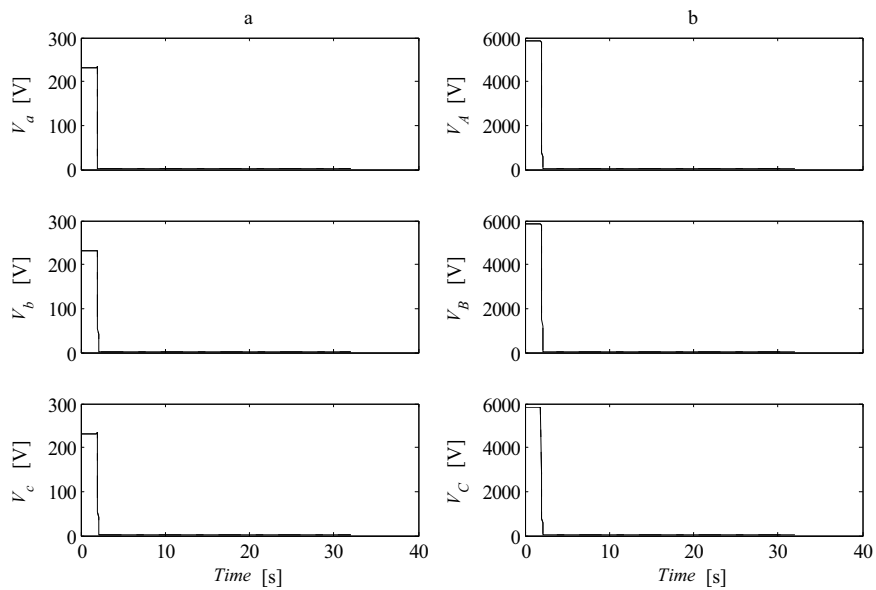

Figure A1.3.8 Phase a to earth fault. a) Phase voltages at induction generator terminals b) Phase voltages on the high voltage side of step up transformer. $l_{L1} = 2$ km (solid lines) and $l_{L1} = 6$ km (dashed lines). $P_{load} = 5$ kW, $R_f = 0 \Omega$

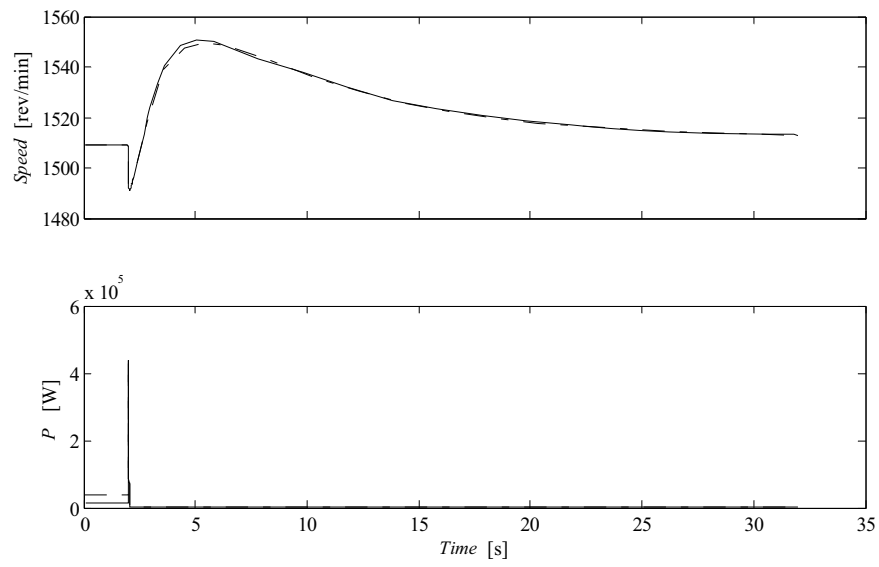

Figure A1.3.9 Phase a to earth fault. Generator speed, generator active power. $l_{L1} = 2$ km (solid lines) and $l_{L1} = 6$ km (dashed lines). $P_{load} = 5$ kW, $R_f = 0 \Omega$

Appendix 1.4 - Phase A-B fault at 10 kV side, EOL of line L2

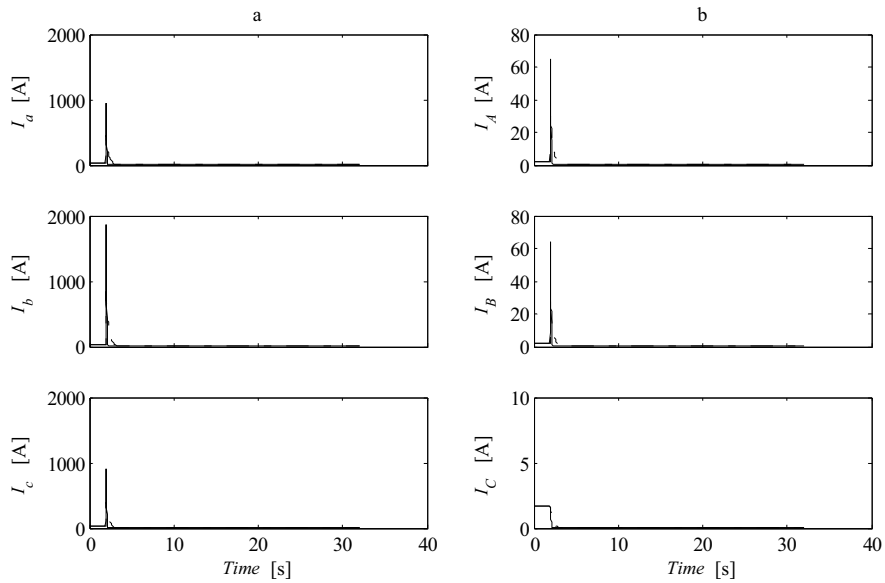

Figure A1.4.1 Phase A-B fault. a) Phase currents at induction generator terminals b) Phase currents on the high voltage side of step up transformer. $R_f = 0 \Omega$ (solid lines) and $R_f = 200 \Omega$ (dashed lines). $l_{L1} = 4 \text{ km}$, $P_{load} = 5 \text{ kW}$

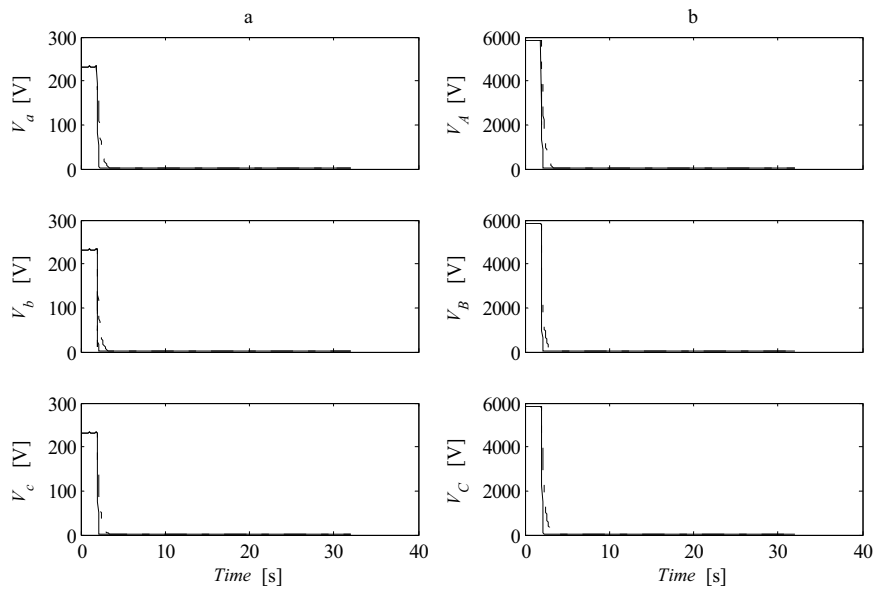

Figure A1.4.2 Phase A-B fault. a) Phase voltages at induction generator terminals b) Phase voltages on the high voltage side of step up transformer. $R_f = 0 \Omega$ (solid lines) and $R_f = 200 \Omega$ (dashed lines). $l_{L1} = 4 \text{ km}$, $P_{load} = 5 \text{ kW}$

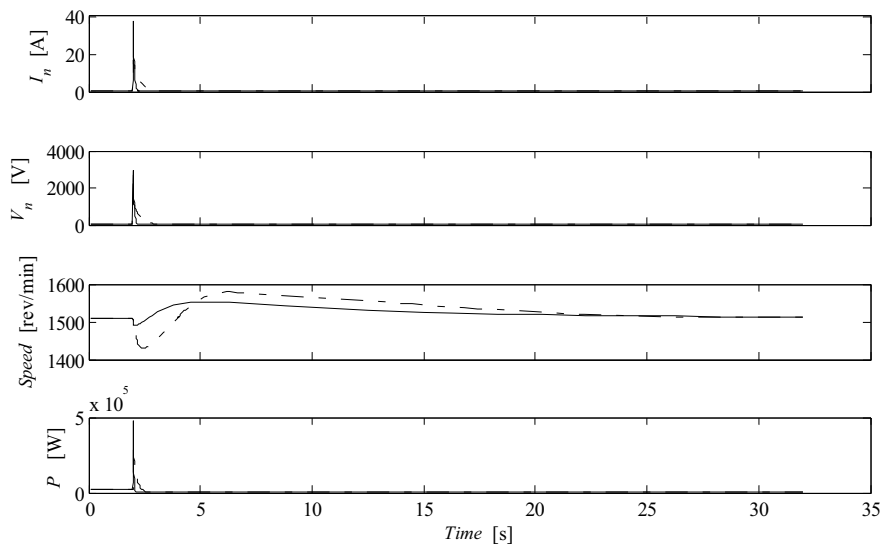

Figure A1.4.3 Phase A-B fault. Negative sequence current and voltage at fault point, generator speed, generator active power. $R_f = 0 \Omega$ (solid lines) and $R_f = 200 \Omega$ (dashed lines). $l_{L1} = 4 \text{ km}$, $P_{load} = 5 \text{ kW}$

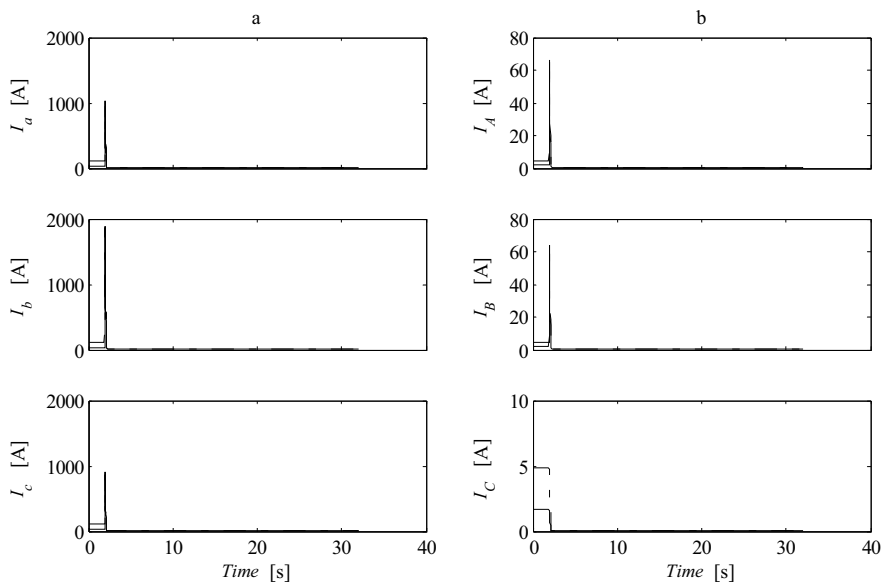

Figure A1.4.4 Phase A-B fault. a) Phase currents at induction generator terminals b) Phase currents on the high voltage side of step up transformer. $P_{load} = 5 \text{ kW}$ (solid lines) and $P_{load} = 85 \text{ kW}$ (dashed lines). $l_{L1} = 4 \text{ km}$, $R_f = 0 \Omega$

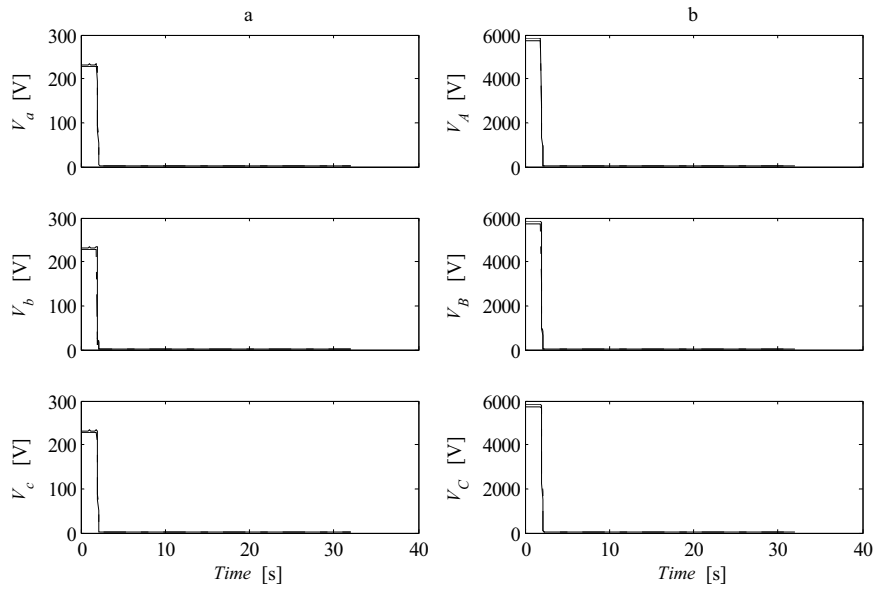

Figure A1.4.5 Phase A-B fault. a) Phase voltages at induction generator terminals b) Phase voltages on the high voltage side of step up transformer. $P_{load} = 5 \text{ kW}$ (solid lines) and $P_{load} = 85 \text{ kW}$ (dashed lines). $l_{L1} = 4 \text{ km}$, $R_f = 0 \ \Omega$

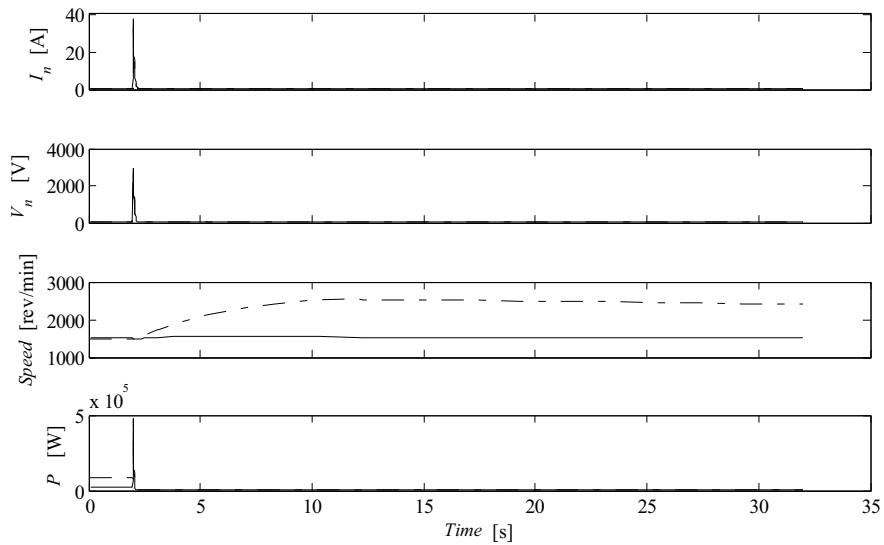

Figure A1.4.6 Phase A-B fault. Negative sequence current and voltage at fault point, generator speed, generator active power. $P_{load} = 5 \text{ kW}$ (solid lines) and $P_{load} = 85 \text{ kW}$ (dashed lines). $l_{L1} = 4 \text{ km}$, $R_f = 0 \ \Omega$

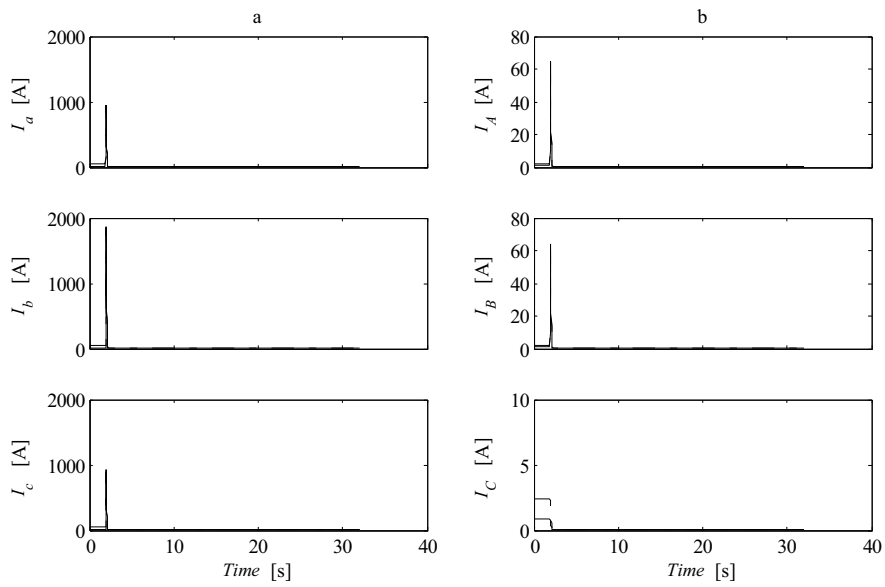

Figure A1.4.7 Phase A-B fault. a) Phase currents at induction generator terminals b) Phase currents on the high voltage side of step up transformer. $l_{L1} = 2$ km (solid lines) and $l_{L1} = 6$ km (dashed lines). $P_{load} = 5$ kW, $R_f = 0 \Omega$

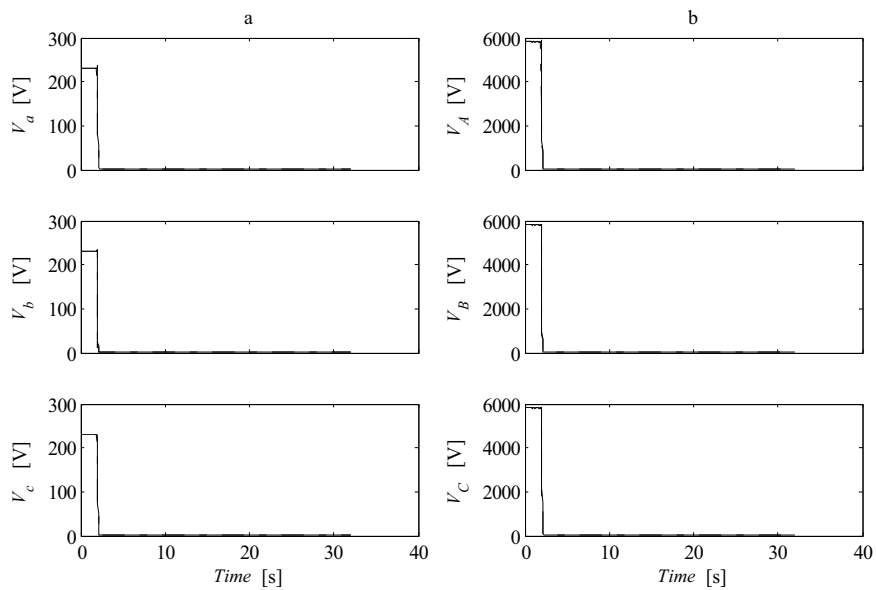

Figure A1.4.8 Phase A-B fault. a) Phase voltages at induction generator terminals b) Phase voltages on the high voltage side of step up transformer. $l_{L1} = 2$ km (solid lines) and $l_{L1} = 6$ km (dashed lines). $P_{load} = 5$ kW, $R_f = 0 \Omega$

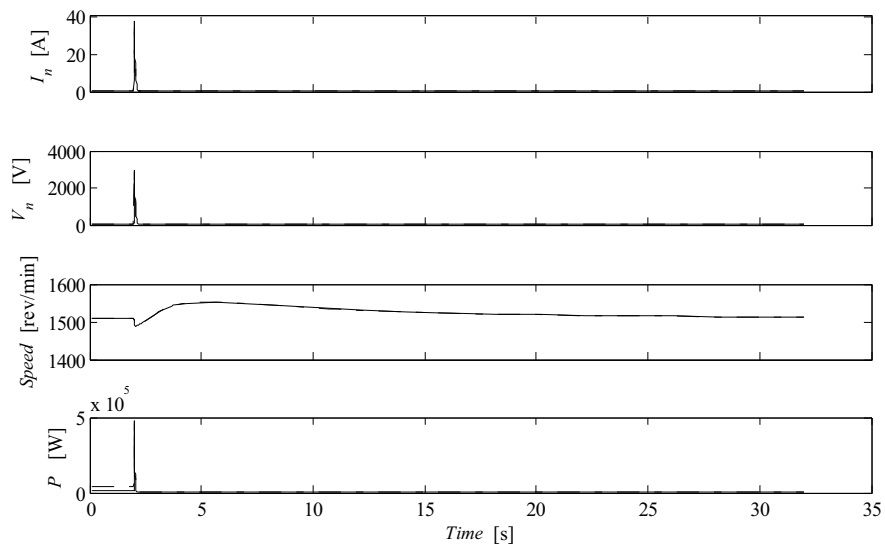

Figure A1.4.9 Phase A-B fault. Negative sequence current and voltage at fault point, generator speed, generator active power. $l_{L1} = 2$ km (solid lines) and $l_{L1} = 6$ km (dashed lines). $P_{load} = 5$ kW, $R_f = 0 \Omega$

Appendix 1.5 - Phase *a-b* fault at 400 V side, EOL of line L3

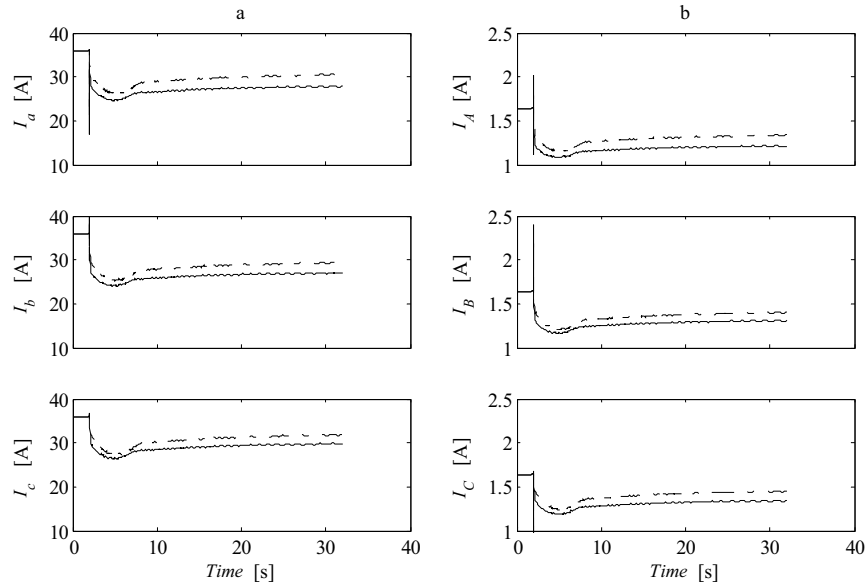

Figure A1.5.1 Phase *a-b* fault. a) Phase currents at induction generator terminals b) Phase currents on the high voltage side of step up transformer. $R_f = 0 \Omega$ (solid lines) and $R_f = 0,6 \Omega$ (dashed lines). $l_{L1} = 4 \text{ km}$, $P_{load} = 5 \text{ kW}$

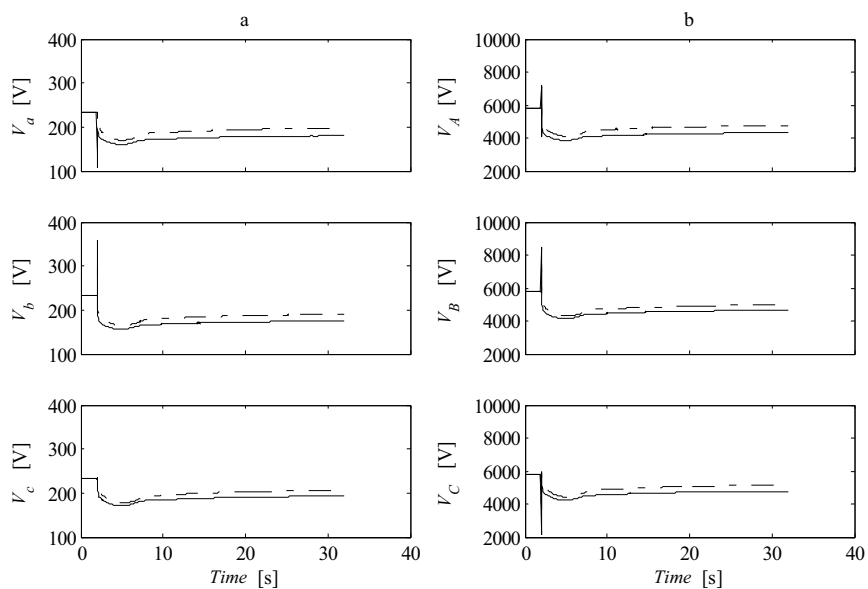

Figure A1.5.2 Phase *a-b* fault. a) Phase voltages at induction generator terminals b) Phase voltages on the high voltage side of step up transformer. $R_f = 0 \Omega$ (solid lines) and $R_f = 0,6 \Omega$ (dashed lines). $l_{L1} = 4 \text{ km}$, $P_{load} = 5 \text{ kW}$

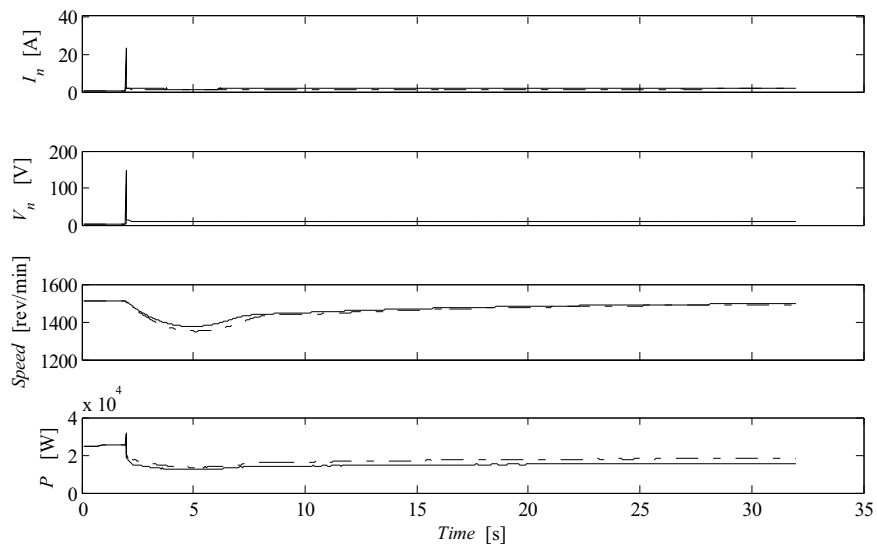

Figure A1.5.3 Phase a-b fault. Negative sequence current and voltage at fault point, generator speed, generator active power. $R_f = 0 \Omega$ (solid lines) and $R_f = 0,6 \Omega$ (dashed lines). $l_{L1} = 4 \text{ km}$, $P_{load} = 5 \text{ kW}$

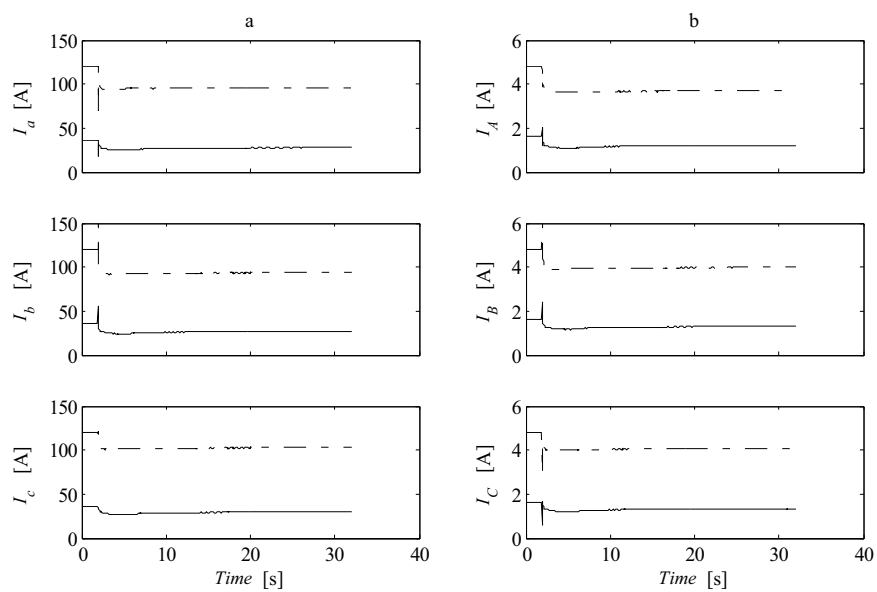

Figure A1.5.4 Phase a-b fault. a) Phase currents at induction generator terminals b) Phase currents on the high voltage side of step up transformer. $P_{load} = 5 \text{ kW}$ (solid lines) and $P_{load} = 85 \text{ kW}$ (dashed lines). $l_{L1} = 4 \text{ km}$, $R_f = 0 \Omega$

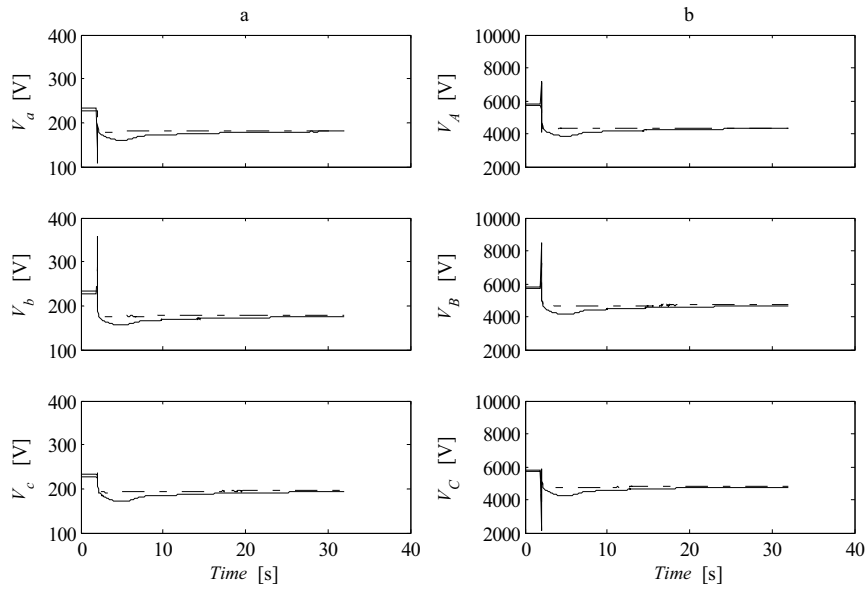

Figure A1.5.5 Phase a-b fault. a) Phase voltages at induction generator terminals b) Phase voltages on the high voltage side of step up transformer. $P_{load} = 5$ kW (solid lines) and $P_{load} = 85$ kW (dashed lines). $l_{L1} = 4$ km, $R_f = 0 \Omega$

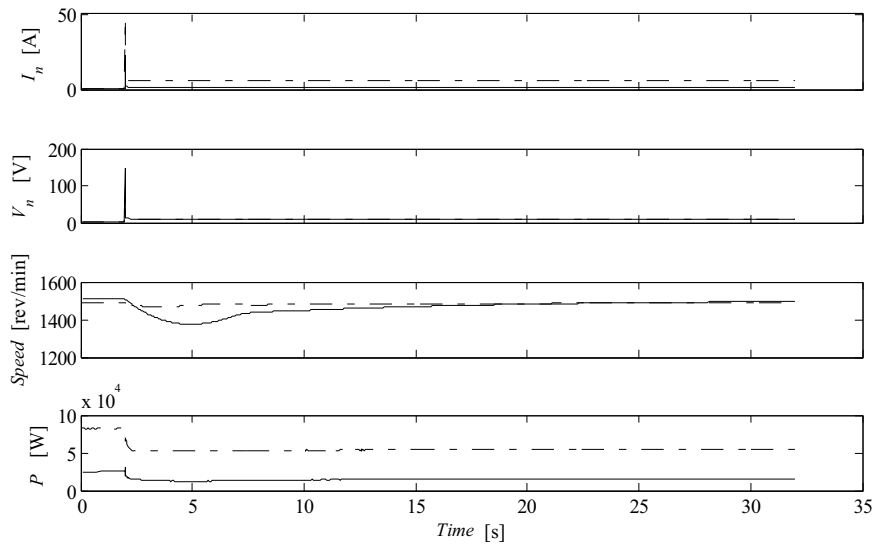

Figure A1.5.6 Phase a-b fault. Negative sequence current and voltage at fault point, generator speed, generator active power. $P_{load} = 5$ kW (solid lines) and $P_{load} = 85$ kW (dashed lines). $l_{L1} = 4$ km, $R_f = 0 \Omega$

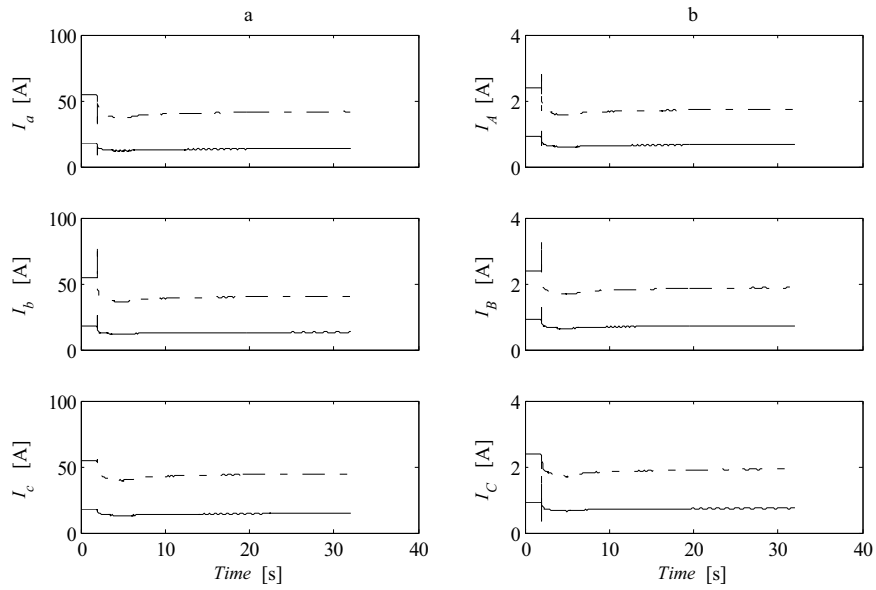

Figure A1.5.7 Phase a-b fault. a) Phase currents at induction generator terminals b) Phase currents on the high voltage side of step up transformer. $l_{L1} = 2$ km (solid lines) and $l_{L1} = 6$ km (dashed lines). $P_{load} = 5$ kW, $R_f = 0 \Omega$

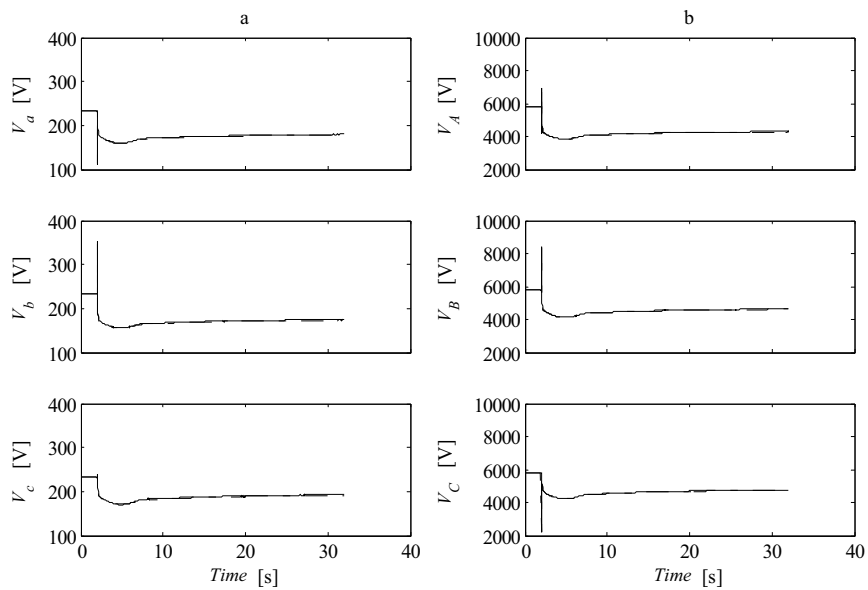

Figure A1.5.8 Phase a-b fault. a) Phase voltages at induction generator terminals b) Phase voltages on the high voltage side of step up transformer. $l_{L1} = 2$ km (solid lines) and $l_{L1} = 6$ km (dashed lines). $P_{load} = 5$ kW, $R_f = 0 \Omega$

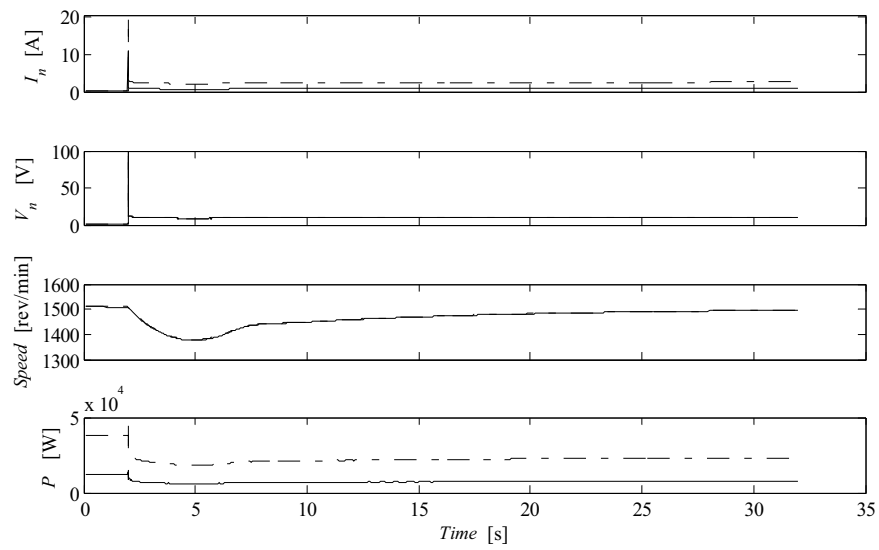

Figure A1.5.9 Phase a-b fault. Negative sequence current and voltage at fault point, generator speed, generator active power. $l_{L1} = 2$ km (solid lines) and $l_{L1} = 6$ km (dashed lines). $P_{load} = 5$ kW, $R_f = 0 \Omega$

Appendix 1.6 - Phase *a-b* fault at 400 V side, IG terminals

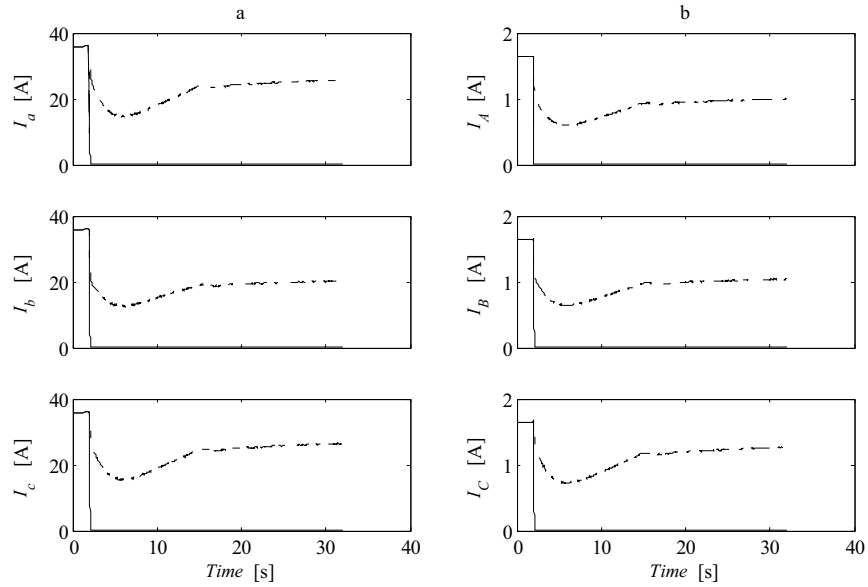

Figure A1.6.1 Phase *a-b* fault. a) Phase currents at induction generator terminals b) Phase currents on the high voltage side of step up transformer. $R_f = 0 \Omega$ (solid lines) and $R_f = 0,6 \Omega$ (dashed lines). $l_{L1} = 4 \text{ km}$, $P_{load} = 5 \text{ kW}$

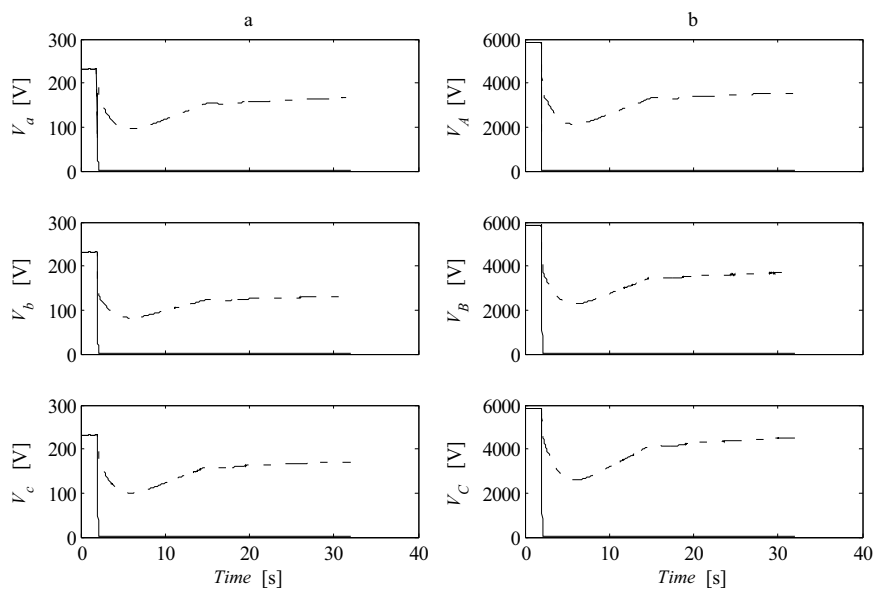

Figure A1.6.2 Phase *a-b* fault. a) Phase voltages at induction generator terminals b) Phase voltages on the high voltage side of step up transformer. $R_f = 0 \Omega$ (solid lines) and $R_f = 0,6 \Omega$ (dashed lines). $l_{L1} = 4 \text{ km}$, $P_{load} = 5 \text{ kW}$

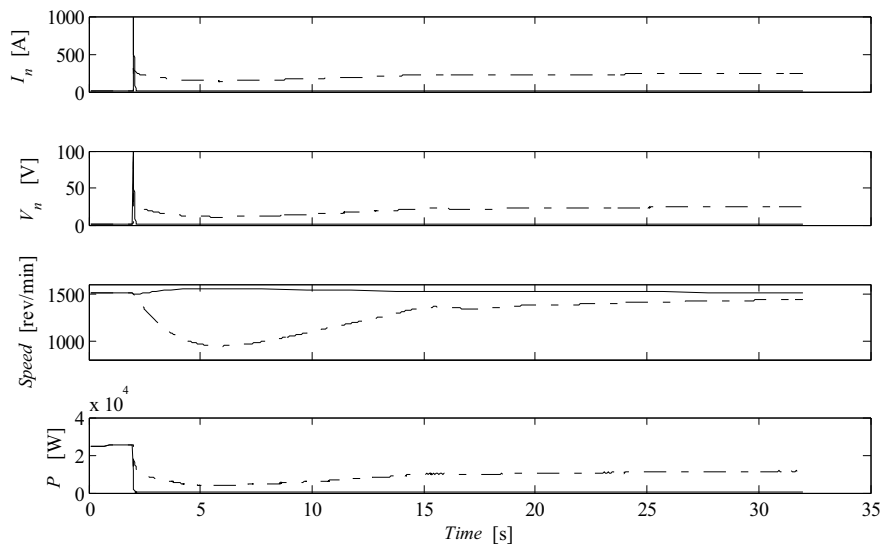

Figure A1.6.3 Phase a-b fault. Negative sequence current and voltage at fault point, generator speed, generator active power. $R_f = 0 \Omega$ (solid lines) and $R_f = 0,6 \Omega$ (dashed lines). $l_{L1} = 4 \text{ km}$, $P_{load} = 5 \text{ kW}$

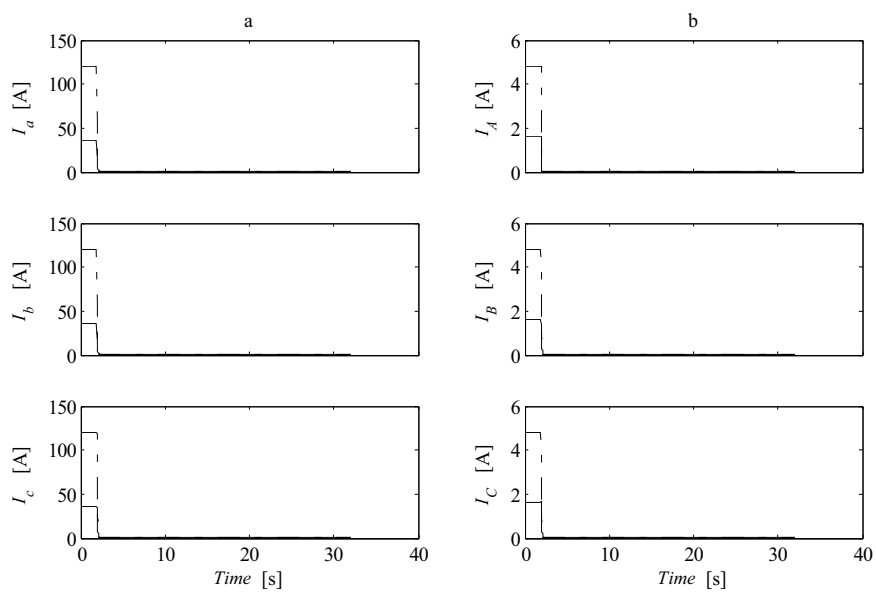

Figure A1.6.4 Phase a-b fault. a) Phase currents at induction generator terminals b) Phase currents on the high voltage side of step up transformer. $P_{load} = 5 \text{ kW}$ (solid lines) and $P_{load} = 85 \text{ kW}$ (dashed lines). $l_{L1} = 4 \text{ km}$, $R_f = 0 \Omega$

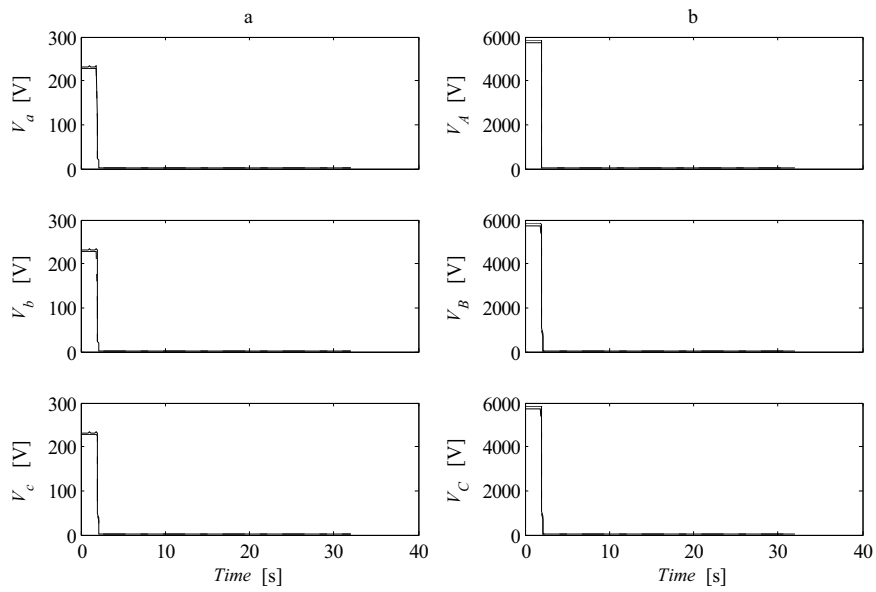

Figure A1.6.5 Phase a-b fault. a) Phase voltages at induction generator terminals b) Phase voltages on the high voltage side of step up transformer. $P_{load} = 5 \text{ kW}$ (solid lines) and $P_{load} = 85 \text{ kW}$ (dashed lines). $l_{L1} = 4 \text{ km}$, $R_f = 0 \ \Omega$

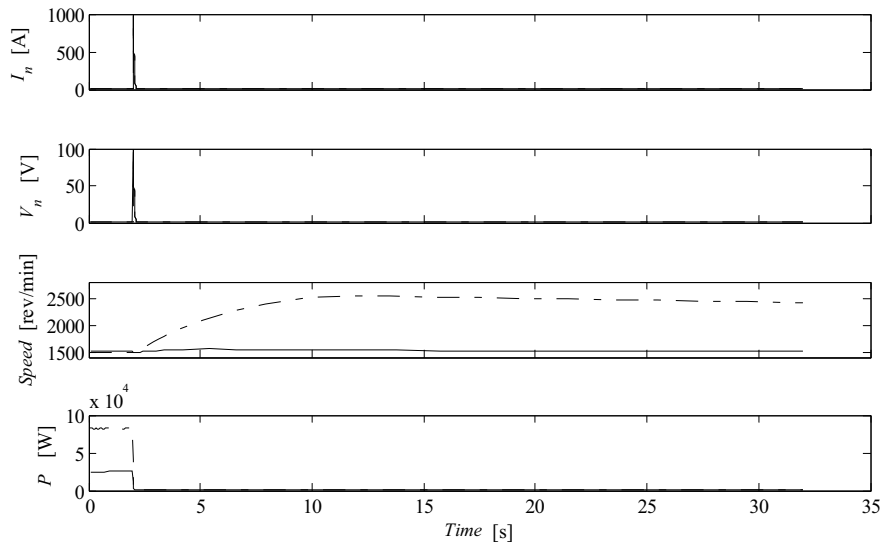

Figure A1.6.6 Phase a-b fault. Negative sequence current and voltage at fault point, generator speed, generator active power. $P_{load} = 5 \text{ kW}$ (solid lines) and $P_{load} = 85 \text{ kW}$ (dashed lines). $l_{L1} = 4 \text{ km}$, $R_f = 0 \ \Omega$

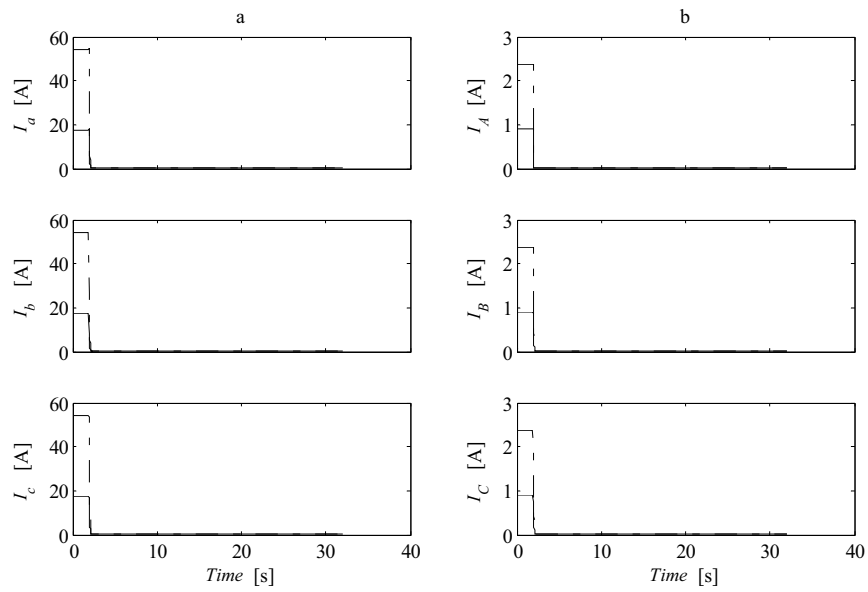

Figure A1.6.7 Phase a-b fault. a) Phase currents at induction generator terminals b) Phase currents on the high voltage side of step up transformer. $l_{L1} = 2 \text{ km}$ (solid lines) and $l_{L1} = 6 \text{ km}$ (dashed lines). $P_{load} = 5 \text{ kW}$, $R_f = 0 \Omega$

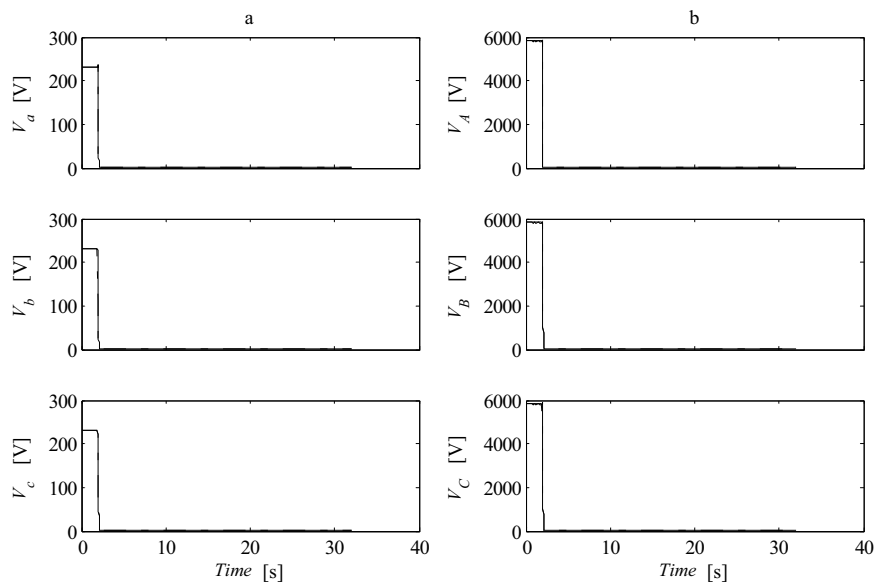

Figure A1.6.8 Phase a-b fault. a) Phase voltages at induction generator terminals b) Phase voltages on the high voltage side of step up transformer. $l_{L1} = 2 \text{ km}$ (solid lines) and $l_{L1} = 6 \text{ km}$ (dashed lines). $P_{load} = 5 \text{ kW}$, $R_f = 0 \Omega$

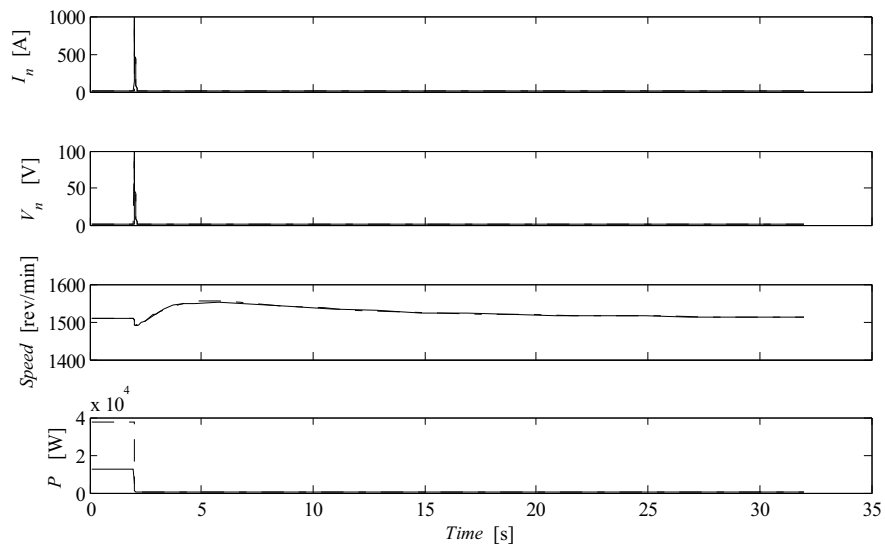

Figure A1.6.9 Phase a-b fault. Negative sequence current and voltage at fault point, generator speed, generator active power. $l_{L1} = 2$ km (solid lines) and $l_{L1} = 6$ km (dashed lines). $P_{load} = 5$ kW, $R_f = 0 \Omega$

Appendix 1.7 – Three Phase fault at 10 kV side, EOL of line L2

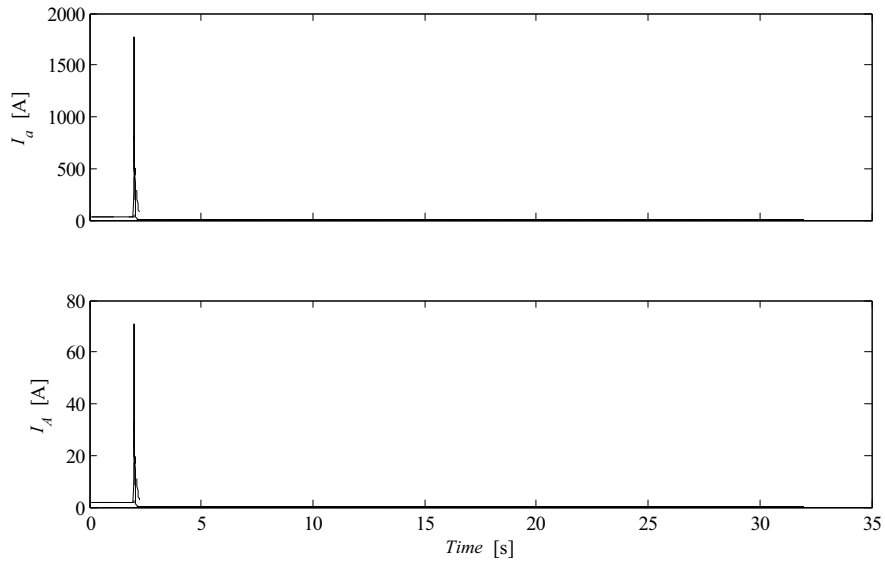

Figure A1.7.1 Three Phase fault. a) Phase current at induction generator terminals b) Phase current on the high voltage side of step up transformer. $R_f = 0 \Omega$ (solid lines) and $R_f = 200 \Omega$ (dashed lines). $l_{L1} = 4 \text{ km}$, $P_{load} = 5 \text{ kW}$

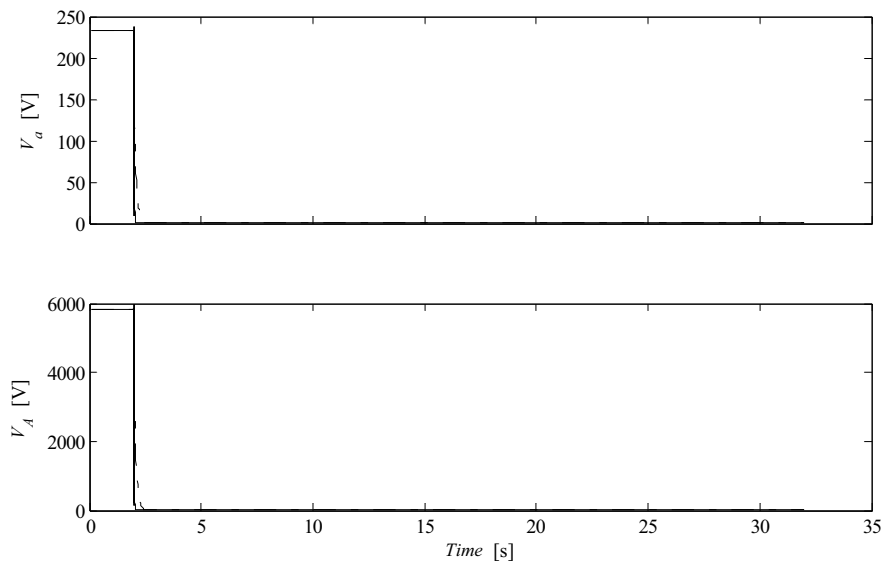

Figure A1.7.2 Three Phase fault. a) Phase voltage at induction generator terminals b) Phase voltage on the high voltage side of step up transformer. $R_f = 0 \Omega$ (solid lines) and $R_f = 200 \Omega$ (dashed lines). $l_{L1} = 4 \text{ km}$, $P_{load} = 5 \text{ kW}$

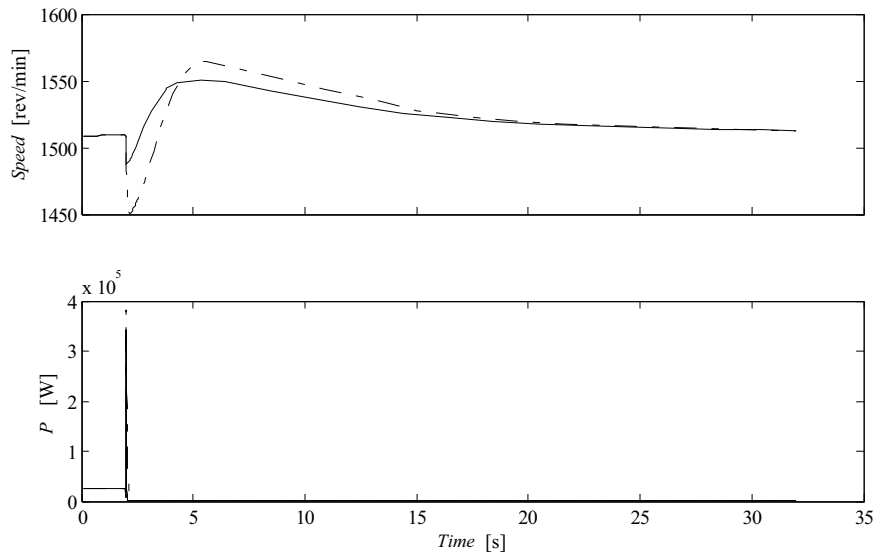

Figure A1.7.3 Three Phase fault. Generator speed, generator active power. $R_f = 0 \Omega$ (solid lines) and $R_f = 200 \Omega$ (dashed lines). $l_{L1} = 4 \text{ km}$, $P_{load} = 5 \text{ kW}$

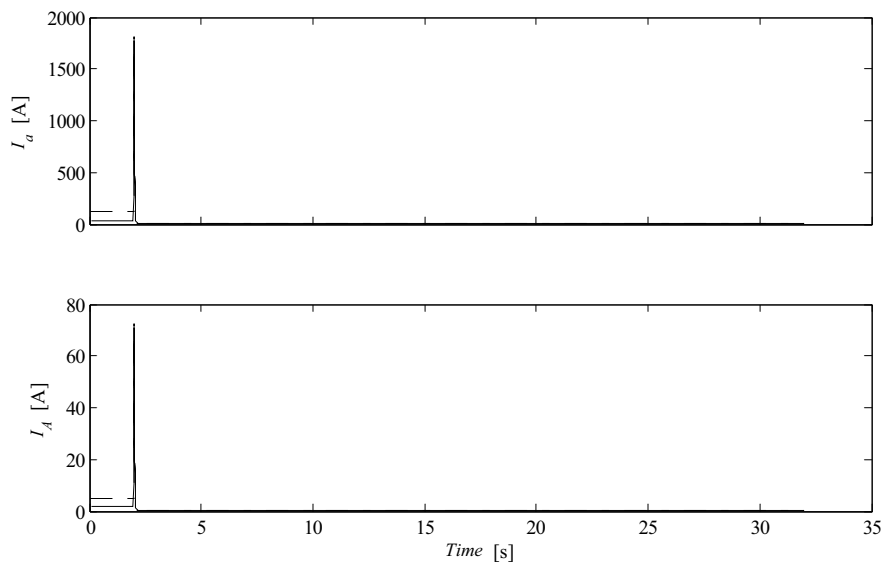

Figure A1.7.4 Three Phase fault. a) Phase current at induction generator terminals b) Phase current on the high voltage side of step up transformer. $P_{load} = 5 \text{ kW}$ (solid lines) and $P_{load} = 85 \text{ kW}$ (dashed lines). $l_{L1} = 4 \text{ km}$, $R_f = 0 \Omega$

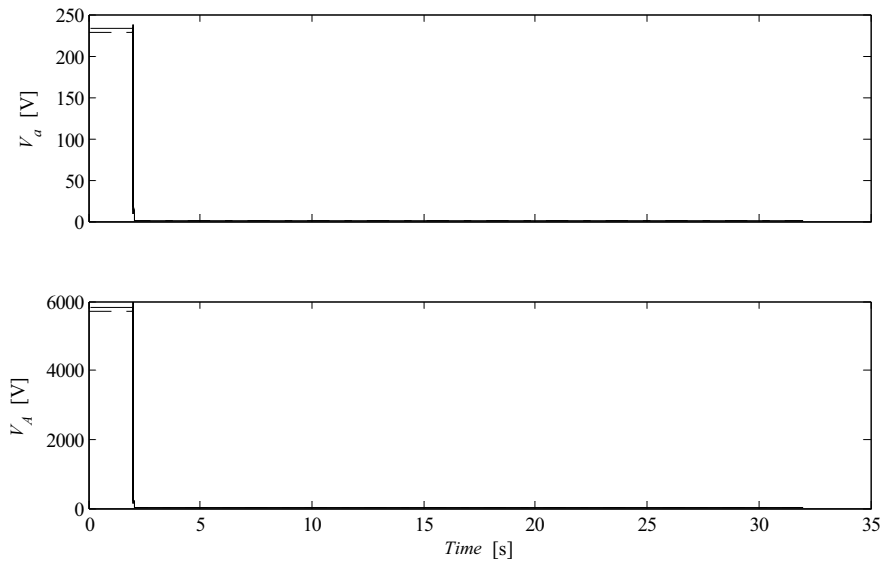

Figure A1.7.5 Three Phase fault. a) Phase voltage at induction generator terminals b) Phase voltage on the high voltage side of step up transformer. $P_{load} = 5 \text{ kW}$ (solid lines) and $P_{load} = 85 \text{ kW}$ (dashed lines). $l_{L1} = 4 \text{ km}$, $R_f = 0 \Omega$

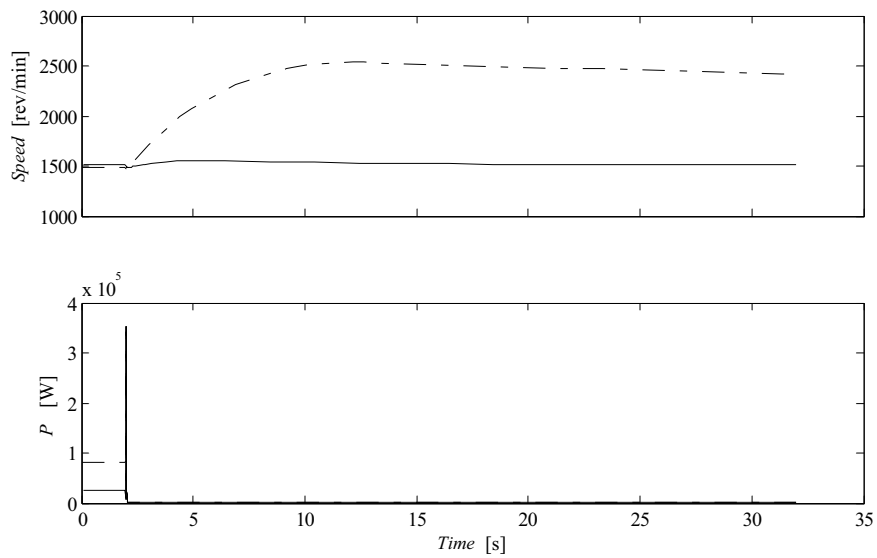

Figure A1.7.6 Three Phase fault. Generator speed, generator active power. $P_{load} = 5 \text{ kW}$ (solid lines) and $P_{load} = 85 \text{ kW}$ (dashed lines). $l_{L1} = 4 \text{ km}$, $R_f = 0 \Omega$

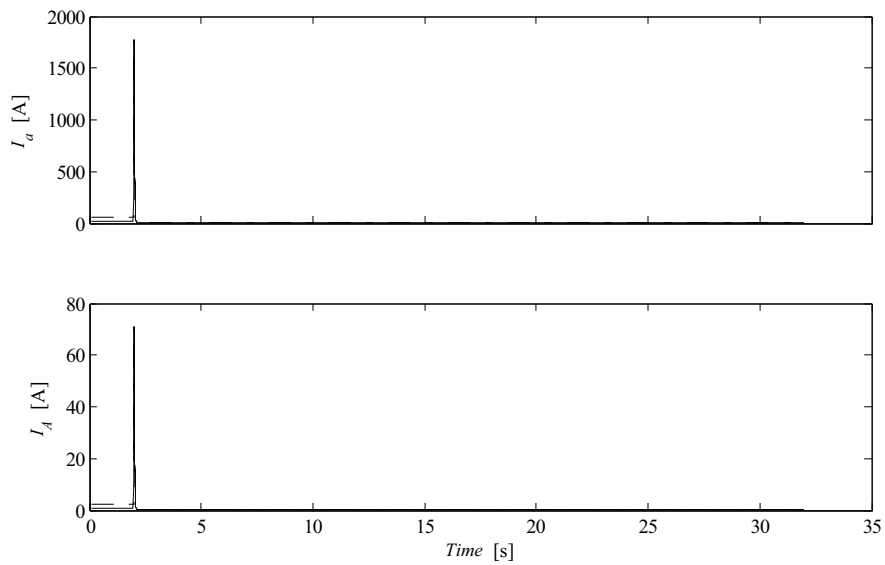

Figure A1.7.7 Three Phase fault. a) Phase current at induction generator terminals b) Phase current on the high voltage side of step up transformer. $l_{L1} = 2$ km (solid lines) and $l_{L1} = 6$ km (dashed lines). $P_{load} = 5$ kW, $R_f = 0 \Omega$

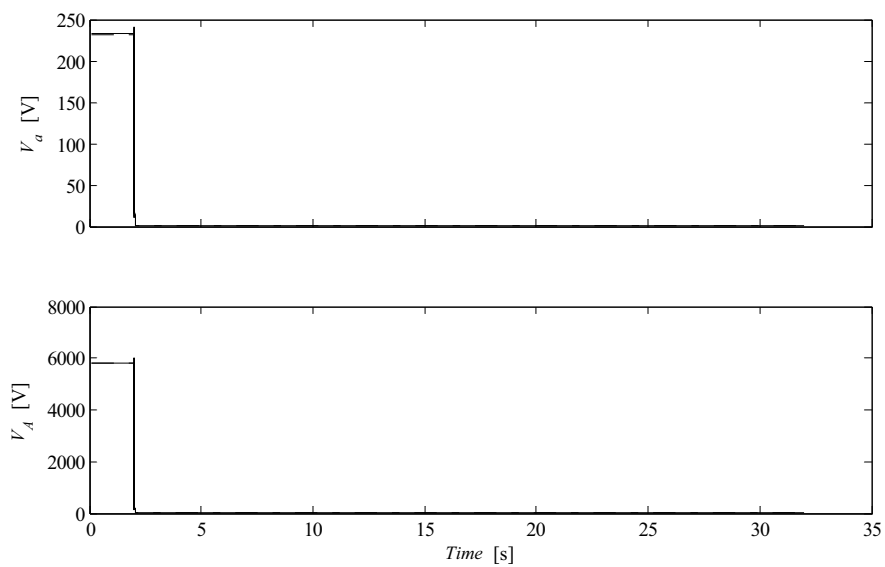

Figure A1.7.8 Three Phase fault. a) Phase voltage s at induction generator terminals b) Phase voltage on the high voltage side of step up transformer. $l_{L1} = 2$ km (solid lines) and $l_{L1} = 6$ km (dashed lines). $P_{load} = 5$ kW, $R_f = 0 \Omega$

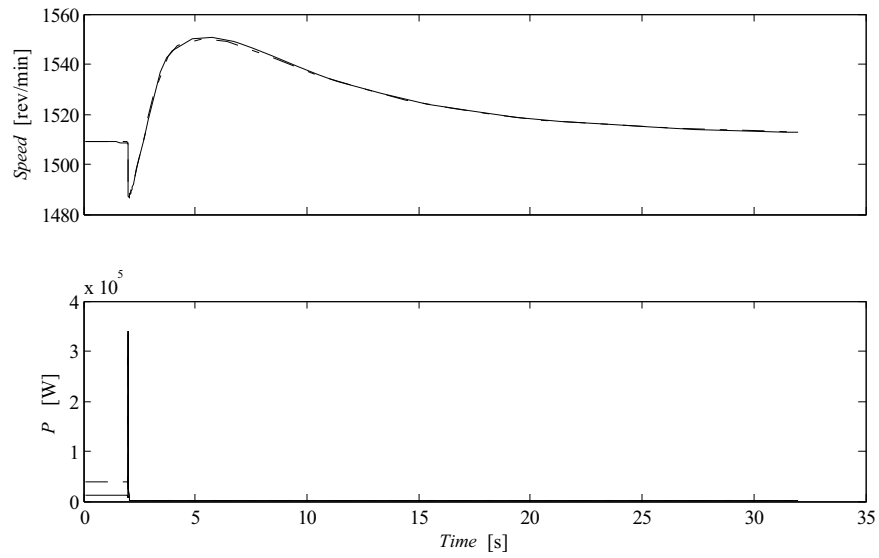

Figure A1.7.9 Three Phase fault. Generator speed, generator active power. $l_{L1} = 2$ km (solid lines) and $l_{L1} = 6$ km (dashed lines). $P_{load} = 5$ kW, $R_f = 0 \Omega$

Appendix 1.8 – Three Phase fault at 400 V side, EOL of line L3

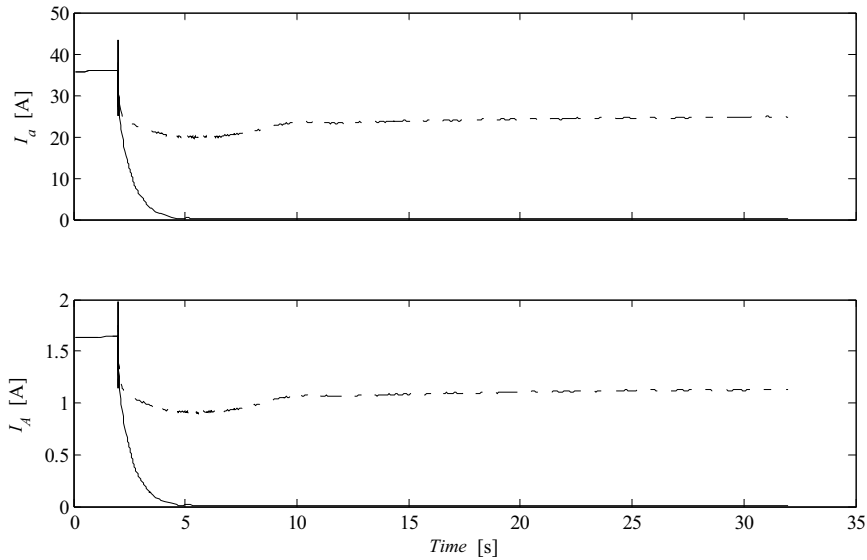

Figure A1.8.1 Three Phase fault. a) Phase current at induction generator terminals b) Phase current on the high voltage side of step up transformer. $R_f = 0 \Omega$ (solid lines) and $R_f = 0,6 \Omega$ (dashed lines). $l_{L1} = 4 \text{ km}$, $P_{load} = 5 \text{ kW}$

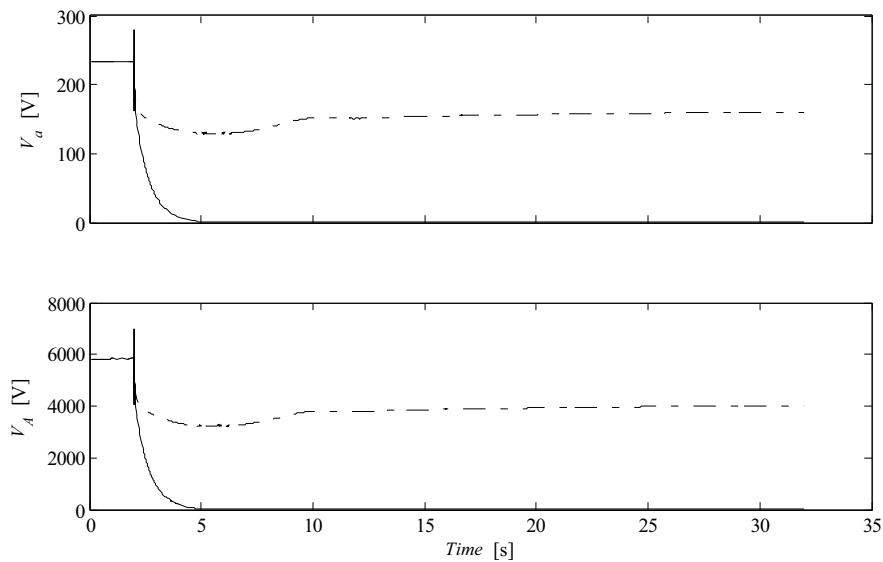

Figure A1.8.2 Three Phase fault. a) Phase voltage at induction generator terminals b) Phase voltage on the high voltage side of step up transformer. $R_f = 0 \Omega$ (solid lines) and $R_f = 0,6 \Omega$ (dashed lines). $l_{L1} = 4 \text{ km}$, $P_{load} = 5 \text{ kW}$

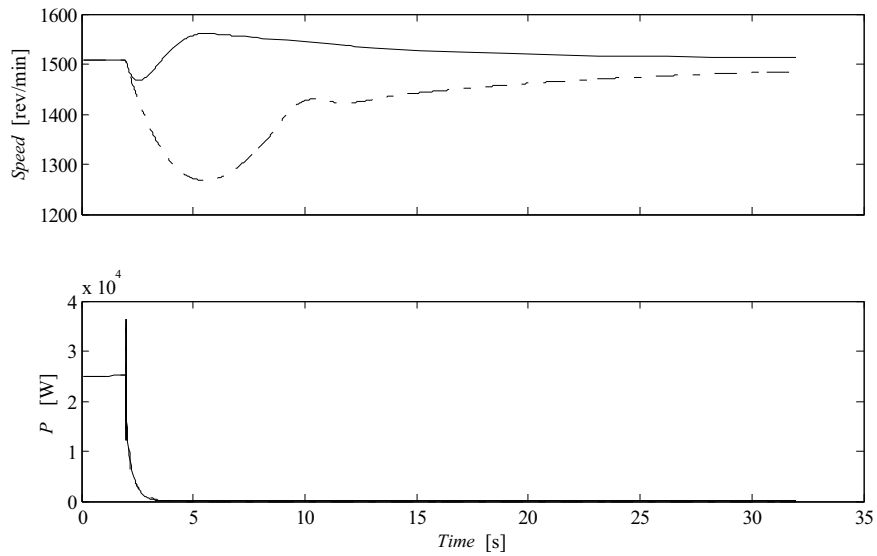

Figure A1.8.3 Three Phase fault. Generator speed, generator active power. $R_f = 0 \Omega$ (solid lines) and $R_f = 0,3 \Omega$ (dashed lines). $l_{L1} = 4 \text{ km}$, $P_{load} = 5 \text{ kW}$

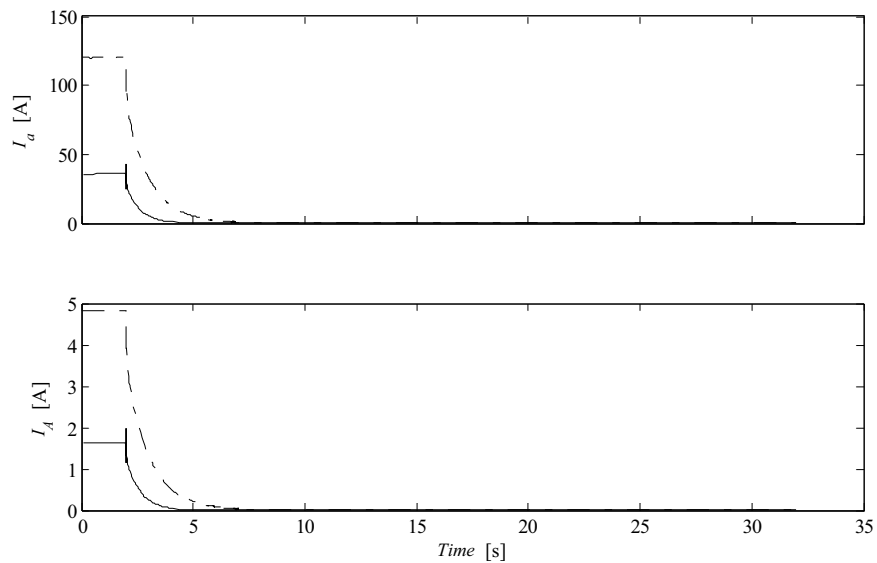

Figure A1.8.4 Three Phase fault. a) Phase current at induction generator terminals b) Phase current on the high voltage side of step up transformer. $P_{load} = 5 \text{ kW}$ (solid lines) and $P_{load} = 85 \text{ kW}$ (dashed lines). $l_{L1} = 4 \text{ km}$, $R_f = 0 \Omega$

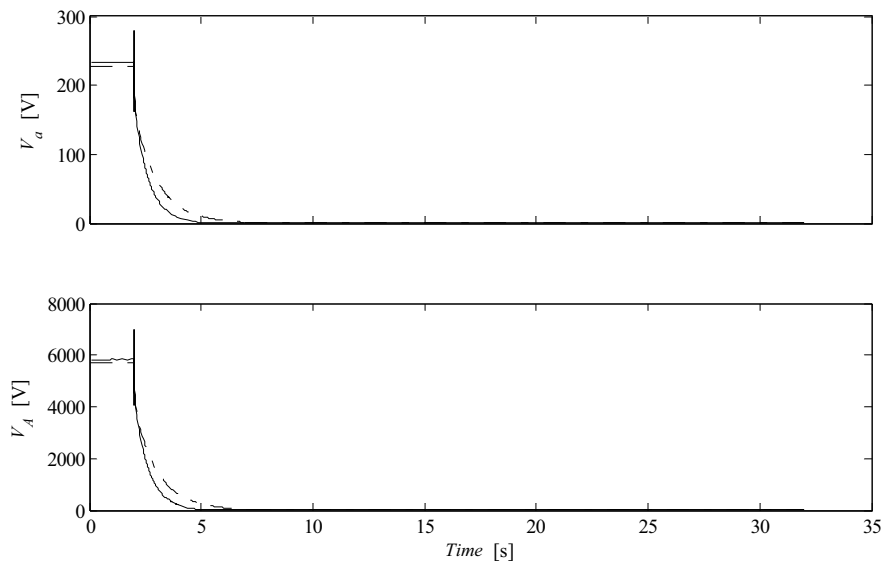

Figure A1.8.5 Three Phase fault. a) Phase voltage at induction generator terminals b) Phase voltage on the high voltage side of step up transformer. $P_{load} = 5 \text{ kW}$ (solid lines) and $P_{load} = 85 \text{ kW}$ (dashed lines). $l_{L1} = 4 \text{ km}$, $R_f = 0 \Omega$

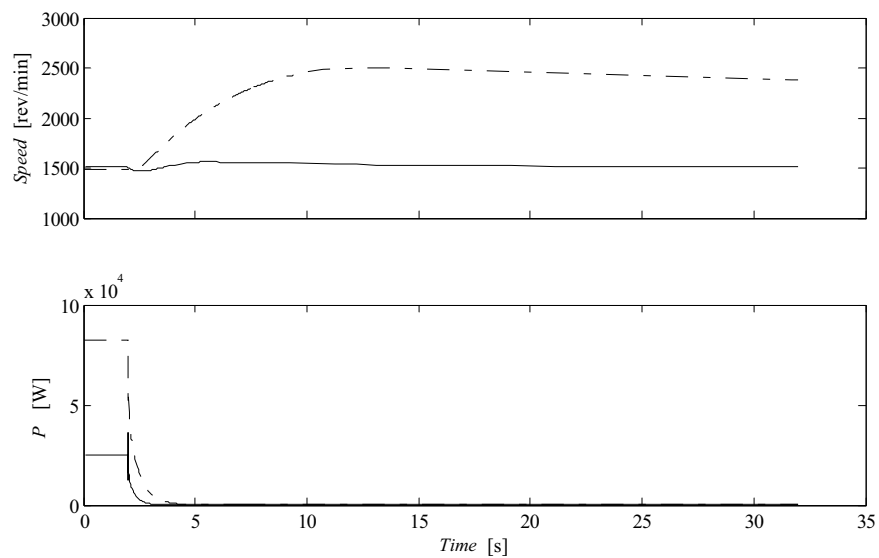

Figure A1.8.6 Three Phase fault. Generator speed, generator active power. $P_{load} = 5 \text{ kW}$ (solid lines) and $P_{load} = 85 \text{ kW}$ (dashed lines). $l_{L1} = 4 \text{ km}$, $R_f = 0 \Omega$

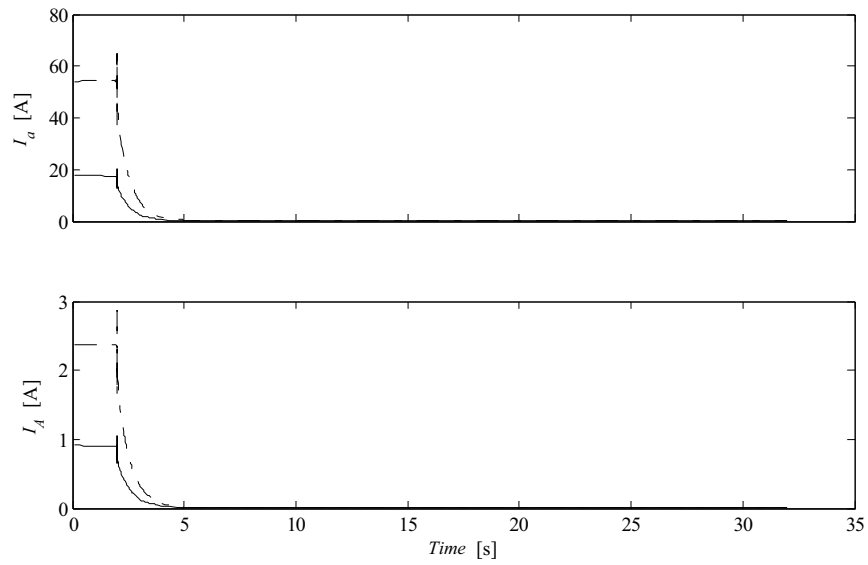

Figure A1.8.7 Three Phase fault. a) Phase current at induction generator terminals b) Phase current on the high voltage side of step up transformer. $l_{L1} = 2$ km (solid lines) and $l_{L1} = 6$ km (dashed lines). $P_{load} = 5$ kW, $R_f = 0 \Omega$

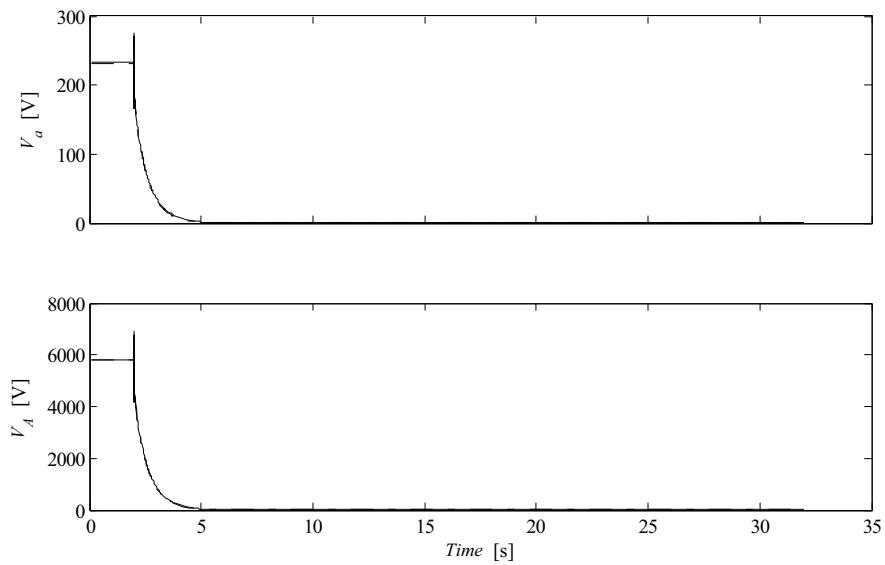

Figure A1.8.8 Three Phase fault. a) Phase voltage at induction generator terminals b) Phase voltage on the high voltage side of step up transformer. $l_{L1} = 2$ km (solid lines) and $l_{L1} = 6$ km (dashed lines). $P_{load} = 5$ kW, $R_f = 0 \Omega$

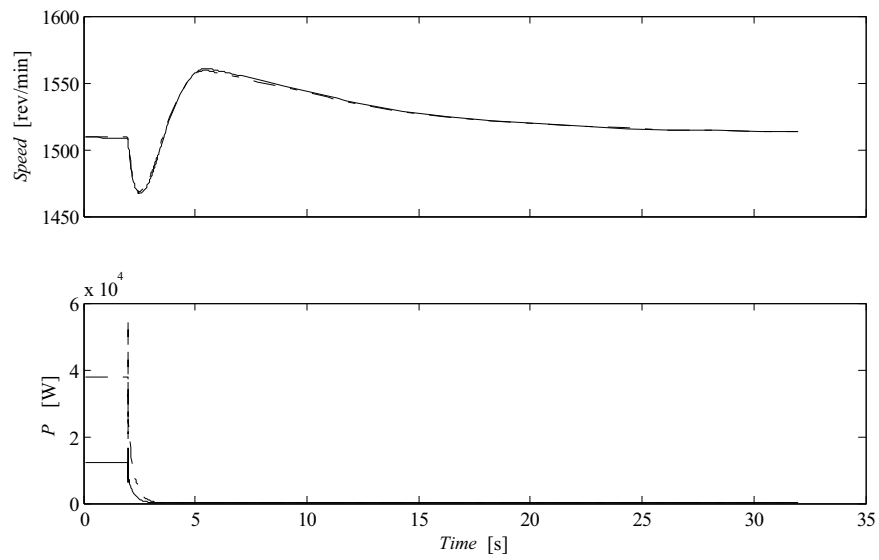

Figure A1.8.9 Three Phase fault. Generator speed, generator active power. $l_{L1} = 2$ km (solid lines) and $l_{L1} = 6$ km (dashed lines). $P_{load} = 5$ kW, $R_f = 0 \Omega$

Appendix 1.9 – Three Phase fault at 400 V side, IG terminals

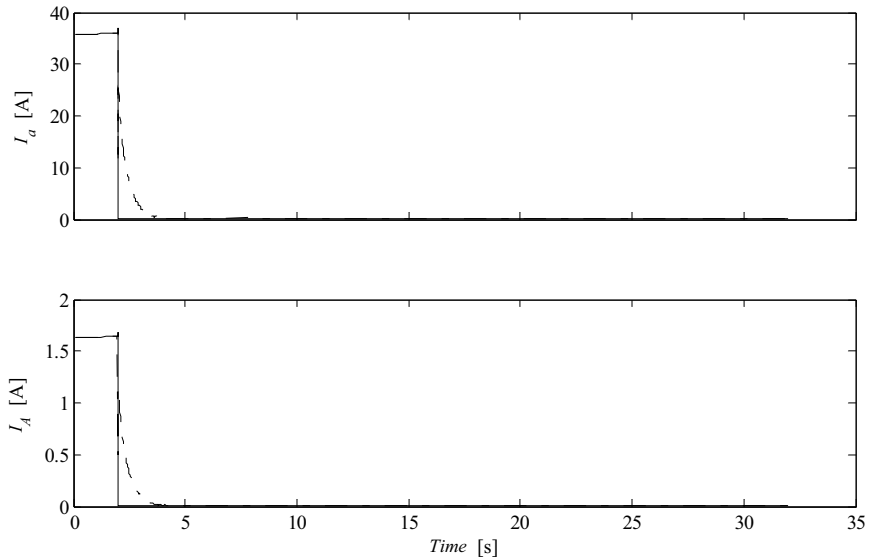

Figure A1.9.1 Three Phase fault. a) Phase current at induction generator terminals b) Phase current on the high voltage side of step up transformer. $R_f = 0 \Omega$ (solid lines) and $R_f = 0,6 \Omega$ (dashed lines). $L_{L1} = 4 \text{ km}$, $P_{load} = 5 \text{ kW}$

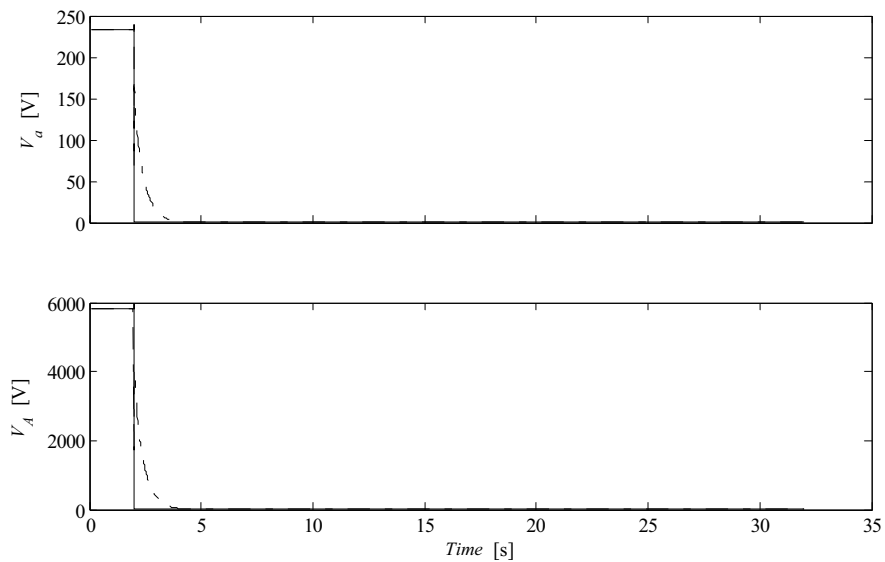

Figure A1.9.2 Three Phase fault. a) Phase voltage at induction generator terminals b) Phase voltage on the high voltage side of step up transformer. $R_f = 0 \Omega$ (solid lines) and $R_f = 0,6 \Omega$ (dashed lines). $L_{L1} = 4 \text{ km}$, $P_{load} = 5 \text{ kW}$

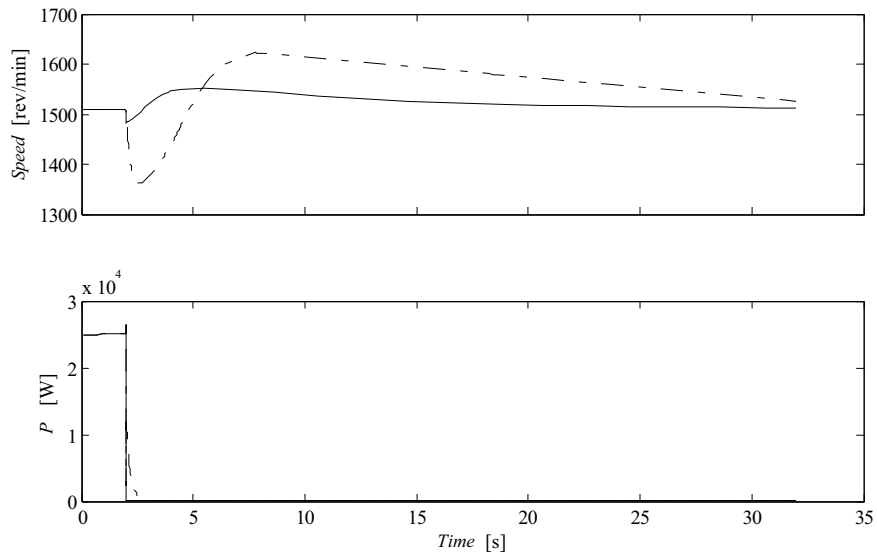

Figure A1.9.3 Three Phase fault. Generator speed, generator active power. $R_f = 0 \Omega$ (solid lines) and $R_f = 0,6 \Omega$ (dashed lines). $L_{L1} = 4 \text{ km}$, $P_{load} = 5 \text{ kW}$

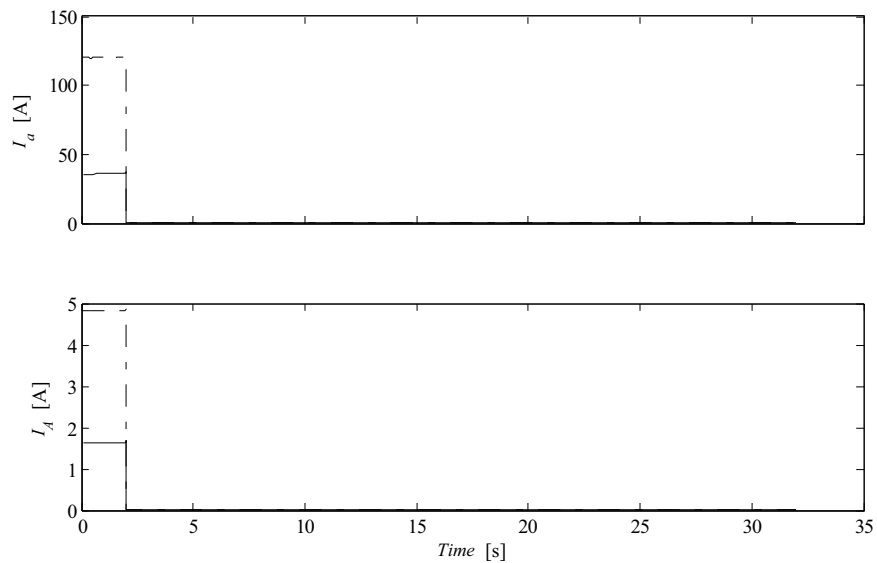

Figure A1.9.4 Three Phase fault. a) Phase current at induction generator terminals b) Phase current on the high voltage side of step up transformer. $P_{load} = 5 \text{ kW}$ (solid lines) and $P_{load} = 85 \text{ kW}$ (dashed lines). $L_{L1} = 4 \text{ km}$, $R_f = 0 \Omega$

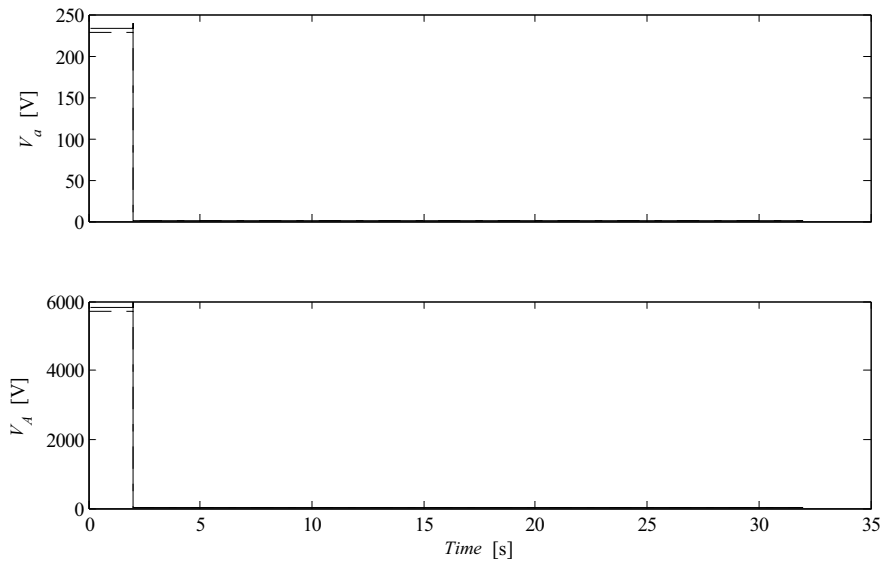

Figure A1.9.5 Three Phase fault. a) Phase voltage at induction generator terminals b) Phase voltage on the high voltage side of step up transformer. $P_{load} = 5 \text{ kW}$ (solid lines) and $P_{load} = 85 \text{ kW}$ (dashed lines). $L_{L1} = 4 \text{ km}$, $R_f = 0 \Omega$

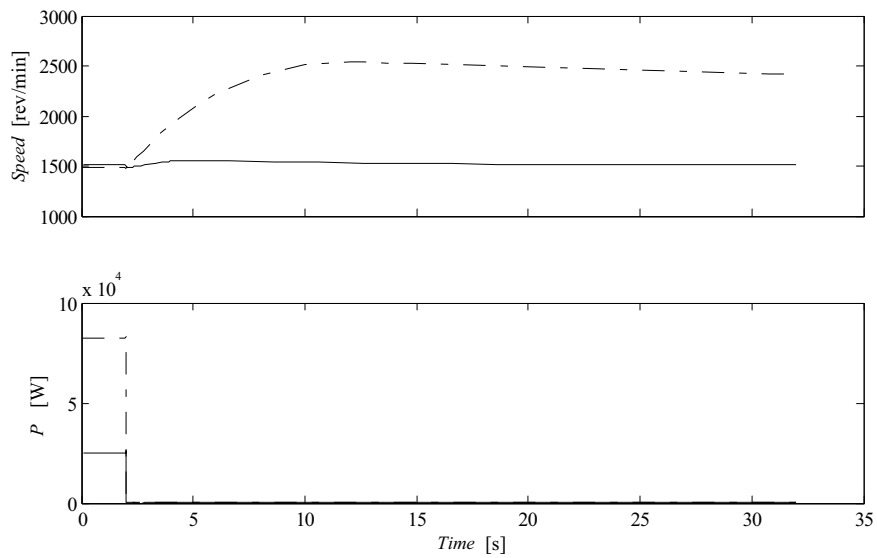

Figure A1.9.6 Three Phase fault. Generator speed, generator active power. $P_{load} = 5 \text{ kW}$ (solid lines) and $P_{load} = 85 \text{ kW}$ (dashed lines). $L_{L1} = 4 \text{ km}$, $R_f = 0 \Omega$

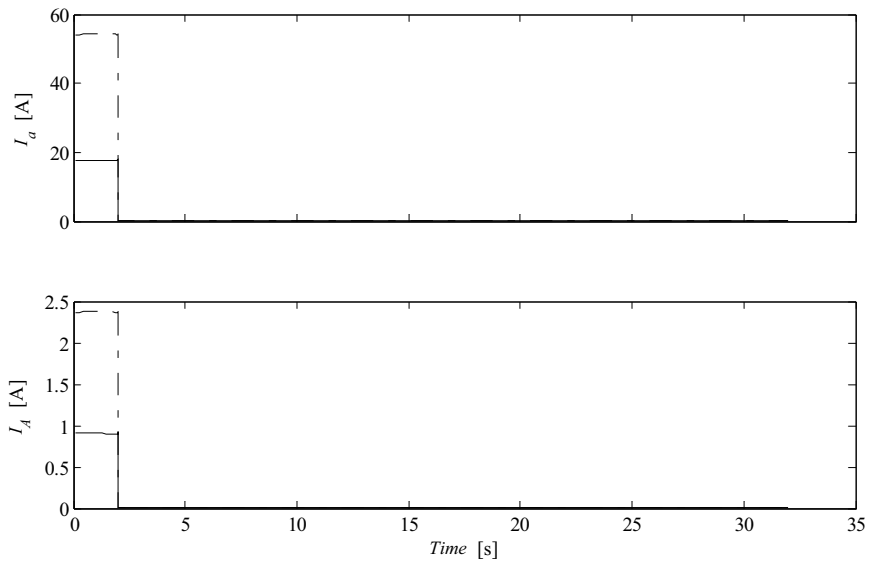

Figure A1.9.7 Three Phase fault. a) Phase current at induction generator terminals b) Phase current on the high voltage side of step up transformer. $l_{L1} = 2$ km (solid lines) and $l_{L1} = 6$ km (dashed lines). $P_{load} = 5$ kW, $R_f = 0 \Omega$

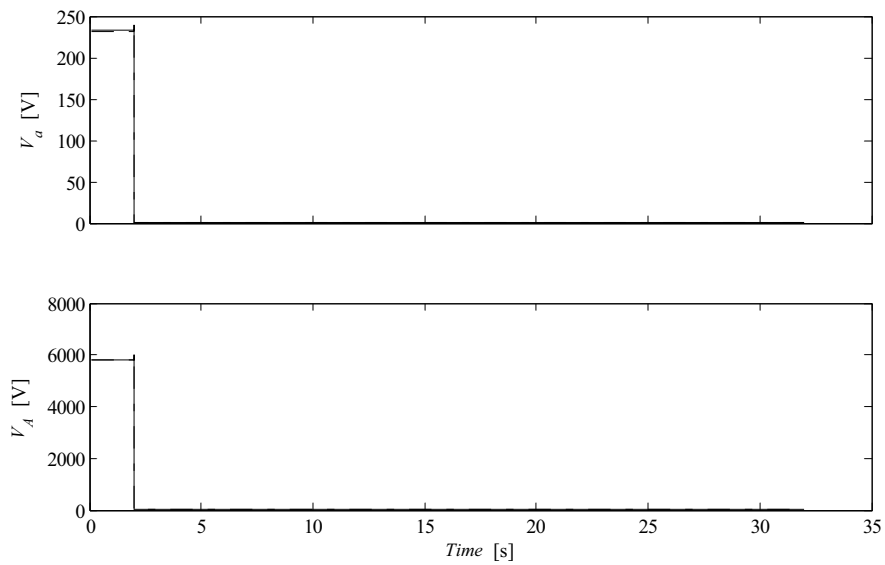

Figure A1.9.8 Three Phase fault. a) Phase voltage at induction generator terminals b) Phase voltage on the high voltage side of step up transformer. $l_{L1} = 2$ km (solid lines) and $l_{L1} = 6$ km (dashed lines). $P_{load} = 5$ kW, $R_f = 0 \Omega$

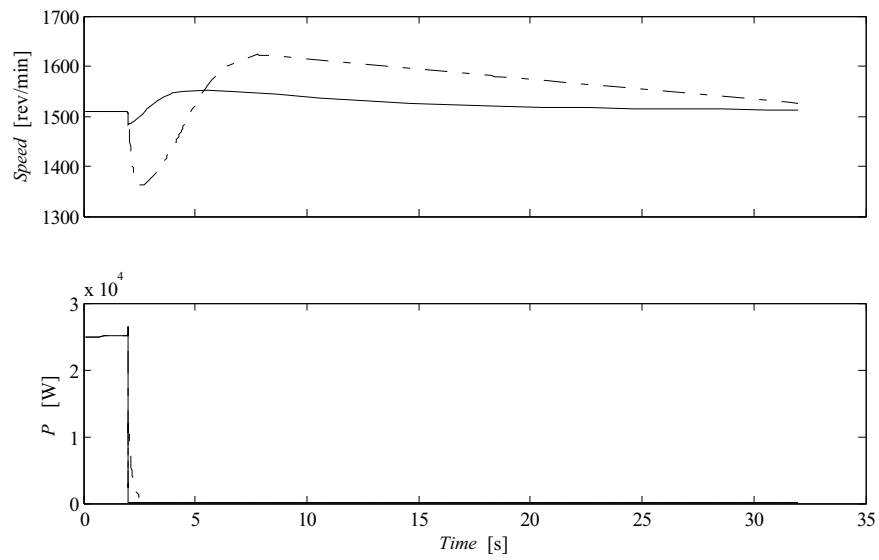

Figure A1.9.9 Three Phase fault. Generator speed, generator active power. $l_{L1} = 2 \text{ km}$ (solid lines) and $l_{L1} = 6 \text{ km}$ (dashed lines). Pload = 5 kW, $R_f = 0 \Omega$