



LUND UNIVERSITY

Particulate Matter Emissions from Partially Premixed Combustion with Diesel, Gasoline and Ethanol

Shen, Mengqin

2016

Document Version:

Publisher's PDF, also known as Version of record

[Link to publication](#)

Citation for published version (APA):

Shen, M. (2016). *Particulate Matter Emissions from Partially Premixed Combustion with Diesel, Gasoline and Ethanol*. Lund University Faculty of Engineering Department of Energy Sciences Division of Combustion Engines P.O. Box 118, SE-221 00 LUND Sweden.

Total number of authors:

1

Creative Commons License:

Unspecified

General rights

Unless other specific re-use rights are stated the following general rights apply:

Copyright and moral rights for the publications made accessible in the public portal are retained by the authors and/or other copyright owners and it is a condition of accessing publications that users recognise and abide by the legal requirements associated with these rights.

- Users may download and print one copy of any publication from the public portal for the purpose of private study or research.
- You may not further distribute the material or use it for any profit-making activity or commercial gain
- You may freely distribute the URL identifying the publication in the public portal

Read more about Creative commons licenses: <https://creativecommons.org/licenses/>

Take down policy

If you believe that this document breaches copyright please contact us providing details, and we will remove access to the work immediately and investigate your claim.

LUND UNIVERSITY

PO Box 117
221 00 Lund
+46 46-222 00 00

Particulate Matter Emissions from Partially Premixed Combustion with Diesel, Gasoline and Ethanol

Mengqin Shen



LUND
UNIVERSITY

DOCTORAL DISSERTATION

by due permission of the Faculty of Engineering, Lund University, Sweden.

To be defended at M-building, LTH, room M: B, 15/06 2016, 10.15.

Faculty opponent

Dr Stephen A. Ciatti, Argonne National Lab, USA

Organization LUND UNIVERSITY	Document name DOCTORAL DISSERTATION	
Author Mengjin Shen	Date of issue	
	Sponsoring organization KCFP and Swedish Energy Agency	
Title and subtitle Particulate Matter Emissions from Partially Premixed Combustion with Diesel, Gasoline and Ethanol		
<p>Abstract</p> <p>To achieve cleaner combustion and higher efficiency in compression ignition (CI) engines, many new combustion strategies have been developed. Among these new concepts, partially premixed combustion (PPC) attracts a lot of attention, because of its possibility to achieve simultaneously low soot and NO_x. Compared to homogeneous charge compression ignition (HCCI) combustion, charge stratification in PPC can lead to increased soot emissions. This thesis deals with questions related to soot emissions in PPC. The main focus is to gain information and better understanding of soot particle characteristics with diesel, gasoline and ethanol fuels with varied in-cylinder emission control parameters.</p> <p>By means of injection timing, it is possible to have combustion from HCCI into PPC mode with the assistance of intake temperature. PPC shows benefits of higher engine efficiency and lower UHC and CO emissions over HCCI. However, it can also face the challenges of higher soot emissions. The study carried out with altered dilutions and different kinds of fuels illustrates that NO_x emissions can be suppressed by increasing exhaust gas recirculation (EGR) or reducing intake pressure, but at the expense of an increase in soot emissions with diesel and gasoline fuels. The significant soot increase and largely reduced engine efficiency in stoichiometric operations also indicated low possibility for clean PPC with simple three-way catalyst with these fuels. On the contrary, ethanol emitted close to zero level soot emissions regardless of variations in engine operating parameters. This has made it an attractive fuel for PPC study.</p> <p>To be compliant with future stringent exhaust gas legislations for CI engines, soot exhaust after-treatment system may need together with new fuel strategies in PPC operations. Hence, information of the corresponding soot particle characteristics, including particle number and size, is necessary. Ethanol, high-octane and low-octane gasoline were used to perform PPC soot emissions investigations, with diesel fuel as a comparison. In-cylinder emission control parameters, such as injection timing, intake temperature, EGR and injection pressure were selected and tested to find their effects on soot emissions. Retarding injection timing can increase fuel stratification, which resulted in increased soot emissions of larger particle size and higher number density. Other engine parameters showed two quite different trends for fossil fuels and ethanol fuel respectively. When EGR increased, first soot mass emissions increased with higher particle number and larger size. Upon higher EGR, soot mass decreased with smaller particles and lower particle number concentration. Increasing intake temperature or reducing injection pressure can promote soot production with larger particle size and higher particle number concentration. Compared to diesel, gasoline showed great improvements in emission levels due to lower particle number emissions and smaller particle sizes, particularly with high octane gasoline fuel. On the other hand, ethanol produced ultra-low soot mass emissions and number emissions in all condition. Consequently it requires less engine efficiency compromises to comply with the legislation standards. In the meantime, the exhaust after-treatment system can be simplified. Very slight soot emission change in response to variations in engine conditions also increases the robustness.</p> <p>In addition to the findings in the exhaust, an in-cylinder soot particle analysis was done via in-cylinder gas fast sampling technique and on-line aerosol instruments. It has revealed that during combustion, EGR reduced both soot formation and soot oxidation, but the more reduced soot oxidation was the main reason for increased soot mass emissions in diesel PPC. Comparison of soot processes with gasoline and diesel indicated that, very low soot formation was the main reason for lower exhaust soot emissions in gasoline PPC. Much larger particles were formed in diesel PPC.</p>		
Key words PPC, PM emissions, Diesel, Gasoline, Ethanol, Particle size distribution		
Classification system and/or index terms (if any)		
Supplementary bibliographical information	Language English	
ISSN and key title 0282-1990	ISBN 978-91-7623-785-4 (print) 978-91-7623-784-7 (pdf)	
Recipient's notes	Number of pages 196	Price
	Security classification	

 Signature Mengjin Shen

 Date 2016-05-12

Particulate Matter Emissions from Partially Premixed Combustion with Diesel, Gasoline and Ethanol

Doctoral Thesis

Mengqin Shen

Division of Combustion Engines
Department of Energy Sciences

Lund, Sweden, June 2016



LUND
UNIVERSITY

To my son

ISBN 978-91-7623-785-4 (printed version)
978-91-7623-784-7 (electronic version)
ISRN LUTMDN/TMHP-16/1118-SE
ISSN 0282-1990

Division of Combustion Engines
Department of Energy Sciences
Faculty of Engineering
Lund University
P.O. Box 118
SE-221 00 Lund
Sweden

Copyright © 2016 by Mengqin Shen. All rights reserved.
Printed in Sweden by Tryckeriet i E-huset, Lund, May 2016.

Abstract

To achieve cleaner combustion and higher efficiency in compression ignition (CI) engines, many new combustion strategies have been developed. Among these new concepts, partially premixed combustion (PPC) attracts a lot of attention, because of its possibility to achieve low soot and NO_x simultaneously. Compared to homogeneous charge compression ignition (HCCI) combustion, charge stratification in PPC can lead to increased soot emissions. This thesis deals with questions related to soot emissions in PPC. The objective is to gain information and better understand the soot particle characteristics from diesel, gasoline and ethanol fuels with varied in-cylinder emission control parameters.

By means of injection timing, it is possible to have combustion from HCCI into PPC mode with the assistance of intake temperature. PPC shows benefits of higher engine efficiency and lower UHC and CO emissions than HCCI. However, it can also face the challenges of higher soot emissions. The study carried out with altered dilutions and different kinds of fuels illustrates that NO_x emissions can be suppressed by increasing exhaust gas recirculation (EGR) or reducing intake pressure, but at the expense of increased soot emissions with diesel and gasoline fuels. The significant soot increase and largely reduced engine efficiency in stoichiometric operations also indicated low possibility for clean PPC with simple three-way catalyst with these fuels. On the contrary, ethanol emitted close to zero level soot emissions regardless of the variations in engine operating parameters. This has made it an attractive fuel for PPC study.

To be compliant with future stringent exhaust gas legislations for CI engines, soot exhaust after-treatment system may need together with new fuel strategies in PPC operations. Hence, information of the corresponding soot particle characteristics, including particle number and size, is necessary. Ethanol, high-octane and low-octane gasoline were used to perform PPC soot emissions investigations, with diesel fuel as a comparison. In-cylinder emission control parameters, such as injection timing, intake temperature, EGR and injection pressure were selected and tested to find their effects on soot emissions. Retarding injection timing increased fuel stratification, which resulted in increased soot emissions of larger particle size and higher number density. Variations of other engine parameters led to two quite different trends of soot emissions with fossil fuels and ethanol fuel. When EGR increased, first soot mass emissions increased with higher particle number and larger size. After reaching a peak value at a certain level, soot mass decreased with smaller particles and lower particle number concentration upon more EGR. Increasing intake temperature or reducing injection pressure promoted soot production with larger particle size and higher particle number concentration. Compared to diesel, gasoline showed great improvements in soot emission levels due to

lower particle number concentrations and smaller particle sizes, particularly with high octane gasoline fuel. On the other hand, ultra-low soot mass and particle number emissions were found with ethanol fuel in all condition. Consequently it requires less engine efficiency compromises to comply with the legislation standards. In the mean time, the exhaust after-treatment system can be simplified. Very slight soot emission change in response to the variations of engine conditions also increases the robustness.

In addition to the findings in the exhaust, an in-cylinder soot particle analysis was done via in-cylinder gas fast sampling technique and on-line aerosol instruments. The results revealed that during combustion, EGR reduced both soot formation and soot oxidation, but the more reduced soot oxidation was the main reason for increased soot mass emissions with EGR. Comparison of soot processes with gasoline and diesel indicated that much lower soot formation was the main reason for lower exhaust soot emissions from gasoline PPC operation. Diesel particle size distributions appeared to have only an accumulation mode, while gasoline particle size distributions had a nucleation mode that was always present and dominated, and a soot/accumulation mode presented only when soot mass was simultaneously detected.

Populärvetenskaplig sammanfattning

Analys av verkningsgrad och partikelutsläpp med delvis förblandad förbränning (PPC) med diesel, bensen och etanol

Slutsatsen från arbetet är att nya bränslestrategier för att komplettera motorns styrparametrar kan vara ett kraftfullt verktyg för fortsatt minskning av partikelutsläpp i dieselmotorer. De förändrade partikelegenskaper som syntes från de olika bränslena kan få konsekvenser för effektiviteten av efterbehandlingssystem. Tillsammans med rätt avgasefterbehandling har PPC stor potential som en ren motor med hög verkningsgrad.

PPC-förbränning är ett nytt förbränningskoncept för kompressionständning / dieselmotorer. Med det här konceptet blandas bränsle och luft mer än vid dieselförbränning, innan blandningen självantänds. Blandningen brinner snabbare än med konventionell dieselförbränning. Genom att använda mycket luft eller avgasåtercirkulation (EGR) sänks förbränningstemperaturen. Den snabba förbränningen och låga förbränningstemperaturen resulterar i att värmeförlusterna minskas. Motorns verkningsgrad är högre än vid konventionell dieselförbränning, följaktligen kan man uppnå lägre bränsleförbrukning. Koldioxidutsläppen (CO_2) är proportionella mot bränsleförbrukningen. Genom att öka verkningsgraden, kan CO_2 -utsläppen minskas vilket minskar påverkan på den globala uppvärmningen. Dieselmotorns höga motoreffektivitet behålls, samtidigt som utsläppen av partiklar och kväveoxider minskas på grund av bättre bränsle-luftblandning och sänkt förbränningstemperatur. Dessutom, vid användning av biobränslen såsom etanol, är det möjligt att ytterligare reducera utsläppen och minska vårt oljeberoende.

I det här arbetet presenteras analys av hög verkningsgrad och låga utsläpp av partiklar med PPC genom att utföra experiment i en dieselmotor av lastbilstyp. Etanol och bensen används för jämförelse med konventionell diesel.

Genom att ändra motorns driftsparametrar såsom mängden luft och recirkulerade avgaser, kunde motoregenskaper och energiförluster analyseras och jämföras mellan de olika bränslena. Etanol gav hög verkningsgrad och nästan inga partikelutsläpp. Bensen gav högre partikelutsläpp, men gav stora förbättringar jämfört med diesel, både för motorns verkningsgrad och partikelutsläpp.

För att kunna utforma ett effektivt efterbehandlingssystem för avgaserna, är det önskvärt att få kunskap om partiklarnas egenskaper, inte bara partikelmassa, som vanligtvis är vad som studeras. Partikelantal och partikelstorlek från förbränning med etanol, bensen och diesel presenteras. Resultaten visar att partiklar

från etanol var mycket små, i storleksordningen 5- 20 nm. Bensin och dieselpartiklar var mycket större än så. Bensin gav lägre partikelantal och mindre storlek på partiklarna än diesel.

List of Publications

This thesis is based on the following papers, which will be referred to in the text by their Roman numerals. The papers are appended to the thesis.

- I** Shen, M., Tuner, M., Johansson, B., "*Close to Stoichiometric Partially Premixed Combustion -The Benefit of Ethanol in Comparison to Conventional Fuels*", SAE Technical Paper 2013-01-0277, 2013, doi:10.4271/2013-01-0277.
- II** Shen, M., Tuner, M., Johansson, B., and Cannella, W., "*Effects of EGR and Intake Pressure on PPC of Conventional Diesel, Gasoline and Ethanol in a Heavy Duty Diesel Engine*", SAE Technical Paper 2013-01-2702, 2013, doi:10.4271/2013-01-2702.
- III** Shen, M., Lonn, S., and Johansson, B., "*Transition from HCCI to PPC Combustion by Means of Start of Injection*", SAE Technical Paper 2015-01-1790, 2015, doi:10.4271/2015-01-1790.
- IV** Shen, M., Malmborg, V.B., Gallo, Y., Waldheim, B. et al., "*Analysis of Soot Particles in the Cylinder of a Heavy Duty Diesel Engine with High EGR*", SAE Technical Paper 2015-24-2448, 2015, doi:10.4271/2015-24-2448.
- V** Shen, M., Johansson, B., Tuner, M., and Tunestal, P., "*Influence of Injection Timing on Exhaust Particulate Matter Emissions of Gasoline in HCCI and PPC*".

Manuscript submitted for publication and presentation at the SAE 2016 International Powertrain, Fuels & Lubricants Meeting, October 24-26, 2016 at Baltimore, Maryland, USA.

- VI** Shen, M., Shamun, S., Johansson, B., Pagels, J. et al., "*Exhaust soot particle size distributions in partially premixed combustion using ethanol, gasoline and diesel in a heavy-duty compression ignition engine*".

Manuscript to be submitted to Journal Fuel, 2016.

- VII** Shen, M., Waldheim, B., Johansson, B., Pagels, J. et al., "*Analysis of in-cylinder soot process in partially premixed combustion with gasoline in comparison to diesel*".

Manuscript to be submitted to Journal Fuel, 2016.

Other related works

- Shen, M., Shamun,S., Johansson, B., Tuner, M. et al., "*Measurement of Gasoline Exhaust PM Emissions with a Wide-Range EGR in a Heavy-Duty Diesel Engine*".

Manuscript to be submitted.

- Arunachalam, P., Shen, M., Tuner, M., Tunestal, P. et al., "*Waste Heat Recovery from Multiple Heat Sources in a HD Truck Diesel Engine Using a Rankine Cycle - A Theoretical Evaluation*", SAE Technical Paper 2012-01-1602, 2012, doi:10.4271/2012-01-1602.
- Shamun,S., Shen, M., Johansson, B., Tuner, M. et al., "*Exhaust PM Emissions Analysis from Alcohol Fueled Heavy-Duty Engine utilizing PPC*".

Manuscript submitted for publication and presentation at the SAE 2016 International Powertrain, Fuels & Lubricants Meeting, October 24-26, 2016 at Baltimore, Maryland, USA.

- Malmborg, V. B., Eriksson, A.C., Shen, M., Nilsson, P. et al., "*Evolution of in-cylinder diesel soot characteristics investigated with on-line aerosol mass spectrometry*".

Manuscript to be submitted for the journal of Environmental science and technology (ES & T).

Acknowledgments

Many people have contributed to the content of this thesis and I am grateful to all of them. First of all, I would like to express my gratitude to Professor *Bengt Johansson* who was my main supervisor for five years from 2010 to 2015. He has very impressive knowledge in combustion engine fundamentals and so many smart ideas. I wish I could have had more time to test them all. I got a lot of confidence and help from him in my research especially when I was frustrated. He also helped to improve my presenting skills. I have learned a lot from him and I would like to thank him for always being so supportive. It was nice and fun to work with him. *Thank you, Bengt!*

I am equally thankful to my current main supervisor, Professor *Per Tunestål*, for all the guidance and support in my doctoral studies. I am always impressed by his profound knowledge, within the field of combustion engines as well as in culture and many other areas. It is very easy and fun to discuss with him. He is very good not only at finding solutions logically and quickly, but also at explaining them clearly to the audiences. His admirable ability of presenting and summarizing inspires me a lot. He was also the first person in the division I contacted. His kind help made my plan to do my doctoral study abroad possible. All those help and supports from him are really appreciated. He is a great mentor and friend to me.

Many thanks go to Dr. *Martin Tunér*, who is my co-supervisor through my whole PhD study. I had a good start thanks to his help. We have many interesting and valuable discussions. I am also thankful to Professor *Öivind Andersson* at our division for his kind help and patience. I have gained a lot of information about soot process through the interesting discussions with him.

I would like to thank the Competence Center for the Combustion Processes, *KCFP*, and the Swedish Energy Agency for financing my project. My project's reference group members also deserve a special thank for their supports in supplying experimental hardwares and fuels. Their feedbacks on my research activities are really valuable.

There have been extensive laboratory work in my engine test cell and I have always felt well supported by all the technicians. They made great efforts to keep my engine running at all times. We have learned and developed together through the successes as well as the failures in the lab. Without their help, I would not have done my work in this thesis. I am specifically thankful to *Bertil, Kjell, Tommy, Anders, Mats*. I am grateful to *Mehrzad* for his support in discussing measurement campaigns and planning lab activities with me. Special thanks go to *Krister* for all his help with computers and emission measurement systems.

I am grateful to *Vilhelm Malmborg* and *Joakim Pagels* from Division of Ergonomics and Aerosol Technology at Lund University. They have given great supports in aerosol diagnostics and we had very nice collaborations. It was a real pleasure to work with *Vilhelm*. He is a truly nice teamwork player and a very inspiring person in trouble shooting and data analysis.

To all my colleagues at the division of combustion engines, it has been great to work with you. I got so much help in the lab, particularly with engine control programs. Thank you all for the great fun, good friendship and precious memories! A special thanks would go to my female colleagues, *Hadeel, Ida, Jessica, Maja* and *Sara*. Thank you for being there when I need help. Special thanks to the old generation, *Ashish, Guillaume, Ulf, Clément* and *Claes*, all your help and kindness are always appreciated!

Last but not the least, I would like to thank my entire family for their love and support throughout the duration of my doctoral studies abroad. Thank my better half *Zheming* for being there all the time, in good, in bad. Dear *Zheming*, thank you so much for your patience and support during the past 10 years. I would not have had come so far without you. To my son *Matthew*, mum is so grateful to your coming. You are the true gift from God and have made our life full of joy. Nothing is impossible when I look at your big smile. Now mum's book is coming and you can have more time with me!

Abbreviations and Symbols

SI	Spark ignition
CI	Compression ignition
GHG	Green house gases
CO ₂	Carbon dioxide
PM	Particulate matter
UHC / HC	Unburned hydrocarbon
CO	Carbon monoxide
NO _x	Oxides of Nitrogen
DPF	Diesel Particulate Filter
SCR	Selective Catalytic Reduction
LNC	Lean NO _x Catalyst
PPC	Partially premixed combustion
PAH	Polycyclic aromatic hydrocarbons
EGR	Exhaust gas recirculation
PN	particle number
TDC	Top dead center
LTC	Low temperature combustion
HCCI	Homogeneous charge compression ignition
PCCI	Premixed charge compression ignition
MK	Modulated kinetics
UNIBUS	Bulky combustion system
RCCI	Reactivity controlled compression ignition
IMEP _g	Gross indicated mean effective pressure
FSN	Filter Smoke Number
ISPM	Indicated Specific Particulate Mass
ISPN	Indicated Specific Particle Number
GMD	Geometric mean diameter
rBC	refractive black carbon
CA50	Crank Angle at 50% completion of heat release
aTDC	After the firing top dead center
CAD	Crank angle degree
λ	Air – fuel equivalence ratio
RON	Research octane number
MON	Motor octane number
CN	Cetane number
A/F_s Ratio	Stoichiometric air/fuel ratio
LHV	Low heating values
MK1	Environmental Class 1 Swedish diesel
EATS	Exhaust after-treatment system

Contents

1	Introduction	1
1.1	Background	1
1.2	Research Motivations	2
1.3	Method	3
1.4	Thesis Contributions	3
2	Diesel Particulates and Advanced Combustion Concepts	5
2.1	PM Emissions from Diesel Engines	5
2.2	PM Exhaust Aftertreatment	8
2.3	Low Temperature Combustion (LTC)	9
2.3.1	Temperature Control	11
2.3.2	Fuel-Air Premixing	11
3	Combustion Diagnostics	15
3.1	Efficiency Parameters	15
3.1.1	Combustion Efficiency	16
3.1.2	Thermodynamic Efficiency	17
3.1.3	Gross Indicated Efficiency	18

3.2	Heat Release Analysis	18
3.3	Evaluations of Particulate Matter Emissions	20
4	Experimental Apparatus	25
4.1	Experimental Setups	25
4.1.1	The Engine	26
4.1.2	Fuel Mass-Flow	27
4.2	Emission Measurement System	27
4.2.1	Exhaust Gaseous Emissions	28
4.2.2	Exhaust Particulate Matter Emissions	28
4.2.3	In-cylinder Particle Sampling System	28
4.3	Control and Data Acquisition System	30
4.4	Fuels	31
5	Results and Discussions	33
5.1	Soot Emission in PPC	33
5.2	Effect of EGR and Intake Pressure	36
5.3	Stoichiometric PPC	38
5.4	Exhaust Particle Size Distribution	41
5.4.1	Injection timing	41
5.4.2	EGR/Intake Oxygen Concentration	44
5.4.3	Intake temperature	48
5.4.4	Injection pressure	50
5.5	Evaluation of In-cylinder Soot Formation	52
5.5.1	Effect of EGR on Diesel	52

5.5.2 Diesel PPC vs. Gasoline PPC	53
5.6 Discussions	56
6 Summary and Conclusions	59
7 Future Work	61
Bibliography	63

Chapter 1

Introduction

1.1 Background

Internal combustion engines have a long history, which can date back to year 1876 when Otto first developed the spark-ignition (SI) engine and year 1892 when Diesel invented the compression-ignition (CI) engine [1]. The internal combustion engines are designed to convert the chemical energy contained in the fuel into mechanical power. Since they are invented, combustion engines have been widely applied in transportation and power generation. Commercial vehicles have been the most important power source for decades.

CI engines or diesel engines have found wider applications than SI engines because of general higher engine efficiency and correspondingly lower specific fuel consumption. They dominant in the heavy-duty sector, both on land and at sea. Despite its long history and wide applications, the demand for the engine improvements are still high. One of the main challenges of today's diesel engines is the negative effect of pollutants on the climate and human health. Nowadays, the global emissions of Green House Gases (GHG) are increasing. The emission of CO₂ from transport sector is considered as a big contributor [2] as the CO₂ emissions are proportional to the consumption of crude oil. In addition to the global impact, diesel engines also pose local threats due to exhaust gaseous and particle emissions. The legislated emissions from diesel engines are: Particulate Matter (PM), nitrogen oxides (NO_x), Unburned HydroCarbons (UHC), and carbon monoxide (CO), among which, NO_x and PM are the two primary pollutants. Nitrogen dioxide (NO₂), a compound of NO_x, has a strong capacity to absorb infrared rays and is about 250 times more threatening to global warming than

1.2. RESEARCH MOTIVATIONS

CO₂ at the same concentration [3]. The reaction of NO_x with sunlight produces photochemical smog. PM emissions, can inhale deeply into the lungs where it can be absorbed into the bloodstream or remain embedded in the lung parenchyma. In particular, the possible carcinogenic character of polycyclic aromatic hydrocarbons (PAH) included in a soluble organic fraction is the major cause for the health risk fears of nano particle emissions from diesel engines [4].

Another challenge with diesel engine is the consumption of conventional petroleum fuels, which is relevant to the energy security as a result of the dependency on oil import. Oil resources are gathered only in a few countries, mainly in the Middle East, which is recognized as a politically unstable region [5]. Large dependence on crude oil can lead to unsustainable energy supply and price.

Recently hydrogen fuel cell driven vehicles and pure electric vehicles have attracted a lot of attentions in an effort to reduce the reliance on fossil fuel and the engine-out emissions. However, technical challenges exist for hydrogen fuel cell systems, including cost, durability, and hydrogen storage capacity [6]. Battery systems face challenges in battery cost, performance, life, and tolerance to abuse [7]. Before those batteries and fuel cell techniques are improved further more and implemented on heavy-duty commercial transport, it is still necessary to continuously improve the efficiency of conventional fossil fuel fed engines and reduce their emissions. The potential reward of that and the potentials to increase the market penetration are still large.

Diesel Particulate Filter (DPF), Selective Catalytic Reduction (SCR) or Lean NO_x Catalyst (LNC) are commonly used to reduce particulate matter and NO_x emissions. However, those devices increase the engine cost. On the other hand, engine efficiency might be compromised to meet strict emissions regulations. It is thereby desirable to reduce the emissions already inside the cylinder with advanced combustion concepts, towards cleaner combustion with higher fuel efficiency.

1.2 Research Motivations

Partially Premixed Combustion (PPC) is a new combustion concept and it provides the potential of significant reduction of NO_x and soot emissions for diesel engines. Simultaneously it maintains high thermal efficiency. The goal of this work is to understand the PPC combustion related questions, with the focus of the engine-out particulate matter emissions from diesel fuel in comparison to that from gasoline and ethanol.

Unlike traditional diesel combustion, PPC combustion relies on a prolonged mixing time to get sufficient premixing between air and fuel prior to the auto-

ignition. It is therefore necessary to understand the effect of charge stratification on soot emissions. Given the engine operating conditions, soot formation strongly depends on air entrainment in the fuel jet as well as the oxygen in the fuel, reflecting the importance of fuel properties. Diesel is well-known as a sooty fuel while other fuels like gasoline produces less soot. Thus, in the investigation presented in this thesis, a big effort was made to sort out the different particulate characteristics between diesel fuel and gasoline, as well as the oxygenated fuel like ethanol. In-cylinder emission control parameters, such as inlet temperature, exhaust gas recirculation (EGR), injection pressure and boost level can affect the fuel-air mixing process and soot oxidations. Thereby, there is a need to get the corresponding influence on exhaust soot emissions to give a more complete picture in response to different fuel strategies. The results are expected to give implications for the efficiency of soot after-treatment systems.

1.3 Method

This work is based on experimental measurement conducted from a single cylinder engine operated in PPC mode. The in-cylinder pressure data, is used as the main source of information to calculate combustion events, such as the heat release, combustion phasing and gross indicated mean effective pressure as well as engine efficiencies. Different engine operating conditions were achieved by adjusting the inlet conditions and injection events. Emission measurement was also performed. In-cylinder soot process with diesel and gasoline fuel in PPC combustion was evaluated by extracting gas from the cylinder into on-line aerosol measurement instruments. In particular, soot particle mass, number and size were measured in the exhaust as well as inside the cylinder.

1.4 Thesis Contributions

The main contribution of the research presented in this thesis is the complementary knowledge of particulate characteristics in PPC combustion with diesel, gasoline as well as ethanol. The main contributions of this work are listed below.

- It has been demonstrated that changing the time delay between fuel injection and start of combustion can largely affect soot output, which sees more sensitivities when EGR is applied. Both particle size and number concentration increase with increased charge stratification. This indicates that injection timing, assisted with intake temperature, can be one useful emission control strategy.

1.4. THESIS CONTRIBUTIONS

- Compared to diesel, in general, gasoline emits lower soot emission of lower particle number density and smaller sizes. The lower sensitivities of soot emissions to the change of EGR, stoichiometry, injection pressure or inlet temperature makes gasoline PPC more attractive.
- The in-cylinder gas sampling results reveal that compared to diesel PPC, gasoline PPC forms much lower soot mass and organic during combustion. The much lower soot formation was the main reason for lower exhaust soot emissions in gasoline PPC.
- Ultra-low soot particle mass and number emissions are observed in ethanol PPC in response to the change of engine operating conditions, such as inlet temperature, inlet pressure, EGR and injection pressure. Very slight change in soot emissions also increases the engine robustness to the variations of operating parameters. More importantly, the non-existent soot-NO_x trade off requires less engine efficiency compromises to comply with the legislation standards while the exhaust after-treatment system can be simplified.
- The results suggest that fuel strategies to complement engine in-cylinder emission control strategies may be powerful tools for continued particle emission reduction in CI engines. The soot size and number properties obtained from different fuels and engine operating conditions could have implications for exhaust after-treatment systems design.

Chapter 2

Diesel Particulates and Advanced Combustion Concepts

2.1 PM Emissions from Diesel Engines

Due to their adverse effects on environment and health, in particular in urban areas, diesel particles have been of great concern in the past years [8]. Great efforts in engine design are taken to reduce the emissions and the regulations are becoming stricter. An example of the lower and lower European limits on PM for heavy-duty engines [9] can be seen in Table 2.1. Since the first stage in 1992, there has been a significant reduction in PM emissions, by approximately 97% from Euro I to Euro VI. In Euro VI stage, a limit value for particle number (PN) was additionally introduced.

The definition of diesel particulate matter is determined by the PM measuring technique that is used. In PM sampling, exhaust gas sample is drawn from the vehicle, diluted with air and filtered through sampling filters. The mass of particulate emissions is then measured based on the weight of PM collected on the sampling filter. Any changes in the procedure, such as a different type of sampling filter or different dilution parameters, may lead to different results [10]. PM is generally composed of three fractions, a solid fraction (soot particles and ash), a soluble organic fraction (derived products from engine oil and fuel) and a last fraction of sulfate particles. For diesel engines, typically, the fraction of soot is higher

2.1. PM EMISSIONS FROM DIESEL ENGINES

Stage	Date	Test	CO	HC	NOx	PM	PN	Smoke
			g/kWh			1/kWh	1/m	
Euro I	1992, ≤ 85 kW	ECE R-49	4.5	1.1	8.0	0.612		
	1992, > 85 kW		4.5	1.1	8.0	0.36		
Euro II	1996.10		4.0	1.1	7.0	0.25		
	1998.10		4.0	1.1	7.0	0.15		
Euro III	1999.10 <i>EEV only</i>	ESC & ELR	1.5	0.25	2.0	0.02		0.15
	2000.10		2.1	0.66	5.0	0.10 ^a		0.8
Euro IV	2005.10		1.5	0.46	3.5	0.02		0.5
Euro V	2008.10		1.5	0.46	2.0	0.02		0.5
Euro VI	2013.01	WHSC	1.5	0.13	0.40	0.01	8.0×10 ¹¹	

a - PM = 0.13 g/kWh for engines < 0.75 dm³ swept volume per cylinder and a rated power speed > 3000 min⁻¹

Figure 2.1: EU emission standards for heavy-duty diesel engines (steady-state testing)

than 50%. Other particulate matter constituents include: un/partially burned fuel/lubricant oil, bound water, wear metals and fuel-derived sulfate [11]. The structure is illustrated schematically in Figure 2.2 to the left. The idealized diesel exhaust particle number and mass weighted size distributions are presented in the same figure to the right. Particles size distributions usually show two modes, named nucleation and accumulation mode according to the particle equivalent diameter. The nucleation mode are made of particles which have equivalent diameters less than about 50 nm. This mode usually consists of volatile organic and sulfur compounds that form during exhaust dilution and cooling, and may also include solid carbon and metal compounds [10]. The accumulation mode is composed of particles which have equivalent diameters ranging from approximately 50 nm to 1000 nm. The particles are generally formed via agglomeration and may associate with adsorbed materials. The nucleation mode typically contains very low fraction of the particle mass but more than 90% of the particle number, while the accumulate mode contributes to the most of the particle mass [10].

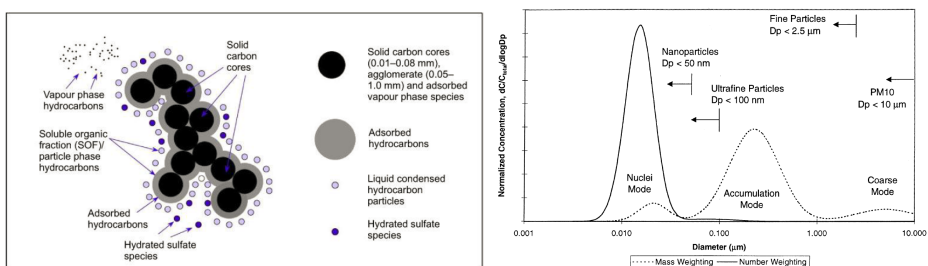

Figure 2.2: Typical composition and schematic structure (left) [12] and both mass and number weighted size distribution (right) of diesel engine exhaust particles [10].

2.1. PM EMISSIONS FROM DIESEL ENGINES

Although soot particles comprise large portion of particulates from engine, there is not a clear definition of it. But in general terms, "soot is a solid substance consisting of roughly eight parts carbon and one part hydrogen" [11]. Soot is formed in fuel-rich regions in burning diesel jets, where unburned fuel nucleates from the vapor phase into solid phase. Hydrocarbons or other available molecules may condense on, or be absorbed by soot depending on the surrounding conditions. Mechanisms behind soot formation are very complex. It can happen from liquid- or vapor-phase hydrocarbons to solid soot particles and possibly back to gas-phase products again. This process involves six commonly identified steps: pyrolysis, nucleation, coalescence, surface growth, agglomeration, and oxidation [11], the first five of which composes the soot formation process as shown schematically below in Figure 2.3.

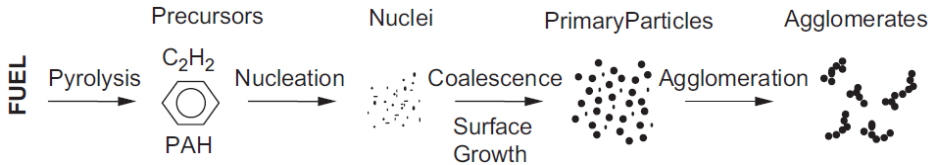

Figure 2.3: Schematic diagram of the steps in the soot formation process from gas phase to solid agglomerated particles. Reproduced from [11].

Firstly, as a result of the fuel pyrolysis, soot precursor molecules like PAH form from unburned hydrocarbons in locally fuel rich regions [13]. Pyrolysis reaction rates depend on both temperature and concentration. Then the next step, nucleation or soot particle inception, is the formation of particles from gas-phase reactants. In surface growth, the hot reactive surface of the soot particles readily accepts gas-phase hydrocarbons, leading to an increase in soot mass while the number of particles maintains constant. At last, particles collide and combine with each other in coalescence and agglomeration. Number of particles decrease as two roughly spherically shaped particles combine to form a single spherically shaped particle in coalescence. Soot aggregates are formed from individual primary particle collisions and they grow by cluster–primary particle and cluster–cluster particle collisions. The primary particles maintain their shape but chain-like structures can be formed [11, 14].

The sixth process, oxidation, is to convert hydrocarbons to CO, CO₂ and H₂O. This can happen at any point in the soot formation process shown in Figure 2.3. Soot oxidation depends on the state of the mixture including the temperature and species. It is stated to occur at a temperature higher than 1300 K [15]. The most active oxidation species are reported to be OH radicals under fuel-rich and stoichiometric conditions while under lean conditions, soot is oxidized by both OH and O₂ [16].

2.2. PM EXHAUST AFTERTREATMENT

The so named term "net soot formation" is the combination of soot formation and oxidation. As shown in Figure 2.4, the in-cylinder soot mass history is a result of competing processes to form and oxidize soot. If soot formed from fuel-rich pockets does not have time to mix and burn before exhaust valve opens, or the oxidation rate is rather low, soot particles then survive after the combustion process and exit in the exhaust. In diesel combustion, soot formation has been found to be strongly dependent on air entrainment upstream of the lift-off length of the fuel jet [17], the oxygen presence in the fuel [18] and the combustion temperature. The rate of soot oxidation depends mostly on turbulence, temperature and available oxygen during combustion. Higher temperatures at the end of combustion enhance the burnout of soot, while high temperatures at the time of injection reduce air entrainment and increase soot formation.

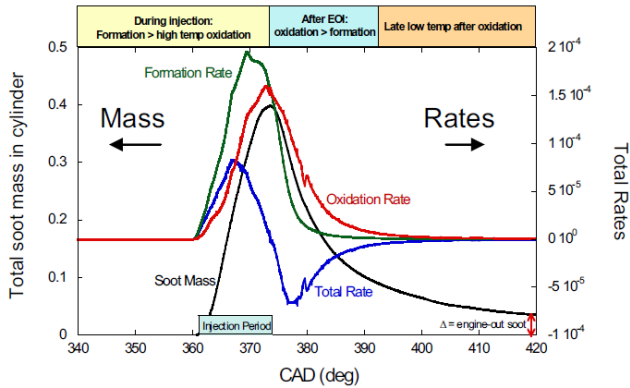

Figure 2.4: General behavior of in-cylinder soot mass history for spray controlled combustion from CFD simulations [19].

2.2 PM Exhaust Aftertreatment

The PM exhaust after-treatment is required to meet the PM emission limits that are getting glower and lower. One preferred approach is the diesel particulate filter (DPF), placing downstream of a diesel oxidation catalyst (DOC). Several types of ceramic and sintered metal DPF have been developed. The most successful and the most commonly used is the design shown schematically in Figure 2.5. A wall-flow monolith is packaged into a steel housing and the porous walls of the monolith are coated with the catalyst. Adjacent channels are alternatively plugged at each end. This forces the exhaust gas flow through the porous walls and traps the particulates in accumulation mode efficiently. In this regard, the DPF can substantially lower PM mass emissions. On the other hand, however, its effect on

2.3. LOW TEMPERATURE COMBUSTION (LTC)

particle number is ambiguous. This is because the mass is dominated by the soot accumulation mode, but the number can largely depend on nucleation particles which is very sensitive to engine operating conditions [20].

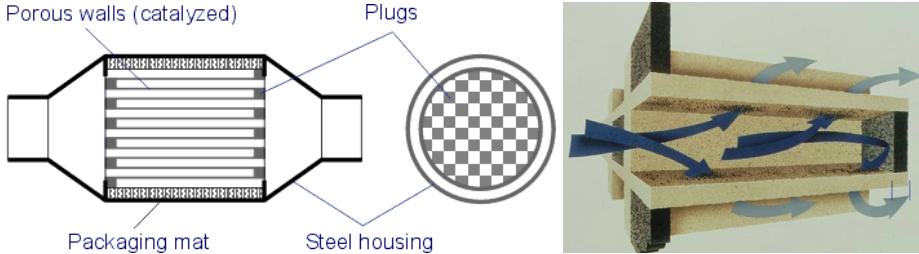

Figure 2.5: Catalyzed Diesel Particulate Filter and the wall-flow monolith [21, 22].

2.3 Low Temperature Combustion (LTC)

Exhaust after-treatment system increases the engine cost meanwhile fuel efficiency might be compromised to meet strict emissions regulations. It is thereby necessary to reduce the emissions already inside the cylinder. In an effort to reduce NO_x and soot emissions while maintaining high thermal efficiency in CI engines, many advanced combustion concepts have been developed over the years. Most these can be classified as low temperature combustion (LTC) [23]. It is very common and easy to illustrate the principles of LTC on the local equivalence ratio (Φ) versus local temperature (T) diagram relating to soot and NO_x formation, as shown in Figure 2.6. In a classic diesel combustion without EGR, a simplified description of the path is shown and indicated by the blue line. After being injected, the fuel spray starts at low temperature and high equivalence ratio and then it mixes with air. Ignition occurs shortly after the start of fuel injection and there can be fuel elements into the soot-formation area (high equivalence ratio and high temperature). As the fuel consumes, the mixing of fuel and air continues and the equivalence ratio decreases further meanwhile temperature increases, resulting in NO_x formation [24]. Since soot is mainly formed in fuel-rich zones, all LTC concepts strive to enhance premixing of fuel and air to avoid the formation of local zones with high equivalence ratio. However, over premixing of fuel and air should be avoided as it can result in too low equivalence ratios and local combustion temperature. The fuel efficiency is compromised due to the high levels of hydrocarbon and carbon monoxide emissions [25]. NO_x forms at high temperature, thus in LTC concepts, a globally dilute environment is also required to keep combustion temperature low thereby avoiding NO_x formation.

2.3. LOW TEMPERATURE COMBUSTION (LTC)

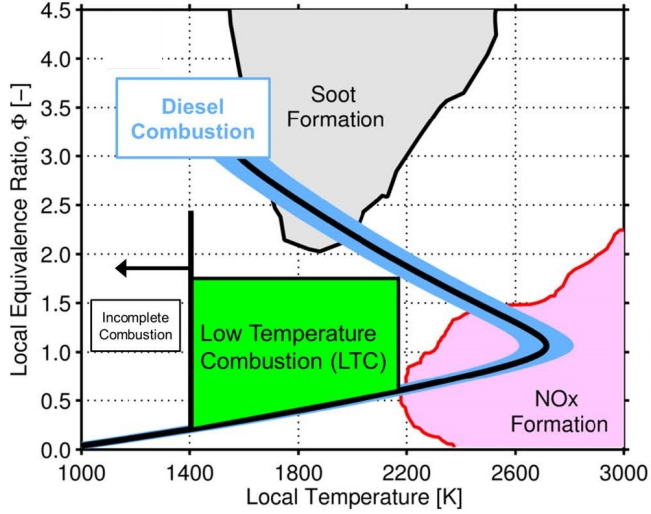

Figure 2.6: Regions of NO_x and soot formation in local equivalence ratio (Φ) versus local temperature space [23], NO_x and soot islands calculated from n-heptane chemical kinetic simulations [18].

In LTC strategies, high dilution with either air or EGR is commonly used as the key factor to reduce NO_x emissions. In terms of the large reduction in particulate matter emissions, most of the concepts have been focused on the restraint of in-cylinder soot formation. The soot emission control inside the cylinder is very complex. Soot emissions depends on temperature, fuel-air mixing and available oxygen (both in the fuel and in the charge surrounding) during combustion. Thereby, low soot levels can be realized by controlling those parameters. One way to do is to lower the combustion temperature below the levels that are required to form soot. A second way is to improve the mixture formation process, to prolong ignition delay thus sufficient fuel-air premixing to avoid soot formation. As pointed out in [18], the size and shape of the soot formation region in Figure 2.6 is strongly fuel dependent [18]. Therefore, another way is to change and control the reactivity of the fuel by reformulating the fuel composition, such as fuel reactivities, oxygen content and C/H atomic ratio. This is from a chemical standpoint. Most LTC strategies have covered all the three aspects but can have one focus to some extent.

2.3. LOW TEMPERATURE COMBUSTION (LTC)

2.3.1 Temperature Control

Smokeless rich combustion [26] has been examined by utilizing a large amount of cooled EGR. The results showed that the smoke suppression was realized as combustion took place below temperatures that are required to generate the soot particles. Smokeless conditions can be obtained regardless of fuel-air mixing quality. However, this concept is limited to relatively light loads. It has been reported that, with increased engine load, the overall excess air ratio fell below the stoichiometric range for smokeless low temperature combustion, meanwhile the combustion efficiency deteriorated to unacceptable levels [27]. This somehow can be improved by utilizing oxygenated fuels [18].

2.3.2 Fuel-Air Premixing

Soot can be reduced by improving the mixture formation process, to achieve either a homogeneous or a stratified charge condition throughout the combustion chamber prior to autoignition. It can avoid the soot formation in mixing controlled combustion. This is based on the dependence of soot particle formation on the equivalence ratio.

HCCI

Homogeneous Charge Compression Ignition (HCCI) concept is based on compression ignition of a fully premixed fuel and air [28–31]. Fuel is injected in the port or very early before compression. With high EGR rates, HCCI combustion has the potential to achieve the near-zero NO_x as well as smoke emissions [32]. Nevertheless, there are challenges associated with combustion efficiency (i.e. UHC and CO emissions), narrow operable load range, high pressure rise rates. Particularly, in HCCI, it is hard to control combustion timing as the initiation of combustion is governed by the chemical kinetics [33, 34]. As a result, there is a need of low temperature combustion that allows some degree of control on the combustion phasing through fuel injection events while having low emissions.

PCCI

Premixed Charge Compression Ignition (PCCI) is considered as a variant of HCCI. It is capable of controlling combustion phasing while still producing HCCI-like emissions [35]. There is a separation in time of the fuel injection and combustion

2.3. LOW TEMPERATURE COMBUSTION (LTC)

events. In practice, this enables prolonged ignition delay, which can be realized via various methods.

Kimura et al.[36] have suggested a low-temperature premixed combustion by using the combination of a large amount of cooled EGR and late injection, named modulated kinetics (MK) combustion. In the concept, with high swirl and EGR level but retarded injection after TDC, a sufficient mixing time is achieved by prolonging the ignition delay. In order to expand the load range, reduced compression ratio was induced with cooled EGR [37]. On the other hand, however, retarding of the injection timing to TDC or after TDC can result in the reduction of the engine efficiency and operating range even with all kinds of injection strategies and increased turbocharger boost pressure.

A relatively early (i.e. at roughly two thirds of the compression stroke) fuel injection strategy can be applied to PCCI combustion [38, 39]. At such early direct injection timings, the gas temperatures and pressures are typically too low to support autoignition, but can facilitate fuel vaporization [35]. Nevertheless, the significant amount of premixing can result in a decoupling of the injection and combustion events [40]. Hasegawa and Yanagihara [41, 42] proposed the concept of Uniform Bulky Combustion System (UNIBUS) with stratified charge compression ignition. In this two-stage injection diesel combustion, a first injection was introduced early during the compression stroke to form premixed mixture and low temperature combustion. The second injection before TDC was used to trigger the combustion. In these approaches with early injections, however, the formation of homogeneous mixture without fuel-wall interaction is the biggest challenge for achieving high efficiencies and reducing UHC emissions.

PCCI performance can be improved by using a less reactive fuel with a lower Cetane Number (CN) [43, 44]. Dual-fuel PCCI has been widely investigated. Reactivity Controlled Compression Ignition (RCCI) concept was developed by Reitz and utilizes at least two fuels differing greatly in reactivities [45–48]. The process is characterized by an early port fuel injection during the intake stroke and a direct injection during the compression stroke. The former one usually employs a low reactivity fuel like gasoline, to create a well-mixed charge of fuel, air and EGR. The latter direct injection with a high reactivity fuel like diesel, allows the ignition of the premixed charge. By changing the ratio between the low- and high-reactivity fuels, the combustion events can be controlled.

The decoupling of the injection and combustion events and high UHC emissions in PCCI with early injection strategy can be improved also by a relatively late injection before TDC. By utilizing fuel that is more resistant to autoignition than diesel, a much earlier injection is possibly without early combustion. Gasoline Partially Premixed Combustion (PPC) has got great attention because of significant reduction of NO_x and soot while maintaining high thermal efficiency

2.3. LOW TEMPERATURE COMBUSTION (LTC)

simultaneously [49–55]. Fuel is injected near TDC during compression stroke and combustion phasing is highly coupled with fuel injection timing. By using low compression ratio, large amount of EGR and different types of fuels, combustion occurs with proper stratified mixture. Adequate but not over premixing of fuel and air results in low soot and low combustion temperature suppresses NO_x formation. CO and UHC emissions are improved in the meantime [51]. The problem with diesel in PPC is the difficulty to achieve a premixed charge at high load conditions even with a high level of EGR. On the other hand, gasoline, due to higher resistance to auto-ignition, can be injected earlier, which allows longer time for fuel to mix with air. Meanwhile, gasoline is a fuel that is less prone to soot formation than diesel. It was observed by Kalghatgi et al. that the engine could be run with gasoline in PPC mode at conditions where it could not be run with early injection in HCCI mode either because of failure to autoignite or because of excessive pressure rise rates [49, 50]. Sellnau et al. [56, 57] also reports that compared to diesel, higher efficiency and much lower soot emissions has been achieved with 91 RON pump fuel gasoline in a single cylinder light duty engine with the Gasoline Direct-injection Compression Ignition (GDCI) strategy. Manente et al. [53, 54] at Lund University developed a gasoline PPC strategy using a variety of gasoline fuels with different octane numbers in a single cylinder heavy-duty engine. Results show that gasoline fuels especially those with high octane number generated close to zero level of soot emissions in a engine load sweep wherein soot increased rapidly with diesel fuel. Recent research indicates that soot emissions can be further reduced by utilizing ethanol and different surrogate fuels with or without oxygen content [58–60].

Despite lower soot mass emissions in PPC with gasoline than diesel, high soot emissions can be produced, especially under high engine load and high EGR conditions [54, 61, 62]. To get a ultra-clean engine over the whole operating range, it is still necessary to have some simple exhaust soot after-treatment system. Consequently, particulate characteristics, not only the particle mass as is usually measured, needs further studies. The main work of the thesis is then devoted to provide informations of particle size and number, as well as soot mass concentration, with different kinds of fuels under various engine conditions.

2.3. LOW TEMPERATURE COMBUSTION (LTC)

Chapter 3

Combustion Diagnostics

This chapter gives an overview of the diagnostic techniques used for extracting and analyzing data in the studies presented in this thesis. Several diagnostic techniques were used to analyze the data collected during experiments to understand the behavior of the in-cylinder combustion and the engine-out emissions. It begins by discussing the efficiency of various stages through converting fuel energy into mechanical work, based on the measured cylinder pressure, fuel flow and emissions in the exhaust. The second diagnostic technique presented is the in-cylinder heat release analysis. The calculation is also based on the measured cylinder pressure. All these calculations refer to the fundamentals of a reciprocating type engine operating on a 4-stroke cycle in [13]. Finally, the methods for evaluating particle emissions are briefly discussed.

3.1 Efficiency Parameters

In an internal combustion engine, fuel chemical energy is converted into mechanical work in several stages which is depicted in a Sankey diagram in Figure 3.1 below. The flow of energy through each of these stages and the energy losses are described in the text below the figure, both presented as Mean Effective Pressure (MEP) which is defined as the work or energy per cycle normalized by the engine's displacement volume. Since in all the studies presented in the thesis are done on a modified single-cylinder engine, the evaluation stops at gross indicated efficiency and the rest of the efficiency calculations are left out of the thesis.

3.1. EFFICIENCY PARAMETERS

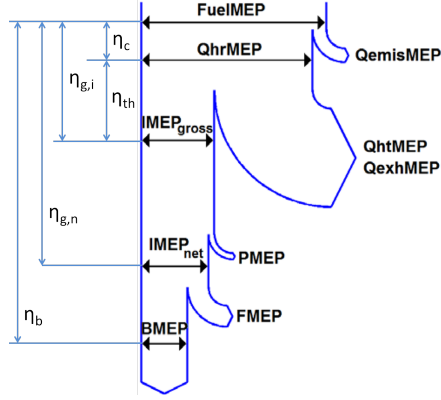

Figure 3.1: Sankey diagram of mean effective pressures

Effective energy or work:

- $FuelMEP$: Energy contained in the fuel
- $QhrMEP$: Chemical energy released in the combustion chamber
- $IMEP_{gross}$: Work delivered to the piston over compression and expansion strokes only
- $IMEP_{net}$: Work delivered to the piston over the entire four-stroke cycle
- $BMEP$: Mechanical work delivered at the output shaft

Energy losses:

- $QemisMEP$: Chemical energy lost due to incomplete combustion
- $QhtMEP/QexhMEP$: Energy (heat) lost by heat transfer and exhaust
- $PMEP$: Energy (mechanical work) lost in pumping work
- $FMEP$: Energy (mechanical work) lost in overcoming mechanical friction

3.1.1 Combustion Efficiency

The conversion starts with the combustion of fuel during which the the supplied fuel energy ($FuelMEP$) is released as heat in the combustion chamber ($QhrMEP$). The energy lost ($QemisMEP$) in this stage is due to incomplete combustion, which can be estimated from the measured emission species like UHC and CO etc. in the engine exhaust. The efficiency of this stage reflects how much of the fuel energy is converted into heat, therefore is named Combustion Efficiency and can be calculated by Equation 3.1.

3.1. EFFICIENCY PARAMETERS

$$\eta_c = \frac{Q_{hr}MEP}{FuelMEP} = 1 - \left(\frac{Q_{emis}MEP}{FuelMEP} \right) \quad (3.1)$$

where, $FuelMEP$ value is calculated by normalizing the fuel energy by the engine displacement volume as expressed in Equation 3.2. The combustion efficiency can be estimated from the incomplete combustion products in the exhaust by Equation 3.3. Hence, the combustion efficiency, η_c , can be calculated as shown in Equation 3.4, where all variables can be measured experimentally.

$$FuelMEP = \frac{m_f \cdot Q_{LHV,f}}{V_D} \quad (3.2)$$

$$Q_{ht}MEP = \frac{\sum_{i=1}^n m_i \cdot Q_{LHV,i}}{V_D} \quad (3.3)$$

where m_f is fuel mass flow per cycle, $Q_{LHV,f}$ is the lower heating value of the fuel, n is the number of combustion products, m_i is the mass flow of the individual combustion product per cycle, $Q_{LHV,i}$ is the corresponding lower heating value and V_D is the engine's displacement volume.

$$\eta_c = \frac{\sum_{i=1}^n m_i \cdot Q_{LHV,i}}{m_f \cdot Q_{LHV,f}} \quad (3.4)$$

3.1.2 Thermodynamic Efficiency

The second stage is the conversion of heat released in the combustion chamber ($Q_{hr}MEP$) into mechanical work delivered to the piston during the expansion phase of the cycle. The biggest energy loss in the entire process can be found during this process. As also shown in Figure 3.1, energy loss during this stage is due to heat transfer ($Q_{ht}MEP$) in the cylinder and heat of exhaust gases ($Q_{exh}MEP$).

The measured cylinder pressure P and the cylinder volume V are used to calculate the mechanical work transfer to the piston. $IMEP_g$ indicates the work delivered to the piston during the compression and expansion stroke while that transferred over all four - strokes is expressed as $IMEP_n$, as shown in equations 3.5 and 3.6, respectively.

$$IMEP_g = \frac{\int_{-180}^{180} P \cdot dV}{V_D} \quad (3.5)$$

3.2. HEAT RELEASE ANALYSIS

$$IMEP_n = \frac{\int_{-360}^{360} P \cdot dV}{V_D} \quad (3.6)$$

Now, using these definitions shown above, the thermodynamic efficiency can be calculated as equation 3.7.

$$\eta_{th} = \frac{IMEP_g}{Q_{hr}MEP} = \frac{IMEP_g}{\eta_c \cdot FuelMEP} = 1 - \left(\frac{Q_{ht}MEP + Q_{exh}MEP}{FuelMEP} \right) \quad (3.7)$$

3.1.3 Gross Indicated Efficiency

The indicated efficiency is the efficiency of conversion of fuel energy into mechanical work, by calculating values of $IMEP$ and $FuelMEP$, which can be expressed as Equation 3.8. With experimentally measured variables, it can be expressed in Equation 3.9.

$$\eta_{g,i} = \frac{IMEP_g}{FuelMEP} = \eta_c \cdot \eta_{th} \quad (3.8)$$

$$\eta_{g,i} = \frac{\int_{-180}^{180} P \cdot dV}{m_f \cdot Q_{LHV,f}} \quad (3.9)$$

3.2 Heat Release Analysis

Heat release analysis is a useful diagnostic tool to understand the rate and extent of energy converted from chemical energy into heat released by combustion. As combustion generally happens during the period when all valves are closed, the combustion chamber can be considered as a closed system, assuming that mass flow across system boundaries due to blow-by etc. is negligible. Considering it as a thermodynamic system with uniform pressure and temperature, the first law of thermodynamics can be used to calculate the rate of energy addition to the system based on a single zone model. More details and discussions can be found in [13], and the final heat release equation can be expressed as Equation 3.10. It should be noted that this equation deals with the energy release excluding the losses due to heat transfer, thereby it presents the net/apparent heat release.

$$\frac{dQ_{net}}{d\theta} = \frac{\gamma}{\gamma - 1} \cdot P \cdot dV + \frac{1}{\gamma - 1} \cdot V \cdot dP \quad (3.10)$$

3.2. HEAT RELEASE ANALYSIS

where Q_{net} is the energy released, γ is the instantaneous ratio of specific heat of the system of gases, P is the cylinder pressure and V is the cylinder volume.

To calculate gross heat release, the heat transfer is modeled as convection heat transfer from gas to a solid surface and the heat flux is expressed by Equation 3.11.

$$\frac{dQ_{ht}}{dt} = h_c(T_g - T_w) \quad (3.11)$$

where h_c is the heat transfer coefficient, T_g is the instantaneous cylinder gas temperature which can be estimated from the ideal gas law, and T_w is the cylinder wall temperature. Several models exist for estimating the heat transfer coefficient and the model proposed by G. Woschni [63] was adopted for all calculations presented in this thesis. The heat transfer coefficient according to Woschni's model is given by Equation 3.12.

$$h_c = 3.26 \cdot B^{-0.2} \cdot P^{0.8} \cdot T^{-0.55} \cdot w^{0.8} \quad (3.12)$$

where B is the cylinder bore expressed in m , P is the instantaneous cylinder pressure expressed in kPa , T is cylinder temperature in K and w is the average cylinder gas velocity [m/s] which can be expressed by Equation 3.13

$$w = \left[C_1 \cdot \bar{S}_p + C_2 \cdot \frac{V_D \cdot T_r}{p_r \cdot V_r} \cdot (P - P_m) \right] \quad (3.13)$$

where \bar{S}_p is the mean piston speed, V_D is the engine's displacement volume, p_r , V_r , T_r are the working fluid pressure, volume and temperature respectively at some reference state (intake valve closing), and P_m is the motored cylinder pressure at the same crank angle as P . C_1 and C_2 used in equation are constants taking different values during different periods of the cycle as given below 3.13.

Gas exchange period:	$C_1 = 6.18 + 0.417 \cdot \frac{v_s}{\bar{S}_p}$	$C_2 = 0$
Compression period:	$C_1 = 2.28 + 0.308 \cdot \frac{v_s}{\bar{S}_p}$	$C_2 = 0$
Combustion and expansion period:	$C_1 = 2.28 + 0.308 \cdot \frac{v_s}{\bar{S}_p}$	$C_2 = 3.28 \cdot 10^{-3}$

where $v_s = \frac{B \cdot \omega_p}{2}$ is the swirl velocity which is a function of ω_p , the rotation angular velocity of the paddle wheel used to measure the swirl velocity (see Equation 3.14, R_s is the swirl ratio which is a known parameter for all the experimental engines.).

$$\omega_p = R_s \cdot (2 \cdot \pi \cdot N) \quad (3.14)$$

3.3. EVALUATIONS OF PARTICULATE MATTER EMISSIONS

Finally, including the heat transfer calculation, the gross heat release in the main combustion chamber can be expressed as in the Equation 3.15 below.

$$\frac{dQ}{d\theta} = \frac{\gamma}{\gamma - 1} \cdot p \cdot dV + \frac{1}{\gamma - 1} \cdot V \cdot dp + \frac{dQ_{ht}}{d\theta} \quad (3.15)$$

3.3 Evaluations of Particulate Matter Emissions

Particulate matter emission, as one of the combustion product, can be measured and sampled from exhaust as well as during combustion process. Both samplings and measurements give indication of the degree of completeness of the combustion and soot particle formation for a given operating condition. The studies in this thesis focus on the exhaust particle mass concentration, which is usually measured, and size distributions. However, an effort was also made to evaluate in-cylinder soot characteristics with on-line aerosol mass spectrometry.

PM is difficult to measure due to its multi-phase constituents. A simplified and indirect way to quantify it is through Filter Smoke Number (FSN) that can be further related to soot mass fraction with empirical correlations [64]. This measurement was used mostly in early stage of the studies with AVL 415 smoke meter. Figure 3.2 to the left illustrates the measurement principle employed in paper filter smoke meters [65]. First, a volume of exhaust gas is drawn and filtered through a paper filter which is then optically evaluated. The reflectance of the filter paper is reduced by the collected soot. The fractional reduction of filter reflectance is the smoke number, as expressed in Equation 3.16. In the studies, the smoke number from the utilized instrument was normalized on a linear scale from 0 to 10. Zero corresponds to the original reflection of the white paper and 10 to the absence of light reflection. However, it is argued that the relationship of FSN to PM mass is empirical and content dependent (size distribution, composition etc.). Therefore the FSN measurement is only qualitatively useful. When exhaust gas and particle compositions change under unusual conditions, the measurement can be less valid.

$$FSN = 1 - \frac{\left(\frac{E}{E_0}\right)}{\left(\frac{E_{clean}}{E_0}\right)} = 1 - \frac{E}{E_{clean}} \quad (3.16)$$

Lately in the studies, photoacoustic soot sensor (micro soot sensor) was utilized parallelly. It is based on the photoacoustic principle [66]. The sample gas with strongly absorbing soot particulates, is exposed to modulated light. The periodical heating and cooling and the resulting expansion and contraction of the carrier gas can generate pressure waves (acoustic), which are recorded by a micro-

3.3. EVALUATIONS OF PARTICULATE MATTER EMISSIONS

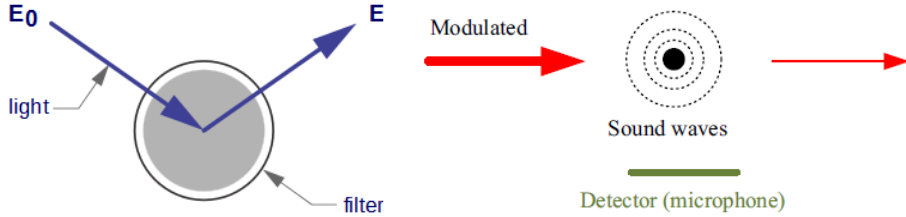

Figure 3.2: Principle of smoke number measurement [65] and photoacoustic soot sensor operation [67].

phone, as depicted in Figure 3.2 to the right. The instrument has fast response with detection limit of around $5 \mu\text{g}/\text{m}^3$ BC and works well with low level soot detection. However, particle properties may vary between different forms of soot, and the organic coating on BC as well as gaseous species can affect the light absorption. Therefore, there is a need to choose an appropriate wavelength for the specific application. With measured particulates mass, the gross Indicated Specific Particulate Mass (ISPM) presented in Chapter 5 can be calculated by Equation (3.17). The ISPM can be used as a way to compare the particle production per unit of work hence can be correlate to the actual relative on-road particle emissions.

$$ISPM = \frac{M m_{total}}{\rho W} \quad (3.17)$$

where M is the mass concentration, m_{total} is the total mass flow rate out of the engine, W is the indicated power of the engine and ρ is the density of the sample exhaust gas at the instrument measurement conditions and can be calculated as:

$$\rho = \frac{P_m}{R_{exh} \cdot T_m} \quad (3.18)$$

where P_m and T_m are the pressure and temperature at the inlet of the measurement instrument, and R_{exh} is the exhaust gas constant calculated using the average molecular weight of the engine exhaust gas.

To obtain further information of particle properties such as size and number, a Differential Mobility Spectrometer (DMS) was employed in the exhaust measurement and a Scanning Mobility Particle Sizer (SMPS) was utilized for in-cylinder soot evaluation. The former can detect and provide particle diameter size in the range of 5 - 1000 nm. As pictured in Figure 3.3, prescribed charge on each particle proportional to its surface area is placed and the charged aerosol is then introduced into a electrical field inside a classifier column. Particles drift through a

3.3. EVALUATIONS OF PARTICULATE MATTER EMISSIONS

sheath flow to the electrometer detectors and are detected depending upon their electrical mobility [68].

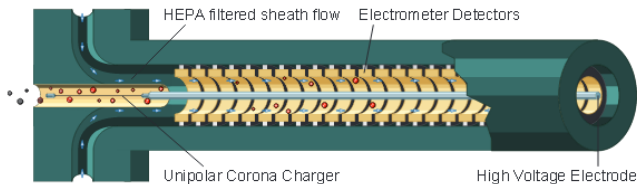

Figure 3.3: Particle detection in DMS [68].

An SMPS (Figure 3.4) can consist of an electrostatic classifier, a Differential Mobility Analyzer (DMA) and a condensation particle counter. It is based on the physical principle that the ability of a particle to traverse an electric field (electrical mobility) is fundamentally related to particle size [69]. In DMA, an electric field is created, and the airborne particles drift in the DMA according to their electrical mobility. Particle size is then calculated from the mobility distribution. More details can be found in [70].

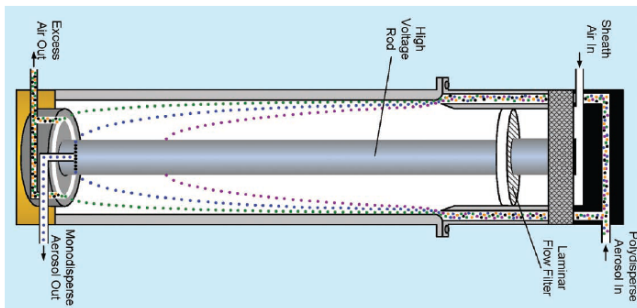

Figure 3.4: Particle detection in SMPS [69].

The geometric mean diameter (GMD) can be calculated from the particle size distributions assuming lognormal distributed data with a unimodal shape following Equation (3.19).

$$GMD = \exp\left[\frac{1}{N_t} \sum_{i=1}^M (N_i \ln(D_{pi}))\right] \quad (3.19)$$

3.3. EVALUATIONS OF PARTICULATE MATTER EMISSIONS

where N_t is the total particle number, i is the size bin, M is the total number of size bins in the measuring instrument, N_i is the particle number in the size bin i and D_{pi} is the midpoint diameter of the size bin.

Similar to the calculation of ISPM, the Indicated Specific Particle Number (ISPN) in the exhaust can be calculated with particle number and engine power, as expressed in Equation (3.20).

$$ISPN = \frac{Nm_{total}}{\rho W} \quad (3.20)$$

where N is the total number concentration, m_{total} is the total mass flow rate out of the engine, W is the indicated power of the engine and ρ is the density of the sample exhaust gas also calculated by Equation 3.18.

To quantify the detailed particle chemical composition, an aerodyne soot-particle aerosol mass spectrometer (SP-AMS) was utilized. The SP-AMS can be run in single or dual (particle) vaporization modes [71]. In the single vaporization mode, non-refractory species can be quantified by impacting and vaporizing the particles on a heated Tungsten plate. The vapor is then drawn into the mass spectrometer. In the dual vaporization mode, refractory species can be quantified. The refractive black carbon (rBC) is vaporized, then ionized and detected in a time-of-flight mass spectrometer. In this way, this provides a powerful tool for the analysis of organic material.

By performing gas sampling in exhaust and in the cylinder using the commercial particle analyzer or the on-line aerosol measurement techniques, more and fundamental information on particle mass, size and chemical compositions can be provided, enhancing the understanding of combustion conditions and soot formation.

3.3. EVALUATIONS OF PARTICULATE MATTER EMISSIONS

Chapter 4

Experimental Apparatus

This chapter gives an overview of the experimental setups used for extracting and analyzing data in the studies presented in this thesis. The first half part of the chapter briefly describes the experimental setup. It was mainly made up of an internal combustion engine in single cylinder configuration and the exhaust emissions systems. A brief introduction to the in-cylinder particle fast sampling system is also included. All these components were operated under flexible laboratory conditions, which was facilitated by precise control of various operating parameters. This was realized through a computer based control and data acquisition system, which is discussed in the second half of the chapter. In the end, properties of all the fuels used in the research are listed.

4.1 Experimental Setups

The schematic diagram of the mostly used experimental setup can be seen in Figure 4.1 and the main components in further details are described in the following sections. In-cylinder gas sampling system, which includes a sampling valve, dilution and on-line aerosol instruments, were only employed in the study of in-cylinder soot. Also, the exhaust soot measurement instruments can be more than the smoke meter as shown in the diagram.

4.1. EXPERIMENTAL SETUPS

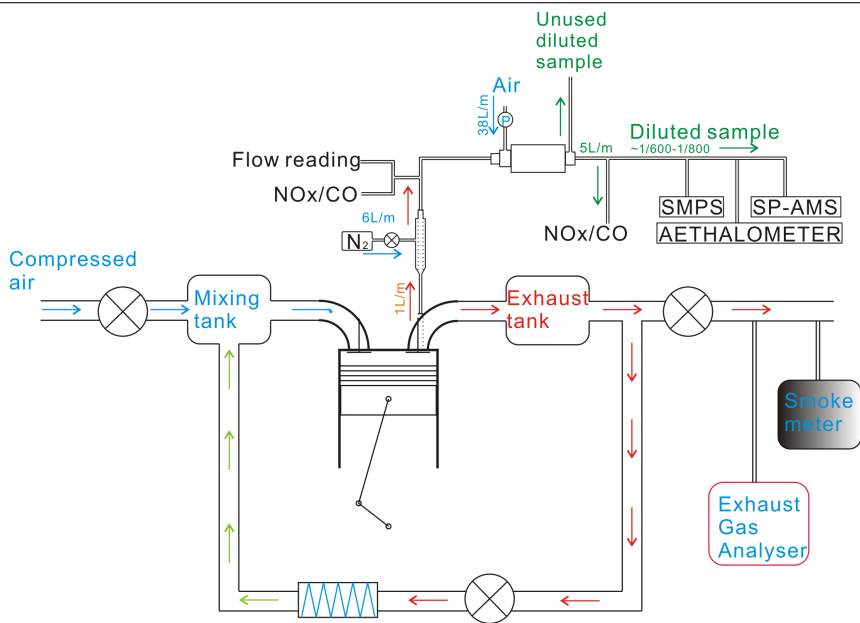

Figure 4.1: Schematic diagram of the experimental setup.

4.1.1 The Engine

The engine is a 13 lite, 6-cylinder heavy duty diesel engine from Scania which was modified to operate with one active cylinder of 2.12 L displacement volume. Non-fired cylinders were motored without compression. The engine was equipped with a production XPI common rail injection system with a wide range of rail pressure that could be achieved easily. Two sets of pistons and injectors were used. The first combination was an original production diesel piston assembled with the original diesel injector. The compression ratio of the piston was 17.3:1. Lately the piston used was a modified piston with a compression ratio reduced to 15:1, assembled with an injector having narrow spray angle. The specifications of the engine and injectors are summarized in Table 4.1 while the pistons are pictured schematically in Figure 4.2.



Figure 4.2: The two engine piston used in the experiments (the original one to the left and the modified one to the right).

4.2. EMISSION MEASUREMENT SYSTEM

Table 4.1: Geometrical properties of the engine and injectors.

Engine specifications	
Displaced volume	2124 cc
Stroke	160 mm
Bore	130 mm
Connecting Rod	255 mm
Number of Valves	4
Swirl Ratio	2.1
IVC	-141 CAD ATDC
EVO	137 CAD ATDC
Injector specifications	
Injector model	XPI
Injector type	Solenoid
Included spray angle	148 /120
Orifices	8
Flow rate	207 pound per hour

4.1.2 Fuel Mass-Flow

Fuel mass flow was measured by a fuel balance (Sartorius CPA 62025) and each operating point was sampled for at least two and half minute. The time difference between each fuel balance reading was recorded by the control system and used to calculate the fuel mass flow. A linear correlation between the fuel injector opening duration and the calculated fuel flow was assumed which was found to be in close agreement with the measured fuel flows.

4.2 Emission Measurement System

The mostly used emission measurement system consisted of the commercial instruments for gas emissions and soot mass. More soot particle analyzers were employed when detailed particulate studies were performed. The sub-sections below discuss those in further details.

Each analyzer was calibrated with an appropriate calibration gas before every set of measurements. When the engine was started and warmed, a stabilization time of 20 minutes was applied prior to each measurement. After this stabilization time, a continuous measurement of at least 2 minutes were carried out for each operating point.

4.2. EMISSION MEASUREMENT SYSTEM

4.2.1 Exhaust Gaseous Emissions

Steady-state measurements of CO, CO₂, O₂, UHC and NO_x in the raw exhaust and CO₂ in the intake were performed by commercial analyzers Horiba measurement system (MEXA-9100EGR) in Paper I -III. In the rest of the papers, this was done with an AVL AMA i60 which was an update in the measurement instruments.

The EGR fraction is measured as the ratio between carbon dioxide volume concentration in the intake gas and exhaust gas respectively as calculated by Equation 4.1. The EGR gas was cooled down before blending with air and introduced into the intake.

$$EGR = \frac{CO_{2Inlet}}{CO_{2Exhaust}} \quad (4.1)$$

4.2.2 Exhaust Particulate Matter Emissions

Soot FSN emission was measured with an AVL415S smoke meter [72] which has a measurement range of 0 to 10 FSN (filter smoke number). Zero corresponds to the original reflection of the white paper and 10 to the absence of light reflection.

Soot mass concentration was measured by an AVL micro soot sensor [73] which can measure the mass concentration from 0.001 to 50 mg/cm^3 with diluted exhaust gas. Clean and dry pressurized air was used to vary the dilution ratio to ensure the measurement values in the proper range.

A DMS550 (differential mobility spectrometer) was employed to determine particles size distribution in the range 5 nm to 1000 nm. It combines electrical mobility measurements of particles with sensitive electrometer detectors, to give outputs of particle size, number and mass in real time. Particles are characterized by their aerodynamic drag/charge ratio [74].

4.2.3 In-cylinder Particle Sampling System

The total in-cylinder particle sampling system has been presented schematically in Figure 4.1. Simply speaking, by controlling the opening of the fast sampling valve (FSV, VOLVO, pat.nr. SE 9002548-7), precise amount of in-cylinder gas could be extracted at the desired crank angle timing. Then the gas was analyzed by different aerosol instruments after being properly diluted.

The gas sampling valve tip was mounted directly into the cylinder head, replacing one of the exhaust ports, as presented in Figure 4.3 below. The gas

4.2. EMISSION MEASUREMENT SYSTEM

samples were taken between two injection jets in the cylinder. With an anticlockwise swirl, the below spray close to the probe will come to the sampling system first.

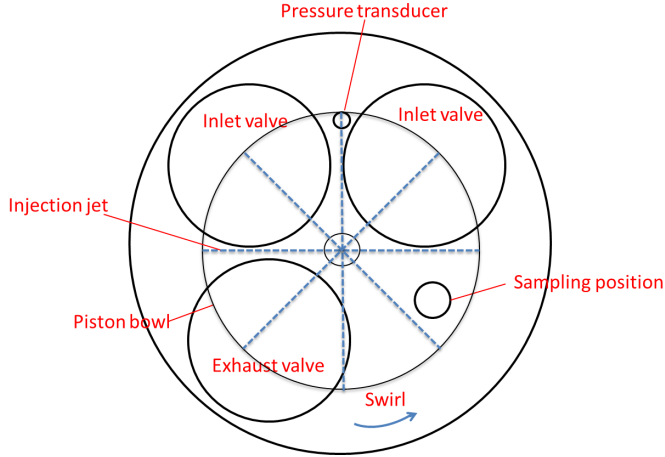

Figure 4.3: Gas sampling location (top view).

Fast Sampling Valve The valve was actuated by a solenoid unit which was controlled by a voltage signal through a computer program and triggered by the crank angle signal. This electronic unit allowed the control of the start time of sampling and sampling flow rate. In the studies, the gas flow was kept constant at 1 lpm (lite per minute) (at ambient atmospheric pressure and temperature) for each sampling point, which corresponds to approximately 0.05% of the total gas in the cylinder before combustion.

Dilution system The sampled in-cylinder gas was diluted in three steps in Figure 4.1. In the first step of the dilution, the extracted gas was diluted with N_2 to ensure a significant decrease of particle coagulation and condensation rates and reduce the risk of particle oxidation as early as possible in the sampling line. After that, the gas was further diluted at a high ratio of 1:100 with air that was filtered by a high-efficiency particulate arrestance (HEPA) filter and activated carbon filters to strip of particles and vapors.

On-line Particle Analysis To quantify the soot or black carbon (BC) mass, a filter based seven-wavelength optical technique was used (Aethalometer, model AE33, Magee Scientific) [75]. A scanning mobility particle sizer (SMPS) [76],

4.3. CONTROL AND DATA ACQUISITION SYSTEM

consisting of an electrostatic classifier (model 3071, TSI inc) and a condensation particle counter (CPC) (model 3010, TSI inc), was used to measure the particle mobility size. To quantify the particle chemical composition, an Aerodyne soot-particle aerosol mass spectrometer (SP-AMS) [71] was utilized. Refractive black carbon (rBC) which were grouped into low-carbons (C1-C5), mid-carbons (C6-C31) and fullerene-carbons (C32-C58), organic species condensed on to the soot particles and PAHs were obtained from it.

To get a result independent from the influence of cyclic variations in the combustion process, each sampling point was taken over 10 minutes or approximately 6000 fired cycles at an engine speed of 1200 rpm. Variations in soot particle concentration and composition were therefore smoothed and less affected by cycle-to-cycle variations than from e.g. total cylinder-gas extraction measurements.

4.3 Control and Data Acquisition System

The control and data acquisition tasks were handled by three computers and one data logger switch unit which interacted with the test engine via different communication channels. A general layout of the control system setup can be seen in Figure 4.4. A standard desktop PC running Windows with a graphical user interface (GUI) was used where target values and running conditions are defined. A target PC from National Instruments, running LabVIEW real-time operating system with a PXI FPGA Multifunction RIO (Reconfigurable Input/Output) card, was used for engine control and data collection. The two separate computers were controlled from the same LabVIEW project. The real-time target PC handled high speed (crank angle resolved) data acquisition from a piezo-electric pressure transducer for in-cylinder pressure, absolute pressure sensors for fast intake and exhaust manifold pressure, and lambda sensor for air-fuel ratios etc. Command signals to various controllers for fuel injection, air heater, pressure regulators and valve positions were also set via GUI and sent to actuators in the test bench. Information of various sensors for coolant temperature, lubricating oil temperature and pressure, intake air flow rates etc came from the data logger (Agilent Technologies' 34970A Data Acquisition Unit). This data acquisition unit communicated directly with the control computer (host computer) via a TCP/IP communication protocol and data was directly read by the main measurement and control program. The third channel was with the emission system which fed data about concentration of CO, CO₂, UHC, NO_x and O₂ in the engine's exhaust gas and CO₂ in the intake charge through an intermediate server (emission computer) to the host computer. Additionally, signals from fuel balance, soot analyzers etc. were recorded through low speed channels directly from the engine side to the host PC.

From the GUI, geometrical data of the engine and parameters used in the

combustion and engine efficiency calculation can be specified. When the calculations are performed, together with all the control and feed back informations from the engine can be seen and read from the GUI. Combustion process and engine conditions are monitored and controlled in this way. All the hardware and supplements together with the precise control enabled some extreme operating points, which are otherwise not possible on a production engine.

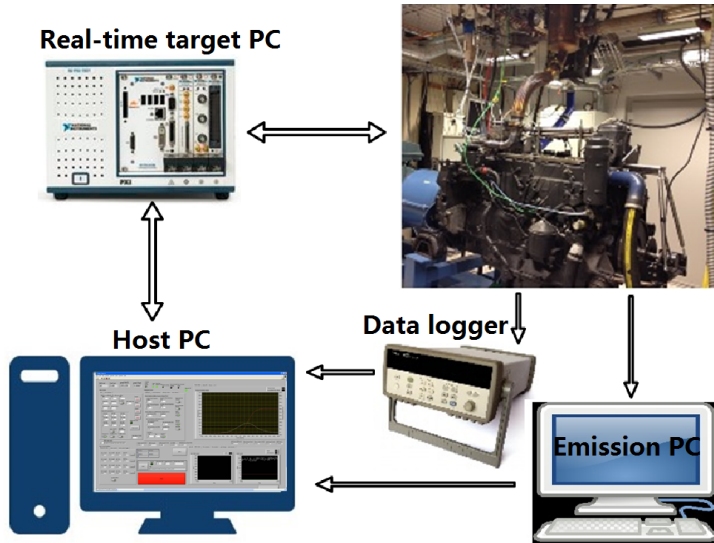

Figure 4.4: General layout of experimental setup.

4.4 Fuels

In total, five fuels, Swedish diesel MK1 (ultra-low sulfur content < 1.0 mg/kg), three gasoline fuels with corresponding octane number RON 89, RON 87 and RON 69 and ethanol were used in the studies. Table 4.2 summarizes the fuel properties.

4.4. FUELS

Table 4.2: Fuel specifications

Fuel	RON	MON	CN	H/C	O/C	LHV [MJ/kg]	A/F_s Ratio
Diesel	-	-	54	1.87	0	43.15	14.9
Gasoline 1	89	80	-	1.88	0	43.50	14.53
Gasoline 2	87	80	-	1.92	0	43.50	14.60
Gasoline 3	69	66	-	1.98	0	43.68	14.68
99.5% Ethanol	108	89	-	3	0.5	26.64	9.0

Chapter 5

Results and Discussions

This chapter presents the observations regarding the particulate matter emissions from PPC with diesel, gasoline and ethanol fuels. The main focus is on the exhaust emissions under varied engine operating parameters. In addition, in-cylinder particulate emission evaluations were performed to investigate the difference in soot formation histories with diesel and gasoline fuel respectively.

5.1 Soot Emission in PPC

By changing the start of injection, it is possible to have combustion from a relatively homogeneous HCCI mode to partially stratified PPC mode with RON89 gasoline fuel, with the assistance of varied inlet temperature, see Figure 5.1. The double-injection strategy was employed to reduce pressure rise rate. The start of the 2nd injection timing was set at -4 CAD aTDC and the injection ratio (fuel energy in the first injection / total fuel energy) was 70%. As shown in the figure, when start of injection is retarded from -120 to -80 CAD aTDC, the required intake temperature is stable, particularly with single injection strategy. It implies that, the fuel/air mixture is fully homogeneous due to the early injection and combustion is similar to traditional HCCI combustion. When injection is later than -45 CAD aTDC, the required intake temperature decreases rapidly. Along with that, HC emissions in Figure 5.3 also decreases rapidly. This indicates that large portion of fuel is likely injected into the piston bowl, and the local fuel-air rich zones promotes the reaction rate and high local temperature. Combustion with injection timing within this time zone is considered as PPC type of combustion.

5.1. SOOT EMISSION IN PPC

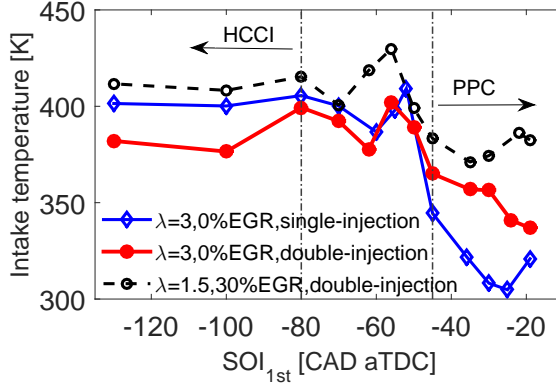

Figure 5.1: Required intake temperature for varied injection timing with single- and double- injection strategies. CA50 (determined by the location of 50% energy conversion) 3 CAD aTDC, input fuel energy FuelMEP 10.5 bar with a constant ambient intake pressure, injection pressure 700 bar and engine speed 1200 rpm.

Compared to HCCI combustion with very early injections, PPC shows a clear advantage of higher combustion efficiency and thermodynamic efficiency, which can be seen in Figure 5.2. Another benefit of PPC over HCCI is the much lowered UHC and CO emissions, as presented in Figure 5.3.

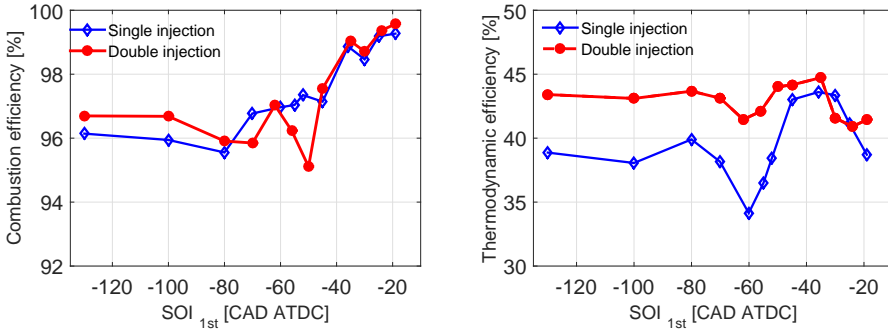

Figure 5.2: Combustion and thermodynamic efficiency for varied injection timings.

To suppress NO_x formation, it is common to utilize high amount of EGR to reduce combustion temperature. However, in PPC, as charge stratification increases with late injections, there is a possibility of increased soot emissions, which can be seen in Figure 5.4. Hence soot generation control in PPC is needed.

5.1. SOOT EMISSION IN PPC

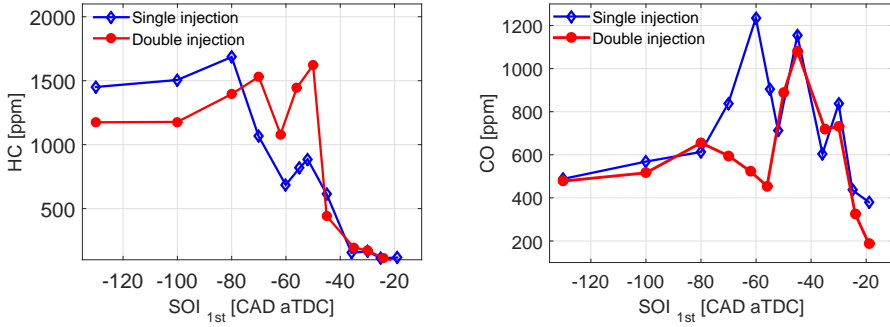

Figure 5.3: UHC and CO emissions for varied injection timings with single and double injections.

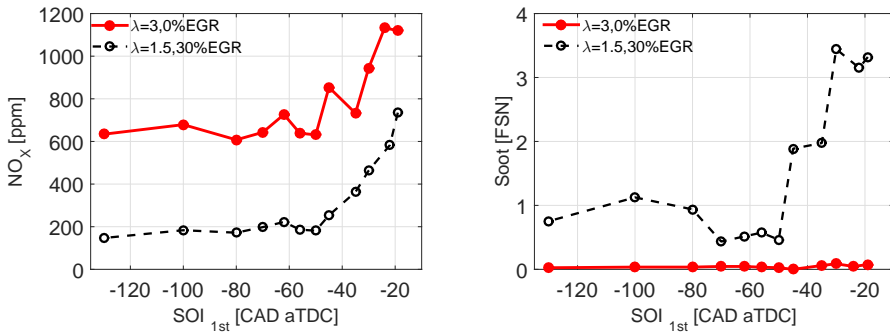

Figure 5.4: NO_x and soot emissions for varied injection timings with double injections.

5.2. EFFECT OF EGR AND INTAKE PRESSURE

5.2 Effect of EGR and Intake Pressure

Previous results have shown that the combination of high boost pressure and EGR is essential for the efficient implementation of PPC strategies [77]. The boost pressure sets the total dilution levels and EGR can indicate oxygen availability. In PPC, generally, high amount of EGR is applied to get ultra-low NO_x [54]. To find the effect of EGR and intake pressure on combustion and soot formation, a study was done at two intake pressure levels (Figure 5.5), with 48%, 32% and 30% EGR ratios. Ethanol, RON69 gasoline and Swedish diesel MK1 fuels were utilized to get the effect of fuel properties on combustion and emissions.

Figure 5.5 presents the averaged cylinder temperature, heat release rate and injector current signal with diesel, gasoline and ethanol fuel in PPC, with varied EGR at a low intake pressure and a higher intake pressure respectively. The corresponding NO_x and soot emissions are shown in Figure 5.6. EGR tends to prolong the time delay between fuel injection and start of combustion, meanwhile reduce the combustion temperature. As input fuel energy flow rate FuelMEP was kept constant, thus, at high intake pressure, combustion is leaner and the effect of EGR becomes less visible. Using the same amount of EGR, higher intake pressure can shorten ignition delay and reduce the combustion temperature as a result of higher dilution.

Soot and NO_x emissions with varied EGR and intake pressure can be found in Figure 5.6. As a general trend, increasing EGR can suppress NO_x , however, higher soot is emitted for diesel and gasoline. Although fuel-air mixing prior to combustion can be enhanced with EGR, this improvement is minor as there is still a large portion of diffusion combustion (Figure 5.5). Meanwhile, lowered oxygen concentration in the intake and lower temperature in the cylinder reduces soot oxidation, resulting in more soot emissions. This soot increase is more significant at lower intake pressure, where there is more reduction in λ or intake O_2 concentration while turbulence level is lower.

Big difference of soot output is noticed by altering the fuel properties, particularly at low intake pressure. Gasoline fuel has lower soot emissions than diesel, while ethanol emits ultra-low soot emissions regardless of engine condition variations. Those results suggest that utilizing fuels other than diesel can give more possibility with respect to soot reduction.

5.2. EFFECT OF EGR AND INTAKE PRESSURE

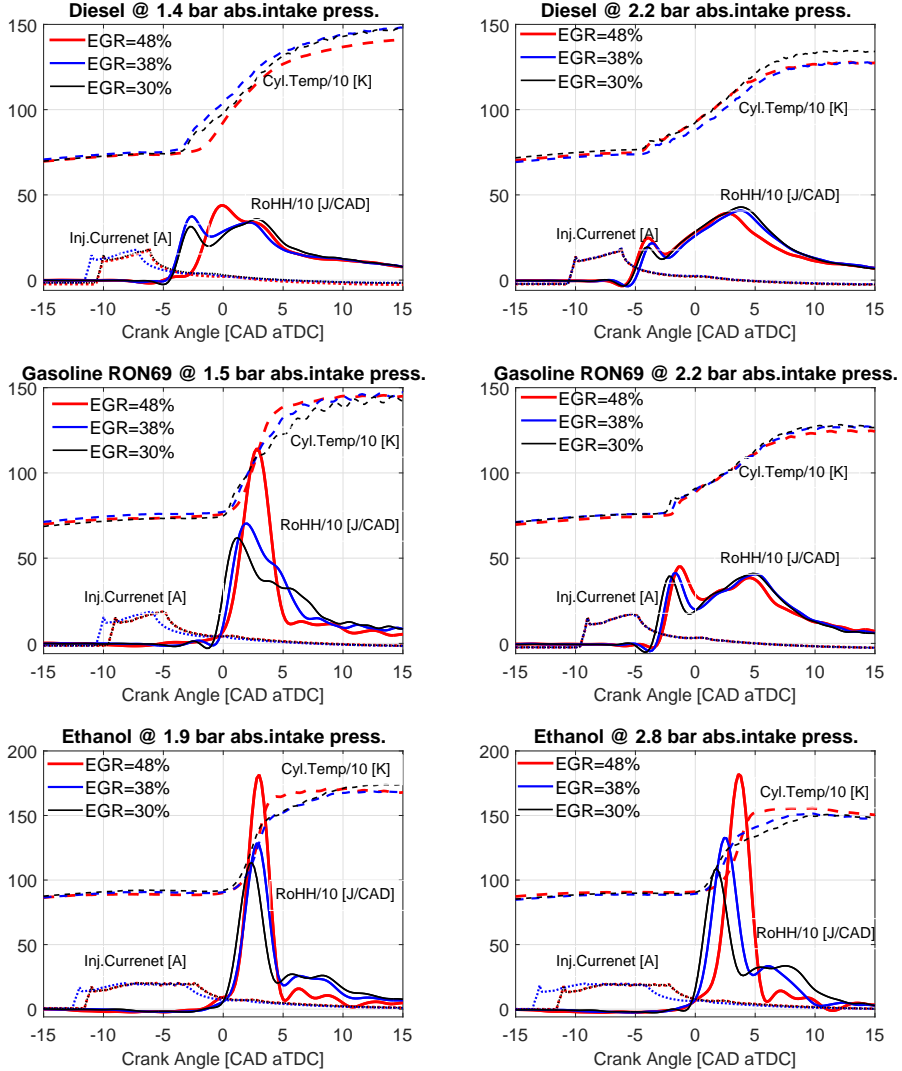

Figure 5.5: Averaged cylinder temperature, heat release rate and injector current for EGR variations at high and low boost (dash line: cylinder temperature, solid line: heat release rate, dotted line: injector current signal), FuelMEP 20.4 bar, CA50 4 CAD aTDC, injection pressure 1200 bar and engine speed 1200 rpm.

5.3. STOICHIOMETRIC PPC

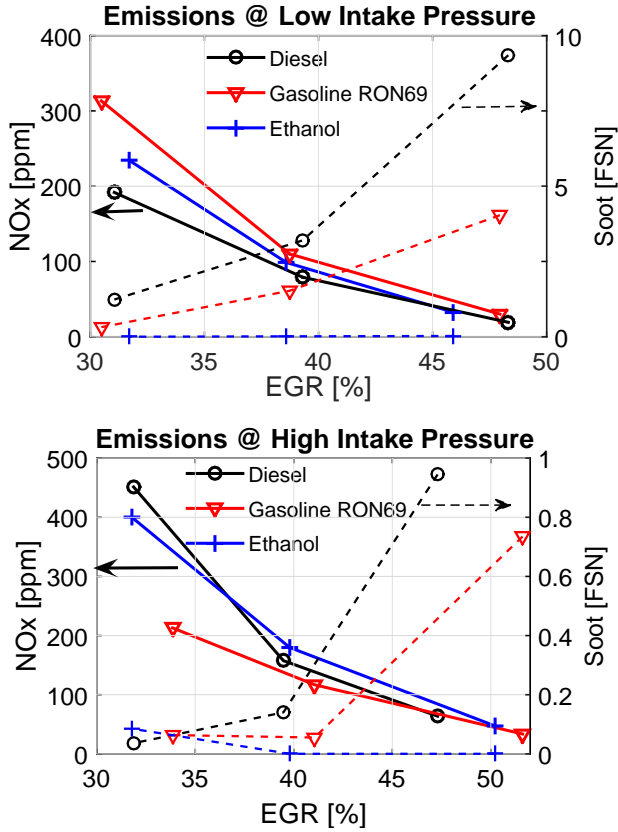

Figure 5.6: NO_x and soot emissions for varied intake pressure and EGR.

5.3 Stoichiometric PPC

The results regarding the different fuel performance suggest possibility for low soot. In this regard, the possibility of extremely low emissions exists for diesel engines in stoichiometric operation with the addition of a three-way catalyst. Then the challenge is to have low particle emissions and to maintain engine efficiency. By utilizing fuel that has little tendency for soot formation, clean stoichiometric PPC is viable if efficiency penalty is low at the same time. The following test was done from lean to stoichiometric combustion with diesel, gasoline of low octane number RON 69 and ethanol. Figure 5.7 shows the engine efficiencies and Figure 5.8 presents the corresponding soot emissions.

As illustrated in Figure 5.7, although λ is down to close to unity, all the fuels show a combustion efficiency that is always higher than 98%, which means that in

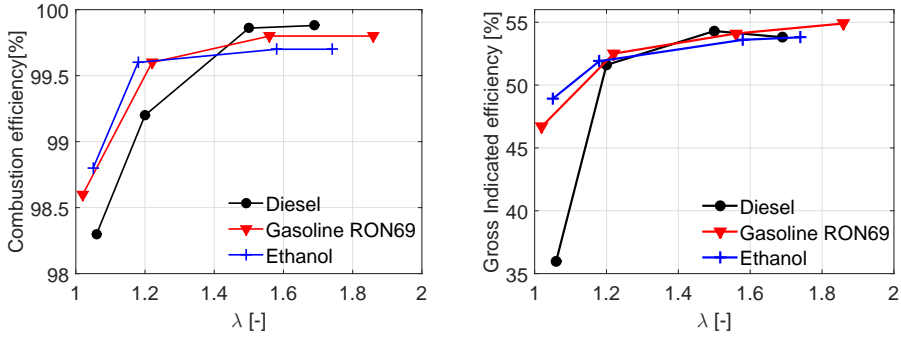

Figure 5.7: Combustion and thermodynamic efficiency as a function of λ from lean till stoichiometric, FuelMEP 20.4 bar, EGR 38%.

general, not much energy is lost through incomplete combustion. However, there is a considerable decrease of gross indicated efficiency, especially with diesel fuel. Gross indicated efficiency is over 52% for all the three fuels when λ is greater than 1.5. In stoichiometric PPC mode, while gasoline shows comparable level of efficiency with ethanol in the range of 47-49%, diesel has a gross indicated efficiency down to 36.0%.

For soot emissions in Figure 5.8, similarly to the trend of gross indicated efficiency, all fuels show promising soot emissions in lean combustion (λ above 1.5). Ethanol maintains the low soot emission then even in stoichiometric operation. However, soot emission for diesel fuel increases to an unacceptable level around 9.5 FSN at close to stoichiometric ratio. Gasoline produces soot emission nearly half of what diesel fuel generates but the soot level for gasoline is still high. Despite the fact that there can be more fuel-air premixing as λ reduces, the even more reduced soot oxidation due to reduced oxygen and intake pressure, are likely the key factors for high soot emissions. High soot formations can result in high radiation during combustion [78], which leads to high engine gross indicated efficiency reduction. Compared to the conventional fuels, the close to zero level of soot and relatively high gross indicated efficiency in stoichiometric operations can be a great advantage of ethanol fuel.

5.3. STOICHIOMETRIC PPC

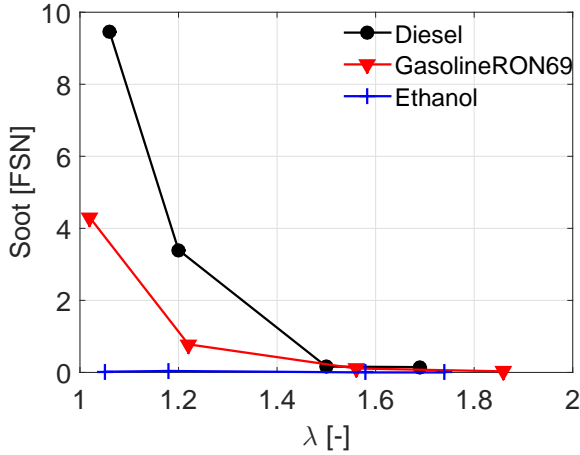

Figure 5.8: Exhaust soot emissions as a function of λ from lean to stoichiometric, FuelMEP 20.4 bar, EGR 38%.

Additional test at varied engine load reveals the same trends of soot emissions from diesel, gasoline and ethanol fuels, see Figure 5.9. Ethanol maintains ultra-low soot emission in all stoichiometric operating conditions. At low engine load, much lower soot penalty is obtained and diesel gives similarly low soot as gasoline. As engine load increases, gasoline emits half amount of soot as that from diesel stoichiometric operation, and eventually similar level of soot is found with low octane gasoline as diesel. This agrees with findings in [61, 62], that as engine load increases, high soot emissions can be also produced with gasoline.

Particulate number emissions together with mass concentration have been incorporated into PM emission regulations recently for internal combustion engines [79], thereby, the needs of providing particulate matter characteristics other than mass concentration arises. Beside soot mass concentration, which is usually measured and widely used, the emphasis in this thesis will be on showing the particle size distributions. Results in Section 5.2 and 5.3 reveal that significant difference in soot mass emissions exists between diesel, gasoline and ethanol. Intake pressure, EGR and fuel-air ratio could affect soot output and induce even more significant difference between fuels when those parameters vary. Hence, another focus here would be the fuel behavior in response to changes in engine operating conditions.

There are various engine parameters that could affect engine-out soot emissions. Among these, bowl shape, injector optimizations, multiple injections, injection timing and pressure, intake pressure, etc. play a role by improving fuel and air mixing. Other parameters, such as intake temperature and cooled EGR, could

5.4. EXHAUST PARTICLE SIZE DISTRIBUTION

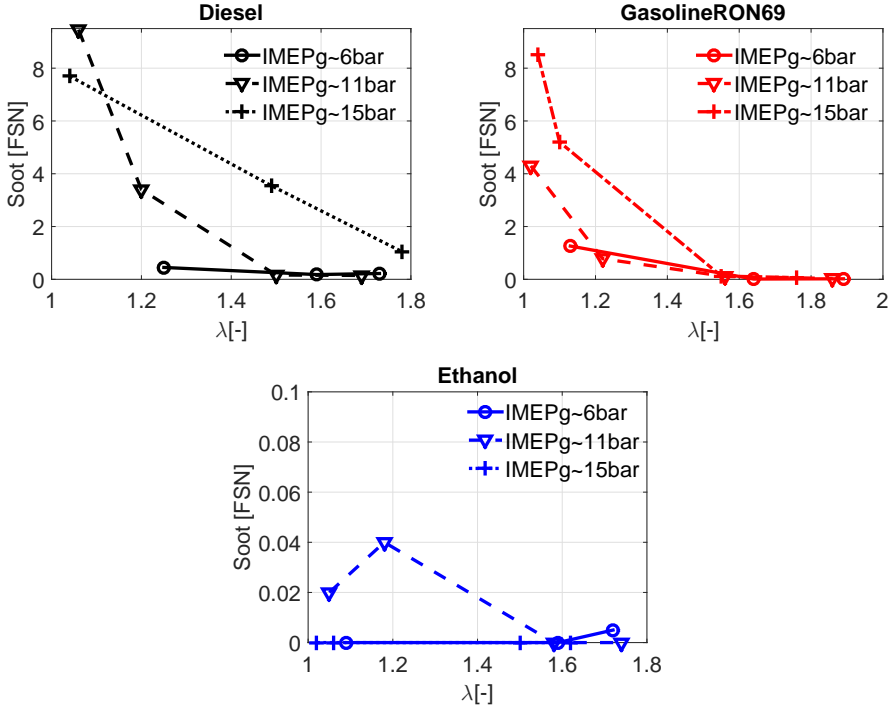

Figure 5.9: Exhaust soot emissions as a function of λ from lean till stoichiometric at varied engine loads, EGR 38%.

affect in-cylinder temperature thus also influence soot emissions. As an early stage of PPC particulate emission study, based on the observations from all the sections above, the effect of injection timing in a single injection event, inlet temperature, EGR and injection pressure were selected to obtain the corresponding effect on the soot emissions from diesel, gasoline and ethanol fuels, to provide a more complete picture.

5.4 Exhaust Particle Size Distribution

5.4.1 Injection timing

As showed in the beginning of this chapter, with the assistance of inlet temperature, it is possible to vary injection timing in a large range to get relatively

5.4. EXHAUST PARTICLE SIZE DISTRIBUTION

homogeneous and stratified charges, which could result in varied exhaust particle emissions. Thereby, the effect of injection timing on soot particle size distribution was studied first. RON89 gasoline was used and CA50 was kept constant at 4 CAD aTDC.

Figure 5.10 shows the particle size distribution results obtained in the study, with no EGR applied. Under this engine operating condition, unlike the traditional bimodal shape of the diesel exhaust particle size distribution [10], a unimodal particle size distribution can be observed in most cases. The nucleation mode highly dominates the particle size distribution. At all injection timings except the earliest one, the size distribution peaks around 15 nm with quite comparable number concentrations.

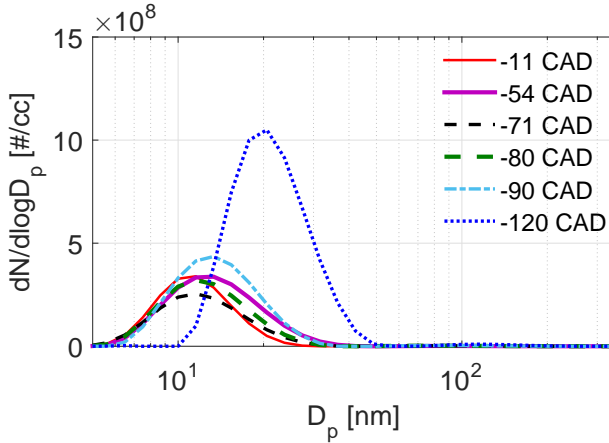

Figure 5.10: Particle size distributions with early to late injections, 0% EGR, IMEP_g 6 bar, engine speed 1200 rpm and injection pressure 700 bar. Injection timing is shown in the legend (aTDC).

When the engine is operated with 30% EGR, particle size distributions of early injections show a similar trend as in none-EGR case, as seen in Figure 5.11.a. At well premixed HCCI conditions (injection timing in the range of -120 to -80 CAD aTDC), size distributions shift to smaller side with retarded injections. However, a noticeable high particle number is seen with injection timing at -120 CAD aTDC and -100 CAD aTDC in 0% and 30% EGR cases respectively. This can be attributed to spray impingement and fuel on the cylinder liner after the end of injection, which may lead to the formation of greater amounts of liquid film and consequent pool-fire during combustion [80]. EGR likely shortens fuel penetration due to increased gas density and then pushes fuel spray impingement towards later injection timing.

5.4. EXHAUST PARTICLE SIZE DISTRIBUTION

Retarding injection from -65 to -45 CAD aTDC, the corresponding particle size distribution shifts to the smaller size and particle number reduces. This is expected to be related to less fuel into the crevice [81].

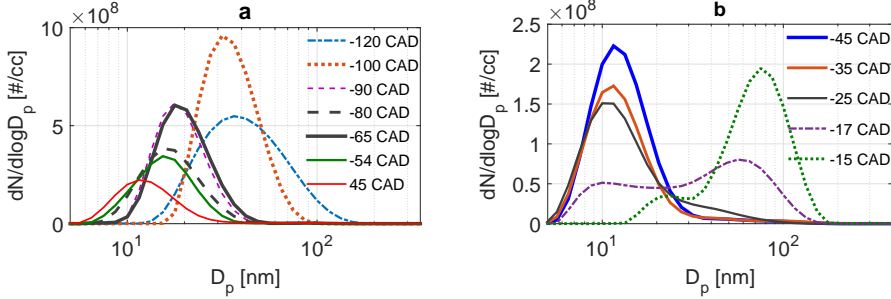

Figure 5.11: Particle size distribution with early to late injections, 30% EGR, 6bar IMEP_g, 1200 rpm and 700 bar injection pressure. Injection timing is shown in the legend (aTDC).

In PPC regime with late injection (-45 to -15 CAD aTDC) in Figure 5.11.b, unlike the none-EGR case, particle size distribution changes from a unimodal shape eventually into a bimodal shape as injection retards. Firstly, relatively slight change of a decreased nucleation mode particle number concentration is observed on the unimodal shape particle size distribution. The slight change also indicates that fuel targets at the piston top-land area. Retarding injection timing to -17 CAD aTDC, the presence of large particles in accumulation mode makes the size distribution into a bimodal shape. It indicates an increased portion of fuel into the bowl. Upon further injection retard, particle number in accumulation mode rapidly increases and dominates the size distribution in the end. Along with this increase, the size distributions are shifted to bigger size for both nucleation mode and accumulation mode, leading to a rapid increase in soot emissions. In this stratified charge mode, the charge heterogeneity and the diffusive combustion of fuel droplets that are not yet vaporized [82–84] are expected to be the main sources of particle formation.

Most injection timings in gasoline PPC operations are relatively late, with the entire or most of the fuel spray injected into the bowl. In this strategy, combustion phasing is mainly controlled by start of injection and almost decoupled from inlet temperature [85]. A particle size distribution in PPC mode with varied injection timing at constant intake temperature is depicted in Figure 5.12. Retarding injection timing increases particle numbers in smaller size; meanwhile, more accumulation mode particles are formed. This can lead to an increase in exhaust soot mass emissions. The main reason for that is the shorter ignition delay and lowered late oxidation temperature with retarded injections.

5.4. EXHAUST PARTICLE SIZE DISTRIBUTION

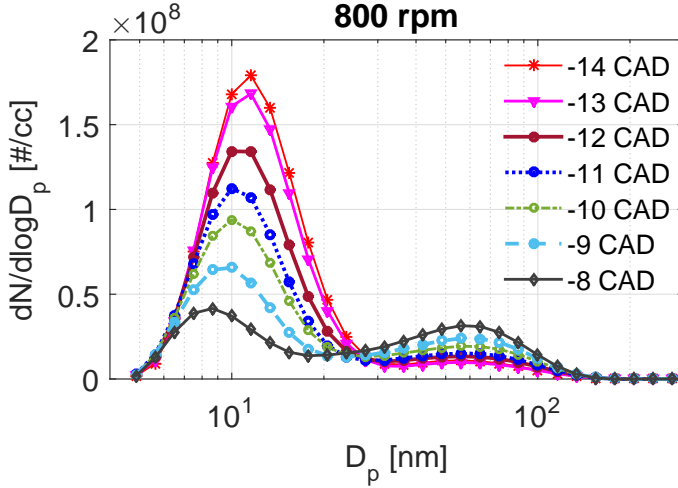

Figure 5.12: Particle size distribution for varied injections in PPC, 44% EGR, IMEP_g 10 bar, engine speed 800 rpm, injection pressure 700 bar. Injection timing is shown in the legend (aTDC).

5.4.2 EGR/Intake Oxygen Concentration

In previous discussions in Section 5.2, EGR effect was investigated within a narrow range wherein combustion temperature is still above the temperatures to form soot. This study presented here utilizing with a much wider EGR range combustion temperatures were largely reduced. Throughout the measurement, with increased EGR, intake oxygen concentration reduced down to approximately 9% and stoichiometric combustion was achieved at 10% O_2 concentration.

The results of heat release rate at a few selected intake oxygen rates are presented in Figure 5.13. Diesel fuel shows the classic two-phase diesel combustion except at stoichiometric and rich ratio, where premixed burn dominates the combustion process. On the contrary, most gasoline and ethanol PPC combustion processes are dominated by premixed burn with one spike and short/no tails in heat release rate curves. Adding EGR first prolongs ignition delay and results in a rapid combustion and higher peak heat release rate. Further increasing EGR, combustion is moderated and heat release rate curves become wider with decreased peak heat release rate, indicating that lower combustion temperature is reached.

5.4. EXHAUST PARTICLE SIZE DISTRIBUTION

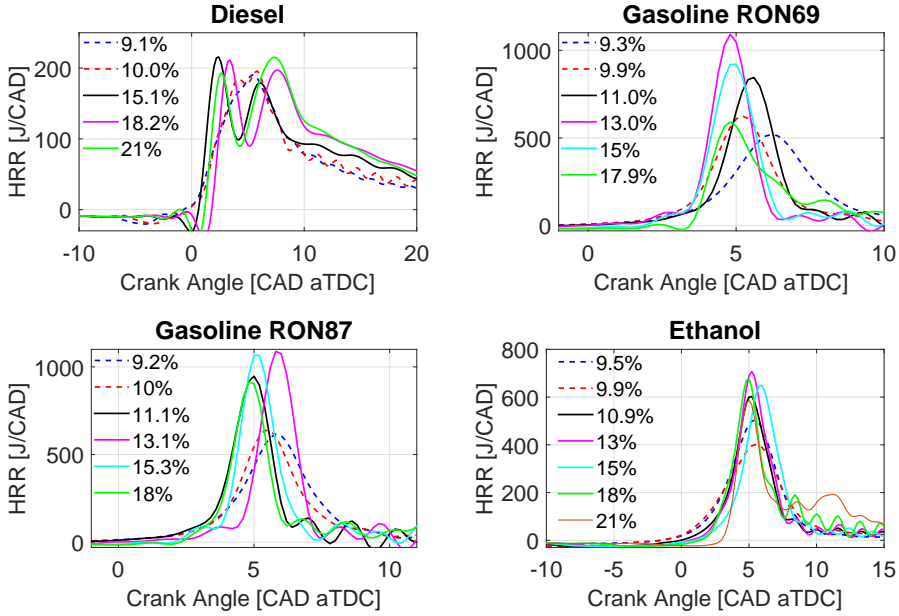

Figure 5.13: Heat release rates at selected intake oxygen rates, IMEP_g 6 bar, engine speed 1200 rpm and injection pressure 1200 bar.

Soot mass concentration, injection timing and soot particle size distributions in response to the intake O₂ are shown in Figure 5.14. For all the fuels, two opposite trends are visible as the intake O₂ reduces. Ultra-low soot mass is emitted with ethanol in all conditions while a soot bump is found in response to the intake oxygen variations with diesel and gasoline fuels. As the O₂ fraction is lowered from 21% to 9%, the engine-out soot mass increases from a value of close to zero, reaches a peak that occurs between 11 and 12% O₂, and then it decreases down to ultra-low level again at approximately 9% O₂. In lean combustion cases (21% to 18% O₂), soot forms fast in local fuel-rich zones with locally high gas temperature. However, it decreases considerably as it is oxidized after mixing with oxygen-rich charge in the piston bowl [86]. With continued reduction of O₂ down to 11%, a greater amount of premixing has occurred as earlier injection timing is employed to maintain constant combustion phasing, see Figure 5.14). This can possibly reduce soot formation. However, because of reduced oxidizers like OH radicals and reduced combustion temperature, soot is even less prone to be oxidized [87, 88]. Consequently, soot mass increases rapidly. Thereby, on the increasing side of the soot bump, soot emission is mainly oxidation-controlled. Soot mass starts to decrease in stoichiometric combustion as a result of much lowered combustion temperature that suppresses soot formation. In rich combustion, smokeless condi-

5.4. EXHAUST PARTICLE SIZE DISTRIBUTION

tions are achieved because combustion occurs place below temperatures that are required to generate the soot particles [26]. Thus, on this increasing side of the soot bump, soot emission changes into formation-controlled [89].

In size distributions, at high oxygen rates, such as 21% to 18% O₂, particle numbers are relatively low and more particles are in nucleation mode other than in accumulations mode. Increasing EGR until 11% O₂, a high number of new accumulation mode particles are produced and the size distributions shift to larger size, indicating high agglomeration rates during combustion. In this range of O₂, the increased residence time of the soot area in the cylinder [90] is likely one of the reasons. Further upon reducing O₂, on the decreasing side of the soot bump, both size and number decrease due to reduced soot formation rate and decreased residence time of the soot area in the cylinder [90].

On the other hand, with ethanol fuel, the soot concentration measurements indicate that when oxygen reduces, soot mass has a slight variation but mostly close to zero levels. The big change in combustion temperature or injection timing does not affect much. Soot formation is largely governed by the fuel property. Regarding the size distribution, a unimodal particle size distribution can be observed at all conditions. It is composed mainly of the characteristic high nucleation mode particles and almost none in accumulation mode. Particle size is in the range of 5-10 nm, which almost does not contribute to soot mass.

5.4. EXHAUST PARTICLE SIZE DISTRIBUTION

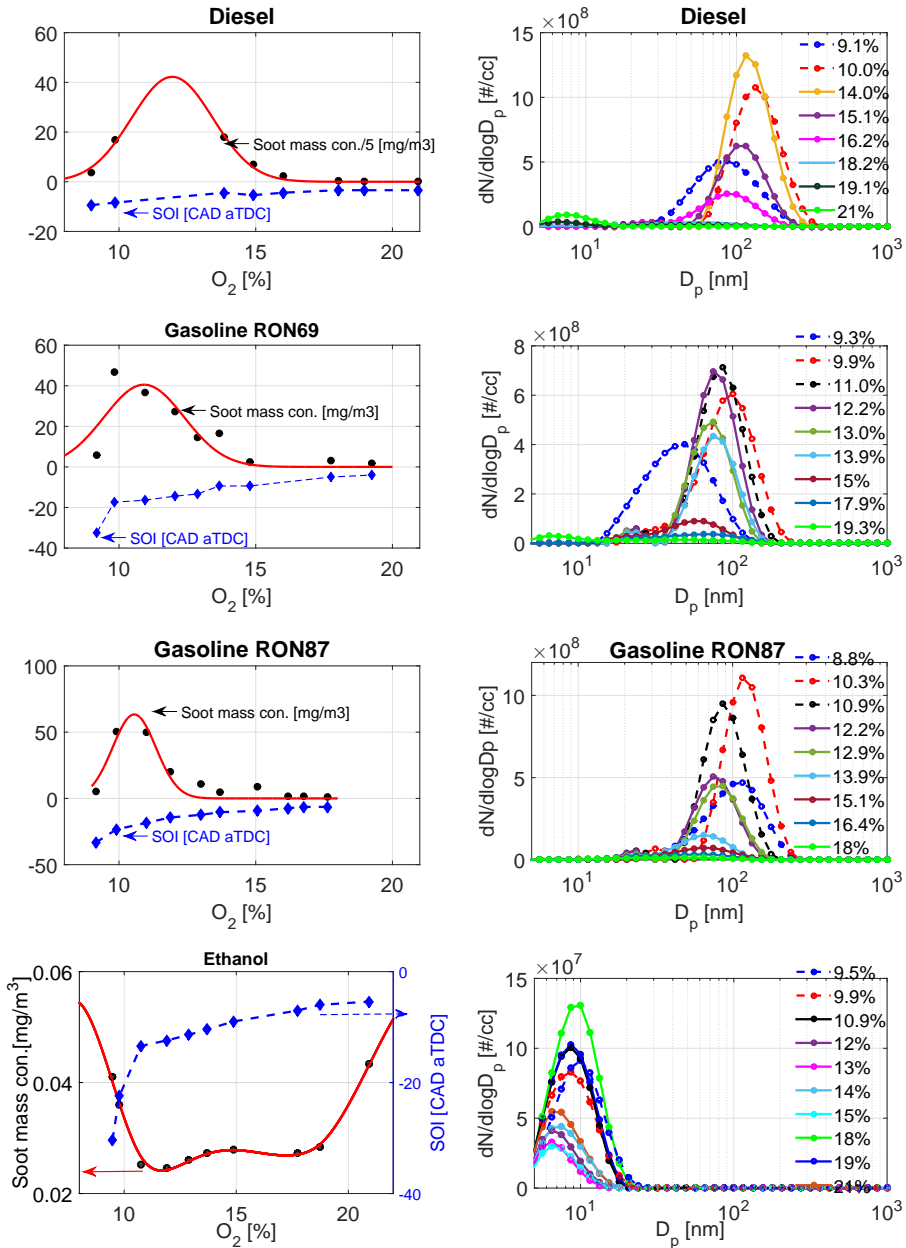

Figure 5.14: Injection timing, particle mass (red solid lines are the fitted curves) and size distributions for varied intake oxygen concentrations.

5.4. EXHAUST PARTICLE SIZE DISTRIBUTION

Figure 5.15 shows the gross indicated specific particulate mass ISPM, and indicated specific particle (larger than about 23 nm) number ISPN of all the fuels. With gasoline and diesel, similarly low soot emissions (both ISPM and ISPN) are generated until 18% O₂. In smokeless rich combustion (9% O₂), soot emissions with diesel are higher than gasoline but at relatively comparable levels. Nevertheless, in between, gasoline fuels show great improvements in soot reduction because of smaller particle size and lower number density. The two gasoline fuels show similar levels of soot emissions through the O₂ variation. On the other hand, slightly lower particle number emissions are observed with RON87 gasoline than RON69 gasoline. Ethanol emits close to zero soot mass emissions with simultaneous ultra-low particle number emissions in all conditions.

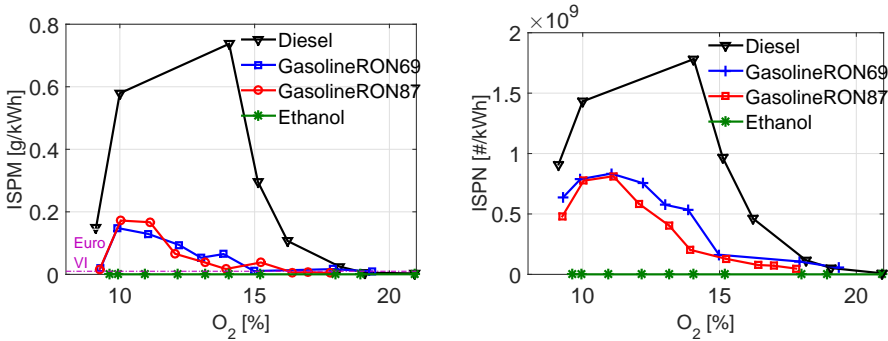

Figure 5.15: Soot mass concentrations, number densities of particles equivalent diameters greater than about 23 nm for varied intake oxygen.

5.4.3 Intake temperature

The results of the experimental analysis of the influence of intake temperature on particle mass concentration and NO_x emissions are shown in Figure 5.16. Soot mass increases as intake temperature rises with diesel and gasoline fuels, while ethanol maintains ultra-low soot mass emissions. The results also indicate the different sensitivity of each fuel to the change of intake temperature. The easier the fuel auto ignites, the more sensitive the soot mass becomes. For instance, diesel soot emission increases rapidly while RON87 gasoline emits close to zero level of soot mass emissions until intake temperature increases to 120 °C. Very little change can be noticed with ethanol in response to increased intake temperature.

As a general rule in diesel combustion, an increase in temperature will enhance the soot generation by decreasing the lift-off length [91]. Soot formation rate increases, however, on the other hand, higher temperature also favors the soot

5.4. EXHAUST PARTICLE SIZE DISTRIBUTION

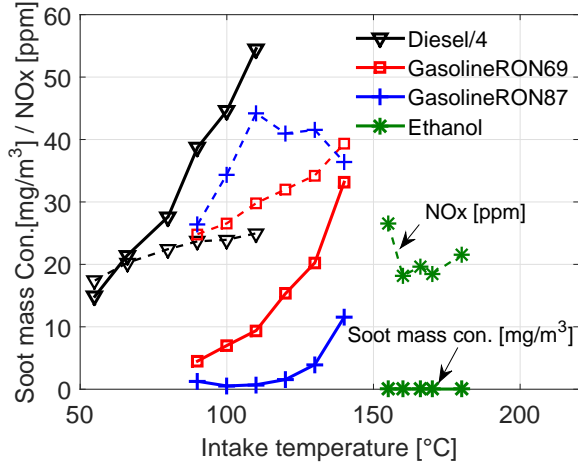

Figure 5.16: Soot mass concentration and NO_x emissions for varied intake temperature, 13% intake oxygen concentration (solid lines: soot mass concentrations [mg/m^3], dash lines: NO_x [ppm]).

oxidation and improves soot burnout. Hence, the engine-out soot mass would be governed by one of the two competing processes. As shown in Figure 5.16, intake temperature tends to increase soot mass emissions with diesel and gasoline fuels. The increase in NO_x emissions indicates an increased temperature that promotes soot formation. More soot is likely formed as combustion can move into the soot islands [87], which can be estimated from the $\Phi - T$ diagram in Figure 2.6. Meanwhile, later injection was employed at higher intake temperature levels to keep combustion phasing constant. Less time for fuel-air premixing can also lead to local fuel rich zones.

Measured soot particle size distributions are presented in Figure 5.17. A unimodal particle size distribution is observed with ethanol and diesel, but dominated by nucleation mode and accumulation mode respectively. On the other hand, a bimodal size distribution but highly dominated by accumulation mode particles is found for both gasoline fuels. Generally, regarding all the fuels, increasing intake temperature increases both soot particle number density and size. With diesel and RON69 gasoline fuel, intake temperature tends to increase accumulation mode particle number and shift the size distributions towards larger size. For high octane number gasoline, this notable change of particle number and size does not appear until temperature is above 120 °C. By then the particle number is largely increased and size distribution shifts to larger size at the same time. The corresponding soot mass increases rapidly as shown in Figure 5.16. In ethanol PPC,

5.4. EXHAUST PARTICLE SIZE DISTRIBUTION

most of the particles are in nucleation mode and the size distribution is centered around 5 nm. Despite increased particle number and size, no significant increase in mass concentration can be observed because of the small size.

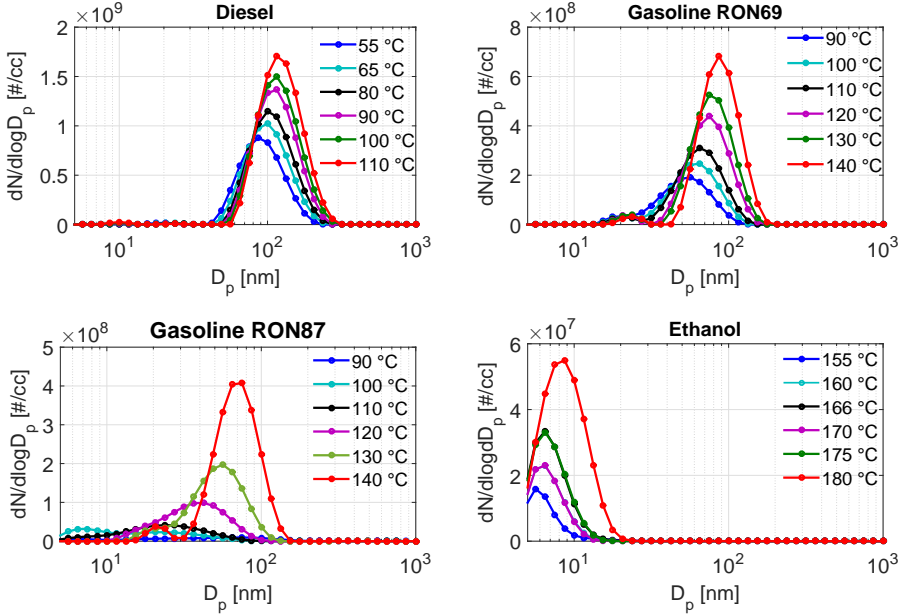

Figure 5.17: Particles size distribution for varied intake temperature.

5.4.4 Injection pressure

The influence of injection pressure on particle mass and the number density of particles larger than 23 nm are shown in Figure 5.18. Similar to the soot emissions in response to intake temperature, the fuel of highest resistance to auto-ignition shows lowest sensitivity to injection pressure, both in particle mass and number emissions. Injection pressure increases the amount of air entrained into the spray and, as a result, the fuel is better mixed with the surrounding air/charge. Higher fuel-air mixing rates lead to leaner conditions and reduce soot formation [92].

5.4. EXHAUST PARTICLE SIZE DISTRIBUTION

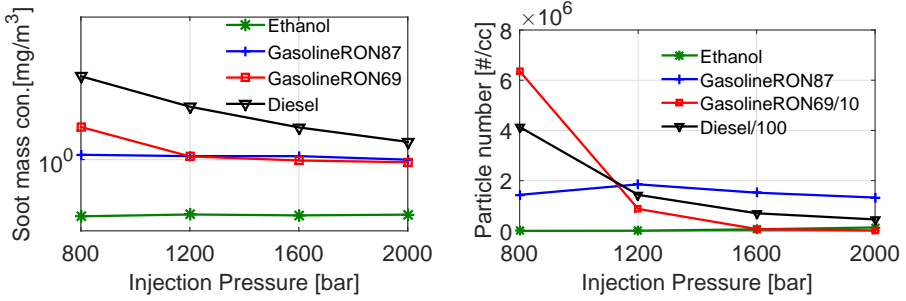

Figure 5.18: Soot mass concentrations and particle number density for varied injection pressure, intake oxygen concentration 14%, IMEP_g 6 bar and engine speed 1200 rpm.

Injection pressure shows two different effects on particle size distributions for fuels with high reactivity and low reactivity respectively in Figure 5.19. Increasing injection pressure, the size distributions in diesel PPC shift to the smaller size and particle number decreases (most particles in accumulation mode). With RON69 gasoline, a characteristic particle mode shift occurs when increasing injection pressure. At low injection pressure, the size distribution consists of a large number of particles in the range of 40 nm to 100 nm and low number of small particles in the range of 20 to 30 nm. Increasing injection pressure, firstly accumulation mode particles are significantly reduced along with an increase in nucleation mode particles. Then the size distribution turns to mainly consist of nucleation mode particles and increasing injection pressure tends to increase particle density and size instead. For high octane gasoline and ethanol, nucleation mode particles dominate the size distributions. Injection pressure tends to mainly cause an increase in the particle number.

5.5. EVALUATION OF IN-CYLINDER SOOT FORMATION

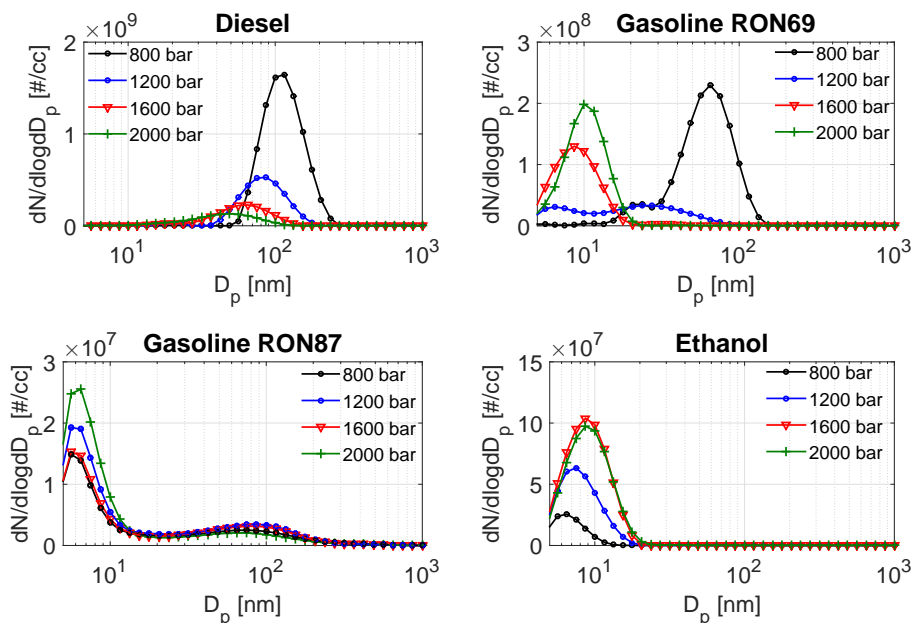

Figure 5.19: Particles size distribution for the fuels investigated with various injection pressure.

5.5 Evaluation of In-cylinder Soot Formation

The extensive studies of soot particles performed in the exhaust stream only represents the product of complex soot processes that involve multi-stage formation and oxidation steps occurring inside the engine cylinder. To get information about the in-flame soot, soot particles were sampled directly from the combustion chamber to particle analysis instruments SMPS (scanning mobility particle sizer) and SP-AMS (soot-particle aerosol mass spectrometer). This study aimed to gain knowledge of the process of soot formation and oxidation with gasoline and diesel fuel. It was accomplished by using a fast sampling valve which was used to draw gas samples from the cylinder at well-defined crank angles. The sampled gas was evaluated in terms of soot mass, particle size distributions and chemical compositions.

5.5.1 Effect of EGR on Diesel

Figure 5.20 depicts soot mass concentration (Black Carbon) during combustion and expansion for three EGR levels. It is clear that EGR reduces the peak soot

5.5. EVALUATION OF IN-CYLINDER SOOT FORMATION

mass during combustion. Reduced temperature suppresses soot formation. However, along with this decrease in soot formation, soot oxidation is even more reduced because of reduced oxidizers like OH radicals and lower temperature. As a result, exhaust soot emissions increases with EGR. Figure 5.20 also shows that soot oxidation rate decreases drastically in late combustion phase. Then constant levels are reached at about 50 CAD aTDC and are maintained until the late expansion stage around 120 CAD aTDC.

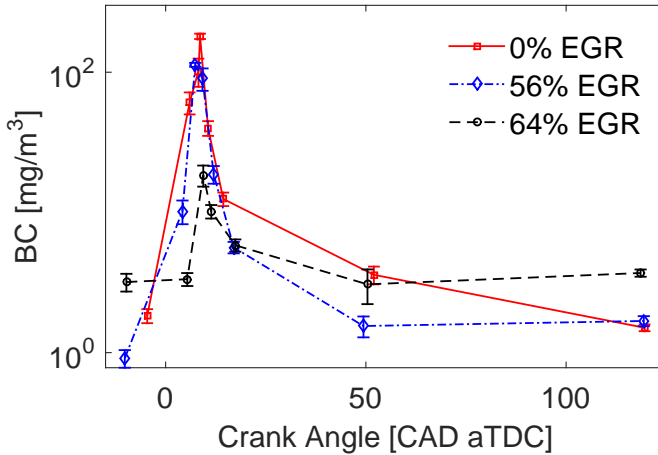

Figure 5.20: In-cylinder soot mass concentrations for varied EGR, 6 bar IMEP_g, 2000 bar injection pressure and 1200 rpm engine speed. Error bars represent standard errors.

Figure 5.21 presents the history of particle size and total particle number density during combustion. The soot mass increase in the early stage is a result of increase in both particle number and particle size. In the burnout stage, these two parameters both decrease and lead to a reduction in soot mass. Relatively speaking, the highest soot mass peak found without EGR is mainly because particle size is generally larger despite lower particle number density. With 64% EGR, the low soot formation is due to both lower particle number density and particle size.

5.5.2 Diesel PPC vs. Gasoline PPC

The averaged in-cylinder heat release rate traces and temperature, injector current signal in PPC combustion with diesel and RON89 gasoline are shown in Figure

5.5. EVALUATION OF IN-CYLINDER SOOT FORMATION

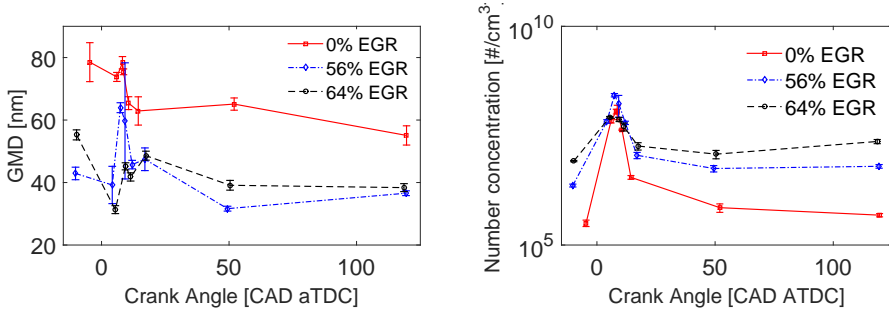

Figure 5.21: In-cylinder geometric mean particle mobility diameter and particle number concentrations for varied EGR. Error bars represent standard errors.

5.22. The fast sampling valve opening timings are illustrated for both combustion processes on the heat release rate traces, with one before injection, one in late combustion phasing, one in expansion stroke and a few during combustion. To keep the combustion phasing similar for both fuels, earlier injection had to be employed in gasoline PPC as a result of its high auto-ignition resistance. Therefore, there is a longer time delay between the fuel injection and start of combustion. After auto-ignition occurs, a fast and rapid premixed combustion takes place, which leads to a higher combustion temperature as shown in the plots. On the other hand, diesel produces lower rate of heat release, with longer combustion duration with significant diffusive combustion.

Figure 5.23 reveals the history of refractive black carbon (rBC), i.e., soot mass concentration in gasoline PPC and diesel PPC during combustion. Soot mass histories with gasoline and diesel show similar trends. In spite of high EGR application in diesel PPC, still much higher BC is formed than that in gasoline PPC. The result illustrates that the very low soot formation is the main reason for lower exhaust soot mass emissions from gasoline PPC. This can be largely attributed to better mixing between gasoline and air. Study from high speed video in an optical engine showed that a gasoline type fuel presented a wider distribution of fuel vapour than diesel fuel due to the higher volatility [?]. Simulation work with detailed chemistry and pollutant formation model has reported that combustion was initiated in at lean equivalence ratios for the gasoline-like fuel whilst at the richest point for the diesel-like fuel [93]. This enables gasoline PPC combustion occurring in a relatively homogeneous environment and avoiding the high PM formation regime. In addition to that, there is more air entrained to the gasoline fuel jet which promotes mixing between fuel and air and soot oxidation.

On the size distributions in Figure 5.24, the main observation with gasoline is a shift in particle number concentration. On the contrary, along with particle number variations, size distribution with diesel particles firstly shifts to larger size

5.5. EVALUATION OF IN-CYLINDER SOOT FORMATION

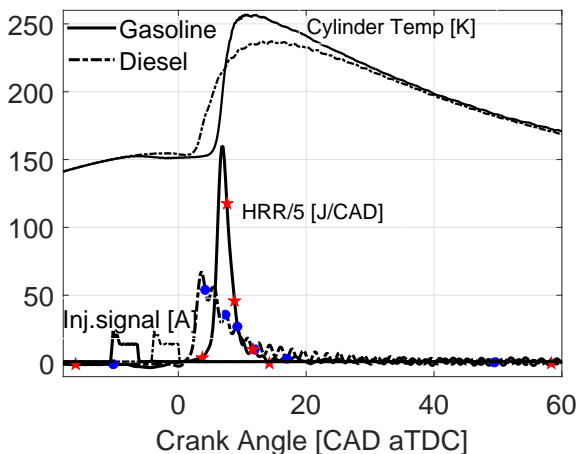

Figure 5.22: Averaged injector current and heat release rate traces for various crank angle locations for both gasoline and diesel fuel. The approximate crank angle locations of the start of soot collection are marked as blue circles for diesel and red stars for gasoline on the heat release rate traces.

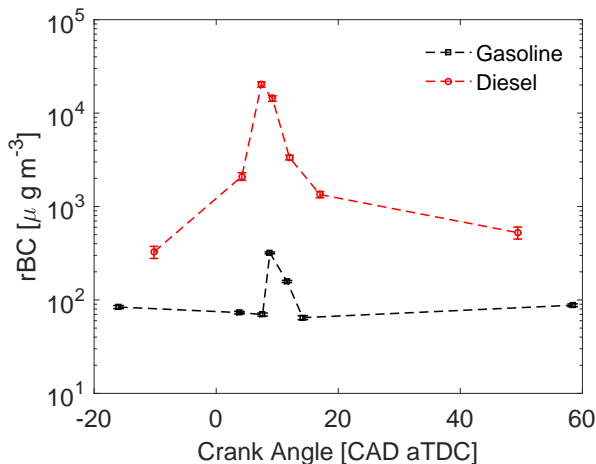

Figure 5.23: In-cylinder soot mass concentration (rBC) during combustion in gasoline PPC and diesel PPC. Error bars represent standard errors.

5.6. DISCUSSIONS

then back to smaller size again. The major difference in gasoline case compared to diesel is the asymmetry apparent in the shapes of the gasoline particle distribution. Diesel particle size distribution appeared to have only an accumulation mode, with the highest number density within the range 40–100 nm. Gasoline particle size distributions had a nucleation mode that was always present, and a soot mode present only when rBC was simultaneously detected. Small nucleation mode particles in the range of 10–30 nm dominate the shape of particle size distributions. The values in expansion stroke indicate that, despite the fact that gasoline PPC generates higher particle number concentration, the non-existent large accumulation mode particles after combustion leads to the ultra-low exhaust soot mass emissions in gasoline PPC operation.

5.6 Discussions

Regarding the challenge of potential soot emissions in PPC, the presented work in this thesis is an attempt to describe soot particle mass and size distributions with fuels that have different soot tendency under varied engine operating conditions. Clearly, diesel fuel generates the highest soot mass emissions among the tested fuels in PPC mode. High reactivity results in shorter ignition delay while there is less air entrained to the fuel jet compared to gasoline fuel. Therefore more diffusive combustion in diesel case is likely the reason. Compared to diesel, because of partially premixed fuel and air prior to combustion in conjunction with lower aromatic and shorter chains in the molecule, soot formation reduces in gasoline PPC. High octane number gasoline can have a longer ignition delay which helps to suppress soot emissions compared to low octane number gasoline. Ultra-low soot is observed in all test conditions in ethanol PPC. Its high resistance to auto-ignition prolongs the time available for the mixing of the fuel vapor with air. At the same time, the oxygen in the molecule can be conducive to suppress soot formation even in fuel-rich zones.

Varying injection timing can affect the charge stratification and thus influence soot emissions. Very early injection timing is a means of producing homogeneous or a premixed stratified charge in the cylinder. In single injection event, as too early injection might face the risk of losing control of combustion phasing and too late injection may cause high fuel stratification and soot formation, multiple injections seem to be more attractive. Particularly in a pilot plus main injection strategy, a portion of fuel injected very early before TDC can generate premixed charge and reduce soot while the main injection near TDC can control combustion phasing effectively. By optimizing the injection timings and fuel injection portion, low soot emission is possible in some conditions where high soot is emitted with single injection. Additionally, it needs to be noticed that, for a given bowl geometry, changing the timing to be either earlier or later may have dramatic effects

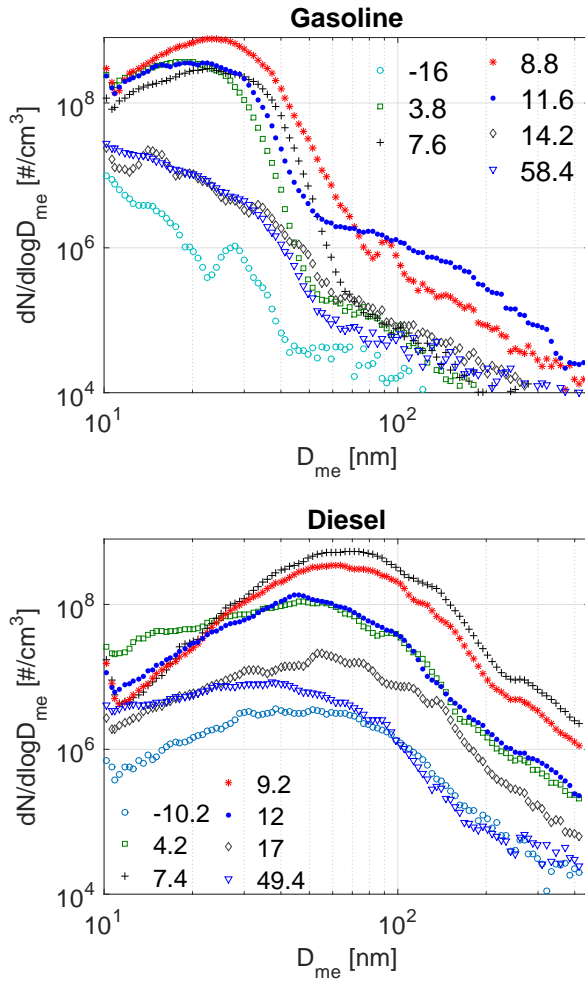

Figure 5.24: Particle size distributions with gasoline and diesel fuels during the combustion process.

5.6. DISCUSSIONS

on particulate emissions if the timing change results in liquid fuel impingement. Therefore, to minimize soot production, parameters that could affect fuel-wall iterations should be taken into account.

In-cylinder emission control strategies, such as intake temperature and pressure, application of EGR and injection pressure have seen an influence on soot emissions for diesel, gasoline and ethanol to a varying extent respectively. Diesel and low octane gasoline fuel are more sensitive to engine operation conditions. Consequently, stoichiometric PPC or very high EGR is not feasible due to the high expense of soot penalty. Additionally, engine efficiency may reduce to compensate soot emissions control. Contrary to that, high octane gasoline shows little change in response to intake temperature or injection pressure, which can give more tolerant control of those parameters. Ethanol emits ultra-low soot in all conditions. The non-existent soot-NO_x trade off makes less engine efficiency compensation possible to comply with the legislation standards. In the meantime, the exhaust after-treatment system can be simplified.

In-cylinder soot evaluation provides soot information during combustion. Comparison of soot processes with gasoline and diesel indicated that much lower soot formation was the main reason for lower exhaust soot emissions from gasoline PPC operation. Reduced soot formation is attributed to well premixed fuel and air. This indicates that in PPC combustion, the premixing quality is the key factor to control in-cylinder soot formation. Premixing duration is one important parameter. On the other hand, if fuel–air premixing process is faster, low soot emission is possible. For instance, higher injection pressure leads to a shorter ignition delay. However, higher fuel velocity results in increased lift off length and makes fuel elements travel faster to mix with air surrounding the jet. As a result, despite of shorter ignition delay, lower soot mass was emitted with higher injection pressure than low injection pressure.

For the fast sampling technique, although further assessment may be required, it provides a valuable tool in future in-cylinder soot studies and may e.g. serve to enhance the interpretation of laser extinction measurements which have much higher time resolution but do not capture all features of the aerosol present in the cylinder.

Chapter 6

Summary and Conclusions

This chapter contains a brief summary of the main observations and contributions of the work in this thesis. The studies in this thesis were performed to improve the understanding of engine-out particulate matter emissions in PPC. The main focus was on the fuel effect, but other engine parameters were also studied to provide a more complete picture.

Compared to HCCI combustion, PPC combustion showed advantages of higher engine thermodynamic efficiency with simultaneously lower UHC and CO emissions. On the other hand, in PPC mode with high amount of EGR and late fuel injection timing, because of increased stratified charge, PM emissions could rise. Exhaust particle size distributions in HCCI were in a unimodal shape dominated by the nucleation mode and soot mass emissions were ultra-low. Retarding injection into PPC mode, particle size distribution eventually changed into a bimodal shape. Particle numbers in accumulation mode rapidly increased and dominated the particle size distribution with the size distributions shifted to larger sizes. Soot mass emission increased correspondingly.

For in-cylinder emission control, generally, reducing intake pressure or increasing EGR was beneficial for keeping NO_x emission low but could result in higher soot emissions. Utilizing fuels that can provide longer time for fuel and air to mix prior to combustion could be one of the solutions. Compared to diesel, gasoline fuel showed high improvement in terms of soot reduction while ethanol emitted close to zero soot mass emissions in all conditions. Non-existing NO_x -soot trade off in ethanol induces possibility of clean PPC operations with three-way catalyst in stoichiometric conditions or with other simple Exhaust After-Treatment System (EATS) in lean burn conditions. In contrast, stoichiometric diesel PPC or low octane numbered gasoline PPC was not a good choice due to severe efficiency and

soot emission penalties.

With diesel and gasoline fuel, increasing intake temperature or reducing injection pressure increased the particle number of the accumulation mode and shifted the size distributions to larger sizes, resulting in an increase of particulate mass. EGR could affect both combustion temperature and soot oxidizers therefore affect exhaust soot output. Soot mass emissions tended to increase first with increased number and size of accumulation mode particles. After reaching a peak value, soot mass decreased. Particle number concentrations reduced and the size distributions shifted to smaller size again, resulting in a smokeless condition in rich combustion. Gasoline fuel with high octane number was found to be less sensitive to the change of engine control parameters than low octane number gasoline and diesel, which makes it more attractive in gasoline PPC applications.

Very slight change in particle mass emissions was observed with ethanol PPC in response to intake temperature, injection pressure and EGR. The maintained ultra-low soot emission level suggests improved robustness in response to variations of those engine parameters and requires less efficiency compromise when complying with the legislation standards.

Compared to conventional diesel, gasoline showed great improvements in soot emission levels because of lower particle number density and smaller sizes. In-cylinder sampled soot analysis revealed that due to longer premixing time and better air entrainment to the fuel jet, gasoline PPC produced much lower soot mass during combustion. Diesel particle size distributions appeared to have only an accumulation mode, while gasoline particle size distributions had a nucleation mode that was always present and dominated, and a soot/accumulation mode presented only when soot mass was simultaneously detected. Unlike in diesel PPC where soot output was mainly soot-oxidation governed, low soot formation was the main reason for low exhaust soot emissions in gasoline PPC. It is concluded that good equality of fuel-air turns to be the key factor to control soot emissions in gasoline PPC operation.

The work in the thesis suggests that new fuel strategies to complement engine in-cylinder emission control strategies in PPC may be powerful tools for continued particle emission reduction in CI engines. The soot properties obtained from different fuels and engine operating conditions could have implications for the efficiency of soot after-treatment systems.

Chapter 7

Future Work

This chapter presents the limitations of the performed study and the suggested work for the future.

The possibility of simultaneous reduction in soot and NO_x while maintaining high engine thermodynamic efficiency has been established utilizing gasoline and ethanol fuel in PPC combustion. The particle size distribution also gives information about the physical characteristics in terms of particle size and number from different fuels. However, there is still a need to further understand the fundamental mechanisms of the soot processes during the combustion in the cylinder with different kinds of fuels. Together with in-cylinder emission control strategies, there is a potential for further improvement and optimization and therefore, some research areas which the author believes should be further explored are listed below.

- In the thesis, regarding the in-cylinder emission control parameters, only single-injection events with variations in inlet temperature and pressure, EGR and injection pressure were tested. However, other injection strategies, such as double injection or triple injection should also be included and properly optimized to find a good trade-off between engine performance and emissions for a specific fuel.
- Soot formation is affected by the mixing between fuel and air thus soot reduction can be improved further by enhancing the fuel-wall interactions in the combustion chamber. In this regard, swirl ratio, injection spray angle, piston geometry and injector parameters should be tested to find a good combination of turbulence and injection process for a specific fuel.

-
- Engine load and engine speed should be extended with various kinds of fuels to provide more complete information for soot after-treatment system design.
 - Particle emissions from PPC require further study including particle chemical composition, optical properties and micro- and nano structure.
 - More fuels, such as gasoline-ethanol blends, gasoline of high octane number or alcohol fuels could also be interesting to investigate.

Bibliography

- [1] John B Heywood. *Internal Combustion Engine Fundamentals*.
- [2] Rajendra K Pachauri, MR Allen, VR Barros, J Broome, W Cramer, R Christ, JA Church, L Clarke, Q Dahe, P Dasgupta, et al. Climate change 2014: Synthesis report. contribution of working groups i, ii and iii to the fifth assessment report of the intergovernmental panel on climate change. 2014.
- [3] Noboru Tanikawa, Toshitada Imai, and Kohei Urano. Characteristics of continuous analyzers for nitrous oxide in flue gas from municipal incinerators. *Science of the total environment*, 175(3):189–198, 1995.
- [4] World Health Organization (WHO) et al. Iarc: Diesel engine exhaust carcinogenic. *IARC Monographs on the Evaluation of Carcinogenic Risks to Humans*. Lyon, France <http://www.iarc.fr/en/media-centre/iarcnews/2012/mono105-info.php>, 2012.
- [5] Colin J Campbell and Jean H Laherrère. The end of cheap oil. *Scientific American*, 278(3):60–5, 1998.
- [6] Jacob Spendelow, Jason Marcinkoski, and Sunita Satyapal. Fuel Cell System Cost - 2013. *DOE Fuel Cell Technol. Off. Rec.*, (13012):1–8, 2013.
- [7] Steven G Chalk and James F Miller. Key challenges and recent progress in batteries, fuel cells, and hydrogen storage for clean energy systems. *Journal of Power Sources*, 159(1):73–80, 2006.
- [8] JoAnn Slama Lighty, John M Veranth, and Adel F Sarofim. Combustion aerosols: factors governing their size and composition and implications to human health. *Journal of the Air & Waste Management Association*, 50(9):1565–1618, 2000.
- [9] <http://www.dieselnets.com/standards/eu/hd.php>.
- [10] David B. Kittelson. Engines and nanoparticles: A review. *J. Aerosol Sci.*, 29(5-6):575–588, 1998.

BIBLIOGRAPHY

- [11] Dale R. Tree and Kenth I. Svensson. Soot processes in compression ignition engines. *Prog. Energy Combust. Sci.*, 33(3):272–309, 2007.
- [12] Martyn V. Twigg and Paul R. Phillips. Cleaning the air we breathe - controlling diesel particulate emissions from passenger cars. *Platin. Met. Rev.*, 53(1):27–34, 2009.
- [13] John B Heywood. *Internal Combustion Engine Fundamentals*, volume 21. 1988.
- [14] Irvin Glassman. Soot formation in combustion processes. *Symp. Combust.*, 22(1):295–311, 1989.
- [15] Irvin Glassman, Richard A Yetter, and Nick G Glumac. *Combustion*. Academic press, 2014.
- [16] CT Bowman. Chemistry of gaseous pollutant formation and destruction, chapter 4 of fossil fuel combustion: A source book. bartok, w., and sarofim, af, editors, 1991.
- [17] D.L. Siebers and Brian Higgins. Flame lift-off on direct-injection diesel sprays under quiescent conditions. *Sae Trans.*, 110(3):400–421, 2001.
- [18] T Kitamura, T Ito, J Senda, and H Fujimoto. Mechanism of smokeless diesel combustion with oxygenated fuels based on the dependence of the equivalence ration and temperature on soot particle formation. *Int. J. Engine Res.*, 3(4):223–248, 2005.
- [19] Venkateswara Rao Surisetty, Ajay Kumar Dalai, and Janusz Kozinski. Alcohols as alternative fuels: An overview, 2011.
- [20] M Matti Maricq. Chemical characterization of particulate emissions from diesel engines: A review. *Journal of Aerosol Science*, 38(11):1079–1118, 2007.
- [21] https://www.dieselnet.com/tech/dpf_wall-flow.php.
- [22] https://www.dieselnet.com/tech/dpf_cat.php.
- [23] A. B. Dempsey, S. J. Curran, and R. M. Wagner. A perspective on the range of gasoline compression ignition combustion strategies for high engine efficiency and low NOx and soot emissions: Effects of in-cylinder fuel stratification. *Int. J. Engine Res.*, 1, 2016.
- [24] PC Miles, D Choi, LM Pickett, IP Singh, N Henein, BA RempelEwert, H Yun, and RD Reitz. Rate-limiting processes in late-injection, low-temperature diesel combustion regimes. In *Proc. THIESEL 2004 Conference*, pages 429–447, 2004.

BIBLIOGRAPHY

- [25] Mingfa Yao, Quanchang Zhang, Haifeng Liu, Zunqing Zheng, Peng Zhang, Zhiqiang Lin, Tiejian Lin, and Jie Shen. Diesel Engine Combustion Control: Medium or Heavy EGR? *SAE Pap. no. 2010-01-1125*, 2010.
- [26] Kazuhiro Akihama, Yoshiki Takatori, Kazuhisa Inagaki, Shizuo Sasaki, and Anthony M Dean. Mechanism of the smokeless rich diesel combustion by reducing temperature. Technical report, SAE technical paper, 2001.
- [27] Tie Li, Yukihiko Okabe, Hiroyuki Izumi, Toshio Shudo, and Hideyuki Ogawa. Dependence of ultra-high egr low temperature diesel combustion on fuel properties. Technical report, SAE Technical Paper, 2006.
- [28] Robert H Thring. Homogeneous-charge compression-ignition (hcci) engines. Technical report, SAE Technical paper, 1989.
- [29] Magnus Christensen, Bengt Johansson, and Patrik Einewall. Homogeneous charge compression ignition (hcci) using isooctane, ethanol and natural gas-a comparison with spark ignition operation. Technical report, SAE Technical Paper, 1997.
- [30] Rudolf H Stanglmaier and Charles E Roberts. Homogeneous charge compression ignition (hcci): benefits, compromises, and future engine applications. Technical report, SAE Technical Paper, 1999.
- [31] Salvador M Aceves, Daniel L Flowers, Charles K Westbrook, J Ray Smith, William Pitz, Robert Dibble, Magnus Christensen, and Bengt Johansson. A multi-zone model for prediction of hcci combustion and emissions. Technical report, SAE Technical paper, 2000.
- [32] Thomas W Ryan and Timothy J Callahan. Homogeneous charge compression ignition of diesel fuel. Technical report, SAE Technical Paper, 1996.
- [33] Andreas Vressner, Andreas Lundin, Magnus Christensen, Per Tunestal, and Bengt Johansson. Pressure oscillations during rapid hcci combustion. *SAE transactions*, 112(4):2469–2478, 2003.
- [34] Jan-Ola Olsson, Per Tunestål, and Bengt Johansson. Boosting for high load hcci. *SAE Transactions, Journal of Engines*, 113(3):579–588, 2004.
- [35] Michael Boot, Erik Rijk, Carlo Luijten, Bart Somers, and Bogdan Albrecht. Spray impingement in the early direct injection premixed charge compression ignition regime. *SAE technical paper*, pages 01–1501, 2010.
- [36] Shuji Kimura, Osamu Aoki, Yasuhisa Kitahara, and Eiji Aiyoshizawa. Ultra-clean combustion technology combining a low-temperature and premixed combustion concept for meeting future emission standards. Technical report, SAE Technical Paper, 2001.

BIBLIOGRAPHY

- [37] Shuji Kimura, Hiroshi Ogawa, Yoichi Matsui, and Yoshiteru Enomoto. An experimental analysis of low-temperature and premixed combustion for simultaneous reduction of nox and particulate emissions in direct injection diesel engines. *International Journal of Engine Research*, 3(4):249–259, 2002.
- [38] Yoshinaka Takeda, Nakagome Keiichi, and Niimura Keiichi. Emission characteristics of premixed lean diesel combustion with extremely early staged fuel injection. Technical report, SAE Technical Paper, 1996.
- [39] Keiichi Nakagome, Naoki Shimazaki, Keiichi Niimura, and Shinji Kobayashi. Combustion and emission characteristics of premixed lean diesel combustion engine. Technical report, SAE Technical Paper, 1997.
- [40] Sage Kokjohn, Reed Hanson, Derek Splitter, John Kaddatz, and Rolf Reitz. Fuel reactivity controlled compression ignition (rcci) combustion in light-and heavy-duty engines. *SAE International Journal of Engines*, 4(1):360–374, 2011.
- [41] Hiromichi Yanagihara, Yasuo Sato, and Jun’ichi Mizuta. A study of di diesel combustion under uniform higher-dispersed mixture formation. *JSAE review*, 18(4):361–367, 1997.
- [42] Leif Hildingsson, Håkan Persson, Bengt Johansson, Robert Collin, Jenny Nygren, Mattias Richter, Marcus Aldén, Ryo Hasegawa, and Hiromichi Yanagihara. Optical diagnostics of hcci and unibus using 2-d plif of oh and formaldehyde. Technical report, SAE Technical paper, 2005.
- [43] Koji Kitano, Ryoji Nishiumi, Yukihiro Tsukasaki, Toshiaki Tanaka, and Masataka Morinaga. Effects of fuel properties on premixed charge compression ignition combustion in a direct injection diesel engine. Technical report, SAE Technical Paper, 2003.
- [44] Sage L Kokjohn, Reed M Hanson, Derek A Splitter, and Rolf D Reitz. Experiments and modeling of dual-fuel hcci and pcci combustion using in-cylinder fuel blending. *SAE International Journal of Engines*, 2(2):24–39, 2010.
- [45] Derek Splitter, Rolf Reitz, and Reed Hanson. High efficiency, low emissions rcci combustion by use of a fuel additive. *SAE International Journal of Fuels and Lubricants*, 3(2):742–756, 2010.
- [46] Derek Splitter, Reed Hanson, Sage Kokjohn, and Rolf D Reitz. Reactivity controlled compression ignition (rcci) heavy-duty engine operation at mid-and high-loads with conventional and alternative fuels. Technical report, SAE Technical Paper, 2011.
- [47] Sage Kokjohn, Reed Hanson, Derek Splitter, John Kaddatz, and Rolf Reitz. Fuel reactivity controlled compression ignition (rcci) combustion in light-and

BIBLIOGRAPHY

- heavy-duty engines. *SAE International Journal of Engines*, 4(1):360–374, 2011.
- [48] SL Kokjohn, RM Hanson, DA Splitter, and RD Reitz. Fuel reactivity controlled compression ignition (rci): a pathway to controlled high-efficiency clean combustion. *International Journal of Engine Research*, 12(3):209–226, 2011.
- [49] Gautam T. Kalghatgi, Per Risberg, and Hans-Erik Ångström. Advantages of Fuels with High Resistance to Auto-ignition in Late-injection, Low-temperature, Compression Ignition Combustion. *SAE Tech. Pap.*, (724), 2006.
- [50] Gautam T Kalghatgi, Per Risberg, and Hans-Erik Ångström. Partially premixed auto-ignition of gasoline to attain low smoke and low nox at high load in a compression ignition engine and comparison with a diesel fuel. *SAE paper*, (2007-01):0006, 2007.
- [51] C Noehre, M Andersson, B Johansson, and A Hultqvist. Characterization of partially premixed combustion. (724):776–790, 2006.
- [52] Magnus Lewander, Kent Ekholm, Bengt Johansson, Per Tunestål, Nebojsa Milovanovic, Nathan Keeler, Tony Harcombe, and Pär Bergstrand. Investigation of the Combustion Characteristics with Focus on Partially Premixed Combustion in a Heavy Duty Engine. *SAE Int. J. Fuels Lubr.*, 1(1):1063–1074, 2008.
- [53] Vittorio Manente, Bengt Johansson, Per Tunestal, and William Cannella. Effects of Different Type of Gasoline Fuels on Heavy Duty Partially Premixed Combustion. *SAE Int. J. Engines*, 2(2):71–88, 2009.
- [54] Vittorio Manente, Claes-goeran Zander, Bengt Johansson, Per Tunestal, and William Cannella. An Advanced Internal Combustion Engine Concept for Low Emissions and High Efficiency from Idle to Max Load Using Gasoline Partially Premixed Combustion. *SAE Tech. Pap.*, 01(2198), 2010.
- [55] Mengqin Shen, Martin Tuner, and Bengt Johansson. Close to Stoichiometric Partially Premixed Combustion -The Benefit of Ethanol in Comparison to Conventional Fuels. *SAE Tech. Pap.*, 01(Dici), apr 2013.
- [56] Mark Sellnau, James Sinnamon, Kevin Hoyer, and Harry Husted. Gasoline direct injection compression ignition (gdci)—diesel-like efficiency with low co2 emissions. *SAE paper*, (2011-01):1386, 2011.
- [57] Mark C Sellnau, James Sinnamon, Kevin Hoyer, and Harry Husted. Full-time gasoline direct-injection compression ignition (gdci) for high efficiency and low nox and pm. *SAE International Journal of Engines*, 5(2012-01-0384):300–314, 2012.

BIBLIOGRAPHY

- [58] Vittorio Manente, Bengt Johansson, and Per Tunestål. Partially premixed combustion at high load using gasoline and ethanol, a comparison with diesel. In *SAE World Congress & Exhibition*, volume 2009. Society of Automotive Engineers, 2009.
- [59] Vittorio Manente, Per Tunestal, Bengt Johansson, and William J Cannella. Effects of ethanol and different type of gasoline fuels on partially premixed combustion from low to high load. Technical report, SAE Technical Paper, 2010.
- [60] Hadeel Solaka, Martin Tuner, Bengt Johansson, and William Cannella. Gasoline surrogate fuels for partially premixed combustion, of toluene ethanol reference fuels. Technical report, SAE Technical Paper, 2013.
- [61] Leif Hildingsson, Gautam Kalghatgi, Nigel Tait, Bengt Johansson, and Andrew Harrison. Fuel octane effects in the partially premixed combustion regime in compression ignition engines. *SAE paper*, (2009-01):2648, 2009.
- [62] Leif Hildingsson, Bengt Johansson, Gautam T Kalghatgi, and Andrew J Harrison. Some effects of fuel autoignition quality and volatility in premixed compression ignition engines. *SAE paper*, (2010-01):0607, 2010.
- [63] Gerhard Woschni. A universally applicable equation for the instantaneous heat transfer coefficient in the internal combustion engine. Technical report, SAE Technical paper, 1967.
- [64] AE Dodd, Z Holubecki, Motor Industry Research Association, et al. *The measurement of diesel exhaust smoke*. Motor Industry Research Association, 1965.
- [65] Smoke Opacity. https://www.dieselnet.com/tech/measure_opacity.php.
- [66] Fred R Faxvog and David M Roessler. Optoacoustic measurements of diesel particulate emissions. *Journal of Applied Physics*, 50(12):7880–7882, 1979.
- [67] Barouch Giechaskiel, Matti Maricq, Leonidas Ntziachristos, Christos Dardiotis, Xiaoliang Wang, Harald Axmann, Alexander Bergmann, and Wolfgang Schindler. Review of motor vehicle particulate emissions sampling and measurement: From smoke and filter mass to particle number. *J. Aerosol Sci.*, 67:48–86, 2014.
- [68] Cambustion. DMS500 for aerosol size, number and mass measurements.
- [69] Scanning Mobility Particle Sizer TM Spectrometer (SMPS) Model 3936.
- [70] Shih Chen Wang and Richard C. Flagan. Scanning Electrical Mobility Spectrometer. *Aerosol Sci. Technol.*, 13(2):230–240, jan 1990.

BIBLIOGRAPHY

- [71] TB Onasch, A Trimborn, EC Fortner, JT Jayne, GL Kok, LR Williams, P Davidovits, and DR Worsnop. Soot particle aerosol mass spectrometer: development, validation, and initial application. *Aerosol Science and Technology*, 46(7):804–817, 2012.
- [72] AVL Smoke Meter. <https://www.avl.com/-/avl-smoke-meter>.
- [73] AVL micro soot sensor. <https://www.avl.com/-/avl-micro-soot-sensor-aviation>.
- [74] <http://www.cambustion.com/products/dms500>.
- [75] http://www.mageesci.com/rack_mount_aethalometer/rack_mount_aethalometer_model.
- [76] Constantinos Sioutas. Evaluation of the measurement performance of the scanning mobility particle sizer and aerodynamic particle sizer. *Aerosol Science & Technology*, 30(1):84–92, 1999.
- [77] Vittorio Manente, Bengt Johansson, Per Tunestal, and William J Cannella. Influence of inlet pressure, egr, combustion phasing, speed and pilot ratio on high load gasoline partially premixed combustion. Technical report, SAE Technical Paper, 2010.
- [78] J Javier Lopez, Jose M Garcia-Oliver, Jaime Martin, Jean Pierre Chemisky, and Alexandre Bouet. A soot radiation model for diesel sprays. Technical report, SAE Technical Paper, 2012.
- [79] W. Majewski. DieselNet Technology Guide. *DieselNet.com*, pages 4–7, 2012.
- [80] Fabrizio Bonatesta, Salvatore La Rocca, Edward Hopkins, and Daniel Bell. Application of computational fluid dynamics to explore the sources of soot formation in a gasoline direct injection engine. Technical report, SAE Technical Paper, 2014.
- [81] Ulf Aronsson, Oivind Andersson, Rolf Egnell, Paul C Miles, and Isaac W Ekoto. Influence of spray-target and squish height on sources of co and uhc in a hsd diesel engine during ppci low-temperature combustion. Technical report, SAE Technical Paper, 2009.
- [82] Marcus Lundgren, Joakim Rosell, Mattias Richter, Öivind Andersson, Bengt Johansson, Andersson Arne, and Marcus Alden. Optical study on combustion transition from hcci to ppc with gasoline compression ignition in a hd engine. Technical report, SAE Technical Paper, 2016.
- [83] Michael C Drake, Todd D Fansler, Arun S Solomon, and GA Szekeley. Piston fuel films as a source of smoke and hydrocarbon emissions from a wall-controlled spark-ignited direct-injection engine. *SAE transactions*, 112(3):762–783, 2003.

BIBLIOGRAPHY

- [84] Peter Eastwood. *Particulate emissions from vehicles*, volume 20. John Wiley & Sons, 2008.
- [85] Changle Li, Lianhao Yin, Sam Shamun, Martin Tuner, Bengt Johansson, Rickard Solsjo, and Xue-Song Bai. Transition from hcci to ppc: the sensitivity of combustion phasing to the intake temperature and the injection timing with and without egr. Technical report, SAE Technical Paper, 2016.
- [86] Ulf Aronsson, Clément Chartier, Öivind Andersson, Bengt Johansson, Rikard Wellander, Mattias Richter, and Paul Miles. Analysis of EGR Effects on the Soot Distribution in a Heavy Duty Diesel Engine using Time-Resolved Laser Induced Incandescence. *SAE Int. J. Engines*, 3(2):137–155, 2010.
- [87] Kazuhiro Akihama, Yoshiki Takatori, Kazuhisa Inagaki, Shizuo Sasaki, and Anthony M Dean. Mechanism of the smokeless rich diesel combustion by reducing temperature. Technical report, SAE technical paper, 2001.
- [88] Feng Tao, Yi Liu, Bret H Rempelewert, David E Foster, Rolf D Reitz, Dae Choi, and Paul C Miles. Modeling the Effects of EGR and Injection Pressure on Soot Formation in a High-Speed Direct-Injection (HSDI) Diesel Engine Using a Multi-Step Phenomenological Soot Model. *SAE Tech. Pap. 2005-01-0121*, 2005(724), 2005.
- [89] D Farrace, M Bolla, Y M Wright, and K Boulouchos. Numerical Study of the Influence of EGR on In-Cylinder Soot Characteristics in a Heavy-Duty Diesel Engine using CMC. *SAE Int. J. Engines*, 7(1):256–268, 2014.
- [90] Ulf Aronsson, Clément Chartier, Öivind Andersson, Bengt Johansson, Rikard Wellander, Mattias Richter, and Paul Miles. Analysis of EGR Effects on the Soot Distribution in a Heavy Duty Diesel Engine using Time-Resolved Laser Induced Incandescence. *SAE Int. J. Engines*, 3(2):137–155, 2010.
- [91] Lyle M Pickett and Dennis L Siebers. Soot in diesel fuel jets: effects of ambient temperature, ambient density, and injection pressure. *Combustion and Flame*, 138(1):114–135, 2004.
- [92] Lyle M. Pickett and Dennis L. Siebers. Soot in diesel fuel jets: Effects of ambient temperature, ambient density, and injection pressure. *Combust. Flame*, 138(1-2):114–135, 2004.
- [93] Andrew J Smallbone, Amit Bhave, Aaron Coble, Sebastian Mosbach, Markus Kraft, Neal Morgan, and Gautam Kalghatgi. Simulating pm emissions and combustion stability in gasoline/diesel fuelled engines. *SAE Technical Paper*, pages 01–1184, 2011.

Summary of Papers

Paper I

Close to Stoichiometric Partially Premixed Combustion -The Benefit of Ethanol in Comparison to Conventional Fuels

Mengqin Shen, Martin Tuner and Bengt Johansson

Division of Combustion Engines, Lund University, Sweden

SAE Technical paper SAE 2013-01-0277

The possibility to operate clean PPC from lean condition to stoichiometric equivalence ratio with reasonable efficiency and non-excessive soot emission was investigated. Significant increase in soot emission and pronounced efficiency reduction makes stoichiometric diesel PPC impossible. Gasoline PPC showed the same trends but with less efficiency reduction as well as less soot emission. Ethanol PPC had the advantage with very low soot emission (below 0.1 Filter Smoke Number) and higher efficiency, which indicated as a viable alternative fuel to produce clean stoichiometric PPC associated with three-way catalyst.

I performed the experiments and post-processed the data as well took the main responsibility of the paper writing. Martin Tuner and Bengt Johansson gave support in experiment planning and paper writing.

Paper II

Effects of EGR and Intake Pressure on PPC of Conventional Diesel, Gasoline and Ethanol in a Heavy Duty Diesel Engine

Mengqin Shen¹, Martin Tuner¹, Bengt Johansson¹ and William Cannella²

¹Division of Combustion Engines, Lund University, Sweden

²Chevron U.S.A., Richmond, California, United States

SAE Technical paper SAE 2013-01-2702

In this paper, the effect of changes in intake pressure and EGR fraction on PPC engine performance (e.g. ignition delay, burn duration, maximum pressure rise rate) and emissions (carbon monoxide (CO), unburned hydrocarbon (UHC), soot and NO_x) was investigated with diesel, gasoline and 99.5 vol% ethanol.

BIBLIOGRAPHY

I performed the experiments and post-processed the data as well took the main responsibility of the paper writing. Bengt Johansson helped with experiment planning and paper writing.

Paper III

Transition from HCCI to PPC Combustion by Means of Start of Injection

Mengqin Shen, Sara Lonn and Bengt Johansson

Division of Combustion Engines, Lund University, Sweden

SAE Technical paper SAE 2015-01-1790

This work focuses on the transition from Homogeneous Charge Compression Ignition (HCCI) to Partially premixed combustion (PPC). Injection strategies, EGR and boost pressure were the main parameters used to present the corresponding effect on combustion and emissions characteristics during the transition.

I performed the experiments with Sara Lonn. I post-processed the data and took the main responsibility of the paper writing which was carried out together with Bengt Johansson.

Paper IV

Analysis of Soot Particles in the Cylinder of a Heavy Duty Diesel Engine with High EGR

Mengqin Shen¹, Vilhelm Malmborg², Yann Gallo¹, Bjorn B. O. Waldheim³, Patrik Nilsson², Axel Eriksson², Joakim Pagels², Oivind Andersson¹ and Bengt Johansson¹

¹*Division of Combustion Engines, Lund University, Sweden*

²*Division of Ergonomics & Aerosol Technology, Lund University, Sweden*

³*Scania CV AB, Sodertalje, Sweden*

SAE Technical paper SAE 2015-24-2448

To better understand how EGR affects soot particles in the cylinder, a fast gas sampling technique was used to draw gas samples directly out of the combustion chamber in a Scania D13 heavy duty diesel engine. It was found that EGR reduces both the soot formation rate and the soot oxidation rate, but the oxidation rate was reduced even more, leading to increased soot mass concentrations in late

expansion and in the exhaust. Generally, increasing EGR reduced the in-cylinder particle mean diameter but increased particle number concentrations.

I performed the experiments together with Vilhelm Malmborg and Bjorn B. O. Waldheim. The engine data was post-processed by me and the soot sampling data was processed by Vilhelm Malmborg. The paper was written with close collaboration with Vilhelm Malmborg, Joakim Pagels, Bengt Johansson as well the other co-authors.

Paper V

Influence of Injection Timing on Exhaust Particulate Matter Emissions of Gasoline in HCCI and PPC

Mengqin Shen¹, Bengt Johansson², Martin Tuner¹ and Per Tunestal¹

¹Division of Combustion Engines, Lund University, Sweden

²King Abdullah University of Science and Technology, Kingdom of Saudi Arabia

Paper VI

Exhaust soot particle size distributions in partially premixed combustion using ethanol, gasoline and diesel in a heavy-duty compression ignition engine

Mengqin Shen¹, Sam Shamun¹, Bengt Johansson², Vilhelm Malmborg³, Joakim Pagels³, Anders Gudmundsson³, William Cannella⁴, Martin Tuner¹ and Per Tunestal¹

¹Division of Combustion Engines, Lund University, Sweden

²King Abdullah University of Science and Technology, Kingdom of Saudi Arabia

³Division of Ergonomics & Aerosol Technology, Lund University, Sweden

⁴Chevron U.S.A., Richmond, California, United States

Manuscript to submitted to Journal Fuel,2016

This paper investigates the particulate matter (PM) emissions in terms of mass concentrations and size distributions from ethanol, high and low octane number gasoline and conventional diesel fuel in PPC combustion. The influences of inlet temperature, EGR and injection pressure were investigated. Very slight

BIBLIOGRAPHY

change in particle mass emissions was observed in ethanol PPC in response to the change of engine control parameters, and most particles are in nucleation mode. Gasoline fuels generated lower soot mass than diesel, and are less sensitive to the change of engine operating conditions. Generally, gasoline emits lower particle number emissions and of smaller sizes than diesel while ethanol generated close to zero soot.

I performed the experiments with help from Sam Shamun. I post-processed the data and took the main responsibility of the paper writing. The other authors gave support in experiment planning and paper writing.

Paper VII

Analysis of in-cylinder soot particles in partially premixed combustion with gasoline in comparison to diesel

Mengqin Shen¹, Vilhelm Malmborg², Joakim Pagels², Oivind Andersson¹, Bjorn B. O. Waldheim³, Bengt Johansson⁴, Martin Tuner¹ and Per Tunestal¹

¹*Division of Combustion Engines, Lund University, Sweden*

²*Division of Ergonomics & Aerosol Technology, Lund University, Sweden*

³*Scania CV AB, Sodertalje, Sweden*

⁴*King Abdullah University of Science and Technology, Kingdom of Saudi Arabia*

Manuscript to submitted to Journal Fuel,2016

This present study investigated soot particles during PPC combustion inside the cylinder of a heavy-duty diesel engine, in order to get knowledge of the process of soot formation and oxidation with both gasoline and diesel fuel. The sampled gas dram from the combustion chamber va a fast sampling valve was analyzed regarding the black carbon mass and particle number concentration, as well as soot particle size distributions. Comparison of soot processes with gasoline and diesel indicated that, very low soot formation was the main reason for lower exhaust soot emissions in gasoline PPC. Much larger particles were formed in diesel PPC. In conjunction with the high soot mass, higher soot organic was also found with diesel.

I performed the experiments together with Vilhelm Malmborg and Bjorn B. O. Waldheim. The engine data was post-processed by me and the soot sampling data was processed by Vilhelm Malmborg. The paper was written with close collaboration with Vilhelm Malmborg, Joakim Pagels as well the other co-authors.