



LUND UNIVERSITY

Aspects of pediatric hemodynamics. A study of young children undergoing corrective heart surgery.

Sigurdsson, Theódór

2020

Document Version:

Publisher's PDF, also known as Version of record

[Link to publication](#)

Citation for published version (APA):

Sigurdsson, T. (2020). *Aspects of pediatric hemodynamics. A study of young children undergoing corrective heart surgery*. [Doctoral Thesis (compilation), Department of Clinical Sciences, Lund]. Lund University, Faculty of Medicine.

Total number of authors:

1

Creative Commons License:

Unspecified

General rights

Unless other specific re-use rights are stated the following general rights apply:

Copyright and moral rights for the publications made accessible in the public portal are retained by the authors and/or other copyright owners and it is a condition of accessing publications that users recognise and abide by the legal requirements associated with these rights.

- Users may download and print one copy of any publication from the public portal for the purpose of private study or research.
- You may not further distribute the material or use it for any profit-making activity or commercial gain
- You may freely distribute the URL identifying the publication in the public portal

Read more about Creative commons licenses: <https://creativecommons.org/licenses/>

Take down policy

If you believe that this document breaches copyright please contact us providing details, and we will remove access to the work immediately and investigate your claim.

LUND UNIVERSITY

PO Box 117
221 00 Lund
+46 46-222 00 00

Aspects of pediatric hemodynamics

A study of young children undergoing corrective heart surgery

THEODOR SKULI SIGURDSSON

DEPARTMENT OF CLINICAL SCIENCES | LUND UNIVERSITY

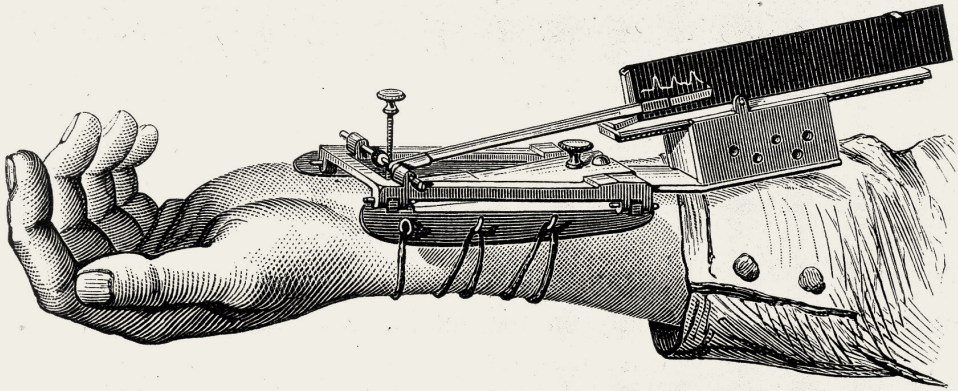

Aspects of pediatric hemodynamics

Aspects of pediatric hemodynamics

A study of young children undergoing
corrective heart surgery

Theódór Skúli Sigurðsson



LUND
UNIVERSITY

Doctoral dissertation

by permission of the Faculty of Medicine, Lund University, Sweden.
To be defended at Föreläsningssal 2, "Blocket", Skane University Hospital, Lund.
Friday 2nd October 2020 at 13:00.

Supervisor Associate Professor Lars Lindberg
Department of Pediatric Anesthesia and Intensive Care, Lund Children's Hospital,
Skane University Hospital, Lund, Sweden

Faculty opponent Professor Willem-Pieter de Boode
Department of Neonatology, Radboud University Nijmegen Medical Centre,
Nijmegen, The Netherlands

Department of Clinical Sciences Anaesthesiology and Intensive Care Author(s) Theódór Skúli Sigurðsson	Document name DOCTORAL DISSERTATION
	Date of issue 2nd of October 2020
	Sponsoring organization
Title and subtitle Aspects of pediatric hemodynamics - a study of young children undergoing corrective heart surgery	
<p>Abstract</p> <p>Background: Assessing critically ill patients is demanding because their clinical signs are not always easy to interpret. This is particularly true for pediatric patients, due to their small size and robust circulatory compensatory mechanism. Physicians working in pediatric intensive care settings seldom use invasive monitoring, due to possible complications and the risks involved. Instead, they rely on simple vital parameters and blood gases during their clinical work. However, a number of studies have shown that this clinical approach can provide inaccurate data when dealing with critically ill patients. There are very few monitors currently available that have been fully validated for estimating hemodynamic parameters in young children.</p> <p>A less invasive hemodynamic monitor could help physicians make clinical decisions and improve future levels of care, by providing more reliable information on the perioperative hemodynamic status of pediatric patients, without additional risks.</p> <p>Purpose: The primary aim of the studies in this thesis was to look at different aspects of pediatric hemodynamics, by comparing the novel hemodynamic COstatus monitor, with earlier reference methods. In our studies we analyzed: 1) agreement and precision of cardiac output, 2) detection and estimation of intracardiac shunts and 3) estimation of different blood volumes. A secondary aim of this thesis was to establish reference values of hemodynamic values in young children using COstatus, and comparing indexing of same values with body surface area and body weight.</p> <p>Methods: Children (under 15 kilograms) undergoing corrective heart surgery at Lund Children's Hospital were enrolled in our studies.</p> <p>Results:</p> <p>Paper I – Estimation of cardiac output</p> <p>The COstatus provided excellent precision and agreement in estimating cardiac output in young children, compared with perivascular flow probe placed around the ascending aorta.</p> <p>Paper II – Estimation of intracardiac shunts. The COstatus detected intracardiac shunts to the same extent as the "gold standard" echocardiography. However, it slightly underestimated the degrees of the shunts in small and moderate shunts when it was compared to two other reference methods, namely perivascular ultrasonic flow probes (placed around the pulmonary truncus and ascending aorta) and the oximetric shunt equation (using arterial and venous blood gases).</p> <p>Paper III – Normalization of hemodynamic parameters. Body weight produced a better normalization of hemodynamic parameters than body surface area in young children.</p> <p>Paper IV – Estimation of oxygen uptake. Indirect calorimetry seemed to overestimate oxygen uptake in young children, compared to the reverse Fick method.</p> <p>Paper V – Estimation of body surface area. Commonly used body surface area formulas disagreed in young children, Mosteller formula came closest to the mean body surface area.</p> <p>Conclusions: COstatus is accurate, precise and less invasive than earlier reference methods and might enable future cardiac output comparison studies in the intensive care setting. COstatus detects shunts accurately but algorithms for shunt size estimations might be overly cautious. Caution is advised regarding the use of indirect calorimetry and direct Fick method in cardiac output comparison studies.</p>	
Key words Cardiac output, heart surgery, hemodynamics, intracardiac shunt, volume estimation, young children	
Classification system and/or index terms (if any)	
Supplementary bibliographical information	Language English
ISSN and key title 1652-8220	ISBN 978-91-7619-977-0

I, the undersigned, being the copyright owner of the abstract of the above-mentioned dissertation, hereby grant to all reference sources permission to publish and disseminate the abstract of the above-mentioned dissertation.

Signature



Date 2020-08-08

Aspects of pediatric hemodynamics

A study of young children undergoing
corrective heart surgery

Theódór Skúli Sigurðsson



LUND
UNIVERSITY

Cover image: Marey's direct sphygmograph

The French physiologist Étienne-Jules Marey (1830–1904) improved the sphygmograph in 1863 by making it portable. His instrument was the first truly non-invasive portable device that could record the pulse wave. It included a specialized instrument that was placed above the radial artery and it was able to magnify pulse waves and record them on paper with an attached pen.

(Credit: The Wellcome Collection gallery: <https://wellcomecollection.org/works> CC-BY-4.0)

Copyright pp 1-75 Theódór Skúli Sigurðsson

Faculty of Medicine
Department of Clinical Sciences
Pediatric Anesthesiology and Intensive Care

ISSN 1652-8220

ISBN 978-91-7619-977-0

Lund University, Faculty of Medicine Doctoral Dissertation Series 2020:114

Printed in Sweden by Media-Tryck, Lund University
Lund 2020



Media-Tryck is a Nordic Swan Ecolabel certified provider of printed material. Read more about our environmental work at www.mediatryck.lu.se

MADE IN SWEDEN 

To my family...

For all children with congenital heart disease...

"If I have seen further, it is by standing upon the shoulders of giants"

Isaac Newton

Contents

- List of papers 11
- Abbreviations 12
- Introduction**..... 13
- Background**..... 15
 - History of cardiac output measurements..... 15
- Reference methods for cardiac output estimations**..... 21
 - The Fick principle 21
 - The Stewart-Hamilton principle..... 22
 - Transit-time flow probes 23
- Cardiac output monitors** 25
 - Invasive monitoring..... 25
 - Pulmonary artery catheter (PAC)..... 25
 - Transcardiopulmonary thermodilution (TPTD)..... 26
 - Minimally invasive monitoring..... 26
 - Lithium dilution technology..... 26
 - Pulse contour analysis..... 27
 - Partial rebreathing method 27
 - Transoesophageal Doppler (TOD)..... 27
 - Non-invasive monitoring..... 28
 - Echocardiography..... 28
 - Electrical cardiometry..... 28
 - Ultrasonic Cardiac Output Monitor..... 29
 - Magnetic resonance imaging (MRI) 29
 - Novel technology in cardiac output measurements 30
 - Transcardiopulmonary blood dilution ultrasound technology (TPUD) 30
 - Possible advantages of ultrasound dilution technology 32
 - Possible limitations of ultrasound dilution technology 32
 - Estimation of cardiac output (subject of Study I)..... 32

Shunt diagnosis and estimation of shunt size (subject of Study II)	33
Normalization of hemodynamic parameters and blood volume (subject of Study III)	33
Calorimetry for estimation of oxygen consumption (subject of Study IV)	35
Body surface area estimations in young children (subject of Study V)	36
Validation of cardiac output monitors	39
The early years (1948-1985)	39
The Bland-Altman years (1986-1998)	39
Modern standards (1999 to the present day)	40
Aim of the study.....	43
Methods.....	45
Patients.....	45
Inclusion criteria.....	45
Exclusion criteria.....	45
Study design	46
Induction of anesthesia and preparation at the beginning of each case:	46
Before surgical correction:	46
After surgical correction.....	47
Statistical analysis	48
Results and discussion	51
Conclusions and future directions	53
Recommendations regarding comparative studies.....	55
Sammanfattning på svenska (Swedish summary)	57
Ágrip á íslensku (Icelandic summary)	59
Acknowledgements	61
Financial support	63
References	65
Appendix: Papers I-V	73

List of papers

This thesis is based on the following original papers, referred to in the text by their respective Roman numerals (I-V):

- I. Sigurdsson TS, Aronsson A, Lindberg L; Extracorporeal arteriovenous ultrasound measurement of cardiac output in small children. *Anesthesiology* 2019; 130(5): 712-718. Editorial with infographics: Trieu CT, Williams TM, Cannesson M, Marijic J; Babies and children at last: Pediatric cardiac output monitoring in the Twenty-first century. *Anesthesiology* 2019; 130: 671-673. In reply: Sigurdsson TS; Cardiac output measurements in young children: Reply. *Anesthesiology* 2020; 132: 209–10.
- II. Sigurdsson TS, Lindberg L; Estimation of intracardiac shunts in young children with a novel indicator dilution technology. *Scientific Reports* 2020; 10: 1337.
- III. Sigurdsson TS, Lindberg L; Indexing hemodynamic parameters in young children. (Submitted for publication)
- IV. Sigurdsson TS, Lindberg L; Indirect calorimetry overestimates oxygen consumption in young children: Caution is advised using direct Fick method as a reference method in cardiac output comparison studies. *Pediatric Cardiology* 2020; 41: 149-154.
- V. Sigurdsson TS, Lindberg L; Six commonly used empirical body surface area formulas disagreed in young children undergoing corrective heart surgery. *Acta Paediatrica* 2020. (In press)

All papers are reprinted with the permission from respective publishers

Abbreviations

ACV	Active circulating volume
ACVI	Active circulating volume index
CBV	Central blood volume
CBVI	Central blood volume index
CE	Coefficient of error
CI	Cardiac index
CO	Cardiac output
CV	Coefficient of variation
CVP	Central venous pressure
EF	Ejection fraction
HR	Heart rate
PPV	Pulse pressure variation
Q _p	Pulmonary blood flow
Q _s	Systemic blood flow
SD	Standard deviation
SV	Stroke volume
SVI	Stroke volume index
SVR	System vascular resistance
SVV	Stroke volume variation
TEDV	Total end diastolic volume
TEDVI	Total end diastolic volume index
TPTD	Transpulmonary thermodilution
VO ₂	Oxygen consumption

Introduction

Assessing critically ill patients is demanding because their clinical signs are not always easy to interpret. This is particularly true for pediatric patients, due to their small size and robust circulatory compensatory mechanism. Physicians working in pediatric intensive care settings seldom use invasive monitoring, due to possible complications and the risks involved. Instead, they rely on simple vital parameters and blood gases during their clinical work (1-2). However, a number of studies have shown that this clinical approach can provide inaccurate data when dealing with critically ill patients (3-5). There are very few monitors currently available that have been fully validated for estimating hemodynamic parameters in young children (6-8).

A less invasive hemodynamic monitor could help physicians make clinical decisions and improve future levels of care, by providing more reliable information on the perioperative hemodynamic status of pediatric patients, without additional risks (9-10).

The aim of this thesis was to examine different aspects of pediatric hemodynamics, with a special focus on the novel minimally invasive, hemodynamic COstatus monitor, which we compared with invasive methods.

Background

History of cardiac output measurements

Since the beginning of time man has been seeking answers to different questions and one of those questions has been what force is responsible for life? In ancient Greece, Hippocrates (460 BC-370 BC), who was the father of modern medicine, was one of the first to state, and document, that the heart played a central role in sustaining life. He also identified the heart as a seat of intelligence, vitality and warmth. The Greek physician Claudius Galen (129-216), whose work with Roman gladiators had given him some fundamental understanding of how the human body worked, started drawing his own conclusions. He was convinced that blood was produced in the liver from nutrients that were extracted from the gut. The blood would then pass from the liver to the heart, which, in turn, would magically gain “life” and spread that life to the other organs of the body. Galen, whose teachings were supported by the church, had to restrict his research to dissecting animals, as human dissection was forbidden.



Claudius Galen (129-216) the godfather of Galenic science, whose ideas dominated Europe for almost 1,400 years. His theories were strongly supported by the church, as the only truth. (Picture: Wikipedia.org)

During the Islamic golden age, physician Ibn al-Nafis (1213-1288) emerged as the leading scientist of the Arabic world. He made important discoveries in the fields of physiology and anatomy, describing pulmonary circulation in his writings and rejecting earlier Galenic views. We know that translated texts of al-Nafis' work reached Italy in the 15th century when traveling western physicians returned from Damascus. Therefore, some of his ideas on human circulation had probably been known for a while when the Flemish physician Andreas Vesalius (1514-1568) began his medical studies at the University of Padua (11). Galenic scientific views were supported by the church as the only truth for more than 1400 years and anyone who dared to challenge those early beliefs risked being accused of heresy. Those who went against the teaching of the church were labelled as scientific heretics and they included Galileo Galilei (1564-1642), who was accused of heresy when he dared to state that it was the earth that circulated around the sun. This did not discourage Vesalius, who had started human dissection when he realized that many of Galen's claims about human anatomy were wrong (12). The English physician William Harvey (1578-1657), who had followed in the footsteps of Vesalius at the University of Padua, was probably the first to fully understand the nature of the heart and how it was related to circulation. He understood that the heart worked as pump, which repeatedly drove the blood around the body time after time in closed circulation. As he said: *"For it is by the heart's vigorous beat that the blood is moved"*. He published his findings in his book *De Motu Cordis* (On the Motion of the Heart) in 1628. Harvey's many experiments demonstrated that the circulation flowed in one direction and that there were two types of main vessels: arteries that brought the blood from the heart to the organs and veins that transported it back (13-14).

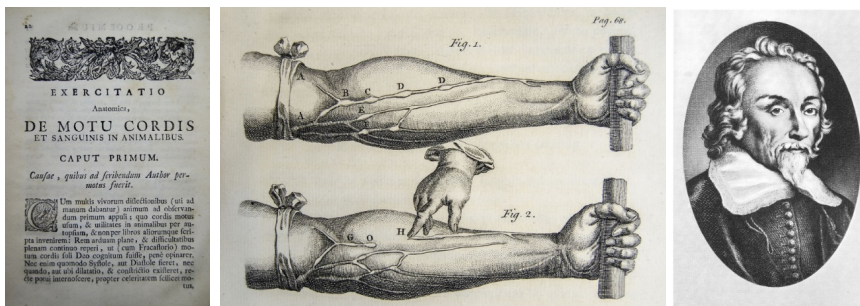

William Harvey and illustrations from his book *De Motu Cordis*, published in 1628. (Illustrations: Flickr.com and Wikipedia.org)

However, German physician Adolph Eugen Fick (1829-1901) was the first to realize how the amount of blood being pumped from the heart could be accurately calculated (15). He presented his theory in 1870 and it became known as Fick's principle. Fick

understood that if we knew the oxygen consumption and the arteriovenous oxygen difference in the heart it would be easy to calculate the amount of blood the heart pumped each minute. He was the first to define cardiac output (CO), measured in liters per minute (L/min), as we know it today. However, due to Fick's own lack of interest and his technical limitations, his ideas remained just that and Fick's principle remained almost forgotten for 50 years.



Adolf Eugen Fick (1829-1901) was an outstanding German scientist who came up with the first method of calculating cardiac output, known as the Fick principle. (Portrait: Wikipedia.org)

It was not until the 1920s that the interest in measuring cardiac output was revived. Fick's principle finally got the attention that it deserved when a number of research groups in Europe and the USA started developing practical methods for measuring cardiac output in humans. Great progress was made in the field of cardiac physiology when the German physician Werner Forssman (1904-1979) inserted a urinary catheter into his own antecubital vein and radiographically confirmed its position in his heart. Forssman's experiment was published in his 1929 paper *Über die Sondierung des Rechten Herzens* (About Probing of the Right Heart) and the era of cardiac catheterization was born (16). The following year, the Czech physician Otto Klein (1881-1968) drew the first mixed venous blood gas from a catheter placed in the right side of a human heart and calculated cardiac output for the first time, according to Fick's principle (17-18). The French physician André Frédéric Cournand (1895-1988) and the American physician Dickinson Richards (1895-1973), who had read Forssman's and Klein's research papers with interest, went on to experiment on humans and developed the standard of cardiac catheterization that we use today. In 1956, Forssman, Cournand and Richards shared the Noble prize for medicine for their

contribution to increasing our understanding of human physiology (19). In hindsight, Klein should have received more credit and fame for his achievements.

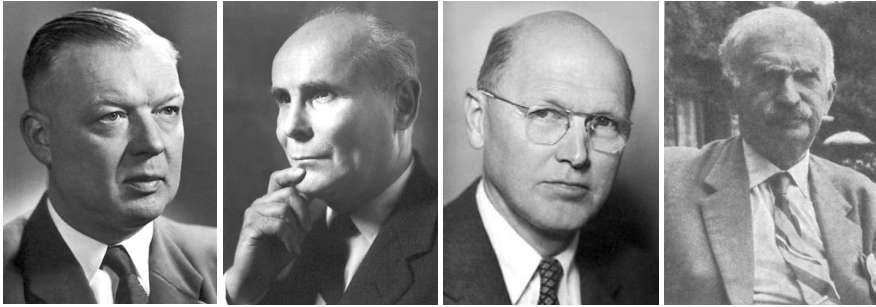

The pioneers of cardiac catheterization (left to right): Forssman, Cournand, Richards and Klein. (Photographs: Wikipedia.org and onlinejacc.org)

In 1897 the Canadian physiologist George Neil Stewart (1860-1930) published his research on using a dilutional method to estimate cardiac output during a series of physiological experiments on animals (20). The American physiologist William Hamilton (1893-1964) improved Stewart's dilutional method and was the first to use a dye dilutional method to measure cardiac output in humans. This became known as the Stewart-Hamilton principle (21). In 1948, Hamilton's and Cournand's research groups conducted a historical landmark clinical study by carrying out 48 cardiac output measurements in 31 patients and comparing the Fick method with the dye dilutional method. Their final conclusion was that both methods were interchangeable with each other (22). As the Fick method was more invasive and labor-intensive, the dye dilutional method became the main method that was used in clinical cardiac output experiments. Soon after that, the first hemodynamic studies in children started to emerge (23-24).

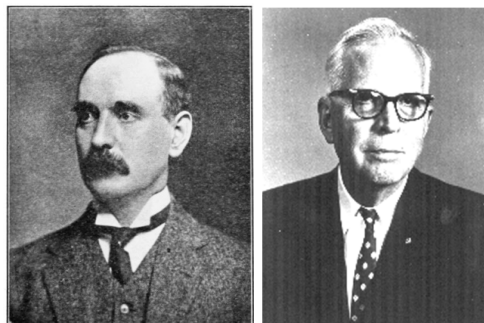

The pioneers of indicator dilution method, Stewart and Hamilton (from left). (Photographs: Wikipedia.org)

In 1954, the Polish physiologist George Fegler (1889-1958) suggested thermodilution as a possible method for measuring cardiac output, after a series of experiments in animals (25). Since the invention of the Swan-Ganz pulmonary artery catheter in 1970, which was named after its inventors Dr William Ganz and Dr Harold Swan, thermodilution has remained the gold standard for estimating cardiac output (26-29).



Dr William Ganz (left) and Dr Harold Swan present their invention, the Swan-Ganz pulmonary artery catheter. (Picture: published with the permission of Peter and Tomas Ganz)

Reference methods for cardiac output estimations

The Fick principle

When Fick presented his theory to colleagues during a meeting in Würzburg in 1870, he was astonished that nobody had come up with the idea before. As he said: “*It really is quite simple, what comes in, must come out*”. His assertion was that if we know the oxygen consumption, and the difference in the oxygenation of venous blood compared to arterial blood, we can calculate the “*minute volume*” of the heart, which is the amount of blood the heart pumps in one minute. Today we call this cardiac output. Fick used the following formula:

$$\text{Cardiac output} = \frac{VO_2}{(CaO_2 - CvO_2)}$$

where oxygen uptake (VO_2) is divided by the difference in oxygen content between arterial and venous blood gases ($CaO_2 - CvO_2$).

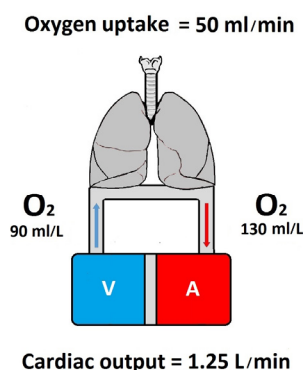

The Fick principle. As this model shows, if oxygen consumption is estimated to be 50 ml/min and the rise in oxygen content in venous blood gas (90 ml/L) to arterial blood gas (130 ml/L) is 40 ml/L, it is easy to calculate cardiac output by dividing the oxygen consumption by the arteriovenous oxygen difference (50 ml/min / 40 ml/min). This results in a cardiac output of 1.25 L/min. (Author's own illustration)

The Stewart-Hamilton principle

It was obvious that when Stewart published his indicator dilution theory in 1897 it was not complete. Changes in indicator concentration were not an on/off phenomenon, as he suggested, but a gradual increase and decrease in concentration and recirculation of the indicator also had to be accounted for. The Danish physiologist Valdemar Henriques (1864-1936) realized this and suggested some modifications of Stewart's work, but when his results were published in a German science journal in 1913, just before the first world war, they did not get the attention they deserved (30). Hamilton knew of Henriques work and made the significant modifications that were needed to what later became known as the Stewart-Hamilton principle (29).

The Stewart method is based on the fact that if you inject a known amount of an indicator (C_0V_0) upstream, the change in its downstream concentration (C_t) will be related to the rate of the flow, where flow or volume over time (t) is the cardiac output (Q).

$$Q = \frac{V_1}{t} = \frac{C_0V_0}{C_1t} \quad (\text{Stewart method})$$

The Hamilton modification simply means that cardiac output (Q) is the amount of indicator (C_0V_0) divided by the area under the curve ($\int_t^0 c(t)dt$)

$$Q = \frac{C_0V_0}{\int_t^0 c(t)dt} \quad (\text{Hamilton modification})$$

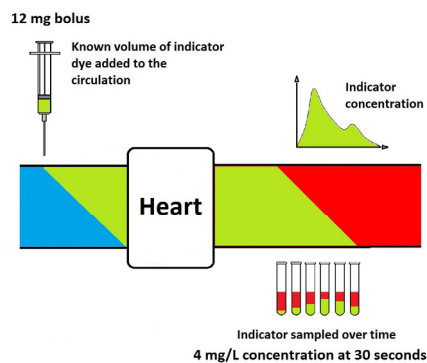

Cardiac output = 6 L/min

(Author's own illustration, example from Hamilton's original publication)

Transit-time flow probes

The AU series COnfidence perivascular flow probes (Transonic Systems, Ithaca, NY, USA) are custom designed to fit around vessels and measure blood flow in real time by ultrasound transit-time technology. Transit-time technology uses four crystals and wide beam illumination to send ultrasonic signals backwards and forwards across the vessel, alternately intersecting the blood in upstream and downstream directions. The flowmeter provides an accurate measurement of the transit time it takes for the ultrasound wave to travel from one transducer to the other. The difference between the upstream and downstream integrated transit times measures the volume flow, not the velocity. The flow probes are available in different diameter sizes (8 to 24 mm) and can be used multiple times because they can undergo standard sterilization. The probes come ready to use and calibrated from the manufacturer, with a certified length of use of more than one year. Transit-time ultrasound perivascular flow probes are considered to be the standard reference method for cardiac output estimation and have been verified by a number of studies (31-33).

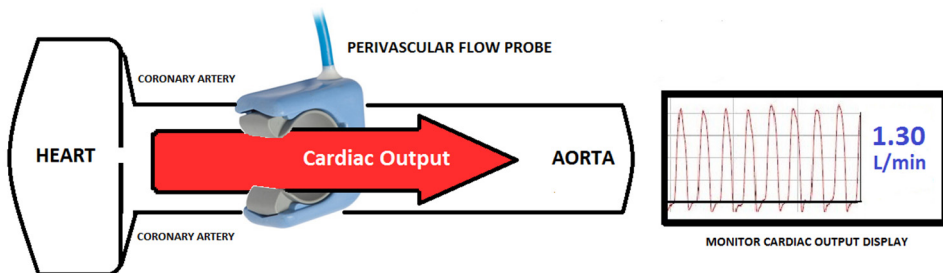

A perivascular flow probe. The ultrasonic measurement of blood flow in the ascending aorta provides an estimation of the cardiac output. However, as the probe can only be fitted to the aorta after coronaries, about 4-10% of the total cardiac output can be missing (Author's own illustration, with adapted picture of flow probe with permission from Transonic Systems Inc).

Cardiac output monitors

Over the years a number of studies have confirmed that good clinical judgement with regard to hemodynamic status is inaccurate in critically ill patients. This appears to be particularly true with pediatric patients (3, 5, 34). Advanced hemodynamic monitoring remains a cornerstone of the management of critically ill patients (35-36). The qualities that an ideal cardiac output monitor should have were highlighted by Shephard et al 25 years ago [9]. Since then many cardiac output measurement monitors have been developed, but none of them have managed to satisfy all of Shephard et al's criteria (37).

Table 1. Shephard's et al's criteria for the ideal characteristics for a monitoring technique [9]

Accurate	Results obtained are a true reflection of the actual value
Reproducible results	Results obtained are comparable with those at different times in individual patients and from different patients
Rapid response	Rapid changes in values can be monitored
Operator independent	Results obtained from different individuals are comparable
Easy to use	The technique can be used without the need for specialized skills or training
No morbidity	No morbidity or mortality should be associated with the technique's use
Continuous use	It should be possible to monitor variables continually, in order to distinguish between short-term and long-term changes
Cheap	The method should be cost-effective

Invasive monitoring

Pulmonary artery catheter (PAC)

This specially design catheter is normally referred to as the Swan-Ganz catheter after its inventors. It uses thermodilution to calculate cardiac output (26-27) and can provide direct pressure readings from different parts of the right side of the circulation, including the pulmonary wedge pressure. Validation studies have showed that the pulmonary artery catheter had good agreement with the dye dilution method, but even better precision. As it was much easier to use in clinical practice than dye dilution, it became very popular in the early 1980s. However, complications occurred and its use

started to decrease in the 1990s when studies failed to show any real benefits with regard to mortality (38-39). Despite its declining use in recent decades, thermodilution with a pulmonary artery catheter has remained the gold standard reference method of choice for cardiac output for the last 50 years (40). Recent surveys in pediatric intensive care units in the United States and Scandinavia have shown that the pulmonary artery catheter is virtually never used these days in pediatric patients (2, 41).

Transcardiopulmonary thermodilution (TPTD)

The Pulse index Continuous Cardiac Output, or PiCCO, (Pulsion Medical Systems, München, Germany) incorporates the transpulmonary thermodilution technique and continuous pulse contour analysis. It is an invasive monitoring technique, as clinicians need to insert a specific arterial catheter that has a thermistor on the end into one of the larger arteries, usually the femoral artery. The method provides a very comprehensive view of hemodynamic status. Thermodilution enables us to estimate cardiac output, global end diastolic volume and extravascular lung water, while pulse contour analysis helps us to evaluate the fluid status by stroke volume variation (SVV). This information provides a better understanding of volume status and myocardial function, leading to optimal titration of fluids and vasoactive medication. PiCCO has been validated in pediatric patients, but, because of its invasive nature, it is unclear if the extra hemodynamic information outweighs the technical risks that are involved (42, 43).

Minimally invasive monitoring

Lithium dilution technology

LiDCO (LiDCO Ltd, London, UK) was the first minimally invasive device to continuously monitor cardiac output with regular calibrations by lithium dilution, as it only uses existing venous and arterial catheters. The device also estimates fluid status, namely the pulse contour analysis of SVV, in critically ill patients. This technology cannot be used if the patient is already medicated with lithium or non-depolarizing muscle relaxants, as it can interfere with the concentration measurements. LiDCO has been validated in pediatric patients, but its use has been limited, due to the use of lithium as the indicator and a blood loss of 3 ml during each repeated calibration (44).

Pulse contour analysis

Advanced analytical interpretations of the arterial pulse contour waveform are emerging from a number of manufacturers and these provide continuous estimations of cardiac output and dynamic blood volumes. FloTrac (Edwards Lifescience Corporation, Irvine, USA) has probably become the most popular alternative in this category in recent years. LiDCO and PiCCO monitors have both incorporated this technology for continuous estimation of cardiac output, but they need to be calibrated at regular intervals. The advantage of this technology is that it only requires an arterial catheter, does not need any external calibration, is independent of the operator and is easy to use. It is based on the principle that there is a linear relationship between the pulse pressure and SV. The pressure recording analytic method (PRAM) MostCare monitor (Vytech, Padova, Italy) has very similar characteristics to the FloTrac technology. High-quality comparison studies in young children with standard reference methods are still lacking for both the FloTrac and PRAM monitors (45).

Partial rebreathing method

The Non-Invasive Cardiac Output (NICO) monitor (Novamatrix Medical Systems, Wallingford, USA) uses a minimally invasive partial rebreathing method to determine cardiac output by means of a differential form of the Fick equation. Although the name implies that it is non-invasive, this is not the case, as it relies on measurements and changes in respiratory carbon dioxide concentrations and those can only be safely estimated in intubated, mechanically ventilated patients.

This approach to cardiac output estimation has been revitalized in recent years, as research groups have been looking into the so-called capnodynamic method and capnotracking method, which are based on similar principles to the NICO monitor (46-48). Although these methods look promising, with regards to estimating and identifying trends in cardiac output, they are still being validated in animal and human studies. It remains to be seen if these methods will ever be reliable in pediatric patients (49).

Transoesophageal Doppler (TOD)

Placing the CardioQ Doppler ultrasound probe (Deltex Medical Ltd, Chichester, UK) in the upper part of the esophagus can detect blood flow in the descending aorta and thus estimate cardiac output (50-52). A smaller pediatric version of this probe is available that provides good continuous trends of aortic blood flow. However, even a

very small amount of displacement can distort the readings, so there have been some issues regarding validation for cardiac output.

Non-invasive monitoring

In recent years, a number of promising non-invasive alternatives that estimate hemodynamic parameters have been emerging, but none of them have really met the standards needed to be comparable with the invasive methods (53-56).

Echocardiography

In the hands of a trained physician, transthoracic echocardiography can provide a good evaluation of the structured morphology of the heart, as well an estimation of cardiac output (57). The SV, which is the volume of blood the heart pumps with each contraction, can be calculated if we know the value of the cross section of the aortic valve (CSA) and multiply this by the blood flow velocity over the valve (VTI). Finally, we can calculate cardiac output (CO) by multiplying the SV with the heart rate (HR). However, there are limitations to this method, as it is highly operator dependent and often very technically demanding. It can be impossible to get the echo graphic view of the heart needed to carry out the necessary calculations (58). A recent meta-analysis that compared estimates of cardiac output with echocardiography with thermodilution concluded that these two methods were not interchangeable (59). The SV and CO can be calculated using the following formulas:

$$SV = CSA \times VTI$$

SV = stroke volume, CSA = cross-sectional area of the aorta, VTI = velocity time integral

$$CO = SV \times HR$$

CO = cardiac output, HR = heart rate

Electrical cardiometry

The thoracic bioimpedance method used by the NICOM device (Cheetah Medical, Tel Aviv, Israel) comprises four adhesive voltage sensing and current transmitting electrodes, which are placed around the neck and chest to detect changes in thoracic bioimpedance. This makes it possible to assess stroke volume and cardiac output, as the

blood is ejected from the heart with every heartbeat. Although this method has been approved for all patients, validation studies have shown that the accuracy and precision of this method is often lacking when it comes to pediatric patients (1, 55, 60, 61). Studies on the bioreactance method, which is a modification of the bioimpedance method, have also been disappointing (62).

Ultrasonic Cardiac Output Monitor

The USCOM monitor (Uscom Ltd, Sydney, Australia) is a portable ultrasonic device that uses the Doppler principle to estimate cardiac output by detecting the aortic blood flow from a suprasternal position. However, there have been some reports on the limitations of this device, as misalignment of the probe may lead to significant errors. This is particularly true for children (63-66).

Magnetic resonance imaging (MRI)

MRI technology estimates cardiac output by using a modulus image for anatomical delineation of the aorta. It has been shown to be accurate and precise. Cardiac output can be calculated by quantifying the SV as the integral of the resulting flow curve and multiplying it by the HR. However, MRIs are mostly used for research, as they are time consuming and impractical and have no value in the daily treatment and estimation of critically ill patients (67-68).

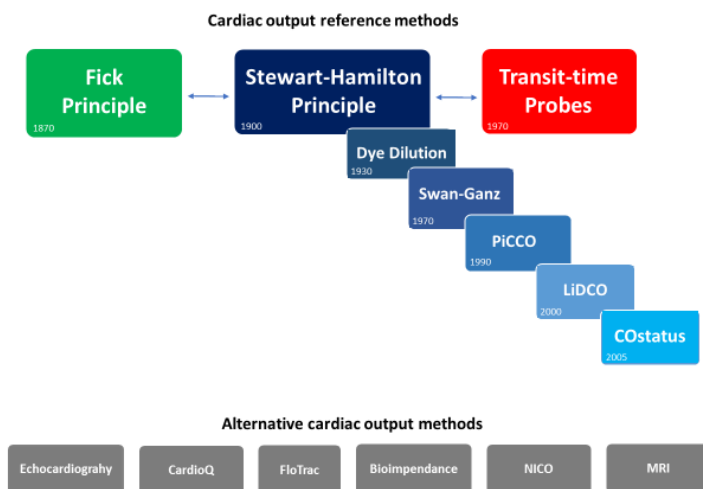

Overview of the technologies available for estimating cardiac output. (Author's own illustration).

Novel technology in cardiac output measurements

Transcardiopulmonary blood dilution ultrasound technology (TPUD)

The COstatus (Transonic Systems Inc, Ithaca, NY, USA) is a minimally invasive cardiac output monitor, which detects blood dilution in an extracorporeal arteriovenous circuit as a saline bolus passes through the heart. This technology which is called “ultrasound dilution” by its manufacturer, is based on the premise that the ultrasound velocity of blood changes in a linear fashion with the level of blood dilution caused by injecting a specified bolus volume of body temperature isotonic saline. The ultrasound velocity in blood is 1560-1585 m/sec and decreases toward the ultrasound velocity of saline (1530 m/sec) after a bolus injection. A single-use extracorporeal arteriovenous loop, connected between the existing arterial and central venous lines, is attached to an external roller pump that maintains a stable blood flow of 10-12 ml/min in the loop. External ultrasound sensors are then attached to specific venous and arterial segments of the arteriovenous loop. The sensors measure the ultrasound velocity and the blood flow at the out-flow (venous) and in-flow (arterial) parts of the loop circuit.

A measurement session begins by entering the patient’s weight, length, arterial blood pressure, central venous pressure and heart rate into the monitor. The connection stopcock to the out-flow and in-flow segments of the AV loop, which has been primed with 5 ml of body temperature, heparinized isotonic saline, is opened. The roller pump starts and a small amount of body temperature physiological isotonic saline (0.5-1.0 ml/kg) is injected into the out-flow segment of the loop on the venous side before the venous ultrasound sensor. The saline is warmed to 37 °C body temperature by a bag warmer that is connected to the monitor. The volume and time of the injected saline is determined by the venous ultrasound sensor. The saline is completely mixed as the blood passes through the cardiopulmonary circulation and creates homogenous blood dilution on the arterial side. The final blood dilution that occurs in the systemic arterial circulation is detected by the arterial ultrasound sensor at the arterial in-flow segment of the loop and an ultrasound velocity curve is generated. The technology simultaneously records the ultrasound velocity at a constant blood flow rate, both at the out-flow and in-flow segments of the loop. This means that the area under the curve can be analyzed. In addition, the time of occurrence, and the form of the dilution curve after it passes through the lungs and heart, can be used to calculate the total end-diastolic cardiac volume, central blood volume and active blood volume and determine and detect cardiac shunts. Cardiac output is calculated by analyzing the area under the curve, based on Stewart-Hamilton’s indicator dilution principle.

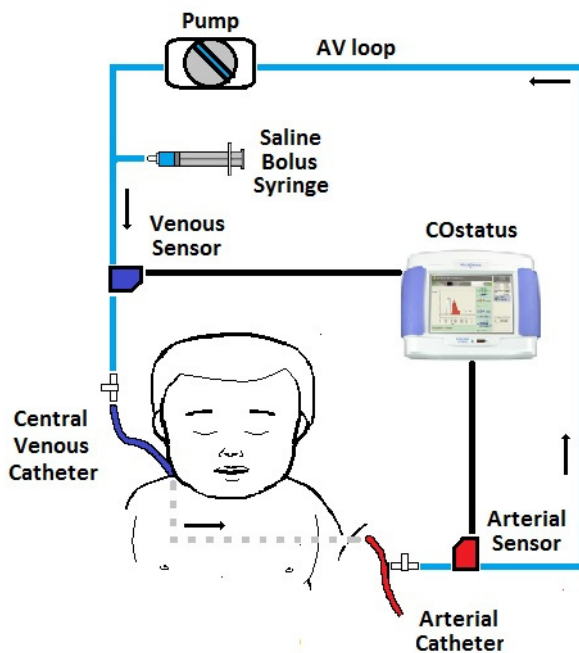

COstatus schematics. (Author's own illustration).

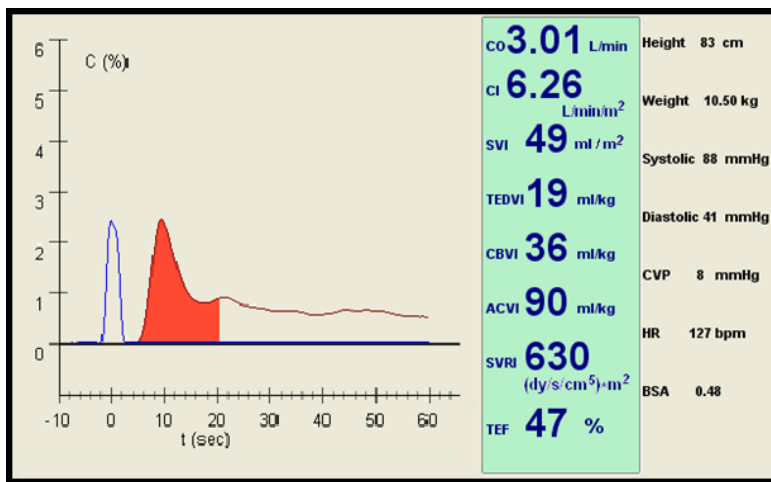

COstatus monitor display. (Author's own research material).

A number of studies have been carried out in adults and children in recent years that have validated, and confirmed, that transcadiopulmonary blood dilution technology is a promising new technology that could help physicians make clinical decisions about critically ill patients (69-70).

Possible advantages of ultrasound dilution technology

- Accurate and precise, with a rapid response
- Innocuous, non-toxic normothermic indicator
- Only uses existing central venous and arterial lines
- Easy and safe to apply

Possible limitations of ultrasound dilution technology

- Still needs invasive catheters
- Repeated indicator fluid boluses are needed for measurements and these can quickly add up
- Continuous cardiac output readings are not yet available, but trials are ongoing with prototypes
- Remains to be seen if this method is cost effective

According to the summary above, the COstatus unit seem to fulfil at least six out of the eight criteria in Shephard et al's list for the ideal cardiac output monitor (9).

Estimation of cardiac output (subject of Study I)

Cardiac output can be calculated using the Stewart-Hamilton principle, as with all other indicator dilutional methods. As body temperature saline is used as an indicator, this avoids the decrease in heart rate that is often seen when ice cold water is used with thermodilution methods. It can be used to evaluate cardiac output in patients with intracardiac shunts, single ventricle anatomy and those receiving extracorporeal support (ECMO) (71).

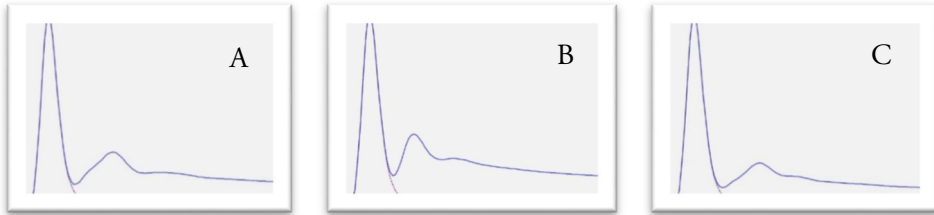

Characteristic changes in the dilution curve, depending on systemic vascular resistance

A) normal, B) vasodilation and C) vasoconstriction

(Pictures from Shunts Modelling Program, version 1.0, Transonic Systems Inc, 2012)

Shunt diagnosis and estimation of shunt size (subject of Study II)

Shunt detection is illustrated in the graphs below, which show the recirculation of the saline bolus. When there is a characteristic change in the dilution curve, this indicates that there might be an intracardiac shunt. Studies that used the COstatus with pediatric patients have shown promising results with regards to diagnosing intracardiac shunts (69, 72).

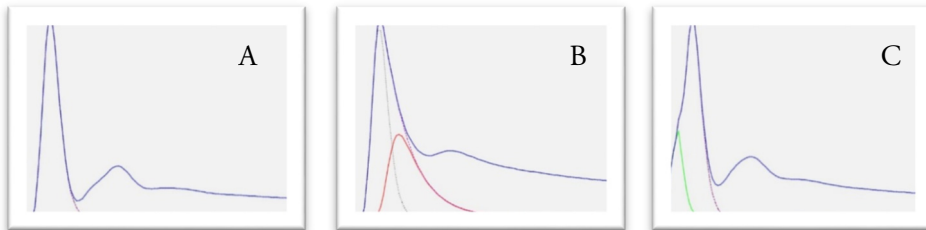

Characteristic changes in the dilution curve when an intracardiac shunt is present.

A) no shunt, B) left to right shunt with red curve showing the shunt and C) right to left shunt with green curve showing the shunt.

(Pictures from Shunts Modelling Program, version 1.0, Transonic Systems Inc, 2012)

Normalization of hemodynamic parameters and blood volume (subject of Study III)

TPUD technology is based on diluting blood and the process starts in the venous circulation and ends in the systemic circulation. This means that it is possible to estimate the blood volume status of the central circulation, namely the larger vessels and the heart. Transonic Systems Inc has called these novel hemodynamic variables the total end-diastolic volume index (TEDVI), the central blood volume index (CBVI) and the active circulation volume index (ACVI).

As far as we know, these hemodynamic variables have not yet been validated in clinical trials.

Study III compared normalization of the hemodynamic parameters and blood volume with both body surface area and body weight and defined reference values for all of the parameters.

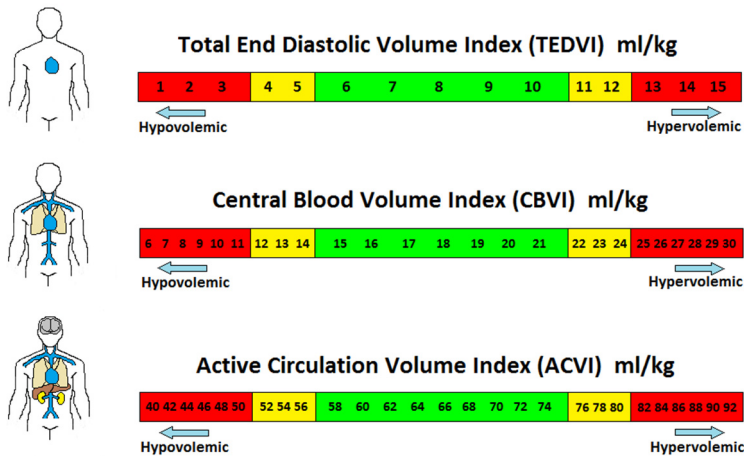

Different blood volumes and normal reference values for the COstatus monitor device
 (Illustrations adapted from the online COstatus Monitoring information booklet by the manufacturer, Transonic Systems Inc).

Total end diastolic volume (TEDV) is the blood volume in the four chambers of the heart at the end of diastole. It is calculated based on the assumption that a major spread of the arterial curve, compared to the venous curve, is due to the indicator traveling through the heart chambers (73). The total end diastolic volume index (TEDVI) is the TEDV normalized to weight (ml/kg), as shown in the following formula:

$$TEDVI = (CO * (1.62 / HR + 0.77 * CHc)) / \text{weight}$$

CHc: $(CH_{art}^2 - CH_{ven}^2)^{1/2}$ where CH_{art} and CH_{ven} are the chord of the arterial and venous curves in minutes

HR: heart rate (beats per minute)

Central blood volume (CBV) is the blood volume between the injection of the indicator saline bolus (central venous line) and the recording site (arterial line) and this includes the volume in the heart, lungs and larger central vessels. The central blood

volume index (CBVI) is CBV normalized to weight (ml/kg), as shown in the following formula:

$$CBVI = (CO * (MTT_a - MTT_v - MTT_t) / \text{weight})$$

MTT_a: time of indicator traveling from the site of the injection (venous sensor) to the site of detection (arterial sensor)

MTT_v: mean time from the venous injection until detection by the venous sensor

MTT_t: mean indicator traveling time in the AV loop until detected by the arterial sensor

MTT_t: V_a/Q_a , where V_a is the priming volume in the AV loop system and Q_a is the estimated blood flow in the AV loop

The active circulation volume (ACV) is the blood volume that the saline indicator mixes in one minute from the time of the injection. It represents the volume in all the major organs (heart, lungs, brain, kidneys, liver) and large vessels. The active circulation volume index (ACVI) is the ACV normalized to weight (ml/kg). The ACVI is of special interest in infants, as it is thought to be close to the total blood volume (71) and this is calculated using the formula:

$$ACVI = (V_{inj} / H) / \text{weight}$$

V_{inj}: volume of injected isotonic saline indicator in milliliters

H: new level of isotonic saline concentration in blood, as recorded by the arterial sensor one minute after the injection

The three COstatus blood volumes, TEDV, CBV and ACV, are static parameters that indicate volume status, namely hypovolemic versus hypervolemic, and are all normalized to weight (74). Comparison studies have suggested that the COstatus estimates blood volumes better than thermodilution, which tends to overestimate blood volumes due to decreases in indicators over time, namely heat loss (75-76).

Calorimetry for estimation of oxygen consumption (subject of Study IV)

The direct Fick method determines cardiac output by dividing the oxygen consumption ($_mV_{O_2}$) by calculating the difference between arterial (Ca_{O_2}) and mixed venous oxygen content (Cv_{O_2}). This is determined by using the Fick equation, as previously described:

$$Q = {}_mV_{O_2} / (Ca_{O_2} - Cv_{O_2}) \quad (\text{Fick equation})$$

Oxygen consumption ($_mV_{O_2}$) is measured with indirect calorimetry. However, there have been calls for greater precision and accuracy in comparison studies in recent years, together with growing concerns about the technical limitations and possible errors produced by using indirect calorimetry. A number of studies have shown discrepancies between $_mV_{O_2}$ measured by indirect calorimetry and calculated $_cV_{O_2}$ measured by the reverse Fick method in adults (77-80). As the direct Fick method relies on measuring oxygen consumption by indirect calorimetry, measurement errors could cause false estimations of cardiac output.

By using the reverse Fick method, oxygen consumption ($_cV_{O_2}$) can be calculated if cardiac output (Q) has been measured by some other means and both the arterial (Ca_{O_2}) and mixed venous blood gas (Cv_{O_2}) values are known. The reverse Fick equation is calculated as follows:

$$_cV_{O_2} = Q * (Ca_{O_2} - Cv_{O_2}) \quad (\text{Reverse Fick equation})$$

Body surface area estimations in young children (subject of Study V)

Since the beginning of the 20th century, body surface area has been used to normalize hemodynamic parameters, such as cardiac output, and this has resulted in the development of the cardiac index and a number of other parameters. These have been produced so that clinicians can react to specific hemodynamic normal values that should apply to all subjects, regardless of age. As individual body surface area measurements are impractical, empirical body surface formulas have been developed instead to estimate body surface areas. However, a number of concerns have been raised in recent decades, as it has become clear to clinicians that using the body surface area might not be as suitable for indexing as previously thought and that estimations in young children were often inaccurate. Today, there are more than 30 different body surface area formulas available and most of them seem to disagree with each other when they are used for young children. One recent study showed that using different formulas to calculate body surface area estimations in children might produce differences of up to 50% (81). As body surface area is often used to determine therapeutic doses for different treatments, such as cytotoxic anticancer drugs and immunosuppression therapy, this could lead to undertreatment or overtreatment of underlying condition and lead to complications (82).

The most frequently used body surface area formula today is the DuBois formula, which was developed by the DuBois brothers in 1916 (83-84). Most people do not know that this formula was only based on measurements from nine heterogeneous subjects, including an obese elderly female, a deformed child and an adult midget (85).

As this formula is used to calculate the cardiac index from cardiac output, false estimations of the true hemodynamic status in young children could cause a delay in supportive treatment in perioperative settings. In our perfusionist protocols at Lund Children's Hospital, we aim for a higher cardiac index in younger children (body surface area < 0.5 m²) during cardiac bypass surgery than in older subjects (2.8-3.3 versus 2.4-2.5 L/min/m²). If normalization with the body surface area was accurate, this correction would not be needed during pediatric heart surgery.

Validation of cardiac output monitors

The early years (1948-1985)

The validation of different technologies was rather limited during the early years, as simple correlation plots and regression analysis were used to compare different methods. However, they did not really provide a clear picture of how well the methods agreed with each other and it was soon obvious that a better way for validating different methods was needed.

The Bland-Altman years (1986-1998)

In 1986, Bland and Altman first suggested their method for comparing agreement between two different techniques that measured the same clinical variable (86). Since then, the Bland-Altman plot and analysis has become the standard way to present results when a new method is being validated against an established reference technique (87). The Bland-Altman plot provides a clear graphical view of the results and objective values, namely bias, standard deviations (SDs) and limits of agreement, which make it easier to understand how well different techniques agree with each other. Bias gives us the average of all differences, SDs of the spread around the bias and limits of agreement ± 1.96 times the SD around the bias (88). Today, new cardiac output monitors should always be validated using the Bland-Altman method, as with all other methods and technologies, and the precision of the reference technology should also be known for comparison purposes when taking repeated measurements into account (89-93).

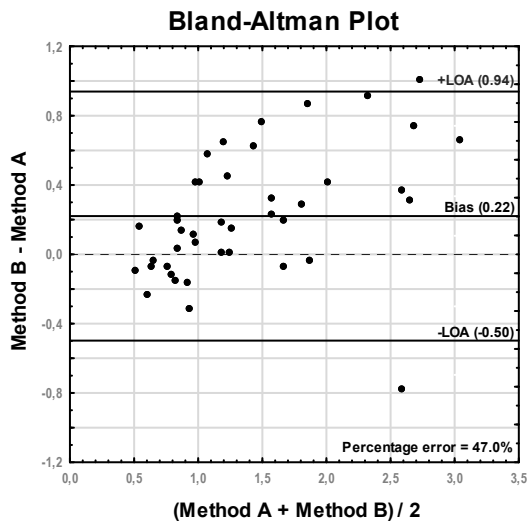
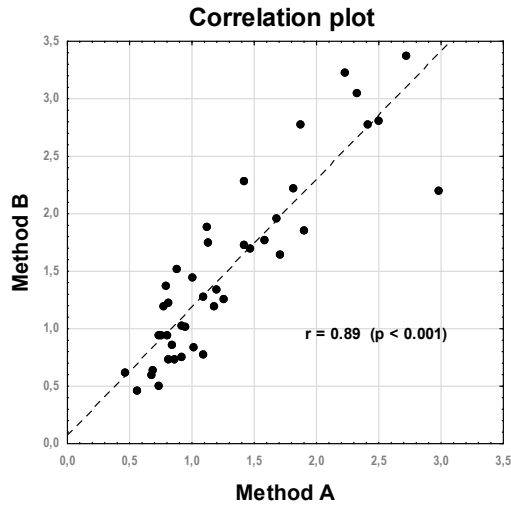

Examples of a correlation plot and a Bland-Altman plot. (Author's own graphs).

Modern standards (1999 to the present day)

Even with the Bland-Altman analysis, we still didn't have the whole picture. Something was missing. We didn't know how much difference between the techniques was acceptable for a new technique to be interchangeable with an established reference technique. In 1999, Critchley and Critchley came up with the answer, after they carried out a meta-analysis on a number of cardiac output studies (94). They suggested

that a percentage error of 30% should be the cut-off value, as they found that a value under 30% meant that both methods were comparative, but a value above 30% meant that they were not (95).

A recent meta-analysis of cardiac output measurements in children highlighted a lot of problems and showed that an overall lack of homogeneity was an alarming concern (10). Studies have claimed to conduct hemodynamic measurements in children but have included patients up to almost 18 years of age, often resulting in average ages between 8-12 years. One even included “children” under the age of 21 years. Clearly this is not what we are looking for when we carry out hemodynamic studies in children under the age of four years, for example. Very young children have a completely different hemodynamic profile to older children, who are almost identical to adults in that respect.

It is of the utmost importance that all missing data are reported or accounted for, as it provides a better picture of the technique being tested. A report that comprises 50 measurements can sound very promising in the beginning, but if you have neglected to mention that there were 100 measurement attempts and only 50 yielded results, you have not been honest about the technique’s true performance. There often seemed to be missing data in many comparison studies from the early years, with five measurements available for comparison from some patients and just one from others. The reason for the inconsistent numbers of measurements were often not explained, which made it hard to evaluate the final results and conclusions (96).

Power analysis for validation studies is not simple, as we often do not know what we are aiming for. If we want to know how many patients we need for a study, one approach is to look at similar studies that have explored the same research areas.

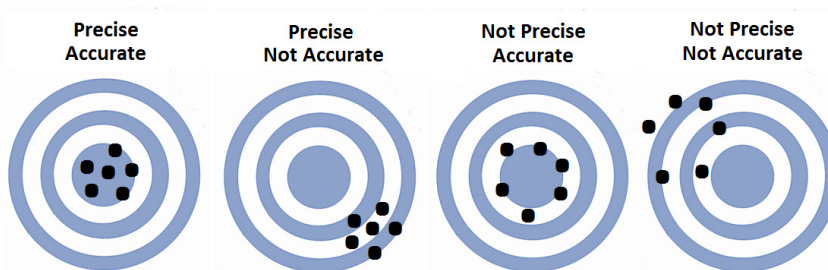

The difference between precision and accuracy. (Author’s own illustration adapted from number of previous publications)

Precision tells us how close repeated measurement are to each other, while accuracy describes how close the measurements are to the real value.

Aim of the study

The aim of the present study was to look at different aspects of hemodynamic in pediatric patients undergoing corrective cardiac surgery. The findings were published in five papers.

Paper I investigated how well the COstatus device estimated cardiac output. It did this by analyzing its agreement and precision with a standard reference method, a perivascular flow probe placed around ascending aorta.

Paper II compared how well the COstatus device detected intracardiac shunts, by comparing the results with transesophageal echocardiography. It also compared the estimated shunt size with two different methodological reference methods, the perivascular flow probe and the oximetric method.

Paper III compared normalization of hemodynamic parameters and blood volume with body surface area and body weight and the effect of intracardiac shunts on the precision of the COstatus device.

Paper IV compared indirect calorimetry estimates on oxygen uptake with the reverse Fick method.

Paper V compared the agreement between common body surface area formulas in young children.

Methods

Patients

Young children undergoing elective cardiac surgery to correct an atrial septal defect (ASD) and/or ventricular septal defect (VSD) were enrolled in the study from June 2014 to June 2017 if they fulfilled all the criteria.

Inclusion criteria

- I. Informed, written parental consent (Papers I-V)
- II. Weight <15 kg (Paper I-V)
- III. ASD and/or VSD defects (Papers I-V)

Since lack of repeatability of the cardiac output measurements could interfere with comparing different methods, it was important that the measurement method and the stroke volume were constant during the measurements.

Exclusion criteria

- I. Shunts: undiagnosed extracardiac or significant residual shunts after surgical correction (Papers I and IV)
- II. Perioperative arrhythmias: supraventricular, nodal tachycardia and atrioventricular heart blocks (Papers I-IV)
- III. Significant valvular regurgitations: aortic, mitral, tricuspid and pulmonary valvular leaks (Papers I-IV)
- IV. Obvious leakage despite cuffed endotracheal tube (Paper IV)
- V. Need for a high fraction of inspired oxygen during measurements (Paper IV)

Study design

This study was approved and registered by the Ethics Committee of Lund University, Sweden. (Dnr 2013636)

Induction of anesthesia and preparation at the beginning of each case:

Anesthesia was induced using fentanyl (5 mcg/kg) and pentothal (5 mg/kg) and maintained with isoflurane (0.5-1.0%). Pancuronium (0.2 mg/kg) was given to facilitate intubation with a cuffed endotracheal tube. All children received a peripheral arterial catheter in the radial artery: Neoflow 24 G in patients <5 kg and Venflow 22 G in patients >5 kg (both BD Ltd, Wokingham, UK). They also received a Multicath triple lumen 6cm, 4.5 F central venous catheter in the right internal jugular vein (Vygon Ltd, Swindon, UK). These catheters are routine for all cardiac surgery. The catheters were then connected to a specific arteriovenous loop, which was primed with heparinized (2 units/mL) normothermic isotonic saline. COstatus ultrasound sensors were then placed on the venous and arterial side of the arteriovenous loop before the start of the surgery. Cerebral and somatic tissue oxygenation was monitored with *in vitro* optical spectroscopy with the INVOS 5100C (Medtronic, Minneapolis, MN, USA), by placing pediatric sensors over the patient's forehead and kidney.

Before surgical correction:

A preoperative transesophageal echocardiography was performed with a Philips S8-3T pediatric transesophageal transducer probe to determine cardiac function and existing defects were identified with a Philips iE33 ultrasound system (both Philips Healthcare, Andover, MA, USA). Conventional cross-sectional echocardiography and Doppler color flow were used to detect the defects.

After exposing the heart, but before the cardiopulmonary bypass was performed, the surgeon consecutively placed AU series COconfidence perivascular flow probes (Transonic Systems, Ithaca, NY, USA) around the ascending aorta and then the pulmonary truncus. The size of the probes made it impossible to fit them both simultaneously without compromising the patient's circulation. Five consecutive measurements were performed on the ascending aortic blood flow at the same time as five measurements with the COstatus device. This was immediately followed by five consecutive measurements of the pulmonary blood flow.

Then the surgeon took blood samples from the pulmonary truncus, inferior vena cava (IVC) and superior vena cava (SVC) by direct puncture. An arterial blood sample was simultaneously taken from the arterial catheter. The fraction of inspiratory oxygen was kept at 0.3–0.4 to ensure full arterial oxygen saturation and, therefore, fully saturated blood in the left atrium. The pulmonary venous oxygen saturation was expected to be full, since the arterial oxygen saturation was 97–100%. The blood gas analyses were performed with the ABL800 Flex Radiometer (Radiometer AS, Brønshøj, Denmark). Finally, the shunt ratio was calculated using the oximetric shunt formula. The oxygen content in the venous blood was estimated using Flamm's formula $(3SVC+IVC)/4$.

During every measurement session the oxygen uptake (VO_2) was obtained by indirect calorimetry using the GE Healthcare S/5 Compact Anaesthesia Monitor (Dantex Ohmeda Inc, Madison, WI, USA) with an E-CAiOVX module with a specific Pedi-lite+ pediatric flow sensor adjusted to pediatric mode.

After surgical correction

All the measurements carried out before surgery were repeated in the same order after surgery, once the patient's spontaneous circulation had returned to sinus rhythm and they had reached normal body temperature.

The surgical results were controlled by a postoperative transesophageal echocardiography investigation, to exclude residual shunts or valvular regurgitations that could affect the results. This was carried out by a cardiologist who was blinded to the results and unaware of the other findings.

Straight after surgery, all the data that were available on the paper prints were entered into a specific Windows Excel Office 365 spreadsheet (Microsoft Corporation, Washington, USA) to prevent any loss of critical data. These were the blood gases, perivascular flow probe results, CO status estimations and oxygen uptake values.

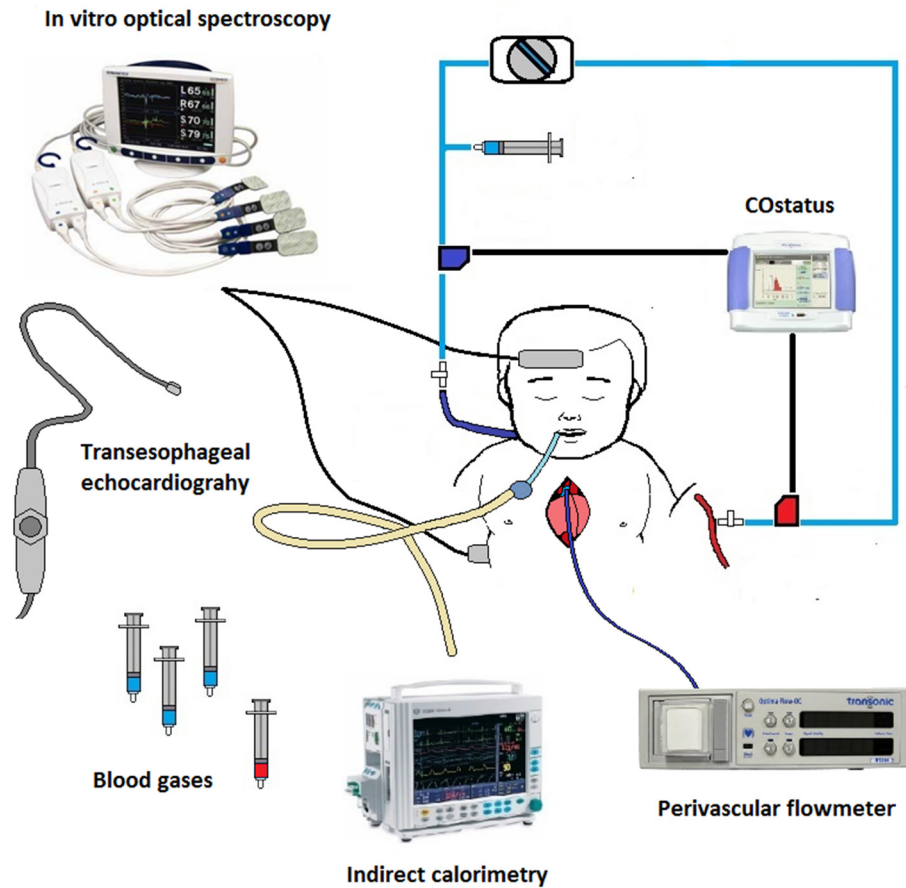

Overview of the study technical setup, devices used and samples taken during measurements sessions (Author's own illustration).

Statistical analysis

The Statistica program (Dell Inc., Tulsa, OK, USA) was used for the statistical analyses in all the papers.

At the start of the study, we did not have an *a priori* power analysis available, as we did not know what bias and standard deviations to use for cardiac output so that we could perform the analysis. We decided that we could use our own results and the results from an earlier cardiac output pilot study conducted at our hospital to calculate the sample size needed at a later stage in the study. During the *post hoc* power analysis,

which was carried out during the study, we estimated that 35 subjects were needed. We had anticipated that this would be the approximate number from our previous experience, and similar studies, and had originally planned to enroll around 40-50 patients.

This matter was addressed and presented during the revision of **Paper I**, but the statistical editor decided that our description of the power analysis did not need to be included in the final version of the paper (97).

In **Papers II - V** we used G-Power 3.1.9.3 software (Kiel University, Kiel, Germany) for the power calculations, as the bias and standard deviations from previous studies on same parameters could be used to estimate the effect sizes and thus the number of subjects needed for each paper. To gain sufficient power in **Papers III and V**, we had to add extra patients from earlier cardiac output study that had been conducted with similar subjects (69).

The Bland-Altman method was used to estimate the bias for all papers that compared different methods, SDs and limits of agreements. We took special care with regard to multiple measurements in the same individual (86, 90, 98). The bias, or mean difference, was calculated and plotted against the average of the comparison. The 95% limits of agreement were calculated as the mean bias of $1.96 \pm \text{SD}$ (SD of the difference between the methods). The percentage error was calculated using the equation $(1.96 * \text{SD}_{\text{bias}}) / (\text{Mean}_{\text{Reference method}}) * 100\%$ [94].

In **Paper II** we used analysis of variance to detect the statistical significance between the three different techniques used to determine the shunt ratios, as the values from the COstatus had to be categorized.

The degree of variation for each method was estimated in both **Paper I** and **Paper III** by the coefficient of error (CE) of the average repeated measurements, calculated as the ratio of the coefficient of variation (CV) divided by the square root of the number (n) of repeated measurements ($\text{CE} = \text{CV} / \sqrt{n}$). The precision of each method was then considered to be two times the CE, namely: $(2 * \text{CE}) * 100\%$ (89).

Results and discussion

Paper I – Estimation of cardiac output

The COstatus provided excellent precision and agreement when it came to estimating cardiac output in young children, compared with the gold standard of a perivascular flow probe placed around the ascending aorta.

As the COstatus is less invasive than the earlier reference methods that have been available, and is easy and safe to use, we believe this should be considered as a possible new reference method for cardiac output estimations.

Paper II – Estimation of intracardiac shunts

COstatus detected intracardiac shunts to the same extent as the gold standard of echocardiography. However, it slightly underestimated the degrees of the shunts in small and moderate shunts when it was compared to two other reference methods, namely perivascular ultrasonic flow probes (placed around the pulmonary truncus and ascending aorta) and the oximetric shunt equation (using arterial and venous blood gases).

Transonic systems algorithms for shunt calculations might be overly cautious.

Paper III – Normalization of hemodynamic parameters

Body weight produced a better normalization of hemodynamic parameters than body surface area in young children.

The presence of an intracardiac shunt caused only a minor decrease in precision.

Paper IV – Estimation of oxygen uptake

Indirect calorimetry seemed to overestimate oxygen uptake in young children, compared to the reverse Fick method.

Caution is advised regarding the use of the direct Fick method as a reference method in cardiac output comparison studies.

Paper V – Estimation of body surface area

Commonly used body surface area formulas disagreed in young children.

This could influence calculations of hemodynamic parameters that are normalized with body surface area and influence drug dosing based on BSA.

Conclusions and future directions

Paper I

It is important that we continue to carry out cardiac output comparison studies with young children. A number of promising non-invasive cardiac output monitors are emerging and these need to be carefully validated in clinical settings with real pediatric patients. As the COstatus device is very accurate, precise and minimally invasive, it permits bedside measurements in pediatric patients who are awake. This will finally enable us to move cardiac output comparison studies from the operating theatre and cath lab to intensive care units.

Paper II

Although the COstatus can detect intracardiac shunts with high sensitivity and specificity, it will never replace echocardiography when it comes to diagnosing and evaluating intracardiac shunts. The final decision to carry out corrective surgery will always be based on clinical symptoms, combined with any preoperative examinations that are available. However, the COstatus may be particularly helpful in the perioperative phase, as it could detect residual intracardiac shunts missed by postoperative echocardiography and determine their size. At the same time it could provide valuable information on hemodynamic parameters and volume status.

Paper III

Indexing of hemodynamic parameters, such as cardiac output and blood volumes, are more appropriate with regard to body weight than body surface area in young children. This produces independent reference values for hemodynamic parameters that are more valid in all age groups and are more independent of body size. Static blood volumes can be estimated with COstatus (ACV and CBV) regardless of intracardiac shunts. This gives an indication of the intravascular volume status in pediatric patients, which has previously not been available, and this could guide fluid therapy in intensive care units. It remains to be seen if the next generation COstatus, which will feature a continuous hemodynamic display, will be able to provide pediatricians with reliable information on dynamic blood volumes (SVV and PPV) and estimated fluid responsiveness.

Paper IV

As indirect calorimetry seems to overestimate oxygen uptake, the direct Fick method should not be considered a standard reference method for cardiac output comparison studies. It is of the utmost importance that cardiac output reference methods are easy and safe to apply, as well as accurate and precise. Otherwise there is a risk that we may reject promising, non-invasive monitors, not due to their own flaws, but because of imperfections in the reference method.

Paper V

It is important that pediatricians understand the limitations of empirical body surface area formulas. It seems clear that the Mosteller formula is the simplest and most reliable body surface area formula that is available for young children. However, caution is advised regarding normalization of the physiological parameters with body surface area in the youngest children.

Recommendations regarding comparative studies

- Use larger sample of subjects and carry out power analyses before starting all studies
- Use homogeneous samples of patients
- Measure the precision of the reference method
- Carry out repeated measurements
- Always report bias, SDs, limits of agreement, precision of methods and percentage errors
- Report if there are any missing data

Sammanfattning på svenska

(Swedish summary)

Befintliga tillförlitliga metoder för att mäta hjärtminutvolymen har bara kunnat användas på större barn och vuxna. För att bedöma hemodynamiken hos små barn har vi varit hänvisade till indirekta mätningar som blodtryck och centralt venttryck. En ny ultraljudsbaserad utrustning som mäter utspädningen av fysiologisk koksalt i blodet har utvecklats för att bland annat bestämma hur mycket blod hjärtat pumpar hos små barn (COstatus, Transonic, Ithaca, USA). Tekniken är lämplig att användas på barn eftersom den är säker, kräver inte några ytterligare blodprovstagningar och utnyttjar befintliga katetrar som alla små barn får i samband med svåra sjukdomstillstånd och större operationer.

Målsättning med detta doktorandarbete var att utvärdera teknikens pålitlighet och dess möjlighet att bedöma hemodynamiken på mindre barn. Data insamlades på barn som genomgick korrekta hjärtoperationer åren 2010-2017 vid Skånes Universitets Sjukhuset i Lund. Förhoppningen med projektet är att kunna visa att tekniken kan användas för att förbättra diagnostiken och intensivvården hos svårt sjuka barn.

Doktorandarbetets första och fjärde studie utvärderade metodens precision och noggrannhet jämfört med dagens två „gold standard“ metoder, d.v.s. direkt flödesmätning på stora kroppspulsådern och direkt Ficks metod. I andra studien utvärderades teknikens förmåga att detektera intrakardiella shunt och bestämma shunt fraktionens storlek. I tredje studien bestämde vi om vikt eller kroppsytan var bäst lämpad för att indexera, dvs jämföra olika uppmätta hemodynamiska parametrar hos små barn vid olika åldrar. I femte studien jämförde vi de mest använda matematiska formlerna som används för beräkning av kroppsytan på små barn och som används för indexering av de olika hemodynamiska parametrarna.

Utvärderingen visade att tekniken var mycket noggrann och hade en hög precision jämfört med använda referens metoder för att bestämma hjärtminutvolymen. Tekniken var säker, mindre invasiv än tidigare tekniker för att bestämma hjärtminutvolym och shuntfraktionens storlek och kunde användas även på de minsta barnen. Enligt vår analys visade tekniken en så hög noggrannhet och precision att den kan användas som referens vid bestämning av hjärtminutvolymen på små barn. Vikten var bättre än

kroppsytan på att indexera de hemodynamiska parametrarna hos barn under 15 kg. Samtidigt visade analysen en skillnad i beräknad kroppsyta beroende på vilken matematisk formel som användes.

Betydelsen av vårt arbete är att vi visat att tekniken är pålitlig och tillför flera hemodynamiska värden som kan användas för att bedöma barnens cirkulatoriska tillstånd under intensivvård och i samband med operativa ingrepp. Tekniken är också lämpad på små barn vid utvärdering av läkemedelseffekter på hemodynamiken.

Ágrip á íslensku

(Icelandic summary)

Mat á óstábilum sjúklingum er ekki eins einfalt og telja mætti. Fjölmargar rannsóknir hafa sýnt fram á að oft er lítið samræmi á klínískum einkennum og mælingum lífsmarka. Ýmis hjálpartæki hafa verið þróuð í gegnum tíðina til að aðstoða við mat á blóðrásarástandi sjúklinga. Þer þar hæst að nefna hinn fræga Swan-Ganz æðalegg (þræddur í lungnaslagæð) til að mæla hin ýmsu blóðrásargildi. Stærð og umgjörð Swan-Ganz æðaleggsins er þó takmarkandi þáttur hvað varðar börn vegna aukinnar áhættu á fylgikvillum við ísetningu (blæðing, æðastífla, æðarof eða hjartsláttartruflanir).

Tækjabúnaður sem gæti metið ástand hjartans og blóðflæði um líkama barna, myndi hjálpa læknum við heildarmat á ástandi alvarlega veikra barna og kæmi að miklu gagni við ákvörðun stuðningsmeðferðar.

Nýlega kom á markaðinn tækið COstatus frá Transonic Systems í Bandaríkjunum sem gerir loksins kleyft að meta þessa þætti sem varpa betra ljósi á ástand barna án þess þó að krefjast ísetningar á meira ífarandi æðaleggjum en almennt þarf hjá gjörgæslusjúklingum (holæða- og slagæðalegg). Tækið framkvæmir mælingar sínar með ómtækni sem nemur blóðflæðisbreytingar í blóðrásinni eftir innspýtingu á fyrirfram ákveðnum magni af saltvatni (byggt á Stewart-Hamilton lögmálinu).

Tækið gerir gjörgæslulæknum kleyft að greina og meta breytingar á útflæði hjartans, viðnámi í æðakerfinu, vökvaástand og hugsanleg op milli hjartahólfa sem oft eru ógreind í ungabörnum.

Markmið þessarar doktorsritgerðar var að meta ýmsa þætti sem snúa að blóðrás ungra barna og gera röð samanburðarannsókna með hinu nýja COstatus tæki við eldri staðalaðferðir.

Frá febrúar 2010 til júní 2017 voru framkvæmdar samanburðarmælingar í tæplega 70 börnum við Barnaspítalann í Lundi sem voru að gangast undir opnar hjartaaðgerðir.

Niðurstöður rannsókna okkar leiddu í ljós að COstatus tækið var öruggt og áreiðanlegt til notkunar í ungum börnum ásamt því að gefa afar nákvæmar niðurstöður í samanburði við fyrri aðferðir.

Nákvæmni COstatus tækisins var slík að það ætti að geta tekið við sem ný staðalaðferð til mats á blóðrásarástandi barna og þannig leysa fyrri ífarandi aðferðir af hólmi. Tækið gæti þannig á næstu árum auðveldað mat á alvarlega veikum gjörgæslusjúklingum og hugsanlega hraðað framþróun minna ífarandi hjálpartækja á sama sviði í framtíðinni.

Acknowledgements

I wish to express my gratitude to...

My mentor, supervisor and friend Lars Lindberg. Without him we would not be here...

Valeria Perez de Sa, my co-supervisor, for her help and inspiration throughout the years...

Lis Kongstad, for seeing “something” in the little guy from Iceland back in 2010...

Per Westrin, for giving me a job at Lund Children’s Hospital and understanding my passion for beer (and not champagne)...

All my co-workers and friends at Lund Children’s Hospital for all their help and support. You know who you are...

The pediatric cardiac surgeons, for placing and holding our ultrasound flow probes in place for countless hours while carrying out our measurements...

Everybody on the cardiac surgery team, and the nurses and perfusionist, for looking after all our devices...

My supportive wife, Guðbjörg, for standing behind me through all those years of research and work, night and day, weekends and holidays, and being almost “always” ready to listen...

My understanding daughters, María Sara and Auður Margrét, for not complaining too much about all the take-away meals...

My Mom and Dad, Auður and Sigurður, for their support and undying belief in me, all my life...

My friend, Svajunas Statkevicius, for his friendship and many discussions and for letting me stay at his apartment during my later visits to Lund...

Finally, I would like to thank all the children and their parents for allowing us to perform our measurements during their heart operations...

Financial support

This work was supported by grants from The Swedish Children Heart Association, Stockholm, Sweden, and The Anna and Edwin Berger's Foundation, Lidingö, Sweden.

“Where are we taking the laptop on holiday this summer?”

Guðbjörg (my wife)

References

1. Fathi EM, Narchi H, Chedid F. Noninvasive hemodynamic monitoring of septic shock in children. *World J Methodol* 2018; 8: 1-8.
2. Luther T, Clausen AH, Ostlund A, Rudolph T, Garcia C, Bentsen G, Sigurdsson TS. How do we treat septic shock in children in the Nordic countries? 35th Congress of the Scandinavian Society of Anaesthesiology and Intensive Care Medicine (SSAI) 2019.
3. Tibby SM, Hatherill M, Marsh MJ, Murdoch IA. Clinicians' abilities to estimate cardiac index in ventilated children and infants. *Archives of Disease in Childhood* 1997; 77: 516-518.
4. Eisenberg PR, Jaffe AS, Schuster DP. Clinical evaluation compared to pulmonary artery catheterization in the haemodynamic assessment of critically ill patients. *Crit Care Med* 1984; 12: 549-553.
5. Egan JR, Festa M, Cole AD, Nunn GR, Gillis J, Winlaw DS. Clinical assessment of cardiac performance in infants and children following cardiac surgery. *Intensive Care Med* 2005; 31: 568-573.
6. Skowno JJ, Broadhead M. Cardiac output measurement in pediatric anesthesia. *Paediatr Anaesth* 2008; 18: 1019-1028.
7. Trieu CT, Williams TM, Cannesson M, Marijic J. Babies and children at last: Pediatric cardiac output monitoring in the twenty-first century. *Anesthesiology*, 2019. 130: 671-673.
8. Roeleveld PP, de Klerk JCA. The perspective of the intensivist on inotropes and postoperative care following pediatric heart surgery: An international survey and systematic review of the literature. *World J Pediatr Congenit Heart Surg* 2018. 9: 10-21.
9. Shephard J, Brecker S, Ewans T. Bedside assessment of myocardial performance in the critically ill. *Intensive Care Med* 1994: 513-521.
10. Suehiro K, Joosten A, Murphy LSL, Desebbe O, Alexander B, Kim SH, Cannesson M. Accuracy and precision of minimally invasive cardiac output monitoring in children: a systematic review and meta-analysis. *J Clin Monit Comput* 2016; 30: 603-620.
11. Parker S. *Medicine, the definitive illustrated history*. 1st Edition 2016, London: Dorling Kindersley Limited.
12. Straus E, Straus A. *Medical marvels, the 100 greatest advances in medicine*. 2006: Prometheus Books.

13. Eger EI, Saidman LJ, Westhorpe RN. The wondrous story of anesthesia. 1st Edition ed. 2014, New York; Springer.
14. Ribatti D. William Harvey and the discovery of the circulation of the blood. *J Angiogenes Res* 2009; 1: 3.
15. Laszlo G. Respiratory measurements of cardiac output: from elegant idea to useful test. *J Appl Physiol* 2004; 96: 428-437.
16. Heiss H. Profiles in cardiology: Werner Forssmann, a German problem with the Nobel prize. *Clin Cardiol* 1992; 15: 547-549.
17. Jhanji S, Dawson J, Pearse RM. Cardiac output monitoring: basic science and clinical application. *Anaesthesia* 2008; 63: 172-181.
18. Stern S. A note on the history of cardiology: Dr. Otto Klein (1881-1968). *JACC* 2005; 45: 446-447.
19. Nossaman BD, Scruggs BA, Nossaman VE, Murthy SN, Kadowitz PJ. History of right heart catheterization: 100 years of experimentation and methodology development. *Cardiol Rev* 2010; 18: 94-101.
20. Stewart G. Researches on the circulation time and on the influences which affect it. *The journal of Physiology* 1897; 22: 159-183.
21. Hamilton WF, Moore JW, Kinsman JM, Spurling RG. Studies on the circulation. *Am J Physiology* 1932; 99: 534-551.
22. Hamilton WF, Riley RL, Attyah AM, Cournand A, Fowell DM, Himmelstein A, Noble RP, Remington JW, Richards DW, Wheeler NC, Witham AC. Comparison of the Fick and dye injection methods for the determination of cardiac output in man. *Journal of Physiology* 1948; 153: 309-321.
23. Jegier W, Sekelj P, Auld PAM, Simpson R, McGregor M. The relation between cardiac output and body size. *Br Heart J* 1963; 25: 425-430.
24. Wood EH. Diagnostic applications of indicator-dilution technics in congenital heart disease. *Circ Res* 1962; 10: 531-568.
25. Fegler G. Measurement of cardiac output in anesthetized animals by a thermo-dilution method. *J Exp Physiol Cogn Med Sci* 1954; 39: 153-164.
26. Ganz W, Donoso R, Marcus HS, Forrester JS, Swan HJ. A new technique for measurement of cardiac output by thermodilution in man. 1971. 27: 392-396.
27. Ganz W, Swan HJ. Measurement of blood flow by thermodilution. *American Journal of Cardiology* 1972; 29: 241-245.
28. Stetz CW, Miller RG, Kelly GE, Raffin TA. Reliability of the thermodilution method in the determination of cardiac output in clinical practice. *Am Rev Respir Dis* 1982; 126: 1001-1004.
29. Reuter DA, Huang C, Edrich T, Stanton K, Shernan SL, Eltzschig HK. Cardiac output monitoring using indicator-dilution techniques: basics, limits, and perspectives. *Anesth Analg* 2010; 110: 799-811.

30. Henriques V. Über die verteilung des blutes vom linken Herzen zwischen dem Herzen und dem ubrigen organismus. *Biochem. Ztschr* 1913; 56: 230.
31. Dean DA, Jia CX., Cabreriza SE, D'Alessandro DA, Dickstein ML, Sardo MJ, Chalik N, Spotnitz HM. Validation study of a new transit time ultrasonic flow probe for continuous great vessel measurements. *ASAIO J* 1996; 42: M671-676.
32. Botero M, Kirby D, Lobato EB, Staples ED. Measurement of cardiac output before and after cardiopulmonary bypass: Comparison among aortic transit-time ultrasound, thermodilution, and noninvasive partial CO₂ rebreathing. *J Cardiothorac Vasc Anesth* 2004; 18: 563-572.
33. Vrancken SL, de Boode WP, Hopman JC, Singh SK, Liem KD, van Heijst AF. Cardiac output measurement with transpulmonary ultrasound dilution is feasible in the presence of a left-to-right shunt: a validation study in lambs. *Br J Anaesth* 2012; 108: 409-416.
34. de Boode WP. Cardiac output monitoring in newborns. *Early Hum Dev* 2010; 86: 143-148.
35. Tibby SM, Murdoch IA. Monitoring cardiac function in intensive care. *Arch Dis Child* 2003; 88: 46-52.
36. Lemson, J, Nusmeier A, van der Hoeven JG. Advanced hemodynamic monitoring in critically ill children. *Pediatrics* 2011; 128: 560-571.
37. Geerts BF, Aarts LP, Jansen JR. Methods in pharmacology: measurement of cardiac output. *Br J Clin Pharmacol* 2011; 71: 316-330.
38. Cholley BP. Benefits, risks and alternatives of pulmonary artery catheterization. *Curr Opin Anaesthesiol* 1998. 11: 645-650.
39. Elliott CG, Zimmerman GA, Clemmer TP. Complications of pulmonary artery catheterization in the care of critically ill patients. *Chest* 1979. 76: 647-652.
40. Gidwani U, Mohanty B, Chatterjee K. The Pulmonary Artery Catheter, a critical reappraisal. *Cardiol Clin* 2013; 31: 545-565.
41. Al-Subu A, Rehder KJ, Ofori-Amanfo G, Turner DA. Current use of invasive and noninvasive monitors in academic pediatric intensive care units. *J Pediatr Intensive Care* 2018; 7: 135-146.
42. Tibby SM, Hatherill M, Marsh MJ, Morrison G, Anderson D, Murdoch IA. Clinical validation of cardiac output measurements using femoral artery thermodilution with direct Fick in ventilated children and infants. *Intensive Care Med* 1997; 23: 987-991.
43. McLuckie A, Murdoch IA, Marsh MJ, Anderson D. A comparison of pulmonary and femoral artery thermodilution cardiac indices in paediatric intensive care patients. *Acta Paediatrica* 1996; 85: 336-338.
44. Linton RA, Jonas MM, Tibby SM, Murdoch IA, O'Brien TK, Linton NW, Band DM. Cardiac output measured by lithium dilution and transpulmonary thermodilution in patients in a paediatric intensive care unit. *Intensive Care Med* 2000; 26: 1507-1511.

45. Ronco R, Riquelme C. Cardiac output measurement in children: What is lacking? *Pediatric Critical Care Medicine* 2008; 9: 333-334.
46. Peyton PJ, Wallin M, Hallbäck M. New generation continuous cardiac output monitoring from carbon dioxide elimination. *BMC Anesthesiology* 2019; 19: 1-10.
47. Peyton PJ, Kozub M. Performance of a second generation pulmonary capnotracking system for continuous monitoring of cardiac output. *J Clin Monit Comput* 2018. 32: 1057.
48. Sander CH, Hallbäck M, Wallin M, Emtell P, Oldner A, Björneet H. Novel continuous capnodynamic method for cardiac output assessment during mechanical ventilation. *Br J Anaesth* 2014; 112: 824-831.
49. Karlsson J, Winberg P, Scarr B, Lönnqvist PA, Neovius E, Wallin M, Hallbäck M. Validation of capnodynamic determination of cardiac output by measuring effective pulmonary blood flow: a study in anaesthetised children and piglets. *Br J Anaesth* 2018; 121: 550-558.
50. Tibby SM, Hatherill M, Durward A, Murdoch IA. Are transoesophageal Doppler parameters a reliable guide to paediatric haemodynamic status and fluid management? *Intensive Care Med* 2001; 27: 201-205.
51. Mohan UR, Britto J, Habibi P, Munter C, Nadelal S. Noninvasive measurement of cardiac output in critically ill children. *Pediatr Cardiol* 2002; 23: 58-61.
52. Møller-Sørensen H, Cordtz J, Østergaard M, Nilsson JC, Hansen KL. Transesophageal Doppler reliably tracks changes in cardiac output in comparison with intermittent pulmonary artery thermodilution in cardiac surgery patients. *J Clin Monit Comput* 2017; 31: 135-142.
53. Saugel B, Cecconi M, Wagner JY, Reuter DA. Noninvasive continuous cardiac output monitoring in perioperative and intensive care medicine. *Br J Anaesth* 2015; 114: 562-575.
54. Thiele RH, Bartels K, Gan TJ. Cardiac output monitoring: a contemporary assessment and review. *Crit Care Med* 2015; 43: 177-185.
55. Peyton PJ, Chong SW. Minimally invasive measurement of cardiac output during surgery and critical care: a meta-analysis of accuracy and precision. *Anesthesiology* 2010; 113: 1220 -1235.
56. Absi MA, Lutterman J, Wetzel GT. Noninvasive cardiac output monitoring in the pediatric cardiac Intensive Care Unit. *Curr Opin Cardiol* 2010; 25: 77-79.
57. Mercado P, Maizel J, Beyls C, Titeca-Beauport D, Joris M, Kontar L, Riviere A, Bonef O, Soupison T, Tribouilloy C, de Cagny B, Slama M. Transthoracic echocardiography: an accurate and precise method for estimating cardiac output in the critically ill patient. *Crit Care* 2017; 21: 136.
58. Olivieri PP, Patel R, Kolb S, Fatima S, Galvagno SM, Haase DJ, Ramani GV, Ludmir J, Alkhatib H, Herr D, Bruno DA, Scalea TM, Murthi SB. Echo is a good, not perfect,

- measure of cardiac output in critically ill surgical patients. *J Trauma Acute Care Surg* 2019; 87: 379-385.
59. Wetterslev M, Møller-Sørensen H, Johansen RR, Perner A. Systematic review of cardiac output measurements by echocardiography vs. thermodilution: the techniques are not interchangeable. *Intensive Care Med* 2016; 42: 1223-1233.
 60. Ballesteros Y, López-Herce J, Urbano J, Solana MJ, Botrán M, Bellón JM, Carrillo A. Measurement of cardiac output in children by bioimpedance. *Pediatr Cardiol* 2011; 32: 469-472.
 61. Jordan HS, Ioannidis JP, Goudas LC, Chung M, Kupelnick B, Miller K, Terrin N, Lau J. Thoracic Electrical Bioimpedance 2002, Agency for Healthcare Research and Quality
 62. Kupersztuch-Hagege E, Teboul JL, Artigas A, Talbot A, Sabatier C, Richard C, Monnet X. Bioimpedance is not reliable for estimating cardiac output and the effects of passive leg raising in critically ill patients. *Br J Anaesth* 2013; 111: 961-966.
 63. Beltramo F, Mentzer J, Razavi A, Khemani RG, Szmuszkovicz J, Newth CJL, Ross PA. Validation of an ultrasound cardiac output monitor as a bedside tool for pediatric patients. *Pediatr Cardiol* 2016; 37: 177-183.
 64. Funk DJ, Moretti EW, Gan TJ. Minimally invasive cardiac output monitoring in the perioperative setting. *Anesth Analg* 2009; 108: 887-897.
 65. Lemson J, Tibby SM. Reliability of the ultrasound cardiac output monitor for pediatric patients. *Pediatr Cardiol* 2016; 37: 618.
 66. Knirsch W, Kretschmar O, Tomaske M, Stutz K, Nagdyman N, Balmer C, Schmitz A, Béttex D, Berger F, Bauersfeld U, Weiss. Cardiac output measurement in children: comparison of the ultrasound cardiac output monitor with thermodilution cardiac output measurement. *Intensive Care Med* 2008; 34: 1060-1064.
 67. Carlsson M, Andersson R, Bloch KM, Steding-Ehrenborg K, Mosen H, Stahlberg F, Ekmeahag B, Arheden H. Cardiac output and cardiac index measured with cardiovascular magnetic resonance in healthy subjects, elite athletes and patients with congestive heart failure. *J Cardiovasc Magn Reson* 2012; 14: 51.
 68. Hundley WG, Li HF, Hillis LD, Meshack BM, Lange RA, Willard JE, Landau C, Peshock RM. Quantitation of cardiac output with velocity-encoded, phase-difference magnetic resonance imaging. *Am J Cardiol* 1995; 75: 1250-1255.
 69. Lindberg L, Johansson S, Perez-de-Sa V. Validation of an ultrasound dilution technology for cardiac output measurement and shunt detection in infants and children. *Pediatr Crit Care Med* 2014; 15: 139-147.
 70. Crittendon I, Dreyer WJ, Decker JA, Kim JJ. Ultrasound dilution: an accurate means of determining cardiac output in children. *Pediatr Crit Care Med* 2012; 13: 42-46.
 71. Transonic Systems Inc. COstatus Monitoring information booklet, 2016.

72. Saxena R, Krivitski NM, Peacock K, Durward A, Simpson JM, Tibby SM. Accuracy of the transpulmonary ultrasound dilution method for detection of small anatomic shunts. *J Clin Monit Comput* 2015; 29: 407-414.
73. Krivitski NM, Kislukhin VV, Thuramalla NV. Theory and in vitro validation of a new extracorporeal arteriovenous loop approach for hemodynamic assessment in pediatric and neonatal intensive care unit patients. *Pediatr Crit Care Med* 2008; 9: 423-428.
74. Saxena R, Durward A, Steeley S, Murdoch IA, Tibby SM. Predicting fluid responsiveness in 100 critically ill children: the effect of baseline contractility. *Intensive Care Med* 2015; 41: 2161-2169.
75. Lemson J, Merkus P, van der Hoeven JG. Extravascular lung water index and global end-diastolic volume index should be corrected in children. *J Crit Care* 2011; 26: 7-12.
76. Galstyan G, Bychinin M, Alexanyan M, Gorodetsky V. Comparison of cardiac output and blood volumes in intrathoracic compartments measured by ultrasound dilution and transpulmonary thermodilution methods. *Intensive Care Med* 2010. 36: 2140-2144.
77. Bizouarn P, Blanloeil Y, Pinaud M. Comparison between oxygen consumption calculated by Fick's principle using a continuous thermodilution technique and measured by indirect calorimetry. *Br J Anaesth* 1995; 75: 719-723.
78. Peyton PJ, Robinson GJB. Measured pulmonary oxygen consumption: difference between systemic oxygen uptake measured by the reverse Fick method and indirect calorimetry in cardiac surgery. *Anaesthesia* 2005; 60: 146-150.
79. Bizouarn P, Soulard D, Blanloeil Y, Guillet A, Goarin Y. Oxygen consumption after cardiac surgery - a comparison between calculation by Fick's principle and measurement by indirect calorimetry. *Intensive Care Med* 1992; 18: 206-209.
80. Cheong KF, Lee TL. Oxygen consumption--a comparison between calculation by Fick's principle and measurement by indirect calorimetry. *Med J Malaysia* 1997; 52: 70-75.
81. Redlarski G, Palkowski A, Krawczuk M. Body surface area formulae, an alarming ambiguity. *Sci Rep* 2016; 6: 1-8.
82. Gurney H. How to calculate the dose of chemotherapy? *Br J Cancer* 2002; 86: 1297-1302.
83. Shuter B, Aslani A. Body surface area: Du Bois and Du Bois revisited. *Eur J Appl Physiol* 2000; 82: 250-254.
84. Du Bois D, Du Bois E. Clinical calorimetry: Tenth paper a formula to estimate the approximate surface area if height and weight be known. *Arch intern Med* 1916; 17: 863-871.
85. Sisson TRC, CJ Lund CJ, Whalen LE, Telek A. The blood volume of infants, I The full-term infant in the first year of life. *J Pediat* 1959; 55: 163-179.
86. Bland JM, Altman DG. Statistical methods for assessing agreement between two methods of clinical measurement. *Lancet* 1986: 307-310.

87. Bland JM, Altman DG. Measuring agreement in method comparison studies. *Statistical Methods in Medical Research* 1999; 135-160.
88. Giavarina D. Understanding Bland Altman analysis. *Biochem Med* 2015; 25: 141-151.
89. Cecconi M, Rhodes A, Poloniecki J, Della Rocca G, Grounds MR. Bench-to-bedside review: the importance of the precision of the reference technique in method comparison studies--with specific reference to the measurement of cardiac output. *Crit Care* 2009; 13: 201.
90. Zou GY. Confidence interval estimation for the Bland-Altman limits of agreement with multiple observations per individual. *Stat Methods Med Res* 2013; 22: 630-642.
91. Bland JM, Altman DG. Agreement between methods of measurement with multiple observations per individual. *J Biopharm Stat* 2007; 17: 571-582.
92. Myles PS, Cui J. Using the Bland-Altman method to measure agreement with repeated measures. *Br J Anaesth* 2007; 99: 309-311.
93. Morley TE. Cardiac output measurements in young children: Comment. *Anesthesiology* 2020; 132: 209.
94. Critchley LA, Critchley J. A meta-analysis of studies using bias and precision statistics to compare cardiac output measurement techniques. *Clin Monit Comput* 1999; 15:85-91.
95. Critchley LA, Yang XX, Lee A. Assessment of trending ability of cardiac output monitors by polar plot methodology. *J Cardiothorac Vasc Anesth* 2011; 25: 536-546.
96. Le Manach Y, Collins GS. Disagreement between cardiac output measurement devices: which device is the gold standard? *Br J Anaesth* 2016; 116: 451-453.
97. Sigurdsson TS, Aronsson A, Lindberg L. Extracorporeal arteriovenous ultrasound measurement of cardiac output in small children. *Anesthesiology* 2019; 130: 712-718.
98. Sigurdsson TS. Cardiac output measurements in young children: Reply. *Anesthesiology* 2020; 132: 209-210.

Aspects of pediatric hemodynamics



Clinical estimation of hemodynamic status in children is very challenging.

This thesis explores and compares different methods for estimation of hemodynamic status in young children undergoing heart surgery.

The picture, shows part of the Sigurdsson family doing hemodynamic estimations.